

Palladium Books® Presents:

RIFFTS®

By Kevin Siembieda



**A complete new role-playing game
compatible with the entire Palladium Books® Megaverse!®**

Warning! _____

The fictional world of **Rifts** is quite violent and deadly. It is an exotic realm where magic is as real as technology, and demonic creatures plague humankind.

Some parents may find the violence and supernatural elements of the game inappropriate for young readers/players. We suggest parental discretion.

Note that none of us at Palladium Books condone nor encourage the occult, the practice of magic, the use of drugs, or violence.



A complete new Role-Playing Game

Compatible with the entire Palladium Books® Megaverse®

This work is dedicated to the troops in the trenches, Maryann, Kevin Long, Alex, and Thorn, all of whom worked diligently and tirelessly to get this special project out on time. Without them, this book would not have been possible.

Special Thanks to Keith Parkinson who is a good friend, as well as a great artist. Also to Richard Cook, whose additional research was a great help, Larry MacDougall who did what had to be done, Jim Osten and Jim Dombrowski for pitching in when needed, Erick Wujcik for the name Rifts, and Cheryl Corey for making sure this one got out on schedule!

Third Printing — May 1991

Copyright © 1983, 1986, 1987, 1988, 1990 by Kevin Siembieda.

Rifts®, Megaverse® and Palladium Books® are registered trademarks owned by Kevin Siembieda. Other titles are trademarks owned by Kevin Siembieda.

Copyright © 1990 by Kevin Siembieda. All rights reserved under the Universal Copyright Convention. No part of this book may be reproduced in part or whole, in any form or by any means, without permission from the publisher, except for brief quotes for use in reviews. All incidents, situations, institutions, governments and people are fictional and any similarity, without satiric intent, of characters or persons living or dead is strictly coincidental.

Rifts® is published by Palladium Books, 5926 Lonyo, Detroit, MI 48210.

Palladium Books®

RIFTS®

Written By: **Kevin Siembieda**

Editors: **Alex Marciniszyn**
Thorn Bartold

Cover Art: **Keith Parkinson**

Interior Paintings: **Kevin Long**
Keith Parkinson

Additional Color/Painting:

Adam Siembieda
Kevin Siembieda
Larry MacDougall

Interior Art: **Kevin Long**

Additional Art: **Kevin Siembieda**
Larry MacDougall

Art Direction & Keylining: **Kevin Siembieda**

Typography: **Maryann Siembieda**



TABLE OF CONTENTS

	Page
Glossary of Terms	
Creating A Character	
The Eight Attributes	8
Hit Points & S.D.C.	9
Mega-Damage	11
How to Determine Psionics	12
Selecting an O.C.C.	12
Money and Equipment	13
Rounding Out One's Character	14
Alignments	14
Experience Points	15
O.C.C. Experience Tables	17
Optional Rules	18
Insanity Tables	19
Player Characters and Skills	22
Skill List	23
Skill Descriptions	25
Modern Weapon Proficiencies	33
Hand to Hand Combat	34
Hand to Hand Combat Tables	37
Combat Rules for High-Tech War Machines	38
Volleys & Bursts	40
Missiles	41
Combat Example	42
Robot and Power Armor Combat Training Tables	44
Missile Chart	46
Occupational Character Classes (O.C.C.)	47
Men of Arms	47
Borg	47
Coalition "Dead Boy" Grunt	51
Coalition Elite RPA O.C.C. (SAMAS)	53
Coalition Military Specialist	54
Coalition Technical Officer	55
Crazies	56
Cyber Knight	62
Glitter Boy	64
Headhunter	66
Juicer	68
Scholars and Adventurers	71
Body Fixer	71
City Rat	73
Cyber Doc	74
Operator	76
Rogue Scientist	78
Rogue Scholar	79
Wilderness Scout	80
Vagabond	82
Practitioners of Magic	83
Line Walker	83
Mystic	84
Shifter	87

	Page
Techno-Wizard	89
Racial Character Classes (R.C.C.)	97
Dragons as Player Characters	98
Horned Dragon	100
Fire Dragon	100
Ice Dragon	101
Thunder Lizard	101
Psychic R.C.C.s	101
Burstster	102
Psi-Stalker	104
Wild Psi-Stalker	106
Coalition Dog Pack	107
Mind Melter	112
Psionic Powers	113
Meditation & Saving Throws	113
Animal P.P.E.	114
Psionic Power Descriptions	115
Healer	115
Physical	116
Sensitive	119
Super Psionics	124
The Time Before Rifts	128
Color Section	129
A World Overview	137
Chi-Town	140
CS State of Missouri	141
CS State of Lone Star	143
The Magic Zone	144
Dinosaur Swamp	146
Northern Gun (Michigan)	147
The Free State of Lazlo (Toronto)	149
CS State of Free Quebec	149
Atlantis	150
Outer Space	152
Color Section	153
Color Map of the Americas & Atlantis	158
Color Map of the Old American Empire	159
Magic	161
Mastery of Magic	162
Ley Lines	163
Learning Spells	164
Magic Combat	165
Alphabetical List of Spell Invocations	166
Spell List by Levels	167
Spell Descriptions Begin	168
Coalition State Weapons & Equipment	191
Body Armor	193
Robot Vehicles	194
Other Vehicles & Equipment	198
Coalition Guns	203

The Black Market	205
Pre-Rift Artifacts	207
Selling to the Black Market	208
Mega-Damage Body Armor	209
Power Armor	211
Robot Vehicles	214
Glitter Boy Armor/Robot	218
Other Weapons & Equipment	223
Energy Weapons	223
Rail Guns	225
Vehicles	226
Cybernetics	229
Bionics	237
Partial Bionic Reconstruction	237
Full Bionic Conversion	238
Prosthetics, Weapons, and Tools	239
Miscellaneous Equipment	243
Game Master Section	246

Quick Find Table

Men of Arms	47	Death's Head Transport	199
S.D.C. for Men of Arms (1D4X 10)	9	Sky Cycle Vehicle	201
Cyborgs ("Borgs") O.C.C.	47	Energy Weapons	203
Bionic Section	237	Explosives	204
Crazies O.C.C.	56	Vibro-Blades	204
Cyber Knight O.C.C.	62	Neural Mace	205
Glitter Boy O.C.C.	64	Additional Weapons & Equipment	205
Glitter Boy Armor	218	Black Market	205
Head Hunter O.C.C.	66	Black Market Pre-Rifts Artifacts	207
Juicer O.C.C.	68	Body Armor (Non-Coalition)	209
Juicer Body Armor	210	Coalition Body Armor	193
Juicer Energy Weapons	225	Coalition SAMAS	193
Coalition O.C.C.s	49	Flying Titan Power Armor	212
Propaganda and Training	49	Glitter Boy Armor/Robot	218
Grunt O.C.C.	51	NG Samson Power Armor	212
Elite Robot Pilot ("Sam") O.C.C.	53	Titan Robot Series	214
Pilot: Robot Combat Elite Skill	30	Weapons (Non-Coalition)	223
Pilot: Tank & APC Skill	30	Techno-Wizard Items	92
Military Specialist	54	Bionics	237
Espionage Skills	26	Cyborg Body Armor	243
Technical Officer	55	Cybernetics	229
Coalition Psychic: Dog Pack	107	Blackmarket Cybernetics	234
Dog Pack Body Armor	193	Combat	
Dog Pack Weapons	204	Weight and Fatigue	9
Dog Pack Optional Tables	111	Hit Points and S.D.C.	9
Coalition Psychic: Psi-Stalker	104	Coma and Death	10
Psionic Power Descriptions	115	Mega-Damage	11
Coalition State: Data & Information		Demolition Skills	28
The Recollections of Erin Tam	191	Physical Skills	28
Coalition Soldier Propaganda	102	Rogue Skills	30
CS State of Chi-Town	140	W.P. Skills	32
CS State of Free Quebec	141	Modern Weapon Proficiencies	33
CS State of Iron Heart	149	Hand to Hand Tables	37
CS State of Lone Star	143	Robot Combat Tables	44
CS State of Missouri	141	Volleys and Bursts	40
Magic Zone & Federation of Magic	144	Called Shot	40
Psychics in the CS	102	Missile Combat	41
Black Market	205	Missile Chart	46
Coalition Weapons & Equipment		Magic Combat	165
Body Armor	193	Psionic Combat	113
Dog Pack Armor	193	Horror Factor	114
SAMAS Power Armor	193	Animals	114
UAR-1 Enforcer 'Bot	194		
Spider-Skull Walker 'Bot	197		
Armored Personnel Carrier	198		

Creating The World of Rifts

The setting in **Rifts** is a crucial element of the game and the story we are trying to tell. The atmosphere and understanding of the world must be clearly established for it is as important as the game rules themselves.

Unlike most other games which take ideas and rules and place them in an already familiar setting, such as fantasy or the contemporary world, I have tried to create an exciting new realm unlike anything you've experienced before. Yes, there are elements that you will recognize from our other games, as well as from literature and film. But I hope to have gone beyond an imitative extrapolation and given you something new and exciting. A world that seems eerily familiar yet disturbingly alien. That is the world of **Rifts!**

When the first hints of **Rifts** began to leak out, everyone seemed to decide that it would be Palladium's version of *cyberpunk*. Yes, there are elements of the cyberpunk genre present, but that's nothing new for us. Heck, back in 1984 when I designed **Heroes Unlimited** it had sections on bionics, robotics, and augmented super-humans that contained elements of the so-called cyberpunk science fiction genre. The current revised edition places even greater emphasis on those aspects, with greater success than in the original RPG. Erick Wujcik's **Ninjas & Superspies**, with its cybernetic implants and cyber-disguises, is as cyberpunk as you can get. Like these games, **Rifts** does have some elements of what is considered to be cyberpunk, but when I first began to develop the ideas for it, five years ago, I thought they were just good science fiction.

One of the central themes of **Rifts** is *human augmentation*. You will see over and over again, man's (fictional) attempts to make himself better; stronger, faster, smarter, more powerful. Sometimes this would be done with artificial implants. Other times it would be through the use of chemicals or genetic mutation. Under the most extreme circumstances, man would completely re-create himself. Not always for the better. This was the world of the not too distant future. Then throw in a random element. Rifts.

Rifts are tears in the very fabric of space and time. They are found at the nexus points where several "lines" of natural energy (that mankind calls magic) intersect and create a surge in the lines of power. It is a terrifying and exciting extrapolation on the concepts of *magic* and *ley lines* as presented in the **Beyond the Supernatural** role-playing game. The science of geomancy had vanished centuries before. Only myths and crackpot practitioners of magic had any inkling about ley lines and mystic energy. Consequently, no one could have anticipated the fate that awaited humankind.

Nuclear holocaust ignited the destruction of the world as we know it, but it was not the primary instrument of destruction. The sudden destruction of a billion people triggered a surge in the ley lines. All that psychic energy released at once. The sudden influx of psychic energy (P.P.E.) sent the energy rippling through the mystical crossroads of earth like an earthquake. Ley lines flowed with energy that had not been felt for a million years. The energy surged and pulsed and crisscrossed across the planet at the speed of light. At ley line intersections (nexus points), rifts in space and time tore open, releasing even more energy. The earth shuddered and heaved. Millions more died, increasing the energy level of the rifts.

The oceans leapt from their basin and washed over the land. Hundred of millions more died, their psychic energy (P.P.E.) drawn into the ley lines, and the natural energies doubled again. A chain reaction was unleashed that could not be halted.

The continent men called *Atlantis* leapt from its watery grave and rose to the light of day for the first time in millennia. Its rebirth changing

the very face of the planet. In its wake, the eastern coast of the United States was engulfed by the ocean, sending the energy of millions more into the relentless rifts.

From the rifts spewed forth energy that tore through man's citadels of steel and concrete like a tornado through a city built out of match sticks. For every million or billion of lives lost, the ley lines surged and destroyed billions more; a nightmare in geometric principles.

The ley lines and the rifts that they opened were not some insidious evil, nor a plot of some malignant intelligence from another world. It was an aspect of nature that science did not even know, let alone understand. Like a child playing with matches in a pool of gasoline, humankind dropped a match into the pool and was instantly engulfed. Once the match was lit and dropped, there was nothing that could be done to undo what had been done. Yet in a strange way, all this death was part of the birth of a new age. And through it all, humankind would persevere. Even the cosmic fury of a world gone mad could not completely eradicate all human life. However, it would take mankind hundreds of years to crawl out of the abyss that swallowed him. It is at this moment, as humankind finally crawls back into the light of a new dawn that our story unfolds.

Rifts is a role-playing game that explores the earth created by the rifts. An earth that has been irreparably changed and is still changing. An earth more alien than any world one might find in another galaxy. A world where man must not only conquer himself and the environment, but a place where the environment is ever changing and the life forms one must compete against are not human.

Glossary OF ROLE-PLAYING GAME TERMS

Attributes: These are numbers used to evaluate the strengths and weaknesses of your character. For example: P.P. means Physical Prowess; how smooth, agile and quick a character is in combat. A P.P. of 4 would indicate that the character is pretty clumsy. A P.P. of 10 would be an average, fairly coordinated human being. While a P.P. of 16 or more would belong only to characters with exceptional speed and reflexes. Attributes are also called Statistics or Stats.

Campaign: A word used to describe an ongoing game. If you play the same characters with the same game master on a regular basis, then you are in a *Campaign*.

Character: Every player (except the GM) has a character that serves as an imaginary playing piece; also called *Playing Character*.

Death: Just as in real life, characters can die. The death of heroes in comic books, or in games, is a fairly rare event. The amount of death in a campaign usually depends on the individual game master. Players should take a character's death calmly. Remember, it's ONLY a game. GMs should allow players to roll up a "NEW" character and include it in the game as soon as is appropriate for the ongoing game. However, characters should not be a dime a dozen.

Dice: There are a variety of different dice used in role-playing games. First of all, there are the standard six-sided dice; the kind you use for most board games. We call them "D6". Often we let you know how many dice to roll with an expression like: "roll 3D6". This means: "Roll three six-sided dice and add the results together." Dice are also available with four-sides (D4), eight-sides (D8), ten-sides (D10), and even twenty-sides (D20). They are available at most hobby stores.

Game Master: (GM) This is the person who controls the game "world". All the non-player characters, innocent bystanders, police and politicians, even the weather, are controlled by the GM.

Player: A player is a person who plays a character in a role-playing game.

Role-Playing Game: Sometimes called a role-playing game (RPG), or fantasy role-playing (FRP), these are games with game masters and imaginary characters.

Roll a Twenty-Sided: Simply roll a twenty-sided die for a number.

Roll Percentile: Take two, ten-sided dice of different colors. Let's say we have one green and one red. First, you declare which die will be high ("I call red high"). Next, you roll the dice. First, you read the *High* die and then the *Low* die; just put the numbers together and you have a percentile. For example: "Red is 4 and green is 8, so I have a 48%."

Creating a Character

The creating of a character is relatively simple, requiring seven main steps.

Step 1: The Eight Attributes

Step 2: Hit Points, S.D.C., and Recovery

Step 3: Mega-Damage Capacity (M.D.C.)

Step 4: How to Determine Psionics (or not)

Step 5: Selecting an O.C.C. or R.C.C. (occupational direction)

Step 6: Money and Equipment

Step 7: Rounding out one's Character

Step 1: The Eight Attributes and Attribute Bonuses

The first step in creating a character is to roll up the eight attributes: I.Q., M.E., M.A., P.S., P.P., P.E., P.B., and Spd. The eight attributes represent your character's natural, mental and physical abilities. Some of the physical skills will increase your physical attributes, so it may be wise to write them in pencil until all modifiers and bonuses are accounted for.

Three, six-sided dice are rolled to determine each attribute. The higher the number, the greater the ability. If an attribute is "exceptional," (16, 17 or 18) then an additional six-sided die is rolled and added to the total for that attribute.

Intelligence Quotient (I.Q.): Indicates the intelligence of the character. The exact I.Q. is equal to the I.Q. attribute multiplied times ten. Characters with an I.Q. of 17 or better will receive a one time bonus added to all the character's skill percentages.

Run: This is just a term gamers use to describe playing a game. Example: "He runs an excellent campaign." or "I ran in Kevin's game last week".

Savings Throw: This is a roll (usually on a twenty-sided die) to avoid some unpleasant event. For example: A character might have to roll a savings throw to avoid being overcome by tear gas.

Scenario: This is a specific adventure that confronts the characters in a role-playing game. A scenario is usually a story with a beginning (hearing about the criminal), a middle (tracking down the criminal's hide-out), and an end (defeating the criminal). Most campaigns are developed around a number of scenarios.

Mental Endurance (M.E.): Measures the amount of mental and emotional stress the character can withstand.

Mental Affinity (M.A.): Shows the character's personal charm and charisma. Natural leaders, with an M.A. of 17 or higher, have a bonus to invoke trust or intimidation in others.

Physical Strength (P.S.): This is the raw physical power of the character.

Physical Prowess (P.P.): Shows the degree of dexterity and agility of the character. A P.P. of 17 or higher is rewarded with bonuses to dodge, parry and strike.

Physical Endurance (P.E.): Demonstrates the character's stamina and durability. The amount of physical punishment, and resistance to fatigue and disease, are determined by P.E. A character can carry the maximum weight load for the P.E. times 4 minutes. Carrying the maximum weight while running or fighting can only be done for the P.E. times 2 minutes. If a character lifts the maximum weight, then it can only be held for as many melee rounds (15 seconds each) as the character has points of P.E. A character can run at maximum speed for one minute for each point of P.E. Characters with a P.E. of 17 or better receive bonuses to save vs. coma, death, toxins, and magic.

Physical Beauty (P.B.): Is an indication of the physical attractiveness of the character. A P.B. of 17 or better will be rewarded with a bonus to charm or impress.

Speed (Spd): Specifically, this is the character's maximum running speed. The Spd. times 20 is the number of yards or meters that the character can run in one minute.

ATTRIBUTE BONUS CHART

	17	18	19	20	21	22	23	24	25	26	27	28	29	30
I.Q. add to all skills. One time bonus.	+3%	+4%	+5%	+6%	+7%	+8%	+9%	+10%	+11%	+12%	+13%	+14%	+15%	+16%
M.E. save vs. psychic attack/insanity	+1	+2	+2	+3	+3	+4	+4	+5	+5	+6	+6	+7	+7	+8
M. A. trust/intimidate	45%	50%	55%	60%	65%	70%	75%	80%	84%	88%	92%	94%	96%	97%
P. S. Hand to Hand Combat: Damage	+2	+3	+4	+5	+6	+7	+8	+9	+10	+11	+12	+13	+14	+15
P.P. parry, dodge and strike bonus	+1	+2	+2	+3	+3	+4	+4	+5	+5	+6	+6	+7	+7	+8
P.E. save vs. coma/death	+5%	+6%	+8%	+10%	+12%	+14%	+16%	+18%	+20%	+22%	+24%	+26%	+28%	+30%
save vs. poison & Magic	+1	+2	+2	+3	+3	+4	+4	+5	+5	+6	+6	+7	+7	+8
P.B. charm/impress	35%	40%	45%	50%	55%	60%	65%	70%	75%	80%	83%	86%	90%	92%
Spd: No special bonuses other than the raw, natural ability to run.														

DIFFERENT APPLICATIONS OF PHYSICAL STRENGTH

Weight

Normal characters, with a P.S. of 3 to 16, can carry 10 times their P.S. in pounds (P.S. x 10 = total in pounds). For Example: A character with a P.S. of 9 can carry 90 pounds (40.5kg). A character with a P.S. of 15 can carry 150 pounds (67.5kg).

Strong characters, with a P.S. of 17 or higher, can carry 20 times their P.S. in pounds. This means a character with a P.S. of 18 can carry 360 pounds (162kg).

Supernatural creatures including dragons are even stronger than extraordinary humans. Creatures with a P.S. of 18 or higher can carry 50 times their P.S. Thus, a creature with a P.S. of 24 can actually carry over half a ton, 1200 pounds! Creatures with a strength of 17 or less are equal to humans; P.S. x 10 in pounds.

Lifting weight is a little different than carrying weight. You may have noticed, yourself, that you can usually lift up a heavier amount than you can carry. I'm not talking about weight-lifting in a body building sense, nor lifting a heavy weight above the chest. Simply the ability to bend over and lift something that weighs more than you can carry. *The simple rule is that a character can lift TWICE as much as he/she could carry.* This means that the character with a P.S. of 9 can carry 90 pounds but, *can lift* 180 pounds. Meanwhile, the super strong creature, with the P.S. of 24, can lift over one ton (2400 pounds).

Throwing Heavy Objects

A character can not throw more than he can carry.

General Effective Range

Object	Normal Person	Extraordinary	*Supernatural
	P.S. 3-16	for Humans P.S. 17-30	Creatures P.S. 18-Up
1/2poundobject	50ft	100ft	300ft
Dart	30ft	60ft	100ft
Throwing Axe	80ft	150ft	300ft
Javelin	100ft	200ft	400ft
Spear	60ft	120ft	220ft
Knife	50ft	100ft	200ft
Sword	15ft	30ft	60ft

*Add one foot to the effective range for every P.S. point; e.g., P.S. 24 add 24 feet.

Note: Objects such as bricks, bottles, and swords are not designed for throwing. Consequently, the effective range is limited regardless of the strength behind it. Darts, knives and throwing axes are designed for throwing, but don't have the weight or balance for great distances. The same is true of most objects weighing less than half a pound. Javelins, more so than spears, are designed for distance throwing.

Miscellaneous items weighing over a pound and less than 10 pounds, such as rifles, can be thrown about *halfas*, far as the 1/2 pound object. Normal and extremely strong characters can hurl a weight equal to the weight he can carry four inches per each P.S. point. This means the person with a P.S. 9 can toss 90lbs up to 2 1/2 feet away. The hero with a P.S. of 17 can toss 340lbs up to 5 ft 6 inches away. **Supernatural strong** can hurl their maximum carrying weight one foot (0.3m) per P.S. point. So the character with a P.S. of 24 can hurl up to 1200 pounds a whopping 24 feet (7.5m).

Movement and Exertion

Keep the game simple and quick moving. Light activity, such as walking, jogging, driving, standing guard, doing repairs and similar activity, can be conducted for hours without affecting the character adversely. Both players and game master should apply common sense and logic to the duration of an activity. Even intense activity, such as

20 minutes of combat followed by rest or light action, will not impair the character's efficiency. It's all a matter of pacing.

Prolonged periods of combat or *heavy* exertion (an hour or more of intense, continual, physical exertion) will take its toll on the character. Reduce the following once every hour:

Speed -2
Initiative -2
Parry and Dodge — 1
Damage -2

STEP 2: Hit Points & S.D.C.

HIT POINTS

Hit points might best be thought of as life points, because they indicate how much physical damage (cuts, bruises, etc.) a character can withstand before he/she dies. These are the points that are observed during a battle (or melee) to determine how much damage is inflicted on friend or foe. Each time a character is struck by a weapon he takes physical damage. The individual players keep score of how many hit points their character has by subtracting the damage from his/her character's hit points each time that character is hit by a weapon. Likewise, the game master keeps score of how much damage the player inflicts upon his opponent. When a character has zero hit points, he is in a coma and will soon die unless extensive medical aid is applied. When a character's hit points have been knocked far below zero, he is dead and beyond saving.

DETERMINING HIT POINTS

Now that you have some idea of what hit points are about, let us get into the technical aspects of their determination and use.

1. **Base Hit Points:** Having rolled up your 8 attributes, you will recall that one is **physical endurance** (P.E.). The physical endurance score indicates your character's base/starting amount of hit points. This number means that he/she can lose that many hit points before dying.

Some of you will have a character with many hit points . . . don't get too cocky; a gun or even a knife in the right hands can whittle you down to size in one melee round. A mega-damage weapon will blow you into atoms. Others will find themselves with a character who has only a handful of hit points (as little as 3) . . . don't despair or feel cheated; you'll just have to use cleverness and cunning in avoiding direct confrontations until you've built up your hit points.

2. **Building Hit Points:** After determining your base hit points, pick up one six-sided die, roll it, and add the number rolled to your hit point base. Only roll one six-sided die one time.

As your character grows in knowledge and experience he will gain more skill and expertise in his chosen profession. At the same time he will also mature physically, increasing his hit points. Thus, each time a character attains a new experience level, roll one six-sided die and add it to the existing hit points.

S.D.C. or STRUCTURAL DAMAGE CAPACITY

There are two types of S.D.C. The first applies to living creatures and is a sort of supplement to hit points. The second applies to inanimate, non-living structures such as chairs, locks, doors, buildings, vehicles and so on.

Determining physical S.D.C. is simple, practitioners of magic and scholars and adventurers roll four 6-sided dice (4D6) for S.D.C., psychic R.C.C.s roll three 6-sided dice (3D6) for S.D.C. Men of Arms roll 1D4x 10, in addition to any O.C.C. and/or skill bonuses. Dragons do not get physical S.D.C. points. Physical S.D.C. can be increased through physical skills, such as boxing. In this way you can build and toughen your character as much as you'd like. *All S.D.C. points/bonuses are cumulative.* Players, a word of caution! Although the characters in

Rifts may have psychic or magic abilities, they are mere mortal men and women with human frailties. They are just as vulnerable to blade and bullet, tooth and claw as any normal person. The character's will have to use more than muscle to survive.

When a character is hurt, the damage is *first* subtracted from his or her *S.D.C. points*. S.D.C. damage is painful, but not deadly. It's like a movie where John Wayne gets shot, punches it out with three desperadoes, and when it's all over, dusts himself off and says "Ah shucks mam, it's only a scratch." S.D.C. in action. *It is only after ALL S.D.C. has been depleted that damage is subtracted from hit points. Hit point damage is serious, and potentially life threatening.*

Inanimate objects, such as buildings, vehicles, furniture and so on, also have S.D.C. In this case, the S.D.C. indicates the total amount of damage that the object can withstand. These S.D.C. function exactly like hit points, except that they apply to non-living things. Any damage sustained is subtracted from the S.D.C. When the S.D.C. is reduced to zero, it is broken or smashed beyond repair. **A NOTE TO THE GAME MASTER:** The S.D.C. system just described is a standard rule in most Palladium Books® games. From time to time I hear the complaint, for example: How can somebody be bashing or shooting into a door and the door is in perfect condition until all its S.D.C. are depleted? My answer is: It's not in perfect condition. Using the example of the door, the G.M. should explain exactly what's happening. "You bash into the door with your shoulder. Its a very solid door and you inflict minimal damage (give S.D.C. damage). You realize that it will take quite a while to gain entry this way and you may hurt yourself." Or "You can feel the door give a little under your great strength (give S.D.C. damage). Another bash and the door's frame cracks and moans, but it still holds (give S.D.C. damage). It will take another couple of attempts (as the door's S.D.C. dwindles), but it's definitely giving." Or "Your sub-machinegun riddles the wood door with a dozen holes (something the player can look through), but the door is still locked and holding strong."

Obviously, attacks on normal objects will scrape, dent, crack, splinter, crumble and so on, even if the object is not destroyed. To smash or destroy something may require multiple attacks, and in some cases, like being locked behind an iron door or bulkhead without a weapon or proper tools, it will be impossible to damage the item at all.

RECOVERY OF HIT POINTS and S.D.C.

After a battle, characters who have sustained physical damage must tend to their wounds. The attending of wounds can be administered by fellow characters, trained medical personnel or by oneself, if the character has first aid skills and is not physically impaired.

First aid-type skills include basic and immediate medical treatment, such as bandaging and cleaning of wounds, stopping of bleeding and so on, until the character can receive better medical care.

Recovery: Nonprofessional treatment. This is basic, first aid-type treatment by oneself, or non-medically trained people. This type of treatment may be used if the character is not able to seek professional treatment immediately. It is not necessarily inferior treatment, especially for a not too serious ailment, but just lacks the full facilities and experience of a major medical institution. **Rate of Recovery:** Two hit points per day (24 hours) and/or 4 S.D.C. points per day.

Recovery: Professional treatment. This is medical treatment from a doctor, clinic, hospital, or psychic healer. **Rate of Recovery:** Two hit points per day for the first two days, and four hit points per day for each following day, until the character has regained all his/her original hit points. S.D.C. points are restored at a rate of 6 per day.

Surviving Coma And Death

When a character's hit points are reduced to zero (or less), he/she collapses, lapsing into a coma. This character is near death, and will die in a matter of hours unless he/she receives immediate medical treatment.

How much damage below zero a character can undergo is indicated by the physical endurance (P.E.) attribute. A character can take one point of damage below zero (negative 1, -2, -3, etc.) for each P.E. point. **Example:** A character with a P.E. of 9 will lapse into a coma at zero hit points, but still lives up to a negative 9. However, if the character receives more damage (which is very possible) than the P.E., he is dead, with no hope of recovery. Thus, if a character with a P.E. of 9 takes 10 points or more below zero, exceeding his P.E., he is beyond medical help and dies.

Coma Length

The length of time a character in a coma will survive without treatment is again indicated by the P.E. Add one hour for each P.E. point. **Example:** P.E. 9 = 9 hours, P.E. 10 = 10 hours, and so on.

Recovery From a Coma

Whether or not a character survives the coma and is stabilized (brought back to, at least, one hit point above zero) is determined by the roll of percentile dice. If the player rolls two, successful recovery rolls out of three tries, the character breaks out of the coma and is no longer in danger of dying. This also means that he is brought up to one hit point above zero. Recovery of hit points from that time on is standard; see Recovery of Hit Points. **Note:** This can be attempted every hour.

Recovery Ratio (roll 2 out of 3)

- Treatment from nonprofessional, medical individual, but with medical skills: 1-18%
- Treatment from an intern or nurse (R.N.): 1-32%
- Treatment from a doctor without proper facilities: 1-46%
- Treatment from a doctor at a clinic (fair facilities): 1-56%
- Treatment from a hospital: 1-66%
- Treatment from a major, large hospital: 1-70%.

Optional Recovery Side-Effects From Severe Damage/Near Death (Hit Points)

Roll on this table when a character has lost all of his/her hit points and has been near death (coma). **Impairment is permanent** as a result of the grave physical damage. **NOTE:** This is not a mandatory table, but is left up to the game master's discretion.

- 1-10** No permanent damage.
- 11-20** Major stiffness in joints; reduce P.P. by 2.
- 21-39** Minor stiffness in joints; reduce P.P. by 1.
- 40-55** Legs impaired; walk with a limp reduce Spd by 2.
- 56-70** Major scarring; reduce P.B. by 2.
- 71-82** Chronic pain; reduce P.E. by 1.
- 83-92** Minor brain damage; reduce I.Q. by 1.
- 93-00** Major brain damage; reduce I.Q. by 2 and M.E. by 1.



OPTIONAL DAMAGE RULES

A character receives serious physical damage when he loses a great amount of hit points. The following is a list of side-effects from physical damage. The effects of the damage are generally temporary and cumulative. Thus, if a character suffers the loss of a great deal of hit points within a short time, he will suffer the multiple effects of physical damage. **Roll each time severe damage is endured.**

Roll Percentile	Damage	Minuses
1-14	Minor bruises and lacerations.	Spd -2 -1 to dodge
15-29	Severely bruised and battered muscles	P.P. -1 Spd -3
30-44	Damaged (sprain, pulled, cut, etc.) arm or shoulder.	P.P. -3
45-59	Damaged leg or hip.	Spd is 1/2 -2 to dodge
60-74	Damaged hand and/or wrist	P.P. -1 P.S. -2
75-89	Head Injury	-5% on all skills; Spd -2
90-00	Damaged back or pelvis.	P.E. -1 P.P. -2 Spd -3

NOTE: None of these effects are permanent nor life threatening. Minuses apply to that one limb. Speed minuses affect the whole body. Remember effects are cumulative; roll each time the character is badly hurt.

Side-Effects from Physical Damage (Hit Points) (Optional)

Roll on this table when 75% to 99% (almost all) hit points are depleted. Impairment is temporary, lasting 1-4 weeks (roll one four-sided die).

Roll Percentile	Damage	Minuses
1-10	Severely battered and bruised	Spd -2 -3 to dodge
11-20	Torn arm muscle	P.P. -3 P.S. -2
21-29	Torn leg muscle	Spd is 1/2 -2 to dodge
30-39	Fractured bone: arm	P.P. -2 P.S. -3
40-49	Fractured bone: leg	Spd is 1/2 -4 to dodge
50-59	Fractured bone: ribs or pelvis	P.E. -2 Spd is 1/2
60-69	Broken bone: arm	P.P. is 1/2 P.S. is 1/2
70-79	Broken bone: leg	Spd is 1/3 -6 to dodge
80-89	Broken bone: ribs	P.E. -3 P.P. -1 Spd -3
90-00	Severe Concussion	-8 on all skills, Spd -3

Step 3: Mega-Damage & M.D.C.

Mega-Damage Capacity (M.D.C.) is a damage system that may be new to many of you. It is a structural damage capacity that reflects the staggering advancements in science and technology. A technology that has created new super-tough alloys, micronized and even nano-size circuits, parts, and batteries, and weapons with more power, precision, and range than anything we can manufacture in the 20th Century. In effect, M.D.C. is a *super-structural damage capacity* that far outstrips the normal S.D.C.

M.D.C. versus S.D.C.

1. Generally, 100 S.D.C. (or hit point) damage equals about one M.D.C. point.

2. This also means that one point of Mega-Damage does approximately 100 S.D.C. points of damage.

3. Most conventional weapons do absolutely no damage to a mega-damage structure, even when combined for a total of 100 or more (See example).

4. **Example:** A Coalition SAMAS power armor unit and two foot soldiers in standard "Dead Boy" body armor are on a routine patrol of Old Chicago ruins. All are wearing M.D.C. armor. Suddenly, they are attacked by thirty rebel bandits. The bandits are armed with old S.D.C. weapons, mostly M-16 assault rifles and sub-machineguns.

The two soldiers in Dead Boy body armor are caught in a hail of bullets. Perhaps as many as 50 rounds hit for a combined amount of S.D.C. damage of about 300, but the soldiers just stand their ground. All the bullets bounce off their mega-damage body armor. The worst is a few scratches. They take no damage!

Four bandits jump one of the soldiers before he can react. They pummel him with the butts of their rifles and steel clubs. Again the attack inflicts no physical damage to the armor or the person inside, however, the force of the attack does knock the soldier down.

One of the bandits screams a warning and points at the SAMAS power armor flying in for an attack. A couple of bandits jump into a souped-up dune buggy and try to make a run for it. The other foot soldier sees them and fires his Mega-Damage (M.D.) energy pistol, a successful strike is made and damage is rolled. A mere three (3) M.D.C. points of damage is inflicted. The dune buggy is blown in half because the 3 M.D. points are equal to about 300 S.D.C., the full S.D.C. of the vehicle.

The SAMAS zooms by and swoops behind a wall of debris where it's pilot saw a battered robot assault vehicle hiding. Sure enough, the moment the SAMAS is visible, the bandits piloting the robot fire! The bandits get the initiative and also roll a successful strike. The SAMAS is hit by a pair of mini-missiles that inflict 5D6 M.D. each, and takes a total of 27 points of M.D.C. damage. Only a scratch to a "Sam." Combat continues.

In the context of this specific book, M.D.C. applies to:

- All high-tech military vehicles including tanks, APCs, robots, aircraft, and all Coalition war machines.
- All high-tech body armor and power armor.
- All bionic body components and bionic body armor (Cybernetic items are generally S.D.C. structures).
- Many supernatural creatures, including dragons and vampires.
- Most force fields.

Combat Note: Typically, only a mega-damage weapon can harm a M.D.C. structure. S.D.C. missiles and explosives that can inflict over 100 S.D.C. points of damage do inflict the equivalent of mega-damage. In these rare cases, approximately every 100 S.D.C. points of damage equals one mega-damage point. Always round down S.D.C. damage. For example: A missile that inflicts 450 S.D.C. equals 4 M.D.C.

Likewise, when a S.D.C. structure is blasted by mega-damage, always round the S.D.C. down when assessing damage. For example: When an object that has 230 S.D.C. is hit by 2 M.D. points of damage, the item is destroyed (all 230 S.D.C.). What little may remain is a useless piece of junk.

M.D.C. Artificial Armor

Through the history of humankind, people have developed different forms of body armor. In days past, this armor would have been S.D.C. types, like bullet-proof vests and chain mail, but in the world of **Rifts**, the body armor is usually a super-strong, yet lightweight, mega-damage structure. Like any other mega-damage structure, they can not be damaged by S.D.C. type weapons, with the possible exception of high explosives and missiles.

A variety of M.D.C. body armor, from padded armor to full power armor exo-skeletons, are described in the equipment section.

M.D.C. Natural Armor

Many supernatural creatures, such as dragons, vampires, many demons, and others have natural protective armor covering or M.D.C. skin, or their supernatural essence makes them a mega-damage structure. In these cases, normal S.D.C. weapons can not harm the creature. However, most are vulnerable to mega-damage weapons, magic, and psionic attacks. *Some* even have odd vulnerabilities, such as fire, sunlight, salt, or iron, which will hurt the supernatural fiend when bullets can't (unusual vulnerabilities will be noted in monster descriptions).

Physical Damage While Inside a M.D.C. Structure

There are a couple instances where a character can suffer physical S.D.C. and/or hit point damage while inside a mega-damage structure. Psionic and magic mind attacks and probes will penetrate most M.D.C. body armor and human size power armor to affect the person inside (can not penetrate SAMAS or Glitter Boys, nor most large vehicle style robots).

A character in body armor or human size power armor can also suffer **impact damage** from falls at great height, or high speed crashes, or from explosions. Most body armor and power armor are carefully designed and padded so that the armor absorbs the majority of impact damage, however, the body inside is still rattled and slammed around. In most cases, the physical damage one suffers is minimal and leads to nothing more than a few bruises.

Impact Damage Rules Applicable to Body & Power Armor

Fall: One point of S.D.C. or Hit Point damage for every 10 feet (3 m) height from a fall.

High speed crash: 1D4 points of S.D.C. or Hit Point damage for every 10 mph (16 km) of speed above 30 mph (48 km).

Impact from an Explosion: One point of S.D.C. or Hit Points for every 10 M.D. point from an explosion.

Chance of being stunned: In each case there is a chance of being stunned. **Fall:** 1-40% chance of being momentarily stunned (no attacks, -9 to strike, parry, and dodge) for 1D4 melees from any fall above 100 feet (30.5 m). 1- 79% chance of being stunned if the fall is 200 feet (61 m) or higher for 1D6 melees. **Crash:** 1-30% chance of being stunned for 1D4 melees if impact is more than 50 mph (80 km), add +5% for every additional 10 miles (16 km) above 50 mph. **Explosion impact:** There is a 1-60% chance of being stunned for 1D4 melees whenever hit by more than 40 M.D.C. at once.

Also, the force of an attack, especially from missiles and rail guns, may knock a character off his feet. Generally, this only happens when the individual is struck by 30 M.D.C.; Game Masters should use common sense in deciding when to use this element in combat. Characters who are knocked off their feet lose one attack/action that melee.

Step 4: How to Determine Psionics

There are three ways of getting a character who has psionic powers. The first, and simplest way, is to select one of the *Psychic Racial Character Classes*. A **master psionic** is the most powerful of all natural psychics and is available only from the *Psychic R.C.C.s*. A psychic character class automatically gets psionic abilities. Each Specific R.C.C. will explain the character's background, orientation, and psi-abilities. However, while the psychic R.C.C. is heavy with psi-powers, it is limited in skill development.

The second way is to select an O.C.C. that has *minor* psionics, like the *operator*, *techno-wizard*, *crazies*, and *cyber-knight*, but these characters have only a tiny bit of psychic powers.

The third way to get a character with psionics is to roll percentile dice on the following random table.

Random Psionics Table

01-09 Major Psionics

10-25 Minor Psionics

26-00 No Psionics

In the world of **Rifts**, psychic powers are comparatively common. Even an average person *may* have some degree of psychic power.

A **minor psionic selects two powers from any one of the following psionic categories:** *Sensitive*, or *Physical*, or *Healer*. Two psi-powers, even spectacular ones, are considered inconsequential and the character must select an O.C.C., without modification. The number of Inner Strength Points (I.S.P.) is determined by taking the number from M.E., roll 2D6 and add both numbers together. This is the base I.S.P.; add the roll of 1D6 per each level of experience.

A **major psionic** is a character who has an impressive amount of paranormal abilities. Unlike the minor psychic who can only select from one category, this individual can select a total of eight (8) powers from one category or a total of six (6) from any of the three categories available. The categories from which a major psionic can select includes: *Sensitive*, *Physical*, and *Healer*. This means the psychic can have a combination of power types. However, the development of extra-sensory abilities means that a certain amount of time and energy was expended on the development of those abilities and not on formal education. The major psionic must select an O.C.C., but all skill bonuses are reduced by half (round down fractions), and the number of "other" skills are also reduced by half. Secondary skills are not affected. Major (and master) psionics must also submit to IC implantation and registration at all Coalition cities.

The number of I.S.P. for a major psionic is determined by taking the number from M.E., roll 4D6, and add both numbers together. This is the base I.S.P.; add the roll of 1D6 + 1 per each level of experience.

NOTE: A player may skip step four entirely if he or she does not want a character with psionics.

Step 5: Selecting an O.C.C. or R.C.C.

It is suggested that readers skim over the O.C.C. and R.C.C. sections before selecting a character. In play test, the dilemma players encountered was that they liked so many of the different characters that they had trouble deciding which *one* they wanted to play first. Personally, I tried to make each character unique, so that each one would have a distinctive flavor and be fun to play. Players should select a character that they find exciting.



I had originally intended to include many more mutants and monsters, and non-human player characters/races than players will find in this book. The reason for this is twofold. First, I ran out of space. This would be a 450 page book if I had squeezed in all my ideas, but rest assured that robots, monsters, and non-human player characters will appear in future supplements, soon. The second reason is that the story quickly developed into the story of humankind's climb from the abyss and back into the light of the world. Humankind still teeters on the brink of extinction and must fight all manner of horrors to reclaim our planet Earth. It is a struggle that will be won only through the wisdom and courage of men and women, human and non-human, who are not afraid to step forward and reshape this strange new Earth of the future.

For the sake of simplicity, each player selects one Occupational Character Class (O.C.C.) or one Racial Character Class (R.C.C.). Each character class will describe the hero's background, orientation, typical views of life, his/her position in society, special powers (if any), and training/skills.

Although most player characters are *human*, they are far from typical or normal humans. Characters like the Borgs, Juicers, Crazies, and high-tech soldiers are augmented by incredible machines. Psi-stalkers, Mind Melters, Burststers, and others possess paranormal powers. Then there are the men of magic.

Note: Non-humans and super-powered humans are generally considered to be mutants or "D-Bees." D-Bee is a slang term for Dimensional Beings, meaning that the individual must be a creature from another dimension.

O.C.C. Requirements

The selection of an O.C.C. is limited only by the minimum attribute(s) required for that occupation and the player's personal taste. Some O.C.C.s have higher requirements than others and generally reflect the strenuous or intellectual demands of that particular profession.

Skills and Skill Selection

Each O.C.C. has three skill categories: O.C.C. skills, Other skills, and Secondary skills.

O.C.C. skills are the areas of expertise and training that all characters receive when they select that profession. The bonus in parenthesis reflects that specialized training.

O.C.C. Related Skills are additional areas of formal training and knowledge. In many cases, these skills will also reflect the character's occupation and interests. Not all skill categories are available for skill selection and will be marked "none." Many of the skill categories that are available will indicate specific restrictions (if any) and possible skill bonuses. Skill bonuses will be indicated in parenthesis. The skills that most relate to one's O.C.C. have the highest bonuses.

Secondary skills are things that have been learned without formal training. They are hobbies, interests, and abilities that a person has learned himself by reading, or watching others and practicing what he has seen. These skills are also selected from the list of available skill categories. However, no skill bonuses are applicable! The bonus indicated in parenthesis applies only to "other" skill selections. Thus, all secondary skills start out at the *Base Skill level*.

Skill Bonuses

The base skill level is denoted in each skill description. Bonuses received by one's O.C.C. are added to that base skill. This is a one time skill bonus.

Characters may also have an I.Q. attribute bonus and this too is added to the base skill level as a one time bonus.

Skill proficiencies increase as characters grow in experience. This is not so much a bonus as a designation of increased mastery over one's abilities. The amount that the skill level increases is also noted in each skill description. **For example:** The communication skill of radio: basic reads: **Base Skill:** 45% + 5% per level of experience. This means that a first level character without O.C.C. or other bonuses has a base skill proficiency of 45%. At second level + 5% is added to increase the skill to 50%. At third level it increases to 55%, at fourth, 60%, and so on.

Maximum skill level is limited to 98%, because there is always a margin for error no matter how skilled one is.

P.P.E. Points

P.P.E. Points is the amount of potential psychic energy (P.P.E.) that a character possesses. Unless stated otherwise under one's O.C.C. or R.C.C., the amount of P.P.E. is minimal, roll 2D6.

Step 6: Money and Equipment

All characters are given a basic list of standard equipment typical for that O.C.C. Likewise, each character has a certain amount of money in the form of credit and/or black market items that can be sold for a few thousand credits. This means that the characters start out with the basics and some cash; poor, but not destitute. Money is a great motivator for action in a role-playing scenario, so it is intentionally kept limited to start. Needing a roof over one's head or food in one's belly can lead a character to consider actions that can develop nicely into an adventure. As always, a character can spend the money immediately for additional equipment or save it for later.

STEP 7: Rounding Out One's Character

The final step is to add color to your character. The only mandatory requirement is the selection of an **alignment** and understanding how the **experience levels/system** applies to you. Everything else is optional, including insanity. Use it or do not. Insanity rules will be most appropriate in long campaigns.

ALIGNMENTS

THE ALIGNMENTS

Good: Principled and Scrupulous

Selfish: Unprincipled and Anarchist

Evil: Miscreant, Aberrant and Diabolic

Alignments are an important factor in developing a character, his/her attitudes and moral principles. ALL players *must* choose an alignment for their character.

NEUTRAL

First of all, there is *no* such thing as an absolute or true neutral. All people tend toward good, evil or self-gratification. An absolute true neutral could not make a decision, go on an adventure, kill, or take any action of any kind without leaning toward good, evil or self-gratification. It is humanly impossible and is, therefore, eliminated in the context of this game. (I realize that some of the philosophers out there may disagree with this, but that's a topic for philosophical debate and not a factor of this game. Sorry, no neutrals).

GOOD ALIGNMENTS

Principled Scrupulous

Because a character is of a good alignment, it does not make him/her a saint. Good characters can be just as irritating, obnoxious, and arrogant; even prejudiced and full of quirks. However, life and freedom are of the highest priority. Such a person can always be trusted in a life and death situation. A fair number of Cyber-knights are principled.

Principled (Good)

Principled characters are, generally, the strong, moral character.

Principled characters will ...

1. Always keep his word.
2. Avoid lies.
3. Never kill or attack an unarmed foe.
4. Never harm an innocent.
5. Never torture for any reason.
6. Never kill for pleasure.
7. Always help others.
8. Work well in a group.
9. Respect authority, law, self-discipline and honor.
10. Never betrays a friend.
11. Never break the law unless conditions are desperate. This means no breaking and entry, theft, torture, unprovoked assaults, etc.

Scrupulous (Good)

Scrupulous characters value life and freedom above all else, and despise those who would deprive others of them. This type of hero is typically portrayed in many Clint Eastwood and Charles Bronson films; the person who is forced to work beyond the law, yet for the law, and the greater good of the people. They are not vicious or vindictive men, but are men driven to right injustice. I must point out that these characters will always *attempt* to work with or within the law whenever possible. Many cyber-knights are scrupulous.

Scrupulous Characters Will ...

1. Keep his word to any other good person.
2. Lie only to people of selfish or evil alignments.
3. Never attack or kill an unarmed foe.
4. Never harm an innocent.
5. Never torture for pleasure, but may use muscle to extract information from criminals or evil characters.
6. Never kill for pleasure; will always *attempt* to bring the villain to justice alive no matter how vile he may be.
7. Always help others.
8. Attempt to work within the law whenever possible.
9. Bend and, occasionally, break the law when deemed necessary. This means they may use strong-arm techniques, harass, break and enter, theft, and so on.
10. Distrust authority.
11. Work with groups, but dislike confining laws and bureaucracy (red tape).
12. Never betrays a friend.

SELFISH ALIGNMENTS (But Not Necessarily Evil)

Unprincipled (Selfish)

This, *basically*, *good* person tends to be selfish, greedy, and holds his/her personal freedom and welfare above almost everything else. He/she dislikes confining laws, self-discipline and distrusts authority. This is the Han Solo, Star Wars, character. The guy who is always looking for the best deal, associates with good and evil characters, is continually tempted to lie and cheat, and hates himself for being loyal and helping others.

Unprincipled Characters Will ...

1. Have a high regard for life and freedom.
2. Keep his word of honor.
3. Lie and cheat if necessary (especially to those of anarchist and evil alignments).
4. Will not kill an unarmed foe (but will take advantage of one).
5. Help those in need.
6. Not use torture unless absolutely necessary.
7. Work with a group, especially if profitable.
8. Never harm an innocent.
9. Never kill for pleasure.
10. Dislike authority.
11. Never betray a friend.

Anarchist (Selfish)

This type of character likes to indulge himself in everything. He is the insurgent, con-man, gambler and high roller; the uncommitted freebooter seeking nothing more than self-gratification. This character will, at least, consider doing anything if the price is right. These people are intrigued by power, glory and wealth. Life has meaning, but his has the greatest meaning. Laws and rules infringe on personal freedom and were meant to be broken. An anarchist aligned person is always looking for the best deal, and will work with good, selfish or evil to get it; as long as he comes out of the situation on top. The anarchist is continually teetering between good and evil, rebelling, and bending the law to fit his needs. Often mercenaries fall into this category.

Anarchist Characters Will ...

1. May keep his word.
2. Lie and cheat if he feels it necessary.
3. Not likely to kill an unarmed foe, but certainly knockout, attack, or beat up an unarmed foe.
4. Never kill an innocent (but may harm or kidnap).
5. Not likely to help someone without some ulterior motive (even if it's only to show-off).
6. Seldom kill for pleasure.
7. Use torture to extract information (not **likely** to torture for pleasure).

8. Does not work well in a group (this is the cocky, loudmouth who is likely to do as he damn well pleases).
9. Have little respect for self-discipline or authority.
10. May betray a friend.

EVIL ALIGNMENTS

Miscreant Diabolic Aberrant

All evil characters are not bent on universal genocide or domination over all living creatures. They are not all maniacal people actively seeking to harm innocent people. Nor are all evil characters sadistic and untrustworthy. Many evil characters may actually seem kind or likable.

There is nothing wrong with playing an evil character, although he may not survive too long if he betrays or harms too many people. This is fantasy role-playing, not reality. You can play any type of character you desire, just continue to play in character.

Evil alignments are a step beyond the self-gratification of the selfish alignments. Evil characters are ruthless individuals who are willing to say or do anything to achieve their goal. Human life has little meaning to them, and friends tend to be (but not always) people to use, and discard when they are no longer of value. Evil aligned people do not automatically slay any good aligned person because of different ethics and philosophy. All the better to use good to achieve their own goals, for the end always justifies the means.

Miscreant (Evil)

This self-serving, unscrupulous character is out only for himself. Power, glory, wealth, position, and anything that will make his life more comfortable is his goal. It matters not who gets caught in the middle, as long as he comes out smelling like a rose. This person will lie, cheat and kill anyone to attain his personal goals.

Miscreant Characters Will . . .

1. Not necessarily keep his word to anyone.
2. Lie and cheat anyone; good or evil.
3. Most definitely attack an unarmed foe (those are the best kind).
4. Use or harm an innocent.
5. Use torture for extracting information and pleasure.
6. May kill for sheer pleasure.
7. Feels no compulsion to help without some sort of tangible reward.
8. Work with others if it will help him attain his personal goal.
9. Kill an unarmed foe as readily as he would a potential threat or competitor.
10. Has no deference to laws or authority, but will work within the law if he must.
11. Will betray a friend if it serves his needs.

Aberrant (Evil)

The cliché that there is "No honor among thieves." is false when dealing with the aberrant character. This is a person who is driven to attain his goals through force, power, and intimidation. Yet the aberrant person stands apart from the norm, with his own, personal code of ethics (although twisted ethics by the standards of good). He expects loyalty from his minions, punishing disloyalty and treachery with a swift, merciful death. An aberrant person will always keep his word of honor and uphold any bargains. He will define his terms and live by them, whether anyone else likes it or not.

Aberrant Characters Will . . .

1. Always keep his word of honor (he is honorable).
2. Lie to and cheat those not worthy of his respect.
3. May or may not kill an unarmed foe.
4. Not kill (may harm, kidnap) an innocent, particularly a child.
5. Never kills for pleasure.

6. Not resort to inhumane treatment of prisoners, but torture, although distasteful, is a necessary means of extracting information.
7. Never torture for pleasure.
8. May or may not help someone in need.
9. Work with others to attain his goals.
10. Respect honor and self-discipline.
11. Never betray a friend.

Diabolic (Evil)

This is the category where the megalomaniacs, violent, and most despicable characters fall. This is the cruel, brutal killer who trusts no one and has no value for anyone or anything that gets in his way. Aberrant aligned characters find these dishonorable people just as revolting as a good aligned character.

Diabolic Characters Will . . .

1. Rarely keep his word (and has no honor).
2. Lie to and cheat anyone.
3. Most certainly attack and kill an unarmed foe.
4. Use, hurt and kill an innocent without a second thought or for pleasure.
5. Use torture for pleasure and information.
6. Kill for sheer pleasure.
7. Likely to help someone only to kill or rob him.
8. Not work well within a group (consistently disregarding orders to do as he pleases).
9. Despise honor, authority, and self-discipline.
10. Associate mostly, with other evil alignments.
11. Betray friends (after all, you can always find friends).

SUPERNATURAL CREATURES

Supernatural creatures must have an alignment. *Most* will be evil; especially miscreant and diabolic. ALL supernatural creatures, whether they are ghostly entities or slithering monsters, will radiate their alignment. This psychic emanation is part of its nature and can not be hidden or disguised. To a psychic sensitive or psi-stalker the emanations of evil are as distinctive and recognizable as pungent odor.

Practitioners of magic for evil purposes, or individuals who associate with supernatural creatures, do not, themselves, radiate an unnatural, evil aura. However, those who knowingly and willfully use such dark forces are always of evil or anarchist alignment. These are the vengeful, greedy or power hungry fools who will stop at nothing to achieve their goals. Goals they will attain even if it means calling upon horrible, evil forces from another world to prey on their own.

EXPERIENCE POINTS

Except in specially devised scenarios and tournaments, there is no winner in a role-playing game. The accumulation of heroic deeds, friends, prestige, weapons, equipment, knowledge, and skills, can be construed to be the results of winning. If a character survives and meets with success in his endeavors, that is winning. However, there are rewards besides the acquisition of material goods and reputation, and those are developing your character's skills, knowledge, and abilities. This is accomplished through the gathering of experience points.

Why An Experience Point System?

The reason I use an experience point system is because I find them extremely realistic and practical. Training is useful, but there is no substitute for experience. I don't know how many times I have read a comic book with the main character thinking to himself, something like "Only my years of experience enabled me to beat him." or "He's good, but lacked the years of experience and training to handle the situation." Practical experience in the field is an important and real factor in the development of a character.

The experience system is specifically designed so that characters will mature fairly rapidly, tapering off as they reach higher levels of experience (around fifth and sixth level).

Why do the experience levels only go to level 15? Because characters are not likely to ever reach that level, even after years of regular play. In my original, **Palladium Role-Playing Game** play-test campaign, after two years of regular, weekly, long (averaged 9 hours) playing sessions; the characters averaged 7th to 9th level and progressing, ever so slowly, toward tenth level. Realistically, a high level character is not necessarily all that much fun to play unless the campaign maintains a high level of challenge and adventure.

Experience Points And Their Application

It is difficult to devise a point system by which a game master can judge and reward his players fairly. The ultimate purpose of experience points and experience levels is to provide a means by which the player's character can grow and develop. Many fantasy role-playing games have their own unique system, charts, equations, and computations for distributing experience points. You may want to adapt one of these systems to this game if that's what you're comfortable with. Many games avoid the whole question of experience points by a system in which points are pumped back into the powers, but this leaves skills undeveloped, as well as being pretty drab.

The subjective method of observation and logic introduced in the **Palladium Role-Playing Game** has been so well received that I'm just transplanting it into **Rifts and all of our games**. I feel that any twit can punch-out or blast a villain that just crawled out of the woodwork. Most experience systems concentrate on the "kill factor," but what about the thought process? What about the decisions, plans, or motives behind a particular action? Doesn't cleverness and a cool head count? Aren't these the true ingredients of good role-playing? Shouldn't the brilliant medical student playing a character with an I.Q. of 4 (and staying firmly in character, saying and doing things as the character would, even though he realizes the stupidity as a player) get experience for playing in character? Hell Yes!!! Considering how flexible and subjective most of the other role-playing conditions and rules are, I don't see the logic in having a strict, limited experience point system.

Each player's character involved in a given situation/confrontation should receive the appropriate experience points. The game master should make a list of his players at the beginning of the game and jot down each player's experience points as they gather them throughout the course of the game. At the end of the game, the game master totals each player's points and gives them the total so that they can keep track of their growing experience and skills.

The difficulty with this system of determining experience points is the subjectivity. The game master must utilize the proceeding experience outline with some thought. **Example:** Eight third level character's brimming with psychic power and armed to the teeth attack and subdue one, lone, fourth level villain or minor monster. The eight players should receive experience points for subduing a minor menace. After all, the poor guy didn't have a chance and presented no real threat to the characters. However, if one or two first or second level characters subdued the same villain, they should receive experience for subduing a major or even a great menace, because the threat and ingenuity involved are much greater.

I have found this method stimulates imaginative playing instead of promoting slash and kill. Game masters, don't be Santa Claus heaping wonderful amounts of experience points; be fair and tolerant. Let your players truly earn their experience points; growing in skill, knowledge and power. If you have a group of players rising rapidly in experience levels, you will know it's because they are clever and imaginative players. And that's what this game is all about!

Character Experience Levels

Each character class has a listing for levels of experience. A character involved in an adventure gains experience points for his thoughts, actions and deeds. As these experience points accumulate, the character will reach new plateaus, indicating his continual growth, development, and mastery over his powers and skills. Each time a player's character accumulates enough experience points to reach the next level of experience, his skill increases accordingly. In most instances, magic and special powers also increase in range, duration, power/damage, and scope. **Example:** When a first level rogue scientist character has accumulated at least 2051 experience points, he has attained second level, and *all* his skills become second level; meaning that he can perform them at a higher level of proficiency.

A clever plan, a quick attack, all earn experience points. The more experience points a character receives, the higher the level he attains and the greater his abilities. **Players**, be certain to keep a careful record of the experience given to you at the end of each game. When a character attains a new level, be certain to tell the game master so that the skills and hit points can be increased accordingly.

Experience And Hit Points

Each time a character reaches a new level of experience the player gets to roll 1 six-sided die and adds the number rolled to the character's hit points. This indicates the physical development and maturity of the character as he develops.

Per Level Of Experience

Per level of experience, or per each level of experience, or per level of the psychic, indicates that the person can perform a skill, psychic power, or ability at his highest level of experience. This often indicates the amount of damage that can be inflicted or a duration of an effect.

EXPERIENCE POINTS TABLE

Awarding Experience Points

Experience Points	Action
25	Performing a skill (successful or not).
25	Clever, but futile idea.
100	Clever, useful idea or action.
100	Quick-thinking idea or action.
200	A critical plan or action that saves the character's life and/or a few comrades.
400-1000	A critical plan or action that saves the entire group or many people.
100-300	Endangering the character's own life to help others.
500-700	Self-sacrifice (or potential self-sacrifice) in a life and death situation (like leaping in front of a fireball meant for someone else to save that person, even though he/she is likely to die, or offering his/her own life to save the group or another).
100	Avoiding unnecessary violence.
100-200	Deductive reasoning and/or insight.
50	Good judgment.
50	Playing in character bonus.
50-100	Daring (clever or not).
25-50	Killing or subduing a minor menace.
75-100	Killing or subduing a major menace.
150-300	Killing or subduing a great menace.

EXPERIENCE LEVELS

<p>CS Grunt Dog Pack</p> <p>1 0,000-1,950 2 1,951-3,900 3 3,901-8,800 4 8,801-17,600 5 17,601-25,600 6 25,601-35,600 7 35,601-50,600 8 50,601-70,600 9 70,601-95,600 10 95,601-125,600 11 125,601-175,600 12 175,601-225,600 13 225,601-275,600 14 275,601-325,600 15 325,601-375,600</p>	<p>CS Technical Officer CS Military Specialist Shifter</p> <p>1 0,000-2,120 2 2,121-4,240 3 4,241-8,480 4 8,481-16,960 5 16,961-24,960 6 24,961-34,960 7 34,961-49,960 8 49,961-69,960 9 69,961-94,960 10 94,961-129,960 11 129,961-179,960 12 179,961-229,960 13 229,961-279,960 14 279,961-329,960 15 329,961-389,961</p>	<p>Cyber-Knight Jucier Crazies</p> <p>1 0,000-2,140 2 2,141-4,280 3 4,281-8,560 4 8,561-17,520 5 17,521-25,520 6 25,521-35,520 7 35,521-50,520 8 50,521-71,000 9 71,001-96,100 10 96,101-131,200 11 131,201-181,300 12 181,301-231,400 13 231,401-281,500 14 281,501-341,600 15 341,601-401,700</p>	<p>Borg Head Hunter Glitter Boy</p> <p>1 0,000-2,100 2 2,101-4,200 3 4,201-8,400 4 8,401-17,200 5 17,201-25,400 6 25,401-35,800 7 35,801-51,000 8 51,001-71,200 9 71,201-96,400 10 96,401-131,600 11 131,601-181,800 12 181,801-232,000 13 232,001-282,200 14 282,201-342,400 15 342,401-402,600</p>
<p>CS RPA Elite Body Fixer</p> <p>1 0,000-1,925 2 1,926-3,850 3 3,851-7,450 4 7,451-14,900 5 14,901-21,000 6 21,001-31,000 7 31,001-41,600 8 41,601-53,000 9 53,001-73,000 10 73,001-103,500 11 103,501-139,000 12 139,001-189,000 13 189,001-239,000 14 239,001-289,000 15 289,001-339,000</p>	<p>City Rat Vagabond</p> <p>1 0,000-1,875 2 1,876-3,750 3 3,751-7,250 4 7,251-14,100 5 14,101-21,200 6 21,201-31,200 7 31,201-41,200 8 41,201-51,200 9 51,201-71,200 10 71,201-101,500 11 101,501-136,500 12 136,501-186,500 13 186,501-236,500 14 236,501-286,500 15 286,501-326,500</p>	<p>Cyber-Doc Rogue Scholar Rogue Scientist</p> <p>1 0,000-2,000 2 2,001-4,000 3 4,001-8,200 4 8,201-16,400 5 16,401-24,500 6 24,501-34,600 7 34,601-49,700 8 49,701-69,800 9 69,801-94,900 10 94,901-129,000 11 129,001-179,100 12 179,101-229,200 13 229,201-279,300 14 279,301-329,400 15 329,401-389,500</p>	<p>Wilderness Scout Operator</p> <p>1 0,000-1,900 2 1,901-3,800 3 3,801-7,300 4 7,301-14,300 5 14,301-21,000 6 21,001-30,000 7 30,001-40,000 8 40,001-53,000 9 53,001-73,000 10 73,001-103,000 11 103,001-138,000 12 138,001-188,000 13 188,001-238,000 14 238,001-288,000 15 288,001-328,000</p>
<p>Burster Psi-Stalker Mystic</p> <p>1 0,000-2,050 2 2,051-4,100 3 4,101-8,250 4 8,251-16,500 5 16,501-24,600 6 24,601-34,700 7 34,701-49,800 8 49,801-69,900 9 69,901-95,000 10 95,001-130,100 11 130,101-180,200 12 180,201-230,300 13 230,301-280,400 14 280,401-340,500 15 340,501-400,600</p>	<p>Mind Melter Lev Line Walker</p> <p>1 0,000-2,240 2 2,241-4,480 3 4,481-8,960 4 8,961-17,920 5 17,921-25,920 6 25,921-35,920 7 35,921-50,920 8 50,921-70,920 9 70,921-95,920 10 95,921-135,920 11 135,921-185,920 12 185,921-225,920 13 225,921-275,920 14 275,921-335,920 15 335,921-395,920</p>	<p>Techno-Wizard</p> <p>1 0,000-2,300 2 2,301-4,600 3 4,601-9,200 4 9,201-18,400 5 18,401-26,500 6 26,501-36,600 7 36,601-51,700 8 51,701-71,800 9 71,801-96,900 10 96,901-137,000 11 137,001-188,100 12 188,001-229,200 13 229,201-279,300 14 279,301-340,400 15 340,401-400,000</p>	<p>Dragon</p> <p>1 0,000-3,000 2 3,001-5,000 3 5,001-10,000 4 10,001-20,000 5 20,001-30,000 6 30,001-50,000 7 50,001-80,000 8 80,001-120,000 9 120,001-170,000 10 170,001-230,000 11 230,001-300,000 12 300,001-380,000 13 380,001-470,000 14 470,001-600,000 15 600,001-800,000</p>

OPTIONAL RULES

Optional Ways to Round Out Your Character

I've found that many players like as much background and details about their characters as possible. Consequently, I've assembled a series of optional tables to satisfy those details. All tables require the roll of percentile dice.

Birth Order

- 1-30 First Born
- 31-44 Second Born
- 45-55 Third Born
- 56-65 Fourth Born
- 66-80 Last Born
- 81-90 First Born of Twins
- 91-00 Illegitimate

Weight

- 1-10 Skinny
- 11-30 Thin
- 31-55 Average
- 56-74 Husky
- 75-89 Potbelly
- 90-00 Obese

Note: Average Weight:
150 to 180lbs (male)
110 to 140lbs (female)

Height

- | | |
|---------------|------------------------------|
| 1-30 Short | Note: Average Height: |
| 31-70 Average | 6ft, male |
| 71-00 Tall | 5ft 6in, female |

Age

I think it is best to generally assume most characters are young — late teens to mid-twenties. It is best to determine the age by the level of the character's education and player preference.

Disposition

- 1-10 Mean, suspicious, vengeful.
- 11-15 Shy, timid, tends to be a loner.
- 16-20 Gung-ho, guts and glory type who sees himself as a hero. Likes combat.
- 21-25 Worry wart, nervous and cautious.
- 26-37 Hot-head, quick-tempered, emotional, but basically nice.
- 38-45 Schemer; gambler who likes to take chances.
- 46-50 Blabber-mouth, nice guy, but too talkative.
- 51-56 Wild man, cocky, overconfident, takes unnecessary risks.
- 57-66 Nice guy, friendly, courteous and hospitable.
- 67-76 Snob, arrogant, feels superior to others.
- 77-84 Tough guy, self-reliant, cocky, a lone wolf.
- 85-89 Paternal, overbearing, overprotective of others, especially young characters.
- 90-94 Complainer, constantly aggravated about something.
- 95-00 Paranoid, trusts no one.

Family Origin

- 01-50 Earth native. Character is human.
- 51-65 D-Bee: human (or close to it), but parents came through a rift from another dimension.
- 66-75 Earth natives, but human mutants with a history of psionic powers in the family. Player character may or may not have psionic abilities.

76-85 One parent was a native Earthling the other a D-Bee. The character may look human, but...

86-00 Earth Mutant (1-50%), or D-Bee (51-90%), or alien (91-00) that is humanoid but has unusual features. Roll twice on the following random table to determine the character's appearance or select two different features.

- 01-05 Has a long bushy dog-like tail.
- 06-10 Has a long monkey-like tail.
- 11-15 Has a long lizard-like tail.
- 16-20 No Body hair.
- 21-25 Body is covered in short fur.
- 26-30 Body is covered in long fur.
- 31-35 Body is covered in tough lumpy skin (+ 2D6 S.D.C.).
- 36-40 Body is covered in scaly skin (add 3D6 to S.D.C.).
- 41-45 Body is extremely thin and tall (add one foot to height).
- 46-50 Facial features are very feline.
- 51-55 Facial features are very ape-like.
- 56-60 Facial features are very lizard-like.
- 61-70 Skin is an odd color like orange, green, purple, etc.
- 71-80 Teeth are fangs.
- 81-85 Teeth are large and flat; large mouth too.
- 86-90 A pair of small horns protrude from the fore head.
- 91-95 Large round eyes and unusual color.
- 96-00 Larger or oddly shaped head.

Type of Environment

- 01-20 Little farm community.
- 21-40 Small wilderness town.
- 41-60 Small to medium city.
- 61-80 Wilderness town or city with magic and/or psychics.
- 81-00 Coalition City or Burbs.

Sentiments toward the Coalition

- 01-20 Like the Coalition. Have mostly seen and heard good things about them and believe that they are humankind's salvation.
- 21-40 Indifferent. Never personally had a bad experience with them.
- 41-60 Wary. Heard lots of things about the Coalition and the bad seems to outweigh the good.
- 61-80 Dislike and distrust the Coalition. You are well informed and know a lot about the CS's philosophies, laws, and activity, and they seem to be pretty unjust if not outright evil.
- 81-00 Hate the Coalition. You have seen the Coalition in action and know them to be cruel and vindictive. Nor can you abide the CS's human supremacist attitude and the horrible actions they inflict on non-humans.

Sentiments toward Non-Humans

- 01-10 Hates and distrusts all non-humans!
- 11-30 Hates all demons and supernatural creatures (including dragons) and does not like nor trust D-Bees, mutants, psychics, and aliens/monsters.
- 31-50 Hates demons, but will give all other non-humans the benefit of the doubt. Still, tends to be wary and suspicious of non-humans.
- 51-70 Hates demons, but believes that all races can live and work in harmony together. Treats humans and non-humans equally, but is a bit suspicious of creatures who are supernatural or whose appearance is extremely inhuman.
- 71-85 Is wary of demons, but has had mostly good experiences with non-humans and treats them as equals, without doubt or suspicion.
- 86-95 Prefers the company of non-humans over humans (had bad experiences with humans, perhaps the subject of ridicule and/or prejudice, but was treated kindly by friendly non-humans).
- 96-00 Suspicious of everybody, humans and non-humans alike! Tends to be a bit paranoid, because "in these times you never really know who's human and who's not. Even the humans can have unusual powers these days. I mean, is a Juicer or Crazy truly human?"

INSANITY

In the context of this game, we will assume that all player characters are mentally and emotionally sound. Any insanities, developed from this point on, will be the result of trauma. A psychological trauma may result from a violent, emotional experience or shock. As psychic investigators, the characters will be somewhat prepared and hardened to frightening, unnatural or bizarre experiences. A trauma that will result in an insanity will have to be quite horrible.

TRAUMA

I've found that having a character roll on the insanity tables after a terrible trauma is very appropriate, realistic and fun; adding a new element to the game. What constitutes a traumatic experience is, in part, up to the game master and the actual situation.

The following is a guide to some traumatic situations requiring a roll on the Random Insanity Tables.

Long period of physical and/or mental torture.

Two to eight weeks: Roll once on the Insanity Table. Nine weeks to months: Roll once on the Insanity Table and once on the Neurosis Table.

Drug Induced Hallucinations that were particularly terrifying, hideous, or realistic.

Roll once on the Phobia Table. If extremely traumatic, lengthy, or recurring hallucinations, roll on the Random Insanity Table. A real life encounter with the subject of the traumatic hallucination is likely to cause more trauma. 70% chance of developing another insanity; roll on the Random Insanity Table.

Witnessing or experiencing a shockingly grotesque atrocity.

Roll on the Phobia Table.

Terrible, frightening or unusual brush with death.

Roll on the Random Insanity Table.

Witnessing the terrible or shocking death of a deeply loved one.

Roll on the Psychosis Table.

Severe physical disability.

60% chance of alcoholism or drug addiction.

The cause (accidental) of several innocent peoples' deaths. (applies to characters of a good alignment).

Roll on the Random Insanity Table.

INSANITY TABLES

RANDOM INSANITY TABLE

(Resulting from Trauma) Roll percentile dice.

- 1-10 **Reborn**; alignment reversal; good becomes evil, evil becomes good (selfish becomes principled or scrupulous).
- 11-20 **Neurosis**; roll on the table that follows.
- 21-25 **Compulsive Liar**; even if of a good alignment.
- 26-30 **Kleptomaniac**; a compulsion to steal, even if of a good alignment.
- 31-40 **Obsession**; roll on the table that follows.
- 41-50 **Phobia**; roll on the table that follows.
- 51-60 **Psychosis**; roll on the table that follows.
- 61-70 **Fear of Animals**; see neurosis.
- 71-80 **Recluse**; prefers to be alone, quiet, unobtrusive.
- 81-90 **Affective Disorder**; roll on the table that follows.
- 91-00 **Fear of the Dark**; see neurosis.

Note: More than one phobia, obsession, psychosis, or affective disorder is possible. If the same one is rolled, ignore it and roll again.

RANDOM INSANITY TABLE (Optional)

- 1-19 Affective Disorders
- 20-45 Neurosis
- 46-65 Phobia
- 66-85 Obsession
- 86-00 Psychosis

AFFECTIVE DISORDERS

- 1-19 **Frightened** by loud noises to the point of cowering and wetting self.
- 20-35 **Disgusted** by anything sticky, and will go to *any* length to avoid touching it.
- 36-54 **Obsessed** with cleanliness, and must clean up any area he/she is at for more than a few minutes.
- 55-75 **Outraged** by acts of violence, becoming violent himself; 72% chance of going berserk and attacking the perpetrator of the violent act without regard for self. Bonuses: +1 to strike, +2 to damage.
- 76-88 **Hates** music and musicians, and will try to destroy or stop the source of those terrible noises.
- 89-00 **Intimidated** by spoken language; cannot speak meaningful sentences, and must use sign language or written communication.

NEUROSIS

- 1-18 **Fear of the Dark** (spent much time locked in closets) to the point of gibbering and total collapse while in the dark.
- 19-34 **Fear of Animals** (chewed on by the family pet while a nipper) to the point of running away when confronted by small, furry things.
- 35-49 **Cannot tell the Truth**; compulsive liar, even if of a good alignment.
- 50-64 **Invasion of the Body Snatchers**: Acute paranoia toward all supernatural entities, those of alien heritage and even humans born off the Earth. ("They're out to get ya! They could be anybody!! even . . . you!?!").
- 65-85 **Fear of Heights** (Uncle Goober used to dangle the character, by one foot, out of windows) to the point of being frozen above the second story; character is fine as long as ground is not visible.
- 86-00 **Fear of Success** (Mom always said you weren't any good): Character will sabotage self at critical moments. The following minuses apply during critical, or high pressure moments (battle, danger, watched by others, etc.): - 15% to all skills, - 3 to hit, dodge, parry and damage.

PSYCHOSIS

- 1-15 **Hysterical Blindness** when under pressure, 1-89% likelihood of happening — roll for each situation.
- 16-28 **Paranoid type**; everyone is out to get you/trusts no one.
- 29-49 **Manic depressive**; alternate severe depression one week (suicidal, nobody loves you — -5% on all skills) with manic episodes the next week (everything is great and I'm the best that there ever was! — +5% on all skills). 30% chance of alcoholism.
- 50-73 **Schizophrenia**; you are passive and easily frightened; jumpy. You hear voices telling you that all the angels are dead; worry about what angels are. 50% chance of alcoholism or drug addiction.

- 74-85 **Mindless aggression**; roll percentile:
- 1-94 Semi-functional : When frustrated, angry, or upset, there is a 72% likelihood of going berserk and lashing out at anyone/everyone around until killed or confined; will take 3-18 minutes of confinement to regain composure.
 - 95-00 Non-functional/homicidal: Continually going berserk until confined or killed; have one lucid day a week and try to talk your way out of confinement.
- 86-00 **Become a psychiatrist** and try to cure everyone around (they're all sick, even if only you have the perspicacity to tell); be sure to demand stiff fees.

PHOBIAS (A deep, overriding fear)

- 1-3 Undead
- 4-6 Reptiles
- 7-9 Scientists
- 10-12 Mutants
- 13-15 Snakes
- 16-19 Ghosts
- 20-22 Confining Enclosures
- 23-26 Skeletons
- 27-29 Darkness
- 30-32 Graveyards/Burial Mounds
- 33-35 Abandoned Old Houses/Buildings
- 36-39 Giant Creatures/Monsters
- 40-44 Basements/Cellars
- 45-48 Corpses
- 49-51 Users of Magic
- 52-54 Spiders
- 55-57 Tombs
- 58-61 Cats
- 62-64 Heights
- 65-67 Dogs
- 68-70 Contamination
- 71-73 Psychic Strangers
- 74-77 Insects
- 78-80 Flying
- 81-84 Bats/Bat-Like Things
- 85-87 Water
- 88-90 Computers
- 91-93 Psychic Healing
- 94-96 Open Spaces
- 97-00 Supernatural Entities

Note: If the same phobia is rolled, the player must re-roll.

PHOBIAS

A phobia is an irrational fear which may result from a horrifying/traumatic experience. The object of the phobia can be anything: bugs, snakes, the dark, heights, flying, guns, typewriters . . . anything which may have been the focus or cause of the severe psychological trauma. While there are scientific names for specific phobias, it is far easier to simply identify the object of the phobia.

To determine a specific phobia, the player can roll on the *random table* which follows, or the game master and player can decide on a phobia which best applies to the severely traumatic experience. In the latter case, the determination of a phobia should be made on a common sense basis. **For Example:** If a character has had a horrifying experience in a haunted house, walked through spider webs, descended into a dark cellar and encountered a walking skeleton; one of the following phobias could easily apply, fear of empty old houses, fear of the dark, fear of spiders or insects, of cellars, of corpses, etc.

G.M. Note: Dealing with the supernatural will constantly send characters into scary, horrifying, bizarre and deadly situations. But it is only

the most horrifying and unexpected experiences that *may* create a phobia or other insanity. Remember, the characters will be prepared and hardened to sights, concepts and creatures that might bedazzle the mind of a normal, unsuspecting person.

Phobic Panic

The character who suffers from a phobia will become terrified when the object of fear is encountered. If the character is surrounded by friends who can talk and soothe away his fears, the person may be able to contain himself long enough to safely avoid it (40% chance). However, if the character is alone, already nervous or feels threatened, he or she will be overcome by fear. This is a phobic panic.

Upon reaching the breaking point, the character's mind will defend itself by causing the character to respond in one of the following ways. (Roll percentile dice).

- 1-25** Pass Out/Fall unconscious for 2 to 8 minutes (roll 2D4).
- 26-80** Flee/run away at top speed. Panic-stricken, the character will ignore the outcry, pleas or needs of his companions. All the terrified person knows is that he or she must escape. The character will run and run until he is certain he's escaped the object of his fear, or until subdued. The person will fight only if there is no other way to escape and then only until he/she can get away and run.
- 81-00** Paralyzed with fear, the character can only cry, whimper or scream. Physically, the character will stand completely rigid or huddled in a corner, immobilized with fear. He/she can *not* run, use skills, fight or move in any way (no attacks per melee), until the object of the fear is removed or destroyed, or he is dragged away from it.

OBSESSIONS

Obsessions are either an intense, irrational love/desire of something, or an intense hatred/loathing. The former is likely to cause the obsessed person to obtain his desire, while the latter is likely to cause the obsessed person to avoid or destroy the object of his obsession. *The game master* can decide which is most appropriate under the circumstances or roll once on the following table . . .

Focus of the Obsession

- 1-50 Love/Desire
- 51-00 Hate/Destroy

Obsessions

- 1-5 Timeliness (either a fanatic about being punctual or always late).
- 6-12 High technology (either loves to acquire/use or loathes it).
- 13-20 Women (or men, if a woman character)
- 21-27 Wealth
- 28-35 Secrecy (either prizes his secrecy above all else, or abhors even the thought of keeping secrets).
- 36-43 Specific individual.
- 44-50 Specific object/item or animal.
- 51-55 Appearance (fashion plate or slob).
- 56-63 Danger (either loves the thrill of danger, which usually means throwing caution to the wind, the more deadly the better; or, despises danger, overly cautious, worry wart, jumpy).
- 64-70 Food (covets only the finest foods and drink, or would, just as readily, eat worms and stale food as anything else; a slob).
- 71-78 Alcohol (either a heavy drinker with a keen taste for the finest liquor, or a fanatical, anti-alcohol prude).
- 79-86 Gambling (will bet it all, or an anti-gambling fanatic).
- 87-92 Solitude (either loves quiet and being alone to the point of growing irrationally angry and frustrated if continually bothered or interrupted; or can't stand the thought of being left alone for even short periods of time).

93-00 Crime-busting: Loves it if a hero; obsessed with stomping out crime and evil everywhere. If a villain "crime lord". Loves the thrill of being a criminal mastermind.

Note: This insanity may drive a character to incredible (even outrageous) lengths, to satisfy his or her obsession.

CURES FOR INSANITY

Affective Disorder or Neurosis: Therapy and counseling, and/or the use of hypnosis. Requires a minimum of three months of therapy, with the following results:

- 1-29 No effect; requires another three months of therapy.
- 30-69 Half cured; person feels occasional return of old neurosis or disorder when under stress, 48% chance.
- 70-00 Total cure.

Psychosis: Therapy and possible use of hypnosis and drugs to control the moods and tension/stress. Requires a minimum of six months of therapy, with the following results:

- 1-33 No effect; requires another six months of therapy.
- 34-68 Psychosis replaced by phobia.
- 69-00 Total cure.

Phobia: There is no cure for phobias, but prolonged or repeated exposure to the object of the fear will lessen the intensity of the fear. Requires a minimum of three months of therapy, with the following results:

- 1-39 No effect; requires more therapy.
- 40-88 Fear is lessened so that the person can function normally, but he/she still doesn't like the phobia object — ugh!
- 89-00 Fear is intensified so that there is a 50% likelihood that the person will become completely paralyzed until the source of the fear is removed, or the person is physically removed.

Therapy sessions generally cost \$75 each, with two sessions per week (this includes treatment for each category of insanity). Similar therapy can help obsessions.

EFFECTS OF ALCOHOLISM

(Roll for effects and disposition while intoxicated)

- 1-10 Mean, hostile, strong; +2 to damage.
- 11-20 Quick temper, argumentative; +1 on initiative, —1 to parry or dodge.
- 21-30 Impulsive, takes risks; +2 on initiative.
- 31-40 Quiet, withdrawn; -2% on all skills.
- 41-50 Paranoid, trusts no one, agitated; +1 on initiative.
- 51-60 Moody, sad; -5% on all skills.
- 61-70 Secure/self-assured only while intoxicated; -2% on all skills when sober.
- 71-80 Depressed, pessimistic; -5% on all skills.
- 81-90 Hyper, agitated, always moving, distracted; —2 on initiative.
- 91-00 Super syndrome; believes he/she is best when intoxicated. +5% on all skills when intoxicated, —10% when sober.

Totally Drunk (staggering)

The alcoholic is in a totally drunken state 25% of the time (intoxicated as often as possible — 80% of the time), and tends to drink even more during a crisis — 50% of the time.

When totally drunk, the following penalties apply:

- —4 on initiative.
- -2 to strike, parry and dodge.
- Reduce speed by half.
- Reduce *all* skills by 12%

Alcoholism can be cured, and requires willingness to seek aid, abstinence from all alcohol, therapy and support of friends.

Withdrawal Symptoms:

First Week: -5% on all skills, -2 on initiative, strike, parry and dodge. Very sick, shaky, insecure. 40% chance will go back to drinking.

Second Week: —2% on all skills, -2 on initiative; -1 to strike, parry and dodge. Still shaky, insecure, craves alcohol. 20% chance will fall back to drinking. Roll for both weeks.

Third through Sixth Week: -2 on initiative. Still shaky, insecure, but feeling more confident. 13% chance will fall back to drinking. Roll for each week.

The next six months: Now it's a battle to stay dry; 15% chance the character will return to alcohol under extreme pressure. Roll for each pressure situation, such as near death (of self or friend), major failure, crucial situation relying heavily or entirely on the person, etc.

After those six months: There is still a possibility of returning to drink when under extreme pressure, as explained above; 5% in a crisis. If the ex-alcoholic should ever drink alcohol again, there is a 43% likelihood of becoming addicted again. Roll for each *drink*. Note: A character can attempt to fight alcoholism repeatedly, regardless of numerous failures.

THE EFFECTS OF DRUG ADDICTION

Drug addiction is generally more severe in its effects and initial withdrawal symptoms. However, once detoxified/dry, the person is less likely to return to drugs than an alcoholic. Most references to drug addiction refers to hard drugs, such as L.S.D., heroin, P.C.P., barbiturates (downers), amphetamines (speed), cocaine derivatives, and mood altering drugs.

Roll for effects and disposition while intoxicated

- 1-10 Quick temper, argumentative; +1 on initiative.
- 11-20 Totally passive, will *not* attack, confused, wants to be left alone. -5 to parry, dodge, and roll with punch or fall.
- 21-30 Extremely paranoid. Trusts no one, not even friends; +1 on initiative.
- 31-40 Disoriented. Has difficulty following movement; -4 to parry and dodge, -2 to strike.
- 41-50 Hallucinations. Totally oblivious to reality; -4 to parry and dodge, 50% chance of not recognizing friend or foe, or attacking a friend (thinking him an enemy), or not recognizing danger, or cringe in terror of battle phantoms.
- 51-60 Withdrawn, quiet; -6% on all skills.
- 61-70 Secure/self-assured only while high; -4% on all skills when not on drugs.
- 71-80 Depressed, pessimistic; -8% on all skills.
- 81-85 Reoccurring hallucinations when under severe pressure/combat. 43% chance of reoccurrence/flash-back, same as hallucination listed previously.
- 86-91 Hyper, agitated, always moving, distracted; -2 on initiative, -2% on all skills.
- 92-00 Super syndrome; believes his abilities are heightened by drugs; +1 to strike, parry and dodge; +6% on all skills when high. —1 to strike, parry and dodge; —12% on all skills when straight (not on a drug-high).

General notes concerning drugs:

- Takes 15 to 20 minutes to take effect.
- Effects last 45 minutes to two hours.
- Remains in system, even after the high is gone, for 48 hours.
- Addicts *need* a continual supply, taken at least once or twice a day (or more often, depending on the drug and desired effects).

Drug addiction can be cured, and requires a willingness to seek treatment and being slowly weaned off its dependency by gradual substitutes. Total withdrawal, or going "cold turkey," is the sudden abstinence from any drugs.

Withdrawal Symptoms (cold turkey)

First Week: -35% on all skills, -8 on all combat skills, violently ill: nausea, vomiting, cramps, etc. Requires regular observation and facilities. 75% likelihood of taking the drug if it's available.

Second Week: -20% on all skills, -4 on all combat skills, very weak, shaky, nauseated. 50% chance of taking the drug if it's available.

Third Week: -10% on all skills, -2 to strike, parry and dodge. Weak and insecure, but feeling considerably better. 28% chance of taking the drug if available.

Player Characters in the World of Rifts

It is odd to me that players often seem, to miss the fact that they are playing *larger than life* heroes in a fantastic world whenever they play any role-playing game. **Rifts** is no different.

The typical person in **Rifts** is a farmer, mechanic, merchant, grunt, or other hard working individual trying to survive in a world gone mad. The average person is not likely to have psionics nor mega-damage weapons and armor. He is not a master of magic nor holder of great truths. He is one of the ordinary folk who live and struggle with the day to day hardships of life.

The masses are the present and future of mankind. They are the innocent and the hopeful who will directly and indirectly motivate the actions of our *heroes'* adventures and heroics. As such, they are also, often, the victims and the prize in the never ending power struggles between the forces which seek to dominate this strange, future Earth.

The player characters in **Rifts** are not Joe Average. For whatever reason, *they have attained knowledge and/or power that has set them apart* from the norm. They have become the *focus* in a small and continuing drama within a much larger story. They are the men and women who can make a difference. The individuals who dare to question what they see and hear. They are the strong who step out of the crowd to protect the weak. They are champions of ideas and ideals. They are individuals who dare to dream and are willing to fight to attain that dream. Individuals who step out of the shadows of reality and into the realm of legend.

The origins of the heroes may be modest and ordinary. They may, at first, seem as typical as anybody else. Their motivations may be selfish or born out of desperation. Their heroics may be deliberate or they may stumble into greatness, but ultimately, they rise above the ordinary and make their mark on the land, and perhaps the pages of history. These are the heroes. This is their story ... and you are the architect of that story.

Earth, the savage realm between dimensions

Players and game masters alike must remember that the world of **Rifts** is that of a transformed and often savage Earth. The planet is largely an unexplored wilderness with tiny pockets of human life and civilization. A wilderness teeming with strange and terrifying creatures that have emerged from the "rifts." Humankind's continuing existence lays in question as *things* that ancient man may have called demons, and other monsters, ravage the land. Then there is the darkness of humankind itself. The capacity for evil, fueled by greed, envy, and the lust for power; in some cases, making man as deadly a foe as any supernatural terror.

In this violent world, our heroes are wanderers and explorers who travel the land. They are likely to scavenge through the ruins of man's past and sell their skills for the price of a warm meal. They may go

Fourth Week: Completely detoxified, only psychological addiction remains. 14% chance of taking the drug if made available. Suggest continued therapy/counseling.

The next six months: This is the battle to stay dry. 10% chance will return to drugs if under extreme pressure.

After those six months: There is little chance of turning to drugs, even under pressure; 3% chance.

Note: A character can attempt to fight addiction repeatedly, despite numerous failures to do so.



by the unflattering titles of *mercenary*, *rogue*, or *sorcerer*, but they are heroes nonetheless, like wandering samurai of old.

Education and Skills

Players will find that there are three *categories of skills*: *O.C.C.* skills, "other" skills, and secondary skills.

O.C.C. skills are training and expertise necessary to perform the occupation selected for the character. All characters who select that same occupational character class receive the exact same *O.C.C.* skills and bonuses.

The bonuses are the percentile numbers found in the parenthesis. The bonus is added to the base skill, indicating the superior level of expertise. For example: Computer Operation (+ 10%) means the character is more knowledgeable in computers than the average hobbieist, so his skill proficiency is higher. Add the + 10% to the base skill of 40%, for a total of 50%. At second level experience another 5% is added, making the skill 55%. At third level another 5% is added and so on.

Note: Most *O.C.C.* skills enjoy a substantial bonus; however, there are rare cases where there is no *O.C.C.* bonus.

Other skills are additional *scholastic* skills, meaning skills learned through formal training, schooling, or apprenticeship. Many of these "other" skills will relate directly to one's O.C.C. while others are simply additional areas of knowledge.

Each skill category is listed with the applicable bonus in parenthesis. Note that some skill areas will not be available to certain O.C.C.s, while other categories may be limited to particular skills or exclude certain skills. Similarly, while a character may be able to select from a particular skill area, he may not get any bonuses; start at the base skill level.

Lastly, the character gets a certain number of **secondary skills**. Secondary skills are additional areas of knowledge that the character has learned through experience. They may be related to the person's occupation, but usually relate to other interests, hobbies, and entertainment. For example: In real life you may have an interest in computers and computer programming. In your spare time you read books and experiment with your computer. Before long, you can operate and understand computers better than ever and can even do some programming. You might even be good at it, but you are not at the same level as a top professional in the field (O.C.C). This is a secondary skill. An area of knowledge, usually self taught, but not at the same level as an expert trained in the subject.

Secondary skills are selected from the same list of skill categories as "other" skills. The same restrictions apply, which means some skill areas may not be available. Other restrictions are that none of the skill

bonuses apply to secondary skills. Nor are major areas of intense study available for selection. Skills not available for selection as secondary skills include: electrical engineering, robot electronics, mechanical engineering, robot mechanics, medical doctor, cybernetic doctor, demolitions and demolitions disposal, acrobatics, boxing, gymnastics, wrestling, and weapon systems. All secondary skills start at the base skill level of proficiency (no bonuses).

Skill Penalties

As a rule of thumb, there is usually a skill penalty of -30 or -40% when trying to figure out, operate, repair, or use *alien* mechanisms and technologies. The technology may be so different that the heroes will be unable to use the simplest of devices. The game master should use his/her discretion when dealing with alien sciences. Likewise, *techno-wizardry* defies conventional science and technology, which means that a mechanic or electrician may be able to ascertain what a device is supposed to do, but will **not** be able to operate, repair, modify, or duplicate it. In fact, they are likely to have no idea of how or why the device works at all. The special skills of techno-wizardry and magic are located in the magic section and not the skill section.

The game master may also impose a reasonable penalty to situations where the character faces an unusually difficult task. A reasonable penalty will range between -10% to -30%. Again, game masters, use your discretion and be fair.

Skill List

COMMUNICATIONS

Cryptography
Laser
Optic Systems
Radio: Basic
Radio: Scramblers
Surveillance Systems
T.V./Video

DOMESTIC

Cook
Dance
Fishing
Play Musical Instrument
Sewing
Sing

ELECTRICAL

Basic Electronics
Computer Repair
Electrical Engineer
Robot Electronics

ESPIONAGE

Detect Ambush
Detect Concealment
Disguise
Escape Artist
Forgery
Intelligence
Pick Locks
PickPockets
Sniper
Tracking
Wilderness Survival

MECHANICAL

Aircraft Mechanics
Automotive Mechanics
Locksmith
Mechanical Engineer
Robot Mechanics
Weapons Engineer

MEDICAL

Criminal Sciences & Forensics
First Aid
Holistic Medicine
Paramedic
Medical Doctor
M.D. in Cybernetics
Pathology

MILITARY

Demolitions
Demolitions Disposal

PHYSICAL

Hand to Hand: Basic
Hand to Hand: Expert
Hand to Hand: Martial Arts
Hand to Hand: Assassin
Acrobatics
Athletics (general)
Body Building & Weight Lifting
Boxing
Climbing
Gymnastics
Prowl
Running
Swimming

S.C.U.B.A.
Wrestling

PILOT SKILLS (Ground, Air, Water)

Airplane
Automobile
Boat: Sail Type
Boat: Motor and Hydrofoils
Boat: Ship
Helicopter
Horsemanship
Hover Craft (ground)
Jet Aircraft
Jet Fighter
Jet Packs
Motorcycle
Robots and Power Armor
Robot Combat: Basic
Robot Combat: Elite
Truck
Tanks and APCs

PILOT RELATED SKILLS

Navigation
Read Sensory Equipment
Weapon Systems

ROGUE SKILLS

Computer Hacking
Concealment
Palming
Pick Locks
Pick Pockets
Prowl
Streetwise

SCIENCE

Anthropology
Archaeology
Astronomy
Biology
Botany
Chemistry
Chemistry: Analytical
Mathematics: Basic
Mathematics: Advanced

TECHNICAL

Art
Computer Operation
Computer Programming
Language
Literacy
Lore: Demons & Monsters
Lore: Faerie
Photography
Writing

WEAPON PROFICIENCIES

Ancient Weapon Proficiencies
W.P. Archery and Targeting
W.P. Blunt
W.P. Chain
W.P. Knife
W.P. Sword
Modern Weapon Proficiencies
W.P. Revolver
W.P. Automatic Pistol
W.P. Bolt Action Rifle (hunting and sniping)
W.P. Automatic and Semi-automatic Rifles
W.P. Sub-Machinegun
W.P. Heavy
W.P. Energy Pistol
W.P. Energy Rifle
W.P. Heavy Energy Weapons

WILDERNESS

Boat Building
Carpentry
Hunting
Identify Plants & Fruits
Land Navigation
Preserve Food
Skin and Prepare Animal Hides
Track Animals

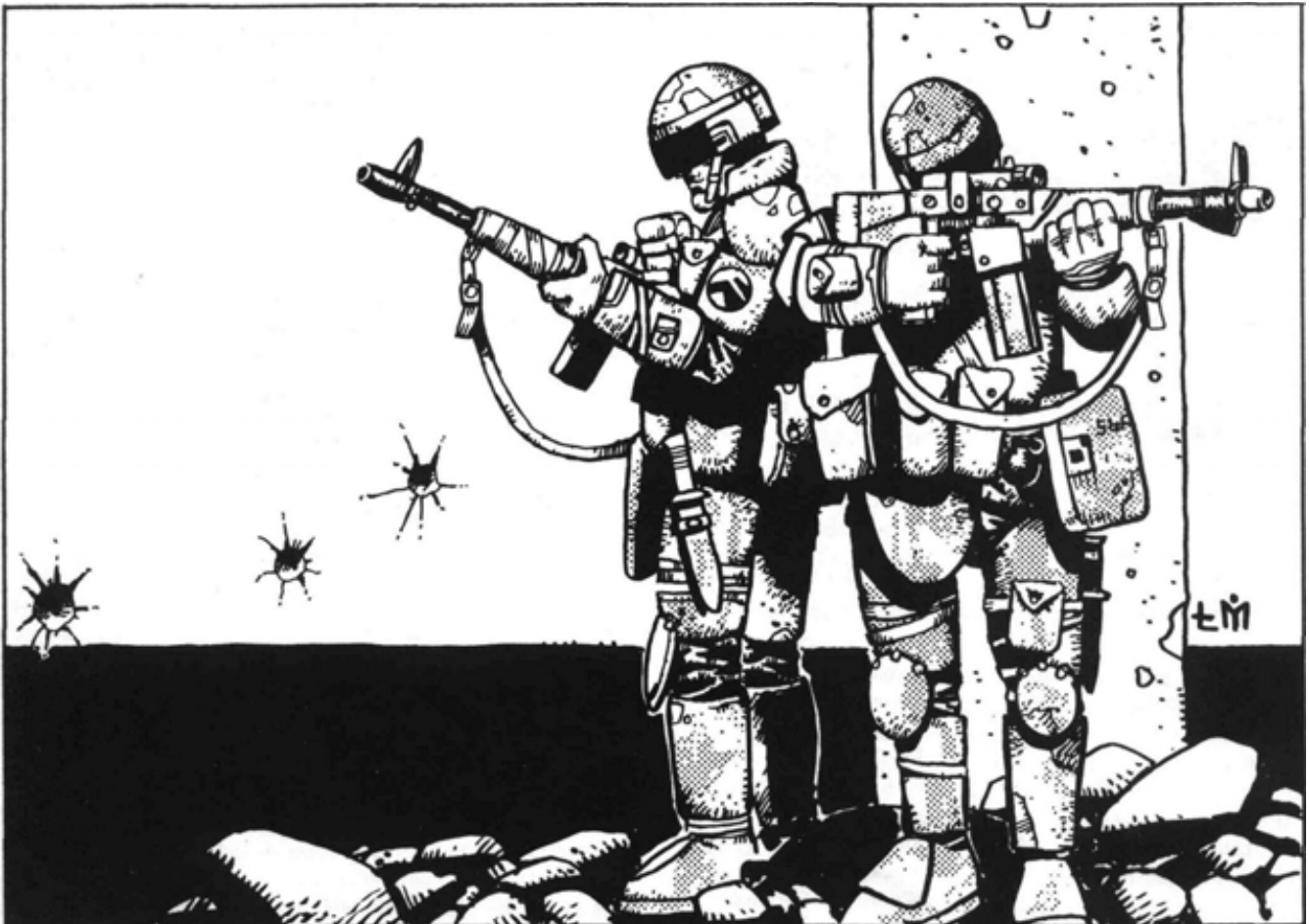

Skill Descriptions

Communications

Cryptography: Skill in recognizing, designing, and cracking secret codes and messages. The character must study the code for two hours to attempt to break it successfully. A failed roll means the individual must study the code for an additional two hours before he can try to break it again. The character may attempt to break the code sooner, after only 10 minutes of study, but suffers a penalty of -30%. **Base Skill:** 25% +5% per level of experience. **Requires:** Literacy.

Laser: This skill provides the character with an in depth knowledge of sophisticated laser communication systems and fiber optic communications. **Base Skill:** 30% +5% per level of experience. **Requires:** The radio: basic, electrical engineer, and computer operation skills.

Optic Systems: Provides expert training in the use of special optical enhancement equipment such as telescopic lenses, laser targeting, thermo-imagers, passive light intensifiers, infrared and ultraviolet systems, polarization, light filters, optical scanners, and related devices. **Base Skill:** 30% +5% per level of experience. Adds a special one time bonus of +5% to T.V./video skill if both are selected.

Radio: Basic: This is the rudimentary knowledge of the operation and maintenance of field radios and walkie-talkies, wire laying, installation, radio procedure, communication security and visual signs/communications, as well as Morse code. It does not include the ability to make repairs. **Base Skill:** 45% +5% per level of experience.

Radio: Scramblers: This is training in the use of electronic masking, scrambling and unscrambling equipment, and codes to help foil the detection, interception and interpretation of radio transmissions by the enemy. **Base Skill:** 35% +5% per level of experience.

Surveillance Systems: This is the study and understanding of the operation, methods, and techniques in the use of surveillance systems. Includes motion detectors, simple and complex alarm systems, audio/visual recording and display equipment, recording methods, amplified sound systems, miniature listening devices (bugs, line tapping), and some optical enhancement systems (specifically as they relate to camera lenses).

Tailing, or following someone without their knowledge, is another form of surveillance. This also includes stake-out procedures. A failed surveillance roll indicates that the subject has spotted the tail and is aware that he is being followed/observed.

A failed roll in the use of surveillance equipment means that the equipment does not function as desired, impairing or preventing surveillance; i.e., bug does not transmit, recording garbled, film blurred or fails to record, etc.

A failed roll when hiding listening devices means the bug does not function and is easily discovered through the course of casual activity.

Base Skill: 30% +5% per level of experience. **Requires:** Electronics: basic or electrical engineering and computer operation and literacy (the latter two are needed only for complex, high-tech systems).

T.V./Video: In depth training in the use of video and audio recording equipment, filming, editing, dubbing, title making, duplication, and transmission. Includes the use of field equipment; i.e., portable video camera, and studio equipment; **Base Skill:** 25% +4% per level of experience.

Domestic

Note: Characters can attain *professional* quality by selecting the same domestic skill twice. Add a one time bonus of +10% and note that the end result is of superior quality.

Cook: Skill in selecting, planning, and preparing meals. A cooking roll failure means that the cooked food is not properly prepared. It is edible but tastes bad (greasy, too spicy, sour, burnt, leaves a bad aftertaste in mouth, etc.). **Base Skill:** 35% +5% per level of experience.

Dance: A practiced skill in the art of dancing. The character is especially smooth and graceful, a joy to dance with. Can learn new dance steps/moves much more quickly than somebody who can not dance. **Base Skill:** 30% +5% per level of experience.

Fishing: The fundamental methods and enjoyment of the relaxing sport of fishing. Areas of knowledge include the use of lures, bait, poles, hooks, lines, and the cleaning and preparation of fish for eating. Also includes a basic knowledge of freshwater fish, their habits and taste. **Base Skill:** 40% +5% per level of experience.

Play Musical Instrument: The individual has learned to play a particular musical instrument with a fair amount of skill. The sound is generally pleasant (except when a bad roll is made). Note that each specific instrument requires the selection of this skill. For example: A character who can play the guitar, violin, and harmonica must select the *play musical instrument* skill three different times, once for each instrument. **Base Skill:** 35% +5% per level of experience.

Sewing: The practiced skill with the needle and thread to mend clothing, do minor alterations, and layout, cut and sew simple patterns. This is not a tailoring ability, but can become tailoring if the player selects this skill twice. **Base Skill:** 40% +5% per level of experience.

Skill: 35% +5% per level of experience.

Electrical

Basic Electronics: This is a rudimentary understanding of the principles of electricity, simple circuits, wiring, and so on. This person can do basic wiring, repair appliances, and read schematics. **Base Skill:** 30% +5% per level of experience.

Computer Repair: Knowledge of the internal electronics of computers and related devices (terminals, printers, modems, etc.). The character can attempt to repair or sabotage computers. Note that figuring out the repair or sabotage procedure counts as one roll, and the actual repair is a second roll. A failed roll means the repair is faulty and does not work (try again). No computer operation or programming skills are included nor required to fix computers. Many computer repair personnel don't even know how to turn the computer on! **Base Skill:** 25% +5% per level of experience.

Electrical Engineer: Knowledge of electricity. Characters can diagnose and locate electrical problems, repair complex electrical devices, wire entire buildings or vehicles, and build electrical equipment. The character can also attempt to bypass security systems, alarms, and surveillance systems, but at a penalty of -20% for simple systems and -50% for complex systems (reduce these penalties by half if the character also has the *surveillance systems* skill). **Base Skill:** 30% +5% per level of experience. **Requires:** Advanced mathematics skill and literacy. **Note:** There is a -30% penalty when working on *alien* or extremely unfamiliar electronics. This includes *techno-wizard devices*. The electrician may be able to puzzle

out some of the basic aspects of a device created by techno-wizardry, and may be able to figure out how to operate the machine, but will not be able to fully fathom how it works nor repair it.

Robot Electronics: This is the complex and specialized study of robotics and robot/military engineering, microcircuitry, and artificial intelligence. It includes knowledge of the Coalition robot assault units, exoskeletons, and robot systems. **Base Skill:** 30% +5% per level of experience. **Requires:** Electrical engineering and computer sciences. There is a -40% penalty when working on *alien* or extremely unfamiliar robot electronics.

Espionage

Detect Ambush: Training which develops an eye for spotting locations and terrains suitable for ambushes and being ambushed. It also provides a rudimentary knowledge of guerilla tactics used by the enemy. **Base Skill:** 30% +5% per level of experience.

Detect Concealment: This is a skill which enables the individual to spot and recognize camouflage, concealed structures/buildings and vehicles, as well as the ability to construct unobtrusive shelters, use camouflage and blend into the environment. **Base Skill:** 25% +5% per level of experience.

Disguise: The character knows how to apply make-up, wigs, skin putty, dyes, and other special effects in order to alter his appearance or that of somebody else. **Base Skill:** 25% +5% per level of experience.

Escape Artist: The methods, principles, and tricks of escape artists. Includes muscle control (tensing and relaxing muscles), flexing and popping joints, knowledge of knots, and the ability to conceal tiny objects on the person. The character can try slipping out of handcuffs, ropes, straightjacket, etc. Note: Picking locks is a separate and distinct skill. **Base Skill:** 30% +5% per level of experience.

Forgery: The techniques of making false copies of official documents, signatures, passports, I.D.s, and other printed material. The forger must have an original or photocopy to work from in order to make an accurate copy. Skilled forgers can recognize other counterfeits at -10%. **Base Skill:** 20% +5% per level of experience.

Intelligence: This is the specific training in the practices and principles of recognizing and analyzing sources of information about the enemy, observation techniques, counter-intelligence measures and proper procedure. This includes the practical assessment of sights and sounds, estimation of ranges, what to report, handling prisoners of war, and handling captured documents and equipment (tagging and reporting to group leader or proper authority). This means the character will be able to accurately estimate ranges, the number of enemies, direction, purpose, and assess the importance of specific information.

Further intelligence training includes a working knowledge of indigenous guerilla warfare, enemy practices, appearance, and current activities. This enables the intelligence officer to recognize suspicious activity as guerilla actions and identify guerilla operatives.

For Example: A particular booby trap, or weapon, or mode of operation, may be indicative of guerilla activity in the area. It may be up to the character to confirm the existence of the enemy and their strength, number, and location.

Another area of training made available to intelligence is the identification of enemy troops, officers, and foreign advisors. This means the person learns the many distinguishing ranks and marks that identify specific military units, special forces, groups, and leaders of the enemy. Such identification can pinpoint and confirm enemy operations, goals, and movement, as well as confirm outside intervention/aid.

Note: A failed roll in any of the areas of intelligence means that evidence is inconclusive, or that the character has incorrectly asses-

sed the information/situation and is uncertain. A failed roll involving individual clues may mean the person has dismissed it entirely as being meaningless (GMs, use your discretion). **Base Skill:** 32% +4% per level of experience.

Pick Locks: The character knows the methods and tools for picking/opening key and basic tumbler type locks. This does not include sophisticated computer or electronic locks.

It takes 1D6 melee rounds for each attempt to pick a lock. A failed roll means the lock holds; try again. **Base Skill:** 30% +5% per level of experience.

Pick Pockets: An ability to remove items from a person without their being aware of it. If a pick pocket attempt fails, the item has NOT been removed and there is a 67% likelihood of the intended victim recognizing the intent of the action. **Base Skill:** 25% +5% per level of experience.

Sniper: This skill represents special training in long range rifle firing and marksmanship. Only rifles that can be made to fire a single round or blast can be used for sniping (no automatic/multi-firing rifles). Adds a bonus of +2 to strike on an *aimed* shot.

Tracking: Visual tracking is the identification of tracks, and following the path of men or animals by the signs they leave on the ground and vegetation. Tracking is a precise art, requiring much practice. The skill includes the evaluation of tracks, indicating whether the person being tracked is loaded down with equipment, running, moving slowly (by measuring the space between steps), and so on. By this means, the tracker can estimate the person's rate of movement, apparent direction, the number of persons in the party, and whether the person knows he is being followed. Other methods of tracking require recognizing other telltale signs, such as blood and other stains, broken and displaced vegetation, overturned rocks, litter (such as cigarette butts, ration cans, candy wrappers, soiled bandages and campfire remains), and even odors carried by the wind.

Tracking also includes the recognizing of dangerous animals by their tracks, habits, and feces. Likewise, tire tracks made by vehicles can reveal much, such as size and type of the vehicle, the weight of its load, etc.

Counter-Tracking techniques are also known, such as covering one's trail, misdirection, parallel trails, avoiding obvious pitfalls like littering and others.

A **failed roll** means that the signs are inconclusive, vague or misleading. Additional signs must be found to verify or clarify (roll again). Three consecutive failed rolls means the tracker has completely lost the trail. Roll once every 40 yards/meters *when following* a trail. Persons attempting to follow a skilled tracker are -25% when following his trail if he is deliberately trying to conceal that trail (however, his rate of travel is reduced by half)- **Base Skill:** 25% +5% per level of experience.

Wilderness Survival: Techniques for getting water, food, shelter, and help when stranded in wild forests, deserts, or mountains. Characters without this skill will not be able to stay healthy for more than a few days in the wilderness once their supplies run out. **Base Skill:** 30% +5% per level of experience.

Mechanical

Aircraft Mechanics: The understanding of aerodynamics and the training to repair, rebuild, modify, and redesign conventional aircraft, including single engines, twin engine airplanes, jets, helicopters and hovercraft. Robot body armors and high tech military vehicles are not included (see robot mechanics). **Base Skill:** 25% +5% per level of experience.

Automotive Mechanics: The ability to repair, rebuild, modify, and redesign conventional vehicles with internal combustion (gas) engines. It also includes body work, turbine engines, methanol, ethanol and diesel truck engines. Working on hover jet systems for ground vehicles is possible, but with a -20% penalty. Working on reactor engines there is a -40% penalty. **Base Skill:** 25% +5% per level of experience.

Locksmith: The study of lock designs and the ability to repair, build, modify and *open* locks. The methods, techniques, and tools of lock picking include the old-style key and tumbler, combination, and modern electrical locking systems. **Time requirements:** 1D4 melees to open an antiquated key type lock or simple tumbler/combination type, 1D4 minutes to open an elaborate tumbler type, 2D4 minutes to open a simple electronic lock (usually by patching in a bypass system), and 1D4 hours to break a complex, state-of-the-art electronic lock system such as those used in high security and restricted areas. Super high-tech systems, such as those used by the Coalition's military and government, will require 3D4 hours and have a skill penalty of -20%.

If an unsuccessful skill roll is made, the lock is not opened and the process must be repeated. If an attempt to open an electronic lock fails, roll again. A second failed roll means that the lock is irreparably damaged and can *not* be opened! **Base Skill:** 25% +5% per level of experience. **Requires:** At least basic electronics skill (—5% penalty when working on complex or high-tech locks) or electrical engineer (+5% bonus).

Mechanical Engineer: Training, understanding, and knowledge of how machinery is designed, operated, built, and maintained. Characters can attempt to redesign, modify, repair, construct, or sabotage mechanical devices (includes nuclear reactor driven turbines and atomic engines). The player must first roll to see if his character can figure out how to operate/analyze/design a machine. When a successful diagnostic roll has been made, roll again to determine when the character can fix/change/build the mechanism. **Base Skill:** 25% +5% per level of experience. **Special Bonus:** Add a one time bonus of 5% to the locksmith and surveillance systems skills if mechanical engineering is also known. There is a -30% penalty when working on *alien* or extremely unfamiliar mechanics. This includes *techno-wizard mechanics*. The mechanic may be able to puzzle out some of the basic aspects of a device created by technowizardry, and may be able to figure out how to operate the machine, but will not be able to fully fathom how it works nor repair it. **Requires:** Basic or advanced mathematics, at least basic electronics, and literacy.

Robot Mechanics: This is the specific study of advanced mechanics as it applies to robotics. Those skilled in this discipline can repair, modify, build, and sabotage robots, including the creations of the Coalition, power armor, and exoskeletons. There is a 30% penalty when working with *alien* or extremely unfamiliar mechanics. **Base Skill:** 20% +5% per level of experience. **Requires:** Mechanical engineer skill and related requirements.

Weapons Engineer: This skill is usually reserved for military personnel. The character can maintain, repair, modify, mount, and figure out most weapon systems, including rail guns, energy weapons, and atomic power systems. He can repair an assault rifle and recharge an energy clip to installing a missile system into a vehicle. The engineer can also add and repair body armor and is an expert welder. **Base Skill:** 25% +5% per level of experience. **Requires:** Mechanical engineering and basic electronics.

Note: Techno-wizardry is a special skill and ability described in the Techno-wizard section.

Medical

Criminal Sciences & Forensics: Basic knowledge of police skills including basic criminal law, fingerprinting, ballistics (matching bullets to weapons and angles of impact), and general investigative techniques.

Forensic medicine is the methods and techniques which enable the character to find evidence regarding the cause of death, time of death, and other details when examining a corpse. **Base Skill:** 35% +5% per level of experience. **Requires:** Biology, chemistry, chemistry: analytical, advanced mathematics, and literacy.

First Aid: Rudimentary medical treatment which includes how to bandage wounds, stop bleeding, administer CPR/artificial respiration, and use antiseptics and common anti-inflammatory drugs and painkillers. **Base Skill:** 45% +5% per level of experience.

Holistic Medicine: Training in the recognition, preparation, and application of natural medicines usually made from whole plants and/or their parts (roots, leaves, fruit). The holistic doctor is basically a natural pharmacist and naturalist who creates drugs from vegetation and studies common ailments. He can find and use plants to create salves, balms, ointments, and lotions to soothe burns, boils, rashes, and insect bites, reduce swelling, as well as create local anesthetics, and to heal wounds faster (twice as quick as normal). Potions and tonics are created to settle upset stomachs, induce drowsiness, or hallucinations. The individual can also make alcohol and poison (hemlock and mandrake for example).

The student of herbology also has a good knowledge of plant lore and when and where to find healing plants, edible fruit, roots, and bark, as well as how to use and/or avoid dangerous flora. The character can also preserve foods and knows how to set and mend bones, bandage cuts, and suture cuts.

Note: Plants are seasonal and the right root or leaf may not be readily available in certain times of the year/season, or may be found exclusively in remote regions. Game masters should use a certain amount of common sense and drama with this skill. **Base Skill:** 20% +5% per level of experience. A failed roll means the treatment or concoction did not work.

Paramedic: An advanced form of emergency medical treatment which includes *all* first-aid techniques, the setting of broken bones, suturing of wounds, use of oxygen and emergency medical equipment, administering of drugs, knowledge of how to move a critically injured person, the removal of cybernetic prosthetics, and other life-saving techniques.

A failed roll means the patient has not responded to treatment or that the treatment has been improperly administered. Note: For serious injury or coma, roll three times, consecutively, on percentile dice. A roll of two successful out of three means the wound has been properly treated or that the patient's condition has been stabilized. Failure means the patient's condition is unchanged. Another character can immediately attempt to apply medical aid or the same player can try again, but only after the character has spent six minutes for reexamination and/or concentration on the problem. **Base Skill:** 40% +5% per level of experience.

Medical Doctor: The medical doctor is a trained surgeon and has a doctorate in the medical sciences.

Areas of training include: clinical skills, medical discipline, code of ethics, physiology (muscle, respiratory, blood, body fluids), pathology (diseases, their structure and function), rudimentary pharmacology (use, reaction, and interaction of drugs), laboratory skills, and techniques and methods of data collection. The medical doctor (M.D.) is also a trained surgeon and has a basic knowledge regarding cybernetics. This means the M.D. can remove and attach most cybernetic mechanisms (although at a penalty of -10%, and -40%

on bionics). **Base Skill:** 60/50% +5% per level of experience. The first percentage number is the doctor's ability to accurately diagnose the problem. The second percentage number is the doctor's skill at successfully treating the problem. **Requires:** Biology, pathology, chemistry, basic or advanced mathematics and literacy.

M.D. in Cybernetics: This doctor in a specialist is the science of cybernetics and a master surgeon. The character has all the basic knowledge and requirements of the regular M.D., although his diagnostic skills are nowhere near as honed, but is a specialist in surgery and the removal of limbs and internal organs and the surgical attachment of cybernetic replacements (artificial organs and prosthetics). He can also repair cybernetic prosthetics (if not too badly damaged). **Base Skill:** 40/60% +5% per level of experience. The first percentage number is the "Cyber-Doc's" ability to accurately diagnose and treat a non-surgical problem/illness. The second percentage number is the doctor's ability to perform complex surgery, remove and install *all* types of cybernetic organs and devices. The cyber-doc can also work on bionic implants and systems but suffers a -15% skill penalty. Bionic sciences is much more complex and machine oriented than cybernetics.

Note: An M.D. in Cybernetics can become a *bionics* surgeon (M.D.B. in cybernetics) by selecting this cybernetics skill twice and electrical engineering (and must have all the M.D. requirements). This will make him a master in all of the cybernetic and bionic sciences. There is now no penalty for installing bionics and there is a **special bonus** of +10 added to the character's surgery skill. The M.D.B. can also repair, modify, design, and build bionic and cybernetic devices. **Game Master's Note:** One can not create a bionic implant in a garage. The character will need access to a cybernetics or bionics laboratory to build or modify an artificial implant. Even a high-tech medical facility will not have the necessary components to create a cybernetic or bionic mechanism, although it may have access to them.

Pathology: This branch of medicine deals with the nature of diseases, their cause, and symptoms, and the functional and structural changes caused by disease. Training includes anatomy, physiology, cell biology, manifestation of disease, tissue injury and repair, abnormal cell structure, metabolism, diagnosis of human diseases, tissue culture methods and applications, analysis of drugs in biological samples and laboratory research, investigative methods, and use of instruments and equipment. **Base Skill:** 40% + 5% per level of experience. **Requires:** Biology, chemistry, and literacy skills.

Military

Demolitions: Demolitions provides the person with an advanced knowledge in the use and workings of explosives and detonation devices for the purpose of blowing up bridges, buildings, and sabotage. This includes *all* types of explosives, such as mines, dynamite, plastics, nitro, blasting caps, etc. It also includes a basic understanding of the strategic placement of mines and booby traps. This will increase the character's awareness of suspicious rope, string, and wire. **Base skill:** 60% + 3% per level of experience. A failed roll means a dud; no explosion.

Demolitions Disposal: This skill enables the character to safely defuse unexploded mines, bombs, explosive booby traps, dud artillery rounds, dud explosive charges, or any other explosive device. **Base Skill:** 60% + 3% per level of experience.

Physical

Special Note: One of the unique aspects of this RPG is that the player can increase his or her character's physical attributes (P.S., P.P., P.E., Spd., S.D.C.) by selecting physical skills that will build and

develop the body's muscles and endurance. ALL attribute and skill bonuses are accumulative. However, a specific physical skill may only be chosen once, including hand to hand skills.

There are four major kinds of fighting techniques available to the characters. Boxing and wrestling adds to the techniques and power of a specific hand to hand training. Characters without combat training have one hand to hand attack per melee at levels one and two, but get a second attack at level three and a third attack at level nine.

Hand to Hand: Basic: Provides elementary fighting techniques and methods of attack and self-defense as taught in military basic training or in self-defense classes. *See the combat section for listing of specific abilities.*

Hand to Hand: Expert: An advanced form of self-defense and unarmed combat usually taught to commandos. *See the combat section for listing of specific abilities.*

Hand to Hand: Martial Arts: This is some form of oriental fighting skill (karate, kung-fu, etc.) that teaches advanced hand to hand combat. *See the combat section for listing of specific abilities.*

Hand to Hand: Assassin: This is an advanced form of combat with an emphasis on immobilizing or killing one's opponent quickly. *See the combat section for listing of specific abilities.*

Acrobatics: Aerial feats of agility and strength, such as walking a tightrope, high wire, trapeze, and stunts performed above ground. Other physical abilities include rolls, somersaults, leaps, and falls. Provides all of the following:

Automatic kick attack at first level; IDS damage.

60% +5% per level — Sense of balance

60% + 3% per level — Walk tightrope or high wire

80% + 2% per level — Climb rope

60% +5% per level — Back flip

40% base climb ability or adds a + 15% to climb skill.

30% base prowl ability or adds a +5% to prowl skill.

+ 2 bonus to roll with punch or fall +1 to P.S.

+ 1 to P.P.

+1 to P.E.

+ 1D6 to S.D.C.

Athletics (general): Training in, and enjoyment of, vigorous exertion for competitive sports, exercises, and contests of strength, endurance, and agility. Provides the following bonuses:

+ 1 to parry and dodge

+ 1 to roll with punch or fall

+1 to P.S.

+1D6 to Spd.

+ 1D8 to S.D.C.

Body Building & Weight Lifting: The building of muscle tone and body strength through weight lifting and exercise. Provides the following:

+ 2 to P.S.

+10 to S.D.C.

Boxing: Classic art of fighting with fists. Training helps build the body and reflexes. Skilled boxers will *automatically* knockout an opponent on a roll of a natural twenty. The victim of a knockout will remain unconscious for 1D6 melees. Unlike normal knockout/stun, the player does not have to announce that he is trying to knockout his opponent before making a roll to strike.

The following bonuses are provided:

+ One additional attack per melee.

+ 2 to parry and dodge

+ 1 to roll with punch or fall

+ 2 P.S.

+ 3D6 on S.D.C.

Climbing: Knowledge of the tools and techniques for climbing up sheer surfaces. Players should roll once for every 20 feet (6 m) of a vertical climb. If the roll fails, it means he is losing his grip; however, every "skilled" climber gets a chance to regain his grip, roll again. Two consecutive failed rolls means the character falls. **Base Skill:** 40% + 5% per level of experience.

Rappelling is a specialized rope climbing skill used in descending from helicopters, scaling walls and cliff facings. For game purposes, rappelling will include ascending and descending climbs. **Base Skill in rappelling:** 30% +5% per level of experience.

Gymnastics: Learning to do falls, rolls, tumbles, cartwheels, somersaults and to work the parallel bars and rings. This sport builds great upper body strength, grace, and balance. Provides all of the following:

Automatic kick attack at first level; 2D4 damage.
 50% + 5% per level — Sense of balance
 60% + 3% per level — Work parallel bars & rings
 70% + 2% per level — Climb rope
 70% + 5% per level — Back flip
 25% base climb ability or adds a +7% to climb skill.
 30% base prowl ability or adds a +5% to prowl skill.
 + 2 bonus to roll with punch or fall
 + 2 **P.S.** +2 to **P.E.**
 + 1 to P.P. +2D6 to S.D.C.

Prowl: This skill helps the character to move with stealth; quietly, slowly, and carefully. Techniques include balance and footing, short steps and pacing, rifle positioning, prone positions for low visibility, and crawling. A failed prowl roll means that the character has been seen or heard. If the prowl roll is successful, then the character is not seen or heard and may make a sneak attack. **Base Skill:** 25% + 5% per level of experience.

Running: A routine of running and exercise to build speed and endurance. Provides the following:

+ 1 to P.E.
 4D4 to Spd
 1D6 to S.D.C.

Swimming: The rudimentary skill of keeping afloat, dives, swimming and lifesaving techniques. The percentile number indicates the overall quality of form as well as skill of execution. A character can swim a distance equal to 3x his P.S. in yards/meters per melee. This pace can be maintained for a total of minutes equal to his P.E./endurance. **Base Skill:** 50% +5% per level of experience.

S.C.U.B.A.: The letters S.C.U.B.A. stand for Self-Contained Underwater Breathing Apparatus. Individuals learn the methods and equipment needed for skin diving and underwater swimming. A character can swim a distance equal to 2x his P.S. in yards/meters per melee. This pace can be maintained for a total of minutes equal to his P.E./endurance. **Base Skill:** 50% +5% per level of experience.

Note: The maximum safe depth one can go without getting the bends is about 120 feet (36.5 m). Deeper depths are possible with depressurization, special suits and submarines. Swimming is required to S.C.U.B.A.

Wrestling: As taught in old high schools and colleges, wrestling is more of a sport than a combat skill, but it does provide some useful combat moves. Provides the following:

Body block/tackle does 1D4 damage and the opponent must dodge or parry to avoid being knocked down (lose one melee attack if knocked down).

Pin/incapacitate on a roll of 18, 19, or 20.

Crush/squeeze does 1D4 damage per squeeze attack.

+ 1 to roll with punch or fall
 + 2 to P.S.
 + 1 to P.E.
 + 4D6 to S.D.C.



Pilot Skills (Ground, Air, Water)

Airplane: Includes old propeller, single and twin engine types. **Base Skill:** 50% +4% per level of experience.

Automobile: Manual and automatic transmission; includes dune buggies, jeeps, and small trucks. **Base Skill:** 60% +2% per level of experience.

Boat: Sail Type: Small sailing and medium-sized sailing yachts, and fishing boats. **Base Skill:** 60% +5% per level of experience.

Boat: Motor and Hydrofoils: These include all types of small motor driven boats and yachts. **Base Skill:** 55% +5% per level of experience.

Boat: Ships: This includes all large sailing and motor driven sea-faring vessels. **Base Skill:** Sailing ships: 45% + 5% per level of experience. Motor driven ships: 44% +4% per level of experience.

Helicopter: The specialized skill required to fly all types of helicopters, including combat 'copters (but must have the weapons systems skill to operate weapons on a combat helicopter). **Base Skill:** 35% +5% per level of experience.

Horsemanship: In this devastated and mutated land, the horse has become a popular means of transportation. The skill includes the basic principles of riding, the care and feeding of the animal, recognizing breed and quality, charging, and jumps. The percentile number is used whenever the character tries to determine breed, quality, and when performing special jumps or maneuvers. **Base Skill:** 40% +4% per level of experience.

Special Bonuses: The horseman has the advantage of height, leverage, and velocity when attacking on a horse. This provides the following bonuses when charging on horseback: + 1 to parry and dodge, +4 damage. Note that a person can not shoot a projectile weapon of any kind (bow and arrow or gun) with any degree of accuracy. An aimed shot is impossible on a moving animal! Bursts are possible if the horse is moving quickly, but not at a full gallop. At full gallop, the shooter can fire only as *wild*.

Hover Craft (ground): The knowledge needed in piloting hover cycles and other hover vehicles used for ground transport. These vehicles can be tricky, because they utilize several air jets and directional thrusters that push the craft along, above the ground, on a cushion of air. The vehicles can usually attain great speeds, are capable of driving over incredibly rugged terrains, and make sensational jumps over small craters and ravines. **Base Skill:** 50% +5% per level of experience.

Jet Aircraft: Includes large and small commercial transport jets. **Base Skill:** 40% + 4% per level of experience.

Jet Fighters: Training includes flying, maneuvering, aerial combat strategies, and typical fighter jet weapon systems. **Base Skill:** 40% + 4% per level of experience.

Jet Packs: This is the piloting skill for backpack like units that strap to the back of an individual to carry him airborne. The typical jet pack is a one person unit capable of hovering above the ground and flying at an average altitude of 300 feet (91.5 m). **Base Skill:** 42% + 4% per level of experience.

Motorcycle: This skill includes the piloting of all two and three wheeled vehicles such as motorcycles of all types, dirt bikes, and mopeds. **Base Skill:** 60% + 4% per level of experience.

Robots and Power Armor: Characters with this skill are taught the fundamentals of maneuvering giant robots (utilized by the Coalition) and power armor suits (such as Glitter Boy armor). These are robot exoskeletons and vehicle type robots that require a pilot and/or crew. The training focuses on piloting, not combat; thus, robot combat is a separate and distinct skill (*see Robot Combat skills*). **Base Skill:** 56% + 3% per level of experience.

Robot Combat: Basic: Unlike the elite robot combat training that follows, the basic combat training gives the pilot a fair working knowledge of most robot-vehicle systems and their most basic combat capabilities. The pilot will be able to pilot and use the various weapon systems and fighting capabilities, but not at full efficiency. Players should take note of the *Basic Robot Combat Training* tables in the combat section.

Robot Combat Elite: Each robot or power armor type has a different weapon system, hand to hand aptitude, and quirks that make each specific type unique. Because each handles differently, the elite pilot studies individual robot war machines to familiarize himself with every element of that specific robot. This means the pilot must select the Robot Combat: Elite skill for each specific robot type in which he desires to be an expert operator to enjoy its maximum combat effectiveness. Elite training automatically gives the pilot a *basic* understanding and ability to pilot ALL standard types of robot vehicles at the "basic" level as well.

The Hand to Hand Bonuses from *Robot Combat Training* lists the exact combat abilities, damage, and bonuses for each specific robot type. They are found in the combat section. Robot Combat: Elite is usually reserved for specialists in the military and mercenaries such as the infamous Glitter Boys; however, just about anybody can learn to pilot and fight with a robot. **Note:** There is no base skill as the pilot has specific skills and bonuses as he progresses in level of experience, much like hand to hand combat.

Power Armor: Man-size and giant

Humanoid exoskeleton type: Man-size and giant Insect style

Truck: This piloting skill specifically applies to large cargo and transport vehicles like eight to sixteen wheeled commercial trucks and multi-ton transports. **Base Skill:** 40% + 4% per level of experience.

Tanks and APCs: Military vehicles often have unconventional controls and handle differently than conventional vehicles, especially the many ton, armored combat vehicles such as tanks and armored personnel carriers (APC). Thus, special training is required to pilot them. **Base Skill:** 36% + 4% per level of experience.



Pilot Related Skills

Navigation: Training in map reading, star charts, course computation, following landmarks, and use of navigational equipment. Includes land, air, and water navigation, as well as piloting by instruments alone. A failed roll means the pilot is off course. Roll 2D6x100 for most aircraft, 4D6 x 100 for jets, and 2D6 x 10 for ground vehicles to determine how many miles/kilometers they are off course. Roll for every hour that one is off course. **Base Skill:** 40% + 5% per level of experience. **Requires:** Basic math, read sensory equipment, and at least minimal literacy.

Read Sensory Equipment: Individuals with this training can operate, maintain, understand, and "read" or interpret sensory data from all types of conventional sensor devices. These devices include radar, sonar, motion detectors, surveillance equipment, optical enhancements, instrument panels, and so on. Note that characters without this skill cannot understand nor operate aircraft, radar, or detection/surveillance equipment. **Base Skill:** 30% + 5% per level of experience.

Weapon Systems: This is the complete understanding of weapon units and systems incorporated into military vehicles, power armor, and robot vehicles. It includes lasers, particle beams, rail guns, missile and grenade launchers, cannons, and vehicle/robot weapon systems. Adds a special bonus of +1 to strike when using these types of weapons; this does not include hand-held weapons (*see Weapon Proficiencies*). **Base Skill:** 40% + 5% per level of experience.

Rogue Skills

Computer Hacking: This is a computer skill similar to computer programming; however, the emphasis of the skill is breaking computer access codes to gain illegal access to other computer systems and steal or sabotage its data. The character is an expert in tracing computer data, bypassing defense systems, and breaking ("hacking") codes; add a one time bonus of +5% to the cryptography, surveillance, and locksmith (electronic and computer controlled locks only) skills if the character is a hacker. **Base Skill:** 15% + 5% per level of experience. **Requires:** The ability to read and write, computer operation, computer programming, and at least basic mathematics.

Concealment: The practiced ability to hide small items on one's body or in hand, usually by continually moving it around from hand to hand or place to place unnoticed. Objects *must* be no larger than 14 inches in height and depth, and six inches in width. The weight must also be 10 pound or less (4.5 kg). The smaller and lighter the object, such as knife, gem, key, credit card, etc., the easier it is to conceal (add a bonus of +5%). Larger items, such as a book, scroll, club, statue, or similarly large or heavy object, are more difficult to conceal on one's person for obvious reasons. **Base Skill:** 20% + 4% per level of experience.

Palming: Simply the ability to pick up and seemingly make a small object, such as a coin, key, credit card, disappear by concealing it in one's hand. Adds a bonus of +5% to the pick pocket skill. **Base Skill:** 20% + 5% per level of experience.

Pick Locks: The character knows the methods and tools for picking/opening key and basic tumbler type locks. This does not include sophisticated computer or electronic locks.

It takes 1D6 melee rounds for each attempt to pick a lock. A failed roll means the lock holds; try again. **Base Skill:** 30% + 5% per level of experience.

Pick Pockets: An ability to remove items from a person without their being aware of it. If a pick pocket attempt fails, the item has NOT been removed and there is a 67% likelihood of the intended victim recognizing the intent of the action. **Base Skill:** 25% + 5% per level of experience.

Prowl: This skill helps the character to move with stealth; quietly, slowly, and carefully. Techniques include balance and footing, short steps and pacing, rifle positioning, prone positions for low visibility, and crawling. A failed prowling roll means that the character has been seen or heard. If the prowling roll is successful, then the character is not seen or heard and may make a sneak attack. **Base Skill:** 25% +5% per level of experience.

Streetwise: This skill instills an understanding of the darker side of city life and the scoundrels who roam the streets. The streetwise character will be able to recognize gang members by their actions and philosophies, gang colors (emblems and clothing that denote membership to a particular organization), gang symbols and mannerisms, and dangerous locations and gangland haunts. The individual will also recognize a potential brawl situation, assess a gang member's rank/power in the organization, and know some of the hangouts, modes of operation, rituals, ethics, and perhaps even notorious gang leaders of the more infamous street gangs. This skill also includes the ability to recognize and locate black market dealers/organizations, illegal cyber-doc clinics, drugs and arms dealers, and similar criminal outfits. **Base Skill:** 20% +4% per level of experience.

Science

Note: In the world of **Rifts**, the majority of people can not read nor write. Most of the science skills require literacy as a prerequisite skill. Anthropology (everything can be committed to memory) and mathematics are the only exceptions.

Anthropology: This is the behavioral study of man and other intelligent life-forms and their environments. Studies include societies, customs and beliefs, religions, political structure, as well as rudimentary history and archaeological background. It is important to note that anthropology is more concerned with the study of modern races and societies than it is with ancient ones. This is especially important when dealing with other races and cultures in the present time in order to avoid accidentally breaking taboos or codes of behavior. It will also tell the anthropologist whether he may be dealing with a dangerous people (hate humans, fear technology or magic, are cannibals, worship demons, etc).

The skill can also be used in the examination of items/artifacts and ruins to identify the probable people/race, purpose, and technological level. The character can identify the period in which the item was used (contemporary or ancient), but is not skilled enough to tell whether an item is an authentic artifact or a forgery.

In the world of **Rifts**, few humans and fewer non-humans know much about humankind or the world before the rifts. The anthropological student is one of the few who is well versed in the legends and few facts about the "Time of Man." As a result, he can often identify pre-rifts technology and man-made creations. He is also knowledgeable in their black market value and the many laws that prohibit the possession, sale, and scavenging of ancient artifacts. **Base Skill:** 20% + 5% per level of experience.

Archaeology: This is the scientific study of relics of ancient civilizations by excavation and other means. Studies include proper excavation (digs) techniques, analysis, preservation, restoration, and dating methods (including carbon dating), as well as a rudimentary history and anthropology background.

Like the anthropological student, the archaeologist is one of the few who is well versed in the legends and few facts about the "Time of Man." He is an expert in the identification of pre-rifts technology and man-made creations, from books and clothing to vehicles and buildings. The character can ascertain whether the item is an ancient artifact or of recent construction, and therefore, if an item is an authentic artifact or a forgery. He is also well versed in their black

market value and the many laws that prohibit the possession, sale, and scavenging of ancient artifacts. **For example:** The possession of books (even comic and children's books), video discs, or other pre-rifts educational or technological data is illegal by the decree of the Coalition. Failure to turn such items over to the government is a serious crime punishable by imprisonment or death. **Base Skill:** 20% + 5% per level of experience.

Astronomy: The study of the stars and other celestial bodies, their movements, positions, cycles, alignments, and interrelations with the earth and each other. This knowledge can also be used to determine direction, approximate distances, identify seasons, and tell the time of day. **Base Skill:** 25% +5% per level of experience.

Biology: Basic understanding of cells, anatomy, physiology, evolution, and genetics. The character will know how to use a microscope, cultivate bacteria, and how to classify new organisms. **Base Skill:** 30% + 5% per level of experience.

Botany: Plants, their categories and functions, are studied extensively. Characters will know the basics of cross-fertilization and germinating, as well as growing experimental plants. **Base Skill:** 25% + 5% per level of experience.

Chemistry: The basic understanding of chemical principles and formulae. Characters know enough chemical laboratory procedures for analyzing and synthesizing chemical compounds to act as competent assistants. **Base Skill:** 30% +5% per level of experience.

Chemistry — Analytical: Training in chemical engineering theories useful in the analysis of compounds and their practical applications. Characters will be highly skilled in the use of laboratory equipment and can analyze and synthesize chemicals. **Base Skill:** 25% +5% per level of experience. **Requires:** Chemistry, advanced mathematics, and literacy. Computer operation is strongly suggested but not required.

Mathematics — Basic: Knowledge of basic math, including the ability to count, addition, subtraction, multiplication, division, and fractions. **Base Skill:** 45% + 5% per level of experience.

Mathematics — Advanced: Knowledge of all basic and advanced mathematics, including algebra, geometry, trigonometry, calculus, and techniques for using advanced mathematical formulae. **Base Skill:** 45% + 5% per level of experience.

Note: Literacy and Computer skills are found under *Technical Skills* and computer hacking is found under *Rogue Skills*.

Technical

Art: The ability to draw or paint or sculpt or do craft-work. Scholastic art training indicates a professional quality, while a secondary skill indicates a talented amateur. **Base Skill:** 35% +5% per level of experience.

Computer Operation: A knowledge of how computers work, along with the skills to operate peripherals like keyboards, printers, and modems. Characters can follow computer directions, enter and retrieve information, and similar basic computer operations. However, this does NOT include programming or hacking. **Base Skill:** 40% +5% per level of experience. **Requires:** Literacy.

Computer Programming: Advanced computer knowledge that includes designing, programming, debugging, and testing computer programs and software. Hacking is possible, but at a penalty of —40% unless the character also has the computer hacking skill (*see Rogue Skills*). **Base Skill:** 30% +5% per level of experience. **Requires:** Computer operation and literacy.

Language: Characters with a language skill can understand and speak in a language other than their own native tongue. Language is one of the few skills that can be selected repeatedly in order to select

several different languages. Each selection gives the character knowledge of a different language and costs one skill selection each time.

There are nine major languages in the world of Rifts, they include: American (English, the universal language of the American continents), Techno-can (Basic but modified American/English; a universal computer/techno language used in high-tech computer communications and systems. Not used as an everyday spoken language but as a specialized tech-language developed for technical journals and as a universal computer language), Spanish (the second major tongue of the Americas), Japanese, Chinese, Euro (a blend of Russian, German, and Polish), Dragonese (elven from the Palladium Fantasy RPG), Gobbely (goblin, hob-goblin, orc, and ogre from the Palladium RPG), and Faerie Speak (faerie folk as found in the Palladium RPG). **Base Skill:** 50% +5% per level of experience.

Literacy: The written word is more valuable than ever in the world of Rifts, yet, sadly, the majority of the world's population can not read or write. Illiteracy is encouraged by the Coalition as it is a means of securing the empire's power base and hold over the people. Those who are literate will be viewed with suspicion unless they are a member of the Coalition's elite aristocracy or military.

Like the language skill, the character may be able to read and write several different languages, but each language counts as a separate skill selection. American/English is the official written language of the Coalition. **Base Skill:** 30% +5% per level of experience.

Lore — Demons and Monsters: This is the study of demonic creatures and supernatural monster lore throughout the ages and around the world. It includes the beliefs of ancient and primitive cultures, as well as documentation in the modern Rifts world regarding demons, vampires, possession, places of magic, reputed places of demonic habitation or attraction, and the study of legendary and known supernatural beings, including their known habits, appearance, weaknesses, strengths, powers, and abilities. The master of demon lore may be able to identify a particular type of monster by hearing its description or a description of its actions, seeing a drawing or photograph or footprint, or by how it acted, killed, or exhibited certain abilities. **Base Skill:** 25% +5% per level of experience.

Lore — Faerie: This skill is effectively the same as the previous Demon and Monster lore skill, except that the emphasis of the lore is on faerie folk. Since the coming of the rifts and magic, the faeries of ancient myths have proven to be quite real and often encountered in the wild, especially near ley lines and nexus points. Faerie folk include faeries, sprites, pixies, brownies, bogies, toad stools, pucks, kelpies, gnomes, ogres, and a host of other supernatural beings. **Base Skill:** 25% + 5% per level of experience.

Photography: Training in the art of still photography, the use of lighting, cameras, lenses, filters, and other camera equipment, as well as storage, development, enlargement, and duplication of film/photos. **Base Skill:** 35% +5% per level of experience.

Writing: The ability to write prose (stories), poems, or journalistically (articles, reports, news). Scholastic training indicates a professional quality, while the secondary skill indicates a talented amateur. A failed roll means an awkward and poorly written work that is boring and difficult to understand. Try again. Note that the written word can be a powerful tool in the ignorant and oppressed society of the Coalition. **Base Skill:** 25% +5% per level of experience. **Requires:** Literacy.

Weapon Proficiencies

Note: There are two categories of weapon proficiencies (W.P.): Ancient and Modern.

Ancient Weapon Proficiencies: Each ancient W.P. provides combat training with a particular type of weapon. The result is hand to hand combat bonuses to strike and parry whenever that particular weapon

is used. All bonuses are accumulative. Each W.P. counts as one skill. The character may select several W.P.s or few. **Note:** Characters without a W.P. *can* use any weapon, but without benefit of the W.P. bonuses.

W.P. Archery and Targeting: This is an expertise with thrown and bow weapons. It includes throwing spears, forks, slings, short bows, long bows, crossbows, and modern bows. **Bonuses:** Add 20 feet (6 m) to the normal effective range per level of the character, + 1 to parry with that weapon (effective at level one), and + 1 to strike at levels 2, 4, 6, 8, 11, and 14. **Note:** The character loses all bonuses and rate of fire is half when riding on horseback or a moving vehicle. **Rate of Fire:** Two at level one, +2 at level three, + 1 at levels 5, 7, 9, and 12.

Bow Type and Ranges

Bow Type and Ranges	Damage Per Arrow/Weapon
Boomerangs — 60 ft/18 m	1D6 damage
Throwing Sticks & Irons — 30 ft/9 m	1D6 damage
Sling — 80 ft/24 m	1D6 damage
Spear — 100 ft/ 30. 5 m	1D6 damage
Short Bow — 340 ft/104 m	1D6 damage
Long Bow — 640 ft/195 m	2D6 damage
Modern Compound Bow — 700 ft/213 m	2D6 damage
Traditional Crossbow — 600 ft/182 m	1D8 damage
Modern Crossbow — 700 ft/213 m	2D6 damage

W.P. Blunt: Training with all types of blunt weapons including maces, hammers, cudgels, pikes, staves, and clubs. **Bonuses:** + 1 to strike and parry at level one, add another + 1 to strike and parry at level four, and another + 1 to strike and parry at levels eight and 13.

W.P. Chain: Training with all types of chain weapons including ordinary lengths of chain, nunchaku, flail, and ball or mace and chain. **Bonuses:** + 1 to strike at level one, add another + 1 to strike and parry at level four, add another + 1 to parry at level eight, and + 1 to strike and parry at level 13.

W.P. Knife: Training with all types of knives. **Bonuses:** + 1 to strike when thrown on level one, + 1 to strike and parry at level two, add another +1 to parry at level four, add another +1 to strike and throw at level seven, add + 1 to parry at level eight, and + 1 to strike, parry, and throw at level 11 and 15.

W.P. Sword: Combat skills with large and small swords, including fencing type training. Includes rapiers, sabers, two handed, and short swords. **Bonuses:** +1 to strike and parry at level one, an additional + 1 to strike and parry at level three, add another at levels seven, eleven, and fourteen.

Modern Weapon Proficiencies: These are areas of training and practiced skill with a particular type of modern weapon. Each W.P. counts as one skill selection. Modern W.P. bonuses are found in the combat section under *Modern Weapon Proficiency Explanation*. Characters with no knowledge of modern weapons can fire loaded weapons, but will take twice as long to reload and always shoot "wild"; no bonuses to strike.

W.P. Revolver: All cylinder style handguns; not automatic (trigger must be pulled each time the gun is fired).

W.P. Automatic Pistol: All modern military automatic pistols (automatic means the weapon keeps firing while the trigger is depressed and until the trigger is released or the rounds are all expended).

W.P. Bolt Action Rifle (hunting & sniping): Includes most hunting rifles; not an automatic firing weapon.

W.P. Automatic and Semi-automatic Rifles: Includes all assault rifles like the M-16 and AK-47.

W.P. Sub-Machinegun: Includes all small arms automatic weapons like the uzi.

W.P. Heavy: Includes machineguns, bazookas, LAWS, and mortars.

W.P. Energy Pistol: Includes lasers and all types of energy firing small arms.

W.P. Energy Rifle: Includes all long range energy firing rifles.

W.P. Heavy Energy Weapons: Includes plasma ejector, rail guns, and similar high tech, mega-damage weapons.



Wilderness

Boat Building: This skill enables the character to build a variety of rafts, small rowboats, large flatbed boats, and canoes. A small raft (two man) can be made within 1D6+ 1 hours if the lumber or other suitable materials and tools are readily available. A large raft will take about 4D6 hours, a canoe, 2D6 days, rowboat, 4D4 days, large flatbed, 1D4x 10 days. Time is doubled or tripled if trees must be cut down and wood prepared. Of course, the time can be reduced if several knowledgeable people are working on the construction. A failed skill roll means the boat has leaks. Trying to patch it will require 4D4 hours. **Base Skill:** 25%+5% per level of experience.

Carpentry: A fundamental knowledge of working with wood. The character knows how to prepare, treat, and preserve wood, recognize quality craftsmanship, can repair damaged wood and wood items, and build (chests, chairs, tables, cabinets, houses, etc.). Adds +5% bonus to the boat building skill if taken. **Base Skill:** 25%+5% per level of experience.

Hunting: The skill of killing and preparing an animal for food. **Special Bonuses:** Add the following bonuses to the appropriate skills: +2% prowl, +5% track animals, +5% skin animals, +5% wilderness survival, and +5% to cook the catch only. No base skill.

Identify Plants & Fruits: Training in the recognition of the many different types of plants and vegetation and where they grow. The emphasis is placed on edible, herbal, and poisonous plants. **Base Skill:** 25%+5% per level of experience.

Land Navigation: This skill enables the person to stay on course while traveling over land by means of observation. It includes mentally marking/recognizing geographic landmarks, estimating distance and movement, recognizing sounds, night travel, and other navigational tricks. The player should roll once for approximately every three miles (4.8 km) traveled. A failed roll means the character is drifting off course; 2D10x100 yards/meters. Consecutive failed rolls means the individual does not realize that he's off course and continues in the wrong direction.

Note: A group of average men can cover about five miles (8 km) an hour at a brisk, but relaxed, pace through grassland, along dirt roads or pavement. Travel through dense forest or jungle at a cautious pace, with eyes open for danger, is about one mile (1.6 km) an hour. Heavy rain or snow, fog, swamps, etc., will also reduce speed.

Base Skill: 36%+4% per level of experience.

Preserve Food: Knowledge in the preparation of foods for storage and later consumption. Includes canning fresh fruit and vegetables, making jams and honey, drying fruit, vegetables, and herbs, drying meat and fish, plus various smoking, salting, and pickling methods. **Base Skill:** 25%+5% per level of experience.

Skin and Prepare Animal Hides: Training in the methods and techniques in skinning, tanning, stretching, and preserving animal hides as fur or leather. Adds a +5% bonus to the sewing skill. **Base Skill:** 30%+5% per level of experience.

Track Animals: This skill enables the character to identify an animal by its tracks, scent, spoor, and habits. The individual can also follow the animal's tracks and other signs. This means he can also estimate how fresh the tracks are, what direction they are heading, whether the animal is hurt or sick, and guess its age. The habits and habitats of animals and animal behavior are also learned.

Tracking humans with this skill is also possible, but is done with a penalty of -20%. **Base Skill:** 20%+5% per level of experience.

MODERN WEAPON PROFICIENCIES

The system for modern weapons presented here is identical to the rules and those found in the pages of the **The Revised Heroes Unlimited, Ninjas & Superspies, TMNT and Robotech™**.

The following rules *can* be applied to all of *Palladium Books** role-playing games.

Weapon Proficiencies (W.P.) are areas of training and practiced skill with a particular type of weapon, such as revolver or sub-machine-gun. This skill provides special bonuses to strike when using that weapon. Do not add this strike bonus to your character's hand to hand or combat skill bonuses to strike.

Weapon Proficiencies provide the following bonuses:

Aimed: +3 to strike.

Burst: +1 to strike.

Wild: No bonus or penalty.

Training also enables the character to easily reload, disassemble, unjam, clean and otherwise maintain the weapon. **Recognizes weapon quality** — 30% at level one and +6% per each additional level of experience. **Add a bonus** of +1 to strike for every THREE levels of experience beyond level one. When firing a weapon, there are three main modes or categories of attack: *aimed, burst or wild*.

AIMED

An **aimed shot** means a person takes the time to carefully aim and squeeze off one, well placed shot. Each individual shot takes one full attack. Thus, if a character has four attacks per melee he/she can shoot FOUR aimed shots. This applies to all weapons. Roll to strike for each shot.

Bonus to Strike is +4 with a revolver or +3 for all others.

BURST

A **burst** is the shooting of several rounds, immediately one after another. Aim is more hasty and the recoil moves the weapon with each shot, reducing the accuracy. *Semiautomatic/automatic weapons, machineguns and sub-machine guns*, are designed for burst firing. The concept is that, while accuracy is reduced, the odds of hitting one's target with multiple rounds is increased because more shots are fired. **Bonus to Strike** is +1 with all weapons.

Note: Roll to strike once to see if the entire burst hits. Do not roll for each individual bullet. If the burst misses its target, then all the rounds in that burst miss.

BURSTS OR SPRAYS FROM AUTOMATIC WEAPONS AND SUB-MACHINE GUNS

Short bursts fire 20% of the entire magazine; i.e., 30 round magazine — 6 rounds/bullets are fired. **Damage:** Roll the normal damage dice for ONE round X 2. Uses up one attack. Can be fired at only one target.

Long burst fires 50% of the entire magazine; i.e., 30 round magazine — 15 rounds/bullets are fired. **Damage:** Roll the normal damage dice for ONE round x 5. Uses up one attack. Can be fired at only one target.

Entire magazine: Shooting off the entire clip/magazine within a melee round is possible. 100% of the rounds are fired. **Damage:** Roll the normal damage dice for ONE round x 10. Uses up *two* attacks that melee. Can be fired at only one target. Machineguns are the only exception to this rule.

Spray: Shooting a burst at several targets at once is possible, but the same as shooting wild. You must fire a *long burst or an entire magazine* in order to spray. See shooting wild.

SHOOTING WILD

Shooting wild occurs when a trained character shoots without taking time to aim. This usually applies when the person is blinded, angry, running, rolling, leaping, shooting from a moving vehicle, etc.

Bonus to Strike: With W.P. there is no bonus or penalty; with no W.P. the person strikes at -6. Long bursts or the entire magazine must be fired. Counts as two attacks. Can be fired at one target or in a spray. **Damage for shooting wild at one target:** Roll normal damage dice for ONE round x 2. Roll once to strike with the wild burst. **Hitting an innocent bystander** is a real possibility when shooting wild; 20% chance. Roll for each wild burst fired. **Damage** is the normal damage from one round (a wild shot).

Spraying an area with bullets can be dangerous and is considered to be shooting wild. The object of a spray is to hit several targets simultaneously. **First**, roll once to determine if you strike the target area; 1D20; 5 or higher strikes as usual. Then roll 1D4 to determine how many individual targets are struck within the target area. However, each target gets a roll to dodge to avoid getting shot. **Damage** is the normal damage from one round. **Hitting an innocent bystander** is even more likely; 50% chance. Damage is from one round (wild shot).

Bursts or Sprays from a machinegun is different only in the number of rounds fired, targets struck, and chance of hitting a bystander. Machineguns have a much greater ammunition capacity, so it does not have to use the same percentage of its entire clip.

Short burst/one target: 10% of rounds/magazine; inflicts normal round damage x 2. Counts as one attack.



Short burst spray: 10% of rounds/magazine; inflicts normal damage from ONE round, hits 1D4 targets.

Long burst/one target: 30% of rounds/magazine; inflicts normal damage x 5. Counts as one attack.

Long burst spray: 30% of rounds magazine; inflicts normal damage from ONE round, hits 1D8 targets. Counts as one attack.

Empty the entire magazine/one target: All rounds fired; inflicts normal round damage x 20. Counts as all melee attacks/one full melee.

Empty the entire magazine in a spray: All rounds fired; inflicts normal round damage x 2, hits 2D8 targets. Counts as ALL melee attacks/one full melee. Chance of hitting innocent bystanders is 70%.

A Special Note About Shotguns:

Shotguns can fire once or twice per melee (double-barrel). It can fire both rounds simultaneously or one at a time. Buckshot scatters, and will strike the specific target plus 1D4 others within its blast area (approximately a 15ft/4.6m area).

NATURAL ENERGY BLASTS

Supernatural characters whose power enables them to emit energy blasts, whether it be fire, electricity, or other forms of energy, can use their energy attack as often as their combined hand to hand attacks allow. **For Example:** If the creature has FOUR hand to hand attacks, it can fire energy blasts as often as FOUR times per melee (15 seconds). If the character has five or six hand to hand attacks, five or six blasts can be fired. As always the types of attacks can be combined.

HAND TO HAND COMBAT

The combat system is really just an adaption of the rules from *Heroes Unlimited* and *Ninja Turtles*. It is designed to be fast moving and easy to understand. All combat strikes, parries and dodges are resolved by rolling **twenty-sided dice**.

STEP 1: Determine Initiative

Any time opponents square off for battle, the game master must determine who has the initiative. In other words, who will attack first. Successful *Sneak Attack* or *Long Range Attack* will always have initiative for that melee. Otherwise, whoever *rolls highest* on a twenty-sided die will attack first. In the case of a tie, reroll. Initiative is rolled only once per melee. That roll will determine the pace for that entire melee.

STEP 2: Attacker Rolls Strike

The next step is for the first attacker to **roll a twenty-sided die**. If the result is a four or less (counting bonuses), then the attacker misses. *Any roll above a four (4) hits the opponent*. But, if the roll is a five (5) or better, and less than the opponent's Armor Rating (A.R.), then damage may be done only to the S.D.C. of the opponent's armor (see A.R./Artificial Body Armor). A roll over the opponent's A.R. does direct damage to the character's S.D.C. and Hit Points. Note that special attacks like Knockout/Stun or Death Blow must be declared BEFORE rolling to strike.

STEP 3: Defender May Parry, Dodge or Entangle

Any time an attacker rolls a successful hit, the defender can choose to parry, dodge, or entangle. *Parrying* can be done automatically by anyone trained in any form of Hand to Hand combat. That means that the parry can be performed without wasting a melee attack. *Non-combat trained characters will lose* their next melee attack every time they parry.

NOTE: Bullets and energy attacks cannot be parried, but CAN be dodged. Defending by dodging or entangling means automatically giving up the next melee attack.

Entangle means the character actually pins or snares an opponent's weapons or arm.

The defender can only defend against attacks within his line of vision. Attacks from the rear cannot be parried, dodged or entangled.

STEP 4: Attacker Rolls Damage

If a successful strike is not parried, dodged or entangled, the attacker rolls for the amount of damage inflicted and adds any damage bonuses. Critical strikes do *double damage*. Combined critical strikes, like a natural twenty and a jump attack, do triple damage. Add the damage bonus to the roll before doubling or tripling. A natural, unmodified, 20 is always a critical strike. A punch inflicts 1D4 damage.

STEP 5: Defender May Attempt To Roll With Punch

If the attack is a blunt, physical attack (fist, foot, club, staff, etc.), then the defender can attempt to Roll With The Punch. In order to roll with punch, the defender must match or better the attacker's roll to strike. Successfully rolling with a punch means the character takes *half* damage. Successfully rolling with a knockout punch means the character takes double damage, but is NOT unconscious or stunned. Rolling with a death punch results in loss of half of all remaining S.D.C. and hit points. Failing to roll with punch means taking full damage off of the defender's S.D.C. and/or hit points. The same rules apply to falls as well.

Continuing The Combat

Once the above is completed, the process is repeated for whoever lost the initiative. So long as the opponents have melee attacks left, the combat continues back and forth. When *all* the attacks or actions per melee round of all opponents are finished, it's time to start a new melee round. Initiative is redetermined at the *beginning* of every melee round. That is to say, that if a character has four attacks per melee, when *all* attacks are used, a new melee round begins.

COMBAT TERMS

Death Blow: An automatic kill. The defender can try to roll with death blow by rolling over the attacker's strike. If the defender is not killed, then the current S.D.C. and hit points are reduced to half. This attack is available only under certain conditions.

Dodge: A character dodges by moving out of the way of the attack. Dodging always takes up one attack/action per melee round. To Dodge, the defender must roll higher than the attacker's strike roll on a twenty-sided die.

Entangle: A defender can attempt to trap the weapon or arm of an attacker. This is done instead of parrying or dodging, and takes up one attack per melee. An entangle is successful if the defender rolls above the attacker's strike roll. It takes one attack and a roll to entangle to keep an opponent's arm or weapon entangled every melee round. In order to get free, the entangled opponent must roll a dodge against the entangle roll.

Hand to Hand Combat: Fighting skills that provide the characters with attacks per melee, bonuses, and techniques. Characters without combat training have only one attack per melee and have *no* automatic chance to parry.

Hit Points: This is the number of points of damage a character can take before dying. Characters don't lose hit points until their S.D.C. is down to zero. A character's base hit points is the P.E. plus 1D6. Another 1D6 of hit points is gained every time the character advances an experience level. Lost hit points are not recovered without medical attention.

Damage Table (Basic)

HumanFist	1D4
HumanKick	1D6 or 1D8
Blackjack	1D6
Bull Whip	1D8
Thrown Small Objects	1D4
Falling	1D6 per 10ft
Collision	1D8 per 10mph
Smashing through Glass	1D4
Dropped or Thrown	
Large Objects	1D8 per 100lbs 1D8 per 40ft, and 1D4 per 4mph

Initiative: Whoever gets to attack first is considered to have the Initiative. Initiative is automatic in sneak attacks and long-range attacks. In most other cases, each opponent rolls a twenty-sided, highest roll gets the initiative. Rolling for initiative takes place at the beginning of each melee round of combat.

Kick Attack: This is a karate-style kick. It is a normal attack that does 1D4 damage for the *untrained*, or higher with hand to hand skills (1D6 or 1D8). Anyone trained in hand to hand combat can do a kick attack.

Knockout/Stun: Anyone hit by a knockout or stun attack will be temporarily incapacitated. The victim is not necessarily unconscious, just dazed.

Jump Kick: A Jump Kick is performed by leaping completely off the ground and attempting to land feet-first on an opponent. Jump Kick can be used only by those skilled in hand to hand martial arts. The advantage of a jump kick is that it works as a *critical strike* and doubles the normal damage inflicted. The disadvantage of a jump kick is that no other attack may be performed in that melee round (all attacks for that melee are used up in the kick). The jump kick must be the character's first attack of that melee round. For the rest of the melee round, the character can only parry, dodge or move into position.

Leap Attack: An airborne assault where the weapons and/or fists are wielded in mid-leap. A leap attack must be made only at the beginning of a melee round and, like the jump kick, uses up *all* attacks for that melee. Usually, only a single strike can be made during a leap attack. However, if two opponents are close together, the attacker can leap between them and strike both of them at the same time; roll to strike for each character. After the leap, the character may not attack again until the next melee round, but can parry or dodge or move into position. Automatic parries work in mid-leap, but dodges are impossible. A successful leap attack is a critical strike and does double damage.

Long-Range Attack: By using a long-range weapon from a distance, an attacker can perform an undetected, *first strike*. Provided the attacker is not seen, the defender automatically loses initiative and may not dodge the first attack that melee round.

Melee or Melee Round: Exactly 15 seconds. The segment of time combatants have to strike, counter and/or return strike. Generally, playing characters have two or more attacks per melee.

Multiple Attackers: Takes place when an opponent is faced by more than one attacker. Characters with hand to hand combat skills can attempt to parry any attacks within their line of sight. The defender from multiple attackers can strike at only one target at a time (see leap attack for a rare exception).

Natural Twenty: This is the result of 20 when rolling a twenty-sided die. A strike with a natural twenty will always be a critical strike. If someone with a strike bonus of +2 rolls an 18, then they have an attack roll of 18 *plus* unnatural, bonus modification; NOT a natural twenty, and is not a critical strike. A natural twenty beats all other rolls and can only be parried or dodged by *another natural twenty*.

Paired Weapons: Certain kinds of weapons, such as Sais, Nunchaku, knives, clubs and swords, can be used as paired weapons. Users of paired weapons can strike and parry simultaneously, can do twin strikes against a single target or against a pair of targets, and can parry two, different opponents at the same time. In other words, warriors skilled in paired weapons often can do two actions for every one of their melee attacks. BUT, every time they use twin actions they LOSE their automatic parry.

Parry: A defender can attempt to parry most physical attacks. This is done by blocking the attacker's blow with a weapon or hand. Characters trained in hand to hand combat can parry without losing melee attacks. Bullets and energy attacks *cannot* be parried!

Pull Punch: The ability to control the force of a hand to hand attack. Usually used to reduce the blow to less than killing force. The character can choose to half damage, quarter damage, a single point or no damage at all. A character must declare a pulled punch, and the player must roll 11 or better on a twenty-sided die; failure means full damage is inflicted.

Roll with Punch/Fall: Hand to Hand combat fighters can reduce the damage from blows and falls by rolling. If the defender is successful, then only half damage is taken. Roll with punch/fall does not work against energy blasts, bullets, fire, bladed weapons, psionics or radiation. Victims must roll higher than the attacker's roll. *Falling* characters must roll a 14 or higher, on a twenty-sided die, to roll with the fall.

Saving Throws: Occasionally, characters must roll to save against exotic attacks like poison, gas, insanity, psionics, etc.

Lethal Poison	14 or better
Non-lethal Poison	16 or better
Harmful Drugs	15 or better
Acids	No save possible—Dodge!
Insanity	12 or better
Psionics	12 for major & minor psionics 10 for master
Magic	12 vs spell magic 16 vs ritual magic

S.D.C.: This stands for *Structural Damage Capacity*, which is the amount of damage an object can absorb before breaking. Living creatures also have S.D.C.; it represents their physical resistance to damage. All the S.D.C. of a living thing must be reduced to zero before the hit points can be affected. Note: A cousin to S.D.C. is M.D.C. or Mega-Damage Capacity. M.D.C. applies to robots, and is explained in the Robot Combat section which follows shortly.

S.D.C. Table (Basic)

Below are the S.D.C. values for a variety of objects. When an object's S.D.C. is reduced to zero, it is considered broken. Game masters should exercise common sense in applying these values. For example, a normal human cannot break through a vault door with bare fists, no matter how many times natural twenties are rolled.

-I

The S.D.C. of different weapons is applied *only* if someone is actually attempting to break the weapon. A properly wielded sword can inflict or parry many times its S.D.C. On the other hand, using the sword to wedge open a door could easily snap it off.

It is also important to note that the S.D.C. applies to the entire object. A bullet can penetrate many objects with only a small fraction (about 2%) of S.D.C. loss. For example, if a bullet punching through an exterior brick wall hit a target, it would inflict normal damage minus the 4 points of S.D.C. it wasted getting through the wall.

Airplane, Single Engine	400S.D.C.
Airplane, Jet Airliner	2000S.D.C.
Boat, Canoe/Rowboat	40S.D.C.
Boat, Cabin Cruiser	450S.D.C.
Boat, Cargo Freighter	8000S.D.C.
Box, Cardboard	2S.D.C.
Box, Wood Shipping Crate	12S.D.C.
Box, Metal Shipping Crate	48 S.D.C.
Car, Compact	250S.D.C.
Car, Luxury	450S.D.C.
Car, Door Only	150S.D.C.
Car, Windshield Only	100S.D.C.
Door, Interior Wood	100S.D.C.
Door, Exterior Wood	170S.D.C.
Door, Metal Grill	350 S.D.C.
Door, Solid Metal	600 S.D.C.
Door, Metal Safe	800S.D.C.
Door, Bank Vault	5000S.D.C.
Handcuffs, Regular	60S.D.C.
Handcuffs, Heavy	120S.D.C.
Lock, Common Latch	40 S.D.C.
Lock, Dead Bolt	100S.D.C.
Lock, Heavy Padlock	75 S.D.C.
Motorcycle	100S.D.C.
Truck, Medium Sized Pick-up	450S.D.C.
Truck, Half-Ton Pick-up	600 S.D.C.
Truck, 18 wheeler	800 S.D.C.
Wall, Interior Plaster	120S.D.C.
Wall, Exterior Wood	150S.D.C.
Wall, Exterior Brick	200S.D.C.
Wall, Cinder Block	300S.D.C.
Wall, Reinforced Concrete	400S.D.C.
Weapon, Hard Wood	40S.D.C.
Weapon, Metal Sword	100S.D.C.
Weapon, Small Pistol	35 S.D.C.
Weapon, Assault Rifle	75 S.D.C.
Weapon, Artillery Piece	1500S.D.C.
Window, Ordinary Glass	20S.D.C.
Window, Plexiglass	35 S.D.C.

Simultaneous Attack: Instead of defending with a parry, dodge or entangle, a character can choose to do a simultaneous attack. In this case, the character does not defend ("Go ahead, hit me; I can take it!") and simply attacks in response. The advantage of a simultaneous attack is that *neither* opponent can parry, dodge or entangle. In all probability, both will take damage. *Exception:* An opponent with paired weapons can engage in simultaneous attack (with one weapon) AND parry (with the other), OR, both the paired weapons can be used to strike with NO parry.

Sneak Attack: An attacker may lie in wait (ambush), attack from behind, or sneak up (prowl) on an opponent. If the foe does not discover the attacker, then the sneak attack is successful. The sneak attacker always has initiative, and the defender is not able to parry or dodge the sneak attack.

Strike: Anyone attempting to hit an opponent must roll to strike. As with all combat rolls, a roll to strike is made with twenty-sided dice.

Throw: Simply, this means throwing a weapon. Rolling to throw is exactly the same as rolling to strike, except that there are different bonuses per weapon type. See Weapon Proficiency.

NOTE: A character may use ANY type of weapon, but gets no combat bonuses, such as strike or parry, unless he has a Weapon Proficiency (W.P.) in that particular weapon. This applies to modern and ancient weapons.

HAND TO HAND: BASIC

- Level 1** Two attacks per melee; +2 to pull/roll with punch, fall or impact.
- 2 +2 to parry and dodge.
 - 3 Kick attack does 1D6 points damage.
 - 4 + One additional attack per melee.
 - 5 +1 to strike.
 - 6 Critical strike on an unmodified roll of 19 or 20.
 - 7 +2 to damage.
 - 8 Judo-style body throw/flip; does 1D6 damage, and victim loses initiative and one attack per melee.
 - 9 + One additional attack per melee.
 - 10 An additional +2 to pull/roll with punch, fall or impact.
 - 11 An additional +1 to parry and dodge.
 - 12 An additional +1 to strike.
 - 13 Critical strike or knockout from behind.
 - 14 An additional +2 to damage.
 - 15 + One additional attack per melee.

HAND TO HAND: EXPERT

- Level 1** Two attacks per melee to start; +2 to pull/roll with punch, fall or impact.
- 2 +3 to parry and dodge.
 - 3 +2 to strike.
 - 4 + One additional attack per melee.
 - 5 Kick attack does 1D6 damage.
 - 6 Critical strike on an unmodified roll of 18, 19 or 20.
 - 7 Paired weapons.
 - 8 Judo-style body throw/flip; does 1D6 damage, and victim loses initiative and one attack.
 - 9 + One additional attack per melee.
 - 10 +3 to damage.
 - 11 Knockout/stun on an unmodified roll of 18, 19 or 20.
 - 12 An additional +2 to parry and dodge.
 - 13 Critical strike or knockout from behind (triple damage).
 - 14 + One additional attack per melee.
 - 15 Death blow on a roll of natural 20.

HAND TO HAND: MARTIALARTS

- Level 1** Two attacks per melee to start; +3 to pull/roll with punch, fall or impact.
- 2 +3 to parry and dodge; +2 to strike.
 - 3 Karate-style kick does 1D8 damage.
 - 4 + One additional attack per melee.

- 5 Jump Kick (critical strike). Entangle.
- 6 Critical strike on an unmodified roll of 18, 19 or 20.
- 7 Paired Weapons.
- 8 Leap Attack (critical strike).
- 9 + One additional attack per melee.
- 10 Judo style body throw/flip; does 1D6 damage victim loses initiative and one attack.
- 11 An additional +4 to damage.
- 12 An additional +2 to parry and dodge.
- 13 Knock-out/stun on an unmodified roll of 18, 19 or 20.
- 14 + One additional attack per melee.
- 15 Death blow on a roll of a natural 20.

HAND TO HAND: ASSASSIN

- Level 1** +2 to strike (one attack per melee).
- 2 +2 additional attacks per melee.
 - 3 +3 to pull/roll with punch/fall.
 - 4 +4 to damage.
 - 5 + One additional attack per melee.
 - 6 +3 to parry/dodge. Entangle.
 - 7 Knock-out/stun on an unmodified roll of 17-20.
 - 8 + One additional attack per melee.
 - 9 Kick attack does 1D6 damage.
 - 10 Critical strike on an unmodified roll of 19 or 20.
 - 11 +2 to strike.
 - 12 Death blow on a roll of a natural 20.
 - 13 + One additional attack per melee.
 - 14 +2 to damage.
 - 15 +2 to strike.

Note Hand to Hand Assassin: This is taught to characters trained by secret organizations (CIA, Mafia, etc.), this is the specialized science of killing. It includes learning Automatic Parry, Pull Punch, Roll with Punch/Fall, Kick Attack (1D6 damage), Knock-Out/Stun, Critical Strike and Death Blow. It does NOT include the ability to do Jump Kick or Leap Attack.

PSYCHIC COMBAT

ATTACKS PER MELEE

Psychic combat is quick and simple. Each psychic attack counts as one of your character's physical attacks. Thus, if your character has four hand to hand attacks per melee he or she can substitute up to four psychic attacks. Of course, a player can mix the physical and psychic in any combination, three physical and one psi-attack or two physical and two psychic attacks and so on. Most psychic powers are not appropriate for combat, but during a combat sequence each physical and psychic *activity* counts as one *combat action/attack* that melee. The total number of combat actions per melee is equal to the total hand to hand attacks per melee. Note that some psi-abilities require time to prepare which might make any other attacks/action impossible.

A reminder: All *player* characters automatically start off with two attacks/actions per 15 second melee. Additional attacks per melee are gained from the hand to hand skills and boxing. **A typical non-player character** gets only two attacks per melee plus hand to hand combat and/or boxing skill additions. **Supernatural creature's** number of attacks vary with each individual type, usually two to six attacks per melee. The rules for mixing or substituting psychic attacks still apply.

SAVINGS THROWS AGAINST PSYCHIC ATTACKS

Psychic attacks which assail the mind, emotions or physiology of a person can always be fought off through the force of one's own will and mental endurance. Psychic attacks that fall into this category include: empathy, empathic transfer, telepathy, mind control, hypnosis, and

bio-manipulation. Some psychic powers for which there is no savings throw are telekinesis, levitation, pyrokinesis, presence sense, and see aura.

Even ordinary people have a chance of fighting or saving against a psychic attack. However, those who have psychic abilities have a much better defense against such attack than ordinary people.

To save against a psychic attack a 20-sided die is rolled to mentally parry the attack. A high roll will successfully save against the assault, indicating that the person is NOT affected by the psi-power (no damage or reaction).

Non-psychics must roll a 15 or higher to save against psi-attacks.

The minor & major psychics need to roll a 12 or higher.

The Master psychics need only to roll a 10 or higher.

Note that many of the characters also get a bonus to save vs psionic attack. For simplicity sake *all supernatural creatures* must roll a 15 or higher to save, but most have bonuses to save against psi-attacks.

INNER STRENGTH POINTS

The use of a particular psionic ability draws upon the astral body or inner strength of the individual. Each specific psionic power will indicate exactly how many I.S.P. are required to perform that ability. When a psionic has exhausted all of his I.S.P. he is unable to perform any more psionic feats until he has had sufficient rest.

The recovery of I.S.P. can be done in one of two ways: *Total Relaxation* and/or sleep at a rate of two I.S.P. for every hour, or through meditation. *Meditation* is a skill ability in which the psychic places himself in a simple hypnotic trance. This meditative trance provides maximum relaxation, recovering six (6) I.S.P. per hour.

Combat Rules for High-Tech War Machines

The following are the rules that are used when playing characters who operate power armor or robot vehicles. You will find that the basic rules are only minor modifications of the standard, **Palladium Books'** combat rules just described. The use of giant war machines requires some special considerations, modifications and clarification.

Generally, giant, robot-like constructions and armored battle suits respond to the pilot's every movement as if the construction was an extension of his own body. Weapon systems, such as railguns, auto cannons and missile launchers, are built directly into the machine, providing the pilot with more firepower than a division of 20th century tanks.

Resolving Combat

The basic steps of resolving combat are essentially unchanged. Players must still determine initiative, roll to strike, the defender may parry or dodge, damage is determined, and defender may attempt to roll with the punch or impact. These are always the basic combat actions.

Mega-Damage, S.D.C. and M.D.C

It is crucial that players clearly understand the concept of Mega-Damage and Mega-Damage Capacity (M.D.C.). Basically, M.D.C. indicates a super tough armor or physical structure. A structure so tough, that normal weapons will not damage it. To damage a Mega-Damage Capacity (M.D.C.) structure you must use something that inflicts Mega-Damage (M.D.).

Consider this example with a contemporary M.D.C. structure we all recognize, a tank. There you are, sitting inside a tank; a powerful, heavily armored (M.D.C.) weapon. A kid walks up to your tank and begins to bounce a hard rubber ball against the hull of the tank. He can do this all day long without damaging the tank in the tiniest way. The kid picks up a rock and throws it, hard, against the tank. Again, no damage is done other than a tiny nick in the paint. Now, pounding with all his might against the hull with a baseball bat, the kid is scuffing the daylights out of the paint job, but still does *no* damage. Yet, all of these items could affect and damage most items with a normal Structural Damage Capacity (S.D.C.).

You're still sitting in your tank when somebody waltzes up and lets! go with a .357 Magnum at point-blank range. The bullets bounce off the tank's armored hull, leaving only large gouges in the paint and scratched armor. No damage is done. His two buddies whip out an Uzi sub-machinegun and an M-16 assault rifle, and spray the tank with a hail of bullets. The combined attack must number into the *hundreds* of S.D.C. damage. But the tank's hull is undamaged because it is super tough . . . M.D.C.! Normal weapons, even when combined, can not I damage a mega-structure. Only a weapon that inflicts mega-damage (M.D.) can harm the tank.

A car skreeches to a halt 60ft away. Two men with a heavy duty bazooka take cover behind their compact car. *Now the tank is in trouble!* Why? Because the bazooka is a mega-damage weapon. You think: "Who are all these lunatics in this example and why are they beating on my tank?!?" **COMBAT:** The player of the tank pilot rolls a twenty-sided die (1D20), the player of the bazooka team does likewise, to determine *initiative*. The high roll goes to the bazooka team; they have initiative, which means they strike first. Again, a 1D20 is rolled, this time to *strike*. A seven is rolled. Since the tank is too large and too slow to *dodge* the bazooka team shoots and successfully strike and do damage. If the tank is lucky, it will take minimal damage (a low damage roll). If unlucky, the shell will inflict severe damage (a high roll of damage).

The tank is damaged, but can still operate because the total M.D.C. has not been depleted. As the bazooka team gets ready to fire another shell, it's the tank's turn to strike/counterattack. It aims, and the cannon is fired at the compact car the two men are hiding behind. The car has a Structural Damage Capacity (S.D.C.) of 300 and an Armor Rating (A.R.) of 6. However, the tank's cannon inflicts mega-damage, so the Armor Rating does not apply. A successful roll to strike is quickly followed by a damage roll. The roll is low. A measly 4 M.D. points. The car is a burning mass of twisted metal. Why? Because the 4 M.D. points of damage are equal to 400 S.D.C. The car is destroyed.

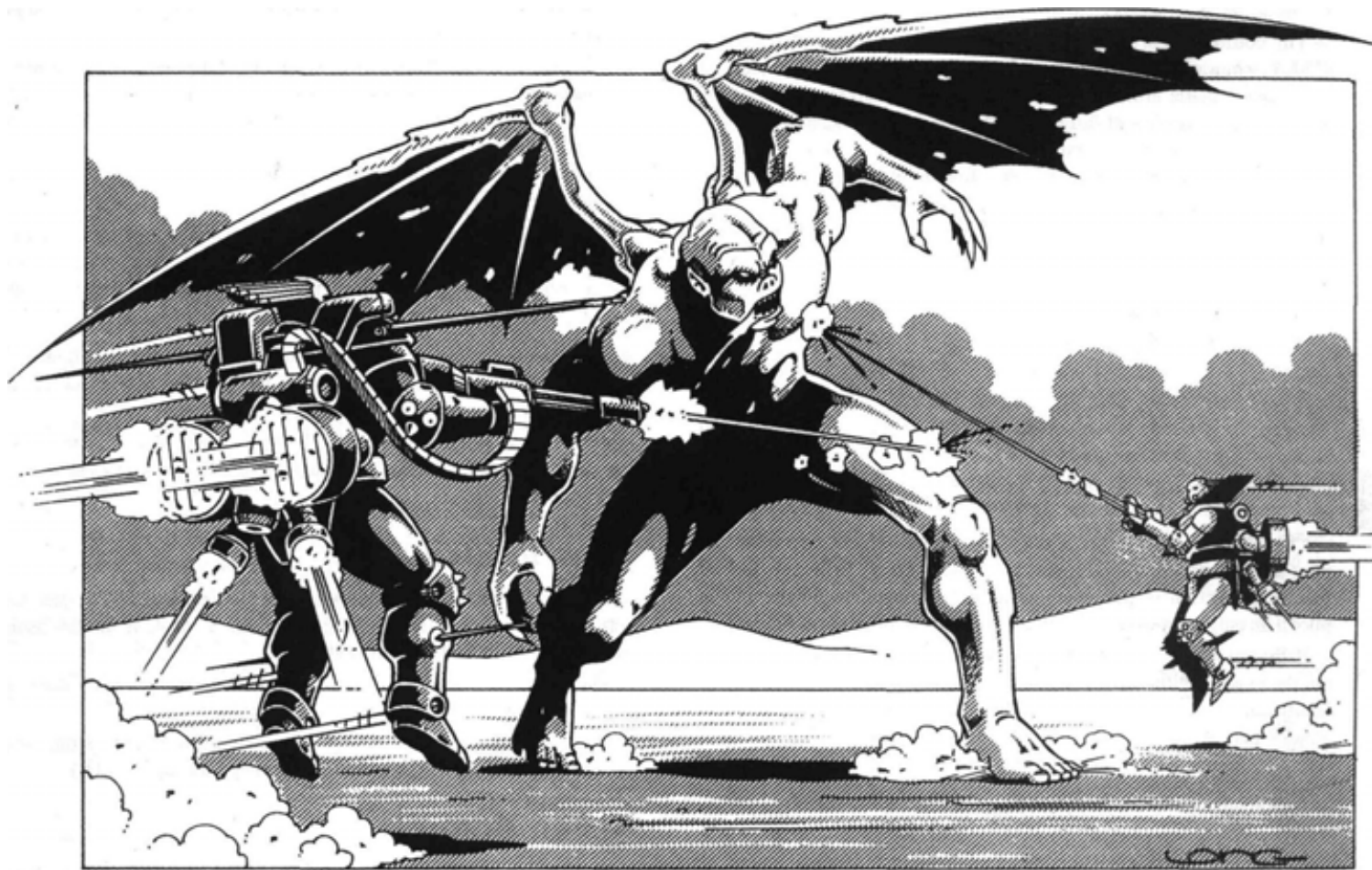

Quick Mega-Damage and M.D.C. Reference Chart

- 1 M.D. Point equals approximately 100 S.D.C. points.
- 1 M.D. Point equals 100 Hit Points.
- Armor Ratings do *not* apply when up against a weapon that inflicts mega-damage. This is always true, except with the cyber-armor.
- Normal weapons do absolutely no damage to mega-structures (M.D.C.), even if the combined total damage is over 100 S.D.C.
- Only weapons that do M.D. can damage M.D.C.

Also See Mega-Damage and M.D.C. explanation in the beginning of the book.

Armor Rating

Armor Ratings do not apply to combat robots, bionics, power armor, or any Mega-Damage Capacity (M.D.C.) structures. Either you strike and do damage, or you miss.

Armor Ratings apply only to conventional S.D.C. combat. Armor ratings do *not* apply when struck/attacked by a weapon that inflicts mega-damage. Of course, one can always attempt to dodge or roll with an attack to avoid or minimize damage.

A.R.: This is a character's **Armor Rating**. The A.R. indicates what an attacker must roll in order to do damage to the character. Any roll of 3, or better, will strike a character with no body armor. Characters with **Artificial Body Armor**, metal armor, bulletproof vests, etc., can easily be successfully attacked by rolls falling under the artificial armor's A.R.; doing damage to the S.D.C. of the *body armor*, but not to the S.D.C. of the defender. Or, by striking above the armor's A.R., damaging the character's personal S.D.C. and/or

hit points, but not the body armor S.D.C. **Example:** A defender has a natural A.R. of 5 and is wearing body armor with an A.R. of 8. If the attacker rolls 9 or better, then damage is done directly to the defender. A roll of 5, 6, 7, or 8, would only hurt the body armor, not the wearer. A roll of 1, 2, 3, or 4, would totally miss.

Determining the Number Of Attacks Per Melee and Combat Bonuses

All power armor and robot vehicles possess a design element, which creates a symbiotic link between the pilot and the machine. This symbiotic relationship enables the machine to respond to human reflexes, agility, dexterity, and mobility with amazing accuracy. The pilot's physical abilities to strike, parry, dodge, roll and attack, *do* combine with the machine's, which can effectively double all hand to hand combat abilities.

This is how it works. Players will find two skills that exclusively determine the pilot's number of attacks when piloting a high-tech robot or power armor: 1) The pilot's normal, hand to hand combat skill, and 2) The pilot's *Robot Combat skill*. Simply combine the number of attacks gained from each skill. The total number indicates the total attacks per melee possible. Most first level pilots, with both skills, will have a total of FOUR attacks per melee.

The same is done to determine the pilot's combat bonuses to strike, parry, dodge, etc. This means, if the pilot has a +2 bonus to dodge in Hand to Hand Combat and a +1 bonus to dodge in Robot Combat, the two are added together for a total of +3 to dodge. Note: The

P.P. attribute bonus is also applicable and is added to the total bonus to strike, parry or dodge.

The combining of number of attacks and combat bonuses apply ONLY when piloting Robots and Power Armor! When outside of the massive battle armor, the pilot must rely *exclusively* on his or her Hand to Hand skills and *not* the combined abilities of the two skills. Why? Because the Pilot Robot Combat skill is not a physical training, but a mechanical proficiency which relies on eye/hand coordination, reflex and dexterity as they relate directly to the machine. The Pilot Robot Combat skill does not build physical strength, endurance or combat techniques.

Who Can Pilot a Robot Vehicle?

The operation of a giant robot war machine or power armor requires special training. Without that training it is impossible to operate any robot vehicles. Other piloting skills are *not* applicable. Just because you can drive a car, doesn't mean you can operate a tank or fly an airplane. The same is true of robot vehicles and exo-skeletons like power armor. Characters must have the *Basic* or *Elite Robot Combat* skill to operate robot vehicles.

Characters who have some degree of robot vehicle operation can pilot most human designed robots and power armor. However, lack of formal instruction in that specific machine's operation means he can pilot it on only the most fundamental level. Restrictions are as follows:

If the pilot has only the normal, hand to hand combat skill, those are the exact abilities that apply to the Robot in combat. There are NO additional bonuses added. A first level character will usually have two attacks per melee. If the pilot does not have hand to hand combat training, he or she is limited to one attack per melee and **no** special bonuses. Furthermore, the robots maximum speed/manueverability is reduced by 30%.

Weapon Selection

The Robot pilot usually has several modes of attack available to him. These may include energy weapons, machineguns, grenade launchers, missiles, and hand to hand combat. Weapons or modes of attack, can be used in any combination. You are limited only by the number of attacks per melee and possible, payload and rate of fire restrictions. **For example:** A character piloting a Coalition Urban Assault hot (Enforcer UAR-1) has five attacks per melee. The character fires a burst from its right shoulder rail gun (attack #1), fires a volley of four missiles (attack #2), launches a pair of medium range missiles at a fleeing hovercraft (attack #3), fires another burst from its rail gun (attack #4), and punches a guy in power armor who flew close to it (attack #5). All this in one melee round or 15 seconds. Wait a minute, you say. The UAR-1 fired a total of six missiles, as well as two rail gun bursts and a punch. Isn't that NINE attacks? No, and here's why.

Volleys & Bursts

One volley or one burst *counts as one attack*, even if a dozen, yes 12, rounds are fired. How? Because it requires only one attack/action to fire several rounds, *simultaneously*, at *one* specific target. Roll to strike and dodge as usual.

Disadvantages

1. The entire volley or burst must be directed at ONE specific target. The character can *not* divide a volley or burst between several targets. To attack more than one target the pilot must take time to aim and fire at each, which means each is a separate attack that melee. **For Example:** A Coalition Urban Assault Bot is up against four bandit Robots. The pilot decides to launch four of his 12 missiles at *one* enemy. That's one attack, leaving three more that melee. He can *not* fire the four missiles simultaneously at all

four of the enemy. To strike all four, the pilot must fire at *each*, individual target separately. However, this will take up all four of the pilot's attacks that melee.

- 2. Must roll to strike for the entire volley or burst, as if it were one unit.** This generally means that the entire volley or burst, either strikes and does multiple damage (roll for each missile in the volley) or the entire volley misses, doing no damage at all. Do *not* roll to strike for each, individual missile or round. Also see Missiles for related combat data.
- 3. Continuous fire of bursts** can often be maintained for the entire melee. While the full melee burst counts as one attack and does significant damage, that particular weapon can not be used against any other targets for that entire melee round.
- 4. Payload:** Volleys and bursts usually deplete a limited number of missiles or rounds quickly. Once the payload is expended, the weapon is temporarily useless.

Note: Unless limited by volleys, bursts, or other listed restrictions, the same weapon can be fired repeatedly in the same melee or in tandem with others.

How to Strike

The procedure for ascertaining a strike is unchanged. The attacker rolls a 20 sided die (1D20). A roll of 1, 2, 3, or 4, is an automatic miss. A roll of 5 or higher is a strike/hit.

The only way a M.D.C. target can avoid being struck is by dodging out of the way or parrying the attack, if possible.

Remember, Armor Ratings (A.R.) do not apply to M.D.C. structures, or when up against weapons that inflict mega-damage (M.D.).

Strike Bonuses

Bonuses to strike can be gained by skills, such as hand to hand combat and/or Robot combat and/or from a high Physical Prowess (P.P.) attribute. All bonuses are accumulative. Remember, bonuses from Robot combat apply only when a Robot is being piloted.

Critical Strike

A critical strike occurs when a player with hand to hand combat skill makes an extremely high die roll to strike without the aid of bonus modifiers. An unmodified, "natural" 20 is always a critical hit, regardless of hand to hand training.

Critical strikes do double damage. Optional damage tables have been provided for additional side effects from critical strikes. Their inclusion in the game is up to the GM and/or players.

Close Proximity Strike Bonuses

Technological advances have made war a long-range affair, with soldiers firing missiles at opponents, who appear as tiny blips on a radar screen miles away. However, the creation of battle armor, has restored the strength of the infantry, making close range combat possible. Thus, if opponents are within close proximity of one another (within 500ft/152m), they gain a bonus of + 1 to strike. This bonus applies to all combatants, skilled and unskilled, using weaponry or hand to hand combat with Robots and Power Armor. It does not apply to normal hand to hand combat among humans.

Called Shots

A character may attempt to shoot a specific target or area. This is done by clearly stating what the exact target is before the roll to strike is made. Once the shot is "called", the player rolls the usual 1D20 to

strike. A successful roll, above a 12, hits exactly whatever the intended target was, unless the opponent dodges.

Called shots can be an important strategy enabling characters to *disable* robots and military vehicles rather than destroy the whole unit. This means a character can destroy specific targets on robots and vehicles, such as radar antennas, weapon barrels, sensors, mechanical legs, arms, etc.

Note: Any shot which is not called will strike what is identified as the *main body* of the robot or vehicle. The main body is the largest, bulkiest part of the target and most likely to be hit. If a player calls his shot, but misses by rolling under 12, but above 4, he/she still strikes, but hits the *main body* instead of the specific, "called" target.

I avoid random hit location tables because I feel the randomness is too fluky and unrealistic.

To Roll With a Punch, Fall, or Impact

This is a saving throw of sorts, or a second dodge, to minimize damage. Players of Heroes Unlimited will already be familiar with this hand to hand combat rule. In this case, if the player fails his dodge to roll and is about to be hit by a missile(s), he has a sort of second dodge or saving throw, where the character tries not to resist the explosive impact and rolls *with* it. A successful roll with impact works similar to a dodge. The player must roll 1D20 and match or better the roll to strike. A success means the character suffers only *halfdamage*. A failed roll means a direct hit and full damage. A character can roll with the impact from explosive missiles, punches, body blocks, falls, and similar impact damage.

You can *not* roll with the impact of attacks from auto cannons, railguns, machineguns, energy weapons, or plasma/napalm missiles.

The Dodge

The dodge for giant robots is identical to its hand to hand counterpart. The defender must roll a twenty-sided die (1D20), and match or better his attacker's roll to strike. A successful roll means he has moved out of the way and takes no damage. A failed roll means the dodge was not a success and the character is hit, taking full damage.

Missiles

The descriptions of war machines in this game, will specifically state if they can launch missiles. It will also denote the type of missile as *short, medium, long range, or mini-missiles, a vehicle can fire two types of missiles, such as medium and long range*. Under each range category you will find a selection of specific types of warheads, such as high explosive, fragmentation, plasma, reflex, and so on. Not all missile warheads are of a destructive nature and can be smoke, tear gas or chemical (i.e. fire retardant, and knockout gas). Combat vehicles can fire one warhead type, or any combination of missile types, as long as they are listed under the appropriate range category.

Strikes: Guided Missiles

Missiles do not enjoy the pilot's combined bonuses to strike. Since they are all self-guided, missiles are launched as separate units with their own bonus of +3 to strike. Smart bombs are +5 to strike.

Rolls to strike are made on the usual, twenty-sided die. Missiles can be launched one at a time (roll to strike for each), or in volleys of two or more (roll once to determine whether the entire volley strikes its target).

It is possible to dodge one, two, or even three missiles. However, it is impossible to dodge a volley of four or more missiles. It is also possible to shoot a missile(s) down before it hits you. *See Volleys and Bursts, and Dodging Missiles for more details about missile combat.*

Damage From Missile Strike

Direct hits do full damage. A volley of missiles inflicts full damage from each and every missile in the volley.

Near misses do half damage. **The First** is by being within the blast radius of the target struck by a direct hit. **For example:** Your companion standing 10ft (3m) away, is hit by a high explosive missile with a 30ft (9m) blast area. He takes full damage from a direct hit, but you are also caught in the blast because you were standing too close together. Fortunately, your character takes half damage since he was not caught directly in the blast. Damage can be reduced by half again if the player makes a successful die roll to "roll with punch, fall or impact".

The Second way one takes half damage from a near miss is by successfully "rolling with the punch, fall or impact" or an attack. In this case, the player fails his dodge roll and is about to be hit by a missile(s). However, he has a sort of second dodge or saving throw, where the character tries not to resist the explosion and rolls with the impact. A successful roll means the character suffers half damage. A failed roll means a direct hit doing full damage.

Dodging Guided Missiles

ALL the missiles used by the Coalition and most other high-tech forces, are self-guided missiles. Generally, most are preprogrammed to respond to specific images (video camera/sensor mounted in the nose of the warhead), or specific heat or radiation levels which clearly identify the enemy.

Smart Bombs that can identify the enemy and chase it down will keep going until they find a target, or are destroyed. They can actually dodge attacks directed at them, and turn around to attempt to hit a target if it misses, or if the target dodges the first attack.

Conventional Guided Missiles: +3 to strike.

Smart Missiles: +5 to strike, +4 to dodge; Two attacks per melee (until it hits). All missiles always strike the *main body*.

Contrary to what one might think, you *can* dodge one, two and even three, guided missiles. The dodge rules are the same as always. However, it is impossible to dodge a volley of four or more missiles launched simultaneously. A volley of four or more missiles will strike every time, with each and every missile in the volley hitting and inflicting damage. The character has two options to avoid or minimize the damage of a massive missile volley; try to roll with the impact, taking half the normal damage; or shoot the missiles down before they strike.

Shooting Missiles

Shooting and depleting the M.D.C. of a missile can detonate and destroy it. However, there are restrictions.

1. The character must have an attack(s) available to him/her that melee to assail the missile. If all the attacks for that melee have already been used up, the character can not shoot at the missile(s).
2. Can only shoot at *one* missile, within the volley, at a time. A volley of six missiles would require six attacks, which is impossible at the speed missiles travel. This means the player has only one or two attacks (GM's discretion) to shoot at one or two missiles within the volley. However, if one missile is detonated, there is a 45% chance (1-45%) that its explosion will detonate the other missiles in the entire volley.

The player can also use his own missiles, if available, to shoot down a missile volley. Under this circumstance, there is a 75%

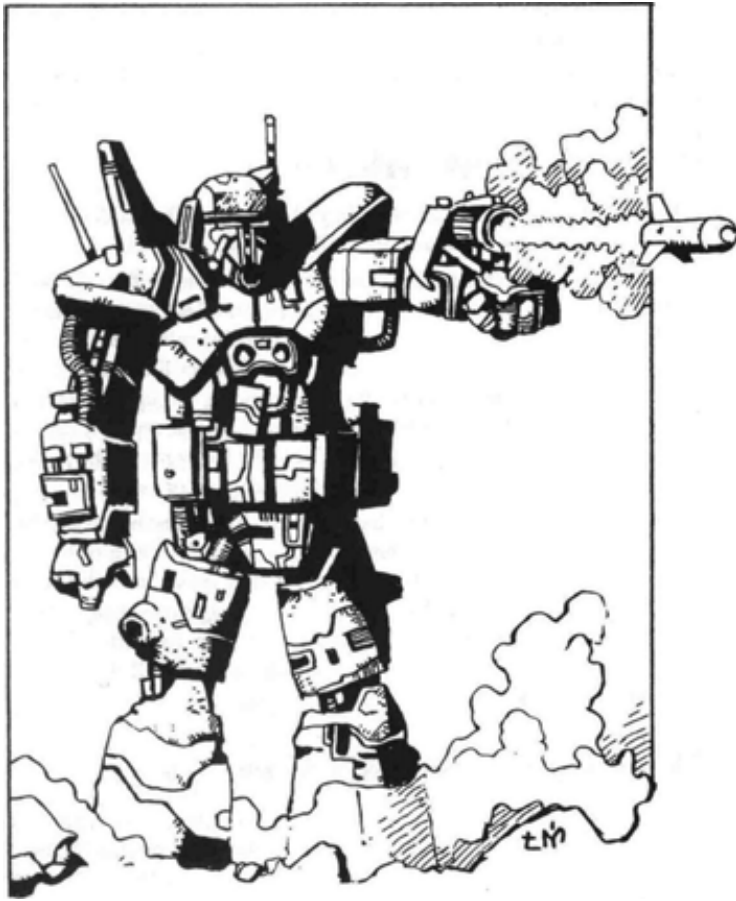

(1-75%) likelihood of detonating the entire volley of missiles.

3. If the M.D.C. of the missile is not completely depleted, it is damaged, but does not detonate and will still strike its target, inflicting full damage.
4. Attacks on a missile count as a normal attack.

Special Missile Defense Tactic

If a missile can not be dodged, the pilot can sacrifice his robots arms by covering its main body with them, thus allowing the arms to take the damage instead of the body. The disadvantage of this tactic is that the arms are likely to be blown to smithereens. If the arms are not destroyed, I strongly suggest the GM, or player, rolls on the *Optional Critical Damage Tables* under "arms", to determine specific damage and side effects.

Other Combat Terms

Payload: Indicates the finite number of missiles or rounds. Energy weapons are generally considered to have unlimited payload or have energy batteries (E-Clips) that work like the ammo clips for automatic weapons.

Range: The maximum effective range or distance a weapon can fire; or a missile or vehicle can travel.

Rate of Fire: This will indicate any limitations as to how many times a weapon can be fired per melee, and/or the number of rounds or missiles in a burst or volley.

Generally, a weapon, especially energy weapons, can be fired repeatedly, equal to the pilot's combined, hand to hand and Robot combat skills. Any combination of weapons can be used per melee.

Missile Notes

1. **The terms**, light, med. or medium and heavy, found in parenthesis after the warhead type, refers to the destructive force of the warhead.
2. **All missiles** are self-guided; +3 to strike.
3. **Smart missiles** are self-guided smart bombs which can be programmed to seek out and attack a specific target. It can change course, adjust speed to conserve fuel, dodge attacks aimed at it, and turn around to try to strike a target again if it misses the first time. +5 to strike (instead of +3), +4 to dodge; 2 attacks per melee. Radar 100 mile (160km) range.
4. **Multi-warhead missiles** are usually a cluster of medium range missiles housed inside the casing of a large, long range missile. When the body casing runs out of fuel or reaches its target, it fires the four medium range missiles.
5. **Plasma** is a concentrated, liquid heat, ten times hotter than normal napalm.
6. **Fragmentation** missiles are missiles that send out fragments, or shards of metal, upon impact, affecting a larger area.
7. **Fire Retardant** missiles explode, releasing a chemical foam that puts out fires.
8. **Smoke** missiles release large, billowing clouds of smoke, filling the blast radius. They are used to provide cover or to mark an area.
9. A **Proton Torpedo** is a longer range, more powerful, explosive, energy missile.
10. **The maximum range** is the maximum effective range of the missile.
11. Missiles have been assigned a M.D.C.; depletion of the M.D.C. from attack will detonate the missile.
12. **The speed** is provided to give players an idea of how fast the missiles travel.
13. **The blast radius** is the full area damaged by the missile impact. The specific target of the missile takes FULL DAMAGE, while all else in the blast radius takes half damage.

Mini-Missiles

Many of the smaller robots and power armor suits utilize mini-missiles; small, powerful bazooka type rockets that inflict mega-damage. Range is generally half as great as the standard short-range missiles, but the mega-damage is comparable.

Unlike its larger predecessors, the mini-missile is not self-guided and has no special bonuses to strike. **Strike bonuses** are the same as *modern weapon proficiencies*; **aimed** (firing no more than two missiles, +3), bursts (firing a volley of missiles in any quantity, 3 to 60) and **wild** (firing a missile or volley of missiles without taking time to stop and aim). A character can also add in any strike bonus from a high Physical Prowess (P.P.) attribute.

An Example of Combat

Combat as a pint sized human or a giant robot are fundamentally the same. The following example utilizes giant robot war machines.

Lets go back to our previous example of the Coalition Enforcer UAR-1 from *Weapon Selection*. We already know what weapon selections were made, but lets see how it all works in an actual combat melee.

The scene. The UAR-1 Enforcer walks into a small group of high-tec bandits buying stolen Coalition SAMAS power armor from a black marketeer on the out-skirts of the Burbs. The deal has just been concluded and the seller of the stolen armor is taking off in his hover jet. The bandits, know they are in trouble and move to attack. One bandit is already in SAMAS armor, another is frantically hurrying to finish putting on the rest his armor. The rest scramble for cover.

The fight! First, ALL parties, including those scrambling for cover, roll a twenty sided die (1D20) to see who has the initiative; include possible bonuses, the higher the roll the better. *Initiative* a reaction roll to see who has first attack and then who is next, an so on. Once the initiative is established combat follows. Here are the results of the initiative rolls.

19: Scrambling group of bandits.

17: Bandit in SAMAS power armor.

16: UAR-1 Enforcer.

13: Hover jet trying to make an escape.

7: The poor chump struggling to get into his power armor.

The scrambling bandits have first initiative and successful hide behind debris and vehicles before the Enforcer can react. They are going to stay out of combat and try to sneak away during the fight.

The second person to act is the bandit SAMAS! In this case, the pilot has a total of four (4) melee attacks. On his first attack he stands and opens up with a rail gun burst on the Enforcer. **A roll to strike** is made (1D20). A roll of 14+ 1 (burst W.P. bonus), plus another +1 from a basic power armor training makes the total strike roll a 16. A definite hit. Damage is rolled; 20 mega-damage (M.D.) is inflicted on the UAR-1 Enforcer.

The third character to attack is the Enforcer. The pilot has opted to ignore the SAMAS shooting at him and fires his right shoulder rail gun at the unfortunate bandit who is half dressed in his power armor. The logic is that two "Sams" will make for a difficult fight, so try to take-out this one before it gets into action! A twenty sided die (1D20) is rolled to strike. The strike roll with bonuses combined is a 14. A hit is certain death for the bandit, so he rolls a dodge! (Note: the defender can always roll a parry or dodge to defend himself, which ever is appropriate). 1D20 is rolled and a 14 is the total with bonuses. A tie! This fellow has lucked out. Defenders always win ties. He successfully dodges the hail of bullets, but they are so close that he can feel the breeze they make as they shoot past.

The fourth person to make a move is the pilot of the hover jet. He punches the throttle and blasts the hell out of there!

The fifth person to attack/act is the bandit trying to get dressed in the SAMAS power armor, however, he was forced to use an attack/melee action when he made his dodge. He'll have to wait a few second till the next series of attacks this melee round.

Note that all of this has happened in a matter of two to four seconds and is only the first series of attacks/combat action of the first melee round. Combat continues.

Combat continues. Second attack. The bandits are all trying to run away so they are not involved in the melee.

The next guy in line to attack is the SAMAS bandit because he has the initiative over the Enforcer. He stands his ground, lets loose with a battle cry and another burst from his rail gun! 1D20 is rolled to strike. A natural 20 is rolled (a twenty before bonuses are added). A critical hit! Double damage!! A total of 60 mega-damage (M.D.) is rolled and inflicted on the main body of the Enforcer.

Its the Enforcer's turn to counter attack. He's decided that the guy in the power armor is too dangerous and launches four (4) short range missiles from the bot's right shoulder. Four missiles can not be dodged, so the SAMAS tries to blast the volley before they hit (a smart move, but uses up his next melee attack). 1D20 is rolled to strike the missiles. A 14 is a strike and 20 M.D. is inflicted detonating one of the missiles. Percentile dice are rolled to see if all the missiles are detonated. The chance for success is 1-45%, unfortunately a 72 is rolled and three of the missiles strike. Damage is $3D4 \times 10$ (three fragmentation missiles) inflicting a total of 90 mega-damage point on the SAMAS (that hurts).

The other bandit spends his melee action getting into his SAMAS armor rather than trying an attack.

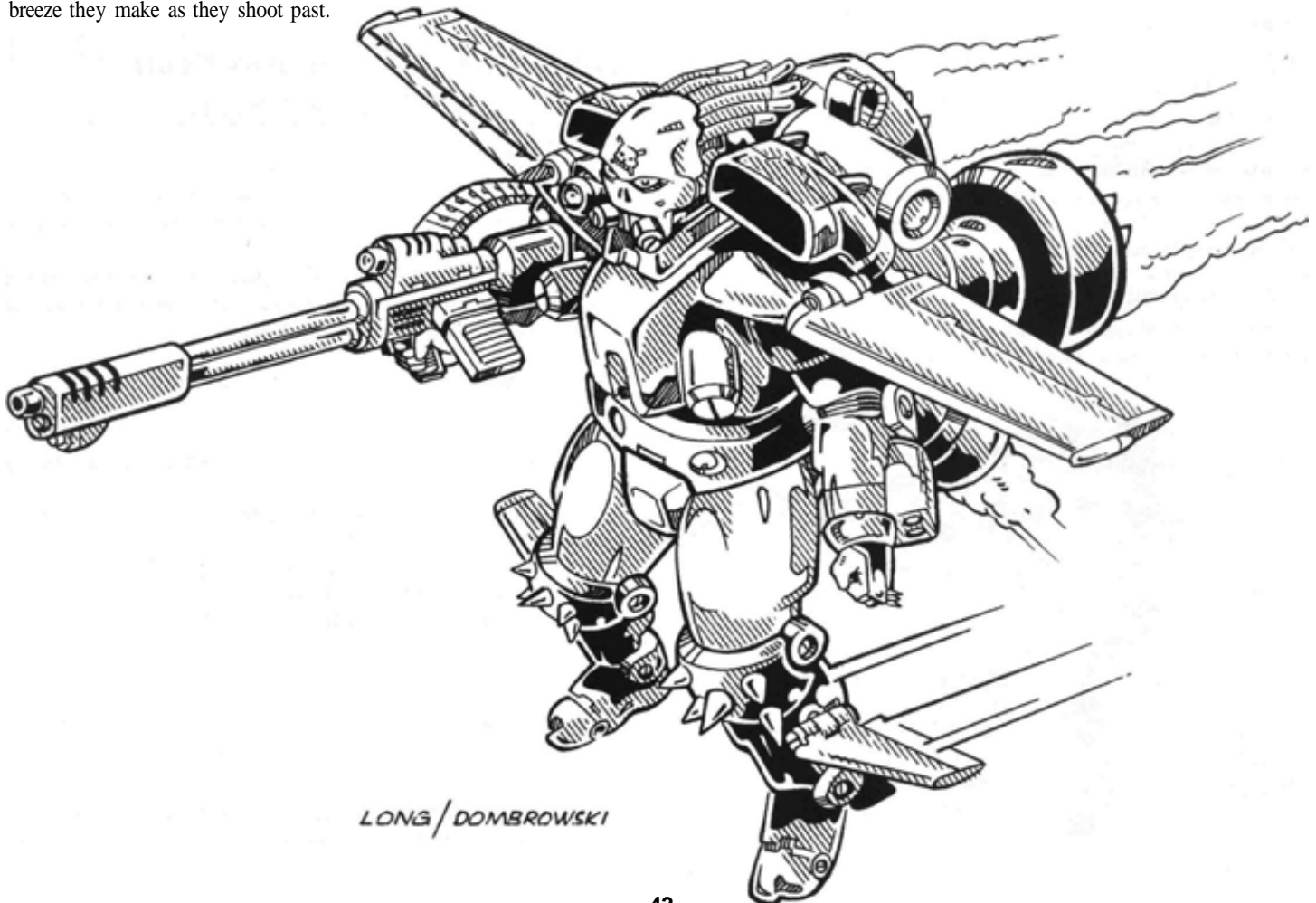

Combat continues. **Third Attack.**

The first SAMAS bandit. Because the first SAMAS bandit used his next attack on shooting the missiles he has *lost the initiative and what would have been his third attack!*

The UAR-1 Enforcer attacks. Turning his attention to the speeding hover jet, he fires a pair of medium range, high explosive missiles from the missile launcher above his left shoulder. One die 20 is rolled to strike for the pair. An 11 +3 (guided missile bonus) makes a strike roll of 14. The pilot can attempt a dodge by rolling 1D20. The dodge roll with bonuses is 12. The missiles hit inflicting 180 mega-damage (4D6 x 10M.D.). The hoverjet is crippled and falls earthward in flames.

The second SAMAS bandit spends this combat action completing getting dressed in the armor. He's ready for action in the next second.

Combat continues. **Fourth Attack.**

The first SAMAS bandit regains the initiative because he was not attacked last melee, but mainly because the UAR-1 Enforcer turned his attention to a different target. He fires the rail gun, rolls 1D20 to strike, hits, and rolls damage as usual. The damage to the Enforcer is noted.

The UAR-1 Enforcer counter attacks firing back with his rail gun. 1D20 to strike is rolled, hits, and damage is rolled as usual. The damage to the SAMAS is noted (this armor is in bad shape, another blast or two and he may be finished).

The Second SAMAS bandit is ready for action, but only has one attack left, out of his four, because he use two melee actions getting into the armor and one dodging. He decides that discretion is the better part of valor and attempts to fly away. While flying away he buzzes the Enforcer and fires a *wild burst* from his rail gun. 1D20 is rolled to strike, he misses (a 4 is rolled).

Combat continues. **Fifth attack.**

Both of the SAMAS bandits are out of melee attacks.All they can do is defensive maneuvers; e.g. parry and dodge.

The UAR-1 Enforcer has a fifth attack. He can shoot missiles, the rail gun, lasers, or engage in hand to hand; punches, kicks, stomps, etc. Perhaps foolishly the pilot swats at the second SAMAS buzzing past his head. 1D20 is rolled: an 18 to strike with bonuses. The SAMAS fails to dodge (a 15) and is hit taking 5 M.D. points of damage. 15 seconds of combat has passed.

NEXT melee round!

Initiative is rolled again to determine the order of attack and combat continues until somebody surrenders, escapes, or is destroyed.

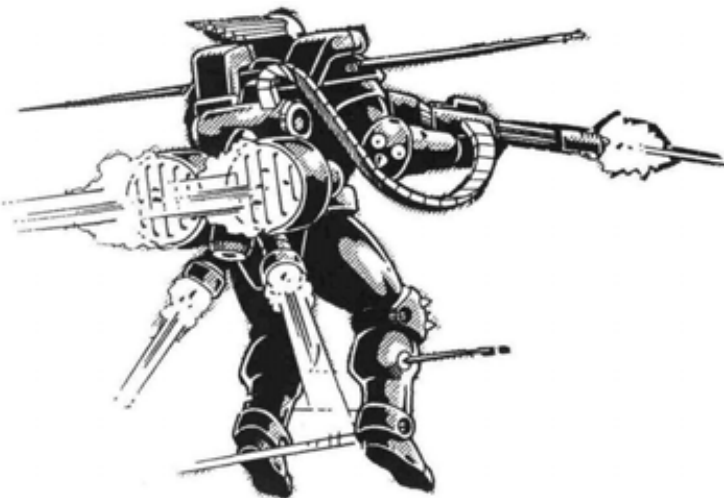

Robot and Power Armor Combat Training and Bonuses

Hand to Hand Bonuses From Robot Basic Combat Training

- Pilot is familiar with the piloting of most giant robots, including the Coalition and Titan series.
- One hand to hand attack per melee (plus those of the pilot)
- Body block/tackle/ram — 1D6 M.D. plus a 50% chance of knocking opponent down (this will cause the victim to lose initiative and one attack that melee). Counts as TWO attacks.
- No body flip
- No kick
- + 1 to strike at second level
- + 1 to parry at second level
- No dodge
- + 1 to roll with punch, fall or impact (explosion), reducing damage by half.
- Critical strike same as pilot's hand to hand.
- One additional hand to hand attack at level six.
- One additional hand to hand attack at level twelve.

Damage: Standard per each specific robot.

Note: Training in a *specific* Robots will get the character the full range of bonuses and abilities possible from that robot. Basic training is just a rudimentary knowledge of piloting giant robots with little actual piloting time.

Hand to Hand- Bonuses From Titan Assault Robot Series Combat Training

- Two hand to hand attacks per melee (plus those of the pilot).
- Body flip/throw — 1D4 M.D. plus victim loses initiative and one attack that melee.
- Body block/tackle/ram — 1D6 M.D. plus a 75% chance of knocking opponent down (this will cause the victim to lose initiative and one attack that melee). Counts as TWO attacks.
- Kick attack
- + 1 to strike
- + 2 to parry
- + 2 to dodge
- + 2 to roll with punch, fall, or impact (explosion), reducing damage by half.
- Critical strike same as pilot's hand to hand.
- One additional hand to hand attack at level six.
- One additional hand to hand attack at level eleven.

Damage: **Restrained Punch** — 1D4 M.D.

Full Strength Punch — 2D6 M.D.

Kick — 1D6 M.D.

Leap Kick — 2D6 M.D.

Body Flip — 1D4 M.D.

Body Tackle — 1D6 M.D.

Stomp — 1D4 M.D.; effective only against small objects (12ft/3.6m tall or smaller).

Remember, these bonuses are in addition to the pilot's own hand to hand training and attribute bonuses. They do *not* apply to the pilot's physical abilities outside the robot.

Hand to Hand Bonuses From Reconnaissance Type Robot Combat Training

- One hand to hand attacks per melee (plus those of the pilot).
- Body flip is impossible.
- Body block/tackle/ram — 2D6 M.D. plus an 68% chance of knocking opponent down (this will cause the victim to lose initiative and one attack that melee). Counts as TWO attacks.
- Kick attack is impossible
- +1 to strike
- +1 to parry
- No roll with fall or impact bonus.
- Critical strike same as the pilot's hand to hand.
- One additional attack at level six.
- One additional attack at level twelve.

Damage: **Punch** — 1D6 M.D.

Body Block — 2D6 M.D.

Stomp — 1D4 M.D.; effective only against small objects (18ft/5.4m tall or smaller).

Remember, these bonuses are in addition to the pilot's own hand to hand training and attribute bonuses. They do *not* apply to the pilot's physical abilities outside the robot.

Hand to Hand Bonuses From UAR-1 Enforcer Combat Training

- Two hand to hand attacks per melee (plus those of the pilot).
- Body flip/throw — 1D4 M.D. plus victim loses initiative and one attack that melee.
- Body block/tackle/ram — 2D4 M.D. plus a 76% chance of knocking opponent down (this will cause the victim to lose initiative and one attack that melee). Counts as TWO attacks.
- Kick attacks
- +1 to strike
- +3 to parry
- +2 to dodge
- +2 to roll with punch, fall, or impact (explosion), reducing damage by half.
- Critical strike same as pilot's hand to hand.
- One additional hand to hand attack at level five.
- One additional hand to hand attack at level ten.

Damage: **Restrained Punch** — 1D4 M.D.

Full Strength Punch — 2D6 M.D.

Power Punch — 3D6 + 4 M.D.

Tear or Pry with Hands — 1D6 M.D.

Kick — 1D6 M.D.

Leap Kick — 3D6 M.D.

Body Flip/Throw — 1D4 M.D.

Body Block/Tackle — 2D4 M.D.

Stomp — 1D4 M.D.; effective only against small objects (12ft/3.6m tall or smaller).

Remember, these bonuses are in addition to the pilot's own hand to hand training and attribute bonuses. They do *not* apply to the pilot's physical abilities outside the robot.

Hand to Hand Bonuses From Power Armor Elite Combat Training

- Two hand to hand attacks per melee (plus those of the pilot).
- Body flip/throw: 1D4 M.D. plus victim loses initiative and one attack that melee. Possible only in battloid mode.
- Body block/tackle/ram: 1D6 M.D. plus a 70% chance of knocking opponent down (this will cause the victim to lose initiative and one attack that melee). Counts as TWO attacks.
- Kick attack.
- Leap kick; counts as two attacks.
- +2 to strike.
- +2 to parry.
- +2 to dodge in normal combat; +5 to dodge flying.
- +3 to roll with punch, fall or impact (explosion), reducing damage by half.
- Critical strike, same as pilot's hand to hand.
- One additional hand to hand attack at level six.
- One additional hand to hand attack at level eleven.

Damage: **Punch** 1D6 M.D.

Kick 1D6 M.D. (possible only in battloid).

Leap Kick 2D6 M.D.

Body Flip/Throw 1D6 M.D.

Body Block/Tackle 1D6 M.D.

Remember, these bonuses are in addition to the pilot's own hand to hand training and attribute bonuses. These power armor combat bonuses do *not* apply to the pilot's physical abilities when outside the armor.

Hand to Hand Bonuses From Power Armor Basic Training

- One hand to hand attack per melee (plus those of the pilot).
- Body flip/throw: 1D4 M.D. plus victim loses initiative and one attack that melee.
- Body block/tackle/ram: 1D4 M.D. plus a 50% chance of knocking opponent down (this will cause the victim to lose initiative and one attack that melee.) Counts as TWO attacks.
- Kick attack.
- Leap attack; counts as two attacks.
- +1 to strike.
- +1 to parry.
- +1 to dodge in normal combat, +3 to dodge flying.
- +2 to roll with punch, fall, or impact (explosion), reducing damage by half.
- Critical strike, same as pilot's hand to hand.
- One additional hand to hand attack at level six.
- One additional hand to hand attack at level twelve.

Damage: **Punch** 1D6 M.D.

Kick 1D4 M.D.

Leap Kick 2D4 M.D.

Body Flip/Throw 1D4 M.D.

Body Block/Tackle 1D4 M.D.

Remember, these bonuses are in addition to the pilot's own hand to hand training and attribute bonuses. These power armor combat bonuses do *not* apply to the pilot's physical abilities when outside the armor.

MISSILES RANGES WARHEADS DAMAGE



Short Range Missiles

<u>Warhead</u>	<u>Mega-Damage</u>	<u>Speed</u>	<u>Maximum Range</u>	<u>Blast Radius</u>	<u>M.D.C.</u>
High Explosive (light)	1D4x10	500mph(804kmph)	3 miles (4.8km)	10ft (3m)	5
High Explosive (Med.)	1D6x10	500mph (804kmph)	2 miles (3.2km)	15ft (4.6m)	5
Fragmentation (light)	1D4x10	450mph (724kmph)	2 miles (3.2km)	20ft (6.1 m)	5
Armor Piercing (Med.)	1O6x10	650mph(1045kmph)	5 miles (8km)	5ft (1.5m)	5
Plasma/Napalm (Med.)	1D6x10	500mph (804kmph)	3 miles (4.8m)	15ft (4.6m)	5
Tear Gas	None	200mph(321kmph)	1/2 mile (.8km)	10ft (3m)	5
Knock-Out Gas	None	200mph(321kmph)	1/2 mile (.8km)	10ft (3m)	5
Smoke (colors available)	None	300mph(482.7kmph)	1 mile (1.6km)	20ft (6.1 m)	5
Fire Retardent	None	200mph(321kmph)	1/2 mile (.8km)	20ft (6.1m)	5

Medium Range Missiles

<u>Warhead</u>	<u>Mega-Damage</u>	<u>Speed</u>	<u>Maximum Range</u>	<u>Blast Radius</u>	<u>M.D.C.</u>
High Explosive (light)	1D6x10	1200mph(1929kmph)	50 miles (80.4km)	20ft (6.1m)	10
High Explosive (Med.)	2D4x10	1200mph(1929kmph)	40 miles (64.3km)	20ft (6.1m)	10
High Explosive (Heavy)	2D6x10	1200mph(1929kmph)	40 miles (64.3km)	30ft (9.1m)	10
Fragmentation (Med.)	2D4x10	1000mph(1608kmph)	40 miles (64.3km)	40ft (12.2m)	10
Armor Piercing (Med.)	2D4x10	1600mph(2571kmph)	60 miles (80.4km)	20ft (6.1m)	10
Plasma/Heat (Heavy)*	2D6x10	1400mph(2251kmph)	40 miles (64.3km)	40ft (12.2m)	10
Multi-Warhead*	2D4x10	1200mph(1929kmph)	80 miles (128.7km)	20ft (6.1m)	10
Smoke	None	1000mph(1608kmph)	40 miles (64.3km)	40ft (12.2m)	10

Long Range Missiles

<u>Warhead</u>	<u>Mega-Damage</u>	<u>Speed</u>	<u>Maximum Range</u>	<u>Blast Radius</u>	<u>M.D.C.</u>
High Explosive (Med.)	2D4 x 10	2010mph(Mach3)	500 miles (804km)	30ft (9.1m)	20
High Explosives (Heavy)	3D4 X 10	2010mph(Mach3)	500 miles (804km)	40ft (12.2m)	20
Fragmentation (Heavy)	3D4 x 10	1400mph(2251kmph)	400 miles (643km)	80ft (24.4m)	20
Armor Piercing (Med.)	2D4x10	2010mph(Mach3)	800 miles (1286km)	30ft (9.1m)	20
Plasma/Heat (Med.)	2D6x10	1400mph(2251kmph)	500 miles (804km)	40ft (12.2m)	20
Plasma/Heat (Heavy)*	3D6x10	1400mph(2251kmph)	500 miles (804km)	50ft(15.2m)	20
Proton Torpedo (Heavy)*	4D6x10	2010mph (Mach 3)	1200 miles (1928km)	50ft (15.2m)	25
Nuclear (Med.)*	2D6x10	2010mph(Mach3)	1000 miles (1608km)	40ft (12.2m)	20
Nuclear (Heavy)*	3D6x10	2010mph(Mach3)	1000miles(1608km)	50ft (15.2m)	20
Nuclear Multi-Warhead*	4D6x10	2010mph(Mach3)	1800 miles (2893km)	50ft (15.2m)	25

Mini Missiles and Special Armaments

<u>Warhead</u>	<u>Mega-Damage</u>	<u>Speed</u>	<u>Maximum Range</u>	<u>Blast Radius</u>	<u>M.D.C.</u>
High Explosive	5D6	500mph (804kmph)	1 mile (1.6km)	5ft (1.5m)	1
Fragmentation	5D6	500mph (804kmph)	1/2 mile (0.8km)	20ft (6.1m)	1
Armor Piercing	1D4x10	1400mph(2251kmph)	1 mile (1.6km)	3ft (0.9m)	2
Plasma/Heat	1D6x10	1200mph(1929kmph)	1 mile (1.6km)	15ft (1.5m)	1
Smoke	None	500mph (804kmph)	20ft (6.1m)		1

*Available as smart bombs, +5 to strike.

Occupational Character Classes

Men of Arms

- Borgs
- Crazies
- Cyber-Knights
- Glitter Boys
- Juicers
- Headhunters
- Coalition Grunt
- Coalition Military Specialist
- Coalition RPA Elite or "Sam"
- Coalition Technical Officer

Scholars & Adventurers

- Body Fixers (Doctor)
- City Rats (Streetwise adventurer)
- Cyber-Docs (Cybernetics M.D.)
- Operators (Mechanical or Electrical Engineer)
- Rogue Scholar
- Rogue Scientist
- Vagabond (Unskilled)
- Wilderness Scout

Practitioners of Magic

- Line Walkers (wizards beyond style; understand ley lines)
- Techno-Wizards (magic & technology as one)
- Shifters (summoners and dimensional travelers)
- Mystics

Racial Character Classes (R.C.C.)

- Dragons

Psychic R.C.C.s

- Bursters (pyrokinesis on a mega-scale)
- Coalition Dog Pack
- Psi-Stalkers
- Mind Melters

Men of Arms

Borg O.C.C.

"Borg" is the popular slang term for cyborg. Cyborgs are men and women who have been surgically augmented with machines for the purpose of war. The combat design and intent is the main aspect that separates bionics from cybernetics, even though the basic principles are the same. Another difference is that subjects for the bionic augmentation are not, as a rule, replacing missing or damaged body parts with mechanical replacements, but allowing perfectly good, functioning limbs and organs to be surgically removed and substituted with mechan-

ical counterparts. A rather extreme and grisly thing to do if you stop to think about it. Of course, bionic technology is so developed that a complete bionic conversion (all limbs plus implants) can be performed in just under eight hours, and, it is said, with minimal discomfort to the subject.

While it is true that bionic reconstruction is virtually painless, the person is giving up a portion of his humanity forever. The bionic limbs are obviously mechanical, can not be cosmetically concealed, and can never be replaced with real flesh and blood structures, only bionic ones. The psychological impact can be devastating; consequently, most willing participants in bionic reconstruction undergo a thorough psychiatric evaluation and hours of consultation to prepare them for their new life. Those who are properly prepared live long and happy lives. A surprising 89% are completely adjusted to life as a living machine. However, there are unscrupulous tyrants, slavers, and high-tech bandits who capture unwilling subjects for bionic conversion for use as slaves, laborer, or warriors. Of slave-borgs, only 32% are content with their transformation. 21% will attempt suicide over and over again.

Coalition Borgs

The Coalition has only begun utilizing borgs in the last few years and these are limited to a few elite troops and the occasional officer. Bionics, especially full conversion, goes against the mentality of the human purists; however, limited use of bionic conversion has been authorized. All Coalition borgs are volunteers. 40% are soldiers who were seriously injured in combat, 20% are healthy volunteers, and the remaining 40% are human mercenaries who have volunteered and enlisted for the mandatory six years of service. Borgs who go AWOL are hunted down and destroyed on the spot. At this time, the Coalition States do not create slave-borgs; however, the Emperor is considering the possibility.

Borg citizens must be registered with CS authorities. Registration records the borg's current place of residence, family, employer, and bionic capabilities. The same is true of temporary mercenary laborers occasionally hired to work in the city. Military personnel are automatically registered.

Partial Bionic Reconstruction

Partial bionic reconstruction means that the trunk of the body, neck, and head remain human. The two legs, feet, hands, and arms are completely removed and replaced with mechanical limbs. The pelvis/hip area, shoulders, collarbone, and spine are all reinforced with metal rods and cybernetic implants to support the new bionic additions. Weak or sickly looking internal organs, especially the heart and lungs, are likely to have been replaced with guaranteed cybernetic constructs as well (1-70% likelihood). If the lungs are replaced, they will have all the cybernetic options (see cybernetics section for lungs and internal organs).

Partial reconstruction for *military* purposes usual include at least minor eye, hearing, and sensory enhancements, as well as a handful of bionic weapons. *See the Bionic Section for exact bionic systems.*

Partial reconstruction for *slave labor* will seldom include any sensory, hearing, or optical enhancements, and never include bionic weapons. What is desired in slave-borgs is raw strength and endurance. Anything more would make the slaves too dangerous. Of course, weapon systems can be added later.

Full Bionic Conversion

Full bionic conversion means that the character is over 90% machine. The entire body has been replaced with a mechanical one. The remaining human parts are restricted to the brain, often, but not always, the face, and a few other original human components, especially the tongue, throat, and head. The rest of the body has been discarded and the few human components kept are placed in a bionic body. The body is effectively a fully functioning robot that responds to the human brain with the precision of the flesh and blood body. The internal workings of the new body systems are strangely similar to the human body with scores of tubing carrying life sustaining fluids. Electro-magnetic relays and nano-technological workings make up the rest of the internal system. The new body is hundreds of times more durable, faster, stronger, and deadlier.

Full conversion for *military* purposes means the best optic systems, hearing, headjack, and weapons. Physical capabilities are generally taken near the maximum, and the mechanized warrior is outfitted with five bionic weapons.

Full conversion for *slave labor* means the subject has basic or minimum optical enhancement and no weapons or other sensory enhancement (unless it specifically relates to the labor).

Psionics and P.P.E.: A person who possesses psionics will retain his psi-powers only in the case of a partial bionic reconstruction and even then, I.S.P. is permanently reduced by half. Full conversion destroys all psionic essence. Scientists do not understand why this is, but speculate that the psionic essence is somehow linked to the physical body, as well as to the mind.

Likewise, no borg, partial or full, can operate techno-wizardry devices nor practice magic. However, borgs do enjoy a **bonus to save versus magic** of +3 and are impervious to psionic bio-manipulation and see aura. P.P.E.: Virtually nonexistent, 1D4.

Skills of the Slave-Borg

The slave-borg will have the skills and knowledge of whatever O.C.C. he or she may have been before the conversion. Most slave-borgs are simple people with few formal skills and little or no education.

A typical slave-borg comes from a peasant background and has the following skills: Hand to Hand: Basic (can increase to expert at the cost of two other skills or martial arts for three), cook, dance, fishing, pilot automobile or truck (pick one), lore: demon or faerie (pick one), W.P. blunt, and can speak American (96%) and two other languages at 75% proficiency.

At first level the slave-borg can select four "other" skills, each with a +5% bonus.

The character can also select four Secondary skills without benefit of bonuses. At third and eighth levels an additional two secondary skills can be selected.

Available skill categories are limited to any: Communication: radio: basic; Domestic, Medical: holistic medicine or first aid only, Physical (any except acrobatics, gymnastics, boxing, and SCUBA), Pilot, Pilot Related, Rogue (excluding computer hacking), Science: basic math only, Technical (excluding all computer), W.P., and Wilderness. Any of the skills are available unless otherwise stated.

Standard Equipment: Runaway Slave-Borg

May or may not wear clothing, but is likely to wear some kind of mega-damage body armor. Also has back pack, a couple sacks, utility/ ammo belt, sunglasses or tinted goggles, air filter or gas mask, and personal items.

Weapons will include a couple knives, and two other weapons of choice. Cannot use techno-wizardry weapons.

Vehicle is limited to horse or non-militar' vehicles such as hover vehicles, motorcycle, or car. Often goes for inconspicuous looking vehicles.



Money: The character starts out with no credit and 2D4x 1000 in saleable black market items.

Cybernetics and Bionics: Basic; see previous descriptions. Can upgrade whenever he/she can afford to and a cyber-doc and bionics are available.

Skills of a Coalition Borg Or a Military Mercenary Borg

The mercenary combat borg was created for combat and has undergone some basic military training. The following Coalition military skills are known.

Radio: Basic (+10%)
Pilot Hovercraft (+10%)
Pilot Tank & APC (+5%)
Read Sensory Equipment (+10%)
Weapon Systems (+5%)
Climbing (+5%)
W.P. Energy Pistol
W.P. Energy Rifle
W.P. two of choice
Hand to Hand: Expert

At first level the borg can select six "other" skills, each with a +5% bonus, and speaks American and one other language at 96%. The character can also select eight Secondary skills without benefit of bonuses. At fourth and eighth levels select an additional two secondary skills.

Available skill categories are limited to: Communication, Domestic, Electrical: Basic only, Mechanical: Automotive only, Military, Medical: First aid only, Physical (any except acrobatics and boxing), Pilot, Pilot Related, Science: Math only, Technical, and W.P. Any of the skills are available unless otherwise stated.

Standard Equipment: Coalition Borg and Mercenary Borg

Modified Coalition "Dead Boy" armor suitable for the bulk of a borg or conventional cyborg armor for the merc, energy side arm, energy rifle and field equipment. Additional equipment may be available upon assignment, same as the *Coalition Grunt*. However, Borgs are seldom issued robot vehicles, never SAMAS power armor, and usually restricted to hover vehicles and motorcycles. In most cases, the Borg does not need a vehicle unless traveling great distances or needs great speed. **Money for a Coalition Borg** is 2400 credits a month and the usual military benefits. Plus the Coalition pays for the entire bionic conversion, but the borg must pledge to enlist for a minimum of six years. Longer service is rewarded with additional bionics. Borgs are considered a new elite force in the Coalition army.

Coalition Borg standard bionic capabilities: Full bionic conversion (seldom a partial unless requested by Coalition officer); P.S. 28, P.P. 20, average Speed 132 (90 mph/ 148 km), built-in language translator and the standard items described in the Bionic Section *full bionic conversion for military purposes*.

Vehicles for mercenary borgs are limited to non-military hover vehicles or souped-up motorcycle, truck, or car.

Money: The mercenary borg starts out with 6D6x 100 in credit and 1D4x 1000 in saleable black market items. Note that mercenary borgs can often make big dollars in areas of military conflict and as exterminators in areas plagued by supernatural beings, magic, or psychics. The Coalition sometimes hires borg mercenaries at 3000 credits a month, plus free room and board and free bionics cleaning and maintenance (repairs, not new bionics).

Cybernetics: Starts with none. Tend to avoid implants in favor of natural powers.

Coalition Soldier O.C.C.s "Dead Boys"

The term "Dead Boys" is the common slang used by most city down siders, rogues, criminals, and wilderness folk to identify Coalition soldiers. The nickname arose from the soldiers skull-like, death's head, face masks and black armor. The skull motif continues to be found in the designs of military power armor, robots, and vehicles. The military uses the death symbology to invoke fear and awe. It is a psychological edge and feeling of power that helps the soldiers in their duties as peace keeping police officers, military force, and exterminators.

Coalition Soldier O.C.C.s

It is important to understand that the Coalition States (CS) is a political entity that governs a group of people. The current administrator, his aides, political elite, and military leaders, are generally power-hungry men and women who are willing to use the innocent to capture and maintain that power. Who can say what it is that drives a person to desire the intangibles of power so much so that he will lie, steal, maim, degrade, and kill others to get it. Whatever it is, Emperor Prosek is its slave. He and his advisors are cruel manipulators and exploiters of the people. They are as evil and demonic as anything that crawled out of a rift. However, this does not mean that every person who is a member or citizen of the Coalition is just as evil. Most have no idea about the government's indiscretions and lies. The majority believe their propaganda and think of their lives as fruitful, good, and happy. Sure, everybody has their complaints and concerns (especially the poor), but few think of the CS as evil or maniacal.

The Coalition soldier is no different. He or she is just one of the concerned citizens who believes in, and loves, their emperor, life, and country. Being in the army will frequently mean that the character is a little more militant, gung-ho, and pro-government than the average citizen, but that doesn't make them evil either. In fact, most see themselves as heroes. Champions of humanity and the front line against the ever encroaching forces of evil and monsters from the rifts!

Propaganda

The Coalition soldier, especially the grunt, believes in the *American* way of life. Remember, the Coalition States represent the embodiment of humankind on the American continents, and paints itself as the protectors of the human race and preservers of the old ways, the American way. Unfortunately, some of those ways include the ugly and destructive beliefs in isolationism and racial superiority. Again, one must understand that the time of **Rifts** is a strange and frightening period with horrible creatures and supernatural terrors in abundance. The concept of self-preservation through isolation, preserved by a powerful army, is not unreasonable. Sadly, Emperor Prosek's lust for power and his own Nazi-like views have pushed the situation to the extreme. Most citizens are too complacent to question how it is that their life style is maintained. They just want their lives to continue as things are, and Emperor Prosek is the man to do it.

Regarding Non-human Invaders

The soldier has been indoctrinated to believe that all non-human creatures are invaders and a threat to human life. Even the most open minded character will find it difficult to trust non-human creatures.

The official Coalition line on the matter is: "Do not give pause in your beliefs. Unnatural invaders have the power, both psychic and magical, to cloud your mind. To listen to their words is to open oneself to evil. Stay clean. Stay pure. Kill them without hesitation or remorse, knowing that your actions save the human race."

On Technology

The typical soldier perceives his way of life to be right and good. They are provided with superior medical care and cybernetics, given some of the most powerful weapons and equipment in the known world, and fight for a great cause as protectors of the people. They are well fed, well trained, and well accounted for by the CS government. In many ways, even the grunt is a member of the Coalition elite, a respected and honored hero in the eyes of the people and government alike.

Of course, the army provides everything. The clothes, the food, the weapons, and their inspiration. There is no need for the soldier to read or write beyond the recognition of certain symbols and call numbers.

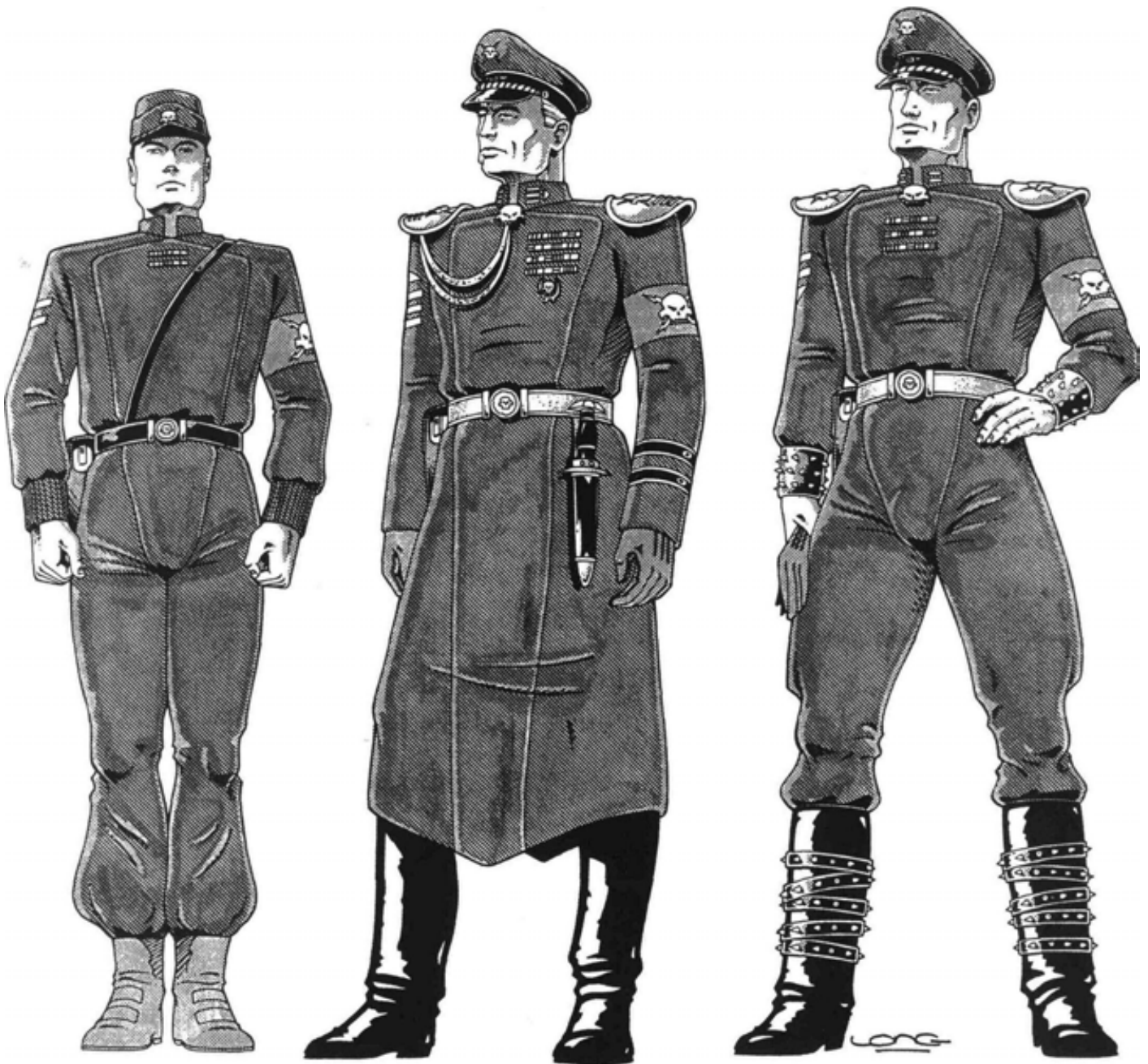

There is no need to understand history or science. There is no need to understand much of anything. The government is always correct. The soldier's job is to follow instructions without hesitation and without question. Sadly, these "heroes" are killing machines directed by an evil and ambitious power, Emperor Prosek.

The official line is: "The Coalition will provide you all that you need. Know that we ask you what no man should ask another, to put your brave lives in danger so that others may live. To sacrifice your own safety, and perhaps life, so that a child may grow. You are the embodiment of the human race's hopes and dreams. The army shall provide you with all you need so that you may concentrate in full on the terrible task at hand."

On Magic

All soldiers are taught that magic is a dangerous and unpredictable energy source responsible for many of today's problems. The use of magic in any way is prohibited in Coalition territory. This is done to protect human life not restrict it. Those who refuse to obey the law and continue to use magic are designated to be selfish fools or maniacs with no regard for human life. They are considered to be just as dangerous

as any creature from the rifts and are never to be trusted (remember, they need no hand-held weapon to destroy with a whisper).

The official line is: "Magic is a thing from the rifts. Its energies are alien and corrupting. Those who are foolish enough to use it are placing all life in danger, for the energies are unstable and unpredictable. Magic attracts the supernatural. Magic is our doom. Do not trust it, nor those who use it, lest you are ready to betray all you believe in."

On the cruelty of war

Training prepares soldiers for the horror of war and hardens them to the grim consequences of death.

The official line is: "Some will call you the dogs of war, others, tyrants and puppets. Know in your hearts that you are noble warriors asked to do terrible things so that one day we can know peace. Be ever alert, ever vigilant. Do not doubt what you know to be truth. Act quickly. Compassion is a quick end to one's enemy."

The Coalition Soldiers

What follows are the major types of Coalition State military O.C.C.s. The basic indoctrination for each are nearly identical, only the attribute requirements and specific areas of training (MOS) vary. All have access to CS power armor, robots, vehicles, and weapons. Equipment is provided on an as needed basis. Depending on rank and the circumstances, the character can easily acquire energy weapons, ammunition, vehicles and armor by simply requesting them from his commanding officer. A good rapport with one's chain of command can be an important factor in getting properly outfitted for one's assignment.

Coalition Soldiers as player characters

As I hope I have pointed out, the Coalition soldier is not innately evil and can make an exciting and fun addition to any group of players. The soldier can freely associate with characters who might otherwise be considered criminals of the State, if he or she is assigned to reconnaissance, spying, observation, or exploration of the wilderness and wastelands.

This is acceptable for two reasons: One, if the characters are outside Coalition territory, they are not under CS jurisdiction and can live by their own "twisted" laws and morals. The soldier can live and work with these heathens, but is told to try to maintain his ethics and do not accept these creatures as equals or friends. Secondly, it is crucial for the Coalition to know what these rogues and the other wilderness people are doing. Thus, the soldier must tolerate their sinister or foolhardy behavior to learn important data that will preserve the CS.

Unfortunately, many soldiers assigned to the outback come to see these other people as friends and allies. The soldier may even learn other values and reject the years of propaganda. This too is okay as long as he keeps his feelings to himself. If the Coalition learns of the warrior's skewed views, he could be branded a traitor.

Soldiers gone bad

Inevitably, soldiers who are regularly assigned to the down side, wastelands, wilderness, and long-term exploratory missions, find their view of the world changing. Often that view contradicts the edicts of the Coalition. The officers of the Coalition States' Armed Forces are surprisingly tolerant of eccentric behavior and individualistic modes of expression and operation, as long as it serves to further the Coalition's needs. Savagery against mutoids, D-Bees, Auto-Gs, aliens, demons, psychics, and men of magic is encouraged. However, expressing opinions that go against the official line can be dangerous.

Any words or actions that can be construed as sympathetic toward non-humans or magic will get the offending individual placed on observation. Further incidents will cause that soldier to undergo psychiatric examination, debriefing, and reorientation. If the soldier does not respond to reorientation, he will be dishonorably discharged and placed on the civilian list of suspected dissidents.

Serious crimes against the State can result in imprisonment and/or execution. These include things like helping a non-human, using magic or magic items, consorting with criminals (just about any O.C.C, other than mercenaries), condoning criminal activity (such as administering medical treatment to a mutoid, allowing or encouraging literacy, holding forbidden items like books, and so on). The soldier accused of such deeds is in terrible trouble. Many in this situation go AWOL. This is the mark of death, although frequently the only chance for survival. Accusation of collaboration with the enemy, compounded by desertion, brands the individual as a dangerous criminal, a rebel, and a traitor!

Traitors are ranked in the same category as demons, scholars, and mages. They are considered to be armed and dangerous; desperados who are to be eliminated on sight: Capture is left to the discretion of the officer in charge and is not encouraged.



Coalition Grunt O.C.C.

The grunt is the everyday infantry soldier. Generally, the soldier has no significant education or skills other than combat. In regard to combat, they are rough and ready warriors who greet the jaws of death with a smile.

Attribute Requirements: A high P.S. and P.E. are suggested but not required. Anybody with the spirit to fight for humanity can be a Coalition Grunt.

O.C.C. Skills:

- Radio: Basic (+10%)
- Pilot Hovercraft (+10%)
- Pilot Tank & APC (+14%)
- Robot Combat: Basic
- Read Sensory Equipment (+10%)
- Weapon Systems (+ 10%)
- Body Building
- Climbing (+ 5%)
- Running
- W.P. Energy Pistol
- W.P. Energy Rifle
- W.P. of choice
- Hand to Hand: Expert

Hand to Hand: Expert can be changed to Hand to Hand: Martial Arts at the cost of one "other" skill, or assassin, if an evil alignment, for the cost of two "other" skills.

O.C.C. Related Skills: Select 8 other skills. Plus select two additional skills and a W.P. at level three, two at level six, one at level nine, and one at level twelve. All new skills start at level one proficiency.

- Communications: Any (+5%)
- Domestic: Any
- Electrical: Basic electronics only
- Espionage: None
- Mechanical: Automotive only
- Medical: First Aid only
- Military: Any (+15%)
- Physical: Any, except acrobatics.
- Pilot: Any
- Pilot Related: Any (+5%)
- Rogue: Any
- Science: Math only
- Technical: Any
- W.P.: Any
- Wilderness: Carpentry, hunting, land navigation only.

Secondary Skills: The character also gets to select seven secondary skills from the previous list. These are additional areas of knowledge that do not get the advantage of the bonus listed in parenthesis (). All secondary skills start at the base skill level. Also, skills are limited (any, only, none) as previously indicated in the list.

Standard Equipment: Coalition "Dead Boy" body armor, energy rifle and energy sidearm of choice, four extra E-clips for each, two grenades, three signal flares, survival knife, utility belt, air filter and gas mask, walkie-talkie, uniform, combat boots, canteen, and additional non-energy weapon of choice.

Equipment available upon assignment: Any weapon types, extra ammunition, Spider-skull Walker, Enforcer UAR-1, other robot vehicles, hovercraft (especially hovercycle), tank, jet pack, camera, disc recorder, optical enhancement, and food rations for weeks. Vehicle and equipment repair. Note: All weapons and equipment are given out on an as needed basis, with the commanding officer deciding whether or not the item(s) is really necessary or not. If the officer doesn't like the character(s), the availability of items may be extremely limited.

Money: The grunt gets a roof over his head, food, clothing, and all other basics provided free as part of his pay, as well as military facilities. Plus a monthly salary of 1700 credits. Starts off with one month's pay.

The soldier's quarters is a nice dormitory arrangement shared by four individuals. Each gets a private bedroom/study complete with CD stereo system, television and VCD, mini-refrigerator, desk, dresser, and comfortable bed.

Cybernetics: None to start and usually restricted to medical implants and prosthetics, not augmentation.



GRUNT



PLATOON LEADER.



OFFICER.



ELITE ROBOT PILOT



PSI-STALKER.



SKY CYCLE PILOT

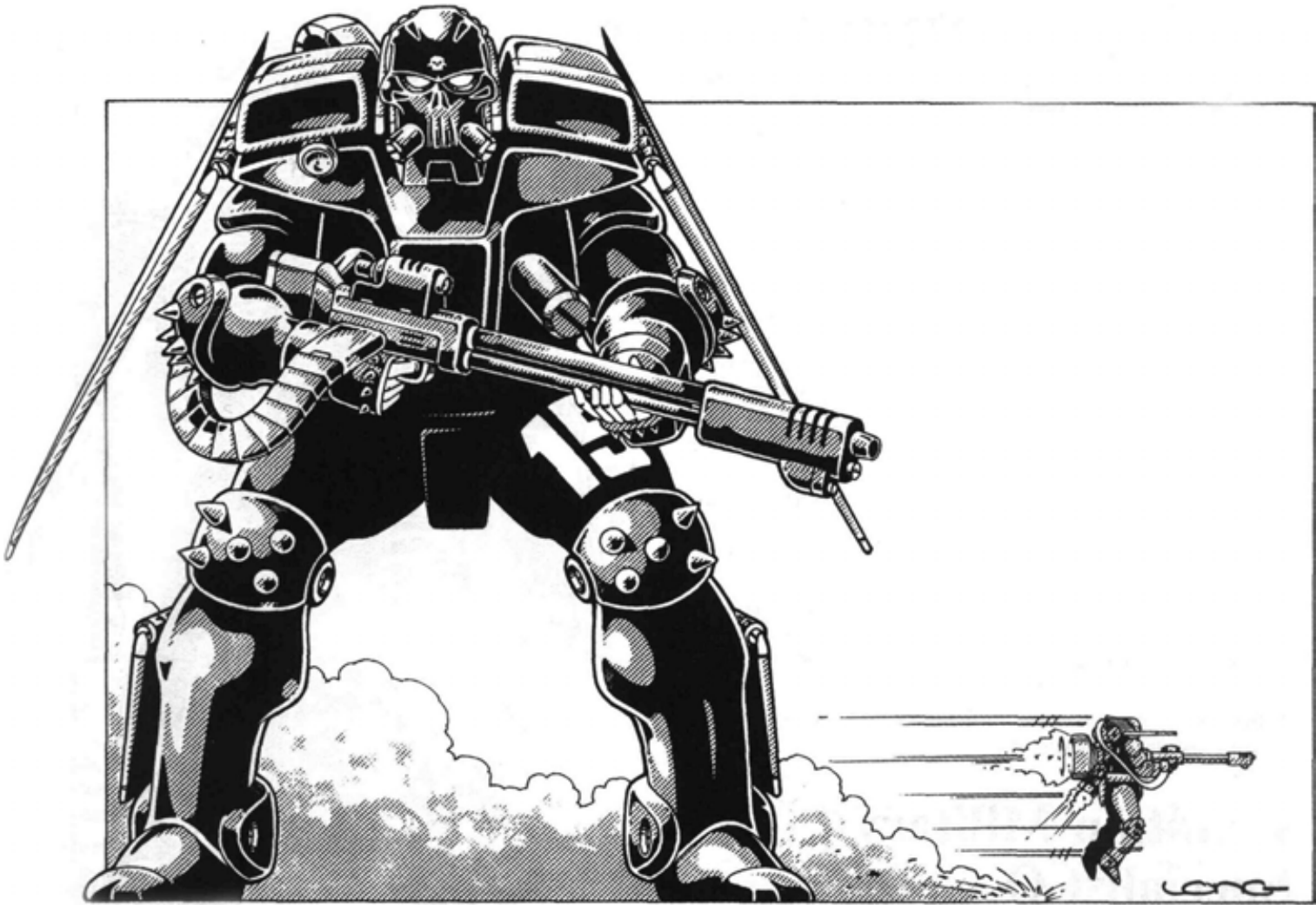

Coalition Elite RPA O.C.C.; "Sam"

The Robot Power Armor (RPA) elite are specially trained pilots and experts in the use of power armor and robots. These are the men and women behind the terrifying visage of the sky cycles, SAMAS, Enforcer UAR-1s, and Spider-skull Walkers. Because they are normally issued the SAMAS power armor for field operations and urban defense, they are known by the nickname "Sam."

Attribute Requirements: I.Q. 10, P.P. 10

O.C.C. Skills:

- Radio Basic (+ 10%)
- Pilot Automobile (+15%)
- Pilot Hovercraft (+15)
- Pilot Tank & APC (+15%)
- Robot Combat: Elite
- Read Sensory Equipment (+15%)
- Weapon Systems (+15%)
- Running
- W.P. Energy Pistol
- W.P. Energy Rifle
- W.P. of choice
- Hand to Hand: Expert

Hand to Hand: Expert can be changed to Martial Arts (or assassin if an evil alignment) for the cost of two "other" skills.

O.C.C. Related Skills: Select 10 other skills, but at least three must be selected from pilot. Plus select two additional skills at level three, two at level six, one at level nine, and one at level twelve. All new skills start at level one proficiency.

- Communications: Any (+ 10)
- Domestic: Any (- 5% penalty)
- Electrical: Basic electronics only (+5%)
- Espionage: Wilderness survival only
- Mechanical: Aircraft and automotive only (+ 10%)
- Medical: First aid only
- Military: Any (+ 5)
- Physical: Any, except acrobatics
- Pilot: Any (+15%)
- Pilot Related: Any (+10%)
- Rogue: Streetwise only
- Science: Math only
- Technical: Any
- W.P.: Any
- Wilderness: Land navigation and hunting only

Secondary Skills: The character also gets to select eight secondary skills from the previous list. These are additional areas of knowledge that do not get the advantage of the bonus listed in parenthesis ().

All secondary skills start at the base skill level. Also, skills are limited (any, only, none) as previously indicated in the list.

Standard Equipment: Coalition "Dead Boy" body armor, energy rifle and energy sidearm of choice, four extra E-clips for each, two grenades, three signal flares, survival knife, utility belt, air filter and gas mask, walkie-talkie, uniform, combat boots, canteen, and additional non-energy weapon of choice. Conventional military vehicle of choice (motorcycle, jeep, hovercycle, etc.) for daily use and a SAMAS for field use only.

Equipment available upon assignment: Vehicles include SAMAS power armor, Spider-skull Walker, Enforcer UAR-1, other robot vehicles, hovercraft, sky cycle, jet pack, tank, APC, skull heavy transport, and aircraft. Any weapon types, extra ammunition, camera, disc recorder, optical enhancement, and food rations for weeks. Vehicle and equipment repair. **Note:** All weapons and equipment are given out on an as needed basis, with the commanding officer deciding whether or not the item(s) is really necessary or not. If the officer doesn't like the character(s), the availability of items may be extremely limited.

Money: The elite pilot gets a roof over his head, food, clothing, and all other basics provided free as part of his pay, as well as access to military facilities. Plus a monthly salary of 2000 credits. Starts off with one month's pay.

The soldier's quarters is a nice dormitory arrangement shared by four individuals. Each gets a private bedroom/study complete with CD stereo system, television and VCD, mini-refrigerator, desk, dresser, and comfortable bed.

Cybernetics: None to start and usually restricted to medical implants and prosthetics, not augmentation.

Coalition Military Specialist O.C.C.

The arts of espionage and reconnaissance are the trademarks of the Coalition military specialist. These guys are always officers who have undergone special training and cybernetic augmentation. Starting rank of Lieutenant.

Attribute Requirements: I. Q. 12 or higher, M.E. 12 or higher, P.E. 10.

O.C.C. Skills:

Radio: Basic (+ 10%)
Literacy (+10%)
Computer Operation (+ 5%)
Intelligence (+10%)
Pilot Hovercraft (+10)
Robot Combat: Elite
Read Sensory Equipment (+ 15%)
Weapon Systems (+10%)
Running
W.P. Energy Pistol
W.P. Energy Rifle
Hand to Hand: Expert

Hand to Hand: Expert can be changed to Hand to Hand: Martial Arts at the cost of one "other" skill (or assassin if an evil alignment).

O.C.C. Related Skills: Select 12 other skills, but at least four must be selected from espionage. Plus select two additional skills at level three, two at level six, one at level nine, and one at level twelve. All new skills start at level one proficiency.

Communications: Any (+10%)
Domestic: Any

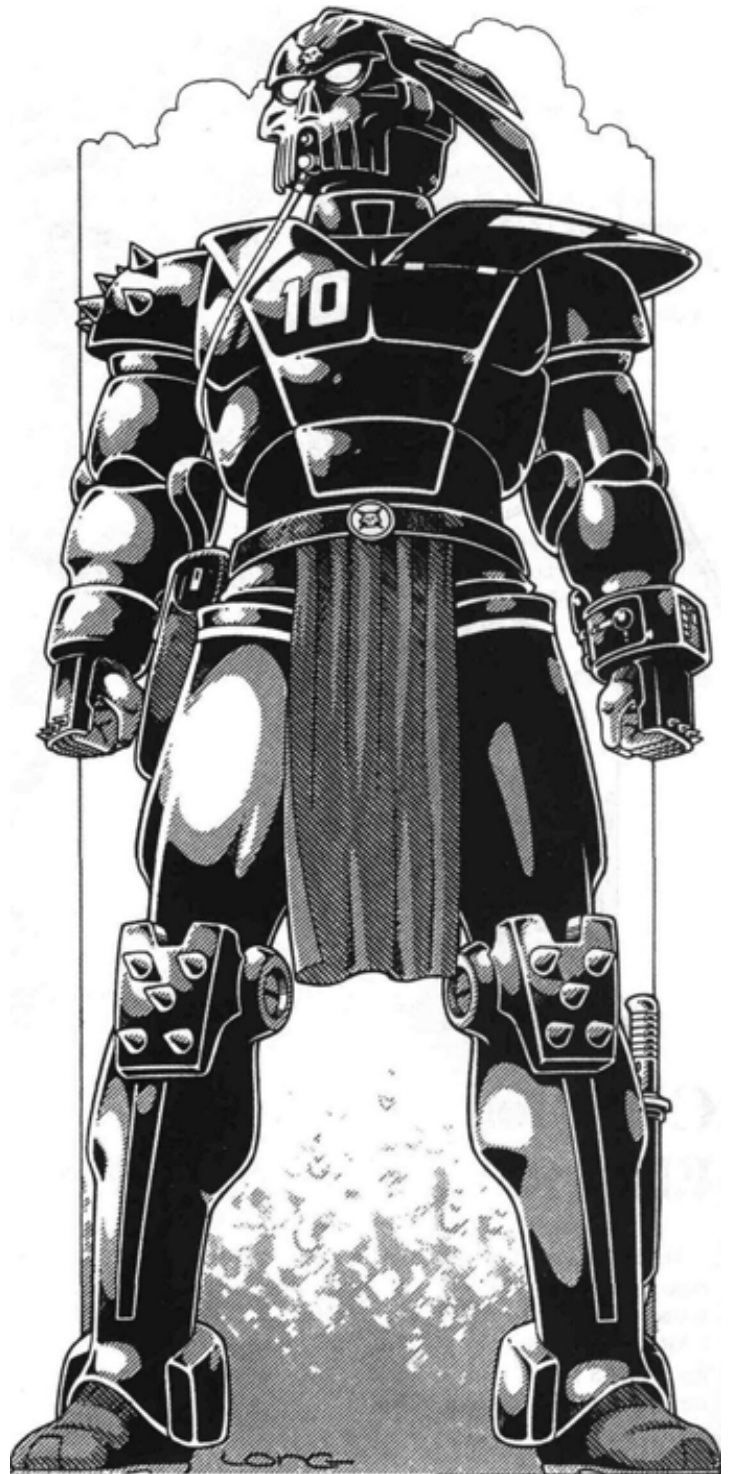

Electrical: Basic electronics only (+ 5%)
Espionage: Any (+ 10%)
Mechanical: Automotive only (+ 5%)
Medical: Paramedic only
Military: Any (+15%)
Physical: Any, except acrobatics.
Pilot: Any
Pilot Related: Any (+ 5%)
Rogue: Any
Science: Math and chemistry only (+ 10%)
Technical: Any (5%)
W.P.: Any
Wilderness: Any

Secondary Skills: The character also gets to select eight secondary skills from the previous list. These are additional areas of knowledge that do not get the advantage of the bonus listed in parentheses (). All secondary skills start at the base skill level. Also, skills are limited (any, only, none) as previously indicated in the list.

Standard Equipment: Coalition "Dead Boy" body armor, energy rifle and energy sidearm of choice, four extra E-clips for each, four grenades, three signal flares, survival knife, distancing binoculars, robot medical kit, disc recorder, pocket computer, utility belt, air filter and gas mask, walkie-talkie, uniform, combat boots, canteen, and additional non-energy weapon of choice. Conventional military vehicle of choice (motorcycle, jeep, hovercycle, etc.) for daily use and a Spider-skull Walker for field use only.

Equipment available upon assignment: Vehicles include SAMAS power armor, Spider-skull Walker, Enforcer UAR-1, other robot vehicles, conventional military vehicles, hovercraft, jet pack, tank, APC, and aircraft. Any weapon types, extra ammunition, surveillance equipment, camera equipment, sensory equipment, optical enhancements, and food rations for weeks. Also has access to computer equipment, laboratory facilities, and vehicle and equipment repair. **Note:** All weapons and equipment are given out on an as needed basis, with the commanding officer deciding whether or not the item(s) is really necessary or not. If the officer doesn't like the character(s), the availability of items may be extremely limited.

Money: The military specialist gets a roof over his head, food, clothing, and all other basics provided free as part of his pay, as well as access to military facilities. Plus a monthly salary of 2200 credits. Starts off with one months pay.

The officer's quarters is a private apartment with a private bathroom, living room, bedroom/study complete with CD stereo system, personal computer, large screen television and VCD, mini-refrigerator, desk, dresser, and comfortable bed.

Cybernetics and bionics: Select two augmentations from cybernetics (any category) and one from bionics (optional) from the category of weapons or bionic appendage (hand and arm, leg, etc).

Coalition Technical Officer O.C.C.

This character automatically starts off as a corporal and has specialized training in a particular area. Select one of the following areas of knowledge (MOS) and select a total *five* skills from that category, with a bonus of + 15% for each of those skills.

Communications

Engineering (select from Electrical and Mechanical skills)

Technician (select from Technical and Science)

Weapons (select from Military and W.P.)

Attribute Requirements: I.Q. 9 or higher

O.C.C. Skills:

Literacy (+ 20%)

Basic Math (+ 30%)

Radio: Basic (+ 5%)

Running

W.P. Energy Pistol

W.P. Energy Rifle

Hand to Hand: Basic

Plus five MOS skills discussed previously.

Hand to Hand: Basic can be changed to Hand to Hand: Expert at the cost of one "other" skill, or Martial Arts (or assassin if an evil alignment) for the cost of two "other" skills.

O.C.C. Related Skills: Select seven other skills. Plus select two additional skills at level three, two at level six, one at level nine, and one at level twelve. All new skills start at level one proficiency.

Communications: Any

Domestic: Any

Electrical: None unless MOS

Espionage: None

Mechanical: None unless MOS

Medical: First aid or Paramedic (counts as two skills) only

Military: Any (+ 5%)

Physical: Any, except wrestling and acrobatics.

Pilot: Any

Pilot Related: Any (+ 5%)

Rogue: None

Science: None unless MOS

Technical: Any

W.P.: Any

Wilderness: None

Secondary Skills: The character also gets to select six secondary skills from the previous list. These are additional areas of knowledge that do not get the advantage of the bonus listed in parenthesis (). All secondary skills start at the base skill level. Also, skills are limited (any, only, none) as previously indicated in the list.

Standard Equipment: Coalition "Dead Boy" body armor, energy rifle and energy sidearm of choice, four extra E-clips for each, two grenades, three signal flares, survival knife, pocket computer, tool kit if applicable, utility belt, air filter and gas mask, walkie-talkie, uniform, combat boots, canteen, and additional non-energy weapon of choice. Conventional military vehicle of choice (motorcycle, jeep, hovercycle, etc.) for daily use.

Equipment available upon assignment: Vehicles include: Spider-skull Walker, Enforcer UAR-1, other robot vehicles, hovercraft, jet pack, tank, APC, and aircraft. Any weapon types, extra ammunition, camera and recording equipment, optical enhancement, tools, and access to library, laboratory and repair facilities. Vehicle and equipment repair. **Note:** All weapons and equipment are given out on an as needed basis, with the commanding officer deciding whether or not the item(s) is really necessary.

Money: The officer gets a roof over his head, food, clothing, and all other basics provided free as part of his pay, as well as access to military facilities. The officer's quarters is the same as for the espionage officer. Monthly salary is 2000 credits. Starts off with one month's pay. **Note:** Pay increased to 2200 at the rank of lieutenant and to 2500 at captain.

Cybernetics: None to start and usually restricted to medical implants and prosthetics, not augmentation.

Dog Pack R.C.C. & Psi-Stalker R.C.C.

These two Coalition character classes are found in the psychic Racial Character Class section.



Crazies O.C.C.

The warriors known as "Crazies" are a cross between ninja masters and raving lunatics. They are trained warriors schooled in the arts of combat and athletics. Then they are augmented through the implantation of tiny electromagnetic devices placed in the brain.

The original project was developed in South America where scientists were experimenting with new methods of curing mental disorders caused by physical damage, such as brain tumors and scar tissue. They discovered a way to artificially stimulate the brain to countermand certain mental disorders and brain damage. Again, nano-technology made it possible to implant tiny devices directly into the brain to control its electrical impulses. Soon they found that they could also influence the performance of the physical body by controlling the motor section of the brain, etc. Pain can be virtually ignored, the healing process can be accelerated, and the body made to perform at an incredible level of efficiency. The brain implants and neurological stimulation also provided the surprising bonus of instilling or bringing out minor psionic abilities in all subjects.

Suddenly, the priority of finding medical cures was thrown out the door in favor of the more lucrative and spectacular developments in human augmentation. The project was renamed *M.O.M. Works* (Mind Over Matter). The goal, as with the Juicer, was to create the super human, except instead of chemical enhancement, the brain is effectively *rewired* to respond in a particular way.

Surprisingly, this augmentation works better on humans than on animals or even mutant animals. Unfortunately, the M.O.M conversion has a tendency to wear out the human body. But the worst side effect is that the subject becomes increasingly psychologically and/or emotionally unbalanced, hence the name "Crazies" (these characters are sometimes referred to as "Mamma Boys," a slang term derived from the M.O.M. acronym).

One can become a Crazy by enlisting in an army of a feudal state that offers brain augmentation technology. The usual deal is mental conversion, good pay (3D4 x 10,000 credits a year), and two years of loyal service in their army. After the two years service, the individual is free to stay or go. Some high-tech bandits also offer the conversion in exchange for services rendered, or at the price of a half million credits.

The Coalition has outlawed this technology and will rarely hire Crazies as mercenaries. Anyone convicted of creating Crazies is executed. Still, an occasional Body-Chop-Shop will offer M.O.M. conversion at a price of about 350,000 credits or an agreement to work for the chop-shop proprietor for a period of time, or to perform an extremely dangerous mission.

Crazies' Powers

- 1. Super endurance.** Add 3D6 x 10 S.D.C., add 5D6 hit points, and + 1D6 to P.E. attribute. Can lift and carry two times more than a normal person of equivalent strength and endurance, and can last 10 times longer before feeling the effects of exhaustion. Can remain alert and operate at full efficiency for up to three days (72 hours) without sleep. Normally needs only four hours of sleep per day.
- 2. Increased strength.** Add 2D4 to P.S. attribute. **NOTE:** Minimum P.S. is 19, if lower, adjust up to P.S. 19.
- 3. Increased speed.** Add 4D6 to Spd attribute. Can leap 20 feet (6 m) across after a short run (half from a dead stop), and 15 feet (4.6 m) high (half without a short run).
- 4. Heightened reflexes, agility, and senses.** The combination of training and enhanced physical capabilities provides the following bonuses. **Bonuses:** +4 to roll with punch, fall, or impact; +2 on initiative, add one extra attack per melee, and exceptional balance and grace (reflected in physical skills bonuses). Also add 1D6 to P.P. attribute. Minimum P.P. attribute is 17, if lower, adjust up to P.P. 17.

Enhanced vision provides the character with perfect 20/20 vision and exceptional long range vision equal to a hawk, enabling the person to read a small sign or recognize a face from up to two miles (3.2 km) away.

Enhanced sense of smell enables the character to instantly recognize odors (65%), recognize a person by scent (25%), and even track by smell (30%).

Enhanced sense of touch enables the character to recognize very slight differences in textures by touch. Adds a + 10% bonus to all skills that require a delicate touch, such as both demolition skills, pick pockets, pick locks, palming, electronics, etc.

- 5. Saving throw bonuses.** +2 to save versus psionics, +6 to save versus mind control (psionic and chemical), +4 to save versus toxic gases, poisons, and other drugs.
- 6. Enhanced healing.** Heals two times faster than normal. + 10% to save vs coma and death. Virtually impervious to pain, no amount of physical pain will impair the Crazy until he is down to 10 hit points or less. At this point the warrior will suddenly realize his condition and start to feel the effects of the injury. However, the crazy can go into an intense meditative trance that will induce bio-regeneration, healing damage in moments.
- 7. Bio-regeneration.** This ability is a little different than the psionic power, although related. The Crazy must stop to slip into a meditative trance. While in the trance, he is completely helpless and can not move or take any action. All of his concentration is being focused into an accelerated bio-feedback program that will restore 2D6 hit points, 3D6 S.D.C., and close wounds in a matter of 2D4 minutes. An extended period of bio-regeneration, over a period of six hours, will restore all S.D.C. and an additional 4D6 hit points.
- 8. Minor psionics.** Select three psionic powers from either the psychic sensitive or physical psychic categories (excluding object read, astral projection, ectoplasm, and telekinesis).
- 9. Suffers from delusions and insanity.** Everything is fine initially, but as time goes on, the character gets increasingly more disturbed.

At second level of experience roll once on phobia table.

At third level roll once on the affective disorder table.

At fourth level roll on the *Crazy Hero Tables*. This can lead to multiple personalities and all types of maladies.

At seventh level roll on obsession table.

At ninth level roll on the neurosis table.

At twelfth level roll on psychosis table.

At fifteenth level roll for random insanity.

Attribute Requirements: None, just a willingness to subject oneself to M.O.M. conversion.

P.P.E.: 6D6 P.P.E. Crazies have an unusual amount of psychic energy, perhaps another unexpected side effect of the M.O.M. conversion.

I.S.P.: 6D6 + M.E. attribute number is the base I.S.P., plus 1D4 per additional level of experience.

O.C.C. Skills:

Radio: Basic (+10%)

Radio: Scrambler (+ 10%)

Surveillance Systems (+10%)

Escape Artist (+ 10%)

Acrobatics (+10%)

Climbing (+15%)

Prowl (+ 20%)

Land Navigation (+ 10%)

Streetwise (+10%)

W.P. Ancient (choice of two)

W.P. Modern (choice of two)

W.P. Energy Rifle

Hand to Hand: Martial Arts (or Assassin if evil)

O.C.C. Related Skills: Select 6 other skills. Plus select one additional W.P. and two additional skills at level three, two at level six, one at level nine, and one at level twelve. All new skills start at level one proficiency.

Communications: Any (+ 5%)
 Domestic: Any
 Electrical: None
 Espionage: Any (+ 10%)
 Mechanical: Automotive and locksmith only
 Medical: Paramedic or holistic only (+ 10%)
 Military: Any (+ 5%)
 Physical: Any (+ 10% where applicable)
 Pilot: Any (+ 5%)
 Pilot Related: Any
 Rogue: Any (+ 5%)
 Science: Math and astronomy only
 Technical: Any
 W.P.: Any
 Wilderness: Any

Secondary Skills: The character also gets to select six secondary skills from the previous list. These are additional areas of knowledge that do not get the advantage of the bonus listed in parenthesis (). All secondary skills start at the base skill level. Also, skills are limited (any, only, none) as previously indicated in the list.

Standard Equipment: A suit of personalized, light or heavy (usually light), mega-damage body armor, including Coalition armor. A set of dress clothing, and a set of black clothing for covert operations. Also a gas mask and air filter, tinted goggles, hatchet for cutting wood, knives (1D4), two ancient weapons of choice, an energy handgun and rifle and four extra ammo-clips for each, tent, knapsack, back pack, saddlebags, two canteens, emergency food rations (two week supply), Geiger counter, and some personal items. **NOTE:** Crazies are known to have a fondness for ancient weapons and modern day mega-damage equivalents such as vibro-blades, neuro-mace, etc., and they love magic weapons used in close combat, like flaming swords.

The Crazy's mode of transportation can be just about anything, but they lean toward fast and silent or big and flamboyant, conventional to military. They are also known to use magic devices. Rarely use power armor or robot vehicles.

Money: The character starts off with 2D6x 100 in credit, and has a black market item that will garner another 1D6 x 1000 credits. Generally, spends money on pleasure and weapons as fast as they can make it.

Cybernetics: None, other than M.O.M., but may consider optical, lung, and weapon implants. Will avoid bionics! They take great pleasure in their supposedly *natural* abilities.

THE CRAZY HERO

The creation of a wacko character is easy. He or she is designed exactly like any other character in Rifts. Determine the attributes, hit points, S.D.C., skills, alignments, power category and powers, just like always. The twist comes in how the character sees himself or how some random crazy element effects his or her life. The exact type of affliction can be selected from one of the following or determined by random rolls. All the crazy elements are presented in a chart/table form so that percentile dice can be used if desired. As you already know I personally favor the random roll.

Some things to keep in mind when playing one of these estranged characters, is that they truly believe the conditions of their affliction and nobody is going to convince them otherwise. This is true even under life threatening situations.



Select one wacko characteristic or roll on the Random Crazy Element Table.

RANDOM CRAZY ELEMENT TABLE

Roll Percentile Dice

1-30	Frenzy
31-60	Power by Association
61-85	Multiple Personalities
86-00	Crazy Man

FRENZY

The hero who suffers from a frenzy will appear normal most of the time, but will fly into a wild, uncontrolled rage under certain, high pressure, conditions. What triggers a frenzy varies somewhat, but is usually on the following (roll percentile dice).

1-20	Intense Frustration
21-50	Intense Anger
51-80	Intense Pain
81-00	Extreme Tension

INTENSE FRUSTRATION arises when the character feels helpless, very confused or trapped into a situation he/she can not tolerate. At a certain point the person can not endure any more and snaps, flying off into a frenzy.

INTENSE ANGER is probably the most common catalyst for a frenzy. As in all the cases for frenzy, we are talking about high pressure situations that already have the characters blood boiling and adrenaline pumping. Not common little peeves or dislikes. The anger frenzy is likely to occur in battle if things are not going well (the thought of defeat is too much to bear), an innocent person or ally is hurt or tortured or if the villain(s) verbally mock the hero and his buddies. Anger can also happen when extremely frustrated by bad luck or carelessness/

stupidity by others (or self). It is not wise to make the character mad! "Watch it buddy, you won't like me when I'm mad." Truer words were never spoken.

INTENSE PAIN can also be a catalyst for a frenzy. The character will only endure so much before he/she is suffocated by a sense of overwhelming failure, fear of death and physical pain. The hero flies into a frenzy when *all S.D.C.* points are gone and/or approximately *half his hit points* are depleted. When this happens the person is engulfed by an uncontrollable rage (frenzy).

EXTREME TENSION is another inducer of frenzy. If the hero is super nervous or so pent-up/tense about something, he/she is likely to fly into a rage. This occurs when the character feels under a lot of pressure, especially do or die type situations. At a critical point, where tension is greatest, the person becomes frenzied.

When the character succumbs to a frenzy he or she is overcome by emotion and supplemented by adrenal and other chemical reactions in the body. This plunges the character into a berserker rage or bloodlust that blinds the person to everything but the focus of the rage. All sense of personal safety is lost. The environment, dangers, purpose, and friendships are forgotten when the enraged person is engulfed in an unreasoning frenzy. He can only lash out wildly, desperately, to destroy the source of frustration, anger, pain or tension. The frenzied hero's thoughts are primal and ferocious: kill or be killed, escape or die, fight until the enemy is stopped or he stops you! Because the character can no longer distinguish between friend or foe, he will lash out at anybody who gets in the way. The frenzied hero caught in a blood lust must lash out. Wants to hurt and destroy. If no living target/enemy is available he will vent his rage on a room, destroying everything within it, or vehicle, or machinery, and so on. Whatever is handy or perceived to be a part of the problem will become a target to be smashed. The ferocity of the onslaught is terrifying for there is no restraint nor thought, only action.

Although a timely frenzy can be helpful and save lives, it is equally likely to hurt or even kill innocent people. For Example: Combat is going badly. The villains seem to be triumphing; tension is high. A friend and fellow hero is blasted from behind into unconsciousness and almost killed. The hero who suffers from frenzy is outraged by this act of treachery against his friend. Suddenly everything becomes a blur as the rage takes over. The frenzy begins. The crazed hero becomes a wild man, attacking with incredible speed, skill and ferocity. The villains fall, one after another. A pair try to flee, but are struck down. Their pleas for mercy fall upon deaf ears. A figure steps from around the corner. The wild man sneers and attacks. His victim shouts "Halt! Police!", but the words are meaningless. The policeman falls to the hammering assault. The law officer could just as easily have been a woman or child. To the frenzied character there is no distinction. He pauses looking for more "enemy". The mayhem will continue until the frenzy wears off, all opponents are defeated, or the wild man is subdued.

The power of the frenzy: Lost in an unreasoning berserker rage the character will first lash out at the focus of his/her rage and then all known enemies. Anybody else, innocent bystander, friend or foe, who tries to stop the character or even attracts his attention, will be attacked with full force. As soon as one target is rendered helpless (this can mean stunned, unconscious, coma, trapped, killed or otherwise incapacitated) the wild man turns his attention to the next target. Instinctively, the most dangerous target is attacked first, unless others get in the way.

Frenzy bonuses and abilities: One additional attack per melee, +30 S.D.C., +1D6 damage which applies to all physical attacks, as well as superpower type blasts and beams (does NOT apply to mechanical weapons like guns), +1 to strike, parry, dodge, roll, and speed is increased by 30%. Duration: The frenzy will not stop until all opponents are defeated, the frenzy wears off or the character is subdued. A frenzy will normally last one melee (15 seconds) for each Physical Endurance

(P.E.) attribute point. For Example: A hero with a P.E. of 12 will be lost in a frenzy for 12 melees. That's three minutes. After that time the character will snap out of the rage and function normally. **All affects and bonuses of a frenzy are temporary!** This includes the 30 S.D.C. Don't be confused by the temporary S.D.C. Any damage comes off of that temporary physical S.D.C. bonus first. After the frenzy and extra S.D.C. fades the damage sustained by the temporary 30 S.D.C. is little more than painful cuts and bruises. Do NOT subtract those 30 S.D.C. damage from the character's normal physical S.D.C.

POWER BY ASSOCIATION

This unusual fixation has the character convinced that he gains his strength, skills or powers from some sort of object or other worldly source. This is not true. The hero's abilities are natural or achieved through training and have nothing to do with any outside force. Yet, psychologically, the character is totally dependent on the object of his fixation. A sort of super security blanket that gives him/her the confidence to be a super crimebuster and champion of justice. These characters are so dependent on their imagined source of power that they are powerless without it. Even if threatened with death they will not change their belief. The mind is a powerful force that remains a mystery. It is very possible that without the psychological focus and security of a particular word, object or perspective, that the person would never have discovered his special abilities nor become a hero.

There are six common factors that seem to stimulate superhuman response and abilities. Roll percentile dice to determine which one affects your character.

HERO BY ASSOCIATION

Powers Stem From . . .

- 1-16 Daytime Complex
- 17-30 Nighttime Complex
- 31-50 Popeye Syndrome
- 51-70 Magic Object
- 71-85 Power Words
- 86-00 Solar Syndrome

THE DAYTIME COMPLEX is the belief that ones abilities exist only during *daylight hours*. Thus, from the first few seconds of dawn till the last rays of sunlight disappear with the setting sun, is the character endowed with exceptional abilities. At night the powers are gone and he or she is a relatively normal human. Although the hero believes his/her powers are linked to the sun, it is not the same as being solar powered. This character's powers and abilities are unimpaired by being indoors or locked in darkness. As long as it is daytime the person is a super endowed hero. It is the time of day that affects the abilities. Bonuses and Penalties: During nighttime hours the hero believes he has no special powers or skills, but can still use his/her conventional skills and training just as any normal human. If the character is invulnerable or super strong he will imagine pain and vulnerability, or normal human strength (P.S. 12 maximum). The hero's identity/name is likely to refer to the sun, heat or light.

THE NIGHT TIME COMPLEX is identical to the daytime complex except that the character believes his/her powers exist only during *night hours*. From dusk till dawn this person is a super human. With the first light of day those powers and abilities fade. All the same conditions listed under the daytime complex apply to the nighttime complex except during night hours. Being exposed to any kind of light during night hours has no adverse effects. The only applicable factor is the hour of the day (nighttime). **Note:** The hero is likely to use a code name that reflects the night or darkness, such as Night Hunter, Moon Beam, etc.

THE POPEYE SYNDROME is the belief that a particular type of food or drink gives the character his super abilities. Without this special food the hero is just an ordinary Joe with no unusual powers. Con-

sequently, the power giving foodstuff must be eaten before super heroics can begin. The metamorphosis happens just like the old Popeye cartoons. The would-be hero pops a handful of his/her special "power" food and zowie! . . . an instant powerhouse.

Conditions and limitations: Generally, the "power food" can be eaten raw or prepared in any way. Quite literally *one full handful* of the stuff will instill the character with powers (Whatever powers or abilities the person may actually possess. Nothing new or random). **Duration:** One handful will instill superhuman powers for approximately **THREE HOURS**. At the end of that time another handful of the power food will be needed to remain super endowed. There is no limit to how many times per day the food or drink can be eaten. **Type of Food:** The food or drink should be an exotic, or bizarre item or combination of items. Players can make-up something or use the table that follows.

RANDOM POWER FOOD TABLE

Roll Percentile Dice

1-5	Garlic
6-10	Asparagus dipped in vanilla yogurt.
11-14	Raw Rhubarb (crunchy, celery-type sticks with tough, stringy fibers).
15-19	Granola Bar (fruit types are the best).
20-23	Chicken Livers
24-27	Raw Brown Rice
28-32	Pig's Ear
33-36	Parsnips and Pumpkin Seeds
37-40	Dogfish Croquettes
41-45	Corn Husks (just the husks)
46-49	Eel Marinated in Red Wine
50-53	Fresh Chives and Parsley
54-57	Anchovy Stuffed Grape Leaves
58-62	Oxtail
63-66	Carrot Juice
67-70	Apple Cores
71-75	Cabbage Quiche
76-79	Pickled Herring
80-83	Instant Breakfast Mix (must be mixed with low fat milk).
84-88	Collard Greens (a green, leafy vegetable, like spinach)
89-92	Walnuts and Bay Leaves
93-96	Raw Eggs and Bean Sprouts
97-00	Twinkies

Why does the character believe these foods give him/her incredible powers? The simplest, most common reason is because his/her super abilities manifested itself for the first spectacular time right after eating that particular food or drink. As a result, the powers are associated with a specific type of food. The character may have all kinds of ridiculous explanations or theories, but it's purely psychological.

THE MAGIC OBJECT SYNDROME is the absolute certainty that a special object is the source of the person's powers. The source of the power is usually *thought* to be *mystical, supernatural or extraterrestrial*. Without the object the hero is powerless, just an ordinary human (or so he/she believes). If the power object is lost the hero will become depressed and despondent for 3D6 weeks. The only exception is the time spent searching for the lost item. If the item can not be recovered the character will become an ordinary person, leading an ordinary life. His exceptional powers forever locked within him.

G.M. Note: If the power object is permanently lost, you could, at your discretion, allow the character to become empowered by some new, equally silly means, such as one of the other conditions listed in this section. However, this should occur only after a painfully long time and if it does NOT screw-up your game continuity. Most of the time (60%) the character will never find an alternative, psychological power source.

The object is not really magic so it can be anything: A ring, old coin, favorite childhood toy (teddy bear), earmuffs, medallion, staff, walking stick, jewelry, cloak, cape, shoes, belt, flashlight or bottle cap. Anything at all. The object is usually small enough to carry or be worn and should have some odd or distinguishing feature.

THE SOLAR SYNDROME has the character convinced that he is solar powered. This is different than the Daytime Complex in that the hero believes he actually draws on the sun's energy like a solar battery. With sunlight shining brightly and/or directly on the hero, he/she is at absolute full power and confidence. So confident that the hero is tougher and better at everything.

Bonuses and penalties: *In full daylight* or in direct sunlight the character is at full power; adds + 10 to his/her S.D.C. and 5% to all skills. In shadow, artificial light or a gloomy day, all the abilities are half and skills are (minus) -5%. *In darkness* or at night (without artificial light) the character has NO superhuman powers, and skills are — 20%, because of his lack of confidence and feeling of inadequacy.

POWER WORDS are another form of hero/super association that has the person believing to be empowered by a word code or phrase. Usually the person believes the word(s) to be of magic, supernatural or alien origin. To become a superhuman the person needs only to shout the super words, and sha-zoom — a hero is born. The person is completely convinced that he/she is an ordinary person with NO powers. It is the power words that make them something more. Thus, the word(s) must be *shouted* in order to become a superbeing! If the word(s) are not spoken the person remains a mere, powerless mortal.

MULTIPLE PERSONALITY

One of the more unusual phenomena are heroes with several distinct personalities. Each of these different personalities manifest themselves as a completely different person, with different dispositions, attitudes, and beliefs. This is a much more complex character and will require rolling on several tables.

STEP ONE: How Many Separate Personalities?

Roll Percentile Dice

1-30	Two
31-50	Three
51-65	Four
66-89	Five
90-00	Six

STEP TWO: Who Is The Dominant Personality?

This is the main hero personality, so it should be among the most "good" and competent of all the personalities.

- Name:** Player's choice.
- Alignment:** Player's choice of principled, scrupulous or unprincipled.
- Disposition:** *Roll or pick* from the optional rules section for rounding out one's character.
- Rejects** the belief of having a split personality, so he/she does *not* know about the other personalities.

The main personality will be the one most often in control.

STEP THREE: Who Are The Other Personalities?

- Name** each one.
- Roll for random alignment of each personality.

1-20	Principled
21-35	Scrupulous
36-50	Unprincipled
51-65	Anarchist
66-77	Miscreant
78-89	Aberrant
90-00	Diabolic
- Personality Quirks/Attitude:** Roll for *each* personality (or choose).



C. Personalities of Good Alignment:

- 1-10 **Despondent:** Withdrawn; curls up into a fetal position and gurgles. Can not fight or take any action. Can not use powers or even communicate.
- 11-20 **Coward:** Afraid of everything: heights, flying, fighting, knives, guns, etc. Will fight only if absolutely necessary, and then only enough to escape. This character will surrender at the slightest hint of trouble. Super abilities can be used, but only for self-preservation. He may use the powers to help friends, but would rather stay on the sidelines. Penalties: Always the *last* to attack in a melee round. Skills are - 10%. Doesn't know any of the other personalities.
- 21-30 **Pacifist:** Gentle, merciful and compassionate. This character is as bright and bold as the main personality (maybe even more so), but will not fight. This personality is adamant against fighting for any reason. If confronted he will dodge, parry and try to otherwise incapacitate a foe, all the while delivering a speech against fighting and cruelty. He can use his powers, but will rarely use them against others. Will NEVER kill, torture or strike out of anger. There are no power or skill penalties. Bonuses: + 2 to dodge, + 1 to parry and roll. Knows about the dominant personality only. There is a 40% chance that he can be convinced to let the dominant personality back into control, but only under extreme protest (too violent).
- 31-40 **Arrogant Warrior:** Cold, aloof, snob, but extremely capable and confident (*over* confident). Tends to be incredibly independent, rude and insensitive. To this personality there are two points of view to everything; the wrong one and *his* (the only

right and logical opinion). This personality uses his powers and skills as he sees fit; usually cold and calculating. There are no skill penalties. Bonuses: + 10% on all skills, + 1 to parry. Knows all the other personalities, but will *not* willingly let any of them resurface. After all they are inferior to him.

- 41-50 **Righteous Indignation:** A personality that has a black and white view of the world. Evil must be crushed at all costs. This is a war, thus the end justifies the means. He tends to be judgmental, reactionary and brutal toward evil. Gentle and compassionate to the good and innocent. A potentially volatile and dangerous character. There are no skill or ability penalties, nor bonuses. He uses his extraordinary abilities well. Knows and despises all the other personalities for one reason or another. There's a 50% chance of convincing him to let any of the other personalities out, *except* the arrogant warrior.
- 51-60 **The Normal:** A very mundane, innocent, bumbling nerd-like youth (teenager) who knows nothing about super abilities, crimefighting or heroics. He is friendly, but shy, and totally bewildered about super beings. He has no recollection of his other personalities or super abilities. Penalties: Can NOT use his extraordinary abilities, has no combat training (one attack per melee), and only high school equivalent skills and knowledge. This is a normal kid!
- 61-70 **The Wildman:** An overzealous, gregarious, and extremely hyperactive personality with delusions of grandeur. He is fanatically loyal and dedicated to crime fighting, justice and the American way. He is very reactionary, takes needless risks, and has a complete disregard for his personal safety. This is a character whose intentions are always 100% sincere, but acts without considering the consequences. Basically, a nutcase with a heart of gold. Penalties: Suffers from the Frenzy condition discussed elsewhere in this section (triggered by anger or pain). Bonuses: Can use all powers and skills equal to the dominant personality. +4 to roll, + 1 to parry and dodge. Add 10ft to leaping (up and across) abilities and 20% to climbing, swimming and balancing skill abilities. This personality knows all the others, and can be convinced to let any of them take control if it is for the good of the group or a good cause; 80% likelihood.
- 71-80 **Hypochondriac:** A personality obsessed with cleanliness, and avoiding injury and disease. He will continually whine about potentially filthy or germ laden environments, and instruct his comrades about proper eating habits, vitamins, medication and sanitation. If injured in the slightest (one S.D.C.), the personality will whine and moan about it for hours. Penalties: Never takes the initiative, - 5% on all skills. Bonuses: + 1 to parry and dodge, and has a paramedic skill with an 86% skill proficiency. Knows all the personalities, but is hesitant to let any take control because they are either too reckless or whimpy and might get him hurt. And they are all "so filthy!!!!" However, there is a 50% chance of being convinced to let any of them take control, except the wildman because "that guy's crazy". If letting another personality take control is likely to prevent his death or grievous injury, there is an 88% likelihood of letting out a different personality (player's choice, but the dominant personality is most likely).
- 81-90 **Opposite Sex:** Pick from or roll on the optional rules Disposition table to determine the general attitude of character. May or may not know of the super abilities; 1-40% — does not, 41-100% — does know. If she/he doesn't know about the power or abilities, then all skills are -20%, there is no combat skill (one attack per melee), and extraordinary powers can NOT be used. If the personality does know about the abilities he/she knows about the other personalities. There is a 40% chance of it being convinced to let a different one surface. If he/she knows nothing about the other personalities and can not willingly let a different one surface.

91-00 **The Anti-Super Dude:** This personality is against the entire concept of super powered beings and vigilantism. Consequently, while he knows about the special powers he possesses he will not use them for any reason. Nor will he engage in superheroics. Penalties: — 10% on all skills, no combat skill (one attack per melee and no bonuses to strike, parry, dodge or roll). Bonuses: None. Knows about the other personalities, but will NOT let any of them take control!

C. Personalities of Evil Alignments: Roll or choose for *each* personality:

- 1-10 **Jack the Ripper:** A twisted personality that preys on the weak, mostly women. Some demented obsession drives this personality to hurt and torment women. If any opponents are female, she will be his first target. The more she fights, the better he likes it. This is a sick individual who loves to torture and watch torment. Penalties: — 10% on all skills because he is physically oriented. Bonus: + 1 to strike. Knows about his other personalities, but will NOT willingly let any of them take control. Uses his super abilities and skills well. Prefers blade weapons above all others.
- 11-20 **Traitor:** A personality that goes with what is always best for him. He will betray a friend or cause for money, revenge, or to save himself. He will sell or steal information, equipment or persons without hesitation. To this personality, everything has a price and he intends to cash in on it. The character is amoral, cold and merciless, taking action that will benefit only him. Completely untrustworthy. Penalties: None. Bonuses: None. He can use all powers and skills. Knows about the other personalities and uses them freely to get his way or save his skin.
- 21-30 **Greedy:** A personality that craves wealth and fame. He will always look for the profit and value of any activity. He is a stingy braggart who always connives to get the most money and all the glory. He tends to be secretive, sneaky, deceptive, underhanded and self-centered. Penalties: None. Bonuses: None. Uses all skills and powers equally as well as the dominant personality. Although he knows about the other personality. Although he knows about the other personalities he is extremely reluctant to let any of "these losers" take control (20% chance).
- 31-40 **Kleptomaniac:** A compulsive thief who just likes the challenge of stealing. Steals from everybody all the time, just for fun. Penalties: Has *none* of the dominant character's skills. Bonuses: Knows the following skills at the proficiencies listed: Pick Pockets 65%, Pick Locks 55%, Prowl 55%, Disguise 60%, Surveillance Systems 50%, Hand to Hand: Basic (2nd level with 4 attack per melee total), Pilot Automobile 88%, Motorcycle 68%. Knows all the other personalities and about his exceptional abilities.
- 41-50 **Blood Thirsty:** A personality that loves to fight, hurt people, torture and kill. A sadistic bully who shows no mercy and intentionally strikes to do maximum damage. This is the personality's way of proving his superiority, as well as satisfying his cruel pleasures. Penalties: -5% on all non-combat oriented skills. Bonuses: + 1 to strike, parry, and dodge, + 10 S.D.C. He can use the super abilities well. Although he knows about the other personalities he will pretend not to and will refuse to willingly let another take control.
- 51-60 **Megalomaniac:** Arrogant, feels far superior to all others; mean, cold and calculating. *This personality is totally self-serving.* The means justifies his ends and there is only the wrong opinion and his opinion. Those who ignore or chastise his opinion are either fools or potential enemies. The personality is only a team player in the sense that he can use the team to achieve his desires. Tends to be domineering (will try to usurp the leadership), insensitive and *ruthless*. There are no skill penalties.

Bonuses: + 10% on all skills. He knows and uses all the skills and powers of the dominant personality.

61-70 **The Psychopath:** A wild, daring, deadly personality who thrives on danger. Nothing is too risky or impossible. Tends to be reactionary, cruel, and strikes with deadly force. Also likes cat and mouse games, as long as he is the cat. Penalties: Does not know the dominant personality's skills. Bonuses: Knows the following skills at the proficiency level listed: Hand to Hand: Expert (3rd level for a total of 4 attacks per melee), W.P. Blunt, W.P. Knife, W.P. Revolver, W.P. Automatic Pistol, W.P. Rifle, Sniper, Prowl 55%, Climbing 65/45%, Pilot Automobiles 92%, Motorcycle 72%, Truck 76%, and Escape Artist 45%. Add +20 S.D.C. (applies only when the psychopath personality is in control). Can use all extraordinary powers equal to the dominant personality. Will not willingly allow any other personality dominance.

71-80 **Opposite Sex:** Pick from or roll on the optional rules Disposition table to determine the general attitude of character. May or may not know of the super abilities; 1-40% — does not, 41-80% — does know. If she/he doesn't know about the power or abilities then all skills are - 20%, there is no combat skill (one attack per melee), and extraordinary powers can NOT be used. If the personality does know about the abilities he/she knows about the other personalities. There is a 40% chance of it being convinced to let a different one surface. If he/she knows nothing about the other personalities and can not willingly let a different one surface.

81-90 **Hypochondriac:** A personality obsessed with cleanliness, and avoiding injury and disease. He will continually whine about potentially filthy or germ laden environments, and instruct his comrades about proper eating habits, vitamins, medication and sanitation. If injured in the slightest (one S.D.C.), the personality will whine and moan about it for hours. Penalties: Never takes the initiative, - 5% on all skills. Bonuses: + 1 to parry and dodge, and has a paramedic skill with an 86% skill proficiency. Knows all the personalities, but is hesitant to let any take control because they are either too reckless or whimpy and might get him hurt. And they are all "so filthy!!!!" However, there is a 50% chance of being convinced to let any of them take control, except the wildman because "that guy's crazy". If letting another personality take control is likely to prevent his death or grievous injury, there is an 88% likelihood of letting out a different personality (player's choice, but the dominant personality is most likely).

91-00 **The Normal:** A very mundane, innocent, bumbling nerd-like youth (teenager) who knows nothing about super abilities, crimefighting or heroics. He is friendly, but shy, and totally bewildered about super beings. He has no recollection of his other personalities or super abilities. Penalties: Can NOT use his extraordinary abilities, has no combat training (one attack per melee) and only high school equivalent skills and knowledge. This is a normal kid!

STEP FOUR: When Do The Different Personalities Take Control?

The dominant personality is the one who is usually in control. He or she is the main force behind the character and the one who has decided to become a super crimefighter. Another personality takes over under the following circumstances:

1. **Severe shock or trauma,** such as seeing a loved one killed or seriously injured, psionic or drug induced hallucinations, feeling completely helpless, or intense pain/torture. In these cases, the personality best suited to handle the situation will take control.
2. **Coma or near death:** Any one of the other personalities will take random control.
3. **Hypnosis:** 50% chance of calling forth a specific personality. If the roll fails, roll to see who takes random control. There is an 80%

chance of bringing the dominant personality back into control when using hypnosis.

4. **Telepathic Probe:** 65% chance of pulling out a specific personality. If the roll fails, roll to determine which personality surfaces to take control. Once the personality is aware that a psionic probe is being used to suppress him and bring out a different personality, he gets a +4 to save vs psionics and is likely to attack the psionic. If he fails to make the savings throw, there is a 65% chance of pulling forth the specific personality desired.
5. **Hypnotic Suggestion (psionic):** Has a small chance of being used to pull out a specific personality (30%). The current personality automatically gets a +3 to save vs psionic attack when hypnotic suggestion is being used.
6. **Mind Wipe (psionic):** Whenever a mind wipe is being used the current, dominant personality will retreat into the subconscious, automatically breaking the effect of the mind wipe and bringing out a new personality. Roll for random control.

DETERMINING RANDOM CONTROL

Determining which personality takes random control is easy. If you have TWO personalities, 1-3 represents the dominant personality, 4-6 the other, secondary, personality. THREE personalities: 1-2 is the dominant, 3-4 a secondary personality, 5-6 the other. FOUR personalities: 1-3 represents the dominant, 3, 4, 5 and 6 each represents one of the secondary personalities. FIVE personalities: 1-2 the dominant, 3, 4, 5 & 6 each represents one of the other personalities. SIX personalities #1 is the dominant, 2, 3, 4, 5, and 6 each represent one of the other personalities. *Assign a numerical designation to each personality and roll a six-sided die to determine which one is in control.*

THE CRAZYMEN

The crazy-man type hero is a wild, flamboyant, and jocular character. This person might be a cross between Daffy Duck, Errol Flynn and a stand-up comic on speed. Zany, dynamic, caustic and hyper. This guy is the wisecracking daredevil who seems to be as cocky and carefree leaping into the jaws of death as he is at a tea party. He will batter his opponent with sarcastic quips, bad jokes and silly observations while he's socking it out with him or facing the barrel of a gun.

These characters are always fidgeting. Tapping fingers, cracking knuckles, tapping feet, wringing hands, pacing, rocking, standing on one's head, doing cartwheels, suspended by rope, bouncing a ball, flipping a coin, juggling, etc. They are extremely hyper and can't seem to sit still. In combat, they are usually the one bounding into a group of baddies, hanging out the window, or displaying dazzling footwork.

The crazy-man heroes seem to have a consistent habit of laughing, giggling or snickering at the most unusual times. Usually this occurs during combat, under high pressure situations and triumph. Sometimes this can be extremely effective in rattling one's foe. Other times it is downright annoying. They also tend to come up with inane battle cries.

In combat, the crazy-man hero usually appears to be fearless, leaping into a foray with a joke on his lips and armed with his bare hands and a crowbar (that's a joke, son). They tend to be reactionary, believe themselves to be indestructible, take needless risks, and have a complete disregard for personal safety, especially when an innocent life is at stake.

Bonuses and Penalties: These heroes tend to be physically and action oriented, thus they are usually too impatient to master skills that require sitting still and/or intense contemplation or study. - 10% on all skills other than physical, piloting and weapon proficiencies. Add + 10% to prowl, climbing, swimming, gymnastics and dancing skills. Add +4 to roll with punch, fall and explosion. Also +1 to dodge. **Note:** As a reactionary, the crazy-man hero tends to be naive and a sucker for a sad tale, good cause or pretty face. *Also* roll twice on the *phobia table* and once on the *obsession table* found in the insanity section. These are additional little quirks that plague the hero.



Cyber-Knight O.C.C.

Nobody knows exactly where they came from or why, but about 80 years ago the cyber-knight emerged. Some believe the cyber-knights came into being to oppose the ever growing and corrupt Coalition. Others say that they came to fight the hordes of supernatural beings that terrorize the land. The truth is that they are the champions of all who are oppressed, weak, and innocent, whether they be threatened by the Coalition or monsters from a rift.

As to the knights' origin, not even they seem to know for certain. Legend has it that a group of great and noble warriors, who called themselves the Defilers, came to the land. Their group was composed of many different manner of men and monsters, yet they showed by example of their courage, honor, and actions, that all people were equal and meant to be free. When the group left, years later, they had made a great impression on the wilderness people. One, in particular, a tall, dark haired male, by the name of Coake, stayed (by the people's request) to train others in the way of the knights. It is said that Coake too, would leave, but not before creating the legacy that is the Cyber-Knights.

Today, being a cyber-knight is a way of life, based on an ideology and code of ethics. It is not an actual organization. One becomes a knight only if he or she is accepted as an apprentice and is instructed in the ways of knighthood by an accomplished master. After years of tutelage and training, the dedicated apprentice may achieve knight status as well. These knights in turn, teach others and the tradition continues. Rumor has it that there exists a monastery that teaches the way of the knights and that Lord Coake, himself, is its spiritual teacher. But if it exists, the Coalition has yet to find it. Nor does anyone else seem to know its location.

The Cyber-Knights are living legends. The great heroes of the North American wastelands and wilderness. A knight answers to no authority other than the callings of his own heart and the code of chivalry. It is the code of the knighthood that keeps the champions on the true path of honor, nobility, and goodness. They are obsessed with the protection of innocent life, both human and non-human, and freedom for the oppressed. They do not go looking for trouble, but in the endless struggle for survival in the rugged lands of the Rifts world, trouble never seems far. The warriors rarely travel together in groups larger than a pair. A troop of five or more can only mean that some horrible danger is near. Instead, they disperse, each roaming the land on horseback or vehicle, seeking and righting injustice wherever it is found. They will oppose injustice and evil in all its forms, from demon or dragon to the Coalition or a fellow knight gone bad. Like self-appointed sheriffs in a wild land, they deal out justice as judge, jury, and executioner. Although their methods are extreme, these are extreme and unusual times.

It is this autonomy of action, their legendary hero status, and phenomenal combat skills, that make them a threat to despot kings and would-be tyrants. The Coalition takes a keen interest in the knights' activities. Officially, the Coalition has little to say about the folk heroes, negative or positive. However, the powers that be see the knights as a threat and secretly eliminate them whenever the opportunity avails itself.

Training

The training of a cyber-knight is fastidious and strenuous. It builds both the mind and the body, becoming a way of life, not just a simple philosophy. In that respect, it is similar to the ancient martial arts of pre-Rifts Earth. Although not a hard and fast requirement, most cyber-knights possess some degree of psychic abilities. Mental disciplines include learning to use their psionic powers, meditation, literacy, the pursuit of truth and knowledge, and mastery over their emotions. The hero is taught to understand and control himself. To recognize one's emotions, but not to let emotion overcome reason. Take, for example, this cyber-knight proverb: "It is easy to give oneself to fear and hate, and therefore destroy that which you fear or loathe. But striking out at darkness does not eliminate it. Destruction out of anger, without reason or purpose, is simply destruction. One must learn to control fear and anger for they can blind you to the truth. One must re-channel emotion, and learn to see in the dark. Become a builder, not a destroyer. Yet remember, one must tear down that which has become infested with rot in order to let the good live."

Physical training involves years of study and practice with numerous weapons, body building, gymnastics, horsemanship, and martial arts.

Other areas of training include an understanding and appreciation for all life forms, an openness and tolerance to all ideas and philosophies, and an openness to magic and the unknown. The cyber-knight recognizes magic to be just another energy source that can be tapped and used for good or evil. This open mindedness makes them one of the few O.C.C.s which can intuitively understand and use items created through *techno-wizardry*.

Psionic Powers

Eighty percent of all cyber-knights possess limited psychic powers. Roll percentile dice. A roll of 1-80 means your character has psychic abilities. A roll of 81-00 means none.

Next, if psychic, roll 6D6+ 10 to determine the character's amount of I.S.P. Add 1D6 I.S.P. per level of experience. **Note:** The cyber-knight is considered to be a major psionic (mainly because of the psi-sword ability). **Saving Throw** versus psionic attack is 12 or higher.

Lastly, pick three permanent powers from the following list. A full description of these psi-abilities is found in the section on psychics and psychic powers.

Empathy
Mind block
Object read
See the invisible
Sense evil
Sense magic
Sixth sense
Speed reading
Summon inner strength

The cyber-knight is also the only O.C.C., other than the Mind Melter, who can create a *psi-sword!* A psi-sword is a mega-damage energy weapon that the warrior can mentally will into existence! The sword appears as a shimmering blade of energy that resembles a glowing sword. The sword's actual appearance will generally reflect its creator. A character who is impressed by strength and power will create a huge claymore-like weapon. A character who prides himself on speed and agility is likely to create a rapier or saber type blade, while a hero who enjoys cunning and subterfuge may create a short sword. Each is equally powerful regardless of its form and size.

The creation of the psi-sword is a very personal thing and requires years of training, study, and conviction. Once a shape has been decided, that is how the sword will always appear. When a knight in training can create a psi-sword, he or she is ready to become a full knight errant.

It is important to note that the cyber-knight's psi-sword is quite different than the mind melter's super psi-sword. First, the knight can create the weapon in an instant; in many respects it is a living part of the hero. Second, there is no expenditure of I.S.P. in the conventional game sense, the knight's will and conviction is the driving power behind the blade. Third, there is no limit as to how long the sword remains in effect nor any limit as to how many times a day the weapon can be created.

Lastly, the cyber-knight's psi-sword is not quite as powerful as the mind melter's, but it is still a weapon to be feared. **Psi-sword damage:** 1D6 Mega-Damage (M.D.) at first level, plus an additional 1D6 M.D. is gained at levels three, six, nine, twelve, and fifteen.

Note: A true knight will never use a psi-sword against a foe who is unarmed or not equipped with an equivalent weapon, or who is not a supernatural creature or dragon.

Knight Requirements and skills

Attribute Requirements: High I.Q., M.A., P.S., and P.E. attributes (all 10 or higher) are suggested but not required.

What is required is a strong will (M.E. 11 or higher), a lust for life, and a good heart with a thirst for justice (as a rule, good alignments only, but aberrant and anarchist are acceptable, and a knight may be corrupted and turn evil like anybody else).

Special Bonuses: Add +1D4 to M.A., M.E., P.S., P.E., and Spd attributes. Also add 1D4x10 S.D.C., +1 to initiative, and one additional attack per melee. These are in addition to other attribute or skill bonuses.

Permanent Base P.P.E.: Roll 6D6

O.C.C. Skills:

Literacy (+ 20%)	
Language (speaks both American and Dragonese/Elf at 96%, may select two additional at + 30%)	
Lore: Demon (+ 20%)	
Anthropology (+15%)	
Paramedic (+10%)	
Land Navigation (+12%)	
Horsemanship (+15%)	Swimming (+ 10%)
Climbing (+ 10)	W.P. Ancient (select 2 of choice)
Body Building	W.P. Modern (select 2 of choice)
Gymnastics (+ 5%)	Hand to Hand: Martial Arts

O.C.C. Related Skills: Select 12 other skills, but at least two must be selected from physical and another two must be W.P.s. Plus select two additional skills at level three, three additional W.P.s at level five, two other skills at level six, two other skills at level nine, and one at level twelve. All new skills start at level one proficiency.

Communications: Any
Domestic: Any
Electrical: Basic only
Espionage: Any (+5%)
Mechanical: Automotive only
Medical: None other than O.C.C. skill
Military: Any
Physical: Any (+5% when applicable)
Pilot: Any
Pilot Related: Any (+5%)
Rogue: Any
science: Any
Technical: Any (+5%)
W.P.: Any
Wilderness: Any (+5%)

Secondary Skills: The character also gets to select six secondary skills from the previous list. These are additional areas of knowledge that do not get the advantage of the bonus listed in parenthesis (). All secondary skills start at the base skill level. Also, skills are limited (any, only, none) as previously indicated in the list.

Standard Equipment: A suit of personalized, heavy, mega-damage body armor, including Coalition armor. A suit of light M.D. body armor, a set of dress clothing, and a set of black clothing for covert operations. Also a gas mask and air filter, tinted goggles, hatchet for cutting wood, knife (or two), ancient weapon of choice, modern handgun and rifle (probably energy weapons) and three extra ammo-clips, first-aid kit with extra bandages and antiseptic, suture thread and painkiller, tent, knapsack, back pack, saddlebags, two canteens, emergency food rations (two week supply), Geiger counter, and some personal items.

The knight's mode of transportation can be just about anything, but they lean toward real horses, robot horses, hover cycles, and modified motorcycles. They are also known to use magic devices. Rarely use power armor or robot vehicles.

Money: The character starts off with 2D6x 100 in credit, and has a black market item that will garner another 1D6x 1000 credits. As always, money can be spent immediately on additional equipment or saved.

Cybernetics: The cyber-knight is not necessarily opposed to cybernetic augmentation, but starts out with only one, *cyber-armor* (A.R. 16, 50M.D.C.).

The Code of Chivalry

1. To Live

Live one's life so that it is worthy of respect and honor.
Live for freedom, justice, and all that is good.

2. Fair Play

Never attack an unarmed foe.
Never use a psi-sword on an opponent not equal to the attack.
Never charge an unhorsed opponent.
Never attack from behind.
Avoid cheating.
Avoid torture.

3. Nobility

Exhibit self-control.
Show respect to authority.
Obey the laws if they do not supersede the rights of life.
Administer justice.
Administer mercy.
Protect the innocent.
Respect women.

4. Valor

Exhibit courage in word and deed.
Defend the weak and innocent.
Fight for an ideal, like freedom.
Fight with honor.
Avenge the wronged.
Never abandon a friend, ally, or noble cause.

5. Honor

Always keep one's word of honor.
Always maintain one's principles.
Never betray a confidence or comrade.
Avoid deception.
Respect life.
Honor all life.
Respect all views of life.

6. Courtesy

Exhibit manners.
Be polite and attentive.
Be respectful of host, women, and honor.

7. Loyalty

To one's principles and heart.
To one's friends and those who lay their trust in thee.
To the code of chivalry.

Glitter Boy O.C.C.

One of the most famous creations of the Time Before Rifts, as well as in the time of **Rifts**, is the "Glitter Boy." The name is derived from the laser resistant chrome of the Glitter Boy robot power armor. The armor is extremely light reflective and glitters in a dazzling array of light and color.

Glitter Boy power armor stands about ten feet (3 meters) tall and is the most heavily armored and reliable robot in the world. It is also a complete environmental suit that filters impurities from the air and will automatically switch to its own oxygen supply (four hours supply) if the outside air is toxic and can not be purified by its air purification and circulatory system.

All standard units feature the equally famous "Boom Gun," a powerful rail gun that hurls 200 projectiles simultaneously at Mach two speed. The massive seven foot (2.1 m) weapon is attached to a swivel unit on the right shoulder and is stored, locked into place, behind the shoulder.

Glitter Boy armor can be used by any character trained in piloting robot power armor, but they pilot the shimmering vehicle at the basic level. Only the pilots of the Glitter Boy O.C.C. are specifically trained in the complete understanding and operation of the armor. These mechanized warriors are one with their machine. *See Hand to Hand Bonuses from Robot Combat Training section.*

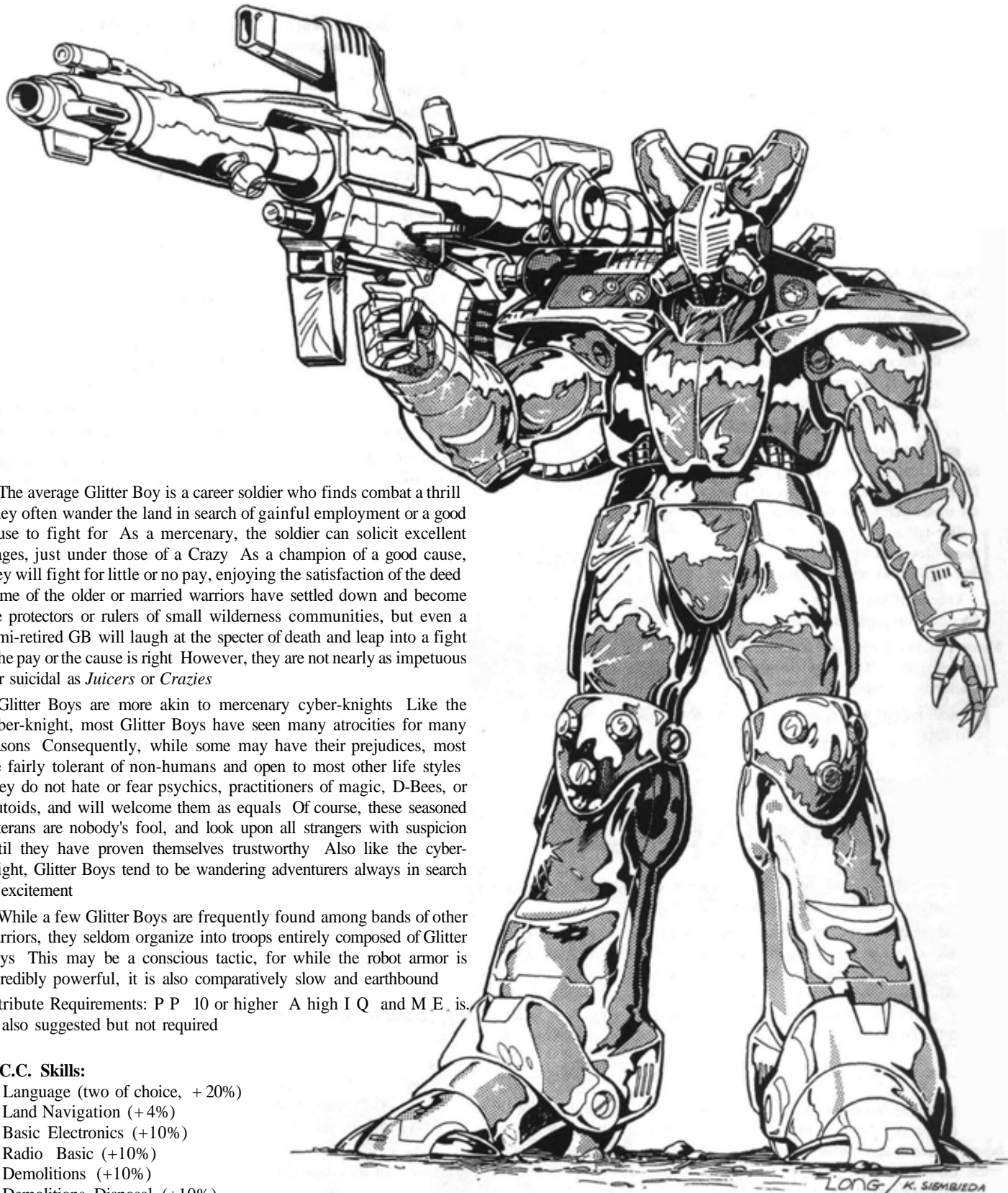

The average Glitter Boy is a career soldier who finds combat a thrill. They often wander the land in search of gainful employment or a good cause to fight for. As a mercenary, the soldier can solicit excellent wages, just under those of a Crazy. As a champion of a good cause, they will fight for little or no pay, enjoying the satisfaction of the deed. Some of the older or married warriors have settled down and become the protectors or rulers of small wilderness communities, but even a semi-retired GB will laugh at the specter of death and leap into a fight if the pay or the cause is right. However, they are not nearly as impetuous nor suicidal as *Juicers* or *Crazies*.

Glitter Boys are more akin to mercenary cyber-knights. Like the cyber-knight, most Glitter Boys have seen many atrocities for many reasons. Consequently, while some may have their prejudices, most are fairly tolerant of non-humans and open to most other life styles. They do not hate or fear psychics, practitioners of magic, D-Bees, or mutoids, and will welcome them as equals. Of course, these seasoned veterans are nobody's fool, and look upon all strangers with suspicion until they have proven themselves trustworthy. Also like the cyber-knight, Glitter Boys tend to be wandering adventurers always in search of excitement.

While a few Glitter Boys are frequently found among bands of other warriors, they seldom organize into troops entirely composed of Glitter Boys. This may be a conscious tactic, for while the robot armor is incredibly powerful, it is also comparatively slow and earthbound.

Attribute Requirements: P P 10 or higher A high I Q and M E. is also suggested but not required.

O.C.C. Skills:

- Language (two of choice, +20%)
- Land Navigation (+4%)
- Basic Electronics (+10%)
- Radio Basic (+10%)
- Demolitions (+10%)
- Demolitions Disposal (+10%)
- Robot Combat Elite (specifically, Glitter Boy Power Armor)
- Robot Combat Basic (general)
- Read Sensory Equipment (+10%)
- Weapon Systems (+10%)
- W P Energy Pistol
- W P Energy Rifle
- Hand to Hand Basic

Communications: Any
 Domestic: Any
 Electrical: None, other than O.C.C. skill.
 Espionage: Wilderness survival and intelligence only.
 Mechanical: Automotive only (+5%)
 Medical: First aid or paramedic (pick one).
 Military: See O.C.C. skills
 Physical: Any except acrobatics or gymnastics.
 Pilot: Any
 Pilot Related: Navigation (+5%)
 Rogue: Any
 Science: Any
 Technical: Any
 W.P.: Any
 Wilderness: Any

Secondary Skills: The character also gets to select six secondary skills from the previous list. These are additional areas of knowledge that do not get the advantage of the bonus listed in parenthesis (). All secondary skills start at the base skill level. Also, skills are limited (any, only, none) as previously indicated in the list.

Standard Equipment: Glitter Boy personal armor or any light body armor, energy rifle and energy side arm of choice, four extra E-clips for each, one additional non-energy weapon of choice, two grenades, six signal flares, survival knife, utility belt, air filter and gas mask, walkie-talkie, two pairs of fatigues, lightweight velcro-strapped boots (designed for silence and comfort), canteen, robot medical kit and IRMSS, as well as personal items.

Vehicle is the Glitter Boy Power Armor complete with Boom Gun and full payload of ammunition.

Money: Glitter Boys have a tendency to live it up and spend their money quite freely. 4D6x 100 credits and another 1D4x1000 in black market items.

Cybernetics: Start with none, but may purchase cybernetic augmentation later.

Headhunter O.C.C.

The term "Headhunter" has come to be the designation for most human mercenaries and bounty hunters.

A headhunter is a mercenary; a warrior-for-hire. However, a "true" headhunter is an expert in weapons and tracking. They are the die-hard men-of-arms who love the challenge of combat and the chance to cheat death. All they know is combat. They have fought all their lives and will die fighting. The headhunters credo is "Fight the good fight and die with the enemy's heart in your hand."

A typical headhunter is armed to the teeth and complemented with cybernetics and/or bionics. Most of these mercenaries will accept any being, human or non-human, who demonstrates courage and the warrior spirit. Consequently, a group of headhunters is likely to be composed of a variety of humans, mutants, aliens, dog boys, and even practitioners of magic. Although headhunters may allow men of magic to join their ranks, headhunters themselves seldom use magic or magic devices.

The individual headhunter lives by his own code of ethics (determined by his/her alignment). The notoriously evil and self-serving (will work for anybody who is willing to pay the most) headhunters are the most talked about, but many headhunters are as noble and trustworthy as a cyber-knight. Most see themselves as freewheeling "ronin" samurai; nomadic warriors without any one master.

Attribute Requirements: P.E. and P.P. 12 or higher, a high P.S. and I.Q. are also suggested but not required.

O.C.C. Skills:

Radio: Basic (+15%)
 Radio: Scrambler (+10%)
 Detect Ambush (+10%)
 Detect Concealment (+ 15%)
 Tracking (+10%)
 Land Navigation (+ 10%)
 Weapon Systems (+10%)
 Read Sensory Equipment (+ 10%)
 Pilot Jet Pack (+12%)
 Pilot Tanks and APCs (+ 10%)
 Pilot (select two additional pilot skills, + 5% each)
 Lore: Demon (+ 10%)
 Language (select three, + 10%)
 W.P. (select five)
 Hand to Hand: Expert

Hand to Hand: Expert can be changed to Hand to Hand: Martial Arts (or assassin if an evil alignment) for the cost of one "other" skill.

O.C.C. Related Skills: Select four other skills. Plus select two additional skills at level three, one at level six, one at level nine, and one at level twelve. All new skills start at level one proficiency.

Communications: Any (+5%)
 Domestic: Any
 Electrical: Basic electronics only
 Espionage: Any
 Mechanical: Automotive only (+5%)
 Medical: Paramedic only
 Military: Any (+15%)
 Physical: Any, except acrobatics.
 Pilot: Any
 Pilot Related: Any
 Rogue: Any
 Science: Math only
 Technical: Any
 W.P.: Any
 Wilderness: Any

Secondary Skills: The character also gets to select six secondary skills from the previous list. These are additional areas of knowledge that do not get the advantage of the bonus listed in parentheses (). All secondary skills start at the base skill level. Also, skills are limited (any, only, none) as previously indicated in the list.

Standard Equipment: A suit of personalized, light or heavy (usually heavy), mega-damage body armor, including Coalition armor. A set of dress clothing, and a set of camouflage clothing for covert operations. Also a gas mask and air filter, tinted goggles, hatchet for cutting wood, knives (1D4), an energy handgun and rifle and six extra ammo-clips for each, three additional weapons of choice, 1D6 grenades, robot medical kit and IRMSS, tent, knapsack, back pack, saddle bags, two canteens, freeze-dried food rations (five week supply), and some personal items.

The headhunter's mode of transportation can be just about anything, but they lean toward military vehicles, robots, and power armor. They never use magic devices.

Money: The character starts off with 1D6x100 in credit, and has a black market item that will garner another 1D6x1000 credits. Generally, spends money on pleasure, cybernetics/bionics and weapons as fast as they can make it.

Cybernetics: Has 1D4 cybernetic implants of player's choice, plus *one* bionic limb (hand, or hand and arm, or leg and foot) and two bionic weapons for that limb.



Juicer O.C.C.

In man's search to create the ultimate human, it was inevitable that, sooner or later, someone turned to *chemical enhancement*.

The creation of the chemical man came from Eastern Europe, where was seen the rise of the super athlete/warrior. At first, drugs were used to build the natural body through the use of synthetic hormones, such as steroids to build muscles, and EPO to increase blood flow and physical performance. However, it soon became apparent that the chemical condition was too difficult to maintain at peak level over long periods of time. Unless the individual was carefully monitored and drug intake adjusted, the person would experience severe performance drop-offs, lulls, and highs. A consistent level of optimum performance was necessary in order to create the perfect human super-machine.

New designer drugs were combined with a computerized biological monitoring and drug dispensary system with incredible results. The computer system monitored every aspect of the body: blood flow, air intake, oxygen levels, adrenaline release, sugar levels, hormone levels, respiration, neurological responses and stimuli, digestion, and other aspects of the functioning human body. Microscopic implants placed in the vascular system, brain, and muscles mapped out the body in unimaginable detail. Nano-technology and chemical advancement would herald the day of the super-human without the extreme mechanical augmentation of bionics.

The first step in creating the chemical super man is the implantation of two tiny mega-computers called *the bio-comp system*. The postage stamp sized devices are implanted in the subject's head and/or chest. The dual system served as a fail-safe feature that enables one bio-comp system to override the other in case of malfunction. Only one system operates at a time, although both are neurologically linked to hundreds of microscopic sensors implanted throughout the body. These tiny implants constantly relay data about the subject's physiology as the body reacts and changes in response to stimuli like drugs, stress, pain, and combat. The bio-comp system is also designed to trigger different natural and artificial chemical responses to thousands of specific conditions. For example: If the body needs a jolt of adrenaline, the bio-comp system triggers a microscopic implant to release it precisely when needed. If it needs more than the natural amount of adrenaline, the system sees to it that more is delivered. If the body is feeling fatigued, a form of super EPO synthetic hormone is injected to increase the oxygen flow into the blood, which decreases fatigue and increases physical performance by an amazing 16 to 21 percent! Other sensors, implants and chemicals are utilized to negate pain, clot blood, and stimulate chemical reactions.

An injection collar around the neck, wrists, upper arm, and legs, deliver the needed synthetic chemicals. The man-made drugs are contained in a soft, padded harness worn under clothing and battle armor. Tubes run from the central dispensary system of the harness to the specific injection collars. This is especially useful in the immediate treatment of specific areas of the body, especially for pain and muscular disorders.

In addition to initiating or countering specified chemical reactions, the bio-comp system also *maintains* the body at maximum levels of efficiency. All aspects of optimum physical conditioning are monitored and maintained. The individual's body weight, calorie intake, breathing, muscles, bulk, flexibility, reflexes, alertness, vision, and sensitivity are all maintained on a constant basis.



But there is still more! The same nano-technology that make the bio-comp system possible is also responsible for the *IRMSS Internal Robot Medical Surgeon System*, a battery of microscopic robots programmed to perform internal surgery! The Juicer has two IRMSS housing units, one *external* housing and one *internal housing*. The external robots are similar to the IRMSS portable kit. The medical robots are released by injecting them into the bloodstream, where they will navigate to the trouble zone and affect repairs. Unlike the portable kit, the Juicer has a circular chest plate over his heart that will inject the robots by pounding on the plate. The robots are injected directly into one of the main heart arteries so that they are rushed into the circulatory system. They can reach a torn vein or artery anywhere in the body within 60 seconds.

The internal system is located in the neck and is controlled by the bio-comp system. Unlike the IRMSS kits (and chest unit), whose robots cease to function after a while and are flushed from the body, these tiny medical units can be guided back to their housing and recharged by the body's own electro-magnetic energy, to be used over and over again. All IRMSS units are designed to stop bleeding, suture veins and arteries, and aid in the internal repair and healing of the body. The bio-comp system assists by increasing or decreasing blood flow, the number of red or white blood cells, and by dispensing natural and synthetic painkillers, sedatives, antibiotics, and so on.

The end result is a super man!

The chemically "juiced-up" subject is 10 times faster, stronger, and more alert than the average human. One reason is that the controlled metabolism is actually increased to such a level during combat that perceived time and movement are slowed down. The Juicer sees the world much the same as a fly, with everything around him moving in slow motion while he moves with lightning speed and agility.

Live fast. Die young.

Despite these apparent marvels, the subjects of this chemical enhancement pay a terrible price: an early death. The chemical and physical demands placed on the body are horrendous. The strain on all systems is so terrible that the body literally burns out, both internally and externally. The heart of a 20 year old Juicer can just explode one day. The chemicals have all kinds of side effects, making the blood too thick, too many or not enough red or white blood cells, muscle spasms, crumbling bones, deterioration of internal organs, destruction of the immune system, neurological disorders, and *complete* and *total* drug dependency. The price of physical and, to a lesser degree, emotional perfection. Without exception, a Juicer over five years old will die of a stroke or heart failure before his eighth year of service. The average life expectancy of this warrior is six years!!

In today's world of **Rifts**, Juicers are generally psychopathic killers who don't care if they die young, the foolish who don't believe the stories they hear, or the desperate who believe that they must become a Juicer to support a family or extract revenge. On occasion, slaves and captives are unwillingly turned into Juicers by unscrupulous warlords.

One can become a Juicer by enlisting in an army of a feudal state that offers Juicer technology. The usual deal is Juicer conversion, big bucks (4D4 x 10,000 credits a year), and two years of loyal service in their army. After the two years service, they are free to stay or go. Juicer mercenaries are among the most highly paid and feared in the Americas.

The Coalition has outlawed Juicer technology and will not hire Juicer mercenaries. Anyone convicted of creating a Juicer is executed. Still, an occasional Body-Chop-Shop will offer Juicer conversion at a staggering three to four hundred thousand (400,000) credits. And still, people submit themselves to the punishment of drugs to attain, what they see as, a brief period of perfection.

Juicer Powers

- Super endurance.** Add 1D4x100 S.D.C., add 1D4x10 hit points, and 2D6 to P.E. attribute. Can lift and carry four times more than a normal person of equivalent strength and endurance, and can last 10 times longer before feeling the effects of exhaustion. Can remain alert and operate at full efficiency for up to five days (120 hours) without sleep. Normally needs only three hours of sleep per day.
- Super strength.** Add 2D6 to P.S. attribute. **NOTE:** Minimum P.S. is 22, if lower, adjust up to P.S. 22.
- Super speed.** Add 2D4 x 10 to Spd attribute. Can leap 30 feet (9.1 m) across after a short run (half from a dead stop), and 20 feet (6 m) high (half without a short run).
- Super reflexes and reaction time.** An accelerated metabolism makes everything around the Juicer seem to move in slow motion. **Bonuses:** +4 to roll with punch, fall, or impact; +4 on initiative; gets an automatic parry or dodge on all attacks, even from behind/surprise; add two extra attacks per melee, and add 2D4 to P.P. attribute. (**NOTE:** Minimum P.P. attribute is 20, if lower, adjust up to P.P. 20.) **Penalties:** Can not sleep without sedative or tranquilizers. Tends to be a bit jumpy and anxious; boredom is a constant enemy (bio-comp will counter with tranquilizers and euphoria drugs to make feel good/zone-out, but can instantly make the juicer alert and ready for action in 15 seconds/one melee).
- Saving throw bonuses.** +4 to save versus psionics, +6 to save versus mind control (psionic and chemical), +8 to save versus toxic gases, poisons, and other drugs. **NOTE:** Bio-comp can slow the blood flow or increase oxygen levels to slow the effects of drugs or inject natural and synthetic chemicals to counteract immediately. Likewise, the Juicer can slip into a trance-like state to conserve oxygen.
- Enhanced healing.** Heals four times faster than normal. +20% to save vs coma and death. Virtually impervious to pain, no amount of physical pain will impair the Juicer until he is down to 5 hit points or less. At this point the warrior will collapse, falling into a trance/coma, which is really a bio-comp induced state of accelerated healing.
- Player's Note:** The Juicer character will die after five (5) years and 4D6 months of being a chemically induced super man! There are no exceptions!! No saving throws, no hope. The body is destroyed; used up. Not even psionic healing or magic restoration or resurrection (— 50%) can help.

Juicer Detoxification; a chance for survival!

A Juicer's only chance for longevity is to *attempt* to cleanse himself of the chemical system and the drugs that are pumped into his body. However, this must be attempted within the first three (3) years of life as a Juicer. After three years the success ratio is severely reduced and it eventually becomes impossible.

The process of detoxification is painful, terrifying, and both physically and emotionally debilitating. The character will need a safe, quiet place, and the support of friends and doctors to survive. The worst pains of physical withdrawal will last 1D4 weeks. During this time the body will convulse, vomit, and burn with fever. The individual is completely helpless (no combat abilities, even for defense). That's the easy part.

The next step is fighting the psychological and emotional dependency. This is complicated by the fact that the character is, by comparison, a mere shadow of his former super self (*see #3, the price of drugs*).

The Steps required for detoxification of a Juicer

- Removal of the Bio-Comp System.** To free oneself from the drugs, the character *must forever* forsake being a Juicer! The bio-comp system must be removed (the thousand microscopic data implants can

remain, with no ill effects), and the drug harness destroyed. The removal of the bio-comp system is critical, because even without the drug harness, the system stimulates the body to create natural hormones and chemicals to unnatural and ultimately deadly proportions. Surgery, preferably performed by a cyber-doc, is necessary.

2. Select a new O.C.C. The character must select a new O.C.C. to continue his life. The Juicer O.C.C. is a combat occupation. The character is trained as a warrior, consequently, only the following O.C.C.s are available to him. *Headhunter/mercenary, Borg, City Punk, and Vagabond.* Note that after his experience as a Juicer, the character is likely to avoid all means of artificial augmentation such as bionics (Borg) and all cybernetics.

Since the character is already trained in combat, he retains those skills and can select a total of seven (7) new skills from the new O.C.C.'s skills and/or from the "other" available skills. The new skills increase as normal, beginning at level one. The old Juicer skills remain frozen until the individual reaches an equivalent level of experience in the new O.C.C., at which point the old skills continue to increase per level of experience thereafter.

3. The price of drugs. Penalties!

First, all the Juicer bonuses and powers are permanently gone! The character must be effectively rebuilt and will never come close to his former life as a Juicer.

Second, reduce all physical attributes to eight (8) regardless of bonuses from previously selected physical skills, then add the roll of 1D4 to each. These are the character's new physical attributes. To the ex-juicer, this is a nightmare. Reflexes and speed will seem like a snail's and strength like a baby's. Such is the price of drug abuse.

Third, the character looks 10 years older than he really is for every one year as a juicer. Also reduce P.B. attribute by 1D4.

Fourth, S.D.C. is reduced to 5D6. Hit Points are P.E. plus 1D6 per level of experience, as normal.

Fifth, poor reaction time and reflexes. Remember, all the Juicer's chemically enhanced powers no longer apply. Attacks per melee is normal as per hand to hand combat training and now — 2 on initiative. Physical endurance and fatigue are also normal.

Lastly, roll on the following permanent side effect table.

01-10 Lucked out! No side effects.

11-30 Permanent stiffness and pain in body joints; - 1 to strike, parry, dodge, and roll.

31-50 Immune system is weakened; — 1 to save on all saving throws and - 10% to save vs coma.

51-70 Memory retention is poor; reduce all skills by —5%.

71-90 Dependent on some other drugs or alcohol. *See drug and alcohol addiction in the Insanity section.*

91-00 Roll once on the phobia table and once on the neurosis table. *See Insanity section.*

IMPORTANT NOTE: If detox is happening within the first or second year, the character is not quite as ravaged by drugs and gets the following bonuses: +6D6 S.D.C., +2 to P.S., P.P., and P.B., plus 2D6 added to Spd attribute. Also, do not roll on the previously listed side effect table. If the character has been a Juicer for five or more years, the GM may also have the character roll for a random insanity.

Detox Success Ratios

The player must roll two out of three successes to purge the character of the drugs. The character can try again and again, as often as once per week, to see if he or she can shake the body's craving for the drugs until successful or gives up.

Percentile of success: Year one: 1-89%, year two: 1-76%, year three: 1-59%, year four: 1-27%, year five: 1-9%, year six: 1%, year seven: 0%.

A failed roll means the character is in misery and craves drugs. Roll on the following table:

01-40 Becomes addicted to other drugs or alcohol (*See the effects of drug and alcohol addiction in the insanity section.*)

41-80 Depressed, despondent, racked with chills, fever, and the shakes. Also terrified by the thought that he/she is insignificant and a failure. Skills are all at half proficiency, attacks and combat bonuses are also reduced by half, speed attribute is reduced by half too. Tends to be moody, withdrawn and drinks heavily. This is a permanent condition unless the character actively tries to successfully shake the drugs again.

81-90 Wants to become a Juicer again, even if it means his death.

91-00 Can not bear to live this way and commits suicide.

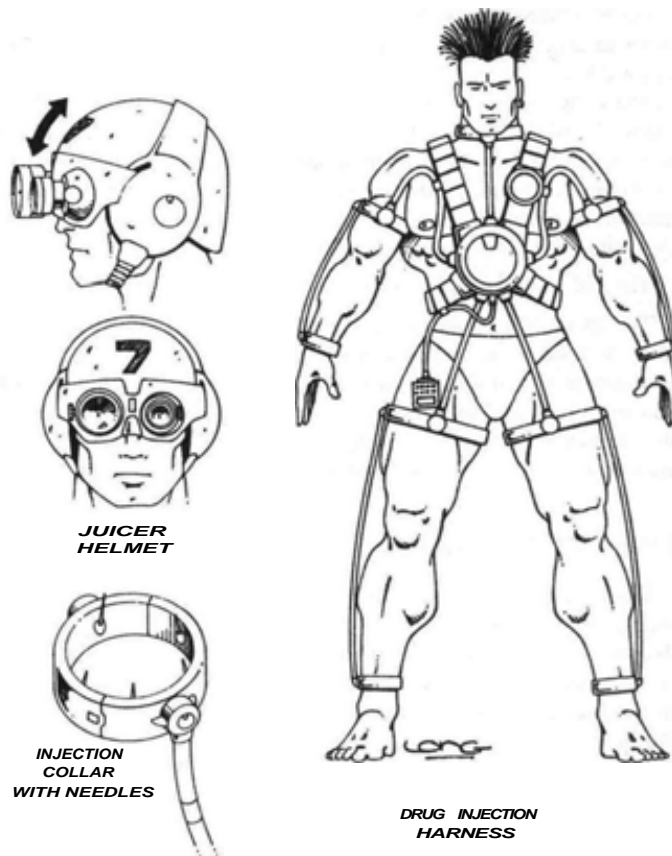

Attribute Requirements: None, just a willingness to submit to deadly chemical bombardment and dependency.

O.C.C. Skills:

- Radio: Basic (+10%)
- Wilderness Survival (+5%)
- Land Navigation (+5%)
- Piloting (two of choice at +10%)
- Language (three of choice at +10%)
- W.P. Knife
- W.P. Energy Rifle
- W.P. (two of choice)
- Hand to Hand: Expert

Hand to Hand: Expert can be changed to Martial Arts or Assassin (if an evil alignment) for the cost of one "other" skill.

O.C.C. Related Skills: Select 7 other skills. Plus select two additional skills at level three, one at level six, one at level nine, and one at level twelve. All new skills start at level one proficiency.

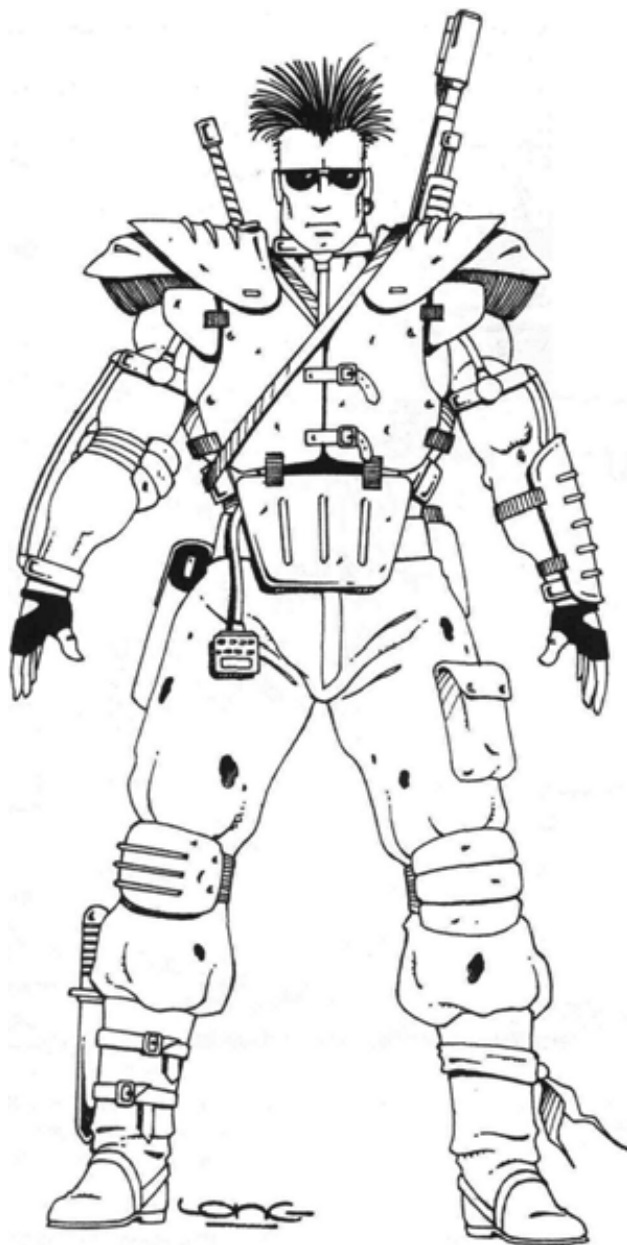

Communications: Any
 Domestic: Any
 Electrical: Basic only.
 Espionage: Intelligence, escape artist, detect ambush, and detect concealment only. (+5%)
 Mechanical: Automotive only
 Medical: None
 Military: Any (+10%)
 Physical: Any (+10% where applicable)
 Pilot: Any (+5 on all military types)

Pilot Related: Any (+5%)
 Rogue: Any (+15% to Prowl)
 Science: Basic Math only
 Technical: Any
 W.P.: Any
 Wilderness: Any

Secondary Skills: The character also gets to select six secondary skills from the previous list. These are additional areas of knowledge that do not get the advantage of the bonus listed in parenthesis (). All secondary skills start at the base skill level. Also, skills are limited (any, only, none) as previously indicated in the list.

Standard Equipment: Bio-comp and bio-data implants, drug harness and drug supply (usually needs to be replenished once or twice a year), Juicer lightweight flex-plate armor, optic helmet, portable IRMSS kit, camouflage fatigues and armor, extra set of grey fatigues, boots with knife holster, gloves, back pack, utility belt, sunglasses, canteen, compass, and personal items.

Weapons include the Juicer Assassin's JA-11 energy rifle, energy pistol, 2D4 E-clips for each, choice of two non-energy weapons,

choice of three ancient weapon types (knife, mace, sword, etc.), and a vibro-blade (in boot).

Vehicles can be just about anything, but the faster the better. These guys are speed junkies and hate slow-moving vehicles. Consequently, hover vehicles, jet packs, and helicopters are their favorites. Seldom want slow-moving tanks/APCs or lumbering robots.

Money: Juicers live life while they can so they seldom have much money saved, even though they can earn much. 4D6 X 100 credits and another 4D6x 100 in black market items.

Cybernetics: Start with none. Juicers are so arrogant and confident their own superhuman abilities, that most take pride in the fact that they do not need mechanical augmentation.

NOTE: Juicers tend to be bold, outspoken, cocky, and self-reliant warriors who live for action! They are always looking for something to do and will frequently take unnecessary risks and accept challenges of strength and combat skill to prove themselves the ultimate warriors.

Scholars and Adventurers

Body Fixer O.C.C.

"Body Fixer" or "Fixer" is the slang term for a medical doctor (M.D.); a person who can fix or heal the human body. The Body Fixer O.C.C. is a tough adventurer and, sometimes, freedom fighter dedicated to life and the pursuit of happiness. It is a rogue class, which means that they are not a legal medical doctor as recognized or authorized by the Coalition States. This means most fixers are criminals or rebels in the eyes of the Coalition. Why? Because traditionally, body fixers are more concerned with the human spirit and human body than they are profit or power. They offer their expert services to anybody who needs them and tend to treat undesirables like down siders, the poor, wilderness peasants, and wasteland vagabonds and adventurers. Even more despicable, the body fixers are doctors who treat mutants, psychics, men of magic, aliens, and intelligent creatures of all kinds. Unfortunately, associating with any of the previously mentioned people are crimes against the State.

Ironically, the doctor's criminal or rabble-rouser label has made the Body Fixer O.C.C. a sort of a mercenary with a humanitarian cause, and a folk hero among the downtrodden. Although most fixers will try to avoid violence and the inflicting of serious injury, many are as good with a gun or a knife as they are with a scalpel, and are not afraid to use either. Some of the older veterans of medicine are downright militant and hate the Coalition for their negligent and heartless treatment of people in general, and non-humans and mutants in particular. But even the most grizzled body fixer tends to be gentle and caring as a healer.

Of course, a man of medicine can be a man of action and strength and still remain a pacifist. Or he can be a rough and tumble he-man mercenary. Depending on circumstance and upbringing, the character can be a criminal, butcher, or humanitarian. All are passionate individuals who are willing to fight for what they believe in, whether that be for noble reasons, or for glory, power, or profit. The character can be any alignment, good, selfish, or evil.

The Body Fixer can use any type of weapon, body armor, robot, or vehicle, but tends to travel light, giving priority to medical equipment

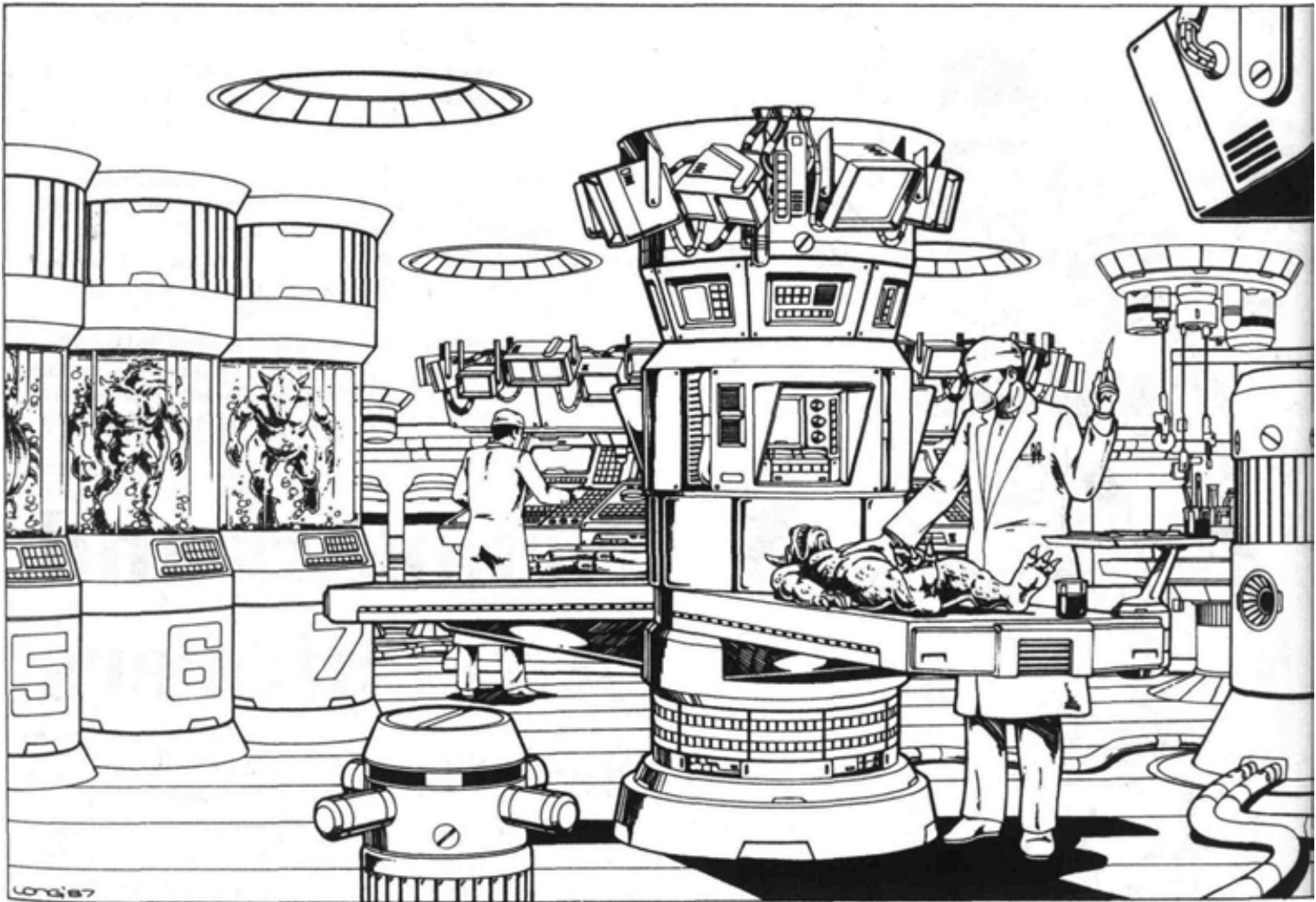

over everything else. Likewise, their skills can range from the medical sciences to wilderness survival and mechanics. However, their major orientation will always be medicine and science.

Perhaps because they know and cherish the pure physical body so much, the body fixer will generally refuse to have cybernetic mechanisms implanted in himself, unless it is a lifesaving organ or prosthetic, and will seldom implant unnecessary augmentation in others. In fact, the doctor will try to convince other characters to avoid artificial augmentation entirely. He will frown when he sees an excessive or medically unnecessary use of cybernetics and bionics. Despite their disdain for these sins against the human body, they are familiar with the medical use of cybernetics and are skilled surgeons capable of implanting and removing most cyber-parts. Bionics is a much more complex and specialized science. The body fixer is —40% whenever working on bionic modifications.

Note: The doctor suffers a penalty of -30% when dealing with extremely alien physiologies and/or alien cybernetics.

Attribute Requirements: I.Q. 10 or higher; a high P.P. and M.A. are suggested but not mandatory.

O.C.C. Skills:

- Medical Doctor (+ 10%)
- Biology (+ 30%)
- Pathology (+ 30%)
- Chemistry (+ 20%)
- Basic Math (+ 15%)
- Literacy (+ 30%)
- Language (select 1 additional; +20%)
- Pilot Automobile (+ 5%)

- Athletics General
- Body Building
- W.P. Knife

Hand to Hand combat can be selected as an "other" skill as follows: Basic counts as one skill selection, Expert as two, Martial Arts three, and Assassin counts as four (4) skill selections.

O.C.C. Related Skills: Select 12 other skills, but at least two must be selected from technical or the sciences. Plus select three additional skills at level three, two at level six, one at level nine, and one at level twelve. All new skills start at level one proficiency.

- Communications: Radio: Basic only (+5%)
- Domestic: Any (+10%)
- Electrical: Basic electronics only (+5%)
- Espionage: Wilderness survival only (+10%)
- Mechanical: Automotive only
- Medical: Any (+15%)
- Military: None
- Physical: Any, excluding wrestling and acrobatics.
- Pilot: Any (+5%)
- Pilot Related: Any
- Rogue: None
- Science: Any (+5%)
- Technical: Any (+10%)
- W.P.: Any
- Wilderness: Identify plants, Land Navigation, and Hunting only.

Secondary Skills: The character also gets to select eight secondary skills from the previous list. These are additional areas of knowledge that do not get the advantage of the bonus listed in parenthesis (). All secondary skills start at the base skill level. Also, skills are limited (any, only, none) as previously indicated in the list.

Standard Equipment: Two surgical gowns, dozen pair of disposable surgical gloves, one pair of reusable surgical gloves, surgical kit (includes scalpels, clamps, suture, needles, etc.), medical kit (first-aid kit, bandages, antiseptics, protein healing salve, aspirin, painkiller, antibiotics, hypodermic gun, stethoscope, pen flashlight), IRMSS/Internal Robot Micro-Surgeon System, RMK/Robot Medical Kit, hand-held computer, hand-held blood pressure machine (computerized), thermometer, six unbreakable vials, and other basic items, portable compu-drug dispenser, and portable laboratory.

The body fixer is also likely to have some sort of lightweight mega-damage body armor and carry a weapon(s), particularly if his travels take him through the wilderness and wastelands; select one automatic weapon and one mega-damage energy weapon, both have 1D6 extra ammo clips. The fixer is also handy with a knife/scalpel and is likely to carry a few combat knives in addition to his surgical knives.

The character's vehicle can be just about any kind of non-military ground vehicle; player's choice. Like all **Rifts** characters, he can use most types of weapons and wear body armor (except during surgery), but prefers light armor for greater mobility.

Money: A city doctor will have 4D6x 1000 in credit. The wandering fixer will have 1D4 x 1000 in credit and 4D6 x 1000 in black market saleable items. This money can be used to purchase specific weapons and equipment when the character is created or later, if the opportunity arises.

City Rat O.C.C.

The city rat is one of the denizens of the city's who lives in its lower levels, tunnels, and sewers. Most have never been beyond the city walls and view the outside world as wondrous, scary, and alien. Their world is the dark city streets, crowded with people, garbage, vehicles, and vermin. They know the back streets, and often the sewers and access tunnels, like most know the highways and avenues. They can spot a drug dealer from a 1000 feet away and know the advantages and dangers offered by the cyber-doc.

Those who live in the lower levels of a city are generally nicknamed "Down Siders," but the city rat is a designation for a Down Sider *troublemaker*. Rats are usually young men and women in their teens or 20's who walk on the wild side. They crave adventure and find it by bucking the system. A city rat may be an idealistic rebel who seeks reform and justice in a corrupt and unjust society like that of the Coalition, or he may be a computer hacker, beggar, thief, or gangland thug. The individual's orientation and skills will reflect his alignment, ideals, ethics, and goals.

The *heroic* city rat is generally an anarchist in the full sense of the word. He tends to see himself as beyond the law and believes that boundaries are made to be stepped over. Whether he is a thief who plunders a corrupt government and/or the wealthy (a la a self-serving Robin Hood who steals from the rich and gives to the poor, himself included), or a computer hacker who craves to know things (just to know what is forbidden or secret because it is forbidden or secret), or a rebel who believes it is his duty to make people stop and think about their lives and injustice by disrupting their lives (revealing embarrassing facts about government officials or laws, skirmishes with law enforcers, vandalizing government/police property, etc.), the city rat revels in his perceived image of being a self-made, swashbuckling hero (or anti-hero). The *hero* can be any alignment except principled, and tends to be anarchist, unprincipled, or scrupulous.



Villainous city rats are the street scum that prey on innocent people. These are the bandits, assassins, drug dealers, cyber-snatchers, gang members, and truly vicious and cruel street criminals. They are the brutes who think power is the ability to hurt and humiliate, and to use and destroy, their fellow man. Alignments are always evil or anarchist.

Whether a brigand or a hero, the city rat is always a cocky, freewheeling scoundrel, bold, and macho. He or she is as conscious of personal image as they are personal goals. The image is one of strength, resourcefulness, success, and looking cool/new wave, even if that image is mostly flash and little substance. They tend to be attracted to glamour, wealth, and fame.

A child of the city and technology, the rat has often subjected his body to cybernetic improvements, usually in the area of implants, not prosthetics or bionics. The rebel may be extremely literate and versed in computers, or a complete illiterate who puts his money on skill and cunning rather than words.

Attribute Requirements: Generally, the city rat is fast, clever and agile, but there are no real requirements.

Needs an I.Q. 10 or higher to be a hacker, P.P. of 10 or higher to be a thief, I.Q. 10 and P.P. 14 or higher to be an assassin, P.S. of 14 or higher to be a thug/muscle man.

O.C.C. Skills:

Streetwise (+20%)
Pilot Motorcycle (+15%)
Pilot Automobile (+10%)
Math: Basic (+10%)
Running
W.P. of Choice (1)
Hand to Hand: Basic

Hand to Hand: Basic can be changed to Hand to Hand: Martial Arts (or assassin if an evil alignment) at the cost of one "other" skill.

O.C.C. Related Skills: Select IS other skills, but at least three must be selected from physical skills and two from rogue skills. Plus select two additional skills at level three, two at level six, one at level nine, and one at level twelve. All new skills start at level one proficiency.

Communications: Any (+10% to radio: basic and surveillance systems)
Domestic: Any (+5%)
Electrical: Basic only (+5%)
Espionage: None
Mechanical: Automotive only (+10%)
Medical: First aid or paramedic (+10%), but the paramedic skill counts as two skill selections.
Military: Any
Physical: Any (+5% where applicable)
Pilot: Any ground vehicles, jet pack, robot basic combat (+10%), no aircraft or boats.
Pilot Related: Any
Rogue: Any (+15%)
Science: Mathematics: Advanced and chemistry
Technical: Any (+10%)
W.P.: Any
Wilderness: None

Secondary Skills: The character also gets to select 10 secondary skills from the list above, except from physical and those listed as "None." Select an additional four at level five. These are additional areas of knowledge that do *not* get the advantage of the bonus listed in parenthesis (). All secondary skills start at the base skill level. Also, skills are limited (any, only, none) as previously indicated in the list.

Standard Equipment: Two sets of "working colors." This is either gang colors or what is considered to be a fashion statement for heroes. The city rat tends toward the color black and leather, chains, high boots, gloves, and often a cape or cloak. He will also have a fashionable wardrobe of other clothing, for play and entertainment, located in a tiny apartment in the worst part of town.

Other equipment will include a knife, handgun, energy pistol and two E-clips, flashlight, 900 pound test strength nylon cord/rope and grappling hook, RMK/Robot Medical Kit ("Sticker"), PDD/Pocket Digital Disc player and recorder, personal items such as wallet, comb, hat, etc. His vehicle will be a motorcycle (player's choice of type; no hovercycles). Mega-damage body armor can be of any type, including Coalition (probably stolen or traded for on the black market). Undoubtedly, the armor will be personalized with working colors, designs, slogans, and other ornamentation.

A thief will have lock picking tools, pry bars, and glass cutter, as well as a set of conventional tools.

An assassin will have a bolt-action rifle and an energy rifle with four extra E-clips.

A hacker will have a portable, hand-held computer and a full size computer and printer.

Money: 6D6x 100 credits is available for additional purchases. And a black market item of some kind worth 3D4x 1000 credits.

Cybernetic Implants: The character may also have 1D4+ 1 cybernetic implants. It is entirely up to the player to decide whether his or her character has any implants, and if so, which ones. This initial implant selection is restricted to *black market cybernetics* (excluding cyber-armor and disguises), and *sensory* (excluding the sensor hand, radio supplements to the headjack, and the multi-optic eye). The character is likely to add to his augmentation throughout his life.

Cyber-Doc O.C.C.

In the broadest sense of the word, a cyber-doc is any doctor, surgeon, or scientist who specializes in *cybernetics* and/or *bionics*. However, the term "cyber-doc" usually refers to the notorious underworld figure found in the Down Side of most cities.

The Down Side cyber-doc is a cybernetics doctor who offers his *illegal* services on the black market, much like the old abortion clinics of 1960's America. The doc can be a well-trained, well-meaning cybernetics physician or he can be an opportunist or a butcher. Since the operations are illegal, the patient has little say about the success or failure regarding the outcome of surgery. Because medical treatment and authorized implantation are generally reserved for the military, political heads, and the wealthy, both are scarce and insufficient for the poor and non-political elite. Thus, in the Down Side, illegal clinics are in unbelievable demand. Cyber-docs can be found all over the place, if you know where to look.

The incredible demand for cybernetic augmentation has spawned unthinkable clinics known as "Body-Chop-Shops." They are filthy and crude facilities operated by the most nefarious malefactors one can find. The proprietors of chop-shops will pay fair prices (20% to 40% of list), *no questions asked*, for cyber and bionic prosthetics, implants, and organs. This has led to the creation of grisly criminals called cyber-snatchers; fiends who will assault, and often kill, a person to steal an artificial limb or implant for resale at a body-chop-shop. The poorest of the poor and the most desperate are the clientele of these horrid places. *See the section on Cybernetics (and Bionics) for more information about cybernetics and criminal operations.*

In player context, the Cyber-Doc O.C.C. player character is a medical doctor and specialist in the cybernetic sciences. He or she is not one of the disreputable doctors who butcher or blackmail people in some darkened alleyway for cybernetic surgery. They are *healers* who use their unique skills to help the less fortunate. They are versed in all aspects of cybernetics, skin grafting, organ transplants, artificial organ replacement, robot prosthetics, implants, internal medicine, neurology, and cybernetic mechanics. Because the focus of their expertise is surgery and cybernetics, they are not as expert in recognizing and treating more mundane diseases/illnesses as the medical doctor (M.D.), but they are trained in the medical sciences. This character can replace a heart or implant cybernetic devices, service and attach prosthetics, and even build and modify existing artificial parts, providing the facilities, equipment, and materials are available.

Often the Cyber-Doc O.C.C. is a wandering surgeon helping who he can along his travels. Some join up with rebels and adventurers to oppose tyranny or to explore new places and discover new people. The character can be a soft-spoken pacifist or a gun-toting adventurer. The exact disposition and combat orientation of the character will depend on the desires of the player and the types of adventures he is a party



to. The doc is usually considered a rogue, and probably a criminal, if he is practicing medicine without local government authorization, especially in Coalition territory. However, to those in the wastelands, the cyber-doc or any man of medicine is a gotsend.

Note: The cyber-doc suffers a penalty of — 30% when dealing with extremely alien physiologies and/or alien cybernetics.

Attribute Requirements: I.Q. 11 or higher and a P.P. 12 or higher.

A high M.E. is also helpful but not mandatory.

O.C.C. Skills:

Medical Doctor

M.D. of Cybernetics (+10%)

Pathology (+10%)

Biology (+20%)

Chemistry (+10%)

Computer Operation (+5%)

Advanced Mathematics (+10%)

Literacy (+40%)

Language (select 1 additional; +20%)

Pilot Automobile (+6%)

W.P. Knife (Special bonus of +1 to strike)

Hand to Hand combat can be selected as an "other" skill as follows: Basic counts as one skill selection, Expert as two, Martial arts three and Assassin counts as four (4) skill selections.

O.C.C. Related Skills: Select 10 other skills, but at least two must be selected from technical. Plus select two additional skills at level three, one at level six, one at level nine, and one at level twelve. All new skills start at level one proficiency.

Communications: Radio: Basic only.

Domestic: Any

Electrical: Any (+5%)

Espionage: None

Mechanical: Any (+5%)

Medical: Any (+10%)

Military: None

Physical: Any, excluding wrestling and acrobatics.

Pilot: Any (+5%)

Pilot Related: Any (+5%)

Rogue: Streetwise and palming only.

Science: Any (+5%)

Technical: Any (+10%)

W.P.: Any

Wilderness: Hunting and Skin Animals only (+5%)

Secondary Skills: The character also gets to select six secondary skills from the list above, excluding those marked "None." These are additional areas of knowledge that do not get the advantage of the bonus listed in parenthesis (). All secondary skills start at the base skill level. Also, skills are limited (any, only, none) as previously indicated in the list.

Standard Equipment: Two surgical gowns, dozen pair of disposable surgical gloves, one pair of reusable surgical gloves, surgical kit (includes scalpels, clamps, suture, needles, etc.), medical kit (first-aid kit, bandages, antiseptics, protein healing suave, aspirin, pain-killer, antibiotics, hypodermic gun, stethoscope, pen flashlight, hand-held blood pressure machine (computerized), thermometer, six unbreakable vials, and other basic items, IRMSS/robot micro-surgeon kit, portable compu-drug dispenser, and portable laboratory.

The traveling cyber-doc is likely to carry some sort of weapon(s), particularly if his travels carry him through the wilderness and wastelands; select one automatic weapon and one mega-damage energy weapon, both have 1D4 extra ammo clips. The doc is also an expert with a knife/scalpel and is likely to carry several combat knives and perhaps a sword, in addition to his surgical knives. Mega-damage body armor can be of any type, although light varieties will be preferred.

The character's vehicle can be just about any kind of non-military ground vehicle; player's choice. Like all **Rifts** characters, he can use most types of weapons and wear body armor (except during surgery).

Money: A city doctor will have 4D4x 1000 in credit. The wandering cyber-doc will have 6D6x 100 in credit and 2D6x 1000 in black market saleable items. This money can be used to purchase specific weapons and equipment when the character is created or later, if the opportunity arises.

Cybernetics: The cyber-doc, unlike the body fixer, sees cybernetics and augmentation of the human body as a good and wondrous thing. Consequently, they see nothing wrong with implants and are likely to have cybernetic implants/parts themselves. Whether the character has cybernetic implants/body parts is left up to the player. If the decision is yes, the cyber-doc can select 1D4 + 2 mechanisms from *any* of the cybernetic categories, excluding: the multi-optic eye, disguises, and oxygen cell.

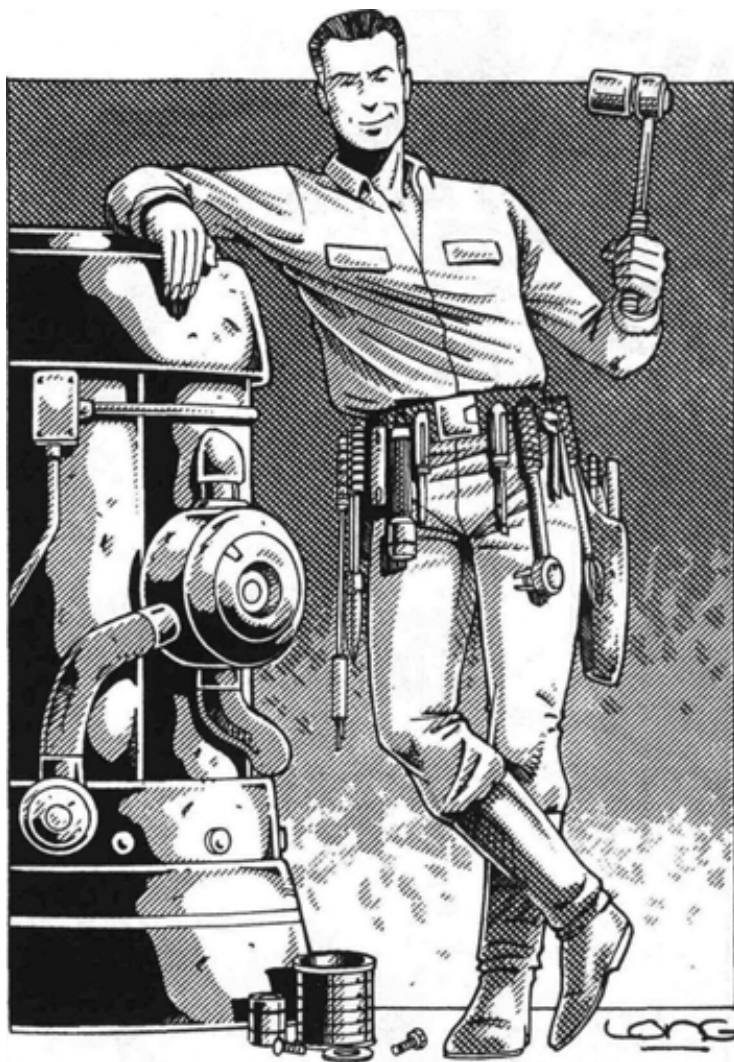

Operator O.C.C.

The operator is a sort of mercenary repairman. They are the mechanical and electrical whiz-kids who can fix just about anything. As such, they are always a welcome sight in any community and are treated with respect and admiration. An operator rarely has to pay for his own meals or a bed to lay on. Of course, the proprietor or town council may have some little repair job that they'd like him to do for a reasonable fee.

There are no set fees for a particular job, so the fee and currency changes from place to place. Repairing an irrigation system at a wealthy town may mean 30,000 in credit, at a poor town payment may be a hot meal, a broken-down horse, and some basic supplies.

Remember, while pre-Rift machines and technology are in use, there are few individuals who fully understand how they work. Consequently, they can not successfully maintain and repair them. The Coalition charges highly for their services. Often the price includes an oath of fealty to a Coalition State, binding the community to it financially and obligating the town to perform certain services, or provide goods, or allegiance to support the CS. This is how the Coalition increases its power base and territory, slowly absorbing the smaller communities around them. The next step is official union with a Coalition State, usually in exchange for military protection, economic support, and forgiving one's previous debt. Of course, once this happens, the Coalition sends in its advisors and makes the town *conform* to its standards, routing out magic users, seizing all books and historical documents, and eliminating dangerous dissidents. Consequently, the operator represents the only means for many small communities to maintain their independence.

Although the operators have no formal organization or guild, they are an unofficial class within the civilized human societies of the Americas, similar to the Freemasons of old. They have no leader, no gathering place, nor doctrine by which all operators adhere to. Instead they are a loosely knit group of like-minded men and women who share a love and knowledge of forgotten science. How operators came to be is not exactly known. Most will tell you that some of those who survived the Time Before Rifts also saved many of the old secrets. These secrets were handed down from father to son, generation to generation, until today. Indeed, if there is any common thread among operators, it is secrecy. Operators will not share their knowledge with anybody except a fellow operator, relative, or an apprentice.

As a rule, an operator tends to disguise the extent of his knowledge with false modesty and cryptic talk about the Time of Man (or Time Before Rifts) and ancient secrets. In reality, the character is as knowledgeable about modern, high-tech engineering as any Coalition engineer. Furthermore, their love of mechanics keeps them looking and learning more. These individuals love what they do and take an almost fanatical pride in their craft. They are hard workers, inventive, and resourceful.

It has recently come to light that some operators have developed a degree of psychic power that helps them in their work. Approximately 40% of all operators are psychic. The focus of their psychic abilities is mechanics. Roll percentile dice. 1-40% means that your Operator character has limited psionic powers. Note that all psi-operators are considered to be *minor* psionics.

Attribute Requirements: I.Q. 9 or higher, a high P.P. and P.S. is handy but not mandatory.

O.C.C. Skills:

Basic Math (+20%)
Electrical Engineer (+20%)
Mechanical Engineer (+20%)
Weapons Engineer (15%)
Computer Repair (+10%)
Radio: Basic (+15%)
Read Sensory Equipment (+20%)
Pilot (choice of three at +15% each)
W.P. Blunt
Hand to Hand: Basic

Hand to Hand: Basic can be changed to hand to hand Expert at the cost of one "other" skill, or Martial Arts (or assassin if an evil alignment) for the cost of two "other" skills.

O.C.C. Related Skills: Select 10 other skills, but at least two must be selected from mechanical. Plus select two additional skills at level three, two at level six, one at level nine, and one at level twelve. All new skills start at level one proficiency.

Communications: Any (+15%)
Domestic: Any
Electrical: Any (+10%)
Espionage: None
Mechanical: Any (+10%)
Medical: First Aid or paramedic, but the latter counts as two skill selections.
Military: Any (+15%)
Physical: Any, except acrobatics, gymnastics, or wrestling (+10% for SCUBA).
Pilot: Any (+10%)
Pilot Related: Any (+10%)
Rogue: Lock picking only (+15%)
Science: Math, chemistry, and chemistry: analytical only (+5%)
Technical: Computer operation, computer programming, language, literacy, and photography only (+10%).
W.P.: Any
Wilderness: None

Secondary Skills: The character also gets to select six secondary skills from the previous list. These are additional areas of knowledge that do not get the advantage of the bonus listed in parenthesis (). All secondary skills start at the base skill level. Also, skills are limited (any, only, none) as previously indicated in the list.

Standard Equipment: Portable tool kit with an electric screwdriver and additional interchangeable heads, wrenches, etc, large tool kit, soldering iron, laser torch (for welding), a roll of duct tape, two rolls of electrical tape, pen flashlight, large flashlight, a dozen flares, 200 feet (60 m) of super lightweight rope (total weight 10 lbs/4.5 kg), a couple knives, notebook, portable disc recorder, portable language translator, protective goggles, work gloves, one pair of thin doctor's gloves, and similar basic tools of the trade.

More expensive diagnostic equipment, computers, optical enhancements, and sensory equipment may be purchased later.

Weapons: Select two energy weapons of choice (gets two E-clips for each), and two blunt weapons of choice (hammer, staff, etc).

The character's vehicle can be of any kind of non-magical vehicle, including military vehicles, robot vehicles and power armor, (**Note:** The character must have the appropriate piloting skills to operate these special vehicles, and is limited to *basic* robot combat). The operator's distinguished position in society, combined with his or her mechanical skill, means that the super mechanic can get and repair some state-of-the-art transportation. Even more, conventional vehicles will be souped-up or modified with armor and weapons. For some reason, it seems that most operators prefer fast, mobile vehicles like hovercrafts, or large, powerful, but comparatively slow vehicles like spider-skull walkers or other robots.

Money: An operator will have little available cash. Most of his money and trade items go into his supply of tools, equipment, fuel, and vehicle. The city operator will have 4D4x1000 in credit. The wandering operator will have 5D6x100 in credit and 3D4x1000 in black market saleable items. This money can be used to purchase specific weapons and equipment when the character is created or later, if the opportunity arises.

Cybernetics: None to start. However, many operators do have cybernetic implants installed to help them in their work. These are usually limited to sensors and optic systems. The majority prefer to *use* machines in their work, not to become a machine themselves. •

Psionic Powers (special): Forty percent of all operators possess limited psychic powers. Roll percentile dice. A roll of 1-40 means your character has psychic abilities. A roll of 41-00 means none. If not psionic, add 1D4x1000 to available money.

Next, if psychic, roll 3D6 + 6 to determine the character's amount of I.S.P. Add 1D4 I.S.P. per level of experience. Note: The operator is considered to be a minor psionic.

Lastly, pick three permanent powers from the following list, or the one super psi-power of telemechanics. A full description of these psi-abilities is found in the section on psychics and psychic powers.

Mind Block

Object Read (limited to the history and operation of the device)

Resist Fatigue

Sense Magic

Speed Reading

Sixth Sense

Total Recall

In addition to the psi-powers, the operator has an innate understanding and compatibility with all machines (machines do not intimidate the character; he/she feels comfortable with all machines). Likewise, the individual can intuitively sense what the problem is and how to fix it. For this reason the operator suffers only *half* the normal penalty when dealing with alien machines and techno-wizardry.

Rogue Scientist O.C.C.

One of the new Earth's great frontiersmen is the rogue scientist. These men and women suffer from an insatiable lust for knowledge that drives them into the wastelands and wilderness to rediscover their planet, and humankind's past. They explore the ruins of toppled cities and the habits of new and menacing life forms that have emerged from the rifts.

The rogue scientist is not the stereotypical bookworm or lab rat of the 20th century, but a tough, self-reliant explorer of a harsh and unforgiving world. They are usually versed in survival skills and proficient in at least two weapons. In many cases, they look more like your average headhunter than a scientist.

Far from the cities of the Coalition States (CS), they are highly regarded as men of science and knowledge. They are a welcome and, sometimes desperately, needed addition to most adventurer groups, mercenary groups, and wilderness towns. Yet these rugged pioneers of our future Earth are frequently feared by superstitious wilderness folk and by the average people of the Coalition States (CS). Why? Because the scientists bear weapons and words beyond their comprehension. Rumor has it that rogue scientists and scholars cavort with all manner of beings: aliens, monsters, and worse. They also dare to enter forbidden places and hell-spawned dimensions where no god-fearing man would set foot. To many, scientists seem to be men of magic, because, in the eyes of the peasant population, they know and do *unnatural*, almost magical, things.

The propaganda from the Coalition States only fuels the flames of fear and superstition. The illiterate are constantly bombarded by talk and radio and video telecasts about insane or rebellious rogues who threatened the sanctity of the city. Reports will always have some inflammatory statement like, "Only the demented mind of a rogue scientist (or scholar) could have conceived of anything so diabolical." Or "Several books were found among the assailant's possessions, obviously the source of his delusions." Or warnings like, "Remember, these

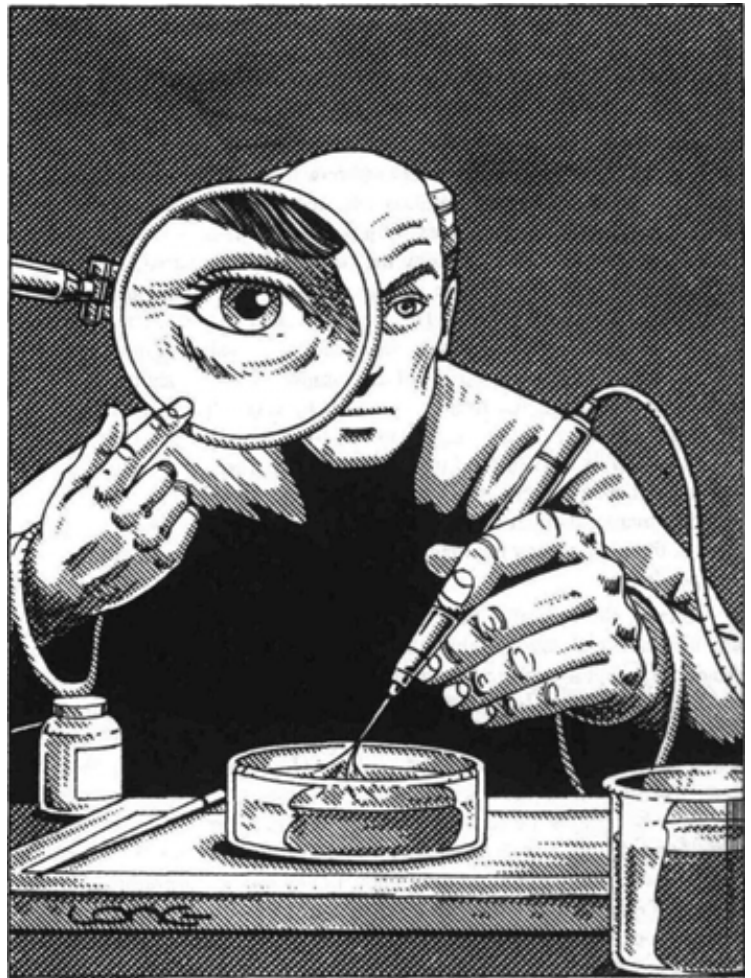

self-proclaimed men of science are liars and extremely dangerous. They are misguided hermits who unearth false and dangerous knowledge from the wastelands. Or they are madmen taught dark secrets by inhuman creatures from the rifts! Just think. Where do these rogues come from? Where have they been? Out in the wastelands. Living on what? Doing what? Is it no wonder that these poor fools go mad? the wastelands are not places for civilized men. Wastelands are empty, devastated territories rife with horrors from the rifts. Remember, it is your duty, as honored citizens of the Coalition States, to report anyone who claims to be a scientist, scholar, teacher, or doctor who does not have a state authorization card. Likewise, report psychics, magic users, mutants, or any suspicious activity to the authorities at once! The life you save may be your own!"

The Coalition intentionally paints a demonic and frightening picture of the rogue scientist, because it fears their knowledge. The Coalition knows all too well the power of knowledge and the disruption that an inquisitive mind can cause. The Coalition's leaders see the rogue as a troublemaker on every level. They are literate, questioning, curious, resourceful, strong in body and mind, and independent. They are not the sheep that typifies the average CS citizen. They are wolves among the sheep. Wolves who, by their words and actions, may show the sheep how to become wolves themselves. A most frightening and dreaded possibility.

An inventive and resourceful scavenger, the scientist combines all levels of technology to his best benefit. He can often repair machines and vehicles, and is skilled in technical areas and the sciences. The exact orientation and skills are left up to the individual player. This means that one scientist may be a whiz-bang mechanic/engineer, but know little about biology or nature, while another is an expert anthropologist and linguist, but can't hook up a stereo without difficulty. The O.C.C. skills represent some logical basic areas of necessary expertise.

Attribute Requirements: I.Q. 12 or higher, a high M.E. and P.E. is helpful but not mandatory.

O.C.C. Skills:

Computer Operation (+20%)
Land Navigation (+4%)
Literacy (+40%)
Advanced Math (+20%)
Radio: Basic (+10%)
Read Sensory Equipment (+20%)
Basic Electronics (+20%)
Pilot Automobile (+10%)
W.P. Energy Rifle

Hand to Hand combat can be selected as an "other" skill as follows: Basic counts as one skill selection, Expert as two, Martial Arts three, and Assassin counts as four (4) skill selections.

O.C.C. Related Skills: Select 14 other skills, but at least four must be selected from science. Plus select two additional skills at level three, two at level six, two at level nine, and one at level twelve. All new skills start at level one proficiency.

Communications: Any (+10%)
Domestic: Any (+5%)
Electrical: Any (+10%)
Espionage: Wilderness Survival only (+5%)
Mechanical: Any (+10%)
Medical: Any (+5%)
Military: Any (+10%)
Physical: Any, excluding wrestling and acrobatics.
Pilot: Any (+5%)
Pilot Related: Any (+10%)
Rogue: Any
Science: Any (+20%)
Technical: Any (+15%)
W.P.: Any
Wilderness: Any (+10%)

Secondary Skills: The character also gets to select six secondary skills at level one and another four at level four from the previous list. These are additional areas of knowledge that do not get the advantage of the bonus listed in parentheses (). All secondary skills start at the base skill level. Also, skills are limited (any, only, none) as previously indicated in the list.

Standard Equipment: One P.D.D.: pocket audio digital disc recorder & player (plays one inch discs, two hours per disc, powered by tiny one year battery) and a dozen blank discs, note pad, variety of markers, mechanical pencil, portable hand-held computer with micro-printer, pocket laser distance finder, conventional tape measure, 35mm camera (still photos) and a dozen discs of film, multi-optics band, pen flashlight, large flashlight, hand pick (1D4 damage), survival knife (1D6 damage), back pack, knap-sack, utility belt, ammo-belt, canteen, sunglasses and goggles, walkie-talkie radio, air filter, gas mask, 100 feet (30 m) of lightweight rope, and tool kit. If applicable, the character may also have a half dozen specimen cases, a dozen specimen dishes, six test tubes, 1D4 jars, two dozen microscope slides, portable microscope, scalpel, pins, and tweezers.

Weapons can include just about anything. Starts with one energy rifle and three extra E-clips, plus select one ancient weapon, one automatic weapon, and one additional energy weapon. Body armor can be of any type.

The vehicle can be any non-military type ground vehicle. Often a hover truck, or conventional rough terrain pickup truck or jeep.

Money: The rogue scientist will have 1D6 x 100 in credit and an additional 4D6x 1000 in black market saleable artifacts.

Cybernetics: Starts with none. May or may not be opposed to cybernetics and bionics.

Rogue Scholar O.C.C.

The rogue scholar may not be quite what you expect. Like the scientist, he or she is frequently a rugged, physically fit explorer and keeper of knowledge. Also like the scientist, the rogue scholar is on the Coalition States' top most wanted list of criminal activists. They are considered to be more dangerous than the men of science, because the scholar seeks out knowledge and truth and *teaches* it to others. Science is confusing and intimidating to most people, but the scholar teaches on a much more rudimentary level and is therefore much more dangerous. By simply instilling uneducated people with curiosity, teaching them little things like how to read, write, and arithmetic, can sow the seeds of destruction. This completely undermines the Coalition's carefully executed plan to keep its citizens illiterate, uneducated, and complacent. A curious mind will always ask questions and ultimately challenge the authority before it when those questions are not satisfactorily answered. Something the powers that be dislike.

Rogue scholars and scientists are men and women of the world, having shared time with mutants, D-Bees, men of magic, and other societies not under the repressive regime of the Coalition States (CS). The CS has built an empire using secret technology, forgotten sciences, and fear. Fear of the unknown. Fear of that which is different. The rogue's teachings could destroy the walls of fear with the light of knowledge and the walls of differences could tumble down by learning just how similar people of all kinds really are. To give their words greater impact, scholars frequently possess forbidden artifacts from man's past and articles from other civilizations of the present. Terrible objects such as books, photographs, artwork, recordings, film, and



other things from the past and present. Things that could threaten the Coalition States' empire.

In a strange way the CS respects the scholars and scientists who dare to pursue knowledge knowing full well that it may cost them their lives. The Coalition also recognizes that these men and women may have uncovered knowledge that could be vital to the CS. Remember, while the Coalition States promotes ignorance among its citizens, its political network, military elite, and own scientists are extremely educated. As a rule, rogues are captured and interrogated. A cooperative individual who comes to realize that he was "misguided," may be released or asked to join the Coalition as one of their operatives. The more stubborn will be imprisoned for years. The defiant will have their knowledge painfully extracted during a period of imprisonment that could be a matter of weeks or years, before being executed as terrorists.

The rogue scholar is usually clever, resourceful, and given to thinking before he acts. This can make for the beginnings of a good strategist, tactician, and diplomat. Scholars tend to be charismatic and long to share what they know as much as they desire to learn more.

Scholars are notorious collectors. They adore books and video discs, appreciate art, and value learning in all its varied expressions. This means that they will gather quite an array of items over the course of their travels. Items often incredibly valuable on the black market, and a death sentence if apprehended by Coalition forces. The problem is that the scholar can seldom bear to sell the precious items. Ah the price of knowledge and art.

Attribute Requirements: I.Q. 10 and M.A. 10 or higher; a high M.E. is helpful but not mandatory.

O.C.C. Skills:

Literacy (+ 50%)

Two additional languages of choice (+ 30%)

Basic Math (+ 25%)

Computer Operation (+ 20%)

Pilot Automobile (+10%)

W.P. of choice (2)

Hand to Hand combat can be selected as an "other" skill as follows: Basic counts as one skill selection, Expert as two, Martial arts three, and Assassin counts as four (4) skill selections.

O.C.C. Related Skills: Select 16 other skills, but at least four must be selected from technical and two from science. Plus select two additional skills at level three, two at level six, two at level nine, and one at level twelve. All new skills start at level one proficiency.

Communications: Any (+ 5%)

Domestic. Any (+10%)

Electrical: Any (+ 5% to basic electronics)

Espionage: Any

Mechanical: Any (+ 5% to automotive mechanics)

Medical: Any, except M.D. and M.D. of Cybernetics (+ 10%)

Military: Any

Physical: Any, except wrestling, gymnastics, and acrobatics.

Pilot: Any (+ 5%)

Pilot Related: Any (+ 10%)

Rogue: Any

Science: Any (+10%)

Technical: Any (+ 20%)

W.P.: Any

Wilderness: Any (+ 5%)

Secondary Skills: The character also gets to select eight secondary skills from the previous list. These are additional areas of knowledge that do not get the advantage of the bonus listed in parenthesis (). All secondary skills start at the base skill level. Also, skills are limited (any, only, none) as previously indicated in the list.

Standard Equipment: Portable compact disc recorder/player (CD that plays three and one inch *audio* discs) and headphones, video disc player (also plays one and three inch audio and video discs), portable language translator, notebook, sketch pad or blank paper, a dozen pencils and markers, old-fashion dip pen and ink, magnifying glass, normal binoculars, hat, set of traveling and a set of dress clothes, survival knife, Knapsack, back pack, carrying case for artifacts, extra pack or sack for books and/or discs, a long range radio, and personal items.

Weapons can include just about anything. Starts with one energy weapon of choice and two extra E-clips, plus select one automatic weapon. Body armor can be of any type, but lean toward light so they can carry more books and artifacts.

The vehicle can be any non-military type ground vehicle. Often a hover truck, or conventional rough terrain pickup truck or jeep.

Money: The rogue scholar will have 2D6 x 100 in credit and an additional 5D6 x 1000 in black market saleable artifacts.

Cybernetics: Starts with none. May or may not be opposed to cybernetics and bionics.

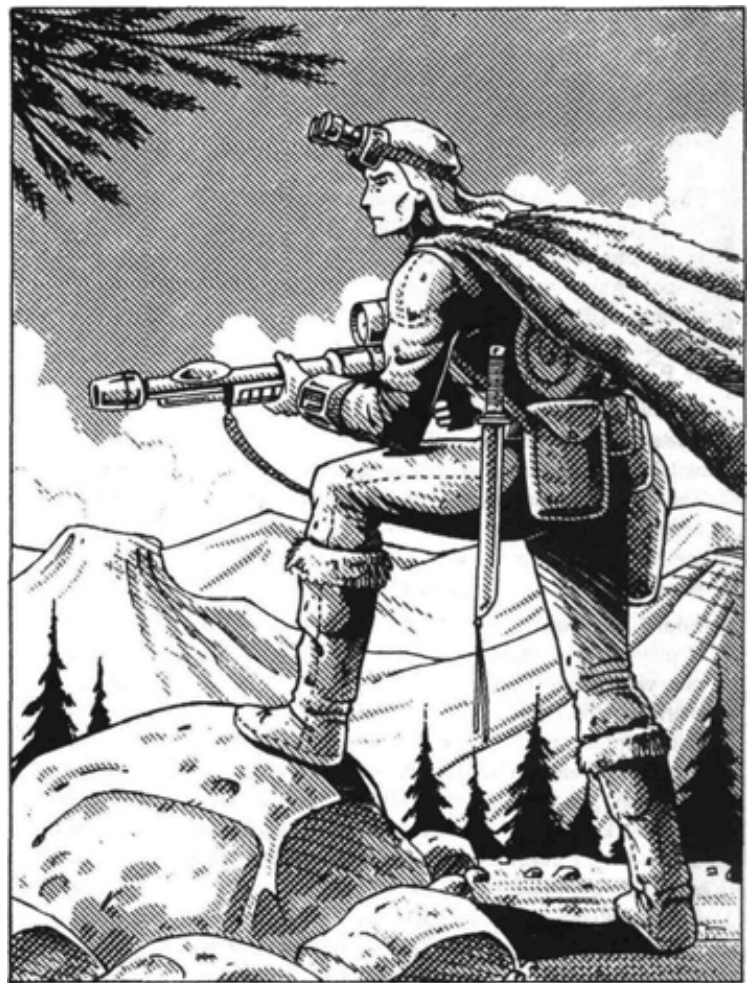

Wilderness Scout O.C.C.

The known world is one vast wilderness with tiny pockets of civilization, both human and alien, low technology and high. Most civilized people stay away from the wilderness or challenge the forces that roam the wilds with mechanical juggernauts that can bash through the toughest terrain and monsters. Peasant villagers, farmers, and nomads traverse

the wilderness. They have learned to adapt to their environment. But none have learned the secrets of the wild like the wilderness scout.

Wilderness scouts are individuals who have learned to live in the wilderness without forcing nature to conform to their needs. They know the land, the plants, the animals, and many of nature's secrets. The scout can live off the land with ease, and walk through her leafy abode without leaving a trace that he was there.

A scout can be a native raised in the wilderness or a city slicker who has come to learn the ways of the wild. They are also, often, experts in demon and faerie lore. Regardless of their origin, the character is a walking encyclopedia about hunting, trapping, wildlife, and the land. Sadly, most are complete illiterates, unable to read or write a word. On the other hand, most are captivating storytellers who love to weave tales about the things they have seen and done. They are knowledgeable, self-reliant, resourceful, and stealthy.

Generally, a wilderness scout is a rough and tumble fellow, who enjoys tests of skill, strength, and cunning, and who enjoys life to its fullest (and purest). The years of life in the out-doors means the individual is powerfully built, conditioned to harsh climate and environments, and whose weathered skin makes him look ten years older than he/she really is.

Despite what many might consider to be a primitive life style, the wilderness scout is not a primitive barbarian (although they may be sorely lacking in social graces). The scout is no stranger to technology and is likely to be garbed in high-tech mega-damage body armor, armed with energy weapons, along with an ancient bow and arrow, and pilot a hovercraft with the same skill as his horse. Still, the typical wilderness scout, no matter how acquainted he is with technology, will be uncomfortable in the confines of a city. His place is the wide open spaces of the wilderness. That is his home and his choice.

Attribute Requirements: I.Q. 8 and P.E. 12 or higher, a high P.S. and M.E. is helpful but not mandatory.

Special Bonus: Add 3D6+10 to the character's physical S.D.C. and a roll of 1D4 to P.E. attribute.

O.C.C. Skills:

Cooking (+ 5%)

Climbing (+ 20%)

General Athletics

Language (choice of three, + 15%)

Land Navigation (+ 20%)

Horsemanship (+ 20%)

Identify Plants (+ 20%)

Hunting

Fishing (+10%)

Prowl (+15%)

Track Animals (+ 20%)

Wilderness Survival (+ 20%)

W.P. Knife

W.P.s of choice (select 3)

Hand to Hand: Basic

Hand to Hand: Basic can be changed to hand to hand Expert at the cost of one "other" skill, or Martial Arts (or assassin if an evil alignment) for the cost of two "other" skills.

O.C.C. Related Skills: Select 10 other skills, but at least three must be selected from physical and one from wilderness. Plus select three additional skills at level three, one at level six, one at level nine, and one at level twelve. All new skills start at level one proficiency.

Communications: Any

Domestic: Any (+15%)

Electrical: Basic Electronics only

Espionage: Any (+ 10%), except forgery and pick locks.

Mechanical: Automotive only

Medical: First Aid (+ 10%) or holistic medicine (+ 20%), but the latter counts as two skill selections.

Military: None

Physical: Any, except acrobatics (+10% when applicable)

Pilot: Any

Pilot Related: Any

Rogue: Any

Science: Math: basic, anthropology, biology, and botany only.

Technical: Any (+15% applies to both lores and languages only)

W.P.: Any

Wilderness: Any (+ 20%)

Secondary Skills: The character also gets to select eight secondary skills from the previous list. These are additional areas of knowledge that do not get the advantage of the bonus listed in parenthesis (). All secondary skills start at the base skill level. Also, skills are limited (any, only, none) as previously indicated in the list.

Standard Equipment: Set of wilderness clothing; this can be anything from camouflage fatigues to buckskin. Extra pair of boots, a set of mega-damage armor (probably light armor to provide maximum movement and stealth), hat or helmet, sunglasses or tinted visor, air filter, first-aid kit, knapsack, back pack, utility/ammo belt, a couple sacks, several short pieces of cord for tying things, 100 feet (30 m) of lightweight rope, 6 iron spikes, 6 wooden spikes (as much for vampires as anything else), a hammer and a mallet, hand axe, utility knife, animal skinning knife, fishing line and hooks (pole optional), animal snares, and six flares. Infrared binoculars with digital distancing readout, a pair of passive nightvision goggles, and a telescopic sight for a gun.

Weapons can include swords, knives, axes, or bow and arrow, to energy weapons and guns. Players can choose a variety, but should be careful not to overencumber their character. A person can only carry so much. Extra items must be left at a camp or carried on a horse and/or pack animal.

Vehicle can be any non-military means of transportation. Most common choices by scouts are quiet and small, maneuverable vehicles, including a good riding horse (and a second, slower, pack horse or mule), motorcycle, or hover vehicle. Scouts tend to stay away from constricting and noisy power armor and robot vehicles. The only exception is the robot horse (not available initially).

Money: Typical scout will have 4D6 x 10 in credit, and another 3D4 x 1000 in black market items. A mercenary scout will have 1D4 x 1000 in credit and 2D4 x 1000 in black market items. There's just not much need for money in the wilderness. Usually trades animal furs and services for items. Mercenary scouts will hire themselves out to civilized men, industry, or governments to do scouting, track down pests (both humanoid and animal), lead expeditions into or through the wilderness, etc. But even then, the scout is likely to spend his money quickly on better equipment, vehicle, weapons, and pleasure.

Cybernetics: Most wilderness scouts will avoid "unnatural" cybernetic augmentation except when needed as a prosthetic.





Vagabond Non-Skilled O.C.C.

Not everybody who gets involved in adventure is a specialist in combat or other area of training. Some are just ordinary people who get swept up in the flow of events or decide that it is time they make a change in their life. Others are characters who possess some natural power, but do not have great training or education other than in the use of their powers.

The unskilled character is usually a spirited individual full of life and curiosity. However, they are rarely very educated in any formal sense, nor literate, and seldom seek higher education. They tend to live by the seat of their pants and rely on their wits and natural abilities/attributes.

Sadly, at least 50% of the population of the Coalition States are illiterate, uneducated laborers. Worse, the Coalition prefers to keep its people ignorant and fearful of the outside world, because it keeps them dependent and subservient to their protector, the government. Most of wilderness wanderers, peasants, and farmers, as well as many psychics and mutants, fall into this category as well.

Attribute Requirements: None

O.C.C. Skills:

Speaks American and one language of choice at 90% proficiency.

Cook (+10%)

Pilot Automobile (+5%)

The unskilled character may know a little bit of everything, but is a master of none. Consequently, the character gets only a few basic O.C.C. skills to start with, but does get a greater selection of skills as he grows in experience.

Other Skills (general): Select eight other skills at level one. Plus select four additional skills at levels two and three, two at level six, one at level nine, and one at level twelve. All new skills start at level one proficiency. These selections get the benefit of any bonuses that may be noted.

Communications: Any, except laser and cryptography

Domestic: Any (+10%)

Electrical: Basic electronics only

Espionage: None

Mechanical: Automotive only

Medical: First aid only (+5%)

Military: None

Physical: Any, except acrobatics, gymnastics, and wrestling

Pilot: Any (+5%), except jets, ships, and tanks.

Pilot Related: Any

Technical: Any (+2%)

Rogue: Any (+2%)

W.P.: Any

Science: Any

Wilderness: Any

Secondary Skills: The character also gets to select six secondary skills from the previous list, at first level and another four at level three. These are additional areas of knowledge that do not get the advantage of the bonus listed in parentheses (). All secondary skills start at the base skill level. Also, skills are limited (any, only, none) as previously indicated in the list.

Standard Equipment: The clothes on his back and an extra set, baseball cap, jacket or coat, knife, gun with one extra clip of ammo, flashlight, back pack, sleeping bag, wallet with I.D., a couple bandages, pack of aspirin, comb, toothbrush and paste, a bar of soap, several pieces of candy, a sturdy plastic bag for extra stuff, and an old, rusty junker of a car or motorcycle. **Money:** 3D4 x 1000 in credit.

Cybernetics: None to start. May purchase implants later, if desired.

Practitioners of Magic

Line Walker Magic O.C.C.

The Line Walker is more of a traditional spell casting wizard who is especially attuned to ley line energy. The mage is so attuned to ley lines that he can see magic energy emanating from even weak ley lines normally invisible to the human eye. Likewise, he can see invisible magic energy (P.P.E.) radiating from living beings, enchanted/magic objects, techno-wizard devices, and supernatural creatures. This is not a see aura, but an ability to actually see mystic energy waves. Furthermore, the Line Walker can feel the presence of ley lines, pinpoint nexus areas, and tell when a rift has opened nearby.

The pursuit of magic is a means to utilize natural energy and direct it with one's own mental abilities. The ley line walker spends years learning to focus his thoughts and build his will in order to direct and mold mystic energy. He also spends years learning how to let the ley line energy flow into and through him, building his tolerance for magic energy and making the walker a sort of living relay station and energy transformer, as well as a P.P.E. battery. At these moments, the line walker becomes part of the energy he is directing and it gives him much greater control and range of magic abilities.

The inquisitive nature of the line walker means that the character is usually open to new ideas, people, and philosophies. They are often literate, may study areas of science and have no aversion to using high-tech weapons, vehicles, and equipment. Lightweight weapons and armor are generally preferred because they are less cumbersome.

Line Walker Abilities

1. **Sense ley line and magic energy.** This power is somewhat similar to the psi-stalker and mutant dogs. The line walker can see and feel the presence of magic. All the following sensing abilities are automatic powers and do not require the expenditure of P.P.E.

Sense ley line: The walker is able to feel whether there is a ley line within the area of his sensing abilities, 10 miles (16 km) per level of experience, and can tell whether it is near or far. He can also follow the feeling to locate the ley line at a skill level of 30% + 5% per each additional level of experience.

Sense ley line nexus: Once the ley line has been found, the walker can follow the ley line to as many nexus points as it intersects. Skill level is 40% + 5% per each additional level of experience.

Sense a rift: The mage will automatically feel the sensation of a rift opening anywhere within a 50 mile area (80 km) +10 miles (16 km) per each additional level of experience. Although he can not tell exactly where this rift is, the walker will know whether it is near or far and whether it is big or small.

Sense magic in use: The expenditure of magic in the form of a spell, rifting, or techno-wizardry can be felt, if not seen, up to 100 feet (30.5 m) away per every level of experience. The line walker will not know the location nor be able to trace it, but he will feel its energy and know that magic is being used in the area of his sensing range. Note: This does not include the use of psionic powers.

See magic energy: The line walker can see magic energy/P.P.E. radiating from people, creatures, objects, and areas, as long as more than 20 P.P.E. points are present. The sensing ability is so acute

that the character can see things made invisible by magic and invisible things that are magic, including many supernatural creatures. **Range:** Line of sight, about 1000 feet (305 m) without obstructions.

2. **Read Ley Lines.** This power instills the mage with instant information about the line in a matter of moments. The walker will know the following: what directions the ley line runs (and therefore, his location; north, south, east, west, etc), how long the line runs, whether there are any nexus points and in what direction they are located, and whether or not there are any rifts presently open along the line. The character will also know of any major natural disasters currently happening along the line, such as forest fire, flooding, hurricane, or earthquake. War and magic are not natural disasters. The power is automatic and does not require the expenditure of personal P.P.E.

3. **Ley Line Transmission.** A line walker can send a verbal and/or visual message directly along a ley line to another person so long as that person is located somewhere on the line. The best messages are brief ones of under a hundred words to avoid over-whelming the recipient. Unfortunately, the message is a one way transmission unless the other person is also a Line Walker or other mage with the Transmission spell. Range is limited only by the length of the ley line and the people's position on the line. The time lapse between sending and receiving a ley line transmission is only a matter of seconds. The message can be sent to several people (one person per level of experience) at different locations, as long as they are all on the ley line.

The only danger is that a telepath (psionic or magic) may be able to listen in on the message. There is a 1-20% chance that any psionic or magic character with telepathy power will sense a ley line transmission coming through, and there is a 1-31% chance that they too can receive the message. There is no way for the sender to know if others have eavesdropped on his message. Nor is there any way to scramble the message. This power is an automatic ability for the line walker and does not require the expenditure of personal P.P.E.

4. **Ley Line Phasing.** The ley line walker also has the power to instantly teleport from one place on a specific ley line to another place on the same ley line. To initiate a ley line phase/teleport, the mage must concentrate, opening himself to the ley line energy and focusing all of his thoughts to the task of teleporting to a new location. Engaging in conversation or combat, even self defense, will break the concentration, forcing the mage to start over. The process will require ID4 melees (15 to 60 seconds) every time a phase is done. The teleport is always on target, because the line walker is one with the ley line and will appear exactly at the point along the ley line he desires (whether he has ever been there before or not). However, there is no way that the walker can know what else is also presently in that area and he could phase right into the middle of an armed camp.

Although the phasing is an automatic ability common to all line walkers (costs no P.P.E.), it does take its toll on the body. The maximum number of phasings possible in an hour is *four*. The maximum number of phasings in a 24 hour period is four plus one per each level of experience (5 at level one, 6 at level two, etc). More than this is impossible.



6. **Ley Line Rejuvenation.** The walker can absorb ley line energy to double the rate of natural healing. To do this, the character must concentrate and relax on a ley line, letting the mystic energy fill him and heal him over a period of days. The wizard can also perform an instant rejuvenation as often as once every 24 hours at the site of a ley line. After about ten minutes of concentration, the character is completely rested, alert, and 2D6 hit points and 2D6 S.D.C. are restored. No personal P.P.E. is expended.

7. **Ley Line Observation Ball.** A globe of light, about the size of a soccer ball, can be conjured out of thin air and linked to the line walker like a third eye. The sphere of blue or white light can be directed by its creator to zoom ahead or behind like a remote control spy device or familiar. Everything that the ball sees and hears is instantly transmitted to its maker. The sphere will remain in existence as long as the ley line walker stays within the ley line, or until he dispels it, or until it is destroyed.

A Typical Observation Ball:

S.D.C.: One per level of its creator. (No hit points as it is not alive). Range: Up to 500 feet (152 m) away from its creator. Speed: Up to Spd 33 (22 mph). Bonuses: + 3 to dodge. Has no offensive capabilities other than to buzz onlookers and possibly startle them (not likely). Actions are directed by the Ley Line Walker and count as his melee actions/attacks.

8. **Initial Spell Knowledge.** In addition to his ley line powers, the Ley Line Walker is a master of spell magic (tends to avoid ritual magic, but can perform rituals if so needed). At level one experience, players may select three spells from each magic level 1-4, for a total of twelve spells (three from each). Each additional level of experience, the character will be able to figure out/select one new spell equal to his own level of achievement/experience.

9. **Learning New Spells.** Additional spells and rituals of any magic level can be learned and or purchased at any time regardless of the walker's experience level. *See the Pursuit of Magic.*

10. **Magic Bonuses.** +4 to save versus horror factor. +1 to save versus magic at levels three, six, nine, eleven and fourteen. +1 to spell strength (the number others must save against when you cast a spell) at levels three, seven, ten, and thirteen.

11. **P.P.E.:** Like all men of magic, the Ley Line Walker is a living battery of mystic energy that he can draw on to create magic. Unlike the other magic O.C.C.s, the Line Walker has the greatest amount

The only other limitations are: 1) That the line walker can only teleport himself and his possessions, nobody else (due to the intermingling with the ley line energy). 2) The locations one can teleport to must be along the same ley line (directly on the path of the ley line), like a mystic railway. To switch to a different line, the character must travel to another ley line or change direction at a ley line nexus, the point where several different ley lines cross paths.

5. **Line Drifting.** The line walker can open himself to the ley line energies and walk or float through the air along the length of the ley line. The speed factor is a mere Spd 10, but is relaxing and requires no exertion. As usual, the mage does not need to expend any personal P.P.E., but draws on the existing energy of the line.

of permanent P.P.E., like a super battery. **Permanent Base P.P.E.:** 2D4x10+20, in addition to the P.E. attribute number. Add 3D6 P.P.E. per each additional level of experience. Of course, the mage can also draw P.P.E. from ley lines, nexus points, and other people whenever available.

Attribute Requirements: I.Q. 10, P.E. 12 or higher. A high M.E. is also suggested but not mandatory.

O.C.C. Skills:

Climbing (+5%)
Land Navigation (+4%)
Wilderness Survival (+5%)
Pilot Hover Craft (+5%)
Lore: Demon (+10%)
Math: Basic (+10%)
Speaks two additional languages of choice (+15% each)

Hand to Hand: Basic can be selected as one "other" skill, Hand to Hand: Expert at the cost of two "other" skills, or Martial Arts (or assassin if an evil alignment) for the cost of three "other" skills.

O.C.C. Related Skills: Select seven other skills, but two must be selected from the science category and one from technical. Plus select two additional skills at level three, one at level six, one at level nine, and one at level twelve. All new skills start at level one proficiency.

Communications: Radio: Basic only
Domestic: Any (+10%)
Electrical: None
Espionage: Intelligence only (+5%)
Mechanical: None
Medical: First Aid or Paramedic (latter counts as two skills, +5%)
Military: None
Physical: Any except Wrestling and Gymnastics.
Pilot: Any (+2%)
Pilot Related: Any (+2%) Technical: Any (+5%)
Rogue: Any W.P.: Any
Science: Any (+10%) Wilderness: Any

Secondary Skills: The character also gets to select six secondary skills from those listed. These are additional areas of knowledge that do not get the advantage of the bonus listed in parentheses (). All secondary skills start at the base skill level.

Standard Equipment: Robe or cape, set of clothing, set of traveling cloth, light M.D.C. body armor (seldom wear heavy armor, because it reduces their speed and mobility by half), knapsack, back pack, 1D4 small sacks, one large sack, six wooden stakes and mallet (for vampires and other practical applications), canteen, binoculars, tinted goggles or sunglasses, air filter and gas mask, flashlight, 100 feet of light weight cord and grappling hook, pen or pencils and note or sketch pad. Ley line walkers like techno-wizard items and can use them well.

Weapons will include a survival knife, hand axe, automatic pistol or sub-machinegun (player's choice), energy rifle, and several extra clips of ammunition.

The vehicle of choice is usually a techno-wizardry device or hover vehicle or motorcycle or jet pack. They tend toward inexpensive and easy to replace items (or items they can carry, like a wing board), because they often have to leave their vehicle behind when traveling along ley lines (phasing).

Money: Starts with 1D4x1000 in credit and 3D4x1000 in black market items.

Cybernetics: Starts with none and will avoid getting any cybernetic or other forms of physical augmentation because it interferes with magic. However, cybernetic prosthetics will be considered if necessary.

Mystic Magic O.C.C.

A mystic is more of an intuitive fellow who can sense different aspects and happenings on the physical and metaphysical levels of life. They are often acclaimed advisors and prophets who can glimpse the future. The intuitive nature of the mystic's power means that they simply accept suddenly knowing something and have learned to trust their feelings. This also means that most mystics disregard formal education in favor of following their cosmic path. Most believe that too much education creates walls that block one from the natural psychic emanations and deadens one to the true world around them. They also believe that too much reliance on technology will have the same effect. Consequently, a mystic will avoid cybernetic, bionic, and all other forms of human augmentation, but will use tools, energy weapons, and body armor. With this attitude, it is little wonder that many mystics are renowned philosophers and love philosophical and metaphysical debates.

An individual can be taught by a mystic in the ways of mysticism, usually philosophy, meditation, and in opening one's mind and body to the world, but most mystics will tell you that one does not learn to become a mystic, but is born with the "gift."

Their powers are a combination of psychic and magic. Psychic powers are limited to the categories of *Sensitive* and *Healer*. Magic is limited to the more simple and sense oriented spells.

Psionic Powers

The mystic has the following psionic abilities.

1. **Sense Supernatural Evil.** The mystic is keenly aware of the world around him, thus, he or she will feel or sense any major disturbances nearby. One such disturbance is the presence of supernatural evil. All supernatural beings radiate their alignment. Most are evil. The mystic can feel that evil like an icy chill cutting through him. The sensation is unmistakable, costs no I.S.P., and is automatic, meaning that the character does not have to concentrate or focus himself to sense evil. The evil essence will just wash over the character, warning him like an alarm.

The sensation is very general, alerting the mystic to the presence of supernatural evil, but not specific data. For example, the mystic will know that a supernatural being is in the area, but not its exact location. However, he will know whether the being is near or far, a horrible evil or lesser evil. **Range:** 300 feet (91 m) plus 10 feet per each additional level of experience.

Along these same lines, the mystic can sense when a person is possessed by a supernatural force, and recognize magic enchantment. Base Ability: 50% +5% per each additional level of experience.

2. **Opening oneself to the Supernatural.** The mystic can also open himself to the supernatural, with dramatic effects. The mage can become a medium through which entities and other forces can temporarily communicate to speak to others. The character is also receptive to all forms of telepathic and empathic communication, including +10% to receive a Ley Line Transmission when in the "opened" state.

An open state trance requires that the mystic focus all his thoughts and essence on becoming one with the supernatural energies. In this state, the mystic can not speak or take any action. He simply sits motionless, like a statue. While in the trance, the character becomes completely invisible to all psionic probes (sort of a cosmic mind blank) and even becomes invisible to those around him as he seems to physically melt into the environment. One might think of this as

a psychic prowler or magic chameleon, only the mystic does not move. Success ratio for invisibility is 50% + 5% per each additional level of experience. Even if detected, the character is +8 to save versus psionic attack and +4 to save versus magic attacks, while in the trance state.

3. **Other more common psionic powers automatic to the mystic include:** Clairvoyance, Exorcism, and Sixth Sense.
4. **Select three additional psychic abilities** from the Sensitive category and two from the Healer category. At fourth level the mystic can select one (1) ability from the Super category.
5. **I.S.P.:** Roll 1D4x10 plus the character's M.E. number to determine the base Inner Strength Points. The mystic is considered a *major* psionic so he or she receives another 1D6 + 1 I.S.P. per each additional level of experience.
6. **Saving throw versus psionic attack:** As a major psionic, the character needs a 12 or higher to save vs psionics. However, the mystic also receives a bonus of +1 to save vs psionics at experience levels four, eight, and twelve.



Magic Powers

1. **Initial spell knowledge.** The mystic's spell knowledge, like everything else, comes from within the character himself, on an intuitive level. The character spends years pondering about life, his place in it, and how magic might help him find that place in the world. Then, when he is ready to find or make his place in the world, the mystic enters into six days of meditation.

At the end of the sixth day, he or she somehow knows how to cast six specific spells. The nature of the spell magic will, generally, reflect the mystic's current view of life and his place in life. If that view is happy and optimistic, the spells are likely to be of a helpful and defensive nature. If his life view/goal is power, wealth, and/or prestige, the spells are likely to be of a more aggressive and offensive nature and certainly lean toward the flamboyant. A dark view of the world will result in spells that are defensive and revealing, as well as a few offensive ones. If the mystic is arrogant or mild mannered, the spells are likely to reflect that too.

At first level select a total of six (6) spells from the magic levels of one and two. These are part of the mystic's permanent spell casting capabilities. Once selected, they can not be changed.

2. **Learning new spells.** The mystic will intuitively sense when he or she has reached a new metaphysical plateau (new level of experience). At each new junction in life (experience level), the character will find the time to meditate on life, his goals, and magic.

At second level experience the mystic can select a total of **four** (4) additional, new, magic spells from levels one, two, and three. Upon reaching third level of experience, the mystic can select **three** (3), new, spells from magic levels one through four. At fourth level and each additional level of experience, the mystic can select **two** (2) additional, new, spells from any of the levels, up to his corresponding experience level. Thus a sixth level mystic can select two new spells from any of the levels 1-6. An eighth level mystic can select two (2) new magic spells from levels 1-8 and so on. Unlike the other magic O.C.C.s, the mystic can not be taught nor purchase additional spell knowledge. In fact, the character never even *tries* to learn additional spells. The character simply does not have the mastery of magic to go beyond this point, and the mystic accepts this without question or regret. Mystics may use techno-wizard devices and the occasional rare scroll (if literate).

3. **P.P.E.:** Like all men of magic, the Mystic is a living battery of mystic energy that he can draw on to create magic. **Permanent Base P.P.E.:** 1D6 x 10 plus P.E. attribute number. Add 2D6 P.P.E. per additional level of experience. Of course, the mystic can draw P.P.E. from ley lines, nexus points, and other people.
4. **Magic Bonuses.** +2 to save versus horror factor. +1 to save versus magic at levels three, six, nine, and twelve. +1 to spell strength (the number others must save against when you cast a spell) at levels four, eight, and twelve.

Attribute Requirements: I.Q. 9, M.E. 9, and M.A. 9 or higher.

O.C.C. Skills

Select 1D6 additional languages (all +15%)
 Play musical instrument (select two; both +10%)
 Dance (+15%)
 Horsemanship (+10%)
 Wilderness Survival (+15%)

Hand to Hand combat must be selected as an "other" skill. Hand to Hand: Basic costs one skill selection, Expert counts as two, and Martial Arts or Assassin (if evil) count as three skill selections.

- O.C.C. Related Skills: Select eight other skills. Plus select one additional skill at level three, one at level six, one at level nine, and one at level twelve. All new skills start at level one proficiency.

Communications: Radio: Basic
 Domestic: Any (+10%)
 Electrical: None
 Espionage: Escape artist and Disguise only (+5%)
 Mechanical: None
 Medical: Holistic Medicine only (counts as 2 skill choices; +10%)
 Military: None
 Physical: Any except Boxing, Wrestling, and Acrobatics.
 Pilot: Any except Jet Aircraft, Robots, and Tanks.
 Pilot Related: Any
 Rogue: Any, except Computer (+5%)
 Science: Any
 Technical: Any, except Computers (+5%)
 W.P.: Any
 Wilderness: Any (+5%)

- Secondary Skills:** The character also gets to select four secondary skills from those listed. These are additional areas of knowledge that do not get the advantage of the bonus listed in parentheses (). All secondary skills start at the base skill level.

Standard Equipment: Set of clothing, set of traveling clothes, light M.D.C. body armor (seldom wear heavy armor, because it reduces their speed and mobility by half), knapsack, back pack, 1D4 small sacks, one large sack, six wooden stakes and mallet (for vampires and other practical applications), canteen, binoculars, tinted goggles or sunglasses, air filter and gas mask, at least one musical instrument, and often wear a hooded cloak.

Weapons will include a survival knife, automatic pistol or sub-machinegun (player's choice), energy rifle, and several extra clips of ammunition.

The vehicle of choice is often a living animal, horse, fury beetle, or other animal. Mystics also seem attracted to motorcycles, dune buggies, and ground hover vehicles.

Money: The importance and amount of money coveted by a mystic will depend on his life orientation. Some will acquire great wealth, while others will squander or give away their wealth. The mystic starts with 2D4x 1000 in credit and 2D6x 1000 in black market items.

Cybernetics: Starts with none and will avoid getting any cybernetic or other forms of physical augmentation like the plague.

Shifter Magic O.C.C.

The Shifter O.C.C. is similar to the Summoner of the **Palladium Fantasy Role-Playing Game**. Shifters are students of magic whose emphasis is mastery of the rifts, in regard to opening dimensional portals and summoning creatures from the rifts! These mages have a reputation of being irrational and evil. However, it is an undeserved reputation, for there are as many good and kind shifters as there are good wizards of the other magic occupations. The difference is that shifters obviously deal with supernatural forces that are terrifying to most people.

The Shifter's focus of mystic study is understanding how ley lines and nexus points work and how to use them for trans-dimensional travel and summoning. Unlike the ley line walker, the shifter is not so much a vessel where magic energy is drawn into him, but instead, the shifter learns to manipulate the energy around him. For example, he will direct and change the nexus point energy to open a rift, but he does not draw the energy inside of him. Likewise, a shifter will draw upon the P.P.E. of those around him to create magic (this can lead to human sacrifice among evil shifters).

Shifter Magic Powers

1. Initial magic knowledge; spells to summon and control. The shifter's orientation is power over the rifts and control over the supernatural forces that come out of the rifts. This means that the character's spell knowledge is mostly limited to this area.

The following rift and dimensional related spells are known by the young Shifter: Sense P.P.E., Sense Magic, Turn Dead, Trance, Chameleon, Concealment, Shadow Meld, Time Slip, Call Lightning, Constrain Being, Summon & Control Canines, and Summon Lesser Being.

2. Learning new spells. All new spells must be learned, purchased, or acquired as usual. The nature of the shifter's O.C.C. means that the most coveted spells will be dimensional and environmental manipulation and summoning (like animate and control dead, negation, anti-magic cloud, teleport, etc.), next in preference are magic forms of control and the manipulation of other beings (like protection circles, calling, exorcism, create zombie, etc.), followed by illusions

(multiple image, apparition, etc.). The Shifter will seldom pursue magic that does not directly relate to his preoccupation with rifts, dimensional travel, and manipulation of the world around him.

- 3. Magic Bonuses.** +7 to save versus horror factor. +1 to save versus magic at levels three, seven, ten, and thirteen. +1 to spell strength (the number others must save against when you cast a spell) at levels four, seven, ten, and thirteen.
- 4. P.P.E.:** Like all men of magic, the Shifter is a living battery of mystic energy that he can draw on to create magic. **Permanent Base P.P.E.:** 1D6x 10+ 10 plus P.E. attribute number. Add 3D6 P.P.E. per additional level of experience. Of course, the mystic can draw P.P.E. from ley lines, nexus points, and other people.
- 5. Dimensional rift home.** The shifter is so attuned to the dimensional nuances that he can always find his way home from another dimension. Better yet, he can always dimensional teleport home at the cost of a paltry 150 P.P.E.; unfortunately, his ability to dimensional teleport back home only applies to himself and his familiar and not anybody else (a full rift or dimensional portal is necessary to take others with him). The ability to rift home means that the Shifter is often tempted to explore new worlds by stepping through a rift.
- 6. Sense rifts.** Similar to the ley line walker's ability, the shifter can feel the ripples and surge of energy whenever a rift is within 50 miles (80 km) or when a new rift appears. He will also instantly know what general direction the rift is located and whether the rift is big or small. **Note:** This sensing ability specifically relates to dimensional portals/rifts and not ley nexuses and ley lines.
- 7. Familiar link.** The shifter can mentally and physically link with an animal or creature from a rift/D-Bee animal (animal intelligence and not supernatural). Generally, the animal of choice is a small, inconspicuous animal like a weasel, squirrel, bat, bird, cat, dog, wolf, etc., so that it can be used for spying and reconnaissance. However, larger animals like tigers, lions, and bears can also be used. Insects and intelligent mutant animals can not be used as familiars.

No matter how wild or mean the animal may have been, it will become instantly linked to the shifter and obey his every command, verbal and mental. The two are now one. The creature and its master are now extensions of each other. What one sees, hears, smells, tastes, and feels, so does the other. Consequently, the familiar makes a great spy, listening to conversations and prowling into areas not easily accessible to its master.

Special endurance. Both the shifter and the familiar gain an additional six hit points as a result of the mystic connection between the two, and both man and animal are +1 to save versus poison and +1 to save versus mind control. However, if the familiar is hurt, the mage will feel its pain as well. If the animal is killed, the shifter will permanently lose 10 hit points (the six from the link and four additional). There is also a 1-50% chance that the shifter will suffer shock from the ordeal and lapse into a coma for 1D6 hours. Another familiar can not be linked for a period of one year.

Note: Although the animal understands and obeys its master, it can not actually speak to him. For a basic list of animals, see the psionic section in **Rifts**. For a complete list of about two hundred animals, check out **Palladium Books' Monsters & Animals** source book, suitable for use with our fantasy game, **Rifts**, and just about any RPG.

- 8. Link to the Supernatural!** Just as the shifter can connect himself to an animal familiar, he can also connect himself to a supernatural force. The supernatural force must be a greater being such as a greater elemental, demon lord, alien god, or alien intelligence. This union is much more dangerous, for while it bestows upon the shifter great power, it also gives a powerful alien/supernatural force a physical link to our world. Almost always an evil force!



The process of a link to a supernatural being begins with communicating with it through a rift. A small dimensional portal/rift is created at a ley line nexus point. The shifter then speaks to the force which responds usually via telepathy. The two strike up a deal in which the supernatural intelligence agrees to link with the character and bestow great power upon him. Often there is a condition attached to this dangerous union, such as securing a particular device or item, or to hurt or kill somebody, usually another shifter who is linked to a rival force or someone who is interfering with the intelligence's plans/games. If the shifter agrees, the alien/supernatural force projects a portion of its psychic essence into the shifter. This gives the mage great power, as will be described shortly, but it also gives the supernatural force a link to our world.

The link to a supernatural force is not quite the same as the animal familiar link. In this case, the shifter may be thought of as the familiar servant. Most shifters make the mistake of believing that they can control the supernatural force, even if it is evil, and use their powers for good. Unfortunately, the supernatural intelligence is a great and cunning force that often uses the shifter as its pawn in a game where humans/mortals are its playing pieces and the Earth, its game board. The force can often manipulate the shifter into helping it win its game. For example: The creature may agree to link and empower the mage if he agrees to destroy a particular person or place. In all likelihood, the person or place is one of evil and its destruction will make the world a safer and nicer place, so the shifter agrees. However, what he or she does not know, is that the target for destruction is the pawn of a rival force or somebody who is jeopardizing the creature's own evil plans, so it wants the target eliminated.

The shifter can usually communicate with the supernatural force by opening a tiny communication rift at a nexus point to his dimension and speak into the rift. Here the fiend can counsel and advise its foolish human pawn. Often its advice will be good, but this only to lure the mage into a false sense of security and trust. Once it has established a relationship of trust, it can abuse that trust by giving the shifter bad advice or mislead him. **Note:** These supernatural intelligences are not omnipotent, as some pretend, but make evaluations and decisions based on information which it has gathered.

The most powerful of these creatures will claim to be gods and demon lords and may establish a group or cult of followers/pawns. In some cases, the vile intelligence may even pretend to be a couple different entities and create two or three very different, sometimes rival, groups of humanoid pawns. This is all just part of its game to amuse itself. Note that these most powerful supernatural beings can link with a score of individuals at the same time without the others knowing it.

Perhaps worst of all, is that the link with the shifter gives the monster a connection to our own dimension. Without this connection, the creature can not enter into our world, but the physical link to our planet, through the shifter, means that it can now rift into Earth. Fortunately, these greater beings usually remain in their own dimension, where they are safest (the creature can only be killed if it comes into the Earth dimension or if an enemy goes into its dimension).

The abilities gained by a link with the supernatural are as follows:

Additional 1D6x10 P.P.E., additional 1D4 x 10 physical S.D.C., additional +3 to save vs horror factor, +2 to save vs magic and psionic attacks, and +1 on initiative rolls. Also the shifter will be granted his choice of six additional magic spells selected from magic levels 6-14.

Attribute Requirements: I.Q. 12, M.E. 12 or higher.

O.C.C. Skills:

Astronomy (+20%)
Mathematics: Basic (+15%)
Lore: Demon (+20%)
Lore: Faerie (+15%)
Language (select two additional languages; both are +15%)
Land Navigation (+10%)
Wilderness Survival (+5%)

Hand to Hand combat must be selected as an "other" skills. Hand to Hand: Basic costs one skill selection, Expert counts as two, and Martial Arts or Assassin (if evil) count as three skill selections.

O.C.C. Related Skills: Select six other skill. Plus select two additional skills at level three, two at level six, one at level nine, and one at level twelve. All new skills start at level one proficiency.

Communications: Radio: Basic, Surveillance Systems, and TV/Video.

Domestic: Any (+5%)

Electrical: Basic Only

Espionage: Intelligence only (+5%)

Mechanical: None

Medical: Holistic Medicine or Paramedic only (+5%)

Military: None

Physical: Any, except Boxing, Wrestling, and Gymnastics.

Pilot: Any, except Robot, Jets, and Tanks.

Pilot Related: Any

Rogue: Any (+2%)

Science: Any (+5%)

Technical: Any (+5%)

W.P.: Any

Wilderness: Any

Secondary Skills: The character also gets to select six secondary skills from those listed, excluding those marked "None." These are additional areas of knowledge that do not get the advantage of the bonus listed in parentheses (). All secondary skills start at the base skill level.

Standard Equipment: Set of clothing, set of traveling clothes, light M.D.C. body armor (seldom wear heavy armor, because it reduces one's speed and mobility by half), knapsack, back pack, 1D4 small sacks, one large sack, pocket mirror, silver cross, 2D4 cloves of garlic, six wooden stakes and mallet (for vampires and other practical applications), salt, canteen, binoculars, tinted goggles or sunglasses, air filter and gas mask, pocket laser distancer, pocket digital disc recorder/player for recording his observations, and a hand-held computer if proficient with computer operation. Often wear hooded robes and dark clothing.

Weapons will include a survival knife, hand axe, sub-machinegun (player's choice), energy rifle, and several extra clips of ammunition. Also a javalin-like iron rod sharpened at on end. The rod generally measures about three feet (0.9 m) long for easy carrying and is used to dispel certain magic illusions and monsters.

The vehicle of choice is often a motorcycle, hover vehicle or horse. The vehicle is often inexpensive and easily replaced in case it is destroyed by a creature from a rift or left behind when he explores a rift.

Money: The Shifter starts with 1D6x 1000 in credit and 2D6x 1000 in black market items.

Cybernetics: Starts with none and will avoid getting any major cybernetic or other forms of physical augmentation. But may consider some minor cybernetic implants, specifically sensory and enhanced optics, but will never get more than three total.

Techno-Wizard O.C.C.

The techno-wizard (TW) is the most unconventional of the magic occupational character classes. They are men of magic who have learned to combine magic with technology. Although the techno-wizard can cast spells and read scrolls, the focus of their magic is the creation of magic devices. The wizard has learned to direct his potential psychic energies into machines, enabling those devices to do strange and magical things that seem to defy known science.

Many of these devices seem to only emulate existing magic and psionic abilities, however, they offer several advantages. One advantage is that unlike a spell that can only be spun by a person knowledgeable in magic, or a psionic power that can only be utilized by the psychic who possesses it, many devices created and empowered by techno-wizardry can be used by any one who has sufficient psychic or magic energy. This means that a fellow practitioner of magic or psychic can use a techno-wizard's machine.

Another advantage is that people who are not psychic or mystically oriented can not operate the device at all. Sort of a built-in safety feature. **For Example:** Somebody who is not a mage or psychic can not fly a wing board or operate a TK-machinegun. In fact, to a normal person, the devices seem like worthless junk without any apparent power source or functioning internal workings. They do not realize that the operator of the device itself is the power source! Techno-wizards have taken the concept of a person being a living battery of potential psychic "energy" to its logical conclusion (or so it seems to them). Thus, they create devices that are powered by the individual's energy and directed by the person's thoughts and desires. The need for other energy sources is greatly reduced (not quite completely eliminated).

A third advantage to using P.P.E. as a means to power devices is that the energy is non-polluting, non-toxic, odorless (except to psi-stalkers, mutant dogs, and supernatural creatures), and has no known ill effects on human life.

A fourth advantage is that the devices are usually easy to conceal and do not often appear to be magic. Whenever the device is not in use, it does not radiate magic, because it is not currently empowered by magic. When the device is not in use, it is nothing more than a construct of machine parts and wires.

Techno-Wizard Psionic Powers

1. **The techno-wizard has the following psionic powers:** mind block, speed reading, total recall, and tele-mechanics (*see the Psionic Section for descriptions*).
2. **I.S.P.:** Roll 4D6 plus the character's M.E. number to determine the base Inner Strength Points. The techno-wizard is considered a *minor* psionic so he or she receives another 1D4 I.S.P. per each additional level of experience.
3. **Saving throw versus psionic attack:** As a minor psionic, the character needs a 12 or higher to save vs psionics.

Techno-Wizard Magic Powers

1. **Initial Spell Knowledge.** In addition to his techno-wizardry powers, the character has a solid understanding of spell magic and how to tap into ley lines and nexus points for additional P.P.E. The techno-wizard is not the master of spell magic the Ley Line Walker or Shifter are, but is still pretty capable. It is not a lack of understand-

ing in magic that limits the techno-wizard's spell casting abilities, but his orientation. That orientation is magic used in conjunction with machines. Consequently, his spell casting abilities are not the same as other spell casters. **Spell Casting Penalty:** All spell ranges, durations, M.D.C./S.D.C. and damage are *halfwhen* cast as a spell or ritual rather than channeled through a TW device.

A techno-wizard is *primarily* interested in energy spells needed to power mystic devices. The wizard spends much of his time building and tinkering with new devices rather than seeking out new spells.

At level one experience, the character knows the following spells fundamental to his needs for empowering TW devices! Blinding flash, globe of day light, ignite fire, fuel flame, fire bolt, call lightning, energy bolt, energy field, impervious to energy, and telekinesis.

At third level a total of three additional spells can be selected from magic levels 1-4.

Note: Other spells can be used to create other devices. For example: Superior invisibility can be used to create a vehicle or suit that can turn invisible.

2. **Learning new spells.** Additional spells and rituals of any magic level can be learned and or purchased at any time regardless of the wizard's experience level. The techno-wizard's area of interest will first be in energy spells, followed by physical manipulation that can be applied to devices, such as invisibility, armor of Ithan, fly, talisman, teleport, dimensional portal, and related. The character is not usually interested in other areas of magic and never acquires summoning or circle magic.
3. **Magic Bonuses.** +2 to save versus horror factor. +1 to save versus magic at levels three, seven, ten, and thirteen. + 1 to spell strength (the number others must save against when you cast a spell) at levels four, eight, and twelve.
4. **P.P.E.:** Like all men of magic, the techno-wizard is a living battery of mystic energy that he can draw on to create magic. **Permanent Base P.P.E.:** 2D4x 10, in addition to the P.E. attribute number. Add 2D6 P.P.E. per each additional level of experience. Of course, the mage can also draw P.P.E. from ley lines, nexus points, and other people whenever available.

Attribute Requirements: I.Q. 12, M.E. 12 or higher. A high P.E. and P.P. is also suggested but are not mandatory.

O.C.C. Skills:

- Literacy (+10%)
- Radio: Basic (+10%)
- Carpentry (+10%)
- Computer Operation (+ 5%)
- Computer Programming (+ 5%)
- Computer Repair (+ 10%)
- Basic Electronics (+15%)
- Automotive Mechanics (+10%)
- Read Sensory Equipment (+ 10%)
- Mathematics: Basic (+ 20%)
- Land Navigation (+5%)
- Language (select two additional languages; both are + 15%)

Hand to Hand combat must be selected as an "other" skill. Hand to Hand: Basic costs one skill selection, Expert counts as two, and Martial Arts or Assassin (if evil) count as three skill selections.

O.C.C. Related Skills: Select seven other skills. Plus select two additional skills at level three, two at level six, one at level nine, and one at level twelve. All new skills start at level one proficiency.

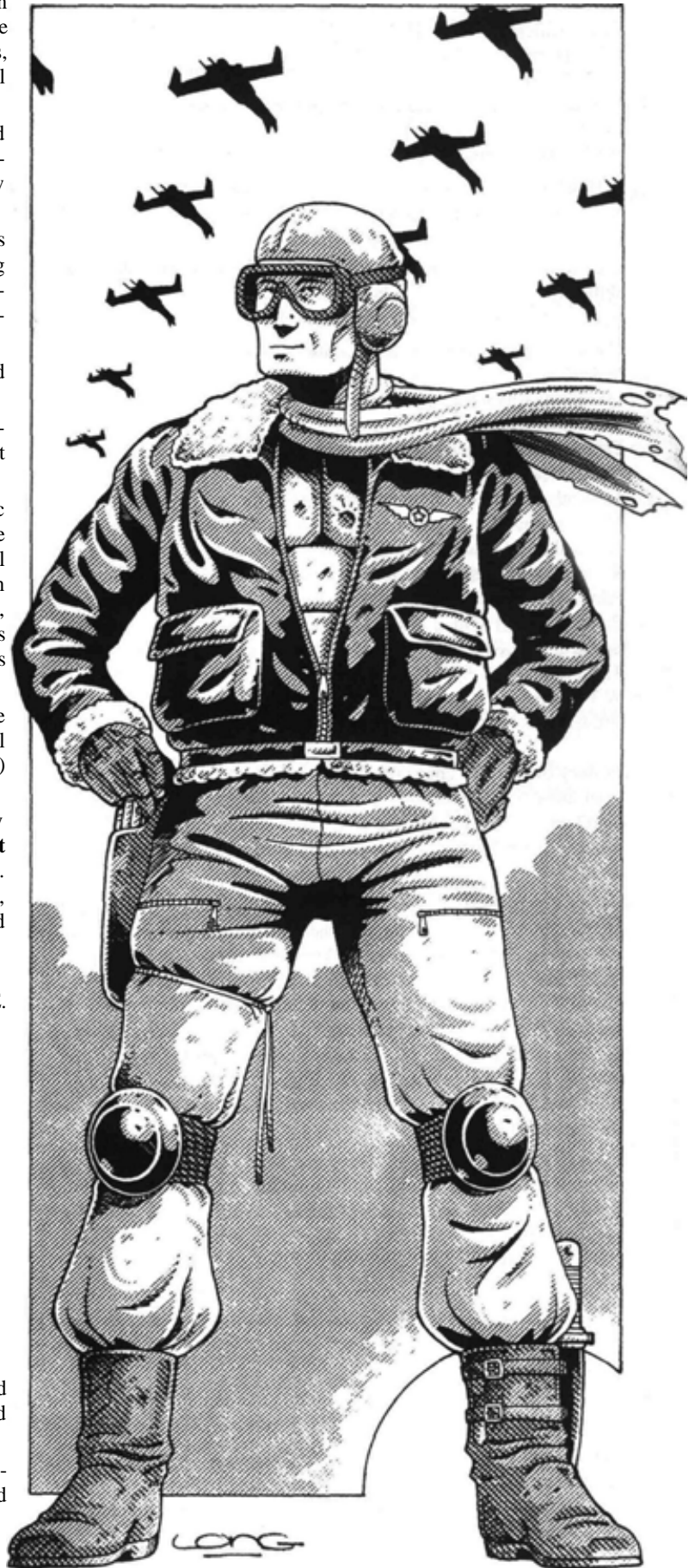

Communications: Any (+5%)
 Domestic: Any
 Electrical: Any, but each skill counts as two skill selections.
 Espionage: Wilderness Survival only.
 Mechanical: Any, but each skill counts as two skill selections.
 Medical: First Aid only.
 Military: Any
 Physical: Any, except, Boxing, Wrestling, and Acrobatics.
 Pilot: Any (+5%)
 Pilot Related: Any (+5%)
 Rogue: Any (+5%)
 Science: Any (+10%)
 Technical: Any (+10%)
 W.P.: Any
 Wilderness: Any

Secondary Skills: The character also gets to select five secondary skills from those listed, excluding those marked "None." These are additional areas of knowledge that do not get the advantage of the bonus listed in parentheses (). All secondary skills start at the base skill level.

Standard Equipment: Work overalls, set of nice clothes, pilot style jumpsuit, tinted goggles, sunglasses, multi-optics band, magnifying glass, pocket flashlight, large flashlight, six signal flares, mini-tool kit, knapsack, back pack, 1D4 small sacks, one large sack, pocket mirror, silver cross, six wooden stakes and mallet (for vampires and other practical applications), canteen, binoculars, air filter and gas mask, pocket laser distancer, pocket digital disc recorder/player for recording his observations, and a hand-held computer. Note: Favorite clothing is Pre-Rifts aviator uniforms, flight jackets, jumpsuits, headgear, goggles, boots, etc. Currently considered to be high fashion among techno-wizards.

Light M.D.C. body armor (seldom wear heavy armor, because it reduces one's speed and mobility by half) that has two special magic features of player's choice, excluding invisibility and impervious to energy.

Weapons will include a survival knife, magic energy converted energy rifle and pistol.

Vehicles: One wing board or tree trimmer. One magic energy converted vehicle of choice with one additional magic feature, excluding invisibility and impervious to energy. Favorite types of vehicle tend to be souped-up motorcycles, dune buggies, and hover vehicles.

Money: The Techno-Wizard starts with 1D6 x 100 in credit, 1D4 x 1000 in black market items and 2D4 x 1000 in quartz crystals and gems; everything has been spent on equipment.

Cybernetics: Starts with none and will avoid getting cybernetic except for medical reasons.

Special Techno-Wizard Powers

Change power source to magic P.P.E.

The techno-wizard can modify an existing machine that requires some form of energy, other than kinetic, to operate on psionic and magic energy. This can be done to anything from an energy weapon to an automobile. The changes generally require electrical modifications, the elimination of the existing energy system and the use of crystals, especially quartz and crystal-type gem stones such as rubies, sapphires,

emeralds, and diamonds. **Note:** Man-made crystals do not work! The stones must be natural earth stones.

The time required to make the modifications will vary with the complexity of the machine and the amount of energy needed to power the device. The following is a basic table of time and parts needed for modifying some specific and general items.

Note: Only practitioners of magic can operate/empower items that require spell magic to be cast. *Psychics*, as well as men of magic, can operate Ley Line devices and psionic powered items like telekinetic weapons. A person without magic abilities (or psionic when applicable) can not use a techno-wizard device even if fully charged. This is one of the innate aspects and links between the mystic mechanisms and its paranormal user.

Conversion Costs and Requirements

Note: The term P.P.E. Cost refers to the initial cost for the techno-wizard to install the magic modifications, including the link between magic and machine. This is a one time creation cost.

The term Spell Needed refers to the additional P.P.E. cost and spell knowledge required to activate/empower the machine. Sometimes more than one spell is required. The Physical Requirements are the components and cash necessary to convert the energy system. Duration will indicate how long the charge will last or how many energy bolts a weapon can fire before needing a recharge. Time indicates how long it takes to do the conversion. Cost is the average added black market cost of magic conversion, in addition to the item itself; i.e., a laser pistol costs 10,000 credits in addition to the 30,000 credits for a magic energy system. Note that the techno-wizard can not sell the item/conversion to the black market at the average retail price, but at about 20% to 25% of the retail price. Thus, a conversion of a laser pistol that retails for 40,000 credits will only net the wizard 8,000 to 10,000 credits. Magic items are usually fairly uncommon, especially in Coalition territory.

- Small battery cell:** This is the replacement of small electrical power sources like a 9 volt or standard C/D batteries for things like flashlights, transistor radios, calculators, computers, etc.
P.P.E. Cost: One, Spell Needed: Blinding flash (1 P.P.E.), Physical Requirement: Small clear quartz crystal worth one credit or more, Duration of Charge: six months. Time: 1D4x10 minutes. Cost: 20 credits.
- Medium-size heavy-duty battery:** This includes field type dry cell batteries like nickel cadmium, lithium, liquid mercury, etc.; for field radios, optical systems, etc.
P.P.E. Cost: One, Spell Needed: Globe of Day Light (2 P.P.E.), Physical Requirement: Green tourmaline crystal, Duration of Charge: two months. To Recharge: All you need is to cast a Globe of Day Light into the energy cell. Time: 1D6x10 minutes. Cost: 200 credits.
- Wet cell, chemical type batteries:** These are like the lead-acid or gelatin car-type batteries.
P.P.E. Cost: four, Spell Needed: Globe of Day Light (2 P.P.E.), Physical Requirement: Green tourmaline crystal worth at least 50 credits, Duration of Charge: one year. To Recharge: Cast a Globe of Day Light (2 P.P.E.) Time: 1D4 hours. Cost: 250 credits.
- Laser energy weapons:** Handguns and rifles. The TW replaces the energy system, converting the weapon completely to magic energy, meaning normal energy clips designed for the weapon will no longer function.
P.P.E. Cost: eight. Spells Needed: Globe of Day Light (2 P.P.E., the source of the amplified light) and Energy Bolt (5 P.P.E., as an energy booster). Physical Requirement: Rose quartz crystal worth 100 credits or more. Duration of Charge: 10 laser blasts that inflict 2D6 M.D. per blast, weapon's range is unchanged, only the power

- source is different. To Recharge: Casting another Globe of Day Light and Energy Bolt (7 P.P.E. total) will charge the weapon with another 10 blasts. Time: 2D4 hours to build. Cost: 30,000 credits.
5. **Ion energy weapons**: Handguns and rifles. The TW replaces the energy system, converting the weapon completely to magic energy, meaning normal energy clips designed for the weapon will no longer function. P.P.E. Cost: 10. Spells Needed: Call Lightning (15 P.P.E.) and Energy Bolt (5). Physical Requirement: Ruby worth 100 credits or more. Duration of Charge: 10 ion blasts that inflict 3D6 M.D. per blast, weapon's range is unchanged, only the power source is different. To Recharge: Casting another Call Lightning and Energy Bolt (20 P.P.E. total) will charge the weapon with another 10 blasts. Time: 2D4 hours to build. Cost: 40,000 credits.
 6. **Plasma energy weapons**: Handguns and rifles. The TW replaces the energy system, converting the weapon completely to magic energy, meaning normal energy clips designed for the weapon will no longer function. P.P.E. Cost: 10. Spells Needed: Fire Bolt (7 P.P.E.) and Energy Bolt (5). Physical Requirement: Diamond worth 1000 credits or more. Duration of Charge: 5 plasma blasts that inflict 4D6 M.D. per blast, weapon's range is unchanged, only the power source is different. To Recharge: Casting another Fire Bolt and Energy Bolt (12 P.P.E. total) will charge the weapon with another 5 blasts. Time: 3D4 hours to build. Cost: 40,000 credits.
 7. **Particle beam weapons can NOT be converted to magic!** However, the wizard can convert an ion blaster into a *lightning blaster*. P.P.E. Cost: 15. Spells Needed: Call Lightning of fifth level strength or higher (15 P.P.E.) and Energy Bolt (5). Physical Requirement: Violet amethyst worth 500 credits or more. Duration of Charge: Two blasts that inflict 5D6 M.D. per blast, weapon's range is unchanged, only the power source is different. To Recharge: Casting another Call Lightning and Energy Bolt (20 P.P.E. total) will charge the weapon with another 2 blasts. Time: 6D4 hours to build. Cost: 80,000 credits.
 8. **TK-Machinegun**: Rifle or machinegun style (not sub-machinegun) weapons that are quite large and menacing looking. The weapon amplifies and directs telekinetic energy to fire bullet hard bolts of force. The basic principle is not unlike the rail guns except instead of firing metal at high speeds, the TK-machinegun fires high speed bolts of force. **Note**: The TK bolts leave no telltale casings, bullets, or muzzle flash. Bolts that hit a target puncture or tear through it, but there is no physical round/bullet. Once it hits, the force bolt is gone. P.P.E. Cost: 40. Spells Needed: Telekinesis (8 P.P.E.) and energy bolt (5). Physical Requirement: Rose quartz crystal worth 1000 credits or more. Duration of Charge: Fires eight (8) bursts per telekinesis spell or per 20 I.S.P. (can be used by psychics, too). Damage is 2D6 M.D. per burst. Range is 4000 feet (1200 m). To Recharge or add more TK-bursts: Eight bursts per each telekinesis spell or 20 I.S.P. points. Maximum TK Capacity: 80 bursts. A person who is not psionic or a mage can not fire even a charged TK weapon. Time: 8D6 hours. Cost: 120,000.
 9. **Electric engine conversion**: To convert an electric engine to a P.P.E. powered system is easy. P.P.E. Cost: 30. Spell Needed: Call Lightning (15 P.P.E.). Physical Requirement: Large clear quartz crystal worth 1200 credits, plus another 1D4 x 100 credits in parts. Duration of Charge: 1000 miles (1600 km) or one month of constant operation. To Recharge: Cast another Call Lightning spell. Time: 2D6x10 hours. Cost: 85,000 credits.
 10. **Combustion engine conversion**: Converting a combustion engine to a P.P.E. powered system is difficult. The entire engine must be replaced with either an electrical engine and batteries (electric spells) or a steam engine powered by heat (fire magic). **Electric Conversion**: P.P.E. Cost: 50. Spell Needed: Call Lightning (15 P.P.E.). Physical Requirement: Large clear quartz crystal worth 1000 credits, plus another 3D4x 1000 credits in parts and equipment. Duration of Charge: 1000 miles (1600 km). To Recharge: Cast another Call Lightning spell. Time: 3D4 x 10 hours. The additional time and cost is because the old engine must be removed and the new electric engine installed requiring more time, parts, and equipment. Cost: 110,000 credits. Maximum Speed: 150 mph (240 km).
Steam Conversion: P.P.E. Cost: 60. Spells Needed: Ignite Fire (6 P.P.E.), Fuel Flame (5 P.P.E.). Physical Requirement: Large red sapphire worth 2000 credits and small blue topaz worth 200 credits, plus another 3D4 x 1000 credits in parts and equipment. Duration of Charge to stoke the engine: 500 miles (800 km). To Recharge: Cast another Ignite Fire and Fuel Flame (11 P.P.E.). Time: 4D4x 10 hours. Maximum Speed: 80 mph (128 km). Cost: 50,000 credits
 11. **TK-Engine Conversion**: This is another difficult and time consuming project that also requires a great amount of P.P.E. to create. The wizard removes the engine and installs a new *telekinesis powered engine*. The TK engine is powered by telekinetic energy pumped into it by the telekinesis *spell or by psychic I.S.P.*, which means a psionic individual can mentally fuel this vehicle. The vehicle can be any type of conventional ground vehicle, including cars, trucks, motorcycles, and even hover vehicles designed to hover only a few feet off the ground (not hover aircraft). The TK-engine can also be installed in motorized boats, but not aircraft. P.P.E. Cost: 260. Spells Needed: Telekinesis (8 P.P.E.), Energy Bolt (5 P.P.E.), and Energy Field (10). Physical Requirement: Purple amethyst worth 2000 credits, rose quartz worth 500 credits, and highly polished, clear quartz crystal worth 500 credits, plus another 3D4x 1000 credits in parts and equipment. Duration of Charge: Telekinesis magic (8 P.P.E.): 50 miles (80 km) per spell, Psionic: Two (2) I.S.P. per every 10 miles (16 km); TK-Battery can hold up to 50 miles' worth of I.S.P. (10). To Recharge: Cast another telekinesis spell (8 P.P.E. for 50 mile/80 km or ten I.S.P. for 50 miles). Time: 1D6x 100 hours. Maximum Speed: 210 mph (336 km).
 12. **Mystic Generator**: A basic electrical generator that is powered by magic energy to create electricity. P.P.E. Cost: 20 for a small generator that could power a good-size house, 50 for a medium size generator that could power an office building, and 200 P.P.E. for a large generator that could power a small town. Spells Needed: One, two, or four Call Lightnings (15 P.P.E. each), Energy Bolt (5), Energy Field (10), and Impervious to Energy (20). Physical Requirement: 2,4, or 8, twelve inch long lengths of Topaz worth about 10,000 credits each, plus another 5000, 10,000, or 20,000 credits' worth of equipment and parts. Duration of Charge: One, two, or four Call Lightnings (15 P.P.E. each), depending on the size of the generator, will power the generator for about one month, depending on energy consumption. Time: 2D4 days, 4D4 days, or 2D4 weeks. Cost: 80,000 small, 250,000 medium, 600,000 credits large.

Adding an Element of Magic to Technology

There are numerous mystic elements a techno-wizard can add to his creations. However, the wizard *must* possess the spell knowledge and cast it, along with the required P.P.E., in order to install these special magical features. An alternative to knowing the spell is to have a scroll, or have another mage perform the spell. Unfortunately, working with a magic user who is not a techno-wizard is more difficult and reduces the odds for success (1-20% +6% per level of the techno-wizard).

Only practitioners of magic and psychics can use these techno-wizard devices. To activate the magical power one must expend either magic P.P.E. or psionic I.S.P. The cost in potential psychic energy (raw magic) is always less than psionic inner strength.

The Initial Creation Cost is the amount of P.P.E. required for the techno-wizard to instill the magic ability in the item/mechanism. There will always be some sort of addition to the device that symbolizes the added mystic power. For example: a suit of armor that has the *breathe without air* ability is likely to have an air tank and/or oxygen mask or helmet built into it. If that item is removed or destroyed, that techno-wizard power is lost. *Impervious to fire* may mean the armor is red in color and has some additional gadget attached to it. And so on.

The Cost indicates what the average price for such a magical addition will be on the black market! Remember, these items are fairly uncommon and can only be used by men of magic and psychics. Magic items are illegal in all Coalition States. Possession of magic in CS territory is a serious offense, punishable by 10 years imprisonment for each item found in one's possession. Magic dealers are usually subjected to a humiliating public trial and executed!

Features that can be added to power and body armor

Not applicable to robots or cyborgs. As many as four powers can be built into one armor.

Armor of Ithan: This spell is activated by thought and 10 P.P.E or 20 I.S.P.; works same as the spell. Duration is subject to the level of its creator. Initial Creation Cost in P.P.E.: 200.

Cost: 50,000 for each 10 magical M.D.C. of the armor.

Breathe without Air: The magic is activated by thought and 5 P.P.E or 10 I.S.P.; works same as the spell. Duration is subject to the level of its creator. Initial Creation Cost in P.P.E.: 100. Cost: 100,000 credits.

Chameleon: The magic is activated by thought and 6 P.P.E or 12 I.S.P.; works same as the spell. Duration is subject to the level of its creator. Initial Creation Cost in P.P.E.: 100. Cost: 120,000 credits.

Escape: The magic is activated by thought and 8 P.P.E or 16 I.S.P.; works same as the spell. Duration is subject to the level of its creator. Initial Creation Cost in P.P.E.: 150. Cost: 170,000 credits.

Impervious to fire: Activated by thought and 5 P.P.E or 10 I.S.P.; works same as the spell. Duration is subject to the level of its creator. Initial Creation Cost in P.P.E.: 200. Cost: 70,000 credits.

Impervious to Energy: Activated by thought and 20 P.P.E or 40 I.S.P.; works same as the spell. Duration is subject to the level of its creator; typically 4-6 level (8 to 12 minute duration). **Note:** This spell will make M.D.C. armor vulnerable only to magic, physical attacks/punches, missiles/explosives, and telekinetic weapons. Initial Creation Cost in P.P.E.: 400. Cost: 500,000 credits.

Invisibility Superior (self): The magic is activated by thought and 20 P.P.E or 40 I.S.P.; works same as the spell. Duration is subject to the level of its creator; typically 4-6th level (12 to 18 minutes). Initial Creation Cost in P.P.E.: 400. Cost: One million credits.

Invulnerability: Activated by thought and 25 P.P.E or 50 I.S.P.; works same as the spell. Duration is subject to the level of its creator. Initial Creation Cost in P.P.E.: 500. Cost: 200,000 credits.

Levitation: The magic is activated by thought and 5 P.P.E or 10 I.S.P.; works same as the spell. Duration is subject to the level of its creator. Initial Creation Cost in P.P.E.: 100. Cost: 70,000 credits.

Mystic Portal: Activated by thought and 60 P.P.E or 120 I.S.P.; works same as the spell. Duration is subject to the level of its creator. Initial Creation Cost in P.P.E.: 1200. Cost: 500,000 credits.



Shadow Meld: The magic is activated by thought and 10 P.P.E or 20 I.S.P.; works same as the spell. Duration is subject to the level of its creator. Initial Creation Cost in P.P.E.: 800. Cost: 200,000 credits.

Superhuman Speed: Activated by thought and 10 P.P.E or 20 I.S.P.; works same as the spell. Duration is subject to the level of its creator. Initial Creation Cost in P.P.E.: 200. Cost: 40,000 credits.

Superhuman Strength: The magic is activated by thought and 10 P.P.E or 20 I.S.P.; works same as the spell. Duration is subject to the level of its creator. Initial Creation Cost in P.P.E.: 250. Cost: 50,000 credits.

Features that can be added to Vehicles

Applicable to all conventional and military passenger vehicles, and giant robot vehicles. A man of magic or psionic must be the pilot in order to activate the magic. As many as four powers can be built into one vehicle.

Breathe without Air: The magic spell affects all passenger of the vehicle and is activated by the thoughts of the psionic or wizard pilot and 5 P.P.E or 10 I.S.P.; works same as the spell. Duration is subject to the level of its creator. Initial Creation Cost in P.P.E.: 300. Cost: 200,000 credits.

Chameleon: The magic is activated by thought and 6 P.P.E or 12 I.S.P.; works same as the spell, except it applies to the entire vehicle and passengers, as long as the vehicle and passengers stay motionless inside the vehicle. Duration is subject to the level of its creator. Initial Creation Cost in P.P.E.: 300. Cost: 220,000 credits.

Impervious to fire: Activated by thought and 5 P.P.E or 10 I.S.P.; works same as the spell, except that the entire vehicle is temporarily impervious to fire (no damage). However, the passengers inside will suffer from the heat and smoke unless the vehicle is airtight, has its own air supply, or breathe without air spell. Duration is subject to the level of its creator. Initial Creation Cost in P.P.E.: 500. Cost: 170,000 credits.

Impervious to Energy: Activated by thought and 20 P.P.E or 40 I.S.P.; works same as the spell, except that it applies to the vehicle, not the passengers. Duration is subject to the level of its creator. Initial Creation Cost in P.P.E.: 750. Cost: 800,000 credits.

Invisibility Superior (self): The magic is activated by thought and 20 P.P.E or 40 I.S.P.; works same as the spell, except it is the vehicle that turns invisible. If a passenger opens the door both the interior of the vehicle and the person will be plainly visible. Duration is subject to the level of its creator. Initial Creation Cost in P.P.E.: 450. Cost: Three million credits.

Shadow Meld: The magic is activated by thought and 10 P.P.E or 20 I.S.P.; works same as the spell, except the magic applies to the vehicle, not the passengers inside. If a passenger opens a door or any form of communication or sensory equipment is used (including passive sensors), the spell is broken and the vehicle will become visible. Duration is subject to the level of its creator. Initial Creation Cost in P.P.E.: 800. Cost: 750,000 credits.

Ley Line Magic Devices

Ley line devices are mechanisms that can be used by men of magic and psychics, but only along mystic energy lines, because they need that extra energy. These creations will take into consideration basic scientific principles and designs, like aero-dynamics, but these devices can be little more than a plank of wood, a few wires, and a power crystal. Away from a ley line, the device is worthless, but on a ley line, the mechanism may have a multitude of impressive applications.

Magic Ley Line Mechanisms

Note: The techno-wizards enjoy a sort of intuitive skill knowledge and ability that enables them to pilot any ley line vehicle with astounding skill, even if they normally have no piloting skill whatsoever. For example: A wizard without a pilot airplane skill can pilot a TK-Flyer with ease, but he could not get the same aircraft off the ground under normal circumstances without a ley line. This natural aptitude comes from the Techno-Wizard's link to techno-wizardry devices and magic energy. The Ley Line Walker also enjoys a similar intuitive knowledge when piloting a TW vehicle that rides along ley lines. **Techno-wizard Base Piloting Skill:** Applies to all ley line guided vehicles; 74% + 2% per level of experience. **Ley Line Walker Base Piloting Skill:** Applies to all ley line guided vehicles; 60% + 2% per level of experience. AH

others mages and psychics must have the appropriate piloting skill or they can not operate the vehicle. Wing boards are the only exception Anybody can fly one with a little practice.

1. **TK-Flyer:** The techno-wizard's magic is not normally sufficient to power aircraft, but with the additional energy of the ley line, they can utilize flying devices. The vehicle can be virtually any design of *small* flying aircraft, from propeller biplanes, to gliders, single and twin engine airplanes, two or three person hover vehicles, helicopters, gyroplanes, and jet packs. The TW must replace the engine with a telekinetic engine and off one goes. The TK-engine is powered by telekinetic energy pumped into it by the telekinesis *spell* or by *psychic I.S.P.*

P.P.E. Cost: 180. Spells Needed: Telekinesis (8 P.P.E.), Energy Bolt (5 P.P.E.), and Energy Field (10). Physical Requirement: Purple amethyst worth 1000 credits, rose quartz worth 200 credits, and highly polished clear, quartz crystal worth 500 credits, plus another 2D4 x 1000 credits in parts and equipment. Duration of Charge: Telekinesis magic (8 P.P.E.) or 10 I.S.P. to initiate takeoff. The aircraft will stay in flight for the length of the ley line and can switch directions wherever there is an intersection of ley lines (nexus point). In some instances one can fly for hundreds of miles powered by a single burst of mystic energy, and the flow of P.P.E. along the line maintains the flight. To Recharge: Another telekinesis spell (8 P.P.E.) or ten I.S.P. are needed to start the vehicle every time. Time: 1D6x 100 hours. Maximum Speed: 220 mph (352 km). Maximum Height: 5000 feet. Black Market Cost: 60,000.

Dual Engine Option: TK-Flyer capabilities can be built into an aircraft by adding the telekinetic engine and maintaining the conventional engine. The system is set up in such a way that the conventional engine can be engaged when there is no ley line energy available, and turned off when a ley line is there to follow. Costs, time, and spells are all the same, the only differences are that passenger space is reduced by half (and fuel storage on some smaller craft) to make room for the TK-engine, and maximum speed when on ley line power is reduced to 200 mph (320 km).

2. **Wing Boards or TK-Gliders:** Is a popular and amazing one person glider that works on a similar principle as the TK-Flyers, only it doesn't have an engine. A wing board might best be thought of as a flying surf board that rides the wind and ley line energy. To launch a wing board, the character sits or lays on his board and must either use levitation or telekinesis to raise himself and board into the sky (at least 60 feet/18 meters, a hundred feet is better) and release himself on the next gust of wind (even a tiny wind gust). Or the person can hurl himself from a tower, building, tree, or cliff as long as it is on a ley line. The wing board does not need any special ignition or spell to fly along a ley line. Just remember, no ley line energy no flight!

To land, one simply directs the board down like a glider; there are maneuvering controls. Base Skill proficiency is equal to the jet pack skill. Techno-wizards are automatically skilled pilots of ley line devices due to their link to both the machine and the magic energies. **Base Flying Skill:** 40%. Roll whenever evasive or special maneuvers are being tried. A failed roll means the board crashes or the person falls off. This base skill applies to practitioners of magic and psychics other than techno-wizards and ley line walkers.

P.P.E. Cost: One. Spell Needed: None. Physical Requirements: Rose quartz crystal and an aerodynamic board with steering mechanism. Time: 2D4 days for a nice board, four weeks for a fancy board. Maximum Speed: 150 mph (240 km). Maximum Height: 1000 feet (305 m). Cost: 1000 to 3000 credits

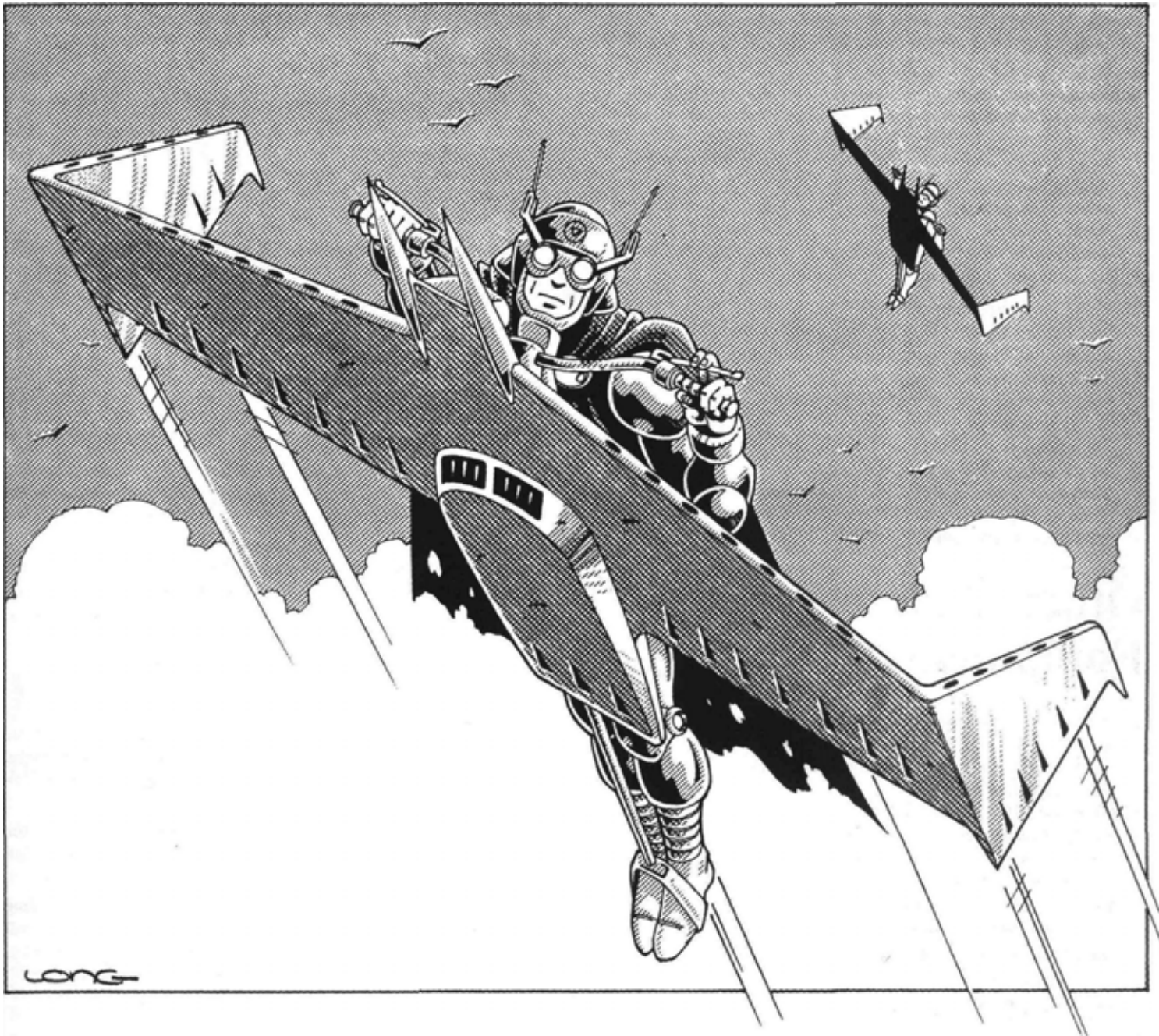

3. **Tree Trimmers:** A strange, low flying, one or two person hover vehicle for ley line cruising. The tree trimmer is basically a bicycle that has two paddles in the front and back instead of wheels. The person pedals, the paddles spin, and the flying bicycle goes. Can be designed for one or two pedallers (and one passenger on handlebars or rear). It is called a tree trimmer, because the maximum height is about treetop level.

P.P.E. Cost: 5. Spell Needed: Telekinesis (8 P.P.E.). Physical Requirement: Clear quartz crystal. Duration of Charge: Telekinesis magic (8 P.P.E.) or 10 I.S.P. to initiate take off. To Recharge: Another telekinesis spell (8 P.P.E.) or ten I.S.P. are needed to start the vehicle every time. Time: 4D6x 10 hours. Maximum Speed: 220 mph (352 km). Maximum Height: 200 feet (61 m). Black Market Cost: 7000 credits.

4. **Sky Boats.** This is just what it sounds like, sailboats in the sky. These vessels can be large or small depending on the needs of the maker or purchaser. Thus the vessel could be a little two person sailboat or a full size frigate. The boats move by means of wind, telekinesis, and ley line energy. Telekinesis or levitate will be needed to land the vessel.

P.P.E. Cost: Two person 10 P.P.E., small (6-8 person) 30 P.P.E., medium, yacht/fishing boat size (10-14 people) 60 P.P.E., or large, ship size (25 to 50 people) 180 P.P.E. points. Spells Needed: Telekinesis (8 P.P.E.), wind rush (20 P.P.E.), energy bolt (5). Physical Requirement: Clear quartz crystal. Duration of Charge: Telekinesis magic (8 P.P.E.) or 10 I.S.P. to initiate take-off; costs double for ships. Also need telekinesis (8) or levitate (5) magic or equivalent psionic abilities and I.S.P. to land the vessel on the ground. Otherwise, the boat will slowly drift away (spd 3) at about 100 feet (30.5 m) above the ground. **Note:** Remember that the sky boat will only float along ley lines. Whether it is a seaworthy vessel depends on its construction (add 30% to cost). The boat can switch direction at a ley line nexus. To Recharge: Another telekinesis spell (8 P.P.E.) or ten I.S.P. are needed to start the vessel from a dead stop. Time to build is based on a quick, not high quality boat (double or triple the time if the boat is very finished and/or seaworthy): Two-person boat 1D6 days; small 2D4 weeks, medium: six months plus 2D4 weeks, large ship: 12 months plus an additional 2D6 months. Maximum Speed: Small and medium: 100 mph (160 km), large: 150 mph (240 km). Maximum Height: 1000 feet (305

m). Minimum Height: (without landing) 200 feet (61 m). Black Market Cost: 7000 credits for 2 person, 10,000 for small, 30,000 to 60,000 for medium, 250,000 and up for ship.

- Energy Field Generator.** The apparatus resembles two small field generators about 10 feet (3 m) apart. In the center is the mage and his belongings. The generators create an energy field around the mage and the generators. The generator devices keep the force field in place indefinitely or until the field is destroyed. The force bubble generator devices create a force bubble that protects the wizard from the elements and from attack. The strength of the force field is 120 M.D.C. at places of ley line energy. Remember, the energy field generator only works at ley lines.

P.P.E. Cost: 40 for the pair. Spells Needed: Energy Field (10 P.P.E.) and Energy Bolt(5). Physical Requirement: Clear quartz crystal. Duration of Charge: Energy field and generators will work indefinitely when on a ley line or until the field is turned off. The field must be turned off to enter/exit unless one can teleport. To Recharge: 201.S.P. or the spell energy field (10 P.P.E.) must be cast to activate the generators; the field appears within five seconds. M.D.C. damage to the energy field will be restored to full every time the energy field spell is cast or 20 I.S.P. is directed into the generators. Note: Each generator has a M.D.C. capacity of four (4) points. Time: 4D4 days. Black market Cost: about 40,000 credits.

Other Techno-wizard Equipment

- Communication Band:** A headband with several little metal or plastic boxes and/or small circuit panel from a transiter radio or computer. The band will instantly translate *any* spoken language, human and alien.
P.P.E. Cost: 15. Spells Needed: Globe of Day Light and Tongues. Physical Requirement: rose quartz worth 500 credits or more. Duration of Charge: 15 minutes per level of user. To Recharge: Casting another tongues spell (12 P.P.E.) or 24 I.S.P. will charge the band for another 15 minutes per level of the user. Time: 2D4 days to build. Cost: 50,000 credits.
- Magic Optic System:** A pair of goggles that give a person mystic optical enhancement. Abilities include: see aura, see the invisible, and detect concealment; all same as their spells.
P.P.E. Cost: 30. Spells Needed: Globe of Day Light, Energy Bolt, See Aura, See the Invisible, and Detect Concealment. Physical Requirement: Blue topaz worth 1200 credits or more. Duration of Charge: 15 minutes. To Recharge: Casting an energy bolt spell (5 P.P.E.) or 10 I.S.P. will charge the goggles for another 15 minutes per level of the user. Time: 2D4 days to build. Cost: 40,000 credits.
- Psionic Mind Shield (For Psionic Characters ONLY!):** An odd looking helmet encrusted with quartz. The helmet makes a person completely impervious to psionic attacks and probes of all kinds!
P.P.E. Cost: 330. Spells Needed: Globe of Silence, Energy Bolt, Energy Field, Impervious to Energy, Invulnerability, Telekinesis, Befuddle, and Negation. Physical Requirement: 12 rose quartz, 6 clear quartz, 6 lapis, and 2 yellow topaz worth 200 credits each. Duration of Charge: One minute. To Recharge: Costs 30 I.S.P. to activate for one minute, plus 10 I.S.P. for every additional minute. Time: 4D4 weeks to build. Cost: 250,000 credits.

Note: Can be modified to be used by non-psionics (need to add the life drain spell during the initial creation), but the helmet drains one's life force at a rate of 10 hit points per minute and can kill the individual wearing it. Hit points are restored at the normal rate for physical damage.

Techno-wizard Weapons

Flaming Sword

Range: Hand held

Duration: Two minutes (8 melees) per level of the experience.

Damage: 4D6 Mega-Damage!

Energy Requirements: 15 I.S.P. or Fire Bolt spell (7 P.P.E.) or a Circle of Flame spell (10).

To Create: 75 P.P.E., two rubies worth 1000 credits each.

Black Market Cost: 70,000 credits

The flaming sword is a simple sword hilt made of wood or metal and no blade. At the top of the hilt is a thin slot where one might expect a sword blade to be inserted. Inside the handle is a ruby, worth at least 100 credits, mounted on a copper bracket with three wires running down the handle and connected to a second ruby at the base of the handle.

To activate the flaming sword, the appropriate amount of I.S.P. or spell and P.P.E. must be pumped into the handle. A moment later, a crackling, red, orange, or yellow flame appears and can be used a magic sword.



Lightning Rod

Range: Shoots lightning bolts up to 1200 feet (366 m).

Duration: Effects last one melee per level of experience.

Damage: 1D6 mega-damage per bolt. Four bolts per melee.

Energy Requirement: 30 I.S.P. or Call Lightning (15 P.P.E.) P.P.E. to Use: Techno-wizard: 10 P.P.E., Others: 30 P.P.E.

To Create: 150 P.P.E., iron rod, and gold or copper plating

Black Market Cost: 55,000 credits.

The lightning rod is a two to three foot (0.9 m) long rod of metal, usually plated in gold or copper (costs about 150 credits), that resembles the old-fashion lightning rods with insect, half moon, or other design at the tip, and a heavy, insulated rubber handle on the other end.

The rod has two functions. 1) Shoots four small lightning bolts per melee. Just point, aim, and fire (by thought). Mega-damage is 1D6 Mega-Damage per bolt; +2 to strike. Targets can attempt a dodge.

2) The person using the weapon is impervious to energy, including electricity, fire, heat, plasma, lasers, and so on. However, he is still vulnerable to magic energy attacks, other forms of magic, psionics, rail guns, explosives, and even normal kinetic attacks like punches.

Mystic Power Armor

A suit of plate like body armor made out of crystals. The suit is incredibly powerful and incredibly rare.

The Powers of the Mystic Power Armor include the following:

Optics: Eyes of the Wolf and See the Invisible.

Offensive Weaponry:

1. Call Lightning: 6D6 M.D., range: 1200 feet (366 m), payload: Two lightning bolts per melee.

2. Fire bolt: 4D6 M.D., range: 1200 feet (366 m), payload: Two bolts per melee.

3. Magic Net: Ensnares victim, range: 200 feet (61 m), see spell for full description.

Special Features:

1. Fly as the Eagle, same as spell, indefinite duration.

2. Globe of Day Light, same as spell, available on demand.

3. Superhuman Speed, same as spell, available on demand.

4. Superhuman Strength, same as spell, available on demand.

Environmental Features:

1. 150 M.D.C. (Armor of Ithan and 100 P.P.E. will restore all mega-damage).
2. Breathe Without Air, same as spell, perpetually in effect.
3. Chameleon, same as spell, can be used at will.
4. Impervious to fire, same as spell, constantly in effect.

P.P.E. Cost: 3800. Spells Needed: Equivalent spells for all powers/features. Physical Requirement: 50,000 credits worth of clear quartz crystal and a diamond worth 20,000 credits. Duration of Charge: Permanent. M.D.C. may be restored by casting an Armor of Ithan spell and feeding it 100 P.P.E. points. Time: Nine months of constant labor. Black Market Cost: Two million credits.

Racial Character Classes

Of course, all characters have some type of training, skills, and orientation that help direct the hero's life and adventures. Usually, these aspects of a character are developed by selecting an Occupational Character Class or O.C.C. The O.C.C. works great in most cases, however, in **Rifts** there are some unique creatures where an O.C.C. doesn't quite fit. These creatures fall into a more general *racial* classification, with skills and orientation based on racial characteristics and unusual powers rather than a typical *human* occupation.

The result being the introduction of the *Racial Character Classes* (R.C.C.). The R.C.C.s are non-human beings with unique natural abilities and limited human-type skills. I think you will find them satisfactorily exciting.

Dragons

Dragon Hatchling R.C.C. _____

Dragons are very strange and powerful creatures by human standards. Until the rifts changed everything, dragons were relegated to human myth and fantasy. However, humans now know that the dragons are very real.

Dragons are not indigenous to Earth, but are beings from an unknown dimension. They seem to have left behind any *homeworld* they may have had in favor of transdimensional exploration, for dragons have been found to inhabit numerous worlds and dimensions. As creatures of magic, they are inexorably drawn to realms where magic energy is high. The Earth of **Rifts** is overflowing with magic energy, so they come.

Dragons have no apparent society nor feeling of kinship, even among the same species. They act with complete autonomy from one another, with no laws, ethics, or codes of conduct shared by any. Each does as he pleases independent of the other. There is seldom any camaraderie or even pleasantries exchanged between dragons. Except for mated pairs, dragons tend to shun the company of fellow dragons. Even offspring are left to fend for themselves a few days after hatching.

There are many reasons for this antisocial behavior. Dragons have abandoned society eons ago. The why is simple, they didn't need one. Dragons are unimaginably powerful, especially on worlds like Earth where magic energy is in abundance. They are nearly indestructible (on the Rifts' Earth they are mega-damage creatures), they can heal and regenerate within hours, live for thousands of years, breathe fire, possess monstrous strength, can change their physical forms at will, instinctively know how to channel and use mystic energy, and can shift from one dimension to another. Other than a fellow dragon, and perhaps other intelligent life forms, these powerful beings have no natural enemies. Their longevity provides them with the time to become incred-

ibly knowledgeable and powerful as they learn to use their natural strengths and abilities, as well as a limited use of technology.

The ability to traverse different dimensions makes them creatures of the universe, and not any one world. It is probable that dragons don't originate in our galaxy and may be a wandering race of beings from the edge of the universe. Who knows? The dragons don't.

It is apparent that dragons have visited Earth many times as its magic energies swelled and ebbed over the passing millennia. It is equally plausible to believe that some of the ancient gods of primitive, pre-Rifts, Earth were not myth but did exist, perhaps as dragons who adopted a human form or toyed with the amusing little humans. Zeus, Thor, Isis, and all the rest, dragons of a bygone era. But our concerns are with the dragons of today.

Some facts about dragons

Although creatures of magic are the embodiment of immense power, dragons should not be viewed as gods. Like most things, there are reasonable explanations, origins, actions and reactions. Here are the simple facts about dragons.

As previously stated, they are an otherworldly species of animal, just like humans, and are in fact, mammals. Like humans, they are predators, aggressive and territorial. Unlike humans, they lack society and without it, the laws and mores that society generates. This explains, in part, the lack of uniform behavior among different dragons of the same species. Since they do not frequently intermingle among their own kind, they develop their sense of ethics, loves, likes and dislikes from their associations with *other*, non-dragon, races. They observe and adopt the morals that appeal to them.

The giant serpents are also similar to humans in their expression of emotions and in their capacity for good or evil. The environment and experiences of a hatchling will shape the way the dragon grows, both emotionally and idealistically. The bestial, ravaging savages are spawned from a life of conflict, with little or no contact with other intelligent beings. They become more animalistic, mean, extremely aggressive, and territorial. For them, might is right and they must be the mightiest. They live for confrontation and combat.

By contrast, those who have had a great deal of contact with intelligent life may have adopted recognizable ethics (and alignments), whether they be good or evil, friendly or manipulative. These serpents will exhibit decidedly more human emotions, morals, and quirks. Some will view the universe with compassion and love, respecting all life in its myriad forms. These are the peaceful and good dragons. Unfortunately, eons of life and cynicism can create the monsters most men know dragons to be. These are the ancient, vindictive schemers who have grown cold and jaded over the passage of time. Terrible beasts who have become either so removed from other beings, or so bitter and hate filled, that they view all creatures as lesser animals or playthings to occupy their time. They can be unbelievably, sadistic, twisted, and

unspeakably evil. These nefarious fiends kill, maim, and torment for the sheer pleasure. They occupy their boredom with cruel and damaging schemes that will hurt others, but entertain themselves. They crave and gather magic and power, but use that power only to inflict more torment, create more hate, more pain. Humans are a favorite plaything, and the situation on the rift torn Earth, with its many intelligent creatures, mutants, and monsters, has only served to make the game more interesting.

Dragon Instincts

Baby dragons, or hatchlings, emerge from their eggs after an incubation period of several years. Like most animals, the little 20 foot (6 m) serpent is physically mature, aware, and guided by instinct.

A dragon only minutes old will instinctively know how to fly, use its breath weapon, use its psychic powers, teleport and metamorphosis. More amazing is that the behemoth will be able to speak, read and write dragonese (elven), and understand basic math, both at 98% proficiency. It will also know and understand the principles of magic. Scientists believe that the psionic nature of the dragon enables the mother to impart a comprehensive amount of information to her offspring before it hatches.

Animal instincts and other aspects unique to dragons

A dragon reaches full physical maturity at approximately 600 years of age. Until this point, most young are much more tolerant and accepting of other dragons and alien life forms.

Dragons are aggressive predators. They love to stalk and toy with their prey, both physically and psychologically. **Note:** Claws inflict 2D6 Mega-Damage, Bite does 2D4 Mega-Damage.

Instinctively dislike other dragons. They tend to be very intolerant and petty when dealing with others of their ilk. This is especially true among older dragons (600 years and older). Mature dragons will often attempt to kill younger dragons whenever encountered.

Tend to be solitary creatures, even those who associate with other intelligent beings like to be by themselves from time to time. They will try to avoid working with other dragons. However, some of the more cultural/civilized dragons can develop a friendship with fellow dragons, especially of a different species.

They will tolerate each other when courting a prospective mate and will stay a mated pair for life.

When forced to live around other dragons, the serpents will compete fiercely on every level. Each will try to prove his superiority over the others until an unofficial pecking order is established with one as the accepted pack leader.

A mated pair will establish a nesting cave/place and stay at that location for 2D4 decades before an egg is conceived and fertilized. The parents will guard and protect the egg with their lives; however, the two will abandon the hatchling and the nest forever, a few days after its birth.

Dragons instantly recognize parents and siblings, even if they have never met before (again, the implication of a psychic bond between parent and offspring). Males will generally take an instant dislike to each other as they would any other dragon. Fathers and sons are notorious for their immediate hatred of each other, especially if of an evil alignment, and have been known to duel to the death over a nasty look. However, the mother will at least temporarily receive her child, male or female, with warmth and happiness. But she too will soon become hostile, mirroring the response of her mate.

Dragons are extremely territorial. They may travel the multi-verse, but the place they choose as their home for the moment is all important. The beasts will not tolerate intrusion of their lair by any creature. Even a friendly dragon's knee-jerk reaction is to strike to kill. Fortunately, this reaction can be controlled.

The 50 mile (80 Km) surrounding area, around the lair, is also part of its territory, but the giant serpent is much more placid and tolerant about what goes on there. He will become agitated if his territory is disturbed or if that which he considers to belong to him (this can include people, fauna, and flora) is invaded, damaged, altered, or threatened. However, the dragon will not tolerate the presence of another dragon within his territory (sometimes within 100 miles/160 km of its territory). The dragon whose turf has been invaded will emerge from his lair to confront the intruding dragon. Unless the intruder backs down and leaves, a titanic fight will ensue. The fight is over only after one has fled or is dead.

The Dragon ——— Player Character

Players can select a dragon hatchling as a player character. The character is quite powerful by human standards, but only a fraction as powerful as a mature adult, and comparable with augmented humans, mutants, and wielders of magic.

Age

Roll percentile dice to determine how old the character is. At this stage in the dragon's young life, he or she is fairly innocent and naive. The attitudes and values that the dragon will adopt in later years may be influenced now by the creature's current companions, encounters, and experiences (adventures).

01-10 6D6 hours old

11-20 1D6 days old

21-40 2D6 days old

41-60 3D6 days old

61-80 5D6 days old

81-00 8D6 days old

Note: A dragon is considered to be a hatchling until it reaches full maturity, which is approximately 600 years later.

Alignment

If the player has a definite idea of the alignment desired for the character, he can select it now. Otherwise, the hatchling will start off as having the anarchist alignment; self serving, self obsessed, greedy, and snotty. He/she will tend to be helpful and cooperative only when it suits him, and will whine and complain when things don't go his way. With luck, this will change quickly, but like any child, the hatchling must learn that it is not the center of the universe and must also learn what it means to have friends, trust, love, to be considerate of others, etc.

At level three of experience, the player must select a definitive alignment for his character (if he hasn't already). The dragon can be of any alignment, good, selfish, or evil.

Size

A hatchling reaches 80% of its full size within 3D4 weeks after it hatches. So depending on how old the hatchling was when the group first met it, they could be witness to a rather dramatic growth period. The hatchling is born one-third its mature size and does not reach full maturity until it is 600 years old.

Note: Dragons do not need to eat for nourishment and only do so for the pleasure and taste treat sensation eating provides. As creatures of magic, they actually absorb and are sustained by magic energy.

Skills

At first level the Hatchling can select six skills, but is automatically literate in dragonese and one additional language (player's choice, but probably American) and also knows basic math. Each of these three skills are at 98% proficiency. At fourth and eighth levels an additional four skills can be selected. Available skill categories are limited to:



Communication, Domestic, Military, Pilot, Pilot Related, Rogue, Technical, and Wilderness. There are no skill bonuses other than a possible I.Q. bonus. The hatchling is too busy testing his natural abilities, instinctively developing magic skills, and learning about the cosmos to concentrate on mundane human skills.

Species of Dragon

There are several different species of dragon. The one constant is that they all resemble giant lizards or dinosaurs. Only the four most notorious dragons are presented here, taken from the pages of the **Palladium Role-Playing Game** and modified to represent the dramatic influence that a magic energy rich environment, like the world of Rifts, has on dragons.

Note: The other species of dragons will be included in the **Rifts Conversion Book**, which will specifically convert major creatures and characters from several of Palladium Books' other RPGs for use in Rifts. The first **Rifts World Book** may add a few species, as well as some new creatures and a lot of info about the rest of the planet. Both books will be released as soon as possible.

Great Horned Dragon Hatchling

Attributes: The numbers indicated under each attribute is the number of dice to be rolled for each. For example: I.Q. 5 means that five six-sided dice (5D6) are rolled to determine the I.Q.

I.Q. 5, M.A. 4, M.E. 5, P.S. 6, P.P. 4, P.E. 5, P.B. 6, Spd. 4

These attributes stay pretty constant until the dragon reaches full maturity at about 600 year old. At that time the *physical* attribute increase dramatically.

P.P.E.: 2D6x10

Mega-Damage/Hit Points: 1D4x 100 + 50 M.D. points

Armor Rating: Skin is a mega-damage substance that is impervious to normal weapons. Magic, psionics, and mega-damage weapons have full effect.

Natural Abilities: Fly 70mph (112 km), nightvision 90 ft (27.4 m), see the invisible, fire and cold resistant (does half damage), and can bio-regenerate 1D4x 10 M.D. points every five minutes.

Metamorphosis: Is another natural ability. The dragon can completely alter his physical shape, transforming himself to look like any living animal, from human being to raven. There are some limitations; the dragon can not metamorphosize into inanimate objects or insects. The minimum size is about the size of a cat and the maximum size can not exceed his own. The transformation can last two hours per level of experience (an adult dragon can maintain the transformation for 48 hours). If on or near a ley line or nexus point (within two miles/3.2 km), the time is tripled. Note: Regardless of his shape, a dragon is a dragon, with all its natural powers and abilities. So a hatchling metamorphed to look like a bunny rabbit can still talk, cast spells, and kick with the strength of a dragon. The metamorphosis does not instill any of the abilities of the animal, only its appearance.

Teleport: 28 + 2% per level of experience. Teleportation is a special power common to most dragons. The character can teleport, at will, up to five miles away. At the hatchling stage, he can only teleport himself. The percentage number indicates the likelihood of being able to activate the teleportation. A failed roll means the teleport does not happen. The hatchling can attempt a teleport once every other melee round. Only a mature dragon can perform a dimensional teleport without using a ley line nexus.

Fire Breath: 2D6 M.D., range: 60 feet.

Psionics: Major psionic; player can select a total of eight psychic powers from any of the psychic categories except super. Select an additional four at fifth level and another four at tenth level. I.S.P.: 3D4 x 10

Magic Knowledge: Full understanding of magic, but knows no spells yet. However, can intuitively use all types of *techno-wizardry* devices without instruction, can read magic, use scrolls, and recognizes magic circles and enchantment. Can also sense ley lines and nexus points and other dragons; range: 20 miles (32 km). Note that this sensing ability can not pinpoint specific locations, only nearness and general direction.

Spells: Can be learned by the usual means beginning at third level. The hatchling can cast two new spells per level of experience.

Combat abilities: Equal to hand to hand: basic, + 1 melee attack.

Average Life Span: 6000

Fire Dragon Hatchling

Attributes: The numbers indicated under each attribute is the number of dice to be rolled for each. For example: I.Q. 4 means that four six-sided dice are rolled to determine the I.Q.

I.Q. 4, M.A. 4, M.E. 4, P.S. 5, P.P. 4, P.E. 5, P.B. 5, Spd. 5

These attributes stay pretty constant until the dragon reaches full maturity at about 600 year old. At that time the *physical* attribute increase dramatically.

P.P.E.: 2D4x10

Mega-Damage/Hit Points: 1D4x100 M.D. points

Armor Rating: Skin is a mega-damage substance that is impervious to normal weapons. Magic, psionics, and mega-damage weapons have full effect.

Natural Abilities: Fly 50 mph (80 km), nightvision 90 ft (27.4 m), see the invisible, impervious to fire (no damage), and can bio-regenerate 1D4x10 M.D. points every five minutes.

Metamorphosis: Is another natural ability. Same as the Great Horned Dragon.

Teleport: 22 + 2% per level of experience. Teleportation is a special power common to most dragons. The character can teleport, at will, up to five miles away. At the hatchling stage, he can only teleport himself. The percentage number indicates the likelihood of being able to activate the teleportation. A failed roll means the teleport does not happen. The hatchling can attempt a teleport once every other melee round. Only a mature dragon can perform a dimensional teleport without using a ley line nexus.

Fire Breath: 6D6 Mega-damage, range: 60 feet (18 m).

Psionics: Minor psionic; player can select a total of six psychic powers from either the sensitive, physical, or healing categories. Super is not available. Select an additional two at fifth level and another two at tenth level. I.S.P.: 1D6x10

Magic Knowledge: Full understanding of magic, but knows no spells yet. However, can intuitively use all types of *techno-wizardry* devices without instruction, can read magic, use scrolls, and recognize magic circles and enchantment. Can also sense ley lines and nexus points and other dragons; range: 20 miles (32 km). Note that this sensing ability can not pinpoint specific locations, only nearness and general direction.

Spells can be learned by the usual means beginning at third level. The hatchling can cast two new spells per level of experience.

Combat abilities: Equal to hand to hand: basic, + 1 melee attack.

Average Life Span: 6000



Ice Dragon Hatchling

Attributes: The numbers indicated under each attribute is the number of dice to be rolled for each. For example: I.Q. 4 means that four six-sided dice are rolled to determine the I.Q.

I.Q. 4, M.A. 4, M.E. 4, P.S. 5, P.P. 4, P.E. 5, P.B. 5, Spd. 5

These attributes stay pretty consistent until the dragon reaches full maturity at about 600 year old. At that time the *physical* attributes increase dramatically.

P.P.E.: 2D4x10

Mega-Damage/Hit Points: 1D4x 100 M.D. points

Armor Rating: Skin is a mega-damage substance that is impervious to normal weapons. Magic, psionics, and mega-damage weapons have full effect.

Natural Abilities: Fly 50mph (80 km), nightvision 90 ft (27.4 m), see the invisible, impervious to fire (no damage), and can bio-regenerate 1D4x 10 M.D. points every five minutes.

Metamorphosis: Is another natural ability. Same as the Great Horned Dragon.

Teleport: 22 + 2% per level of experience. Teleportation is a special power common to most dragons. The character can teleport, at will, up to five miles away. At the hatchling stage, he can only teleport himself. The percentage number indicates the likelihood of being able to activate the teleportation. A failed roll means the teleport does not happen. The hatchling can attempt a teleport once every other melee round. Only a mature dragon can perform a dimensional teleport without using a ley line nexus.

Ice Breath: 5D6 Mega-damage, range: 60 feet (18 m)

Psionics: Minor psionic; player can select a total of six psychic powers from either the sensitive, physical, or healing categories. Super is not available. Select an additional two at fifth level and another two at tenth level. I.S.P.: 1D6x10

Magic Knowledge: Full understanding of magic, but knows no spells yet. However, can intuitively use all types of *techno-wizardry* devices without instruction, can read magic, use scrolls, and recognize magic circles and enchantment. Can also sense ley lines and nexus points and other dragons; range: 20 miles (32 km). Note that this sensing ability can not pinpoint specific locations, only nearness and general direction.

Spells can be learned by the usual means beginning at third level. The hatchling can cast two new spells per level of experience.

Combat abilities: Equal to hand to hand: basic, + 1 melee attack.

Average Life Span: 6000

Thunder Lizard Dragon Hatchling

Attributes: The numbers indicated under each attribute is the number of dice to be rolled for each. For example: I.Q. 4 means that four six sided dice are rolled to determine the I.Q.

I.Q. 4, M.A. 4, M.E. 5, P.S. 5, P.P. 4, P.E. 5, P.B. 4, Spd. 6

These attributes stay pretty consistent until the dragon reaches full maturity at about 600 year old. At that time the *physical* attributes increase dramatically.

P.P.E.: 2D4x10+10

Mega-Damage/Hit Points: 1D4x 100 + 50 M.D. points

Armor Rating: Skin is a mega-damage substance that is impervious to normal weapons. Magic, psionics, and mega-damage weapons have full effect.

Natural Abilities: Nightvision 90 ft (27.4 m), see the invisible, resistant to fire and cold (half damage), and can bio-regenerate 1D4x 10 M.D. points every five minutes. Does not have wings and can not fly.

Metamorphosis: Is another natural ability. Same as the Great Horned Dragon.

Teleport: 26 + 2% per level of experience. Teleportation is a special power common to most dragons. The character can teleport, at will, up to five miles away. At the hatchling stage, he can only teleport himself. The percentage number indicates the likelihood of being able to activate the teleportation. A failed roll means the teleport does not happen. The hatchling can attempt a teleport once every other melee round. Only a mature dragon can perform a dimensional teleport without using a ley line nexus.

Poison Breath: The thunder lizard can emit a gaseous vapor from his mouth that has magic properties. Unless the intended victim(s) have an independent oxygen supply (air filters are not good enough), the vapor will paralyze them for 2D6 melees unless they makes a successful save versus magic (13 or higher). A successful save means no effect. Range: 60 feet; area affected: 5 feet (1.5 m), vapors dissipate within 5 seconds.

Psionics: Minor psionic; player can select a total of six psychic powers from either the sensitive, physical, or healing categories. Super is not available. Select an additional two at fifth level and another two at tenth level. I.S.P.: 2D4x 10

Magic Knowledge: Full understanding of magic, but knows no spells yet. However, can intuitively use all types of *techno-wizardry* devices without instruction, can read magic, use scrolls, and recognize magic circles and enchantment. Can also sense ley lines and nexus points and other dragons; range: 20 miles (32 km). Note that this sensing ability can not pinpoint specific locations, only nearness and general direction.

Spells can be learned by the usual means beginning at third level. The hatchling can cast three spells at level three and two additional per level of experience.

Combat abilities: Equal to hand to hand: basic, + 1 melee attack.

Average Life Span: 6000

Psychic

Racial Character Classes (R.C.C.)

Many of the life forms, both human and non-human, possess psionic powers. Psionics or psychic abilities are still paranormal phenomena which can not be fully explained by science. The powers seem to come from the individual rather than being drawn from a foreign energy source such as magic. However, there is some sort of connection or similarity between psychic energy and magic (both use P.P.E.) This is evident in numerous ways. Psychics can instantly and intuitively operate devices created through techno-wizardry, while others can not. They can also sense the supernatural and magic, just as supernatural beings can sense (and are drawn to) them. Also like the men of magic, the psychic's powers are enhanced when near a ley line nexus point (rift).

In the world of **Rifts**, many creatures possess some *small* degree of psi-powers; they are considered to be minor psionics and are of little consequence. In the section that follows, we examine the master psionic. Beings with exceptional psychic powers in their many different and powerful forms. (See *Step 3 of creating a character for more data on the minor and major psionic.*)

Generally speaking, psychics of all kinds are feared. The reason is that they are indistinguishable from *normal* people. The paranoia is that a psychic could be sitting among you and you would never know it. Further paranoia and loathing arises from the notion that the psychic

could be reading someone's mind, or mentally manipulate others, or destroy a person with a thought. Unlike the practitioners of magic, who must usually speak a spell or take some noticeable action before they strike, the psychic does not have to make any indication of his true nature to attack. He can be sitting down, drinking a cup of coffee, and kill somebody without so much as blinking, and nobody will be able to tell where the attack came from. Or so the theory goes. In actuality, few psychics have the power to kill so easily, but those few are enough to fuel the flames of hate and fear.



The Coalition, who is truly terrified of psychics, has capitalized on those fears by convincing normal humans that all psychics are *not* "true" humans, but a mutation and a potential danger to ordinary people. After a masterful propaganda campaign, the people overwhelmingly (88%) approved the institution of the Psychic Registration Program (PRP) and the creation of the *psi-stalker* enforcement officers and their *Dog Packs*. The PRP requires that all citizens must register if they exhibit paranormal abilities. Those who register are thoroughly examined, 2D4 days, to determine the extent of their powers, and placed in the PRP file. *Minor psionics* are simply recorded on the computer log. However, *major* and *master psionics* are required to submit to Identification Coding (IC).

IC is a process in which a special, scannable bar code, about two inches square, is tattooed into the skin on the back of the neck and a tiny, scannable implant is placed under the skin in the chest. Both the tattoo and the implant (a double fail-safe system) will activate psi-scanners to alert security that a psychic is present.

Psi-scanner mechanisms are located at all government facilities, at most industrial complexes, and even at many businesses, stores, restaurants, and private homes. When a registered psychic passes by the scanner (usually placed in or near a doorway), an alarm, silent or audible, is activated to alert the owner, or security, to the presence of

a psychic, and identifies the psychic by code number and photograph. This can often be an embarrassing situation and many establishments will not allow psychics on the premises. Frequently, government facilities require that a psychic be escorted by a pair of psi-stalkers or a dog pack, especially in restricted areas, even if the authorities have authorized their access to the area.

To refuse identification coding means being branded as a dissident and expulsion from the city. A known dissident is never allowed into any Coalition city. Likewise, the removal of the bar code and/or implant is a crime. If the offending party has not committed any other crimes, the individual will be required to resubmit to IC, is placed on a suspected dissident list, must periodically report to an IC center for inspection, and pays a fine of 10,000 credits. If the psychic was involved in a criminal activity, he will serve the normal sentence for that crime, plus an additional two years for removing the IC code and implant, and is automatically re-encoded. Upon release, the convict is placed on a *suspected* dissident list and monitored. The penalty for a second offense in the removal of the IC and/or other crimes is time served for the crimes (four years, this time, for removing the IC) and permanent expulsion from the city. A serious crime may mean life imprisonment or execution. Criminal cases involving psychics are always highly publicized.

Psychic visitors to a Coalition city must also report their psychic nature and are given an identification card that must be carried on their persons at all times. Failure to report one's psionic nature, or failure to carry the ID card, will result in an arrest and quick trial. If no ill intent is perceived, the character will be fined 2000 credits and issued a new card. If the psychic is even suspected of foul intent, he or she will be fined, belongings gathered, and escorted out of the city. The character will not be allowed entry into a CS city for a period of six months. Additional incidents will lead to permanent blacklisting, and possibly imprisonment or execution as a spy. If the ID card is lost or stolen, the psychic must immediately report to the nearest IC center to get a new card issued. A fine of 100 credits is charged as a reprocessing fee. The ID card functions exactly like the permanent IC implants, registering on all psi-scanners and alerting personnel to the presence of a psychic.

Note: Psi-Stalkers and Dog Packs always guard the entrances to the Coalition cities to check out "visitors" much like pre-Rifts custom officers and trained dogs used to check luggage for explosives or drugs. The psi-stalkers are fairly thorough, but there is always a chance of slipping by undetected; roll percentile dice, 1-20% means the psychic has not been recognized. Increase the chance to 1-40% if there is a serious commotion happening nearby. The psi-stalkers and dog pack also patrol the city, checking ID and sniffing out psionics and magic.

Burster R.C.C._____

A physical psychic whose powers manifest themselves in the area of pyrokinesis, the creation and manipulation of fire, is called a "Burster". As the name suggests, these psychics can create fire out of thin air, causing things to simply burst into flames. This rather spectacular display of power has made the burster one of the most feared of all the psychic characters, second only to the Mind Melter.

Burster Pyrokinetic Powers

Note: The following powers are different or more powerful than the more common pyrokinetic powers and are limited to the Burster O.C.C.

- 1. Impervious to fire and heat:** A psionic aura radiates around the burster, making him, and what he is wearing, completely impervious to fire and heat. Even mega-damage plasma, napalm, and magic fires do one-tenth damage (and that is from the impact of the blast, not the flames). Electricity does half damage.

This natural ability also enables the burster to see and breathe in smoke with only minor difficulty; reduce vision by half, reduce speed by 10%, combat penalties are - 1 to strike, parry, and dodge. This character never sweats.

Duration: Constant. I.S.P.: None, natural ability.

- 2. Extinguish Fires:** The power to instantly put out flames without need of chemicals or water. The fire just disappears. **Range:** 100 feet (30.5 m) + 10 feet (3 m) per level of experience. **Duration:** Permanent until fire is reignited. I.S.P.: 4
- 3. Flame Burst:** The psychic can seemingly cause himself to burst into flames, completely obscuring his body, but is really more of a fiery aura around him. Nothing on the burster's person is actually on fire, so nothing is damaged. Furthermore, the character can move around without difficulty. However, the fire will ignite anything he touches, such as carpeting, drapes, furniture, paper, wood, etc. **Range:** Self. **Duration:** 2 minutes per level of experience. **Damage:** 6D6 S.D.C. damage per strike to anyone or thing that he touches. Damage is accumulative. Plus, all combustible articles, such as clothing, will catch on fire, doing an additional 6D6 damage per melee until extinguished. The flames are not powerful enough to damage M.D.C. items/armor unless within a mile (1.6 km) of a ley line nexus point, then the damage can be increased to 1D4 M.D. (and 2D4 at a nexus) at the cost of two extra inner strength points. I.S.P.: 4
- 4. Fire Bolt:** A fiery energy bolt can be hurled or fired from the hands, even if an artificial appendage, or forehead. **Range:** 200 feet (61 m) + 20 feet (6 m) per level of experience. **Duration:** Instant. **Bonus to strike:** +4. **Damage:** Mini-bolt 2D6 S.D.C., medium bolt 4D6 S.D.C., heavy bolt 6D6 S.D.C. or mega-damage plasma bolt 2D6 M.D.C. I.S.P.: 2 regardless of the size and damage of the S.D.C. blasts and 4 to create a M.D. blast.
- 5. Fire Eruption:** The pyrokinetic can cause a fire to erupt in front of somebody or an area (never directly on a living creature) instantly, and without the need of combustible material. The size of the flame can be controlled to be only a few inches tall and cover only an inch or two area, or several yards/meters across and tall. The flame will burn as long as its creator wills it to (costs one additional I.S.P. per ten minutes) and can not be extinguished by normal means (it is fueled by psychic energy). If the psychic is rendered unconscious or distracted, the flames will disappear.

If the fire eruption is created in an area where other combustible items are located (including carpets, flooring, walls, ceiling, etc), the surrounding items/area will be set on fire. This is a regular fire that can be extinguished normally, but will spread and can cause immense damage just as any fire would.

Range: 100 feet (30 m) + 20 feet (6 m) per level of experience. A specific target must be visible, while a target *area* does not have to be visible, it must be known to the burster; i.e., causing a fire to erupt in the adjoining room or the room directly above him.

Duration: The flame eruption will continue burning for 10 minutes or until the burster cancels the effect. The psychic can keep the fire burning by expending an additional one I.S.P. every ten minutes, but must stay within range and *concentrate* on maintaining the fire. Melee actions are reduced by half and fighting is impossible unless he breaks his concentration, causing the fire to disappear. However, any combustible items set ablaze will continue to burn and the fire will spread until extinguished, even after the fire eruption is gone.

Bonus to Strike: This is a little different than the usual strike attack. The burster must learn to judge distances and focus his thoughts in order to create the eruption exactly where he wants it. So instead of an attack bonus, there is a **Base Skill:** 48% +4% per level of experience (roll percentile dice). A failed roll means the eruption happens 2D6 yards/meters off target.

S.D.C. Damage: Tiny flame 1D4 S.D.C., a few yards/meters fire 4D6, a towering pillar or wall (6 feet/1.8 m tall or bigger) 1D4x10, filling a room or 20 square foot area or larger causes 2D4 x 10 damage per melee or whenever somebody attempts to run through it.

Mega-Damage: The fire can be increased to mega-damage destruction by expending twice as many I.S.P.; applicable only to the larger fires, walls, pillars, and area. **Mega-Damage** wall or pillar is 2D6 M.D., 20 square foot area is 4D6 M.D., and 40 feet or bigger is 6D6 mega-damage. Note that combustible items burn and fire spreads four (4) times faster.

I.S.P.: 10 for S.D.C. fires regardless of size. 20 I.S.P. to create a mega-damage fire. **Maximum Size Limitations:** 20 square foot area (6 m) plus 5 additional square feet (1.5m) per level of experience.

- 6. Sense Fire:** This psionic ability enables the character to sense if there is fire as small as a candle burning nearby. To sense the fire, the psychic must stop and concentrate for a moment (15 seconds/one melee). The psychic impressions he receives will indicate the approximate size (big, small, tiny), the approximate distance (near, far, up or down), whether it is spreading (contained, spreading slowly, raging out of control), whether it is a natural/accidental fire or an intentional/man-made or magic fire (arson), and how long it has been burning (minutes, hours, days). The psychic can also examine burnt objects or ashes to get an impression of how long ago the fire last burnt and whether it was natural or man-made. This power will also recognize fire elementals.

Note that this skill does not disclose who made the fire, nor how many were involved, nor exact locations (although it can be used to pinpoint a fire in a search) or any other exact data. Also note that the sense fire ability applies to *fires*, not machines that radiate heat.

Range: Sensing for a burning fire will cover an 800 foot (244 m) area +100 feet (30.5 m) per level of experience. Examining ashes or burnt remnants requires touching the item. **Duration:** About 15 seconds of initial concentration for psychic impressions, then the burster can remain in tune to the fire(s) for another 4 minutes to search for its location (i.e.: "We're getting closer ... oh no, it's spreading ... it's behind that door"). **Damage:** None. I.S.P.: 2

- 7. Super Fuel Flame:** The character can feed a fire with psychic energy, increasing its size by as little as twofold or as much as 10 times. **Affects** a 20 foot (6 m) area per level of experience. **Range:** 100 feet (30.5 m) per level of experience. **Damage:** Increased proportional to the size of the fire. I.S.P.: 8.
- 8. Can select three minor psionic powers from the following list.**

Death Trance	Resist Thirst
Levitation	Resist Hunger
Mind Block	
Resist Fatigue	

Attribute Requirements: None. A high M.E. and at least average I.Q. (8) is suggested, but not required.

P.P.E.: Most of the person's P.P.E. has been expended in the development of psychic abilities. The remaining **Permanent P.P.E. Base** is 2D6.

I.S.P.: To determine the character's initial amount of Inner Strength Points, take the number of M.E. as the base, roll 3D4 x 10 and add it to the base number. The character gets another 10 I.S.P. for each additional level of experience.

I.S.P. is regained at the rate of 2 per hour of activity, or 12 per hour of meditation or sleep.

Considered a master psionic, needs a 10 or higher to save versus psionic attack.



The influence of ley line energy

The *duration* and *range* of the burster's psychic powers are increased by 50% whenever on or near (one mile/1.6 km) a ley line.

The *duration*, *range*, and *damage* of the powers are doubled when at or near (one mile/1.6 km) a ley line nexus point!

Skills: Like most psychics, the burster has minimal education, having spent much of the time learning and mastering the pyrokinetic powers. The individual has come to rely on those powers, wits, and experience. The typical burster is a cocky, self-confident adventurer who prefers to use his or her powers and courage rather than skills or machines.

At first level the psychic can speak American and one other language at 90% proficiency, selects two piloting skills (both with a + 10% bonus), and can select six "other" skills, each with a 10% bonus. The only combat skill is Hand to Hand: Basic. Hand to Hand: Basic can be changed to Hand to Hand: Expert at the cost of one "other" skill, or Martial Arts (or assassin if an evil alignment) for the cost of two "other" skills.

The character can also select eight (8) Secondary skills without benefit of bonuses. At third and eighth levels an additional four secondary skills can be selected.

Available skill categories are limited to any: Communication, Domestic, Electrical: Basic only, Mechanical: Automotive only, Military, Medical: First aid only, Physical (any except acrobatics and wrestling), Pilot, Pilot Related, Rogue, Science: Math only, Technical, W.P., and Wilderness.

Standard Equipment: A couple sets of clothing, light mega-damage body armor, sleeping bag, back pack, utility/ammo-belt, canteen, sunglasses or tinted goggles, air filter or gas mask, food rations for a week, and personal items. Weapons will include a knife, one energy and one non-energy; player's choice.

Vehicle is limited to non-military means of transportation, and may include hover vehicles or souped-up motorcycle or car.

Money: The burster starts out with 4D6 x 100 in credit and 4D4 x 1000 in saleable black market items.

Cybernetics: Starts with none. Tend to avoid implants in favor of natural powers.

Psi-Stalker R.C.C.

The Psi-stalker is a mutant whose psychic sensitive powers enable him to sense other psychics, psychic energy, and magic. The character can be human, or a D-Bee, or a mutoid. Unlike normal humans, the psi-stalker is a natural predator and P.P.E. vampire! The predator senses the use of psychic energy (I.S.P. and P.P.E.) and can follow the distinctive energy trail like a bloodhound following a specific scent. Even though all creatures have a certain level of potential psychic energy (P.P.E.), the psi-stalker can tell the subtle differences between normal energies and psychic and magic energies. Some innate instinct draws the stalker to those creatures who are psionic or magic. This same instinct makes the mutant want to *kill* his prey and drink its P.P.E. (which, for a brief instant, doubles when the victim dies). Fortunately, psi-stalkers can train themselves not to kill, although they prefer to kill and feed, and love the thrill of the hunt!

The Coalition States (CS) have trained people with the psi-stalker instincts and abilities to become an elite military police force, specializing in hunting down psychic and magic criminals, supernatural beings, and paranormal interlopers. In addition to the stalker's natural abilities, the warriors are trained in basic military procedure and combat skills.

They are also trained to control their urge to kill. The Coalition Psi-Stalkers will not kill unless the soldier is given authorization to use deadly force, which is always approved when stalking a demon or other supernatural being, and frequently when in pursuit of dangerous criminals. NOTE: Because of the Coalition's stand against non-humans, most of their psi-stalkers are completely human in appearance. They can be distinguished from other Coalition soldiers by their spiked helmets and the letters "PSI" emblazoned on the chest of their armor and uniforms. ALL psi-hunters are registered psychics with the IC and bear the IC bar code and implant.

Coalition Stalkers generally lead a Dog Pack, or are given easy access to a Dog Pack. The Coalition Dog Pack is a group of four to six specially trained, intelligent mutant dogs used specifically to hunt and eliminate psychics, practitioners of magic, and supernatural menaces. See the *Dog Pack R.C.C.* also described in this section.

Wild Psi-Stalkers are humanoid predators usually encountered in the wilderness and among the ruins of ancient cities. Fifty percent of these are cannibals who eat part of their victims or tear them to shreds. The act of cannibalism, or unnecessary violence, is a manifestation of the predatory killing instinct, because the psi-stalkers only have minimal need for flesh and blood nourishment or water. Remember, they feed on psi-energy. Even those occasional stalkers who live along a ley line, where P.P.E. is available without killing, are instinctively driven to hunt for living prey. The Coalition scientists hypothesize that the psi-stalker is an evolutionary answer to the proliferation of psychic and magic creatures. No one really knows. **NOTE:** With rare exception, the psi-stalkers never hunt or kill a fellow psi-stalker.

These characters, whether socialized or wild, tend to be very primal and combat oriented. Even the most intelligent is rarely literate. Most are interested in skills that are generally physical in nature or deal with piloting, weapons and combat. Stalkers often speak in low, guttural tones, and have a habit of grunting and growling.

Psi-Stalker Powers

Note: The following powers are different or more powerful than the some of the common psionic powers which these abilities may resemble and are limited to the Psi-Stalker R.C.C.

1. **Sense Psychic and Magic Energy:** Like a bloodhound smelling a familiar scent, the psi-stalker can detect the presence of psychic energy; specifically, fellow psionics (I.S.P.) and magic (P.P.E. specifically oriented toward magic, techno-wizardry, and wizardry devices). The ability is constant and automatic. The moment a psychic "scent" is within the character's range, he or she will recognize it. For example: If a psychic (minor, major, or master) enters the room, the psi-stalker will instantly sense it, as well as be able to trace it to the specific individual.

Furthermore, the stalker has a chance of recognizing that specific person's psychic scent again. This ability also enables him to stalk/track a specific psychic scent. **Base Skill:** 20% + 5% per additional level of experience. If the psi-stalker has a bit of hair, skin, blood, or an article of clothing recently worn (4 hours or less) by the subject being hunted, the ability to follow the psychic trail enjoys a bonus of +20%.

If psionic power or magic is being used within the psi-stalker's range of sensitivity, he will sense that too. The psychic impression will indicate whether the energy source is far or near, up or down, and whether it is a small or great amount of energy. If the energy is being continually expended, like a series of magic or psionic attacks, or a long duration effect, the predator can track it to the source with ease. **Base Skill:** 60% + 5% per level of experience (roll once every melee). It is also likely that the character will recognize the scent again if encountered at some other time; 20% + 5% per level of experience.

The presence of other P.P.E. sources of energy may confuse the scent; - 10% skill penalty. Close proximity to a ley line (2 miles/3.2 km) will reduce the ability to track a specific psychic scent by half. Close proximity to a ley line nexus point (4 miles/6.4 km) will completely obliterate the scent, making it impossible to find or pick up later. This is one reason why psi-stalkers are rarely found near a ley line unless a large number of prey inhabit the area. Of course, this also means that a psi-stalker can sense ley lines or a nexus point from up to 10 miles away (16 km) plus one mile (1.6 km) per level of experience.

Ranges: Sensitivity to a fellow psychic or magic practitioner not using his powers is 50 feet (15 m) + 20 feet (6 m) per each additional level of experience.

Sensitivity to psionic and magic powers being used is a 600 foot (182 m) area + 100 (30.5 m) per level of experience.

When tracking a psychic scent, roll percentile dice every 1000 feet (305 m) to see if the hunter is still on the trail.

Duration: Automatic and constant. I.S.P.: None, automatic ability.

2. **Sense supernatural beings:** Identical in function to the previous ability, except one senses the super distinctive psychic scent of the supernatural. The ability to identify the specific type of paranormal creature is **Base Skill:** 40% + 5% per level of experience, and includes demons, vampires, and entities.

The tracking by psychic scent is **Base Skill:** 30% + 5% per level of experience. 70% + 3% per level of experience if the supernatural being is expending psionic or magic energy.

Ranges: Sensitivity to the presence of a supernatural being not using its powers is 50 feet (15m) per level of experience.

Sensitivity to supernatural magic or psionics being expended through spell weaving or attack is 1000 feet (305 m) + 100 feet (30.5 m) per additional level of experience.

Duration: Automatic and constant. I.S.P.: None, automatic.

NOTE: Close proximity to ley lines and nexus points have the exact same adverse effects.

3. **Psi-Bonuses:** As a master psionic, the psi-stalker needs to roll a 10 or higher to save versus psionic attack and enjoys a bonus of + 4 to save (additional bonuses from M.E. not applicable). This means the character must roll a 6 or higher to save!
4. **Magic Bonuses:** Natural magic resistance provides a bonus of + 1D4 to save versus magic attacks of any kind. **Horror Factor Bonus:** + 6 to save vs horror factor!
5. **Physical Bonuses:** + 10 on physical S.D.C., + 1 attack per melee, + 1D6 to M.E. attribute (psi saving bonuses not applicable), + 1D6 to P.E. attribute, + 2D6 to speed attribute. Also + 5 to save vs mind controlling/altering drugs. Remember, needs little food and water to live.
6. **Nourishment:** The stalker must feed on a minimum of 50 P.P.E. a week, preferably 80 to 100. To feed without killing, the predator must hunt down a psychic, practitioner of magic, or supernatural creature, physically capture the prey, cut it, and psionically drain *all* its available P.P.E. points. Other than the cut (1D6 S.D.C. damage) the victim suffers, he loses all P.P.E.; a potentially dangerous situation for a magic user, but hardly life threatening. Psychics lose half their I.S.P. from a psi-stalker energy drain, as well as all their P.P.E. for the moment. Once the stalker begins to feed, he can not stop until *all* the P.P.E. has been absorbed. The absorption process is instantaneous (about 5 seconds). The P.P.E. will recover naturally, but temporarily disrupts the victim's psychic essence, and mages are left with no personal P.P.E. to draw upon to cast magic.

NOTE: The psi-stalker can not feed on the P.P.E. of non-psychics. They can absorb mystic ley line energy, but the taste is bad, like sour milk, and the ley lines disrupt the stalkers' senses.

The preferred form of nourishment, even among civilized psi-stalkers, is to hunt and kill one's victim. The victim can be a psychic, practitioner of magic, or supernatural being. At the moment of death, the victim's P.P.E. is doubled. The stalker can absorb the energy of his kill from as far as 300 yards/meters.

No need for normal food or water. The P.P.E. energy vampires have little need to consume solid food or drink water. The mutant does not require more than one pound (0.45 kg) of meat and eight ounces of water a week to remain healthy. Furthermore, the psychic can go without food or water for up to three weeks, if necessary, without ill effect. However, being deprived of the proper P.P.E. energy will inflict physical damage and the character will die of starvation within three weeks.

- 7. Other Psionic Powers:** Choose six psi-powers from the *Sensitive* category of powers.
- 8. Psionic empathy with animals.** Psi-stalkers automatically have an affinity with animals of all kinds. Domesticated animals will always take an immediate liking to a stalker and will do their best to please him; +15% bonus to ride a horse and work with all domestic animals.

Wild animals, with the exception of felines and mutant and alien predators, will react to the stalker as if he was a fellow woodland creature, allowing him to walk among them without fear. This ability enables psi-stalkers to operate in the wild without causing animals to react to their presence; birds do not fly away, animals do not run, and therefore do not indicate the approach of an intruder. Even watchdogs will not sound a bark of alarm at the presence of a stalker.

Felines and mutant and alien predatory animals seem to see the psi-stalker as a fellow hunter and a danger. Wild cats and mutants will frequently select a psi-stalker as their first target in an attack and will not positively respond to the character at all.

NOTE: This affinity with animals means that the character will hunt and eat meat only for food, never for pleasure, and feels sadness whenever he sees an animal in distress.

Attribute Requirements: None. A high M.E. and P.P. are suggested but not required. Roll 3D6 for each of the eight attributes as normal. See *Psi-stalker Powers number 5* for attribute bonus rolls and other bonuses.

The influence of ley line energy

As described earlier, ley lines and nexus points impair and even obliterate the stalker's psychic sensing and tracking abilities. However, the other six psychic sensitive abilities are enhanced. *Range* and *duration* are increased by 50% when near a ley line (about 2 miles/3.2km) and doubled when within a mile (1.6 km) of a nexus point.

P.P.E.: Most of the individual's P.P.E. has been expended in the development of psychic abilities. The remaining **Permanent P.P.E. Base** is 2D6.

I.S.P.: To determine the character's initial amount of Inner Strength Points, take the number of M.E. as the base, roll 1D6 x 10 and add it to the M.E. number. The character gets another 10 I.S.P. for each additional level of experience. Considered a master psionic.

I.S.P. is regained at the rate of 2 per hour of activity, or 12 per hour of meditation or sleep.

Considered to be a master psionic, so needs to roll a 10 or higher to save versus psionic attack.



Skills of the Wild Psi-Stalker: The wild psi-stalker has had less formal education than most psychics, having spent nearly all of the time learning to hunt humanoid and supernatural prey. The typical stalker is cunning, sneaky, selfish, and silent; often a solitary hunter (loner) who uses his or her powers and fighting abilities rather than skills and machines (other than weapons).

All wild psi-stalkers have the following skills: Hand to Hand: Basic (can increase to expert at the cost of one other skill or assassin for two), Wilderness Survival (+30%), Tracking (humanoids, not animals, +10%), Detect Ambush (+5%), Escape Artist (+5%), Prowl (+10%), Climbing (+5%), three ancient W.P.s of choice, two modern weapon W.P.s of choice, and can speak American and two other languages at 70% proficiency.

At first level the psychic can select five "other" skills, each with a +5% bonus.

The character can also select six (6) Secondary skills without benefit of bonuses. At third and eighth levels an additional three secondary skills can be selected.

Available skill categories are limited to any: Communication: radio basic, Domestic, Medical: Holistic Medicine only, Physical (any except acrobatics), Pilot, Pilot Related, Rogue (excluding computer hacking), Science: Basic Math only, Technical (excluding all computer), W.P., and Wilderness.

Standard Equipment: Wild Psi-Stalker: May or may not wear clothing, mega-damage body armor, back pack, a couple sacks, utility/ ammo-belt, sunglasses or tinted goggles, air filter or gas mask, and personal items.

Dog Pack R.C.C.

Weapons will include a couple knives, and four other weapons of choice. May use techno-wizardry weapons too, but not suggested as part of the initial equipment (GM's choice).

Vehicle is limited to horse or other animal mount (has an affinity with all non-predatory animals, including D-Bees and aliens), or non-military vehicle, and may include hover vehicles or souped-up motorcycle or car. May use a techno-wizard vehicle, but not recommended to start (GM's choice).

Money: The character starts out with no credit and 4D6 x 1000 in saleable black market items.

Cybernetics: Starts with none. Tend to avoid implants in favor of natural powers. If cybernetics are used, they are usually sensory or optical enhancements.

Skills of a Coalition Psi-stalker Or a Civilized Mercenary Stalker

The civilized stalker has undergone some basic military training. The following Coalition military skills are known.

Radio: Basic (+10%)
Pilot Hovercraft (+10%)
Robot Combat: Basic
Read Sensory Equipment (+ 10%)
Weapon Systems (+ 10%)
Body Building
Climbing (+ 5%)
Running
Prowl (+10%)
W.P. Energy Pistol
W.P. Energy Rifle
W.P. two of choice
Hand to Hand: Expert

At first level the psychic can select four "other" skills, each with a + 5% bonus, and speaks American and one other language at 96%.

character can also select eight (8) Secondary skills without benefit of bonuses. At fourth and eighth levels an additional two secondary skills can be selected.

Available skill categories are limited to any: Communication, Domestic, Electrical: Basic only, Mechanical: Automotive only, Military, Medical: First aid only, Physical (any except acrobatics), Pilot, Pilot Related, Science: Math only, Technical, and W.P.

Standard Equipment: Coalition Psi-stalker

Coalition "Dead Boy" armor, weapons, equipment, money, and cybernetics are all the same as the *Coalition Grunt*. Plus a few of the *Dog Pack* special hand to hand weapons such as the neuro-mace, vibro-knife, and fist spikes.

Standard Equipment: Civilized Mercenary

Coalition "Dead Boy" armor if an ex-soldier, otherwise light or heavy mega-damage armor (probably the latter), a couple sets of clothing, sleeping bag, back pack, extra sack or pack for stowing equipment, utility/ammo-belt, canteen, sunglasses or tinted goggles, air filter or gas mask, and personal items.

Weapons will include a knife or two, two energy or heavy weapons and 1D6 ammo-clips for each, plus one non-energy weapon; player's choice.

Vehicle is limited to non-military means of transportation, and may include hover vehicles or souped-up motorcycle or car.

Money: The mercenary stalker starts out with 6D6 x 100 in credit and 4D4x 1000 in saleable black market items. Note that psi-stalkers can often make big dollars as exterminators in areas plagued by supernatural beings, magic, or psychics.

Cybernetics: Starts with none. Tend to avoid implants in favor of natural powers.

Before the Time of Rifts, the quest for human augmentation naturally led to *genetic manipulation*. North America was by far the leader in the area of genetic research. They had enjoyed some spectacular results working on laboratory animals. However, genetic manipulation of human beings proved to be much more unpredictable and deadlier than the alteration of animal genes. Ultimately, this led to extensive animal experimentation. Only the Chinese continued experimentation on human subjects. Eventually, American "gene-splicers," as they were called, could endow animals with human (or at least humanoid) intelligence, speech, and physiology.

The great controversy that arose from the creation of intelligent mutant animals was the fear that humans were establishing a new precedent for slavery. The outcry against slavery was well taken, because the American government had high hopes for, literally, creating a super soldier from animal mutants. Soldiers with the predatory instincts, in-human abilities, strength, and endurance of an animal, complemented by the intelligence of a human. Fortunately, social outrage stopped the creation of a race of mutant soldiers and laborers before it had begun. Still, the government continued secret research in this area for decades to come, just in case the need should arise. In fact, billions were spent on the completion of a genetics engineering facility that included a vast factory-like plant with full design and manufacturing capabilities. Rumor had it that the secret plant could create hundreds of mutant animals a month. Of course, the government denied the existence of any such facility, admitting only that minimal genetic research continued at the Tex-Am Complex, a top secret military base located in Texas.

While society may have had the presence of mind to stop the re-establishment of slavery in the 21st century,

crueler and savage period. The Coalition has created and utilized mutant animals for labor, as soldiers, and for experimentation for years. The *Lone Star* Coalition State is the center for genetic research and development. It is at Lone Star that the majority of the Dog Pack and other mutations are created and trained. As one may have guessed, Lone Star is the *Tex Am Complex*, which, amazingly, survived the apocalyptic time of the rift explosions mostly unscathed. It was its fabulous genetics, manufacturing, military security, and other unique capabilities that enticed solicitation for its addition as a member of the Coalition States. The place is barely a city. Instead, Lone Star is a sprawling 20 mile (32 km) research and manufacturing complex with half the population of Chi-Town. A population that is half mutant animals. However, Lone Star is completely self-sufficient, with both nuclear and fossil fuel power and resources, state of the art science and genetics laboratories dating to pre-Rifts earth, and high-tech manufacturing plants of all kinds (55% are currently in full operation, while the remaining still need massive restoration).

The Coalition Dog Pack R.C.C.

The Coalition's obsession with maintaining the purity of the "true" human race is both the motivation for the creation and enslavement of mutant animals, as well as the one thing that curbs them from even greater exploitation of genetically engineered creations. This purist mentality also means that the genetic manipulation of human beings is strictly forbidden. Animals, on the other hand, are created for use as laborers, soldiers, and special operatives throughout the wilderness. They are usually dispatched to areas where the threat to *human* life is greatest. The thought being, why endanger human life when an "animal" can pave the way?

The most famous of the Coalition's mutant animal creations is the nefarious *Dog Pack*. Although other mutant animals exist, especially



at Lone Star, the one animal used above all others is the dog. The dog has proven to be the most desirable and reliable of all animals for several reasons.

One, they have a long history of cohabitation with human beings. Whether there is any real scientific reason for this special relationship between man and canine is doubtful. However, psychologically, humans quickly accepted, trusted, and liked dogs. This leads to an immediate bonding or friendship between the two. After all, dogs have been "man's best friend" for eons. This acceptance and warm response by humans only serves to make the mutant animals feel loved, cherished, needed, and dedicated to the protection of their masters.

Secondly, dogs are instinctively *pack* animals. Because they see themselves as part of the "human" pack, they automatically accept their social position as subservient members within the pack society. Consequently, they are submissive and steadfastly loyal to humans, whom they perceive as the pack leaders or dominant pack members.

Third, the animals generally love to work with, and be around humans. This social cooperativeness, combined with the animal's loyalty to the pack and desire to please, makes their training and indoctrination very easy and thorough. Nor do they question their orders or balk at danger. Unlike many humans, a mutant dog will leap into the jaws of death with little hesitation to save a human or fellow pack member. An example of the self-perpetuating love/friendship between humans and dogs.

Fourth, as a soldier, the dog offers several advantages. Besides the obvious superiority in physical strength and endurance, dogs possess several additional abilities. In general, the dog's sense of smell is a million times more sensitive than a human's and possess a much more sensitive range of hearing. This makes them much more alert and ideal for tracking.

Fifth, dogs are natural hunters who instinctively chase anything that moves, making them more observant than humans. An ideal trait for a man-hunter.

Lastly, and in some ways, most important to the Coalition, dogs are among the few creatures that are *naturally* sensitive to the supernatural. Dogs are similar to psi-stalkers in that they can automatically sense the presence of magic and the paranormal. An ability which the gene-splicers have been able to maintain and enhance in intelligent mutant canines.

Coalition Dog Packs are a formal part of the CS Armed Forces and receive the same basic training as the Coalition grunt. However, the dog pack also receives special training in honing their tracking abilities and psychic powers. The purpose of the mutants is to be a special forces operative and watchdog against assaults by psychics, magic, and the supernatural. A pack of four or more mutant dogs is always led by a psi-stalker. The team patrols CS cities, military bases, and entrances ever vigilant for the distinctive presence of the paranormal.

Individual members of Dog Pack troops, nick-named "Psi-Hounds" and "Dog Boys," are given free reign to wander the city or military

base to keep an eye out for, and investigate, any suspicious activity or individuals. To rebuke the inquiries of a dog boy will mean a full Dog Pack, led by a psi-stalker, arriving moments later to enforce a full (and unpleasant) investigation. A Dog Pack and psi-stalker have the authority to enter any civilian establishment or home if they have reasonable cause, and *sensing* the presence of magic or the paranormal is probable cause for these psychic sensitives.

The Dog Pack is also used to track criminals, especially magic and psionic criminals, intruders in the city, and supernatural menaces, as well as being used as a general police force. Most CS city dwellers are comforted by the presence of the loyal and courteous Dog Boys, and cooperate with them to the fullest.

In the wilderness, troops of Dog Pack soldiers (or other mutant animals) may be dispatched into areas of conflict. Like the US Marines of old, the Dog Pack is often the first to be sent into a trouble zone for reconnaissance and/or initial assault. More often, they are sent out as scouts and spies in search of covert operators (translation: groups and individuals who practice the arts of magic, consort with non-humans, or study ancient books/ruins/education). They are also sent out on regular reconnaissance, intelligence, and seek-and-destroy missions. The Dog Pack soldier may be a soldier in a completely mutant animal squad, a member of a human team, Dog Pack, or an individual on a solo assignment.

Individual Dog Boys are frequently sent into the wilderness to pretend to be runaways or mercenaries. This subterfuge enables them to observe the activities of real mercenaries or wilderness adventurers firsthand. Of course, some mutant dogs will forsake the Coalition when they discover the freedom that other societies and groups offer. Or are simply enticed to wander the world to personally explore all its marvels. This too, is anticipated by the Coalition and is part of an exercise to see how many Dog Pack soldiers remain loyal when placed under varying conditions of freedom, stress, or danger.

Generally, Dog Pack mutants are treated well and with kindness. They are especially loved by their psi-stalker Dog Pack leader. However, the Coalition and most people in the CS see the mutant animals not as intelligent life forms, and never as equals, but as *trained animals*. They love and care for the mutants just as they might a normal dog, as a pet and servant. As such, they are treated like simple-minded children, often referred to in the third person even when present, and believed to be greatly inferior to human beings.

Since they are seen as specially bred and trained "animals," the mutant dogs are generally considered to be an expendable commodity. A human might feel a bit of a loss over the death of a favorite hunting dog killed by a wild animal, but one simply discards the dead body and goes out to purchase a new dog. This is the general attitude of the Coalition military and most citizens. The mutant dog soldiers are just big doggies that walk on two legs, sport arms and hands, and talk instead of bark. If a job is too dangerous for a human, send in a mutant animal. If it dies, a new one can always be purchased or bred. An attitude that is not shared by the psi-stalkers who act as the team leader of all Dog Packs. In fact, the Coalition's heartless abuse of their animal creations is the one element that could, someday, turn the psi-stalkers away from them.

Oddly, most Dog Pack mutants don't see anything wrong with how they are treated and tend to concur that they *are* expendable, rather than jeopardize a valuable human life (remember the pack mentality). This also means that they rarely feel cheated or abused, and are happy just to be part of the human pack.



Mutant Dog Powers

Note: The following powers are different or more powerful than some of the common psionic powers which these abilities may resemble and are limited to the Dog Pack R.C.C.

- 1. Sense Psychic and Magic Energy:** Basically identical to the psi-stalker, although not quite as developed. Like a bloodhound smelling a familiar scent, the psi-hound can detect the presence of psychic energy; specifically, fellow psionics (I.S.P.) and magic (P.P.E. specifically oriented toward magic, techno-wizardry and wizardry devices). The ability is constant and automatic, just like the psi-stalker. **Range:** 50 feet (15m).

Unlike the stalker, the dog has little chance of recognizing that specific person's psychic scent again. **Base Skill:** 8% +2% per additional level of experience. If the mutant has a bit of hair, skin, blood, or an article of clothing recently (4 hours or less) worn by the subject being hunted, the ability to follow the psychic trail enjoys a bonus of +10%.

If a psionic power or magic is being used within the range of sensitivity, he will sense that too. If the energy is being continually expended, like a series of magic or psionic attacks, or a long duration effect, he can track it to the source with ease. **Base Skill:** 40% +5% per level of experience (roll once every melee). It is also possible that the character will recognize the scent again if encountered at some other time; 10% +4% per level of experience. **Range:** Sensitivity to a fellow psychic or magic practitioner not using his powers is 50 feet (15 m) +5 feet (1.5 m) per each additional level of experience. Sensitivity to psionic and magic powers being used is a 400 foot (121 m) area +50 (15 m) per level of experience. When tracking a psychic scent, roll percentile dice every 1000 feet (305 m) to see if the hunter is still on the trail. **Duration:** Automatic and constant. I.S.P.:None, automatic ability.

- 2. Sense supernatural beings:** Identical in function to the previous ability, except the mutant dog is much more sensitive to the very distinctive psychic scent of the supernatural. **Base Skill:** 62% +2% per level of experience. The ability to identify the specific type of paranormal creature is **Base Skill:** 62% +2% per level of experience, and includes demons, vampires, and dragons.

The tracking by scent **Base Skill** is 35% +5% per level of experience. 70% +3% per level of experience if the supernatural being is using psionics or magic.

Range: Sensitivity to the presence of a supernatural being when it is not using its powers is 100 feet (30.5 m) per level of experience. Sensitivity to supernatural creatures or magic being used is 1000 feet (305 m) +100 feet (30.5 m) per additional level of experience. **Duration:** Automatic and constant. I.S.P.: None, automatic. **NOTE:** Close proximity to ley lines and nexus points disrupts the psychic senses.

- 3. Psi-Bonuses:** As a master psionic, the psi-hound needs to roll a 10 or higher to save versus psionic attack and enjoys a bonus of +1 to save vs psionic attack.
- 4. Other Psionic Powers:** The Dog Pack character automatically gets the following psychic *Sensitive* powers: sense evil, sense magic, sixth sense, and empathy (receiver only, not transmission), plus choice of one other from the sensitive category.
- 5. Physical Bonuses:** All Dog Boys, regardless of breed, get the following bonus rolls and attribute modifications: +20 on physical S.D.C., +2 on initiative roll, +1 to strike, parry, and dodge, +1D4 to P.E. attribute, 1D4 to P.S. attribute, +2D6 to speed attribute. Bite attack inflicts 1D6 S.D.C. damage. Physical endurance as it applies to weight/load and exertion is two times greater than for normal humans. *Also see optional character tables.*

Physical appearance: Human looks, none. The head/face is that of a canine, the body is fur covered, and there is a tail. Hands, full; possess fully articulated hands with human-like opposable thumbs and developed arms. Bipedal stance, usually full, although some are partial and like to run on all fours, but can stand and walk erect. Human speech, partial (occasionally full). Usually speech is a bit guttural and the character still has a tendency to growl, whimper, and howl when excited. Size varies from about four feet to six feet tall (1.2 to 1.8 meters); size levels 6-12.

German shepherds, blood hounds, terriers, and spaniels are the most frequently transformed types of dog. However, experiments have included many other breeds, as well as coyotes, wolves, foxes and bears.

NOTE: Fun Fact: Dogs have limited color vision.

6. **Superior sense of smell.** Dogs are a million times more aware of smells than a normal human. The mutant dog soldier is no exception. The character can follow a scent trail that is four days old and recognize an odor from smelling only a few molecules. Specific abilities are:

Recognize and accurately identify general/common/known smells, including gases, food, and other distinctive odors. **Range:** 100 feet (30.5 m) per level of experience. **Base Skill:** 70% + 3% per level of experience.

Identify specific odors, including the scent of specific individuals, items, or monsters. **Range:** 25 feet (7.6 m) per level of experience. **Base Skill:** 54% + 2% per level of experience.

Track by smell alone! Does not follow tracks or any other visible trail. This also means that a mutant dog can sniff his way through total darkness if there is a scent that can be followed. This also means that the character suffers only *half* the normal penalties to strike, parry, and dodge when blinded or in darkness (can smell and hear his opponent). **Range:** Roll once for every 1000 feet (305 m). **Base Skill:** 40% + 4% per level of experience. A failed roll means the trail has been temporarily lost. Two successful rolls out of three tries means the trail has been rediscovered. Two failures means the trail is lost. **Note:** The psi-hound can smell a scent that is as much as four days old (96 hours), as long as the trail has not been washed away. Can not track through water. Also, despite what many people may think, a dog can not see any better in the dark than humans. However, their exceptional sense of smell and keen hearing helps compensate while in the darkness.

7. **Keen hearing.** The mutant can hear into a higher range of sound than humans and is more alert and sensitive to sounds. This is evident in some of the physical bonuses.
8. **Instinctive hunters,** they notice movement and give chase. This accounts for bonuses to strike, parry and dodge.
9. **Instinctive pack animals.** Loyal and group oriented, most mutant dogs work well in groups and prefer to be in a group than alone. This also affects the character's alignment. Most will be principled, scrupulous, unprincipled, or aberrant (evil).

Characters who are anarchist, miscreant, or diabolic, tend to be loners, mean, and do not work well in a group unless they can be the leader.

Attribute Requirements: None, other than must be an intelligent mutant dog. Other than the physical bonus rolls listed under *Mutant Dog Powers* #5, roll the usual 3D6 dice to determine the eight attributes.

The influence of ley line energy

Ley lines and nexus points impair and even obliterate the psi-hound's psychic sensing and tracking abilities. However, the creatures normal physical abilities/tracking by smell are not affected and the other psychic

sensitive abilities are enhanced. *Range* and *duration* are increased by 50% when near a ley line and doubled when within a mile (1.6 km) of a nexus point.

P.P.E.: Most of the individual's P.P.E. has been expended in the development of psychic abilities. The remaining **Permanent P.P.E. Base** is 3D6.

I.S.P.: To determine the character's initial amount of Inner Strength Points, take the number of M.E. as the base, roll 1D6x10 and add it to the base number. The character gets another 10 I.S.P. for each additional level of experience. Considered a master psionic.

I.S.P. is regained at the rate of 2 per hour of activity, or 12 per hour of meditation or sleep.

Skills of a Coalition Dog Pack Mutant: With rare exception, all mutant dogs, even meres and nomads, began life as a Dog Boy, created, conditioned, and trained as a Coalition soldier. The following military skills are part of all CS mutant dogs trained as Dog Pack Soldiers.

Intelligence (+ 6%)
 Radio: Basic (+ 10%)
 Pilot Hovercraft (+ 10%)
 Read Sensory Equipment (+ 10%)
 Weapon Systems (+10%)
 Climbing (+10%)
 Running
 Land Navigation (+10%)
 Wilderness Survival (+10%)
 W.P. Energy Pistol
 W.P. Energy Rifle
 W.P. one of choice
 Hand to Hand: Martial Arts

At first level the psychic can select five "other" skills each with a +5% bonus. Also speaks American and Dragonese at 90% efficiency.

The character can also select eight (8) Secondary skills without benefit of bonuses. At fourth and eighth levels an additional three secondary skills can be selected.

Available skill categories are limited to any: Communication, Domestic, Electrical: Basic only, Mechanical: Automotive only, Military, Medical: First aid only, Physical (any except acrobatics and boxing), Pilot, Pilot Related, Science, Technical, Wilderness, and W.P.

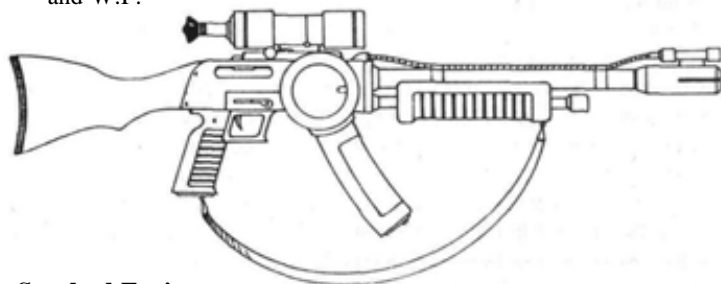

Standard Equipment:

Adventurer who is no longer a member of the Dog Pack

May or may not wear clothing or mega-damage body armor (may be Coalition armor), back pack, a couple sacks, utility/ammo-belt, sunglasses or tinted goggles, air filter or gas mask, and personal items.

Weapons will include a couple knives, a vibro-blade, neuro-mace, and two other weapons of choice. May use techno- wizardry weapons too, but not suggested as part of the initial equipment (GM's choice).

Vehicle may be military or non-military, and may include hover vehicles, jet pack, or souped-up motorcycle or car. Not power armor or robot.

Money: The character starts out with no credit and 4D6 x 1000 in saleable black market items.

Cybernetics: Starts with none. Tend to avoid implants in favor of natural powers. If cybernetics are used, they are usually sensory or optical enhancements.

Note: A Dog Boy who has gone AWOL is generally left alone unless he or she takes action against the CS. However, loyal Dog Boys view deserters/mercenaries as traitors to the human race and as such, are low-life-scum, never to be trusted nor treated with respect.

Standard Equipment: Coalition Dog Pack. Equipment is basically the same as the *Coalition Grunt*. Armor can be the Coalition body Armor or light weight "Dog Pack" armor (less M.D.C.).

Standard weapons include an energy handgun (with 4 extra clips), vibro-blade, neuro-mace, and fist spikes.

Money: The Dog Pack soldier gets a roof over his head, food, clothing, and all other basics provided free as part of his pay, as well as access to military facilities. A modest monthly salary of 700 credits is also provided. Starts off with two months' pay.

The soldier's quarters is a nice dormitory arrangement shared by eight mutants. Each is divided into pairs. Each pair of roommates get a bedroom/study complete with CD stereo system, television and VCD, mini-refrigerator, desk, dresser, and comfortable bed.

Cybernetics: None to start, but may include bionic limbs (especially weapon hands/arms and weapon systems, as well as medically necessary implants and prosthetics).

Optional Character Tables

Dog Boy's Height

- 01-10** Four feet (1.2m)
- 11-30** Five feet (1.5 m)
- 31-50** Five feet, six inches (1.7 m)
- 51-65** Five feet, 10 inches (1.8 m)
- 66-80** Six feet (1.82m)
- 81-90** Six feet, four inches (1.95 m)
- 91-00** Six feet, eight inches (2 m)

Type of Dog

- 01-05 Irish Water Spaniel.** Good tracker, excellent swimmer: base skill 90%; has a coat of fur that's almost totally waterproof.
- 06-10 Wolfhound.** Tracks by sight, not scent; -40% to track by smell, but add 30 S.D.C., 1D4 to P.E. and P.S. attributes and 3D6 to spd attribute; +2 on initiative. Bite does 2D6 damage.
- 11-15 Irish or English Setters.** Good tracker, add 2D6 S.D.C. and +1 to P.E. attribute, fair swimmer: base skill 40%.
- 16-20 Coonhound.** Originally bred to hunt raccoons; a superior sniffer; +2% to track by smell.
- 21-25 Golden Retriever.** Good tracker, hardy, add +3D6 S.D.C., add +1 to P.S. and P.E. attributes; natural swimmer: base skill 80%.
- 26-30 Cocker Spaniel.** Excellent tracker: +4% to track by smell, hardy, add +2D6 S.D.C., and an excellent swimmer: base skill 80%.
- 31-35 Airedale Terrier.** Very good tracker: +2% to track by smell, excellent hunter, alert and aggressive; +1 on initiative, add 10 to S.D.C., fair swimmer: base skill 40%.
- 36-40 Beagle or Foxhound.** Excellent trackers, +6% to track by smell, but reduce size by 10%.
- 41-50 German Shepherd (aka: Alsatian).** Good tracker, alert, highly intelligent and loyal. Add 1D6 to I.Q., P.E., and Spd attributes, plus add 15 S.D.C. and +1 on initiative. Good swimmer: base skill 60%. Note: Loves to help/work with humans and has a friendly disposition.

51-55 Bloodhound. The super scent tracker: +12% to track by smell skill bonus, fair swimmer: base skill 40%.

56-60 Boxer. An excellent tracker (+4% to track by smell), stocky but powerful, with a strong neck and powerful leg and back muscles, capable of jumping great distances. Mutant Boxers can leap 15 feet/4.5 m after a short running start. Add +1 to I.Q. attribute, +1D4 to P.E. and P.S. attributes, and 20 to S.D.C. The creature's bite is also more powerful than most, inflicting 2D4 S.D.C. damage.

61-65 Bull Terrier (aka Pit Bull). Reduce size by 10%, but add +2D6 to P.E. attribute, add 2D4 to P.S. attribute and add 40 to S.D.C. Bite inflicts 2D6 S.D.C. damage. -30 to track by smell.

66-70 American Water Spaniel. Very good tracker: +2 to track by smell, good swimmer: base skill 70%, and +1D6 S.D.C.

71-75 Elkhound. Good tracker, also big and powerful; add 20 to S.D.C., +1D4 to P.S. and P.E. attributes, +2 on initiative, and 3D6 to Spd attribute.

76-80 Lakeland Terrier. Reduce size by 10%, but tough and aggressive, +2 initiative, +1 to strike, add 2D6 to S.D.C., fair swimmer: base skill 40%.

81-85 Greyhound. Tracks by sight, not scent: -40% to track by smell penalty, but add 1D4x10 to spd attribute, +1D4 to initiative, and +1D4 to P.E. attribute.

86-90 Bulldog. Poor tracker: -30% to track by smell penalty, but tough and powerfully built. Add 20 S.D.C., +1D6 to P.S. and P.E. attributes. Reduce spd attribute by 1D4 points.

91-95 Rottweiler. A fair tracker by smell (-5%), powerfully built and ideal for outdoor work and as a guard dog. Add +1 to I.Q. attribute, +1D6 to P.S. and P.E. attributes, +2D6 to spd attribute and +20 to S.D.C. Works well with humans and is very clever and loyal.

96-00 Wolf. A good tracker and powerfully built; add 30 S.D.C., add +1D6 to P.S. attribute, 2D4 to P.E. attribute, 3D6 to spd attribute, and +2 on initiative. Bite does 2D6 damage.

Mutation Abnormality

- 01-15** Unusually small. Three feet, four inches tall (1 meter), about 45 lbs (20 kg); add bonus of +5% to prowl and climbing skills if applicable.
- 16-30** Unusually large. Seven feet, three inches tall (2.2 meters), 400 lbs (180 kg); add a bonus of 2D6+10 to physical S.D.C. and +1 to P.S. attribute.
- 31-45** Near full human appearance, no body hair, full human speech.
- 46-50** Ambidextrous: can use both the right and left hand with equal skill and dexterity. Add one additional attack per melee, +10% to climbing skill, +5% to pick locks, pick pockets, palming, and concealment skills.
- 51-60** Tough, scaly skin, adds 30 S.D.C.
- 61-76** Full 20/20, color vision!
- 77-85** Extremely hairy and unusual hair color: stark white, light green, bright red (pick one color).
- 86-90** Additional psionics, choose one more psychic sensitive power.
- 91-95** Great psionic power, choose three additional psychic sensitive powers.
- 96-00** Recessive gene fluke; instead of psychic sensitive powers, the mutant has no sensitive powers (including sense supernatural and sense/track by psychic scent of magic and psionics)! Instead, the character may select seven *physical* psionic powers.





Mind Melter R.C.C.

The Mind Melter is the most powerful and feared of all psychics. They are one of the few (the only one in this book) characters that can select psychic powers from absolutely all the psychic power categories, including *super!*

Like most psychics in the world of **Rifts**, the Mind Melter relies more on his super psychic powers than education or anything else. The more arrogant Mind Melters may even refrain from using more than a handful of modern weapons and devices as a sign of just how powerful they are, or believe they are. But this is more than sheer arrogance, for the mind melter is far from foolish, they are truly powerful beings. The telekinetic force field is equal to any man-made or magic body armor and can be invisibly erected with a thought. The psi-sword is a mega-damage weapon that can be created out of thin air, as can fire and water. Yet, the most terrifying power are the Melter's ability to influence and control the minds of others. It is these powers of mental manipulation from which the name Mind Melter is derived.

Mind Melters are forbidden entry to all Coalition cities. Their strong psychic essence is easily detected by Psi-Stalkers and Dog Boys, and they are always pursued by them.

The Powers of the Mind Melter

At first level the character automatically has the following psionic powers.

- Alter Aura (self)
- See Aura
- Sixth Sense
- Mind Block

Also select three (3) additional powers from *each* of the four psionic power categories, Sensitive, Physical, Healing, and Super. In regards to the *Super* category, the following can not be selected at first level: Mind Wipe, Psi-sword, and Possess Others. These three are not available until third level.

At second level the psychic can select a total of three powers from the Sensitive, Physical, and/or Healing categories, and one from the Super category (except Mind Wipe, Psi-sword, and Possess Others).

At third level the psychic can select a total of three powers from the Sensitive, Physical, and/or Healing categories, and one from the Super category (including Mind Wipe, Psi-sword, and Possess Others).

At fourth level the Melter can select two powers from the Super category only.

From Fifth level on the psychic can select a total of two psychic powers from any of the categories.

The influence of ley line energy

Range and *duration* are increased by 50% when near a ley line and doubled when within a mile (1.6 km) of a nexus point. The damage from psionic energy attacks such as psi-sword, pyrokinesis, electrokinesis, and telekinesis is also doubled when within a mile of a ley line *nexus point*. The strength/M.D.C. of a telekinetic force field is also doubled.

P.P.E.: Most of the individual's P.P.E. has been expended in the development of psychic abilities. The remaining **Permanent P.P.E. Base** is 2D4.

I.S.P.: To determine the character's initial amount of Inner Strength Points, take the number of M.E. as the base, roll 3D6x10 and add it to the base number. The character gets another 10 I.S.P. for each additional level of experience. Considered a master psionic.

I.S.P. is regained at the rate of 2 per hour of activity, or 12 per hour of meditation or sleep.

As a master psionic, the character needs to roll 10 or higher to save versus psionic attack.

Attribute Requirements: None, however a high I.Q. and M.E. of 10 or higher are strongly suggested.

Skills: Like most psychics, the Mind Melter has minimal education, having spent much of his time learning and mastering the complexities of psionic powers. The individual has come to rely on those powers, wits, and experience. The typical Melter is a cocky, self-confident adventurer who prefers to use his or her powers and courage rather than skills or machines.

At first level the psychic can speak American and two other languages at 90% proficiency, selects two piloting skills (both with a +5% bonus), and can select six "other" skills, each with a +10% bonus. The only combat skill is Hand to Hand: Basic.

Hand to Hand: Basic can be changed to Hand to Hand: Expert at the cost of one "other" skill, or Martial Arts (or assassin if an evil alignment) for the cost of two "other" skills.

The character can also select eight (8) Secondary skills without benefit of bonuses. At third and eighth levels an additional four secondary skills can be selected.

Available skill categories are limited to any: Communication, Domestic, Electrical: Basic only, Mechanical: Automotive only, Military, Medical: First aid only, Physical (any except acrobatics and wrestling), Pilot, Pilot Related, Rogue, Science: Math only, Technical, W.P., and Wilderness.

Standard Equipment: A couple sets of travelling clothing and an extensive wardrobe of expensive and fashionable clothing. Light mega-damage body armor only, sleeping bag, back pack, utility/ ammo-belt, canteen, sunglasses or tinted goggles, air filter or gas mask, knife, food rations for a week, and personal items.

Weapons will include one energy and one non-energy rifle or other weapon of player's choice. Melters find techno-wizardry items fascinating and may adopt one as a favorite weapon and/or vehicle. **NOTE:** Mind Melters are not machine or weapon oriented and are not likely to have more than two or three weapons; however, they

will frequently find one, or two, particularly stylish or personally exciting, which they adopt as *a favorite* weapon and prefer to use it above all others.

Vehicle is limited to non-military means of transportation, and may include hover vehicles, jet pack, souped-up motorcycle or car, or techno-wizard vehicle. The great psychic power of the Mind Melter enables the character to easily understand and operate most techno-wizardry devices; however, remember that the Melter's reliance on his own powers means that he/she will not use many devices of techno-wizardry or any other, no matter how powerful. Almost never pilot robots or power armor.

Money: Starts out with 4D6 x 100 in credit and 2D4 x 1000 in saleable black market items. Has spent the rest on pleasure and clothes (so players, make this guy's wardrobe expensive and attractive).

Cybernetics: Starts with none. Frowns on cybernetics and bionics as the pitiful devices needed by lesser beings to make themselves better. Will use cybernetics only for medical reasons.

Optional! _____

Mutant Characters from Other Games

Players may bring in other types of mutant animals and mutant characters from any of Palladium Books' other role-playing games such as **Heroes Unlimited and Teenage Mutant Ninja Turtles and Other Strangeness**.

Mutant animals can be the creation of Lone Star experimentation or creatures from another place (a different dimension) or time (Earth's past via a rift in space and time). Characters from another dimension retain their powers, skills, and abilities from the originating game (they are strangers in the strange land of Rifts). Do not change, trade, or select skills, powers, or abilities from one game to **Rifts**. It is these strange powers (from the other games) that will set them apart from the indigenous creatures of **Rifts** Earth.

Mutant animals other than dogs may be the creations of genetic manipulation at Lone Star. Players may use the basic mutant animal creation rules and animals from any of the **TMNT role-playing and After the Bomb** series of books to create different Lone Star mutants. In such cases, players build the rudimentary creature as usual, determining appearance, size, looks, and human characteristics. Then buy whatever animal characteristics or powers that may be available to that creature with BIO-E points as usual. Then the player may elect to purchase either animal psionics from that RPG or roll to determine **Rifts** psionics (note that the character may not be psionic at all). The Lone Star creature will then be conditioned to loyalty and trained in basic military or assistant skills (literacy is rarely one of them). Available O.O.C.s are limited to *Coalition Grunt* (less half "other" skill selections) or *Vagabond*.

Mutant animals from another dimension can also be a *Burster* or *Mind Melter*, but in these cases can not have any animal powers or animal psionics from the other RPG system.

Non-mutant animals, but mutant humans, humans with super powers, monsters or alien looking creatures are considered to be either "mutoids," mutations that have turned "true" humans into hideous, inhuman monsters (at least in the eyes of the Coalition), or "D-Bees," other Dimensional Beings (D.B./D-Bee for short). These characters from other Palladium game books retain their powers and abilities from those books. Do not give them any new powers or skills as found in

Rifts. Of course, they can beg, borrow, or steal **Rifts** weapons and equipment. After a while, like after attaining about 5000 experience points on the **Rifts** Earth, they can select two language skills, one piloting skill, and one W.P. energy weapon skill. This applies to other dimensional mutant animals as well.

IMPORTANT NOTE: Rules for the complete integration of mutant animals, super heroes, and other characters from Palladium Books' other role-playing games will be presented in the upcoming **Rifts Conversion Source Book!**

This book will clearly present and discuss the different modifications and considerations in bringing just about any of Palladium Books' characters into the world of **Rifts**.



Who Has Psionic Abilities?

See Creating a Character, Step Four.

Inner Strength Points

Every use of a psionic ability temporarily uses up a certain amount of psychic energy we call Inner Strength Points (I.S.P.). Each specific psionic power will indicate exactly how many I.S.P. are required to perform that ability. When a psionic has exhausted all of his I.S.P. he is unable to perform any more psionic feats until he acquires sufficient rest.

Meditation & Recovery of Inner Strength Points

Meditation is an automatic skill/ability known to all psychics. It is the only ability that can be done at any time and costs no I.S.P. to perform. Meditation is not so much a psi-power as it is a mental discipline that enables the psychic to concentrate deeply and focus one's abilities and thoughts. The exact techniques of meditation may vary from focusing on a mental object or notion to chanting or humming a mantra. The result, regardless of technique, is a deep relaxation and focus to achieve insight and harmony into one's self and the world around him.

A relaxing meditative state also offers the following benefits to all psionics: one hour of meditation restores six (6) I.S.P. and is the equivalent of two hours of sleep/rest for the physical body.

Inner Strength Points can also be restored during sleep and/or total relaxation at a rate of two (2) per hour.

Saving Throws Against Psionic Attacks

Psionic attacks which assail the mind, emotions, or physiology of a person can always be fought off the force of one's own will and mental endurance. Psionic attacks that fall into this category include empathy, empathic transmission, mind wipe, telepathy, hypnotic suggestion, and bio-manipulation. Some psionic attacks for which there is no saving throw include levitation, pyrokinesis, telekinesis, presence sense, healing touch, force field, and mind bolt. However, a parry or dodge may be appropriate in some cases, like dodging a mind bolt or telekinetic attack.

All saving throws are made on a 20 sided-die. **Non- psionic** characters must roll a IS or higher to save vs psionic attack. **Minor** and **Major**

psionic individuals must roll a 12 or higher to save. **Master psionic** characters, including all psychic R.C.C.s need to roll a 10 or higher to save. Note: Be certain to add any possible bonuses from the M.E. attribute and/or magic/tech devices/protection.

The Influence of Ley Line Energy

Range and *duration* are increased by 50% when near a ley line (within two miles/3.2 km) and doubled when within a mile (1.6 km) of a nexus point.

Damage from psionic energy attacks, such as psi-sword, pyrokinesis, electrokinesis, and telekinesis, is doubled when within a mile of a ley line *nexus point* (no additional damage from a ley line alone). The strength/M.D.C. of a telekinetic force field is also doubled.

Attacks per Melee

Equal to the number of physical hand to hand attacks (usually 2 to 5). See *Psychic Combat in the Combat Section*.

The Horror Factor

All supernatural creatures have a horror factor. The horror factor represents either the hideous appearance of the monster or its overwhelming aura of evil and power (or a combination of the two). Whenever a human encounters one of these monstrosities the character must roll a 20 sided die to see whether or not he or she is momentarily stunned by the sheer horror of the thing. This horror factor roll might be thought of as a savings throw or mental parry. Fortunately, the characters only need to roll for the first melee of each encounter, *not* every melee of combat.

To save against the Horror Factor (H.F.) the player must roll a 20-sided die. Just like a parry the roll must be equal or higher than the horror factor. **For Example:** A slobbering creature, with a horror factor of 10, emerges from a crypt. All characters must roll to save against horror. A successful save is 10 or higher on one roll of a 20-sided die. Everybody except poor Tom rolls above a 10. Tom rolls a 6, his character is momentarily stunned with horror.

A failed roll means that the character is so overwhelmed with horror that he or she is temporarily stunned. What this translates to in game terms is that the character loses initiative (don't even roll for it), loses one attack/action that melee, is the *last* person to attack/take action and can not defend himself against the creature's *first* attack that melee (no parry or dodge). Fortunately, the character snaps out of the shocked stupor quickly and can join in the combat that same melee. By the second melee the character has completely regained his senses, functioning as normal.

Psionic Abilities in Animals

Most larger mammals seem to have innate natural psychic senses that warn them about the presence of supernatural forces. As odd as it may seem animals associated closely with humans on a friend/helper level have the most pronounced psi-abilities.

Dogs, cats and horses exhibit the greatest extrasensory perception. Each animal has the following abilities:

- See the Invisible
- Sense Evil
- Sense Magic
- Sixth Sense
- Empathy (receives)

Each ability is an automatic instinct that helps the animals *avoid* the supernatural. Range: 600ft area (183m). The animals will sense the use or presence of these forces in the area, but also in specific people or creatures as well. The animal's reactions will always be the same; intense nervousness, jumpiness, whimpering, hissing, growling, howling and alertness when the energies are sensed to be in the area. If

possible the animals will try to leave the area and will flee if they get the opportunity. Only a *loyal* canine companion may stay with his human friend/master. When *cornered* face to face with the source of magic or supernatural forces the animal will attack and attempt to flee. A dog or cat will raise the hairs on its back, bare fangs and growl or hiss in a menacing warning. A horse will whinny, stomp and rear. If the person or creature does not back off the animal will attack. The cat and horse will attack only to make a path of escape and to let the unnatural being know that they know its true essence. 1-60% of the time all canines will attack to kill! The remaining 40% of the time (61-00) the animal will flee. **Note:** Dogs and cats can not be trained to sniff out magic or supernatural creatures. Their natural instinct is to run away. They will **NOT** search out these forces for anybody or any reason and will flee as soon as the opportunity arises.

The animal's use of psychic abilities is automatic and natural. Consequently, they do not get an I.S.P. rating.

Animals and Magic

All living creatures have potential psychic energy points. A practitioner of magic, especially evil ones, may sacrifice an animal to get its potential psychic energy. Remember, the P.P.E. of all creatures doubles at the moment of death and a mage can capture and use that unleashed energy.

The following is a list of animal types, their P.P.E., and Hit Points:

- Birds (small) — 1D4 P.P.E./1D4 Hit Points
- Birds of Prey — 2D6 P.P.E./1D6 Hit Points
- Mouse — 1D4 P.P.E./One Hit Point
- Rat/Other Rodents — 2D4 P.P.E./1D4 Hit Points
- Domestic Cat — 3D4 P.P.E./2D4 Hit Points
- Wild Cats (Predator) — 3D6 P.P.E./6D6 Hit Points
- Large Wild Cats (Lion/Tiger) — 4D6 P.P.E./6D6 + 20 Hit Points
- Small Canine — 2D6 P.P.E./3D6 Hit Points
- Large Canine — 3D6 P.P.E./4D6+ 10 Hit Points
- Wolf — 4D6 P.P.E./6D6+ 15 Hit Points
- Bear — 2D6 P.P.E./3D4x10 Hit Points
- Mustelid (Weasel/Badger) — 2D6 P.P.E./4D6 hit Points
- Cattle — 4D6 P.P.E./4D6+ 10 Hit Points
- Horse — 4D6 P.P.E./6D6 + 10 Hit Points
- Monkey — 2D6 P.P.E./2D6 Hit Points
- Ape — 3D6 P.P.E./4D6 + 6 Hit Points
- Lizard — 1D6 P.P.E./1D6 Hit Points
- Fish — 1D4 P.P.E./1D4 Hit Points

Saving Throws

Animals, like humans, get an automatic roll to save vs magic attacks, however, all such saves are —4.

Animals also get to save vs psychic attacks and must roll a 15 or higher to save.

Note: An incapacitated animal prepared for sacrifice is helpless and an automatic kill (death blow).



Descriptions of Psionic Abilities

Healing

Bio-Regenerate (self) (6)
Deaden Pain (4)
Detect Psionics (6)
Exorcism (10)
Healing Touch (6)
Increased Healing (10)
Induce Sleep (4)
Psychic Diagnosis (4)
Psychic Purification (8)
Psychic Surgery (14)
Resist Fatigue (4)

Sensitive

Astral Projection (8)
Clairvoyance (4)
Empathy (4)
Mind Block (4)
Object Read (6)
Presence Sense (4)
See Aura (6)
See the Invisible (4)
Sense Evil (2)
Sense Magic (3)
Sixth Sense (2)
Speed Reading (2)
Telepathy (4)
Total Recall (2)

Physical

Alter Aura (2)
Death Trance (1)
Ectoplasm (varies)
Impervious to Cold (2)
Impervious to Fire (4)
Impervious to Poison (4)
Levitation (varies)
Mind Block (4)
Nightvision (4)
Resist Fatigue (4)
Resist Hunger (2)
Resist Thirst (6)
Summon Inner Strength (4)
Telekinesis (varies)

Super

(Limited to the
Mind Melter O.C.C.)

Bio-Manipulation (10)
Bio-Regeneration (super) (20)
Electrokinesis (varies)
Empathic Transmission (6)
Group Mind Block (22)
Hydrokinesis (varies)
Hypnotic Suggestion (6)
Mentally Possess Others (30)
Mind Block Auto-Defense (special)
Mind Bolt (varies)
Mind Bond (10)
Mind Wipe (special)
P.P.E. Shield (10)
Psi-Shield (30)
Psi-Sword (30)
Pyrokinesis (varies)
Telekinesis (super) (10+)
Telekinetic Force Field (30)
Telemechanics (10)



Note: The number in parenthesis indicates the amount of I.S.P. needed to use the psi-power.

HEALER

Bio-Regeneration

Range: Self
Duration: Permanent
I.S.P.: 6
Savings Throw: None

This the ability to mentally heal oneself of disease, poison, or physical damage. Unfortunately, this ability is limited to the healing of oneself and can not help others. The process requires one full minute of concentration, meaning the character can not use any other psionic power during that time. Bio-Regeneration does not restore missing limbs, but does not restore 2-12 (2D6) hit points, or 3-18 (3D6) physical S.D.C.

points per melee. In addition, when cuts and scrapes are healed through bio-regeneration there is NO scarring. The psionic can regenerate as often as once every other minute.

Deaden Pain

Range: Immediate proximity, touch or within 3ft (0.9m).
Duration: One hour per level of experience.
Length of Trance: Two minutes (8 melee rounds).
I.S.P.: 4

The ability to deaden pain can be used as a pain killer which temporarily negates existing pain or as an anesthetic to be used for surgery.

Detect Psionics

Range: Self, sensing range is 30 feet (9 m) per level of experience.
Duration: One minute per level of experience.
I.S.P.: 6

This is a mental probe that will indicate the presence of psionic energy within the immediate area. The probe can not be used to pinpoint the exact location of psychic energy nor the level of power other than a vague sense of weak, medium, or powerful, but will indicate whether an individual is psychic by directing the probe at a specific person (does not reveal the type or strength of the person's powers other than low, medium, high). It will also indicate whether a group mind block is in effect and if a person is psionically possessed.

Exorcism

Range: Immediate area, touch or within 8ft (2.4m).
Duration: Instant, if successful.
Length of Trance: 30 minutes of preparation and 6D6 minutes with the possessed person or animal. **Note:** can only exorcise the living.
I.S.P.: 10

The healer can perform a rite of exorcism that uses psychic energy to expel the loathsome being from its mortal, host body. A completely successful exorcism will free the victim of the supernatural force that controls him and send it back to its own non-earthly world. A partially successful exorcism will drive the evil force out of the possessed person or animal, but does *not* send the damnable thing back to its own dimension. Thus, it can try to possess the healer or flee to wander the Earth in search of new victims. An exorcism can only be used on living persons or animals whose bodies are inhabited by a supernatural entity or creature.

Roll to determine success for an exorcism at the end of the time period. **First**, roll to see if the being has been expelled from its victim's body. **Success ratio:** 28% + 7% per each additional level of experience. **Second**, roll to see if the thing is forced back into its own dimension. **Success Ratio:** 21%+ 7% per each additional level of experience. A failed roll means the creature can remain in our dimension, but it must leave the area and can not possess the same individual for at least six months. **Note:** The chance of a successful exorcism on a *nega-psychic* is reduced by half, as is the success ratio for sending the being back to its own dimension. The same is true of some of the more powerful supernatural beings.

During the exorcism the possessing force can use whatever powers it may have, as well as physical attacks or any special psychic abilities of its host body. Fortunately, the rite of exorcism weakens the creature, reducing its number of attacks per melee by half. It is wise to always have one or more assistants to help defend against the being's attacks and actions. Sedating the physical host body will immobilize it, but

will not prevent psychic attacks or the creature's use of its natural powers. Too many assistants or spectators can be a liability, for the creature may attempt to flee by possessing one of them. An exorcism can be attempted on the same individual as often as the healer desires.

Healing Touch

Range: Touch.

Duration: Instant, with lasting effects.

Length of Trance: Two minutes (8 melee rounds).

I.S.P.: 6

The healing touch is a remarkable healing ability that can instantly heal cuts, burns, bruises and similar physical wounds. The touch restores 1D8 hit points *or* 2D6 S.D.C. The healing touch can only be used on other living creatures, never on himself.

Increased Healing

Range: Touch or within 3ft (0.9m).

Duration: 2D4 days.

Length of Trance: 1D6 hours.

I.S.P.: 10

The healer is able to stimulate *another* person's healing energies, dramatically increasing one's recuperative powers. Hit points and S.D.C. recovery are double the normal professional treatment rate.

Induce Sleep

Range: Touch or within 6ft (1.8m).

Duration: One hour per level of experience (or until awakened).

Length of Trance: Two minute preparatory meditation.

I.S.P.: 4

Savings Throw: Standard; plus unwilling victims are +5 to save vs psychic attack.

This is not an offensive ability, but is intended to be a recuperative power to induce sleep on those who are ill, exhausted, or an insomniac. The person will fall into a normal, restful sleep from which he can be easily roused. Unwilling victims of the induce sleep psi-power get a +5 bonus to save (because this is not the intent of the ability) and can not be involved in combat at the time.

Psychic Diagnosis

Range: Touch or within 3ft (0.9m).

Duration: Immediate knowledge.

Length of Trance: 2D4 melees of meditation.

I.S.P.: 4

Savings Throw: None; except for the nega-psychic, standard.

The psychic healer can sense physical pain, damage, disease and possession with absolute clarity. This pinpoint accuracy enables the character to suggest treatment or to conduct psychic surgery.

Psychic Purification

Range: Touch

Duration: Immediate

Length of Trance: 6D6 minutes of meditation.

I.S.P.: 8

Savings Throw: None; except for the nega-psychic, standard.

The healer can use his abilities to slow a person's metabolism and destroy chemicals, drugs, poisons, and toxins in the body. The effects of the drugs/impurities are immediately halted at the beginning of the meditation, and completely destroyed/negated by its end. Damage sustained prior to the psychic's intervention still exists.

Psychic Surgery

Range: Touch

Duration: Varies with injury.

Length of Trance: 2D6 minutes of preparatory meditation, plus the duration of the surgery (which is half the time of conventional modern medicine).

I.S.P.: 14

Psychic surgery is used to repair broken bones, internal injuries, the removal of foreign objects (bullets, etc.), or when a character has suffered so much damage that he or she has lapsed into a coma (zero or less hit points). *The recovery from a coma* (near death) is equal to treatment from a hospital, 1-66%, when psychic surgery is used. Note that there is absolutely no scarring from psychic surgery and minimal pain (no pain if the deaden pain psi-ability is used). No tools are needed, only the psychic's hands. **Note:** A psychic diagnosis *must* be made before surgery is possible.

Resist Fatigue

Range: Self

Duration: One hour plus 20 minutes per level of experience.

Length of Trance: 1D6 melees of preparatory meditation.

I.S.P.: 4

A mind over matter discipline which enables the character to engage in physical activity without suffering from exhaustion. Although fatigue is temporarily suspended, the psychic will feel extremely tired and may even collapse when the psi-power's time limit lapses.

PHYSICAL

Alter Aura

Range: Self

Duration: One hour per each level of experience.

I.S.P.: 2

Savings Throw: None

A truly unique power that many psychic investigators claim is impossible and does not exist. Only a handful of physical psychics can manipulate their physical energy in such a way that it changes their aura. The altered aura will send the wrong message to those who can see auras. Alterations include:

- General level of experience can be made to seem much lower (level 1 or 2) or much higher (2D4 levels higher) than it really is.
- Conceal the presence of psychic powers.
- Conceal level of base P.P.E. (made to seem much lower).
- Conceal the presence of magic.

Death Trance

Range: Self

Duration: As long as the psychic senses he must feign death, up to a maximum of four days.

I.S.P.: 1, (It's easy for the physical psychic to control his body, because that's the focus of his powers).

A state of mind over matter that slows the metabolism to such a degree that it creates a temporary state of suspended animation, simulating death. Without hospital facilities, even a medical doctor is likely to believe the character is dead (1-89% likelihood). The effects of drugs, toxins and chemicals are slowed to a crawl, doing 1/4 damage or effect, but will take full effect the instant the death trance is stopped (unless treatment is administered first). While in the death-like state, the psychic can not be roused or respond to any type of stimulation, including psychic probes. This means he is incapable of attacking or defending himself in any way until the trance is broken.

Ectoplasm

Range: 40ft + 5ft per level of experience(12.2+ 1.5m).

Duration: 4 minutes (16 melees) per level of experience.

I.S.P.: Vapor — 6 I.S.P., Solid — 12 I.S.P.

This mystifying ability enables the psychic to create a slightly luminous, vapor-like substance that is exuded from the pores. Ectoplasm has two forms: an invisible vapor and a luminous, solid state.

The **vapor** is a sort of floating, probing finger that can snuffout candles, open doors, knock over or pick up small objects (weighing under 9 ounces/255 grams), tap somebody on the shoulder, rustle leaves and knock on a door. The ectoplasmic vapor can be seen only by its creator, psychics and supernatural beings who can *see the invisible*, or with *infrared optic systems* (including i.r. camera lenses, i.r. gun sights, etc.). Ectoplasm, although an invisible vapor, has *physical properties*, which means it can not go through walls or other solid obstructions. Thus, a person walking into an ectoplasm stream may feel a slight sensation, like walking into a spider's web or brushing against a cotton ball. Often a person will unwittingly walk into and snag the stream of floating ectoplasm, pulling or stretching it along without being aware of it. In such cases, the psychic must maneuver the snagged portion to loop around the human obstruction. The creator of the vapor can control the full length of the vaporous stream like a floating tentacle. Although the vapor can not go through solid objects it can slip through keyholes, cracks under doors or loose seals around a window. If a breeze can blow through, so can ectoplasm. The only drawback is that the character must be able to see the ectoplasm to maneuver it.

The solid state of ectoplasm can be a startling sight, for it is clearly visible to everyone. In this form the ectoplasm can be shaped into an extra limb, such as a hand or arm and hand, or tentacle or even a foot. The ectoplasmic limb appears as a white, slightly luminous appendage connected to a trail of ectoplasm stretching back to its creator like a life-line of silly putty. The appendage and its connecting line can hover, float, levitate and fly (at a speed of 18). The solid ectoplasmic limb has much greater strength; able to carry, lift or hold up to 40lbs/18kg, but can not squeeze through the tiny openings that the vapor can. An opening must be at least the size of a quarter for solid ectoplasm to fit, and then the limb must be turned into a thin tentacle and reformed on the other side of the opening. Ectoplasm can also be used to create a face or even a full figure, although detailed features are impossible. Ectoplasmically created images may explain apparitions reported during some seances.

Ecto-Combat: The ectoplasm vapor and solid form both have an *automatic dodge* against all attacks directed at any of its length. That means an attempt to hack the middle of the ectoplasmic stream/connecting line will see that portion of the ectoplasm suddenly swerve, loop or bend with a life of its own to avoid the attack. The dodge at the midsection (or anywhere else) does not count as an attack/action by the appendage at the other end. The appendage also gets an automatic dodge in addition to its attacks/actions per melee. A vapor or solid appendage *must* be controlled by its creator at all times (except the automatic dodge); thus, it has a number of attacks/actions equal to its creator's. So, if the psychic has four attacks per melee, the ectoplasm appendage also has four attacks. However, each attack/action by the ectoplasm counts as one of the character's attacks/actions that melee.

The solid ectoplasm appendage is not a great tool for combat. It limits the person's attacks/actions per melee and has minimal strength; equal to about a P.S. attribute of 4. A punch or kick does a mere one point of damage. Damage can be increased by the appendage using any type of hand-held weapon under 40lbs and less than five feet (1.5m) in length. Small modern weapons, such as a pistol or revolver, can be used, but are *minus -10 to strike*. The *vapor* can not use any weapons weighing more than 9 ounces and can inflict no damage of its own.

Ecto-Combat Statistics

- Vapor and solid get an *automatic* dodge against all attacks, including multiple or simultaneous attacks.
- +5 to dodge; applies to vapor and solid.
- +1 to parry; applies to vapor and solid.
- +1 to strike; applies to vapor and solid.
- Astral S.D.C. is 40 plus one hit point. Applies to vapor and solid. If the ectoplasm is destroyed the creator takes one hit point and 10 S.D.C. of physical damage.
- Vapor inflicts no physical damage, but can touch, tap or pickup and carry objects weighing 9 ounces or less.
- Solid ectoplasm inflicts one point of damage in combat or by weapon.
- Attacks or actions per melee are equal to its creator's. Each attack/action by the ectoplasm, excluding dodges, counts as one of the character's attacks that melee. A pair of ectoplasmic limbs will divide the attack between the two equally.
- Sunlight or bright artificial light (250 watts) reduces the range to half.
- Maximum range possible for vapor and solid is 40ft plus 5ft per level of experience (12.2+1.5 meters per level).
- One full melee (15 seconds) is required to create an ectoplasm vapor or solid appendage.
- Half a melee (7 seconds) is needed to withdraw/return ectoplasm into its creator.

Impervious to Cold

Range: Self

Duration: 20 minutes per level of experience.

Length of Trance: 1D4 melees for preparatory meditation.

I.S.P.: 2

A mind over matter discipline which enables the character to suffer absolutely no ill effects or discomfort from exposure to even extreme freezing conditions.

Impervious to Fire

Range: Self

Duration: 3 minutes per level of experience.

Length of Trance: 2D4 melees for preparatory meditation.

I.S.P.: 4

Another mind over matter discipline enabling the psychic to endure intense heat, fire, boiling water, hot coals, and so on, without suffering pain, damage or scarring. Magic fires inflict *half* damage.

Impervious to Poison/Toxin

Range: Self

Duration: 2 minutes (8 melees)

I.S.P.: 4

The character can negate the full effects of poisons and toxic chemicals which he has ingested (eaten or drank) or introduced into the bloodstream, as long as he/she has advance knowledge of its deadly properties. A poison, toxin, or drug which has been unknowingly inflicted (and starting to take effect) can be negated too, but will do *half damage* or effect before it can be completely negated. **Bonuses:** Identify poisons — 30% + 4% per level of experience; +2 to save vs poisons and drugs.

Levitation

Range: Up to 60ft/18.3m away.

Duration: 2 minutes per level of experience.

I.S.P.: Small — 2, medium — 6, large — 6 plus 1 per every 10 lbs over 20lbs.

Savings Throw: None

Levitation is a limited form of telekinesis that can raise an object (or even a person) straight up into the air and suspend it there (hover).

Small objects weighing two pounds (0.9kg) or less are the easiest to levitate. Maximum height is 8ft (2.4m) plus one foot (0.3m) per each level of experience. Medium size objects weighing 3 to 20 pounds (1.4 to 9.1kg) are more difficult, requiring greater concentration. Maximum height is 6ft (1.8m) plus one foot (0.3m) per level of experience. Large objects or people weighing over 20lbs cost 6 I.S.P. plus 1 I.S.P. for every 10 lbs beyond 20. Thus, a 125lb weight (56.7kg) would require 17 I.S.P. to raise it into the air. Maximum height is 4ft (1.2m) plus one foot (0.3m) per level of experience.

Mind Block

Range: Self

Duration: 10 minutes per level of experience.

I.S.P.: 4 (per each duration period)

This is the ability to completely close or block oneself from all psychic/mental emanations. When intentionally closed to supernatural or psychic forces the character can not sense anything, can not use psychic abilities, nor be influenced by others. A mind block will prevent penetration of telepathy, empathy, hypnotic suggestion, and empathic transfer. It can be an invaluable protective mask when dealing with malevolent psychic forces. Adds a bonus of +1 to save vs all psychic and mental attacks.

Nightvision

Range: Self, visual range about 600 feet (183 m)

Duration: 10 minutes per level of experience.

I.S.P.: 4

The psionic can adjust his visual capabilities through a form of bio-manipulation. The eyes are made to become much more light sensitive and basically works on the same principles of mechanical light amplification. The eyes simply amplify existing light, such as candlelight or star and moonlight, to see clearly. There must be some source of light to see (can not see in total darkness).

Note: If suddenly exposed to light brighter than a single candle, the psychic will be temporarily blinded for 3D4 melees. The nightvision power can also be used to change one's vision to polarized sight, reducing glare as would a pair of polarized sun glasses.

Resist Fatigue

Range: Self

Duration: 1 hour + 20 minutes per level of experience.

I.S.P.: 4

A mind over matter discipline which enables the character to engage in physical activity without suffering from exhaustion. Although fatigue is temporarily suspended, the psychic will feel extremely tired and may even collapse when the psi-power's time limit lapses.

Resist Hunger

Range: Self

Duration: 6 hours

I.S.P.: 2

Another mind over matter discipline that subdues any feeling of hunger, allowing the character to function at full effectiveness without nourishment. It is important to point out that while the psi-power maintains full operations, the body is still suffering from malnutrition and starvation. Loses 3lbs of weight per day. **Note:** A psychic can survive up to 60 days, functioning as normal, without any food by continually using resist hunger. On day 61 the character will lapse into a coma. Under this extreme condition, 60 days of food deprivation while still fully active physically, the character is — 20% to save vs coma/death.

Resist Thirst

Range: Self

Duration: 6 hours

I.S.P.: 6

This ability is identical to the resist hunger psi-power except it applies to the consumption of water. It does not negate the long-range damage from dehydration.

Summon Inner Strength

Range: Self

Duration: 10 minutes per level of experience.

I.S.P.: 4

This psi-power enables the character to draw on his inner reserves of strength to ward off pain and fatigue. Every time the psychic calls upon his inner strength the following bonuses apply:

- Add +10 S.D.C.
- Add +2 to save vs poison or toxins.
- Add +5% to save vs coma/death.
- Fatigue is temporarily forgotten and the character can function as if he was fully rested for the full duration of the summon inner strength power.

Telekinesis

Range: Up to 60ft (18.3m) away.

Duration: 2 minutes per level of experience.

I.S.P.: Small — 3, medium — 8, large (over 20lbs) — 8+1 per every 10 lbs of weight.

Telekinesis is the ability to move objects without any other means than directed psychic energy. The character can make an object hop, fall, roll, rise into the air, suspend it there (hover) or make it fly across the room.

In order to move an object by telekinesis, the item must be clearly visible, within the psychic's range (60ft/18.3m) and the point of focus. As usual, the psychic must concentrate on what he is doing; thus, each telekinetic feat counts as one of the character's physical attacks. The total number of telekinetic attacks is equal to the character's number of physical attacks per melee; usually 3 or 4. One can attack with telekinesis by hurling an object as if thrown or causing it to buzz about a room, swinging and hitting like a club controlled by an invisible hand. Several objects can be telekinetically thrown around within the same melee round, but not simultaneously. The psychic can only concentrate on one item at a time. **For Example:** A physical psychic with four, normal, hand to hand attacks per melee can perform four attacks with telekinesis. First, he makes a flower vase fly from the table, aiming it at his opponent's head. Second, he makes the lamp hurl at the guard at the door. Third, the table is suddenly flipped up on end and, fourth, the doorknob is turned and the door flung open. Four attacks or actions using telekinesis.

As we can see in the example, telekinesis can be used to do more than making objects fly around. The telekinetic power can be used to open doors, flick switches, press buttons, turn knobs and dials, open windows, make a rocking chair rock and so on. The range of possibilities is extensive when you stop and think about it. Remember, each action counts as one of the character's physical actions/attacks per melee.

It is easiest to move or hurl small objects weighing two pounds (0.9kg) or less). Maximum height or distance is 60ft (18.3m). Medium size objects weighing 3 to 20 pounds (1.4 to 9.1kg) are more difficult to manipulate. Maximum height or distance is reduced by half— 30 feet (9.1m). Large or heavy objects weighing over 20lbs are the most difficult to maneuver, reducing maximum height and distance to 15ft (4.6m). I.S.P. cost for large, heavy objects is 8 I.S.P. for the first 20lbs (9.1kg) plus one I.S.P. for each additional 10 lbs (4.5kg) of weight. This means it would cost 19 I.S.P. to move a 125lb (56.7kg) weight (8 I.S.P. for



the first 201bs+ 11 I.S.P. for the remaining 1051bs). Remember, the height and distance of effect is limited to 15ft (4.6m) for such a heavy item.

Combat Bonuses:

- +3 to strike with telekinesis; physical/skill bonuses to strike do not apply when telekinesis is used.
- +4 to parry with telekinesis, by using a controlled object to parry or sheer telekinetic force to block an attack. Counts as a medium heavy object; costs 8 I.S.P.
- Damage from Hurled Objects:
 - Small: 6 ounces to 1 pound — 1D4
 - Small: 1 1/2 to 2 lbs — 1D6
 - Medium: 3 to 41bs — 2D4
 - Medium: 5 to 10 lbs — 3D4
 - Medium: 11 to 251bs — 3D6
 - Large: 26 to 401bs — 4D6
 - Add 1D6 for each additional 201bs of weight.

Note: Telekinesis is not a force field, thus, while it can be used to parry/block a punch, kick, club, knife or even sword, it can not stop bullets, arrows, gas, flying tackles, and similar attacks. Furthermore, a failed roll to telekinetically parry means the psychic did *not* parry and *is* struck by his opponent.

SENSITIVE

Astral Projection

Range: Self

Duration: 5 minutes per level of experience.

I.S.P.: 8

Through intense concentration/meditation (4D4 minutes of preparation) the psychic can free his mind, or inner self, from his physical body. This psychic inner self is the astral body, a whitish, transparent, ghostly image of the character's physical form. A long silver thread or *cord* connects the astral body with its physical self. If the cord is severed the character is likely to die of sudden shock as body and soul are torn asunder. There is only a 30% chance the astral self can locate its physical body without the silver umbilical cord (roll best 2 out of 3).

The physical body lapses into a coma-like trance when the astral self has left it. In this state the body is completely helpless. It can not walk, move or think; completely catatonic.

The hazards are threefold. **First**, if the physical body is killed, the astral body is forever lost and will die, fade away, within six hours. **Second**, if the astral body gets lost or captured while in the astral plane, the body will begin to waste away and die. (Note: One minute of our time is equal to one week in the astral plane). **Third**, the astral body is vulnerable to psychic attacks and attacks from ghosts, entities and creatures of the astral plane.

There are two levels of astral projection, *coexistence* (physical body and spirit form) in the material world and/or *the astral plane* (another dimension). Astral projection from the physical body into the *material world* creates a ghostly specter of the astral self which can be seen only by other psychics, young children under 13 years old, animals and most supernatural creatures. While in astral form the character automatically gains the ability to float, fly (mach one/670mph maximum), see the invisible, pass through solid objects, impervious to physical harm (including cold, heat and energy), and see and hear as usual. The astral body can not communicate with the physical world except through telepathy or empathy, nor speak to, smell or touch anything on the material plane. The astral self is little more than a mute, ghostly observer. Of course, this is a great way to locate invisible supernatural entities, as well as spy on other humans on the material plane (although limited by short sprints. See duration).

Traveling in astral form has its own very special dangers. While the character can see the invisible and other astral travelers, they can also see him. This makes him susceptible to their psychic and astral form attacks, for two astral travelers can lock into hand to hand combat as well. The most vulnerable target is the silver cord which is the astral traveler's lifeline to the physical world. Fortunately, the cord has an *Astral S.D.C.* which is two times that of the person's physical hit points and *S.D.C.* combined. The thread-like silver cord is a difficult target to hit; attackers are — 6 to strike. The astral body also has twice an *S.D.C.* two times greater than the hit points and *S.D.C.* of the physical body combined. This means if the character has 18 hit points and 28 *S.D.C.* both the astral body and its silver cord have 92 *Astral S.D.C.* each ($18 + 28 = 46 \times 2 = 92$ each). Remember, magic and psychic influence have full effect on the astral body. This includes exorcism, which will force the astral traveler to leave the immediate area (400ft radius) and not return for 24 hours. The astral traveler has the same number of attacks per melee, bonuses, hand to hand, skills, knowledge and psychic powers that he or she has in the material plane.

Entering the astral plane is like entering the twilight zone. After a minute of concentration the astral gateway appears as a bright patch of shimmering, white light. Once the astral traveler passes through it, he will find himself in an endless expanse of white light, and rolling, white clouds. There is no up or down, no bottom or top; no north or south, no land or air or sea, just endless, slowly swirling white. Time too, is a different or altered state, for what would seem to be a week in the astral plane is barely one minute in the physical world. Time and space twisted and distorted, the astral traveler can travel from one end of our planet to the other, in the blink of an eye, by hopping through the astral plane. While this may sound wonderful, the astral plane has its dangers as well. **First**, the distortion of place and time makes it extremely difficult to find the material world and one's dormant, physical body. Even trying to follow the silver cord can lead to nowhere.

To return from the astral plane to the physical body, roll on the following table: Each roll will determine the astral traveler's state of mind and sense of direction. The percentile dice can be rolled up to three times per melee (15 seconds). The player must roll "definitely certain" to successfully return. The player may keep trying until he succeeds or time elapses.

Location of the Physical Body

Roll Percentile Dice to Return from the Astral Plane

- 1-30 Hopelessly Lost (roll again).
- 31-50 Uncertain, Confused (roll again).
- 51-76 Fairly certain of location; on the right track (roll again).
- 77-00 Definitely certain of location. (Whew! Made it Back).

*Astral travel with a *partner* is a much safer way to travel, because if one can find his body, he can lead the other one out with him.

Note: Traveling on the material plane in astral form is infinitely easier than the astral plane. To find the physical body the character need only return to where he left it. If it has been moved or hidden the astral self can sense its location with a 60% efficiency (roll once per melee).

The other danger lies in being attacked by other beings in the astral plane. Entities and elemental creatures of magic live in the astral plane or travel through it. These beings are usually hostile, evil forces. While the astral body can not touch or communicate with the material world, the astral body is quite solid to other inhabitants of the astral plane. The astral body is also vulnerable to magic and psychic powers, as well as physical assault by astral entities.

The energy which composes the astral plane is responsive to thoughts and desires. The strongest astral beings can mentally or magically control what a small area might look like. This means that the astral plane is made up of hundreds or perhaps thousands or even millions of tiny astral "kingdoms" adrift within the vast whiteness. Exactly what these

kingdoms look like is up to the entity that creates it. Some may look like a modern city, other castles or forests, while still others, a frightening landscape. Perhaps this is where legends of visitations to heaven and hell originate? It is always wise to avoid an astral kingdom, because only the most powerful entities and astral beings can create and maintain them. In Professor Victor Lazlo's book, "Worlds Within Worlds," he provides us with this firsthand account of astral travel:

"Although I myself have only minuscule psychic abilities, what might be considered a latent psychic (very latent), I had never been able to achieve astral projection. However, lord, high priest Vish-taal assured me that he could help me achieve the reputed state and lead me into the astral plane. So I bravely began my excursion into the ethereal realm that coexists with our own. After nine days of fasting, consuming only herb broth prepared by Vish-taal once per day, I was ready at last. We meditated together for three hours then, before I realized it, I was looking down at my own body. The sensation must be akin to floating in the weightlessness of space. The room seemed somewhat out of scale and distorted, like looking through a fish-eye lens. Suddenly I realized Vish-taal was floating next to me. He assured me that all was well and that after a few more out of body experiences I could see the material world as clear as normal. But today our goal was the astral plane. He took hold of my shoulder and beckoned me to come. With that, we both rose upward through the ceilings of the next three floors, the roof and skyward. I must confess that my 23 years as an investigator of the paranormal had not prepared me for this experience. All my professional cool had fled me the moment I left my body. I was so enthralled with the events and images that without the guidance of Vish-taal I would have bobbed about the room like a dumfounded child seeing Disneyland for the first time. Everything seemed to sweep by me, stealing my full attention for that moment, giving away to the next sensation and the next. As one sped skyward at a speed I can not begin to guess, the sparkling body of my astral guide caught my attention. For the first time, I noticed that our astral bodies were aglow with a bright translucent, blue-white light with countless tiny flashes of white, yellow, and blue light, like a thousand microscopic strobe lights set for a slow pulse. A thread of translucent silver unreeling itself as we rocketed ahead. Vish-taal yanked my attention with the words 'the gateway'. Before us was a glittering wall of light which we plunged through at great speed without pause. Suddenly we were plunged into a world of swirling white, broken only by wisps of white clouds. There was no longer any sense of up or down. Direction had no meaning. Without my astral guide to calm me I would have become lost in the vastness of the white infinity. Vish-taal assured me that with training one could sense the material world and use it like an invisible compass. I must admit that after what seemed to be about a half hour, I was able to discern shapes and patterns in the endless white clouds and mists. A strange calm seemed to take hold of me and made the whiteness seem far less alien. Then, after a long while, appearing through a fog-like mist stood a forest. Shades of green and brown and grey leaped out of the whiteness. A blue sky broken by cumulus clouds radiated around the green. Without realizing it, I had automatically gravitated toward the oasis of color. Suddenly, the sensation of evil shot through me like a hundred burning needles. Never in my experience as a minor psychic sensitive had I ever felt such hatred, such loathing. To my left a billow of grey and black storm clouds began to roll out from the green trees. The blue sky darkened and the clouds shot toward me with an anger I can not describe. Vish-taal's voice echoed in my ears: 'Go now we must, Victor. We should not try battle with this one. Now Victor, away from the dark. Flee with me and look not back.' We sped through the white and I did not look back. Obviously, I survived to tell this tale. When we returned to our physical

bodies I was still shaking. Vish-taal smiled knowingly and said, 'Victor, you see much adventure this day. I will send food while you much relax.' With a wink, the old yogi left me with my own thoughts.

"The experience seemed to last several hours. I would have hazard to guess eight or nine. Yet the wall clock confirmed with my wristwatch that less than six minutes had actually elapsed. Did I experience astral travel? Or was it sensory deprivation? The wily old priest could have easily drugged my broth or even hypnotized me. I had seen him expertly use hypnosis on others on countless occasions. But the old man and I had been friends for years and I honestly don't think my mentor would deceive me. So this then was the astral plane. I wish I could relate the details with greater clarity, but as I said, my objectivity and skills as an investigative reporter deserted me. One thing that did strike me was how much my astral plane experience seemed to mimic the transmissions of Lt. Taylor from Flight 19, which disappeared in 1945 over the Bermuda Triangle. In that celebrated and much disputed case, five Air Force Avenger Torpedo Bombers disappeared during a routine flight near Ft. Lauderdale, Florida. The leader's (Lt. Taylor), radio transmissions were bizarre. He reported that both compasses were out, and on a fairly clear winter afternoon, could not find Ft. Lauderdale. Other transmissions speak of vast whiteness and swirling clouds. Of not being able to find the sun or ascertain any sense of direction. Not even up or down. The transmissions faded in and out until they stopped. The final transmission: "We'll fly west until we hit the beach or run out of gas." Flight 19 disappeared without a trace. The most logical explanation is that the five aircraft perished in a sudden squall; not that any storms were known to have arisen that afternoon. Is it possible that some mysterious force opened a portal into the astral plane? A portal that the five bombers, and a sixth search aircraft and its crew of thirteen, inadvertently flew into? It is a possibility I must investigate further."

Excerpted from Victor Lazlo's *WORLDS WITHIN WORLDS*, 1977.

Clairvoyance

Range: Self (although the image could pertain to people or places thousands of miles away).

Duration: 6D6 Melees

I.S.P.: 4

Base Skill: 58% + 2% per level of experience.

This allows the psychic to see or feel glimpses of the possible future. This is achieved through meditation or intense concentration in which the clairvoyant thinks about a particular person, event or place. Add + 5% to the base skill if the person involved is a friend or loved one. Clairvoyance is unpredictable and can not be turned on and off like a light bulb. Sometimes it works (if the roll is under the base skill) and sometimes it does not (when the roll is above the base skill). A failed roll means the psychic received no insight to the future.

A clairvoyant trance can be attempted as often as *twice every day*. The message can be a sudden feeling that somebody is in need ("... something's wrong. It's... it's... Janet! I've got to see her!") or, more often, a sudden flash of insight, a sudden image that races through the mind. The image is like a brief snippet of film from a movie or a dream. Often all the details are not clear, but the potential danger is. For example, "The psychic character is in a trance or meditation, thinking about his/her friend Janet. Suddenly, the mind is flooded with an image of Janet rushing down a crowded street. It's dusky, like morning, twilight or evening. She seems very upset. The traffic light changes to amber. Janet races into the street, ignoring the light. It turns red. There's a car, squeal of tires, Janet screams. The image ends. Is Janet hurt? Killed? Unknown, but the danger is clear. There are also other hints

of information: the time of day, Janet seeming upset, rushing, etc. The glimpse into the future could be twenty minutes, eight hours, 24 hours, or a week. The psychic has no way of knowing. Of course, he has the advantage of recognizing the potential danger as it begins to unfold and may be able to avoid it, stop it or change the outcome. The image may last a few minutes or be a sudden flash lasting but a few seconds. The flash could be a peculiar noise, a face, or a specific image, like a particular door or object.

It is important to note that sometimes a clairvoyant image will occur unintentionally, without the psychic trying to do so. These most often manifest themselves as dreams or nightmares during sleep. The clairvoyant dream is exactly like the image from a meditative trance described previously. The precognitive flash of the future may also occur unbeckoned while awake, but this is extremely rare. These brief glimpses of the possible future happen because the clairvoyant is acutely attuned to his world. Anything that might hurt or change that world (including people and places) will often be foretold in a flash of insight.

Game Masters: Be careful of revealing too much. Use the examples provided as a guide. Remember, these are brief glimpses of the possible future, not a motion picture. The psychic can NOT engage in any actions, combat or otherwise, during a moment of clairvoyance or the image will instantly stop. It usually requires 2D4 melees of concentration or meditation before the image occurs. Remember, a failed base skill roll means absolutely nothing happens, but still bums up the 4 I.S.P. and time.

Empathy

Range: 100ft area (30.5m)

Duration: Two minutes (8 melees) per level of experience.

I.S.P.: 4

Savings Throw: Standard; a save vs empathy means the psychic can not get a clear sense of the emotions of that particular person. To save vs empathy the person must roll to save once each melee that the psychic is using empathy. Mind block will prevent any empathic emanations from the blocked person.

Empathy is a psi-ability that makes the psychic aware of, or feel, the emotions of other people, animals and supernatural creatures. The strongest emotions are easiest to sense: hate, anger, terror, love. Feeling for emotions can often be used to establish that somebody or something is nearby, but can not be used to pinpoint an invisible or hiding person/creature. Empathy can be especially helpful in recognizing and communicating with ghosts and other supernatural creatures.

Questioning a person/being while using empathy can be very handy in establishing how they are reacting to you. In a limited sense, empathy can be used like a lie detector to see if the emotions match the verbal response. **For Example:** "Did you know the deceased?" The verbal answer is no, but there is a sudden flare of nervousness and fear (or hate). This doesn't mean the guy is the killer, but it might mean he is lying about knowing the dead man. Further questions might pull out a strong emotion such as anger or hate (or happiness), which may confirm the psychic's suspicions that this man might be involved in the murder. However, remember that this is, at best, circumstantial evidence and definitely inadmissible in court. Physical proof must be found, but the empathic readings may put characters on the right track. Also, remember that the empathic psychic is feeling the person's real emotions, but interpreting their significance. A very nervous person may always radiate fear or anxiety, while a cold-blooded, pathological killer may feel nothing at all and stay calm and cool as he lies through his teeth. The feeling of hate may mean that the person did know the murder victim, or knew of him, and hated him for any number of reasons. That does not mean he killed him. As you can see, interpreting emotions can be a tricky thing.

Haunting ghosts and entities rarely mask their emotions. Thus, the psychic can easily tell if one or more is nearby (within 100ft/30.5m)

and what it is feeling. "I sense great sorrow." or "Do as it says! It is angry, almost crazed. I think it will carry out its threat if you try to stop it."

Mind Block

Range: Self

Duration: 10 minutes per level of experience.

I.S.P.: 4 (per each duration period)

This is the ability to completely close or block oneself from all psychic/mental emanations. When intentionally closed to supernatural or psychic forces the character can not sense anything, can not use psychic abilities, nor be influenced by others. A mind block will prevent penetration of telepathy, empathy, hypnotic suggestion, and empathic transfer. It can be an invaluable protective mask when dealing with malevolent psychic forces. Adds a bonus of +1 to save vs all psychic and mental attacks.

Object Read (Psychometry)

Range: Touch

Duration: Varies; usually about 2D6 minutes.

I.S.P.: 6

Savings Throw: None

Base Skill: *Impressions:* 56% +2% per level of experience. *Images:* 48% +2% per level. *Present:* 38% +2% per level of experience.

This uncanny ability enables the psychic sensitive to receive impressions and images from an object regarding its use, history and last owner. This is done by holding the object and concentrating on a specific line of thought or opening up to general impression (the latter is always more vague and random). Just as a psychic must open himself to sense evil or magic, he must open himself to the object. If successful, he will receive impressions and/or images revealing bits of information.

Impressions include: General alignment of its last owner (good, selfish, evil), general emotional state of mind (anger, happy, sad, hate filled, confused, etc.), the object's general purpose (what it is used for), whether or not the last owner is living or dead, and whether the item has been used with/by magic or supernatural forces. Object read will also conclusively indicate whether the item is currently enchanted or contains a supernatural force/entity (as well as *its* alignment and emotions). If the item *is* possessed, an object read makes the reader totally vulnerable to psychic attack (no bonuses to save).

Images: The psychic can also see images of isolated events which have happened in the past. This will provide brief *snippets* of images and events that will offer glances of the previous owner and others close to him. Traumatic and emotion filled events/images are the easiest to see. Impressions will accompany the images, adding to the story as it unfolds. *Information includes:* approximate age, height, weight, build, race, sex, sometimes occupation, hair color and length; special facial or body features, such as a scar or tattoo or beard (very often the exact facial features are out of focus, blurred or obscured); the object's use/purpose; and some special event, usually very traumatic, important or happy. Often the event image will be fragmented as if it was a piece of movie film edited by a crazy man. The event will always be one in which the object was involved in some way.

The success or failure of an object read: roll percentile dice once for impressions and once for images. The roll must fall under the character's base skill ability to succeed. A roll higher than the base skill means a failure and the psychic feels and/or sees nothing. Impressions and images are two different things, so *roll for each*. The psychic may get no impressions, but see images or vice versa. The present can *not* be seen unless the psychic was successful on at least one of the previous read impressions or images rolls. Once an object has been read it can *not* be read again by the same psychic, even if he did not see or feel a thing. Of course, the psychic can attempt to object read other items, but each attempt will cost 6 I.S.P.

The present can also be glimpsed, but costs an additional 4 I.S.P.,

with no guarantee of success. Sometimes the psychic can focus in to see and feel the last owner as he or she is at that very moment. This will provide an idea of what is his current state of mind/emotion, appearance/dress, general location (that is to say, a bedroom, office, street, outdoors, etc. No address or sense of close or far is provided), general features (shaved his beard, dyed hair, etc.) and so on. The psychic may be able to identify a place or person by feature, if he has seen it before or runs into it/him in the near future.

Presence Sense

Range: 120ft/36m area

Duration: 2 minutes (8 melees) per level of experience.

I.S.P.: 4

Savings Throw: None

Presence sense is a sixth sense which will alert the character to the presence of supernatural and magic creatures in the area. The ability can not pinpoint the location of the presence, but will give the psychic the impression of whether it is near (within 50ft/15.2m) or far (beyond 90ft/27.4m). It will also give the character a vague idea of how many presences there are; one (1 or 2), a few (3 to 6), several (7 to 14), or many (15 or more). The psychic can also sense human presences, but with much less accuracy. It is more of a feeling of "We are not alone." The person's distance is undeterminable and the number of people is limited to a sense of one or two or many (and that is only right 50% of the time).

See Aura

Range: 60ft and must be visible.

Duration: 2 melees (30 seconds)

I.S.P.: 6

Savings Throw: None, but a mind block will hide the presence of psychic abilities, the level of P.P.E., and possessions by a supernatural force.

All things, organic and inorganic, have an aura. The aura has many distinctions and can be used to see or sense things invisible to the eye. *Seeing an aura will indicate the following:*

- Estimate the general level of experience. Low (1-3), medium (4-7), high (8th and up).
- The presence of magic (no indication of what or power level).
- The presence of psychic abilities.
- High or low base P.P.E.
- The presence of a possessing entity.
- The presence of an unusual human aberration which indicates a serious illness, non-human, or mutant, but does not specify which.

Note: Can not tell one's alignment from "see aura".

See The Invisible

Range: 120ft/36m distances.

Duration: 1 minute per each level of experience.

I.S.P.: 4

Savings Throw: None

The character can see forces, objects and creatures which can turn invisible or are naturally invisible. Even if the creatures have no form per se, the psychic will be able to discern the vaporous image or energy sphere which is the being. This includes ghosts, entities and the astral body.

Sense Evil

Range: 140ft/42.7m area.

Duration: 2 minutes (8 melees) per level of experience.

I.S.P.: 2

Savings Throw: None

This psi-power is a much more refined ability to feel the presence of evil. All supernatural creatures radiate their alignment, good or evil. A psychic sensitive will automatically feel supernatural evil without



spending a single I.S.P. However, to get a clearer picture of the evil force(s) the character must open himself and use the sense evil ability.

The sense evil psi-power will indicate the general number of *supernatural evil*: one, a few (2-6), several (7-14), or many (15 or more). It can also register the intensity of the evil and pinpoint the general location of the source(s) to a particular room(s), possessed object or person, or distance; i.e. very near (within 15ft/4.5m), near (within 50ft/15.2m), or far (60 to 140ft/18.2 to 42.7m). The character can track the source of supernatural evil, like a bloodhound, by sensing how close it is to him.

Evil emanations from human beings are much less distinct and can *not* be felt unless the source-person has an immediate evil intention and has psychic powers or is psychotic. The former can mask his evil intentions with a mind block.

Sense Magic

Range: 120ft/36m area

Duration: 2 minutes per level of experience.

I.S.P.: 3

Savings Throw: None

The ability to sense magic is much like the sense evil psi-power. The psychic can feel magic energy, tell whether it is near (within 20ft/6.1m) or far (up to 120ft/36m away) and follow the emanations to pinpoint their source as a particular place, room, person or object.

Note: Invisible, magical supernatural creatures or objects can only be traced to a general area, like a specific room or corner. The psychic will also be able to sense whether or not an object has magic powers, if a person or item is enchanted/under a magic spell (this does *not* include psychic powers), when magic is being used within the area (120ft) and when a person is casting a spell (users of magic do *not* radiate magic energies until they call upon them).

Sixth Sense

Range: 90ft/27.4m

Duration: Until the danger passes or happens.

I.S.P.: 2

Savings Throw: None

The sixth sense is a power that gives the psychic a precognitive flash of imminent danger to himself or somebody near him (within 90ft). The character will not know what the danger is or where it will come from, nor who it will be directed at when in a group. All he will know is that something life threatening will happen within the next 60 seconds (4 melees)! The sixth sense is triggered *automatically*, without the consent of the psychic, whenever his life is in great peril or the life of somebody he greatly cares about (friend, loved one, etc.). The sixth sense is only triggered by an *unexpected, life threatening* event which is already set into motion and will happen any second. The power *can not* be called upon at will to sense for traps or ambush. Instead, it works like an automatic reflex. If the character has used all his I.S.P. the sixth sense is temporarily rendered inoperative.

Bonuses:

The sudden flash of insight provides the following bonuses. All bonuses apply only to the initial *melee* when the attack occurs.

+6 on initiative roll

+2 to parry

+3 to dodge

The character can not be surprised by a sneak attack from behind.

Speed Reading

Range: Self

Duration: 3 minutes per level of experience.

I.S.P.: 2

This is the ability to read and comprehend the written word extremely quickly. Speed of reading is 30 pages per minute/4 melees. The psychic will retain the information as he would normally. Highly technical texts will reduce the speed reading by half (15 pages per minute) and may require two readings.

Telepathy

Range: Read surface thoughts up to 60ft/18.3m away or two-way telepathic communication — 140ft/32.7m.

Duration: 2 minutes per level of experience.

I.S.P.: 4

Savings Throw: Conditional. When a person suspects that he is being telepathically probed he can resist, getting the *standard* savings throw. Mind blocks will completely prevent telepathic probes or communications as long as the block is up.

The power of telepathy allows the psychic to eavesdrop on what a person is thinking at a particular moment. This is done by focusing on that one person and picking up on his or her surface thoughts. *Surface thoughts* are those thoughts and musings uppermost in a person's mind. A deep probe into memory is *not* possible. Although the psychic can read the thoughts of several people, he can only do so by focusing on *one* person at a time. Simultaneous, multiple mind reading is impossible for the character.

Limited telepathic communication is also possible. The telepath can *send* a directed thought message to one person at a time. The message must be as brief and clear as possible. Like, "John, I need you immediately. Hurry!" or "Stop! Don't do that." "Come here," "Look Out" or "Press the green button." However, two-way telepathic communication is not possible except between two telepathic psychics.

Total Recall

Range: Self

Duration: Permanent **I.S.P.:** 2

The character remembers every word he reads. Specific blocks of information can be recalled in perfect detail at will. Each block of information costs 3 I.S.P. to recall in absolute detail. If all I.S.P. have been expended the memory is a little fuzzy, so that exact quotes and details may be impossible to recall. *Roll percentile:* 1-50—remembered

in full detail, word for word; 51-80 — details are forgotten, but the full essence of the ideas are clear; 81-00 — can only recall the most basic concepts; no details nor strong comprehension.

SUPER PSIONICS

Bio-Manipulation (the evil eye)

Range: 160ft/48.8m

Duration: 4-16 minutes (roll 4D4)

I.S.P.: 10

Savings Throw: Standard

The psychic is able to induce physical trauma to the nervous system of others by sheer force of will and psychic energy. This psi-power is often known as "the evil eye."

There are seven types of bio-manipulation effects. Each affects only one person per attack and can be used in any combination. Intended victims must be within line of vision or their exact location known to the psychic. Each costs 10 I.S.P. to inflict.

This psychic power enables the psychic to temporarily manipulate specific biological functions or conditions in human and animal life-forms. *The duration can be extended* 4-16 (4D4) minutes per additional 6 I.S.P.

Blind: Temporarily knocks out the victim's optic nerves, rendering that person quite helpless. Victims are — 9 to strike, parry and dodge.

Deafness: Can be caused by manipulating the eardrum. Victims can not hear anything, and are — 6 to parry or dodge attacks from behind. In addition, the shock of suddenly becoming deaf makes them — 3 to strike, parry or dodge any other attacks, and they automatically lose the initiative on all attacks.

Mute: Impairs the victim's vocal cords, making speech impossible. Victims are likely to be shocked and panic, making them — 2 to strike, parry and dodge for the first melee ONLY.

Pain: By manipulating the nerve centers the psionic can induce terrible pain, shooting throughout the body. Victims are — 6 to strike, parry, and dodge, and take one point of damage off their hit points (not S.D.C.) per each minute affected.

Paralysis: Immobilizes the motor part of the brain, causing legs and arms to stop functioning. Victims are completely incapacitated for the duration.

Stun: This attack disorients and confuses its victims. Victims forfeit one attack per melee, speed is cut by half, and are — 4 to strike, parry and dodge.

Tissue Manipulation: Affects the tissue's connecting nerve fibers which can cause a variety of effects. By irritating the nerve fibers a victim will suddenly feel itchy, as if suddenly breaking out in a severe rash. Through endothermic manipulation the victim can be made to suddenly feel cold or hot while everyone around him feels fine. This is done by manipulating the body chemical which absorbs heat. ALL three conditions are more annoying or frightening than physically impairing. In each case the victims are — 1 to strike, parry and dodge.

Savings Throw: Standard; if a character successfully saves against the attack he is not affected at all. This applies to all seven bio-manipulative attacks.

Bio-Regeneration (Super)

Range: Self

Duration: Permanent

I.S.P.: 20

Another bio-manipulation power that enables the psionic to direct

his psychic energies to immediate self healing. The character must concentrate for one full minute while his body instantly heals itself. 4D6 hit points and 4D6 S.D.C. points are simultaneously restored at the end of 60 seconds! As usual, there is no scarring.

Electrokinesis

Range: Varies

Duration: Varies

I.S.P.: Varies

Electrokinesis is a psychic power that allows the psychic to exert amazing physical control over electricity.

- 1. Electrical Resistance.** The psychic can manipulate his body so to become resistant to electricity. Up to 60,000 volts will inflict no damage or ill effect. Currents greater than 60,000 volts, including lightning and magic electricity, do half damage. **Range:** self. **Duration:** 3 minutes per level of experience. **I.S.P.:** 4.
- 2. Electrical Discharge:** The character can cause *static* electricity within a six foot (1.8m) area, as well as emit an electrical discharge by touch. *The discharge* can be a little jolt or inflict up to 1D6 damage as often as once per melee. **Range:** touch or 2ft distance. **Duration:** Instant. **I.S.P.:** 2 per each discharge.
- 3. Manipulate Electrical Devices:** Through focused thought the psychic can enforce a limited control over electrical devices, such as turn off and on light switches, computers, televisions, radios, blenders, microwave ovens, flashlights, toys (battery and plug types), windshield wipers, and all types of electrically operated appliances, toys and devices. He can also manipulate the controls of the device, such as volume, channel selection, tuners, speakers, change speed, dim lights, and so on. A dozen different electrical functions can be manipulated each melee. This can mean flicking the light off and on six times (12 functions/6 off, 6 on) or turn on the T.V., turn its volume up to the max. and turn on 10 other appliances (12 functions in all). **Range:** 45ft + 5ft per level of experience (13.7+1.5m per level). **Duration:** 2 minutes per level of experience. **I.S.P.:** 4. **Note:** The character does not need to see the devices to manipulate them. He can feel their presence.
- 4. Sense Electricity:** The psychic can sense or feel electricity and pinpoint its exact location with fair expertise. **Range:** 45ft + 5ft per level of experience. **Duration:** 2 minutes of extreme sensitivity when he can pinpoint every source of electricity in the area. **I.S.P.:** 2 per every two minutes. **Base Skill:** 55% + 5% per each additional level of experience. *A failed roll* means only 1D6 x 10% of all the electrical devices/sources of electricity could be sensed.

Empathic Transmission

Range: 60ft (18.2m)

Duration: 2D6 minutes (2 to 12 minutes)

I.S.P.: 6

Attacks Per Melee: Equal to the individual's psychic abilities; usually 2 or 3 psi-attacks per melee.

Savings Throw: Standard

This incredible ability enables the psychic to instill a powerful emotion into another living creature; person, animal or supernatural being. Each psychic attack/transmission can only affect one creature at a time. Several supernatural creatures have this ability or some aspect of it.

Despair or Sorrow: Invokes great emotional upheaval, deep sorrow and a sense of loss. There is a 50% chance of the victim surrendering or leaving without a battle; furthermore victims are - 2 to parry and dodge.

Confusion: Disorients the person so badly that he has no sense of direction, time, or of what is exactly going on. Victims are - 3 to strike, parry and dodge, and lose initiative in any combat.

Fear: Invokes unreasoning terror in all those affected. Victims are - 3 to strike, parry and dodge, plus there is a 66% chance that those affected will turn and run.

Hate or Anger: Will prompt those affected to act rashly, charge, attack, argue violently, etc. Victims are likely (60% chance) to attack, kill, harm, or betray those they dislike; + 1 (yes, that's plus) to strike, — 1 to parry and dodge.

Love or Peacefulness: Will induce a deep feeling of serenity, dispelling anger, hatred, sorrow, and so on. Hostile opponents are likely (60% chance) to reconsider their actions, deciding not to attack, show mercy, leave without being overtly cruel or destructive, halt a rampage, and so on. It does NOT make its victims docile sheep, but curbs hostility.

Trust: Will make its victims believe everything the psionic tells them, but only while under the empathic influence. Life threatening suggestions that go against deep-seated fears or ideals provide an additional savings throw against the suggested action; with a bonus of + 3 to save.

Group Mind Block

Range: 120 feet (36.6 m)

Duration: 10 minutes per level of experience

I.S.P.: 22

The master psionic can instantly erect a mental barrier or mind block to protect himself and those around him, within a 120 foot area. The group mind block works just like the individual mind block power. It can be a means of protecting those around the psychic from psionic probes and mind attacks, but it can also be used to prevent outside forces (good or evil) from communicating via telepathy or empathy. Thus, a villainous psychic can use the group mind block for his own evil purposes. Everyone within the 120 foot area of affect will be automatically blocked, but the affect is not detectable so they are not likely to know that they are being mind blocked (a detect psionics will indicate a group mind block)!

Hydrokinesis

Range: Varies

Duration: Varies

I.S.P.: Varies

This ability enables the character to use psychic energy to sense and influence water.

- 1. Sense Chemical Impurities:** The psychic can sense whether or not water is polluted/contains other substances. The exact nature of the additive or pollutant may be unknown, but he will know that it is not completely natural. *When sensing water, first roll to determine:*
1) **Pure or Drinkable** (nonhazardous/tap water) 70% + 5% per each additional level of experience. 2) **Second, Roll for general nature of the pollutant;** this identifies whether it is chemical/drug (not deadly, but will cause a reaction if drunk) or poison/toxin (deadly or harmful if swallowed). Success ratio in identifying the general nature of the pollutant is 35% + 5% per each additional level of experience. **Range:** self/six inches. **Duration:** One minute (4 melees). **I.S.P.:** 2 per minute.
- 2. Boil Water:** The psychic can increase the temperature of water raising it to boiling level within one minute (four melees). Up to one gallon (3.8 liters) can be affected. Once set a boiling, it will take the usual amount of time to cool. This power can *not* be made to boil the water or blood in a living creature. **Range:** 8ft (2.4m) + 2ft (.6m) per level of experience. **Duration:** One minute (4 melees). **I.S.P.:** 3 per gallon of water.
- 3. Water Spout:** An ability that enables the psychic to control and hurl water. The effect can be used to make water bubble (but not heated), shoot straight up like a geyser or a water blast hurling across a room like a short, powerful spray from a garden hose. Up

to one gallon of water per level of experience can be manipulated and hurled up to a distance of 20 feet. **Note:** The fluid must be 75% water to be controlled, such as punch, hot coffee, chicken soup, tea, kool-aid, etc. Forget about hurling ice (frozen does not count), paint, gasoline, or cake batter.

Making water leap with a life of its own can be startling to others and can make a great distraction if handled right. Hurling normal water or a cool drink into somebody's face/eyes will momentarily blind and surprise the individual, causing him/her to lose initiative and one attack that melee. Hurling hot or boiling water on the body (especially the crotch) will have the same results. Hurling *boiling water* in the face is horribly painful, causing 2D4 damage, loss of initiative, loss of all attacks for 1D6 melees and temporary blindness for 3D6 melees (-10 to strike, parry and dodge). Characters of a good alignment will not hurl boiling water in the face unless under an absolutely life and death circumstance.

Hurling range: 20ft/6.1m. **Duration:** Instant. **I.S.P.:** 5 **Bonus:**

+ 1 to strike. Making water bubble or rise up like a fountain can be maintained for up to 30 seconds (2 melees). **Note:** The psychic can influence up to one gallon of water per level of experience up to 20ft away, whether he can see it or only feel its presence.

- 4. Sense Water:** The character can sense the presence of any water exposed to the open air automatically at no cost of I.S.P. **Range:** 20ft/6.1m. **Duration:** Permanent. **I.S.P.:** None. **Note:** Underground rivers, airtight containers, etc., can *not* be sensed.

Hypnotic Suggestion

Range: 12ft/3.6m, with eye contact.

Duration: Varies with each circumstance and subject; rarely more than a few hours maximum.

I.S.P.: 6 per idea or attempt to implant an idea.

Savings Throw: Standard

The power of suggestion is a psychically boosted form of simple hypnosis. The power is limited to relaxing/calming somebody down, putting a person or animal in a light sleep, helping a person to relax and focus on a particular thought (good for helping someone to remember things) and implanting subtle ideas. The implanting or "suggestion" of an idea must be subtly worked into a comment. The suggestion must be kept simple and clear, such as "You know you can *trust* me" or "You feel like you *have a fever*. Yes, you do have a *fever*. You're burning up (with *fever*). You should *lie down*." or "You don't want to go there." The power of suggestion can also be used to make the victim imagine sounds and images. "Did you hear that? Listen! *Footsteps!* You hear *the footsteps* . . . yes, you do!" Or, "At *midnight the specter appears*. Everybody who is ever present *sees the specter at midnight*." The poor individual who fails his savings throw will, indeed, imagine he sees something at midnight.

Mentally Possess Others

Range: Touch

Duration: 5 minutes per level of experience.

I.S.P.: 30

The Mind Melter can completely take over and controls another person. The psychic essence of the controlling mind is transferred into the body of another individual. While in the victim's body/mind, the psionic retains all his own knowledge and identity. He can not read the mind of the person he now possesses, nor access any knowledge from the victim's memory. Only the physical body can be controlled, like a living robot.

During the period that the victim is possessed, the person goes into a trance state and remembers nothing about the things that happen while he is possessed. Meanwhile, the Mind Melter's natural body falls into a coma like state and is vulnerable to attack unless protected by others.

The possessing character can return to his own body at any time regardless of distance. When his essence leaves the body of the posses-

sed, the victim suddenly becomes conscious again, as if suddenly being woken up.

Mind Block Auto-Defense

Range: Self
Duration: Special
I.S.P.: Special

The moment the psychic is being mind probed, a personal mind block automatically snaps into place. It also alerts the psionic to the fact that he or she is being probed or attacked by empathy or telepathy. The Character must consciously and willingly lower the mind shield and open oneself to the psi-probes. Otherwise, the automatic defense mind block will stay in effect until the probe/attack is over.

The I.S.P. cost is different in that the character must permanently give up 14 I.S.P. when this power is selected. However, the mind block will automatically take place whenever under telepathic and empathic probes/attacks at no additional I.S.P. costs; it engages automatically.

Mind Bolt

Range: 100 feet (30.5 m) per level of experience.
Duration: Instant
I.S.P.: Varies

The psionic can focus his psionic energy into a powerful bolt of mental force and hurl it at a visible target with amazing accuracy. The amount of damage the bolt inflicts depends on the amount of energy expended.

6 I.S.P. = 1D6 S.D.C. damage, 12 I.S.P. = 3D6 damage, 20 I.S.P. = 6D6 S.D.C. damage, 40 I.S.P. = 2D4 Mega-Damage! All mind bolts are +4 to strike, but adding an additional 10 I.S.P. increases the strike bonus to +8 to strike. Remember, ley lines and nexus points increase the range and damage.

Mind Bond

Range: Touch
Duration: Special
I.S.P.: 10
Savings Throw: Standard

This creates an instant mind link between the psionic and the victim. When this happens, *each* will learn EVERYTHING there is to know about the other. This includes all skills, secret identities, phobias, etc. In both cases the memory is complete for only 3-12 hours (roll 3D4), after that, the characters must roll under 15% to recall any particular item. After one month *all* memories completely disappear. Players should bear in mind that only the psionic knows the memories are not permanent, thus the other person would have no reason to make notes or act quickly before the memories fade.

Note: Skills and skill bonuses are also temporarily absorbed, meaning that the psionic possesses all of his victim's skills and skill bonuses. Physical attributes, such as S.D.C. and attribute bonuses gained through physical training are NOT gained.

Alien or extremely mentally and/or emotionally disturbed minds can permanently impair the psionic's own mind as a result of the bond. If bonded with an alien or extremely disturbed person, roll on the following tables for a permanent insanity.

Roll on Insanity Tables

1-40 No Insanity
41-80 Phobia
81-90 Affective Disorder
91-00 Neurosis

Mind Wipe

Range: Touch
Duration: Special
I.S.P.: Special
Savings Throw: Standard

To mind wipe an intelligent creature the psionic must make physical contact, touching his victim's temples to erase whatever he desires. This is done by verbal suggestion and can erase any past event, knowledge, skill, and so on. The process takes about three minutes to complete.

The loss of memory is temporary, lasting 1D4 days for every 10 I.S.P. expended. The memory can be permanently erased if the psionic exerts 50 I.S.P. at once. A psionic can also permanently wipe a mind completely blank by expending 50 I.S.P. and four Mental Endurance (M.E.) points. This is an extremely gruelling process for the psionic and the loss of the four M.E. points is permanent, even if the opponent successfully saves against the wipe and is not affected.

Savings Throw: Standard; a successful save means the person is unaffected and still retains his memory.

P.P.E. Shield

Range: Self
Duration: 6 minutes per level of experience.
I.S.P.: 10

A psionic defense that can be used to prevent P.P.E. vampires, psi-stalkers, and mages from siphoning off one's psychic energy. The shield works similarly to a mind block, only it prevents others from draining one's P.P.E.

Psi-Shield

Range: Self
Duration: 5 minutes per level of experience.
I.S.P.: 30

A companion power to the psi-sword, in which the psionic can create a mega-damage shield out of thin air. The shield can be used to parry all hand to hand combat attacks including attacks from robots, power armor, and magic. The shield can not be used to parry energy blasts and projectiles. Shield M.D.C. is 80.

Psi-Sword

Range: Self
Duration: 5 minutes per level of experience.
I.S.P.: 30

A psi-sword is a mega-damage energy weapon that the psychic can mentally will into existence! The sword appears out of thin air, as a shimmering blade of energy that resembles a glowing sword. The sword's actual appearance will generally reflect its creator. A character who is impressed by strength and power will create a huge claymore like weapon. A character who prides himself on speed and agility is likely to create a rapier or saber type blade, while a hero who enjoys cunning and subterfuge may create a short sword. Each is equally powerful regardless of its form and size.

The creation of the psi-sword is a very personal thing and requires years of mastery and great psionic power. Unlike the cyber-knight, the Mind Melter can change the shape and even the color of the sword to fit his current mood.

The Mind Melter can create the psi-sword after only a few moments of concentration (about 15 seconds/one melee) and maintain it for five minutes per level of experience. This means a third level Mind Melter can create and maintain a psi-sword for 15 minutes at the cost of 30 I.S.P., while a first level character must expend the same 30 I.S.P. but can maintain the weapon for a mere five minutes. If the psychic is

knocked unconscious, the weapon disappears. Likewise, the character can willingly dispel the weapon with a thought (costs another 30 I.S.P. to create another).

Psi-sword damage: 4D6 M.D. at level three (one can not select this power until level three). Add 2D6 at levels four, seven, nine, twelve, and fifteen.

The psi-sword of the Mind Melter is incredibly powerful and, unlike the knight, can be adjusted to inflict a minimum of 2D6 mega-damage (M.D.) or increased by increments of 1D6 up to the character's current maximum. **For Example:** A fourth level Mind Melter can inflict a maximum of 6D6 M.D., but the character decides, for whatever reason, to decrease the power to the minimum of 2D6 M.D.; he can, at will, increase the damage capability of the sword by increments of 1D6 M.D. up to the maximum of 6D6 M.D. (3D6, 4D6, 5D6, and 6D6).

Pyrokinesis

Range: Varies

Duration: Varies

I.S.P.: Varies

Pyrokinesis is a psychic power that gives a character the power to manipulate fire.

- 1. Fire Resistant:** The psychic can endure great heat and fire with minimal ill effect. **Damage** is reduced by half. Magic fires do full damage. **Range:** Self. **Duration:** 5 minutes per level of experience. **I.S.P.:** 2.
- 2. Spontaneous Combustion:** The ability to create a spark that will ignite combustible material, such as paper, old rags, dry grass, gasoline, etc. Note: Human hair should not be considered a combustible material. This is a slow fire, starting with a tiny spark and grows. Initially, it is not a roaring blaze. **Range:** Can be ignited up to 30ft away (9.1m). **Duration:** Instant; fire will last and spread until it is put out or there is nothing to burn. **I.S.P.:** 2.
- 3. Fuel Flame:** The character can feed the fire with psychic energy, doubling it in size. **Affects** a 10ft (3m) area. **Range:** Up to 30ft + 5ft for each additional level of experience. **Duration:** Instant. **I.S.P.:** 4.
- 4. Extinguish Flames:** The power to instantly put out an area of fire. **Affects** a 15ft (1.5m) area of fire. **Range:** Up to 30ft + 5ft per each additional level of experience. **Duration:** Permanent until set on fire again. **I.S.P.:** 4.
- 5. Create Flame:** The incredible ability to create fire out of thin air. Can be an 8ft pillar of fire affecting a 4ft (1.2m) area or a 6ft wall of fire stretching six feet long (1.8m) plus one foot per each additional level of experience. **Damage:** 4D6 from the pillar, 6D6 from the wall, plus both have a 72% likelihood of setting any combustibles they touch ablaze (including cloth, rugs, curtains furniture, etc.). **Range:** Cast up to 30ft + 2ft per additional level of experience. **Duration:** 2 minutes per level of experience; longer if it sets other things on fire. **I.S.P.:** 20.
Another fire creation ability is the hurling of *afire ball*. **Damage:** 6D6, **Range:** 30ft + 2ft per each additional level of experience. **Duration:** Instant. **Bonus:** +2 to strike. **I.S.P.:** 25.
- 6. Sense Fire:** The psychic can sense or feel the presence of fire and pinpoint its exact location. **Range:** 100ft + 5ft per level of experience. **Duration:** 2 minutes of extreme sensitivity when he/she can pinpoint the exact location of every fire in the area. **Base Skill:** 90% success ratio. A *failed roll* means only 2D4 x 10% of the fires can be located by sensing. **I.S.P.:** 2 per every 2 minutes.

Telekinesis (Super)

Range: 100 feet (30.5 m) per level of experience.

Duration: 2 minutes per level of experience.

I.S.P.: 10 to lift/move/hurl an object that weighs 100 lbs (45 kg), + 10 I.S.P. per each additional 100 lbs.

Damage: 1D4x10 S.D.C. per 100 lbs of weight. Note: 100 S.D.C. points equals one (1) M.D. point.

The power is basically the same as the ability described in the *Physical Category* of psionic powers, but greatly enhanced. Differences are increased range, dramatically increased weight and damage. The character can use telekinesis to manipulate as many as one object per level of experience, as long as the combined weight does not exceed the total weight capacity. **Combat Bonuses** are the same as the non-super telekinetic power.

Telekinetic Force Field

Range: Self or 40 feet (12.2 m) per level of experience.

Duration: 10 minutes per level of experience.

I.S.P.: 30

The psychic can instantly erect a force field around himself or others in the blink of an eye. If the creation of the force field is to parry an attack, the psionic must roll a successful parry to see if he was able to create the field before the attack strikes. A successful parry means the force field beat the attacker's strike and it absorbs the damage.

The force field can be made so that it only encircles its creator or as large as a 10 foot (3 m) area per level of experience and can be created yards/meters away (but always within the line of vision). The smallest force field possible covers about a three foot area (0.9 m).

The field is a mega-damage structure with 25 M.D.C. per level of experience.

Once one field is created, the psionic can create as many others as his I.S.P. will allow. All must be in the character's line of vision. The force field(s) will remain in place until all its M.D.C. is destroyed or its creator dispels it. If the Mind Melter is rendered unconscious or killed the force fields instantly vanish. However, the psionic can leave the area and the force fields will remain in place until the duration time limit expires.

People may be able to move around inside a force field, but the force field itself, can *not* be moved. The force field is actually a force bubble and is air tight.

Telemechanics

Range: Touch or 5ft away (1.5m)

Duration: 10 minutes plus 2 minutes per level of psionic.

I.S.P.: 10

Savings Throw: None

This ability allows the psionic to mentally communicate and understand machines. This psi-power is a bizarre combination of object read and telepathy, except that it applies to mechanical devices only.

By touching any non-artificially intelligent machine, whether it be a bicycle, gun, car or airplane, the psionic will instantly have a complete (although temporary) knowledge of exactly how the machine operates. I must stress that the psionic knows *everything* about the machine; the complete schematic diagram and operation knowledge are clearly seen in his mind's eye. The level of skill expertise is equal to 80% scholastic skill.

When touching an artificially intelligent machine, i.e., computers, the psionic not only understands everything about its operation, repair, access codes, etc., but can actually communicate with it telepathically. This means he can tap into a computer's memory bank without using a terminal because the information would be sent directly into the psionic's mind. Remember, the telepathic link and memory are temporary abilities (although a total recall would be able to call up small bits of info). The psionic's skill knowledge is equal to 88% skill proficiency and applies to *all* aspects of the machine, its operation, repair, special codes, etc.

The Time Before Rifts

From Erin Tarn's book **HUMANKIND'S RISE FROM CHAOS;**
Circa 63 P.A.

Often I am asked about the Time Before Rifts. What was our Mother Earth like and how did the rifts come? To the last question, how did the rifts come, I must offer the unsatisfactory answer that neither I, nor anybody else, knows. But if there is an answer I will do my best to unearth it.

As to the Time Before Rifts, I can tell much. The world was populated by humankind. There were no mutants, no D-Bees, no Juicers or Crazies, no vampires or dragons, no techno-wizards, or magic of any kind. Not real magic, at any rate.

Nor were there any wildernesses, save for the few parks and preserves that some of the old empires saved to remind them of their past. But these were prim and safe places for people to visit, like a potted plant or farm. Not at all like the fearsome wildernesses that we know today.

Huge, towering buildings called "skyscrapers," because they rose high into the sky like a mountain, filled the land. I have seen pictures of these cities, but find it difficult to find the words so that all who read this can understand. For those of you who have seen the growing cities of Chi-Town and Quebec, these cities resemble those before the Time of Rifts. Only the old cities filled the wildernesses and covered the land. I will try to include pictures wherever I can to give life to my words. A typical city would house millions of people. Long concrete roadways would connect thousands of cities and billions of people. It is even said that man had set foot on the moon and could travel the space-ways to get from one end of the world to the other in a matter of hours. How this was accomplished without traversing a Rift is not known.

A few generations before the Time of Rifts, the world enjoyed a great peace and prosperity. The leaders of the day called it the "Golden Age" of man. During this time, many great improvements in medicine and science took place. It was during this period in history that the sciences of bionics, cybernetics, and all types of human augmentation were developed. At the same time, the societies of the world, which had been at conflict for generations, put aside their differences to work together in peace and harmony. Sharing their ideas and technology to build a better world. Trade between each soared and many of the poor became wealthy and joined the world empires. China, Korea, Argentina, were just a few of the empires that rose to stand among the old empires.

I can not help feeling, however, that this was not so much an age of philosophical peace and prosperity as it was a period when the empires simply forgot their differences.

The world seemed to have been enraptured with the notion of "human augmentation"; the idea that the frail human body can be improved in any number of ways. The recordings of those days are filled with the accomplishments and the accompanying wealth of each new discovery. These discoveries would reshape the world, as our forefathers knew they would, but this obsession overshadowed other problems.

For all the accomplishments, there still existed a sort of rivalry between the empires, and soon, a sort of unofficial race began to see who could develop the new sciences faster and make them better. At first, everybody in the race grew powerful and wealthy. This is the so-called Golden Age. As long as the empires, old and new, prospered, they were happy. The old saying, "ignorance is bliss" seems an ironic phrase to use to describe this fabled period of learning, yet I fear it is appropriate. From all that I have learned, the leaders of the day were shortsighted or entirely blinded by the wonders of the Golden Age. They continued to create and produce without thought as to what it was they were accomplishing or where it was all going.

Suddenly, the era of enlightenment stopped. It was as if one of the empires' leaders woke up one morning with a new perspective and shouted to all the others, "Stop! Look at what we are doing. Who is to benefit? Who holds the power now?" and every power of the day stopped and looked, and did not like what they saw. Suddenly, many realized that they were so caught up in the race that they had not noticed that they were losing. Others found that they were so consumed by events that many other problems had come to stand on their very doorsteps. Worse, every empire stopped to examine themselves, and in so doing, examined their rivals. Somehow, none had realized what each other had created, or how some had grown more powerful than others.

As unexpectedly as it had begun, the age of enlightenment ended. The empires looked at each other with suspicion and envy. Soon fear and distrust replaced the happiness and sharing of the Golden Age. The problem? The empires had set out to create *improved* humans. One day, they suddenly realized that they had succeeded beyond their wildest dreams. The problem, not all held the secrets of creating super-men. And among the creators of super humans some were more super than others. They then asked themselves how could these super-men be used and the answer frightened them all. War!

At first, the empires tried to talk and hoped to establish a mutual sharing of each other's knowledge, but not all would agree. This only made matters worse. Soon none would share any ideas. The best that could be achieved was a world pact in which each empire swore an oath to never use their secrets in war. But the definition of what could and couldn't be used, or what even constituted a war, was vague and unacceptable to many, so the pact was seen as a blanket to cover the problem, not solve it. None could offer a better solution.

All this fear caused the empires to slow trade between each other. Some stopped completely. This created widespread poverty among many of the empires. Some saw this as the first steps toward war; to undermine and then conquer the weak. The world became a cold, silent place where brother did not trust brother. Still, by today's standards it was a paradise and the average person had little concern regarding the affairs of the empires.

Sadly, the situation worsened. One of the last recorded events from the Time Before Rifts tells of a small military skirmish in one of the South American empires. One empire sent a small force of the infamous *Glitter Boys* to suppress rebels on its border. Only a dozen Glitter Boys were sent into the area. They routed the rebels and pursued them *across* the border, into the neighboring empire. The neighbor responded to this action as an act of aggression and sent troops to repel the invaders. The exact accounts of what happened, and who was at fault, differ greatly, but without a doubt, a terrible battle erupted. It was over in the horrifying, short period of an hour; a score of tanks, 1200 soldiers, and the town of Guada Marta were laid to waste. 24,000 townspeople were killed. An additional 800 soldiers and 13,000 townspeople were injured. Of the twelve Glitter Boys responsible for the assault, only one was destroyed.

The invading empire who dispatched the Glitter Boys refused to apologize, defending its actions as self defense. The world empires were torn asunder, some condemning the actions, others supporting them, still others, lost to confusion. Regardless of who was at fault, the battle served as a dramatic illustration of what the new technologies could do in a war situation. Those without the super-science felt naked and defenseless (and they were). Fearful, small empires joined larger, more powerful empires, polarizing the people, creating ever more distinct lines of imperial power. The "New Cold War," as it was called, saw all the empires begin to use their knowledge for the creation of war machines and super-soldiers. This is when the Glitter Boys, Juicers, M & M's, Bots and Crazies were fully developed.

The previous decades of peace were lost.

Sometime shortly after this, perhaps within as little time as a decade, the Time of Rifts occurred and reshaped the world.



A view of the transformed Earth. Even from space, the most powerful ley lines can be seen.

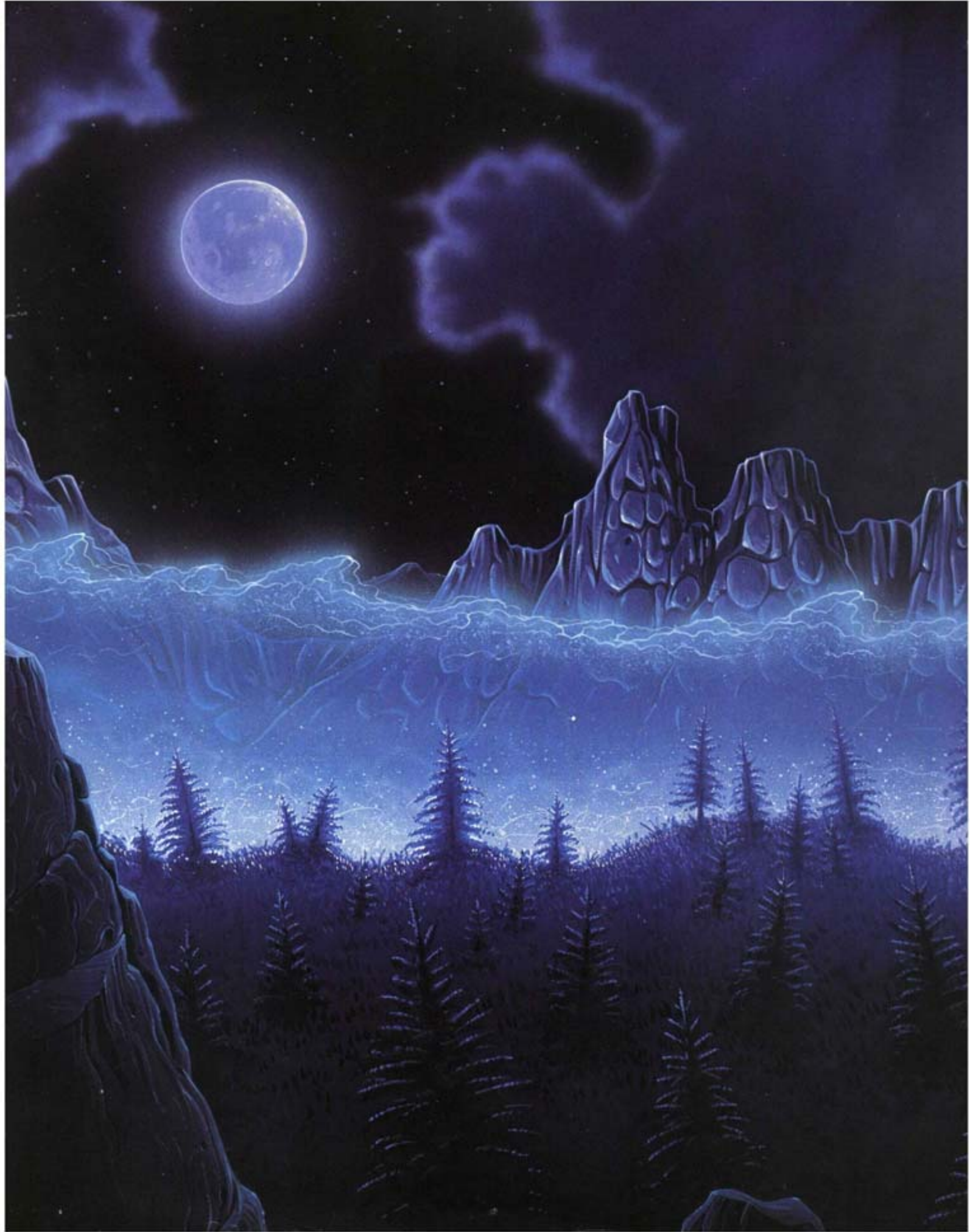

Ley Line energy ripples across the land. A group of adventurers marvel at the 300 foot wall of magic energy that is easily visible at night.

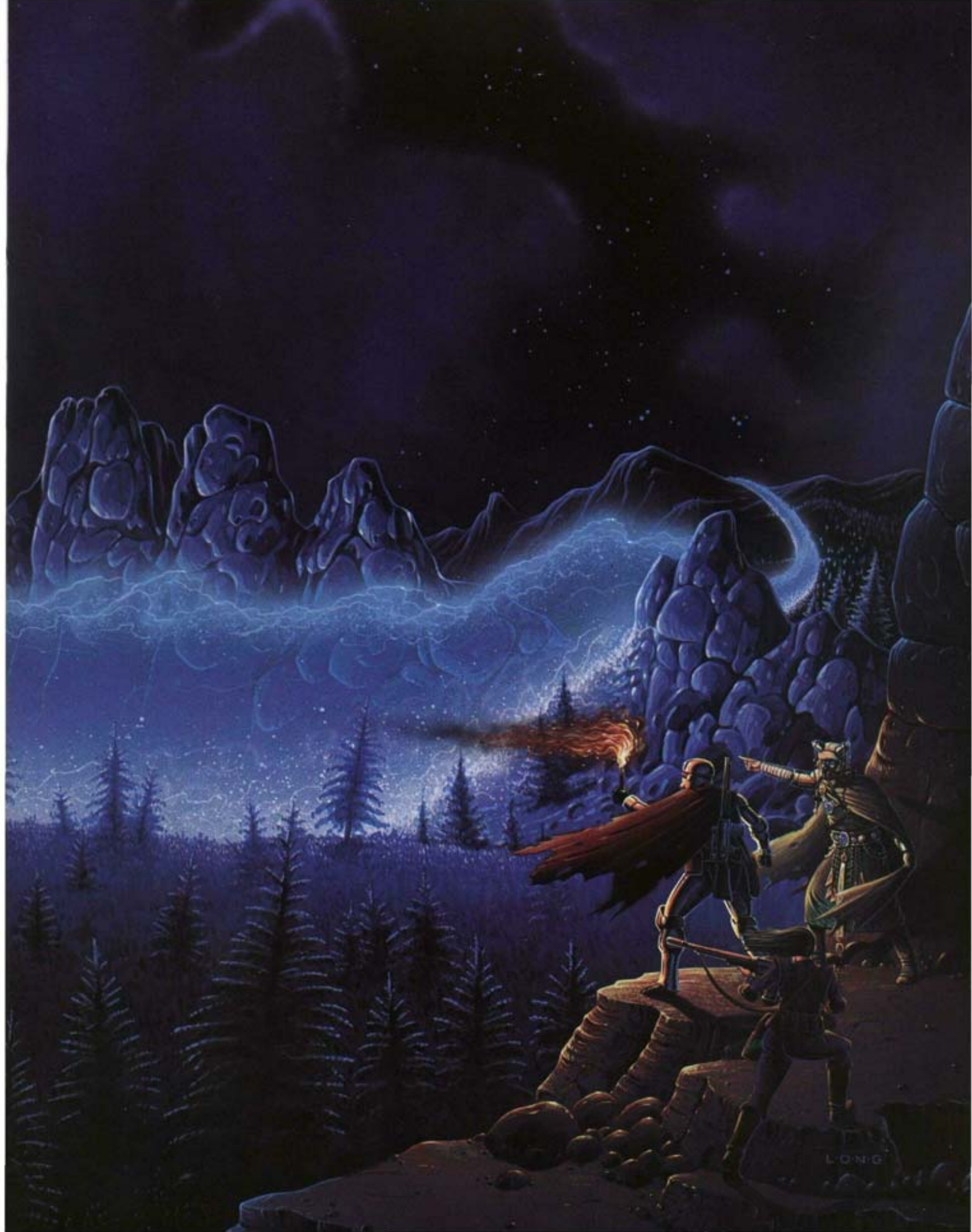

LONG



A swarm of insect-like humanoids swarm out of a rift

The Xiticix are a mysterious race of insect-like humanoids



A typical Ley Line walker, a practitioner of magic



A demon from a rift



Vampires roam the Earth. Marauding tribes hunt along the Rio Grande River.

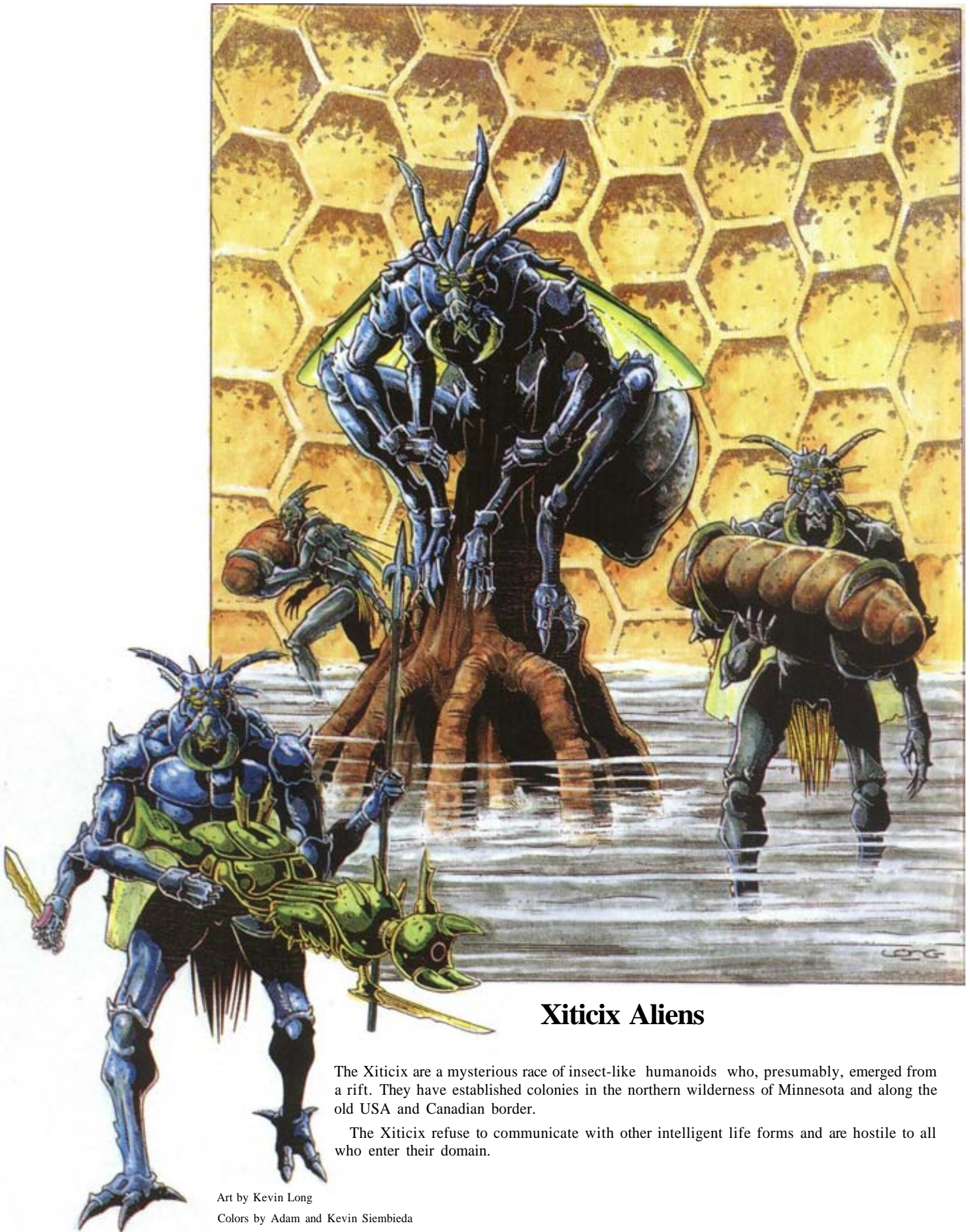

Xiticix Aliens

The Xiticix are a mysterious race of insect-like humanoids who, presumably, emerged from a rift. They have established colonies in the northern wilderness of Minnesota and along the old USA and Canadian border.

The Xiticix refuse to communicate with other intelligent life forms and are hostile to all who enter their domain.

Art by Kevin Long
Colors by Adam and Kevin Siembieda

A World Overview

Through the eyes of Erin Tarn

What follows is a brief world overview written by historian and explorer, Erin Tarn. It is an excerpt from the most recent book that bears her name, **Traversing Our Modern World**. The book is an unauthorized collection of letters and notes from Erin Tarn to various colleagues, and several recountings from people who spoke to her at length on world subjects. The correspondences span the last two decades and include several dozen missives that are as recent as three years old.

Without a doubt, it is the most accurate and inclusive journal/atlas of the **Rifts** world available on the black market. Unfortunately, that is not saying much, as even the intrepid historian Tarn has vast gaps in her knowledge of the world. It is this lack of complete knowledge that made her refuse to write the volume herself, or personally endorse the much sought after publication.

The excerpt which follows is a world overview commissioned by the Council of Learning at Lazlo. It is also the Council at the Free State of Lazlo who have published the tome.

Traversing Our Modern World is forbidden in all Coalition States and affiliates. It currently ranks number one on the list of outlawed books (several of her other books are among the top 20). The Coalition has just recently denounced the 63 year old historian as demonic and a criminal of the Coalition States! Her whereabouts are not known.

The World, Circa 100 P.A. (Post-Apocalyptic Calendar)

I still can not believe that I have let you rascals buy me (or more to the point, my services) for the price of safe passage to England. I again blush at my shameless behavior in my quest for knowledge and adventure. Still, I must console myself in the knowledge that your hearts are good and that, at worst, I help noble minds reach out to discover a world that I have barely glimpsed. But enough of my schoolgirl musings, let me set about to the task of chronicling my journeys. I will begin with a summary outline and elaborate on the places and points which seem to most deserve it in other chapters.

A Global Side Note: Before I go into my overview and discuss specific lands, I feel that it is important to point out a few generalities I have observed. The entire world is mostly wilderness with scattered little towns, villages, and outposts. Cities are fairly uncommon, generally speaking. The environment, regardless of the level of technology or magic, is feudal-like, with kingdoms rather than cities, states, provinces, or nations as thought of in the 20th Century.

The majority of these feudal kingdoms are ruled by, or appoint, or employ; a protector or group of protectors, much like the knights of old. The protector(s) is always a powerful warrior, frequently armed with power armor or giant robot vehicle. Men of arms seem to be the norm among these champions, but they can be mages, psychics, mutants, and even monsters. If a stranger or invader threatens the kingdom, the champion/protector(s) rises to meet the threat. In many cases, an invader who wishes to rule the kingdom, or who seeks to replace the protector as the kingdom's champion, challenges the individual to personal combat, the winner takes all. A battle involving only the champion(s) and the challengers prevents large-scale death and destruction to the kingdom. Of course, it does leave the community vulnerable to the whims of their new lord or champion. These contests of combat are not necessarily battles to the death, but often end up that way when the stakes or emotions run high. However, defeat followed by public banishment and/or destruction of the loser's power armor or main weaponry is often an acceptable alternative.

In some cases, depending on the people involved and the circumstances, a kingdom may refuse one on one combat between their champion and challenger. In this situation, the champion leads the defense of the kingdom, directing its army as a general.

The concept of a champion who serves as protector and peacekeeper has been adopted by many towns and villages as well. Unfortunately, this has often led to establishing tyrants as rulers or high officials. Some of these tiny communities suddenly find themselves in a worse position than they were in before they found their despot protector. The only way to remove such a powerful person(s) is to attempt an assassination (usually beyond the morals and capabilities of most peasant towns) or enlist the aid of mercenary or new, hopefully more benevolent champion to challenge and defeat the present tyrant. This is often where the valiant **cyber-knights** can save the day, although very, very few will ever stay on as champion.

The cyber-knights remind me of the Pre-Rift Texas Rangers of the American ancient West (especially the heroics of the famous *Lone Ranger* and his Indian companion). The knights roam the land looking for bandits, tyrants, and evil in all its forms and destroy them. The stories of a lone cyber-knight riding into an insignificant town and dethroning maniacal champions and evil lords must number into the thousands. The knights will also fight off D-Bees and mages, rout bandits, and slay dragons. The knights rarely ignore a plea for help.

The wandering hero, like the cyber-knights, presently seems to be a phenomenon limited to our North America, although I know of knights who have travelled to The Land of a Thousand Islands (South America), Atlantis, and the Euro/Asian continent.

Now on to specific lands. I will start with *home*, the Old World North American Continent (it is a pleasure to be writing to learned students so that I do not have to stop to explain some forgotten American term or place).

1. The Northern Wastelands: Alaska, Yukon Territory, Northwest Territories, Victoria Island, Newfoundland, and Greenland. Although I have never travelled that far North, I have it on good authority that it is a frozen and desolate land of ice and forest. I am told that few humans, D-Bees, and demons wander these vast expanses. Probably true, but I must question the term wastelands. Too much of the unpopulated wilderness is disregarded as "wastelands," yet these very places once flourished with human life. The old provinces of Alberta, Saskatchewan, Manitoba, and Quebec are considered to be wastelands by most, but we know that life, both human and alien, abounds in these lands. So who can truly say what may or may not await the bold in these so-called Northern Wastelands.

2. The Northern Americas/Old Canada. The territories north of the old American Empire were once the most populated of the landholdings of the Canadian Empire. Today, like much of the old American northwest, they are an endless expanse of forest. My heart flutters with joy to see that the Earth has so easily renewed itself in only a few centuries. This is a rich, lush land waiting for humankind to reclaim it. However, I fear humans may not be up to the task, as already, numerous alien life forms are known to inhabit pockets of the wilderness. I have personally seen *Xiticix* insect warriors as far north as Hudson Bay in Manitoba and I'm told their scouts have been seen up into Saskatchewan.

3. Alberta and Saskatchewan, places of magic. Ley lines run thick along the mountains and prairies of these old Canadian provinces, and with them, monsters. I tend to agree with the stories that credit a

rift in Saskatchewan for the origin of the *Xiticix*. Many are the tales of demons, dragons, and fiendish monsters that emerge from rifts located in these beautiful lands.

The place once known as Calgary is reputedly a ley line nexus of incredible magnitude and I believe it to be controlled by demonic forces. My readings of the works of 20th Century scholar/mage, *Victor Lazlo*, confirm that this area has been known to be strong with magic for all of time. I have followed the trails of antiquity described in Lazlo's books, from forgotten indian mound to medicine wheel, and have found new megaliths and stoneworks erected to mark the locations of magic leys and nexus points. Many of these seem non-human in design or scale. To add to my suspicions, the few local folk who live in the region are simple peasant farmers and shepherders who know nothing about magic, except to avoid the places where megaliths reach for the sky. I have spoken to perhaps a hundred, scattered across the land, and not one person has seen those responsible for the building of the stone megaliths and circles of power. Most foreboding.

4. America's West: California, Oregon, Washington. The America of old is buried and lost. Except for an occasional ruin, the cities of the West have fallen into dust. From California to Vancouver there is only wilderness. Knowing what I do as a historian, I know that the "West Coast" was a center of civilization and culture in the American Empire. But to look at it today, even I have difficulty believing that millions of people once thrived here. There is simply no trace of human-kind ever having set foot on this land. This would seem to confirm the legends of the Rifts' sudden appearance and how the oceans swelled and the earth quaked, completely obliterating Earth's greatest cities. Truly unbelievable.

Today, California through British Columbia is a blend of sub-tropical jungle, forest, and grassy plains. It is alive with wildlife, but few are the people. Another wilderness waiting to be reclaimed.

5. Nevada, Utah, Colorado, Arizona, and New Mexico. The famous American Old West, like the western coastline, is wilderness. The scenery is impressive and much different than the lush, green and rolling hills of the east and northwest. Out here, the landscape is marked by towering mountains, gaping canyons, vast deserts (all of *Nevada* is desert), prairie grasslands, rolling, grass covered hills, and strange flora and fauna. But there are also places of forest, especially near the mountains.

The ruins of ancient, pre-Rifts, cities are remarkably preserved. I understand that as many as one in ten pre-Rifts cities still stand. They are in ruin, but they have not yet crumbled into dust. The ruins are often the sites of small human (and non-human) settlements. However, there is nothing here that we would call civilization. It is a savage land where, like most of the wilderness west of the Mississippi, the law of the land seems to be brutality and/or survival of the fittest. Right is might and roving gangs, degenerate mercenaries, and petty tyrants are the lords of might. Bandits and mutoids are especially common in these areas.

6. Mexico. I've never been more than a few miles beyond the Rio Grande so my knowledge is limited. I understand that the landscape is more or less an extension of the American West, but turns into tropical forest as one goes deep south. Mexico is populated by quiet peasant communities of farmers. Certainly, there is no *known* industrial center nor modern cities.

Rumors abound of seething ley lines and kingdoms of *vampires*. I have heard too many tales to completely rule out the horrible notion that vampires rule old Mexico. We have all heard about roving gangs of vampires that even plague the Coalition cities from time to time, but this is even more disturbing. First, there are definitely barbaric tribes of vampires who run wild in Mexico and *Texas*, especially along the Rio Grande River. This is common knowledge to all who live in the area. But now, stories emerge of a vampire empire located in the heart of old Mexico. An empire composed of three great cities, each centered

around a ley line nexus point, and surrounded by scores of smaller villages. The cities offer the greatest luxury and the greatest number of vampires; I am told, one for every ten humans. The cities utilize both magic and technology, although separately, not the synthesis we see in techno-wizardry along the Mississippi. Here humans are bred as slaves and food, like work animals and cattle. Believe it or not, I am told this has been the way for a hundred years.

I ask, how can this be? How is it that no one has learned this terrible truth? The answer I receive is chilling. These are civilized vampires. Clever and calculating. They encourage the nomadic vampire tribes to continue their barbaric ways and horrible raids against human life along the northern border. A tactic intended to frighten away the curious. Meanwhile, the civilized manipulators conceal their inhuman nature among the trappings of humanity and civilization. They do not invade other human kingdoms, but keep to themselves, slowly, quietly expanding. The cities are surrounded by peaceful villages populated by humans, with only a few overseers left behind to keep things under control. Inside the city, the vampires are lost among a thriving human populace, so all appears normal. There is no outward sign that these people are slaves who build and maintain the city and toil in the fields for inhuman masters.

The sadness I will feel will know no bounds if this next portion is true. The majority of humans are said to be happy or at least complacent. They live simple, unworried lives as cared for pets, slaves, and companions. This is the life the people have come to expect. Apparently, the vampires do not kill their human host population, but nourish and protect them so that they may feed on them time and again, generation after generation. Those who attempt to flee or fight are killed and the world knows none the difference.

Impossible? A wild yarn to scare little children? Perhaps. Yet I think not. While I had heard an occasional wild tale regarding the wilds of Mexico, I had dismissed them as foolishness. Then, one night, along



the furious river still known as the *Rio Grande*, I met a convincing stranger. He knew who I was and it was he who told me what I have related for the first time on paper. Then he smiled, his fangs glinting in the light of the moon, and rasped, "Now, Erin, you die." It was only by the courageous actions of my dear friend Tyrone, a cyber-knight of some repute, that I survived. For years we convinced ourselves that the story was the malicious lies of a wild vampire, but I can fool myself no longer.

The silliness of an old woman? I do know of individuals who have sailed the Gulf of Mexico and others who have traveled the Gulf Coast with no reports of vampires or demonic empires. But none I have spoken to have traveled more than 40 miles inland. Believe what you will, but consider this. Mexico is known to have a large human population, yet is not known for the political upheaval experienced in most of the world. Where are the feudal kingdoms? The conquerors? I personally know of at least three armed forces that rode into old Mexico for the intent of conquest. All three were well suited to the task. All three simply vanished. None of us, including myself, have ever stopped and seriously asked ourselves what happened to these conquering armies. The great Victor Lazlo knew Mexico to be a place of great magic and writes of "Aztec" temples and pyramids which marked some of the most potent ley line nexus points of his day. Could these sites, known to Lazlo and ancient man as places of great magic, be the locations of the three vampire cities? We know that Mexico and South America were ravaged by the coming of the Rifts. Presumably, magic energy is great there, yet we hear little about them in the way of magic.

Mexico is remote and far from the burgeoning kingdoms east of the Mississippi and so it is easily forgotten. Its people are quiet and never troublesome, so they too are forgotten. But why is it that we have never heard of Mexican conflicts, or of the fates of the would-be conquerors who invaded her lands. Why were they never heard from again? I have met individuals from every walk of life and virtually every corner of the world, but not one has been to the Mexican interior, nor have they met any adventurers from the interior. There is something wrong. My scientific mind sees too many unanswered questions and too few logical answers.

Lastly, dear Tyrone could no longer let these questions go unanswered and gathered an expedition to explore Mexico. His departing words to me were, "I swear to you that I shall return with the answers we seek." He rode into Mexico with four stout knights, a borg, a psi-hound, and techno-wizard, all of great experience, none of whom have ever returned. It has been over 20 years. I pray for their souls.

7. Wyoming. The American sector once known as Wyoming is a range of grassland and dense forest where faerie folk abound. There is a feeling of magic about the entire place, although there are no apparent mystic or supernatural forces at work. I had the opportunity to visit the famous medicine wheel secluded up in the *Big Horn Mountains*, as described in the writings of the famed 20th Century scholar/mage, Victor Lazlo. I was amazed to see that it still stands, not a stone disturbed. Our mystic guide reported that the wheel was a small nexus point for three ley lines and rippled with magic energies. Yet, unlike most ley lines, we could not see any of the familiar blue-white glow of ley line energy even at night.

We set our base camp not far from the wheel to spend the night. No signs of intelligent life can be found for hundreds of miles and yet we could not shake the feeling that we were not alone. Three times, that night, my fellow adventurers and I woke simultaneously, gripped in fear. Yet each time there was nothing to see, nothing to fear. Years later, I was told a convincing story of how, on one eve of a summer solstice, energy erupted from the wheel and a rift crackled to life. A horrendous, laughing demon, towering well over 30 feet tall, set one foot out of the rift, leaned the bulk of his personage out of the dimensional doorway (but never stepped entirely out) and flailed about at the pitiful humans who had built their camp on the site. The demon devoured

15 men and six pack animals before slipping back into its world, laughing all the while. Only three people survived that night of horror. I've heard similar tales from third parties, but this recollection came from one of the three survivors and I believed him. I could see the horror of that night still dancing in his eyes and the terror leapt from his trembling lips.

Local legend insists that the wheel is the home of "little people" who live in caverns beneath it and feed on the big horn sheep. This is fascinating, as Victor Lazlo recounts an identical legend from the extinct Shoshone Indians.

8. Montana and Idaho. This land is similar to its neighbors to the west and north, a wilderness of forest broken by occasional grasslands and mountains. I have never been to either, but assume that since they border the magic rich Wyoming and Alberta, they are also strong in mystic energy and populated by creatures not of this Earth. Rumor has it that the cyber-knight monastery, headmastered by the legendary Coake, is located in this region. Of course, I've heard the same to be said of Saskatchewan and Manitoba and a half dozen other areas.

9. The Dakotas, Nebraska, Kansas, Oklahoma. This is the new frontier. Although mostly wilderness, new human settlements seem to be prospering. Cyber-knights are known to roam these lands, for many are the tales of their valor among the tiny settlements.

10. Minnesota, a place under siege! This area was a haven for civilized people. Its many small communities and feudal kingdoms were mostly dedicated to peace and learning. The communities are both composed of humans exclusively (along the southern borders of Chi-Town), and an eclectic variety of races coexisting in other communities farther north. These multi-racial towns have prospered and grown over the last 40 years, though still tiny by Coalition standards. This prosperity has made Minnesota human neighbors bitter and the Coalition nervous. Its close proximity to the Coalition State Chi-Town (which includes the northern half of old Illinois and most of Iowa) has made it a target of their paranoia and imperial expansion.

Just recently (*Editor's note*: August 101 P.A.), CS troops have been dispatched to Minnesota. Mutant Dog Pack Troops and Psi-Stalkers have been sent to roam the territory and progress ever northward. They spearhead reconnaissance and engage in search and destroy missions throughout Minnesota. Human troops patrol the borders. Recent indications are that a full invasion is imminent with SAMAS troops and Borgs to lead the way.

The Coalition's immediate opposition will be the city **Tolkeen**, that stands on the bones of the pre-rifts city, Minneapolis. Without question, Tolkeen is the largest and most powerful city in the area. It has good industry and a formidable magic community composed of technowizards, line walkers, psychics and other mystics. To my limited knowledge, it is second only to Lazlo in mystic knowledge and scholarly pursuits. The city's greatest strength is that it rests on the shoulders of an incredibly powerful ley line nexus (at old Minneapolis) and is surrounded by a network of nearly 100 ley lines. Despite this, I fear Tolkeen has no hope for survival against an all-out siege by the CS.

The real opposition that awaits the Coalition is the alien insect race known as the *Xiticix*. These humanoid insects appeared about 20 years ago and have already earned a reputation as ferocious and merciless warriors. The Xiticix society seems to function much like that of earth bees; they live in large hive communities, and are ruled by a queen. The aliens are intolerant of all other humanoid races and aggressively protect their domain. Currently, that domain includes a central hive city located near old Duluth, with several smaller communities stretching to Winnipeg. Many races have expressed the fear that the Xiticix's numbers are growing rapidly and that they may pose a major threat to all intelligent life. Xiticix scouting parties have been reported in Saskatchewan, Manitoba, Minnesota, Iowa, Illinois, Nebraska, and the Dakotas. Perhaps the CS has decided to eliminate the potential alien threat before they actually become a serious threat to the empire.

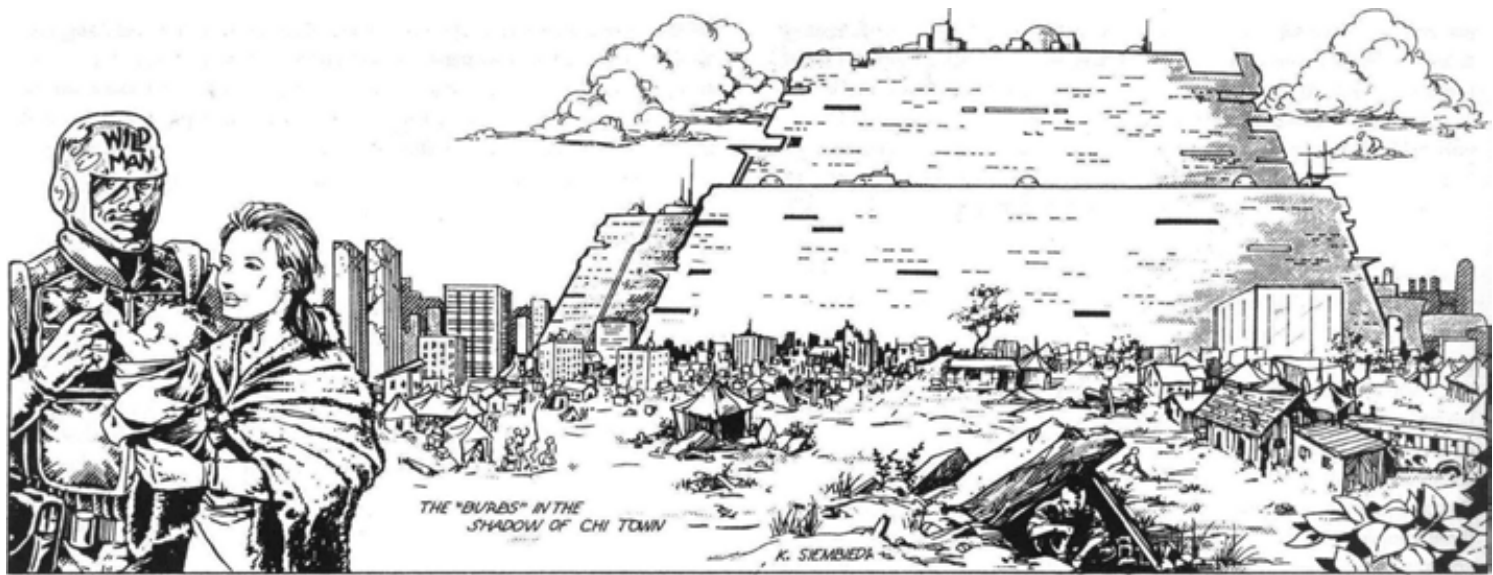

11. The Coalition State of Chi-Town! The Coalition States (CS) are a loosely knit allegiance between *five* industrial kingdoms that rose out of the ashes of the Apocalypse in North America (US & Canada). Some of the Coalition States are nicer/meaner/tougher than others. Likewise, some are more tightly and actively allied than others.

What can be said about Chi-Town that isn't already known? Chi-Town is the biggest and meanest (evil) member of the CS, and the instigator of the Coalition. Its leaders share delusions of a political/military empire. My feeling are that the CS government under the maniacal rule of self-proclaimed Emperor Karl Prosek is totally corrupt. The city is a den of iniquity, but without question, the most powerful military and high-tech force in North America (perhaps the world).

The Coalition State of Chi-Town encompasses Northern Illinois and all of Iowa. The *Iowa* section is 70% farmland and 30% livestock, pigs and cattle. Tiny farm communities can be found every 50 miles or so. Only the occasional military base breaks the peace and beauty of this simple country. SAMAS and sky-cycles patrol the skies. Human troops and a few Dog Packs patrol the borders and keep the peace. Estimated population is 1.3 million.

The Illinois portion of the Chi-Town State is the undisputed hub of North American civilization. Hundreds of small towns and villages dot the land around a dozen large cities (each city has an average population of approximately 200,000 citizens). The pervasive presence of the military is evident everywhere. Despite the dictatorial government of the last 30 years, the people seem quite content and blissful. Sadly, the anti-magic and human supremacist attitude seems to be shared by the vast majority of Chi-Town's people. This is due, at least in part, to the territory's history of struggle against supernatural fiends from the rifts to the south, and the Federation of Magic's invasion of 12 P.A.

Chi-Town, the city itself, is the seat of the Coalition government, the iron fist of the military, the mother of propaganda, and home of the illustrious Emperor, Karl Prosek. Chi-Town boasts a strictly human population of two million, with an additional three million living in the slums, known as "The Burbs."

The Burbs spread across the land for miles around the fortified city. They range from small city-like communities with 10 and 12 story buildings scattered among the homes and smaller two and three story dwellings, to the pathetic tents and shacks of the shanty-towns on the furthest outskirts. Except for the merchants who make their livings from the mercenaries and drifters who frequent the Burbs, most of its population are hopeful applicants waiting to be accepted as citizens of the ever growing Chi-Town fortress. I'm told the present waiting period is six years, but the people wait, dreaming of the famous grandeur and prosperity that the city has to offer. Sadly, I understand that 20% die of disease or famine every year. (I am not surprised. Except for the

older, more affluent sections, nearest Chi-Town, such as *City Side* and *Hillcrest*, the squalor and lack of sanitation is appalling.) Another 15% will fall victim to demons and D-Bees. The survivors must fight a daily battle against dark forces. Still, there are always other hopefuls to take their place.

The Burbs are also crime ridden, especially in the shanty-town areas. Body-Chop-Shops are common, as are gambling houses, and all manner of places of ill repute. Roaming street gangs, bandits, slavers, crazed mystics, vicious psychics, malicious D-Bees, and supernatural predators all prowl the burbs in search for victims or easy prey. Dog Packs and Psi-stalkers are an ever present force on the streets, just as the SAMAS and sky-cycles are in the air. However, these police/soldiers are not so much concerned with protecting the people in the Burbs as they are with containing the criminals to the Burbs. Yes, this is Chi-Town's first line of defense against non-humans and malevolent forces.

Although the Burbs are considered a free-port, where all races and philosophies are welcome (and do indeed attract a vast number of adventurers and travelers), non-humans, practitioners of magic, scholars, and psychics are viewed with great prejudice. The Coalition peacekeeping forces seldom lift a finger to help a D-Bee or mystic even if they are witnesses to the attack. The murder of a D-Bee or practitioner of magic in the Burbs is rarely investigated, and then, only if the murderer appears to be another "undesirable," like a psychic, wizard, or D-Bee. Ironically, the Dog Packs are among the most reliable and helpful of the Burb's protectors. They take a sincere and serious attitude regarding murder and any violence taken against humans. They are particularly alert and aggressive toward crimes and atrocities committed by psychics, magic users, and supernatural beings. And they are ever vigilant for demonic fiends and monsters from the Rifts.

Chi-Town, the fortress city, towers a thousand feet above the squalor of the Burbs, like a man-made mountain of concrete and steel. Inside, the city is a comparative paradise. The upper levels, beginning at about levels 23 through 35, are the domain of the upper middle class and the wealthy. Despite their wealth most are illiterate, but content laborers, which is how the CS likes its citizens. Each level has attractive stores, entertainment centers, and parks. The higher one goes, the more affluent and attractive the city becomes. Above level 35 are the very wealthy and the political elite. There is even a university and medical/science center on level 40, near the very top. A place of learning for the elite 12% of the population that enjoys formal education and full literacy.

Levels 22 through level four are the homes of the lower middle class and the poor. The lower one goes, the older and shabbier the city becomes. This is the home of city rats, cyber-clinics, bargain stores, pawnshops, and the black market. The lowest levels look almost like a sewer and are as corrupt and dangerous as the Burbs. This is a place



reason is that two dozen ley lines slice through the ruins and a ley line nexus sits in what was once the downtown metropolis, a few miles from the shores of Lake Michigan. This means that it is the source of strange occurrences, attracts magic and supernatural creatures, as well as admits strange, alien beings from rifts that periodically open. A typical patrol of 2-6 SAMAS or sky-cyclists cross the skies hourly, while ground patrols of Dog Packs, psi-hunters, urban assault robots, and eliminator squads make daily patrols into the city itself. Spider walkers defend the perimeter between the old ruins and Chi-town.

Chi-town will not allow a magic, psychic, supernatural, or any other community to establish itself in Old Chicago, because of its close proximity, and because of the memory of the Federation of Magic's invasion, which established a stronghold in the old ruins that cost Chi-town thousands of lives. Any individual found practicing magic in old Chicago is terminated on the spot. Demons and D-Bees are also destroyed without hesitation. Scavengers, bandits, and wayward travelers are escorted beyond the dead city's limits. Any resistance means death. Vampires and other supernatural menaces are constantly found to inhabit the ruins.

12. The Coalition State of Missouri. Missouri is a tactical addition to the Coalition and is one of the weakest and most timid of the allied States. It is a rich farmland and neighbor to the Chi-Town State. Thus, it was given official "State" status in an effort to surround oneself with allies, especially if the enemy is on the other side, to the east. The Coalition has pumped a great deal of money and resources into the development of Missouri, which is quickly becoming a new haven for humankind. However, the State is lightly populated, with an estimated 225,000 CS citizens and perhaps another 50,000 squatters. The land north of the Missouri River (an arm of the Mississippi River) is predominantly farms, with a couple dozen little communities and one major city, *New Chillicothe*, civilian population: 98,000. It is the seat of the Missouri government and a major military base equipped with a full

of shattered dreams. The place where too many of the hopeful, waiting patiently beyond the city's walls, fall between the cracks and end up suffocating in humanity's own cruelty and apathy.

Levels three through one are the high security government levels. The Chi-Town military, research facilities, and manufacturing plants are all located in this vast lower bowl. Beyond this is the *Imperial Sanctum*, several (I'm told five) subterranean levels that house the Emperor, his family, military elite troops, generals and their families, fantastic research and science facilities, bionics wing, independent life support system and power plant, and the great, allegedly destroyed, Chi-Town library. All subterranean levels are maximum security areas restricted to the most powerful and elite members of the CS and Chi-Town. I am told that the Imperial Sanctum is virtually impervious to attack and could withstand a nuclear bombardment.

The fabled Chi-Town Library is said to have been destroyed in a titanic battle in 77 P.A., five years after Emperor Prosek rose to power. It was reported that nothing survived. But this is a lie! The library still exists as a secret source of lost history and technology for the Chi-town Coalition. **ALL OTHER BOOKS ARE FORBIDDEN!!!!** The possession of a book or any form of recorded history/data/literature is punishable by imprisonment and torture. A second offense is a DEATH sentence. This is part of the Emperor's plan to control and manipulate his people. A plan that both he and his son (head of propaganda) have executed masterfully.

Chi-town is not built on the remains of Chicago, but exists miles away. In fact, "Old Chicago" still stands in ruin. Much of it has been completely destroyed, but portions of its skyscrapers and city-scape are still present.

The ruins of Old Chicago can be found some 80 miles northeast of Chi-Town. The area is a forbidden zone with hundreds of warning signs and barricades warding away the curious and scavengers. The

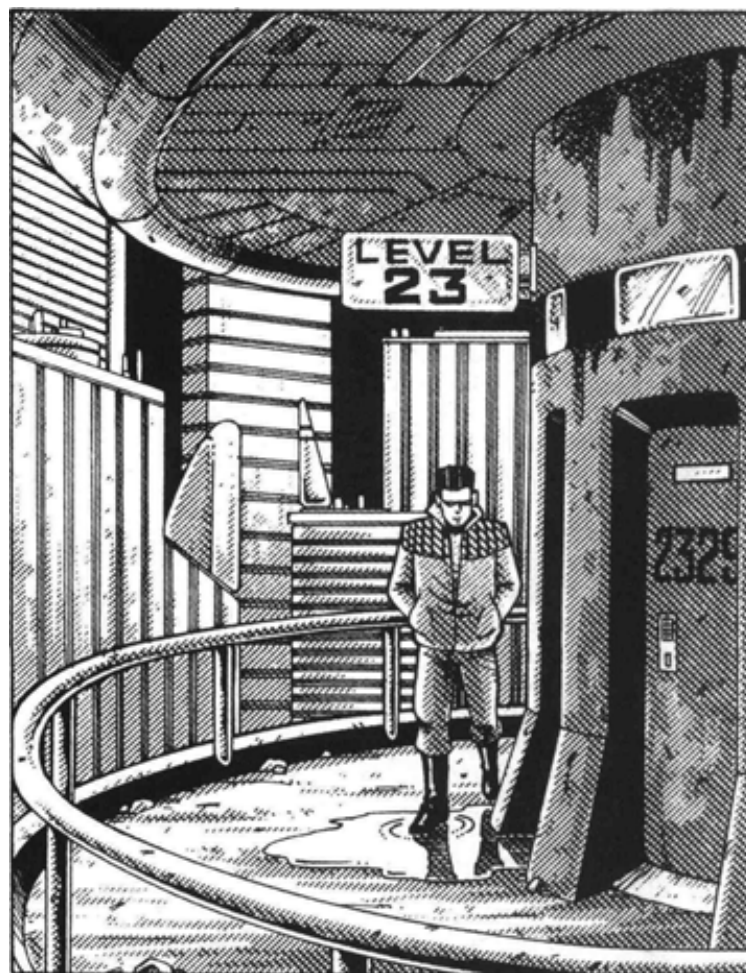

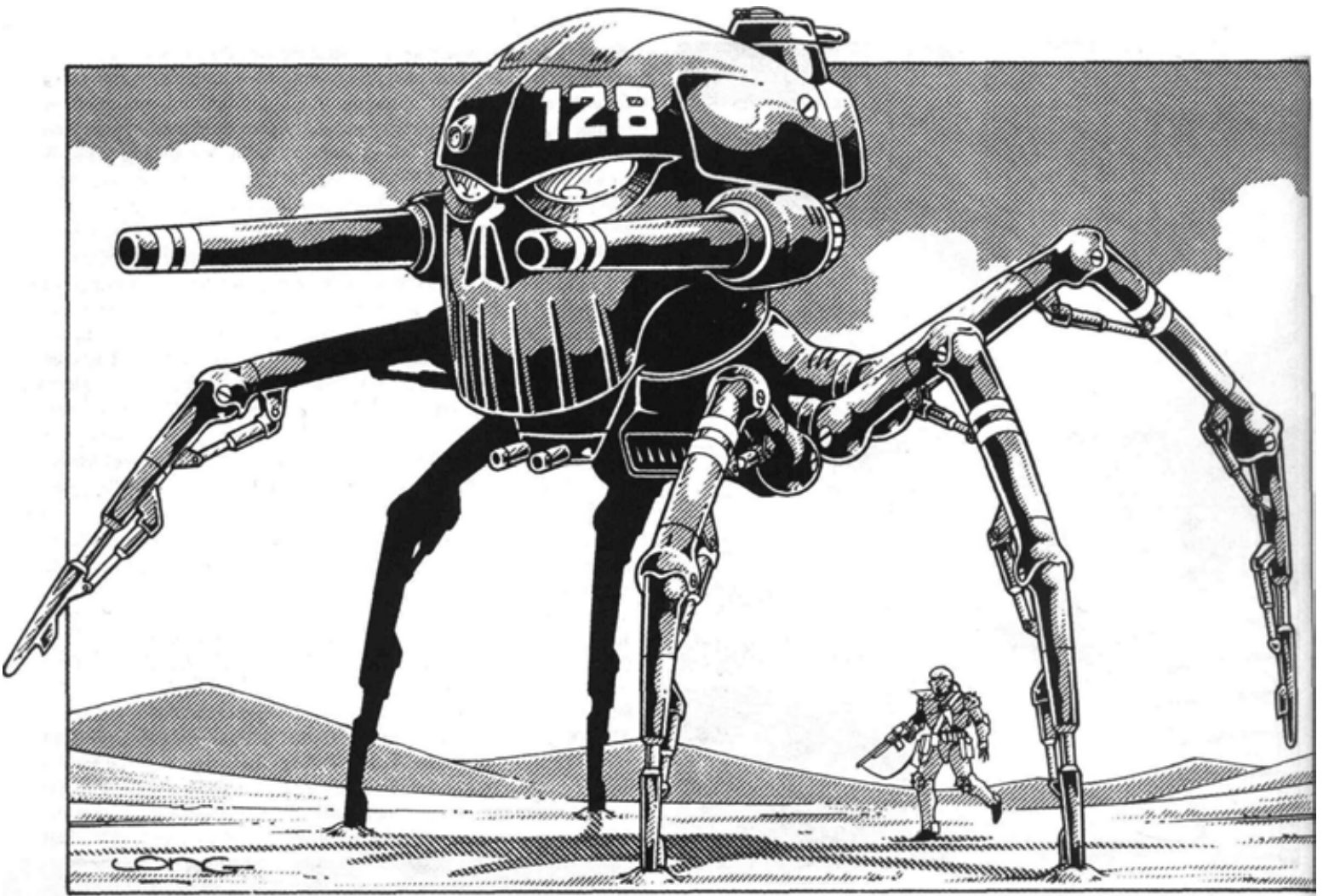

battalion of SAMAS and Spider Walkers, and bolstered by a score of giant urban assault bots and a borg squad.

Below the Missouri River is mostly wilderness, with an occasional Coalition settlement and/or military outpost. There are also two small, but belligerent kingdoms near what was once *White Plains* and *Poplar Bluff* that both insist that they are independent kingdoms.

The most powerful is the predominately human kingdom of **Whykin** (formerly *Poplar Bluff*). Its population is over half the entire Missouri Coalition State at about 140,000. The kingdom has been bombarded with propaganda to join the Missouri CS and enjoy the prosperity of the Coalition. The CS hopes to win over the kingdom, because it is a completely self-sufficient lumber producer and industrial site. It is also coveted because the people are militantly anti-magic and a powerful military force. The kingdom has been beset by countless demons, D-Bees, and power hungry mages for decades, due to their closeness to several major ley line nexus points. This also makes Whykin of strategic importance in the Coalition's fight against the supernatural/magic.

Whykin's military strength comes from generations of warriors (40% of the population has years of combat experience) and expertise in combating the paranormal. Their current army of 20,000 includes psychics, operators, psi-stalkers, a division of 42 Glitter Boy power armor, over a hundred other robot combat units, and miscellaneous military hardware accumulated over the years. A middle-aged (10th level) Cyber-Knight, by the name of Jaspin, is counsel to the king and a champion of the kingdom. Rumor has it that the CS is considering to offer Whykin official membership as a new and independent Coalition State.

Kingsdale is the second kingdom that troubles the CS. Unlike Whykin, this community, of about 80,000, embraces magic and D-Bees. Half the population is non-human and approximately 30% of the over-all

citizens practice some level of magic (mostly low level mages; 2-4th level). They also employ an army of 2000 mercenaries, half of which are Headhunters, a quarter Juicers, and the remainder miscellaneous warrior mutants. Kingsdale is reputed to be a manufacturer of *Juicers* and has a small, but very skilled *cybernetics/bionics* manufacturing and medical facility. This would explain their constant supply of Headhunter and Juicer mercenaries.

13. Arkansas. Is mostly wilderness covered in forest. However, there is a surprising number of human and non-human towns and tiny feudal kingdoms sprinkled here and there. Fur trappers, hunters, wilderness scouts, and cyber-knights are often encountered during one's travels here. The largest communities are found to the south. The largest is the Coalition ally, but free kingdom, known as **Fort El Dorado**. The community of 120,000 live on the site of the old El Dorado city and control the entire southern border from the Ouachit River to Texas. An additional 80,000 live in the little villages along the border. 80% of the people are human. The remaining 20% are loyal D-Bees and mutants.

Fort El Dorado's strength lays in its control over oil fields and oil refining plants, as well as a few sawmills and a natural gas facility (50 miles to the west). The kingdom also grows and processes cotton. All are commodities needed by the Coalition.

Fort El Dorado has politely spurned membership in the Coalition, although the invitation has been left open and the kingdom does consider the offer from time to time. Despite their declining to join the CS, they have an extremely friendly relationship with the CS and trade goods and services with both Chi-Town and Lone Star on a regular basis. Fort El Dorado has even allowed the Coalition to establish a military base five miles north of the city (400 armored troops) and a second small outpost (72 armored troops) near the Red River to help protect

the natural gas plant. The El Dorado army is mostly infantry in nature, with many armored ground vehicles and robots. The kingdom's closeness to rifts has made the presence of the CS troops a welcome addition.

The city is surrounded by a 30 foot high wall that resembles the type used around the fortified cities of ancient Europe. El Dorado is lively but drab, with soot filled skies and large sections devoted to factories. The tech-level is fairly high; I'd estimate equal to the late 20th Century of Pre-Rifts Earth. They have improved cybernetic facilities, thanks to their CS allies, and may be adding full bionic technology.

The people are fairly open to other races, but share the Coalition's disdain for magic and psionics. Their acceptance of non-humans has made the territory a friendly place for adventurers and provides for a lively tourist trade. Fort El Dorado, in particular, is a common stop for adventurers and wilderness explorers/travelers. It is a place where they can safely rest, get news of the world, and purchase supplies. Practitioners of magic and psionics are allowed into the city, but are viewed with suspicion and hatred. The use of magic and psionics is forbidden. Any paranormal activity is against the law and even the most harmless magic will get the individual thrown in jail or expelled from the city.

To the northeast, along the Mississippi River is a last major cluster of ley lines and nexus points that compose the infamous *Magic Zone*. The entire area between the White River to the Mississippi, from the Missouri border to the ruins of Helena, are considered to be a no man's land for humans. The area is rich in magic and known to harbor a handful of human settlements. The settlements are tiny, usually less than a thousand people strong, and mostly peaceful. However, the area is at the mercy of the rifts that unleash all manner of horrors upon the land. Ley line nexus points are known to exist at or near the old American cities of Blytheville, West Memphis (three are found here), Forrest City, and Helena (the city ruins are known to be haunted and filled with monsters from the rifts).

14. The Coalition State of Lone Star (Texas). The Coalition claims dominion over all of old Texas, however, the territory they really control is limited to the northwestern wedge from about Odessa to Amarillo and east to Wichita Falls. The rest of the state is a modern day American Old West with high-tech desperados.

Lone Star City is a vast Pre-Rifts military complex of ground level buildings and an underground network located just west of New Lubbock. The original buildings cover a 30 mile area and are filled with the most advanced manufacturing, genetics (mutant animals), cybernetics, bionics, and robot facilities in the world! They can also create Juicers and Crazies, but this is forbidden by the Coalition and these sections have been closed. Lone Star City has been expanded an additional 20 miles and has dozens of little peasant farm villages all around it. The military complex is currently only operating at about 55% efficiency (or so I am told), but is still the major producer of robots, bionics, and weapons in the CS. Its most significant feature is the phenomenal genetics research and mutation facilities, which accounts for a full 30% of the entire complex. It was here that the first mutant animals and, later, the Dog Packs were created.

The city is governed by a council of scientists and engineers whose forefathers first discovered and reclaimed the forgotten base. Their primary concern is the pursuit of knowledge and the mastery of super-technology. Consequently, they welcomed the opportunity to join the Coalition States because their knowledge would help all of humankind and because the CS would become their protectors, enabling them to devote all of their time to research and development. The city council seldom has any idea of what is happening beyond the boundaries of the city. Regional governors, appointed by Chi-Town, deal with the daily operations of the remaining territories in the Lone Star State.

Lone Star City, however, is an anomaly to the rest of the CS. Its currently population is about 50,000 humans, 70% of which are literate

and educated. 10% are psychic operators and 50% are scientists of the highest caliber. This figure does not include the 15,000 illiterate peasant farmers in the surrounding region.

The remaining city population of 81,000 is composed of loyal mutant animals! Half are dogs of one breed or another, the rest are a variety of creatures, from birds to snakes. The city army is led by an armored battalion of humans, but the remaining 8000 are mutant animals, 20% of whom have been trained as military specialists and "Sams" (this is forbidden anywhere else). This also means that at least 10% of the animals are educated, which is also an unspeakable act anywhere else in the Coalition. All the mutant animals are trained as either military personnel, laboratory assistants, or as laborers. All are taught that humans are superior and their masters. However, generally, the mutants are treated with the same respect and freedom as most human citizens at Lone Star. Most are completely loyal and subservient to their human masters.

Amarillo is a tiny military outpost that protects a human settlement of 1800 people who live and work at a small oil station and refinery.

Wichita Falls is a mid-size military base that protect an oil field and refinery, as well as a large cattle range and dairy plant. The population of non-military personnel is 12,000. Surrounding communities who work peach groves and cotton farms adds another 6000.

Odessa is a military outpost of 300 troops (half are mutant animals) surrounded by a grungy shanty town of under 1000 humans. The town offers a variety of illicit entertainment, booze, women, fights, and gambling.

Everything south of Odessa is the badlands. A dozen dirty, little feudal kingdoms claim the land and war between themselves constantly. Several are known to create *Crazies and Juicers*, others hire mercenaries, D-Bees, and mages to do their fighting for them.

New **El Paso** is rich in silver and cattle land. Its decadent ruler hires the worst scum and assassins to do his bidding.

The Pecos Empire, located East of the Pecos River, 90 miles south of Odessa, is a barbaric community of marauding bandits who claim to rule all the land south of the Colorado River. They remind me of the ancient barbarians of Europe. They are savage, cruel, and wild. Their base of operations is a small farm and sheep raising area. They have no industry and low technology, stealing what they want or need, plundering neighboring communities, travelers, and even the Coalition. The Pecos Empire will attack as a mass army or send out much smaller



raiding bands of 10 to 60 members. The raiders are a wide mix of mutants, monsters, D-Bees, and humans (less than 40% are human). Juicers, Crazies, Headhunters, rogue Dog Packs, Psi-stalkers, and brutes of all races ride among those of the Pecos Empire. The overall empire has been estimated at over a million people, but only about a third are the barbarian raiders. Pecos Raiders have been known to travel as far north as Iowa, as far east as Alabama, and as far west as Nevada. They seldom travel beyond the Rio Grande River because there is nothing to steal and it is the domain of vampire bandits.

(GM NOTE: A typical, human, Pecos raider would fall under the O.C.C. of Wilderness Scout. All are exceptional on horseback and tend to ride horses, motorcycles, and hover vehicles. Weapons range from the sword and the bow to explosives and energy rifles. Only about 30% of the humans fall into the other warrior O.C.C.s of Juicers, Borgs, etc. However, Pecos Raiders also include D-Bees (Dimensional Beings), psychics, mutants, and supernatural creatures/demons/monsters who comprise the remaining 60% of the population.)



New Del Rio is built amidst the ruins of the old city. It is a poverty-stricken kingdom ruled by a tyrannical and decadent family. In recent years it has become a haven for outlaws.

Los Alamo is a powerful kingdom built near the old city of Austin. It has early 20th Century industry/technology and hydro-electric power. It is a known creator of Juicers and has some limited knowledge of cybernetics. Population 76,000; predominately human.

Beaumont, Bay Town, Port Arthur, Galveston, Corpus Christ!, Brownville, and Matamoros (Mexico) have been obliterated and now lay under hundreds of feet of water. The Gulf of Mexico coastline now extends some 50 miles beyond the 20th Century coast.

The only ley lines in all of Texas are located North of the Sabine River. The one small nexus point is found in what was once known as Texarkana. This makes the territory desirable to the CS.

15. The Magic Zone! The Mississippi River is a wide and flowing behemoth that snakes its way from the Gulf of Mexico to Xiticix country in Minnesota. The river is about 300 feet across at its narrowest and

over a mile at its widest. It is also the site of hundreds of ley lines and several nexus points. Major nexus points and places of magic are clustered along the river between St. *Louis* Missouri and Illinois, down through Arkansas and into Northern Louisiana. Another major cluster branches to the east along the Ohio River (an arm of the Mississippi) and dominates the Ohio Valley.

The center of the Magic Zone is located on the banks of the Mississippi in what was once known as *East St. Louis*, Illinois. This area is intersected by over 200 ley lines and has 13 nexus points within an 80 mile area, the biggest and most powerful being an old Indian mound in East St. Louis. The Indian Mound Nexus is reputed to be one of eleven mega-powerful Nexus epicenters. Unfortunately, the incredible amount of magic energy in this region and the Ohio Valley has made it uninhabitable by human life. Demons and all manner of supernatural creatures emerge from the many ley line nexus points, while other monsters are attracted by the incredible magic energy. At Summer and Winter Solstice, during eclipses and planetary alignments, the 13 nexus points and ley lines at the Magic Zone *center* glow with such intensity that their light can be seen a thousand miles away. When this occurs, all 13 places of magic turn into rifts for 12 to 24 hours, admitting more supernatural nightmares into our world.

The Devil's Gate, located across the Mississippi in St. Louis, Missouri and directly across from East St. Louis, Illinois, is a dimensional rift that spans the opening of the old St. Louis Memorial Park Gateway Arch (how ironically named). Several ley line walkers I have spoken to believe that the Arch was deliberately constructed (and named the Gateway Arch) by a secret society of occultists who had knowledge of the location's magic energies and the potential power it could yield as a megalith. Indeed, when the Time of Rifts came, a dimensional portal opened and permanently fused with the arch. The magic energies have also made the archway indestructible. Centuries have passed since the rift first opened and the Devil's Gate remains a doorway to other worlds to this day. Try as they may, the CS has been unable to close or destroy the gateway.

The Magic Zone is a constant source of fear and trouble for Chi-Town and the neighboring territories. Few humans, other than practitioners of magic, psychics, and the foolish, dare to travel the forests of southeastern Missouri and Arkansas, southern Illinois, or the Ohio Valley (southern Indiana and Ohio). For seven years, beginning back in 68 P.A., the CS tried to establish a military containment force to destroy demons as they emerged from the rifts. However, the cost in human lives and equipment was devastating and the CS was forced to abandon the plan. However, reconnaissance patrols and fly-bys are still common in the area (and the most dreaded assignment a Coalition soldier can get).

16. The Ohio Valley (Ohio and Indiana). The Ohio Valley region is a vast wilderness shunned by the Coalition, because it is rich in magic. This is the Eastern extension of the Magic Zone. Hundreds of ley lines and nexus points fill the southern portions of Ohio and Indiana. Although one can find tiny towns, villages, and farms scattered throughout the region, few people view this land as a place to settle. Because the land is ignored by the Coalition, it has become a haven for practitioners of magic, psychics, and refugees fleeing from persecution by the CS.

My travels in this land are limited, but I have heard and seen a few things of great importance regarding the region.

The Federation of Magic, believed to have been extinct for generations, survives in the Ohio Valley. They have become a cult of necromancers that operate in this region and to the east. I have personally seen many of their mutilated victims and sacrificial shrines. The practice of unnecessary human sacrifices is just one aspect of their evil, for they are creatures of evil whose goal in life is to satisfy their own selfish desires. Most are said to be ley line walkers, shifters, mystics, and extremely powerful psychics.

The term "Federation" would imply that these mages work together for some common cause. Fortunately, this is not the case. The only thing these fiends have in common is their disdain for all things that are good. Otherwise, they function as individuals and small groups of less than a dozen, intent on their own schemes. They share few secrets with their cult brethren and trust nobody. In fact, competition and jealousy is so strong that there is constant feuding between the different members as each struggles to gain more recognition and power in the eyes of the world and the Federation. Wizard duels are legendary, as is the wholesale death and destruction inflicted on the surrounding area. Indeed, the Federation of Magic is the darkest force of evil to walk the Earth since the Dark Ages of the Rifts Time. If they could stop their petty squabbling and work together, they could make the world tremble at their feet. Fortunately, they are far too selfish, paranoid, and envious to work together.

The exact number of true members in the Federation of Magic is unknown. Most estimates put their number at under 2000 continent wide. But this number is deceptive, for these fiends of magic are among the most powerful and diabolic on the planet. Furthermore, they enlist the aid of supernatural creatures and assemble their own troops of mercenaries, assassins, and evildoers to implement their schemes. A handful have established their own little kingdoms, and numerous are the sanctums and towers of foul wizards nestled in the seclusion of a woodland meadow or peasant village (usually on or near a ley line or nexus).

The largest and most powerful kingdom of the Federation is a place called Dunscon. It is named after its founder and arch-mage, Lord Alistair Dunscon. It is Lord Dunscon who has kept the Federation of magic alive, and it is he alone who recognizes and initiates new members to the true Federation. It is said that he travels the dimensions and that his court is composed of demons and headed by a thunder lizard (dragon) that he has met in his travels.

Alistair Dunscon is a direct descendant of the original founder of the Federation, Nostrous Dunscon. It was Nostrous who had established a true community of magic. In those days, thousands of mages lived and worked together in Illinois and the Magic Zone. They even established a thriving community in the ruins of Old Chicago. For a time, peace and prosperity reigned, but soon, Nostrous and the other masters of magic began to feel superior and a lust for power that grew into a foolish plot to conquer the Americas. This ultimately led to the Federation of Magic's assault on Chi-Town in the year 12 P.A. Despite their magic powers, the Federation overestimated their own strength and underestimated the ferocious opposition they would meet, especially from Chi-Town.

As the Federation of Magic tells the tale, after many months of battle, the Chi-Town army had finally routed the last Federation stronghold in Old Chicago. In that fateful confrontation, the great Dunscon had been wounded and was being swept away to a safe place by loyal supporters. They were pursued by Chi-Town troops led by a young General named Joseph Prosek. As they tell the story, General Prosek's forces slaughtered Nostrous' protectors and the General, himself, killed the unconscious, helpless, Nostrous. General Prosek then led a two year campaign of genocide that was thought to have been successful in obliterating all members of the Federation of Magic (and 13,000 innocent people *suspected* of using magic or of being Federation sympathizers). This would establish Chi-Town as the reigning power in the land and catapult Joseph Prosek to the position of heroic leader of Chi-Town. After Joseph's death, his son, Karl Prosek, would become the chairman-elect of Chi-Town. Karl would build on the political foundation his father had established, preying on the people's fears of magic and the supernatural. He would build an army without equal, create the Coalition States, and proclaim himself Emperor Karl Prosek, the First. As one might suspect, Alistair Dunscon despises the Prosek family and the Coalition.

I am sad to report that while I am certain the kingdom of Dunscon exists, I do not know where it is located. Reports that I have accumulated place it at a dozen different locations. The most common sites attributed to it are all along the Ohio River and include Owensboro, Kentucky, Paducah, Kentucky, New Albany, Indiana, Aurora, Indiana, Cincinnati, Ohio, Chillicothe, Ohio, Gallipolis, Ohio and Mansfield, Ohio. I have never had the opportunity to investigate these locations myself. My personal suspicions place it at one of two locations: Aurora, Indiana or Cincinnati, Ohio. Both are locations of extensive ley line energy and both are far enough away from the Coalition's expansion to remain hidden. I also recall a vagabond woman coming into our village when I was a child, with tales of a band of wizards who closed a rift that had existed in the ruins of old Cincinnati for as long as she could remember. The old woman tearfully recounted how their leader, a bitter teenage male, whose name I recall as "Duncan" (it could have been Dunscon), warned the scavengers and peasants to leave or suffer the consequences of his rule, for he would "run no longer" and claimed this place "rich in magic" for himself and those like him. She and many of her people fled, never to return. Coincidence? I wonder.

Psi-World is a community of psychics also said to be located somewhere in the Ohio Valley. The people are peaceful isolationists who hide from the world of men. Their plan is to create a Utopian society free of the fear and hatred they experienced in the world beyond their kingdom. They are a powerful, but benevolent community who welcome all races from every walk of life. However, it is a sanctuary for psychics, so only 25% of the population has no psionic abilities at all. The rest all have varying degrees of power. To augment their power and to protect their domain they stay near ley lines and nexus points. Few practice magic only because the people are proud of their heritage and are taught to rely on psionics and knowledge rather than magic and technology.

As to the location, I am told that it could be any one of the quiet villages or farms of the Ohio Valley, it could be one of the outskirt communities. Fanciful legend? Maybe ... or maybe not.



17. Kentucky and Tennessee. Both of these old American Empire States are wildernesses with dense woodlands and rolling hills. Civilization is a rare thing in these parts, although there are many tiny settlements and feudal kingdoms. Magic is also strong in these areas, which make them prime locations for supernatural monsters. But the strangest occurrence is what natives call "D-shifting." One moment you are walking along a forest path, the next moment the entire forest blurs and then shimmers with silver light. Suddenly, the forest has been replaced by an alien forest or a desert! You are still in the same geographic location but the environment around you has changed. Nobody seems to have an explanation as to how the environment can change but the people remain. It's almost like walking through a holographic image that randomly changes. An unsettling experience no matter how many times one experiences it.

The northeastern portion of Tennessee (and along North Carolina) is another huge area exploding with mystic energy. The old cities of Bristol, Johnson City, Newport, Athens, Chattanooga, and Knoxville are all known sites for ley line nexus points and frequent D-Bee activity.

18. The Deep South. The lands once known as Louisiana, Mississippi, and Alabama have been reshaped by the emergence of Atlantis. There is a new Southern coastline, the old flooded under the waves of the Gulf. 60% of Louisiana, 40% of Mississippi, and 10% of Alabama are gone. The new coastline begins at the ruins of Alexandria, Louisiana, continues east to the old city of Port Gibson and Laurel, Mississippi, to Atmore, Alabama. Much of lower Alabama is swamp and lakes. And although Mobile, Alabama is submerged, the old Mobile River is bigger and deeper than ever. There is an occasional farm community and feudal kingdom here and there, but it is safe to call the regions wilderness.

Ley line activity is slight, with only four nexus points *known* to exist in the three territories, none in Louisiana, one near the ruins of Oxford, Mississippi, the other three are all in Alabama; Selma, Talladega, and Guntersville. The last is the most powerful of the four and has a handful of tiny communities around it. Wild psi-stalkers are known to roam these lands, preying on psychics, mages, and monsters. Cyberknights also frequent the Deep South.

19. Dinosaur Swamp (Georgia and Florida). Most of Florida is gone! Everything South of Tampa Bay was reduced to rubble during the Time of Rifts and lays sunken under 200 feet of water. Today, what remains of Florida and most of Georgia is a giant marshland, like an expanded Everglades. Thanks to the rifts, this region is the domain of dinosaur-like creatures. A scholar in the region tells me he has identified 32 types described in a Pre-Rifts text. He has pointed out two to me that do indeed appear to be the creatures once known as the Stegosaurus and Duckbilled dinosaurs.

What does this mean? How can creatures that died millions of years ago walk the land today? Is it possible that the rifts are portals through time as well as space? Or are these creatures from another world and only greatly resemble the dinosaurs of ancient Earth? Certainly dinosaurs and monsters of all kinds seem more common to the eastern portion of the old American Empire than anywhere else. I believe this is true because of the great many rifts along the Mississippi, the cluster in North Carolina and Virginia, and the infamous Bermuda Triangle to the East. The area is a natural place for otherworldly creatures to settle.

20. The East Coast. This land has been dramatically reshaped. Half of North Carolina and a third of Virginia are under the Atlantic Ocean. The lower portion of Maryland, south of Washington D.C., is submerged, as is everything east of the Chesapeake Bay, including all of Delaware and 40% of New Jersey (everything south of Mount Holly)!

Nearly all the ancient cities of the East are mangled mounds of debris. My understanding is that when the rifts came, the entire eastern coastline was bombarded by tidal waves, hurricanes, and earthquakes that shook the land for a decade. As a result, the cities of the coast were pulverized



in a wave of destruction that reached as far as the Appalachian and Allegheny Mountains. Having visited these lands, I can attest to the complete and terrifying destruction that must have seemed like the end of the world.

South Carolina is smaller, with 40 miles of its old eastern coast land reclaimed by the ocean. It is a woodland alive with dinosaurs and monsters from the rifts.

North Carolina is half gone. The new coastline begins at Lumberton, and runs to Fayetteville and Raleigh, and north to the mouth of the old Roanoke River. It is also a forest filled with monsters. The western portion and the neighboring part of Tennessee is throbbing with ley line energy and has numerous rifts and areas of "D-Shifting."

Virginia also has a third of its land submerged under water. Emporia, Peterburg, Richmond, Fredricksburg and Alexandria are the new coastal city ruins. Except for the western tip around the ruins of Bristol, Grundy and Wytheville, the land is free of mystic energy, but is inhabited by psi-stalkers and creatures from the neighboring rifts. A few tiny feudal kingdoms are scattered toward the east and north.

Pennsylvania is mostly wilderness, with a few human and non-human settlements.

The city of Washington is in ruins, although a thriving tech-center, calling itself the "Republicans," lays claim to the old ruins and subterranean tunnels of the old subways. They are a growing power in the East (60% human; little magic, but heavy on all forms of augmentation and psionics).

The island of Manhattan has risen and is now a peninsula of what was once New York State. The island city is a mass of rubble. Not one building stands. All that remains are piles of rubble. Still, I have known scavengers who claim to have dug hundreds of feet below the debris and found ancient pre-rift artifacts in salvageable condition.

However, Manhattan, known today as "Mad Haven," is regarded as a haunted graveyard and avoided by most humans. I've also heard tales of subterranean creatures living under the city's ruins.

The rest of the coast is mostly wilderness, with tiny pockets of intelligent life.

21. Northern Michigan. The Northern section of Michigan, once known as Upper Michigan, or the Upper Peninsula, is an area thriving with human life and the site of a hundred tiny human communities. The largest are Manistique and Ishpeming, both industrial kingdoms of fair power.

Ishpeming, also known as the "Northern Gun," is an arms manufacturer known to supply many of the non-Coalition communities, bandits, and mercenaries. The kingdom offers limited cybernetic and bionic augmentation (partial bionic conversion and repairs), MOM conversion (Crazies), and bio-comp chemical augmentation (Juicers). In addition to a regular array of Crazies and Juicers, Ishpeming also has an impressive army of military weapons and vehicles, power armor and a handful of Glitter Boys (they can repair Glitter Boy armor, but can not build it from scratch). Magic is not outlawed, but it is viewed with suspicion. Education levels are equal to the late 20th Century Pre-Rifts industrial era and most of the city's populace is literate (88%). Estimated population: 110,000 plus mercenary army of about 35,000 (20% Juicers, 30% Crazies, 25% robot pilots, 15% Borgs, 10% infantry). They are also allied with numerous powerful organizations, including the Chi-Town black market and Tolkeen (Minneapolis).

The Manistique Imperium is located along the southern coast and includes the Pre-Rifts city of Escanoba and several smaller communities. The Imperium is diverse in its people, education, and resources, which include fishing, mining, metal processing, manufacturing, sawmills, trapping, farming, and cattle/dairy. In many respects it is the central city/kingdom of the north and is allied with scores of tiny towns and villages who look at the Imperium as their friend and protector. The diversity of its people, which includes D-Bees and mutoids (30%), means that the education levels vary greatly, from technicians and scholars in the city to completely illiterate fanners and wilderness scouts/trappers. The population at the industrial city of Escanoba is about 220,000 (literacy is 54%). The population of the city of Manistique is about 380,000 (literacy is 72%). Both cities have trade schools, libraries, and Manistique has one of the great universities. The estimated population of the surrounding communities that rely on the Imperium adds an additional 100,000 (10% literate).

The Manistique Imperium is armed with a fair number of robot and hover vehicles, energy weapons, rail guns, power armor, and limited bionic and cybernetic augmentation (philosophically limited, as they have full bionic conversion capabilities). They also have wilderness scouts, a sizable number of psychics, including psi-stalkers and mind melters, and a loyal community of techno-wizards. Less than 10% of their 40,000 troops are mercenaries. They are on friendly, but wary terms with Ishpeming and are on very favorable terms with Lazlo (old Toronto), to the east, exchanging both goods and knowledge/literature. Both kingdoms would certainly rush to the aid of the other. Or so I believe. There are several smaller feudal kingdoms to the north and



east with some industrial capabilities, but populations number under 100,000 and are of little political significance at this time. The reason for this abundance of human life and Pre-Rifts technologies is that the peninsula fell into a pocket that was, comparatively, spared the devastation of the remaining continent. I believe this is largely due to the fact that the peninsula is devoid of ley lines or nexus points. Only two ley lines (no nexus) run parallel along the northern coast of Lake Superior, from the city of Hancock to *Tolkeen* in Minnesota. Being surrounded by the lakes has also served to isolate the land from invaders and monsters from the rifts. Still, the peninsula suffered and is only now attaining its place as a potential power in the new Rifts World.

22. Southern Michigan. Unlike its northern cousin, southern Michigan, or the "Lower Peninsula," is a territory torn apart by the rifts and mystic energy. It is rich with magic energy and dotted with dozens of ley line nexus points and hundreds of ley lines, particularly along the entire length of its eastern coast and the borders of what were once Ohio and Indiana. It is here that the line walkers and mystics ride the giant **fury beetles**, and creatures from the rifts dominate the land.

Nexus points have been recorded by the Imperium and Lazlo at the Pre-Rift cities of Alpena, Harrisville, Mikado, Tawas City, Standish, Amelith, Bay City, Saginaw, Bad Axe, Palms, Lapeer, Crosswell, St. Clair, Pontiac, Farmington, Detroit, Monroe, Adrian, Jackson, Battle Creek, Kalamazoo, Cassopolis, and Niles. As well as at neighboring Toledo, Ohio and Angola, and South Bend, Indiana.

Several feudal kingdoms of magic and/or psychics, as well as D-Bees and supernatural creatures, can be found throughout the land. Dragons are reportedly common to the wilderness forests that cover the land, but I can not personally substantiate this rumor. I can tell you that like the days of old, the land is a wilderness with little human life other than trappers (wilderness scouts) and tiny settlements along the lakes.

Old Detroit, once a manufacturing center of the American Empire, lays in ruin. Only a few crumbling buildings still stand (the same is true of Windsor, across the Detroit River). Four nexus points are located in the old city limits, making the area a haven for monsters. However, I have heard tell of excavations that have unearthed some fabulous finds in the way of technology and literary artifacts. I've also heard rumors that in the last decade, monsters from the rifts have claimed the site as their own and are building a city in the old downtown area, over the salt mines.

Windsor (Canada, two miles directly across the river) is also a haven for supernatural fiends, with three nexus points of its own.

Ann Arbor, Michigan is about 50 miles west of Detroit and is a small, but thriving community of magic practitioners and scholars, known as "New Lazlo." The place was the site of a sprawling university before the Time of Rifts and many marvellous books, recordings, and artifacts have been uncovered from the ruins, including several works by the illustrious Victor Lazlo. In practicality, New Lazlo is a town that has grown from an archaeological outpost started by Lazlo, to the east (Toronto, Canada). The town prospers with a mixed population of humans and non-humans surrounded by friendly farm communities. The population of about 40,000 is happy and consumed with the pursuits of magic and knowledge.

I see New Lazlo as a disaster waiting to happen. I suspect that the Coalition is not yet aware of its existence. As we all know, the CS views Lazlo as an enemy and has left it alone because they do not feel powerful enough to wage a war through lands brimming with magic energy, and because Lazlo is a safe 600 miles away. New Lazlo, on the other hand, is a threatening 300 miles closer. I believe it is only a matter of time before the Coalition learns of New Lazlo and destroys it. The ruling council is bold and confident in their people's psionic and magic powers. Overconfident in my opinion. I do not believe their psychics and wizardry is any match for the power and ferocity of the Coalition. They are mostly a people of learning and lack the blood lust

and military skills to match the CS. Furthermore, if the Coalition doesn't get them, demons from the rifts will. Bear in mind that it is only 50 miles from Detroit. Perhaps I am getting too pessimistic in my old age. I wish them my best.

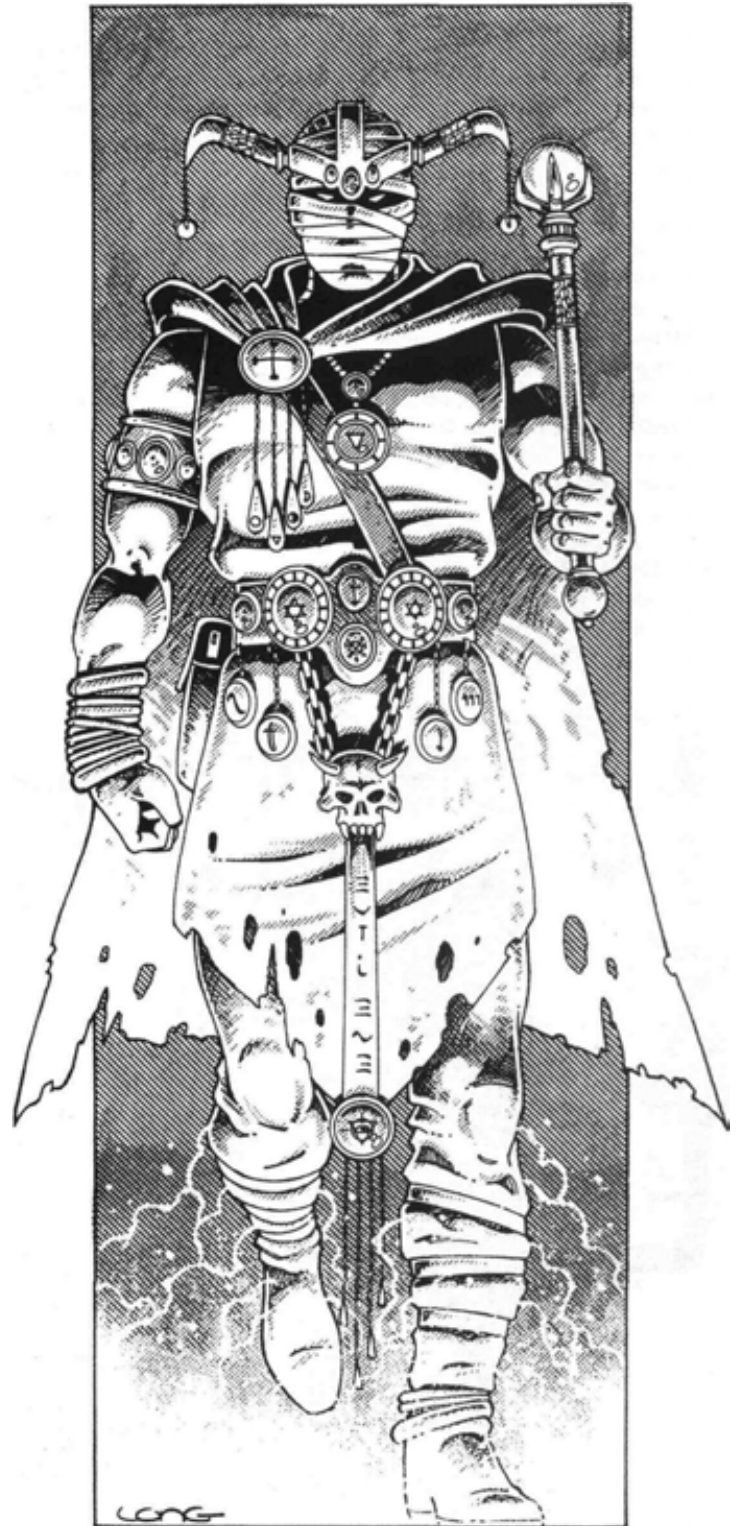

23. Wisconsin. The southern portion of Wisconsin, from Green Bay and Marshfield south to the Illinois border, is second in magic energy only to the Magic Zone. It is designated as a forbidden area by the Coalition and is a constant source of consternation. Ley line nexus points are known to exist at Marshfield, Stevens Point, Green Bay, Oshkosh (three), Wautoma, Big Rats, Montello, Adams, Mauston, Sparta, West Salem, Richland, Bridgeport, Madison (three), Juneau,

Watertown, Waukesha, Milwaukee (four), Lake Geneva, and Beloit. Chi-town sends SAMAS teams to patrol the skies along the Illinois/Wisconsin border daily, and have established military installations near Lake Geneva and Madison. Dog Packs and mutant animal infantry soldiers are sent about 50 to 100 miles into the interior on reconnaissance and destroy missions to combat the magic and demonic threats drawn to the rifts. Chi-Town's paranoia has even led to several massive bombings of land areas, including Milwaukee, Waukesha, and Madison; all of which are barren wastelands as a result.

I have heard consistent rumors of a magic kingdom known as "Shaedo," ruled by a dragon (Kee-thh is the name I've heard), or dragons, somewhere in the Marshfield/Stevens Point area, but have no evidence to support its existence. The territory is mostly wilderness and wastelands under the constant scrutiny of the CS. Few humans live in the southern portion.

24. The Free State of Lazlo, the Empire of Magic. Ley lines and nexus points run along both sides of the Saint Lawrence River, American and Canadian. At the site of what was the Pre-Rifts city of Toronto, Canada is the thriving city of Lazlo. With the tragic corruption of Chi-Town, I see this place as humankind's true hope for a free and civilized world.

Lazlo began as a tiny community of mages who had developed a new science. A science that blended magic and technology in a new way. It has since grown to become the capital of *techno-wizardry* and a center for learning. The name, Lazlo, is derived from the famed 20th Century scholar/mage, Victor Lazlo. It was this humble historian who introduced the writings of Victor Lazlo to that community and I take great pride in knowing that I am responsible for the name of this marvellous place.

All creatures are welcome. All philosophies are discussed. There are schools, a university of learning, a university of magic, a dozen libraries, museums, art, history, and law, as well as industry and science. The city of 400,000 inhabitants is powered by harnessing the energy of a rift! A feat I still marvel at. And mechanisms of magic and technology are every where. Another 200,000 people can be found living in the peaceful towns and farms that surround the city. All are loyal allies and willing members of the Free State of Lazlo.

Lazlo is governed by two political bodies that serve as a check and balance system of government, they are the *Congress of the Electorate* and the *Council of Learning*. Both are composed of compassionate and intelligent beings, human and non-human, who are dedicated to freedom and the betterment of all life. A cyber-knight named Thomm heads the Congress, and an ancient great horned dragon, known as Plato, heads the Council.

The defenses are composed of citizens who form an elite militia when danger threatens. The militia includes several dragons (both young and old), techno-wizards, mages of all sorts, psychics, and men of arms. All are volunteers. The chore of day to day peace keeping is placed in the capable hands of Arl Xzzyn, a kind D-Bee man-wolf of vast tolerance and understanding. In his own world, his kind is known as "Wolfen." His is a world much like our own, where there are many races, but little understanding and constant conflict. Arl has organized a well trained and gentle force of peace keepers of every race and power. Most are of noble heart and free of corruption.

Since it is the Council of Learning who has commissioned this writing, I will not dally on information that they know far better than I.

25. The Coalition State of Iron Heart (Canada). Iron Heart is arguably, the third largest and therefore, third most powerful member of the Coalition States, followed by Lone Star and Missouri. The state itself covers a vast territory of wilderness that ranges from North Bay (west of the Ottawa River), west to Lake Nipigon and north to James Bay (the eastern half of the old Ontario Province and the southwest tip

of the Province of Quebec). It includes several small hunting, fishing, and mining towns with a combined population of about 700,000 humans, 100,000 non-humans, and 100,000 squatters.

The capital of Iron Heart is the City of Iron, a rough and dirty old city built on the ruins of Canada's old Sudbury. It is an early 20 Century style industrial community with smoke spewing factories and coal stoked furnaces. The city is actually much larger than its pre-rifts days. Its factories, mines, and saw mills provide people with employment and offers the luxury of civilization, technology, and protection by the Coalition in an inhospitable, cold, land of endless forest. Mines and processing plants for iron, nickel, copper, coal, and a bit of silver and gold are the City of Iron and Iron Heart's greatest resource. But it was another asset that convinced Chi-Town to accept Iron Heart as a member of the Coalition States. Pre-Rifts Sudbury was the home of "Science North," one of the largest science museums in all of Canada, as well as another extensive mining museum. The secrets contained in these places were unearthed by the local government of Iron Heart during an exploratory mining operation. Secrets coveted by Chi-Town. Part of the arrangement in becoming a CS member included giving all the archaeological finds of the Science North excavations to Chi-Town for identification, research, and assimilation into the CS network (supposedly to be shared by all members of the Coalition).

In all honesty, it is unlikely that the powers that be at Iron Heart would have used the knowledge to its full potential. The territory's populace is mostly illiterate, including city dwellers and much of its ruling body. The literacy rate is less than 15%. Most people are laborers, the rest are wilderness scouts, headhunters, vagabonds, or peasant fishermen and farmers.

Iron Heart, is a model member of the Coalition States who they perceive as the great new empire of the Americas and the salvation of humankind. They have adopted all CS laws and methods of operation and execute them to the letter. Like the other members of the CS, Iron Heart forbids magic and dislikes psychics, mutants, and D-Bees. In fact, before the *civilizing* influence of the Coalition, Iron Heart was known for its "witch hunts" in which practitioners of magic and D-Bees were hunted down and slaughtered. Under the guidance of the CS, this procedure is much less brutal and disguised as military peace-keeping operations.

They maintains a full army of CS foot soldiers, SAMAS power armor, a Dog Pack Division, and a squad of robots. However, Iron Heart's real military strength is its huge troops of wilderness scouts and psi-stalkers. Nobody knows the old American north and Canada like the scouts of Iron Heart. These men and women (and psi-stalker mutants) are masters of wilderness survival and have traveled as far as the American northwest and the Canadian Northwest Territories. They have been crucial to the Coalition States' surveillance of the Xiticix in neighboring Minnesota and Manitoba, and are responsible for the Coalition's extensive knowledge of the northern lands.

26. The Coalition State of Free Quebec. The second most powerful member of the CS, after Chi-Town, is Free Quebec. Although the Coalition State claims all of what was once the province of Quebec, the fortified city of Free Quebec is found in eastern Canada, about 100 miles west of the ruins of old Quebec. It is small by comparison to Chi-Town, with a population of about one million, but it is a high-tech, industrial giant and completely self supporting. The people hate magic and share Chi-town's human supremacist attitudes, which is one of the reasons Free Quebec agreed to join the Coalition. However, while it is equally as fascist, it is extremely independent, which has caused several incidents of contention between the two powers. The most recent and continuing is Free Quebec's refusal to disband its army of Glitter Boys and convert completely to standard CS robots and power armor. Free Quebec currently has a force of about 200 Glitter Boys and another 40 in the field. They were also quick to incorporate bionic augmentation, something that disturbs the power magnates at Chi-Town. Other matters

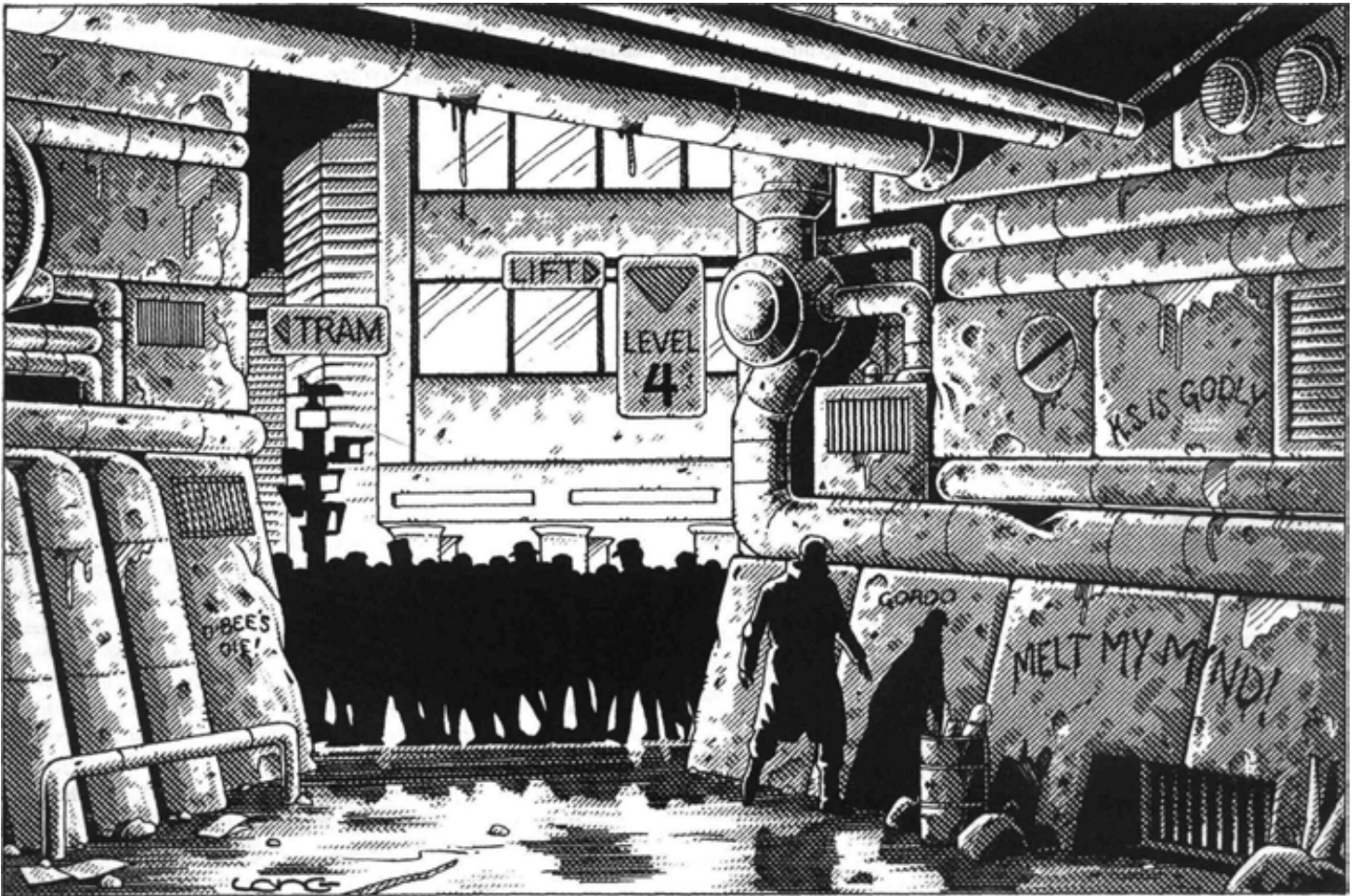

over which there have been hard feelings include the use of mutant animals (Free Quebec views it as an abomination and will have no part of it; e.g., no Dog Packs), and the abolishment of Juicer creation (Quebec has grudgingly complied, but sees nothing wrong with creating Juicers).

Located around the city are small villages and farm communities under its protection. This accounts for another 50,000 people (90% human). To the north is an expanse of forested wilderness. It is the home of wilderness scouts, trappers, and a few sawmill towns. Most find Free Quebec a friendly and hospitable place to trade/sell one's goods and to purchase supplies.

Well over 90% of the wilderness people are illiterate. However, the city dwellers are 70% literate and 50% are educated and skilled professionals. Still, I'd rate Free Quebec's tech-level as 25% lower than Chi-Town, perhaps as much as 40%; it is difficult to determine without ever having seen Chi-Town's secret resources. Without a doubt, the Quebec university and library are far inferior, but unlike Chi-Town, education is far more accessible to the average citizen. The propaganda level is also much, much less severe than Chi-Town. I would even dare to say that Free Quebec has a free press and an informed population. Not surprisingly, this is another issue where the two powers do not agree (Chi-Town would prefer a less informed, less educated general populace).

The ruins of old Quebec is the site of a ragtag trader's town called the "Old Bones." The population of about 60,000 is a mixture of huntsmen, furriers, merchants, and farmers, all predominately human (75%). There are a couple Body-Chop-Shops and even a magic shop or two. The atmosphere is bawdy, with loud music, wild dancing, shouting, gambling, and illicit pleasures. Generally speaking, the buildings are dirty and not very well kept, but not quite the squalor one finds

at the Chi-Town Burbs or some of the other disreputable border towns that dot the country. All races and people are welcome to come and do business, although D-Bees and men of magic have been known to disappear.

What most people do not realize is that Free Quebec secretly manages Old Bones. The majority of the the shops are normal merchants trying to make a living, but virtually all the illicit establishments, thieves' guild, and the black market traders are spies for Free Quebec. In this way, the authorities can keep a keen eye on potential trouble and an ear to what is happening around them, especially from adventurers who may have valuable information and ancient artifacts that the Coalition can procure.

Free Quebec sees Lazlo as a growing problem, but does not feel that they are powerful enough to tackle them in an armed conflict. At this point, their policy is one of neutrality, as long as Lazlo leaves them alone, they will leave them alone. At least for the time being.

27. **Atlantis.** The mysterious continent of Atlantis has risen in the middle of the Atlantic Ocean, between Bermuda and the Azore Islands. I had made plans to visit the continent on three separate occasions, but each time the *Bermuda Triangle* was in a fury and my guides felt conditions were too dangerous. On the third occasion, I was so steadfast in my desire to visit the island content that I waited nine weeks for the turbulence to pass, but it did not.

I can report the following. The Bermuda Triangle is a dangerous and frightening body of water in the Atlantic. It is a triangular pattern of ley lines over the ocean, with three connecting nexus points; one off the coast of Florida, a second off the coast of the now submerged island of Puerto Rico, and a third off the northeastern tip of Bermuda and right off the coast of Atlantis. This portion of the ocean glows an eerie

pale blue, night and day, and is the scene of countless supernatural spectacles. The triangle is effectively a giant dimensional gate way that opens and closes without warning and to varying effects. I have witnessed the sky suddenly change color from the natural blue to green, yellow, violet, and red in the blink of an eye as if the entire area suddenly D-shifted into another world. Rifts suddenly appear in the sky or above the waves. Sometimes the rifts are accompanied by terrible storms, while other times the ocean remains serene. The waters of the Atlantic Ocean, especially in the Bermuda Triangle and around Atlantis, are brimming with sea monsters.

Atlantis is suspected to be a source of great mystic energy. Most seem to believe that it has greater ley line energy than England or the Magic Zone, but I attribute this to superstition rather than fact. To my knowledge, nobody really knows.

The continent is said to be inhabited by D-Bees from the rifts. Exactly who or what they may be is largely a mystery. I do know that Atlantis is the home of a fiend who calls himself "Splugorth the Terrible." Whether Splugorth and his people dominate the continent is unknown. What I have heard is that Splugorth is also the name of a race of D-Bees, presumably ruled by Splugorth the Terrible. They are humanoid giants that tower some 20 feet tall and have eight tentacles in addition to a pair of powerful arms. Their face is demonic and their visage is terrible to behold. (**Editor's Note:** The cover of **Rifts** depicts a Splugorthian Slave Barge. Full details will be revealed in the **Rifts World Book**.)

The Splugorthians are known to capture humans and all interesting life forms, including supernatural creatures, to be sold into slavery. Splugorth the Terrible has a lucrative trans-dimensional slave trade going. Invading slave barges and Splugorthian armies of D-Bees have been known to raid entire cities and have been sighted only on the east coast of the American Continent. I personally witnessed the passage of a slave barge and its army of goons. Retracing their steps days later, we found several towns and villages destroyed and devoid of life.

The two things that scare me most about the Splugorthians is that they have no compassion for other life forms and they utilize the science of techno-wizardry in a way not known to humans. A dangerous combination.

28. England, Wales, and Scotland, the Realm of Magic. No other place in the world is as rich with magic energy as the island known as England. The entire island is like our Magic Zone. Even I could feel its energies coursing through my body. The old civilization of Pre-Rifts Britain has been virtually obliterated, much like the American coastal cities.

Unlike our own land, the human inhabitants, and many D-Bees, have forsaken technology in favor of magic (not entirely illogical under the circumstances). They have adopted a philosophy of harmony with nature and have learned how to become one with their environment. And I mean truly one. The "new Druids," as they call themselves, have



developed magic to alter and manipulate natural forces unlike anything you can envision. They can control the rains and the temperature. Homes are formed magically from living trees and giant mushrooms whose trunks are as wide as a house. Towns are encircled by living walls of thorns or trees. One city I visited had a 40 foot tall wall of jutting stone erupt from the ground to form a protective barrier against a troop of monstrous D-Bees. The creatures ran screaming.

Fruits and vegetables are grown in magical fields often protected by faerie folk (who are abundant here). Others are grown on more traditional farms, but are three to five times larger than normal.

Human life on the entire island may be as many as 400,000, plus another 400,000 D-Bees. But all are scattered in tiny villages of two to five hundred members each. The largest may be as many as 3000, but these are few and far between.

The neighboring isle of Ireland is even less inhabited than England/Scotland. It too is the home to the druids, but the place had an eerie feeling about it. I could not put my finger on it. Perhaps it was just my imagination.

29. France is also a ley line haven with numerous places of magic. It is also the site of a dozen warring feudal kingdoms of some significance. Technology level is about equal to the early 20th Century to pre-industrial. Estimated total population, four million humans and two million non-humans.

30. Spain. As one moves away from France and England, the magic energy levels drop dramatically. Spain has about two dozen known nexus points, as does the much smaller Portugal. The population and tech-level is about equal to France.

31. The rest of Europe and the world is mostly wilderness with scattered little towns, villages, and outposts. Cities are fairly uncommon, generally speaking. The environment, regardless of the high technology and/or magic, is hostile and difficult. Many of these kingdoms are ruled by a protector or group of protectors, much like the knights of old. If a stranger or invader wants the town, he challenges the town's champion/protector(s); the winner takes all. These contests of combat are not necessarily to the death, but often end up as battles to the death when the stakes or emotions run high. However, banishment and or destruction of the robot is often acceptable.

The Slavic countries and Russia are vast wastelands and wilderness, broken only by the occasional city ruins or new village. Tech-levels are generally low. Populations unknown.

Germany and the **Scandinavian countries** suffered horribly during the Time of Rifts, but have managed to survive and prosper. The "New Republic" is the German equivalent of Chi-Town, with its population of about 5 million humans and 1.5 non-humans. Unlike the condensed and fortified Chi-Town, the New Republic is much more sprawling and filthy. Advanced medicine, cybernetics, bionics, Juicers, and Crazies technology are all common. Juicers and Borgs are particularly common. The east is largely industrial/factories. The west is high technology and research.

Amsterdam is a cultural, educational, and entertainment center with about three million people, predominately humans. It is an ally of the New Republic, whom it relies on for military and economic support.

Denmark was devastated by the rifts and remains a wasteland.

Norway and **Sweden** are also, comparatively, densely populated and technologically advanced. About equal to the New Republic.

32. India is a jungle with little human life and even less technology. It is rumored to be inhabited by savage, cannibalistic D-Bees.

33. China is reputed to be a mystic play ground for demons and supernatural monsters. Its human population, once numbering into the billions, is believed to be less than 60 million today (and declining). It is avoided by most adventurers.

34. Japan was besieged by tidal wave and volcanic activity that toppled its great cities and killed millions. Today it is a quiet little cluster of wilderness islands.

35. Africa is again the "Dark Continent," mysterious and wilderness.

36. The land of the Nile and Egypt is a place of great magic energy which the ancients once marked with pyramids. It is said one of the largest and most powerful ley line nexus points/rifts is located here.

37. South America is now known as the Land of a thousand Islands. The Amazon River is bigger than ever and has dozens of new branches that have fractured the land. The terrain is one of three things: swamp, jungle/rain forest, or mountains. Only a few pockets of civilization remain, most notably in the old territory of Argentina. Brazil is all forest and primitive tribes. Argentina offers several cities and a handful of rival kingdoms. Glitter Boys, Juicers, Crazies, and 20th Century technology are present.

Note: I know nothing of Australia and the rest of the world.

38. Outer Space. I mention outer space, because it has a dramatic effect on our world. As you know, space travel, including the travel in earth orbit (satellites) is impossible. The most common theory is that one or more orbital, robot, "Killer" space stations/satellites shoot down anything that reaches earth orbit. As I said, this is the most common belief, but it is not necessarily true.

A group of scientists at Tolkeen offered this theory, which I find to be a more believable hypothesis. Debris, even tiny debris, like particles of sand, placed in counter orbit, would quite literally shred to pieces anything launched into its path. The debris could have been put into orbit deliberately by one or more of the old empires just before the Time of Rifts, or have been the result of an accident, or perhaps a side affect of the rifts. I tend to concur with these men of science and suggest that such a cloud of particles encircles our planet.

One might say to himself, who cares? But the fact of the matter is, this debris prevents our utilization of space age technology. Global and continental communications is impossible, because satellites can not be placed into orbit. It is this lack of a communication network that has prevented humankind from rising out of the dark age of Rifts sooner. Even today, we do not have an accurate picture of what is happening in distant lands such as China, and not so distant lands such as Mexico and Canada. Without satellites, communications is limited to ground systems and fiber optics which requires broadcasting/relay stations or ground cables. Only the Coalition and a few of the largest cities have the means to implement such systems (the Coalition States all have an impressive broadcast and telephone system). Smaller cities and villages must rely on limited range, wide band, directional radios and messengers. Messengers deliver written, audio, video, and verbal communications by traveling in ground or air vehicles and, in some remote regions, by horse or on foot. The lapse between messages can be hours, days, or even weeks. It reminds me of stories about the days of the American Empire's old west and pony express. Of course, I have seen some amazing forms of quick communication by magic means, such as ley line transmissions, teleportation, and magic flight, but these are often limited by the location of ley lines and rifts. The age of instant communication is, for the time being, a thing of the past.



A pair of full conversion "Borgs" stalk among the ruins of an ancient city

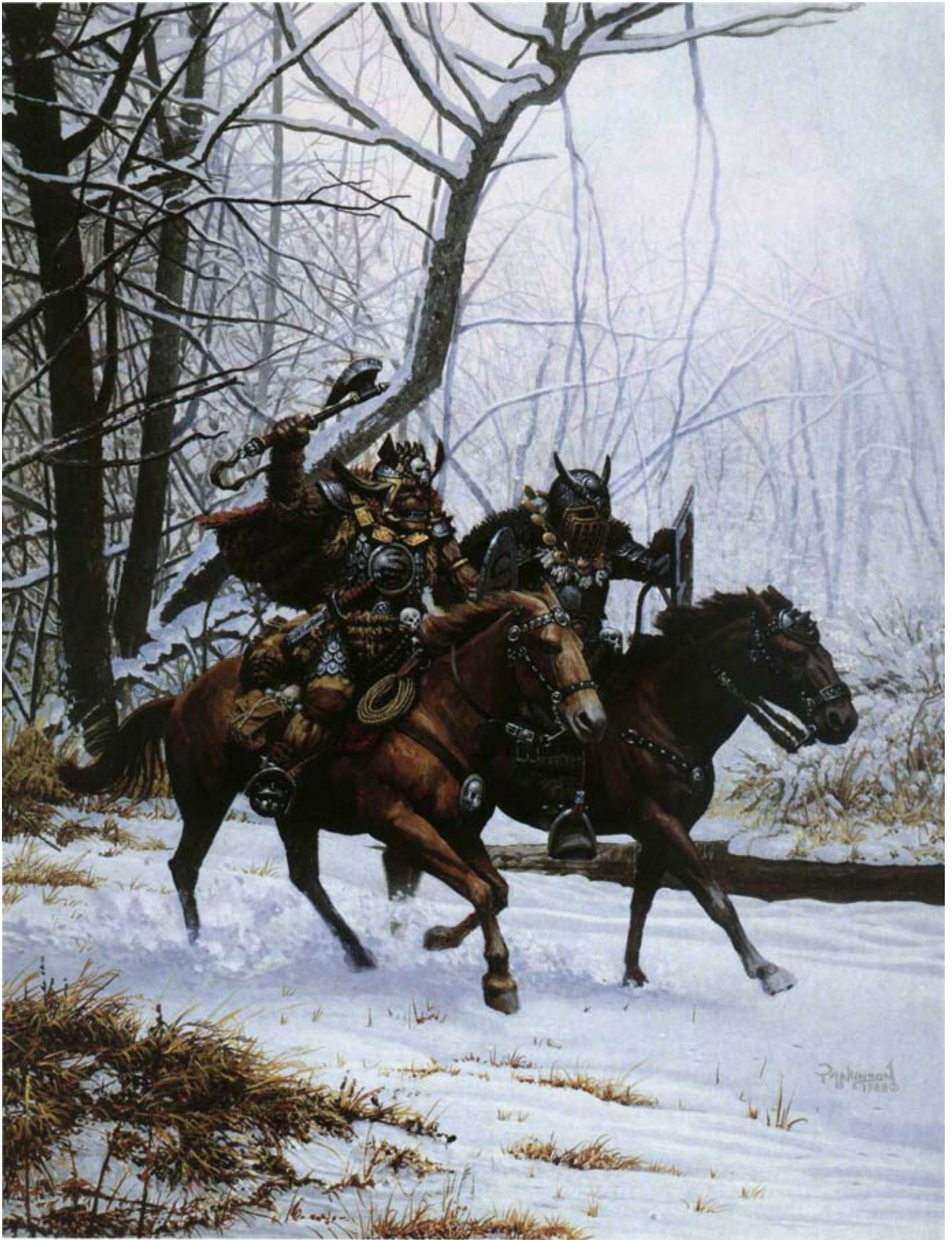

A cyber-knight and a D-Bee companion ride through a snow covered forest

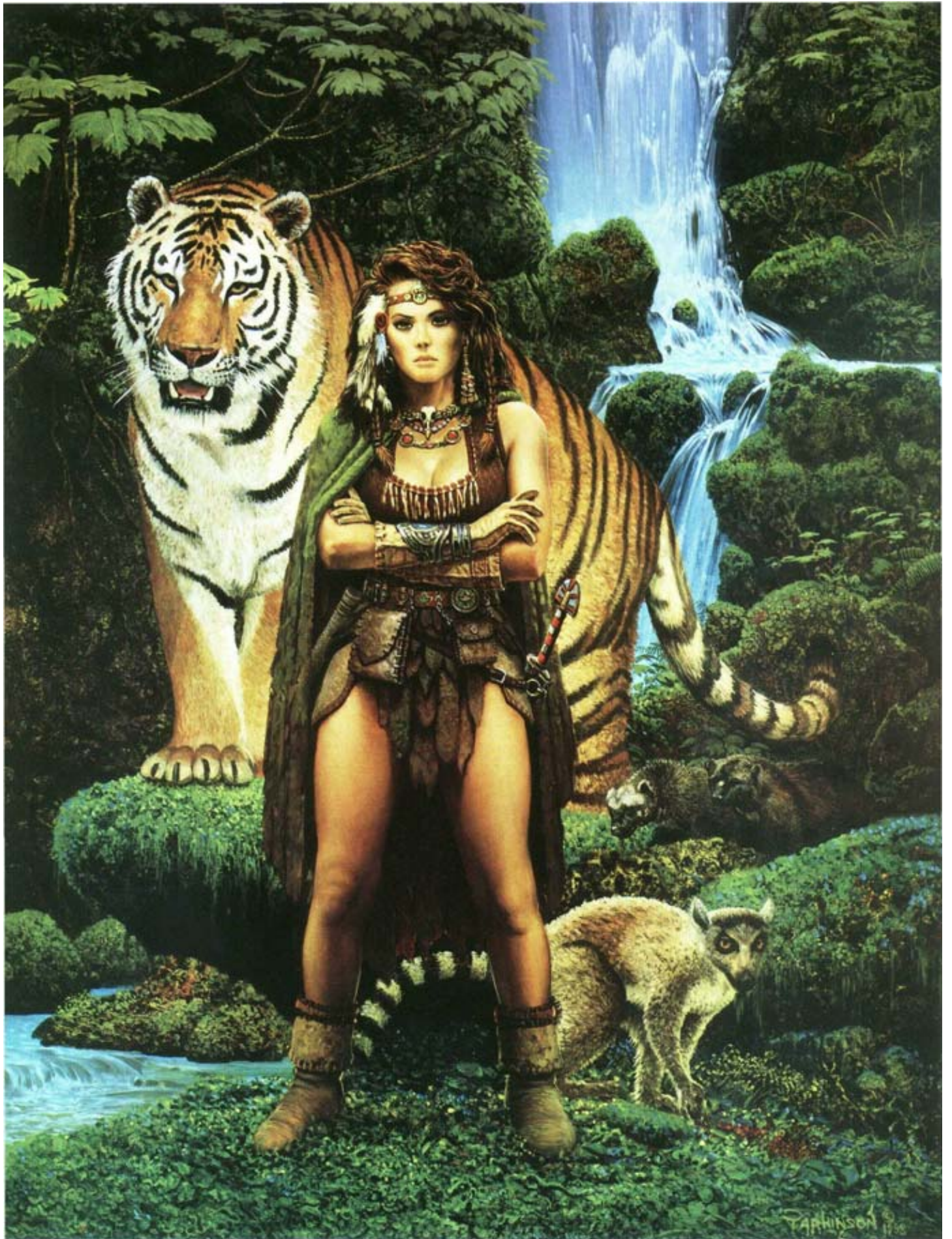

A mystic druid tar from her home in England



Coalition SAMAS power armor in action

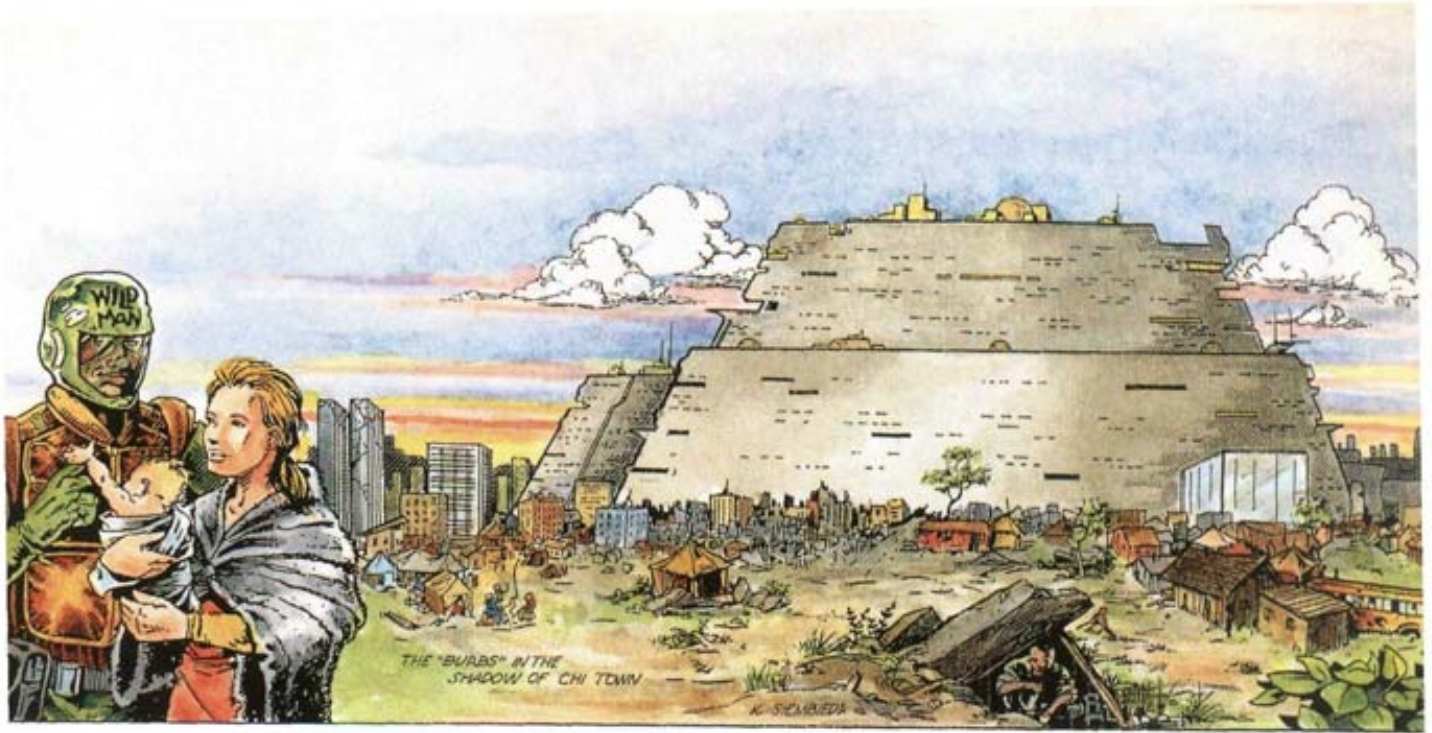

Chi-Town

The heart of the Coalition

Outside, Chi-Town rises above the squalor and human refugees of the "Burbs" like a man-made volcano

Inside is an incredible megalopolis where the elite true, humans and their protectors live The upper levels are beautiful, white, and clean The lower levels are reserved for the poor and are dark and dirty

There are five Coalition States Chi-Town (includes Northern Illinois & Iowa), Lone Star (Texas), Missouri, Free Quebec, and Iron Heart (Sudbury)

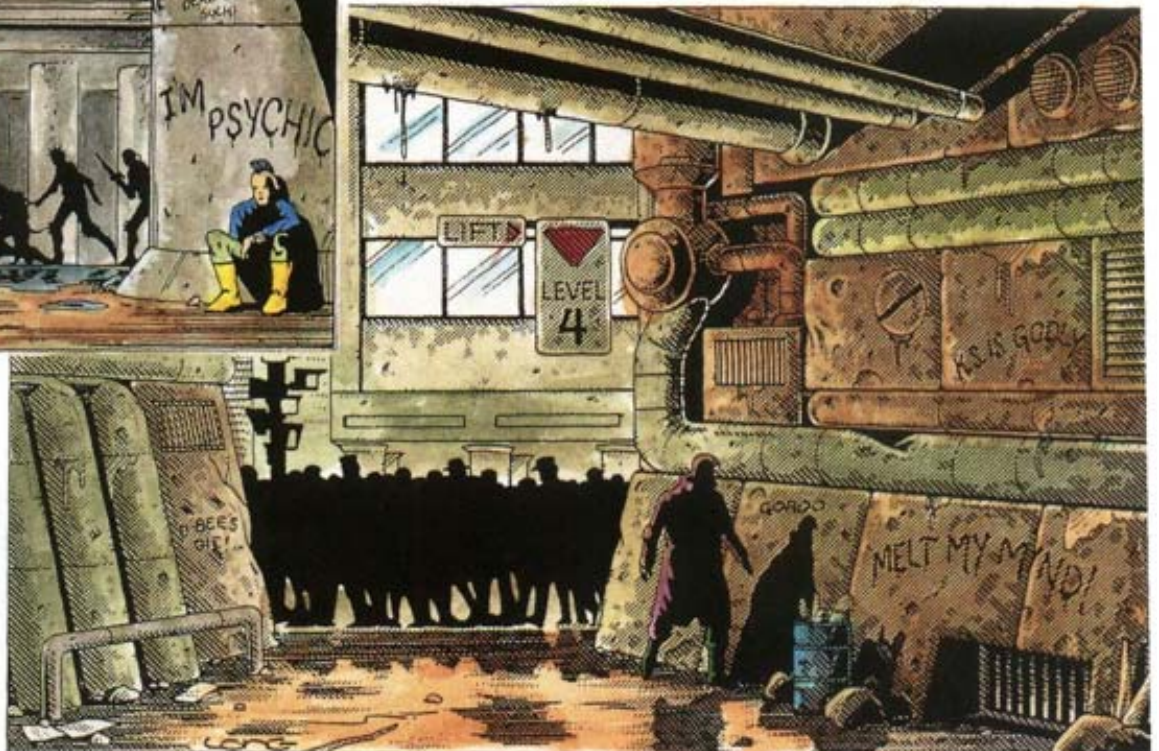
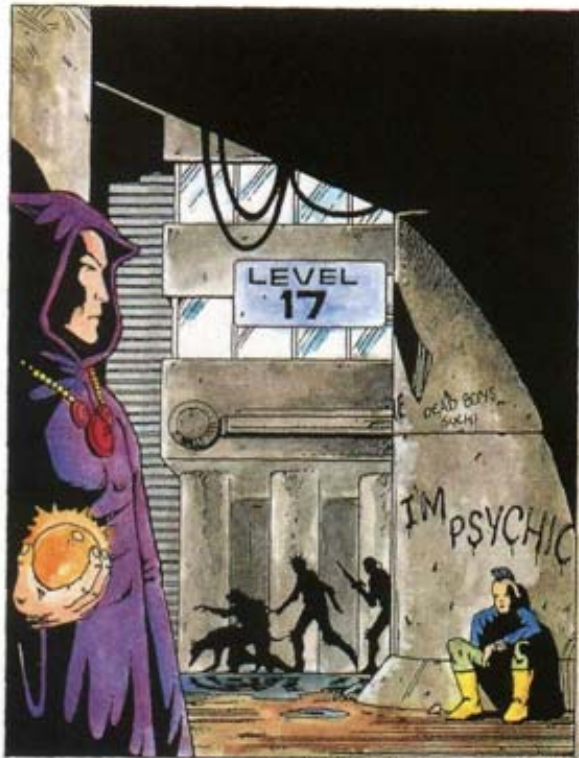

A Map of the Americas & Atlantis

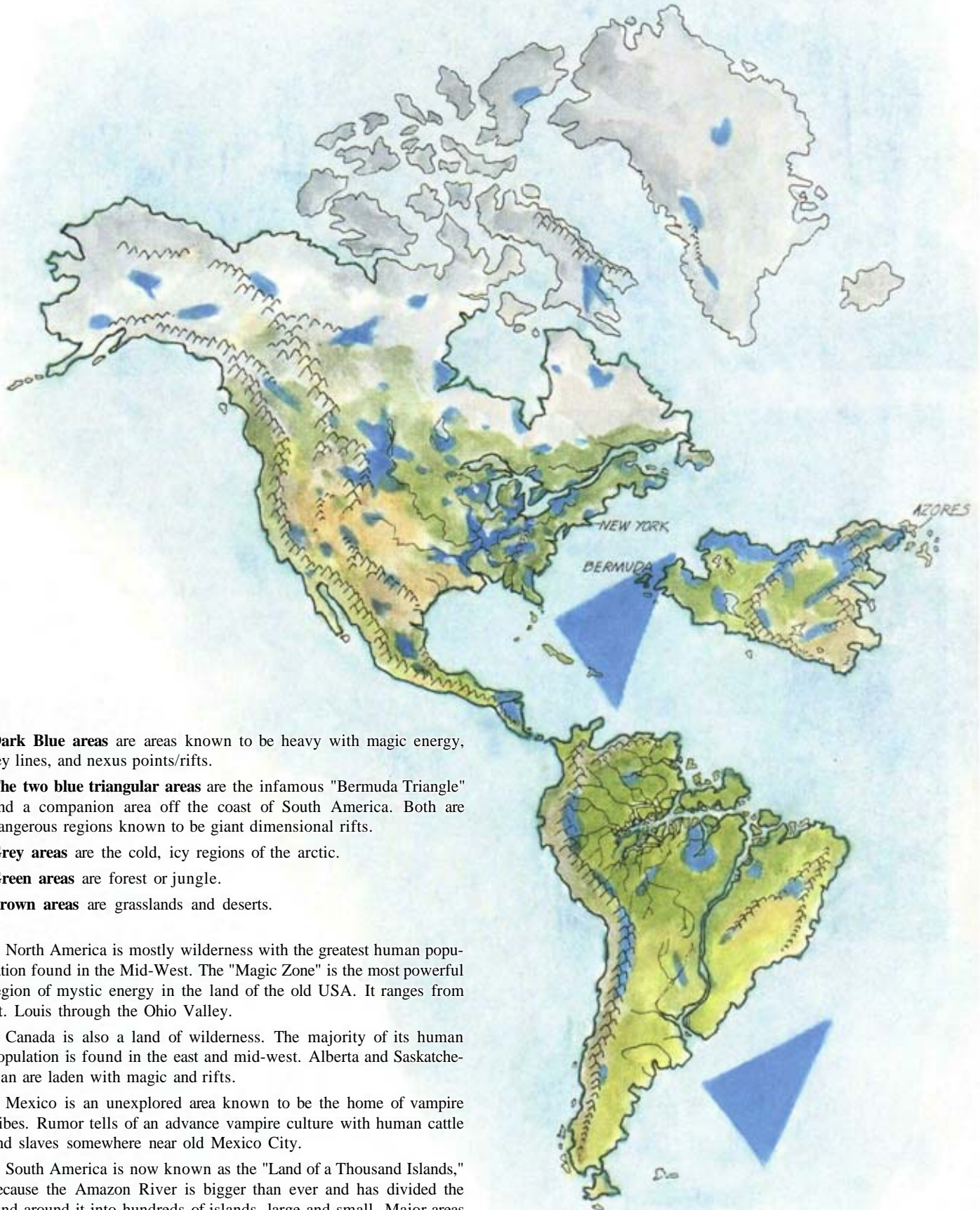

Dark Blue areas are areas known to be heavy with magic energy, ley lines, and nexus points/rifts.

The two blue triangular areas are the infamous "Bermuda Triangle" and a companion area off the coast of South America. Both are dangerous regions known to be giant dimensional rifts.

Grey areas are the cold, icy regions of the arctic.

Green areas are forest or jungle.

Brown areas are grasslands and deserts.

North America is mostly wilderness with the greatest human population found in the Mid-West. The "Magic Zone" is the most powerful region of mystic energy in the land of the old USA. It ranges from St. Louis through the Ohio Valley.

Canada is also a land of wilderness. The majority of its human population is found in the east and mid-west. Alberta and Saskatchewan are laden with magic and rifts.

Mexico is an unexplored area known to be the home of vampire tribes. Rumor tells of an advance vampire culture with human cattle and slaves somewhere near old Mexico City.

South America is now known as the "Land of a Thousand Islands," because the Amazon River is bigger than ever and has divided the land around it into hundreds of islands, large and small. Major areas of magic are found in the Andes and a portion of Brazil in the Amazon jungle.

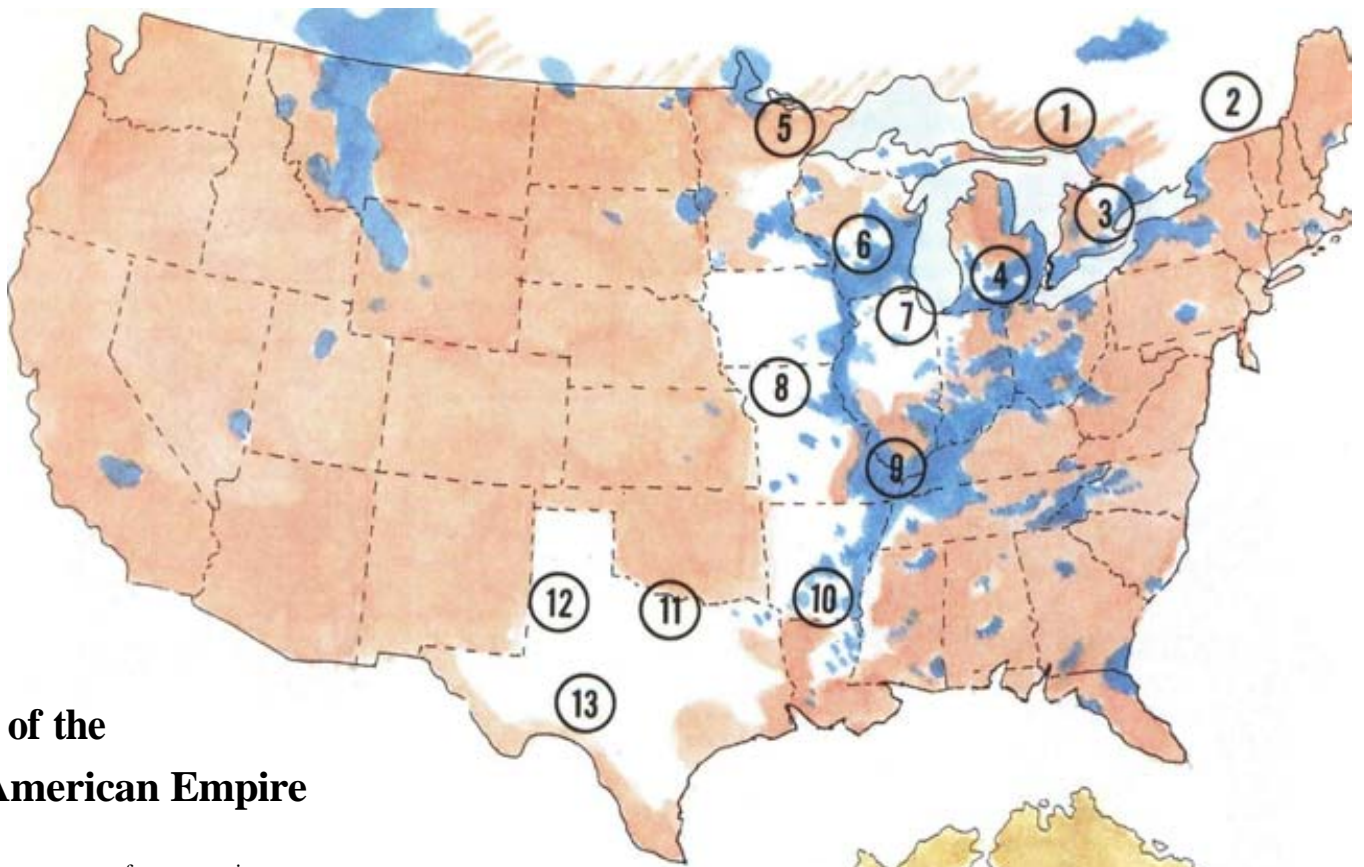

Map of the old American Empire

Blue indicates areas of great magic

Red indicates wilderness areas. These lands are dotted with towns, villages, and the occasional feudal kingdom, but are mostly wild, untamed areas and inhabited by D-Bees, mutants, and monsters

White indicates the more civilized and populated areas.

- 1 Iron Heart
- 2 Free Quebec
- 3 Lazlo
- 4 New Lazlo
- 5 Xiticix Territory
- 6 Tolkeen
- 7 Chi-Town
- 8 Chilhcothe
- 9 Magic Zone
- 10 El Dorado (CS ally)
- 11 Wichita Falls (CS base)
- 12 Lone Star Complex
- 13 Pecos Empire

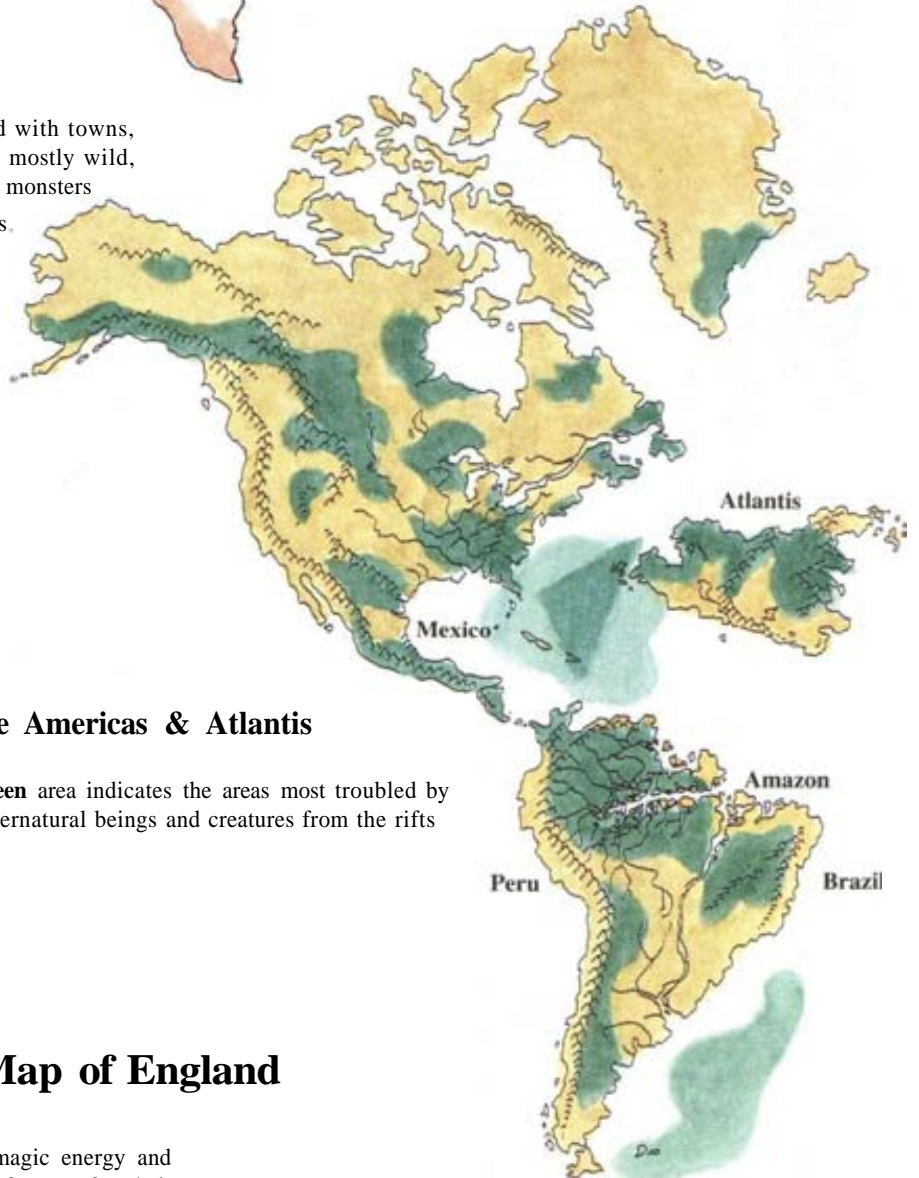

The Americas & Atlantis

Green area indicates the areas most troubled by supernatural beings and creatures from the rifts



Map of England

Virtually all of the British Isles are bathed in magic energy and avoided by most people. The **green** areas are infamous for their monsters



A typical "Operator" in traveling clothes



A wild "Psi-stalker"

Magic

Please Note: Throughout this section, magic is treated as a real, existing force, complete with theories and history. This is done for dramatic purposes. We must again express that **Rifts** is a purely fictional work and has absolutely no bearing on the *real* world!

The magic system is fairly simple and a sort of hybrid between the basic system found in the **Palladium Role-Playing Game** and the later version found in **Beyond the Supernatural**. I have stayed with the Beyond version, with its P.P.E. points, for two reasons. One, the point expenditure system of P.P.E. is similar to psionics and I.S.P., which has been a proven success in the Palladium system for years, and Two, it makes **Beyond the Supernatural**, and its wealth of psychic, magic and supernatural monsters and characters, that much more interchangeable.

How does Magic Work?

The basic concepts behind magic are simple. First, Magic is very real. It is a natural force that has existed since the dawn of time. Perhaps ancient humans, like the mysterious builders of Stonehenge and other megaliths, once knew about the supernatural and could actually perform great feats of magic. However, humankind lost the secrets of magic and turned to science. Over the generations, magic became a myth, an element in the pages of fantasy and science fiction, nothing more. Yet unknown to man, mystic energy was very real and continued to ebb and flow as it had done for eons.

So-called "magic" energy is invisible, like a lot of forces of nature. It is also a constant and ever present energy, like electro-magnetism. Parapsychologists of the 20th Century (as fictionally recounted in **Beyond the Supernatural**) called this energy *Potential Psychic Energy (P.P.E.)*; after all, the term "magic" is a misleading misnomer. Why they called it "Potential" Psychic Energy is because everybody seems to possess a certain amount of this energy, yet only a few are able to use that energy in a *paranormal* or magical way.

They also discovered that natural rivers and streams of this potential psychic energy ran across the planet like an invisible web of mystic energy. These invisible streams are called *ley lines*. Where two or more ley lines cross over each other is called a *ley line nexus point* or energy junction. P.P.E. is at its greatest at nexus points. Investigators were surprised to find that ancient man had somehow known about ley lines and nexus points and had marked these spots with stone circles and towers known as megaliths. In North America the ancients marked these places with huge mounds or animal effigies. In Central America and Egypt, great pyramids were erected.

Further research showed that many of these places had long histories, going back hundreds, and in many cases, thousands of years, regarding these areas as sacred, magical, or haunted. Some were said to have healing powers, while others were attributed to be portals to hell! It was theorized that these places, so rich in P.P.E., could have their energies tapped and used by men of magic. Primitive man may have seen supernatural visitors from other dimensions as inhuman monsters or demons.

It was also found that many of the megaliths had astronomical significance and usually indicated the dawn of winter and summer solstice, planetary alignments, and other astronomical occurrences. The revelation that followed was that these occurrences caused the P.P.E. energy

to dramatically increase for a brief period, lasting a few minutes to several hours. At these occasions, a man of magic could utilize the sudden burst of energy to create powerful magic or know that this was a time of danger and the area was to be avoided. The danger was that dimensional portals or "rifts" would sometimes tear open, releasing strange and/or horrible monsters from other dimensions into our own. Worse yet, demon-like supernatural creatures were lured to the flux of mystic energy like moths to a flame. When the energy flux ended, the dimensional door closed, trapping the creatures in our world, where they adapted to hunt new prey, humans.

Assuming all this was true, why was magic virtually unknown to modern man? Investigations revealed that monsters may have certainly existed. All types of supernatural and magical phenomena were ignored or explained away with semirational explanations like mass hysteria, hoax, swamp gas, hypnosis, insanity, and so on. The more spectacular occurrences were accepted as "the unexplainable," but relegated to late night TV specials, exploitive books, and sensationalizing tabloids, and forgotten. Modern man simply refused to believe in the paranormal and magic.

This refusal to believe in the paranormal was the single most significant reason why modern man had lost the secrets of magic. At best, so-called magic is a metaphysical phenomenon that functions on a different level of understanding than the laws of science held dear by 20th Century people. Mental discipline and belief are the two keys to unlocking the secrets of magic. Without them, magic is impossible.

This explained why some people could seem to perform magic or possessed psychic powers and others did not. Theoretically, everybody has potential psychic energy and at some point in life, has a great deal of it. As human beings mature both physically and mentally the P.P.E. changes. The average adult has little P.P.E., yet an average teenager has more than at any other time in his life. What happens is that the P.P.E. energy is used up in one way or another. Its most constructive use is focusing on a particular area of interest. This could be where the concept of a natural talent arises. A person's focus to develop a particular skill/talent is so strong that the potential psychic energy is channeled in developing that specific area. But this is only a fraction of what is possible. By focusing and developing one's P.P.E., the individual can develop psychic or magic powers.

The Earth of Rifts A Place of Magic

When the Time of Rifts came, the Earth was transformed. The once subtle and forgotten magic energies that quietly flowed across the planet are now rushing rivers and seething oceans of mystic energy. Magic can not be ignored, because it is a daily reality. At night, the ley lines glow an eerie white blue; even during the day, the most powerful ley lines and nexus points can still be seen to glow. Dimensional rifts appear across the land every time there is an eclipse, planetary alignment, and every summer and winter solstice, letting in more creatures from the rifts. Madmen and practitioners of magic, who seek to tame the lines of magic, open new rifts and attract menaces from hell spawned worlds. "Demons," supernatural horrors, unimaginable monsters, aliens, mutants, and other dimensional beings (D-Bees) of all kinds claim the decimated planet as their domain.

The planet Earth has never been so rich in P.P.E./magic energy. The supernatural and paranormal are commonplace. Thus, the element of disbelief in magic is eliminated. Everybody knows magic is real. The new problem is that many people now fear magic and the supernatural and consciously want nothing to do with it. This effectively prevents a vast number of people from ever developing their potential psychic energy in any paranormal way. However, the prevalence of magic makes it much more easy for those who wish to develop magic potential to do so. The energy is all around them, theirs for the taking.

The Mastery of Magic

Step One: Belief

The first step in becoming a practitioner of magic is believing that magic is real and that one can master the knowledge and skill to perform it. The individual must see magic as an innate energy, a tool, and not to be feared. It is man, not magic, that uses the energies for good or evil purposes. This must be 100% conviction, any glimmer of doubt will destroy any chance of learning magic.

Step Two: Mental Discipline

Theoretically, anybody can learn magic; however, it is an extremely difficult process that proves to be impossible for most people. The young student of magic must decide to channel his mystic development toward a particular focus of magic. In this book those areas of focus are the *Ley Line Walker*, *Mystic*, *Shifter* and *Techno-wizard*. Other forms of magic, such as the Druids of England (to be described in a future supplement), are also possible, but these four are the most common to the Americas.

Each of the magic disciplines has a different outlook, orientation and objective. Each will offer similar magic capabilities, as well as a variety of very different abilities.

The Ley Line Walker is a master of spell magic and ley line energy. These men and women can utilize ley lines like none of the other magic O.C.C.s. **The Mystic** has developed both psychic and magic abilities on an intuitive and emotional level. **The Shifter** is a spell caster and manipulator of rifts. **The Techno-wizard** combines magic and technology to create a variety of weapons and devices that are truly unique to both the world of magic and technology.

Step Three: Understanding Magic

Magic is an energy that can be controlled and manipulated by the humanoid mind and force of will. It is a fabulous power that can calm a storm, create a fire ball, or open a door to another world. It is a force that, except for techno-wizardry, requires no external casing or internal mechanism to use; only the mind. It seems to be an inexhaustible energy that continually renews itself. A force of nature that can be harnessed by a single individual.

Individual P.P.E.

Every person has some degree of Potential Psychic Energy (P.P.E.). Most humans and D-Bees have very little, but the practitioners of magic have learned to nurture and hold P.P.E., becoming living batteries of magic energy. The typical mage will have 10 to 30 times more P.P.E. energy than the average person. This energy can be drawn upon at will, much like the psionic characters drawing on their psionic inner strength (I.S.P.) to create/cause magic.

Each magic spell or ritual requires a certain amount of P.P.E. to create. Each spell description will indicate how many P.P.E. points are needed to perform the magic. P.P.E. costs range from as little as one to as much as 2000. Casting a less powerful spell requires one to about 50 P.P.E. The mage should be able to summon forth his own impressive amount of potential psychic energy to cast the spell with comparative ease.

Recovery of P.P.E.

Like psionic I.S.P., the loss of P.P.E. points is temporary and they will replenish themselves naturally at the rate of about five (5) points

for every hour of rest or sleep. **Meditation** is a skill known and practiced by all men of magic. It is used to focus one's concentration and to relax and open oneself to mystic forces. A meditative state will restore expended P.P.E. at a rate of 10 per hour and is equal to an hour of sleep. Meditation will not restore more P.P.E. than the character has expended.

Other Sources of P.P.E.

The spell caster actually has a few options at his disposal. He or she can draw the energy needed from within himself or draw that energy from another source. These other sources include magical talismans, ley lines, ley line nexus points, and other, living creatures, including humans.

Drawing P.P.E. from magic artifacts. There are some magic artifacts that act as a portable P.P.E. battery from which a mage can draw additional magic energy. These items are quite uncommon, but immediately recognized by practitioners of magic.

Drawing P.P.E. from other living beings is a fairly easy task. As stated previously, all living creatures have a certain amount of P.P.E. and taking it from them does no damage. There are certain conditions under which P.P.E. can be taken from others.

Drawing P.P.E. without one's knowledge. The mage can usually draw on anybody's P.P.E. without their consent or knowledge. The man of magic simply focuses his concentration on the target from which he intends to plunder the magic energy and tries to absorb it. The intended target(s) automatically gets a save versus magic attack and must roll a 12 or higher to save. A successful save means that the mage was not able to draw the energy to him and must try again or abandon the plan. A character's failure to save versus magic attack means that the mage was successful in absorbing *half* of the target's P.P.E. to him. **Note:** A mage can never absorb more than half of the victim's total P.P.E. without the individual's consent. Also note that P.P.E. can be drawn from animals as well as people (see animal list in Psionic Section). The spell caster can attempt to simultaneously absorb P.P.E. from several individuals, as many as two targets per level of experience. Range: 10 foot (3 m) radius per every level of experience. Stolen P.P.E. returns at the normal rate of five points per hour of sleep.

Drawing P.P.E. with a person's knowledge and consent. Having willing donors of P.P.E. is much more effective than stealing it from people. What happens when the person is willingly donating his or her magic energy is that the attempt is an automatic success (no save vs magic attack) and the mage can absorb 70% of the person's energy! Better yet, several people can link together by holding hands and concentrating on giving their P.P.E., enabling the mage to use 70% from each person simultaneously. There is no limit to the number of people who can join in an offer of their energy. This is the basic purpose behind a cult or coven and ritual magic.

Drawing P.P.E. from an unwilling subject. Anyone who is aware that a mage wishes to absorb P.P.E. can put up great resistance and prevent his energy from being used by the wizard. It does not matter why the individual resists, whether its out of fear, hate, anger, etc, only that he/she resists is enough. A person who resists/refuses to give his P.P.E., or a fearful animal, will not give up any of his energy. The mage must look for a more receptive target. **Note:** In a combat situation/melee, *all* opponents are on the defensive and considered to be *unwilling* subjects.

Drawing P.P.E. from another practitioner of magic is impossible! These men and women of magic are too attuned to and in control of their magic energies for it to be plundered. Years of training has built in numerous mental defenses. Of course, they can willingly give their P.P.E. or have it taken in a blood sacrifice.

Taking P.P.E. from the living. The most terrible method of extracting P.P.E. from a living creature is by killing it. This is where animal

and human sacrifices come into play. For reasons unknown to scholars and mages alike, a living being's P.P.E. doubles at the moment of death. An evil mage takes advantage of this by murdering his subject and absorbing *all* the victim's doubled P.P.E. **Note:** Only characters of an evil alignment will consider blood sacrifice as a means to acquire magic energy. Principled and scrupulous alignments will not even consider animal sacrifices.

Other sources of P.P.E. are ley lines and nexus points.

Ley Lines, Nexus Points, and P.P.E.

Ley lines are a matrix of natural potential psychic energy that run in *straight lines* across the globe. The source of the energy is unknown and apparently inexhaustible. At places where several ley lines cross, the energy is at its greatest. These P.P.E. intersections are called ley line nexus points.

In the world of **Rifts** the ley line energy is at an all time high and offers a seemingly endless source of mystic power. Practitioners of magic, psychics, supernatural creatures, and demons can stand on or near a ley line and freely feed on its energy.

Ley Lines and Magic

Ley lines have the following effects on men of magic.

Close proximity to a ley line. Being near a ley line, within two miles (3.2 km), increases the range and duration of spells by 50%.

Being at/on a ley line or one mile from a nexus point doubles the range, duration, and *damage* of magic spells. The mage can also draw an additional 10 P.P.E. per level of experience (second level mystic 20 points, third level mystic 30 P.P.E., etc.) every 12 hours. Plus his own P.P.E. recovers at the increased rate of 10 P.P.E. per half-hour, without meditation!

Being at a ley line nexus point or within 200 feet (61 m) of a nexus point triples the range, duration, and damage of magic incantations. The mage also enjoys a bonus of +2 to save vs magic and horror factor. His personal spell strength is also increased by +1. The mage can draw an additional 30 P.P.E. per level of experience every 6 hours. Plus his own P.P.E. recovers at the incredible rate of 20 points per half-hour!!

Periods of increased energy at a nexus point. There are also periods of time during the day and during the year that the ley line energies increase. These increases are most dramatic at the ley line nexus points. It is at these periods that a rift may tear open. It is also at these periods that men of magic can work their most amazing magic. The following are the *additional* amounts of P.P.E. available at specific periods. **Note:** Other, competing and evil forces may also seek out a ley line nexus at these peak moments and may not wish to share the mystic energy (or be seen). Combat may ensue if someone does not yield to the other and leave.

Midday (noon) and midnight: Add 20 P.P.E. per level of the mage.

Vernal (spring) and Autumnal Equinox: Energy runs high during the daylight hours of the vernal equinox and the nighttime hours of the autumnal equinox. During this time a mage may add 100 P.P.E. per level of experience. Note: However, that there is also a 1-30% chance that a rift will appear (roll once for every light or night hour of equinox).

Summer and Winter Solstice: Solstice occurs twice a year, when the sun is farthest from and closest to Earth's equator (June 21st, summer and December 21st, winter, the longest and shortest days of sunlight a year). These two days send the ley line nexus junctions boiling with energy! The P.P.E. available during the 24 hour period is the same as the equinox and there is a 1-40% chance of a rift opening every hour.

At the dawn of a solstice, the nexus erupts with energy for a five minute period. At this time the mage can tap into 300 P.P.E. per each

level of the mage's experience. However, there is a 1-70% chance that a rift will also open and remain open for 3D4 hours. Something(s) bad will definitely come crawling out.

At sunset, another, although smaller, five minute energy flare erupts. The sorcerer can add 200 P.P.E. per level of experience. This time there is a 1-55% chance that a dimensional rift will appear.

Lunar Eclipse happens when the Earth is in a straight line between the sun and the moon. A lunar eclipse happens about once a year and lasts about an hour and a half. During this 90 minute period, practitioners of magic can tap into an extra 400 P.P.E. per level of experience. There is a 1-77% chance of a rift appearing.

A Partial Solar Eclipse occurs when the moon passes in front of the sun and the earth, but is close enough to the Earth that the sun is briefly blocked from sight. This rare solar event happens about once every ten years and lasts for about two to eight minutes (roll 2D4). It has a profound effect on ley line junctions. The mage can tap into 1000 P.P.E. per level of experience. All spell duration, range, and damage is increased by 10 times, mages are +6 to save versus magic, and recover P.P.E. at a rate of 50 a minute! There is also a 1-88% likelihood of a gargantuan rift appearing in the sky. **Note:** The same effects occur when three or more of the planets' orbits put them in a straight line, about every 20 years.

Remember, the additional magic energy is only accessible directly at a ley line nexus and must be used while it is available. The P.P.E. can not be saved and used later. This makes timing a critical factor.

Super Nexus Points

There are about a dozen *known* places in the world where scores of ley lines intersect to create a nexus point of unusual magnitude. These include one super nexus point at 1) Calgary (Canada), 2) Mexico City (Mexico), 3) Andes Mountains (Peru, S. America), 4) The Devil's Gate at St. Louis (Missouri, USA), 5) East St. Louis (Illinois, USA), 6) in the Ohio Valley (Adams County, Ohio, USA), 7) Stonehenge (England), 8) Macs Howe (Scotland), 9) Newgrange (Ireland), 10) Standing Stones of Carnac (France), and 11) the site of the Giza pyramid (Egypt). Presumably, there are super powerful nexus points in places such as the Himalaya Mountains, India, China, Easter Island, Australia, and others, but these are distant lands from the Americas.

The usual available P.P.E. is doubled at super nexus points, but the chance of a rift opening at all peak periods is also increased to 94%.

Random Ley Line Table

The size and length of ley lines can vary from as little as a mile or two to several hundred miles. The following table will help game masters quickly determine the length of a randomly encountered ley line. All ley lines are about a half mile wide (approximately 2700 feet/823 m). **Note:** One mile is about 1.6 kilometers.

01-10	3D4 miles long.	51-60	4D6 miles long.
11-20	3D6 miles long.	61-70	2D4x 10 miles long.
21-30	1D6 miles long.	71-80	1D6x 10 miles long.
31-40	2D6 miles long.	81-90	3D6x 10 miles long.
41-50	6D6 miles long.	91-00	5D6x 10 miles long.



The Pursuit of Magic



Spells, Rituals, Summoning, and O.C.C. Powers.

There are four major categories of magic: spells, rituals, summoning, and special O.C.C. powers.

Spell magic is spoken incantations that serve as a focus to create/cast magic. **The Base Saving Throw** against spell magic is 12. As a mage increases in experience levels he receives bonuses that increase his spell's strength. For example: The spell of a fourth level mystic has a +1 added to his spell strength. This means his magic is now more potent and victims of his mystic assault must roll a 13 or higher, instead of the base 12, to save.

Ritual or ceremonial magic tend to apply to the more powerful magic invocations and may need several participants and require components and the drawing of a circle or pentagram. Any spell incantation from level seven and higher can be cast as a spell or ritual. Spells of level seven through level ten will require ten minutes of ritualizing to cast, but the caster enjoys an enhanced saving throw. Incantations level eleven to fifteen performed as ritual magic will require 1D6 X 10 minutes + 15 minutes to complete.

The Base Saving Throw to save vs ritual magic is 16! Spell strength bonuses are not applicable to *ritual* magic.

Summoning magic can be spell or ritual, but often requires a formal ceremony to summon something or to create a supernatural force such as a zombie or golem. Control incantations always offer their victims a saving throw of 12 (plus spell strength bonus) if a spell and 16 if a ritual. Most summoning and all creation incantations are automatically successful. Summoning magic is predominately used by sorcerers of evil alignments.

O.C.C. powers are special magic abilities that only practitioners of that particular form of magic can perform. For example: Only the Ley Line Walker can teleport along a ley line without expending P.P.E.

Learning Spells

Practitioners of magic, except for the mystic, can learn and cast spells far above their actual experience level. This means a second level ley line walker could cast a tenth level spell, providing he had sufficient magic energy. The line walker and shifter are both proficient enough that they can even figure out a new spell incantation every time they reach a new level of experience. However, there are still a multitude of incantations one can learn. The trick is learning them.

It is far easier to learn an already existing incantation than it is to create one from scratch. This is due, in part, to the knowledge that the existing spell is proven to work. It simply adds to the level of conviction and therefore insures the success of the spell. Remember that spells are designed to focus one's concentration and will so strongly that the mage can create a magic effect. This is more difficult than one might imagine.

Magic Guilds and Brotherhoods

A mage can learn new spells through several different means. The most common, but sometimes compromising, way is to join a **magic guild or brotherhood**. The brotherhood will usually teach new invocations to its members, but usually demands total allegiance to the guild, meaning that the member will donate at least 10% of his annual income to the brotherhood and other support (cleaning, building, maintenance, teaching) and protect it from enemies. The latter may lead to being sent on research, archaeological, reconnaissance, and even combat assignments. This could also lead to one's services being rented out to outside forces, such as a local kingdom who needs the talents of a mage for whatever reason and is willing to pay the guild handsomely for it. Rivalries between magic guilds and individuals can also lead to gang wars and acts of vengeance.

Initiates to a guild will usually be given a speech about the benefits of membership (there are some real benefits too, such as low room and board, sanctuary from outside forces, access to mystic knowledge and books in general, and communication with fellow mages). After the new member has offered a reasonable donation, 5000 credits or more, he will be officially accepted and have full benefits of membership. However, spell knowledge is likely to be withheld for a few months until he or she has proven to be loyal and worthy. Acts of heroics, dedication, and generosity (big donations) are likely to increase one's acceptability dramatically and earn the character loyal acceptance and the right to be taught a couple new spells (level 1-6 most freely given).

Spell knowledge is power, thus it is guarded jealously by most mages. Even in friendly and open magic societies like Tolkeen, Lazlo, and New Lazlo, there are some spells that are guarded secrets, rarely taught; these generally include most spells above level ten. The easiest spells to find are levels 1-4, followed by levels 5-7. Beyond this, the secrets of magic are just that, secret.

Generally, any action that significantly helps the guild will earn the mage the right to be taught 1D4 new spells of his choice (assuming the spells are known by its membership). Spell level is usually kept to magic levels 1-5. An incredible act of heroics or self sacrifice will earn the character 4+ 1D4 spells selected from levels 1-6, or any one spell from any level beyond six. Nonmembers who save or protect the guild at great risk to their own lives are offered guild membership and a reward of two spells from levels 1-4 (non-mages will be healed, fed, given free room for a week, and 2D6x 100 in silver or credits).

Purchasing Magic

Practitioners of magic can occasionally purchase spell magic from magic or alchemist shops. Some of these establishments are owned by a mage or have access to a mage or guild and can teach spell magic.

However, the prices are usually quite steep, 5000 each for level one, 10,000 each for level two, 20,000 each for each level three, 30,000 each for each level four, 40,000 for each level five, 70,000 for each level six, 90,000 for each level seven, 120,000 for each level eight, 160,000 for each level nine. Ten and higher are rarely available (10% chance) and will cost between 250,000 and a million credits. Add 10% for offensive spells, add 20% for metamorphosis and summoning spells. Also, not all magic shops can offer the full range of spells (levels 1-4 are most common) and many will not be able to teach spells at all! Prices will change from place to place.

It is important to remember that the practice of magic frightens a lot of people and terrifies others. The majority of people at places like the Coalition cities hate and despise magic users. Mages will certainly not find any magic shops or fellow mages established in these communities. Instead, they will find only fear, hatred, and prejudice that can get them into serious trouble (some communities shoot or hang mages on the spot).

Demons and other supernatural fiends will sometimes teach magic for money or more often, for trade of a particular item, information, or service. However, it is always dangerous when dealing with demons for obvious reasons.

Boons and Grants. Spells or incantations are sometimes granted as a reward by some communities or kingdoms to get mages to work for them. This is basically another means to trade one's services for mystic knowledge.

Magic Scrolls

Magic scrolls are extremely uncommon for two reasons. 1) A good many practitioners of magic are illiterate (about 70%). 2) Few are willing to write a spell incantation down for fear the other mages will learn the spell from the scroll.

Scroll magic is slightly different because it has a certain amount of magic built right into it. However, a literate mage has a chance of learning spells from scrolls. **Base skill:** 10% + 2% per level of experience. Note that the spell is instantly activated the moment it is read aloud and the words then disappear.

Magic Combat

Magic Attacks Per Melee

To avoid a complicated magic system, all magic invocations/incantations can be found as both spells or rituals/ceremonies.

Spells are *usually* low level invocations taking the form of a chant or mantra, require minimal potential psychic energy (P.P.E.) and can be performed quickly. Two low level spells (levels one through six) can be cast per melee (15 seconds). The higher levels of magic are more complex and require more time. One spell per melee can be cast from seventh thru tenth level magic. One spell every two melees (30 seconds) for levels eleven thru fifteen. Some incantations must be performed as a ritual.

Knowing the spell version of an invocation does not mean the mage also knows the ritual, and vice versa. However, the character can learn *both* the spell version and the ritual version(s) of the same invocation. Also, remember that there are dozens of variations of spells and, especially, rituals to invoke the same basic magic. For example: Demonic, necromantic, and other evil forms of magic, frequently require a blood sacrifice or act of evil or cruelty. But the same invocation, that is, the same magic power/effect, also exists as other, non-violent, non-wicked rituals as well. It is simply a matter of finding these rare, lost secrets of magic.

Saving Throw

In many cases, when magic is used to attack or influence somebody, that person, or any living creature, automatically gets a saving throw. A *saving throw* is like a mental or magical parry to fight off/block the influence of magic. A **successful saving throw** against magic means the magic has no effect on the person. A **failed roll** to "save vs magic" means the magic has full effect on the victim. Physical magic assaults, such as cloud of smoke, energy bolt, fire bolt, objects hurled by telekinesis, call lightning, and similar attacks in which a visible, real, physical force is being used, can not be avoided by rolling a saving throw. In those instances, the saving throw does not apply. However, the physical attacks can be dodged like any physical attack. **Non-living** objects get no saving throws. **Animals** are —4 to save.

To save against a magic attack, the player rolls a 20-sided die and must match or better the magic attack.

To save vs spell magic, the player must generally roll a 12 or higher against individuals who are of levels 1, 2, or 3 experience; 13 or higher against mages who are 4th, 5th, 6th or 7th level; 14 or higher against individuals who are 8th, 9th, 10th and 11th level; 75 or higher for mystics who are 12th, 13th, 14th or 15th level or higher.

To save vs ritual/ceremonial magic, the player must roll a 16 or higher. The saving throw for ritual magic is much higher than that for spell magic because of the preparation time, deep concentration, high emotion and, usually, the greater number of people participating in the ritual.

Canceling Magic

The creator of the magic can cancel/stop its effect or influence instantly at any time. Likewise, the magic-weaver does not have to create the magic for its full duration, but can impose any amount of time, as long as it does not exceed the maximum possible duration.

Interrupting a spell caster, preventing him from completing the spell, will force the mage to stop and start, again, from the beginning. But no potential psychic energy is lost. A spell caster can stop reciting a spell in mid-incantation without expending P.P.E. or causing any side effect.

Ritual/Ceremonial magic, although usually more powerful, is also more fragile. **An interruption of the ritual, lasting more than 30 seconds** preventing the arcanist leader from continuing, will ruin the ceremony, as well as cause 30% of the total available P.P.E. to leak away unused. **Incapacitating the leader** for over 30 seconds will have the same effect. **Incapacitating the other** participating members/cultists (rendering them unconscious, pulling them away, etc.) will only reduce the amount of available potential psychic energy. Of course, if the available P.P.E. is reduced to below the invocation's requirement, the magic can not be performed. **The negate magic** spell or ritual can also be used to cancel/stop the effects of magic.

Magic Terms

Level of experience/spell caster refers to the experience level of the person who is casting the magic. This is a very important distinction, particularly in a combat situation, because the higher the experience level of the spell caster, the more powerful the spell. Many invocations will indicate something like "*Duration: 5 melees per level of experience.*" or "*One die damage per level of the spell caster.*" and so on. **This means** that a *third level mage* with a spell duration of 5 melees per level of the spell caster, upon casting a spell, can maintain the spell's effects for a maximum duration of 75 melees (5 melees for each level of experience = 15 melees).

Range: Indicates the maximum distance the magic can be cast with: X number of feet, touch, or radius (area of spell effect).

Area affect magic are incantations that affect everyone in a given area or radius. A spell with a 15ft radius affects *all* within the circle of its power/radius. Those just outside the area are not affected.

Line of vision means that the mystic's target/victim must be within his sight (line of vision) to be affected. If the target is not seen, is totally obscured by obstacles, darkness, invisibility, or just not seen by the spell caster (hiding, behind him, beyond normal vision), the magic can not be used. However, some line of vision spells can be directed in a specific area that the spell caster can see to affect someone invisible or hidden.

Touch means that the magic's effects can only be transmitted through physical contact.

Duration: This indicates how long the magic's effects last, whether it be *instant* like a Fire Bolt or *long-lasting* like a Fly as an Eagle spell. Long-lasting magic will indicate exactly how many melees or minutes it lasts, "*per level of experience.*"

Base magic strength/attack for spell magic is 12.

Base magic strength/attack for ritual magic is 16. No bonuses apply to increase the strength of ritual magic.

Alphabetical List of Invocations by Page

- Agony (20) — pg. 177
Amulet (290) — pg. 186
Animate/Control Dead (20) — pg. 178
Anti Magic Cloud (140) — pg. 185
Apparition (20) — pg. 176
Armor of Ithan (10) — pg. 170
Astral Projection (10) — pg. 172
Banishment (65) — pg. 183
Befuddle (3) — pg. 169
Blind (6) — pg. 172
Blinding Flash (1) — pg. 168
Breathe Without Air (5) — pg. 170
Call Lightning (15) — pg. 176
Calling (8) — pg. 174
Calm Storms (200) — pg. 186
Carpet of Adhesion (10) — pg. 172
Chameleon (6) — pg. 169
Charismatic Aura (10) — pg. 172
Circle of Flame (10) — pg. 174
Climb (3) — pg. 169
Close Rift (200+) — pg. 189
Cloud of Smoke (2) — pg. 168
Commune with Spirits (25) — pg. 180
Compulsion (20) — pg. 176
Concealment (6) — pg. 169
Constrain Being (20) — pg. 177
Control/Enslave Entity (80) — pg. 183
Create Zombie (250) — pg. 187
Create Mummy (160) — pg. 185
Create Golem (700 or 1000) — pg. 188
Create Magic Scroll (100) — pg. 185
Cure Minor Disorders (10) — pg. 172
Cure Illness (15) — pg. 176
Curse: Phobia (40) — pg. 182
Death Trance (1) — pg. 168
Detect Concealment (6) — pg. 169
Dimensional Portal (1000) — pg. 190
Dispel Magic Barrier (20) — pg. 178
Domination (10) — pg. 174
Energy Field (10) — pg. 172
Energy Bolt (5) — pg. 170
Energy Disruption (12) — pg. 174
Escape (8) — pg. 175
Exorcism (30) — pg. 180
Extinguish Fire (4) — pg. 169
Eyes of Thoth (8) — pg. 175
Eyes of the Wolf (25) — pg. 180
Familiar Link (55) — pg. 182
Fear (5) — pg. 169
Fingers of Wind (5) — pg. 170
Fire Ball (10) — pg. 176
Fire Bolt (7) — pg. 173
Float in Air (5) — pg. 170
Fly (15) — pg. 175
Fly as the Eagle (25) — pg. 178
Fool's Gold (10) — pg. 172
Fuel Flame (5) — pg. 170
Globe of Daylight (2) — pg. 168
Globe of Silence (20) — pg. 178
Hallucination (30) — pg. 180
Heal Wounds (10) — pg. 175
Heavy Breathing (3) — pg. 169
Horrific Illusion (10) — pg. 175
Id Barrier (600) — pg. 189
Ignite Fire (6) — pg. 171
Impenetrable Wall of Force (600) — pg. 190
Impervious to Fire (5) — pg. 171
Impervious to Energy (20) — pg. 176
Impervious to Poison (5) — pg. 171
Invisibility: Simple (6) — pg. 171
Invisibility: Superior (20) — pg. 178
Invulnerability (25) — pg. 178
Levitation (5) — pg. 170
Ley Line Transmission (30) — pg. 173
Life Drain (25) — pg. 178
Locate (30) — pg. 180
Luck Curse (40) — pg. 180
Magic Pigeon (20) — pg. 176
Magic Net (7) — pg. 173
Mask of Deceit (15) — pg. 176
Memory Bank (12) — pg. 177
Metamorphosis: Mist (250) — pg. 187
Metamorphosis: Human (40) — pg. 180
Metamorphosis: Insect (60) — pg. 182
Metamorphosis: Superior (100) — pg. 183
Metamorphosis: Animal (25) — pg. 179
Minor Curse (35) — pg. 181
Multiple Image (7) — pg. 173
Mute (50) — pg. 182
Mystic Portal (60) — pg. 184
Mystic Alarm (5) — pg. 170
Negate Poisons/Toxins (5) — pg. 171
Negate Magic (30) — pg. 181
Oracle (30) — pg. 181
Paralysis: Lesser (5) — pg. 171
Protection Circle: Superior (300) — pg. 188
Protection Circle: Simple (45) — pg. 182
Purification (Food/Water) (20) — pg. 179
Reduce: Self (20) — pg. 177
Remove Curse (140) — pg. 185
Repel Animals (7) — pg. 173
Resist Fire (6) — pg. 171
Restoration (750) — pg. 190
Sanctum (390) — pg. 189
Seal (7) — pg. 173
See Aura (6) — pg. 168
See the Invisible (4) — pg. 168
Sense Evil (2) — pg. 168
Sense Magic (4) — pg. 168
Shadow Meld (10) — pg. 173
Sickness (50) — pg. 181
Sleep (10) — pg. 175
Speed of the Snail (50) — pg. 183
Spoil (Water/Food) (30) — pg. 181
Stone to Flesh (30) — pg. 181
Summon Fog (140) — pg. 186
Summon Shadow Beast (140) — pg. 184
Summon and Control Canine (50) — pg. 183
Summon and Control Rodents (70) — pg. 184
Summon and Control Rain (200) — pg. 187
Summon and Control Lesser Being (425) — pg. 189
Summon and Control Storm (300) — pg. 188
Summon and Control Entity (250) — pg. 187
Summon and Control Animals (125) — pg. 186
Superhuman Speed (10) — pg. 175
Superhuman Strength (10) — pg. 175
Swim as a Fish (6) — pg. 174
Swim as a Fish: Superior (12) — pg. 175
Talisman (500) — pg. 189
Telekinesis (6) — pg. 171
Teleport: Lesser (15) — pg. 177
Teleport: Superior (600) — pg. 190
Thunderclap (4) — pg. 169
Time Hole (210) — pg. 187
Time Slip (20) — pg. 177
Tongues (12) — pg. 177
Trance (10) — pg. 174
Transferal (50) — pg. 183
Transformation (2000) — pg. 190
Turn Dead (6) — pg. 170
Wards (90) — pg. 184
Water to Wine (40) — pg. 183
Wind Rush (20) — pg. 179
Wisps of Confusion (40) — pg. 182
Words of Truth (15) — pg. 177

An Alphabetical List of Invocations by Level

The number in parenthesis () are the number of P.P.E. required to use the magic.

Level One

Blinding Flash (1)
Cloud of Smoke (2)
Death Trance (1)
Globe of Daylight (2)
See Aura (6)
See the Invisible (4)
Sense Evil (2)
Sense Magic (4)
Thunderclap (4)

Level Two

Befuddle (3)
Chameleon (6)
Climb (3)
Concealment (6)
Detect Concealment (6)
Fear (5)
Heavy Breathing (3)
Levitation (5)
Mystic Alarm (5)
Turn Dead (6)

Level Three

Armor of Ithan (10)
Breathe Without Air (5)
Energy Bolt (5)
Fingers of Wind (5)
Float in Air (5)
Fuel Flame (5)
Ignite Fire (6)
Impervious to Fire (5)
Invisibility: Simple (6)
Negate Poisons/Toxins (5)
Paralysis: Lesser (5)
Resist Fire (6)
Telekinesis (6)

Level Four

Astral Projection (10)
Carpet of Adhesion (10)
Blind (6)
Charismatic Aura (10)
Cure Minor Disorders (10)
Energy Field (10)
Fool's Gold (10)
Fire Bolt (7)
Ley Line Transmission (30)
Magic Net (7)
Multiple Image (7)
Repel Animals (7)
Seal (7)
Shadow Meld (10)
Swim as a Fish (6)
Trance (10)

Level Five

Calling (8)
Circle of Flame (10)
Domination (10)
Energy Disruption (12)

Escape (8)
Eyes of Thoth (8)
Fly (15)
Heal Wounds (10)
Horrific Illusion (10)
Sleep (10)
Superhuman Strength (10)
Superhuman Speed (10)
Swim as a Fish - Superior (12)

Level Six

Apparition (20)
Call Lightning (15)
Compulsion (20)
Cure Illness (15)
Fire Ball (10)
Impervious to Energy (20)
Magic Pigeon (20)
Mask of Deceit (15)
Memory Bank (12)
Reduce: Self (20)
Teleport: Lesser (15)
Time Slip (20)
Tongues (12)
Words of Truth (15)

Level Seven

Agony (20)
Animate/Control Dead (20)
Constrain Being (20)
Dispel Magic Barrier (20)
Fly as the Eagle (25)
Globe of Silence (20)
Invisibility: Superior (20)
Invulnerability (25)
Life Drain (25)
Metamorphosis: Animal (25)
Purification (Food/Water) (20)
Wind Rush (20)

Level Eight

Commune with Spirits (25)
Eyes of the Wolf (25)
Exorcism (30)
Hallucination (30)
Locate (30)
Luck Curse (40)
Metamorphosis: Human (40)
Minor Curse (35)
Negate Magic (30)
Oracle (30)
Sickness (50)
Spoil (Water/Food) (30)
Stone to Flesh (30)
Wisps of Confusion (40)

Level Nine

Curse: Phobia (40)
Familiar Link (55)
Metamorphosis: Insect (60)

Mute (50)
Protection Circle: Simple (45)
Summon & Control Canine (50)
Speed of the Snail (50)
Transferral (50)
Water to Wine (40)

Level Ten

Banishment (65)
Control/Enslave Entity (80)
Metamorphosis: Superior (100)
Mystic Portal (60)
Summon Shadow Beast (140)
Summon/Control Rodents (70)
Wards (90)

Level Eleven

Anti Magic Cloud (140)
Create Mummy (160)
Create Magic Scroll (100)
Remove Curse (140)
Summon & Control Animals (125)
Summon Fog (140)

Level Twelve

Amulet (290)
Calm Storms (200)
Create Zombie (250)
Metamorphosis: Mist (250)
Summon Entity (250)
Summon Rain (200)
Time Hole (210)

Level Thirteen

Create Golem (700 or 1000)
Protection Circle: Superior (300)
Summon Storm (300)
Summon Lesser Being (425)
Sanctum (390)
Talisman (500)

Level Fourteen

Close Rift (200 +)
Id Barrier (600)
Impenetrable Wall of Force (600)
Restoration (750)

Level Fifteen

Dimensional Portal (1000)
Teleport: Superior (600)
Transformation (2000)

INVOCATION DESCRIPTIONS

LEVEL ONE

Blinding Flash

Range: 10ft (3m) radius; up to 60ft (18.3m) away.

Duration: Instant

Saving Throw: Standard

P.P.E.: One

This invocation creates a sudden burst of intense, white light, temporarily blinding everyone in its ten foot radius (3m). Victims are blinded for one to four melees, a penalty of —5 to strike, and —10 to parry and dodge. The chance of falling is 50% every 10ft (3m). The magic can be cast up to 60ft (18.3m) away. Saving throw is standard; those who successfully save vs magic are not blinded. **Note:** Does not effect bionic or cybernetic eyes.

Cloud Of Smoke

Range: 90ft (27.4m)

Duration: 4 melees per level of experience.

Saving Throw: None

P.P.E.: Two

This magic enables the arcanist to create a cloud of dense, black smoke (30ft x 30ft X 30ft maximum size) up to ninety feet away. Victims caught in the cloud will be unable to see anything beyond the cloud, and their impaired vision allows them to see no more than three feet in the cloud (and that means only a blurry shape). While in the cloud, victims will be -5 to strike, parry, and dodge.

Death Trance

Range: Self

Duration: 10 melees (2½ minutes) per level of experience.

Saving Throw: None

P.P.E.: One

A magically induced trance which makes the mage appear to be dead. There is no breathing, pulse, heartbeat, or any other signs of life. While in the trance, the arcanist is quite helpless, unable to speak, move or invoke magic. Only minor physical sensations felt by the mage are recognizable, like being jostled, carried or hearing voices, but no specific identification or memories are possible. The magic can be canceled at will.

Globe of Daylight

Range: Near self or up to 30ft (9.1m) away.

Duration: 12 melees (3 minutes) per level of experience.

Saving Throw: None

P.P.E.: Two

A small globe or sphere of true daylight is magically created. The light is bright enough to light up a 12ft (3.6m) area per each level of its creator's experience. Because it is daylight, it can ward off most vampires, keeping them at bay just beyond the edge of light. The creator of the globe can mentally move it along with himself, or send it up to thirty feet (9.1m) ahead. The maximum speed at which the globe can travel is equal to a speed attribute of 12.

See Aura

Range: 100ft (30.5m)

Duration: 1 melee

Saving Throw: None; but a psychic mind block will mask the presence of psychic abilities, the level of P.P.E., and possession.

P.P.E.: Six

All things, organic and inorganic, have an aura. The aura has many distinctions, and can be used to see or sense things invisible to the eye. *Seeing an aura will indicate the following:*

- Estimate the general level of experience. Low (1-3), medium (4-7), high (8th and up).
- The presence of magic (no indication of what, or power level).
- The presence of psychic abilities.
- High or low base P.P.E.
- The presence of a possessing entity.
- The presence of an unusual human aberration, which indicates a serious illness, non-human, or mutant, but does not specify which.

Note: Can not tell one's alignment from "see aura".

See the Invisible

Range: 200ft (61m)

Duration: 1 minute (4 melees) per each level of experience.

Saving Throw: None

P.P.E.: Four

The character can see forces, objects and creatures which can turn invisible or are naturally invisible. Even if the creature has no form per se, the mystic will be able to discern the vaporous image or energy sphere which is the being. This includes: ghosts, entities and the astral body.

Sense Evil

Range: 90ft (27.4m) area

Duration: 2 minutes (8 melees) per level of experience.

Saving Throw: None, except a psychic mind block, or a protection from magic pentacle which will prevent the spell from working on anyone in the circle. The psychic's equivalent power of sense evil is not blocked by the magic pentacle.

P.P.E.: Two

The sense evil invocation will enable its spell caster to feel or sense the presence of *supernatural evil*. It will indicate approximately how many supernatural evil presences are within the 90ft (27.4m) area; one, a few (2-6), several (7-14), or many (15 or more). It can also register the intensity of the evil and pinpoint the general location of the source(s) to a particular room(s), possessed object, or person, or an approximate distance (very close, near, far, etc.).

Evil emanations from human beings are much less distinct and can not be sensed unless the source/person has an immediate evil intention.

Sense Magic

Range: 120ft (36m) area

Duration: 2 minutes (8 melees) per level of experience.

Saving Throw: None

P.P.E.: Four

This magic ability enables the character to sense or feel the presence of magic. Like a Geiger counter, the individual can tell if he is near (within 20ft) or far (toward the limit of the range). The ability can also indicate whether a person or object is enchanted/under a magic spell

(this does not include psychic powers), is in the process of invoking magic, or if magic is being used in the range area. **Note:** Men of Magic and most supernatural beings do not register as magic except when actually casting a spell/using magic.

Thunderclap

Range: Directly affects the immediate area (30ft/9.1m around the magic weaver), but can be heard up to one mile away.

Duration: Instant

Saving Throw: Save vs Horror Factor

P.P.E.: Four

The invocation produces a booming clap of thunder that is so loud that it seems to make the air vibrate. A thunderclap is an excellent means of alerting or signaling allies, as well as a means of intimidation. As an intimidation device, it will momentarily startle and distract everyone other than the spell caster. This provides the creator of the thunder with a bonus of +5 on his initiative, +1 to strike, parry and dodge, and creates a horror factor of 8 (all characters within 30ft/9.1m must roll to save vs horror factor, except the mage who made the thunder).

LEVEL TWO

Befuddle

Range: 100ft (30.5m)

Duration: 2 minutes (8 melees) per level of experience.

Saving Throw: Standard

P.P.E.: Six

An enchantment that temporarily causes its victim to become confused and disoriented. Concentration and reactions are impaired. Those affected are —2 to strike, parry and dodge; attacks per melee are reduced by one-half and all skills suffer a penalty of —20%. Each invocation affects only one person each time it is cast. A successful save vs magic means the intended victim suffers no impairment.

Chameleon

Range: Self or Others by touch

Duration: 18 melees per level of spell caster

Savings Throw: None

P.P.E.: Six

This spell enables the affected person to seemingly alter the color and pattern of his clothes and physical body, enabling him to blend into the surrounding environment. Movement destroys the effectiveness of this magic.

90% undetectable if unmoving.

70% undetectable if moving 2 feet per melee or slower.

20% undetectable if moving 6 feet per melee.

Totally ineffective if moving any faster.

Climb

Range: Self, or others up to 40ft away (12.2m).

Duration: 5 minutes (20 melees) per level of experience.

Saving Throw: None

P.P.E.: Three

An enchantment that enables the enchanted person to climb with exceptional, almost inhuman, skill, speed and agility. Skill level is 98% for *normal*, rough, climbable surfaces; speed is equal to speed attribute. Smooth, presumably unclimbable or extremely difficult surfaces to climb normally can be scaled with a skill level of 60%. Rappelling is included.

Concealment

Range: Small objects up to 40ft away (12.2m).

Duration: 5 minutes per level of experience.

Saving Throw: Standard

P.P.E.: Six

This magic makes any small object sort of invisible. Actually, it affects the perception of anybody who looks at it. Unless the person(s) makes a successful saving throw, the item can not be seen. This can be applied to an item on one's person or out in the open. Only one object is affected each time the magic is invoked. The object can not be living and must be smaller than 14 inches in length and height 6 inches in width, and weigh 14 pounds (6.4kg) or less. Each person who looks at the place where the enchanted object is resting must roll a saving throw versus magic. A failed roll means that particular individual will not see it until the magic lapses. **Note:** If the object is used as a weapon or picked up by the mage or anyone who does see it, the enchantment is broken and it becomes clearly visible to all.

Detect Concealment

Range: Area affect: 30ft (9.1m).

Duration: Instant

Saving Throw: None

P.P.E.: Six

A magic invocation that will instantly negate any concealment spell(s) and reveal any object(s) which may have been mystically concealed. Can be directed at a specific area or individual, or made to affect an entire area of 30ft (9.1m).

Extinguish Fire

Range: 20ft (6.1m) area, up to 80ft away.

Duration: 1 minute (4 melees) per level of experience.

Saving Throw: None

P.P.E.: Four

The mage can instantly put out up to a 20ft (6.1m) area of fire 80ft away (24.4m). A total of 40ft (12.2m) can be extinguished every 15 seconds (one melee).

Fear (Horror Factor: 16)

Range: 20ft (6.1m) area, up to 100ft away (30.5m).

Duration: 1 minute (4 melees) per level of experience.

Saving Throw: Special; Save vs Horror Factor

P.P.E.: Five

The invocation creates a sensation of fear over a particular area (20ft maximum area of affect). The mystic can place the enchantment on an area occupied with people, or an area that is not presently occupied. Anybody entering the area of enchantment must roll to save vs horror factor 16. A failed roll means the person is suddenly washed with terror and will be momentarily stunned, loses initiative, is the last person to attack, and can not defend against an opponent's first strike each melee the person is in the area of fear. Also see "the Horror Factor" explanation in the combat section of the book.

Heavy Breathing

Range: 60ft (18.3m) away.

Duration: 5 melees per level of experience.

Saving Throw: Standard

P.P.E.: Five

The mage is able to conjure a mysterious, frightful sound of heavy, labored breathing, as if something invisible was lurking about. The mage can mentally manipulate the sound, increasing or decreasing the breathing rhythm, and move the sound around up to 60ft away. The breathing can be heard in a six foot radius. Those hearing the breathing

will become fearful and panicky. There is a 60% chance that the frightened fellow will flee in terror. Those who hear the breathing, but do not run, will be —2 to strike, and —1 to parry and dodge as they shake in their boots.

Saving Throw: Standard; those who save are not affected/fearful.

Levitation

Range: Up to 60ft (18.3m) away.

Duration: 3 minutes (12 melees) per level of experience.

Saving Throw: Standard

P.P.E.: Five

Magic levitation enables the invoker of the magic to raise himself, or other people, or an object, straight up into the air and suspend it there (hover). Movement is limited to straight up and down; no horizontal motion is possible. Weight is restricted to 200lbs (90kg) plus 20lbs (9.1kg) per level of experience. Unwilling victims of the magic get a saving throw; a successful roll means the person is *not* affected by the levitation and remains planted firmly on the ground. Maximum height possible is 60ft (18.3m) plus 10ft (3m) per each level of experience. Targets can be affected up to 60ft (18.3m) away.

Mystic Alarm

Range: 12ft (one object)

Duration: One year per level of experience.

Saving Throw: None

P.P.E.: Five

The arcanist can protect his possessions and domicile by placing mystic alarms on them. The invocation creates invisible, ward-like symbols on any *one*, specific, non-living object. If this object is touched or disturbed by anyone other than the spell caster, a silent alarm will buzz in the mage's head, alerting him to the intrusion. The alarm will alert him instantly, even if he is thousands of miles away or in another dimension. Once disturbed, the alarms disappear. The mystic alarm has a limited life of one year per level of arcanist.

Turn Dead

Range: Up to 60ft (18.3m) away

Duration: Instant effect.

Saving Throw: Standard

P.P.E.: Six

The utterance of this magic will turn/repel 1D6 animated dead per level of experience. This means that those creatures affected will turn and immediately leave the area without harming the spell caster or anyone near him. The dead turned will not come back for 24 hours. This magic only affects "animated" dead, and skeletons or corpses that are magically animated like marionettes, but will *not* affect vampires, zombies, or any corpse or skeleton possessed by a living entity.

LEVEL THREE

Armor of Ithan

Range: Self or Other

Duration: 4 melees per level of the spell caster

Savings Throw: None

P.P.E.: Ten

This powerful spell creates an invisible, weightless, noiseless, full suit of mystic armor instantly upon the spell caster. Named after the magic armor of the dwarf king Ithan, this mystic armor has a M.D.C. of 10 per level of experience. Magic, fire, lightning, and cold do one-half damage.

The armor can be instantly created upon anyone, as long as the spell caster invokes the spell while touching the intended recipient.

Breathe Without Air

Range: Self or others by touch.

Duration: 12 melees (3 minutes) per level of experience.

Saving Throw: None

P.P.E.: Five

This invocation enables the person to function normally without air, whether it be underwater or in a vacuum, or in an area with little or no oxygen. Unfortunately, the magic does not protect the person from magic toxins or other types of magic, but *does* protect against natural and man-made gases.

Energy Bolt

Range: 150ft (45.7m)

Duration: Instantly

Damage: 4D6 S.D.C.

Saving Throw: Dodge of an 18 or higher.

P.P.E.: Five

The incantation creates an energy bolt that the mage can mentally direct by simply looking at his intended target. The bolt may appear to fire from a hand or finger or the eyes, but needs *no* physical gesture, such as pointing. S.D.C. damage is normally four six-sided dice (4D6), but is increased to 6D6 under the influence of a *ley line* and 8D6 at a *ley line nexus*; P.P.E. cost is still only five despite the increased damage capability. *One* energy bolt can be fired at one target per each spell invocation.

Fingers of the Wind

Range: 90ft (28m)

Duration: 3 melees per level of experience.

Saving Throw: None

P.P.E.: 5

The magician can conjure a wind and manipulate it to touch, tap, bump, or press against a person or object. It can also put out candles, slam doors shut, or move or knock over small items weighing less than 10lbs (4.5kg)

Float in Air

Range: Self or others within 30ft (9.1m).

Duration: 10 melees per level of experience.

Saving Throw: None

P.P.E.: Five

This spell creates air currents which hold a person or object aloft, hovering about one foot above the ground. It can be used to slow someone's descent from a fall or used to float on top of water. Movement is awkward and slow while in the air. The floating person suffers the following penalties: All attacks, strikes, parries and dodges are at —1; normal speed/movement is reduced to half.

Fuel Flame

Range: 100ft (30.5m)

Duration: Instant

Saving Throw: None

P.P.E.: Five

The magic feeds any existing fire, doubling it in size. It can affect a 10ft area (30.5m) up to 100ft away.

Ignite Fire

Range: 40ft (12.2m)

Duration: Instant (counts only as one attack; fire lasts until it is put out).

Saving Throw: None

P.P.E.: Six

A magic that cause spontaneous combustion. The magic will ignite any material that can burn. This means the mystic could set a chair on fire, a jacket, hair, and so on. **Note:** Volatile substances that are *contained in something*, like gasoline in the gas tank of a car, can NOT be ignited. The target to be set on fire must be clearly *visible*. Maximum area of affect is 3ft (0.9m). If somebody's clothes or hair are set on fire, they have two melees (30 seconds) to get it off or put the fire out before damage is inflicted; no other combat or action is possible. Damage from the small fire is 2D6 S.D.C. per melee (beginning after the first 2 melees).

Impervious to Fire

Range: Self or others up to 60ft (18.3m) away.

Duration: 5 minutes (20 melees) per level of experience.

Saving Throw: None

P.P.E.: Five

A magic invocation that makes the individual temporarily impervious to fire. Normal and magical fires do no damage to the person or to anything he is wearing/on his person.

Impervious to Poison

Range: Self or others by touch.

Duration: 5 minutes (20 melees) per level of experience.

Saving Throw: None

P.P.E.: Five

This enchantment makes the person temporarily impervious to poisons, deadly toxins and poison gases.

Invisibility: Simple

Range: Self only (includes clothes and articles on one's person).

Duration: 3 minutes (12 melees) per level of experience.

Saving Throw: None

P.P.E.: Six

The spell caster and anything he is wearing or carrying at the time of the invocation are turned completely invisible. Any object picked up after the character has become invisible remains visible. Likewise, any item on his person that is dropped becomes visible. Neither normal nor nightvision can detect invisibility; only beings who can naturally, psychically or magically "see the invisible" are able to see an invisible person. Infrared and heat detectors can also pinpoint an invisible person.

Although the invisible person is imperceptible to the eye, he still retains physical mass. This means he can not go through walls nor can weapons pass harmlessly through him. The character still makes noise, leaves footprints, and physical and magical contacts/attacks still affect him as usual.

While invisible, the mage can talk, weave spells, walk, climb, run, open doors, carry objects, and perform other acts of physical exertion, including combat, and remain invisible. The invisibility is terminated when the magic's duration time elapses or the mage cancels the spell.

Note: If cut, only the blood is visible.

Negate Poison/Toxin

Range: Self or by touch.

Duration: Instant

Saving Throw: None

P.P.E.: Five

The arcanist can magically turn a poisonous substance inert, rendering it harmless. The magic can also be used to instantly negate poison in the bloodstream preventing further damage by the foul substance. However, any damage caused by the poison before the magic is used can not be reversed.

Paralysis: Lesser

Range: 60ft (18.3m)

Duration: The effect lasts one minute (4 melees) per level of experience.

Saving Throw: Standard

P.P.E.: Five

This magic attack temporarily paralyzes a part of its victim's body; immobilizing that particular limb. A paralyzed hand means that the person can not pick up or hold objects or write, or use the hand in any way. A paralyzed arm means the limb dangles uselessly at the person's side. A paralyzed leg will make standing difficult and movement almost impossible; reduce speed by 90%, -2 to parry and dodge. **Note:** The incantation will paralyze only one limb per each invoking of the magic. Internal organs can *not* be affected, so the mage can not paralyze a heart or lung, etc. Paralysis can not effect people inside a vehicle, robot, power armor, or M.D.C. body armor.

Resist Fire

Range: Self or Others

Duration: 20 melees per level of spell caster

Savings Throw: None

With this spell the spell caster can make himself, or one or two others, fire resistant. This means heat has no ill effect and fire, normal and mystic, does half damage. The spell can be cast up to 60ft.

Telekinesis

Range: 60ft (18.3m)

Duration: 1 minute (4 melees) per level of experience.

Saving Throw: Dodge

P.P.E.: Eight

The telekinesis invocation temporarily empowers the spell caster with the psychic ability to move objects with thought. This power can be used to move or hurl objects, bring them to him, open doors, flick switches, press buttons, and so on.

Rules and Limitations:

- Maximum Total Weight: 60 pounds (27kg).
- Attacks Per Melee: Equal to the number of hand to hand attacks per melee that the character may have.
- Bonuses to Strike: +3 with telekinesis; physical and skill bonuses to strike do not apply when telekinesis is used.
- Bonuses to Parry: +4; physical and skill bonuses to parry do not apply to telekinesis.
- Damage from Hurled Objects:
 - Small: 6 ounces (0.2kg) to 1 lb (0.45kg) — 1D4
 - Small: 1 1/2 to 2 1/2 lbs — 1D6
 - Medium: 3 to 4 1/2 lbs — 2D4
 - Medium: 5 to 10 lbs — 3D4
 - Large: 11 to 25 lbs — 3D6
 - Large & Heavy: 26 to 60lbs — 4D6
 - Add 1D6 for each additional 20lbs of weight.
- Object being manipulated must be visible.

- Telekinesis can be combined with hand to hand combat, but does *not* add extra attacks per melee.
- Influence from ley line energy doubles the amount of weight and range possible.
- Ley line nexus energy triples the amount of weight and range.

LEVEL FOUR

Astral Projection

Range: Self

Duration: 5 minutes per level of experience.

Saving Throw: None

P.P.E.: Ten

The incantation sends the spell caster's astral body into the astral plane, another dimension. This magic functions exactly like the psychic sensitive ability of the same name.

Blind

Range: Touch or 10ft (3m) away.

Duration: 1 minute per level of experience.

Saving Throw: Standard

P.P.E.: Six

An enchantment that can blind one person or animal each time the spell is cast. The intended victim must be visible and within range. The victim will be temporarily blind; —5 to strike, —10 to parry and dodge, and likely to stumble and fall for every 10ft (3m) of movement (50% chance). Does not effect people inside M.D.C. body armor power armor, robots or vehicles.

If the blind spell is cast upon another spell caster he can not use any spells which require his vision. If the blind spell caster uses any defensive/assault spells, such as magic net, call lightning, fire ball, carpet of adhesion, etc., there is a 65% chance that spell will be misdirected upon his own comrades.

Carpet of Adhesion

Range: 30ft (9.1m) per level of the spell caster

Duration: 10 melees per level of spell caster

Savings Throw: Special

P.P.E.: Ten

The spell caster creates a sticky carpet, up to 10ft wide by 20ft long, that will adhere firmly to anyone who touches it. The victim will stay stuck until the carpet spell time elapses or until the spell caster cancels the spell. The carpet can be cast on a floor, table, wall, etc., or actually cast upon a person. The spell caster can create this super flypaper up to 90ft (28m) away and can alter the size and shape (without exceeding the stated limit of 200 square feet (18.6 sq.m)).

Savings Throw: If a successful saving throw vs magic is made, that player rolls 2 six sided dice to see how many melee rounds it will take him to pull free. Those failing to make the saving throw are stuck for the entire duration of the spell. Effective even against borgs, power armor, and robots.

Charismatic Aura

Range: 60ft radius (18.3m)

Duration: 6 melees per level of experience.

Saving Throw: Standard

P.P.E.: Ten

A particularly handsome tool of deception, this magic can be cast upon the spell caster or another person. The spell instantly enhances

that person's physical beauty by eight (8), increasing his charisma and charming all who behold him. Although the focal point of the spell is the person on whom it was cast, it affects everybody in a 60 foot radius (emanating from the person with the charismatic aura). Thus, *everybody* in that radius is allowed a saving throw vs magic. Those who successfully save will not be affected at all; those who fail to save are affected and will respond accordingly.

The person with a charismatic aura can invoke one of three responses: *friendship/trust, power/fear, and successful deception.*

Friendship/Trust: The first few words spoken will set up the response. Thus, a statement of friendship, peace, or trust will inspire those sentiments in everyone affected.

Power/Fear: A statement of power, anger, strength, or vile intent, will strike awe and fear into everyone affected. (Example: "Lay down your weapons and let us pass, lest you suffer my wrath!"). **Horror Factor:** 13.

Successful Deception: This enables the charismatic aura person to *convincingly lie* like a master con-man. There is an 80% chance that those affected will believe anything he tells them. This response is triggered by a phrase like: "Trust me completely . . ." or "I would never lie to you."

Cure Minor Disorders

Range: Touch or 10ft (3m).

Duration: Instant

Saving Throw: Standard (if unwanted)

P.P.E.: Ten

A unique bit of curative magic that will instantly relieve *minor* physical disorders and illness, such as headaches, indigestion, gas, heartburn, nausea, hiccups, muscle stiffness, low fever (under 101 degrees) and similar. This invocation will also negate simple curses that inflict minor disorders.

Energy Field

Range: Self or others up to 60ft (18.3m) distance.

Duration: One minute (4 melees) per level of experience or until it is destroyed.

Saving Throw: None

P.P.E.: Ten

The magic creates a protective field of energy around the mystic, others, or an object. The maximum area of protection is about 8ft (2.4m), which means it can protect a small roomful of people (about 6 to 8 individuals). The energy field appears as a semitransparent wall or bubble that shimmers with a blue-white light. The field normally provides a total protection of 60 M.D.C., but is doubled at ley lines and tripled at ley line nexuses. Armor Rating is 4.

Fool's Gold

Range: 5ft (1.5m)

Duration: 20 melees per level of spell caster.

Savings Throw: Standard

P.P.E.: Ten

This elemental magic enables the magician to cause any object to appear to be made of gold. After the magician leaves, the object will still retain its gold appearance until the spell elapses. The effect is temporary, and upon close examination by those who can recognize precious metals it is seen that it is not gold.

Savings Throw: Standard; with those who save recognizing it to be fool's gold.

Fire Bolt

Range: 100ft (30.5m) plus 5ft (1.5m) per level of experience.

Duration: Instant

Damage: 4D6 M.D.C.

Saving Throw: Dodge

P.P.E.: Seven

Like the energy bolt, the mage can create and direct a bolt of fire. Bonus to strike is +4. **Damage** is normally 4D6 M.D.C., or 1D6 x 10 S.D.C. (the mage can adjust the damage).

Ley Line Transmission

Range: Limited by the length of the ley line.

Duration: Instant

Saving Throw: A psionic mind block will block and destroy the message.

P.P.E.: 30

The spell caster can send a verbal and/or audio message directly along a ley line to another person so long as that person is located somewhere on the line. The best messages are brief ones of under a hundred words to avoid over-whelming the recipient. Unfortunately, the message is a one way transmission unless the other person is a Ley Line Walker or other mage with the Transmission spell. Range is limited only by the length of the ley line and the people's position on the line. The time lapse between sending and receiving a ley line transmission is only a matter of seconds. The message can be sent to several people (one person per level of experience) at different locations, as long as they are all on the ley line.

The only danger is that a telepath (psionic or magic) may be able to listen in on the message. There is a 1-20% chance that any psionic or magic character with telepathy power will sense a ley line transmission coming through, and there is a 1-31% chance that they too can receive the message. There is no way for the sender to know if others have eavesdropped on his message. Nor is there any way to scramble the message.

Magic Net

Range: 60ft (18.3m)

Duration: 2 melees per level of the spell caster

Saving Throw: Special

P.P.E.: Seven

This spell creates a net composed of magic fibers which will snare 1-6 human sized victims within a 10ft area. Normal weapons can not cut through the net; only mega-damage weapons, magic weapons, and magic can effect this net. Even then it requires a full two melee rounds to cut or blast out (a dispel magic barriers will dispel it instantly). Anyone caught in the magic net is helpless and unable to attack or defend. The spell caster can cancel the net at any time.

Savings Throw: Although there is no save vs magic, intended victims can try to dodge being snared by rolling a 16 or higher.

Multiple Image

Range: Self

Duration: One minute (4 melees) per level of experience.

Saving Throw: Special penalty of -4 to save.

P.P.E.: Seven

An illusion that creates three identical images of the mage which mimic his every movement exactly. Only piercing the false image with iron will dispel that particular image. This is a great way to confuse, scare and distract an opponent(s). Provides the mage with a bonus of +2 on initiative, +2 to dodge, +1 to strike.

Saving Throw: Viewers may be able to see through the illusion and identify the true person, but such rolls vs magic are at a minus six (-4).

Repel Animals

Range: 30ft (9.1m)

Duration: Immediate

Saving Throw: Standard for animals.

P.P.E.: Seven

The character can invoke an enchantment that will make even a hostile predatory animal stop, turn, and leave the area without harming the mage or anybody near him. The animal will not return for hours. The enchantment can affect six animals simultaneously.

Seal

Range: 100ft (30.5m)

Duration: Two minutes (8 melees) per level of experience.

Saving Throw: None

P.P.E.: Seven

The mage can magically prevent any inanimate object from being opened. The mystic can seal shut a door, gate, window, drawer, lid, and so on. There is no sign of force, the lock can be unlatched, but the door, or whatever, will not yield/open regardless of the character's physical strength. The only way to get in or out or open is to smash or chop through the obstacle.

At early levels, the mystic can only seal one item per incantation. However, at fourth level of experience and beyond, the arcanist can seal every door, window and enclosure within an 100ft area (that can be an entire 50 to 80 foot house up to 3 stories high).

Shadow Meld

Range: Self

Duration: Two minutes (8 melees) per level of experience.

Saving Throw: None

P.P.E.: Ten

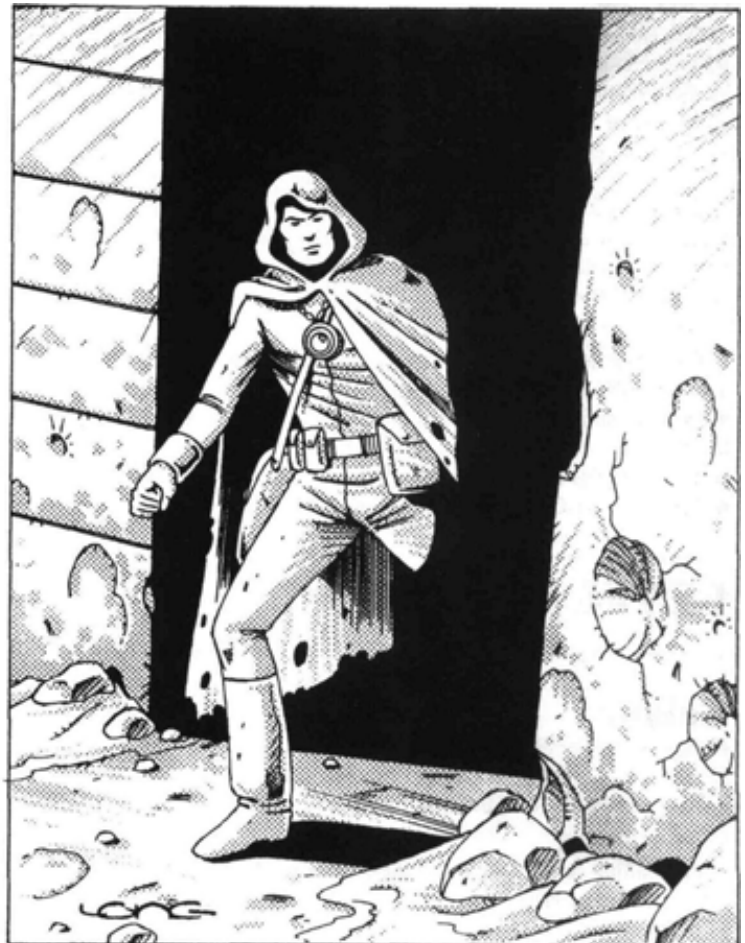

This unique magic enables the mage to step into shadows, becoming totally invisible, even to a "see the invisible" spell. The shadow must be at least five feet tall to become an effective hiding place. The shadow serves as a superior means of hiding or moving unseen. The mage can move, walk, or run through the length of shadow or from shadow to shadow. While in shadow/darkness, the mage prowls at a 60% proficiency (or at +15% to normal skill, whichever is higher).

Intense light will dispel the shadow, leaving the mage revealed. Of course, sanctuary can be found by fleeing into another shadow. Feeble light, less than 10 torches or 300 watts, will only create more shadows.

While hidden in shadow, the character is still susceptible to magic, psychic and physical attacks, although attackers are -5 to strike him (because they can not see him). Area affect magic does not suffer any penalty. *Infrared* optics are the only means that can be used to see somebody in a shadow.

Swim as a Fish

Range: Self or others up to 10ft (3m) away.

Duration: 5 minutes (20 melees) per level of experience.

Saving Throw: None

P.P.E.: Six

An incantation that provides the character with exceptional swimming abilities. Equal to Advanced Swimming and S.C.U.B.A. skills combined: Base Skill is 96%, can swim a distance of 100 x P.S. in yards/meters without tiring, additional +1 to parry and dodge while in water, and can hold breath for two minutes at a time.

Trance

Range: Touch or within 12ft (3.6m).

Duration: 5 minutes per level of experience.

Saving Throw: Standard

P.P.E.: Ten

This enchantment places another person into a zombie-like state in which the entranced person is in a hypnotic daze, unaware of his environment or happenings around him. He can not formulate thoughts, use skills, or act on his own. While entranced, the individual is only aware of the enchanter's voice and will follow extremely simple commands, such as stay, sit, follow me, get inside, lay down, give me your hand, etc. The entranced victim can NOT engage in any type of combat to any degree, nor any actions that require skill or thought, and offers no resistance. The magic is meant to incapacitate more than it is to enslave. Evil men of magic often use trance on prisoners or intended victims of a human sacrifice.

While entranced, the person can *not* be made to reveal secrets, betray a friend, harm himself, or act against his alignment. All physical attributes function as if they are half of what they really are; thus, a speed of 10 is 5 while entranced. The victim of a trance will remember nothing of the events that occurred while entranced. Can not effect people inside power and M.D.C. body armor, robots, or vehicles.

LEVEL FIVE

Calling

Range: 2 miles (3.2km) per level of experience.

Duration: 5 minutes per level of experience.

Saving Throw: Standard

P.P.E.: Eight

The calling is like a limited form of telepathic communication in which the mage can mentally call a specific individual. To use "the call," the mystic must know the person's whole name (first and last),

must have personally met the individual (even if only briefly) and must be within range. The call sends a telepathic message to that particular person, calling him or her by full name, and leaves an impression of where the mage can be found. A typical call message will be something like "Erick Wujcik, come to me." or "Richard Burke, I need you." Only the individual to whom the call is made can hear it, no one else. If a successful saving throw is made, the call, and impression of location, is heard only once. If the saving throw is not successful the call will repeat itself over and over again, three times per melee, until the spell elapses or the person goes to the mage. Nothing except a mind block can block out the call. A failed roll means the call keeps coming and coming, compelling the person to answer it.

Circle of Flame

Range: 10ft around self.

Duration: 2 minutes (8 melees) per level of experience.

Saving Throw: None

P.P.E.: Ten

The mystic can create a circle of flame around himself. No combustible material is required. The flame is five feet tall and inflicts 6D6 S.D.C. damage to anybody who tries to pass through the fire.

Domination

Range: Touch or within 4ft (1.2m).

Duration: 15 minutes per level of experience.

Saving Throw: Standard

P.P.E.: Ten

Domination is another trance-like enchantment that enables the mystic to impose his will over his victim's, forcing the person to do his bidding. The victim of domination will appear to be acting oddly, dazed, confused, slow and unfriendly (ignoring friends, etc.). The enchanted person has one goal, to fulfill the command of the mage. Under the enchantment of domination, the character's alignment does Not apply. He will steal, lie, assist in crimes, kidnap, betray friends, reveal secrets and so on. The victim is under (almost) complete control of the spell caster. The only things the bewitched individual will *not* do are commit suicide, inflict self-harm, or kill a friend or loved one. A good aligned character, principled, scrupulous and even unprincipled, can not be made to kill anybody; it is too deeply against their alignment.

The enchanted person is not himself and suffers the following *penalties*. Attacks per melee are half, speed is half, all skills are half their usual proficiency, speech is slow, and the person seems distracted or a little dazed.

A successful saving throw versus magic means the magic has no effect. The person is 100% his normal self. The effects of the domination magic can *not* be faked. Can not effect a person inside M.D.C. or body armor, robots, or vehicles.

Energy Disruption

Range: 60ft (18.3m)

Duration: 3 minutes (12 melees) per level of experience.

Saving Throw: None

P.P.E.: Twelve

A particularly useful magic in a tech environment. The invocation will temporarily knockout, stop, or immobilize, any electrical device it is aimed at. This includes normal automobiles, computers, radios, surveillance cameras, sensors, appliances, entire fuse boxes, batteries, electric alarm systems, etc. The apparatus is not harmed in any way, it simply ceases to function. When the magic elapses, the item(s) will work perfectly, with no sign of malfunction or energy loss. Can not effect M.D.C. or power armor, robots or military vehicles.

Escape

Range: Self, touch or 5ft (1.5m).

Duration: Instant

Saving Throw: None

P.P.E.: Eight

The escape invocation enables the mage to magically escape any bonds, or open any locking mechanism that bars his way. This includes being tied with rope, handcuffs, prison cells, doors, trunks, locks, straightjackets, etc. One restraint or lock can be undone per each invocation (one per melee is possible). Only gagging the mage will prevent the use of this magic.

Eyes of Thoth

Range: Self or others by touch.

Duration: 10 minutes per level of experience.

Saving Throw: None

P.P.E.: Eight

Thoth is the god of knowledge and wisdom of the ancient Egyptians and said to know all languages. This invocation enables the character to read and understand ALL written languages, modern and ancient. However, the spoken languages are incomprehensible unless a tongues spell is also invoked or the person has an education in that language.

Fly

Range: Object by touch.

Duration: 6 minutes per level of experience.

Saving Throw: None

P.P.E.: Fifteen

The arcanist can magically bestow the power of flight only to an inanimate object not made of *metal or plastic*. He or she can then use that object to fly. This is the origin of the myths about the witch and her broom and of flying carpets. The object must be big enough to hold onto or, preferably, large enough to sit on. If the item is small, the mage must hold on for dear life, and if his grip should give way, he will fall to his doom. To avoid muscle strain and tragedy, it is best that the object can be comfortably sat upon. The maximum length and width of the enchanted item must not exceed six feet (1.8m). This maximum size is enough to accommodate three additional adult passengers or six children. **Note:** The magic will not work if the object has any metal or plastic on it, including nails.

Maximum altitude is 1000ft (305m). Maximum speed is 35mph (56kmph); the object can be made to hover stationary.

Heal Wounds

Range: Touch or 3ft (0.9m) distance.

Duration: Instant

Saving Throw: Standard, if the person resists the magic.

P.P.E.: Ten

This powerful invocation will instantly heal minor physical wounds, such as bruises, cuts, gashes, bullet wounds, burned flesh and pulled muscles. It will *not* help against illness, internal damage to organs or nerves, broken bones or poisons/drugs.

In the case of bullet wounds, the bullet should be removed first. If the bullet is left inside a person it will be a constant irritant causing chronic pain; reduce the character's P.E. attribute by one and P.P. attribute by one due to stiffness and discomfort.

The heal wound magic restores 3D6 S.D.C. and 1D6 hit points.

Horrific Illusion

Range: 30ft (9.1m)

Duration: 2 minutes (8 melees) per level of experience.

Saving Throw: Save vs Horror Factor 14.

P.P.E.: Ten

The arcanist creates a frightening, illusionary image of a horrible sight using common images, such as a hundred large (presumably poisonous) spiders or other bugs or snakes, or a vicious, rabid animal(s), or fire, and similar. Everybody who sees the illusion must roll to save vs horror factor: 14. A failed roll means that the character is momentarily stunned, with the usual horror factor combat penalties applicable for that one melee. However, the illusion is so real that any character who fails to save will not go past the illusion, but can try to find another route around it.

Sleep

Range: Touch or 1ft (0.3m).

Duration: Becomes inert within 15 minutes; affects last 10 minutes per level of experience.

Saving Throw: Standard

P.P.E.: Ten

The invocation can turn any normal, drinkable fluid or food into a sleep inducing potion. Immediately after two bites of enchanted food or two gulps of fluid, the person will fall into an enchanted sleep. The victim can not be awakened by any means except by the mage canceling the magic or until the magic's duration time lapses. A successful save means the enchanted food or drink has no effect.

Superhuman Strength

Range: Self or others by touch.

Duration: 2 melees per level of experience.

Saving Throw: None

P.P.E.: Ten

The incantation magically increases the character's physical strength (P.S.) to 30 and physical endurance (P.E.) to 24 and adds 30 S.D.C. for the duration of the magic.

Superhuman Speed

Range: Self or others by touch.

Duration: 1 minute per level of experience.

Savings Throw: None

P.P.E.: Ten

The invocation bestows the character with the incredible speed attribute of 44 (equal to 30mph) and adds a bonus of +2 to parry and +6 to dodge for the duration of the magic. All movements performed during this period are done without fatigue.

Swim as a Fish (Superior)

Range: Self or Others

Duration: 40 Melees/10 minutes per level of spell caster

Savings Throw: None

P.P.E.: Twelve

This spell can be cast on oneself or on one or two people at a time by speaking the incantation and touching the intended targets. The enchanted persons are then able to breath underwater and swim expertly (at a speed of 20). Base skill 98%. No distance or fatigue factor; swims with ease for the full duration of the spell. Bonus of +2 to parry and dodge while in water.

LEVEL SIX

Apparition

Range: 30ft (9.1m)

Duration: One minute (4 melees) per level of experience.

Saving Throw: Standard

P.P.E.: Twenty

The wizard can create a realistic apparition in the form of a horrible creature or weird thing that will attack anybody who comes within 20ft of it. Apparitions are commonly used to block passages and guard entrances. Although an illusion, it will appear completely real, interacting with an opponent's actions. The illusion will appear to sweat and bleed, but can not be killed or stopped. The illusion can appear as any known supernatural creature or an imaginary "thing," like a man-eating refrigerator and so on.

There are only three ways to destroy the illusion: 1) A successful save vs magic will cause the thing to disappear (at least for that individual). *Each* character must make a saving throw. 2) Plunge a rod or something made of *iron* into it. 3) Wait for the magic's duration time to elapse.

The person who sees the apparition will believe it to be real in every way and will even imagine it inflicting damage to him. Combat should be conducted as usual, although the damage is imaginary and disappears when the apparition is destroyed. Should the opponent of the apparition die (or so he believes), he will fall unconscious for 2D4 minutes from shock. The experience is traumatic; roll to save vs insanity (a 12 or higher saves). If the roll is a failure, roll percentile dice on *the Random Insanity Table*. **Note:** No physical damage is actually sustained.

The creature will always have at least 3 attacks per melee, but no more than 6; +2 to strike, +3 to parry, +6 to dodge, incredibly strong and has a horror factor of 10.

Call Lightning

Range: 300ft (91m)

Duration: Instant

Damage: 1D6 M.D.C. per level of caster

Saving Throw: None

P.P.E.: Fifteen

This spell creates a lightning bolt which can be directed at any specific target up to 300ft away. The lightning bolt shoots down from the sky, hitting the desired target. The target or area must be within the spell casters line of vision. The lightning bolt does one 6 sided die (1D6) of M.D.C damage per level of spell caster.

Compulsion

Range: 60ft (18.3m) and within line of vision.

Duration: 24 hours

Saving Throw: Standard

P.P.E.: Twenty

The spell caster can implant a sudden desire or need in another person's mind. The focus of the irresistible impulse should be something reasonable and attainable, although the motive may seem quite irrational. The enchanted person will be consumed with the object or action of the implanted compulsion, whether it be something very simple, like a craving for a candy bar, or the need to visit somebody or something more extravagant. The victim of this enchantment will be obsessed with attaining whatever it is for the full duration time of the incantation or until it is attained. A "remove curse" will also negate the compulsion.

Cure Illness

Range: Touch or 3ft (0.9m)

Duration: Instant cure

Saving Throw: None; standard if the person resists treatment.

P.P.E.: Fifteen

A potent magic that can cure ordinary disease and illness, such as fever, flu, and other common diseases. The magic can *not* cure cancer, lung disease, wounds, broken bones or internal damage to organs. Nor can it cure magically induced sicknesses or disorders.

Fire Ball

Range: 90ft

Duration: Instant

Savings Throw: Dodge

P.P.E.: Ten

The spell caster creates a large fire ball which hurls at its target at an awesome speed, inflicting 1D4 Mega-Damage points of damage per each level of the spell caster. The fire ball is magically directed and seldom misses.

Savings Throw: None except dodge, but the victim must know the attack is coming and must roll an 18 or higher.

Impervious to Energy

Range: Self or others by ritual.

Duration: 2 minutes (8 melees) per level of experience.

Saving Throw: None

P.P.E.: Twenty

The arcanist can make himself impervious to all forms of energy including fire, heat, electricity, lasers and so on. Energy attacks do no damage whatsoever. Physical attacks, guns, knives, clubs etc., do normal damage.

Magic Pigeon

Range: Immediate area

Duration: 2 months per level of spell caster.

Savings Throw: None

P.P.E.: Twenty

Through the means of a special incantation the spell caster is able to create a mystic facsimile of a pigeon. The magic pigeon is able to deliver a spoken (30 words or less) or written message to anyone, anyplace in this world (in the same dimension). However, the spell caster must know at least the general location of the recipient of the message and a specific person (or two) to receive the message. Upon reaching its destination it will seek out that person and immediately deliver the message. If the recipient of the message is not at the prescribed destination it will wait until he returns or until the spell duration elapses and it fades away.

The magic pigeon looks exactly like a real pigeon, but needs no food or rest; thus it can fly 720 miles every 24 hours at a speed of 30mph. Normal weapons can not harm or capture the pigeon, but magic spells of entrapment can capture it. Only a dispel magic spell can destroy it.

Mask of Deceit

Range: Self

Duration: 10 minutes per level of experience.

Saving Throw: Standard

P.P.E.: Fifteen

A useful tool for deception, it magically creates an illusionary mask over the person's own facial features. Age, gender, skin color, hair, hair length, and specific features are composed with thought. However, the magic is limited to facial features and does not apply to any other part of the body. The mage can attempt to imitate a specific person's face, but has a mere 20% + 5% per level of experience skill level; if

the character has the disguise skill, use that base skill instead. **Saving Throw:** Everyone encountering the person gets a save vs magic, but is —4 to succeed. A successful save means the true features are seen, not the mask.

Memory Bank

Range: Touch

Duration: 3 months per level of experience.

Saving Throw: None if willing; standard if unwilling.

P.P.E.: Twelve

The mage can implant a block of memory/information deep into another person's subconscious mind without them ever knowing what it is. The mage can then retrieve it at any time with a mere touch. This technique can be used to safely record and hide phone numbers, addresses, incantations, or any other data under 1000 words. The information can be stored for three months per level of the enchanter. **Note:** A mind block will make it impossible to implant or retrieve a memory bank. There is no limit to the number of memory banks a mage can implant in the same person. The memory will fade away after the magic's duration time has elapsed.

Reduce Self (6 inches)

Range: Self

Duration: 10 melees per level of spell caster

Savings Throw: None

P.P.E.: Twenty

This spell instantly shrinks the spell caster, his clothes and possessions to six inches tall. Note that reduced weapons do virtually no damage. Weapons that normally inflict Mega-damage do a mere ONE point of damage. All others just sting for a moment.

Teleport: Lesser

Range: Five miles (8km) per level of experience; touch.

Duration: Requires two full melees (30 seconds).

Saving Throw: None

P.P.E.: Fifteen

The power to transmit matter from one place to another. The lesser teleport invocation is limited to non-living substances. Up to 50lbs (22kg) can be instantly transported from the location of the spell weaver to any location miles away. The only requirements are that the mage *touches* the object to be teleported and that the location of where it is being sent to is *known* to the him. Success Ratio: 80%+ 2% per level of the arcanist. An unsuccessful roll means that the object never arrived where it was supposed to and could be anywhere within the mage's range.

Time Slip

Range: Self

Duration: 1/2 melee (7 seconds).

Saving Throw: None

P.P.E.: Twenty

The invocation momentarily suspends time, enabling the spell caster to slip 7 seconds into the future. The mage can move forward seven seconds while all around him are caught in the past. The magic is such that the arcanist can not physically hurt any living creature, but can move about the physical environment, open doors, grab an item, run, etc. The effect will appear, to others, as if the character disappears for an instant and then suddenly reappears a few seconds later. All around him lose two attacks that melee round, but the mystic retains all of his.

The time slip is ideal for a quick escape. **Note:** Whatever actions the magician takes within the seven seconds are unseen and unknown to the other characters.

Tongues

Range: Self or others by touch.

Duration: 3 minutes (12 melees) per level of experience.

Saving Throw: None

P.P.E.: Twelve

The magic enables the character to perfectly understand and speak all spoken languages; 98% proficiency. An understanding of written languages is not provided by this magic. *See the "Eyes of Thoth."*

Words of Truth

Range: 5ft (1.5m)

Duration: 1 minute (4 melees) per level of experience.

Saving Throw: Standard

P.P.E.: Fifteen

A person affected by this enchantment is compelled to answer all questions truthfully. The arcanist must be within five feet and can ask two brief questions per melee. It is wise to keep questions simple and clear to avoid confusion.

Saving Throw: The enchanted person makes a saving throw for each question asked. A successful save means he doesn't have to answer. Questions can be repeated.

LEVEL SEVEN

Constrain Being

Range: 30ft (9.1m)

Duration: 2 minutes per level of experience.

Saving Throw: Standard

P.P.E.: Twenty

This invocation is useful for controlling lesser supernatural creatures. The enchantment forces the being to obey the arcanist to a very limited degree. Mainly, the mage can hold the "thing" at bay with an order like: "Back, stay back", "go. . . begone," "Stay there . . . don't move." "No." "Stop." "Back away." No commands more elaborate than that will be obeyed. The "constrain being" incantation works in the same way as a cross holds a vampire at bay. As long as the mage and his allies stay out of the creature's reach, the magic will hold it at bay. If it can reach out and hurt somebody, it will. If it is attacked, the enchantment is broken and it is free to lash out at everybody. **Note:** Possessing entities and the greater supernatural beings are not affected by this magic, nor are non-supernatural D-Bees or aliens.

Agony

Range: 5ft (1.5m) per level of experience.

Duration: 1 minute (4 melees).

Damage: Special

Saving Throw: Standard

P.P.E.: Twenty

A particularly cruel and painful invocation that incapacitates its victim with pain. Under the influence of the magic, the victim has no attacks per melee, can not move or even speak; only writhe in agony. Although there is no physical damage (no S.D.C. or hit points are lost), the pain *is* very real, and it will take another minute for the victim to regain his full composure. During that minute his number of attacks per melee are reduced by half, speed is reduced by half, and he suffers a penalty of — 1 to strike, parry and dodge. Only one person can be affected per invocation.

Animate and Control Dead

Range: 400ft (122m)/line of vision.

Duration: 5 minutes (20 melees) per level of experience.

Saving Throw: None

P.P.E.: Twenty

With this incantation the arcanist can animate the remains of dead bodies, human, animal or monster, and mentally control them like a puppetmaster would a marionette. The remains are not alive and do not have any intelligence whatsoever. It is the sorcerer who controls their actions.

Restrictions:

1. The mage can animate and control only two corpses/skeletons, plus one per level of experience.
2. The animated dead must remain in his line of vision. If it can not be seen, it can not be animated.
3. The animated dead can be a corpse or skeleton. *Attacks per melee:* two each, *Speed:* 7, *Damage:* 1D6 from punch, bite, claw or blunt weapon. Modern weapons, such as guns of any kind, can not be used by animated dead.
4. Only total destruction will stop an animated dead, or knocking out the controlling mage. **S.D.C.** of a small corpse/skeleton, about 3 or 4ft (0.9-1.2m) tall, is 50 S.D.C.; medium, 5 or 6ft (1.5-1.8m), is 80 S.D.C., large, 7 to 12ft (2.1-3.6m), is 140 S.D.C. **Note:** Bullets do 1/3 damage, blunt and smashing attacks do full damage, fire does double normal damage. Animated dead can not be stunned nor affected by a death blow or critical hit. They are S.D.C. structures and inflict S.D.C. damage unless they wield an M.D.C. weapon like vibro-blade.

Dispel Magic Barriers

Range: 100ft (30.5m)

Duration: Instant

Savings Throw: Standard

P.P.E.: Twenty

The dispel magic barriers spell negates/dispels all magic barriers of any kind including the sorcerer's seal, carpet of adhesion, wall spells, wards, etc.

Savings Throw: The magic spell being attacked automatically gets a standard savings throw (12) as if it were a person. If a successful savings throw is made the negate magic barriers spell has no effect; the barrier remains.

Fly as the Eagle

Range: Self or others up to 100ft (30.5m) away.

Duration: 20 minutes per level of the spell caster

Savings Throw: None

P.P.E.: Twenty-Five

The power of flight is bestowed upon the spell caster or person it is cast upon. It is especially effective out of doors, and in large, open areas. Maximum Speed — 50mph. Bonuses: +1 to parry, +2 to dodge and +2 to damage on a diving attack. Bonuses apply only when in flight.

Globe of Silence

Range: 90ft (28m)

Duration: 6 melees per level of caster

Savings Throw: None

P.P.E.: Twenty

This spell immediately creates an invisible, 10ft radius globe which stops *all* sound. Voices, screams, footsteps, everything within that 10ft radius is absorbed by the globe. This means that absolutely no sound can leave the globe or penetrate it. So while it can prevent those within the globe from making noise, it also prevents sound from outside to enter. Those within the globe can not hear anything. A spell caster,

reliant on spoken incantations, is completely powerless inside a globe of silence because his words can not be heard.

The spell affects those within its radius; stepping beyond the radius frees that person from its effect. The globe itself can be fixed in a stationary area or mentally moved and manipulated by the spell caster. However, the spell caster can not cast another spell while manipulating the globe, and once fixed to one spot, that is where it remains until the spell duration time elapses or it is cancelled. *The globe can be cast up to 90ft away.*

Savings Throw: There is no savings throw because it is actually the physical space around the person that is being altered. A negate magic spell could dispel/cancel the globe and its influence.

Invisibility (Superior)

Range: Self or others by touch.

Duration: 3 minutes (12 melees) per level of experience.

Saving Throw: None **P.P.E.:** Twenty

A powerful incantation that makes the spell caster invisible to all means of detection. Infrared, ultraviolet, heat, motion detectors, and even an animal's sense of smell, can not locate the invisible person. No footprints are made, and little sound (Prowl 84%). The magic is broken only if the character makes a hostile move, engages in combat/attacks. At that instant, he becomes completely visible. **Note:** The invisible character is not ethereal and can not walk through walls; he must still use a door. The act of forcing open a door or window, picking a lock, tapping somebody, accidentally bumping somebody, or accidentally getting shot or hurt, is not considered an act of aggression or combat, so invisibility is maintained.

Invulnerability

Range: Self or others by touch.

Duration: 1 melee (15 seconds) per level of experience.

Saving Throw: None

P.P.E.: Twenty-Five

The magic makes the individual impervious to fire and all energy attacks, impervious to poisons/toxins/gases/drugs, and provides a form fitting energy field which appears as a glowing aura around the body (35 M.D.C.). Once the 35 M.D.C. from the energy field are exhausted, the person will suffer normal damage to his own M.D.C. and hit points. The invulnerable character is also +10 to save vs magic, psychic assault and horror factor.

Life Drain

Range: 30ft (9.1m)

Duration: 2 melees (30 seconds) per level of experience.

Damage: Special; see description.

Saving Throw: Standard

P.P.E.: Twenty-Five

The life drain is a debilitating magic that weakens an opponent. The victim will turn pale and experience weakness. Reduce S.D.C. by half, hit points by half, speed by half, attacks per melee by one, and skills are -10%.

Low level arcanists (1-3) can only affect one individual per each spell cast, but at fourth level the mage can also cast the magic on a 15ft (4.6m) area, affecting everyone who enters and remains in the area of enchantment.

Once the magic's duration time has lapsed, the victim's skills and attacks per melee return to normal, S.D.C. returns at a rate of 8 per hour, and hit points return at a rate of 4 per hour. Reduced speed (half) and a feeling of weakness remains for six hours.

A successful saving throw means the magic has no affect on the person. Characters inside power and M.D.C. body armor, robots, or military vehicles are affected. Borgs are not.

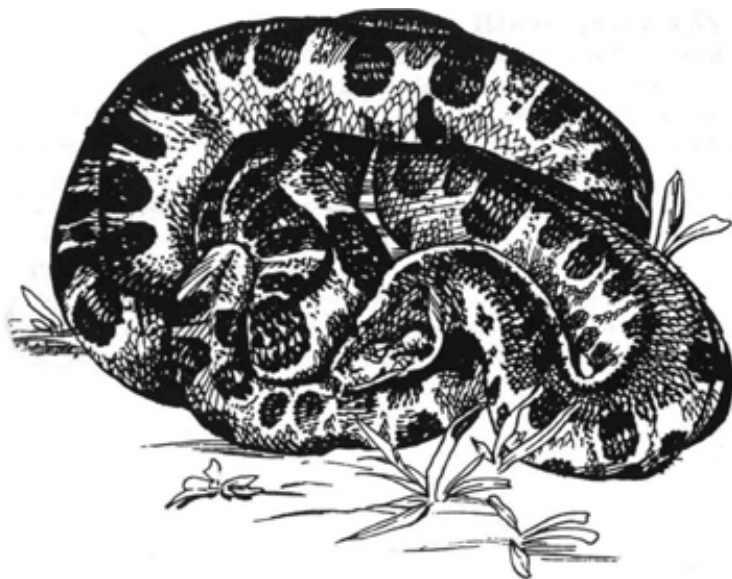

Metamorphosis: Animal

Range: Self or other by ritual.

Duration: 20 minutes per level of experience.

Saving Throw: None

P.P.E.: Twenty-Five

The invocation can completely transform a character into a particular animal, from an alley cat or cocker spaniel to a lion, wolf, alligator or bird. As the animal, the character gets all the inherent abilities and defenses which that animal form may offer, but retains his *own* I.Q., ability to speak, memory, S.D.C. and hit points. The mage can return to human form (naked) at will.

To determine the general abilities of an animal type, use the following tables. Note: For an in depth description of animals and their abilities (monsters too), you might want to take a look at *The Palladium Book of Monsters & Animals*.

Retractable Claws: Small Cats (lynx, bobcat), damage — 1D6.
Big Cats (lion, tiger), damage — 2D6.

Claws: Digging (badger, wolverine), damage — 1D8.
Miscellaneous (rodent, lizard), damage — 1D4.
Birds of Prey, damage — 1D6.
Bear, damage — 1D8.

Teeth: Bear, damage — 2D4; Polar Bear — 2D6.
Canine, damage — 1D6; Wolf — 2D6.
Feline, damage — 1D6; Tiger/Lion — 2D6.
Musteline, damage — 1D4; Badger/Wolverine — 1D6.
Herbivores, damage — 1D4 (horse, goat, ape, human).
Birds of Prey (beak), damage — 1D4.

Antlers: Small Antlers — 1D4.
Large Antlers — 2D4.

Horns: Small Horns — 1D6.
Large Horns — 2D6.

Hooves: Small — 1D6 (kick).

Speeds:

Wild Canine — about 35mph maximum for up to an hour.
Small Wildcats — 15mph in spurts of 10 to 20 minutes.
Large Wildcats — 30mph in spurts of 10 to 20 minutes.
Cheetah — 90mph in 3 to 5 minute spurts.
Deer/Antelope — 30mph maximum for up to an hour.
Horse — 40mph maximum for up to an hour.
Elephant — 25mph for up to an hour long.
Rhinoceros — 35mph in 3 to 8 minute spurts.
Alligator — 35mph in 2 minute spurts.
Lizards — 10 to 20mph in 2 to 5 minute spurts.
Typical Birds — 30mph for up to 1D4 hours.
Birds of Prey — 40mph for up to 1D4+ 1 hours.

NOCTURNAL ANIMALS

Abilities and Bonuses:

1. Extraordinary vision approximately 10 times better than a normal human's. This means the character can clearly see an 18 inch item up to two miles away (3.2km).
2. Nightvision — 600ft (183m); can see in the dark.
3. Extraordinary sense of smell allows the character to detect very faint scent traces. Tracking by smell is at a skill level of 35% + 5% per level of experience. Identify person by scent is a 48% chance.
4. Natural Prowl skill is 65% + 5% per level of experience.

Purification

Range: Touch or 3ft (0.9m).

Duration: Instant

Saving Throw: None

P.P.E.: Twenty

The mystic can purify food or water, cleansing it of disease, bacteria and poison/toxins. Up to 50lbs (22kg) of food or 10 gallons of water/fluids can be purified.

Second Sight

Range: 5 miles (8km) per level of experience.

Duration: 2 melees (30 seconds).

Saving Throw: None; mind block will temporarily prevent the use of second sight.

P.P.E.: Twenty

A unique use of magic that enables a mage to see and hear what another person is doing at that very moment. To use second sight, the arcanist must have previously encountered/met the individual. The mage just has to think about that person and he will get a clairvoyant-like vision showing what that person is doing and saying, and who he/she is with. The vision is what one might expect to see in a crystal ball except that the arcanist sees it in his mind. The vision lasts only 30 seconds each time the magic is invoked.

A mage can also use second sight to transmit his present activity to another person. This is a great way to show somebody that you are in trouble. **Note:** The image always consists of true events showing exactly what is happening when it is happening. The vision can not be altered or doctored in any way. Only a mind block will prevent the person from being seen through second sight.

Wind Rush

Range: 120ft (36.6m)

Duration: 1 melee (15 seconds).

Saving Throw: Standard; to keep balance.

P.P.E.: Twenty

This spell creates a short, powerful wind gusting at 60mph, which is capable of knocking people down, knocking riders off mounts, blowing small objects 20 to 120ft away, or creating dust storms.

The wind can be directed by the spell caster at a specific target or a general sweep (maximum wind width — 20ft) can be made. Anyone caught in the wind is helpless and unable to attack or move forward. It takes an additional melee to recover, and 1-8 melees to gather up all items blown away.

Saving Throw: A roll of 18 to 20 saves one from losing one's balance and/or losing some item(s).

LEVEL EIGHT

Commune with Spirits

Range: Self, or others by ritual; 200ft (61m) distance.

Duration: 5 minutes per level of experience.

Saving Throw: None

P.P.E.: Twenty-Five

The incantation enables the arcanist to see and speak with all types of "entities," including poltergeists, haunting spirits, trapped entities, imprisoned entities and possessing entities. The ability to see and communicate with these ghostlike beings does not mean that they will obey the character, but a dialogue can be exchanged. **Note:** In this case, the term "entity" specifically refers to the type of supernatural beings known only as entities. See the monster section for details.

Exorcism

Range: 30ft (9.1m).

Duration: The spell lasts 3 minutes, results last 6 months or longer.

Saving Throw: Standard; 12 by spell or 16 by ritual.

P.P.E.: Thirty

Exorcism is a powerful magic that forces a possessing supernatural being to relinquish its control over the enslaved person, animal or object. Forced out of its host body, the evil intelligence will try to possess any other human or animal within the immediate area (30ft/line of vision). The horrid thing gets two attempts at possession. Fortunately, the exorcism incantation protects the person who was its original victim with a bonus of +12 to save vs possession and the mage conducting the exorcism a bonus of +6 to save vs possession. Anybody else in the area has no extra bonus and is in great peril. **If the evil force fails** in both of its attempts to take possession of a host body, roll percentile dice on the following:

1-52 The evil intelligence is instantly returned to its own dimension.

53-00 The being can continue to exist in our world, but must immediately flee the area and can not return for at least 6 months.

Note: Ritual exorcism always has a greater chance for success. An exorcism can be repeated by the same character on the same person as often as needed (just be certain the mage has sufficient P.P.E.).

Eyes of the Wolf

Range: Self or Other

Duration: 20 melees per level of spell caster

Savings Throw: None

P.P.E.: Twenty-Five

Bestows the following abilities:

Nightvision — 60ft (18.3m)

See the invisible — 75%

Identify plants/fruits — 70%

Identify tracks — 85%

Track — 50%

Recognize poison — 65%



Hallucination

Range: Touch, or 3ft (0.9m).

Duration: 3 minutes (12 melees) per level of experience.

Saving Throw: Standard

P.P.E.: Thirty

The invocation creates a mystic illusion or delusion that the mage implants in the character's mind, thus only that one person experiences the illusion. Whatever the illusion is, whether it be a monster or fire, or bottomless pit or a void or whatever, seems completely real to its victim. The person hallucinating will react and interact with the hallucinatory image regardless of what anybody else may say or do. A successful save vs magic means that the magic has no effect. **Note:** A mind block adds a +3 bonus to save vs hallucination.

Locate

Range: 15 miles per level of experience.

Duration: Instant

Saving Throw: None

P.P.E.: Thirty

Locate is a magic invocation that enables the arcanist to sense the general location of his quarry. The location is limited to a general area or environment, like a specific apartment building, house, shopping mall, church, park, on an airplane headed for New York (or wherever), etc.

To locate a particular person the arcanist must have either personally encountered the individual or a photograph must be provided. **The success ratio for a spell is 41%. The success ratio for a ritual is 89%**, but this also requires an object owned by the person or a lock of hair, or fingernail clippings, or dried blood from that person.

Luck Curse

Range: Touch or 10ft (3m).

Duration: 24 hours per level of experience.

Saving Throw: Standard; 12 by spell, 16 by ritual.

P.P.E.: Forty

The incantation inflicts the person with *bad luck*. The victim's **normal bonuses** to strike, parry, dodge, and initiative, and roll with punch, are all reduced to zero; no bonuses! **Critical strikes** do normal damage (except a natural 20 which always does double damage); a death or knockout/stun punch does only 1D4 damage. **Kick attacks** have a 60% chance of causing the character to trip and fall down. **Prowl skill** turns into a clumsy roll, making noise every time it is tried. **All skills** are minus —40%, but only during critical situations. The GM can add other minor occurrences of bad luck.

Only a "remove curse" invocation can negate the effect of this enchantment.

Metamorphosis: Human

Range: Self, or other by ritual.

Duration: 20 minutes per level of experience.

Saving Throw: None

P.P.E.: Forty

A human mage can shape change, altering his or her physical structure. The ultimate disguise, the character can change his height, weight, age, hair color, hair length, skin color, gender, and features. A non-human being can transform itself to appear completely human.

To attempt to impersonate a real, existing person, the arcanist must have the disguise skill, even though he/she is mentally molding his/her features through magic. A good photograph is required. **The success ratio** for imitating/impersonating the appearance of a real person is the mage's *disguise skill* + 20%. The better he knows the person the more complete the disguise.

In a ritual version of this same magic, the mage can metamorphosize somebody else, rather than himself. Also in the ritual magic, the mage can metamorphosize someone else into an exact duplicate of himself. Furthermore, a captive at the ceremony can be duplicated without flaw. **Note:** The metamorphosis process only changes the appearance of the body. The transformed person retains his own voice, memory, skills, and attributes/abilities.

Minor Curse

Range: Touch or 10ft (3m).

Duration: 24 hours per level of experience.

Saving Throw: Standard

P.P.E.: Thirty-Five

The spell caster can inflict a curse in the form of minor physical disorders that cause a constant irritation. Such disorders include:

Fever: —2 on initiative, -5% on all skills, reduce speed and endurance (P.E.) by 25%. Fever ranges from 99 to 102 degrees, victim feels drained, tired, uncomfortable.

Gas: Some indigestion and nausea, bloated feeling. Farts once every two melees (pee-u). —2 on initiative, sneak attacks and prowl are impossible.

Headache: Dull, throbbing headache; sleep and concentration are difficult. All skills are -10% and all saving throws are —1 (lack of focus).

Hiccups: Annoying; interrupts speaking constantly. Language skills are —15%, mental affinity (M.A.) is reduced by half. Prowl is impossible. Spells can still be cast with little difficulty.

Ingrown Toenail: Painful to walk, victim limps. Reduce speed by 1/3, prowl is -10%, climb is -15%.

Itching and Rash: Very uncomfortable; almost maddening itch that can be relieved only by scratching. Reduce mental affinity (M.A.) by half, —4 on initiative and minus one attack per melee.

Pimples: Dozens of pimples break out all over the face and arms. Reduce physical beauty by half.

Nausea: Stomach ache, loose bowels and vomiting, slow this poor victim down. Reduce speed to a comfortable half normal (running faster is possible, but there is a 50% chance of vomiting). Sudden movements, bumpy rides or high speed chases (50mph or faster), have a 60% chance of inducing vomiting or diarrhea. The victim is -6 to strike, parry and dodge while throwing up, and has no initiative.

Runny Nose and Cough: The victim suffers from a nagging, constant cough, watering eyes and runny nose. Reduce physical beauty (P.B.) by 25%. Prowling and sneak attacks are impossible. Spell casting is unimpaired.

Vertigo: The character gets dizzy when running (speeds higher than 8), during high speed chases (50mph or faster), or when exposed to heights (must be looking out a window or standing on a ladder or ledge, and so on, higher than 10ft). When vertigo hits, the character is almost helpless: reduce attacks per melee to one, no initiative, (minus) -8 to strike, parry or dodge. The vertigo will last as long as the victim is exposed to what induces it.

No normal medicine or cures will rid a character of a curse. Only a remove curse incantation can do it, or waiting until the duration time of the curse elapses. A negation spell can be tried, but it has only a 25% possibility of success.

Negate Magic

Range: Touch or 60ft (18.3m).

Duration: Instant

Saving Throw: Special (Ritual magic has a greater chance of success).

P.P.E.: Thirty

This incantation will instantly cancel the effects or influence of most magic. To determine whether the negation is successful or not roll a

saving throw. If the roll is a successful save against the magic used, its influence is immediately destroyed/negated/canceled. 12, 13, 14, or 15 is needed for spell magic depending on the experience level of the mage (usually 12 or 13 is needed, or 16 and higher to save vs ritual magic). A failed save means the negation attempt did not work. Try again if sufficient P.P.E. is available.

Negation will not work against possession, exorcism, constrain being, banishment, talisman, amulet, enchanted objects, symbols/circles of protection, wards, summoning magic, zombies, golems, restoration or healings/cures. Negation can be attempted to cancel a curse, but only has a 25% possibility of succeeding, and that's only if the saving throw was successful. Of course, it has *no* affect against psychic abilities or the machines of a psi-mechanic.

Oracle

Range: Self

Duration: 1 minute (4 melees)

Saving Throw: None

P.P.E.: Thirty

The oracle is the magic equivalent of clairvoyance. The arcanist receives a dream-like vision of a possible future. The focus of the vision will depend on what, when or whom the mage is thinking about. The same basic rules that apply to clairvoyance apply to the "oracle" invocation.

Sickness

Range: Touch or 20ft (6m).

Duration: 12 hours per level of experience.

Saving Throw: Standard

P.P.E.: Fifty

Sickness is a debilitating magic which afflicts its victims with the symptoms of a specific disease. Only the symptoms of the disease manifest themselves, not the actual disease. Consequently, a medical examination will show there to be no physical cause to the illness. At best, it will be diagnosed as psychological or unknown. No matter how ill or helpless the victim may become he can not die from the magic sickness. But the character will suffer greatly.

All sickness inflicted by this magic is severe, inflicting the following penalties and modifiers: Attacks per melee are reduced to one, physical endurance is reduced by 70%, -4 to strike, parry and dodge; no initiative, and skills are reduced by 40%. The person is very weak, disoriented and uncomfortable.

Spoil

Range: Touch or 3ft (0.9m)

Duration: Instant

Saving Throw: None

P.P.E.: Thirty

Basically, this magic is the opposite of the purification (food/water) incantation. In this case, the mage can instantly transform good food into spoiled, affecting 50lbs (22kg) or 10 gallons (37.9 liters) of water/fluids, making the food inedible and the water undrinkable. Anybody who forces themselves to eat or drink the horrible tasting food or drink will get sick with stomach cramps and diarrhea. Penalties: -1 on initiative, —1 to strike, parry and dodge.

Stone to Flesh

Range: 12ft (3.6m)

Duration: Instant/permanent

Savings Throw: None

P.P.E.: Thirty

This spell transforms stone to flesh and can restore people who have been turned to stone back to normal. The spell caster can change 50 pounds (22kg) of stone per level of experience.

Wisps of Confusion

Range: 90ft

Duration: 5 melees per level of the spell caster

Saving Throw: Standard

P.P.E.: Forty

Wisps cause 1-8 people/creatures to become confused and disoriented. Those affected strike, dodge, and parry at minus five; attacks per melee are reduced by one-half.

LEVEL NINE

Curse: Phobia

Range: Touch or 20ft (6m).

Duration: 24 hours per level of experience.

Saving Throw: Standard

P.P.E.: Forty

The phobia curse implants in its victim an unreasoning fear of something (see phobia in the Insanity section). The arcanist can select one of the phobias listed in the insanity section or make a random roll on that table or introduce a new phobia (new phobias must be approved by the game master). The victim of the curse will have a phobic reaction every time he encounters that fearful thing. Only a "remove curse" is an 100% cure, "negation" has a 25% chance of success, and, of course, the mage who created the curse can cancel it at any time.

Familiar Link

Range: Self and animal/600ft (183m).

Duration: Indefinite

Saving Throw: None

P.P.E.: Fifty-Five

At third level, a practitioner of magic is experienced enough to mentally link with a small animal (mammal, bird or lizard). This link is permanent, producing a rather impressive symbiotic relationship. No matter how wild or mean the animal may have been, it will be instantly linked to the mage, becoming docile and submissive to him and him alone. The two are now one. The spell caster is its friend and master, an extension of the animal. The animal familiar will understand and obey any command, verbal or mental. For the mage, the familiar is now a sensory extension enabling him to see, hear, smell, taste and feel everything the animal experiences. Thus, familiars make great spies; listening to conversations and prowling into areas not easily accessible to its master. Although the familiar understands and obeys its master, it can not actually speak to him.

Just as the arcanist knows what the familiar is feeling, so does the familiar know what its master is experiencing. If one is in danger the other will know it. Because of the magical nature of the union, the mage and the familiar both get an additional six hit points. However, if the familiar is hurt or attacked, its master also takes the same damage even if miles apart. **If the familiar is killed**, the arcanist *permanently loses 10 hit points*. There is a 50% chance he will also suffer shock from the ordeal; if he does, he will lapse into a coma for 1-6 hours. Another familiar link can not be tried again for at least 1 1/2 years.

Other Limitations:

1. Telepathic/empathic communications: maximum range: 600ft (183m).
2. Familiar possesses its normal animal abilities.
3. Size: 25 pounds (11kg) maximum.
4. Usual animal types used: cats, dogs, coyotes, foxes, weasels, rodents, birds, lizards, and snakes.

Metamorphosis: Insect

Range: Self, or others through ritual magic.

Duration: 20 minutes per level of experience.

Saving Throw: None

P.P.E.: Sixty

The mage can transform himself into an insect, including spiders, that is no smaller than a half inch (12.7mm) and no larger than six inches (152.4mm). In insect form, the mage retains his own I.Q., memory, knowledge, hit points, and S.D.C.; however, the performance of human skills is impossible as a bug. Likewise, magic can not be cast because as an insect he can not speak. The metamorphosis can be cancelled at will, but the arcanist will be naked.

The following are some typical bug abilities:

Bite or Sting:

Nonpoisonous: One hit point or S.D.C. point.

Non-Lethal Poison: 1D6 damage, causes swelling and discomfort.

Speed:

Running: Spd. attribute equal to eight.

Climbing: Spd. attribute equal to six.

Flying: 20mph (32km) for extended flight.

35mph for short bursts (30 seconds).

Note: Seems to never tire and can walk on any surface.

Abilities and Bonuses:

1. Prowl: Small insects, 2 inches or smaller — 90%; larger insects, 2 1/2 inches or bigger — 66%.
2. Natural climbing ability on any surface is 98%, spiders can rappel.
3. Bonus to automatically dodge is +6.
4. Range for hearing is 50ft (15.2m).
5. Range for vision is 50ft (15.2m), but has 180 degree peripheral vision, making sneak attacks impossible (automatic dodge).

Mute

Range: 30ft (9.1m)

Duration: 20 melees per level of spell caster

Savings Throw: Standard

P.P.E.: Fifty

This spell *temporarily* affects the voice box and vocal cords, preventing any voice or sounds to be uttered.

Protection Circle: Simple

Range: Radius of the circle.

Duration: 24 hours, plus 4 P.P.E. to reactivate after the circle's initial creation.

Saving Throw: None

P.P.E.: Forty-Five

Even as a spell, this invocation might be considered a ritual, for it requires the physical drawing of a circle and symbols while the spell incantation is recited. Chalk or charcoal, or almost any substance, can be used to draw the circle. 45 potential psychic energy points are needed to initially create the circle, but a mere four P.P.E. is all that is needed to reactivate it. Anybody with sufficient P.P.E. and desire can reactivate a protection circle. However, if the circle is damaged (scraped, scarred, rubbed out, etc), it will not function and a new one will have to be created.

The simple protection circle will protect everybody inside its radius by keeping *lesser* supernatural creatures five feet (1.5m) away from the circle. The creatures can not come any closer, nor enter the circle. The circle also provides its occupants with a bonus of +2 to save vs magic and psychic attack.

Although lesser supernatural beings, such as entities, ghouls, and gremlins, can not come near or enter the circle, they can hurl objects, use weapons, or use magic and psychic powers against the person(s)

inside the circle. *Greater beings*, such as vampires, elementals and demi-gods, are not affected by the simple circle and can enter effortlessly. No bonuses vs magic apply against these powerful beings either.

Summon & Control Canines (Pentacle)

Range: Varies

Duration: 5 hours per level of experience.

Saving Throw: Standard animal, but only if a part of the player characters' group.

P.P.E.: Fifty

All pentacles or pentagrams are used for summoning or potentially evil intent. The Chinese geomancers found that *circles* represent mutual support, the cycle of life, and flowing energy. But the *pentode*, the five pointed star, represented mutual destruction and evil. That is why all protection magic incorporates the circle symbol and all summoning utilizes the pentagram.

The summon & control canines pentacle will provide 1D4 canines (dogs, wolves, etc.) plus one additional canine per level of experience. The animals will be under the complete control of the mage, obeying his every command, and will fight to the death. The pentacle will also give the arcanist the power to control any other canines which were not originally summoned, within 200ft/line of vision, as long as the mystic remains in the pentacle. The canines originally summoned will obey the arcanist in and out of the pentagram for the duration of the enchantment, then leave.

Speed of the Snail

Range: 60ft (18.3m)

Duration: 2 melees per level of the spell caster

Savings Throw: Standard

P.P.E.: Fifty

This time distortion spell reduces the physical prowess, speed, and mobility of its victims to one-third their normal ability. Speed, attacks per melee, dodge, and parry are all reduced to one-third. Spell casting is not reduced.

This spell can be cast upon 1D6 persons up to 60ft away (18.3m), but within the spell caster's line of vision. Affects robots and vehicles as well as people.

Transferral

Range: Touch or 10ft (3m).

Duration: One hour per level of experience.

Saving Throw: Standard

P.P.E.: Fifty

The spell caster can use this magic to temporarily transfer his mystic essence into another person by transferring all but 4 P.P.E. and experience into that individual. A See Aura would reveal no magic, little P.P.E. and no level of mystic experience. It is an excellent way to hide one's mastery of magic when needed.

The person to whom the P.P.E. and experience have been transferred is completely unaware of the power within him and can *not* use it. *The mystic* who has temporarily drained himself of magic retains his mystic knowledge, but has only 4 P.P.E. and can create magic only at first level proficiency. He can regain his power by touching the person who holds it or by waiting until the magic's duration time elapses.

Water to Wine

Range: 12ft (3.6m)

Duration: Instant/permanent

Saving Throw: None

P.P.E.: Forty

Another transformation spell, the spell caster is able to change ordinary *fresh* water into wine, affecting ten gallons (37.9l) per level of the spell caster's experience. The wine is of fair to average quality, with the quality increasing by 5% per each level of his experience.

LEVEL TEN

Banishment

Range: 100ft (30.5m)

Duration: 2 weeks per level of experience.

Saving Throw: Standard

P.P.E.: Sixty-Five

A useful invocation for controlling supernatural beings is Banishment. The magic forces one lesser supernatural being/demon, per experience level of the spell caster, to leave the immediate area (600ft/183m radius). The creature(s) can not return for at least two weeks per level of experience. Each lesser being gets to roll to save vs the magic. A successful save means it is not banished and can stay to cause trouble. As always, a banishment ritual has a greater chance of success (16 or higher is needed to save.)

Control/Enslave Entity

Range: 30ft (9.1m)

Duration: 48 hours per level of experience.

Saving Throw: Standard

P.P.E.: Eighty

Another incantation used to control supernatural forces. This magic does not summon entities, but does enable the mage to control them when encountered. The arcanist can control two entities per each of his levels of experience. All varieties of entities are susceptible to this enchantment. Each individual entity gets to make a saving throw vs magic. A successful save means it is not controlled by the arcanist. A failed roll means it will obey the arcanist to the best of its ability (some are barely intelligent).

At the end of its mandatory service to the arcanist, the mage can try to renew his control by invoking the control invocation again, banish the creature (see Banishment), or just let his control slip away. The latter can be dangerous, because the evil beings *may* turn on the mage to extract vengeance or just out of spite. On the other hand, the more intelligent types may willingly agree to work with an arcanist, especially an evil one, if it will help the diabolical being in its own schemes or to inflict pain and suffering.

Metamorphosis: Superior

Range: Self, or other by use of ritual only.

Duration: 20 minutes per level of experience.

Saving Throw: None; standard if an unwilling victim.

P.P.E.: One Hundred

This incantation enables the spell caster to transform himself into any real, living creature: animal, human, D-Bee or insect. The usual limitations and abilities still apply. The mage can also transform himself to *resemble* a supernatural creature, but does not possess any of its powers or abilities, only his own normal, human abilities (I.Q., memory, attributes, hit points, S.D.C. et cetera.).

A person other than the arcanist can be transformed, but a lengthy ritual magic must be performed to do so. The individual will remain in metamorphed form until the spell's duration elapses or the mage who invoked it cancels it.

Mystic Portal

Range: 20ft (6.1m)

Size: 10ft wide by 20ft tall portal/opening

Duration: 4 melees per level of the spell caster

Savings Throw: None

P.P.E.: 60

This spell creates a dimensional rift in the fabric of space allowing the spell caster to use it in the following ways:

Pass through solid walls. The caster has but to weave the spell targeting a particular, blocked area. The area will shimmer bright and suddenly, a portal or passage will appear as if cut out of the very stone. The portal can create a 12ft (3.6m) deep passage per each level of the spell caster in any substance.

Teleportation: The portal can also teleport someone to another location known to the spell caster instantly, as well as flawlessly. *Limitations:* as per Teleport. The portal can be placed on a vertical wall. Looking into it reveals what will appear to be just the other side of the wall, even though the view may be completely incongruous to ones present location. Stepping through it will instantly place the person in that location. Range is a meager 100ft (30.5m) per level of experience.

The major limitation of this spell, in all its modes of transport, is that the portal provides only *one-way* passage to or through all the aforementioned places. Once a person steps through a mystic portal the portal behind him is gone (although people on the portal side can see both the portal and the person). To return, a new portal must be made on the other side by invoking another mystic portal spell.

Summon and Control Rodents (ritual)

Range: 600ft (183m)

Duration: Five hours per level of experience.

Saving Throw: Standard animal

P.P.E.: Seventy

This pentacle of summoning produces an army of mice or rats that obey the will of the arcanist who summoned them. As long as the mage stands in the pentagram he can control any other types of rodents. Note: Familiars are not affected.

The sorcerer can summon 30 rodents per level of experience. Mice and rat bites inflict one point of damage each. Mice have one attack per melee, rats have two. All are +1 to dodge and are excellent climbers.

Summon Shadow Beast

Range: Immediate

Duration: Special

Saving Throw: None

P.P.E.: One Hundred Forty

This inter-dimensional spell summons a creature not of this world to do the bidding of the spell caster. Shadow beasts are large, vicious predators of some other, strange world. They stand 9 to 12ft tall, with sharp claws and wicked fangs. Deadliest of all is their ability to completely merge into the smallest shadow, becoming completely invisible. While hidden in shadows they are undetectable, even by a See the Invisible spell, since they are not truly invisible, but *one with the shadow*.

Abilities in darkness or shadows

I.Q. 7, M.E. 7, M.A. 7

P.S. 30, P.P. 24, P.E. 30

Spd. 24, Hit Points: 90, M.D.C.: 2

Attacks Per Melee: 3

Damage: 1D6 M.D.

Dodge/Parry bonus +5

Strike bonus +5

Invisible

Prowl 90%

Abilities in Light

I.Q. 7, M.E. 7, M.A. 7

P.S. 18, P.P. 16, P.E. 15

Spd. 8, Hit Points: 45, S.D.C.: 200

Attacks Per Melee: 2

Damage: 6D6 S.D.C.

Dodge/Parry bonus +1

Strike bonus +1

Visible

Prowl 45%

The spell caster can command the shadow beast in a combat situation for six melees per level of experience, or in a non-combat situation, send the beast on a simple mission ("Bring me so and so", or "Slay so and so"). The shadow beast will remain in this dimension until the mission is completed or it is slain.

There is a 15% chance that the shadow beast will not return to its own dimension and will no longer obey the spell caster who summoned it. If this happens, it will remain in our world wreaking havoc and killing innocent people for food and pleasure. Likewise, it will kill any who try to send it back.

Wards

Range: Varies with type.

Duration: Effects vary with type.

Saving Throw: Standard; spells are base 12, wards created by ritual magic are 16.

P.P.E.: Ninety

The ward's invocation creates mystic symbols used to protect items of value, to protect dwellings, and as booby traps. The ward can be cast on a door or window, a section of floor, a cabinet or on a specific item such as a book or statue. The ward symbols on the object are always obvious, to serve as a *warning*. When somebody, other than the arcanist who created them, touches the object, a spell is triggered. The following wards can be created. Each ward invocation will create two separate wards, the ritual invocation will create three. The object to be warded must be present.

Alarm: A screeching, siren-like noise is instantly sounded and continues to blare for TEN minutes. The sound can be *easily* heard through closed doors up to 100ft away.

Fear: An aura of fear engulfs everybody within a 20ft area of the ward. Each person must roll to save vs magic or be overwhelmed by terror. Effects are identical to the second level fear invocation.

Fire Bolt: The person touching the item is struck by a fire bolt causing 6D6 damage; no saving throw is applicable. Same as the fourth level invocation.

Paralysis (lesser): The ward temporarily paralyzes the person's hand and arm for 1D4 hours. Effects are identical to the third level invocation.

Sleep: The ward will put to sleep everybody within a ten foot area around it. Each person must roll to save versus magic. The sleep lasts for 6D6 minutes. Effects are identical to the fifth level spell.

Agony: The person who touches the object is wracked with agony for 2D8 melees. The effects are identical to the seventh level invocation.

Curse (minor): Inflicts a minor curse identical to the eighth level invocation except that it will linger for 1D6 weeks.

Curse (phobia): Inflicts a phobia curse identical to the ninth level invocation except that it will linger for 1D4 weeks.

Banishment (counts as two wards): Will instantly force lesser supernatural beings from the area, just like the tenth level invocation. Plus, the creature must leave the object where it rests.

After a ward has been triggered, its magic is used up and it disappears. A ward can last for centuries if left undisturbed. The life span of a ward is 150 years per level of the arcanist.

LEVEL ELEVEN

Anti-Magic Cloud

Range: 100ft (30.5m) radius per level of the spell caster

Duration: 20 melees per level of the spell caster

Saving Throw: Special

P.P.E.: One Hundred Forty

Those who are ignorant of the great old magics insist that this spell never existed, that it is impossible, merely another myth. They are wrong. This incredible spell creates an ominous, dark grey-brown cloud large enough to hang over an entire town. It can not be dispelled magically or by manipulating elemental/atmospheric conditions. The cloud's effect is as singular as it is spectacular; it simply **negates all magic!** Spell casters can not use magic of any kind, techno-wizard devices, potions and charms are impotent. Any object of magic (except runes and magic weapons) is rendered harmless as long as it is under the anti-magic cloud. The magic returns when the cloud is cancelled. Only the creator of the cloud is *not* affected. **Savings Throw:** Only an 18 to 20 saves against the cloud, and even these lucky few will find their magic reduced to half strength. If outside the cloud's range the magic abilities return.

Create Mummy (ritual)

Range: Touch

Duration: Exists until destroyed.

Saving Throw: None

P.P.E.: One Hundred Sixty

The mummy invocation is a necromantic ritual that turns a corpse into one of the undead. The ritual involves treating pure linen strips of cloth with a mystic solution and wrapping the body in the cloth. The incantation brings to life (if you can call it that) a sort of humanoid robot devoid of emotions and fearless. Like a machine, the barely intelligent "thing" follows simple orders to the best of its ability. The mummy is incapable of understanding complex commands, or performing any skills. It is simply a lumbering corpse. Of course, this combined with its near indestructibility makes it an ideal guardian. A simple command like "Kill all who enter." (with the exception of the mage) is all that it needs to know. A mummy can not speak (or read) but grunts, growls and howls.

The most devastating aspect of the damnable creature is that it is dead, and feels no pain or emotions. Bullets, knives, clubs, and even most magic, have no affect against the monster. Physical attacks simply nick or poke holes into a lifeless husk. Magic charms, sleeps, curses, illusions, illness, paralysis, and turn dead (the mummy is an undead) do nothing at all. Banishment does not work because the mummy is not actually a living supernatural creature. Negation simply does not work and remove curse is not applicable.

The only way to stop a mummy is to: 1) Trap or imprison it. 2) Blow it to bits. 3) Burn it up. **Note:** Protection circles will hold a mummy at bay. *Fire* is its one major weakness and it knows that, so a wall of fire or a torch or flamethrower may also keep it at bay. The magic is present in both the dead body and the linen wrappings. *If the wrappings are destroyed*, fire does double damage to the corpse, and even sunlight will inflict 3D6 points of damage per melee of exposure.

The Mummy

- I.Q. 4, P.S. 20, Speed 7
- Three attacks per melee, 2D6 S.D.C. damage by hand/punch.
- +5 S.D.C. to damage.
- +1 to parry, no dodge or initiative bonus.
- Most psychic powers and magic have no effect.
- Fearless; no horror factors scare it. However, small fires have a horror factor of 7 and larger fires, man-sized or bigger have a horror factor of 13.
- S.D.C. of linen wrappings: 50 (bullets do effectively no damage).
- S.D.C. of Corpse: 70, but only fire and explosives damage it. Sunlight hurts it only if all or most of the protective cloth wrappings have been destroyed. A typical torch will do 1D6 damage each time it is struck by one. **Note:** Mummies can be dressed in M.D.C. body armor and given hand held weapons like swords and clubs. They are not capable of shooting guns or using equipment.

Create Magic Scroll

Range: Identical to spell placed on scroll

Duration: As per scroll.

Saving Throw: Standard magic save; 12 or higher.

P.P.E.: 100 plus the P.P.E. needed to cast the magic spell placed on the scroll.

This spell is similar to the amulet and talisman spells in that the arcanist is able to transfer mystic energy and powers in to an inanimate object. In this case, the mage can magically make the words to a magic spell appear on paper. The only real limitation other than sufficient P.P.E. is that the mage must be able to read and write. If he can not read, he can not create a scroll.

Literate mages summon forth the energy needed and write the words of a spell in the sand or dirt with a stick while speaking the words aloud. The words magically appear on the paper as he writes and speaks them. When done the spell has been transferred to the paper and can be read and used by anybody who can read the particular language it was written in. Because the paper or parchment has been charged with P.P.E., any one, fellow mage or house wife, can read the scroll and the magic spell will be cast. To activate the scroll the spell must be read aloud.

The words on a scroll disappears the moment they are read aloud leaving only a blank piece of paper. No camera of any kind can photograph/record the mystic writing (appears blank) and for some inexplicable reason, a person can never seem to copy the spell down no matter how literate and educated he may be. This is why scroll conversion is so difficult.

Note: The power of the scroll-spell can be controlled by its creator and can range from level one potency to the current level of its creator. However, the creator's enhanced spell strength can not be transferred, so all saving throws from scroll magic are 12 if created as a spell or 16 if created as part of a ritual.

Remove Curse

Range: Touch or 10ft (3m).

Duration: Instant removal.

Saving Throw: None

P.P.E.: One Hundred Forty

The mage can attempt to remove any type of curse using this incantation. To determine success a 20-sided die is rolled (plus bonuses) to save vs magic. A successful save means that the curse is instantly gone. A failed roll to save means the curse is still in effect. Try again with a new invocation and another 140 P.P.E.

The remove curse is a powerful magic that provides bonuses to save vs magic and to remove that curse. Those bonuses are:

Spell: +5 to save

Ritual: +10 to save



Summon and Control Animals (ritual)

Range: 600ft (183m)

Duration: 5 hours per level of experience.

Saving Throw: Standard for animals.

P.P.E.: One Hundred Twenty-Five

A superior summoning pentacle, the invocation empowers the arcanist to summon and control any type of animal.

Tiny animals like frogs and mice — 40 per level of experience.

Medium-sized animals like dogs and cats (up to 30lbs) — 8 per level of experience.

Large animals like horses — 6 per level of experience.

Exotic animals, including animals which are not indigenous to the area; i.e., animals such as a tiger, panther or elephant are not native to New York city. Only *one* per level of experience.

As usual, any animal which comes into the arcanist's 600ft (183m) range while in the pentagram will obey the mage unless it makes a successful save vs magic. Familiars are not influenced by the control animal pentagram.

Summon Fog

Range: Up to 10 miles away per level of experience.

Duration: 1 hour per level of experience.

Saving Throw: None

P.P.E.: One Hundred Forty

The spell caster can call forth a dense fog that will impair vision and make travel difficult. **The fog** is so thick that a person can see clearly for four feet (1.2m) and see only blurred, shadowy figures and shapes for about another 10ft (3m). Anything beyond 10ft (3m) is totally obscured by fog. The fog can be made to cover a *one mile area* (1.6km) per each experience level of the arcanist.

Safe travel is slowed to a crawl. On foot, a safe speed is 10 or less, and even then there is a 30% chance of tripping over something every 30ft or so (9.1m). A completely safe speed is 3. Running faster than

a speed of 10 is hazardous, with a likelihood (60%) of falling every 30ft of travel. All sense of direction is lost. A safe speed for an automobile is 5mph (8kmph). Up to 20mph can be attained, but the risk of running off the road is 60%, and for every half mile there is a 40% chance of crashing into something. Traveling faster than 25mph is certain disaster, with an 85% likelihood of running off the road and a 70% chance of crashing. Roll for every 600ft (183m). Air travel is impossible.

Bonuses or penalties? The fog adds a +20% to prowl skills. *Long-range combat* and gunfights are extremely difficult. All such attacks, including distance magic and psychic attacks, are —5 to strike and opponents are +2 to dodge each other's attacks.

The summoner can cancel the fog at any time or let it last out its full duration. It can be summoned day or night, any time of the year.

LEVEL TWELVE

Amulet

Range: Holder/wearer of the amulet.

Duration: Exists as long as the medallion is not destroyed.

Saving Throw: None

P.P.E.: Two Hundred Ninety or more.

The "amulet" is a potent invocation that instills a medallion or charm with mystic properties that will protect an individual from magic or supernatural forces. The only requirement of the invocation is that the amulet be made of one metal purified by fire or made of semiprecious stone.

The sole purpose of an amulet is to protect. Protection is provided in several different ways. Any one of the following can be created by the amulet invocation.

Charm: A general ward against magic, that provides a bonus of +1 to save versus magic and psychic attacks. **P.P.E. Cost:** 290.

Protection Against Sickness: Amulet that specifically protects against the eighth level magic invocation "sickness." Bonus of +6 to save. **P.P.E. Cost:** 290.

Protection Against Insanity: Adds a bonus of +4 to save against *all* magically induced insanities. **P.P.E. Cost:** 320.

Protection Against the Supernatural: Adds a bonus of +2 to save vs horror factor. **P.P.E. Cost:** 300.

See the Invisible: Enables only the wearer of the medallion, to see the invisible. **P.P.E. Cost:** 500.

Sense the Presence of Spirits: The amulet changes color whenever a(n)entity(s)isinthearea. Range: 60ft (18.3m). **P.P.E. Cost:** 310.

Turn the Undead: A charm that will prevent any of the undead from physically touching them while they wear or hold the amulet. The amulet works much like a cross does against vampires. Effective against all undead including mummies, zombies and vampires. **P.P.E. Cost:** 400.

Calm Storms

Range: Immediate area around the mage, affecting a one mile (1.6km) area per level of experience.

Duration: 1 hour per level of experience.

Saving Throw: None

P.P.E.: Two Hundred

The arcanist can calm the tumultuous tempest of nature with a simple invocation and 200 points of potential psychic energy. As a spell, the mage can slow a downpour to a light rain, reduce wind speed by half, reduce waves by half and lighten the dark, stormy skies.

Using ritual magic the mystic can turn a torrential rain into a drizzle, reduce winds to a gentle breeze, shrink ocean waves to normal, disperse a tornado in an instant and get the sun to peek through clearing skies.

Note: Calm Storms is effective against natural and magically induced storms.

Create Zombie (ritual)

Range: Touch

Duration: Exists until destroyed.

Saving Throw: None

P.P.E.: Two Hundred Fifty

The zombie invocation is a necromantic ritual that turns a corpse into the undead. To create a zombie, the sorcerer must find a recently deceased body, no more than six hours dead, lay it on a white or silver linen, draw a circle around it and light three scented candles. The candles are then placed on the body: one on the forehead, one on the mouth and one on the chest above the heart. As the incantation reaches its climax, the mage cuts his finger and draws a pentagram on the corpse's throat with his still warm blood. Moments later, the monstrosity rises to pseudo-life, the obedient slave of his creator. The ceremony must be done secretly in a graveyard or burial place during a night of a full moon.

The zombie is more intelligent than the mummy and can speak, read simple signs and sentences, perform simple tasks and even drive a car. This means a zombie(s) can be sent to retrieve an artifact, follow somebody, kidnap a person and so on. A zombie will only obey the person who created it and individuals whom its creator may designate as authorities.

Like the mummy, a zombie is a walking corpse. It feels no pain, no fears, no goals and little emotion. Bullets, knives, clubs, and other physical attacks do NO damage. Mental assaults by psychics, magic charms, illusions, sleeps, curses, sickness, paralysis, and other similar attacks, do no damage. Turn dead does not work because the zombie is an undead. Banishment doesn't work because it is not actually a living supernatural being. Negation simply does not work and remove curse is not applicable. However, the zombie is more vulnerable than the mummy, the trick is knowing what to use.

A zombie is vulnerable to *magical energy attacks*, such as energy bolt, fire bolt, circle of flame, and call lightning, all of which do full damage. *Normal electricity*, lasers, particle beam weapons and similar energy weapons do half their normal damage. *Normal fire* inflicts full damage. Weapons made of, or covered in *silver*, will do full damage whether it be blade or bullet. Zombies can also be trapped/imprisoned and blown up.

Zombies will rise again, even if riddled with silver bullets or blown to bits, unless their heads are severed from their bodies and buried separately, or an exorcism is performed. Otherwise, it will regenerate *all S.D.C.* and body parts within *48 hours* and seek out its master for new instructions. There is no limit to the number of zombies a mage can command. Horror stories in Haiti whisper of entire sugar cane plantations worked by zombie laborers.

ZOMBIES

- Horror Factor: 12
- I.Q. 7, P.S. 20, Speed 10.
- Two attacks per melee, 2D4 S.D.C. damage by hand/punch or by weapon. Guns can be used, but at —4 to strike.
- +2 to parry and dodge. No initiative bonus.
- Most psychic and magic powers have no effect, only energy.
- Fearless; no horror factor scares it. However, large fires and energy weapons/barriers will hold it at bay. A protection circle will also keep it away.
- S.D.C.: 150; will regenerate within 48 hours unless head and body are buried separately. Can Wear M.D.C. body armor or power armor.

Metamorphosis: Mist

Range: Self; or others through ritual magic.

Duration: 20 minutes per level of experience.

Saving Throw: None; standard if an unwilling subject.

P.P.E.: Two Hundred Fifty

Said to be the most powerful of all the metamorph magics, the mage can transform himself into a mist. As a mist, no physical or energy attacks can harm him. No locked door can stop him, for he can slip through the tiniest crack or keyhole. Although the mystic can not communicate or cast magic, he can hear and see events around him as would a normal human being. Of course, he can materialize (naked) with a thought.

The mist moves at a maximum speed of 14. Prowls (natural, innate ability) at an 80% skill proficiency, is completely silent, can hover up to 100ft high (30.5m) and is semitransparent.

Summon and Control Entity (ritual)

Range: Not applicable.

Duration: 24 hours per level of experience.

Saving Throw: None

P.P.E.: Two Hundred Fifty

An impressive ritual, the magic invocation plucks an entity (specific type can be designated) out of its native dimension, and magically teleports it to appear before the conjurer. The alien being is automatically under the mage's control and will obey him without question. The entity can be used for any purpose: manual labor, protection, assault, etc.

The supernatural creature can be returned to its own world at any time before the duration time of the invocation elapses. After the duration time elapses, the entity slips out of the mage's control and remains in our world. If it suits the entity, it may elect to work with the arcanist or it can be enslaved by other mystic means. An unhappy or vengeful entity may attack the mage at the first opportunity after the mage loses control.

Summon and Control Rain (ritual)

Range: Immediate area around the mage or up to 10 miles away per level of the experience.

Duration: 1 hour per level of experience.

Saving Throw: None

P.P.E.: Two Hundred

The sorcerer can create a rainstorm out of thin air. The rain can be controlled to be a drizzle, light rain or downpour. One mile (1.6km), per level of experience, can be affected by the rain. A heavy storm will reduce visibility and slow travel.

Time Hole

Range: Self

Duration: Special

Saving Throw: None

P.P.E.: 210

The mage can teleport himself and his possession into a sort of stasis field in limbo-like dimension. The time hole is a white void in which the wizard inhabits/controls a 20 foot (6 m) area per level of experience. He can not go beyond his area of control. There is nothing to see or do in the time hole, except for what the person may have brought with him. Likewise, there is no food or water except what is taken into the time hole.

The advantage of the time hole is that a man of magic can effectively disappear for days or weeks and be nowhere to be found. In this way the mage can hide away from enemies when he needs to recover from physical or P.P.E. damage/exhaustion. He can also use the time to prepare of combat or to study in seclusion.

In the time hole time passes normally, so the character will age normally. However, outside the time hole time is moving at much slower rate, thus for every 12 hours inside a time hole, only two hours pass outside. This means the mage can spend two days/48 hours in the time hole but appear to have been gone for only eight hours. The mage can stay in a time hole for 24 hours (four hours real time) per level of experience.

LEVEL THIRTEEN



Create Golem (ritual)

Range: Touch

Duration: Exists until destroyed.

Saving Throw: None

P.P.E.: Stone: 700 or Iron: 1000

The sorcerer first draws a pentagram in animal blood. Second, he sculpts a golem (humanoid shape) from clay. Third, he places two onyx gems, valued at no less than 1000 credits each, for eyes. Fourth, he places a heart, molded out of iron, into the clay body. Lastly, the mage recites the ritual ceremony. At the end of the ritual, the mystic places a single drop of his blood on the behemoth's forehead to bring it to life. The process permanently drains the mage of 6 S.D.C. points.

Both the stone and iron golems are mystical mega-damage creatures born of magic and almost indestructible. Since they are not of flesh and blood, psychic and magic attacks designed for the human physiology and mind do not affect them. That means charms, sleeps, bio-manipulation, illusions, paralysis, etc., have no effect. Since the horrid thing was never alive, turn dead is *useless*, as is banishment, negation and remove curse. *Physical attacks* and *energy magic* can hurt a golem, but do half damage (even explosives). In many respects, a golem is like the mummy, only bigger and tougher. It can not speak, nor read or understand complex commands. It has no emotions, no fears, and is like a robot waiting for a direction. Golems will obey only the person who created it. When the creator dies, the golem will follow his last command until it is destroyed.

GOLEM

- Horror Factor: 16
- I.Q. 6, P.S. 25, Speed 8, Height: 6ft to 18ft (1.8-5.4m).
- Four attacks per melee, 1D6 M.D. damage by hand/punch.
- No bonus to parry or dodge or on initiative.
- Impervious to most psychic and magic attacks. Magic energy attacks and normal weapons, like guns, knives and clubs, will do only half damage.
- Impervious to normal fire (magic fire does half damage).
- M.D.C.: 35 stone or 80 iron.
- Regenerates completely within 24 hours unless its heart is removed.

Protection Circle: Superior

Range: Radius of the circle.

Duration: 24 hours; but can be reactivated immediately at a cost of 20P.P.E.

Saving Throw: None

P.P.E.: Two Hundred Fifty

In principle and function, the superior protection circle is just like the simple circle, only stronger. The arcanist must recite the invocation while drawing the circle in chalk or any substance. 300 P.P.E. are needed to initially create the circle, but a mere 20 P.P.E. points will reactivate it. Anybody with sufficient P.P.E. and desire can reactivate a protection circle. The circle ceases to function only if it is seriously marred.

The superior protection circle will protect everybody inside its radius by preventing all supernatural creatures from coming any closer than 20ft (6.1m) from its edge. Even greater beings are held at bay. *Lesser beings* can not stand to be within *line of sight* of the circle and are forced to leave (even if it's only to the next room with the door shut). This means no attacks are possible for the lesser beings.

The circle also provides the following bonuses to all occupants: +5 to save vs all magic and psychic attacks, impervious to possession, +8 to save vs horror factor. Plus it provides an *extra* 10 P.P.E. to each mage and 10 I.S.P. to each psychic. Of course, the characters are vulnerable to conventional weapons and thrown objects.

Summon and Control Storm

Range: Immediate area around the mage or up to 10 miles (16km) away.

Duration: 1 hour per level of experience.

Saving Throw: None

P.P.E.: Three Hundred

The spell caster can create a destructive storm out of thin air. A rainstorm will create a torrential downpour of 4 inches of rain per hour, causing flooding even in cities. Flooded roads will *immobilize* all vehicles (water is 3 to 5ft high). Poor visibility will slow travel to about 20mph. Traveling fast is likely to cause an accident; roll on the following table for every *two miles* (3.2km) traveled.

- 1-30** No problem, keep going.
31-39 Vehicle stalls out. 1-50% chance of restarting.
40-69 Vehicle runs off road and is immobilized.
70-00 Vehicle crashes into an obstacle or another vehicle. Vehicle is immobilized. All passengers *roll 2D6 damage for every 10mph of vehicle speed*. The storm is accompanied by damaging winds gusting to 35 and 45mph (54 to 72km). The rain and wind makes air travel impossible.

A *windstorm* may be accompanied by light rain, but the real threat is high winds. Winds gust up to 70 and 90mph (112 to 144km) uprooting small trees, knocking down tree branches and electrical wires, and even overturning an occasional car. Travel on foot is very difficult, reducing a character's speed by 90%. Travel in automobiles is slowed to about 20mph. Traveling any faster is likely to cause the vehicle to run off the road or flip over. Roll 40% + 10% for every 10mph (16kmph) above 20mph (32kmph). Roll once for every 4 miles of travel (6.4km). Air travel is extremely hazardous, but not impossible.

Summon Lesser Being (ritual)

Range: Not applicable.

Duration: 24 hours per level of experience.

Saving Throw: None

P.P.E.: Four Hundred Twenty-Five

An impressive ritual that plucks a supernatural being out of its native dimension and magically places it before the mystic in our world. A specific lesser monster can be summoned if desired, or a random creature can be called for.

The supernatural being is automatically under the arcanist's control and will obey him without question. The only things it will not do is commit suicide and it may not fight to the death.

The monster can be returned to its own world at any time before the duration time of the invocation elapses. If the creature is not returned and the duration lapses, the mage loses control of the thing and it remains in our world. The creature can be enslaved by other means, may elect to stay with the mage, or wander off to wreak havoc. The only way to send it back to its world is to open a dimensional portal.

See Monster Section for specific creatures.

Sanctum

Range: 30 x 30ft room; can be created up to 200 miles away.

Duration: The lifetime of the mage or until canceled.

Saving Throw: None

P.P.E.: Three Hundred Ninety

The mage can protect a room of up to 30 x 30ft (9.1m x 9.1m) from mystic influence by using the sanctum invocation. The room is instantly turned into a safe haven, or sanctum, free of mystic disturbance. While inside the room, the mage can not be found by the *locate spell*, can not be seen by *second sight*, and can not be affected by *bonding magic* (but only while in the room). Even more impressive is that *animated dead* and *undead* can not enter the sanctum. *Lesser monsters* can not enter unless they save vs magic; greater beings and humans are not affected and enter at will.

Talisman

Range: Varies with type of spell.

Duration: Talisman exists until destroyed.

Saving Throw: Standard

P.P.E.: Five Hundred

The term talisman is believed to have its roots in the Arabic language and means "to make marks like a magician." Indeed, that is what a talisman is, an extension of magic, an item that contains magic power.

A talisman can be made from almost anything, although it is most commonly designed as a medallion, necklace, mantle, pin, charm, small statue, headdress, or hand-held symbol. A talisman is designed to perform one function only. The invocation enables the arcanist to empower an ordinary object with magic powers. The only substances which can not be used are iron and plastic, and the object can not be larger than two feet (0.6m) tall, long or wide. Once an object is transformed into a talisman, the arcanist can empower it with one magic spell. The spell can be selected from levels one through eight, excluding illusion types. Of course, to implant the spell the arcanist must already know it and it must be a *spell* invocation, not a ritual.

After its initial creation, the talisman can be used to cast its one spell for a total of three times. After all three have been cast, the object is drained. The mystic who created the talisman can replace its three exhausted spells by casting that same spell invocation combined with part of the talisman spell or ritual. The cost of the recharge is 50 P.P.E. plus the cost of the spell invocation. Note that the process must be repeated for each of the three identical spells (each at a cost of 50 P.P.E. plus the spell's P.P.E. cost). Thus, to recharge all three identical spells would cost 150 P.P.E. plus. The aspect of three spells attributed to a magic item may be the source of legends that grant three wishes.

A talisman can be used for one purpose other than spells. The mage can elect to make it a potential psychic energy battery. Instead of spells, the mystic can put up to 50 P.P.E. into it initially and recharge it with 30 P.P.E. at the cost of 60. The talisman can then be used at a later time to bolster the character's normal P.P.E. reserve. A P.P.E. battery can never hold spells.

A talisman can be destroyed by smashing it, That's all there is to it. If the arcanist who created it is killed or can not be found, the talisman will be good only for whatever number of spells that are currently inside it and can *not* be recharged. Remember, only the mage who created it can recharge it.

LEVEL FOURTEEN

Close Rift

Range: 100 feet (30.5 m)

Duration: Instant results

Saving Throw: Standard

P.P.E.: 200 plus 2 P.P.E. from character's permanent P.P.E. base!

The master of magic can close a rift by sheer force of will. However, the monumental effort permanently drains the mage of two P.P.E. points from his permanent base, whether successful or not. The mystic nature of the dimensional gateway gives it an automatic save versus magic attack, consequently a Close Rift Ritual will increase one's odds for success (16). The rift will instantly vanish if successful. A failure means the rift is not affected and the wizard has lost 2 P.P.E. forever; try again. **Note:** This incantation will not close the St. Louis Gateway rift.

Id Barrier

Range: Up to 200ft (61m) away, plus 100ft (30.5m) per each additional level of experience.

Duration: 3 minutes (12 melees) per level of experience.

Saving Throw: Standard, and vs horror factor.

P.P.E.: Six Hundred

The character can erect a powerful, defensive shield of semitransparent energy. The barrier itself emanates horror, and a character must save vs *horror factor 14* to even come within 10ft of it. Those who fail to save vs horror factor can *not* pass through the barrier.

Anybody who braves the barrier must roll again; this time to save versus magic. A successful save means the character passes through the barrier with only a headache and loses one attack that melee. A failed save means the character must face an apparition of his greatest fear. The *apparition* is exactly like the sixth level invocation and will last as long as the barrier remains up. Only the mage who created the Id Barrier can make the apparition vanish, or cancel the barrier before its normal duration time.

Impenetrable Wall of Force

Range: 100ft (30.5m)

Duration: 5 melees per level of the spell caster

Savings Throw: None

P.P.E.: Six Hundred

This spell creates a shimmering wall of light that no creature, weapon, or object may penetrate. Only a Dispel Magic Barrier spell or a powerful Negate Magic will destroy the wall. The spell caster is able to create a wall of force that measures 20 x 20 feet per level of experience. The wall can be cast up to 100ft away.

Restoration

Range: Touch or 3ft away (0.9m).

Duration: Instant/permanent

Saving Throw: None

P.P.E.: Seven Hundred Fifty

This is a powerful healing incantation. The magic will instantly, and completely, heal wounds, cuts, bruises, burns, etc., restoring full S.D.C. and hit points, while leaving only minimal scarring. It is so powerful a magic that it can heal internal organs and mend bones. Even bullets or shrapnel will magically disappear and the wounds heal. The invocation can also restore severed limbs, such as a hand, arm, finger, foot, leg, etc., providing that the limb has not been severed from its body for more than 48 hours. Substitute limbs and organs can not be used. Nor can this invocation restore life or replace missing limbs or organs, nor can it be used to repair bionic or cybernetic parts.

LEVEL FIFTEEN

Dimensional Portal

Range: A few feet away.

Duration: 30 seconds (2 melees) per level of the spell caster, or one minute (4 melees) per level of experience when performed as a ritual.

Saving Throw: None

P.P.E.: One Thousand

The dimensional portal invocation opens a two-way door to another dimension. The mage can open a door to a specific world or randomly. This is the only way a greater being can enter into our dimension. Once the dimensional portal closes, the only way back in or out is to open another portal. One of the real dangers of using this magic is that some "thing" unwanted always slips through.

Teleport: Superior

Range: Self or others; distance of 300 miles per level of experience.

Duration: Instant

Saving Throw: None

P.P.E.: Six Hundred

The arcanist can instantly transport himself and up to 1000lbs (450kg), per level of experience, hundreds of miles away. To teleport, the mage must have a mental picture of his destination. The best results can be achieved when the character is personally acquainted with the target

destination, some place he has visited or knows well. However, locations seen in photographs or described in detail can also be reached, but there is always a chance of a miscalculation.

The mage can teleport himself alone, or other people and objects within 20ft (6.1m) of him. The total number of people and items which the mystic can teleport is limited by the amount of weight he can handle (1000lbs per level of experience).

The following tables indicate the chance of a success and the results of a failed teleport.

Chances of a successful teleport:

1. Teleporting to a familiar location or a destination visible from one's starting point: 99%.
2. A place seen only a few times before (2-6 times): 85%.
3. A place seen in a photo (the photograph is being looked at during the moment of teleportation): 80%.
4. A place never visited before, but described in detail: 58%.
5. A place never before visited and known only by name or brief description: 20%.

Results of an Unsuccessful Teleport

(Roll percentile dice for random occurrences.)

- | | |
|-------|---|
| 1-40 | Appear at the wrong place. No idea of present location; 3D6 x 100 miles off course. |
| 41-75 | Appear at the wrong place. No idea of present location; 1D6 x 100 miles off course. |
| 76-98 | Teleport several feet above the ground; everybody falls, suffering 2D6 damage. |
| 99-00 | Teleport into an object; instant death. |

Transformation (ritual)

Range: Touch

Duration: 3 days per level of experience.

Saving Throw: Standard (minus) -3 to save.

P.P.E.: Two Thousand

Transformation is a powerful spell that transforms a normal human being into a grisly, demonic monster. After the transformation is completed, the pitiful creature will be a mindless slave of the mage who transformed him/her. As a monster, the character has no recollection of his/her life as a human, retains no skills, knowledge or memory, or even attributes. The "thing" will obey the mage without question and most of the time, regardless of its original alignment. However, principled, scrupulous and unprincipled characters will not kill or hurt a child, or a very dear friend or loved one. Some half remembered fragment of lost memory and emotion prevents it. Likewise, the character can not be made to commit suicide or fight to the death.

The only way to recognize the transformed character is with see aura, clairvoyance, object read or telepathy.

There are four ways to return the person to normal. 1) Wait until the duration time elapses. 2) Convince the mage who made the transformation to cancel the spell. 3) Kill the mage. 4) Remove curse has a 1-19% chance of negating the magic (roll percentile dice). The negation spell has no effect against this powerful magic.

To determine the appearance and abilities of the transformed person, roll on the random supernatural creature tables in the monster section. The transformed human will not have any spell casting powers, but may have psychic abilities.

Coalition State Weapons & Equipment

The Coalition States (CS) have a standardized army with standard weapons and equipment. Generally, only CS weapons and equipment are issued to its soldiers. Only wilderness, reconnaissance, and covert operatives are allowed to use weapons other than standard issue. The Coalition has the most powerful army in the known world. Their level of technology is unsurpassed in the Americas.

The recollection of Erin Tarn

The introduction from The Great Historian Erin Tarn's book, HUMANKIND'S RISE FROM CHAOS, circa 63 P.A.

I have taken it upon myself to capture human history before it is entirely lost. Many say that it is of little importance since the planet Earth is forever transformed and the human race will never be as it was. All the same, I believe there are generations who will wonder how and why things came to pass as they did and I hope my works will help to answer their queries.

I am not an educated woman. Thus, my words may not read as eloquently as those spoken by the new gentry rising to power in the middle Americas. I am a nomad who has come to see and hear many things in her travels. Things, that I now realize are pieces of our vanishing past. Things that too few people remember. Such as the 52 United States, the names of the old Empires like Japan, *Korea*, *China*, *Canada*, and *even our own USA*. I'm told that I am a fool, because few people today read American (or what was once called English), or read at all. Still, I will try to capture our past for the sake of our children and their children. So when the day comes that they ask why, when, how, and who, that they will have at least a few of the answers.

Ancient history of the world I will leave to the old books and video discs that still exist. I have seen an astounding number of civil and private libraries of incredible proportions. It makes me glad to see that so many books and recordings have survived. My own humble collection numbers 72 paper-books and 31 vid-discs, as of this writing. Of course, no library can compare to the library of *Chi-town*. It is without exception the greatest library in the world! Books, magazines, antique computer discs and films, video tapes and video discs, micro-film, and original artworks. I am told that many of the books were found in the catacombs of a place called the *Smithsonian* and other sites in the city of Washington, D.C., which served as the USA Empire's seat of government and knowledge. The months I spent pouring over those volumes was one of the greatest thrills of my life. I look forward to my return there one day in the years to come.

I will focus my records of history to the period just before the Time of *Rifts* and the centuries of chaos which followed. I will try to separate fact from fantasy and indicate rumor, myth, and legend when facts are not available.

Please forgive my shortcomings.

Chi-Town

A study in the corruption of the soul From the diary of Erin Tarn; Circa 78 P.A.

I fear that I am a firsthand witness to the birthing of a sad new saga of human tyranny. A despot named Karl Prosek sits as the chairman-elect of *Chi-Town*, but I can see storm clouds rushing swiftly from the horizon. He is the second of the Prosek family to hold the illustrious seat of chairman-elect. And only one in a long line of heroes and visionaries who helped to build the industrial city out of the ashes of destruction. However, unlike his forefathers, Karl Prosek is a vicious opportunist who sees the opportunity to create a family dynasty and has seized that opportunity.

Perhaps it is from my position as a historian that I can see the progression of events as something far more dangerous than others around me can. I see the wheels of an oppressing dictatorship turning and gathering momentum. It is classic. The control and manipulation of the media by the Chairman and his government (for the betterment of the people), subtle and not so subtle indoctrination, the quiet abolishment of free speech, and the restriction of knowledge. There is talk of superiority and the inherent rights and benefits of being superior. Small, almost inconsequential acts of aggression under the guise of "security" weaves an unmistakable pattern of growing military strength and imperialistic conquests. These *inconsequential* acts of self preservation have increased the landholdings of Chi-Town by 12% and have increased manufacturing and political strength by as much as 35%. These actions are far from inconsequential. They are part of a calculated plan to expand the power base of the Chi-Town Empire.

I can not help seeing distinct similarities between this political regime and the Hitler Regime of 20th Century Germany. In fact, I can not shake the feeling that Chairman Karl Prosek is intentionally patterning himself after this insane 20th century dictator. This is doubly terrifying for me when I realize that few people in the world today know anything about Hitler, World War II, or the deliberate extermination of millions of people. People executed because they were not among the chosen elite. Chairman Prosek's recent proclamations regarding the superiority of humans over mutants and non-humans smacks of the beginning of a political campaign to stir the people to his way of thinking.

Perhaps I am reading too much into what I see. Yet, in an obscure political essay written by Chairman Prosek as a student at Chi-University, he states: "Hitler was a genius who fell to madness and greed of power. He alone inspired a nation whose people were among the most downtrodden and depressed. Within a decade he had given the people's hearts and minds wings of inspiration and dreams of power and glory that they had not dared to imagine. Powered by these dreams, he was able to build an army unlike any the world had yet known. An army created from the ashes of despair turned into hope and prosperity. An army that made the world tremble. Had he proceeded more slowly and let his people enjoy their prosperity, letting them feed and grow fat with each new triumph, he would have built an Empire that could not have been toppled. He should have fed their greed, for a people who are without want do not look far from its golden doorway. They do not question the inhumanity or plight of others, but only thank the gods that they are so fortunate. Then when somebody threatens their prosperity they are terrified and will sanction any acts necessary to preserve their way of life, especially if they are not asked to do the deeds themselves. That is the secret; control over one's ambitions and over the people he rules. Use fear and ignorance, for they are tools of incredible power. And patience."



The essay continues with references to Hitler's genius and his methods. I pray that the paradise of Chi-Town is not being corrupted by the insane vision of a 20th Century madman. This world knows too much pain already.

Coalition "Dead Boy" Body Armor

The famous Death's Head motif of the Coalition's armor and war machines has struck fear in the hearts of its opposition for nearly 40 years. It has led to the soldiers being dubbed "Dead Boys."

The armor is a lightweight ceramic, with metal accents, bonded on a molecular level, making it stronger than steel. Each suit of armor offers mega-damage protection and complete environmental systems, making it a self-contained unit, like a space suit. Air filters, circulation and cooling, and independent oxygen supply (engages when needed) means that toxic fumes, gas attacks, and smoke will not affect the soldier protected in the suit unless the armor is breached.

The CS body armor is a variation of an old infantry armor developed by the United States military shortly before the time of Rifts. The process and factories for its creation were unearthed at Lone Star and has since been duplicated at both Chi-Town and Free Quebec.

There are two types of Dead Boy armor, light and heavy. However, other than weight and M.D.C., there is no obvious design distinction. All CS body armor has the same design, only the head piece is different to indicate rank and different divisions within the armed forces.

All Coalition "Dead Boy" body armor has the following properties.

- 50 M.D.C., CA-2 Light Body Armor: weight 9 pounds (4 kg). Worn by pilots and city police forces, as well as for espionage type operations. 80 M.D.C., CA-1 Heavy Body Armor: weight 18 pounds (8.1 kg). Worn by the infantry.
- Complete environmental battle armor suitable for use in all hostile environments, including space.
- Computer controlled life support system.
- Internal cooling and temperature control.
- Artificial air circulation systems, gas filtration, humidifier.
- Computer controlled, independent oxygen supply and purge system that automatically engages in low oxygen or contaminated air environments. Five hour oxygen supply.
- Insulated, high temperature resistant shielding for up to 300 degrees centigrade. Normal fires do no damage. Nuclear, plasma, and magic fires do full damage.
Radiation shielded.
Polarized and light sensitive/adjusting tinted visor.
Built-in loudspeaker; 80 decibels.
Directional, short range radio built into the helmet. Range is 5 miles (8 km).
Helmet face plate is removable.
- Wrist Mini-Comp: A multi-purpose miniature computer and display that will indicate system errors within the armor, damage levels, and oxygen supply, as well as direction (compass), time, and date.
- Ammo and supply waist belt, shoulder belts, and shoulder holster. Pilots and officers have their choice of shoulder or hip holster.
- Boot survival knife or vibro-blade for officers and military specialists.
- Prowl Penalty: -10% in CA-2 light armor, - 25% in CA-1 heavy.

Note: Standard issue of weapons to the infantry is the C-12 laser assault rifle, C-18 laser pistol, and a survival knife. Other weapons are available upon assignment.

Dog Pack DPM Light Riot Armor

The Dog Pack force is a recent addition to the Coalition armed forces. The mutant dogs are used for reconnaissance and city law enforcement, specifically in the areas of tracking fugitives, supernatural monsters, magic, and psionics. The armor is light, allowing for maximum mobility and stealth. Unfortunately, it offers minimal physical protection. This is due, in part, to the Coalition's perception that the intelligent mutant dogs are little more than trained animals and quite expendable.

The DPM armor offers none of the environmental systems of the full Dead Boy suits and serves mostly as protection against gunfire. Note that many Dog Packs (about 40%) assigned to wilderness and reconnaissance operations are given CA-2 light body armor.

- M.D.C. 30
- Weight 8 pounds (3.6 kg)
- Full mobility, no prowl penalty.

Note: Standard issue to city Dog Pack soldiers is fist and wrist spikes, a pair of vibro-blades or a blade and neural mace. A laser pistol may be issued in some situations. Infantry forces in the field are issued a vibro-blade of choice or neural mace and a C-12 laser rifle. Other arms may be issued as needed. Dog Boys in the field often add/purchase other non-official, non-Coalition weapons to add to their personal equipment.

Coalition SAMAS Power Armor

The SAMAS, or "Sam" as it is commonly called, is a complete environmental body armor that has been enhanced, through robotics, with additional superhuman capabilities. The SAMAS, like all power armor, is basically a robot exo-skeleton with M.D.C. plating, superhuman strength, and weapon systems. The pilot fits inside the exo-skeleton as he would with any body armor.

The SAMAS is a significant element of the Coalition's armored troops. The suit is designed for assault and defense. It can fly and hover and is incredibly small (basically man size compared to giant robots like the UAR-1) and maneuverable.

SAMAS Power Armor

Model Type: PA-06A

Class: Strategic Armor Military Assault Suit

Crew: One

M.D.C. by Location:

- Shoulder Wings (2) — 30 each
- Main Rear Jets (2) — 60 each
- Lower Maneuvering Jets — 25 each
- Ammo Drum (rear) — 25
- Rail Gun — 50
- Forearm mini-Missile Launcher (1 left) — 50
- *Head — 70
- **Main Body — 250

* Destroying the head of the power armor will eliminate all forms of optical enhancement and sensory systems. The pilot must now rely on his own human vision and senses. No power armor combat bonuses to strike, parry, and dodge! **Note:** The head is a small and difficult target to hit (shielded by exhaust tubes and weapon drum). Thus, it can only be hit when a character makes a *called shot* and even then the attacker is — 3 to strike.

** Depleting the M.D.C. of the main body will shut the armor down completely, making it useless. **Note:** Destroying a wing will make flight impossible. However, even with no wing(s) the SAMAS can make jet powered leaps and hover stationary above the ground.

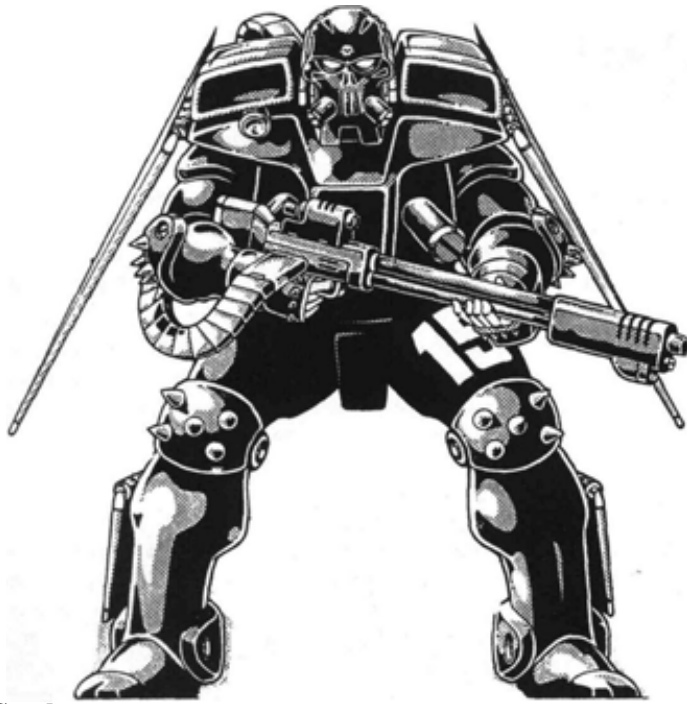

Speed

Running: 60 mph (96 km) maximum. Note that the act of running does tire out its operator, but at 10% of the usual fatigue rate thanks to the robot exo-skeleton.

Leaping: The powerful robot legs can leap up to 15 feet (4.6 m) high or across unassisted by the thrusters. A *jet thruster assisted* leap can propel the unit up to 100 feet (30.5 m) high and 200 feet (61 m) across without actually attaining flight.

Flying: The rocket propulsion system enables the SAMAS to hover stationary up to 200 feet (61 m) or fly. Maximum flying speed is 300 mph (480 km), but cruising speed is considered to be 150 mph (240 km). Maximum altitude is limited to about 500 feet (152 m).

Flying Range: The nuclear power system gives the SAMAS decades of life, but the jet rockets get hot and need to cool after a maximum of ten hours of flight when travelling at speeds above cruising, and twenty hours of cruising speed, can fly indefinitely with rest stops.

Statistical Data

Height: 8 feet (2.4 m)

Width: Wings down: 3.5 feet (1.06 m)

Wings extended: 10 feet (3m)

Length: 4 feet, 6 inches (1.4 m)

Weight: 340 lbs (153 kg) without rail gun.

Physical Strength: Equal to a P.S. 30

Cargo: None

Power System: Nuclear; average SAMAS energy life is 20 years.

Black Market Cost: 1.6 million credits for a new, undamaged, fully powered suit complete with rail gun and one full ammo-drum. Rarely available.

Weapon Systems

1. C-40R SAMAS Rail Gun (1): This is standard equipment for the SAMAS and is considered to be the most powerful, accurate, and lightweight rail gun in the world. Other heavier rail guns can be substituted in an emergency. See *Other Weapons* section for a full description of rail guns and their use as machineguns. Note that the SAMAS has a greater payload than the machinegun version. Also, there is no separate power pack; the unit is hooked directly to the armor's nuclear power supply.

Primary Purpose: Assault

Secondary Purpose: Defense

Weight: Gun: 92 lbs (41.4 kg), One SAMAS Ammo-Drum: 190 lbs (85.5 kg).

Mega-Damage: A Burst is 40 rounds and inflicts 1D4x 10 M.D., one round does 1D4 M.D.

Rate of Fire: Equal to number of combined hand to hand attacks (usually 4-6).

Maximum Effective Range: 4000 feet (1200 m)

Payload: 2000 round drum, that's 50 bursts. A second drum can be hooked to the undercarriage of the rocket jets, but must be manually removed by another SAMAS or character with a strength of 26 or higher can replace the used drum. Reloading a drum will take about 5 minutes for those not trained, but a mere one minute by somebody trained in the use of SAMAS power armor.

2. CM-2 Rocket Launcher: The forearm not used to operate the rail gun, usually left, is armed with a mini- missile rocket launcher.

Primary Purpose: Anti-Aircraft

Secondary Purpose: Defense

Missile Type: Any mini-missile can be used, but standard issue is armor piercing (1D4X 10 M.D.) or plasma (1D6X 10). Fragmentation will be used for anti-personnel operations.

Mega-Damage: Varies with missile type.

Range: Usually about a mile.

Rate of Fire: One or two.

Payload: Two

3. Energy Rifles and other normal weapons can be substituted in an emergency or as a back-up weapon. Space limitations and the bulk of the armor limits additional handguns or rifles to one.

4. Hand to Hand Combat: Rather than use a weapon, the pilot can engage in mega-damage hand to hand combat. See *Power Armor Combat Training* in the Robot Combat section.

5. Sensor System Note: The SAMAS has full optical systems, including laser targeting, telescopic, passive nightvision (light amplification), thermo-imaging, infrared, ultraviolet, and polarization. Plus all other features common to all power armor.

Sensor Bonuses: Applicable to long range weapon combat only, not hand to hand. +2 to strike and +1 to dodge. See *Power Armor Combat Training* in the Robot Combat section for other bonuses.

Coalition UAR-1 Enforcer Robot

The UAR-1 is an Urban Assault Robot, meaning that it is a ground unit specifically designed to combat ground forces in a city environment. The development of this mechanized behemoth grew out of the conflict with the Federation of Magic in the ruins of Old Chicago, in the year 12 P.A. The enemy forces were firmly entrenched in the old ruins and were difficult to extract and cost the lives of thousands of Chi-Town's soldiers. A few years later saw the appearance of the UAR-1 Enforcer's predecessor. The current model has been used for over 20 years now and has proven to be an exceptional deterrent against armed assaults, riots, and combating supernatural monsters from the rifts.

The 20 foot giant is usually operated by a pilot and a co-pilot/gunner, but can be just as easily piloted by one lone operator. The giant robot is armed with a variety of weapon systems, good in hand to hand combat, and mobile.

UAR-1 Enforcer Assault Robot

Model Type: UAR-1

Class: Urban Assault Robot

Crew: One or two

M.D.C. by Location:

Right Shoulder Rail Gun — 100 (shielded)

Left Shoulder Medium Range Missile Launcher — 150

Shoulder Mounted Laser Turrets (2) — 50 each

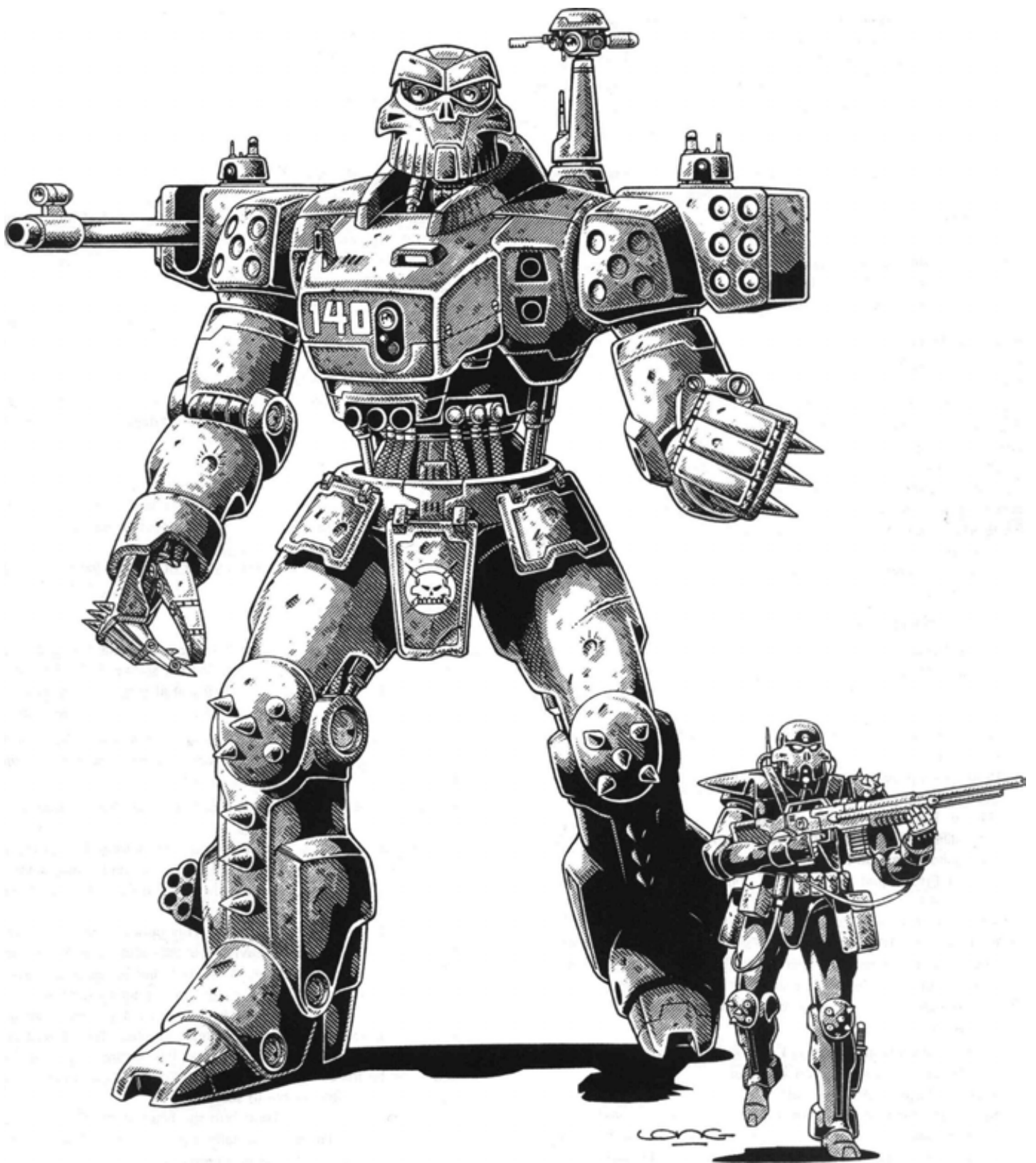

Shoulder Missile Launchers (2) — 60 each
 Waist Mini-missile Turret — 25 each
 Right Leg Smoke/Gas Dispenser — 25

Chest Spotlight and Video Camera — 10
 *Sensor Turret (left shoulder) — 50
 **Main Body — 350

Head —90
Arms (2) — 150 each
Hands (2) — 75 each
Legs (2) — 200 each
Reinforced Pilot's Compartment — 100

* Destroying the sensor turret on the left shoulder of the Enforcer will destroy the radar and targeting system. The pilot must now rely on his own human vision and other optical enhancements of the robot.

Note: The turret is a small and difficult target to hit. Thus, it can only be hit when a character makes a *called shot* and even then, the attacker is —2 to strike.

Depleting the M.D.C. of the main body will shut the robot down completely, rendering it useless. **Note: The chest spotlight and video camera are destroyed when the main body has endured 200 or more points of damage.

Speed

Running: 60 mph (96 km) maximum.

Leaping: The powerful robot legs can leap up to 15 feet (4.6 m) high or across. Add 10 feet (one meter) with a running start.

Statistical Data

Height: 19 feet, 7 inches (6 m)

Width: 12 feet (3.6 m)

Length: 7 feet, 6 inches (2.3 m)

Weight: 18 tons fully loaded.

Physical Strength: Equal to a P.S. 40

Cargo: Minimal storage space; about three feet (0.9 m) behind seats for extra clothing, weapons, and personal items.

Power System: Nuclear; average Enforcer energy life is 20 years.

Black Market Cost: 28 million credits, and up, for a new, undamaged, fully powered Enforcer complete with rail gun and missiles. Eight to 10 million for a rebuilt or without missiles and rail gun. Rarely available.

Weapon Systems

1. C-50R Enforcer Rail Gun (1): This is a standard weapon system for the UAR-1 and is more powerful than that of the SAMAS. The gun draws its power from the main, nuclear power supply. The rail gun is in a fixed forward position, but can move up and down in a 30 degree arc. To shoot at a target to the left, the pilot must turn the robot's entire body.

Primary Purpose: Assault

Secondary Purpose: Defense

Weight: Rail Gun: 700 lbs (315 kg).

Mega-Damage: A Burst is 80 rounds and inflicts 1D6x 10 M.D., one round does 1D6 M.D.

Rate of Fire: Equal to number of combined hand to hand attacks (usually 4-6).

Maximum Effective Range: 4000 feet (1200 m)

Payload: 20,000 round drum, that's 250 bursts. Reloading an Enforcer's rail gun requires special equipment or another giant size robot. It will take about 15 minutes for those not trained, but a mere five minutes by somebody trained in robot mechanics (or an Operator).

2. CR-6 Medium Range Rocket Launcher: This is the more powerful missile launcher over the left shoulder.

Primary Purpose: Anti-Aircraft

Secondary Purpose: Anti-Armor (tanks, robots, dragons).

Missile Type: Any medium range missile can be used, but standard issue is high explosive (heavy 2D6 x 10 M.D.), plasma (2D6 X 10), or multi-warhead smart bomb (2D4x 10 and +5 to strike).

Mega-Damage: Varies with missile type.

Range: About 40 to 80 miles.

Rate of Fire: One at a time or in volleys of two, three, or four.

, Payload: Six

3. CR-10 Short Range Rocket Launchers (2): Each of shoulders is short range missile launcher.

Primary Purpose: Anti-Aircraft

Secondary Purpose: Anti-Armor (tanks, robots, dragons).

Missile Type: Any short range missile can be used, but standard issue is armor piercing, high explosive, and/or plasma (all 1D6x 10).

Mega-Damage: Varies with missile type.

Range: About two miles.

Rate of Fire: One at a time or in volleys of two, three, or four.

Payload: Ten, five in each shoulder

4. CR-20 Mini-Missile Turret: A turret mounted in the midsection of the robot can rapid fire mini-missiles.

Primary Purpose: Anti-Personnel

Secondary Purpose: Defense

Missile Type: Any type of mini-missile can be used, but standard issue is fragmentation (anti-personnel, 5D6 M.D.) and plasma (1D6X10).

Mega-Damage: Varies with missile type.

Range: About one mile.

Rate of Fire: One at a time or in volleys of two, three, or four.

Payload: Twenty

5. CR-2T Laser Turrets (2): A pair of laser turrets, one on each shoulder, are mounted on the top of the rail gun and the medium missile launcher. Both are capable of 360 degree rotation and a 90 degree angle of fire (up and down).

Primary Purpose: Anti-Personnel

Secondary Purpose: Defense

Mega-Damage: 2D6 M.D. per single blast, or 4D6 per simultaneous blast; e.g., both lasers fire at the same target simultaneously.

Range: 4000 feet (1200 m)

Rate of Fire: Equal to the total number of hand to hand attacks per melee (usually 4 to 6).

Payload: Effectively unlimited.

6. Smoke Dispenser: A smoke dispensing unit is attached to the right leg. The unit can release a dense cloud of smoke that will cover an 80 foot (24 m) area in front of it. It can also release tear gas.

Payload: Five total. The usual mix is three smoke and two tear gas.

7. Hand to Hand Combat: Rather than use a weapon, the pilot can engage in mega-damage hand to hand combat. See *Power Armor Combat Training* in the Robot Combat section.

8. Sensor System Note: The UAR-1 Enforcer has some special optical features.

1. Thermo-Imager: A special optical heat sensor that allows the infrared radiation of warm objects to be converted into a visible image. Enables the pilot to see in the dark, in shadows, and through smoke. Range: 2000 feet (610 m).

2. Infrared and Ultraviolet Optics: This optical system projects a beam of infrared light that is invisible to the normal eye. The infrared beam enables the pilot to see in the dark and to see other infrared beams. The ultraviolet system enables the pilot to see into the ultraviolet spectrum of light and is mostly used to detect the light beams of ultraviolet detection systems. **Note:** The infrared light beam can be seen by anybody who also has infrared optics, and the beam can be traced back to its source. Smoke impairs the infrared beam making it impossible to see.

3. Infrared Searchlights: Built into the head of the Enforcer are a pair of red eyes. These are actually a pair of infrared searchlights. The lights can be used to scan an area at night using the invisible light to avoid detection. Only somebody who can also see infrared light will see the beams. Range: 500 feet (152 m).

Sensor Bonuses: Applicable to long range weapon combat only, not hand to hand. +1 to strike. See *Robot Combat Training* in the Robot Combat section for other bonuses.

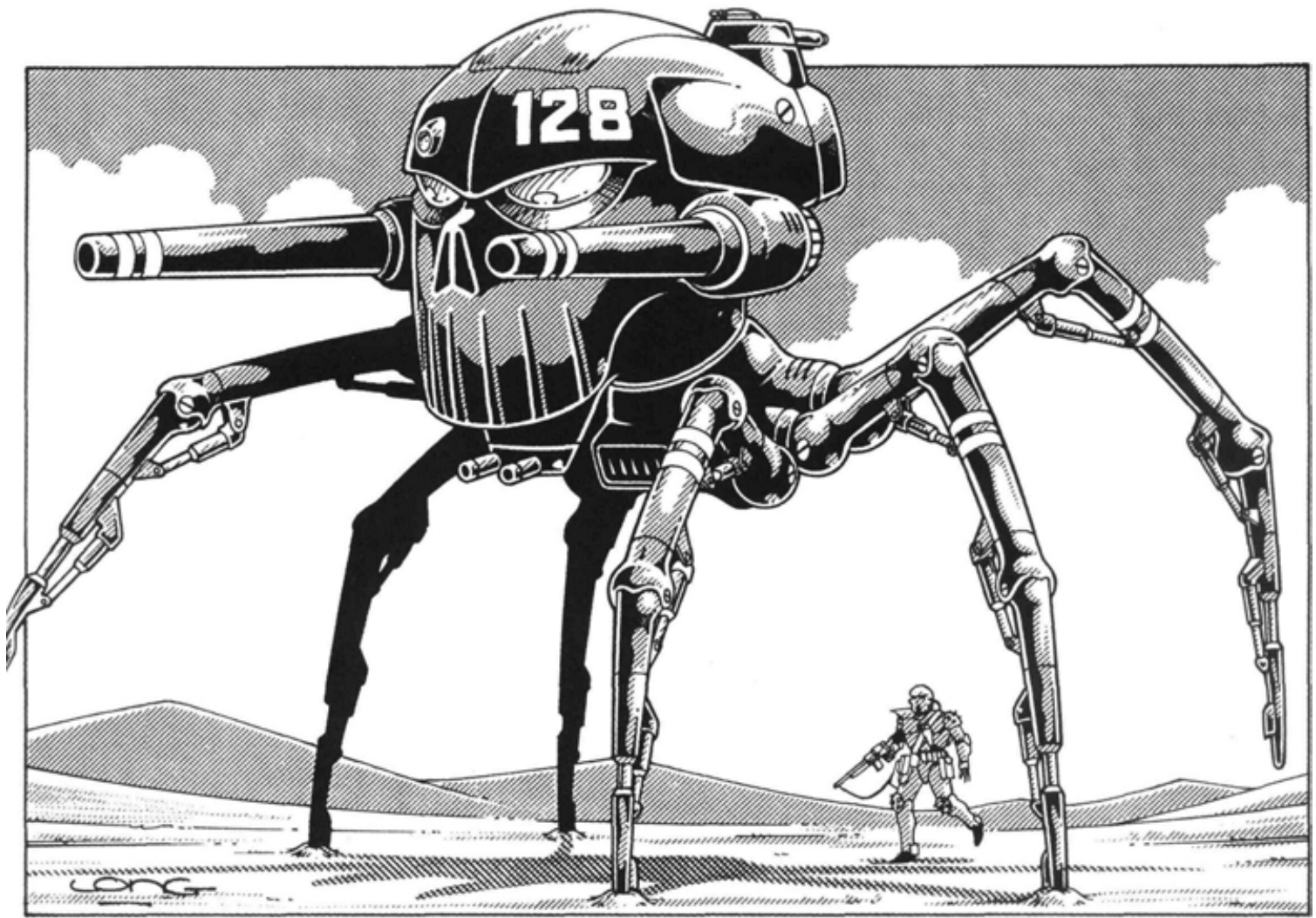

Coalition Spider-Skull Walker

The Spider-Skull Walker is a frightening looking all-terrain robot vehicle that walks on six insect-like legs (**Editors Note:** Yes, we know spiders have eight legs.) The horrific thing towers nearly 30 feet high and is remarkably fast. It can easily amble through the debris of ruined cities and is a fair climber if the terrain is not too steep (40 degree incline, maximum).

The giant robots are primarily used in the patrol of CS borders, at wilderness bases, and on reconnaissance patrols, as well as in city defense.

Coalition Assault Walker Robot

Model Type: CR-003 Spider-Skull Walker

Class: Multi-purpose, All-Terrain Assault Robot

Crew: One pilot and copilot, and can seat six additional passengers.

M.D.C. by Location:

Rail Guns (2) — 150 each

Lower Laser Turret — 80

Upper Laser Turret (rear) — 80

Legs (6) — 120 each

Eye Searchlights (2) — 30 each

*Main Body/Skull — 500

Reinforced Crew Compartment — 150

*Depleting the M.D.C. of the main body will shut the robot down completely, rendering it useless. **Note:** The robot can lose one leg on each side and not be unbalanced. Speed is reduced by 10%.

Speed

Running: 80 mph (128 km) maximum.

Leaping: Not possible.

Statistical Data

Height: 28 feet, 9 inches (8.8m)

Width: Skull is 13 feet wide (3.9m), the legs extend to about 20 feet wide (6 m).

Length: Skull is 15 feet (4.5 m), the rail guns extend the length to about 18 feet (5.4 m).

Weight: 28 tons fully loaded.

Physical Strength: Not applicable.

Cargo: Storage space of about 6x6x6 feet (1.8 m) for additional clothing, weapons, supplies, and specimens. This is in addition to a weapons locker that contains six C-12 laser rifles, two C-14 Fire Breather rifles, one C-27 plasma rifle, and one rocket launcher, as well as 24 standard E- Clips, four canister E-Clips, and a dozen fragmentation grenades.

Power System: Nuclear; average life is 15 years.

Black Market Cost: 36 million credits and up for a new, undamaged, full powered walker complete with full missile systems. Only two are known to have ever been made available on the black market in the last 20 years.

Weapon Systems

1. C-100R Spider Rail Guns (2): Two huge cannon-like guns protrude from the side of the walker. As usual, the weapons draw their power from the main, nuclear power supply. The rail guns are in a fixed forward position. The only way to aim them in another position is

to adjust the skull-head main body. The skull-head body can rotate 360 degrees and can tilt up and down at a 90 degree angle.

Primary Purpose: Assault

Secondary Purpose: Anti-Armor (tanks, robots, dragons, etc.)

Weight: Rail Guns: 1.2 tons each.

Mega-Damage: A Burst is 80 rounds and inflicts 2D4x 10 M.D., one round does 2D4 M.D.

Rate of Fire: Equal to number of combined hand to hand attacks (usually 4-6).

Maximum Effective Range: 6000 feet (1828 m), about 1.2 miles.

Payload: 20,000 rounds per each gun, that's 250 bursts each. Reloading a rail gun requires special equipment and takes about an hour.

- 2. CR-4T Laser Turrets (2):** A pair of double-barrelled, heavy laser turrets, one under the chin of the skull (front) and another mounted on the top of the skull (rear), are the gargantuan robot's other means of attack. Both are capable of 360 degree rotation and a 90 degree angle of fire (up and down).

Primary Purpose: Anti-Personnel

Secondary Purpose: Defense

Mega-Damage: 6D6 M.D. per dual blast.

Range: 4000 feet (1200 m)

Rate of Fire: The pilot can operate all weapon systems at a rate equal to the combined number of hand to hand attacks per melee (usually 4 to 6). **Note:** The pair of rail guns, front lasers, and rear lasers can each be operated by a different person (3 plus pilot). This means that each gunner gets four attacks each with their respective weapon.

Payload: Effectively unlimited.

- 3. Smoke Dispenser:** A smoke dispensing unit in the rear undercarriage can release a dense cloud of smoke that will cover an 80 foot (24 m) area in front of it. It can also release tear gas.

Payload: Eight total. The usual mix is four smoke and four tear gas.

- 4. Hand to Hand Combat:** The Spider-Skull Walker is a robot vehicle that is not designed for hand to hand type combat. Its only two attack modes are *Body Block/Ram*, which inflicts 1D4 M.D. for every 20 mph of speed, and *Stomp*, which inflicts 2D6 M.D., effective against any object 12 feet (3.6 m) or smaller.

- 5. Sensor System Note:** The Spider-Skull Walker has the same special features as the AUR-1 Enforcer; thermo- imager, infrared and ultraviolet optics, and infrared searchlights (the giant pair of eyes).

Sensor Bonuses: Applicable to long range weapon combat only, not hand to hand. + 1 to strike.

Coalition Mark V: Armored Personnel Carrier

The Coalition Mark V armored personnel Carrier (APC) is a deadly front line combat unit of incredible power. It is heavily armored and armed to the teeth. It is designed to get in and get out, even if it means cutting a swath through the enemy to do it.

The land vehicle can transport twenty troops and six SAMAS quite comfortably. A pair of SAMAS may be substituted with a pair of hover cycles or four soldiers in jet packs.

Coalition Mark V APC

Model Type: APC

Class: Infantry Assault and Transport Vehicle

Crew: Five: pilot, copilot, communications, and two gunners.

Troop Transport Capabilities: Standard is 20 armored troops, four SAMAS power armor units and two hover cyclists.

M.D.C. by Location:

Top, Rear Rail Gun Turret — 100 (shielded)

Center Laser Turret — 50

Side Laser Turrets (4) — 20 each

Forward Mini-Missile Launchers (2) — 40 each

Smoke/Gas Dispenser (2) — 15 each

Hatch Laser Guns (3) — 5 each

Forward Auto-Cannon (2) — 10 each

Forward Headlights (2) — 2 each

**Main Body — 350

Reinforced Crew Compartment — 100

Wheels (8) — 50 each

Note: The side turrets and hatch guns are small and difficult targets to hit. Thus, they can only be hit when a character makes a *called shoi* and even then, the attacker is -3 to strike.

**Depleting the M.D.C. of the main body will shut the APC down completely, rendering it useless.

Speed: 90 mph (144 km) maximum on land. In water, speed is about 30 mph (48 km).

Statistical Data

Height: 16 feet, 8 inches (5.1 m)

Width: 9 feet (3.6m)

Length: 33 feet, 6 inches (10.2 m)

Weight: 18 tons fully loaded.

Cargo: Minimal storage space; about four feet (1.2m) for extra clothing, weapons, and personal items; 12 C-14 Fire Breather assault rifles, 12 C-12 laser rifles, four C-27 plasma rifles, and four rocket launchers and 24 fragmentation mini- missiles are stored in locked overhead compartments.

Power System: Nuclear; average energy life is 15 years.

Black Market Cost: 21 million credits, and up, for a new, undamaged, fully powered Coalition APC complete with rail gun and missiles. Eight to 10 million for a rebuilt or without missiles and rail gun. Three million rebuilt and without any weapon systems. Seldom available.

Weapon Systems

- 1. C-40R Rail Gun (1):** The weapon can rotate a full 360 degrees and up and down in a 70 degree arc. As usual, all the weapon systems are powered from the vehicle's nuclear power supply.

Primary Purpose: Assault

Secondary Purpose: Defense

Weight: Rail Gun: 700 lbs (315 kg).

Mega-Damage: A dual burst is 80 rounds and inflicts 1D6X 10 M.D., one round does 1D6 M.D.

Rate of Fire: Equal to number of combined hand to hand attacks (usually 4-6) of the gunner.

Maximum Effective Range: 4000 feet (1200 m)

Payload: 20,000 round drum, that's 250 bursts. Reloading an Mark V's rail gun requires special equipment or another giant size robot.

It will take about 15 minutes for those not trained, but a mere five minutes by somebody trained in robot mechanics (or an Operator).

- 2. CR-4T Laser Turrets (2):** A double barrelled, heavy laser turret is in the center of the APC and like the rail gun, can rotate 360 degrees and has a 70 degree angle of fire (up and down).

Primary Purpose: Anti-Personnel

Secondary Purpose: Defense

Mega-Damage: 6D6 M.D. per dual blast.

Range: 4000 feet (1200 m)

Rate of Fire: Can shoot up to six times per melee.

Payload: Effectively unlimited.

- 3. C-2T Dual Laser Turrets (4):** There are two light laser turrets on either side of the APC. These are usually operated by the second gunner against enemy troops. Each has full 360 degree rotation and a 90 degree arc of fire.

Primary Purpose: Anti-Personnel

Secondary Purpose: Defense

Mega-Damage: 4D6 M.D. per dual blast.

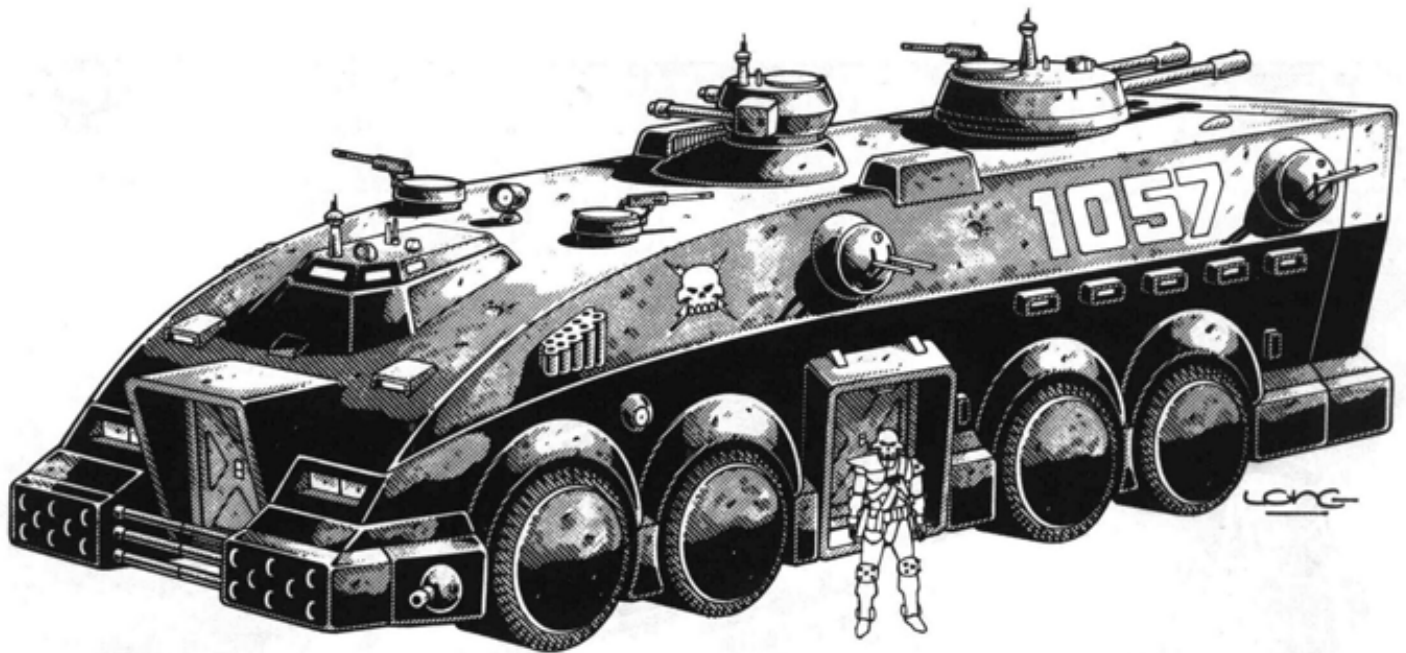

Range: 4000 feet (1200 m)

Rate of Fire: Can shoot up to six times per melee.

Payload: Effectively unlimited.

- 4. CR-10 Forward Mini-Missile Launchers (2):** Located in the very front of the APC are rapid-fire mini-missile launchers. The missiles are usually fired by the pilot.

Primary Purpose: Anti-Personnel

Secondary Purpose: Defense

Missile Type: Any type of mini-missile can be used, but standard issue is fragmentation (anti-personnel, 5D6 M.D.) and plasma (1D6X10).

Mega-Damage: Varies with missile type.

Range: About one miles.

Rate of Fire: One at a time, or in volleys of two, three, five, ten, or twenty!

Payload: Forty (40), twenty per each launcher

- 5. Forward Auto-Cannons (2):** Mounted on both sides of the mini-missile launchers are auto-cannons usually operated by the pilot or copilot. Each auto-cannon can be rotated 180 degrees.

Primary Purpose: Anti-Personnel

Secondary Purpose: Defense

Mega-Damage: 3D6 M.D. per fragmentation round; area affected is a 20 feet (6 m).

Range: 2000 feet (610 m)

Rate of Fire: Standard

Payload: 60 total, 30 each.

- 6. Hatch Laser Guns (3):** A laser rifle type gun is mounted at the two forward hatches and the rail gun hatch. These can be manned by members of the crew or the troops being transported. Each has a 360 degree rotation and a 90 degree angle of fire (up and down).

Primary Purpose: Anti-Personnel

Secondary Purpose: Defense

Mega-Damage: 2D6 M.D. per single blast.

Range: 4000 feet (1200 m)

Rate of Fire: Aimed shots are equal to the total number of hand to hand attacks per melee (usually 4 to 6). Firing bursts or shooting wild one can shoot eight times per melee.

Payload: Effectively unlimited.

- 7. Smoke Dispensers (2):** A smoke dispensing unit is attached to each side of the APC. The unit can release a dense cloud of smoke that will cover a 40 foot (12m) area in front of it. It can also release tear gas.

Payload: Twenty total, ten each. The usual mix is half smoke and half tear gas.

- 8. Hand to Hand Combat:** See combat troops being transported.

- 9. Sensor System Note:** The Mark-V APC has all the basic features as the robot vehicles.

Coalition Death's Head Armored Transport

The most terrifying sight one can see is a force of Coalition flying troop transport vehicles. The huge vehicles are nearly 300 feet long and are designed with the familiar Death's Head visage. The versatile vessel can attain a speed of Mach One and slow to a complete stop to hover above a battlefield to allow troops to disembark. Although quite powerful, the juggernaut is seldom used as an offensive weapon, but maintained as a transport, rescue, and support measure.

The transport section of the vessel is the large, long portion that rests upon a smaller saucer shaped section. The lower flying saucer shaped section provides complete hover capabilities from a stationary hover a few feet above the ground to maneuvering in city ruins and forest. The saucer also enables the transport to slow down and execute a full 360 degree turn in seconds and vertical take-offs and landings. If necessary, the two sections can detach. The saucer will fall to the earth or be set on automatic pilot to land at a predetermined rendezvous location. The main body still has full speed, but its hover capabilities are greatly diminished. Vertical landings and take-offs are no longer possible (an airstrip is needed), nor can the vessel perform quick stops or 360 degree turns/spins.

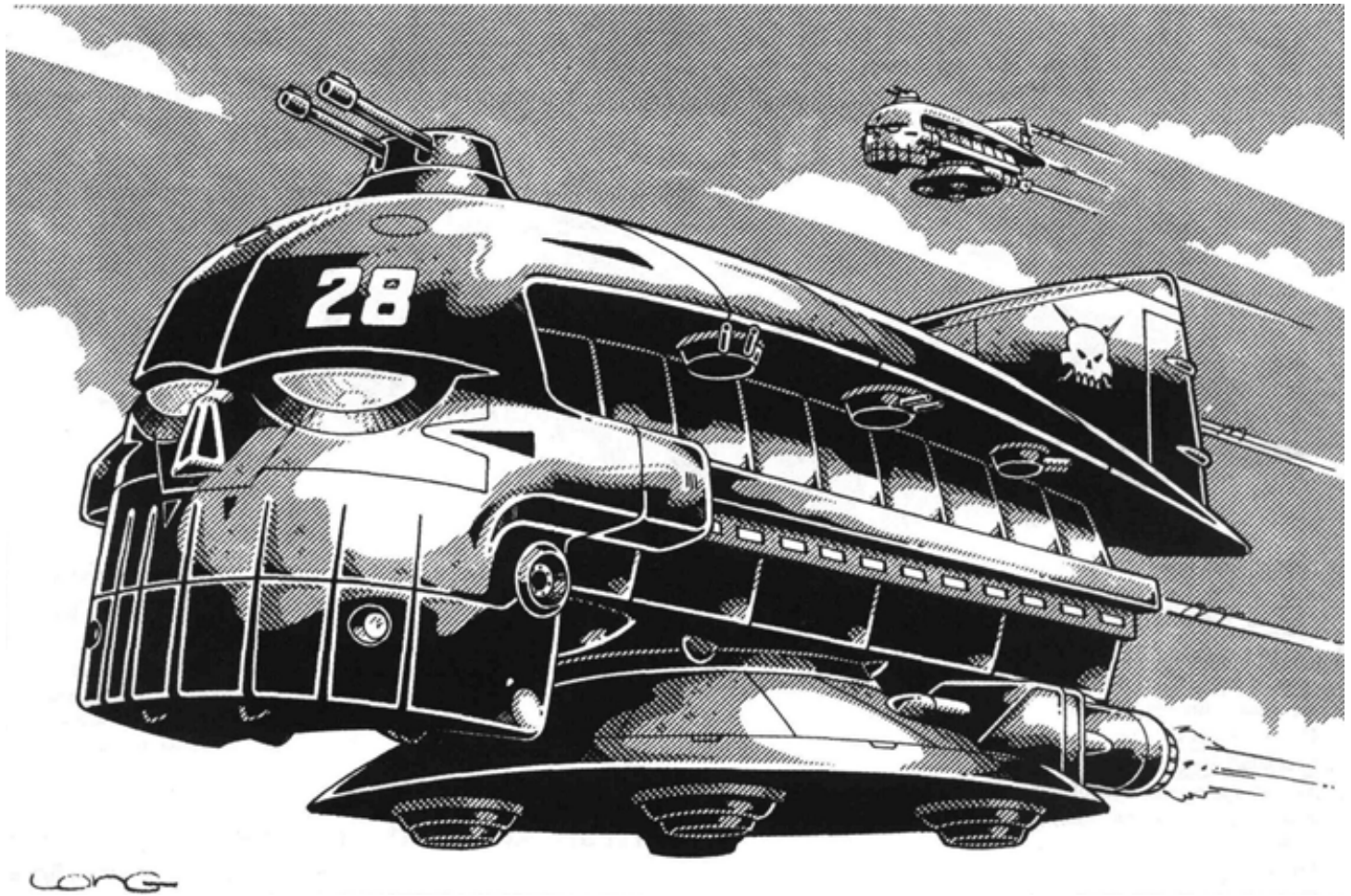

Coalition Death's Head Transport

Model Type: AFC-050

Class: Air Armored Troop Carrier

Crew: Nine: one pilot, one copilot, two gunners, two communication engineers, three technical officers.

Troop Transport Capabilities: Standard troop transport includes two APCs and their 20 troops each, two UAR-1 Enforcers, one Spider-Skull Walker, and 96 infantry soldiers; these may or may not include SAMAS. Without the vehicles/robots, the transport can hold approximately 384 soldiers and one Spider-Skull Walker (the walker has a special containment area that does not interfere with the troops).

M.D.C. by Location:

Forward Observation Windows (2 eye shaped) — 80 each

Forward Twin Rail Gun Turret (1) — 150

Side Mounted Laser Turrets (6) — 50 each

Tail Fin — 125

Lower Saucer — 400

Rear Jets (3) — 200 each

*Main Body — 1300

Reinforced Crew Compartment — 200

*Depleting the M.D.C. of the main body will destroy the transport. Destroying the saucer portion impairs the transport's mobility and hover capabilities.

Speed

Driving on the ground: Not possible.

Flying: The rocket propulsion system enables the Death's Head to hover stationary up to 2000 feet (610 m) or fly. Maximum flying speed is Mach One, about 670 mph (1072 km), but cruising speed is considered to be about 350 mph (560 km). Maximum altitude is limited to about

40,000 feet (12192 m). Flying Range: The nuclear power give the transport years of life, but the jet rockets get hot and need to cool after a maximum of twenty hours of flight when travelling at speeds above cruising, and indefinitely with rest stops and/or at cruising speeds.

Statistical Data

Height: 76 feet (23.2 m)

Width: 104 feet (32. 7m)

Length: 240 feet (73 m)

Weight: Approximately 1250 tons fully loaded.

Cargo: There is minimal storage space for prisoners and captured equipment. Standard storage compartments are usually equipped with a dozen first aid kits, complete with RMK Robot Medical Kits, food and water to accommodate 288 soldiers for two weeks, 144 C-12 laser rifles, 48 C-10 laser rifles, 96 C-14 Fire Breather assault rifles, 48 C-27 plasma rifles, and 24 rocket launchers, 144 fragmentation mini-missiles, and 1440 standard E-Clips. There are usually a dozen SAMAS as well.

Power System: Nuclear; average cycle's energy life is 20 years.

Black Market Cost: A Death's Head transport has never been available on the black market.

Weapon Systems

1. **C-200DH Rail Guns (1):** One dual cannon turret is mounted on the top of the forward, skull, section of the armored transport. As usual, the turret draws its power from the main, nuclear power supply. The turret can rotate 360 degrees and can tilt up and down at a 90 degree angle.

Primary Purpose: Assault

Secondary Purpose: Anti-Armor (tanks, robots, dragons, etc.)

Weight: Rail Gun: 1.2 tons each.

Mega-Damage: A Burst is 100 rounds and inflicts 2D4 x 10 M.D., one round does 1D4 M.D.

Rate of Fire: Equal to number of combined hand to hand attacks (usually 4-6).

Maximum Effective Range: Two miles (3.2 km).

Payload: 40,000 rounds per each gun, that's 400 bursts each. Reloading a rail gun requires special equipment and takes about an hour.

2. **CR-51 Medium Range Missile Launchers** (2). Two missile launchers are concealed in the forehead of the skull-like front section. A panel slides open and the missile is fired.

Primary Purpose: Anti-Aircraft

Secondary Purpose: Anti-Armor (tanks, robots, dragons, etc).

Missile Type: Any type of medium range missile can be used, but standard issue is high explosive and plasma (2D6 x 10 M.D.) and/or multi-warhead smart bomb (2D4x 10 and +5 to strike).

Mega-Damage: Varies with missile type.

Range: About one miles.

Rate of Fire: One at a time, or in volleys of two or four.

Payload: Ten missiles, five in each launcher.

3. **CR-6T Laser Turrets** (6): Three heavy laser turrets are mounted on each side of the transport. Each is capable of 180 degree rotation and a 90 degree arc of fire, up and down.

Primary Purpose: Anti-personnel

Secondary Purpose: Defense

Mega-Damage: 1D4 x 10 M.D. per dual blast.

Range: 6000 feet (1890 m)

Rate of Fire: The pilot can operate all weapon systems at a rate equal to the combined number of hand to hand attacks per melee (usually 4 to 6).

Payload: Effectively unlimited.

4. **Smoke Dispenser:** A smoke dispensing unit in the rear undercarriage can release a dense cloud of smoke that will cover an 80 foot (24 m) area in front of it. It can also release tear gas.

Payload: Twelve total. The usual mix is eight smoke and four tear gas.

5. **Hand to Hand Combat:** None. See troops.

6. **Sensor System Note:** Has all the standard robot sensors and systems, as well as the following.

1. Thermo-Imager: A special optical heat sensor that allows the infrared radiation of warm objects to be converted into a visible image. Enables the pilot to see in the dark, in shadows, and through smoke. Range: 2000 feet (610 m).

2. Infrared and Ultraviolet Optics: This optical system projects a beam of infrared light that is invisible to the normal eye. The infrared beam enables the pilot to see in the dark and to see other infrared beams. The ultraviolet system enables the pilot to see into the ultraviolet spectrum of light and is mostly used to detect the light beams of ultraviolet detection systems. **Note:** The infrared light beam can be seen by anybody who also has infrared optics, and the beam can be traced back to its source. Smoke impairs the infrared beam, making it impossible to see.

3. Infrared Searchlights: Built into the face of the Death's Head are a pair of headlights that also serve as infrared searchlights. The lights can be used to scan an area at night using the invisible light to avoid detection. Only somebody who can also see infrared light will see the beams. Range: 500 feet (152 m).

4. Enhanced Radar: Can identify and simultaneously track up to 96 different targets. Range: 200 miles.

Special Bonuses: +1 to dodge when flying at cruising speeds and +2 to dodge when flying over 300 mph. Trained CS pilots get an additional +10% to pilot the Coalition transport. Note that city maneuvering/combat usually requires piloting rolls.

The Coalition Sky Cycle

The sky cycle is not a robot, but a vehicle of war often used in conjunction with the CS robots and power armor. The sky cycle is a high speed, one man, urban fighter designed to maneuver between buildings and capable of sharp turns and a vast range of speeds. The vehicles are used to patrol the cities and neighboring towns and borders areas, as well as air support for the CS infantry and reconnaissance.

Sky Cycle

Model Type: AFC-023

Class: Air Urban Assault Vehicle

Crew: One. Can possibly seat one passenger, but dangerous and uncomfortable for the passenger.

M.D.C. by Location:

Forward Mounted Laser Turret — 50

Mini-missile Launchers (2) — 50 each

Rear Jets (3) — 50 each

*Main Body— 150

Note: The pilot is shielded and a small and difficult target to hit. Thus, he can only be hit when a character makes a *called shot* and even then the attacker is —3 to strike.

*Depleting the M. D. C. of the main body will destroy the sky cycle.

Speed

Driving on the ground: Ground speed is 40 mph (64 km) maximum. The sky cycle does have limited ground capabilities for parking and maneuvering, but it is designed as an aerial hover craft.

Flying: The rocket propulsion system enables the Sky Cycle to hover stationary up to 2000 feet (610 m) or fly. Maximum flying speed is 520 mph (832 km), but cruising speed is considered to range between 80 and 150 mph (128 and 240 km). Maximum altitude is limited to about 5000 feet (1520 m).

Flying Range: The nuclear power give the Sky Cycle decades of life, but the jet rockets get hot and need to cool after a maximum of twenty hours of flight when travelling at speeds above cruising, and indefinitely with rest stops and/or at cruising speeds.

Statistical Data

Height: 10 feet (3 m)

Width: 4 feet (1.2m)

Length: 9 feet, 4 inches (2.8m)

Weight: One ton fully loaded.

Cargo: Minimal storage space; about three feet (0.9 m) behind seats for extra clothing, weapons, and personal items.

Power System: Nuclear; average cycle's energy life is 20 years.

Black Market Cost: One million credits, and up, for a new, undamaged, fully powered Sky Cycle complete with laser turret and mini-missiles. Half million for a rebuilt cycle without missiles and laser. Not often available.

Weapon Systems

1. **CR-21 Mini-Missile Launcher** (2): A pair of mini-missile launchers are mounted on the sides of the sky cycle, near the landing gear. Each contains a total of ten mini-missiles.

Primary Purpose: Anti-Personnel

Secondary Purpose: Anti-Armor (tanks, robots, dragons, etc).

Missile Type: Any type of mini-missile can be used, but standard issue is fragmentation (anti-personnel, 5D6 M.D.) and plasma (1D6X10).

Mega-Damage: Varies with missile type.

Range: About one mile.

Rate of Fire: One at a time or in volleys of two, three, four, or five.

Payload: Twenty, ten missiles in each launcher.

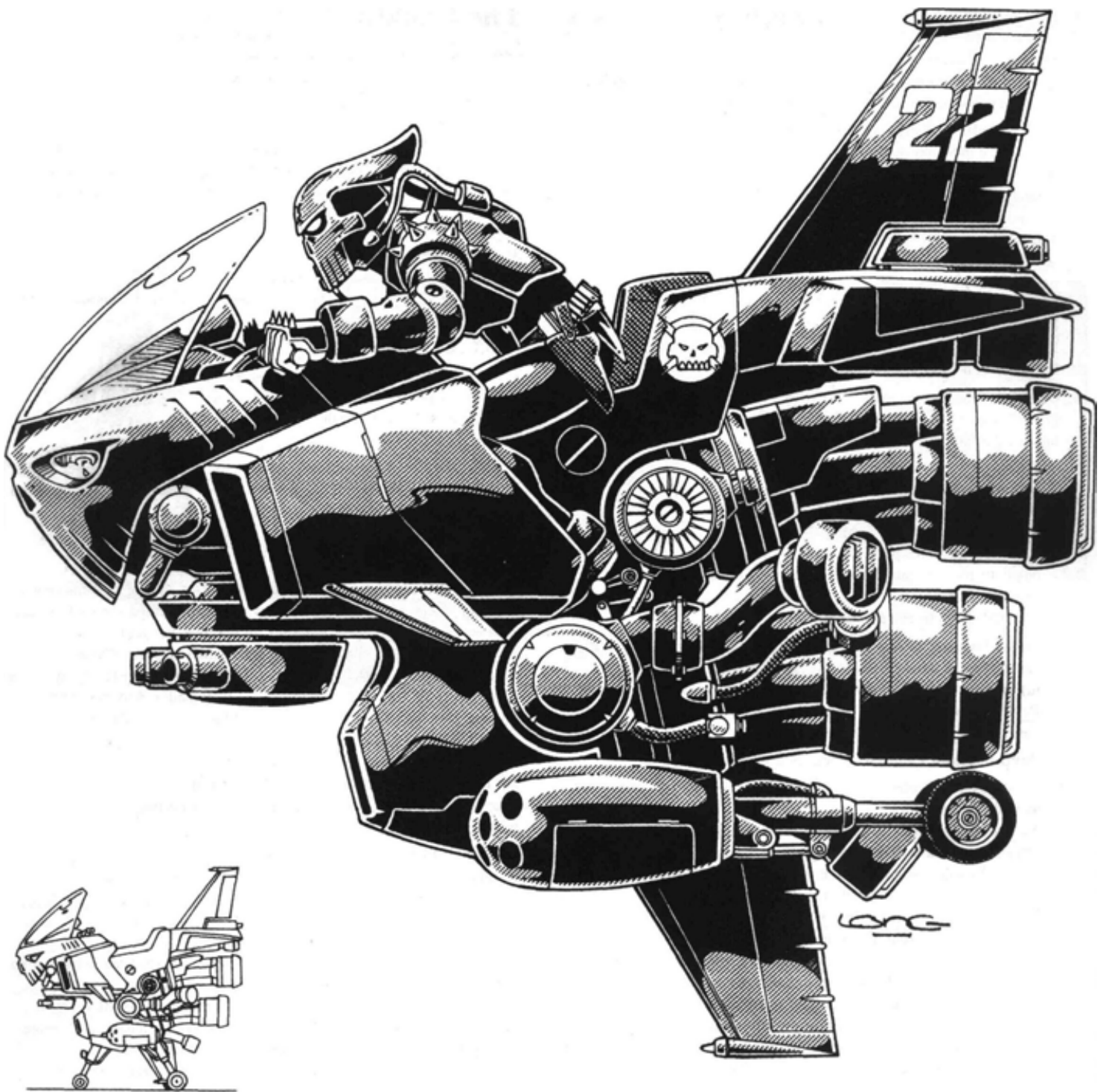

2. CR-4T Laser Turret (1): A heavy laser turret is mounted in the forward section of the cycle. It is capable of 180 degree rotation and a fixed, straight angle of fire.

Primary Purpose: Anti-Personnel

Secondary Purpose: Defense

Mega-Damage: 6D6 M.D. per dual blast.

Range: 4000 feet (1200 m)

Rate of Fire: The pilot can operate all weapon systems at a rate equal to the combined number of hand to hand attacks per melee (usually 4 to 6).

Payload: Effectively unlimited.

3. Smoke Dispenser: A smoke dispensing unit in the rear undercarriage can release a dense cloud of smoke that will cover an 80 foot (24 m) area in front of it. It can also release tear gas.

Payload: Six total. The usual mix is three smoke and three tear gas.

4. Hand to Hand Combat: None.

5. Sensor System Note: Has all the standard robot sensors and communications capabilities, including radar.

Special Bonuses: +3 to dodge when flying at cruising speeds and +5 to dodge when flying over 250 mph. Trained CS pilots get an additional +5% to pilot the Coalition Sky Cycle. Note that city combat usually requires piloting rolls.

Coalition Weapons



C-18 Laser Pistol

This is the standard issue sidearm of the Coalition.

Weight: 4 lbs (1.8 kg)

Mega-Damage: 2D4 M.D.

Rate of Fire: Standard, see Modern Weapon Proficiency Section.

Effective Range: 800 feet (244 m)

Payload: 10 shots.

Black Market Cost: 12,000 credits.

C-10 Light Assault Laser Rifle

The C-10 light laser rifle is an earlier version of the C-12 and greatly resembles the heavy laser. The only difference in appearance is a longer barrel and there is a built in computer enhanced laser targeting system. It is a favorite sniper rifle and is known for its accuracy and durability in the field. While the rifle is excellent, there is a problem with the computer enhanced targeting system. It is not as reliable as the weapon itself and is known to fail after rugged action in the field (1-23% chance every time it undergoes strenuous combat, 1-40% after a hard fall). The experimental targeting system was too touchy and has been scrapped from all later weapons.

Weight: 5 lbs (2.3 kg)

Mega-Damage: 2D6 M.D., no variable settings.

Rate of Fire: Aimed, burst, wild; see Modern Weapon Proficiencies.

Effective Range: 2000 feet (610 m)

Payload: 20 blasts from standard E-Clip or 30 from a long E-Clip.

Laser Targeting: Add +3 to strike on an aimed shot, but only when the laser targeting system is functioning. No bonus when on the blink.

Black Market Cost: 16,000 credits for the rifle. Standard clip and recharge costs. An E-Clip canister can not be used with this weapon.

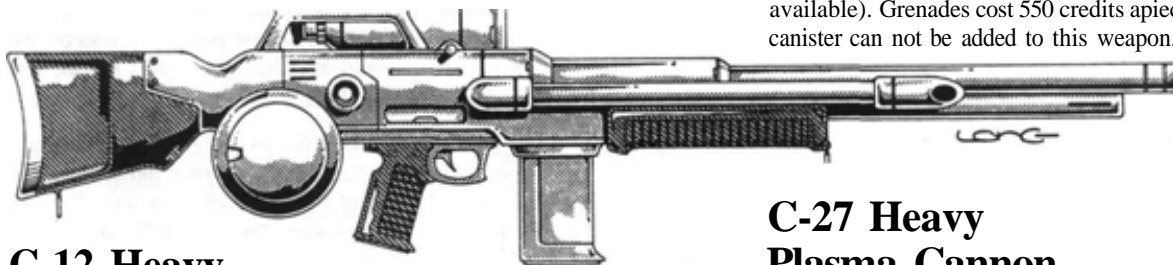

C-12 Heavy Assault Laser Rifle

The standard weapon of the infantry is the C-12 heavy laser assault rifle, a sturdy and reliable rifle that can survive a great amount of combat abuse and activity without mechanical failure. The rifle has three settings, one S.D.C., and two M.D.C. settings. The rifle can also be set to fire a single shot or a burst of five. Comes standard with a passive nightvision scope and laser targeting.

Weight: 7 lbs (3.2 kg)

Mega-Damage: Setting one: 4D6 M.D. or Setting Two: 2D6 M.D.

S.D.C. Damage: Setting Three: 6D6 S.D.C.

Rate of Fire: Aimed, burst, wild; see Modern Weapon Proficiencies.

Effective Range: 2000 feet (610 m)

Payload: 20 M.D. blasts from standard E-Clip or 30 from a long E-Clip, plus another 30 can be added with one E-clip *canister*, a new Coalition invention. Note that six S.D.C. shots equals one mega-damage blast.

Laser Targeting: Add +1 to strike on an aimed shot.

Black Market Cost: 20,000 credits for the rifle, 6000 credits for a new, fully charged, standard E-clip; 1500 for a recharge. An E-Clip canister costs 10,000 new and fully charged. A canister recharge costs 2000 credits.

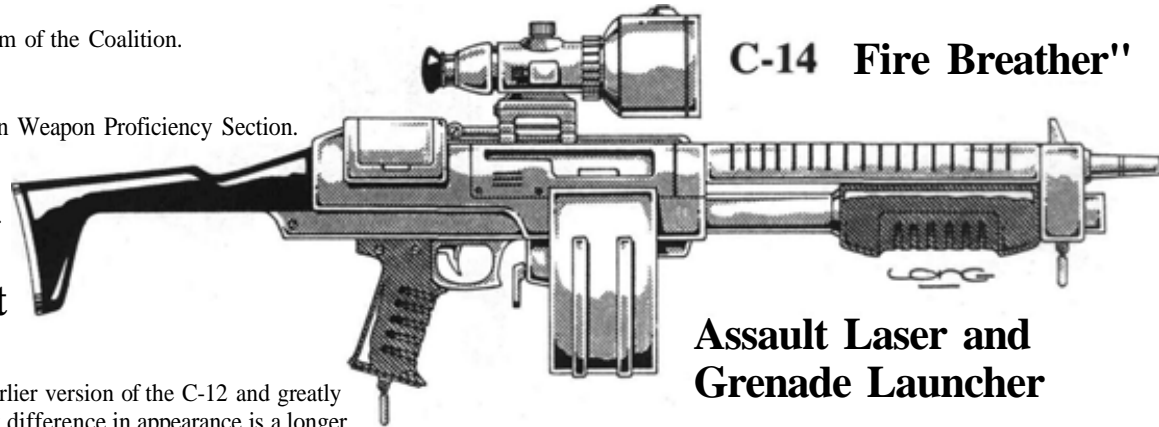

C-14 Fire Breather" Assault Laser and Grenade Launcher

A popular, new over-and-under heavy infantry weapon with high marks for durability and reliability in action. A laser comprises the top portion of the weapon and a pump-action grenade launcher is fitted under the laser barrel. Standard issue includes a passive nightvision scope.

Weight: 10 lbs (4.5 kg)

Mega-Damage: Laser is 3D6 M.D., Grenades 2D6 M.D. to a blast area of 12 feet (3.6 m)

Rate of Fire: Laser standard; see Modern Weapon Proficiency Section.

Grenades: one aimed, four fired in rapid succession (burst if all at same target, wild if sprayed into an area).

Effective Range: Laser is 2000 feet (610 m).

Grenade Launcher is 1200 feet (365 m).

Payload: Laser is 20 blasts, Grenade Launcher is 12.

Reloading the Launcher: Requires one full melee, 15 seconds, to manually reload the grenade launcher. As always, reloading an E-Clip takes about five seconds or equal to one melee action/attack.

Black Market Cost: 30,000 credits, and a hot commodity (not commonly available). Grenades cost 550 credits apiece or 4500 a dozen. An E-Clip canister can not be added to this weapon.

C-27 Heavy Plasma Cannon

The plasma cannon is a heavy support weapon of the infantry. It is coveted for its dependability and incredible damage. Standard issue includes a telescopic and laser distancing scope.

Weight: 12 lbs (5.4 kg)

Mega-Damage: 6D6

Rate of Fire: Standard, see Modern Weapon Proficiency Section.

Effective Range: 1600 feet (488 km).

Payload: 10 blasts

Targeting Scope: Add a bonus of +1 to strike on an aimed shot.

Black Market Cost: 32,000 for the rifle, can only be used with an E-Clip Canister which costs 10,000 credits new and fully loaded. A recharge is 2000 credits.

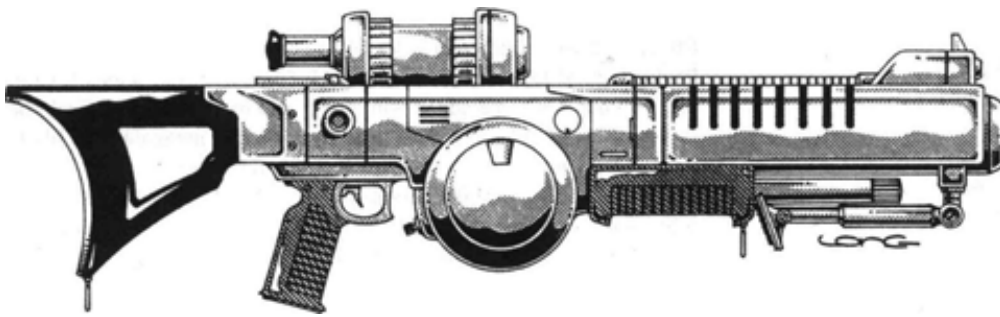

C-27 Heavy Plasma Cannon



CR-1 Rocket Launcher

The CR-1 rocket launcher is a reusable mini-missile launcher with a multi-optic scope. The capabilities of the scope include telescopic (x20 magnification, 2 mile/3.2 km range), infrared (2000 foot/ 610 m range), passive nightvision (2000 ft), and laser targeting.

Weight: The launcher weighs 14 lbs. (6.3 kg), each missile weighs about one pound (0.45 kg).

Mega-Damage: Any mini-missile can be used, but is usually armor piercing or plasma (1D4x 10 or 1D6x 10 M.D.C.).

Rate of Fire: The weapon fires only one mini-missile, but a two-man team can load and fire three missiles per melee/15 seconds. A single operator can only fire one per melee.

Effective Range: One mile.

Payload: A carrying side pack can hold six mini-missiles (weighs about ten pounds/4.5 kg), a back pack can hold 12 missiles and a portable carrying case (10 M.D.C.) can hold 24 mini-missiles (weighs about 40 lbs/18 kg).

Black Market Cost: 18,000 for the launcher and 1000 credits for each light damage missile (5D6 M.D.) and 2200 for each plasma or armor piercing.

CS Explosives

Fusion Block

A fusion block is a little square case about the size of a hand-held computer. On top of the block is a small key pad for programming the time of detonation. An automatic 30 second delay is built into each fusion bomb as a safety feature to avoid instant detonation.

Mega-Damage: There are three types of fusion block bombs. 1) 1D4X10M.D., 2) 2D6x 10M.D., 3) 4D6x 10 M.D.C. Blast radius is contained to a 10 foot area (3 m).

Range: The blocks are made for placement, not throwing or shooting; however one can try throwing the explosive. Typical range is 1D6 x 10 feet (3 to 18 m); fusion blocks are not aerodynamic.

Black Market Cost: 1000, 3000, and 8000 credits respectively.

CS Hand Grenades

Smaller explosive canisters designed for throwing.

Fragmentation: 2D6 M.D. to a 20 foot (6 m) area.

High Explosive: 3D6 M.D. to a 6 foot (1.8 m) area.

Plasma: 5D6 M.D. to a 12 foot area (3.6 m) area.

Smoke: No damage, but creates a smoke screen that covers a 40 foot area (12 m).



Effective Range When Throwing a Grenade: About 40 yards/meters.
Black Market Cost: 250 credits for fragmentation, 200 credits for high explosive, 350 credits for plasma, and 70 credits for smoke.

Vibro-Blades & Other Hand Weapons

The Chi-Town weapon designers had invented a hand-held energized blade that they called a "vibro-blade," years ago. But the designs sat on the drawing board, because the weapon seemed to have minimal practical application in this age of long range weaponry. However, with the advent of the psi-stalker and Dog Pack city patrols, the blades were suddenly an ideal weapon.

CS officials were hesitant to give non-humans, even the Dog Pack, access to heavy weapons. Furthermore, mega-damage weapons in a city could prove to be incredibly hazardous to both human life and property. The dilemma was that the enemy, often powerful men of magic, demons, and D-Bees or well armed criminals, had few compunctions about using mega-damage weapons and armor. Thus, the Dog Packs needed to have some kind of M.D. weapon or they would be sitting ducks. Then somebody mentioned the vibro-blades and the solution was found.

All Dog Pack city patrols are issued either two vibro-blades of choice, or a blade and a neural mace, along with their armor and spikes. The mega-damage blades give the mutant animals a defensive and offensive weapon against the criminals and monsters that they sniff out. Against an unarmed foe or a foe in body armor and/or armed with light mega-damage weaponry, the dogs and their blade are a formidable force. However, they are still hopelessly outgunned if the opponent is heavily armed. Coalition officials really don't care, because they'd rather not give non-humans powerful weapons for any reason, see the intelligent and loyal mutants as expendable *animals*, and figure they can always grow more.

Over the last few years, the vibro-blades have become popular among city rats, criminal gang members, and psi-stalkers. The mutant dogs love them.



Vibro-Blades

All vibro-blades are blade weapons surrounded by an invisible high-frequency energy field that gives them mega-damage capabilities.

Vibro-Knife: 1D6 M.D.

Vibro-Saber (short sword): 2D4 M.D.

Vibro-Sword (larger, one-handed sword): 2D6 M.D.

Vibro-Claws: 2D6 M.D.; usually three hooked blades attached to a forearm gauntlet or protective plate. Great for parrying and slashing.

Note: The ancient weapon proficiency skill and bonuses apply to the vibro-blades. Claws fall into the W.P. Knife category.

Neural Mace

Another hand-held weapon used by the Dog Pack is a neural mace. The mace is effectively a stun weapon that releases an energy charge that temporarily short-circuits the nervous system. There is a chance of rendering an unarmored person unconscious, but even if the individual remains conscious, the charge will impair his movements. **Penalties:** — 8 to strike, parry, and dodge for 2D4 melees. The duration of the impairment is increased 2D4 melees for every hit by the mace (also roll each time to see if knocked unconscious). **Save vs Neural Mace** is the same as saving against non-lethal poison, 16 or higher. The character must save each time he or she is struck. **Note:** The mace is ineffective against environmental M.D.C. body and power armor, but is effective against Dog Pack armor and half suits, or body armor without a helmet (not fully environmental without the helmet attached). **Physical damage** from the mace is 1D8 S.D.C, plus P.S. attribute bonus. However, the mace is a M.D.C. structure and can be used to parry M.D. attacks from robots and power armor.

Dog Pack Spikes

One of the Dog Pack's patented images is one of spikes. This is largely a stylistic gimmick to evoke a feeling of fear and power. Spiked collars, arm and wrist bands, kneepads and gloves are all available. **Damage** for all spikes is S.D.C, damage. The spiked gloves are weighted, sap gloves, and add 1D6+1 S.D.C, damage to punches. The kneepads have the weight and power of the legs behind them and add 1D6 S.D.C, to knee kicks. All others inflict 1D4 S.D.C, damage. The hand and arm spikes can also be used to parry normal S.D.C, attacks; + 1 bonus when parrying with spiked arm bands or glove only.

The Black Market

Levels of Technology

The technological levels will vary greatly from area to area and town to town. There may be a small community of farmers that resembles an old 18th Century village or a town out of the Old West. They have no plumbing at all, let alone indoor plumbing, they get their water from the well or the stream (one must use the out-house at the edge of town and a leaf). They have no electricity, no refrigeration, no stores, and few vehicles (ride horses). They are a community of families living off the land the best they can. But even here we see the disparity between tech- levels. Old Zeke down by the big oak tree (there are no streets) is the village doctor. He has an old electrical generator and lights in his study and medical office (a travelling Operator installed it), the rest of the house is lit by oil lanterns like the rest of the village. The doc is a master of holistic medicine, but also utilizes a laser scalpel and modern tools traded for at the big city down a piece. Mr. Kramer's pride and joy is his hover truck, Bobby hunts rabbit with his M-14 carbine as often as he hunts with his bow and arrows, and Kenny gunned down some D-Bee bear-monster with his ion blaster.

A hundred miles away is a factory town. It looks like a cross between something out of World War II and the Jetsons. There are automobiles and hover craft, horses and power armor, giant robots and bicycles, gunpowder weapons and energy weapons, huge, clunky factories and micro-computers. There are also stores and places for entertainment, when most of the amenities we think of today are available. The town may be a member of a larger community or kingdom, or be completely independent. It may be a democracy or a dictatorship. It may have a champion/protector/king or it may have a militia or full army.

It is 500 miles to the next town of any kind, other than the neighboring fanners. The rest is wilderness. To the east, another 500 miles, is a rift and rumors of monsters and wizards. A thousand miles to the South is wasteland. In between is the occasional nomad, wilderness tribe, huntsman/trapper, bandit (high and low tech), headhunter, psi-stalker, D-Bee, wizard, and demon.

Throughout the wilderness are tribes and nomads who live off the land, hunting and scavenging. They too are likely to have a mix of technology, from bow and arrow to laser rifle, from hand woven clothes and buckskin to M.D.C. body armor and bionics.

One may travel hundreds or even thousands of miles without encountering anybody or anything. Or one can encounter, monsters, magic, mercenaries, bandits, and fiends of all kinds. There are thousands of tiny little towns, cities, and feudal kingdoms scattered throughout the continent. Some are friendly and peaceful, other are foul and hostile. Many are ruled, dominated, or influenced by individuals and groups who possess mega-damage weapons and technology.

The advent of the augmented human and high-tech soldier heralded the age of *superhumans*. Thus, three or four soldiers/mercenaries/rogues (sometimes a lone individual) will enter a town and claim it as their own. Who is going to stop them? Not a bunch of farmers or workers with no, or few, mega-damage weapons and little combat skill. Remember, we are talking about three or four individuals who can level a home with one or two blasts from just his energy *pistol*. These men, even if only wearing M.D.C body armor and armed with energy weapons, are the equivalent of a twentieth century tank. So, three walking tanks come into town and say, "I like it here. Think we'll stay." Who is going to say no? Add a giant robot, power armor, bionics or some other form of augmentation and you have trouble with a capital "T." Sadly, there are thousands of these mean natured rogues who have used their powers and abilities to become two-bit tyrants preying on helpless towns and villages. The primary victims of these tyrants are the low-tech communities who have no way to protect themselves.

Player characters, generally represent the high-tech end of the scale whether a combat or adventurer O.C.C. or practitioner of magic. Their high-tech skills, specialized combat training, and special equipment set them apart from the norm. They are the exception rather than the rule. Consequently, many of the small communities will look at them with fear and apprehension (Are these rogues who will try to seize the town as their kingdom? Or will trouble follow them to the town?) The alternative is that they will see them as heroes and protectors who will be asked to save the town from danger, such as bandits, demons, and villains of all kinds.

The Black Market

"The" black market specifically refers to the underground, criminal network that sells contraband items in Coalition Territory. They are high-tech brokers who sell just about anything they can. The general term, black market, refers to any criminal organization that operates illegally and sells contraband goods and services.

The black market in the Coalition States is a huge, well organized and well financed operation. It deals in the selling of contraband, drugs, gambling, prostitution, fencing stolen goods, forgery, illegal cybernetic and bionic operations, extortion and murder. It has an arm of the

organization in every CS city and many border towns and wilderness outposts, especially if there are soldiers to be fleeced or contraband to be acquired.

The following is a basic listing of goods and services available on the black market.

High Technology

High-Tech contraband in CS territory includes:

1. **Cybernetic parts**, implantation, repairs, and disguises. Usually full cybernetic facilities are available. **Note:** Very few *Body-Chop-Shops* are owned or operated by "the" black market. These disreputable places are usually independent operations owned by unscrupulous cyber-docs or other criminal organizations.
2. **Bionic parts**, implantation, and repairs are also available, although the components are much more difficult to get and therefore, more expensive. About one in ten black market cybernetic clinics can provide expert bionic facilities and be able to implement a partial bionic reconstruction (full conversion is rare, costly, and difficult).
3. **Energy weapons**. The sale of illegal energy weapons and energy clips (E-clips) is part of the black market's main stock in trade. Virtually every weapon on the open market is available on the black market (although availability will fluctuate). This includes *Coalition* arms. Currently, CS vibro weaponry, as used by the Dog Packs, are all the rage on the streets among gangs and city rats. Other Coalition weapons are also available.
4. **Explosives**, including hand grenades and plastic explosives are difficult to acquire and not particularly practical nor desirable in this age of mega-damage weaponry. **Missiles** for robots and power armor cost a premium, because they are said to be difficult to get, but the black market gets them through their connection with the *Northern Gun* (see World Overview, number 21: Ishpeming), as well as from scavengers and bandits.
5. **Body Armor** of all kinds, including CS "Dead Boy" armor, usually repainted white, grey, green, or brown, is always available.
6. **Power armor** is more difficult to acquire and expensive, but usually available. SAMAS armor is a rarity!
7. **Black market mechanic shops** will repair and soup-up just about any vehicle brought to them. They also sell vehicles. The most requested and, therefore, most common vehicles available on the market are motorcycles, dune buggies and all-terrain type cars, small, rugged jeeps and trucks, small hover vehicles, especially hover cycles, and jet packs. Larger vehicles are also available. Special orders will take 1D6 weeks to acquire and will cost 20% to 30% more. Add another 30% to 60% if the acquisition of the vehicle is dangerous or the item is rare.
8. **Giant all-terrain robot vehicles** can be made available for sale but are considered dangerous items, so add 40% to the going rate and the sale must take place outdoors. The Coalition's UAR-1 Enforcers are a rarity and cost two to four times as much as the most expensive robot in the Titan series.
9. **Weapon systems for robots and military type vehicles** are also available from many mechanic shops, but prices vary greatly depending on current availability and pressure from the law.
10. **Drugs and medical systems** for field use, clinics, and personal recreation are sold on the black market. One out of every twenty black market cybernetic clinics can perform Juicer, bio-comp, augmentation (costs several million) and all sell the drugs and Juicer injection equipment.
11. **Other, more conventional items** like pocket digital disk equipment, video discs and other visual and audio items, cameras, language translators, computer equipment, and other every day items

available on the open market are available too. In and around the CS cities, prices are 10% to 20% less than market. In wilderness areas or when selling to an individual whom the black market knows to be a fugitive (can not buy these items on the open market himself), the prices are 10% to 30% higher.

12. **Also sells information**. Accurate information will be sold for hundreds or thousands of credits depending on the situation and the importance of the information.

Illegal Documentation

Visitor's Visa: Only CS citizens and authorized visitors are allowed into the Coalition Cities. There are a variety of different visitor's passes. Naturally, the black market sells forgeries to individuals who wish to gain entry into the city, usually to buy equipment or enjoy services, from medical to food and entertainment, available only at a CS city.

There are three levels of black market papers: **Acceptable** should get one through most routine visa checks and identification confirmations (1-87% chance of successfully passing as the genuine article every time it is examined). **Superior** forgery will look as official and perfect as one can get without being 100% authentic. Costs twice as much as an acceptable forgery (1-96% chance of success). **The real thing!** The black market has its connections within the bureaucracy and can get official visitor passes. These will cost ten times as much as an acceptable forgery and are 100% legal documents. **Note:** Only a top military or diplomatic security card will give a character clearance to visit the military and governmental levels of one through three. Costs 50 times more than the standard pass.

How Visitor Papers Work

The "papers" are inspected when a person is entering the city. The person is logged on the visitor's manifest, which includes finger printing and photograph, and the papers (actually a wallet-size card) is coded with an identification number and tracer chip which will enable the law to locate the card. The card is to be turned in when the person leaves the city and he is then removed from the visitor's manifest. Failure to turn a card in before it expires will place the character on a refugee list and he will also be hunted by a Dog Pack and sought by law officers to be expelled from the city. The only other time that visitor papers are examined is when a person may be questioned by the law or when involved in illegal activity. **Note:** People, especially people who do not look like they are citizens (D-Bees in particular), may be asked for identification quite often. Psychics must register and submit to IC coding (see Psionic R.C.C. for details). A person will also be asked if he or she practices magic. Practitioners of magic are not allowed into the city unless they have a High Security Military pass. Remember that a Dog Pack is always at all city gates and are likely to sniff out a man of magic. Also, robots, vehicles, weapons, and all armor are not allowed into the city. Storage arrangements must be made in the burbs outside the city. Refusal to comply means no admittance.

An Expired Card

A person found with a visitor's card that has expired within the last 24 hours is escorted to his lodgings, his belongings are gathered and he is escorted out of the city. A person whose visitor's card has expired days ago, or longer, is presumed to be a refugee who gained temporary access to the city and has been living there illegally ever since. This person is imprisoned, questioned, his place of living (if found) is ransacked, and all possessions other than cloth and extremely personal items are confiscated. A fine of 2000 credits per day is charged to the person, which is taken out of the confiscated possessions if credits are not available. Whatever is left is given back to the individual and all are dumped outside of the city. If there isn't enough credits to pay for the fine, a judge will decide whether the person is to be escorted out of the city with just the clothes on his back, forced to do labor in a wilderness work camp for several months or be imprisoned (1D4 years).

Note: If contraband items were found, including weapons, armor, books, and magic, the person could face days of interrogation, years of imprisonment, and/or execution!

Visitor Passes

The following are the types of visitor papers available. The cost listed is the average price for an *acceptable* forgery, increase the cost appropriately for better paper.

1. Four hour delivery pass. The papers only allow the individual entry to make a delivery of a package(s) to somebody inside the city. Note that the package(s) is likely to undergo an extensive inspection. Only a 1-15% chance that an inspection will not take place. Costs 6,000 credits.
2. Six hour courier pass. Allows one courier into the city to deliver a personal message. Costs 8,000 credits.
3. One day visitor's pass. The person can stay in the city for 24 hours, but no longer. Costs 16,000 credits
4. Three day visitor's pass. Costs 30,000 credits.
5. Seven day visitor's pass. Costs 60,000 credits.
6. Fourteen day visitor's pass. Costs 110,000 credits.
7. Thirty day visitor's pass. 200,000 credits
8. Six month visitor's pass. 1.2 million credits.

Other Types of False I.D.

Prices are for acceptable forgeries.

1. Armed Forces, Dead Boy Grunt. Costs 50,000 credits.
2. Armed Forces, Officer (Captain or Colonel). Costs 200,000 credits.
3. Psychic IC Clearance, fake psi-registration. None of the data is accurate, but appears legitimate. The character does not actually submit to IC registration. Costs 500,000 credits.
4. Authorized Courier card. Can come and go from the city as he pleases numerous times a day. However, he can not spend more than 18 hours a day within city limits. Remember, this card is examined every time the character enters the city. Limited to one specific Coalition Territory and is good for one year. Costs Five million credits.
5. Citizen's card. This card indicates that the individual is an official citizen of the CS and has normal access/freedom to all CS cities. Costs Forty million and more.
6. Contraband card. Authority to transport contraband items, including books, artifacts, and magic (no military items). Costs One million credits.
7. Weapons Permit. A card that allows a person to carry a concealed weapon. Costs 200,000 credits.

Pre-Rifts Artifacts

Books are also available on the black market. New books are recent publications printed for the CS literate elite (not meant for others) or publications produced and distributed by the literate underground. A typical CS paperback book or video disc costs about 20 credits. Underground books/discs cost about 30 to 50 credits. Forbidden books, such as Erin Tarn's *Traversing Our Modern World*, will cost 200 to 800 credits (2D4x 100). **Old, Pre-Rifts books** will vary greatly in price, depending largely on what the collectors' market is currently like or the availability of its content. Technological journals of all kinds tend to get top dollar. Here are some typical prices.

1. Comic books, newspapers, and magazines: 200 to 1000 credits.
2. Children's books and paperbacks: 300 to 1000 credits.
3. Hardbound fiction: 300 to 1200 (3D4 x 100).
4. Hardbound history 1000 to 4000 (1D4x 1000).

5. Hard or softbound natural science books; school, mass market, and reference types: 1000 to 6000 credits (1D6x 1000).
6. Hard or soft bound science manuals; elaborate data, how-to instruction, and/or data with practical applications: 10,000 to 60,000 credits (1D6X 1000) and higher.
7. Valuable technical journals, how-to instructions, blueprints, schematics, formulas, etc.: 40,000 to 240,000 (4D6 x 10,000) credits. Some high-tech journals/instruction manuals can be worth millions and all are highly illegal in the CS.

The same prices and CS restrictions are applicable to audio and video items of the same nature. Add 50% to excellent instructional films, including microfilm and video tapes and discs.

Note: All Pre-Rifts books and recordings (both film and audio) are outlawed in the Coalition States! If a book is found, it is to be given to the authorities without being read. There are also new books that the CS has found to be *dangerous* and are forbidden! They are usually books that speak against the Coalition, like the Erin Tarn series of history and geography books, or are deemed to be anarchist or subversive in content and/or ideas, included are *true* history (the CS has rewritten history) and ideas like freedom of speech, equality to all, literacy, philosophy, magic (even magic in a fairy tale context), religion (because of its mystical/magic aspects), and similar ideas. Any citizen or visitor found to read, collect, distribute, or sell such contraband anywhere in CS territory is severely punished. As a result, books and other recordings are hot items on the black market and are involved in carefully guarded, secret, transactions.

Other Pre-Rifts Artifacts

Almost anything recognizable as an authentic Pre-Rifts artifact has some value. Even old soda pop cans and bottles are sold for 1D6x 10 credits in the cities. Of course, value is a subjective thing. Old artifacts, especially worthless items like old cans and books (most people can not read, so books have little value), have no value to the hard working people of the wilderness. People in a wilderness town may like something that isn't functional just because it's pretty, but they are not likely to pay a whole lot for it. They must concentrate on the important day to day needs of life and survival. An old Pepsi soda can is just an old can. It isn't worth a rusty spoon, let alone the 50 or 60 credits that "those crazy city folk" pay. It's a matter of the perception of the potential buyer and the degree of want and availability. The following is a list of Pre-Rift artifacts that have value on the collectors or salvage market. All prices are average to low.

1. **Old car or truck with no functioning parts:** 50 credits for metal value.
2. **Old vehicle that's too broken down to fix but is good for parts:** 2D6x 100 credits.
3. **Old vehicle that's in pretty good shape and drives:** 3D4 x 1000 credits depending on its condition; presumably it's only in fair condition.
4. **Old vehicle in great condition and rides great:** 1D6x 10,000 credits.
5. **Old vehicle in mint condition (a rarity):** 2D4 x 10,000 credits, possibly as much as 3D4 X 10,000 to a collector.
6. **Old working military vehicles, specifically tanks and armored personnel carriers:** 3D4X 10,000 credits. Add 50% if hover vehicle.
7. **Working radio equipment:** Pair of walkie-talkies: 500 credits, long range radio (HAM type): 1500 credits, good radio receiver (entertainment type): 300 credits. Similar radio and electrical items, range about 1D6 x 100. Computers and video disc items command two to four times as much, but only if they are not the really ancient ones, from 1995 or earlier.
8. **Working S.D.C Weapons:** Old handguns: 1D6 x 100 credits, old hunting rifles: 2D4 x 100 credits, old sub-machineguns and assault rifles: 2D6x 100 credits, hand grenades: 1D4x 100.

9. **Working Mega-Damage Weapons:** See the regular descriptions of energy weapons in the equipment section for price. It doesn't matter whether the weapon has been newly built or sitting in storage for 200 years and recently unearthed, cleaned and recharged, it is still an excellent working weapon. In fact, many mercenaries, especially Headhunters, prefer an authentic Pre-Rifts weapon and will pay 30% more for it. **Note:** There is no practical difference between old and new weapons. Any perceived difference is purely psychological.
10. **Precious Metals:** Gold is currently worth about 1000 credits an ounce. Silver is 300 credits an ounce. Bronze, 50 credits an ounce. Copper, 20 credits an ounce. Platinum, about 1500 credits an ounce, Palladium is 3000 an ounce. **Note:** Old coins in nice condition can be worth between 1D6X 100 each to a collector.
11. **Works of Art.** Works of art have a low resale value. Even works by famous masters sell for little. Most people are not art conscious, nor do these items have any great historical significance in the current time of Rifts. A Kevin Long or Keith Parkinson painting is as likely to be worth as much as a Rembrandt or Van Gogh simply because they are Pre-Rift artworks. Average value is a paltry 8D6 x 100 credits, sometimes less, other times more, depending on the purchaser and the market.
12. **Miscellaneous.** There are all kinds of things, from trinkets to industrial machinery, that could have value in the World of Rifts. However, Game Masters will have to fend for themselves on these things. GMs should use common sense working up the values of other items. Consider the market, who might want this item and the practicality of the item. Items of practical value will have the greatest sales potential; i.e., one is likely to sell an energy rifle faster and for more money than one can sell a statue by Rodan.

Here is a very general table for miscellaneous stuff. The prices are what the items sell for on the black market and do not necessarily reflect what a character can sell them for.

Trinkets: Odds and ends like old junk jewelry, toys, plastic statues, Knicknacks, rusty tools, pottery, pots and pans, photos of Elvis, etc., sell for about 8D6 credits each.

Glassware, pottery, statues: Sell for about 1D4x 100 each.

Clothing: Most clothing that may have survived is considered junk or sells for around the normal market price. However, leather articles of clothing can bring in big bucks. Leather/suede jackets, pants, skirts, etc., cost about 1D6x 1000. Full length coats sell for 2D4 x 1000 and more. Aviator style clothing is the rage among techno-wizards, who will pay two and three times as much for a period article. Likewise, city rats love the old punk and motorcycle leather jackets, clothing, and studded leather and will pay double for an ancient "anarchist" symbol.

Jewelry: Jewelry made of precious stones and metals will always be valuable. As always, the best prices will be available at the cities, because people have more money and more leisure time. The actual value of the jewelry will depend more on the value of the metals and gems than on the craftsmanship. Generally, an item of jewelry from today is worth about three times more in the time of Rifts, mainly because the precious metals are worth more.

Working industrial equipment will sell for thousands to somebody who needs it. The problem is finding a buyer for large machinery. The Coalition doesn't need it because they manufacture their own, so one must look to poorer industrial kingdoms and towns. Farm and irrigation items are the fastest selling items. Values are listed by size: Small equipment is 1D6X 1000 each, medium is 3D6X1000, large is 6D6X1000, very big is 2D4 x 10,000, huge is 3D6 x 20,000.

Magic

Magic is not a commodity that the black market deals in, especially in the city, because it is far too dangerous. Dog Packs scour the city

streets sniffing out magic and their success rate is frighteningly high. The black market kingpins have failed to bribe the loyal and trustworthy mutant animals and their psi-stalker commanders. Thus, magic inside CS cities is extremely uncommon (the item would have to be worth a lot of money to take that kind of risk). However, the sale of magic items is more common in the burbs around the cities and at border towns, but even then, magic is not a commodity that the black market likes to deal with.

Selling to the Black Market

The black market is always looking to purchase contraband, from weapons to pre-rifts artifacts, for resale. Unfortunately, the wholesale purchase price is never anywhere near the selling. This is basic marketing. The retail price is always much more expensive than the raw cost to produce an item. The cost is increased by overhead expenses and other people who get a cut of the sale price for their involvement, like a mechanic who makes a new gun or vehicle look like new and run smoothly, or the forger who has to make false documents or the city official who must be bribed, and so on.

The alternative to selling to the black market is not good. Selling to other criminal operators could lead to getting attacked and/or robbed by the prospective purchaser, preferred payment is trade rather than credit (and the items are usually not of the same good quality of the black market), and the prices are usually equally poor. The smaller organizations are also more likely to sell items that are traceable by the authorities and are more likely to be raided while one is making a deal.

Trying to find buyers at the retail level is nearly impossible. First, how does one find prospective clients; "Excuse me, sir, would you like to buy a forbidden book ... a laser rifle, perhaps?" Second, infringing on the criminal market is going to get the law, the black market, and probably several gangs very upset. And they will come looking for that rival dealer. It won't be pretty when they find him either.

The following are the percentages that the black market will pay for different categories of items for resale. All numbers are the percentages from the average retail price. A few odd items list current prices in credits.

1. **Weapons.** There is always a market for weapons, but the current availability and demand of the item will reflect the high or low price. Typical purchase price is 10% to 30% of retail for high-tech, mega-damage weapons. 20% to 35% for robot missiles and mini-missiles. 10% to 15% for S.D.C. modern weapons such as handguns, rifles, flamethrowers, explosives. 5% for ancient weapons like knives, swords, crossbows, etc.; add 5% if it has collector value as an authentic Pre-Rifts artifact, but there must be some evidence that it is Pre-Rifts.
 - **Coalition weapons.** 15% to 25% of the retail.
 - **Coalition vibro-weapons.** Currently paying 25% to 40%.
 - **Weapon energy clip.** Fully charged E-clips will get 10% to 15%.
 - **Body armor.** 10% to 20%, add 5% for Coalition armor.
 - **Power armor.** 20% to 35%, add 10% for Coalition SAMAS.
 - **Cybernetic parts.** 15% to 30%
 - **Bionic parts.** 20% to 40%
 - **Complete Crazy's M.O.M. system.** 70,000 credits.
 - **Complete Juicer Bio-Comp and drug system.** 100,000 credits
 - **Robot weapons and vehicle parts.** 15% of retail.
 - **Giant robots.** 10% (hard to hide and liquidate), add 10% for Titan series.
 - **Vehicles.** 10% to 20%
 - **Electronic equipment.** 10%

- **Modern day forbidden books.** 10%
- **Pre-Rifts trinkets.** 10%
- **Pre-Rifts books, comics, magazines.** 15% to 25%
- **Pre-Rifts high-tech technical manuals.** 20% to 40%
- **Pre-Rifts jewelry.** 20% to 30%
- **Pre-Rifts coins/precious metals.** 40% to 50%
- **Pre-Rifts clothing and miscellaneous.** 15% to 25%
- **Magic.** Will rarely purchase magic items or techno-wizardry devices/conversions for sale in the city. At facilities outside the city they will consider it. Mainly interested in weapons, armor, transportation, and communication magic. Prices vary greatly, 10% to 40%, depending on the magic level, power of an item, and current market demand. May also acquire the services of a mage to sell magic spells, scrolls, and services, 15% to 30%.
- **Accurate information of importance.** 10% to 20% (tend to trick people into sharing information that they can sell for the cost of a few drinks).
- **Wilderness items: Furs.** 15% to 30%
- **Wilderness items: Herbs and drugs.** 10% to 20%
- **Wilderness items: Horses and exotic animals.** 15% to 30%

The dangers of dealings with the black market

Characters should always remember that the black market, no matter how friendly their contact may be, is a criminal organization whose members include smugglers, thieves, spies, thugs, assassins, and all sorts of scoundrels. Most of these guys are tough and mean. Many are combat trained and augmented in some way. They will use and cheat the characters whenever possible. Of course, good clients are treated well until they become a liability or not so good clients.

There is also the perpetual danger of being arrested by law officers while involved in an illegal transaction with the black market. Other problems include Coalition spies posing as black marketeers and paying premium prices for inferior goods (actually black market items are pretty good and reliable).

Mega-Damage Capacity Body Armor

There are several different types of M.D.C. body armor from light padded armor to full environmental armor.

- **411 environmental body armor have the following properties.**
- A minimum of 30 M.D.C.
- Complete environmental battle armor suitable for use in most hostile environments.
- Computer controlled life support system.
- Internal cooling and temperature control.
- Artificial air circulation systems, gas filtration, humidifier.
- Computer controlled, independent oxygen supply and purge system that automatically engages in low oxygen or contaminated air environments. Five hour oxygen supply.
- Insulated, high temperature resistant shielding for up to 200 degrees centigrade. Normal fires do no damage. Nuclear, plasma, and magic fires do full damage.
- At least minimal radiation shielding.
- Polarized and light sensitive/adjusting tinted visor.
- Directional, short range radio built into the helmet. Range is 5 miles (8 km).
- Helmet face plate or visor is removable.
- Prowl Penalty: - 10% in light armor, -25% in heavy.

Coalition Dead Boy

Full Environmental Body Armor

- Black market costs: Light armor (50 M.D.C.) 40,000 credits.
- Heavy armor (80 M.D.C.) 70,000 credits.
- Often repainted dark grey, light grey, black and grey, crimson, green, and camouflage.

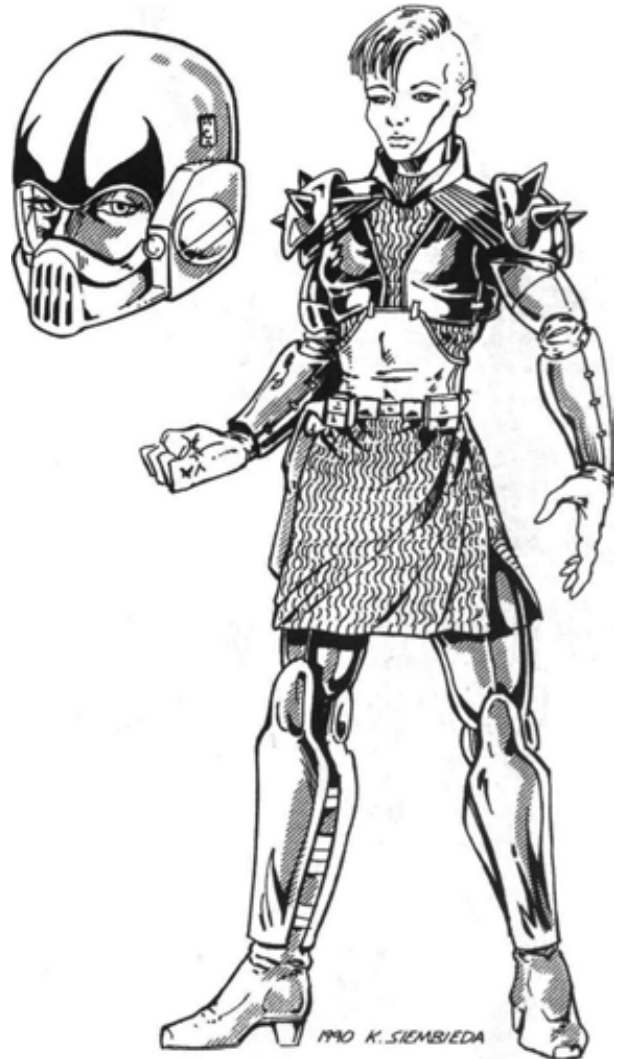

The Gladiator

Full Environmental Body Armor

One of the most popular medium weight full environmental suits recently introduced to the market. The body utilize the new super light weight fiber armor that resembles chain mail and light plates of armor. The suit offer excellent mobility and equally excellent physical protection. The fiber skirt is standard for both male and female suit and offers one of the best forms of protection to the groin area. Comes in white, tan, silver, light grey, dark grey, and black.

- M.D.C. 70
- Weight 21 pounds (9.5 kg)
- Excellent mobility, —5% prawl penalty.
- Black market cost: 50,000 credits.

The Crusader

Full Fibre Environmental Body Armor

As the name implies, this full suit of body armor resembles the knights of the ancient crusade because of the chain mail like M.D.C. fiber and knee length skirt. Recent fashion has provided a traditional

knights' surcoat and even the helmet is often designed to resemble the European knights of old.

- M.D.C. 55
- Weight 11 pounds (5 kg)
- Full mobility, no prowl penalty!
- Black market cost: 40,000 credits.

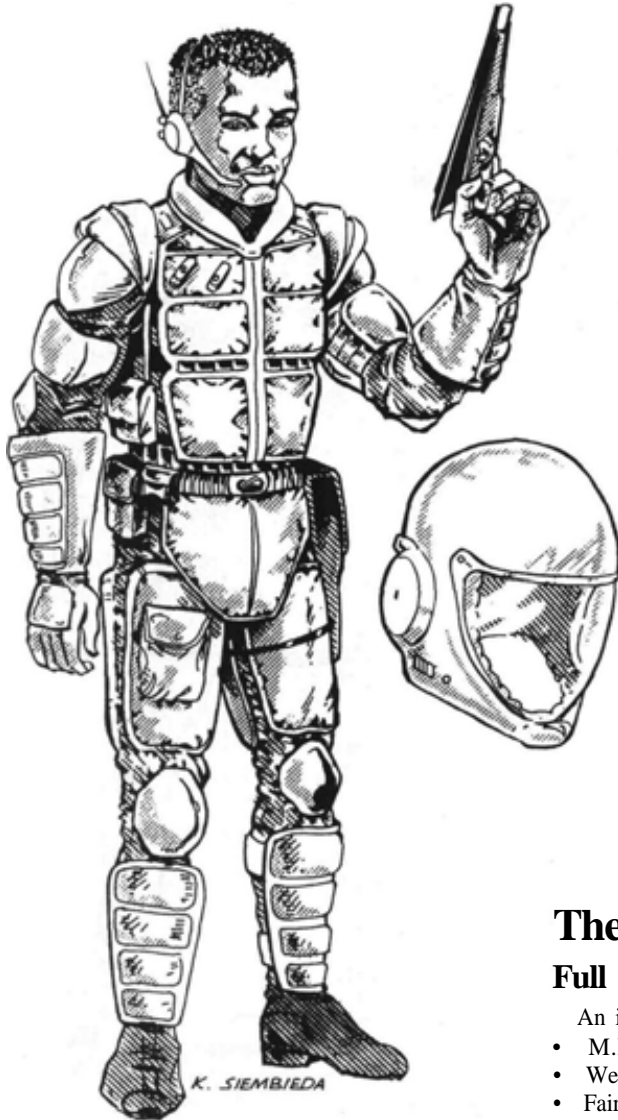

The Plastic-Man

Full Plastic Environmental Body Armor

An inexpensive armor made of light weight polycarbonate plate

- M.D.C. 35
- Weight 13 pounds (5.8 kg)
- Fair mobility, — 10% prowl penalty.
- Black market cost: 18,000 credits

The Urban Warrior

Full Padded Environmental Body Armor

A light weight body armor that has been popular with adventurers and many city law enforcement officers for over a decade. This armor is a full body suit with special flexible padding and strategic placement of light metal plates. Usually comes in white, light grey, and tan colors.

- M.D.C. 50
- Weight 11 pounds (5 kg)
- Good mobility, — 10% prowl penalty.
- Black market cost: 35,000 credits



Juicer

Assassin's Plate Armor

This is the famous medium weight armor worn by the chemically augmented Juicer.

- M.D.C. 45
- Weight 18 pounds (8 kg)
- Good mobility, — 5% prowl penalty.
- Black market cost: 28,000 credits

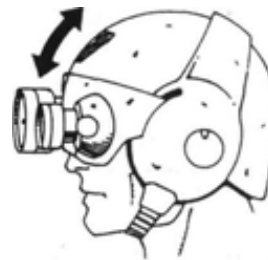

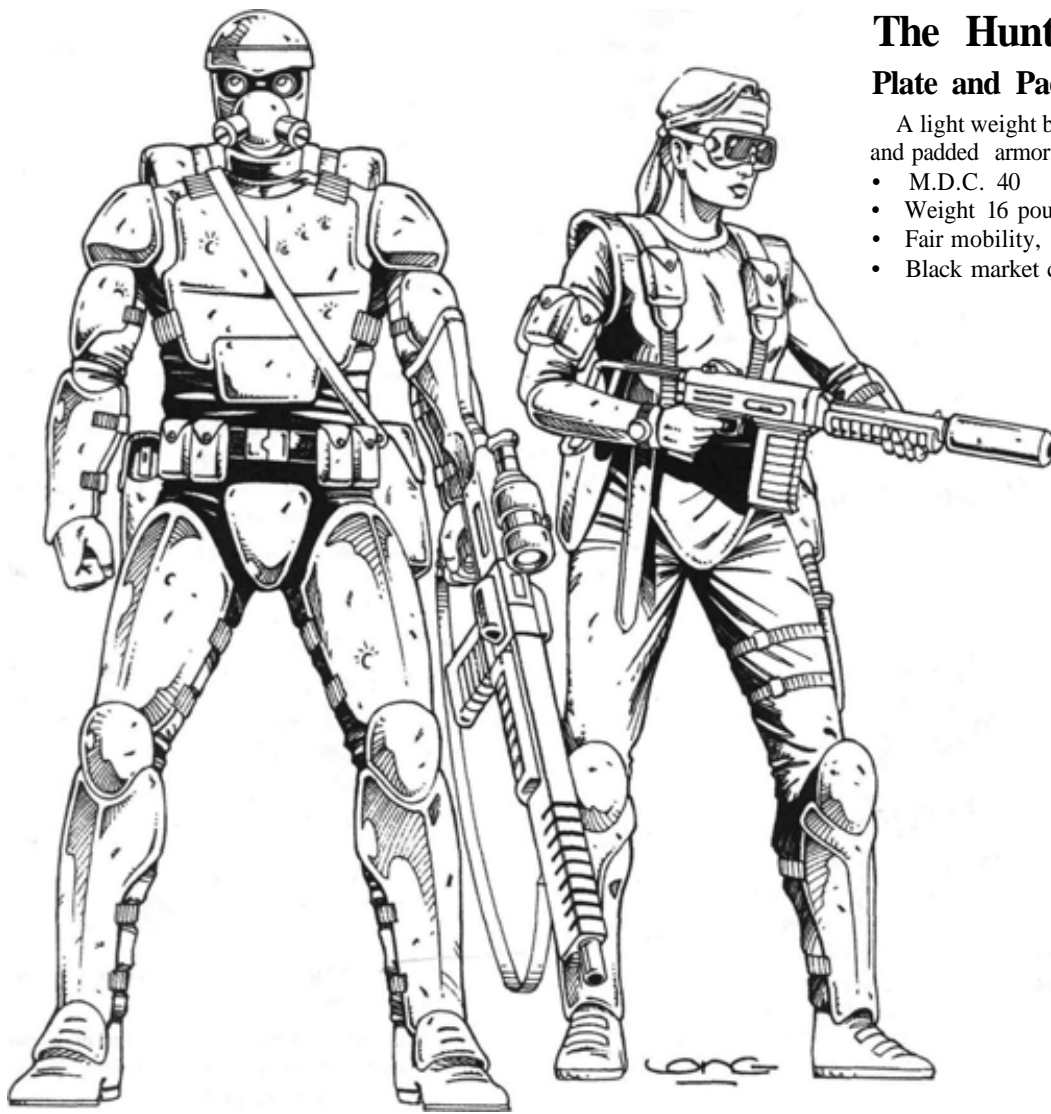

The Huntsman

Plate and Padded Armor

A light weight body with a heavy plate and padded vest and padded armor with leg and arm plates.

- M.D.C. 40
- Weight 16 pounds (7.2 kg)
- Fair mobility, - 10% prowl penalty.
- Black market cost: 20,000 credits

The Bushman Full Composite Environmental Body Armor

A light weight padding, kelvar, and plate composite armor. Comes in green, tan, black, and camouflage.

- M.D.C. 60
- Weight 17 pounds (5 kg)
- Good mobility, - 10% prowl penalty.
- Black market cost: 32,000 credits

Power Armor

Power armor might be thought of as a sort of super-suit of body armor. Body armor is a protective plating or padding much like the knights of old wore, only much lighter and flexible. Power armor is a body armor in that it protects its wearer completely, but it is also much more. Power armor is a form fitting, robot exo-skeleton designed for combat. It is a form of mechanical augmentation that does not require the user to submit to any physical alterations. The armor is basically a robot suit. The human pilot steps into it and activates the armor. The moment the armor is activated, the suit becomes a self-contained environmental system and offers superhuman speed and abilities to its pilot.

Power armor is always a one person unit that is usually human size, although most power armor adds one to three feet to one's height. Some older styles of power armor are larger and may tower as high as twelve

feet (3.6 m). Anything larger is considered to be a full robot vehicle.

All Power Armor have the following features.

- 1. Nuclear Powered:** Which means they have an effectively unlimited fuel capacity and power source. Average life: 15 to 20 years.
- 2. Radar:** Can identify and track up to 24 targets simultaneously at a range of 10 miles (16 km).
- 3. Combat Computer:** Calculates, stores, and transmits data onto the head-up display (H.U.D.) of the pilot's helmet. It is tied to the targeting computer.
- 4. Targeting Computer:** Assists in tracking and identification of enemy targets. Ten mile range (16 km).
- 5. Laser Targeting System:** Assists in the selection and focusing of specific targets and adds a bonus of +1 to strike when using long range weapons. Does not apply to hand to hand combat or SAM AS.
- 6. Radio communication:** Long range, directional communication system with an effective range of about 500 miles (800 km), as well

as a directional, short range radio. Range is 5 miles (8 km). Plus a built-in loudspeaker; 80 decibels.

7. **Complete environmental battle armor:** Suitable for use in all hostile environments, including under water (150 foot max. depth) and space. The following features are included.
- Computer controlled life support system.
 - Internal cooling and temperature control.
 - Artificial air circulation systems, gas filtration, humidifier.
 - Computer controlled, independent oxygen supply and purge system that automatically engages in low oxygen or contaminated air environments. Eight hour oxygen supply.
 - Insulated, high temperature resistant shielding for up to 400 degrees centigrade. Normal fires do no damage. Nuclear, plasma, and magic fires do full damage.
 - Radiation shielded.

Northern Gun Samson Power Armor

The folks up at Ishpeming, Michigan, a.k.a Northern Gun, have created an infantry version of power armor with more M.D.C. and fire power. Unlike the previous types, this unit can not fly.

NG-X9 Samson Power Armor

Model Type: NG-X9

Class: Armored Infantry Assault Suit

Crew: One

M.D.C. by Location:

Rear Booster Jets (2) — 50 each

Ammo-Drum (rear) — 30

Rail Gun — 50

Forearm Mini-Missile Launcher (2) — 50 each

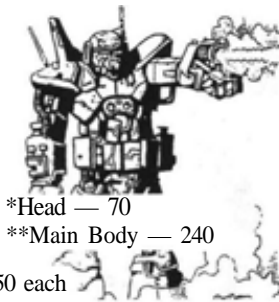

*Head — 70

**Main Body — 240

* Destroying the head of the power armor will eliminate all forms of optical enhancement and sensory systems. The pilot must now rely on his own human vision and senses. No power armor combat bonuses to strike, parry, and dodge! **Note:** The head is a small and difficult target to hit (shielded by exhaust tubes and weapon drum). Thus, it can only be hit when a character makes a *called shot* and even then the attacker is - 3 to strike.

** Depleting the M.D.C. of the main body will shut the armor down completely, making it useless.

Speed

Running: 150 mph (240 km) maximum. Note that the act of running does tire out its operator, but at 10% of the usual fatigue rate thanks to the robot exo-skeleton.

Leaping: The powerful robot legs can leap up to 25 feet (7.6 m) high or across unassisted by the jet boosters. A *jet booster assisted leap* can propel the unit up to 100 feet (30.5 m) high and 200 feet (61 m) across. This is not flight.

Statistical Data

Height: 11 feet (3.3 m)

Width: 5 feet (1.5m)

Length: 4 feet, 6 inches (1.4 m)

Weight: 460 lbs (207 kg) without rail gun and drum, 1000 pounds (450 kg) fully loaded.

Physical Strength: Equal to a P.S. 30

Cargo: Small storage area for extra supplies and personal weapons.

Power System: Nuclear; average life is 15 years.

Black Market Cost: 850,000 credits for a new, undamaged, fully powered suit complete with rail gun and one full ammo-drum. Not often available.

Weapon Systems

1. **NG-202 Super Rail Gun** (1): This is standard equipment for the Samson and is a powerful weapon. Note that the NG-202 Super has a greater payload than the machinegun version. Also, there is no

separate power pack; the unit is hooked directly to the armor's nuclear power supply.

Primary Purpose: Assault

Secondary Purpose: Defense

Weight: Gun: 210 lbs (94.5 kg), One Super Ammo-Drum: 300 lbs (135 kg).

Mega-Damage: A Burst is 60 rounds and inflicts 1D6X 10 M.D., one round does 1D6 M.D.

Rate of Fire: Equal to number of combined hand to hand attacks (usually 4-6).

Maximum Effective Range: 4000 feet (1200 m)

Payload: 6000 round drum, that's 100 bursts. A second drum can be hooked to the undercarriage of the rocket jets, but must be manually removed by another Samson or character with a strength of 26 or higher can replace the used drum. Reloading a drum will take about 5 minutes for those not trained, but a mere one minute by somebody trained in the use of Samson power armor.

2. **Forearm Rocket Launcher:** Mini-missile rocket launchers are built into each forearm.

Primary Purpose: Anti-Aircraft

Secondary Purpose: Defense

Missile Type: Any mini-missile can be used, but standard issue is armor piercing (1D4 X 10 M.D.) or plasma (1D6 x 10). Fragmentation will be used for anti-personnel operations.

Mega-Damage: Varies with missile type.

Range: Usually about a mile.

Rate of Fire: One or two.

Payload: Four, two per arm.

3. **Knuckle blades:** Three vicious looking blades extend from the hand and are used in hand to hand combat. Add 1D6 M.D. to punch attacks.
4. **Energy Rifles** and other normal weapons can be stored in a compartment about the size of a footlocker.
5. **Hand to Hand Combat:** Rather than use a weapon, the pilot can engage in mega-damage hand to hand combat. See *Power Armor Combat Training* in the Robot Combat section.

Flying Titan Power Armor

The Flying Titan power armor is manufactured by the same mysterious source as the robots. It is extremely light, fast, and maneuverable, which makes it ideal for reconnaissance, rescue, and infantry support. **Note:** The Titan does not usually utilize a rail gun. The pilot is usually armed with energy rifles and his or her wing missiles.

Flying Titan Power Armor

Model Type: FT-005

Class: Strategic Armor Military Exo-Skeleton

Crew: One

M.D.C. by Location:

Shoulder Wings (2) — 30 each

Rear Jet Pack (2) — 50 each

Lower Maneuvering Jets — 25 each

*Head — 70

**Main Body — 180

* Destroying the head/helmet has a 1-70% chance of knocking the pilot unconscious. If conscious, the pilot has two problems: one, no power armor combat bonuses to strike, parry, and dodge, and two, the human head is now vulnerable to attack. **Note:** The head is a small and difficult target to hit (shielded by exhaust tubes and weapon drum).



Thus, it can only be hit when a character makes a *called shot* and even then the attacker is —3 to strike.

Depleting the M.D.C. of the main body will shut the armor down completely, making it useless. **Note: Destroying a wing will make flight impossible. However, even with no wing(s), the armor can make jet powered leaps and hover stationary above the ground.

Speed

Running: 50 mph (80 km) maximum. Note that the act of running does tire out its operator, but at 20% of the usual fatigue rate thanks to the robot exo-skeleton.

Leaping: The powerful robot legs can leap up to 15 feet (4.6 m) high or across unassisted by the thrusters. A *jet thruster assisted leap* can propel the unit up to 100 feet (30.5 m) high and 200 feet (61 m) across without actually attaining flight.

Flying: The rocket propulsion system enables the Flying Titan to hover stationary up to 200 feet (61 m) or fly. Maximum flying speed is 400 mph (640 km), but cruising speed is considered to be 200 mph (320 km). Maximum altitude is limited to about 4000 feet (1200 m).

Flying Range: The nuclear power system gives the armor decades of life, but the jet rockets get hot and need to cool after a maximum of ten hours of flight when travelling at speeds above cruising, and twenty hours of cruising speed, indefinitely with rest stops.

Statistical Data

Height: 7 feet (2.4 m)

Width: Wings down: 2.5 feet (0.76 m)

Wings extended: 11 feet (3.3 m)

Length: About 3 feet (0.4 m)

Weight: 160 lbs (72 kg) without missiles.

Physical Strength: Equal to P.S. 24.

Cargo: None

Power System: Nuclear; average life is 20 years.

Black Market Cost: One million credits for a new, undamaged, fully powered suit complete with missiles. Not often available.

Weapon Systems

1. **Wing Lasers (2):** A tiny laser turret is mounted on the underside of each wing. Both can rotate 360 degrees and have a firing arc of 90 degrees (up and down). The turrets are hooked directly to the armor's nuclear power supply.

Primary Purpose: Assault

Secondary Purpose: Defense

Mega-Damage: 2D6 M.D. per blast

Rate of Fire: Equal to number of combined hand to hand attacks (usually 4-6). Fired by voice command or by pressing a concealed firing stud on the forearm.

Maximum Effective Range: 4000 feet (1200 m)

Payload: Effectively unlimited.

2. **Wing Rockets:** Six mini-missiles or three of the larger short range missiles can be mounted on each wing (12 or 6 total). Like the lasers, the missiles are launched by voice command or by hidden firing studs in the forearm.

Primary Purpose: Anti-Aircraft/Armored Vehicle.

Secondary Purpose: Defense

Missile Type: Any mini-missile or short range missile can be used.

Mega-Damage: Varies with missile type. The short range missiles are generally more powerful.

Range: Varies with missile type.

Rate of Fire: One at a time or in volleys of two, three, or four.

Payload: Total of 12 mini-missiles or 6 short range missiles.

3. **Energy Rifles** and other normal weapons are also used by the pilot of a Flying Titan. The less bulky armor allows for sidearm, rifle and the usual supply belts, harness, and containers. The only limitation is that a belt and especially sacks and containers are subject to flying off when travelling at speeds beyond 100 mph.
4. **Hand to Hand Combat:** Rather than use a weapon, the pilot can engage in mega-damage hand to hand combat. See *Power Armor Combat Training* in the Robot Combat section.

Robot Vehicles

All Robot Vehicles have the following features.

1. **Nuclear Powered:** Which means they have an effectively unlimited fuel capacity and power source. Average life: 15 to 20 years.
2. **Radar:** Can identify and track up to 48 targets simultaneously at a range of 30 miles (48 km).
3. **Combat Computer:** Calculates, stores, and transmits data onto the head up display (H.U.D.) of the pilot's helmet. It is tied to the targeting computer.
4. **Targeting Computer:** Assists in tracking and identification of enemy targets. 30 mile range (48 km).
5. **Laser Targeting System:** Assists in the selection and focusing of specific targets and adds a bonus of + 1 to strike when using long range weapons. Does not apply to hand to hand combat or SAMAS.
6. **Radio communication:** Long range, directional communication system with an effective range of about 500 miles (800 km), as well as a directional, short range radio. Range is 5 miles (8 km). Plus a built-in loudspeaker; 80 decibels.
7. **External Audio Pickup:** A sound amplification listening system that can pick up a whisper 300 feet (91.5 m) away.
8. **Spotlights:** Most will have at least one or two spotlights. Typical range is 600 feet (182 m).
9. **Ejector seat:** In case of an emergency, the pilot and crew can be instantly ejected (about 1000 feet) and parachute to safety.
10. **Self-Destruct:** A last resort measure to prevent one's robot from being captured by the enemy. The explosive damage is fairly self contained, destroying most of the internal systems with 2D6 x 10 M.D. However, it is very likely, 1-89% chance, that the nuclear power system is spewing forth deadly levels of radiation!
11. **Voice Actuated Locking System:** The robot's access hatch is sealed by an automatic locking system. A six digit spoken code programmed to a specific voice(s) pattern (six voice memory) is standard operating procedure. A manual key pad is provided in case of system failure/override.
12. **Complete environmental pilot and crew compartment:** The compartment can usually seat 2 to 6 people and is reinforced to protect the people from mega-damage. It is air tight, pressurized and suitable for use in all hostile environments, including under water (500 foot max. depth) and space. The following features are included.
 - Computer controlled life support system.
 - Internal cooling and temperature control.
 - Air purification and circulation systems, gas filtration, humidifier/dehumidifier automatically engages when needed. Can recirculate breathable air for up to four weeks before getting to stale to breathe.
 - Computer controlled, independent oxygen supply and purge system that automatically engages in low oxygen or contaminated air environments. Twelve hour oxygen supply.

- Insulated, high temperature resistant shielding for up to 400 degrees centigrade. Normal fires do no damage. Nuclear, plasma, and magic fires do full damage.
- Radiation shielded.
- Polarized and light sensitive/adjusting tinted visor.

Titan Series of Robot Vehicles

The Titan Series of robot vehicles and power armor is available through the black market, but nobody seems to know who the manufacturer is. Rumor has it that the 'bots come from Atlantis, while other rumors claim they are German in origin. No one knows.

Regardless of who manufactures the robots, they are of excellent quality and are of a more general, all-purpose design. Thus, they are popular among adventurers and explorers who can afford such exceptional robot vehicles. There are currently three robots in the Titan series, the largest is the combat 'bot armed with missiles and rail gun, the next is a smaller exploration and light combat version, and the comparatively tiny reconnaissance robot.

Titan Combat Robot

The Combat Titan model is a fairly tough robot opponent and a reasonable match for the Coalition UAR-1 Enforcer. It is especially popular on expeditions into bandit, demon, and magic territories.

Titan Combat Robot

Model Type: TR-001

Class: Ground/Infantry Assault Robot

Crew: One pilot and can accommodate two passengers.

M.D.C. by Location:

Right Forearm Rail Gun — 75

Shoulder Missile Launchers (2) — 150 each

Waist Laser Turret — 25 each

Lower Leg Mini-Missile Launchers(2) — 25 each

*Sensor Turret (left shoulder) — 20

Head — 90

Hands (2) — 50 each

Arms (2) — 170 each

Legs (2) — 250 each

**Main Body — 370

Reinforced Pilot's Compartment — 100

* Destroying the sensor turret on the left shoulder of the Enforcer will destroy the radar and targeting system. The pilot must now rely on his own human vision and other optical enhancements of the robot.

Note: The turret is a small and difficult target to hit. Thus, it can only be hit when a character makes a *called shot* and even then, the attacker is — 2 to strike.

**Depleting the M.D.C. of the main body will shut the robot down completely, rendering it useless.

Speed

Running: 60 mph (96 km) maximum.

Leaping: The powerful robot legs can leap up to 15 feet (4.6 m) high or across. Add 10 feet with a running start.

Statistical Data

Height: 28 feet, 5 inches (8.6 m)

Width: 15 feet (4.5 m)

Length: 9 feet, 4 inches (2.8 m)

Weight: 22 tons fully loaded.

Physical Strength: Equal to a P.S. 36

Cargo: Minimal storage space; about four feet (1.2 m) for extra clothing, weapons, and personal items.

Power System: Nuclear; average energy life is 15 years.

Black Market Cost: 24 million credits, and up, for a new, undamaged, fully powered Combat Titan complete with rail gun and missiles. Eleven million for a rebuilt or without missiles and rail gun. Fair availability.

Weapon Systems

1. **T-001 Rapid-Fire Rail Gun (1):** The rail gun is in a fixed forward position on the forearm, requiring the entire arm to be moved into firing position much as one must do when firing a pistol.

Primary Purpose: Assault

Secondary Purpose: Defense

Weight: Rail Gun: 900 lbs (405 kg).

Mega-Damage: A Burst is 80 rounds-and inflicts 1D4x 10 M.D., one round does 1D4 M.D.

Rate of Fire: Equal to number of combined hand to hand attacks (usually 4-6).

Maximum Effective Range: 4000 feet (1200 m)

Payload: 20,000 round drum, that's 250 bursts. Reloading a rail gun requires special equipment or another giant size robot. It will take about 15 minutes for those not trained, but a mere five minutes by somebody trained in robot mechanics (or an Operator).

2. **T-001 Medium Range Rocket Launcher:** is the more powerful missile launcher over the left shoulder.

Primary Purpose: Anti-Aircraft

Secondary Purpose: Anti-Armor (tanks, robots, dragons).

Missile Type: Any medium range missile can be used.

Mega-Damage: Varies with missile type.

Range: About 40 to 80 miles.

Rate of Fire: One at a time or in volleys of two, three, or four.

Payload: Ten total, five each arm.

3. **T-001 Mini-Missile Leg Launchers (2):** Mounted on the side of each leg is a small missile launcher.

Primary Purpose: Anti-Personnel

Secondary Purpose: Defense

Missile Type: Any type of mini-missile can be used, but standard issue is fragmentation (anti-personnel, 5D6 M.D.) and plasma (1D6X10).

Mega-Damage: Varies with missile type.

Range: About one mile.

Rate of Fire: One at a time or in volleys of two, three, or four.

Payload: Twelve, six on each leg.

4. **T-001 Laser Turrets (1):** A laser turret is mounted in the chest, capable of 90 degree angle of fire (up and down).

Primary Purpose: Anti-Personnel

Secondary Purpose: Defense

Mega-Damage: 4D6 per twin blast

Range: 2000 feet (610 m)

Rate of Fire: Equal to the total number of hand to hand attacks per melee (usually 4 to 6).

Payload: Effectively unlimited.

5. **Hand to Hand Combat:** Rather than use a weapon, the pilot can engage in mega-damage hand to hand combat. See *Power Armor Combat Training* in the Robot Combat section.

Retractable Vibro-Claws: Adds 2D6 M.D. to open hand slap/clawing and tear damage.

Titan Exploration and Light Combat Robot

A smaller cousin to the Combat Titan is the Explorer Titan, a smaller faster all terrain robot with minor combat capabilities.

Titan Exploration and Light Combat Robot

Model Type: TR-002

Class: Ground/Infantry Assault Robot

Crew: One pilot and can accommodate four passengers.

M.D.C. by Location:

Shoulder Missile Launchers (2) — 120 each

Waist Ball Laser Turrets (2) — 25 each

Waist Searchlight — 5

*Sensor Turret (left shoulder) — 20

Head — 90

Hands (2) — 40 each

Arms (2) — 150 each

Legs (2) — 200 each

**Main Body — 300

Reinforced Pilot's Compartment — 100

* Destroying the sensor turret on the left shoulder of the Enforcer will destroy the radar and targeting system. The pilot must now rely on his own human vision and other optical enhancements of the robot.

Note: The turret is a small and difficult target to hit. Thus, it can only be hit when a character makes a *called shot* and even then, the attacker is —2 to strike.

**Depleting the M.D.C. of the main body will shut the robot down completely, rendering it useless.

Speed

Running: 90 mph (144 km) maximum.

Leaping: The powerful robot legs can leap up to 15 feet (4.6 m) high or across. Add 10 feet with a running start.

Statistical Data

Height: 20 feet, 8 inches (6.3 m)

Width: 11 feet (3.3 m)

Length: 7 feet, 2 inches (2.1 m)

Weight: 17.6 tons fully loaded.

Physical Strength: Equal to a P.S. 32

Cargo: Minimal storage space; about four feet (1.2 m) for extra clothing, weapons, and personal items.

Power System: Nuclear; average energy life is 20 years.

Black Market Cost: 14 million credits, and up, for a new, undamaged, fully powered Explorer Titan complete with laser and missiles. Six million for a rebuilt or without missiles and laser. Fair availability.

Weapon Systems

1. **T-002 Short Range Rocket Launcher:** This is the more powerful missile launcher over the left shoulder.

Primary Purpose: Anti-Personnel

Secondary Purpose: Anti-Armor (tanks, robots, dragons).

Missile Type: Any medium range missile can be used.

Mega-Damage: Varies with missile type.

Range: About one mile.

Rate of Fire: One at a time or in volleys of two, three, or four.

Payload: Ten total, five each shoulder.

2. **T-002 Laser Ball Turrets (2):** A laser on a rotating ball socket is mounted on either side of the lower chest. Each can be directed at a separate target or at the same target. Capable of 360 degree rotation and 180 degree angle of fire (up and down/side to side).

Primary Purpose: Anti-Personnel

Secondary Purpose: Defense

Mega-Damage: 3D6 per single blast or 6D6 per twin blast directed at the same target from both turrets.

Range: 2000 feet (610 m)

Rate of Fire: Equal to the total number of hand to hand attacks per melee (usually 4 to 6).

Payload: Effectively unlimited.

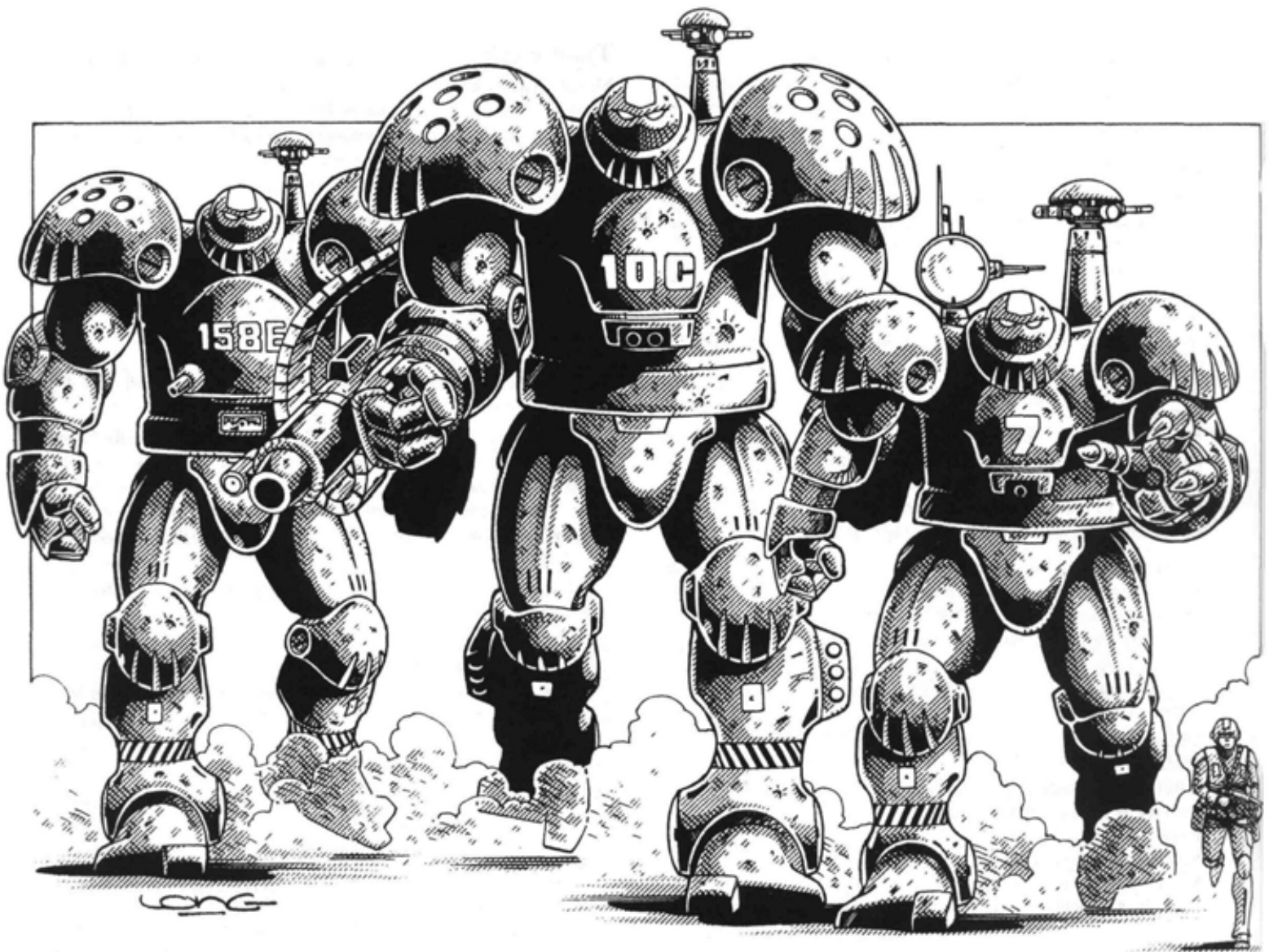

3. Hand to Hand Combat: Rather than use a weapon, the pilot can engage in mega-damage hand to hand combat. See *Power Armor Combat Training* in the Robot Combat section.
Retractable Vibro-Claws: Adds 1D6 M.D. to open hand/claw and tear damage.

Titan Reconnaissance Robot

The Titan Reconnaissance 'bot is a comparatively tiny brother of the larger robots in the series. However, unlike its big brothers, the small 'bot is the fastest and has a full range of sensor capabilities.

Titan Reconnaissance Robot

Model Type: TR-003

Class: Ground/Infantry Reconnaissance Robot

Crew: One pilot and can accommodate one passenger.

M.D.C. by Location:

Upper Arms/Shoulders (2) — 110	
Waist Laser Turret (2) — 25 each	
Right Shoulder Searchlight — 5	
*Sensor Turret (left shoulder) — 20	
Head — 90	Arms (2) — 100 each
Hands (2) — 40 each	Legs (2) — 150 each
**Main Body — 270	
Reinforced Pilot's Compartment — 100	

*Destroying the sensor turret on the left shoulder of the Enforcer will destroy the radar and targeting system. The pilot must now rely on his own human vision and other optical enhancements of the robot. **Note:** The turret is a small and difficult target to hit. Thus, it can only be hit when a character makes a *called shot* and even then, the attacker is —2 to strike.

**Depleting the M.D.C. of the main body will shut the robot down completely, rendering it useless.

Speed

Running: 150 mph (240 km) maximum.

Leaping: The powerful robot legs can leap up to 15 feet (4.6 m) high or across. Add 10 feet with a running start.

Statistical Data

Height: 16 feet, 4 inches (4.9 m)

Width: 7 feet (2.1 m)

Length: 4 feet, 6 inches (1.4 m)

Weight: 10 tons fully loaded.

Physical Strength: Equal to a P.S. 28

Cargo: Minimal storage space; about four feet (1.2 m) for extra clothing, weapons, and personal items.

Power System: Nuclear; average energy life is 20 years.

Black Market Cost: 10 million credits, and up, for a new, undamaged, fully powered Reconnaissance Titan complete with laser and infrared spotlight. Six million for a rebuilt or without full sensory systems. Fair availability.

Weapon Systems

- 1. T-003 Mini-Laser (1):** A small laser turret is mounted in the chest, capable of 90 degree angle of fire (up and down).
Primary Purpose: Anti-Personnel
Secondary Purpose: Defense
Mega-Damage: 3D6 per blast
Range: 2000 feet (610 m)
Rate of Fire: Equal to the total number of hand to hand attacks per melee (usually 4 to 6).
Payload: Effectively unlimited.
- 2. Hand to Hand Combat:** Rather than use a weapon, the pilot can engage in mega-damage hand to hand combat. See *Power Armor Combat Training* in the Robot Combat section.
Retractable Vibro-Claws: Adds 1D6 M.D. to open hand/claw and tear attack damage.
- 3. Sensor System Note:** The Reconnaissance Titan has some of the best sensory equipment available in a robot vehicle.
 - 1. Thermo-Imager:** A special optical heat sensor that allows the infrared radiation of warm objects to be converted into a visible image. Enables the pilot to see in the dark, in shadows, and through smoke. Range: 2000 feet (610 m).
 - 2. Infrared and Ultraviolet Optics:** This optical system projects a beam of infrared light that is invisible to the normal eye. The infrared beam enables the pilot to see in the dark and to see other infrared beams. The ultraviolet system enables the pilot to see into the ultraviolet spectrum of light and is mostly used to detect the light beams of ultraviolet detection systems. **Note:** The infrared light beam can be seen by anybody who also has infrared optics, and the beam can be traced back to its source. Smoke impairs the infrared beam, making it impossible to see.
 - 3. Infrared Searchlights:** Built on to the right shoulder of the Reconnaissance Titan is a dual white light and infrared searchlight. The light can be used to scan an area at night using the invisible light to avoid detection. Only somebody who can also see infrared light will see the beams. Range: 500 feet (152 m). The light is capable of 360 degree rotation and a 90 degree tilt.
 - 4. Enhanced Radar:** Can identify and simultaneously track up to 96 different targets. Range: 100 miles (160 km).

The Behemoth Explorer

An unusual robot vehicle is the massive Behemoth Explorer, another Pre-Rifts survivor. The giant robot is a science laboratory and house trailer on legs. Typically, the Behemoth will have a laboratory divided into three separate sections, ten separate living quarters that can accom-

modate 30 to 40 people comfortably (80 cramped), a communal dining/lounge/observation area (the glass enclosure on top of the main body), and storage bay that can hold four small vehicles like hover cycles and a half dozen suits of power armor with room to spare. The pilot and crew compartment is located in the center protrusion on the nose of the robot, between the two huge searchlights. Four smaller spotlight turrets are located on the side of the robot in the front and toward the rear. Two smaller spotlights are on either side of the arms.

The arms are designed for investigation and well suited for grasping. A pair of smaller retractable arms are also housed in the forearms. The robot is used by expeditions, usually sponsored by wealthy kingdoms, to explore the wilderness. The Behemoth has only a mini-missile launcher on the side of each arm as a means of protection. Sometimes, rail guns and laser turrets are added by energetic organizations, but too many weapons are a waste of time and resources, as the Behemoth Explorer is not suited for combat at all!

Behemoth Explorer Robot

Model Type: EX-5

Class: Mobile Medical/Research Robot Vehicle

Crew: Three; one pilot, one copilot, one communications officer and can accommodate 30 to 80 passengers.

M.D.C. by Location:

Upper Arms/Shoulders (2)—120 each
Forearms (2) — 200 each
Hands (2 large) — 60 each
Hands (2 small, retractable) — 30 each
Legs (2) — 250 each
Side & Arm Searchlights (6) — 5 each
Top Mounted Searchlights (2) —10 each
*Sensor Turrets (2, rear) — 30 each
Pilot's Compartment — 200
Observation Deck (Top) — 300
**Main Body — 500

* Destroying the sensor turrets in the rear will reduce sensor range and capabilities by half. The pilot must now rely on his own human vision and other optical enhancements of the robot. **Note:** The turret is a small and difficult target to hit. Thus, it can only be hit when a character makes a *calledshot* and even then, the attacker is — 1 to strike.

**Depleting the M.D.C. of the main body will shut the robot down completely, rendering it useless.

Speed

Running: 40 mph (64 km) maximum.

Leaping: Not possible.



Statistical Data

Height: 60 feet (18.2 m)

Width: 20 feet (6.1 m)

Length: 82 feet (25 m)

Weight: 1563 tons fully loaded, but with empty cargo bay.

Physical Strength: Equal to a P.S. 40.

Cargo: 15 foot storage area. 200 ton limit.

Power System: Nuclear; average energy life is 12 years.

Black Market Cost: 100 million credits, and up, for a new, undamaged, fully powered robot. 30 million for a rebuilt or with half the normal M.D.C. and sensory systems. Fair availability.

Weapon Systems

1. **Mini-Missile Forearm Launchers (2):** Mounted on the side of each arm is a missile launcher.

Primary Purpose: Anti-Personnel

Secondary Purpose: Defense

Missile Type: Any type of mini-missile can be used, but standard issue is fragmentation (anti-personnel, 5D6 M.D.) and plasma (1D6X10).

Mega-Damage: Varies with missile type.

Range: About one mile.

Rate of Fire: One at a time or in volleys of two, three, or four.

Pay load: 48,24 in each arm. Hundreds can be stored inside the robot.

2. **Hand to Hand Combat:** Rather than use a weapon, the pilot can engage in mega-damage hand to hand combat. See *Power Armor Combat Training* in the Robot Combat section.

Large Arms/Claws: 4D6 M.D. punch and tear/pry, 2D6 M.D. crush.

Retractable Arms: Do 1D4 M.D.

Stomp: 2D6 M.D.

Body Block: 2D4 M.D. with a 70% of knocking one's opponent down.

Power Armor Units or Vehicles may be stored inside.

3. **Sensor System Note:** The Behemoth has some of the best sensory equipment available in a robot vehicle.

1. Thermo-Imager: A special optical heat sensor that allows the infrared radiation of warm objects to be converted into a visible image. Enables the pilot to see in the dark, in shadows, and through smoke. Range: 2000 feet (610 m).

2. Infrared and Ultraviolet Optics: This optical system projects a beam of infrared light that is invisible to the normal eye. The infrared beam enables the pilot to see in the dark and to see other infrared beams. The ultraviolet system enables the pilot to see into the ultraviolet spectrum of light and is mostly used to detect the light beams of ultraviolet detection systems. **Note:** The infrared light beam can be seen by anybody who also has infrared optics, and the beam can be traced back to its source. Smoke impairs the infrared beam, making it impossible to see.

3. Infrared Searchlights: The two front headlights that also serve as infrared searchlights, the lights can be used to scan an area at night using the invisible light to avoid detection. Only somebody who can also see infrared light will see the beam. Range: 500 feet (152m).

4. Enhanced Radar: Can identify and simultaneously track up to 96 different targets. Range: 100 miles (160km).



Glitter Boy

The Glitter Boy environmental suit was the first fully field operational power armor to be deployed by the US military. The unit is an amazingly small and mobile, one person, armored robot vehicle. The robot suit stands approximately 10 feet tall (three meters) and offers fully articulated hands and the mobility of the human body. As such, it is considered an all terrain vehicle. The super-dense chrome armor is constructed on a molecular level and can withstand more mega-damage than any other robot created since.

The robot frame is nearly indestructible, resilient, and virtually maintenance free. The armor shielded joints and padded pilot's compartment enables the machine to absorb impacts and cushion its pilot. It is also one of the few robots or power armor designed to comfortably accommodate a pilot for days or even weeks if necessary. A refrigeration unit holds 10 gallons of drinking water, while another contains a high protein, multi-vitamin nutrient paste (about a four weeks supply), as well as a few other storage compartments where additional food or personal items can be contained. However, it is not recommended that the pilot remain inside the cushioned and air-conditioned unit for more than 24 hours at a time. The operator must exercise or muscles will begin to cramp and stiffen, especially the legs, which are the most restricted. Prolonged inactivity enclosed in the Glitter Boy or any armor (3 or more weeks) will also reduce muscle strength. **NOTE:** Temporarily reduce P.S., P.P., and Spd attributes by 1D4 until serious measures have been taken to *restore* strength by long hours of exercise and physical activity; at least four hours a day for 1D4 weeks. Periodic walks, exercise, and activity outside the body armor will prevent loss of muscle tone and strength.

The Coalition State of Free Quebec is the only kingdom within the Coalition that manufactures and deploys Glitter Boys, a policy that will be discontinued if Emperor Prosek has anything to say about it (he seeks a consistent and unified force and GBs are not part of his plan). However, for the time being, Free Quebec deploys and maintains several troops of Coalition Glitter Boys and has no plans to eliminate them from their armed forces (and a potential source of conflict between it and the other Coalition States). Free Quebec also maintains a tiny factory that can create as many as a dozen new Glitter Boy suits a month.

Other than the factory at Free Quebec and armor that has survived the centuries into the Time of Rifts, there are no *known* manufacturers of Glitter Boy power armor. However, there has been a sudden proliferation of *new* looking suits over the last year. Rumor has it that a pre-Rifts cache of Glitter Boy armor was excavated from an old American military installation in the western wilderness and sold by high-tech bandits. However, the Coalition suspects that there is a manufacturing facility in production in the West and intends to find it and destroy it.

Glitter Boy Power Armor/Robot

Although the Glitter Boy is generally considered a power armor suit, it is so heavily armored and powerful that it is listed under the robot category. Another robot consideration is its more developed environmental aspects. Power armor or robot, the Glitter Boy armor is a force to be reckoned with.

Model Type: USA-G10

Class: Laser Resistant Armored Infantry Personnel Assault Unit
Crew: One pilot.

M.D.C. by Location:

Right Forearm Rail Gun (Boom Gun) — 175

Head — 290

Hands (2) — 100 each

Arms (2) — 270 each

Legs (2) — 450 each

*Main Body — 770

Reinforced Pilot's Compartment — 110

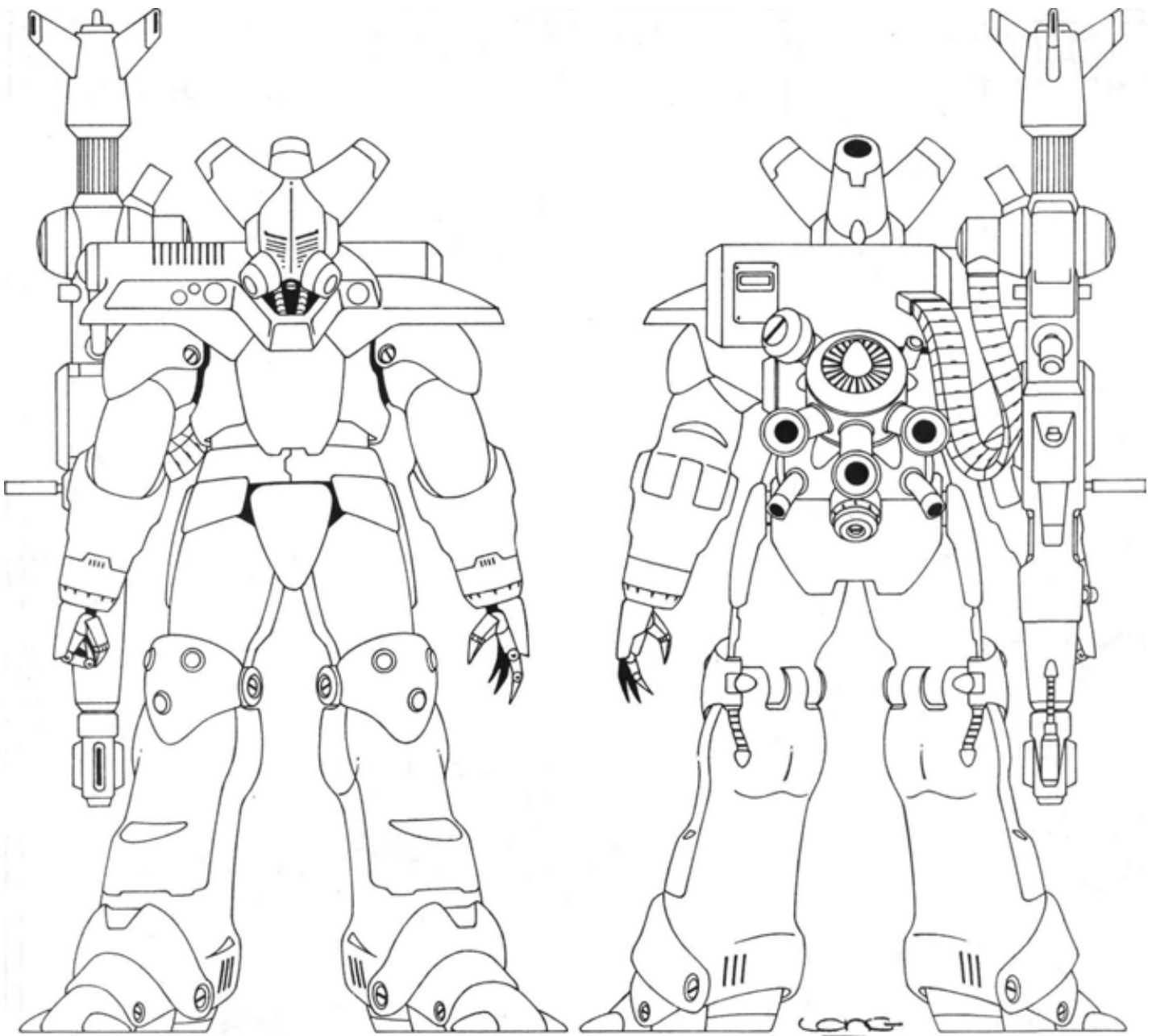

Note: The head and hands are small and difficult target to hit. Thus, they can only be hit when a character makes a *called shot* and even then the attacker is -3 to strike.

*Depleting the M.D.C. of the main body will shut the robot down completely, rendering it useless. **Note:** Laser weapons do half damage!

Speed

Running: 60 mph (96 km) maximum.

Leaping: The powerful robot legs can leap up to 12 feet (3.6 m) high or across. Add 10 feet with a running start. Jet thruster assisted leaps can hurl the power armor 80 feet (24 m) up or across. If necessary, the thruster can momentarily hold the GB a loft as high as 12 feet (3.4 m) off the ground, but only for 1D6 x 10 seconds. The thrusters are not made for flying.

Statistical Data

Height: 10 feet, 5 inches (3.1 m)

Width: 4 feet, 4 inches (1.3 m)

Length: 4 feet (1.2 m)

Weight: 1.2 tons fully loaded.

Physical Strength: Equal to a P.S. 30

Cargo: Minimal storage space; a foot compartment and storage for a rifle, handgun, survival knife and first-aid kit..

Power System: Nuclear; average energy life is 25 years.

Black Market Cost: 25 million credits and up for a new, undamaged, fully powered Glitter Boy complete with boom gun. 15 million for a rebuilt or without gun. Poor availability.

Weapon Systems

- 1. RG-14 Rapid Acceleration Electromagnetic Rail Gun (1):** The famous "Boom Gun" is a unique rail gun that can accelerate its flechette style rounds to a speed of Mach 2 and actually creates a sonic boom when fired. The weapon is the most powerful Pre-Rifts weapon to survive the Time of Rifts and has not yet been successfully duplicated or seen as a worthwhile item for duplication (other comparable weapons exist without the detriments of a sonic boom and shock waves to be overcome). The weapon is attached to the back and right shoulder of the armor. When not in use, the gun is flipped back and stored in an upward position. When needed for combat, the GB's operator simply reaches back, grasps the handle and pulls forward. The blast is so powerful that without the automatic stabilization system, the Glitter Boy would be thrown to the ground and knocked back 30 feet.

GLITTER BOY PILOT'S SUIT

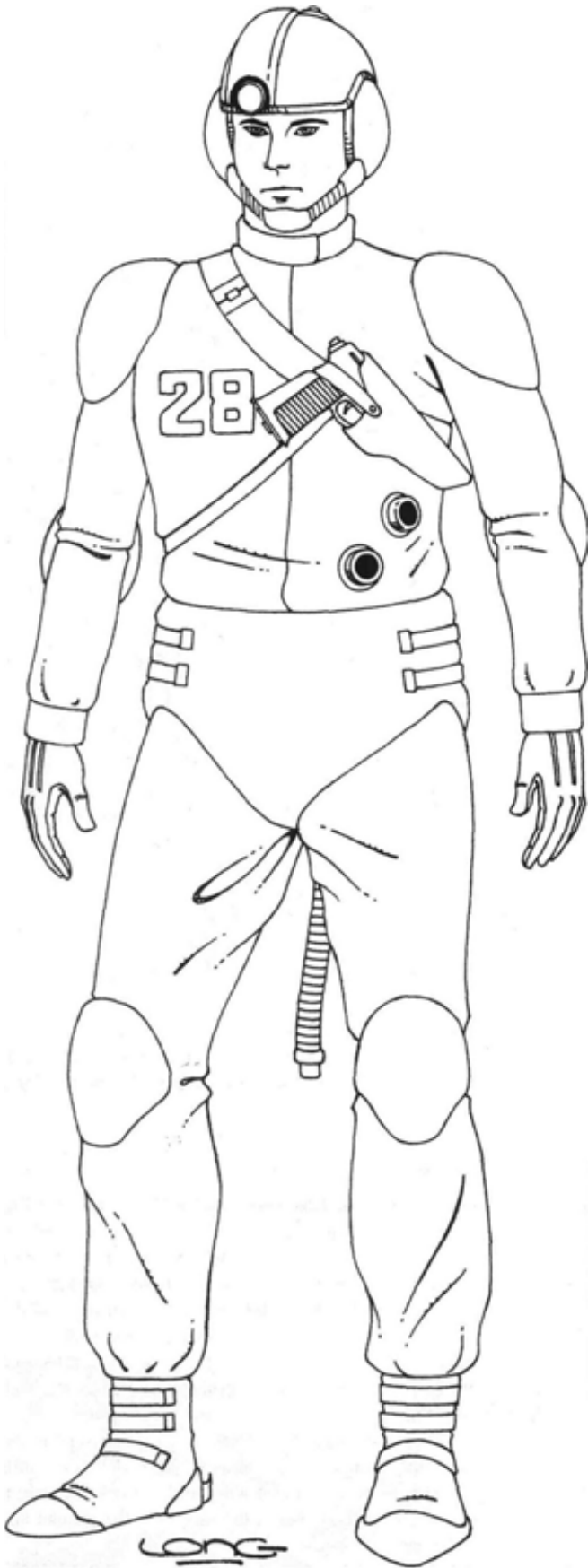

PILOT HELMET

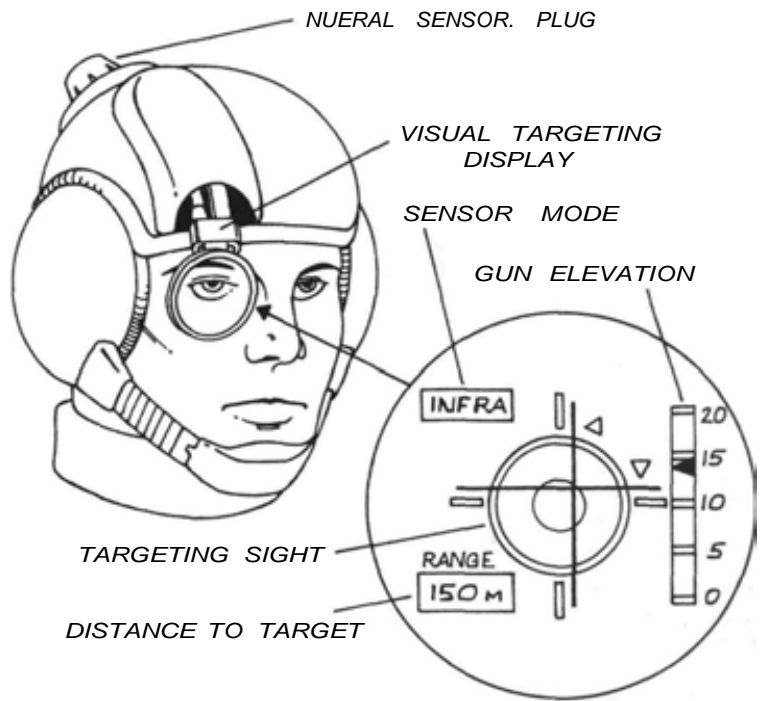

ARMORED HEAD INSTRUMENTATION

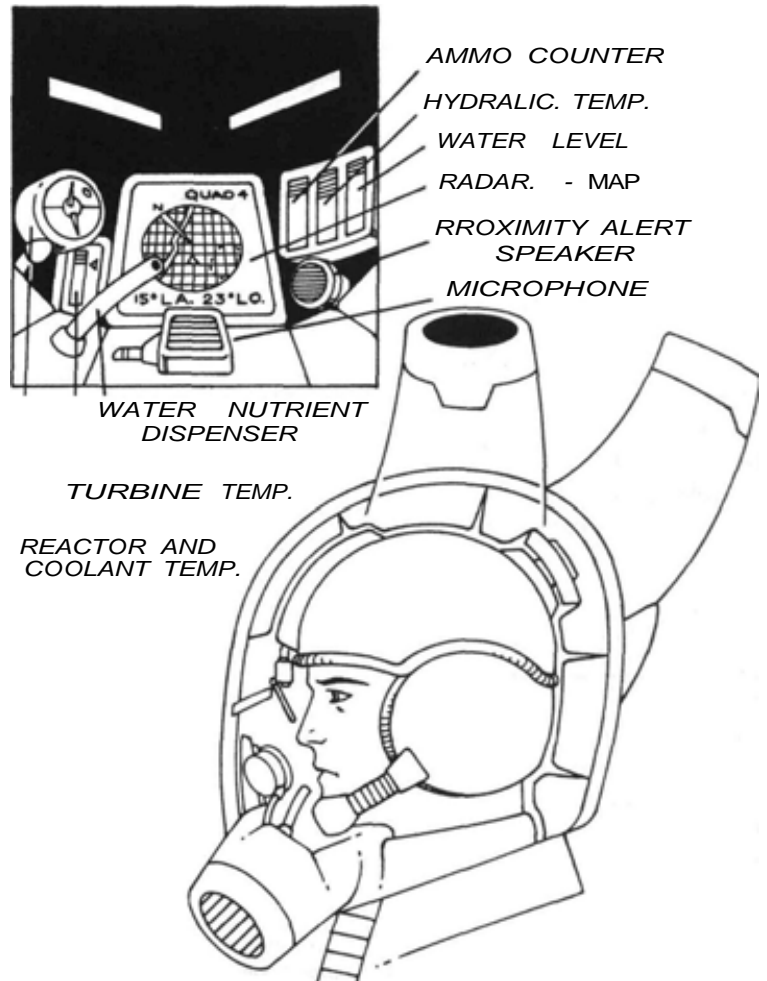

GLITTER BOY MAIN GUN

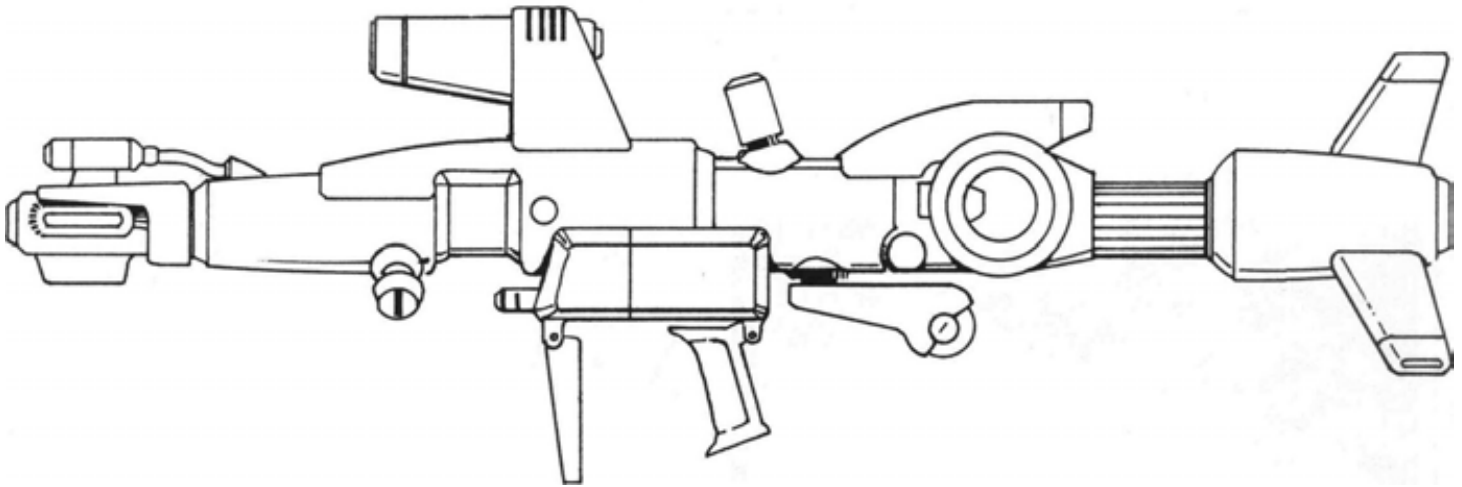

RETRACTABLE GUN GRIP

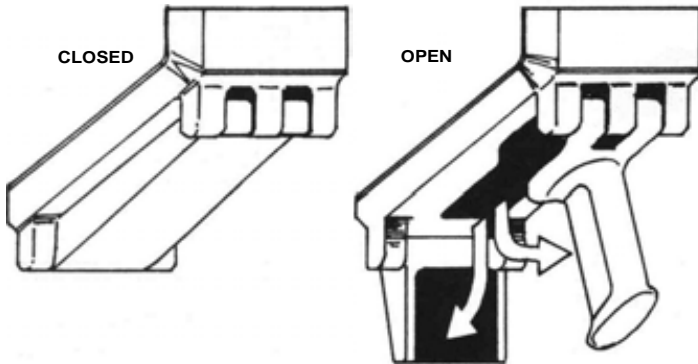

AMMUNITION DRUM

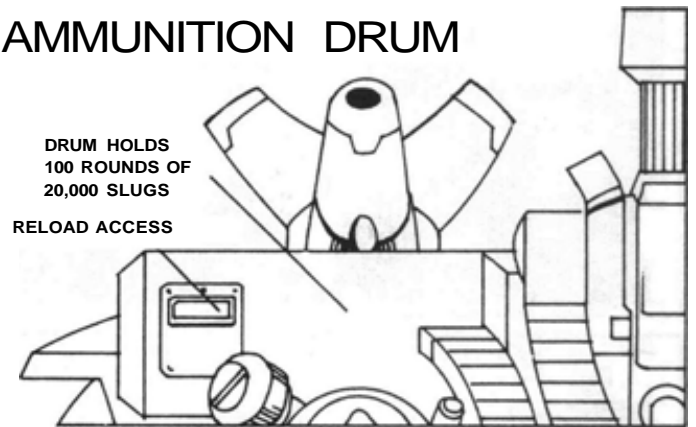

CASING-EJECTOR

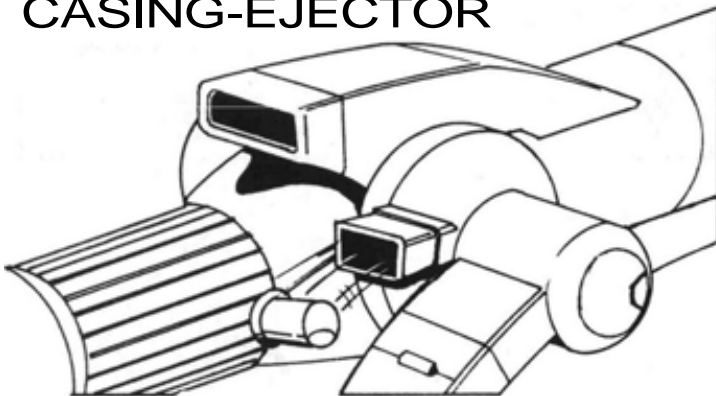

LASER TARGETER

USED IN CONJUNCTION WITH COMPUTERIZED
TARGETING SYSTEM - LASER BEAM
RANGE OF 4000 FEET.

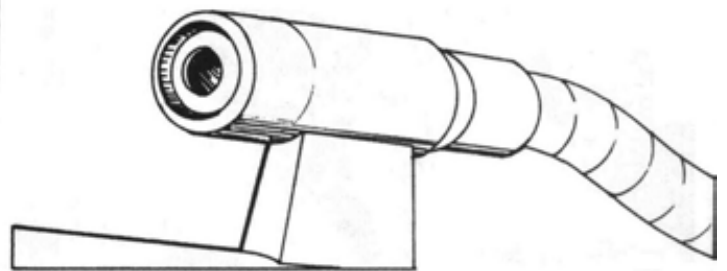

AMMUNITION

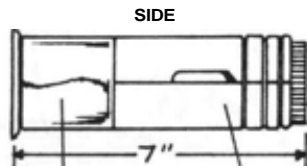

SHELL CASING

FALL AWAY SHEATH
HOLDING 200
SLUGS

FRONT



50 SLUGS WITH 3
MORE SETS OF 50
BEHIND THEM.

SLUG

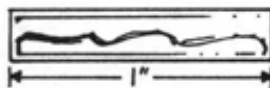

SIGHT ARRAY

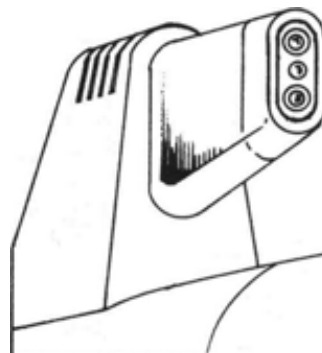

SIGHTS

IMAGE
INTENSIFIER
SIGHT

VISUAL
SIGHT

PASSIVE
THERMAL
IMAGER
SIGHT
(INFRA-RED)

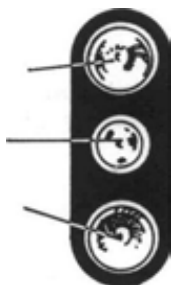

GLITTER BOY RECOIL SUPPRESSION

RECOIL DAMPENING THRUSTERS

THRUSTERS ARE SYNCHRONIZED TO GUN ELEVATION AND SIDE TO SIDE SWEEP. THRUSTERS FIRE ONLY WHEN GUN IS FIRED.

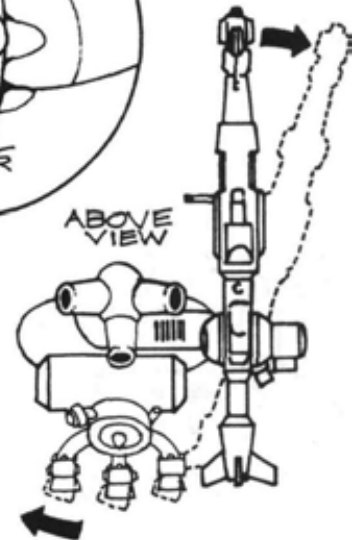
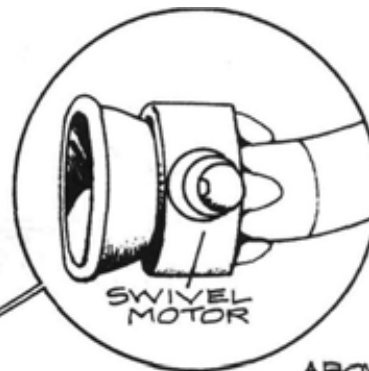
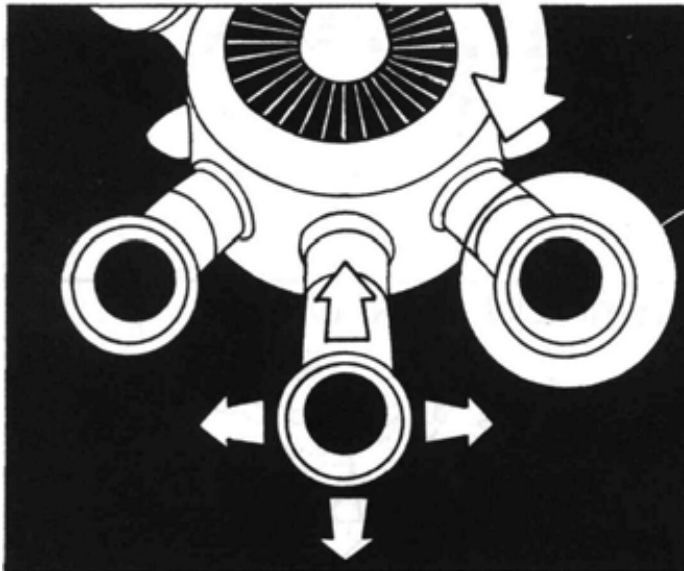

TELESCOPING-ANTI-SWAY PYLONS (WITH LASER DRILL)

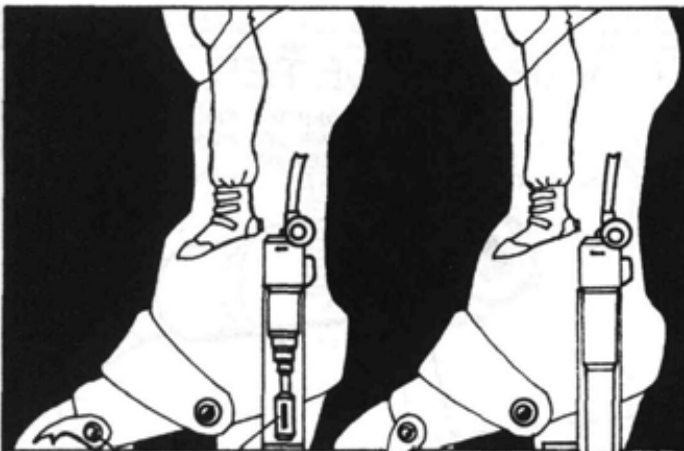

ANTI-SWAY PYLONS AND TOE HOOK ARE ACTIVATED JUST BEFORE GUN IS TO BE FIRED. GUN WILL NOT FIRE IF PYLONS (ONE-EACH LEG) ARE NOT ACTIVATED. PYLONS AND TOE HOOKS ARE INITIATED THROUGH HYDRAULICS. RELEASE RETURN TO ORIGINAL POSITION

TOE HOOK & PYLON IN STAND-BY.
TOE HOOK & PYLON HYDRAULICALLY ACTIVATED.

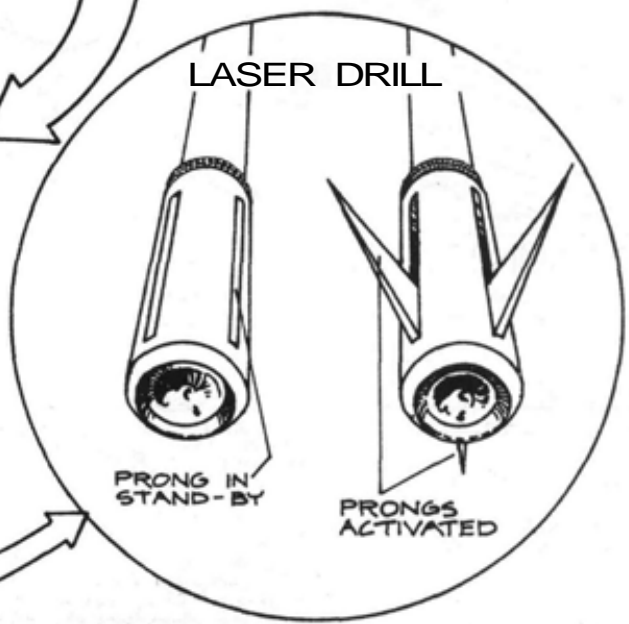
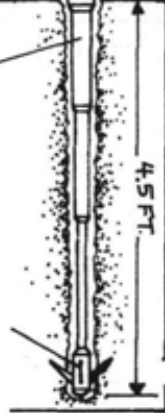

Other Weapons & Equipment

The automatic stabilization system is a synchronized system of jet thrusters and retractable reinforcement pylons in the legs that hold the armor steady. The pylons and the jets fly into action the moment the Boom Gun is fired.

Primary Purpose: Assault and Anti-Armor.

Secondary Purpose: Anti-Aircraft

Weight: Rail Gun: 867 lbs (390 kg).

Mega-Damage: One Boom Gun Flechette round holds 200 slugs that inflict 3D6x 10 M.D.

Effects of the Sonic Boom: The GB suit is specially insulated from the shock waves of the Boom Gun, however, everybody within 200 feet will be temporarily deafened. Characters without any type of head/ear protection will be temporarily deafened for 2D4 minutes and are -8 on initiative and -3 to parry and dodge. Characters who are in protective body or power armor will have some protection, but are still temporarily deafened for 1D4 minutes; same penalties apply. Each sonic boom adds to the duration of the deafness. The sonic boom will also affect the physical surroundings by shaking buildings and shattering S.D.C. windows within 300 feet of the boom.

Rate of Fire: Equal to number of combined hand to hand attacks of the pilot and his power armor (usually 4-6, see Power Armor Training). Bursts and sprays are not possible!

Maximum Effective Range: 11,000 feet (about two miles/3.2 km).

Payload: 100 rounds. Unlike some of the other power armor suits, the Glitter Boy's Boom Gun can be reloaded by hand, one round at a time, by the pilot. It will take about 15 minutes to load approximately 40 rounds. A carrying drum of 40 rounds is sometimes used to carry extra rounds. The drum has 30 M.D.C. and can attach to the hip/waist or left forearm.

2. **Hand to Hand Combat:** Rather than use a weapon, the pilot can engage in mega-damage hand to hand combat. See *Power Armor Combat Training* in the Robot Combat section for specifics.
- Combat Bonuses: +1 on initiative, +1 to parry and dodge, and +3 to roll with punch, fall, or impact (very shock resistant). All bonuses are in addition to the normal Power Armor Training Bonuses.

3. **Sensor System:** The Glitter Boy has some special features.

1. Thermo-Imager: A special optical heat sensor that allows the infrared radiation of warm objects to be converted into a visible image. Enables the pilot to see in the dark, in shadows, and through smoke. Range: 2000 feet (610 m).

2. Infrared and Ultraviolet Optics: This optical system projects as beam of infrared light that is invisible to the normal eye. The infrared beam enables the pilot to see in the dark and to see other infrared beams. The ultraviolet system enables the pilot to see into the ultraviolet spectrum of light and is mostly used to detect the light beams of ultraviolet detection systems. **Note:** The infrared light beam can be seen by anybody who also has infrared optics, and the beam can be traced back to its source. Smoke impairs the infrared beam making it impossible to see.

Advanced Laser Targeting as well as the usual robot standard features. The Boom Gun is +2 to strike. See *Power Armor Combat Training* in the High Tech War Machine section for other bonuses and data.



E-Clip costs are pretty standard. Generally, a new, fully charged, standard E-clip (short) will cost 5000 credits. Recharging an E-Clip costs about 1500 credits. Some rifles can use what is called a "long" E-clip which usually holds 30 shots. A Long E-Clip will cost 8000 credits new and 2000 to recharge. An energy clip can be recharged hundreds of times before the storage cell burns out.

The Coalition has introduced a new type of weapon cell called a **canister E-Clip** or "CE-Clip." The canister E-Clip can hold more charges and can be used in conjunction with an E-Clip, providing a weapon with a greater number of shots. At this time, only the Coalition uses the canister clip and only a few weapons are designed to use the new clip. **Note:** A canister clip will only be used on the two or three CS weapons designed to use them. They can not be used on any other energy weapons! The cost for a CE-Clip is 10,000 credits and a recharge is 2300 credits.

Conventional S.D.C. Rounds: Available types include a standard round that inflicts the listed S.D.C., or armor piercing add 1D6 S.D.C., or high explosive 1D6x10 S.D.C. damage.

Prices listed are the average black market prices. Costs may fluctuate 10% to 20%, up or down, depending on the seller and the usual market factors.



Wilk's 320 Laser Pistol

An excellent laser pistol known for its durability, range, accuracy and light weight. It is a sleek, black plastic and ceramic weapon popular among most mercenaries and adventurers; headhunters and city rats are especially fond of the Wilk's series of laser weapons.

Weight: 2 lbs (0.9 kg)

Mega-Damage: 1D6 M.D.

Rate of Fire: Standard, see Modern Weapon Proficiency Section.

Effective Range: 1000 feet (305 m)

Payload: 20 shots.

Bonus to Strike: +2 bonus to strike on an aimed shot because of the light weight and superior balance.

Black Market Cost: 11,000 credits.

Wilk's 447 Laser Rifle

A rifle version of the handgun that is a sleek, black plastic and ceramic weapon with all the usual features of a Wilk's product.

Weight: 5 lbs (2.25 kg)

Mega-Damage: 3D6 M.D.

Rate of Fire: Standard, see Modern Weapon Proficiency Section.

Effective Range: 2000 feet (610 m)

Payload: 20 shots standard clip, can not use a long E-Clip.

Bonus to Strike: +1 to strike on an aimed shot.

Black Market Cost: 18,000 credits.

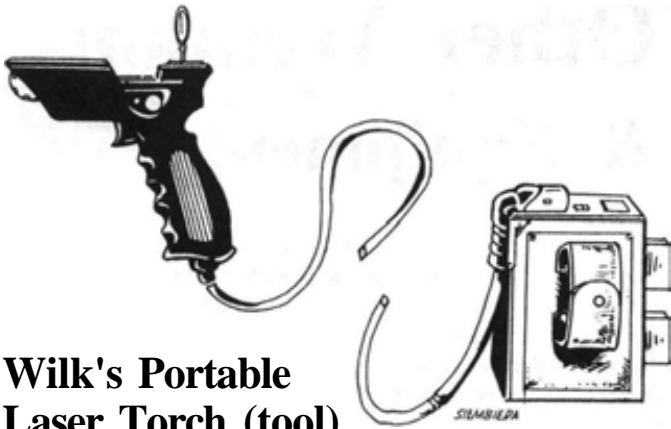

Wilk's Portable Laser Torch (tool)

A wonderful tool for cutting and welding. The laser welding gun is the familiar Wilk's black, lightweight plastic and ceramic construction. A power cord connects the gun to its portable power pack that can be hooked to a belt or fit in a back pack, tool case, or duffle bag. The power pack is charged by two standard weapon E-clips. The torch has a variety of mega-damage and S.D.C. settings. It is designed to be a tool, not a weapon. Welding is normally done only a few feet from the object of the work, but the torch's beam can be increased up to ten feet.

The torch can cut through a S.D.C. structure like butter. Remember, one M.D. point is about one hundred S.D.C., thus the torch can slice all around a 600 S.D.C. point metal door in 15 seconds on setting number 1D6 M.D. (1D4 M.D. setting to weld); a higher setting might shoot past the door and hit/hurt someone/thing of value.

Weight: 1lb (0.45 kg)

Mega-Damage: 1D4, 1D6, 2D4, 3D6, and 4D6 M.D.

S.D.C. Damage: 1D6, 3D6, 6D6, 1D6X 10 S.D.C.

Rate of Fire: Standard, see Modern Weapon Proficiency Section.

Maximum Effective Range: 10 feet (3 m)

Payload: 100 shots or about two hours of continuous use per pair of E-Clips.

Black Market Cost: 7000 credits.

Wilk's Laser Wand (tool)

A small pen or pocket flashlight size item, about 6 inches long. It is designed for detail laser work on electronics. The handy little device has one mega-damage setting and four S.D.C. settings. It is designed for close work, one to three feet, and not meant to be a weapon.

Weight: Two ounces

Mega-Damage: One M.D. point.

S.D.C. Damage: 1D4, 1D6, 2D6, or 3D6 S.D.C.

Rate of Fire: Standard, see Modern Weapon Proficiency Section.

Maximum Effective Range: 10 feet (3 m)

Payload: 50 shots.

Black Market Cost: 2000 credits. Mini-Energy Clip costs 200 credits.

Wilk's Laser Scalpel

This is a laser tool designed for delicate surgery. The scalpel has several settings for under one S.D.C. point of damage and can inflict as much as 1D6 S.D.C. points. It is not meant to be used as a weapon. Range is six inches.

Black Market Cost: 2500 credits.



NG-57 Northern Gun Heavy-Duty Ion Blaster

The Northern Gun, located in the northern peninsula of Michigan (see World Overview, number 21), is one of the largest manufacturers of non-Coalition arms on the continent. The NG-57 is a sturdy pistol that packs a wallop, but is comparatively heavy. A variety of scopes can be attached. The scope in the illustration is a standard telescopic sight for pistol or rifle.

Weight: 5 lbs (2.25 kg)

Mega-Damage: Two settings, 2D4 or 3D6 M.D.

Rate of Fire: Standard, see Modern Weapon Proficiency Section.

Effective Range: 500 feet (152 m)

Payload: 10 shots.

Black Market Cost: 8,000 credits.



NG-Super Laser Pistol and Grenade Launcher

The NG-Super is a dynamic short range weapon with the dual functions of laser gun and grenade launcher. Critics of the weapon complain that it is not a general purpose weapon, but a gun designed for augmented humans and D-Bees. The Super is twice the size of the C-18 laser pistol and three times as heavy. The weapon resembles a sub-machinegun or a sawed off shotgun more than a pistol. The kick from the grenade launcher is tremendous and the weapon's weight is a problem for the average adventurer. Characters with a strength of 19 or less are -3 to strike firing one handed, and — 1 to strike when bracing it with both hands or on something, whether firing it as a laser or a launcher. This is why the gun is not popular among most humans, but extremely popular among bionically augmented headhunters, juicers, crazies, and those who are unusually strong.

Weight: 13 lbs (5.8 kg)

Mega-Damage: Laser 2D4 M.D., grenade launcher 2D6 M.D. to a blast area of six feet (1.8 m).

Rate of Fire: Laser standard; see Modern Weapon Proficiency Section.

Grenades: one aimed, four fired in rapid succession (burst if all at same target, wild if sprayed into an area).

Effective Range: Laser is 800 feet (224 m).

Grenade Launcher is 500 feet (152 m)

Payload: Laser is 20 blasts, Grenade Launcher is a standard six hand loaded into the gun plus an additional eight in a top feeding grenade clip.

Reloading the Launcher: Requires one full melee, 15 seconds, to manually reload the grenade launcher. As always, reloading an E-Clip takes about five seconds or equal to one melee action/attack.

Black Market Cost: 21,000 credits. Grenades cost 400 credits apiece or 3800 a dozen.

NG-33 Northern Gun Laser Pistol

Looks like a sleeker ion blaster with a pointed nose.

Weight: 4 lbs (1.8kg)

Mega-Damage: 1D6 M.D.

Rate of Fire: Standard, see Modern Weapon Proficiency Section.

Effective Range: 800 feet (244 m)

Payload: 20 shots. Black Market Cost: 6,500 credits.

NG-L5 Northern Gun Laser Rifle

A durable, heavy-duty laser rifle that suffers from the usual problem of weight, but can endure a massive amount of abuse and keep on working.

Weight: 14 lbs (6.3 kg)

Mega-Damage: 3D6 M.D.

Rate of Fire: Standard, see Modern Weapon Proficiency Section.

Maximum Effective Range: 1600 feet (488 m)

Payload: 10 shots standard clip or 20 shots long E-Clip.

Black Market Cost: 16,000 credits.

NG-P7 Northern Gun Particle Beam Rifle

Another heavy-duty weapon that is a bit heavy and awkward, but sturdy and dependable in combat.

Weight: 21 lbs (9.45 kg)

Mega-Damage: 1D4x 10 M.D.

Rate of Fire: Standard, see Modern Weapon Proficiency Section.

Maximum Effective Range: 1200 feet (365 m)

Payload: 8 shots.

Black Market Cost: 22,000 credits.

L-20 Pulse Rifle

A common frontier weapon is the L-20 pulse laser rifle manufactured by the black market and several kingdoms across the land. It is a dependable, lightweight weapon with the added feature of multiple laser bursts.

Weight: 7 lbs (3 kg)

Mega-Damage: 2D6 M.D. single shot, or 6D6 multiple pulse burst (three simultaneous shots).

Rate of Fire: Standard, see Modern Weapon Proficiency Section.

Maximum Effective Range: 1600 feet (488 m)

Payload: 40 shots short E-Clip or 50 shots long E-Clip.

Black Market Cost: 25,000 credits.

JA-11 Juicer Assassin's Energy Rifle

The Juicer Assassin's rifle is a Pre-Rifts design of remarkable ingenuity. The weapon can fire a single, hand loaded 7.62 mm round for S.D.C. damage, fire a high intensity laser beam, or switch to an ion beam. The weapon also has a built-in laser targeting system and comes standard with a telescopic (2 mile/3.2 km) and infrared scope.

The standard Juicer optics helmet offers passive nightvision and other optical enhancements.

The JA-11 is also has a *canister* energy cell similar to the new CS canister E-Clips, and this is presumably where the Coalition got the idea to develop the device. The difference between the two is that the canister on the JA-11 can not be physically removed from the rifle, but can be recharged. Other than this, the energy cells work identically adding more power to the E-clip's capacity. In the case of the JA-11, the E-clip is used up first. Apparently, the canister was considered to be an energy reserve system.

Weight: 6.5 lbs (2.9 kg)

Mega-Damage: Laser has two settings: 2D6 M.D. and 4D6 M.D., both work on different light frequencies too.

The ion beam does 3D6 M.D. It was probably meant as a heavy assault or defensive weapon to be used against a large number of troops.

S.D.C. Damage: Single, hand loaded 7.62mm shell. Available types include a standard 7.62mm round that inflicts 5D6 S.D.C., or armor piercing 6D6 S.D.C., or exploding 1D6X 10 S.D.C. damage.

Rate of Fire: The laser is meant to be a precision sniper/assassin weapon and as such, can only be fired as an aimed shot. Total shots are equal to the total number of hand to hand attacks per melee. It can not fire bursts.

Ion beam: Aimed, burst, or wild as standard, see Modern Weapon Proficiency Section.

The 7.62mm round can be loaded and fired once for every two hand to hand attacks per melee; one to load and one to aim and fire.

Maximum Effective Range: Laser: 4000 feet (1200 m), Ion Beam: 1600 feet (488 m), S.D.C. 7.62mm round: 2000 feet (610 m).

Payload: Short clip 10 shots, Long clip 30 shots.

Canister Cell: Adds 30 shots.

7.65 mm round: One loaded in weapon, others to be added.

Laser Targeting Bonus: + 1 on an aimed shot.

Black Market Cost: 40,000 credits.

JA-9 Juicer Assassin Variable Laser Rifle

Another German Pre-Rifts design for the Juicer. A variable light frequency laser to overcome the laser resistant armors, like that of the Glitter Boy power armor. The juicer can adjust the frequency of the laser to blast through a Glitter Boy's defenses (or anybody else). Greatly resembles the JA-11, complete with laser targeting and scope.

Weight: 6 lbs (2.7 kg)

Mega-Damage: 2D6 M.D.

Rate of Fire: Standard, see Modern Weapon Proficiency Section.

Maximum Effective Range: 4000 feet (1200 m)

Payload: 10 shot with a short E-Clip or 30 with a long E-Clip.

Laser Targeting Bonus: + 1 to strike on an aimed shot.

Black Market Cost: 20,000 credits.

Rail Guns

A rail gun is an electro-magnetic system mass driver that fires metal spikes, balls, or rings at such a high velocity that the projectiles inflict massive amounts of damage. The projectiles need no gunpowder or explosive charges to inflict mega-damage, thus they are inexpensive to make and popular throughout the land. The famous "Boom Gun" of the Glitter Boys is a rail gun.

The down side to the rail guns are their size, weight, kick, loudness, and expensive and potentially dangerous power source. Few humans other than those with bionic augmentation can operate a rail gun as a handgun. Rail guns are most commonly used with power armor where

they are perhaps their most formidable, mounted on vehicles and giant robots, or as heavy, tripod mounted machineguns.

The loudness of the weapons, other than the glitter boy's Boom Gun, has been mechanically suppressed, but are still terribly loud (about equal to 85 decibels) and gun operators must still wear protective headgear to muffle the sound. Prolonged operation of a rail gun without a sound suppressor will cause permanent damage to the ears and eventual deafness. Many military rail gun operators have cybernetic sound filtration systems installed.

The size, weight, and kick of the massive gun is unavoidable and is why the weapon is restricted to power armor, robots and vehicles. Rail guns are generally two and three times larger than 20th Century heavy machineguns and weigh around a hundred pounds, not including the power pack and ammunition. When used as a machinegun, the person transporting the rail gun must have a minimum strength (P.S.) of 22 and is often assigned to a two or three man team with a combined strength of 42 or higher. One carries the tripod and huge case of ammunition (sometimes on wheels), while the other carries the rail gun and nuclear power pack.

The nuclear power pack presents a danger to life from radiation leaks. However, the power pack is well shielded and encased in a lightweight mega-damage alloy (40 M.D.C.). Note that the power pack will not explode if breached or even destroyed, but it will contaminate the area with deadly radiation. A radiation alarm system sounds an alarm to warn the operator of a leak.

C-40R Coalition SAMAS Rail Gun

The SAMAS rail gun is listed here because it has been widely duplicated (the CS is not pleased by this) and is light enough to be used as a vehicle mounted or tripod mounted machinegun.

Weight: 92 lbs (41.4 kg), Power Pack: 60 lbs (27 kg), One Ammo-Belt: 30 lbs (13.5 kg), Case of six belts: 190 lbs (85.5 kg).

Mega-Damage: A burst is 40 rounds and inflicts 1D4X 10 M.D., one round does 1D4 M.D.

Rate of Fire: Standard, see Modern Weapon Proficiency Section.

Maximum Effective Range: 4000 feet (1200 m)

Payload: As a machinegun: 400 round belt.

Black Market Cost: 110,000 credits. Rarely available.

NG-101 Rail Gun

Weight: Gun: 128 lbs (57.6 kg), Power Pack: 80 lbs (36 kg), One Ammo-Belt: 25 lbs (11 kg), Case of six belts: 160 lbs (72 kg).

Mega-Damage: A Burst is 30 rounds and inflicts 6D6 M.D., one round does 1D4 M.D.

Rate of Fire: Standard, see Modern Weapon Proficiency Section.

Maximum Effective Range: 4000 feet (1200 m)

Payload: As a machinegun: 300 round belt.

Black Market Cost: 70,000 credits. Not often available.

NG-202 Rail Gun

Weight: Gun: 198 lbs (89 kg), Power Pack: 100 lbs (45 kg), One Ammo-Belt: 35 lbs (16 kg), Case of six belts: 210 lbs (94.5 kg).

Mega-Damage: A Burst is 40 rounds and inflicts 1D4x 10 M.D. One round does 1D4 M.D.

Rate of Fire: Standard, see Modern Weapon Proficiency Section.

Maximum Effective Range: 4000 feet (1200 m)

Payload: As a machine gun: 300 round belt.

Black Market Cost: 70,000 credits. Not always available.

Note: Also see robots and power armor for other rail guns usually not suitable for use as a machinegun.

Vehicles Commonly used by Adventurers

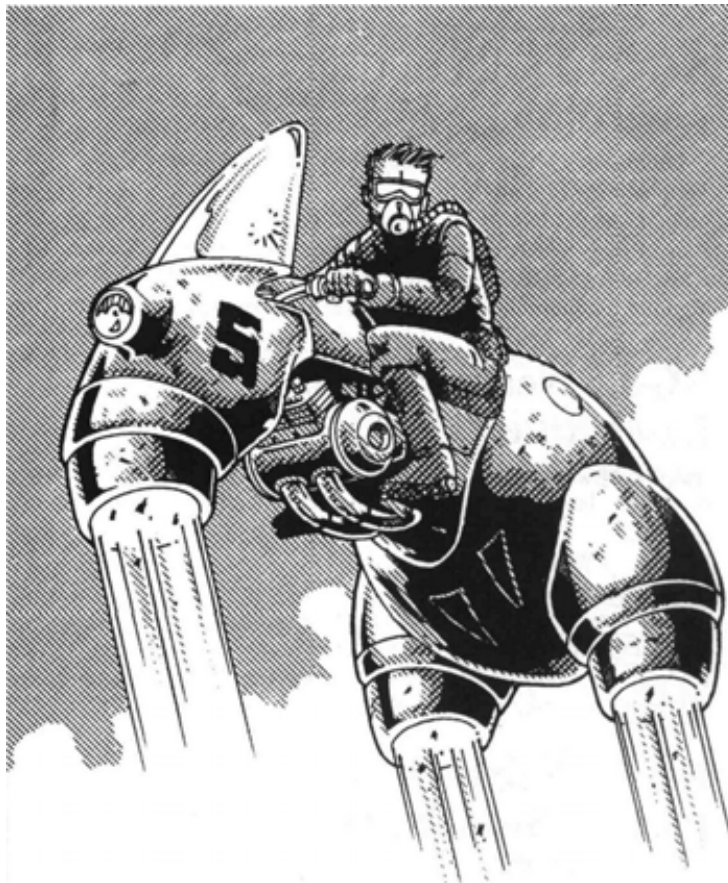

A.T.V. Speedster Hover Cycle

A fast all terrain hover vehicle common throughout the land.

Vehicle Type: Hover cycle

Crew: One rider, one passenger is possible, but not comfortable on long trips

Maximum Speed: 220 mph (192 km)

Engine: Combustion or electric engine.

Maximum Range: 800 miles (1280 km)

Length: 9 feet (2.7 m)

Weight: 700 lbs (315 kg)

M.D.C. by Location:

Main Body — 75

Black Market Cost: 98,000 credits gasoline engine or 110,000 credits for electric, or 450,000 nuclear with a 10 year life. Add 4000 for machinegun and 11,000 for laser.

Weapons: Laser: 1D6 M.D., range, is 1200 feet (366 m), payload is 20 shots. Or machinegun: 1D4 M.D. per burst of 50 rounds, range: 2000 feet (610 m), payload is 600 rounds (12 bursts). Mini-missile launchers can be added to the sides. The small launchers fire two mini-missiles each and cost 55,000 credits for the pair.

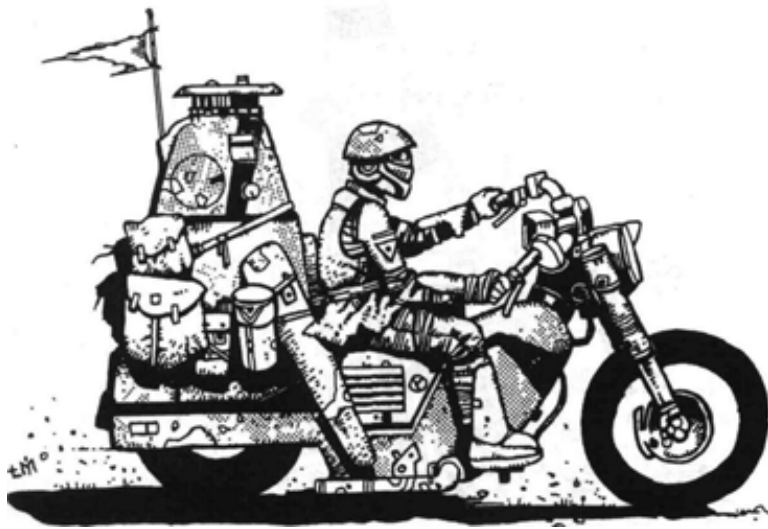

The Wastlander Motorcycle

A heavy duty rough terrain vehicle with a large storage area built into the back end.

Vehicle Type: Motorcycle

Crew: One rider.

Maximum Speed: 120 mph (192 km)

Engine: Combustion or electric engine.

Maximum Range: 400 miles (480 km)

Length: 9 feet (2.7 m)

Weight: 800 lbs (360 kg)

M.D.C. by Location:

Tires (2) — 1 each

Main Body — 45

Black Market Cost: 18,000 credits gasoline engine or 21,000 credits for electric. Add 4000 for machinegun and 11,000 for laser.

Weapons: None

The Highway-Man Motorcycle

A fast, rugged vehicle common to the city and flat lands. Comes standard with a laser or heavy machine gun.

Vehicle Type: Motorcycle

Crew: One rider.

Maximum Speed: 180 mph (288 km)

Engine: Combustion or electric engine.

Maximum Range: 400 miles (480 km)

Length: 6 feet (1.8 m)

Weight: 240 lbs (108 kg)

M.D.C. by Location:

Tires (2) - 1 each

Main Body — 75

Black Market Cost: 24,000 credits gasoline engine or 29,000 credits for electric. Add 6500 for machinegun and 12,000 for laser.

Weapons: Laser: 1D6 M.D., range, is 1200 feet (366 m), payload is 20 shots. Or machinegun: 1D4 M.D. per burst of 50 rounds, range: 2000 feet (610 m), payload is 600 rounds (12 bursts).



The Big Boss A.T.V.

A popular all terrain vehicle with good speed and good fuel mileage.

Vehicle Type: ATV Dune Buggy Type

Crew: One pilot and can accommodate three passengers comfortably.

Maximum Speed: 150 mph (240 km)

Engine: Combustion or electric engine.

Maximum Range: 300 miles (480 km)

Length: 16 feet (4.8 m)

Weight: One ton

M.D.C. by Location:

Tires (4) - 5 each

Main Body - 65

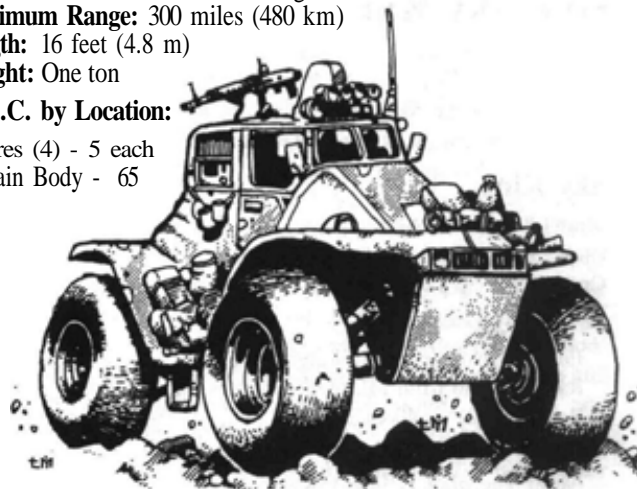

Black Market Cost: 24,000 credits gasoline engine or 28,000 credits for electric. Often comes with a sun roof and standard laser rifle attached to the roof; 360 degree rotation and 90 degree arc of fire. Add cost of rifle to vehicle.

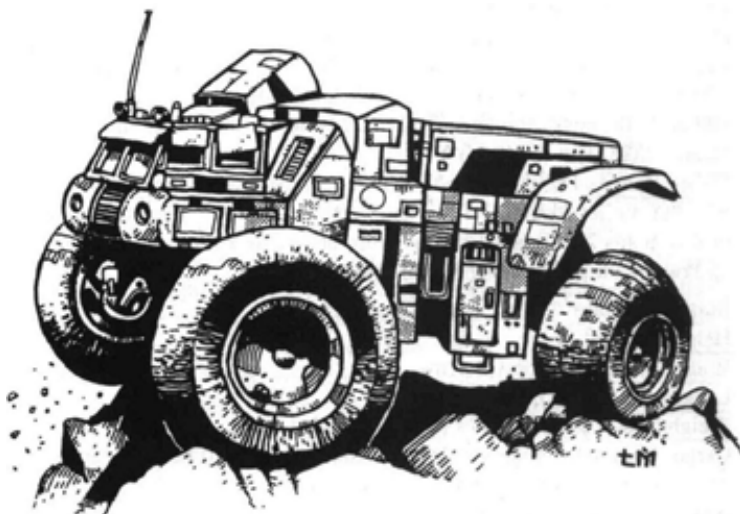

The Mountaineer A.T.V.

An extremely popular armored, all terrain vehicle. It has a pilot's compartment that can seat five and a large, enclosed cargo bay (10x8x8 foot cargo area).

Vehicle Type: Three wheeled armored ATV transport vehicle.

Crew: One pilot and can accommodate four passengers comfortably, plus cargo area.

Maximum Speed: 120 mph (192 km)

Engine: Combustion or electric engine or nuclear.

Maximum Range: 600 miles (480 km), has an extra large tank or batteries.

Length: 25 feet (7.6 m)

Height: 18 feet (5.4 m)

M.D.C. by Location:

Super Tires (3) — 25 each

Weight: 6 tons

Main Body — 140

Reinforced Pilot's Compartment — 50

Black Market Cost: 64,000 credits for basic vehicle (gasoline engine). Other features such as radar, radio, rail gun, etc. cost separately. 70,000 credits for electric engine and 500,000 for nuclear with a 20 year life. Additional armor can also be added at a cost of 10,000 credits per 30 M.D.C.

The Northern Gun Sky King

The most famous and popular combat vehicle created by the kingdom of Ishpeming (aka "The Northern Gun") is the heavy assault hover vehicle called the Sky King. The vehicle is fast, tough and reliable. Most importantly, it is brimming with weapons.

Sky King

Model Type: NG-A70

Class: All-Purpose Air Combat Vehicle.

Crew: One.

M.D.C. by Location:

Forward Mounted Nose Laser — 40

Rail Gun and Mini-Missile Launchers (2) — 50 each

Rear Jets (2) — 40 each

*Main Body — 130

Note: The pilot is shielded and a small and difficult target to hit. Thus, he can only be hit when a character makes a *called shot* and even then the attacker is - 3 to strike.

*Depleting the M.D.C. of the main body will destroy the Sky King.

Speed

Driving on the ground: Not possible.

Flying: The rocket propulsion system enables the Sky King to hover stationary up to 1000 feet (305 m) or fly. Maximum flying speed is 570 mph (912 km), but cruising speed is considered to range between 100 and 200 mph (160 and 320 km). Maximum altitude is limited to about 10,000 feet (3048 m).

Flying Range: The nuclear power gives the NG-Sky King decades of life, but the jet rockets get hot and need to cool after a maximum of twenty hours of flight when travelling at speeds above cruising, and 48 hours with rest stops and/or at cruising speeds.

Statistical Data

Height: 17 feet (5 m)

Width: 5 feet, 6 inches (1.7 m)

Length: 11 feet, 5 inches (3.5 m)

Weight: 2600 pounds (1170 kg) fully loaded.

Cargo: Minimal storage space; about four feet (1.2m) behind seats for extra clothing, weapons, and personal items.

Power System: Nuclear; average sky kings energy life is 12 years.

Black Market Cost: 1.5 million credits, and up, for a new, undamaged, fully powered NG-Sky King complete with laser, mini-missiles, and rail guns. About a half million for a rebuilt cycle without weapon systems. Fair availability.

Weapon Systems

1. Modified NG-101 Rail Gun and Mini- Missile Launchers(2): A rail gun and mini-missile launcher is mounted on each the sides of the NG-Sky King, near the midsection, above the concealed landing gear. Each contains a total of six mini-missiles.

Primary Purpose: Anti-Personnel

Secondary Purpose: Anti-Armor (tanks, robots, dragons, etc).

Missile Type: Any type of mini-missile can be used, but standard issue is fragmentation (anti-personnel, 5D6 M.D.) and plasma (1D6X10).

Mega-Damage: Mini-Missiles: varies with missile type.

Rail Guns: 6D6 per 30 round burst from one rail gun, or 2D4x 10 per double burst (both rail guns firing at the same target simultaneously). **Range:** About one mile.

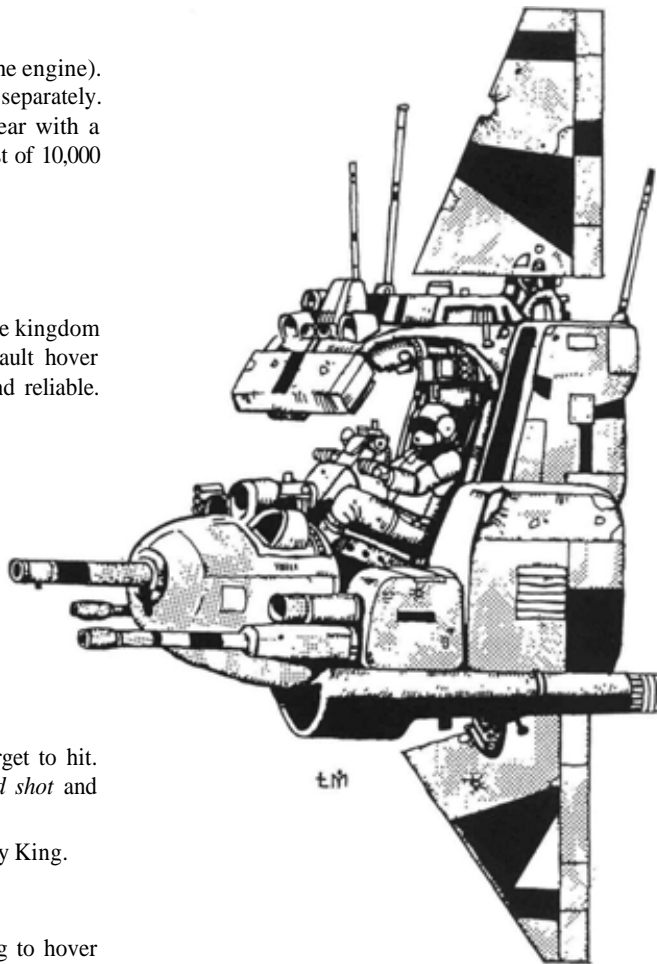

Rate of Fire: Missiles: One at a time or in volleys of two. Rail Gun is standard.

Payload: Mini-Missiles is twelve (6 in each side).

Rail Guns have 600 rounds each, that's 20 bursts each.

2. NG-101 Forward Mounted Heavy Laser (1): A heavy laser is mounted in the nose of the jet hover vehicle. It is fixed forward and can only shoot straight ahead.

Primary Purpose: Anti-Personnel

Secondary Purpose: Defense

Mega-Damage: 4D6 M.D. per blast.

Range: 4000 feet (1200 m)

Rate of Fire: The pilot can operate all weapon systems at a rate equal to the combined number of hand to hand attacks per melee (usually 4 to 6). **Payload:** Effectively unlimited.

3. Sensor System Note: Has all the standard robot sensors and communications capabilities, including radar.

Special Bonuses: + 2 to dodge when flying at cruising speeds and + 5 to dodge when flying over 350 mph.

Wilk's Jet Pack

A small personal jet pack capable of sustained flight. The Wilk's jet pack comes as a back pack like harness equipped with helmet, neck support, short range radio, and compass. **Vehicle Type:** Jet Pack

Crew: One rider

Maximum Speed: 120 mph (192 km)

Engine: Combustion or electric engine or nuclear.

Maximum Range: 800 miles (1280 km)

Length: 3 feet (0.9 m)

M.D.C. by Location:

Weight: 45 lbs (20 kg)

Main Body — 20

Black Market Cost: 38,000 credits gasoline engine or 50,000 credits for electric, or 350,000 nuclear with a 10 year life.

Weapons: None built into the pack, but normal hand guns and rifles can be used in flight.

Cybernetics

Cybernetics is the science of bio-mechanics, in which electronics and mechanical systems are integrated with biological systems; i.e., a mechanical heart implanted in a living being as a substitute for the flesh and blood organ.

Cybernetics began in the medical laboratories with the creation of crude mechanical hearts and prosthetics as early as the 1960's. While progress was made over the next several decades, it was the dramatic leaps in nano-technology that broke through the barrier that divided man from machine. The science of nano-technology enabled scientists to enter a new era of super-science. The development of cybernetic systems was among the most dramatically affected areas of science.

The development of *artificial tissue*, an organic flesh-like substance that was synthetically grown under controlled laboratory conditions, was the next incredible breakthrough in medicine. This meant scientists could literally grow skin and vein-like tubing and other organic substitutes to exact genetic specifications. This is much more awesome than it may sound. It was a revolutionary development that saved millions of lives. Collapsed and clogged veins and arteries were easily replaced with living, albeit synthetic, tissue grown to the genetic requirements of the patient. Burn victims were given a new lease on life. By using the artificial skin substitutes, skin grafts became comparatively simple. The need for finding undamaged flesh or a donor was eliminated and the risk of biological rejection was reduced to less than 1%.

The more spectacular developments occurred when the science of genetically manipulated tissue was combined with cybernetics. Doctors could now create mechanisms made of artificial flesh and micro-mechanics. It became not only possible, but common place to actually create man-made organic substitutes for damaged flesh and blood internal organs. The mechanism was usually encased in the synthetic living flesh, with artificially grown veins and arteries attached to the individual's real tissue/organs. The odds of the body rejecting these implants was reduced to almost zero. Most implant recipients, 88 percent, have no need to take anti-rejection drugs, while the remaining 12% need to take daily medication and have semiannual check-ups.

The perfection of the artificial heart implant, with a 40 year life, was a mega-success. The artificial kidney and liver would herald the age of medical miracles. Cybernetics was also one of the key events that brought to life the concept of the *improved* human being. Out of the pages of science fiction and into the real world sprang cyborgs, artificial life simulation (androids and robots), and genetic mutation as part of everyday life. Twenty years later, every nation would have some type of *bio-mechanical augmentation program* developing new miracles on what seemed to be a monthly basis.

In the modern world of the not too distant future, cybernetics and bionics became two distinctly different areas of science. Cybernetics was restricted to the world of medicine, where its technology was used to create artificial organs, skin, and prosthetics. The aim was restoration, not augmentation.

Bionics, although it uses many of the cybernetic principles, goes far beyond simple replacement organs and artificial limbs. The science of bionics deals with the deliberate *modification* and *augmentation* of biological systems through cybernetics and robotics in order to make human beings more powerful. A *bionic* individual, or cyborg, is as much machine as he is a living creature. By the time of rifts, the military had great success in creating super soldiers that were more machine than flesh. Living, thinking beings that could pack the wallop of a tank. See *Bionics for details*.

Cybernetics in the world of Rifts

The science of bio-mechanical implants

The technology of cybernetics (and bionics) has survived into the future world of **Rifts**. However, in this war torn and ever changing planet, the technology, training, facilities, components, and manufacturing of cybernetics is controlled and dominated by a mere handful of organizations. One place where the science of cybernetics flourishes is *Chi-Town* and the other members of *The Coalition States*.

The Coalition government strictly controls the training and availability of cybernetics. Consequently, its secrets are not taught in universities, but limited to government and military institutions. The average citizen of Chi-town can receive cybernetic medical treatment, which includes skin grafts, artificial organs, mechanical prosthetics/limbs, and even minor augmentation, but the surgery is prohibitively expensive. "True citizen," is a status reserved for rich business people and government officials who have a distinguished history for supporting the Coalition. These individuals are allowed to purchase cybernetics with ease and are often given scarce cybernetics and bionic limbs, weapons, and augmented sensors as rewards for their loyalty.

However, a cybernetic black market thrives in Chi-Town and other places where high technology is found. Individuals can purchase implants of all kinds and, in some instances, bionic augmentation as well. The cost is phenomenally high and may require more than a credit card. Often the "cyber-doc" will demand criminal service or acquisition of a particular item in exchange for his work.

Player Characters and Cybernetics

Any character can get and use cybernetics. Some characters like the *city rat* and *cyber-doc* have limited cybernetics to begin with. Others can add them later. There are no O.C.C.s entirely opposed to using cybernetics for medical purposes. However, players should be aware that the incorporation of cybernetics means altering the character's physical body by removing part of the living body and replacing it with a mechanical substitute. Even the best mechanisms are not the same as the original physical body, and despite the obvious enhanced abilities, the character is forever changing his body; for better or worse, what's done is done, and he or she will have to live with it. While many individuals, like the cyber-doc and headhunter, love cybernetic enhancements and are delighted to have them (and want more), others may regret their decision later in life.

Modified Men (M & Ms)

Beings who are obviously brimming with cybernetic implants or who are recognized to have 20% or more artificial body parts are commonly called "modified men" or "M & Ms." There is some degree of prejudice toward M & Ms for a number of reasons. One is that many, especially the simpler peasant folk, see cybernetics as unnatural and modified men as inhuman or even monsters. They cannot bring themselves to trust a Modified Man nor to feel comfortable with one in the village. Others see M & Ms as either the decadent rich, criminal rich, or mercenaries, all of which are viewed with suspicion and resentment. Lastly, there is a growing movement toward naturalism. Unless the cybernetics is needed strictly for medical reasons, naturalists believe that its use is an offense to the flesh and look upon modified men with disdain.

Of course, others see nothing wrong with mechanical enhancement. Cybernetics is widely accepted, not to mention commonplace, in the big cities of the Coalition States. Furthermore, many wilderness explorers and most men of combat see cybernetics and bionic augmentation as necessary and wonderful.

Cybernetic Augmentation Mechanisms

Cybernetics for the purpose of augmentation are mechanisms that have special and superhuman capabilities. They are designed to make the human body *better*, stronger, and more alert. Augmentation implants are usually mechanical and seldom utilize the melding of flesh and machine that occurs in cybernetic bio-systems.

Sensory Implants

Clock Calendar: A device that can be implanted almost anywhere, that continuously keeps track of the exact time, down to 100th of a second, as well as the calendar date. Data can be transmitted as an audio report through one of the ear implants or to a wristwatch-like receiver. **Cost:** 200 credits.

Gyro-Compass: A device that can be implanted almost anywhere, that can always locate North and the other directions, as well as up and down. Particularly useful when piloting aircraft. Data can be transmitted as an audio report through one of the ear implants or to a wristwatch-like receiver. **Cost:** 600 credits.

Sensor hand: A special prosthetic hand filled with sensors can be used to replace a severed human hand. Either the cruder mechanical hand or the deluxe bio-system hand, with living tissue, can be integrated. As usual, the hand will simulate the function of the original limb (see prosthetics, described later); however, this hand also has numerous other features.

The sensor hand is implanted with the following sensors:

Heat: The hand can precisely measure hot and cold temperatures emanating from objects, areas, people by touch (if not too hot, like taking a person's temperature), or by placing the hand near the subject in question, such as a hot grill, engine, campfire, etc. This can be extremely useful in telling if an engine has been recently used, hot and therefore, how old a campfire may be, locating heat sources, detecting fever, etc.

Range is limited to touch or about four to six inches from the heat subject. Remember that touching something that is extremely hot will damage/burn the hand just as it would a normal flesh and blood hand.

Motion Detector: The artificial hairs on the hand, or tiny hair-like wire on the mechanical prosthetic, are actually tiny motion detectors. The reliability of the detector is quite limited, but can be used to accurately assess wind direction and change, wind speed, and the rapid approach of large moving objects, which cause a disturbance in the air, such as a vehicle or aircraft. The latter ability is primarily useful in the dark because the speeding object must usually be within 500 feet (150 m) to create a detectable air current, a range where it would be easily detected by vision and probably sound in daylight. Likewise, the motion sensors will detect the movement of somebody/thing moving near by, within 40 feet (12 m), but only if the sensor hand is motionless or barely moving itself. The sensor can also detect sudden changes in air current and pressure caused by somebody opening a door or window, and can estimate speed of travel when inside an open-air (or open window) vehicle.

Radiation Detector: Detects and measures the amounts of harmful types of radiation and warns its owner. Includes nuclear, atomic, and microwave.

Radar Detection: A warning is transmitted whenever the sensor detects that it is being bombarded by radar signals (and radio waves). Unfortunately, the level of accuracy is only 68% (roll percentile dice) for determining direction.

Gyro-Compass: Always indicates north and all other directions, as well as up and down.

Clock Calendar: A simple device that continuously keeps track of the time, down to a 10th of a second, and the calendar day.

Total cost of the sensor system: 33,000 for a bio-system prosthetic hand or 20,000 credits for a mechanical hand, plus receiver(s) cost.

The data can be transmitted either electronically to a tiny ear receiver attached to the eardrum or to a wristband receiver (audio and digital readout on an LCD screen; looks like a wristwatch), or a hand-held radio-like unit the size of a pocket calculator. **The cost** of the ear receiver is 1000 credits (can be added to other ear implants), the wristband is 250 credits, and the pocket receiver is 100 credits. More than one of the receivers can be linked to the system in case one is damaged.

Ear and Head Implants

Universal headjack & ear implant: This is a special connector or jack that is built into the skull, usually at the base of the head or behind the ear. A tiny receiver is then inserted into the ear and linked to the headjack. The combination enables characters to plug into audio, sensory, robot, and computer equipment, including most communications equipment, radios, video systems, radar, detection/warning devices, microphones, surveillance systems, and more conventional items like CD players, television, disc recorders, and so on.

The headjack receives transmissions from the device that is plugged into it and transmits them to the tiny receiver inside the ear. The audio sounds are clear and distinct to the listener, but being implanted in the inner ear, they are so quiet that only the character can hear the message. Even creatures and devices with enhanced hearing will be unable to hear the sounds inside the ear.

The headjack is easily concealed by hair or by folds of skin. The receiver is so tiny that it is attached on or near the eardrum and can only be seen by carefully looking into the ear with a light. **Cost:** 8400 credits for basic system.

Special augmentation: The basic system can be upgraded to include a built-in radio receiver and transmitter which will allow the character to receive and send radio transmissions as if he were using a walkie-talkie. It is so effective that the character can transmit a whisper, or the voices of other people within six feet (1.8 m) of him. Range: 3 miles (4.8 km). **Cost:** 16,000 credits in addition to the basic headjack system.

Increasing the system for long range, wide band transmission will require additional surgery, a jaw implant for calibrating and switching channels, a high-powered battery, micro-amplifier, and an antenna implant in the skull. Range is increased to 20 miles (32 km) and further increased to 100 miles (160 km) if an additional long range, telescoping antenna is plugged into the headjack. **Cost:** 48,000 credits plus the basic headjack system.

The headjack can also be combined with the artificial video camera eye or optic nerve implant to see video images without needing an external monitor. *See eye augmentation.*

Amplified Hearing: A system of tiny sound amplifiers, microphones and receivers are built into the ear canal, enabling the character to hear almost inaudible sounds at 100 yards/meters away.

At 75 feet (22.9 m), sounds as quiet as one decibel, softer than a whisper, can be heard.

At 150 feet (45.8 m), sounds as quiet as 10 decibels, a whisper, can be heard clearly.

At 360 feet (110 m), sounds in the normal conversation range of 30 decibels can be heard as if the character was standing only a few feet away. This is the maximum range for eavesdropping on conversations; only sounds 70 decibels or louder can be accurately heard and location pinpointed from 500 to 1000 feet away (152.4 m to 304.8 m).

The amplified hearing also enables the character to accurately estimate the distance and location of the sound source, and recognize specific sounds and voices at a base skill of 35% plus 5% per level of experience. Bonuses: +1 to parry, +2 to dodge, +6 on initiative.

Note: Background noise, such as other conversations, traffic, machine noise, etc., as well as closed doors and wall, will decrease the range and clarity of what can be heard. GMs use your discretion.

The Decibel Scale

A 20 decibel sound is 10 times louder than a 10 decibel sound, 30 decibels is 100 times louder than 10 decibels and 40 decibels is 1000 times louder. One decibel is the smallest difference between sounds detectable by the human ear.

10 decibels: a light whisper

20 decibels: a quiet conversation

30 decibels: a normal conversation

40 decibels: light traffic

50 decibels: loud conversation

60 decibels: shouting

70 decibels: heavy traffic

80 decibels: loud noise like subway train, rock concert

90 decibels: very loud, thunder or explosion

100 decibels: jet take-off; temporarily deafening (2D4 seconds).

140 decibels: Sonic boom; painful, temporarily deafening (2D4 minutes).

Cost for amplified hearing: 20,000 credits.

Ultra-ear: Similar to *amplified hearing* except that it increases hearing perception into the ultrasonic range of high frequency sound, like the hearing of a bat. The character endowed with this additional range of hearing can hear the highpitched whine of a television capacitor or dog whistle, inaudible to normal humans, up to 300 feet (91.5 m), and the flapping of a bird's wings up to 150 feet away (45.8 m). The ultra-ear will also enable the individual to hear the whine of low frequency transmissions, footsteps, the ruffle of fabric rubbing against other fabric, and the scurry of a mouse at 150 feet. However, whenever the ultra-ear is engaged, sounds in the normal decibel range are *unintelligible*, sounding like a recording slowed down to the point that a normal conversation sounds like a deep rumbling noise and not words at all. For this reason, the ultra-ear can be turned on and off as needed.

Cost: 11,000 credits as a separate unit, 5500 credits if being added to the amplified hearing system.

Sound filtration system: This is an ear accessory that can be combined with a headjack and ear receiver, amplified ear, or ultra-ear. The filter will automatically react to potentially damaging sounds by filtering or plugging the ear. Sounds are muffled to protect the character from deafening or disorienting levels of sound such as gunfire, explosions, heavy machinery, and painful sound waves.

Cost: 3500 credits, but can only be added to an already existing cybernetic ear implant.

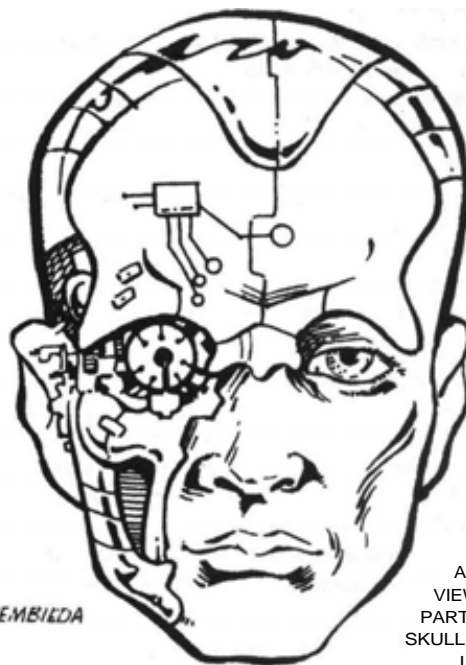

A CUT AWAY VIEW OF WHAT A PARTIALLY REBUILT SKULL AND EYE MIGHT LOOK LIKE.

Eye Augmentation

All mechanical augmented eyes look more like a camera lens than a real eye. The recipient of one of these implants will be unable to disguise the cybernetic eye except by covering it with tinted glasses or goggles, or an eye patch.

Mechanical eye with polarized filters: A robot-looking eye that simulates normal human vision, with the added feature of polarized vision. The glare of bright light and sunlight is polarized as if the individual were wearing the best polarized sunglasses available. Can look directly into the sun without being blinded. Engages automatically as needed. Choice of lens color. Perfect 20/20 vision. **Cost:** 10,000 credits; 16,000 for pair.

Thermo-imager eye: This artificial eye simulates normal human vision, with the added feature of an optical heat sensor. The lens converts the infrared radiation of warm objects into a visible image. The character is able to see heat as represented by bands of color and can see in darkness, shadows, and through smoke. Perfect 20/20 vision. **Cost:** 12,000 credits; 20,000 for pair.

Old-fashion infrared eye: This type of optical enhancement relies on a source of infrared light, a pencil thin beam of light projected from the eye to the target. The narrowness of the beam limits the viewing area to a small area of about seven feet (2 m). Range: 1200 feet (366 m). The eye also simulates normal human vision. **Cost:** 6000 credits; 9000 credits for a pair.

Telescopic eye: In addition to normal 20/20 vision, the eye has a telescopic lens for long distance viewing. 8 x magnification, range: 6000 feet (1830 m). **Cost:** 12,000 credits; 20,000 for pair.

Targeting sight: This is a feature that can be added to any of the mechanical eyes. Cross hairs are superimposed over the visual image to help focus on a specific target area. Adds a bonus of + 1 to strike when using any weapon. Note: Two targeting eyes still provide only a + 1 bonus to strike, not +2. **Cost:** 4000 credits.

Multi-optic eye: A mechanical optic system that includes the following:

Telescopic: 4x magnification, range: 6000 feet (1830 m)

Macro lens: 8x magnification, range: 3 feet (1 m)

Passive night vision: Range: 2000 feet (610m)

Thermo-imaging: Range: 2000 feet (610 m)

Light filters: Reduces glare.

Targeting display: Adds a bonus of + 1 to strike with any weapon.

Cost: 55,000 credits; 100,000 for pair.

Video camera eye: The camera provides no form of simulated vision, but is a full micronized video camera system. The tiny video recorder tapes everything the person looks at and hears. The images are recorded on a two hour, one inch video disc that is slipped into an implant in the skull. The disc can be easily ejected from a tiny slot and a new one put in.

The addition of a *headjack* enables the character to plug directly into a video monitor and display it for viewing without ever removing it. The headjack also enables the character to plug into recording and duplicating equipment, allowing him to duplicate his disc or duplicate his disc onto another, or record video transmissions. **Cost:** 20,000 credits for one eye.

Optic nerve video implant: This advanced operation implants an optical sensor right on the optic nerve. The implant works very similarly to the inner ear implant of the headjack, except instead of receiving audio transmissions, it enables the recipient to *see* video transmissions in his head/eyes. This can be incredibly useful for secretly monitoring video transmissions and video discs. The combination of the headjack and optic implant will enable the character to both see and hear audio video messages. **Cost:** 35,000 credits, because of the delicate nature of the operation.

Note: Experiments with the optic nerve video implant have also been found useful in restoring sight in blind people. 1-45% chance of full restoration of vision, 46-80% chance of restoring 65%, 81-95% restores 40%, 96-00% only 10% (legally blind).

Lung Implants

Oxygen Storage Cell: A special chemical cell, controlled by micro-processors, that stores oxygen from the character's normal breathing. Then, when oxygen is low, the oxygen is released back into the lungs. The net effect is to give the character the ability to go without breathing for up to 30 minutes. Note that the character must breathe normally for about an hour to recharge the cell between uses. **Cost:** 60,000 credits.

Toxic Filter: A mechanism designed to filter *most* toxic gases out before they enter the lungs. The filter is effective against all types of tear gas, smoke, and purely chemical fumes. There is an 80% chance that it will also work against nerve gases and poison gases. **Cost:** 40,000 credits.

Molecular Analyzer: This micro-chip based sensor is used for testing and analyzing impurities in the air. It can specifically identify any chemical, or strange and dangerous molecules, like the presence of gas, oil, pollution, or other chemicals in the air. Data can be transmitted as an audio report through one of the ear implants or to a wristwatch-like receiver. It does not enable one to track. **Cost:** 35,000 credits.

Bio-Systems

Cybernetic bio-systems are cybernetic implants built into or combined with living tissue and organs. These are the most advanced and natural of the implants, often combined with genetic manipulation and cloning to create true synthesis of man and machine; basically, living machine parts for the human body. Although they rarely have the spectacular abilities that the mechanical augmentation cybernetics and bionics are famous for, these implants offer the recipient the luxury of a real, non-mechanical appearing simulation that will look and function close to 100% natural.

Bio-systems always cost much more than mechanical simulations, because of the complexity in creating a cyber-part that combines both living matter and micro-machinery, and because of the cosmetic superiority of the item. People are vain and will pay exorbitant prices to look perfect or natural. *See cybernetic augmentation and black market cybernetics for prosthetics and sensory implants that offer exceptional mechanical capabilities.*

The following items are all available cybernetic implants and prosthetics. Most of these items were not designed with the intention of deliberately changing the original human body for the purpose of augmentation with superior mechanical substitutes, but were created for medical purposes. However, the abusive use of cybernetics, and to a somewhat lesser degree, bionic augmentation is commonplace among the technologically advanced civilizations of **Rifts**.

Artificial Bio-System Eyes

A character can have a damaged eye restored (or a good eye replaced) with a living cybernetic replacement. In addition to restoring full 20/20 vision and creating a perfect and natural cosmetic appearance, there are also modified eyes which offer visual capabilities beyond the range of normal human vision. **Note:** One eye or both eyes can be replaced. If only one eye is replaced with an augmented bio-system eye, the natural eye must be closed in order to use the augmented one. It is not recommended to get two different augmented eyes due to eyestrain and sensory confusion that can cause severe headaches (—2 on initiative and —10% on all skills) and eventual impairment of vision. Clients should purchase one augmented eye to complement the natural eye, or a pair of the same type of augmented eye.

Simulated eye: A natural, realistic eye that appears and functions exactly like the real thing, but is created in the laboratory with synthetic tissue and nano-technology. Choice of eye color. Perfect 20/20 vision. **Cost:** 20,000 credits per each eye; 35,000 for pair.

Polarized eye: Looks completely natural, but has the capability of polarized vision. The glare of bright light and sunlight is filtered as if the individual were wearing the best polarized sunglasses available. Can look directly into the sun without being blinded. Engages automatically as needed. Choice of eye color. Perfect 20/20 vision. **Cost:** 30,000 credits; 53,000 for pair.

Underwater eye: The cornea is designed to automatically distort when submerged underwater, enabling it to compensate to the new watery environment without need of goggles or other eye protection. The character can see with crystal clarity underwater. 20/20 vision. Choice of eye color.

The eye also contains a self-replicating oil that is automatically released into the eye whenever the water is murky or bright with sunlight. The oil droplets are haze filters which reduce glare from sunlight and filter out reflections and haze from tiny debris particles floating in the water, allowing for quality vision. The oil droplets are also released above water when exposed to bright light, creating a natural and instant filter/sunglasses effect, reducing glare (not as good as polarized vision, but equal to a cheap pair of sunglasses). **Cost:** 35,000 credits; 65,000 for pair.

Infra/Ultra eye: A natural, but a bit unusual looking eye. The pupil is noticeably larger than a normal eye's and the iris is an unusual violet or alizarin color. This eye enables the character to see into the infrared and ultraviolet spectrums of color. This means that the character can see in the dark equal to an infrared camera (range is about half the distance of normal day vision), as well as see infrared and ultraviolet light (such as used by the older surveillance and optical enhancement systems), normally invisible to humans. However, this does change color perception for the character. Normal vision sees the colors blue, green, and red. The infra/ultra eye sees

the colors blue, green, and ultraviolet, so everything is seen in hues of purple-blues, deep greens, purple, and violet, much like wearing red or purple tinted sunglasses all the time.

Note: The character can not see the invisible nor see heat emanations, only far red light (infrared) and ultraviolet light. 20/20 vision.
Cost: 70,000 credits; 125,000 for pair.

Artificial Bio-Systems For The Head

Inner ear: Completely rebuilds inner ear and eardrum to create perfect human hearing. Not augmented. **Cost:** 20,000 credits per one ear; 36,000 for pair.

Outer ear: A cosmetic procedure that replaces a damaged or missing outer ear with a natural living ear. **Cost:** 1500 credits to make the replacement match the other original ear's skin color perfectly. 500 credits for a generic replacement that does not match the skin color nor ear shape of the original.

Nasal passages: Restores or replaces damaged nasal passages with synthetic skin and smell sensors. Duplicates the human's natural ability to smell odors at 75%. **Cost:** 5000 credits.

Outer nose: A cosmetic procedure that replaces a damaged or missing nose with natural looking living tissue built over a synthetic frame. **Cost:** 2000 credits to make the replacement match the original nose, or a nose structure of choice, and natural skin color to match the face perfectly. 900 credits for a generic replacement that does not match the skin color nor perfectly match the shape of the face (could be a little too big, too small, or too wide).

Lips: A cosmetic procedure that replaces damaged or missing lips with natural looking living tissue. **Cost:** 600 credits.

Tongue: Replaces a damaged tongue with a synthetic one composed of living tissue, blood vessels, and taste buds/sensors. Duplicates the natural ability to taste by 63% and offers full speech articulation. **Cost:** 14,000 credits.

Larynx and voice box: Replaces the damaged organ with a synthetic bio-system that can simulate human sound/voice. The voice can be made to simulate the original voice exactly, as long as a quality recording is provided. Or the patient may create a new voice by selecting the desired aspects and quality of that voice, all of which are programmed into the replacement unit. **Cost:** 18,000 credits.

Internal Organs

Artificial Heart: 40 year life. **Cost:** 70,000 credits.

Artificial Lungs: 40 year life. **Cost:** 50,000 credits.

Artificial Kidney: 30 year life. **Cost:** 30,000 credits.

Artificial Liver: 30 year life. **Cost:** 30,000 credits.

Artificial Spleen: 30 year life. **Cost:** 30,000 credits.

Artificial Intestine: 25 year life. **Cost:** 10,000 credits.

Artificial Skin/Plastic Surgery: 50 year life. **Cost:** Varies depending on the complexity of the job and amount of reconstructive surgery necessary; 1D4X 1000 credits for minor skin grafts like on a hand or small fleshy area, 2D6 x 1000 for minimal work on a large fleshy area like the leg or back, 1D4 x 10,000 or more for muscle and skin reconstruction, 2D6x 10,000 or more for muscle, skin and bone reconstruction. Add 20% when working on the face.

Cybernetic Prosthetics

Prosthetics are artificial limbs and appendages designed to take the place of a damaged or missing appendage. They include fingers, hands, arms, toes, feet, legs, nose, and ears.

The simplest type of ancient prosthetic was a wood, metal, or plastic replacement part with no feeling and few, if any, moving parts. Cybernetic prosthetics are the most advanced artificial reconstructions possible. The appendage looks, feels, and responds just like the genuine article.

Bio-System Prosthetics Arms & Hands, Legs & Feet

The deluxe bio-system appendages are the most expensive. These mechanical limbs even have what looks and feels to be real skin and offers the individual some genuine sensation of touch and nearly full, life-like articulation. The use of artificial skin grafted to the real skin makes scarring minimal. Connecting veins and blood circulation keeps the artificial skin alive and helps create the sensation of touch.

The mechanical portions are connected with neural fibers that register and translate the electro-magnetic impulses of the body's muscles causing the artificial limb to respond exactly like the real appendage. An arm bends, a hand opens and closes, the fingers feel and grip, toes wiggle.

On the down side, even with sensors and computerized memory, the appendage does not have full, truly human feeling. The best possible is about 56%. This means that while the motor response of the prosthetic is nearly perfect, 96%, it can not completely simulate the feeling of touch. It can not 100% feel the warmth of a breeze, or the touch of a gentle kiss from a loved one. However, it is a miraculous alternative to having no hands or legs at all.

Mechanical Statistics: Attribute maximums for hands and arms are P.S. 8, P.P. 10; S.D.C. 25. Weight: 6 lbs. Legs are the same, with a maximum speed attribute of 10 and a S.D.C. of 40. Weight: 15 lbs. Skill penalty of — 5% due to lack of full articulation and sense of touch.

Medical Statistics: If the appendage is cut (or burnt), it will bleed real human blood and must be bandaged and/or sewn to prevent blood loss. If the damage is not too severe, the artificial skin and blood vessels will heal by themselves at about the same rate as real skin.

Severe damage is irreversible and will cause the skin to die and the appendage may cease to function properly, if at all, if the links to the neural synapse system are broken (1-50 % chance). Broken neural links will immediately render the appendage numb and immobile. Both situations can be life threatening, causing the limb to decay and sending gangrene poisoning through the entire body. Unless the appendage is removed within 48 hours of the damage, the blood poisoning will inflict 2D6 damage direct to hit points every 24 hours. These hit points can not be restored until the decaying appendage is removed and medical treatment is administered. Of course, a new cybernetic prosthetic may be attached later, when the patient is well.

Average Costs

Finger or toe: 1000 credits

Hand or foot: 20,000 credits

Arm: 22,000 credits

Leg: 45,000 credits

Hip: 35,000 credits

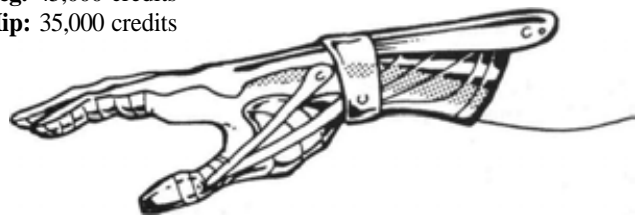

Mechanical Prosthetics

Mechanical cybernetic appendages are much less expensive and function basically the same as the bio-systems with neural attachments and have excellent motor response. The major difference is that the skin covering is not living flesh, but an obviously synthetic and feeling-less covering. The skin is usually a soft, skin-colored plastic, but it can be hard plastic or even metal.

The disadvantage, other than its more obvious nature, is that there is no true sense of touch, only sensors designed to respond to heat and pressure. The lack of touch can be emotionally and mentally debilitating. However, the mechanical substitute is still a marvelous alternative to no limb at all.

Mechanical Statistics: Attribute maximums for hands and arms are P.S. 10, P.P. 10; S.D.C. 35. Weight: 12 lbs. Legs are the same, with a maximum speed attribute of 10 and a S.D.C. of 50. Weight: 30 lbs. Skill penalty of -15% due to lack of full articulation and no sense of touch.

Medical Statistics: If the appendage is subjected to minor damage from a cut or burn, only surface blemishes and disfigurement of the outer skin casing will result, but the mechanical functions are unimpaired.

Severe damage can snap the neural links (1-40% chance), transforming the limb into an immobile paperweight attached to the body. To avoid unnecessary stress to the connecting portion of the flesh and blood body, the limb should be supported in a sling or brace. Unlike the appendage with artificial skin, there is no flesh or fluids to decay and poison the body. However, the following movement penalties apply to immobile limbs. **Hand/arm:** -2 to strike, parry, dodge, and roll; the person's balance is off even if the arm is not his main one. **Foot/leg:** -2 to strike, parry, and dodge, -2 on initiative, -3 to roll, no kick attacks are possible without falling down and losing one attack; reduce speed by half. Penalties are accumulative for each damaged limb.

Average Costs

Finger or toe: 500 credits

Hand or foot: 12,000 credits

Arm: 14,000 credits

Leg: 32,000 credits

Hip: 25,000 credits

Black Market Cybernetics

As a rule, any of the implants and cybernetics listed can be procured through a black market cyber-doc clinic or body-chop-shop.

The independent and caring black market cyber-doc is a rarity. Cybernetics are simply too costly and dangerous to get unless one has a huge support organization. Because cybernetic augmentation is so desperately wanted by so many, the crime lords make a prosperous living providing it.

Black market cyber-docs are seldom nice guys. They are usually self-serving criminals who work for a larger criminal organization. They prey on the desperation of the sick, the terror of those hunted by the Coalition, and the greed or power of the rich and corrupt to sell their services. They are seldom caring doctors who seek to help the unfortunate. Instead these scavengers are evil and corrupt men and women who sell an illegal service for profit. Big Profit.

Black Market Prices

Most cyber-docs, especially the criminals and chop-shop butchers, won't care if a person is laying on his floor dying. It's pay the price or leave. The price too high? Too bad. The alternative is to find somebody else to do the job or live without the implant (if you can). With luck, the individual will have enough credits for the job, or already have something worthy of trade, like an old artifact, mega-damage weapons or armor, information/secrets, or other commodity that the mob will find valuable. Of course, there are other ways to pay for black market surgery.



The crime kingpins deal in drugs, theft, smuggling, extortion, abduction, assassination, and numerous other illegal activities. This means that the penniless character may be able to trade a service(s) to pay for the operation. This could be just about any criminal activity. The price may be something not too sinister, such as breaking and entering to steal something, or protecting a mob member, or making a delivery, or spying on somebody, etc. Or it could be extremely evil, like assassinating a competing crime boss or a prosecuting witness, or busting up another gang's facility, or going up against Coalition soldiers.

Another way to pay for an implant is to provide the item one desires to have implanted, along with a few extra cyber-parts to pay for the surgery. The malevolent cyber-doc doesn't care whether it has been stolen and won't ask questions. Some may even demand additional components as payment for the surgery.

The worst cyber-doc clinics are called "Body-Chop-Shops," where the most unscrupulous, careless, and evil surgeons operate. The proprietors of chop-shops are always in the market for cybernetic and bionic parts. They pay 40% to 60% of list price and never ask questions. This has created ghoulish gangs of low-life punks, criminals, and junkies called "cyber-snatchers," who look for individuals with cybernetic implants and prosthetics, follow them, and then mug them, taking the implants. Unfortunately, since most implants and prosthetics require surgery, stealing them means murdering the victim or severing the limb from the connecting joint. The fortunate victim of a cyber-snatcher assault is maimed, but lives to replace the implant. Most are not so fortunate. **Note:** Cyber-snatchers are always diabolic or miscreant evil and usually junkies or psychopaths (or non-human monsters and demons). They often travel in pairs or small gangs of 2D6 members. Cyber-snatchers are generally loathed by everybody, including the Coalition, and the majority of the black market operatives.

Black Market Prices by Organization

Generally, **black market prices** are 10% to 30% higher than the list price. This is true of organized crime and most of the tiny independents. However, there are sometimes specials on a particular implant (usually when the market is flooded with a specific stolen component) that matches list price or even drops 10% below it.

The terms for trading contraband will vary with the person one is bartering with and the scarcity and demand of the item for trade. Unless the item is extremely rare and valuable, trade materials must equal at least *two times* (2x) the list value of the implant cost. **For example:** A character who wishes to get amplified hearing, which lists at 10,000 credits, will have to provide at least 20,000 credits' worth of valuables in trade. To complicate matters, the valuables must be something the cyber-doc, clinic, or mob can use and/or resell easily. If the items are of some interest, but of little value, the character may have to provide three or four times the value of the cybernetics to pay for it. On the other hand, if the character has a rare or incredibly valuable item, he will be treated like a king, get his implant and perhaps a line of credit to boot. **Note:** Establishing a line of credit at a black market facility can be good. But it is wise to spend it quickly in case it is closed down by the authorities or is taken over by new management who will not acknowledge old debts or credit.

The rare, well intentioned healer will always try to keep his prices as low as possible, falling in at list and as much as 10% to 20% below list. However, they will seldom service mercenaries or criminals (as in thugs), saving their precious supplies and skill for the poor and needy citizens who don't have anywhere else to turn. Trade will be fair, but limited to items he really needs, like medical equipment and drugs.

The body-chop-shops are the worst and the cheapest facilities available. Prices drop in at about 10% to 30% below list and trade is conducted the same as described previously. However, the quality of the treatment can be despicable. Unnecessary scarring and problems

are common. As one might suspect, the detestable cyber-doc has no sympathy or compassion for the victims of his carelessness and will offer no refund or discount to compensate the character for his problem. Two powerful, cyber enhanced body guards, or more, will see to it that disgruntled patients do not protest too loudly. Needless to say, people rarely mourn the death or disappearance of some of these fiends.

Body-Chop-Shop Side Effects Table

Roll on the following table for side effects every time an implant is installed or repaired at a chop-shop.

- 01-20 No serious problems, although suffer from unnecessary aches and bruises for 1D4 weeks.
- 21-40 Minor, but unnecessary scarring. Will heal with little trace within 3D6 weeks; until then, reduce P.B. by one.
- 41-60 Neural or chemical side effect, suffers from dizziness and headache for 2D6 weeks; penalties are —4 on initiative, —5% on all skills and reduce speed by 10%.
- 61-80 Permanent and unnecessary scarring. Reduce P.B. attribute by one.
- 81-90 Malfunction: Prosthetics are a bit stiff, reduce P.P. of that unit by one. Implants and sensors are not quite up to full efficiency, reduce ranges, percentile levels, and abilities by 10%.
- 91-00 Chronic pain, reduce P.E. by one; permanent effect.

Black Market Specialties

The following items can be created and/or attached by any cyber-doc, but are obviously not your standard medical cybernetics. They are all modifications designed for combat or criminal functions.

Finger Camera: A tiny still camera fits inside the tip of one finger. The camera can shoot 48 photos on microfilm and is designed to automatically adjust for low light and bright light exposures. The camera shoots a picture each time a concealed stud in the finger is pressed. **Cost:** 1200 credits. Film costs about 50 credits per micro roll and takes about 30 seconds to reload.

Finger Gun: One finger is not quite as lifelike and does not bend. This is a one shot gun; point and fire. The bullet must be a small caliber (.22, doing 2D6 damage) or a tiny explosive pellet or energy bolt. Can be reloaded in 10 seconds. Effective range: 300 feet (91.5 m).

Cost: 4500 credits for projectile finger gun. The energy bolt finger costs 20,000 credits and has a special two-blast energy cell that costs 3000 credits each. Each blast inflicts 1D6 mega-damage.

Cost of projectiles: .22 caliber shells, about 40 credits for a box of 100. Special explosive shells that inflict 6D6 S.D.C. damage cost 40 credits each. Mega-damage shells (1D4 M.D.) cost 500 credits each.

Fingerjack: The artificial finger can plug directly into communication systems, radios, sensory equipment, and robots, to receive direct data transmissions. **Note:** Needs amplified hearing or other cybernetic ear augmentation to receive the transmitted data. **Cost:** 2400 credits.

Razor Fingernails: The fingernails are replaced with artificial nails that are razor sharp. These nails can be carefully used as tiny blade weapons in a slashing or clawing attack. Each nail inflicts one point of S.D.C. damage. It is not recommended to get razor fingernails for both hands or on all fingers. Can be attached to normal fingers or prosthetics. **Cost:** 200 credits each.

Explosive Finger Segments: One finger is a false finger, usually the little finger. Each of the three joints can be pulled apart and each thrown like tiny hand grenades. **Cost:** 100 credits for three segments of light explosives, inflicting 1D4 x 10 S.D.C. each. 350 credits for three finger segments of heavy explosives, inflicting 2D6x10 S.D.C. each. 1000 credits for three segments of mega-damage explosives, inflicting 1D6 M.D. each. Area affect of each explosive is

limited to a 5 foot (1.5 m) area. Effective throwing range is approximately 50 feet (15m).

Knuckle Spikes: Suitable only for cybernetic hands. Either by muscle control or verbal command, four retractable spikes emerge from their knuckle housings to instantly create a vicious punching weapon. Adds 1D6 S.D.C. damage to a punch or backhand strike. Also enables the character to parry blade weapons with the knuckles. Cost: 800 credits.

Shooting Knuckle Spikes: Suitable only for cybernetic hands. In this case, the knuckles can fire four tiny spikes from secret housings in the knuckles. The trigger mechanism can be a stud concealed in the palm or first finger. Range is limited to about 50 feet (15.2 m). Cost: 1600 credits for the firing mechanism plus spikes.

Spike Cost: 50 credits per set of four needle-like projectiles that do 1D4 S.D.C. damage each. 120 credits for four explosive spikes that do 3D6 S.D.C. damage each. 3400 credits for four explosive spikes that do 1D4 mega-damage each.

Wrist or Palm Needle: A retractable needle is concealed in the artificial hand or wrist and can be extended to stab, or inject drugs into an opponent.

Cost: Stainless steel stabbing needle does one S.D.C. point of damage and costs 300 credits. A hypodermic needle capable of injecting one dose of fluid costs 1200 credits. Drugs must be purchased separately. The most commonly used include:

Antibiotics: Costs 75 per dose.

Tranquilizer/Sleep: Takes effect within 1D4 melees, lasts 4D6 minutes; costs 100 credits per dose.

Truth Serum: Takes effect in 2D6 minutes, lasts 3D6 minutes; costs 75 credits per dose.

Paralysis: Takes effect in 1D4 melees, lasts 2D6 minutes; costs 150 credits per dose.

Poison: Takes effect in 1D4 melees, inflicts 6D6 S.D.C./hit point damage; costs 200 credits per dose.

Garrote Wrist Wire: A thin, strong wire is hidden inside a prosthetic wrist junction that can be pulled out and used to strangle an opponent. S.D.C. strangle damage applicable only. Cost: 200 credits.

Climb Cord: Similar to the garrote wire, this is a ten foot (3.5 m) length of 500 lb (225 kg) test cord, no thicker than string, that can be pulled out of an artificial wrist or arm. The cord is primarily used by thieves and city rats for prowling and climbing around. The length isn't long, but can be used to loop around projections to steady oneself or scale walls. A favorite ploy of thieves is to use the cord to avoid authorities by dangling, unseen, under a balcony or above, from a pipe.

A weight can be attached and used as a chain-type weapon (1D6 S.D.C. damage) or a small grappling hook can be attached for climbing. Cost: 1500 credits; grappling hook and other attachments extra (can be made or bought for under 30 credits).

Cyber-Armor: This is a unique lightweight armor that is grafted right to the skin. The armor plates are less than an eighth of an inch thick and form fitted around the contours of the body. Cyber-armor is only grafted to the chest, shoulders, shoulder blades, and thighs for two reasons. One, the body needs to breathe through skin pores and secondly, additional armor would greatly impair movement (reduce attacks, bonuses, and speed by half).

The rest of the body is not protected. Consequently, this is one of the few mega-damage armors that has an *armor rating*: A.R. 16. A roll above the A.R. 16 means an unprotected portion of the body has been hit and damaged. The cyber-armor has a total M.D.C. of 50. Adds 20 pounds (9 kg) to body weight. Cost: 55,000 credits.

Cyber-Disguise Type AA-1: A complete cybernetic disguise system built into the face. Bladders placed under the skin enable the person to change the shape of his face. The cheeks can be puffed up to

look fatter or more pronounced, the chin can be made to become rounder or pointier, the nose is adjustable, with four different looks, the ridges of the eyebrows can adjust to protrude or retract, micro gears and bladders around the eyes can add or reduce wrinkles around the eyes or make them appear rounded or slanted, and the lips can be made fuller or thinner.

Chemical units placed in the eye socket inject a non-toxic dye that will change the color of the iris. Similar chemical implants change the color tone of the skin. Artificial hair, that can change into five different colors and 15 different shades, replaces real hair. The hairline is also changeable with a little manipulation.

A larynx manipulator device, surgically implanted onto the vocal cords, stretches or contracts the cords to completely change the person's voice as well. The character can even imitate the voices of others with abase skill of 40% plus 2% per level of experience.

A memory chip implanted in the skull allows the character to program six distinctly different faces into the disguise unit. The transformation of these computer stored faces requires approximately 1D4 minutes to complete. Skin pigmentation changes require one hour. If the person has the disguise skill, he or she can attempt to alter his features manually, with an infinite number of possible guises.

Cost: 450,000 credits

Cyber-Disguise Type AB-2: This is a much simpler and inexpensive disguise package that includes a bio-electric wrinkle manipulator that changes the wrinkles on the face by compressing and stretching the skin. Can go from a youthful, wrinkle free face, to a wrinkle covered grandpa. Also an eyelid compression device used to change the appearance of the eyes from a flat, round eyed Caucasian look, all the way to a full Oriental epicanthic fold. Lastly, a few strategically placed silicon sacks, usually in the cheeks and chin, enables the character to alter his features. A silicon softener is first injected into the sacks; the needle is tiny and only a drop of softener is needed. The character then pushes and molds the silicon with his fingers, like clay. Cost: 85,000 credits.



Bionics

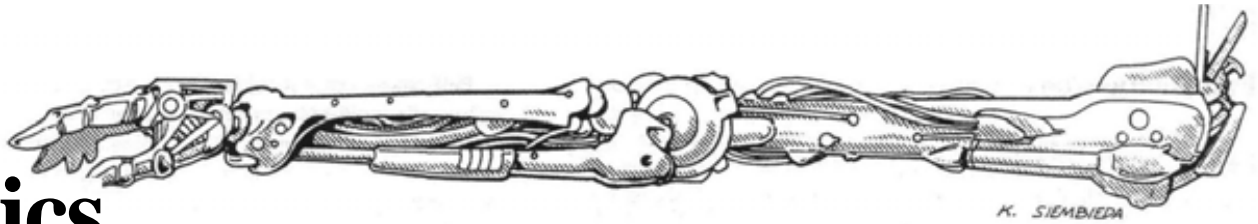

Bionics is a cybernetic process designed to create super soldiers by removing the majority of human body parts and replacing them with superior mechanical facsimiles. Bionics are specifically used for war or heavy labor. Consequently, they are larger, bulkier, and more obviously mechanical than cybernetics. This means that they can not be cosmetically altered to look human.

Who can get bionics?

Only the *Borg O.C.C.* can get a full bionic conversion or a partial reconstruction, which is the minimum that a Borg O.C.C. can receive.

The *Headhunter*, *Coalition Military Specialist*, *Coalition Dog Pack*, and *Cyber-Doc O.C.C.s* are the only other occupational character classes allowed to get any bionic systems, and even then, bionics is limited to a prosthetic weapon limb and weapons for that bionic limb. These O.C.C. characters seldom have more than one or two bionic prosthetics, rarely anything as extreme as a partial reconstruction and never a full conversion.

The only other exceptions are the *occasional* Coalition officer or distinguished Coalition State (CS) citizen or politician. Bionics without official CS authorization is a crime of dissention punishable by the removal of the bionics (without cybernetic replacement) and 2D4 years of imprisonment. Multiple offenders will receive a life time sentence and will be considered for the slave-borg program, should it be instated.

Psychics, *practitioners of magic*, *dragons*, and *most supernatural beings* avoid bionic reconstruction like the plague, because it destroys their psionic and mystic abilities. However, some will augment themselves with minor cybernetics, like a bionic arm or implants. Remember, cybernetics and bionics are two different extremes of mechanical augmentation.

Bionic Augmentation

NOTE: Bionic augmentation is designed for combat. See Cybernetics section for sensors, implants, organs, and natural prosthetics.

Generally, the person undergoing bionic reconstruction or conversion has little to say about the power and agility of his mechanical limbs, because these matters are in the hands of the sponsoring organization. As a rule, military organizations have the best bionic facilities and can offer maximum or near maximum capabilities (maximum capabilities are often reserved for borg officers who have proven their skill and loyalty).

Body-Chop-Shops and most cyber-doc clinics are not set up to handle bionics, their area of expertise is cybernetics. Consequently, bionic systems will be limited to what happens to be currently available (they will take advance orders and try to scrounge for the requested items). Bionic attributes can seldom be offered at maximum levels of efficiency; typically 30% below the maximum is the best they can provide. **NOTE:** Most Body-Chop-Shops can provide little more than a repair service for damaged bionic parts, install cybernetic implants/sensors, and sell body armor. Perhaps as many as one in a hundred can actually perform partial bionic reconstruction and one in a thousand can perform a full bionic conversion. **Black market** and **Chop-Shop** prices are usually 20% to 40% higher than the list price when it comes to bionics.

Isolated Bionic Augmentation

Isolated augmentation is the term used when an individual receives minor bionic reconstruction or implants. An example of isolated augmentation is when an individual has one arm replaced with a more powerful bionic hand and arm. Even if the arm has several bionic weapons, all the work is limited or "isolated" to that one limb, not the majority of the body. The same is true when a person receives bionic lung or head implants. **NOTE:** The attribute limit is the same as *partial reconstruction*.

Partial Bionic Reconstruction

Partial bionic reconstruction means that the trunk of the body, neck, and head remain human. The two legs, feet, hands, and arms are completely removed and replaced with mechanical limbs. The pelvis/hips area, shoulders, collarbone, and spine are all reinforced with metal rods, exoskeleton, and cybernetic implants to support the new bionic additions. Weak or sickly looking internal organs, especially the heart and lungs, are likely candidates for replacement with guaranteed cybernetic constructs (1-70% likelihood). If the lungs are replaced, they will have all the cybernetic options (see cybernetics section for lung and internal organs), or be a bionic lung (described elsewhere in this section).

Partial reconstruction for *military* purposes also means that one, if not both eyes, are replaced with cybernetic eyes, with at least two optical enhancements (GM or player can select, depending on the circumstances). The ear will receive amplified hearing and sound ear plugs. Sensor implants will usually include gyro-compass and clock calendar. Plus three or four bionic weapon systems. Additional appendages are not possible for partial reconstruction.

Limitations and Penalties

NOTE: The partial conversion limits the maximum attribute levels of the bionic limbs because the human portions of the body can not endure the strain. The first number indicates the most common attribute level generally provided to borgs. The second number is the absolute maximum level possible from a partial reconstruction.

Typical Borg Soldier or Mercenary with partial bionic reconstruction:

P.S. 18/max 20, P.P. 16/max 18, Spd 44 (30 mph/48 km)/maximum speed is 50 (35 mph/56 km).

Generally, the maximum levels of performance are reserved for officers who have proven themselves loyal and exceptional soldiers.

Typical Slave-Borg with partial bionic reconstruction: P.S. 18 to 20 max, P.P. 12/max 18, Spd 22 (15 mph/24 km)/maximum speed is 50 (35 mph/56 km).

Partial reconstruction for *slave labor* will seldom include any sensory, hearing, or optical enhancements, and never include bionic weapons. What is desired in a slave-borg is raw strength and endurance. Anything more would make the slaves too dangerous. Of course, escaped slaves can add weapon systems later.

Penalties of Partial Reconstruction: Simulated sense of touch is a mere 52%. Prowl is difficult: —15%. Average weight combined with the average body is 450 pounds and add 2D4 inches to original height.

Full Bionic Conversion

Full bionic conversion means that the character is over 90% machine. While this process creates the most powerful borgs, it is also the most dehumanizing. The entire body is replaced with a mechanical one. Only the brain, often, but not always, the face, and a few other original human components, especially the tongue, throat, and head are all that remains of the original flesh and blood body. The rest of the body is discarded or sold as transplant organs. The new, bionic body is effectively a full functioning robot that responds to the human brain with the precision of the natural body. The internal workings of the new body are strangely similar to the human body, with lengths of tubing carrying life sustaining fluids. Electromagnetic relays and nanotechnological workings makeup the rest of the internal system. The new body is a hundred times more durable, faster, stronger, and deadlier.

Full conversion for *military* purposes means the installation of the *cybernetic* multi-optic system, ultra-ear hearing, headjack, gyro-compass, and clock calendar. *Bionic systems* include a selection of five weapons, including additional limbs (selection is usually two hand to hand type weapons and three energy) and five accessories, such as a finger camera, energy-clip hand port, secret body compartments, or head/throat accessories. Physical capabilities are generally taken to the maximum, and the mechanized warrior is outfitted with LI-B2 mega-damage body armor.

In addition to the bionic weaponry, the Coalition issues its borgs a standard energy rifle, two hand grenades, walkie- talkie, a hovercycle or motorcycle, and a choice of LI-B2 light body armor or HI-B3 heavy body armor depending on the discretion and assignment of the individual borg. Note that the Coalition body armor is black and continues the "Dead Boy" motif. Heavier weapons, explosives, and equipment are available upon assignment.

Limitations and Penalties (Full Conversion)

The first number indicates the standard attribute level provided to most borgs. The second number indicates the absolute maximum level of performance possible.

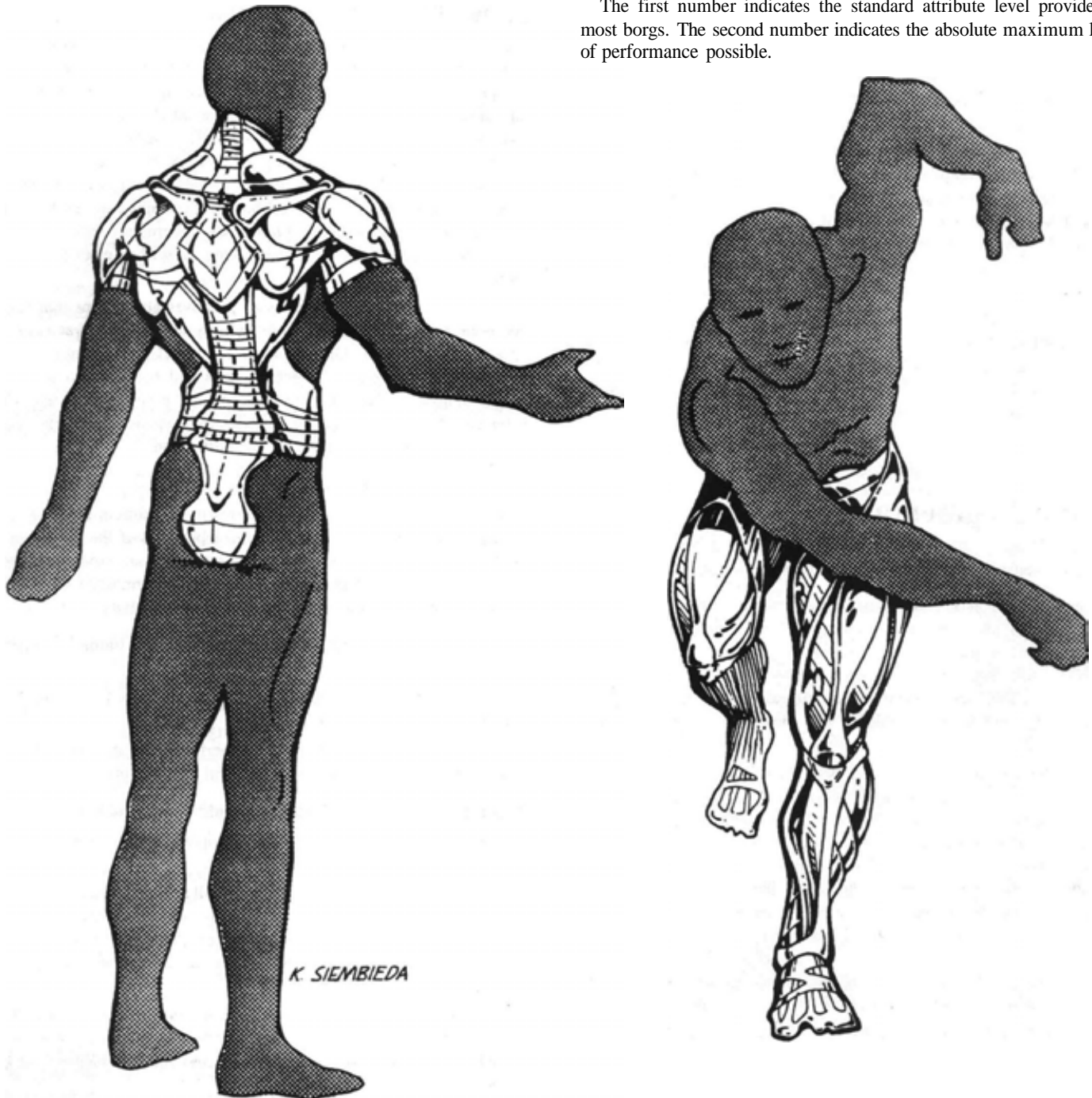

Typical Borg Soldier or Mercenary with full bionic conversion:
P.S. 26/max. 30, P.P. 20/max. 24, spd 132 (90mph/144kmph)/
maximum speed is 176 (120mph/192kmph).

Generally the maximum levels of performance are reserved for officers who have proven themselves loyal and exceptional soldiers.

Typical Slave-Borg with full bionic conversion:

P.S. 24/max. 30, P.P. 18/max. 24, spd 50 (35mph/56kmph)/maximum speed is 176 (120mph/192kmph).

Full conversion for *slave labor* means the subject has basic or minimum optical enhancements and no weapons or other sensory enhancement unless specifically related to the labor.

Penalties of Full Conversion: Simulated sense of touch is a mere 43%. Prowl is very difficult and suffers a penalty of —40%; impossible in heavy armor. Average weight is 1000 pounds (450 kg). Average height is seven to nine feet (2.1 to 2.6 meters).

Prosthetic Weapon Limbs

Weapon prosthetics are bionic limbs made to be combat tough and designed to accommodate the addition of weapon systems and implants. The following are the prices and M.D.C. of prosthetics before the weapon capabilities are added. Individual weapons and costs follow.

Hand: 10 M.D.C., costs 20,000 credits.

Hand and Arm: 10 M.D.C. for hand, 40 M.D.C. arm, costs 45,000.

Foot and leg: 15 M.D.C. for foot, 70 M.D.C. leg, costs 85,000.

Partial Reconstruction: 180 M.D.C., costs 550,000 credits.

Full Body Conversion: 280 M.D.C., costs 900,000 credits.

Attribute Levels

The base attribute level of the standard bionic prosthetic starts at 10 regardless of whether it is an arm or leg.

Additional attribute points can be purchased at a cost of 1000 credits per each limb. See partial and full conversions for the typical and the maximum limits.

Weapons and Tools

Bionic Hands

Only the most useful and/or deadly items are available. Players should remember that bionic items can be changed or replaced, providing the character has the money and facilities.

Energy-Clip Hand or Arm Port: A special connector unit is built into the hand or arm, enabling the borg to slap in additional E-clips to power his bionic energy weapons. A separate port is needed for each individual energy weapon. **NOTE:** A typical E-clip costs 5000 credits new and fully charged. The E-clip is an energy battery that can be recharged hundreds of times at the average cost of 1000 to 1500 credits.

Cost: For each E-clip port is 4000 credits.

Finger Camera: A tiny still camera fits inside the tip of one finger. The camera can shoot 48 photos on microfilm and is designed to automatically adjust for low light and bright light exposures. The camera shoots a picture each time a concealed stud in the finger is pressed.

Cost: 1200 credits. Film costs about 50 credits per micro roll and takes about 30 seconds to reload.

Fingerjack: The artificial finger can plug directly into communication systems, radios, sensory equipment, and robots, to receive direct data transmissions. **Note:** Needs amplified hearing or other cyberne-

tic/bionic ear augmentation to receive the transmitted data.

Cost: 2400 credits.

Laser Utility Finger: A simple laser tool similar to the laser soldering torch.

S.D.C. Damage: Two settings, 1D6 or 3D6 per blast.

Range: 50 feet (15m)

Rate of Fire: Up to 4 per melee.

Payload: 12 blasts before needing to recharge. 30 minutes to recharge.

Cost: 5000 credits.

Laser Finger Blaster: A tiny mega- damage weapon contained in a finger. Note that only two fingers per hand can contain a weapon. Mega-Damage: 1D4 M.D.

Effective Range: 300 feet (91 m)

Rate of Fire: Up to 3 per melee.

Payload: 6 blasts before needing recharging. Requires six hours to recharge. Or a small E-clip can be inserted into the side of the hand for 12 additional energy/blasts.

Cost: 20,000 credits for finger, 5000 per additional energy clip.

High Explosive Finger Joints: Usually limited to the little finger, because the explosive finger has no movement.

Mega-Damage: 2D4 M.D. to a 10 ft area per each joint section (3).

Effective Range: Throw about 100 feet (30.5 m)

Rate of Fire: Equal to attacks per melee.

Payload: Three per finger.

Cost: 1000 credits per explosive joint, 3000 for entire finger.

Retractable Finger Blades: Two to three inch long, double-edged blades retract from the finger.

S.D.C. Damage: 1D4 per each finger (plus P.S. bonus).

Cost: 1200 credits per each finger.

Retractable Knuckle Blades: Four five inch blades retract from the knuckle housings. Adds 3D4 S.D.C. damage to hand to hand attacks, plus P.S. bonus.

Cost: 2500

Knuckle Spikes: Four sharp metal spikes protrude from the knuckles. Adds 1D6 S.D.C. (bonus) damage to a punch or backhand strike. Cost: 800 credits.

Bionic Hand & Arm Weapons & Tools

Additional Hand and Arm: A pair of additional hands and arms can be attached to the reinforced rib cage just below the usual pair. The second set of limbs are a bit smaller and lighter than the normal full body replacements, but are still quite formidable additions. Maximum P.S. and P.P. attributes are 20 (base is 10). M.D.C. of each hand is 5 and each arm is 25. Bonuses: A pair of arms and hands add one attack per melee and a bonus of +1 to strike and parry to the character's overall combat skills. The arm's individual attribute bonuses apply only to that arm and not the character's accumulative combat abilities. A single hand and arm adds only a bonus of +1 to parry.

Cost: 250,000 credits for a pair, 130,000 credits for one.

Additional Non-Human Appendage: This item is similar to the additional arms, but are tentacles instead. A pair of tentacles can be located under the normal arms and/or in the back, attached to the shoulder blades. At the end of each tentacle is a pair of small, mechanical claw fingers. The claws are far inferior to hands and suffer a skill penalty of —30% whenever they are used in place of hands. Sense of touch is a mere 25%. Maximum length is five feet (1.5 m), maximum P.S. and P.P. attributes are 18 (base is 10). M.D.C. of each claw is 5 and each tentacle arm is 20. Bonuses: A pair of tentacles add one attack per melee and a bonus of +1 to

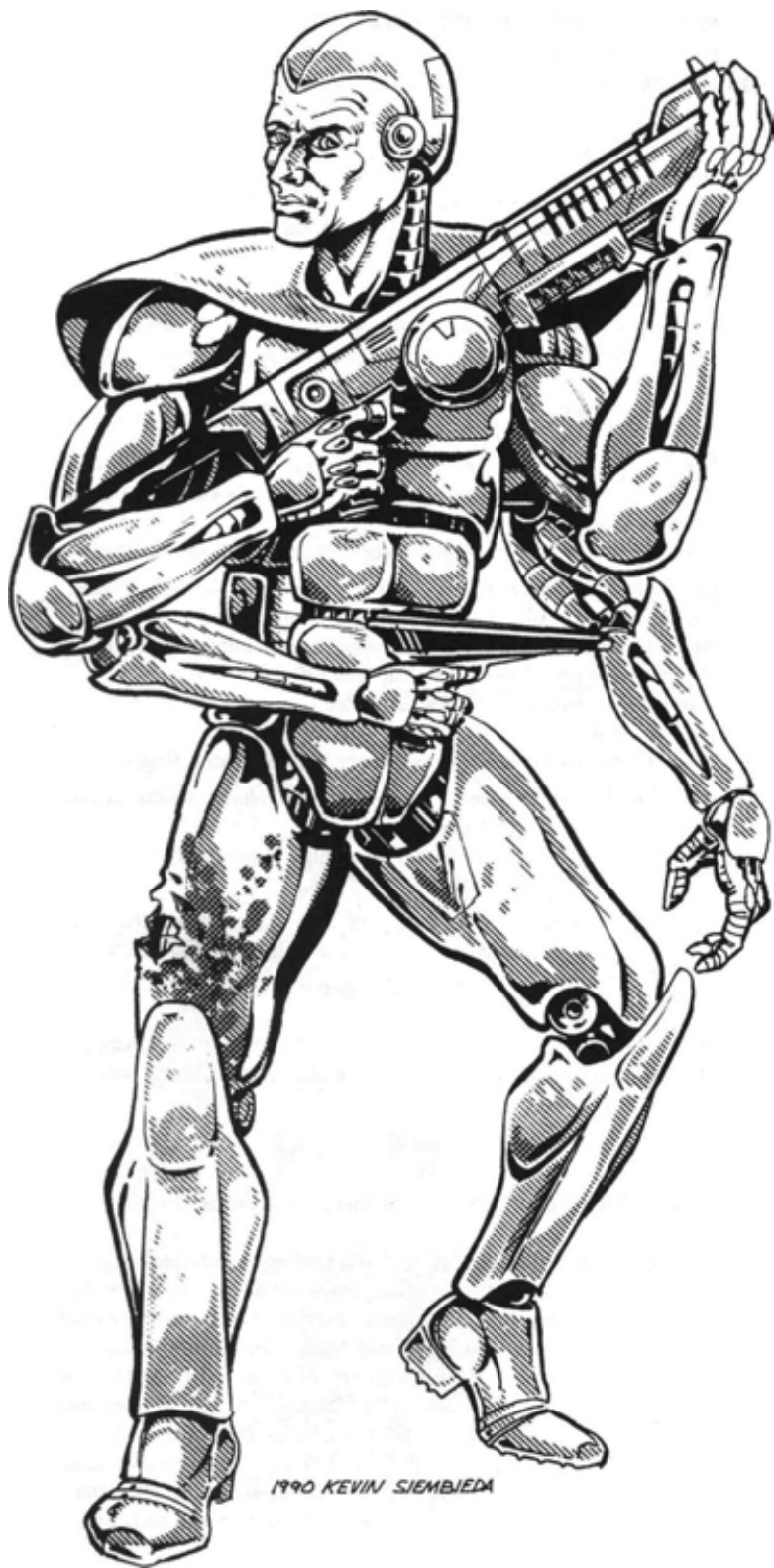

parry to the character's overall combat skills. A single tentacle adds only a bonus of + 1 to parry.

Cost: 210,000 credits for a pair, 100,000 credits for one.

Additional Tail Appendage: Like the additional tentacles, this appendage is a prehensile, tentacle-like tail. The tail can be used much the same way as a monkey uses his tail; i.e., to pickup or grasp items, for climbing, and, unlike a monkey, to attack. The length of the tail can be four to seven feet long (1.2 to 2.1 m) and can whip around to the front of the borg, as well as the back and sides. Maximum P.S. and P.P. attributes are 18 (base is 10). M.D.C. 30.

Bonuses: Adds +5% to balancing abilities, + 10% to climb skill, and the tail itself is + 1 to strike, + 2 to parry and dodge, in addition to attribute bonuses. Note: Only one tail may be attached, but in addition to an extra pair of arms. Does not add an additional attack per melee! The tail can not be used to perform skills meant for a fully developed hand; skill penalty: —70%. Likewise, while it can pick up and carry a gun, it can not fire one.

Cost: 220,000 credits.

Climb Cord: Similar to the garrote wire, this is a 20 foot (6.1 m) length of 1500 lb (675 kg) test cord, no thicker than string, that can be pulled out of an artificial wrist or arm. The cord is primarily used for espionage. A weight can be attached and used as a chain-type weapon (1D6 S.D.C. damage), or a small grappling hook can be attached for climbing.

Cost: 1500 credits; grappling hook and other attachments extra (can be made or bought for under 30 credits).

Garrote Wrist Wire: A thin, strong wire is hidden inside the bionic wrist/junction that can be pulled out and used to strangle an opponent. S.D.C. strangle damage applicable only.

Cost: 200 credits.

Chemical Spray: The chemical spray can be built into the legs or chest and released as an area affect gas around the borg (fills a 10 foot/3 m area). To be able to direct the spray at a particular target, the chemical system must be built into the arm and hand. The directed spray is usually a fluid as twice as many doses can be stored than gas. The following chemicals are available. All affect a five foot (1.5 m) spray area. Spray System Cost: 40,000 credits.

1. Blinding chemical agent, much like mace, temporarily blinds its victim for 3D4 melees. The victim is — 10 to strike, parry, and dodge. Protective goggles/visor or gas mask block this spray attack. Cost: 100 credits per dose.

2. Tear gas causing impairment of vision (unless gas mask is worn), difficulty breathing, and skin irritation. Victims are —10 to strike, parry, and dodge, and lose one melee attack/action for 1D6+ 1 melees. Cost: 150 credits per dose.

3. Burning vapors release a mild acid, causing burning skin and eye irritation, sudden nausea, and 1D6 S.D.C. damage. Victims are also —4to strike, parry, and dodge for 1D4 melees. Cost: 50 credits per dose.

4. Tranquilizer/sleep spray may cause its victim to fall asleep within 1D4 melees and remain a sleep for 2D4 minutes. All victims get to save versus drugs/toxins; needs 14 or higher. Cost: 100 per dose.

5. CO-2 Foam is a concentrated spray used to put out fires. Cost: 100 per dose.

Effective Range: 20 feet (6m)

Rate of Fire: Equal to number of hand to hand attacks.

Payload: Can hold a total of 20 individual doses and as many as five different chemicals. One dosage of CO-2 foam counts as two normal doses.

Computer & Calculator built into the Arm: A miniature computer, similar to the tiny hand—held model, can be built into the forearm, upper arm or even inner side of the thigh. The borg needs the computer operations skill and literacy to utilize it.

Cost: 1200 credits.

Concealed Arm Laser Rod: A small rod-like firing mechanism is housed concealed in the bionic arm. When needed for combat, a release stud on the hand or wrist is pressed and the weapon shoots out of the arm and into the hand like the derringer pistol of the Old West. Mega-Damage: 1D6 M.D.

Effective Range: 800 feet (224 m)

Rate of Fire: Equal to number of hand to hand attacks per melee.

Payload: 10 blasts before needing recharging (E-clip is stored in the arm). Requires six hours to recharge. Or a small E-clip can be inserted into the side of the hand for 10 additional energy/blasts.

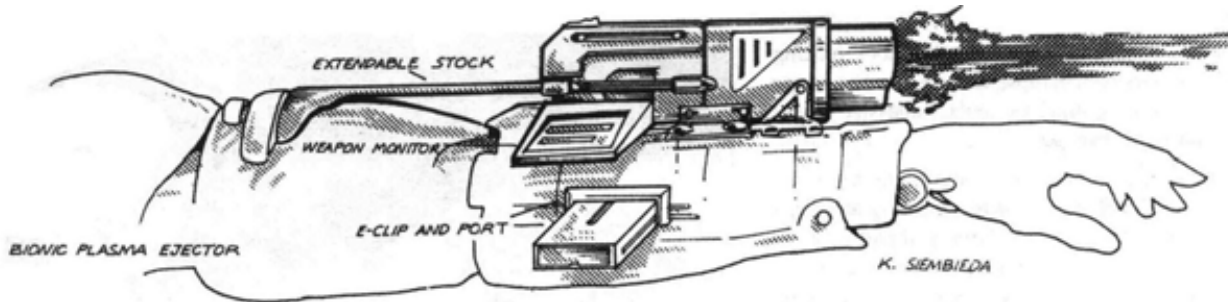

Cost: 20,000 credits for finger, 5000 per additional energy clip, 1500 credits to get an E-clip recharged.

Forearm Blaster: A weapon unit that is built onto the exterior of the arm. A selection from a variety of weapons is available. Only one weapon type can be built onto an individual arm. The extra weight and awkwardness of the weapon inflicts a penalty of — 1 to strike, parry and dodge during hand to hand combat per arm.

Weapon Types, Mega-Damage & Range:

1. Laser Blaster: 2D6 M.D., Range: 2000 ft (609 m), Cost: 25,000
2. Ion Blaster: 2D6 M.D., Range: 1200 ft (336 m), Cost: 20,000
3. Plasma Ejector: 4D6 M.D., Range: 1000 ft (305 m), Cost: 40,000
4. Particle Beam: 6D6 + 6 M.D., Range: 1000 ft (305 m), Cost: 60,000
5. Mini-machinegun: 2D4 M.D., Range: 2000 ft (609 m), Cost: 20,000
6. Mini-Missile Launcher: 1D4x10 M.D., Range: one mile (1.6 km), Cost: 40,000 for launch system and 6,000 per each missile.

Rate of Fire: Aimed, burst, or wild. *See Modern W.P. description.*

Payload: The machinegun can fire 30 bursts (no aimed shots), each inflicting 2D4 damage. All others have removable energy-clips. The laser and ion blaster have 20 blasts per E-clip. The plasma ejector and particle beam can fire 10 blasts per E-clip. A typical E-clip costs 5000 credits new and fully charged, but an energy recharge is only 1500.

The mini-missile launcher holds only three missiles, but an additional 12 missile back pack/carrying case can be carried and manually reload the launcher. Reload takes about five seconds per each missile. Missile case has 20 M.D., weighs 10 pounds (4.5 kg) empty. Each missile weighs 4 pounds (1.8 kg).

NOTE: A forearm blaster type weapon can be fitted into the wrist in place of a hand. The most common and basic weapons are the same as those previously listed but generally costs 10% less. However, weapon-hands are not recommended, because the borg loses the use of a full functioning hand (—15% to all skills that require the use of hands). Borgs fitted with weapon-hands are frequently the product of a Body-Chop-Shop where parts are scarce and a full hand was not available.

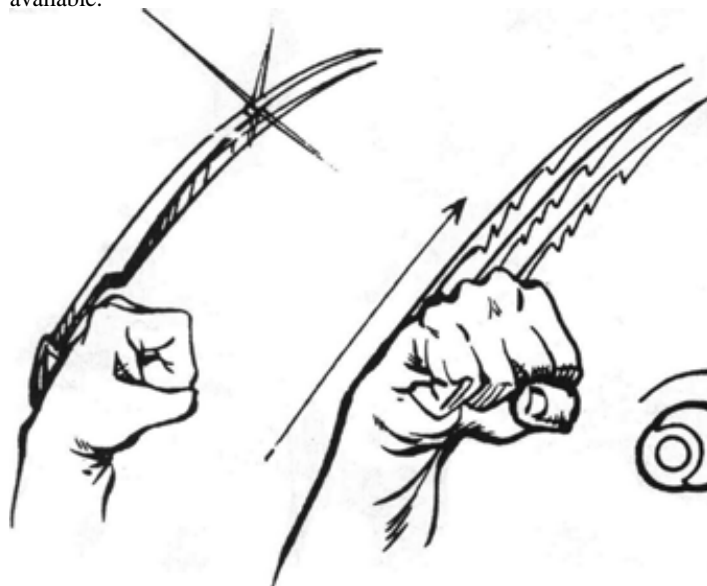

Retractable Blades (large): Two or three long blades, measuring a foot or two (0.3 to 0.6 m), are concealed in the forearm until extended for combat. The blades extend out of access portals on the tops of the bionic hands (can not use any other knuckle weapon). The blades are used like a short sword. Adds 3D6 S.D.C. damage to hand to hand attacks, plus P.S. bonus.

Cost: 3000 credits.

Retractable Vibro-Blades: Basically the same as the normal retractable blades, only the vibro-blades inflict 2D6 mega-damage. Cost: 30,000 credits.

Wrist Needle & Drug Dispenser: A retractable needle is concealed in the artificial wrist and can be detracted to stab or inject drugs into an opponent. A drug dispenser housed in the arm can hold as much as four doses of five different chemicals, 20 doses total.

Cost: Hypodermic needle and drug dispenser is 3000 credits. Drugs must be purchased separately. The most commonly used include:

Antibiotics: Costs 75 per dose.

Paralysis: Takes effect in 1D4 melees, lasts 2D6 minutes; costs 150 credits per dose.

Poison: Takes affect in 1D4 melees, inflicts 6D6 S.D.C./hit point damage; costs 200 credits per dose.

Tranquilizer/Sleep: Takes effect within 1D4 melees, lasts 4D6 minutes; costs 100 credits per dose.

Truth Serum: Takes effect in 2D6 minutes, lasts 3D6 minutes; costs 75 credits per dose.

Bionic Leg Weapons & Accessories

Concealed Weapon Rod: A specially designed energy blaster can be fitted into a hidden bionic leg compartment and released upon mental command, or hooked onto the exterior of a leg or the back.

Mega-Damage, Range, & Cost:

Laser Rod: 3D6 M.D., range: 3000 ft (914 m), cost: 35,000.

Ion Rod: 4D6 M.D., range: 2000 ft (609 m), cost: 30,000.

Rate of Fire: Aimed, burst, or wild; *see Modern W.P. description.*

Payload: Each E-clip can fire 20 blasts.

Secret Compartments, both large and small, can be built into the legs and chest of a borg. The largest possible is approximately 12 inches long (0.3 m) and four to six inches deep, but are usually half that size or smaller. The smallest are about the size of a change purse,

CUT-AWAY VIEW OF RETRACTABLE BLADES HOUSED IN FORE-ARM

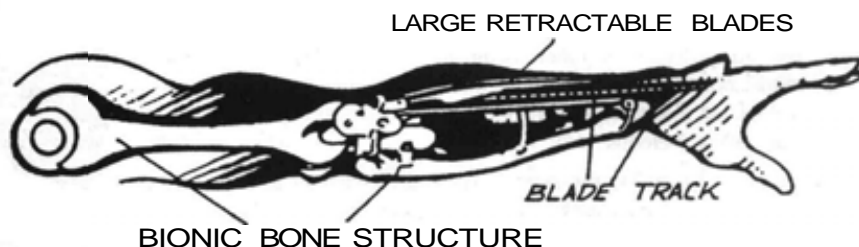

just big enough to conceal a few credit cards, coins, lock picking tools, electronic bugs or components/chips, and so on. The larger compartments are ideal for storing supplies, tools, hand-size equipment, hand grenades, and small handguns.

Game Masters and players should use common sense regarding the number of compartments. Generally speaking, each leg and chest can accommodate two medium-size or one large compartment, or as many as six small each. The arms can only accommodate one small compartment on the forearm and upper arm, but only if no weapon systems are built into/on the arms.

Cost: 1000 credits for each small, 2500 for each medium, and 4000 for each large.

Head & Throat Features

Bionic Lung with Gas Filter & Oxygen Storage Cell: An artificial lung implanted to provide for the special needs of the borg. A chemical cell, controlled by microprocessors, stores oxygen from the character's normal breathing. Then, when oxygen is low, the oxygen is released back into the lungs. The net effect is to give the character the ability to go without breathing for up to two hours. Note that the character must breathe normally for about three hours to fully recharge the cell between uses. The lung also has a gas filtration system designed to filter *most* toxic gases out of the system before they can do damage. The filter is effective against all types of tear gas, smoke, and purely chemical fumes. There is a 94% likelihood that it will also work against nerve gases and poison gases.

Cost: 250,000 credits.

Built-in Loudspeaker: The borg can amplify the loudness of his voice, like a bull horn, to about 80 decibels.

Cost: 6,000 credits.

Built-in Radio Receiver & Transmitter Headjack: A fully operational radio is built inside the head. Channels are switched by working the jaw and transmissions are received directly in the ear identical to the cybernetic headjack. The borg can send transmissions by a mental command and quietly talking out loud. A microphone is built into the jaw.

Range: 20 miles (32 km). Cost: 22,000; add 10,000 for scrambling radio messages and decoding.

Built-in Speech Translator: This head and ear unit works very similar to the portable unit. Several concealed speakers can be made to focus on one particular voice/person (range: 100 feet/30.5 m) and have his words instantly translated (only a three second delay). The translator is fluent in the nine or so major known languages and can be programmed, by a technician, to add six others.

The audio translations are transmitted to the cybernetic ear/headjack and is loud enough for only the borg to hear it. The system also has a limited recording capability. The borg can activate the recorder by a simple jaw movement. Maximum recording time is one hour and the recording disc can be re-used over and over again, with minimal audio distortion. The recording can be secretly played back in the ear of the borg or transmitted over the jaw radio or loudspeaker if available. Translations can also be transmitted over the loudspeaker.

Cost: 11,000 credits.

Molecular Analyzer: This microchip based sensor is used for testing and analyzing impurities in the air. It can specifically identify any chemical, or strange and dangerous molecules, like the presence of gas, oil, pollution, or other chemicals in the air. Data can be transmitted as an audio report through one of the ear or computer implants. It does not enable one to track.

Cost: 50,000 credits.

Modulating Voice Synthesizer: Enables the character to change/disguise his voice by altering tone, bass, pitch, etc. Can also speak in a sound frequency inaudible to normal humans, but audible to normal



and mutant dogs, other borgs, and characters with cybernetic ultra hearing. Base skill at imitating voices is 10% plus 5% per each additional level of experience.

Cost: 25,000 credits.

Bionic Eyes & Sensors

All the same features offered by cybernetics are available from bionics. There are only two differences: one, the eye is obviously mechanical and two, most military borgs are not given a choice of optics, but automatically given the *Multi-Optic* eye. Only slave-borgs will be given normal or slightly enhanced vision. See the cybernetics section for artificial eyes and cost.

Cybernetic sensor can also be purchased. See Cybernetics.

Cyborg Body Armor

Even though the borg's body is a mega-damage structure, it certainly can and does get damaged in combat. Rather than allow the costly bionic constructs to be damaged, the borg wears special body armor

over his or her bionic body. The borgs' unnatural strength enables them to wear the most powerful M.D.C. armor available. The armor is too heavy for humans and can only be worn by a partially reconstructed or full cyborg. All are full body suits, complete with helmet.

LL-SB Light Labor Slave-Borg Armor: 70 M.D.C., Cost: 3500

LE-B1 Light Espionage Armor: 135 M.D.C., Cost: 8,000

LI-B2 Light Infantry Armor: 270 M.D.C., Cost: 20,000

HI-B3 Heavy Infantry Armor: 420 M.D.C., Cost: 32,000

NOTE: The LL-SB and LI-B2 armor are bulky and add a -15% penalty to prowl. Only the LE-B1 armor is free of prowl penalties.

The HI-B3 armor can only be worn by full conversion borgs and even they suffer the following penalties: reduces the borg's speed by 20% and the armor is so bulky that it also inflicts a penalty of -2 to strike, parry, and dodge. Prowl is impossible. There are dozens of different styles of borg armor (the new look is a helmet that looks monstrous) with the same basic classifications and M.D.C.

CONVENTIONAL WEAPONS

All inflict S.D.C. damage unless stated otherwise.

Type	2-Handed	Length	Weight	Damage	Cost*
Axe, Battle	no	2.75ft	4.61bs	2-12	150
Axe, Throwing	no	1.25ft	3lbs	1-4	50
POLE ARMS					
Glaive	yes	7.5ft	6lbs	2-12	200
Halberd	yes	7.25ft	5lbs	3-18	400
Sabre Halberd	yes	8ft	7lbs	3-18	400
Hippe	yes	7.5ft	6.51bs	3-18	350
Military Fork	yes	7ft	5lbs	1-8	220
Scythe	yes	8ft	5lbs	1-8	220
Voulge	yes	7ft	5lbs	3-18	400
SPEARS					
Short Spear	no	4-6ft	4lbs	1-6	100
Long Spear	yes	7- 10ft	6.51bs	1-8	150
Javelin	no	7ft	4lbs	1-6	50
Trident	yes	5ft	4lbs	1-8	100
SHORT SWORDS					
Short Sword	no	2.5ft	3lbs	1-6	125
Falchion	no	2.75ft	4lbs	1-8	150
LARGE SWORDS					
Bastard	yes	3.75ft	4.51bs	1-8 + 2	250
Broadsword	no	3ft	3.51bs	1-8	200
Claymore	yes	4ft	6.51bs	2-12	300
Flamberge	yes	4.25ft	7.51bs	3-18	400
Long Sword	no	3ft	3.51bs	1-8 + 2	270
BALL and CHAIN					
Ball and Chain	no	3ft	4.51bs	1-8	175
Flail	yes	5.25ft	5.51bs	2-12	250
Goupillon Flail	yes	2ft	4.51bs	3-18	360
Mace and Chain	no	3ft	4.51bs	2-12	200
Nunchaku	yes	2.75ft	2.51bs	1-8	30
BLUNT WEAPONS					
Mace	no	2.5ft	4.51bs	-8	120
Cudgel	no	2.75ft	2.51bs	-8	75
Club/Stick/Pipe	no	2.75ft	3lbs	-6	10
Hercules Club	yes	4ft	5.51bs	2-12	175
Morning Star	no	2.75ft	2.51bs	-8	120
War Hammer	no	2.5ft	4.51bs	-8	100

STAVES

Type	2-Handed	Length	Weight	Damage	Cost*
Short	no	4-6ft	3lbs	1-6	75
Long	yes	7-9ft	5lbs	1-8	80
Bo Staff	yes	9.5ft	3lbs	1-8	120
Quarterstaff	yes	6ft	3.51bs	1-8	100
Iron Staff	yes	6-7ft	7lbs	1-8 + 2	100

*All weapon costs are in credits.

REVOLVERS

Reloading: Almost all modern weapons come equipped with easy-to-load clips (magazines). There are even quick loaders for revolvers. This means that attackers can fire a full clip every melee. However, older weapons (bolt action, muzzle-loaders, hand loaded revolvers) and most shotguns will require a full melee round (or more) to reload. Note that it will take much longer to reload while in the thick of hand to hand combat.

Effective Range: This is the longest distance that the weapon can be fired without losing accuracy or damage. Guns can be fired beyond their effective range, but with no W.P. Skill Bonus and with a -4 to strike for every 25 feet beyond the effective range.

Moving Targets: It is a lot harder to hit someone while they are moving. -3 to strike at moving, running or leaping targets. -6 to strike anything speeding 40mph or more.

Strike Bonus: Physical Prowess (P.P.), Physical Training and other strike bonuses *Do Not Apply* to modern weapons. When using a gun, only the W.P. Skill bonuses with that weapon can be used. For example, a character with +5 to strike in hand to hand combat and level 1 skill in revolver would have a +3 *Bonus to Strike* for an aimed shot.

.22 or .25 Revolver

Made by a variety of manufacturers, this is the kind of "Saturday Night Special" most commonly sold in the pre-Rifts U.S. Commonly used for protection or for committing crimes. Generally, they have 6 or 8 shots, are lightweight (roughly lib), and have a limited effective range. **Cost:** From 50 to 500 credits. **Damage:** 1D6 per round.

.38 Service-Six Ruger Revolver

A standard, police officer's side-arm. Roughly the same as all .38 specials. **Cartridge:** .38 special. **Feed:** 6 chamber, side loading cylinder. **Weight:** Just under 21lbs. **Effective Range:** 150ft. **Cost:** 250. **Damage:** 2D6 per round; there is also a .38+ power round that does 3D6 per round.

Barracuda FN Revolver - .357 Magnum

Used by some police officers, government agents and heavily armed criminals. **Cartridge:** .357 magnum. **Feed:** 6 round cylinder. **Weight:** Slightly over 21lbs. **Effective Range:** 150ft. **Cost:** 500. **Damage:** 4D6 per round.

AUTOMATIC PISTOLS

7.65mm PP Walther - 7.65 Automatic

This is typical of the kind of small automatic pistol used for protection and criminal activities. Consider the Walther as top-of-the-line. **Cartridge:** 7.65mm short. **Feed:** 8 round, detachable magazine. **Weight:** 1 1/2lbs. **Effective Range:** 120ft. **Cost:** 600. **Damage:** 2D6 per round.

Browning GP 35 - 9mm Automatic

Used as a side-arm by many military force's personnel, terrorists and well equipped criminals. **Cartridge:** 9mm. **Feed:** 13 round magazine. **Weight:** Just under 21lbs. **Effective Range:** 120ft. **Cost:** 600. **Damage:** 2D6 per round.

.45 Model 15 General Officers - .45 Automatic

Formerly the standard side-arm of the U.S. military, now found commonly throughout the world. This is the ideal weapon for trench warfare, where accuracy is not as important as knock-down power. **Cartridge:** .45 ACP. **Feed:** 7 round magazine. **Weight:** Just over 21lbs. **Effective Range:** 135ft. **Cost:** 400. **Damage:** 4D6 per round.

SUB MACHINEGUNS

7.65mm Model 61 Skorpion - 7.65mm Sub-Machinegun

This is the kind of high rate of fire, easy to hide weapon favored by terrorists. **Cartridge:** 7.65mm or .32 ACP. **Feed:** 10 or 20 round magazine. **Weight:** 3 1/2lbs. **Effective Range:** 150ft. **Cost:** 900. **Damage:** 1D8 per round.

Ingram Model 10 - .45 Sub-Machinegun

A particularly high-powered sub-machinegun. Used by the U.S. government security agencies. **Cartridge:** .45 ACP. **Feed:** 30 round magazine. **Weight:** 6 1/4lbs. **Effective Range:** 600ft. **Cost:** 700. **Damage:** 4D6 per round.

9mm Uzi - 9mm Sub-Machinegun

Almost all international sub-machineguns have the same attributes as the Uzi. Very common with foreign police forces, government security forces and terrorists. **Cartridge:** 9mm. **Feed:** 25 or 30 round magazine. **Weight:** 7 1/2lbs. **Effective Range:** 600ft. **Cost:** 900. **Damage:** 2D6 per round.

The Sub-Machine Pistol — 9mm

This field weapon is a high-powered, 9mm machine pistol. **Cartridge:** 9mm, **Feed:** 30 round magazine. **Weight:** 5 1/2 pounds. **Effective Range:** 500ft. **Cost:** 800 credits on the black market (not made for use by the general public). **Damage:** 2D6 per round.

RIFLES

30-06 Hunting Rifles

There are dozens of different models of hunting rifles. Most have optional, telescopic sights and multiple-shot clip magazines. **Weight** and **range** varies. **Cost** depends on quality; anywhere from 200 credits on up. **Damage:** 5D6 per round.

5.56mm M16A1 - 5.56 Assault Rifle

This is typical of the new, lighter-weight, more reliable rifle being issued to all modern armies. **Cartridge:** 5.56mm. **Feed:** 20 or 30 round magazine. **Weight:** 6 1/2lbs. **Effective Range:** 1200ft. **Cost:** 700. **Damage:** 4D6 per round.

7.62mm AK-47 Assault Rifle

The AK-47 can be found in virtually any, terrorist or revolutionary camp anywhere in the world. **Cartridge:** 7.62mm. **Feed:** 30 round magazine. **Weight:** 9 1/2lbs. **Effective Range:** 900ft. **Cost:** 900 credits. **Damage:** 4D6 per round.

MACHINEGUNS

.30, 5.62mm and 7.62mm Calibre Light Machineguns

These are the most common kind of light machineguns found in military forces the world over. **Cartridge:** .30, 5.62mm and 7.62mm in 100, 200 and 250 round belts. **Weight:** 15 to 25lbs. **Effective Range:** 3000ft. **Rate of Fire:** Can empty the weapon in two melee rounds. **Cost:** 2000 credits and up (mostly illegal). **Damage:** 5D6 per round.

.50 and 14.5mm Heavy Machineguns

These are commonly found mounted on armored military vehicles. As with their lighter cousins, the heavy machineguns are usually found only in military units. Accuracy is poor because they are meant for use against large vehicles or massed soldiers. On the other hand, they will punch right through armor or engine blocks. **Cartridge:** .50 and 14.5mm belts of varying sizes. **Weight:** 30 to 100lbs. **Effective Range:** 3000ft. **Cost:** 5000 and up (highly illegal). **Damage:** 7D6 per round.

SHOTGUNS

Model 3000 Police Smith & Wesson Shotgun

This is fairly typical of pump action shotguns used by police for riot control. **Calibre:** 12 gauge. **Feed:** Single shot (pump action). **Weight:** Under 7lbs. **Cost:** 900; prices for lower priced models could be as little as 300. **Damage:** Buckshot does 4D6 per round. Solid slug does 5D6 per round.

Shotguns: This weapon is usually limited to a maximum of *two* shots. One round can be fired, or two rounds can be fired simultaneously. Can be an aimed shot or wild. Reloading takes one full melee.

HEAVY WEAPONS

Rocket Launcher

Called the "Super Bazooka", it was designed as an antitank weapon, but was sometimes used against bunkers. **Weight:** 12lbs (5.4kg), front and rear tubes; 9lbs, rocket. **Length:** 61 inches (1549mm). **Effective Range:** 3600ft (1200m). **Damage:** 1D4 M.D. or 1D4x 100 S.D.C. **Cost:** 900 credits (mostly illegal). **Blast Radius:** 50ft (15m).

66mm Light Antitank Weapon (LAW)

Light and disposable, this was a favorite weapon for taking out "hardened" positions where the enemy had metal or concrete protection. Against tanks it's not quite as effective, actually killing only about 10% of the time. **Weight:** 5.2lbs (2.6kg). **Size:** 35 inches (889mm), extended. **Rate of Fire:** Single shot and discard. **Effective Range:** 1000ft (325m). **Blast Radius:** 50ft (15m). **Damage:** 1D6 M.D. or 1D6 x 100 S.D.C. **Cost:** 1000 credits (mostly illegal).

90mm Recoilless Rifle

This weapon looks like a bazooka or rocket launcher (see antitank weapons). Fires a single, antitank round. **Weight:** 35lbs (16kg), unloaded. **Feed:** Breech. **Rate of Fire:** (rapid) 10 rounds per minute

(max. of 5 rounds) - sustained rate of 1 round per minute. When firing at the rapid rate, a 15 minute cooling period must be observed after every 5 rounds. **Effective Range:** 1200ft (400m). **Blast Radius:** 80ft (24m). **Damage:** 1D10 M.D. or 1D10x100 S.D.C. **Cost:** 1600 (highly illegal).

40mm Grenade Launcher Mounted on Rifle

This was basically a M-79 installed under the barrel on a M-16 Assault Rifle. **Weight:** 11lbs (5kg). **Length:** 15.6 inches (361mm). **Feed:** Single shot. **Rate of Fire:** 3-5 rounds per minute. **Effective Range:** 1150ft (350m). **Damage:** 1D4 M.D. or 1D4X100 S.D.C. **Cost:** 900 credits (highly illegal).

M-2A1-7 Portable Flamethrower

With a solid stream of fire, a soldier could clear out an entire enemy machinegun nest. In confined spaces (inside a bunker, foxhole or building), everyone in the target area is affected equally. **Damage:** 5D10, plus ignition of all combustible material. **Weight:** 42.5lbs (19kg). **Feed:** Manual. **Effective Range:** 70ft (20m), unthickened; 150ft (45m), thickened. **Cost:** 400 (mostly illegal).

SPECIAL GUNS

Tranquilizer Rifle

This is a rifle designed to fire a tranquilizer dart. Its effective range is about half that of a normal rifle and must be hand loaded, with a maximum capacity of two (both can be fired per melee and require the following melee as a reload time). Saving throw vs. toxin. **Range:** 800ft (240m). **Rate of Fire:** 2 per melee. **Bonus to Strike:** Must have W.P. Rifle. **Damage:** Tranquilizer will render its victim unconscious within 1D4 melees. **Duration:** Effects last 4D4 minutes. **Cost (rifle):** 1000 credits. **Cost (darts):** 10 credits.

Dart Gun

Range: 110ft(33.5m). **Rate of Fire:** 2 per melee. **Bonus to Strike:** Must have a W.P. with Pistol or Revolver. **Damage:** Tranquilizer renders victim unconscious. **Duration:** 4D4 minutes. **Cost (pistol):** 500 credits. **Cost (darts):** 10 credits each. Saving throw vs. toxin.

Gas Gun (pistol)

The gas gun is a long, wide, tubular barreled handgun that fires a gas canister. **Types of gases:** Tear Gas, Tranquilizer (knockout), Nerve Gas, and Smoke Gas/Screen. **Cost (gun):** 200. **Cost of Tear Gas and Tranquilizer Gas Canisters:** 50 credits. **Cost of Nerve Gas:** 75 credits. **Cost of Smoke:** 25credits. **Range:** 160ft(48.8m). **Rate of Fire:** 1 per melee. **Bonus to Strike:** Must have a W.P. with Pistol. **Damage:** Varies with the type of gas used.

Stun Gun (blaster)

This pistol fires an energy charge that short circuits the nervous system. Victims are dazed, — 10 to strike, parry and dodge, for 2D4 melees.

A successful **saving throw** means that the person has successfully fought off the effect and is unimpaired. Roll to save against each blast that strikes. **Range:** 100ft (30.5m). **Rate of Fire:** 5 per melee. **Bonus to Strike:** Must have a W.P. with Energy Pistol. **Damage:** Special. **Saving Throw:** Save vs toxins. **Energy Capacity:** 10 charges. **Cost (gun):** 4000 credits. **Cost (energy clips):** 1000 credits.



Miscellaneous Equipment

OPTICS GOGGLES AND BINOCULARS

Infrared Distancing Binoculars: A high-powered optical enhancement device with infrared adjustments, cross hair indicator lines, and digital readout of estimated distance and rate of travel. **Range:** 2 miles (3km). The I.D. binoculars enjoy extreme popularity among the populace, being used for field work, exploration, recreation, and are standard issue for the military. **Cost:** 1200 credits; wide availability.

Multi-Optics Helmet (M.O.H.): The multi-optics helmet is a special optical enhancement system built into a protective helmet. It includes the following features:

1. **Targeting Sight:** 1600ft (480m)
2. **Infrared Optics System:** 1600ft (480m)
3. **Telescopic Monocular Lens:** Range: 2 miles (3km)
4. **Thermo-imager:** Range: 1600ft (480m)

Special Bonus: + 1 to strike when the optics and targeting sight are engaged. Note that the thermo imager is a special, optical, heat sensory unit that allows the infrared radiation of warm objects to be converted into a visible image. Enables the pilot to see in darkness, shadows and through smoke. **Cost:** 2900 credits. Good availability.

Optics Band: The optics band is a headband type optical system most often used in research, micro-repairs and scientific study. Its range is limited as it is designed for close work, not long-distance or combat surveillance. Features include:

1. **Infrared and Ultraviolet Optic System:** **Range:** 200ft (90m) maximum.
 2. **Magnification Lens** (to the 400th power): **Range:** 7ft (2m)
 3. **Night Sight:** **Range:** 200ft (90m)
 4. **Adjustable Color Filters.**
- Cost:** 800 credits.

Infrared Optic System: **Range:** 1200ft (360m). This type of optical enhancement device relies on a source of infrared light, usually a pencil thin beam of light projected from the goggle or binoculars to illuminate its targets. The narrowness of the beam severely limits the scope of one's view to a small area of about two square meters (7ft). This can make surveying a large area a problem. Another drawback is that the infrared light beam is clearly visible to another infrared optic system, giving away the operator's position. These drawbacks are inherent to ALL infrared systems. **Cost:** about 1000 credits; fair availability.

Thermo-imager: **Range:** 1600ft (480m). Basically an optical heat sensor, it converts the infrared radiation of warm objects into a visible image. These devices allow its operator to see in darkness, shadows and through smoke. Battery powered and electrically cooled. A typical running life is 16 hours. **Cost:** about 1400 credits; poor availability.

Ultraviolet Systems: **Range:** 400ft (120m). Enables its wearer to see into the ultraviolet range of light radiation. It's usually integrated into a larger optics package rather than used alone. **Cost:** 500 credits.

Night Sight: **Range:** 1600ft (480m). A night vision optics system is an image intensifier, meaning that it is a passive system that does not emit any light of its own, but electronically amplifies existing ambient light to provide a visible picture. **Cost:** 1400 credits; poor availability.

Pocket Night Viewer: **Range:** 800ft (240m). This is a mini-night sight, usually a monocular style, easily concealed and portable. **Cost:** 800 credits; poor availability.

Conventional Binoculars: **Range:** 1 mile (1.6km). Magnification through a series of lenses. **Cost:** 700 credits; fair availability.

SENSORY EQUIPMENT

Heat: Special sensors pickup and measure heat emanations. Can monitor temperature, or made directional to pinpoint a specific heat point/target. **Range:** 250ft (76m); field of detection is 25ft (7.6m). Portable/hand held. **Weight:** 8lbs (3.6kg). **Cost:** 1200 credits.

Dosimeter: Picks up and measures radiation levels. **Range:** 20ft (6.1m). Hand-held; **Weight:** 1lb (.5kg). **Cost:** 200credits. Wide availability.

Motion: Detects movement and pinpoints location. Requires sensor placement and monitor screen. **Range:** 60ft (27.4m). Portable; **Total Weight:** 151bs (6.8kg). **Cost:** 400 credits. Fair availability.

Mini-Radar/Sonar: Radar signal unit and monitor. Trained operators (sensory equipment skill) can positively identify readings/objects, pinpoint location and estimate rate of travel and direction at 65% proficiency. **Range:** 5 miles (8km). Portable; **Total Weight:** 181bs (8.2kg). **Cost:** 2500 credits. Fair availability.

Standard Radar/Sonar Unit (large): **Range:** 100 miles (160km). **Weight:** 260lbs (117kg). **Cost:** 16,000 credits.

Radar Detector (portable): Indicates the use/presence of radar in the area. **Range of Detection:** 1 mile (1.6km). **Cost:** 200credits. Poor availability.

Ground Sensor System: Uses seismic and laser sensors to detect vehicles/men, their direction and their numbers. A good communications engineer can make such projections with 75% accuracy. The control unit with digital display, computer mount and monitor, is located at the center of a sensor web or fence. Up to 22, transmitter/receiver, sensor units can be linked to the control unit. Range between transmitters is 800ft (240m) and can register activity up to 10 miles (16km) away. **Cost:** 18,500 credits. Poor availability; generally limited to the military and scientific research.

Microwave Fence: Transmitter and receiver sensor posts emit an invisible, microwave curtain or fence that will light up and send a signal to the control unit when an intruder breaches its curtain. Range between transmitter posts is 500ft (150m). Posts are 7ft (2m) high. Can effectively cover a 14 mile (22km) area. **Cost:** 20,000 credits. Poor availability; primarily used for military purposes.

Medical Systems

SPECIAL EQUIPMENT

Portable Bio-Scan: The bio-scan is an impressive biological monitoring device with a multitude of functions. Sensors are attached to the skin and body which sends information to the computer display screen and/or to be recorded.

1. **Basic bio-mode** indicates and records such basic body functions as body temperature, heartbeat/rate, blood pressure, breathing, and glandular changes in the skin, including sweating.
2. **Stress evaluator** that operates much like a polygraph machine, recording stress and anxiety (without attaching sensors) by monitoring the voice quality of its subject. A communications engineer O.C.C. or field scientist O.C.C. (and *only* those two O.C.C.'s) can use the device as a "lie detector", but the information is often difficult to read and open to interpretation. Even a positive reading can *not* be declared absolute evidence of a falsehood. Chance of proper reading as a lie detector is 25% plus 5% per level of experience.

3. **A Toxic analyzer** that can analyze any liquid (water, blood, etc.) and be able to identify 380 toxins dangerous to humans. Solid items, such as fruits and vegetables, must be pulped or squeezed in order to be analyzed.
4. **A Dosimeter** used to measure radiation. **Cost:** 5000 credits; poor availability, since it's generally reserved exclusively for field expeditions of a scientific or military nature. **Weight** of this unit is 20lbs (9kg).

Portable Laboratory: This is another impressive portable unit that can perform several functions.

1. **Microscope** in a specially padded housing.
2. **One dozen specimen slides** and another dozen specimen trays for storage and transportation of item(s) for further analysis. A variety of vials, jars and test tubes.
3. **An incubation chamber** that is about the size of a VCR (1 1/2ft x 1ft x 8in. deep).
4. **Four burners.**
5. **Instrument tray** with a variety of common tools such as scalpels, tweezers, pins, tape, needles, calculator, etc.
6. **A refrigeration chamber** which is about half the size of the incubation chamber.
7. **An insolation chamber.** A special, airtight, scalable compartment about the size of the incubation chamber.
8. **A chemical cabinet** which holds several dozen chemicals commonly needed in the analysis of chemical structures.
9. **Centrifuge Device.**
10. **Dosimeter.**
11. **Tape recorder.**
12. **Micro-computer.**
13. **Mini-still camera**, 35mm, 32 photo capacity.
14. **Toxic analyzer**, identical to the one used in the "portable bio-scan". **Cost:** 12,000 credits; poor availability. **Weight** of the whole unit is 58lbs (26kg).

Portable Scan Dihilator: The portable scan dihilator is an uniquely comprehensive sensory device with FULL scanning capabilities.

1. **Radar/Sonar:** **Range:** limited to a 5 mile area. A trained operator (read sensory equipment skill) can positively identify readings as specific objects or vehicles, pinpoint location, and estimate rate of travel and direction at 65% proficiency.
2. Sensors include dosimeter, radar detector, heat, infrared, ultraviolet, microwave, and energy sensitive instruments; all of which identify, locate source, and record.
3. **Long range wide band radio** with scrambler. **Range:** 40 mile radius.
4. **Detachable short range (hand-held) communicator.** **Range:** 3 miles.
5. **Video camera** (mini) with both wide and narrow angle lenses. Audio-visual recorder using one or three inch metal discs with digital meter; lens filters, telescopic lens (480m) and tripod included. Capable of radio telemetry when boosted by long range radio.

Cost is about 4200 credits. Fair availability.

Standard First-Aid Kit:tains gauze bandages, 48 bandaids of various sizes, dozen tongue depressors, pen flashlight, a roll of medical tape, a dozen disposable medicated wipes, six butterfly clamps, disinfectant, pair of plastic gloves, scissors, forceps, six razor blades, lighter, tweezers, a thermometer, 100 aspirin tablets, and 24 decongestant tables (allergy/cold). **Cost:** 100 credits.

RMK Robot Medical Kit or "Knitter": A unique medical kit, developed with the mastery of nano- technology, in which a half dozen tiny robots, about the size of a shirt button, are released and automatically seek out cuts in the skin. One sprays the wound with disinfectant, another sprays antibiotics, a third cuts away dead or infected flesh, while the other three surgically suture the cut closed. When

the cut is repaired, the tiny 'bots return to their carrying unit, refill their supplies and wait till activated again.

Equal to a paramedic suturing skill of 90%. Not effective against internal injury, broken bone, or severe wounds. But great for cuts, bruises, bullet and stab wounds. **Cost:** 24,000 credits.

IRMSS Internal Robot Medical Surgeon System: An amazing medical device that injects a dozen microscopic robot units, about the size of a pinpoint, into the bloodstream to repair internal injury. The containment unit is placed over or near the suspected area of damage and the depression of a button releases the micro-surgeons into the body. The tiny robots search for the damage and repair it. Types of internal injury which they can repair include the removal of blood clots, repairing torn/ruptured veins, internal bleeding, and minor damage to internal organs. Equal to a medical doctor's surgical skill of 75%. When the units are done, they simply turn off and are naturally flushed from the body (average life is one hour). They are not reusable. Each IRMSS holds 48 surgical robots for four uses. **Cost:** 42,000 credits.

Compu-Drug Dispenser: A medical tool that is a combination computer, hypodermic gun, and chemical storage and dispensing unit. Can hold 48 different measured shots of drugs. The operator indicates which drug and the amount, presses the gun portion to the patient's arm and injects the appropriate medicine into the individual. **Costs:** 3000 credits plus each drug dose (average drug dose costs 1D4x100 credits).

Protein Healing Salve: This is a special high protein chemical solution that comes in a tube like toothpaste. The salve can be applied to burns, cuts, and rashes to increase the rate of healing (doubles normal healing). **Costs:** 100 credits per eight ounce tube.

MISCELLANEOUS EQUIPMENT

PC-3000 Hand-Held Computer: This is a fully functioning computer that is about the size of an opened paperback book or the size of an average human's hands placed together. When closed, the handle can be folded up and the entire unit can easily fit in most jacket pockets. The computer can be powered by a small, rechargeable battery (about 24 hours of life) or plugged into an electrical outlet. A hard copy of text can be printed out on the thermo-paper printer, but a magnifying glass is needed to read the tiny print. The computer can also be plugged into most video and cybernetic systems for use as a video monitor (no sound). Uses one inch disks. Dual drive system, hard memory is 16 megabytes. Weight: one pound (0.45 kg). **Cost:** 4500 credits

Portable Language Translator: A unique device that is programmed with the nine known languages of the Americas and can hold three additional languages. 12 others can be added with a supplemental language disc. The amazing device can recognize and monitor up to three different voices and two different languages or dialects. Level of accuracy is 98.7%, with a three second delay when directed at one individual, but drops to 78% with a six second delay when translating three speakers simultaneously. The operator must hold the microphone portion of the translator out toward the individual(s) whose words he wishes to translate. The tiny computer inside the hand-held unit identifies and translates the words, transmitting them to the accompanying head/earphones or can be set to broadcast the words over the speaker in the base of the handle. The earphones can be substituted with a cybernetic headjack.

The translator can also be set to translate the operator's words into the language of those he is speaking to with the same level of accuracy and speed. Conversations can be recorded on a one inch audio disk (3 hour capacity, costs about 20 credits each). The unit is about the size of a wireless microphone or a remote control and weighs about a half a pound (0.23 kg). **Cost:** 9600 credits.

Pocket Laser Distancer: A handy item, about the size of a cigarette lighter, that is used for measuring distances. The unit also has a digital display and built-in calendar (day, month, year), clock, and alarm clock capability. Laser range is 4000 feet (1200 m). **Cost:** 1000 credits.

PDD Pocket Digital Disc Audio Player and Recorder: Basically a future CD player with recording capabilities that is the size of a transistor radio or walkman. Plays or records on one and three inch discs. Typical blank disc will cost 10 to 20, credits with a two or three hour recording time. Pre-recorded discs will cost 20 to 80 credits depending on the quality, length of the recording, and availability. **Cost of the PDD:** Varies, usually 1200 to 2400 credits.

PDD-V Pocket Digital Disc Audio and Video Player: A slightly larger and more complex system that plays and records audio discs, but also plays video discs. A four inch, color monitor/TV screen displays the image. The unit can also be used with video equipment as a hand-held video monitor or attached to a larger screen to display its recording. **Cost:** Varies, usually 6000 to 12,000 credits.

Portable Tool Kit: A general purpose tool kit with an electric screwdriver and socket wrench, as well as 36 light weight, high impact conventional tools. Approximate weight is 12 pounds and comes in a convenient carrying case. **Cost:** 400 credits.

Electro-Adhesive Pad: This is a hand-held device that will adhere strongly to any metal surface by means of passing a small current through two, metal electrodes. These pads are commonly used by astronauts and can be used in astronauts shoes, but the hand-held pads are much more flexible and generally preferred. **Cost of the Electro-Adhesive Pads (2) and generator (hip or back-pack):** 30,000 credits. **In shoe form:** 40,000 credits. Can hold up to 1000lbs; works *only* on metal.

Hand Cuffs (novelty item): 10 credits; S.D.C. 40

Hand Cuffs (police): **Cost:** 20 credits; S.D.C. 80

Slap Glove: Six ounces of powdered lead is built into each glove just above the knuckles padding the wearer and adding weight and strength to the force of one blow. +2 to damage. Available from most security guard suppliers. **Cost:** 30 credits.

Fibreglass Nightstick: **Cost:** 10 credits, 1D4 damage.

Steel Rod Encased Nightstick: **Cost:** 20 credits; 1D6 damage.

Automatic Lock Pick; Release Gun: This item is only sold to law enforcement agencies at a cost of about 40 credits. Throws all pins into position at one time and never damages or harms the lock mechanism. Opens all types of locks (tumbler, spool, regular or mushroom). Cost on the street (only 19% chance it is even attainable): 600 credits minimum; may cost as much as 200% more depending on the seller and circumstance.

Lock Pick: The pick can be almost any style or size, but is always a small, thin, steel tool which ends in a slight, upward curve or special tip configuration. It is used to raise the pins of the lock so that it will open. A good range of pick thickness is .025-.035. These are available through locksmiths, and locksmith suppliers, and some establishments that specialize in rare, hot and illegal items. **Cost is usually high. 20 credits per pick, with at least a dozen needed for a proper range.** Note: Smiths and suppliers will not sell these tools to anyone off the street and may investigate or report the inquiry.

COMMUNICATIONS EQUIPMENT

Communications equipment is fairly basic in regards to character's use and needs. Various surveillance and video systems might be added on, depending on the circumstances and the players' ingenuity.

Field Radio: A back-pack-style radio transmitter and receiver with wide band, long-range capabilities, frequency equalizer, field strength detector and scrambler. **Range:** 60 miles (96km). **Weight:** 161bs (7kg). **Cost:** 600 credits; good availability.

Hand Held Communicator: Basically an enhanced walkie-talkie, it is a basic instrument issued to all military personnel and field operatives. Was also used by the public in recreation. **Cost:** Per single unit - 150 credits; excellent availability (common). **Weight:** 6 ounces (170 grams). **Range:** 3 miles (4.8km).

SURVEILLANCE EQUIPMENT

Keyhole or Tube Microphones: A microphone (mic.) with a long, hollow tube which can be flexible or stiff, allowing it to be placed in cracks, mounted in walls or placed in similar, small, "keyhole"-type crevices. Picks up sounds up to 34ft (10m) away and transmits up to 1000ft (300m). **Cost:** 150 credits; fair availability.

Video Wall Mount: This small, remote video camera is only about the size of a man's palm (5 inches in diameter), thus it is easily concealed. The camera is backed with a powerful suction device that will adhere to any smooth surface, whether it be a wall, table, appliance, vehicle and so on. The video wall mount can broadcast continually for 72 hours, or by remote or preprogrammed, regulated intervals. The lens has limited mobility, able to rotate in about a 90 degree radius. It's audio capacity has twice the duration of its video transmission and, able to pickup sounds up to twenty feet (6m) away with crystal clarity. The monitor can be the mini-hand held screen or any variety of larger or multi-unit monitors. **Cost:** 200 credits; fair availability through the conventional market, but a hot commodity at 300 credits on the black market. Hand held monitor costs 150 credits.

Contact Microphone: Translates vibrations into sound, but requires a sounding board such as a wall, windows, large object, etc. Can be as small as a tie tack. Picks up sounds up to 10 yards/meters away, and transmits up to 1000ft (300m). **Cost:** 170 credits; fair availability.

Wireless Microphone: This compact mic. is about the size and thickness of a box of matches. It can pickup sounds up to 14ft (4m) away and broadcast up to 300ft (90m) away. **Cost:** 250 credits; poor availability.

Tracer Bug: This is a tiny device about the size of a checker which has a sticky or magnetic side that can be attached to a vehicle or slipped into a person's pocket, back pack, briefcase, etc. It can transmit a signal that can be followed up to 8 miles (12km) away. Battery powered it has a limited life of 72 hours of constant transmission. **Cost:** 140 credits; fair availability.

Pocket Scrambler: The scrambler will distort or "scramble" outgoing radio signals, preventing interception and interpretation by the enemy. **Cost:** 300 credits; good availability.

Note: Other, more conventional video systems, cameras, lenses and optics, are also effective tools for surveillance.

Ultraviolet Signaler: The signaler is a small strip of ultraviolet sensors and another transmitter strip that can be adhered to a doorway, walls and so on, to create a beam of invisible light blocking that area. When the beam is broken by an intruder or vehicle, etc., it will send a silent signal to a monitoring device and/or trigger a video unit. **Cost:** 900 credits; fair availability.

Game Master's Section

During play tests, some players initially seemed a bit disgruntled over the facts that first, there seemed to be too many good characters to choose from (can there be such a thing?) and second, that character generation took between 20 minutes to an hour. They also grumbled about what seemed to be a great number of skills and, in some cases, abilities. That was preparing for the game.

After the adventure, the same players were completely in love with the characters and **Rifts**. When I suggested reducing the number of skills, they protested vehemently, insisting that the skills and bonuses were perfect. The comments I got went something like, "Yeah, at first I thought there might be too much detail, but during the adventure I found myself using the skills and everything at my disposal. Best of all, after one adventure I feel like I really know this character and want to play him again."

The reason I mention any of this at all is to point out that the sheer volume of material and the elaborateness of the characters may intimidate some players on their initial glimpse of the game. It is not that the game is too complicated or clumsy, but that the character creation and the RPG itself is a bit more demanding than many other role-playing games, including *Palladium's*. This is not a beginner's role-playing game, nor one conducive to hack and slash gaming. Like many of our

games, **Rifts** is a thinking man's game. Perhaps the hostile environment makes it all the more important that one uses his head. Because the world is so *new* and different, there is also a lot of material the players will want to read and familiarize themselves with before they can make a decision. For example, once the players are familiar with the energy weapons, they may make a selection in the blink of an eye, but the first time or two they will want to read all the choices and think about exactly what they want. They are also likely to take into consideration the O.C.C.s of their teammates and the types of powers and weapons they have to better round out the *group's* strengths. Some characters will require more work than others, but will ultimately lead to the creation of exciting and very different adventurers.

On the other hand, I may be overstating the situation. We were play testing on a rather hurried schedule and had only two photocopies of **Rifts** to share between six or eight people, all eager to play. Many of my play testers had only enough time to read the specifics regarding their particular character, nothing more. Just don't let the magnitude of the game overwhelm you or your players. While some of the characters may seem radical and elaborate, the game system is still the tried and true *Palladium role-playing system* and plays very smoothly. Once the players get a handle on their character, you'll find everything moves along at a nice pace. But that initial set-up is likely to take a bit of effort on everybody's part.

Likewise, the richness of the world will be demanding on the game master. Depending on the GM and the players, the adventures in **Rifts** can be incredibly different from player group to player group or from playing session to playing session. Do not be afraid to take charge and shape the world and your adventures to your tastes. Mold it. Play with it. Explore all the possibilities. And most of all, have fun!

Some Shortcuts and Data for the GM

Yeah, so the world of **Rifts** is a colorful place brimming with possibilities. Great. It's still a lot of work for the game master to pull something together and start a campaign. And characters that require a GM to spend half an hour to roll-up do not make life any easier (believe me, I know). So, what follows in this section are a bunch of optional creation tables and stats for a *typical* this and that to help make quick roll characters and encounters easier.

Quick Roll Monsters

A variety of specific, supernatural monsters and demons will be presented in the upcoming supplements; till then, one can use the random monster generation tables, presented here, to create a host of fiends from the rifts.

The world of **Rifts** is filled with supernatural creatures that prey on humans and humanoid life forms. Generally, they are considered to be evil and demonic. Their physical appearance is often that of a monstrous humanoid, usually larger than a human and powerfully built. But they also appear in the form of grotesque animals or a combination of animal and humanoid. Predators almost always have fangs and/or canine teeth for biting and cutting. Many have claws and talons for slashing and climbing.

The exact appearance of the creature I leave to the imagination of the game master. The creature's specific abilities I will help outline and define.

The Animalistic Predator

There are vast numbers of different types of monsters that emerge from the dimensional rifts. Not all are intelligent or empowered with great magic. Some are simple predators who instinctively prey on other animals. Unfortunately, humans and humanoids are often these creatures' prey.

Most supernatural predators will share the following instincts, characteristics, and abilities.

- 1. Instinctive hunters.** Very alert, notice movement and instinctively react by giving pursuit. Quick reflexes; Roll once to see how quick: + 1D4 on initiative, also + 1 to strike.
- 2. Attacks per Melee.** Roll: 1D4 attacks per melee.
- 3. Mega-damage structure.** Most supernatural creatures are the equivalent of a mega-damage structure. This means normal weapons, such as knives, guns, etc., do no damage! Only mega-damage weapons, magic, and usually psionics will have any affect on the supernatural thing. This also means the supernatural menace inflicts mega-damage. **Note:** Most supernatural creatures are especially vulnerable to a particular item/element such as fire, water, or iron, and so on; even weapons (of this element) that are normally **S.D.C.** weapons will inflict mega-damage on the supernatural being. This

is the result of some unusual disparity in the physical laws that govern our world and the dimension in which the being normally exists. *See Weakness.*

To determine the amount of **mega-damage points**, instead of hit points or **S.D.C.**, that the creature possesses, roll 2D4x10. Size may add to the beast's physical **M.D.C.**

- 4. Alignment.** With rare exception, supernatural predators are considered evil, or at best, anarchist. They are evil in the sense that they hunt, kill, and eat humans. They have no remorse for their actions, just as a human has no remorse for shooting and eating a rabbit. Humans and humanoids are just the *animals* the creatures prey on, plain and simple. From the human's perception, they do not see themselves as being an animal like a rabbit eaten by a wolf, and perceive the monsters as being horrible and murderous fiends who will slay and devour man, woman, and child without distinction, which is pretty much the case. These supernatural predators are walking nightmares that stalk the wilderness and cities alike.
- 5. Intelligence.** The predator is an instinctive hunter and may exhibit cunning in the way it stalks its prey, hides, and attacks, but it is not intelligent in the same way as a human. For example, most predators are solitary hunters or hunt in pairs. Their attacks are fairly straightforward, like a cat on the prowl. The majority do not use tools or weapons. Even hand-held weapons such as knives and clubs are generally uncommon, and they rarely use energy weapons, guns, or body armor. The piloting of a vehicle or the use of a computer is beyond their comprehension. These are comparatively primitive and primordial hunters who use their natural powers, teeth, and claws, over weapons, technology and strategy. What sets them above the normal animal predators humans know, like tigers, are their unusual powers and superhuman nature.

To determine I.Q., roll 2D4 for a rough equivalent to human intelligence, but the creature's thoughts are always more linear, direct, and driven by the instinct to hunt and kill. They will usually fight to the death when seriously wounded or cornered/trapped.

- 6. Average Strength.** Physical Strength is usually around 20 or higher; roll 3D6+ 12 to determine the average P.S. of the species.
- 7. Prowess and Endurance.** Roll 2D6+ 12 for P.P. and 4D4+ 12 for P.E. Attribute.
- 8. Speed:** Roll percentile.
 - 01-25 Equal to a human, roll 3D6.
 - 26-50 Fast but still equal to an athletic human, roll 5D6+6
 - 51-75 Fast, equal to many animals, roll 1D6x 10 plus 10.
 - 76-00 Superhuman speed, roll 2D6 x 10 plus 20.
- 9. Horror Factor.** All monsters have a horror factor. Roll 3D4 + 4.
- 10. P.P.E.:** Roll 1D4X10.

Note: All the following tables are set up for random rolls, but the GM may make selections to design his monsters rather than roll randomly.

Size

Roll once or select one.

- | | |
|-------|--|
| 01-10 | Five feet tall (1.5 m), equal to a small human. |
| 11-20 | Six feet tall (1.8 m), equal to typical human. |
| 21-30 | Seven feet tall (2.1 m), equal to a tall human. |
| 31-40 | 10 feet tall (3 m), giant. |
| 41-50 | 12 feet tall (3.6 m); add 1D6 M.D.C. |
| 51-60 | 15 feet tall (4.5 m); add 2D6 M.D.C. |
| 61-70 | 18 feet tall (5.4 m); add 3D6 M.D.C. |
| 71-80 | 20 feet tall (6.1 m); add 4D6 M.D.C. |
| 81-90 | 22 feet tall (6.7 m); add 6D6 M.D.C. |
| 91-00 | 25 feet tall (7.6 m); add 1D6 x 10 M.D.C. |

Natural Weapons

Roll twice or select two. Bite and claws are the most common.

- 01-10** Horn: Stabbing attacks; 2D4 M.D.
- 11-20** 1D4+ 1 Tentacles instead of arms and hands: Quite powerful; 1D6 + 2 M.D. per hit/punch.
- 21-30** Bite: Huge and powerful jaws and canine teeth; 2D6 M.D.
- 31-40** Bite: Small, sharp teeth; 1D6 M.D.
- 41-50** Clawed hands: 1D6 M.D.
- 51-60** Clawed hands: Large retractable claws; 3D6 M.D.
- 61-70** Thick, slashing tail: 2D4 M.D.; does not add to number of attacks.
- 71-80** Prehensile tail: Used like a third arm/hand for hitting and holding; 1D4 M.D. damage but also adds one additional attack per melee.
- 81-90** Prehensile tail with spikes or blade: Used as a third claw or stabbing/slashing weapon; 2D6 M.D.
- 91-00** Fire Breath: Range is 40 feet (12 m), inflicts 3D6 M.D.

Note: Dragons generally inflict 2D6 M.D. with their claws and 2D4 M.D. by bite.

Natural Predator/Hunting Abilities

Roll two times or select two different abilities.

- 01-10** Swim 90%
- 11-20** Prowl 54% +4% per level of experience.
- 21-30** Track by sight (follows trails, footprints, and other visual signs; knows the habits of its prey): 44% +4% per level of experience.
- 31-40** Sense P.P.E. and Magic (same as Dog Pack).
- 41-50** Track by smell 54% +4% per level of experience.
- 51-60** Climb: 80% +2% per level of experience.
- 61-70** Nightvision (Like an owl, can see clearly 200 feet (61 m) in total darkness and 4000 feet in outdoor night/darkness with other sources of light such as stars, moon, etc.).
- 71-80** Keen Hearing (same as Dog Pack); + 1 on initiative and parry.
- 81-90** Sense psychic and magic energy (same as Dog Pack).
- 91-00** Natural sense of direction (never gets lost, homing sense: 80%).

Natural Magic Powers

These are magic powers that are not used in the format of a spell, but instead, the creature can simply use the powers at will as often as once per melee. Roll twice or select two.

- 01-05 Sense magic
- 06-10 Fire ball
- 11-15 Turn self invisible
- 16-20 See the invisible
- 21-25 Chameleon
- 26-30 Fly as the Eagle
- 31-34 Energy field
- 35-37 Breathe without air
- 38-40 Repel animals
- 41-45 Fire bolt
- 46-50 Levitation (self)
- 51-55 Metamorphosis self into insect
- 56-60 Escape
- 61-65 Metamorphosis self into animal
- 66-68 Calling
- 69-71 Shadow meld (self)
- 72-75 Call lightning
- 76-80 Wind rush
- 81-85 Spoil food/water
- 86-90 Metamorphosis self into mist
- 91-95 Blind
- 96-00 Life drain

Feeds on...

Roll once or select one.

- 01-25** P.P.E., by killing its prey and absorbing the potential psychic energy, which is doubled at the moment of death.
- 26-50** Feeds on human flesh; cannibal.
- 51-75** Drinks human blood; vampire- like.
- 76-90** Feeds on fear. A psychic vampire who empathically feels and absorbs his victim's emotions of fear/terror.
- 91-00** None; hunts for the sheer pleasure of the kill. Does not eat or use any part of the prey.

Weakness

Roll once or select one weakness.

- 01-10** Water. Normal water inflicts mega-damage! A squirt from a toy water pistol does 1D4 M.D. per each squirt (typical range 30 feet). A splash from an eight ounce glass of water does 2D6 M.D., a half gallon (1.6 liters) inflicts 6D6 M.D., while a gallon (3.7 liters) does 1D6X10 M.D. points.
- 11-20** Energy. All types of energy including, fire, lasers, plasma, ion blasts, electricity, and nuclear energy inflicts double damage. However, kinetic energy/attacks, including mega-damage punches from robots and power armor, vibro- blades, explosives/missiles, rail guns, and bullets, do absolutely NO damage!
- 21-30** Light. All forms of light blind and frighten the creature (-9 to strike, parry, and dodge when blinded). Lives in a dark cave or dwelling during the day. Hunts only at night. Exceptional night vision equal to a human's day vision. Laser weapons inflict double damage.
- 31-45** Fire. All fires, even normal fires, inflict mega-damage. Mega-damage fire/plasma/magic inflicts double damage.
- 46-55** Weapons of Iron (must be 88% pure iron) inflict the mega-damage equivalent of the normal, ancient, S.D.C. weapon; i.e., a pure iron short sword that normally inflicts 1D6 S.D.C. damage inflicts 1D6 mega- damage (M.D.) against this creature. A 1D8 S.D.C. mace does 1D8 M.D., but only against this creature. Against normal humans the weapons are simple S.D.C. items.
- 56-65** Wood. The supernatural fiend is vulnerable to weapons made mostly of wood (90%). Thus, while bullets may bounce off, a wooden arrow shot from a bow will inflict mega-damage (see S.D.C. conversion to M.D. in the previous *Weapons of Iron* description).
- 66-75** Silver. The paranormal monster is vulnerable to weapons made of silver (including bullets). Basically works the same as *Weapons of Iron*.
- 76-85** Symbols of goodness and purity invoke fear and hold the creature at bay. To be touched by the symbol inflicts 2D4 M.D. and sends the monster running 2D4x100 yards/meters away.
- 86-95** Mirror. The beast's reflection is terrifying, even to itself. If the creature sees its own reflection it must roll against its own horror factor. A failed roll means the creature is momentarily stunned as per the usual horror factor, then flees and hides for 1D6x10 minutes.
- 96-00** Cold. The creature can not stand the cold. Exposure to freezing or below temperatures will inflict 2D6 M.D. every minute. The creature is rarely found in regions where the temperature drops to freezing, although the monster may migrate with the seasons. Shards of ice can be used like a dagger or club and do 1D6 M.D. each (snowballs inflict one M.D. point of damage each). Ice cold/frozen weapons will also inflict mega- damage.

Hunting Orientation

Roll once or select one.

- 01-25** Mated pairs, where there is one, another is near by.
- 26-55** Solitary Hunter, always found alone.
- 56-75** Hunt in small packs of 2D4.
- 76-95** Hunt in medium packs of 3D6.
- 96-00** Hunt in large packs of 6D6.



Intelligent Supernatural Monsters

The intelligent supernatural monsters can appear just as hideous, demonic, and inhuman as the predators. They too, often feed on humans and humanoids, but are much more calculating and clever about it. The intelligent monsters are also motivated by needs and desires other than an instinct to hunt. Like humans, they may crave power, wealth, fame, revenge, etc., as well as feel the emotions of hate, love, anger, greed, envy, etc. Many of these fall into the category of "demons," as humans tend to call them. Evil, maniacal beings that enjoy inflicting pain and sorrow on innocent and unsuspecting humans and possess superhuman powers to help them accomplish their goals.

Most intelligent, supernatural creatures will share the following characteristics and abilities.

- 1. Cold and calculating fiends.** They are alert, clever, and devious schemers who delight in hurting others. They are often quite persuasive and tricky. Roll 4D4+ 10 to determine M.A.
- 2. Attacks per Melee.** Roll: 1D4 hand to hand attacks per melee. **Mega-Damage:** Claws 1D6 M.D., Bite 1D4 M.D., or by weapons or magic or psionics.

Mega-damage structure. Like most supernatural creatures, the intelligent monster is the equivalent of a mega-damage structure. This means normal weapons do no damage and only mega-damage weapons, magic, and, usually, psionics, will have any affect on the monster. This also means the supernatural fiend inflicts mega-damage. **Note:** The intelligent supernatural creatures are also often vulnerable to a particular item/element such as fire, water, or iron, and so on; even weapons that are normally S.D.C. weapons will inflict mega-damage on the supernatural being. *See Weakness.*

To determine the amount of physical **mega-damage points**, instead of hit points or S.D.C., roll 1D6x10. The creature may also utilize technology and wear M.D.C. body armor.

Alignment. With very rare exception, the intelligent supernatural monster is evil, usually miscreant or diabolic. They love to torment others, especially the comparatively weak humans. They have no remorse for their actions and delight in torture, deceit, revenge, and all manner of cruelty. Humans and humanoids are just *the playthings*

in a foul and twisted game or the pawns used for the acquisition of their wants. From the human's perception, these fiends are demons who prey on the misery of man.

5. **Intelligence.** Most are equal to the average human and some are incredibly intelligent. The majority seem to be knowledgeable in magic or possess psionic powers, as well as utilize some rudimentary degree of human technology. Many use human weapons, equipment, vehicles, and even cybernetic implants and bionics. Some disguise themselves as humans or human-like D-Bees to make themselves more accessible to the trappings of humankind. Others pronounce themselves demi-gods and gather cult followers or conquering armies. I.Q.: roll 3D4 + 3, roughly equivalent to human intelligence.
6. **Average Strength.** Physical Strength is usually around 20 or higher; roll 3D6+ 10 to determine the average P.S. of the species.
7. **Prowess and Endurance.** Roll 2D6 + 8 for P.P. and 4D4+ 10 for P.E. Attribute.
8. **Speed:** Roll percentile.
 - 01-20 Equal to a human, roll 3D6.
 - 21-50 Fast but still equal to an athletic human, roll 5D6 + 6.
 - 51-80 Fast, equal to many animals, roll 1D6x10 plus 10.
 - 81-00 Superhuman speed, roll 2D6x10 plus 20.
9. **Horror Factor.** All monsters have a horror factor. Roll 3D4 + 4.
10. **P.P.E.:** See Supernatural Powers and Orientation Table.
11. **Skills:** GM's option. The intelligent demon may also learn/know a handful of skills, select ten, one must be a language. Skills are generally restricted to the following. No bonuses are available to any skills other than possible I.Q. attribute bonus.
 - Communications: Radio Basic only.
 - Domestic: Any
 - Espionage: Disguise, Escape Artist, Intelligence, and Wilderness Survival only.
 - Mechanical: None.
 - Medical: First Aid or Holistic Medicine only.
 - Military: Any
 - Physical: Climbing and swimming only.
 - Pilot: Any, except Robots and Power Armor.
 - Pilot Related: Any
 - Rogue Skills: Any
 - Science: Any
 - Technical: Any
 - Weapon Proficiencies: Any
 - Wilderness: Any

Note: All the following tables are set up for random rolls, but the GM may make selections to design his monsters rather than roll randomly.

Size

Roll once or select one. Intelligent monsters tend to be human size.

- 01-10 Five feet tall (1.5 m), equal to a small human.
- 11-30 Six feet tall (1.8 m), equal to typical human.
- 31-45 Seven feet tall (2.1 m), equal to a tall human.
- 46-60 Eight feet tall (2.4 m), equal to a tall D-Bee or mutant.
- 61-70 10 feet tall (3 m), giant.
- 71-80 12 feet tall (3.6 m); add 1D6 M.D.C.
- 81-90 15 feet tall (4.5 m); add 2D6 M.D.C.
- 91-00 20 feet tall (6.1 m); add 4D6 M.D.C.

Supernatural Powers and Orientation

Roll once or select one.

- 01-10 A strange cross between a techno-wizard and a cyborg. Select two bionic limbs (page 239), select two bionic weapons for those

limbs (TW equivalent weapons like the TK machinegun or P.P.E. powered weapons may be substituted; see pages 91, 92, and 96), select one bionic head or throat feature (page 242), and select two cybernetic implants of choice (cybernetics page 230), but all are powered by P.P.E. energy/batteries made possible through techno-wizardry (the usual life of the artificial limb/implant is unchanged). The creature also knows 1D4 magic spells from levels 1-3, but with the usual TW penalties/limitations. Does not have the usual *Special Techno-Wizard Powers*. P.P.E. is 1D6x10.

- 11-20 Effectively a Line Walker. Has all the Line Walker's abilities from numbers 1-7, and knows 1D4 spells from each magic level 1-7. P.P.E. is 2D4x10+10.
- 21-35 A master psionic similar to a Mind Melter. Select six psi-powers from the Healer or Sensitive or Physical category (6 powers from one category) and select six additional psi-powers from the Super category. I.S.P. is 3D4x10. P.P.E. is 4D6.
- 36-50 Creature of magic. Possesses natural mystic powers. Roll five times or select five powers from the *Natural Magic Power* table and roll once or select one from the *Weakness* table found in the Supernatural Predator section. Plus add 2D6x10 M.D.C to the creature's physical mega-damage structure. P.P.E. is 2D4x10.
- 51-70 Psychic and magic creature. Select two psionic powers from each of the psionic power categories, including super. Then select two spells from each magic level 1- 4. I.S.P. is 2D4x10. P.P.E. is 2D4x10.
- 71-85 Intelligent predator! Roll on all the *Supernatural Predator Tables* listed in the previous section, but has the intelligence and characteristics listed under numbers 1-11 of the intelligent supernatural being in this section. P.P.E. is 1D6x10.
- 86-00 Sorcerer! Has vast spell knowledge and P.P.E. Knows 1D4 spells from each magic level 1-9. P.P.E. is 3D6x10+ 10. Also roll once on the *Natural Magic Power* table found in the Supernatural Predator section.

Optional Tables

For additional color, roll on the *Feeds On...* and *Weakness* tables found in the **Predatory Supernatural Monster** section.

SPEED CHART

The following is a simple conversion table of speed factors into *approximate* miles per hour (mph) and kilometer equivalent.

Speed Factor	Approx. MPH	Kilometers Per Hour
5	3 1/2	5.6
11	7 1.2	12
22	15	24
27	18 1/2	29.7
33	22 1/2	36
44	30	48
50	35	56
55	37 1/2	60
58	40	64
66	45	72
77	53	85
88	60	96
110	75	120
132	90	148
220	150	241
293	200	321

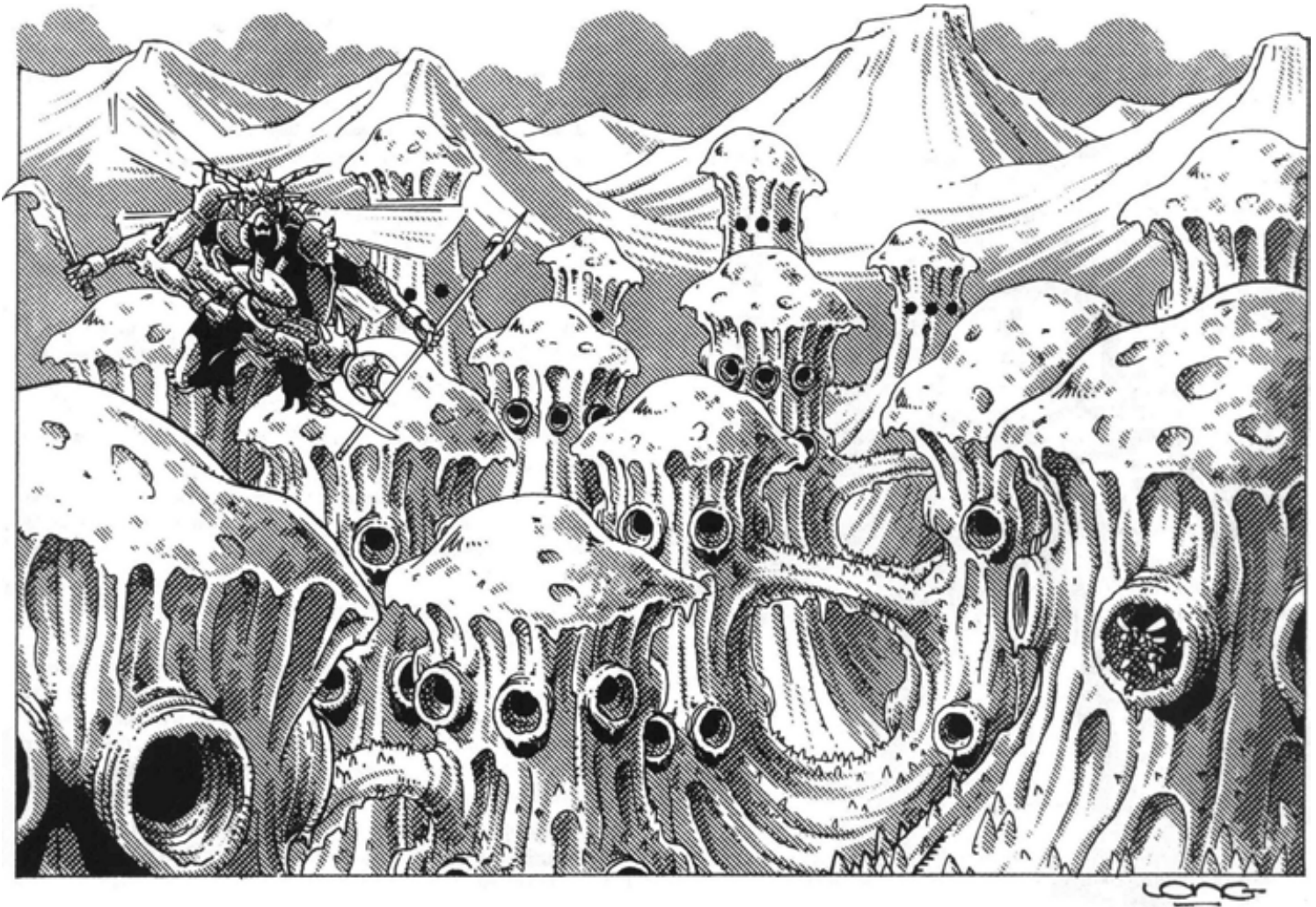

The Xiticix

The Xiticix (pronounced Zy-tick-icks) are a race of insect-like humanoids from another dimension. The first Xiticix was recorded about 20 years ago, but it is likely that a swarm was inadvertently transported into our world years earlier; they just were not noticed because they inhabited the northern wilderness of Saskatchewan and Manitoba. Humans have no idea as to exactly how many Xiticix exist nor exactly what territories they occupy. Most scholars place their numbers at about 20,000, but the Coalition estimates that there are three times that number, and some wilderness scouts claim they number into the hundreds of thousands. The Xiticix threat has only been recorded over the last 20 years as they begin to encroach on the strongholds of humankind.

The insect aliens are an aggressive race of warriors who are extremely territorial. They seem to tolerate only animal life and small groups of inconspicuous humanoids of four or less. Obvious intruders, especially large or noisy robots and vehicles, are instantly attacked, even if a lone individual. Humanoids who are spotted within ten miles (16 km) of a Xiticix hive city are also attacked. Entering a hive city will agitate the entire community and elicit a horde of warriors to attack like a swarm of angry bees.

Each hive network or city has its own queen and distinctive scent (recognizable to other Xiticix and Dog Pack mutants). The living structures resemble giant mushrooms that tower four to eight stories high. Each holds scores of Xiticix. Warriors are found mostly in the upper portions, while workers are found in the lower levels. The entrances to the mushroom towers are always located at the top of the structure. Many of the towers are connected by bridges that can be traversed from the inside through a tunnel or from the outside as a bridge. The city is a mega-damage structure created with mud and secreted resin. The ability to make the mega-damage mud/concrete is instilled in the workers by fluids from the queen. A typical tower/building is about 100 M.D.C.

The queen's chamber is located somewhere under the city in a massive subterranean cavern. Near her are the four birthing chambers where the eggs are stored. Each hive colony has a minimum population level that the queen instinctively knows. When the population drops below that minimum, the queen knows to lay more eggs.

There are three types of Xiticix: the seven foot tall (2.1 m) warrior, the slightly smaller, six foot (1.8 m), drone or worker, and the giant, 20 foot (6 m), queen. All Xiticix look similar. Each has four arms and two legs, a pair of wings, and large mandibles. The queen has a distinctly different head, and supports a huge, swollen eggsack for her lower body.



Xiticix Warrior

Alignment: Considered anarchist or evil. Hate humans and most other intelligent life forms.

Horror Factor: 9 or 12 for a swarm of 10 or more.

Size: 7 feet (1.8 m). Weight: 500 lbs (225 kg).

Attributes: The number of six-sided dice are indicated as follows:

I.Q. 2D6+1 and is considered to be in the same category as a supernatural predator, functioning on instinct as much as intellect.
M.E. 5, M.A. 1, P.S. 6, P.P. 4, P.E. 3, P.B. 1, Spd 4 running, 3D6X 10 flying.

Hit Points/M.D.C.: Like true insects, the aliens wear their skeleton on the outside. The exo-skeletons of the Xiticix are natural mega-damage structures; 1D6X 10+20. The exo-skeleton will slowly regenerate any damage they may sustain at a rate of 1D4 M.D.C. per day.

Combat: Five attacks per melee, +1 to parry and dodge and on initiative.

Weapons: 1. TK-Rifle, works very similar to the principles of technowizardry and the TK- Machinegun. Mega-damage is 4D6 per blast. Range is 4000 feet (1200 m). Payload is 40 blasts before requiring 20 P.P.E. to recharge. The bayonet inflicts 2D6 S.D.C. as a normal blade weapon, but is often coated with poison (see number four).

2. Short sword, a wicked S.D.C. weapon used for parrying. It can parry M.D.C. hand to hand attacks, but inflicts 2D6 S.D.C. damage. W.P. Sword adds a bonus of +2 to strike and parry when using the sword.

3. Spear, another hand to hand weapon that is strong enough to parry a M.D. punch, but itself inflicts 2D6 S.D.C. damage. W.P. Spear skill adds a bonus of +2 to parry and +3 to strike when thrown.

4. Hand to hand combat: Normal Punch or kick does 5D6 S.D.C., Power punch inflicts 1D6 mega-damage (M.D.), but counts as two attacks.

A power leap kick does 2D4 M.D., but also counts as two attacks. Fighting style is similar to human martial arts. Critical strike on a roll of a natural 18-20. Add one extra attack at levels four, nine, and fourteen.

Bite attack with mandibles inflicts 4D6 S.D.C. plus secretes a poison. The poison causes immediate nausea, vomiting and convulsions unless a successful save versus deadly poison is made. Poison damage is 6D6 S.D.C. per each bite/hit.

Note: The Xiticix can secrete the poison and often coat their weapons with the toxin.

Natural Abilities: 1. Poor clarity of vision, making close work and literacy impossible, about half as clear as humans, but is equal to human vision in distance and can see into the infrared and ultraviolet spectrum of light.

2. Natural homing sense equal to the land navigation skill at a 92% skill proficiency.

3. Heightened sense of smell. Recognizes its specific hive, queen, and fellow hive dwellers by scent. Wilderness scouts have learned that covering oneself in the scent of a Xiticix will enable one to pass through their territory unmolested. Unfortunately, the only way to get the fluid to cover oneself with the scent is to kill a Xiticix and remove its scent gland (one gland can cover four humans).

Also can track by smell at 30% +4% per level of experience. Can smell the scent of human blood up to three miles (3.6 km) away.

P.P.E.: 1D6X10+10

Xiticix Worker

The worker is basically the same as the warrior except as follows.

Horror Factor: 8 or 10 for a swarm of 10 or more.

Size: 6 feet (1.5 m). **Weight:** 400 lbs (180 kg).

Attributes: Same

Hit Points/M.D.C.: The exo-skeleton of the Xiticix worker is 1D4X10+10. The exo-skeleton will slowly regenerate any damage they may sustain at a rate of 1D4 M.D.C. per day.

Combat: Four attacks per melee, +1 to parry and dodge and on initiative.

Weapons: Never use any weapons other than the sword and hand to hand attacks; damage is the same as the warrior. The only difference is that the workers have a pair of arms with articulated hands and a pair with giant pincers. The pincers can inflict 1D6 M.D. when used like giant scissors to snip and cut one's opponent.

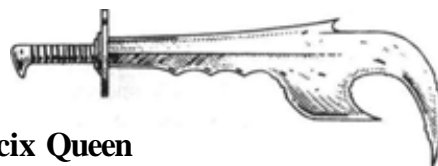

Xiticix Queen

The queen is fundamentally the same as the warrior except as follows.

Horror Factor: 12

Size: 20 feet (6.1 m). **Weight:** 2000 lbs (900 kg).

Attributes: Same, except I.Q. is 3D6+1.

Hit Points/M.D.C.: The exo-skeleton of the Xiticix queen is 1D4 X 100.
The exo-skeleton will regenerate damage at a rate of 1D4X10 M.D.C. per day.

Combat: Four attacks per melee, + 1 to parry and dodge and on initiative.

Weapon: Hand to hand or psionics.

Psionic Powers: Telepathy, empathy, empathic transfer, sixth sense, see the invisible, sense magic, impervious to poison, impervious to cold and fire, levitation, mind block, group mind block, psi-sword, psi-shield, super-telekinesis.

I.S.P.: 3D6X10

P.P.E.: 4D6x10

Fury Beetles

The "Fury Beetle" receives its name from its seemingly erratic and frantic actions and its beetle/insect appearance (although it is not an insect at all!). When on the move, the fury beetle darts along in varying bursts of speed and in a zigzag pattern. When attacked, the monster scampers to and fro and back and forward, while emitting a terrible wailing. Once engaged in combat, the creature fights to the death or until the attacker is slain or gives up the fight and flees. A cornered beetle, or a mother guarding her eggs, will also fight to the death. Fury beetles are easily startled and instinctively lash out at the cause of their surprise.

The gigantic creatures are common to the forests of eastern Canada and the eastern United States. For generations they were feared and shunned, but today (102 P.A.), the beasts are sometimes hunted as food, and for their armor plates to make M.D.C. armor (a full Fury Beetle suit of plate armor offers 70 M.D.C. but weighs 35 lbs/16 kg; costs about 22,000 credits). Some practitioners of magic, wild psi-stalkers, and wilderness scouts have even learned to train young beetles as riding animals! **Note:** A trained riding Fury Beetle will cost 80,000 credits and up.

Alignment: Considered anarchist or evil. They are solitary creatures that travel alone or in mated pairs. They are not particularly aggressive or intentionally evil, but are extremely nervous and easily startled. When startled, frightened, or angered the creatures attack and fight to the death. They are incredibly powerful and a single beetle has been known to level an entire wilderness town. Even a tamed riding animal is known to throw its master when startled or worse yet, to bite him.

Horror Factor: 14.

Size: 20 feet (6 m) **Weight:** 3500 lbs (1575 kg).

Attributes: Animal intelligence and instincts. Most attributes are not particularly applicable. **Speed** is 3D6 x 10 running. Can maintain full speed for 1D6X 10 minutes, slows to about half speed for five or ten minutes, then has another burst of speed at full for another 1D6X 10 minutes. Can run for 24 hours without exhaustion.

Hit Points/M.D.C.: The exo-skeleton of the fury beetle is a natural mega-damage structure; Main Body: 2D4x 100, Head: 1D4X 100, Vulnerable underbelly is 2D4x 10 M.D.C. The exo-skeleton will slowly regenerate damage at a rate of 4D6 M.D.C. per day.

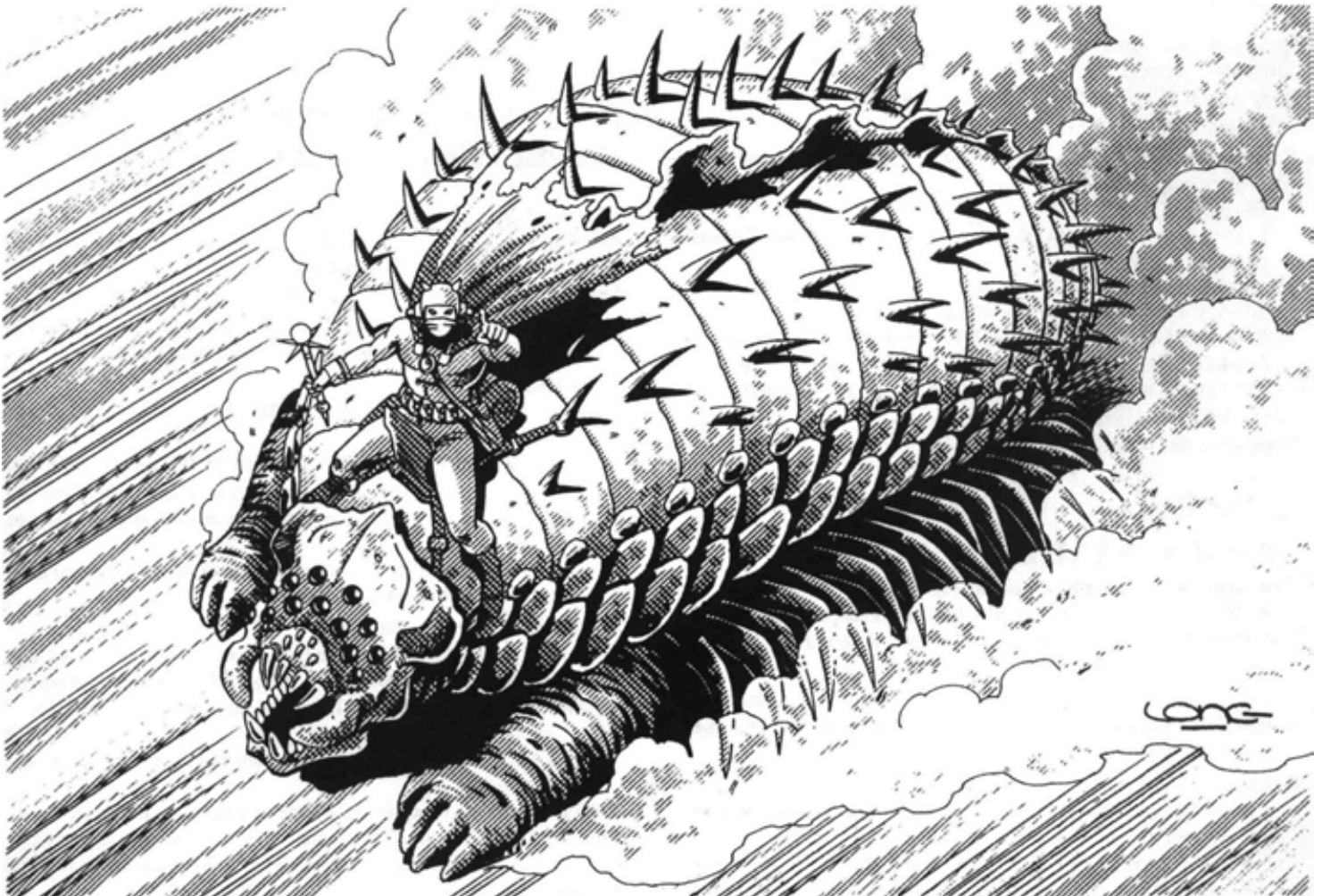

Combat: Four attacks per melee, +3 to strike, +1 to parry and dodge and +2 on initiative. +4 to dodge when running at full speed.

Mega-Damage: Its main mode of attack is its bite, which inflicts 4D6 M.D., swipe from claw 2D6 M.D., charge/ram 3D6 M.D., trample 2D6 mega-damage.

Natural Abilities: 1. Exceptional vision (has 12 eyes), equal to that of a hawk or eagle. Can also see into the infrared and ultraviolet spectrum of color, has polarized vision, and thermo-imaging/targeting.

2. Good sense of direction, equal to land navigation skill at a 52% skill proficiency.

3. Psionic powers: Can sense and locate water within a four mile (6.4 km) area (an automatic ability that costs no I.S.P.), sense evil, sense magic, mind block.

I.S.P.: 1D6X10

P.P.E.: 1D6X10

Note: Eats meat (other animals and humanoids) and vegetation. A fair hunter, but mostly a scavenger.

A Typical Dinosaur

Dinosaurs are mega-damage creatures too, although, thankfully, not as tough as most supernatural creatures.

Small, human size, predators: 3D6 M.D.C., Attacks per melee: Two, Damage: Bite 1D4 M.D. or claws 4D6 S.D.C., Speed: 6D6.

Medium size, 12 to 20 feet (3.6 to 6.1 m), predators: 6D6 M.D.C., Attacks per melee: Two, Damage: Bite 1D6 M.D. or claws 1D4 M.D., Speed: 1D6X10.

Large size, 30 to 50 feet (9.1 to 15.4m), predators: 1D4x 10M.D.C., Attacks per melee: Two, Damage: Bite 2D6 M.D. or forearm claws 1D4 M.D., feet claws 2D6 M.D., Speed: 1D6X 10.

Natural Abilities: Heightened sense of smell. Can track by smell at 60% efficiency. Can smell the scent of blood up to four miles (6.4 km) away. Can leap up to 30 feet (9.1 m).

P.P.E.: 4D6

Rogues and Other Antagonists

A Typical Coalition Grunt

Alignment: Any. If a villain, anarchist or evil.

Attributes: Average.

Body Armor: 50 or 80 M.D.C. Dead Boy armor.

Level of Experience: First.

Combat: Hand to Hand: Expert: Two attacks per melee, generally +1 to parry and dodge.

Weapons:

1. C-18 laser pistol: 2D4 M.D., Range: 800 ft (244 m), Payload: 10 shots.
2. C-12 heavy laser rifle: 2 settings; 2D6or4D6. Range: 2000 feet (610 m). Payload: 20, or 30 with canister.
3. And/or C-14 Fire Breather energy rifle: laser does 3D6 M.D. and grenades do 2D6 M.D. to a 12 ft (3.6 m) area. Range: laser 2000 ft (610 m) and grenade launcher 1200 ft (365 m). Payload: Laser 20 blasts, grenade launcher 12.

Vehicle: Hover cycle or motorcycle.

A Typical Coalition SAMAS

Alignment: Any. If a villain, anarchist or evil.

Attributes: I.Q. 10+ 1D4, P.P. 10+ 1D6, all others average.

Body Armor: 250 M.D.C. main body of Sam power armor.

Level of Experience: Second

Combat: Hand to Hand: Expert plus Elite Power Armor Combat training: 4 total attacks per melee, +2 to strike, +4 to parry and dodge, +5 to roll with impact.

Weapons:

1. C-40 SAMAS Rail Gun: 1D4X 10 M.D., Range: 4000 ft (1200 m), Payload: 50 shots.
2. CM-2 Rocket Launcher: 5D6 M.D. or 1D4X 10 M.D. Range: one mile (1.6 km). Payload: Two.

A Typical High-Tech Bandit (Headhunter)

Alignment: Anarchist or evil.

Attributes: P.P. 10+ 1D6, all others average.

Body Armor: 80 M.D.C. heavy armor.

Level of Experience: Second level, but could range from 1-4.

Combat: Hand to Hand: Expert: 2 attacks per melee, generally +1 to strike, +4 to parry and dodge, +2 to roll with impact.

Hand-Held Weapons:

1. NG-57 ion pistol: 2D4 M.D. or 3D6 M.D., Range: 500 ft (152 m), Payload: 10 shots.
2. NG-P7 particle beam rifle: 1D4X10 M.D.. Range: 1200 feet (365 m). Payload: 8 blasts. Or may select a L-20 pulse rifle, Coalition C-14 Fire Breather rifle, rail gun, or some other heavy damage type weapon.
3. Hand grenades: Fragmentation: 2D6 M.D. to a 20 ft (6 m) area. Range: About 40 or 50 yards/meters.

Bionic and Cybernetic Devices:

1. Bionic arm: P.S. 22 and two bionic weapon systems: Generally, forearm laser blaster (2D6 M.D.), range 2000 ft/610 m) and retractable vibro-blade (2D6 M.D.), but can be any of those available.
2. Cybernetic Implants (3): Often include a universal headjack and ear implant, amplified hearing, and telescopic or thermo- imager eye, but can be any.

Vehicle: Hover cycle or NG Sky King or souped-up motorcycle.

Note: High level bandits/headhunters, fifth level and higher, are likely to have one additional bionic system and 1D4+ 1 additional cybernetic implants or power armor.

- **Nearly 30 character classes: Cyborgs, Juicers, Dragons, Crazies, Cyber-knights, Psi-stalkers, Line Walkers, and much more!**
- **Super-science and high technology: Bionics, cybernetics, power armor, and mega-damage weapons.**
- **A transformed Earth where magic is a reality and supernatural creatures from the rifts stalk human prey.**
- **Compatible with Heroes Unlimited™, TMNT® & Other Strangeness, Beyond the Supernatural™, Mechanoids®, and Palladium's other role-playing games.**



Opening New Dimensions in Role-Playing

\$24.95
Cat. No. 800
I.S.B.N. 0916211-50-9

