

Palladium Books® Presents:

Rifts® Dimension Book™ 13

# Fleets of the Three Galaxies™

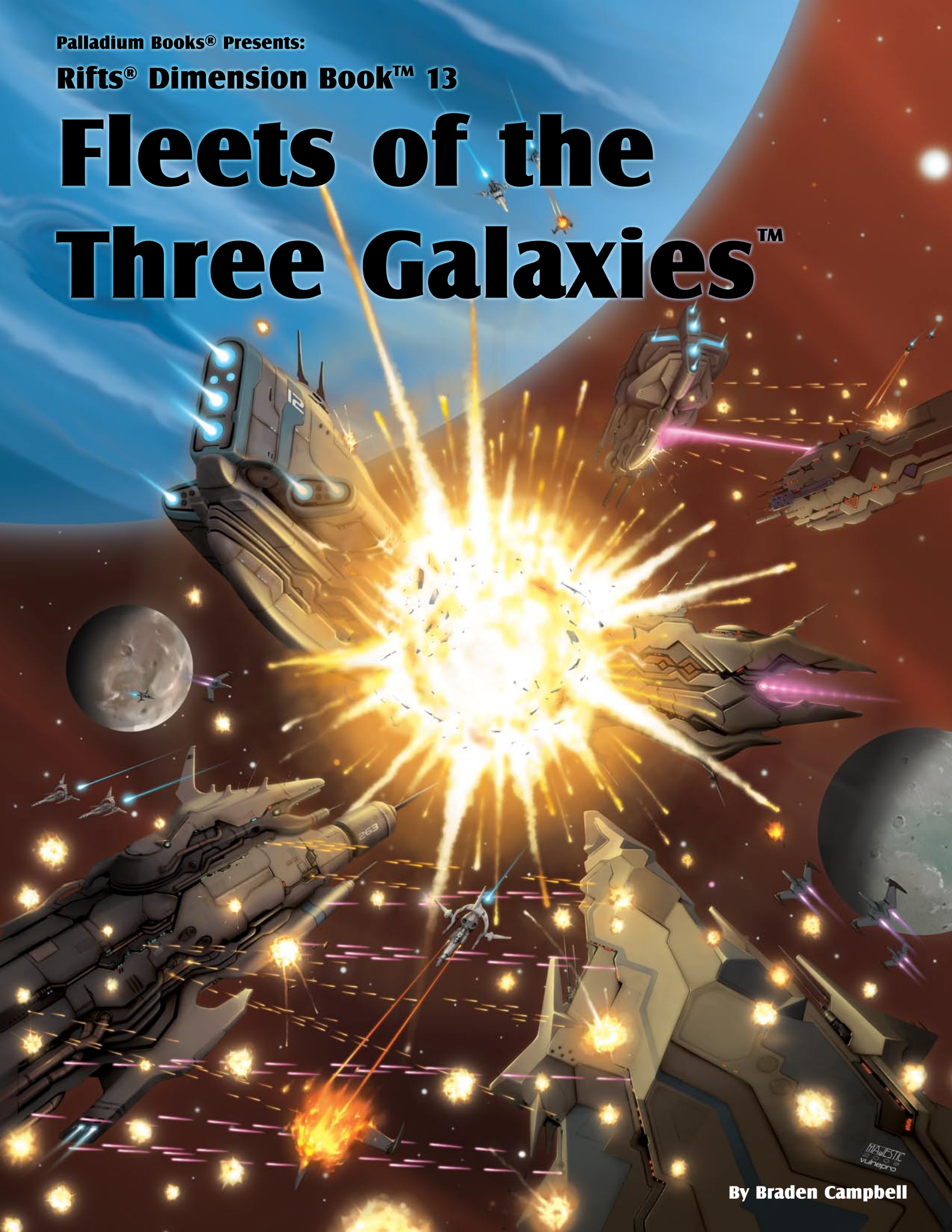

By Braden Campbell

# Warning!

## Violence, War, Magic & the Supernatural

The *fictional* worlds of Rifts®, Phase World®, the Three Galaxies™, and other settings are violent, deadly and filled with aliens, war, magic and supernatural monsters. Other-dimensional beings often referred to as “demons” torment, stalk and prey on humans. Aliens, demons, monsters, vampires, and ancient gods, as well as high-technology, war, magic, insanity, psychic powers and combat are all elements in this book.

Some parents may find the violence, magic, and supernatural elements inappropriate for young readers/players. We suggest parental discretion.

Please note that none of us at Palladium Books® condone or encourage the occult, the practice of magic, the use of drugs, or violence.

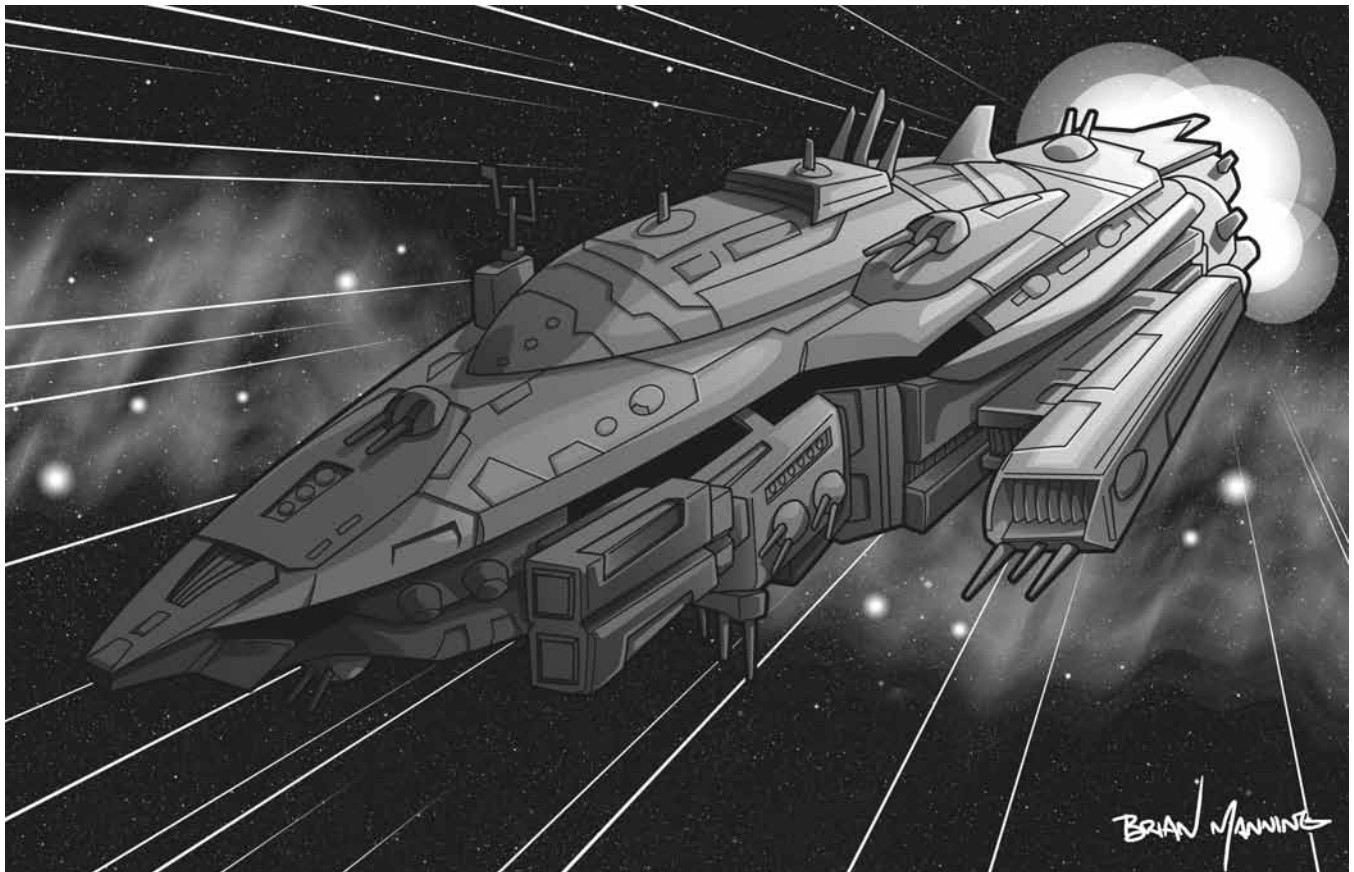

An epic sourcebook for the *Phase World*® series  
and compatible with the entire Palladium Books® Megaverse®

## Dedication

To everyone in my Phase World® gaming crew; and especially to Jason Ford, who asked what the standard features of a starship were.

– Braden Campbell, 2009

## About the Author

Braden Campbell is an actor and playwright, and has been gaming with Palladium products since 1990. He lives in Milton, Ontario, with his wife and young daughter; both of whom have missed him while he was locked away in the basement writing this book.

The cover, by *Michael Majestic*, depicts a space battle somewhere in the Three Galaxies.

## PDF Edition – October 2017

No part of this publication may be scanned, OCR'd, reproduced or distributed in any way for electronic publication on the web/internet or any other medium.

Copyright 2009 Palladium Books Inc. & Kevin Siembieda

All rights reserved, worldwide, under the Universal Copyright Convention. No part of this book may be reproduced in part or whole, in any form or by any means, without permission from the publisher, except for brief quotes for use in reviews. All incidents, situations, institutions, governments and people are fictional and any similarity, without satiric intent, of characters or persons living or dead, is strictly coincidental.

Rifts®, The Rifter®, Phase World®, Megaverse®, The Mechanoids®, The Mechanoid Invasion®, Splicers®, Coalition Wars®, After the Bomb®, RECON®, Nightbane®, and Palladium Books® are registered trademarks owned and licensed by Palladium Books Inc. and Kevin Siembieda.

Anvil Galaxy, Altess, Archie Three, Bio-Wizard, Black Faerie, Body Fixer, 'Bot, 'Borg, 'Burb, Chaos Earth, Chi-Town, Chrysteel, Coalition States, CS, Combat Cyborg, Cosmic Forge, Cosmo-Knight, Consortium of Civilized Worlds, CCW, TGE, UWW, Crazy, Cyber-Doc, Cyber-Knight, The Dominators, Dyval, E-Clip, Glitter Boy, Golgan, Golgan Republik, Great Cataclysm, Headhunter, Juicer, Kittani, Kreeghor, Kydian, Lazlo, Ley Line Walker, Magic Zone, Mind Melter, Minion War, Minions of Splugorth, Naruni, Naruni Enterprises, Rifts Earth, Shifter, Skelebot, Soulmancy, Star Elves, Splynn Dimensional Market, Splugorth, Splugorth Slavers, Techno-Wizard, Tolkeen, True Atlantean, Tattooed Man, Undead Slayer, Vampire Kingdoms, Rifts® Game Master Guide, Rifts® Book of Magic, Rifts® Dark Conversions, Rifts® Atlantis, Wolfen, Wulfen, Mega-Damage, M.D.C., S.D.C., I.S.P., P.P.E., and other names, titles, initials, characters, character likenesses and slogans are trademarks owned and licensed by Kevin Siembieda and Palladium Books Inc.

Palladium Online: [www.palladiumbooks.com](http://www.palladiumbooks.com)

**Rifts® Dimension Book™ 13: Fleets of the Three Galaxies™** is published by Palladium Books Inc., 39074 Webb Court, Westland, MI 48185-7606. Printed in the USA.

**Palladium Books® Presents:**

**Rifts® Dimension Book™ 13:**

# **Fleets of the Three Galaxies™**

Written by: **Braden Campbell**

Additional Text and Ideas: **Carl Gleba, Jason Marker & Kevin Siembieda**

Editors: **Alex Marciniszyn**

**Jason Marker**

**Kevin Siembieda**

**Wayne Smith**

Proofreader: **Julius Rosenstein**

Cover Painting: **Michael Majestic**

Interior Artists:

**Nicholas Bradshaw**

**Kent Burles**

**Irvin Jackson**

**Michael Majestic**

**Allen Manning**

**Brian Manning**

**Nicholas Maradin**

**Vince Martin**

**Michael Mumah**

Art Direction: **Kevin Siembieda**

Typography and Layout: **Wayne Smith**

Based on the RPG rules, text, characters, settings,  
concepts and Megaverse® created by **Kevin Siembieda**.

**Special Thanks to** *Braden Campbell* for his text and ideas, Jason Marker and Carl Gleba for their contributions, to all the artists who helped breathe life into this book, and my stellar staff: Alex, Wayne, Julius, Kathy and Jason, who always give Palladium everything they have.

– *Kevin Siembieda, 2009*

# Contents

<b>The Three Galaxies Selected Time-Line</b>	<b>7</b>
400 years ago (The Machine People)	8
<b>Fleets of the Three Galaxies</b>	<b>9</b>
Why Build a Space Fleet	9
Building Your Fleet	10
Fleet Formations	10
Where Do Battles Occur	11
FTL Combat	11
Space Combat	12
Planetary Battles	12
Ground-side offensives	13
<b>Spaceship Classifications</b>	<b>13</b>
Fighters	13
The Reasoning for Fighters	14
More Space Fighter Combat Applications	15
Space Shuttles	16
Ships of the Line	16
Sub-Capital Ships	16
Frigates	16
Destroyers	16
Cruisers	16
Capital Ships	17
Battlecruisers	17
Battleships	18
Carriers	18
Super-Capital Ships	18
Dreadnoughts	18
<b>Creating New Starships</b>	<b>19</b>
Creation Questions	19
General Rules of Thumb	20
<b>Building Fighters &amp; Shuttlecraft</b>	<b>20</b>
Fighter Design Notes	21
Brief Summary of Notable Space Fighters	22
Mach Speed Chart	22
<b>Building Shuttlecraft &amp; Other Small Spacecraft</b>	<b>23</b>
Brief Summary of Notable Small Spaceships	23
<b>Building Ships of the Line</b>	<b>25</b>
Building Sub-Capital Ships	25
Frigates and Destroyers	25
Brief Summary of Notable Frigates/Destroyers	25
Cruisers	26
Brief Summary of Notable Cruisers	26
Building Capital Ships	27
Brief Summary of Notable Capital Ships	27
Building Super-Capital Ships	28
Brief Summary of Notable Super-Capital Ships	28
Stealth and Cloaking Systems	28
Catastrophic Damage to the Big Ships	28
Random Internal Damage Table	29
<b>Notable Space Fleets of the Three Galaxies</b>	<b>30</b>
<b>The Altess Dynasty</b>	<b>30</b>
Altess Armoria Space Fleet	30
Altess Technology	31
Altess Armoria Ranks	31

A Notable Armoria Facility	32
Jelko Rodula, Weapon Designer	32
Notable Ships of the Altess Armoria	33
Altess Yannar-Class Destroyer	33
Altess Zhokil-Class Battlecruiser	35
<b>Consortium of Civilized Worlds (CCW)</b>	<b>37</b>
Consortium Armed Forces (CAF)	37
Consortium Ship Technology	37
CAF Ranks	38
Captain-General Horace Shaw	39
Notable Ships of the Consortium Armed Forces	40
CAF Araneae-Class Interdictor	40
Emancipation-Class Dreadnought	42
<b>The Dominators</b>	<b>45</b>
The End of Everything	46
Dominator Magic/Technology	47
A Dominator Star Fortress	48
<b>Golgan Republik</b>	<b>50</b>
Golgan Republikan Argosy	50
Golgan Republik Ranks	51
A Notable Argosy Facility	52
Gaus Elia Binjo, 1st Citizen	52
Notable Argosy Ships	53
RAJCF-V4.5 Jesstra Fighter	53
Haelra-Class Troop Shuttle	54
Bindas-Class Cruiser	56
Sylnor-Class Command Ship	57
<b>Naruni Enterprises (NE)</b>	<b>60</b>
Pan-Galactic Consignment Fleet	61
Naruni Uniforms and Colors	62
A Notable Naruni Facility	62
Repo-Bot #400264550	63
Notable Naruni Ships	64
“Fire-Spitter” Attack Ship	64
Naruni Audit Ship	65
Commodity-Class Naruni Super Cruiser	66
<b>The Splugorth Kingdoms</b>	<b>68</b>
Splugorth Repression Fleets	68
Kittani Starship Technology	69
Splugorth Fleet Hierarchy	69
Upov Esunaway	70
Notable Ships of the Splugorth Fleet	71
Raider-Class Combat Shuttle	71
Servitude-Class Cruiser	73
Taskmaster-Class Carrier	75
<b>The Transgalactic Empire (TGE)</b>	<b>78</b>
The Imperial Armada of the TGE	78
Imperial Ship Technology	79
TGE Ranks	80
A Notable Armada Facility	80
Rylcus Yarrl Adan	81
Notable Ships of the Imperial Armada	82
Etherium Stealth Guided Missile Destroyer	82
Executioner-Class Battleship	84
<b>United Worlds of Warlock</b>	<b>87</b>

The Warlock Navy	87	Fleet: Consortium of Civilized Worlds (CCW)	37
Warlock Ship Technology	89	Fleet: Dominators, The	45
Ranks of the UWW	92	Fleet: Golgan Republik	50
A Notable UWW Navy Facility	92	Fleet: Naruni Enterprises (NE)	60
Kern Haze Pennington	93	Fleet: Splugorth	68
Commission Forty-Nine	93	Fleet: Transgalactic Empire (TGE)	78
Notable Ships of the UWW	94	Fleet: United Worlds of Warlock (UWW)	87
Brightwander-Class Multi-Role Capital Ship	94	Goldielox (see Ryan's Landing)	38
Tangent Space Station	97	Golgan Leader of the Kultural Revolution	52
Sentinel-Series Orbital Weapon Platform	98	Gravimetric "Slicer" Cannon (Splugorth)	74
<b>Notable Space Weapons &amp; Equipment</b>	<b>99</b>	Kittani (see The Splugorth Kingdoms)	69
Cruise Missiles	99	Kydians (see The Splugorth Kingdoms)	69
EVA Packs	101	Life-Force Reactors (see The Dominators)	48
Altess Advocate Robot	104	Lords of Entropy (see The Dominators)	46
Golgan Republikan Guard Armor	105	Machine People	8
Argosy G-44 Disruptor Pistol	106	Mach Speed Chart	22
<b>Common Auxiliary Ships</b>	<b>107</b>	Magic: Alchemical Stealth Coating (Splugorth)	73
Bullock-Class Orbital Tug	107	Magic: Dominator Magic/Technology	47
Cargo Runabout	108	Magic: Emulative Throwback Shielding (UWW)	90
Dray-Class Fleet Tender	109	Magic: Planet Ghenhey Ruins (UWW)	92
Artisan-Class Mobile Dry Deep-Space Dock	110	Magic: Regenerative Hulls (UWW)	90
Lifeboat/Escape Capsule	111	Magic: TW Anti-Magic Missile (UWW)	91
<b>Space Magic Spells</b>	<b>112</b>	Magic: TW Force Field (UWW)	90
<b>Quick Find</b>		Magic: TW Hull-Breacher Missiles (UWW)	91
Altess: Advocate Robot	104	Magic: TW Missiles (UWW)	90
Altess: Armoria Central Robot Repository	32	Magic: TW Negate Mechanics Mini-Missiles (UWW)	91
Astralfein (planet)	46	Magic: Space Magic Spells	112
Automaton War	7 & 38	Magic Fleet: Dominators, The	45
Auxiliary Ships	107	Magic Fleet: Splugorth, The	68
Battlecruiser: Altess Zhokil-Class	35	Magic Fleet: United Worlds of Warlock	87
Battlecruiser: CAF Araneae-Class Interdictor	40	Mass Driver (Splugorth)	77
Battleship: Executioner-Class (TGE)	84	Minion War, The (see UWW)	88
Battleship: Sylnor-Class Command Ship (Golgan)	57	Neutron Cannons (Splugorth)	72
Black Hole Projector	47	Notable Space Fleets of the Three Galaxies	30
Carrier: Taskmaster-Class (Splugorth)	75	Orbital Weapon Platform, Sentinel-Series (UWW)	98
Carrier: Brightwander-Class (multi-role, UWW)	94	Oni, The	63
Commission 49 (UWW)	93	Particle Beam Cannon (TGE)	87
Cosmic Energy Weapons (see The Dominators)	48	Prism Laser Cannon (UWW)	96
Cosmic Forge (see UWW)	92	Quantum Tracking Mine Dispenser (Golgan)	60
Cosmo-Knights (see The Dominators)	46	Quantum Wormhole Drives (see The Dominators)	48
Cruiser: Bindas-Class (Golgan)	56	Random Internal (Spaceship) Damage Table	29
Cruiser: Commodity-Class Super Cruiser (Naruni)	66	Sub-Particle Cannon (UWW Weapon Platform)	98
Cruiser: Naruni Audit Ship	65	Shuttle: Haelra-Class Troop Shuttle (Golgan)	54
Cruiser: Servitude-Class Heavy Cruiser	73	Shuttle: Raider-Class Combat Shuttle (Splugorth)	71
Damage Table for Spacecraft	29	Singularity Missile (TGE)	84
Destroyer: Altess Yannar-Class	33	Spaceship Classifications	13
Destroyer: TGE Etherium (prototype)	82	Space Station: Tangent (UWW)	97
Dreadnoughts	18	Star Elves	46 & 87
Dreadnought: Emancipation-Class	42	Star Fortress (see the Dominators)	48
Elder Races (see The Dominators)	45	Stealth and Cloaking Systems	28
Electric Reactive Armor (see The Dominators)	48	Stealth: Alchemical Stealth Coating (Splugorth)	73
Fighters	13 & 21	Stealth: Etherium Stealth Field (TGE)	84
Fighter: Fire-Spitter Attack Ship (see Naruni)	64	Sunaj Assassins (UWW, see Pennington)	94
Fighter: RAJCF-V4.5 Jesstra Fighter (see Golgans)	53	Super-Cannon (Golgan)	59
Fleet: Altess, The	30	Techno-Wizard Devices & Weapons (see UWW Tech)	89

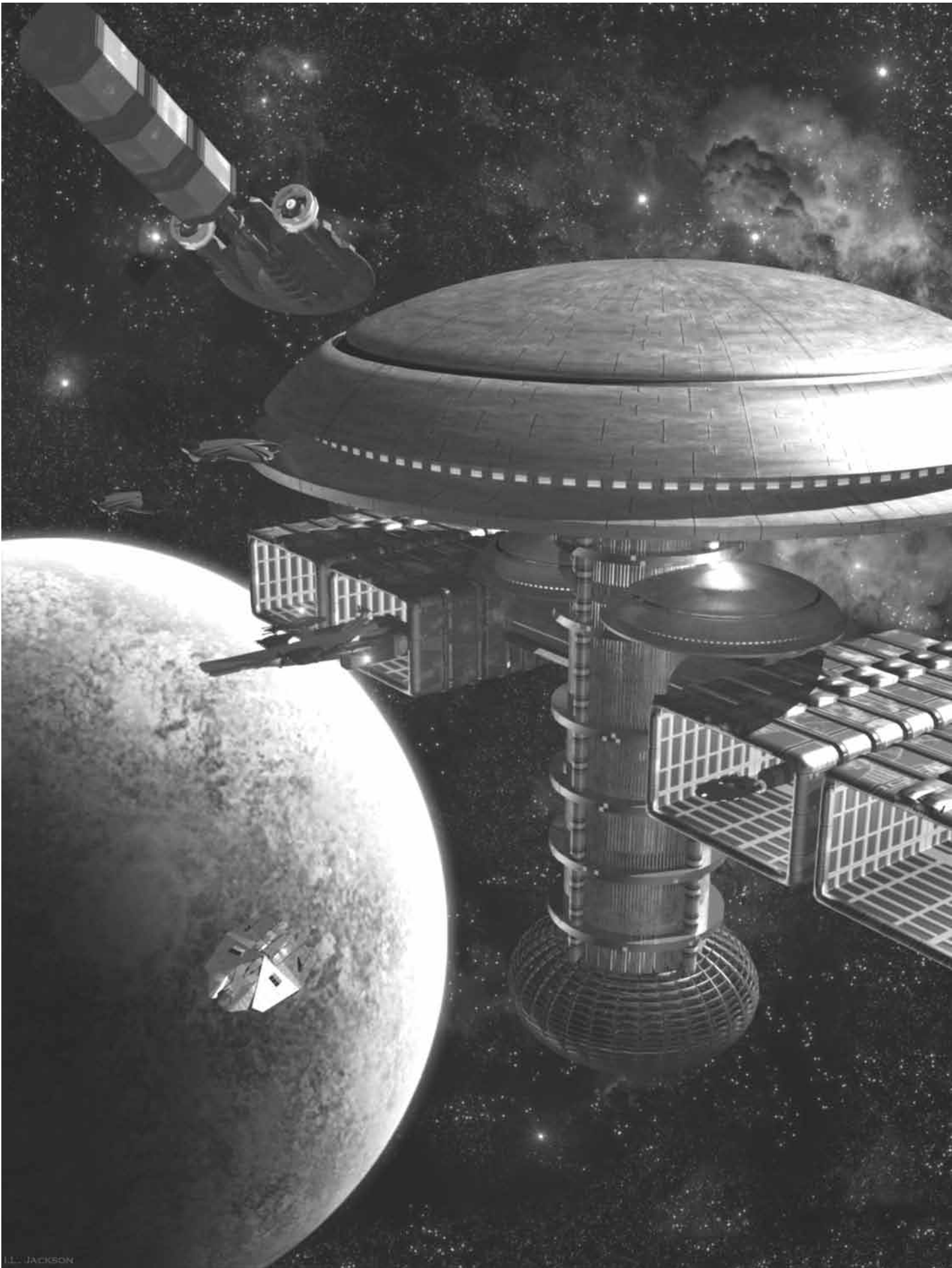

J.L. JACKSON

# The Three Galaxies Selected Time-Line

## The First Galactic Era

**20 billion years ago.** The First Race creates the Cosmic Forge and uses it to fashion the *known universe*. The First are eventually uncreated when The One, the only evil member of the First Race, momentarily gets his hands on the Forge. The Forge then destroys The One, and goes into hiding while the universe burns with “the fires of change.”

## The Second Galactic Era

**5 million years ago.** *Center*, on *Phase World*, is thought to have been constructed. As to whom the builders were, not even the native Prometheans seem to know. If they do, they keep this data a secret.

**1 million years ago.** Ruins are left on *Monro-Tet* by an unknown race.

**100,000 years ago.** The oldest surviving galactic records are written. Any event prior to this point is lost to conjecture and antiquity. The Three Galaxies are populated, at this time, by innumerable, god-like beings collectively called “the Elder Races.”

**50,000 years ago. The War Against the Dominators.** The *Star Elves* foresee that most life in the Three Galaxies will be either extinguished or set back tens of thousands of years. They, themselves, hide away and cloak their planet behind a magical shield. The Dominators attempt to circumvent their destiny by killing or subduing all the races that would bring about their downfall. In the fighting, most of the Elder Races are wiped out. At the end of the war, a Black Hole Projector destroys the Dominator homeworld.

This is end of the Second Galactic Era.

## The Interim

**50,000 to 10,000 years ago.** During this time, The Three Galaxies becomes populated by monsters and Alien Intelligences. Of particular note, at least six *Splugorth* set up their own empires and take over huge swaths of galactic territory. Four of these continue to exist in a reduced form to this very day.

## The Third Galactic Era

**10,000 years ago.** Humans arrive in the Three Galaxies when several ships crash on Terra Prime.

*The Vaast*, a race of evil xenophobes, rule most of the *Anvil Galaxy*. They are so cruel that eventually their neighbors band together to destroy them. The war lasts 400 years. In a last-ditch effort to save their homeworld, they build and launch the battleship *Meganaught*.

**6,000 years ago.** *The Star Hunters* destroy the *Machinist* civilization in the Anvil Galaxy. The few surviving Machinists build the Machine Men, who then turn against them. The Star Hunters are themselves hunted almost to extinction by the *Cosmo-Knights*.

**5,000 years ago.** The Kreeghor overthrow their Splugorthian masters and begin the foundations of the Transgalactic Empire.

*The Human Alliance* is established when the first Faster-Than-Light (FTL) ships leave Terra Prime and head out into the *Corkscrew Galaxy*. Humans are fortunate to discover a perfectly habitable planet in orbit of their closest stellar neighbor. It is jokingly named *Goldielox*, being not too hot, not too cold, but just right.

Center begins keeping a record of all its citizens.

**3,000 years ago.** *The Noro* cause the destruction of their interplanetary neighbors, the *Ironee*. This horrific event changes their entire outlook on life, and they dedicate themselves henceforth to becoming the peacemakers of the Three Galaxies. There are still some Noro renegades, but they are a small minority.

An unnamed enemy destroys all but one of the Machine People’s planets. The robots respond by bombing their attackers back to the Stone Age.

**1,000 years ago.** After centuries of peace, the worlds of the Human Alliance are suddenly conquered by “Network,” a massive, interplanetary artificial intelligence (AI) that enslaves mankind with robotic hordes. The Outer Colonies organize a rebellion to liberate Terra Prime and destroy Network. Thus begin *The Automaton Wars*.

The goddess Ameratsu teaches the Oni the secrets of technology and then leaves them, apparently forever.

**800 years ago.** *The Automaton Wars* come to a close when Network’s primary core is destroyed on Terra Prime. Nearly three billion humans have died over the course of the conflict, and many of the innermost worlds of the Human Alliance are devastated. Mankind pledges to never again let self-aware machines rise to power anywhere.

*An era of rampant piracy* begins across the *Corkscrew* and *Anvil Galaxies*. Tens of thousands of small, poorly equipped bands of raiders ransack every planet they come across. Many are humans who have lost everything in the Automaton Wars. The bands are highly disorganized, but are so great in number that they collectively inflict a great deal of harm upon their targets.

*The Altess Armoria* begins the *Cipher War*, wiping out the piratical *League of Blood*, who thought to extort great sums of money from the Dynasty. The League is completely destroyed, as are their families and friends. This is the last time that the Altess fleets see action to the present day.

**700 years ago.** *The Great Meeting*. The Human Alliance meets with, and allies itself to, the Noro. This marks the beginning of the *Consortium of Civilized Worlds (CCW)*. The new alliance is soon tested by a full-on invasion from the *Transgalactic Empire (TGE)*.

*The First Great War* begins, with the Empire and “Dark Tribe” Wulfen on one side, and the Human/Noro/Loyalist Wulfen on the other.



**500 years ago.** The First Great War between the CCW and the TGE ends with a treaty signing in the *Thundercloud Galaxy*. The *Lanator Accords*, among other things, prohibit the use of Weapons of Mass Destruction within the atmosphere of any populated planet, and divide the Thundercloud up into various territories for expansion.

With the formal creation of the Consortium, one by one the small pirate gangs which had been operating so freely are hunted down and either arrested, killed, or forced into hiding far from the settled portions of the Three Galaxies.

**450 years ago. The Scramble for the Thundercloud.** The Consortium begins aggressively settling this, the least explored and developed of the Three Galaxies. It does so under a policy of “civilizing the stars.” Fearing that they will soon be outnumbered, the Kreeghor do likewise. Hundreds of millions of CCW colonists flood into the Thundercloud Galaxy, generally upsetting every indigenous culture they come across.

**400 years ago.** *The Machine People* beg the Consortium Congress to admit them as a member race and to protect them from Kreeghor domination. The Human delegates, ever leery of thinking machines since the conclusion of the *Automaton War*, refuse their request. They bog the hearings down in endless debate, claiming that these ultra-tech robots will eventually take over the CCW. Finally, the Consortium Prime Minister uses a legislative veto to overrule the Human Alliance, but it is too late. Believing they have no other recourse, the Machine People join the Transgalactic Empire to escape annihilation.

The first discovery of a devastating, explosive crystal substance, called killaryte, on planet *Kazematt*. It is quickly discerned that the *Thundercloud Galaxy* contains more than 80% of all killaryte in the known universe. The rush to extract more of this unique substance for refinement into weapons-grade explosive enhancers drives the unabashed planet grabbing in the Thundercloud to new levels.

**300 years ago.** Someone sets up a penal colony on *Exile-7*. It is not long before the prisoners there overthrow the guards. However, since there are no spaceships at the facility, the convicts are stranded. Eventually, a group of powerful mages arrives to take advantage of the planet’s unusual magic fields.

**250 years ago.** *The Union of Thought*, a collaboration of crazed and evil scientists, begins the *Voidmaker Project*. It is believed that they are trying to build a black hole projector similar to the one that destroyed the Dominators’ homeworld.

**200 years ago.** A group of 2,000 Kittani starships make a suicide run at Kreeghor-Tet, capital world of the Transgalactic Empire (TGE). They are all destroyed before even reaching orbit.

**100 years ago.** On planet *Good Hope*, a revolution begins in the TGE, and it spreads like wildfire. A *Doombringer*-class super carrier is captured, and the *Free Worlds Council (FWC)* is formed. Soon after, a Kreeghor fleet sent to recapture the planet is met with an overwhelming number of rebel ships. Included among the FWC’s supporters are a great many pirate vessels, which play havoc with the more cumbersome Imperial capital ships. All of the raiders fly the same flag. It is the largest single collection of space pirates seen in over four hundred years.

*The T’Zee* are granted probationary CCW (Consortium of Civilized Worlds) member status in exchange for their advanced nanotechnology.

Contact with *Exile-7* is made by members of the *Lohai Mercantile Union*. It is not long before a small space port, named *Pen City*, is established as a stopping off point before ships try to cross the *Void Gulf*.

**75 years ago.** The fighting begins, on *Axis-5*, a world located between the Free World Council and the TGE. A previous treaty known as the *Lanator Accords*, and the fact that the Consortium is watching events there very closely, means the Kreeghor cannot slag the planet from orbit like they wish they could. Instead, they must send in conventional ground troops. The fighting there continues to this day.

**70 years ago.** *Michael Klass*, the Leader of the *Free Worlds Council (FWC)*, is assassinated. The Cadre, the elite group that rules the Free Worlds Council, never releases the full details of this incident to the public or its allies.

**50 years ago.** *Pirate leader Jelka Ghensi* tries to crash land on the planet *Soribu*. In trying to clean up the mess, and keep contamination of the indigenous population to a minimum, the CCW discovers the *Great Complexity*, an alien super carrier. Captain Ghensi is arrested and sent to a Consortium maximum security prison.

The existence of the *Doombringer*-class ships is confirmed by Consortium intelligence agents. CCW scientists begin to design their own “super carrier.”

**30 years ago.** *Naruni Enterprises* begins strip-mining operations on planet *Hydrosphere*.

*The Bushi Federation* joins the Consortium of Civilized Worlds (CCW), but only out of fear that they will be assimilated into the Kreeghor of the Transgalactic Empire (TGE).

**24 years ago.** The Consortium completes the *Balanced Hammond Drive*, and begins constructing the *Emancipation*-class *Dreadnoughts*. These ships are built exclusively within the Human Alliance at the shipyards orbiting *Goldielox*. This causes some distress among the other CCW members.

A border war breaks out between the CCW and the TGE in the *Anvil Galaxy*.

**20 years ago.** The CCW/TGE war ends with victory for the Consortium of Civilized Worlds. As a result, several new worlds are liberated from the Kreeghor, sealing the TGE’s lasting enmity for the CCW.

The first *Emancipation*-class dreadnought, *CSS Emancipation*, enters service.

**10 years ago.** *The Hartigal Combine*, a breakaway subdivision of *Naruni Enterprises*, is formed.

*Gaus Elia Binjo* becomes First Citizen of the *Golgan Republik*.



# Fleets of the Three Galaxies™

## Why Build a Space Fleet?

It is an unavoidable fact: If your species is going to live, work, play, do business, or just plain survive in the Three Galaxies, you're going to need a *space fleet*. If you don't have one, your race is as good as extinct.

As societies throughout the **Three Galaxies** come of age in the safe and comfortable bosom of their homeworlds, what is it that drives them to slip the surly bonds of their planets and seek their destinies among the stars?

What indeed?

The reasons are as varied as the societies themselves. It could be greed or curiosity, or desperation that drives a people to invest in a spacefaring navy. At the end, though, it generally boils down to one simple thing, the need for natural resources.

It is an unavoidable fact, survival in the Three Galaxies depends on the acquisition of resources. Once a technological civilization reaches the point where its numbers outweigh what its homeworld can provide, it faces a critical choice. It can institute population control methods a la the *Kydians*, it can try to continue as is and ration out what little remains, or it can look to *the stars* for the new resources it needs. Most of the species presently living in the Three Galaxies have chosen the latter.

This is called "territorial expansionism," and while generally a joyful and exciting time in a society's history, it can also trap a newly minted spacefaring society in a self-perpetuating loop.

This self-perpetuating loop goes something like this: A society goes out into space to collect more resources for its growing population. The influx of these assets causes a population explosion, which then drives the need for further territorial expansion. In short, spacefaring races soon become gluttons, gobbling up all they can get and staying just one step ahead of disaster. They always need more; more space, more planets, more natural resources and more raw materials to build ever-larger stellar fleets.

This would be fine, except for the fact that the people in the next star cluster are doing the *exact same thing*. Problems then arise when the sphere of one expanding empire comes into contact with another, causing two societies to compete for the same finite resources and clash.

When such an empire comes to realize that it is not alone in the universe, the shock can prove overwhelming. The existence of "aliens" can undermine religious, cosmological, and governmental ideals, any of which might cause that race's downfall. The one, inescapable conclusion that arises from contact with another spacefaring race is that everyone is compelled by nature to survive. So the previous period of expansion can either continue hand in hand with *new friends*, or continue over the *corpses* of the opposition.

The reality is that any technological race which does not develop the means to go out into the larger universe will smother to death on its home planet. Even if they manage to keep their consumption of resources in check with what the world can provide, someday their neighbors, who have not followed such a policy, will come and take their water. Or their air. Or their Killaryte deposits. Hence, even isolationist xenophobes must

construct a fleet of starships, if for no other reason than to keep would-be pillagers off their planet.

**So why build a space fleet?** Defense from hostile neighbors is certainly a good reason, and so is aggressive expansion to new worlds. Yet another reason, as stated above, is the quest for space and resources. If a race is peaceful and curious, the fleet may be highly scientific in nature and used to explore the stars. If a species is entrepreneurial, fleets can be used to engage stellar neighbors in trade. Finally, if a race is overtly insecure about itself, they just might build a shiny new fleet for no other reason than to keep up with the Joneses.

## Building Your Fleet

Once the decision to travel to the stars has been made, then what? It is all well and good to have the ambition or burning need to leave the planet and travel the universe, but how does a society actually *get* there?

The technologies and know-how needed for even a simple “space program,” like that of the *United States* in the mid-Twentieth Century, are incredibly advanced. The best minds in naval architecture, materials science, advanced mathematics, computer, mechanical and chemical engineering and other more esoteric disciplines are needed. Innumerable man-hours and untold amounts of raw materials can be required just for the construction of shipyards and spaceports, to say nothing of the ships themselves. If a society can justify the expense, and can muster the manpower, the question remains: “*Where do we start?*”

A new spacefaring society may start slowly, with single-use rockets powered by crude yet effective chemical drives. Their first forays into space will be to their immediate orbital space, and perhaps to a few close-by moons. Mistakes will be made, men will lose their lives, and lessons will be learned, but slowly and surely the space explorers find their footing and reach further and further into the abyss of space. *Artificial satellites* may slowly begin to fill the skies, and orbital research stations and shipyards are constructed. By this point, most newly formed *space agencies* are likely to have made limited contact, if not entered into a full-blown dialogue with, any close-by galactic neighbors. This may lead to a sharing of information and technology, attract trade delegations and political diplomats or, perhaps, invite *an invasion* by an aggressive and already established spacefaring power.

Whether driven by commerce, exploration or war, once a society reaches the galactic stage, they quickly come to recognize the need for their own *interstellar starships*. This leads to further development in shipbuilding technologies. Ways to quickly travel the vast, empty stretches of space between stars must be developed. *Faster than Light technologies* are researched. New scientific and engineering disciplines emerge: astrophysics, astronomical, graviton and advanced computer engineering, xenobiology and xenopathology. Contact with galactic neighbors, both hostile and friendly, can also spur fast advances in weapons and armor technology, with the advent of shield generators, ablative hull plates, focused energy weapons and intelligent munitions.

**These starships** can be **heavy lifters** designed to carry vast cargoes of trade goods or building materials to other star systems;

they can be **science ships** packed to the gunwales with sensors, computers and all manner of scientific instruments for the exploration of deep space and other star systems; or they can be **warships**, speedy, over-gunned frigates or massive, lumbering battleships the size of a small city, ready at a moment’s notice to bring their firepower to bear on any and all hostile invaders – or opposition to their will. In the course of their usual duties, any one of these ship classes can find themselves, in the blink of an eye, staring down the guns of a hostile ship, light-years from home.

## Fleet Formations

A driving principle behind all fleet tactics is that of “fire and movement,” and any ship’s captain or fleet commodore worth his salt must have a strong grasp on the concept of **battle space**. Battle space is the zone around his fleet within which he is confident of detecting, tracking, engaging, and destroying threats *before* they become a danger. The ability to use battle space to its full potential is often the difference between success and failure, and this is where the importance of *reconnaissance, intelligence* and *accurate, long-range sensors* comes to light.

A **blind fleet** is as good as dead. Whether a speedy fighter or a dedicated reconnaissance frigate, reconnaissance vessels are vitally important to the survival of a fleet. They are the eyes and ears of a fleet, and, as such, are packed with advanced sensors and observation equipment, designed to suss out the movements of opposing forces and detect the approach of invading fleets. They are deployed to the farthest reaches of a fleet’s battle space, or deployed alone into hostile space, ahead of a fleet, to spy on an enemy’s fleet. These reconnaissance vessels, combined with the already formidable sensors on the typical spaceship of the line, make it incredibly hard to surprise an enemy space force.

The advanced detection systems of the *Three Galaxies* means that a commander must commit to battle, or retreat from it, while still as much as an *hour away* from the combat zone. The wake from an FTL engine can be detected out to a distance of *ten light-years*. So defenders know roughly how many ships comprise the oncoming fleet, and at what angle of attack it is approaching long before it arrives. Similarly, the other common drive types in the Three Galaxies, *Contra-Gravitonic*, *Phase Drive*, and *Rift Jump System* are limited as to how close they can be to the gravity well of a planet. The average distance out is about 20,000 miles (32,000 km). So as much as an attacker might love to drop out of warp, nuke the enemy’s capital city, and speed off again, it is *not* going to happen. The defenders will always have a good idea of where their attackers are dropping down into Realspace, and will be waiting for them. And since the attackers want freedom of movement, this tends to eliminate an immediate, orbital attack, because no one wants to be caught between a planet and an enemy fleet.

This is why most conflicts take place in open, *interplanetary space*, also known as “empty space.” The presence of planets, moons, asteroid belts, nebulae, Oort clouds, and rings limits the opportunities for a space fleet to maneuver. Such objects also make it easier for the enemy to predict the location of the attacking fleet, and make the detection of enemy forces more difficult. Freedom of movement is a must. If the fleet cannot move, either

to find a better firing position or to evade incoming fire, it is in serious trouble.

Since a fight will usually take place in “empty space,” with nothing to hide behind, ships tend to travel in packs. Even the mightiest dreadnought does not stand a chance if it attacks alone. Big ships must be protected by smaller ships, which in turn are protected and “screened” by fighters and assault shuttles. These multiple *layers of defense* are collectively known as a fleet “formation.”

Farthest out are the **picket ships**. Pickets are usually stationed at least 1,000 miles (1,600 km) from the main body of the fleet. Next out, about 125 miles (200 km) from the flagship, is the **outer screen**, and the **inner screen** is only fifty miles (80 km) from the fleet’s main body.

The size of the fleet determines what size and class of spaceships makes up the three layers. **In a small attack group**, where a *cruiser* is the command vessel, the inner and outer screens will be comprised of frigates and destroyers, with space fighters and assault shuttles way out on the picket. **In a large armada**, where a carrier or battleship is in charge, the pickets are frigates and destroyers, the outer screen is made up of more destroyers and cruisers, and the inner screen is composed of heavy cruisers and light capital ships like battlecruisers. **In the most massive of fleet maneuvers**, where hundreds or even thousands of ships are in motion, the above *sub-fleets* are grouped together as a “carrier fleet,” and may act and move independently of the main fleet as circumstance dictates.

**This is obviously a general outline of common formations**, and some races have strange variations on this theme. *The Kreeghor*, for example, always put their command ship in the rear of the formation with no other ships behind it. This practice is a natural evolution of a Kreeghor commander’s fear that he will be shot or stabbed in the back by his subordinates. **The Gulgans** typically fly in a forward-facing “V” shape, with their most powerful ship leading. This way, when they have to turn around and retreat (as they always assume they will have to do), their most powerful weaponry can fire at the enemy unimpeded. When the **Kittani** of the *Splugorth Repression Fleets* attack en masse, they use a formation called the “assault wall,” where fighters form a picket for a vertical sheet of ships all stacked in rows and columns, enabling them to fire every forward weapon they have in one titanic volley.

## Where Do Battles Occur?

Once a society builds its fleet and leaves its homeworld, there invariably comes a time when it faces conflict with one or more other spacefaring powers. That conflict may stem from acts of aggression, to inadvertently trespassing in a region of space the other considers to be his domain, to a simple diplomatic misstep. Thus, space travelers must be prepared to run out the guns and defend themselves from another, possibly more advanced, space fleet.

While there are a myriad of factors involved in large scale space combat, one constant of galactic warfare is that battles usually take place in *interplanetary space* – or what might be considered “open” or “empty space.” There are several reasons for this, not the least of which is the nature of *Contra-Gravity (CG) drives* and *Faster Than Light (FTL) velocities*.



## FTL Combat

**A vessel traveling at FTL speeds** is wrapped up in a protective cocoon that cancels out the effect of gravitons. **The CG field**, unfortunately, negates the effect of having a variable force field. Consequently, a ship can either have shields up and move at slower-than-light speeds, or the Contra-Gravity FTL field up, but not both.

**An FTL Contra-Gravity field** is quite powerful and extends outward from the ship’s hull the same distance as that of variable force fields, about 40 feet (12.2 m). Therefore, when a starship moving at FTL speed fires an energy weapon, that energy extends out for 40 feet (12.2 m), and leaves the CG field. It then undergoes a process called *slow-time graviton deceleration*. Simply stated, the beam drops back down into “real space,” and the ship, traveling faster-than-light, leaves it behind. Missiles, space fighters, and kinetic weaponry all suffer the same effect. The instant after they are fired or launched, they get left behind. This effect of relativity means that combat between two ships while in *FTL transit* almost never happens.

**Battling at FTL speed is not impossible, it’s just dangerous and tricky.** If an attacking ship manages to *match speeds* with a target vessel and pulls close enough to it that their *CG fields are overlapping*, it allows for furious, close-range bombardments, and even boarding actions are possible. Under such conditions, the two ships are not moving relative to each other, which is to say that from the perspective of the two ships they are not moving at all. Broadside weapons can be fired from each ship, with attacks landing directly on the other’s unprotected

hull. Attackers from either ship may also perform EVA maneuvers, breach the hull of the enemy vessel, and attempt to board.

Perhaps needless to say, boarding actions are exceedingly rare in FTL transit. Foremost, the maximum distance between two ships in such a situation is a mere 80 feet (24.4 m). A false (or desperate) move, and the two vessels may collide, and the blast radius of many explosives, such as the *cruise missile* for example, is greater than the 40-80 foot (12.2 to 24.4 m) proximity of the two battling ships. This means boarding parties outside on the hull of either vessel could get caught in the blast radius of their own weaponry and other friendly fire. Furthermore, the blast of a cruise missile or other weapon with a wide blast radius is likely to inflict damage to *both* the enemy vessel and one's own. In fact, some desperate combatants might engage in such *insane* tactics to convince the other that they would rather see their own vessel and crew destroyed than allow the vessel to be taken. This may be done in the hopes of getting the other vessel to break off the attack, or the captain of the ship may actually rather be destroyed than be boarded, or he may be suicidal or figure if he's going to perish then he's taking his attacker with him.

**Space combat** can become a very wild and frantic event, where fast thinking and bold action may win the battle and rash or ill-conceived action can kill everyone!

Arguably, more than any other space combat maneuver, the planning and execution of **boarding actions** must be precise and swift. Such actions might include placing spies aboard an enemy vessel or a small, covert, infiltration squad to sabotage key systems (propulsion, weapons, etc.) and cripple the enemy ship, assassinate key personnel (again, in effect crippling operations), or even stealing or causing cargo to be released/dumped into space, among other tactics. However, the risk of boarding actions, especially during FTL travel, often outweighs the benefit, so boarding actions are best conducted by crack commando-style assault teams with plenty of training and drill experience, if not actual real world experience.

## Planetary Battles

Laying siege to an entire world is a massive operation that boggles the minds of even of those who participate in it or witness the event. It is exceedingly rare due to the unfathomable amount of money, resources, and manpower required to "take" an entire planet.

It is nearly impossible to *occupy* a planet in the way that most people think, with massive fleets of spacecraft and drop-ships delivering millions or billions of troops to the surface and then conducting bombing raids and strafing runs to "soften up" the enemy troops and fortified positions. While that can be done, there are all sorts of negatives involved. First, bombing the crap out of a planet probably destroys many of the resources the attacker covets. It also kills millions or billions of people, which may eliminate a certain amount of resistance, but also leaves dead bodies of people and animals to rot and fester, causing worldwide epidemics of disease that affects both enemy and attacking troops. Massive, large scale bombings also cause famine and destroy the infrastructure.

Unless an attacker is out for sheer revenge and wants to blow the civilization on the planet back into the Stone Age, and/or is going for raw resources (i.e., the mining of minerals, stealing

water, etc.), and the survival of the indigenous people are of no concern, bomb away. Even then, if the invader plans on plumb-ing any of the bombarded planet's natural resources, precautions must be taken to leave an environment suitable for some level of occupation and work. The ecosystems of most planets are much more delicate than the average person realizes. Blast too much rock, soot and ash into the atmosphere, and you may cause severe and adverse climate changes, which, in turn, can lead to all sorts of related problems – a severe drop or rise in temperature, storms, geothermal activity, flooding, drought, and on and on.

**Then there is the matter of cost.** Even a modest, distant fringe colony – let's call it *Planet X* – can have a population of up to 100,000 people (see *Anvil Galaxy*, page 152). Their standing military could be as many as 5,000 men and women (about 5% of their population). Thus, an invading army must land at least twice the number of troops in order to even consider an attempt to subdue the people of Planet X. In fact, conventional military wisdom dictates that the invading force should be at least *three to four times greater* than the opposition force. Furthermore, some portion of the civilian population is likely to take up arms and oppose an invading army, so unless the invasion force is sizeable, say 5-8x greater than the actual military defense force, or their technology is vastly superior, trying to seize even a colony planet can be a major operation involving tens of thousands of troops and considerable resources.

That is an expensive proposition.

In the case of Planet X, it would take 2-4 ships the size of Packmaster carrier vessels to have a realistic chance of successfully subduing the colony. Just one Packmaster using all of the fifty CAF assault shuttles on board, each carrying 100 troopers, *equals* the local defense force. Assuming none of the shuttles are intercepted and shot down during their landing run and the CAF suffers few casualties, which is highly unlikely, the minimum cost of taking the planet colony works out to about 27.5 billion credits in machinery alone – and that's just for ONE Packmaster. Now multiply that number by 2, 3 or 4 times, which are the realistic numbers to make a worthwhile invasion attempt. These costs spiral further out of control when you factor in the costs to maintain, feed, clothe, supply, and care for the troops, and much, much more if the invading force must garrison, occupy and hold the planet for any amount of time.

**And then there is the cost of retaliation.** First, Planet X belongs to someone else, and that someone else is very likely to retaliate by sending its own fleet to liberate and retake its colony planet. If the conquering invader intends to hold Planet X for himself, then a space battle or limited planet-side attack is coming. Since it's only a colony, the massive cost of a planet-side siege against a heavily populated, core world does not apply, because the attacker laying siege only has to target the few occupied areas of the colony world and/or the invader's fleet in space. However, retaliation is not likely to stop there. The offended party (the one who lost their colony world) is likely to strike back elsewhere. They might try to take a colony world of the invader's, or attack one or more of its fleets, or a space station or two, or cargo ships in some other part of the galaxy. Maybe they'll do all of the above, or take two colony worlds as a show of force or in a display of righteous indignation. That's how wars escalate, and before you know it you are involved in an interstellar conflict that could last decades.

Taking and occupying a densely populated and extremely precious **Core World** is even more difficult.

Using *Terra Prime* as an example, it becomes painfully obvious that planetary invasion is not an easy option, not if you hope to preserve most of the people and then leave the world inhabitable.

Applying very loose numbers, let us assume that the *human homeworld* maintains a standing marine force equal to 5% of its population – or about *three billion soldiers*. First, an invading force would have to get past Terra's standing *defense fleet*. In this case, that includes at least 170 Protector battleships and Packmaster carriers, 1,220 Warshield cruisers, and over 2,000 destroyers and frigates. The number of space fighters involved in repelling the invasion force would add up to nearly 72,000! Add in the rings of orbiting HI-laser arrays and space stations, and the task of destroying Terra Prime's fleet, not to mention actually holding the planet, fully illustrates the *pointlessness* of thinking in terms of "full-scale planetary invasion." The attacking party is likely to have to commit nearly *all* of its own fleet and incredible resources toward capturing a single core world, and putting all your eggs in one basket is never a wise choice, especially in times of war.

**Ground-side offensives** do take place in the Three Galaxies. However, they are usually leveled against lightly populated worlds, planetary colonies, localized targets, the last action of a much larger and longer war, or as part of a planetary siege that targets several strategic locations in the hope that gaining control of them or destroying them would lead to seizing control of the core world or most of it. Of course, even if successful, this is a tenuous hold over a planet that is brimming with millions, billions or even trillions of hostile citizens, their leaders and military personnel hellbent on **a)** regaining their freedom, **b)** taking back control over their world, and **c)** kicking the invader off of it. And then we are back to the issue of *retaliation*. **Note:** Only key planets such as Motherhome, Noro-Gor, Terra Prime, Kreeghor-Tet, Altess Prime, and Gologo Maxus warrant the kind of expenditures and troop dedications that planetary invasion demands.

This is what makes attacking small colonies, spacecraft and fleets out in the distant reaches of interplanetary or "empty space" much more viable and cost effective. The opposition being attacked is infinitely lighter and smaller, help for them is long and far from coming (if at all), and if you conduct the attack the right way, and make it fast, nobody may ever know who was responsible. This is especially true of raids in which the attacking vessels are unmarked and unidentifiable, or those attacked are all slain (no survivors is easy to accomplish in outer space), or capture all the vessels and crew targeted (even damaged spacecraft have scrap value, and there are plenty of planets involved in the slave trade or needing forced labor) and there is no evidence to be traced back to the attacker. Under this circumstance, the ships, crew and cargo just *disappear* – lost in space. Likewise, ghosts don't talk in the ruins of a shattered space station or the carnage of a space fleet reduced to rubble with no survivors, and that's assuming the drifting wreckage can even be located. Think about how difficult it is for rescue and recovery teams to find wreckage at sea, now multiply that by light-years of infinite outer space and you get the idea. Likewise, small colonies can be "slagged" from orbit, raided or

wiped out long before anybody comes to investigate or rescue them; long being days, weeks or months.

This is why there are *established space lanes* or zones of travel used by transport and cargo vessels: there is safety in (relative) numbers, the lanes are regularly traveled so the chance of being rescued is vastly increased, and armed patrols (just like highway police) also travel space lanes to provide assistance and protection.

# Spaceship Classifications

## Fighters

**Space Fighters** typically weigh in around 15 tons and have a crew of between one and four. Those with four include a pilot, co-pilot, navigator/communications officer and gunner.

Most space fighters are *aerospace fighters*, meaning they are designed for operation in an atmosphere and in outer space. Missions range from air and space combat (aerospace superiority) and interdiction (intercepting and engaging the enemy before he can strike an intended target) to escort, reconnaissance and electronic warfare. Fighters typically have an aerodynamic shape for trans-atmospheric operations, powerful, high-performance engines and carry a wide array of weapons from HI-Lasers and GR-Guns to missiles and torpedoes. While their offensive and defensive systems pale in comparison to even most sub-capital ships, they can often carry ordnance that is out of scale to their size. This allows fighters to punch well above their weight, and makes them an indispensable tool for force projection and combat missions. **Note:** Flying and fighting the numerous aerospace fighters in the Three Galaxies requires the *Pilot: Space Fighter* skill.

Aerospace fighters are unique in that at their heart, fighters are an atavism, a *throwback* to a different time and a different kind of warfare. While fighters are deployed to greater and lesser degrees by the majority of major spacefaring powers, military strategists and historians continue to debate, often hotly debate, the usefulness of fighters in modern military space operations.

The concept of space fighters arises out of the natural technological development of most races in the Three Galaxies: they started on the ground, take to the air – which is where the concept of the "fighter" is born – and go from the air into space. Thus, the majority of races start off treating space, erroneously or not, as just an extension of their homeworld's atmosphere. If they have fighters and bombers in the air, they create fighters and bombers in space. It is interesting to note that the same kind of transposition is made when a species achieves interplanetary or interstellar capabilities as well. Thus, most space fleets become arranged along the lines of ancient naval traditions.

This extrapolation, while certainly understandable and romantic, is at its core, deeply flawed. In a naval fleet, conventional aircraft such as fighters, interceptors, and bombers operate in a completely different medium from their carriers. Jets cannot travel through the water any more than battleships can soar through the air. When operating in space, however, the medium is the same for the battleship as it is for the fighter plane. The question then becomes: If a spacefaring race can

build a 100,000 ton star cruiser with enough weapons to devastate a city, why bother building space fighters?

Opponents of space fighters regularly make this argument. They also contend that given the sheer size and strength of ships of the line, tiny space fighters cannot possibly inflict any significant damage to such large enemy targets. Even the most powerful fighter-based weapon systems do not pose a serious, credible threat to any ship that is cruiser-size or larger. They are simply too small and lack sufficient penetrating power.

So, if space fighters are only good for attacking small ships like shuttles and other space fighters, why are they built at all? Well, there are several answers, some based in practicality and others based in tradition and romance.

## The Reasoning for Fighters

The argument for aerospace fighters is grounded in tradition, logic and the nature of most bipedal, sentient life forms.

**1. Fighters are visceral.** War is about more than hard, cold, advanced technology and firepower. Even among the advanced civilizations of the Three Galaxies, most wars are fought, and certainly led, by flesh and blood troops. This means there are issues about morale, motivations, courage, fear and heroic service. The fighter has a long tradition of representing the elite and heroes. When a squadron of fighters pass by overhead, civilians and soldier cheer. They inspire and motivate. They instill a sense of empowerment and make others feel safer or protected. They are as much a psychological force as they are weapons of war.

**2. The Pesky Fighter.** Just as fighters are less effective against ships of the line, the big ships are less effective at engaging them. In short, these tiny targets are difficult to hit with the big guns of the big ships. After all, the weapons of sub-capital and capital vessels are designed to engage equally large enemy targets. However, while space fighters may be able to dodge the energy attacks of the big guns and get close to the massive ships themselves, opponents insist they are like a swarm of mosquitoes that are little more than an annoyance. Proponents of fighters retaliate with the argument that the fighters' "annoyance" create a valuable, strategic distraction that might give their fellow combatants in the large ships a slight edge, and sometimes that's all that is necessary to win the day.

Furthermore, several fighter squadrons working together *can* put a dent in the big starships. They can create small hull breaches that create a certain amount of internal chaos inside a localized area of the enemy vessel as well as provide a means through which a boarding party may enter the big ship.

**3. Focused attacks.** Against capital spaceships, fighter squadrons can concentrate their attacks on small, strategic targets located on the big ships themselves. These focused attacks serve to harass and impair the enemy by knocking out individual sensor and communication arrays, weapon turrets, docking bays, and so on. Likewise, fighters are extremely effective at engaging enemy satellites, fighters, shuttles and similar small spacecraft.

**4. Boarding operations.** Fighters support boarding parties by taking down any nearby, small defensive weapon systems, hull defenders, and enemy fighters that might be leveled against the boarding operation.

**5. Fighter vs Fighter.** The fact of the matter is, most spacefaring civilizations deploy fighters. As noted previously, the big guns of capital vessels are not well suited against tiny enemy attackers, thus you need to engage fighters with fighters. In an atmosphere, that may be an aerospace fight versus enemy aircraft and aerospace fighters. Likewise, fighters are extremely effective against pirates and raiders, who typically use small, fast attack vessels, fighters, shuttles, small ships and boarding parties.

**6. In planet-side ground assaults,** fighters are as effective as ever in operations in which the attacker is trying to subdue the enemy and not decimate the planet. Under such operations, fighters provide air support to ground troops, shuttles and insertions and extractions, target enemy ground forces, light fortified positions, and strategic targets, as well as air to air combat, and the function of interceptors, escorts, and reconnaissance.

**7. Fighter pilots are cultural heroes.** Whether they are the Transgalactic Empire, a space kingdom, or a democratic republic, the various dictatorships, police states and civilizations across the Three Galaxies all share a special need to create *heroes*. Star fighter pilots are frequently groomed not only to be excellent combatants, but to "look good for the cameras." They often become the face of the war and the heroes of the people.

Within dictatorial regimes, they are the few, the proud, and the ones who get extra rations and a decent place to live. They have been entirely created by the State, from their smiling support of the current Emperor/Chairman, to their steadfast dedication in wiping out the enemies of the land. In this case, the space fighters have living operators not because of a fear of renegade artificial intelligences (A.I.s), but because it helps exert more control over the masses. The pilots are trained from a very young age, and know nothing of poverty or hardship, provided they maintain their abilities and allegiances. They are constantly in the public spotlight, shaking the hands of the Supreme Leader, signing autographs for school children who want to grow up to be just like them, and parading enemy POWs through the city square. They are a *propaganda tool* as much as any poster or video message from the government telling the people "everything is fine, please do not panic."

Likewise, their fighters might even take on a greatness of their own. If a ship does particularly well in a certain battle, it might be honorably retired from service in a lavish public spectacle, and put on display for all to see. Perhaps someday, when the need is great, it will be brought back into service, rising once again to defend the people amidst thunderous applause. In such a case as this, it is the machine that matters more than whom-ever gets to fly it. The pilot becomes a hero just by being there.

Problems can arise for dictatorial powers, however, when there is a change in government. Such a thing is almost always bloody, and the new regime oftentimes decides to get rid of the old regime's "heroes" and start with fresh ones of its own. The old pilots are usually jailed indefinitely, executed as traitors to the new government/ruler, or sent into permanent exile. Many flee the coup, and go on to become much-sought-after mercenaries.

**8. Cultural Bias (Caste Systems and Honor).** "Sure, we could build an ultra-tech guided missile with its own variable force field, a maximum Delta V of 99% light speed, and a de-

structive yield of 1000 megatons, but that would be highly unsportsmanlike.”

Certain societies such as the Wulfen, the Seljuk, and especially the Oni, use space fighters as a matter of honor. This usually comes about in cultures that operate on a Neo-Feudalistic Caste System with Lords, Ladies, nobles, and peasants or peoples who have based their entire society on the concept of *personal honor*. Combat to them is a deeply individual thing, be it for duty or glory, and to be “done right” must be done *up close and personal*. Let the lesser classes pilot the battleships and hide inside a dreadnought or space station, the real test of a warrior is his ability to fight the enemy one-on-one, and at point-blank range.

These pilots are modern day berserkers, samurai or mounted Royal Knights. Their fighters may be mass-produced and top of the line, highly individual, handcrafted machines or old and solid warhorse vehicles passed down through generations. Depending on the race’s religious beliefs, sacrifices might be made to the “spirit of the machine,” or to the “ghosts of ancestral pilots” before battle begins. Seeing *Oni Katana fighters* surrounded by candles and incense on the eve of combat is a 1,000 year old tradition, as is the Wulfen custom of applying the blood of a wild Arda Beast smeared on the tips of the wings before a major conflict to bring the pilot good luck and many kills.

These cultures cannot conceive of any other way to do things, so ingrained are their ideals and traditions. Thus, fighter pilots from such societies can prove to be deadly, even fanatical adversaries. To them, the completion of one’s mission or the killing of one’s enemy means everything, and they would rather die than go home to the shame of defeat. “Come back carrying your shield or on it,” is a common sentiment among the pilots in these cultures. Even if they should perish in combat, they are likely to become renowned heroes who gave the ultimate sacrifice and died with honor.

**9. Phobia of A.I.s** (Artificial Intelligences) is common throughout the Three Galaxies. One of the first problems in maintaining a space fighter force is that it requires pilots, pilots who need years of training and millions of credits in government support. It would be simpler and more effective, some argue, to replace men and women pilots with advanced computers. An artificial intelligence housed in a fighter shell would effectively be termed a “missile bus” – an ordnance delivery system that could take hundreds of Gs in acceleration, never need food or rest, maneuver at 94% efficiency right from the day of its creation, and accurately deliver its payload over 90% of the time. It would also require a *neural-type intelligence*, able to make leaps of logic, create new tactics, and learn from engagements with the enemy. This *A.I. requirement* is precisely why artificial intelligences are almost never built, let alone placed in space fighters.

Although robots are common enough in the Three Galaxies, they are either drones or savant level A.I.s, incapable of deviating from a pre-programmed response. Many cultures have an inherent fear of so-called “thinking machines,” perhaps none more so than the humans of the Consortium of Civilized Worlds (CCW).

It was only a thousand years ago that the **Human Alliance** found itself under the rule of the advanced computers that had helped them to settle the stars. Even though the humans had suc-

cessfully risen up and destroyed their machine overlords prior to contact with the Noro, the 200 year long *Automaton Wars* have scarred humankind in the Three Galaxies forever. CCW humans distrust any computer that can outthink them regardless of any failsafes that might be in place. *TVIA Inspectors* from the Human Alliance not only search the galaxies for violations of the Civilization Compact, but also for rogue or emerging artificial intelligences that they feel might threaten the Consortium of Civilized Worlds.

In fact, it was the *Human Alliance* and their majority of seats in the *Consortium Congress* that repeatedly blocked the admittance of the Machine People as CCW members. As long as the Congress operates on a basis of representation by population, any attempt to create vast numbers of self-aware robots or robot operated space fighters, will be stopped by the Human Alliance time and again. From their unrelenting (albeit traumatized) point of view, it is much *safer* for everyone if there are living, breathing, *controllable people* sitting in the cockpits of any space vessel as opposed to hordes of emotionless robots that might one day decide they should enslave or destroy their creators.

**10. Because everyone else has them.** Finally, there is the harsh reality that if one race uses a certain piece of military hardware, then their adversaries and admirers inevitably must also have them. Even if they don’t really need it, many governments will spend trillions of credits to keep up with the status quo or keep from having a technology gap.

## More Space Fighter Combat Applications

**What are fighters good for? Plenty.** Against larger ships like cruisers and capital ships, a single space fighter is largely ineffective. Be that as it may, they are still good for several things. For starters, space fighters make an excellent torpedo delivery system. A small fighter armed with one or more *anti-matter cruise missiles* can evade more point defenses than a standard missile and shoot its way past enemy fighters. A swarm of fighters can also break formation if need be and then reform, something a volley of missiles cannot do. A wing of 12 fighters, each carrying two torpedoes, can dish out more than 57,000 points of damage, more than enough to seriously damage or destroy anything up to the size of a *heavy cruiser*.

Space fighters can inflict damage to smaller portions of bigger ships, knocking out point defense turrets, communication and sensor arrays, cruise missile launchers, and the like. As a general rule of thumb, their weapons can only hurt spacecraft whose *M.D.C. is 3,500 points or less*. This means that although a fighter can blow holes in the main hull and take out turrets and other smaller targets on a big ship, even thousands of fighters all firing away at a heavy capital ship like a carrier will *not* be able to destroy it. However, if those same fighters are rigged to carry a full-size nuclear or anti-matter cruise missile, they can inflict damage to any M.D.C. structure whose original M.D.C. is greater than 3,500.

It should be noted that any space fighter weapons can damage variable *force fields*, regardless of the field’s M.D.C. level. Thus, fighters are also good for swarming attacks that whittle down an enemy target’s shields so that their *battleships* can fire directly onto an enemy’s hull.

Of course, space fighters are excellent against other space fighters, many of which may be trying to drop anti-capital ship



torpedoes on the player characters own carrier spacecraft. In fact, defense against such missile buses is the primary reason that space fighters are in use. When in fighter to fighter combat, all weapons function normally, with no damage limit or special considerations.

Given the fact that most space fighters can also operate in an atmosphere and are transatmospheric, they excel at “orbital air strikes.” Units on the ground can target large enemy robots, tanks, and structures, giving the exact coordinates to fighters high up in orbit. The weapons of a space fighter, while small in comparison to a starship, are actually quite large and powerful when fired against ground units and can make mincemeat out of most tanks and support vehicles. Likewise, fighters are able to intercept combat troop shuttles with ease.

## Space Shuttles

**Shuttles** average between 1,000 and 2,000 tons and are typically of rugged and highly modular design. Most are some type of transport or cargo hauler. The shuttlecrafts’ ability to fill numerous roles from bulk hauling to military logistics makes these versatile little ships the most common type produced in the Three Galaxies. A full two-thirds of the annual output from major ship builders like *Naruni Enterprises* and *Osbourne & Thrustweight* is made up of shuttle-class hulls. While normally unarmed and lightly armored, shuttles usually have robust power plants and strong keels that lend themselves well to being upgraded with weapon systems and heavier armor. If shuttles have a unifying design feature, it is their usually cavernous cargo holds. Whether configured for carrying passengers, pallets of freight, machinery or armed soldiers, shuttles have a general tendency to carry more than appears possible at first glance. **Note:** Flying the numerous shuttles in the Three Galaxies requires the *Pilot: Small Spacecraft* skill.

## Ships of the Line

Ships of the line are the bread and butter *warships* of the Three Galaxies. Ranging from a few hundred feet/meters to over two miles (3.2 km) in length, these warships come in a dizzying array of configurations and fulfill the majority of the roles in the Galaxies’ spacefaring navies. Spaceships of the line are divided into three general classes; light and versatile *sub-capitals*, powerful *capital ships*, and the rare and massive *super-capitals*. These ships can carry hundreds or thousands of men, fighters, robots and vehicles, and wield planet shattering weapon systems. All of this is overseen by leading edge technology and the finest men and women their respective empires can muster.

## Sub-Capital Ships

Sub-capital vessels are by far the most common of the ships of the line. Relatively cheap to produce and easy to maintain, sub-capitals fall into three general categories; *frigates*, *destroyers* and *cruisers*, and there are numerous variants within these classes. Since they tend to be lightly armed and armored, at least in relation to their capital and super-capital cousins, sub-capital ships tend to rely on massed formations of mixed hulls. A good

mix of frigates, destroyers and cruisers can stop most task forces composed of sub-capital and capital spacecraft in their tracks.

### Frigates (FR)

Frigates are the smallest and quickest of the sub-capital ships of the line. Typically between 100 and 500 feet (30.48 to 152.4 m) long and with a mass of no more than 15,000 tons, they are essentially up-armored and up-engined shuttlecraft. These ships fill a number of support, logistics and escort roles within the navies of the Three Galaxies. Common missions performed by frigates include system patrol, blockades (or blockade running) and reconnaissance.

### Destroyers (DD)

Destroyers are essentially frigate-class hulls outfitted with the types of drives and weapon systems usually found on cruisers. They are fast, hardy ships designed for a number of specialized roles within their fleets. Destroyers are typically built in one of two different configurations, either as Guided Missile Destroyers (DDG) or Destroyer Escorts (DDE).

**Guided Missile Destroyers**, such as the widely feared and respected *Berserker* class of the Imperial Armada, are dedicated ship killers meant to go toe to toe with larger sub-capitals and even capital ships. They typically carry numerous cruise missiles or torpedoes and have fire control systems sophisticated enough to launch their entire payload in seconds. These ships are designed to get into a fight quickly, unload their ordnance at relatively close range and jump away. To this end their captains and crews tend to be highly skilled at fast strike, hit and run tactics, and unchecked, can cause trillions of credits worth of damage to an enemy fleet.

**Destroyer Escorts** trade in their heavy missiles for dozens of High Intensity (HI) Laser or GR-Cannon anti-aerospacecraft batteries. Escorts are designed specifically as an anti-fighter/anti-shuttle platform and are used in both offensive and defensive roles within a fleet.

In their defensive role, Escorts work in groups, screening larger ships like cruisers and battlecruisers from incoming fighters and assault shuttles.

In their offensive role, Escorts are either used to engage enemy fighters and small ships directly, or to provide covering fire for friendly fighter squadrons.

In either role, they are expected to *hold the line* and take part in long engagements and drawn-out slugfests with dozens of fighters and shuttles. Due to the expectations put on them, their shields and armor are more durable than those used on their missile carrying cousins.

### Cruisers (C)

Cruisers are tough and versatile warships of medium tonnage, typically between 500 and 1,500 feet (152.4 to 457.2 m) in length, and are the backbone of most spacefaring navies. Thanks to their large drives, they have a long touring radius and they carry a wide array of anti-ship and anti-installation weapon batteries. Cruisers are produced in light (CL) and heavy (CH) variants, and are designed to fill a multitude of roles without having to alter their weapon or crew configurations.



**Light Cruisers (CL)** are commonly used in interdiction, patrol and long-range reconnaissance roles in hostile areas of space. Their heavy armor and powerful anti-ship batteries give them adequate protection and allow them to readily engage targets of opportunity. In fleets, they can be found in the inner line of ships, flying escort for battleships and carriers, and protecting their larger siblings from other sub-capital ships. Light cruisers are also excellent anti-pirate platforms, and are commonly used to ferret out and destroy piracy and smuggling operations.

**Heavy Cruisers (CH)** are the largest, and arguably the most dangerous, of the sub-capital ships of the line. These heavy hitters carry numerous high-caliber weapons and heavy missile batteries and can usually be found at the heart of small task forces made up of other sub-capitals and small ships. Unlike their lighter sisters, heavy cruisers often carry an air wing made up of aerospace fighters and powered armor. These air wings, combined with powerful point-defense batteries, allow heavy cruisers to quite handily protect themselves and their task forces from opposing fighters and other smaller sub-capitals. The Consortium Armed Forces' *Warshield Cruiser* is a fine example of the strength and versatility of the average heavy cruiser.

## Capital Ships

Capital ships are the heavyweights of the spacelanes. Heavily armed and armored, capital ships are very expensive to build and crew, and are typically designed for a specific role like the *Packmaster carriers* or *Araneae interdictors*. Thanks to the intense amount of men and materiel that go into fielding these behemoths, they are much less common than sub-capitals like cruisers and destroyers. Only the most powerful and wealthy power blocs in the Three Galaxies can justify the expense of fielding these massive ships in their fleets, and even then they are used sparingly and with great caution.

### Battlecruisers (BC)

Sometimes referred to as “pocket battleships,” battlecruisers are a half-step between cruisers and battleships. The smallest recognized class of capital ship, battlecruisers range between 1,500 and 2,500 feet (457.2 to 762 m) in length and typically weigh between one million and eight million tons. Battlecruisers are typically smaller and lighter than battleships, but are equipped with battleship-class drives and weapon batteries, making for an incredibly fast and lethal ship.



## Battleships (BB)

Battleships are heavily armed and armored capital ships with an average length between 2,000 and 4,000 feet (609.6 to 1,219 m), and a mass of 10 to 20 million tons. Much like cruisers, battleships are multi-purpose warships designed to fill numerous roles within a fleet. Typically the designated heavy hitters of any fleet or task force, battleships are heavily armored and carry some of the most devastating weapons in the Three Galaxies. They are designed to take part in massive, extended fleet battles and to withstand the withering amounts of fire that would melt a sub-capital ship to slag.

## Carriers (CV)

Carriers are dedicated troop and/or aerospace vehicle carriers. The second largest recognized ship class in the Three Galaxies, dwarfed only by the massive dreadnought-class super-capital ships, carriers average between one and two miles (1.6 to 3.2 km) in length and can weigh hundreds of millions of tons. These ships carry hundreds of fighters, robots and power armor and thousands of troops. Due to their size and expense, carriers are relatively rare among the major spacefaring navies. They are used conservatively, and usually only sent into a conflict in the case of an all-out war.

## Super-Capital Ships

**Dreadnoughts (DRD)** are the biggest ships currently in existence, with the notable exception of the *Dominator Star Fortresses*. A ship of this class usually weighs in at over 100 million tons, and measures anywhere from one to three miles (1.6 to 4.8 km) in length. They are so powerful and so complicated, that the average construction time for a single ship is five years. The Transgalactic Empire (TGE) currently has twenty-one ships of the *Doombringer* class, the Free World Council (FWC) commands one of the same design. The Consortium of Civilized Worlds (CCW) is trying to catch up as best it can, but, so far, only twelve of the new *Emancipation*-class vessels have been built.

Dreadnoughts are the *least common* type of starship in the Three Galaxies, in large part because of their crippling cost. Using slave labor and the aid of the Machine People, who neither care about money nor require sleep, the TGE can build a dreadnought for a paltry 50 billion credits. For just about everyone else, however, constructing one of these ships can run into the trillions. Development and construction of the *Emancipation*-class ships have cost the Human Alliance a staggering 856 trillion credits. To put this in perspective, the Gross Domestic Product for all of Terra Prime is 400 trillion credits per annum. Thus, in order to match the Kreeghor, the Human Alliance has spent all the money in the world. Twice.

# Creating New Starships

## Some thoughts by the author

Whether your adventures focus on the movements of massive stellar fleets, or are simply about the intrepid crew of one little ship, players and Game Masters alike are going to want to come up with their own ship designs at some point. Until now, there have been a few different ways to go about this. The **Aliens Unlimited™ Galaxy Guide™** and **Mutants in Orbit™** are the two most often used, but neither is quite right for the **Phase World®** setting without a bit of modification and math on the part of the would-be spaceship builder. So, when it came time to compile this sourcebook, a set of ship building “guidelines” was a must have.

Instead of hard and fast rules, below you will find some general guidelines for inventing new spaceships for the Three Galaxies. If you follow them closely, along with the ship equipment list on pages 152-157 of **Rifts® Dimension Book 2: Phase World®**, the resulting new design should be fairly balanced for game play and yet still be very individual. If you stray from the guidelines a bit, then you’ll have to come up with a good story as to why this particular ship is so fast, or so heavily armed, or what have you. But that back-story just might be the seed for countless adventures in itself.

## Creation Questions

Before you even start to load it up with laser turrets, or figure out how much damage it will do if you fly it into a building, there are several questions that should be asked and answered. In a way, these are a lot like the questions that should be asked whenever a new character is created. The more detailed the ship’s background, the more it will be like an extra member of the adventuring party, instead of some intergalactic taxi that no one really cares about.

**1. How big is the ship?** What kind of new ship are you building anyway? Is it a space fighter, a cruiser or a massive dreadnought?

The general type of ship will determine what it can and can’t do, how much cargo it can lug around, and how many weapon systems it can mount. If the ship is being built at the beginning of a new **Phase World®** campaign, this might also give a great deal of insight as to just who the player characters are as well. If the ship is a massive vessel, maybe our heroes are CCW engineers, highly trained and well paid. If it is smaller, they might be aspiring inventors or mad scientists out to prove a theory. If the ship is a prototype, and an unproven one at that, you’re going to need some daring pilots to give it a proper shakedown.

**2. What is the ship’s main function?** Is this to be a cargo ship, or a ship of war? Maybe it is being built to go into deep space for years at a time and explore the unknown galactic cores? Could it be a colony transport?

Starships in **Phase World®** are built for fairly specific tasks, so deciding what you really want your ship to be good at (speed, firepower, stealth, etc.) will help focus the rest of the design.

### 3. Who built it?

This helps determine not only how the ship looks, but what it is capable of doing and handling. A *Naruni fighter* will be quite unlike one built by the *Transgalactic Empire (TGE)*, and an *Atless* cruiser will be an entirely different animal than one built by the *Consortium of Civilized Worlds (CCW)*. This can also be a great avenue for adventure depending on whether the new ship is legal or not. Many governments won’t allow “Joe Citizen” to own and operate a combat spacecraft. Likewise, certain resources such as advanced computer cores, guided missiles and heavy armor may or may not be available depending on where the ship is built and who builds it.

**4. How old is it?** When was the ship built? Is it ancient and well worn, or an unproven prototype?

This can be where the ship takes on a character of its own. If it is an ancient relic, say, 1,000 years or more, what kind of condition is it in? Is it somehow perfectly preserved, or is it a floating wreck just waiting for a talented engineer to fully restore it?

A ship only a few hundred years old might be a reliable clunker that looks worse than she really is (a nice surprise when trying to outrun pirates or outgun an attacker). Or she might be a clunker in constant need of repairs. This could be especially problematic if systems stop working in the middle of a battle or escape attempt. Furthermore, this vessel is likely to have had several owners and a potentially interesting history that could lead to adventure or trouble. Working out the ship’s history is not only fun, but also gives a Game Master enough ideas to run a dozen adventures.

If the spaceship was first built more than ten years ago, chances are it has had at least one previous owner. Who was that owner, and what did they do to the ship before you got it? Could there be hidden, undelivered contraband somewhere in the hull? Will old enemies come looking for the new owners? Again, working out the ship’s history is not only fun, but also gives a Game Master enough ideas to run a dozen adventures.

If the ship is new, it could have serious design flaws, or it could be so advanced that governments and corporate forces are sent to “appropriate” it for study. Or the vessel could just be a shiny, new, reliable spacecraft the player characters can count on.

### 5. What’s wrong with it?

Even a fresh-off-the-lot spacecraft can have a few little niggling things wrong with it that can bug the hell out of the player characters. These don’t have to be major design flaws either. Something as simple as not enough headroom for creatures eight feet (2.4 m) or taller, a blown speaker in the stereo system, or that annoying sympathetic vibration when she hits 4 light-years per hour is enough to be fun and annoying.

### 6. What is the vessel’s name, and why?

Ships have names for many reasons. They are call-signs, pet names, inside jokes, the name of an old girlfriend, the name of a current girlfriend, and easy identifiers. Ships are often named for superstitious reasons. Even in an age of high technology and

FTL travel, most Spacers won't fly on a ship that doesn't have a name because it brings bad luck. Starships that are part of a full navy are named so that the crew serving on board cares about its well-being. Think about it, would you be more willing to give your life in defense of the NX-74205, or the *Defiant*?

Your new ship, no matter its age, *needs a name*. It can be cute, ironic, personal, or mysterious. My first car was called *Sigmund* for reasons that are far too complex to go into here. Everyone knew it as such, and because it had a name, it was more like a *good friend* than a car and means of transportation. I'm certain we all died a little inside when *Sigmund* was finally laid to rest, but no one would have much cared if we had just referred to it by its VIN number.

– Braden Campbell

## General Rules of Thumb

Below are just a few generalizations to keep in mind when designing new spaceships for your game. More specific notes are found below, divided by ship class and size.

Spacecraft that utilize a **contra-gravity engine** for sub-light speeds are technically full transatmospheric vehicles, but in practice, most ships larger than a cruiser will either move so slowly within an atmosphere that it's just not worth it, or are built in such a way that they would collapse under their own weight if they landed on a planet.

**Contra-gravity engines** eliminate G-force stress on all crew members and pilots.

**Point defense systems** built into major military starships of sub-capital size or larger will have an additional *ladar suite* that helps them track incoming missiles. This gives the point defenses a +2 to strike, in addition to bonuses from the Weapon Systems skill.

**The Free World Council (FWC) lacks the ability to build starships from scratch**, since most of their limited budget is directed to their ongoing war effort. They can, however, repair and upgrade any vessel they get their hands on. FWC ships are bought from independent companies such as *Naruni Enterprises* and *Draygon Industries*, or will be the equivalent of pirate ships.

**The Consortium of Civilized Worlds (CCW)** refuses to provide the FWC with any kind of starship that is easily recognizable as being part of the Consortium fleet. This includes decommissioned *Scimitars* and *Warshields*. However, the Free World Council (FWC) may use any kind of liberated Imperial and Wulfen ship, such as the *Hunter Destroyer* and the *Flying Fang*.

**The Kreeghor** still have a “live fast, fight hard, die young” attitude. As a result, their aerospace fighters are less heavily armored than their Consortium counterparts by an average of 150 M.D.C. points!

**The Kreeghor** have yet to build a long-range interceptor, perhaps indicating that they don't feel it necessary.

**The Kreeghor TGE combat shuttles** are expected to take enormous amounts of ground fire as they descend. On average, these shuttles have a main body M.D.C. higher than any other power bloc (between 200 and 1500 points more). However, their

extra plating makes them very slow, with an average speed of Mach 4.

**Kreeghor Imperial sub-capital and capital ships** always have less M.D.C. than Consortium (CCW) vessels.

**The Golgans** lack the ability to produce automated turrets as mentioned elsewhere, nor can they create reliable anti-matter systems.

**Ships from the United Worlds of Warlock (UWW)** always have an *Armor of Ithan* spell of some kind rather than the more commonplace Variable Force Field.

**Ship Construction Note:** The current “top out” mass for starships is 60 million tons. The ship cannot be more than 6,000 feet (1828 m) long, wide, or high. To build it any bigger requires either a *Kelthrot Harmonic Field*, or a *Balanced Hammond Drive*, both of which are classified military secrets. These limitations do not apply to the *Star Hives* or the ships of the *Elder Races*.

**Ship Construction Note:** The “top speed” for a ship at FTL is eight light-years per hour. Anything faster must use a completely new engine design. This limitation does not apply to the *Altess* or the ships of the *Elder Races*.

**Ship Construction Note:** The guidelines that follow do not cover the organic ships used by the *Star Hives* or the *Necrol*. Nor are they applicable to the *Demon Ships* that are being encountered during the *Minion War*.

## Building Fighters and Shuttlecraft

Aerospace fighters are small, one-, two- or four-manned combat machines typically the size of an atmospheric jet fighter. They are designed to handle a range of combat missions, from interception and dogfighting to surgical strikes, troop support, and taking and holding space or “aerospace superiority,” and come in a dizzying array of shapes and styles depending on their primary mission. Fighters are generally transported to and from combat in dedicated carrier ships (battleships, carriers and dreadnoughts), but most sub-capital and capital ships carry at least one squadron (12-24 fighters) for repelling hostile shuttles or other small ships.

### Standard Avionics, Equipment & Features for Space Fighters and Shuttlecraft

**1. Ladar:** Aerospace fighters and shuttles are equipped with a powerful LADAR (*Laser Detection and Ranging*) system that can track multiple targets in all kinds of weather as well as space. The LADAR can also focus its emissions to overload enemy sensors. This gives the ship a limited electronic attack capability and requires an Electronic Countermeasures skill roll. If the character doesn't have the Electronic Countermeasures skill, the Sensory Equipment skill can be used, but at a -15% penalty. A successful roll suppresses enemy RADAR/LADAR for 2D6 rounds. While suppressed, the enemy loses one attack, is -10% to all piloting skill rolls, and is -3 to strike and dodge. LADAR has a range of 1,500 miles (2,400 km) and can track up to 60 targets.

**2. Communications:** Wideband and directional radio communication system with built-in scrambler that transmits both voice and cockpit video. Range is 2,000 miles (3,200 km) but can be boosted indefinitely via satellite relay. Secure laser communication with a range of 250,000 miles (400,000 km).

**3. Tactical Computer System:** All fighters have a powerful on-board computer system that handles all targeting and combat data collection. The combat computer collects data from all sensors, stores it and then displays the information on the pilot's HUD.

**4. Motion Detector and Collision Warning System:** Detects objects within 5,000 feet (1024 m) and alerts the pilot of an impending collision with an alarm and flashing red light; triple the range when fast moving objects are on a collision trajectory (providing 2D6+6 seconds to respond/take evasive action).

**5. Ejection Seat:** There are two separate ejection systems in fightercraft. The first is the *Atmospheric Ejection System* that is a traditional zero/zero ejection seat that exits through the canopy. The second system is for use in space, where the entire fuselage from behind the pilot's compartment forward is jettisoned. This *escape capsule* retains the fighter's life support system and protects the pilot from both vacuum and enemy fire while waiting to be recovered. Shuttles typically have no ejection system, and passengers and crew have to resort to bailing out in emergency EVA suits.

**6. Infrared Sensors:** An array of passive (Infrared Search and Track) IR systems that allow the pilot to fly in darkness and inclement weather with no penalties. Range is 5 miles (8 km) in outer space.

**7. Multi-Spectral Weapon Sight:** This system combines FLIR (forward looking infrared), passive night vision and a thermal imager to allow the fighter to fly and fight effectively in any environment. Range is 5 miles (8 km) in outer space and grants a +1 to strike with all weapons.

**8. Tactical Camera:** This camera, called the "gun camera" by pilots, can record up to 180 minutes of footage into memory that can later be downloaded and analyzed. This footage is usually used in training and combat analysis. It sees directly ahead along the axis of the fighter's main weapon, and can either be controlled by the pilot or set on auto-record.

**9. Tactical Life Support:** Fighters and shuttles have pressurized pilot or crew compartments with an internal oxygen supply good for 48 hours. This can be stretched to a week through the external oxygen intakes. The intakes are equipped with scrubbers to filter out chemical and biological agents. The pilot can hook the life support from his flight suit to the on-board system to extend his personal oxygen supply. They also have heat and radiological shielding to protect the pilot from damaging radiation common to the environment of outer space.

**10. Distress Beacon:** Broadcasts a distress beacon on an encrypted frequency. Range is 250 miles (400 km) in atmosphere, or 25,000 miles (40,000 km) in outer space.

**11. Electronic Countermeasures (ECM):** A combination of sensor jammers, radio-pulse flares and old-fashioned chaff dispensers. This system serves to protect fighters and shuttles against being detected by targeting systems as well as from incoming missiles. When active, these systems impose a -10% penalty to anyone trying to target a fighter or shuttle using the

*Weapon Systems* skill, and cause missiles to lose any targeting bonus. Other fighters and missiles are -3 to strike a shuttle or fighter with active ECM.

**12. Self Destruct:** A last ditch effort to prevent capture of the fighter or shuttle. The blast is largely contained, and destroys the ship and all of its systems, but only 3D6x10 M.D. is inflicted to everything within a 25 foot (7.62 m) radius.

## Fighter Design Notes

**Fighters may have a Main Body M.D.C. no greater than 800.** If the ship is built with variable force fields, their value may be no greater than *200 points per side*.

**The fighter's top speed in space** can be no greater than Mach 16, unless the design includes special, additional thrusters. When operating in an atmosphere, that speed is roughly *cut in half*. Designers may adjust that number up or down by a factor of two.

*Naruni Enterprises* prefers a distinct separation between their traditional atmospheric fighters and their space fighters, as it forces militaries to purchase two ships to do the work of one *aerospace fighter*. *Naruni* space fighters see their space speed reduced to Mach 2 or 3 in an atmosphere.

**Space fighters are never built with FTL capabilities** as it is seen as economically unfeasible.

**Space fighter weapon systems.** Fighters are usually armed with a number of weapon systems that are generally out of proportion to their small size. When designing a new type of fighter, these systems are divided into *Primary*, *Secondary*, and *Missile systems*. All of these are selected from the *Light category of weapons* (**Phase World®**, pages 153-155), with short and medium-range missiles counting as Light weapons.

A fighter may be built with up to **four Primary weapons**, whether focused energy weapons like lasers, GR guns or *Naruni* plasma cartridge weapons. These weapons are always "fire-linked" so that they can be fired individually or in unison, which allows a fighter to bring an immense amount of killing power to bear on a single target.

A fighter may have no more than **two Secondary weapons** and may carry any number of *mini-missile launchers*, but the *total payload* must be an even number, and cannot exceed 32 missiles. Short- and medium-range missiles may be added into the mix, usually mounted on hardpoints under the fighter's wings or fuselage. A space fighter may carry as many as eight short-range or four medium-range missiles. Long-range missiles are not an option.

**Fighter-Bombers.** Some fighters, like the *Naruni Fire-Eater* or *Draygon Industries Nova*, are designated as attack craft dubbed "fighter-bombers." They are usually larger and slower than the traditional fighter by 20-30% and are designed to carry high-yield, *long-range missiles* or *torpedoes*. The primary mission of fighter-bombers is the destruction of space stations and capital and sub-capital ships. They are heavily armored with powerful shields designed to shrug off a large ship's point-defense systems, and are the only fightercraft able to carry missiles with *anti-matter* and some of the *more exotic warheads*. They are usually deployed, en masse, from carrier ships or space stations, and pose a very serious threat to any space vessel *smaller than a battleship*. Fighter-bombers, sometimes referred to sim-

ply as “Attack Craft,” may not have a *Main Body M.D.C. greater than 600*, and can not have more than *two Primary weapon* systems, and have *no Secondary weapon* systems. Fighter-bombers can carry up to 20 medium-range missiles or 16 long-range missiles, but no more than that. Note that the long-range missiles *replace* the medium ones, and are not in addition to them. In the alternative, fighter-bombers may be outfitted with up to six cruise missiles of any type.

## Brief Summary of

### Notable Space Fighters

**Note:** Most of these fighters appear in other **Phase World®** titles.

#### **Fighter Designation/Name: Black Eagle**

Main Body Value: 800 M.D.C. +200 M.D.C. per side from force fields.

Best Speed: Mach 16.

Dimensions: 14x32x45 feet (4.3 x 9.7 x 13.7 m).

Primary Weapon of Note: Lasers: 4D4x10 M.D.

#### **Fighter Designation/Name: Broadsword**

Main Body Value: 550 M.D.C. +200 per side from force fields.

Best Speed: Mach 9.

Dimensions: 10x30x50 feet (3 x 9.1 x 15.2 m).

Primary Weapon of Note: Cartridge Guns – 3D6x10 M.D.

#### **Fighter Designation/Name: Dragon Fang**

Main Body Value: 500 M.D.C. +200 per side from force fields.

Best Speed: Mach 15.

Dimensions: 12x32x32 feet (3.6 x 9.7 x 9.7 m).

Primary Weapon of Note: Particle Beam – 3D6x10 M.D.

#### **Fighter Designation/Name: Fire Eater**

Main Body Value: 550 M.D.C. +200 per side from force fields.

Best Speed: Mach 10.

Dimensions: 12x30x40 feet (3.6 x 9.1 x 12.2 m).

Primary Weapon of Note: Cartridge Guns – 3D6x10 M.D.

#### **Fighter Designation/Name: Flying Fang**

Main Body Value: 480 M.D.C. +200 per side from force fields.

Best Speed: Mach 10.

Dimensions: 14x40x40 feet (4.3 x 12.2 x 12.2 m).

Primary Weapon of Note: Lasers – 2D6x10 M.D.

#### **Fighter Designation/Name: Jestra**

Main Body Value: 300 M.D.C.

Best Speed: Mach 10.

Dimensions: 7x20x40 feet (2.1 x 6.1 x 12.2 m).

Primary Weapon of Note: Disruptors – 2D6x10 M.D.

#### **Fighter Designation/Name: Katana Fighter**

Main Body Value: 600 M.D.C. +300 per side from force fields.

Best Speed: Mach 14.

Dimensions: 12x40x50 feet (3.6 x 12.2 x 15.2 m).

Primary Weapon of Note: Particle Beam – 2D6x10 M.D.

#### **Fighter Designation/Name: Nova Bomber**

Main Body Value: 600 M.D.C. +200 per side from force fields.

Best Speed: Mach 18; uses additional thruster packs.

Dimensions: 16x54x48 feet (4.9 x 16.4 x 14.6 m).

Primary Weapon of Note: Lasers – 4D4x10 M.D.

#### **Fighter Designation/Name: Scorpion**

Main Body Value: 550 M.D.C.

Best Speed: Mach 18 – uses additional thruster packs.

Dimensions: 10x31x34 feet (3 x 9.4 x 10.3 m).

Primary Weapon of Note: Rail Guns – 4D6x10 M.D.C.

#### **Fighter Designation/Name: Shadow Bolt**

Main Body Value: 400 M.D.C. +180 on three sides from force fields.

Best Speed: Mach 9.5.

Dimensions: 13x40x50 feet (3.9 x 12.2 x 15.2 m).

Primary Weapon of Note: Lightning Rod – 1D6x10 M.D.

#### **Fighter Designation/Name: Star Ghost**

Main Body Value: 440 M.D.C. + phase fields.

Best Speed: Mach 12 at normal speed, or 1 light-year per hour at FTL.

Dimensions: 35x40x65 feet (10.6 x 12.2 x 19.8 m).

Primary Weapon of Note: Phase Cannon – 3D6 M.D. to 30 foot (9.1 m) radius.

#### **Fighter Designation/Name: Star Hawk**

Main Body Value: 350 M.D.C.

Best Speed: Mach 20 – uses additional thruster packs.

Dimensions: 10x23x30 feet (3 x 7 x 9.1 m).

Primary Weapon of Note: Lasers – 4D6x10 M.D.

## Mach Speed Chart

**Mach 1:** 761 mph (1,224.7 km)

**Mach 2:** 1,522 mph (2,449 km)

**Mach 3:** 2,283 mph (3,674 km)

**Mach 4:** 3,044 mph (4,899 km)

**Mach 5:** 3,806 mph (6,125 km)

**Mach 6:** 4,567 mph (7,350 km)

**Mach 7:** 5,328 mph (8,575 km)

**Mach 8:** 6,089 mph (9,799 km)

**Mach 9:** 6,850 mph (11,024 km)

**Mach 10:** 7,612 mph (12,250 km)

**Mach 11:** 8,373 mph (13,475 km)

**Mach 12:** 9,134 mph (14,700 km)

**Mach 13:** 9,895 mph (15,924 km)

**Mach 14:** 10,656 mph (17,149 km)

**Mach 15:** 11,418 mph (18,375 km)

**Mach 16:** 12,179 mph (19,600 km)

**Mach 17:** 12,940 mph (20,825 km)

**Mach 18:** 13,701 mph (22,050 km)

**Mach 19:** 14,462 mph (23,274 km)

**Mach 20:** 15,224 mph (24,501 km)

**Mach 21:** 15,985 mph (25,725 km)

**Mach 22:** 16,746 mph (26,950 km)

**Mach 23:** 17,507 mph (28,175 km)

**Mach 24:** 18,269 mph (29,401 km)

**Mach 25:** 19,030 mph (30,626 km)

## Building Shuttlecraft & Other Small Spacecraft

This category covers everything bigger than a space fighter, but not big enough to be classified as a sub-capital. **Note:** All small spacecraft use the piloting skill *Pilot: Spacecraft: Small*.

**Combat shuttles and drop ships** vary wildly in their armaments and lifting capabilities. Some, like the *CAF Assault Shuttle*, can transport as much as 1,500 tons. The Kreeghor Rain of Death, however, can lift over 10,000 tons while being only 1.5 times bigger than the Consortium ship. Obviously, engines, hull design and aerodynamics will play a factor in a shuttle's speed, so I recommend basing any new designs as closely to the established shuttles as you can. If you have access to **The Rifter® #34**, you'll find some great optional rules for designing small spacecraft as well.

**Runner ships**, loaded with all manner of innovative and illegal weaponry, are the hardest sub-class to lay down rules for. Using the *Stick in Your Eye (Phase World®)*, page 181) as the benchmark, we could say that Runner ships are able to mount *one heavy weapon system, two medium weapon systems, and five point defense weapons*. However, Game Masters who allow a player character Runner to have his own ship, should only let that player character start out with the five point defense weapons, and make him acquire the heavier weapons. *A beginning Runner's ship* is very much like the typical version found on page 171 of **Rifts® Dimension Book Two: Phase World®**. Additional systems may be added later, but the player characters will have to find a way to pay for them on their own. The addition of medium and heavy systems will however eat up a lot of space normally reserved for cargo. Each medium weapon reduces the ship's cargo capacity by 150 tons, and a heavy weapon reduces the maximum allowable cargo by 600 tons! Medium and heavy weapon ports can *not* be disguised or placed in retractable turrets on a vessel of this size.

### Brief Summary of

#### Notable Small Spaceships

**Note:** Most of these vessels appear in other **Phase World®** titles.

##### **Small Spaceship Designation/Name: Arcane Mk.II**

Main Body Value: 3500 M.D.C. +2000 magic force field.

Best Speed: Mach 8 in normal space, or 4 light-years per hour.

Dimensions: 70x80x100 feet (21.3 x 24.4 x 30.5 m).

Primary Weapon of Note: Death Cloud!

##### **Small Spaceship Designation/Name: Arcane Mk.XV**

Main Body Value: 3500 M.D.C. +1000 magic force field.

Best Speed: Mach 7.

Dimensions: 65x70x225 feet (19.8 x 21.3 x 68.6 m).

Primary Weapon of Note: Star Fire – 4D6x10 M.D.

##### **Small Spaceship Designation/Name: Assault Shuttle**

Main Body Value: 2200 M.D.C.

Best Speed: Mach 6.

Dimensions: 70x50x240 feet (21.3 x 15.2 x 73.1 m).

Primary Weapon of Note: Laser/Missile – 1D4x10 M.D.

##### **Small Spaceship Designation/Name: Haelra**

Main Body Value: 2500 M.D.C.

Best Speed: Mach 6.

Dimensions: 70x50x240 (21.3 x 15.2 x 73.1 m).

Primary Weapon of Note: Disruptors – 1D4x10 M.D.

##### **Small Spaceship Designation/Name: Proctor**

Main Body Value: 1450 M.D.C. +400 per side from force fields.

Best Speed: Mach 16 in normal space, or 2 light-years per hour in FTL.

Dimensions: 20x50x80 feet (6.1 x 15.2 x 24.4 m).

Primary Weapon of Note: Lasers – 4D6x10 M.D.

##### **Small Spaceship Designation/Name: Raider**

Main Body Value: 2500 M.D.C.

Best Speed: Mach 15.

Dimensions: 55x65x200 feet (16.7 x 19.8 x 61 m).

Primary Weapon of Note: Neutron – 4D6x10+20 M.D.

##### **Small Spaceship Designation/Name: Rain of Death**

Main Body Value: 3700 M.D.C. +200 per side from force fields.

Best Speed: Mach 4.

Dimensions: 80x80x200 feet (24.4 x 24.4 x 61 m).

Primary Weapon of Note: GR Cannon – 4D6x10 M.D.

##### **Small Spaceship Designation/Name: Runner Ship**

Main Body Value: 2000 M.D.C. +300 per side from force fields.

Best Speed: Mach 10.

Dimensions: 30x30x100 feet (9.1 x 9.1 x 30.5 m).

Primary Weapon of Note: Lasers – 2D6x10 M.D. (x3).

##### **Small Spaceship Designation/Name: Shadow Ship**

Main Body Value: 2300 M.D.C. +200 per side from force fields.

Best Speed: Mach 10.

Dimensions: 40x78x140 feet (12.2 x 23.8 x 42.7 m).

Primary Weapon of Note: Lasers – 3D6x10 M.D.

##### **Small Spaceship Designation/Name: Ton-ban**

Main Body Value: 2000 +500 per side from force fields.

Best Speed: Mach 12.

Dimensions: 15x40x70 feet (4.6 x 12.2 x 21.3 m).

Primary Weapon of Note: Star Fire – 2D6x10 M.D. (X4).





# Building Ships of the Line

## Standard Systems for All Ships of the Line:

**1. Advanced Ladar:** Can track and identify up to 2,000 craft simultaneously with a 250,000 mile range (400,000 km). Contra-gravity wakes can be tracked out to 10 light-years. Operators are +10% on their Sensory Equipment skill rolls.

**2. Advanced Sensor Suite:** Radiation, thermal-graphic, motion, gravimetric detectors. 250,000 mile range (400,000 km). Operators are +10% on their Sensory Equipment skill rolls.

**3. Combat Computer:** Calculates, stores, and transmits data onto the gunners' display screens. It is tied into the targeting computer.

**4. Targeting Computer:** Assists in the tracking and identification of enemy targets: 10,000 mile range (16,000 km). +1 to strike with all weapons (in addition to Weapon Systems skill roll if manually operated). If the ship's systems are set on automatic, this computer will select priority targets and fire.

**5. Tachyon Transmitter Array:** The "Tac-line" is the standard FTL comms array. It sends radio signals through hyperspace embedded in a low intensity phase field. Tac-line communications are still not instantaneous however, and audio/video communications travel through space at a rate of about 100 light-years per hour.

**6. Self Destruct:** A last resort measure to prevent the ship from being captured by the enemy, and the duty of every able captain. Causes the ship's computer to dump the anti-matter supply into the main reactor. This explosion is huge: 3D4x1,000 M.D. for a radius of 3 miles (4.8 km).

## Building Sub-Capital Ships

Significantly larger than small spacecraft are sub-capital ships. Sub-capital ships are separated into three general classes: *frigates*, *destroyers* and *cruisers*. These ships can vary in length from 400 to 1,200 feet (122 m to 365.7 m) and can weigh up to 150,000 tons.

## Frigates and Destroyers

A **frigate** has minimal room for carrying cargo, no more than 1000 tons in internal storage holds. They are built with minimal creature comforts for the crew, since they tend to remain in the star system in which they were built, or in a small patrol area. Frigates may mount up to *eight point defense emplacements* of any kind, and may have up to *four weapons* selected from the *medium weapon systems*. Note that a *cruise missile launcher* may be taken as a medium weapon slot, even though the missile itself is a heavy weapon.

**Destroyers** are similar to frigates in their carrying capacities and accommodations. Since destroyers are built as either *Guided Missile Destroyers* or *Destroyer Escorts*, their weapon systems tend to be very specific, and focused to fulfill their stated mission.

**Guided Missile Destroyers** can mount up to 20 long-range missile launchers designed to carry either heavy cruise missiles

or torpedoes. They can also mount up to *10 point defense weapon systems*, but are typically screened by other fighters or Destroyer Escorts. These ships rarely, if ever, carry any medium weapon systems and never mount Heavy weapons.

As designated anti-fighter and anti-sub-capital ships, **Destroyer Escorts** can mount up to *24 point defense* or *light weapon systems*. Destroyer Escorts never mount medium or heavy weapon systems.

As a rule, frigates and destroyers carry a crew of less than 200. These ships, like most ships in the Three Galaxies, are heavily automated and have extensive computer controls and safeguards. The CAF *Hunter* class somehow manages to operate with only twenty-four people, but this is probably due to the superior multi-tasking abilities of the Wulfen.

## Brief Summary of Notable Frigates/Destroyers

**Note:** Most of these vessels appear in other **Phase World®** titles.

### **Frigate/Destroyer Designation/Name: Auntin**

Main Body Value: 5,000 M.D.C. +1000 per side from force fields.

Best Speed: Mach 8 in normal space, 5 light-years per hour in FTL.

Dimensions: 80x140x500 feet (24.4 x 42.7 x 152.4 m).

Primary Weapon of Note: Disruptors – 4D6x100 M.D.

### **Frigate/Destroyer Designation/Name: Berserker**

Main Body Value: 3,000 M.D.C. +1000 per side from force fields.

Best Speed: Mach 9 in normal space, 4 light-years per hour in FTL.

Dimensions: 104x65x300 feet (31.7 x 19.8 x 91.5 m).

Primary Weapon of Note: Lasers – 1D6x100+100 M.D.

### **Frigate/Destroyer Designation/Name: Corister**

Main Body Value: 4,800 M.D.C. +1000 per side from force fields.

Best Speed: Mach 4 in normal space, 4 light-years per hour in FTL.

Dimensions: 130x200x490 feet (39.6 x 61 x 149.3 m).

Primary Weapon of Note: Lasers – 2D6x100 M.D.

### **Frigate/Destroyer Designation/Name: Hunter**

Main Body Value: 4,500 M.D.C. +1000 per side from force fields.

Best Speed: Mach 9 in normal space, 4.5 light-years per hour in FTL.

Dimensions: 70x80x300 feet (21.3 x 24.4 x 91.5 m).

Primary Weapon of Note: Particle Beam – 2D4x100 M.D.

### **Frigate/Destroyer Designation/Name: Merchantman**

Main Body Value: 5,000 M.D.C. +200 per side from force fields.

Best Speed: Mach 7 in normal space, 3 light-years per hour in FTL.

Dimensions: 70x90x600 feet (21.3 x 27.4 x 183 m).

Primary Weapon of Note: Lasers – 3D6x10 M.D.

#### **Frigate/Destroyer Designation/Name: Scimitar**

Main Body Value: 5,000 M.D.C. +1000 per side from force fields.

Best Speed: Mach 8 in normal space, 5 light-years per hour in FTL.

Dimensions: 80x140x500 feet (24.4 x 42.7 x 152 m).

Primary Weapon of Note: Lasers – 2D6x100 M.D.

#### **Frigate/Destroyer Designation/Name: Yannar**

Main Body Value: 11,000 M.D.C. +2000 per side from force fields.

Best Speed: Mach 20 in normal space, 8 light-years per hour in FTL.

Dimensions: 60x230x224 feet (18.3 x 70.1 x 68.3 m).

Primary Weapon of Note: Photon Array – 3D6x100 M.D.

## **Cruisers**

Cruisers are very versatile ships that can be configured to fill roles from cargo hauling to heavy combat. In the *Phase World setting*, cruisers will have a mass between 20,000 and 200,000 tons. They range in length from 300 to 800 feet (91 to 244 m), and should, in general, have an M.D.C. value five or ten times greater than a frigate or destroyer. There are two notable exceptions below; one being the highly advanced *Altess Zhokil cruiser*, and the other being the *CCW Explorer*. In this case, since the Explorer is intended to go into deep space, far from Consortium-friendly ports, it has been built with an unusual amount of armor plating. Thus, it can go years between repairs if it has to, but can also survive an encounter with the space fleet of a hostile new species. Although classified as a *sub-capital*, the Explorer's length and mass push it very close towards being classified as a capital ship.

A **cargo cruiser** has up to four times the capacity of ship of the line. For example, a *CAF Warshield* has a cargo capacity of 10,000 tons, but if gutted to carry supplies could be filled with 50,000 tons. They may only be loaded with *four heavy weapons, eight medium weapons*, but can have as many as *40 point defense guns*. The larger cannons take up too much internal space that is better used for transporting goods. The higher number of small weapons is usually in response to mass pirate attacks that use large numbers of small fighters, as well as to help repel boarding actions.

**Cruisers rigged for war** are ships of the line, and are typically the largest and most powerful of the sub-capital ships. They may be fitted with up to *10 heavy weapons, 16 medium weapon systems*, and as many as *32 point defense emplacements*, including long-range missile launchers. The cost involved in "maxing out" the abilities of a cruiser prevents there from being many like that, only *Altess* and *Splugorthian ships* regularly carry that many armaments. The normal weapon load for the typical *war cruiser* in the Three Galaxies is *four heavy weapons, eight medium weapons*, and *24-30 point defense guns*.

## **Brief Summary of Notable Cruisers**

**Note:** Most of these cruisers appear in other **Phase World®** titles.

#### **Cruiser Designation/Name: Bindas**

Main Body Value: 40,000 M.D.C. +6000 per side from force fields.

Best Speed: Mach 10 in normal space, 6 light-years per hour in FTL.

Dimensions: 190x630x1220 feet (58 x 192 x 371.9 m).

Primary Weapon of Note: Disruptors – 1D6x1000 M.D.

#### **Cruiser Designation/Name: Explorer**

Main Body Value: 135,000 M.D.C. +10,000 per side from force fields.

Best Speed: Mach 13 in normal space, 6 light-years per hour in FTL.

Dimensions: 348x375x2475 feet (106 x 114.3 x 754.4 m).

Primary Weapon of Note: Lasers – 2D6x1000 M.D.

#### **Cruiser Designation/Name: Iron Ship**

Main Body Value: 18,000 M.D.C. +10,000 from magic shield.

Best Speed: Mach 8 in normal space, 4 light-years per hour in FTL.

Dimensions: 80x80x800 feet (24.4 x 24.4 x 244 m).

Primary Weapon of Note: Rift Projector.

#### **Cruiser Designation/Name: Nexus**

Main Body Value: 40,000 M.D.C. +5,000 from magic shield.

Best Speed: Mach 10 in normal space, 6 light-years per hour in FTL.

Dimensions: 150x1200x850 feet (45.7 x 366 x 259 m).

Primary Weapon of Note: Flare Cannon – 1D6x1000 M.D.

#### **Cruiser Designation/Name: Servitude**

Main Body Value: 50,000 M.D.C. +9,000 per side from force fields.

Best Speed: Mach 10 in normal space, 5 light-years per hour in FTL.

Dimensions: 400x400x800 feet (122 x 122 x 244 m).

Primary Weapon of Note: Slicer Gun – 2D6x1000 M.D.

#### **Cruiser Designation/Name: Smasher**

Main Body Value: 18,000 M.D.C. +3,000 per side from force fields.

Best Speed: Mach 9 in normal space, 4 light-years per hour in FTL.

Dimensions: 208x120x600 feet (63.4 x 36.6 x 183 m).

Primary Weapon of Note: Lasers – 1D6x1000 M.D.

#### **Cruiser Designation/Name: Stonewall**

Main Body Value: 30,000 M.D.C. +3,000 per side from force fields.

Best Speed: Mach 5 in normal space, 4 light-years per hour in FTL.

Dimensions: 100x150x500 feet (30.5 x 45.7 x 152 m).

Primary Weapon of Note: Lasers – 1D4x1000 M.D.

### **Cruiser Designation/Name: Warshield**

Main Body Value: 45,000 M.D.C. +5,000 per side from force fields.

Best Speed: Mach 8 in normal space, 5 light-years per hour in FTL.

Dimensions: 120x200x600 feet (36.6 x 61 x 183 m).

Primary Weapon of Note: Lasers – 1D4x1000 M.D. (x2).

### **Cruiser Designation/Name: Zhokil**

Main Body Value: 135,000 M.D.C. +12,000 per side from force fields.

Best Speed: Mach 20 in normal space, 8 light-years per hour.

Dimensions: 670x1870x2100 feet (204.2 x 570 x 640 m).

Primary Weapon of Note: Photon – 4D4x1000 M.D.

## **Building Capital Ships**

Capital ships are massive ships larger than most ocean-going vessels. They range in length from 1,000 feet (305 m) to over two miles (3.5 km), and mass in the millions of tons. Cost is the first factor to consider when designing a new ship of this size. Using a real-world comparison, the United States Navy currently spends \$13 billion every time it builds a new aircraft carrier, a ship that is roughly one-quarter the size of a CAF *Protector*-class battleship. The cost to operate said aircraft carrier averages out to a million dollars a day, so it is safe to assume that the cost to keep a Consortium capital ship running is exponentially equal, maybe 13 million credits per day. Given these kinds of numbers, it is clear to see how only large planetary collectives like the CCW, the TGE, and the UWW can possibly afford to possess a fleet of these machines.

A newly designed capital ship is very likely to be an upgrade of an existing class. The cost to design, develop, build, and test a brand new class of ship would be staggering, and would elicit loud protestations from any planet's governing bodies. Hence, the reason why the *Republikan Argosy* is all but bankrupt and the *Human Alliance* is under investigation for fraud and financial malfeasance relating to the building of the *Emancipation*-class ship. Still, with the ever-increasing Cold War between the *Consortium* and the *Transgalactic Empire*, it just may be that some newer ships come out of the Goldielox or Feydra Beta shipyards.

**Battlecruisers** are the smallest of the capital ships, but mount a fairly heavy weapon loadout for their size. The average battlecruiser can mount *six heavy weapons, eight medium weapons* and roughly *20 point defense systems*. Battlecruisers may, on occasion, carry up to a squadron of fighters (24 ships) and have a crew between 800 and 1200 men.

**Battleships** are big enough to mount 10 heavy weapons, 12 medium ship weapons, and an impressive 60 point defense weapons, including long-range missile launchers. *Cruise missile launchers* count as a heavy emplacement because of their volleying capacity. Battleships may also carry no more than *44 space fighters* of assorted types. They will have a crew average of between 1,000 and 2,000 men.

**Carriers** are dedicated to moving around large numbers of fighters and men, and as such, they usually carry lighter weapon loadouts than their size might suggest. Carriers may only have *five heavy weapon systems* and *eight medium weapon systems*, but as many as *40 point defense weapon systems* including long-range missile launchers. Carrier ships can hold as many as *500 space fighters*, plus additional embarked robots, power armor and vehicles for planetary assault units. Their mass is often so great that they cannot safely enter a planet's atmosphere, so be sure to include an appropriate number of *transport shuttles*. Typical crew complements for these ships will run 1,500 to 2,500 personnel, not including pilots and marines.

## **Brief Summary of Notable Capital Ships**

**Note:** Many of these capital ships appear in other **Phase World®** titles.

### **Capital Ship Designation/Name: Brightwander**

Main Body Value: 120,000 M.D.C. +50,000 from magic defense shields.

Best Speed: Mach 10 in normal space, 2 light-years per hour in FTL.

Dimensions: 1111x600x3333 feet (338.6 x 183 x 1016 m).

Primary Weapon of Note: Prism – 4D6x1000 M.D.

### **Capital Ship Designation/Name: Executioner**

Main Body Value: 175,000 M.D.C. +8000 per side from force fields.

Best Speed: Mach 9 in normal space, 6 light-years per hour in FTL.

Dimensions: 500x600x3000 feet (152 x 183 x 914.4 m).

Primary Weapon of Note: Lasers – 2D6x1000 M.D.

### **Capital Ship Designation/Name: Packmaster**

Main Body Value: 80,000 M.D.C. +8000 per side from force fields.

Best Speed: Mach 7 in normal space, 6 light-years per hour in FTL.

Dimensions: 1000x1000x5500 feet (305 x 305 x 1676.4 m).

Primary Weapon of Note: Lasers – 1D4x1000 M.D.

### **Capital Ship Designation/Name: Protector**

Main Body Value: 250,000 M.D.C. +15,000 per side from force fields.

Best Speed: Mach 9 in normal space, 6 light-years per hour in FTL.

Dimensions: 600x800x4000 feet (183 x 244 x 1219.2 m).

Primary Weapon of Note: Lasers – 1D6x1000 M.D.

### **Capital Ship Designation/Name: Slynor**

Main Body Value: 200,000 M.D.C. +15,000 per side from force fields.

Best Speed: Mach 10 in normal space, 6 light-years per hour in FTL.

Dimensions: 600x800x4000 feet (183 x 244 x 1219.2 m).

Primary Weapon of Note: FM-14 – 4D6x1000 M.D.

### Capital Ship Designation/Name: Taskmaster

Main Body Value: 100,000 M.D.C. +15,000 per side from force fields.

Best Speed: Mach 5 in normal space, 6 light-years per hour in FTL.

Dimensions: 1200x3500x5000 feet (366 x 1066.8 x 1524 m).

Primary Weapon of Note: Mass Driver.

## Building Super-Capital Ships

Currently, there is only one known class of super-capital ship, the mighty *dreadnought*. Super-capital ships are exceedingly rare and staggeringly expensive to build, with a single ship costing as much as a planet's entire gross domestic income. They require millions of man hours to build, and need the largest and most comprehensive shipyards to construct and assemble their systems. These ships require huge and highly trained crews, and the loss of a single ship can cost as much in loss of life and assets as the loss of an entire task force or battle group. Due to these daunting factors, only two navies currently field these powerful ships, the *CAF* of the *Constortium of Civilized Worlds* and the *Imperial Armada of the TGE*.

**Dreadnoughts** are able to mount at least *15 heavy weapon systems*, at least *20 medium weapon systems*, and at least *48 point defense systems*. The crew of a dreadnought will be at least 3,000 people strong, not including fighter pilots and marine troops.

### Brief Summary of

#### Notable Super-Capital Ships

**Note:** The Doombringer appears in the **Phase World® Sourcebook**.

### Super-Capital Ship Designation/Name: Emancipation

Main Body Value: 300,000 M.D.C. +15,000 per side from force fields.

Best Speed: Mach 7 in normal space, 6 light-years per hour in FTL.

Dimensions: 2000x2000x10,500 feet (609.6 x 609.6 x 3200.4 m).

Primary Weapon of Note: Lasers – 2D6x1000+3000 M.D.

### Super-Capital Ship Designation/Name: Doombringer

Main Body Value: 350,000 M.D.C. +15,000 per side from force fields.

Best Speed: Mach 7 at normal speed and 6 light-years per hour at FTL.

Dimensions: 2000x3000x13000 feet (610 x 914 x 3962.4 m).

Primary Weapon of Note: Laser – 4D4x1000 M.D.

## Stealth and Cloaking Systems

Stealth is the process of disguising a ship by reducing its sensor cross-section, and reducing its engine wake as it travels along. It employs radical dampening fields, sensor absorbing coatings, exotic engine components, and because of gravitic/mass limitations it cannot be applied to any ship larger than a

space cruiser. Stealth technology also limits a starship's top speed to four light-years per hour.

**Standard Stealth**, such as most often used by Runners, the Wulfen, and select governmental covert intelligence agencies, inflicts the following penalties on anyone trying to track it: -40% to Sensory Equipment skill when the ship is standing still, and -25% to Sensory Equipment skill when the ship is moving. A successful roll by the enemy means that your vessel *has* been detected.

**Advanced Stealth** is almost non-existent in the Three Galaxies. Only a select few species such as the *Oni* have refined the ability to travel through space with a minimal Contra-Gravity (CG) wake. Anyone trying to locate a starship rigged with this kind of engine package suffers the following negatives: -80% to Read Sensors skill when the ship is standing still, and -40% to Read Sensors skill when the ship is moving.

**Cloaking** is the process of camouflaging a starship's hull, often by placing holographic or photosensitive projectors all over it. This can become ridiculously expensive, with the average cost coming out to around 15,000 credits per every ten square feet (1 square meter) of hull. Due to its steep price and the delicate and finicky nature of most cloaking systems – and the fact that cloaking also prevents the use of any other kind of hull coating, such as laser-reflective sheeting or reactive armor – it is almost never used by the nations of the Three Galaxies. The *United Worlds of Warlock (UWW)* are a special case, and possess the ability to *cloak* their ships using magic such as the *Invisibility: Superior* spell.

Regardless of whether the cloaking is magical or technological in nature, the moment that weapons are fired, the cloaked vessel becomes visible. Also, it should be noted that cloaking does nothing to hide the ship from gravimetric sensors, and it can be easily tracked as it flies through space unless some type of *stealth* is also built into its engines.

## Catastrophic Damage to the Big Ships

Starships are giant machines, many the size of an office building, some the size of a small town. Their hulls are several feet thick, composed of multiple layers of metal and ceramics. However, underneath all that protection is a comparatively fragile and very complex machine. Even the slightest damage to a starship's main components can disable the entire works.

Because ships of the Three Galaxies have so much extra material stacked on top of their chassis, combat is likely to kill or incapacitate the crew long before the total M.D.C. of the ship is reduced to zero (see **Dimension Book Three: Phase World® Sourcebook**, page 108). The blast waves that distort the ship's structure as missiles impact on its surface, the radiation and heat that leak through from large energy weapon strikes, and most dangerous of all, spalling (where parts of the ship implode inwards in a deadly shower of *shrapnel*), all take their toll on the integrity of the vessel and the crew members inside.

Still, there are times when player characters will bravely fight to the bitter end while the rest of the crew climb into the lifeboats and float away to safety. When a ship is relentlessly attacked in such a cinematic moment, its armored hull is ripped

away, leaving only bare superstructure and letting the hostile environment of space into other parts of the ship. With huge sections of the hull stripped away, incoming strikes hit and damage the delicate *internal workings* of the vessel. *This is catastrophic damage.*

**In terms of game dynamics**, we can safely say that starships are 75% armor. So the remaining 25% of the hull section's M.D.C. is considered to be the ship's "Hit Points." This lesser percentage represents the *interior hull*.

Roll on the following table whenever a vessel is knocked down to its bare hull and main operating systems.

### Random Internal Damage Table

Roll percentile dice for a random determination of damage inflicted to a sub-capital, capital or super-capital starship.

**01-11% All weapons offline** – While the ship still has power, the circuits that lead to the weapons are fried. The ship can still launch fighters and power armor, but has *no* other weapon systems whatsoever.

**12-22% FTL propulsion offline** – The CG/Phase/Rift Drive blows out several important components and dies. It is now impossible to go faster than light. Note that the ship still has full power to all other systems.

**23-33% Sub-light propulsion offline** – The conventional drives are destroyed, blown off into space as ribbons of metal and flaming gas. The ship can no longer maneuver in the fight (remember that most space battles will take place in normal space, and so are using sub-light drives to reposition), making it a *sitting duck*. If the ship was moving when the drives died, it will continue on in the same direction and at the same speed until it hits something big enough to stop it. FTL drive is still an option for escape.

**34-44% Gravitic plating failure** – The ship loses all internal gravity, and everything now floats around in Zero Gravity. Anyone left aboard who is not trained in Zero-G maneuvers finds it impossible to do anything but float.

**45-55% Shield generators offline** – The large plates on the exterior hull that project the force field shut down. The fields will no longer regenerate and any force fields that were up and running vanish.

**56-66% Life support offline** – Unless the crew members are wearing independent environment suits, the crew freezes to death in 2D6 hours. Not that it matters much, as they lose their oxygen supply in half that time.

**67-77% Launch/cargo bays destroyed** – A massive tearing sound is heard as the ship's cargo/fighter bays split open and disgorge their contents into space. Anyone still on board has a wonderful view of cargo containers and space fighters drifting off into the void. There is an 80% chance that the fighters/cargo have been totally destroyed in the blast, leaving a wake of debris instead.

**78-88% Main computer offline** – The loss of the computer eliminates all weapons not in manned turrets, all communications, and all sensors. The ship is now *brain dead*. Roll percentile; 01-75% means that the computer core had enough time to isolate its files before it crashed. 76-00 means all data has been forever lost.

**89-00% Anti-matter containment leak** – The magnetic fields used to hold the anti-matter in check are failing! All backups have also failed. The ship will *explode* in 1D6 minutes! See Common Features for damage from ship explosions/self-destruction.



# Notable Space Fleets of the Three Galaxies



## The Altess Dynasty

### Altess Armoria Space Fleet

The Armoria is notable for two reasons, its incredible power and the fact that it seldom uses that power. The Altess fleet might be considered the exception to the rule in terms of composition. The entire Armoria only numbers one million officers, but their active fleet strength reflects a population much greater than that. Only the mind-boggling financial power of the Altess could accomplish such a thing. Just as only the Altess could deploy so few officers, because the majority of the Armoria starships are crewed by *robots*. In fact, there are entire space-ships within the Altess fleet (an estimated 50%) that are crewed exclusively by robots; no humanoids on board. The same applies to Altess missile systems and space fighters, all of which are operated by *robots*. Nowhere else in the Three Galaxies are machine intelligences so prevalent. This is a big deal, because the humans, their allies and many other races in the Three Galaxies are paranoid about the use of robots and artificial intelligences (A.I.s) and refuse to use them.

### Disposition of Fleets

Since the Altess are obliged to stay in their own star systems within the *Anvil Galaxy*, the small but formidable Armoria rarely leaves the confines of Altess space. The whole Armoria numbers 2,500 ships, with roughly 70% of these being sub-capital ships and shuttlecraft. The rest are smaller capital ships like the lovely and deadly *Zhokil battlecruiser*. Due to the nature of the Armoria, with the ships owned by various royal families and essentially “leased” to the government, it operates more like a *loose confederation* of small fleets rather than one large one. Armoria Fleet Command is based on Altess Prime, and the corridors and boardrooms of this building are well known as such a snake pit of politicking and backstabbing that they give the halls of the Capitol Building a run for their money.

The majority of the Armoria is stationed at **Altess Prime**. Here the fleet spends its time constantly orbiting and training and, above all, looking good. A ship or task force assigned to Altess Prime has been accorded the highest military honor, and families tend to do *anything* to get their ships in Altess Prime space. The second largest Armoria deployment is to the planet **Ramis**. While the ships around Altess Prime may be the flashiest and most favored, those stationed at Ramis have perhaps the best pilots and most capable warriors. They are tasked with keeping all non-Altess from setting foot on Ramis, and as such, are constantly in conflict, often armed conflict, with incoming curiosity seekers, spies and pirates. To help the Ramis forces with their mission, the Armoria has recently acquired *Gravitonic*

*Interdiction Field* technology from the Consortium of Civilized Worlds (CWW), and plans on deploying their own force of interdiction ships around this mysterious planet.

**The rest of the fleet** is spread around Altess space, conducting endless drills and constantly polishing their guns. These ships are constantly on the move, being sent hither and yon throughout the Anvil Galaxy at the whim of their owners or high-ranking Armoria officers.

## Altess Technology

Altess starships are luxurious by any race's standards. Guest quarters are huge, opulent rooms. Officer's quarters are even more so. Both the battlecruiser and the smaller destroyer feature gyms, swimming pools, saunas, and recreational VR immersion tanks. No matter where the Altess travel, be it for business or combat, they go in style. By contrast, the areas of the ship dedicated to robotic overseeing, such as the computer core, the engine rooms, and the cargo bays, are spartan in the extreme. After all, the robots and A.I.s that run these areas don't need a lot of space or luxury.

The Altess' advanced engine designs have never been sold to or copied by any other party, possibly because of the unique power systems employed by the Armoria. This is one reason why so many of the major power blocs in the Anvil Galaxy seek out the friendship of the Altess, in hope that someday, the Dynasty might decide to share some of their best kept secrets. (It hasn't happened yet.)

The weapons technology employed by the Altess fleets is also highly advanced, beyond nearly anything else in the Three Galaxies. There is a reason that the Armoria has never seen fit to build a vessel larger than a battlecruiser, they simply don't see the need to do so. Their weapons are so powerful and efficient that they typically outperform other weapons of similar class, allowing the Altess to essentially do more with less. While their ships and ship-class weapons technology is strictly "home-grown," the Altess buy the majority of their small arms, personal armor and other technological items from **Naruni Enterprises**. In fact, the Altess have developed a deep brand loyalty toward Naruni products, and they have become one of Naruni Enterprises' most favored customers.

**Armoria Missiles:** Every missile fired from an Armoria starship is a *smart bomb* with twice the range as their normal counterparts. From point defense mini-missiles to nuclear long-range missiles, each and every one has a K-HEX warhead with built-in robotic drone intelligence (+5 to strike, +4 to dodge, 2 attacks per melee).

**Armoria Cruise Missiles:** Called a *Nezsam torpedo*, these heavy-hitters are built more for speed and accuracy than pure explosive damage. Nezsams inflict as much damage as a *standard anti-matter torpedo*, but are driven by an advanced robotic targeting and maneuvering system. Each torpedo is +2 on initiative, +6 to strike, +8 to dodge, and has 4 actions per round.

**Power Systems:** Each Altess starship uses a power source not employed by anyone else in the Three Galaxies. They do not use anti-matter, but rather compressed quark nuggets, or so-called "Strange Matter." A quark nugget has 14 times the charge of a single proton, and 170 times the mass. By compressing it in a magnetic field, the Altess ships are able to tap un-

imaginable amounts of power. Quark nuggets are what allow for the potency of the beam weapons on board the *Yannar* and the *Zhokil*. They also allow the Altess ships to travel at speeds greater than seven light-years per hour.

**Magnetic Photon Arrays:** Powered by Strange Matter reactors, these energy beams are unique to the Altess Armoria. Dazzling purple in color, and with twice the range of comparable HI-Lasers, magnetic photon beams are designed to interfere with variable force fields. They do *double damage* to all kinds of energy shields, technological or magical, but inflict the listed damage when fired at any other kind of solid material (ships, planets, people, etc).

## Altess Armoria Ranks

The ranking system of the Armoria is also unique in the Three Galaxies. Even the largest crew on a *Zhokil* will never be more than 20 Officers (backed up by one hundred times as many *Advocate robots*). Furthermore, since the Altess are all effectively immortal nobles, every Armoria Officer begins with a rank equal to Lieutenant. How then does one determine a pecking order when everyone is a commissioned officer? By age and experience, of course.

<u>Altess Rank</u>	<u>Human Equivalent</u>
Imak	Admiral
Seenth	Captain
Tassit	Commander
Tialt	Lieutenant

If there are, say, five **Tialt** on board an Altess ship, the one with the earliest date of commission is the most senior one. Thus, someone can be **1st Tialt** on ship A, but if transferred to a different ship, might start all over again as **5th Tialt** on ship B.

A **Tialt** can be called to be a **Tassit**, but only if an **Imak** believes the Officer to be suitable for the position. However, Tassit is not an actual rank. While an Officer cannot be demoted from a rank, anyone can theoretically be a Tassit; they just have to stay on board the same ship long enough.

The first thirty years as Tassit are a kind of junior captaincy. After three decades, if one survives and distinguishes himself, he can be called to be employed in the rank of **Seenth**. Now this is a real rank.

Unfortunately, people only increase rapidly though the ranks in times of war, when commanding officers are killed and need to be immediately replaced. However, as the Altess have not actually gone into combat in over 800 years, the Armoria appears, to outsiders, to be composed of bored junior officers, lorded over by captains who are all at least 1000 years old. They are not far off in this assessment.

## Altess Armoria Uniforms & Colors

The standard Altess uniform for duty aboard ship is a stylish, form-fitting black jumpsuit with bright purple accents. It is a light M.D.C. material with 50 M.D.C. points of protection. It is reinforced at the knees, elbows, spine and lower back and additional armor is worn when actually leaving the ship, usually *Naruni* camouflage armor with a built-in super-heavy force field.



## A Notable Armoria Facility

### Armoria Central Robot Repository

#### Novus IX, Anvil Galaxy

Nine millennia ago, during the final days of the *Altess Atrocity*, the mad scientist *Jurgo Kilter* was forced to fall back to his primary labs and strongholds on this bleak and unforgiving world. **Novus IX** had been an excellent place for him to set up his multiple *research stations* and *extermination camps*. Already, nearly six billion of his fellow Altess had met their fate at his hands, and in his quest to unlock the combined genetic memory of the Altess, Kilter had collected and analyzed DNA samples from each and every one of his victims. Kilter had spent decades refining and researching ways to instill the Altess' knowledge of the *Cosmic Forge* into himself, and thus became an unparalleled expert in genetics and DNA recombination. Some have even suggested he was in league with the *Threshold Genetech*, so great was his expertise with genetic manipulation. Kilter became the first Altess to refine his own genetic code so that he became an M.D.C. being, with Supernatural Strength and a life span of nearly 1000 years.

When he was finally defeated and slain, the combined armies of the Altess Royal Families ransacked his main base of operations on Novus IX. Using the "blood knowledge" from Kilter's own files and twisted experiments, the Altess re-engineered their race to become the graceful and handsome beings they are today. However, in addition to his scientific facilities, Kilter had also built a vast array of *weapon factories* and *storage warehouses* at various locations all around the planet.

Despite the atrocities, the Royal Families could not bring themselves to eradicate all of Kilter's ingenious creations. Instead, they told themselves that they could use his works to do good for the remainder of their race. A special force of soldiers, volunteered from each of the Great Houses, was left behind on the planet to safeguard everything. This was the founding act of the modern Armoria.

Today, Novus IX is an indispensable part of the Dynasty. Not only is it the main training world for Armoria Officers, but it contains weapon factories and city-sized warehouses filled with robots and materiel. Given the Altess preference to pay off enemies and win conflicts through "economic smothering," most of Kilter's original designs, experimental weapons and other inventions have not seen the light of day in centuries. Still, at the heart of the Altess psyche, there is a cold realization that they are a dying race, and they do not plan on becoming extinct for lack of being able to fight. While it is true that most of the planet is filled with excess Naruni gear, the Armoria also stores weapons of their own design on Novus IX, such as the *Advocate Robots*, *advanced missile drones*, and *advanced shipyards* to build both the *Yannar* destroyer and the *Zhokil* battlecruiser. In fact, at last count, there was enough hardware on Novus IX to field a force of over 3 billion men!

And that's the problem.

The planet is slowly but surely generating a massive chronol distortion deep within its core. At some point in the foreseeable future (1D6 years), the entire planet will be shifted in time, and the Altess Dynasty will be dealt a crippling blow. Such an event would reduce the Armoria's strength by nearly 70%. Only ships

and officers on assignment elsewhere in the Dynasty would be spared. The Dynasty would be left nearly defenseless until the Altess could replace their losses. Such a disaster is a perfect opportunity for any number of galactic powers to attack. Possible aggressors include the newly outfitted Golgan Argosy, the Splugorth of Rynncryyl, and the Transgalactic Empire. In order to defend themselves, the Altess will have to either quickly join the CCW (meaning that the Consortium will have to fight whomever comes gunning for the Altess), or they will have to liquidate some assets and hire a mercenary force the likes of which has rarely been seen.

Unfortunately, the "Altess Problem," whereby the Dynasty's finances tie heavily into the economies of the other power blocs, means that should the Altess suddenly need huge amounts of cash with which to hire protection and buy more armaments, the Anvil Galaxy could be plunged into a deep and long-lasting recession.



## A Notable Armoria Commander

### Jelko Rodula, Weapon Designer

#### Harker's Enclave, somewhere in the Anvil Galaxy

Although never an Officer, Jelko Rodula must have special mention whenever discussing or studying the Armoria. Rodula was a weapon designer, and very possibly one of the most intelligent Altess to ever live. His active career spanned nearly 2,800 years, during which he built nearly every weapon design currently in use by both the Altess and the Naruni. He is most famous for building the Rodulan Accelerator (see **Anvil Galaxy**,

page 115) and for his pioneering work with Strange Matter. He even sat on the NE Board of Directors for several centuries. Jelko Rodula was known for his attitude as much as his accomplishments. He was an eccentric genius who believed that his weapons should be works of art, pleasant to behold, and was responsible for the smooth-flowing lines that are the hallmark of Naruni Enterprises.

However, Rodula is most famous for being the only Altess to ever declare *bankruptcy*. Ten years ago, he liquidated all of his known assets and vanished without a trace. The Armoria, fearful of losing his bloodline, have standing orders to find him and drag him back to Altess Prime by any means necessary. The reasons for his disappearing act are unknown to everyone but Rodula, and perhaps some of the top executives at the Hartigal Combine, but they are being tight lipped about it.

**Here's Rodula's story:** In 9990 TE, Jelko's good friend, *Lester M'Kri*, found himself in desperate trouble with Naruni Enterprises. M'Kri had been a designer for the super-corporation, but had left to found his own line of weapons and military systems. His company, *M'Kri Hardware*, was instantly set upon by endless hordes of Naruni lawyers who sued the poor man into oblivion. At the end, M'Kri apparently committed suicide, though many suspected he was "cashed out" by *Naruni Repo Bots*.

Rodula went into a deep depression when he received the news. It was bad enough that he and some fellow Altess owned a majority of the bankrupt company, but it was the death of his good friend, Lester M'Kri, that crushed Jelko's spirit. He couldn't help thinking that his friend died needlessly. M'Kri had shared Jelko's stylistic flair, as could be seen in the statuesque form of the Avenger A-1; his flair and inventiveness would be sorely missed. After a long period of brooding, Rodula finally decided that both the Altess and Naruni had to be made accountable for their actions. He cashed out everything he owned (which caused a three week-long slump on the galactic stock exchange), and filed papers for personal bankruptcy. Then, Jelko boarded a ship of his own design and went to *Harker's Enclave*. He then personally bankrolled the creation of the **Hartigal Combine**, determined to create a company that would hurt his enemies right where it counted: in the pocketbook.

There are rumors that Rodula is assembling a fleet of advanced starships based on Altess designs with the purpose of destroying the Naruni blockade at *Gandon Point* (see **Anvil Galaxy**, page 104). If fighting does break out, the Armoria will be called in to drag Rodula home. Whether or not they get involved in an all-out war between Naruni Enterprises and their competition depends on the Seenth who gets the job.

## Jelko Rodula – Quick Stats

**Alignment:** Anarchist.

**O.C.C. & Experience Level:** 15th level Altess Operator.

**Attributes:** I.Q. 30, M.E. 19, M.A. 15, P.S. 12, P.P. 17, P.E. 20, P.B. 17, Spd 21.

**Hand to Hand:** Basic.

**Special Powers:** Standard psionic powers for the Operator O.C.C.

**Notes:** Rodula's prototype attack ships, the *Guardian* and the *Defender*, are heavy cruisers with many experimental arma-

ments. These include Strange Matter Torpedoes (8D6x100 M.D.) and pulse HI-Lasers. The ships are coated with reactive armor (about 45,000 M.D.C. worth), and take half damage from kinetic and explosive attacks. There are only the two of them *so far*, with an average construction cost of 8 billion credits apiece. They each have a crew of 75.

# Notable Ships of the Altess Armoria

## Altess *Yannar*-Class

### Destroyer

The *Yannar*-class Destroyer Escort is one of the most lethal sub-capital ships in the Three Galaxies. Sleek and graceful with a silhouette reminiscent of a raptor in flight, the *Yannar* carries a potent mix of Altess magnetic photon arrays and K-HEX smart missiles that make these ships a terror for pilots of fighters and shuttlecraft. Like all Altess ships, the *Yannar* is luxuriously appointed and over-engineered by a factor of at least two. This means this relatively tiny ship can out-fly, outshoot and outlast nearly any other ship of its class.

**Model Type:** Destroyer Escort (A-DDE-Mk. II).

**Class:** Yannar Class.

**Ship's Complement:**

Ship's Crew: 200 total (50 Altess and 150 Advocate robots).

Bridge: Ship's Captain (1), Ship's Executive Officer (1), Helm (2), Navigation (2), Comms and Sensors (3), Security (2 Advocate robots and carrying NE-300 Stutterers).

Combat Information Center (CIC): Altess Tassit (1, in charge of ship's air wing and weapons co-ordination), Military Advisory Team (4), Comms (5), Ship's Weapons and Fire Control (5), Security (2 Advocate robots carrying NE-300 Stutterers).

General Operations: Engineering (10), Medical (20), Flight Operations (8), Ship's Security (30), Internal Communications (15), General Ops Robots (89).

Embarked Troops: 12 Advocate robots programmed as pilots. *Yannar*-class destroyers also carry 120 Advocate robots in deep storage. These robots are equipped with the best that Naruni Enterprises can offer, and are used mainly to repel boarders or deploy as spies or commandos.

**Aerospace Group:**

FB-49 "Fire-Eater" Attack Ships: 6

**M.D.C. by Location:**

Interior Bulkheads per 10 feet (3 m) – 50

Interior Hatches – 65 each

Exterior Hatches – 110 each

Magnetic Photon Arrays (10) – 200 each

Mini-Missile Launchers (8) – 150 each

Main Engines – 6,000

\* Forward Hull Section (1/3) – 2,000

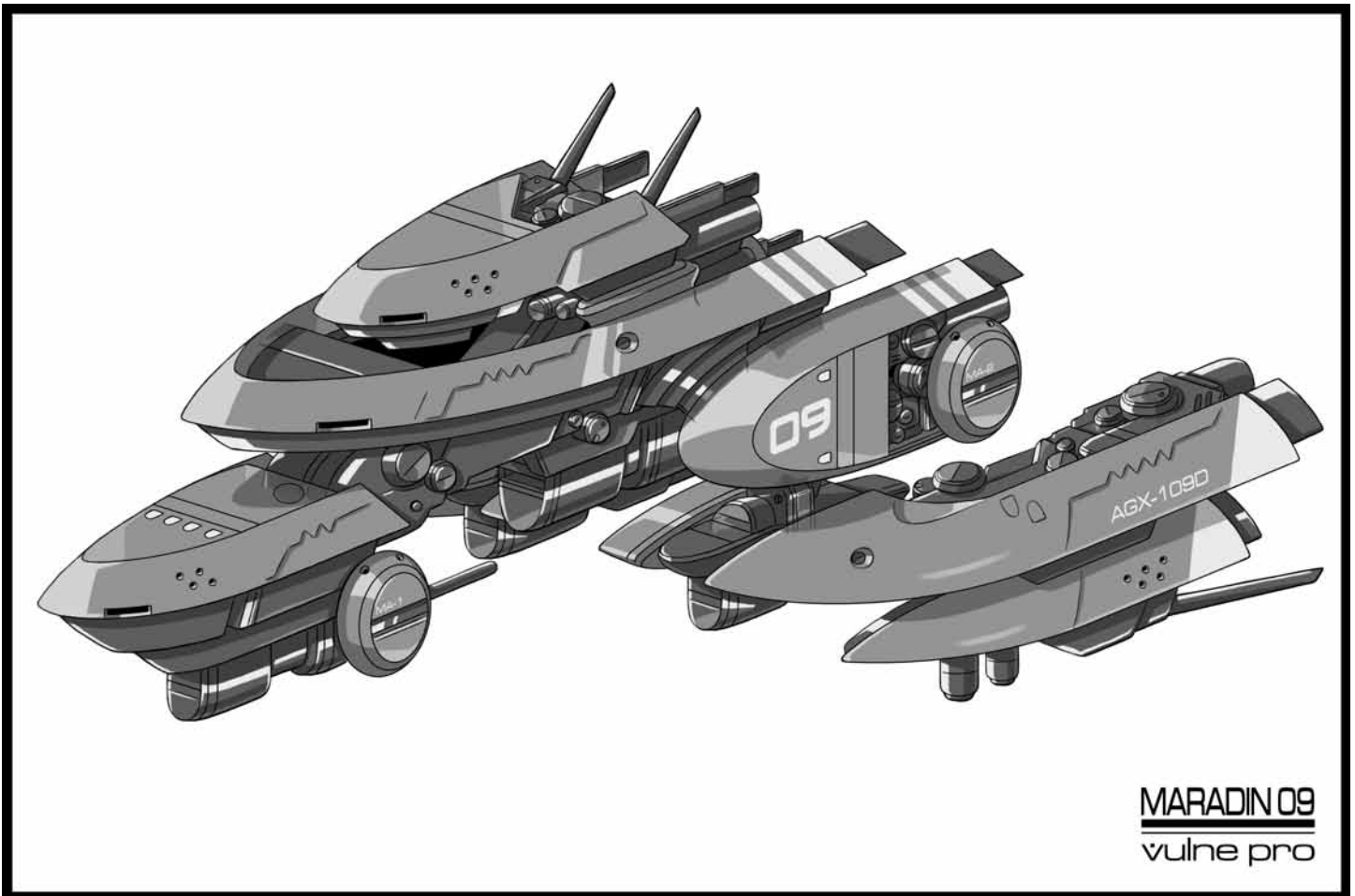

**MARADIN 09**  
vulne pro

\*\* Midships Hull Section(1/3) – 2,000

\*\*\* Aft Hull Section (1/3) – 2,800

\*\*\*\* Hull per 40 feet (12.2 m) – 150

Variable Force Field – 2,000 per side (12,000 total)

\* Destroying the Forward Hull Section will destroy the bridge and primary comms and sensor suite. The ship can still be flown and fought from engineering, but all sensor ranges are reduced by half.

\*\* Destroying the Midships Hull Section will destroy engineering and the majority (75%) of the ship's weapons.

\*\*\* Destroying the Aft Hull Section will destroy the engines and reactor, setting the ship adrift.

\*\*\*\* Punching holes in the hull will cause the damage control system to automatically seal off whatever compartment has been exposed to vacuum.

#### Speed:

Atmosphere: Sleek and aerodynamic, Yannar-class destroyers are very capable in atmosphere. 3,805 mph (6,088 km or Mach 5).

Sub-Light: 13,698 mph (21,917 km or Mach 18).

FTL: 8 light-years per hour.

Range: Limited only by supplies. The compressed quark matter reactors carry enough fuel to operate the ship at full readiness for 300 years, but shipboard stores are only good for twelve months of constant deployment with full crew and complement.

#### Statistical Data:

Length: 480 feet (146.3 m).

Height: 95 feet (29 m).

Beam: 230 feet (70 m).

Mass: 7,500 tons.

Power System: One Ateess AA-90 Compressed Quark Matter Reactor powering two banks of three-nozzle AAS sub-capital thrusters.

Cargo: Up to 2,000 tons of cargo, in addition to standard complement of stores and ammunition.

Market Cost: 4.5 billion to construct.

#### Weapon Systems:

**1. Magnetic Photon Array (10):** Mounted five to a side, port and starboard, along the center line of the ship, these weapons make up half of the Yannar's anti-fighter weapon systems. They are rapid-fire, high-intensity photon beams that hit incredibly hard and can chew up a squadron of fighters in a relatively short amount of time.

Primary Purpose: Anti-Fighter.

Secondary Purpose: Anti-Missile.

Weight: Not applicable, part of the ship's hull.

Range: 30 miles (48 km) in space, 5 miles (8 km) in an atmosphere.

Mega-Damage: 4D6x10 M.D. per burst.

Rate of Fire: Equal to the gunner's number of attacks.

Payload: Effectively unlimited.

Bonus: These weapons are +4 to strike fighters and small ships.

**2. Mini-Missile Launchers (8):** The other half of the Yannar's anti-fighter systems, these rapid-fire missile turrets can saturate an area with smart missiles in a matter of seconds.

Primary Purpose: Anti-Missile.

Secondary Purpose: Anti-Ship.

Weight: Not applicable, part of the ship's hull.

Range: 2 miles (3.2 km).

Mega-Damage: 1D6x10 M.D. per K-HEX missile.

Rate of Fire: Singly or in volleys of 2, 4 or 8 missiles.

Payload: 128 mini-missiles per turret (1,024 missiles). There are two additional complete reloads in storage, which can be changed out by the Advocates within four minutes.

Bonus: Altess mini-missiles are smart missiles, and are +5 to strike.

**3. Ship's Systems of Note:** Tactical life support, escape pods for all Altess, launch and recovery systems for aerospace fighters.

## Altess Zhokil-Class Battlecruiser

The Zhokil battlecruisers have been described by one CCW envoy as "the largest armored limousines in the universe." This description, while certainly tongue-in-cheek, is not far from the truth. The largest ships currently fielded by the Armoria, Zhokil-class battlecruisers, are both lethal and handsomely appointed. The quarters of the Zhokil rival the finest hotels and resorts of

the Three Galaxies, and oftentimes, this ship class is used to host business delegates and foreign ambassadors. Its soft lines, dark coloring, and glowing purple highlights make it a vessel both beautiful and deadly.

Zhokil are fast and incredibly agile for capital ships. Their weapons are extremely powerful and well balanced, giving the ship the ability to not only easily handle sub-capital ships, but to punch well above its weight and present a credible threat to larger capital ships like battleships and carriers. As is typical among Altess ships, Zhokil are the perfect example of the "more with less" design theory espoused by the Altess, and is easily the equal, the Altess would say better, of any capital ship fielded by the CAF or TGE.

**Model Type:** Battlecruiser (A-BC-Mk. X).

**Class:** Zhokil Class.

**Ship's Complement:**

Ship's Crew: 275 total (20 Altess and 255 Advocate robots).

Bridge: Ship's Captain (1), Ships Executive Officer (1), Helm (2), Navigation (2), Comms and Sensors (3), Security (6 Advocate robots carrying NE-300 Stutterers).

Combat Information Center (CIC): Altess Tassit (1, in charge of ship's air wing and weapons co-ordination), Military Advisory Team (4), Comms (5), Ship's Weapons and Fire Control (5), Security (6 Advocate robots wearing light Naruni combat armor and carrying NE-300 Stutterers).

General Operations: Engineering (10), Medical (20), Ship's Security (30), Internal Communications (15), General Ops Robots (164).

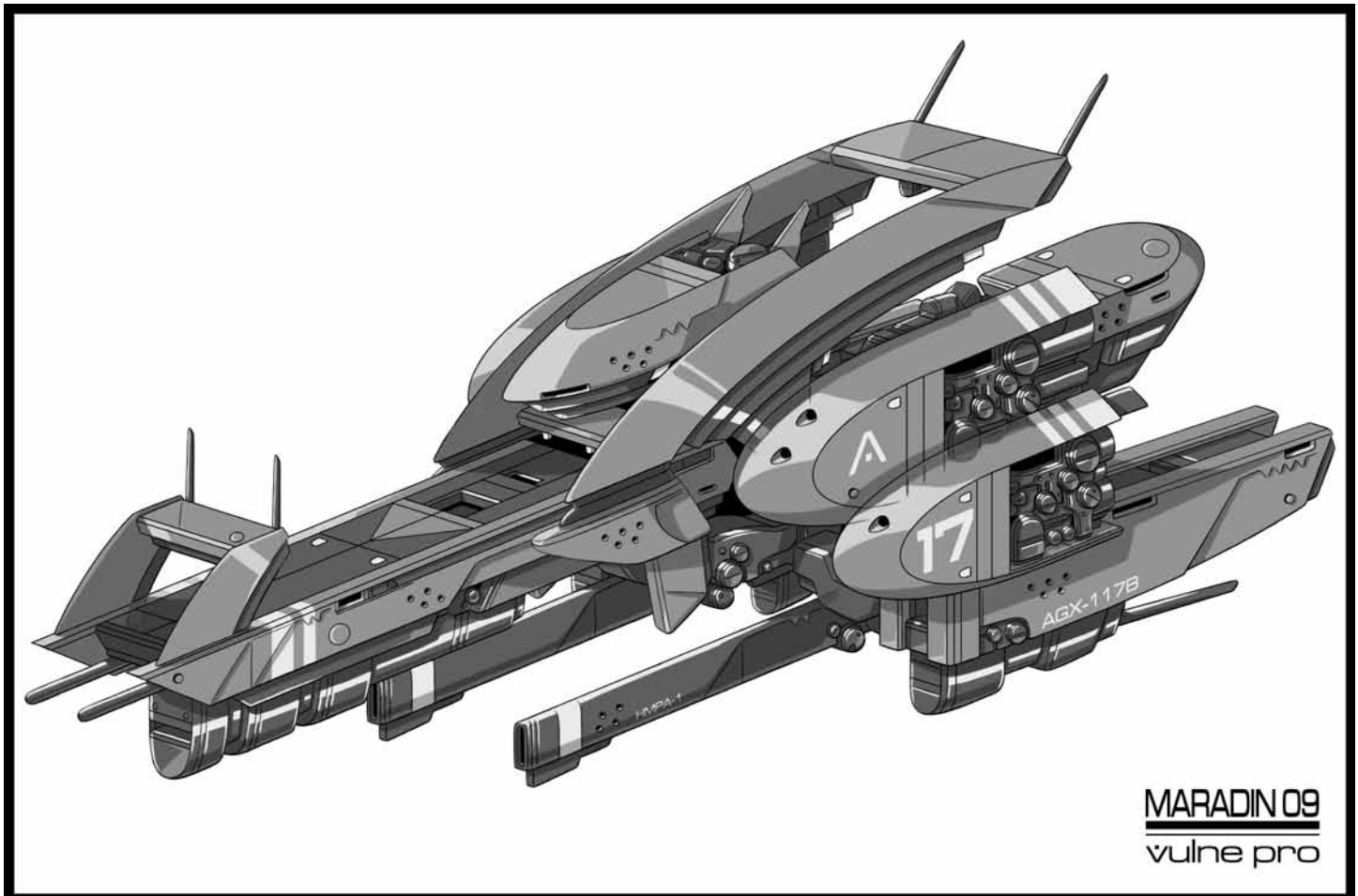

Embarked Troops: 2,500 Advocate robots programmed as Marines and equipped with the finest NE gear.

### **M.D.C. by Location:**

Interior Bulkheads per 10 feet (3 m) – 50

Interior Hatches – 65 each

Exterior Hatches – 110 each

Heavy Magnetic Photon Arrays (2) – 12,000 each

Magnetic Photon Arrays (16) – 200 each

Torpedo Launchers (8) – 800 each

Short-Range Missile Launchers (32) – 250 each

\* Forward Hull Section (1/3) – 27,000

\*\* Midships Hull Section(1/3) – 27,000

\*\*\* Aft Hull Section (1/3) – 34,000

\*\*\*\* Hull per 40 feet (12.2 m) – 150

Variable Force Field – 12,000 per side (72,000 total)

\* Destroying the Forward Hull Section will destroy the bridge and primary comms and sensor suite. The ship can still be flown and fought from engineering, but all sensor ranges are reduced by half.

\*\* Destroying the Midships Hull Section will destroy engineering and the majority (75%) of the ship's weapons.

\*\*\* Destroying the Aft Hull Section will destroy the engines and reactor, setting the ship adrift.

\*\*\*\* Punching holes in the hull will cause the damage control system to automatically seal off whatever compartment has been exposed to vacuum.

### **Speed:**

Atmosphere: Despite its size, the Zhokil can manage a respectable 4,185.5 mph (6,696.8 km or Mach 5.5).

Sub-Light: 15,220 mph (24,352 km or Mach 20).

FTL: 8 light-years per hour.

Maximum Range: Limited only by supplies. The compressed quark matter reactors carry enough fuel to operate the ship at full readiness for 300 years, but shipboard stores are only good for thirty-six months of constant deployment with full crew and complement.

### **Statistical Data:**

Length: 2,100 feet (641 m).

Height: 670 feet (204.2 m).

Beam: 1,870 feet (570 m).

Mass: 4.3 million tons.

Power System: Two Altess AA-90 Compressed Quark Matter Reactors powering two banks of three-nozzle AAS capital thrusters.

Cargo: Up to 500,000 tons of cargo in addition to standard supplies.

Market Cost: 28 billion to construct.

### **Weapon Systems:**

**1. Heavy Magnetic Photon Array (2):** These massive cannons are the Zhokil's primary anti-ship and anti-installation weapons, and are typically used against *space stations* and *larger capital ships* like carriers. They are fixed forward, can de-

liver incredible amounts of energy to a target and can usually drop an enemy's shields in two or three volleys.

Primary Purpose: Anti-Ship.

Secondary Purpose: Anti-Installation.

Weight: Not applicable, part of the ship's hull.

Range: 250 miles (400 km) in space and 50 miles (80 km) in an atmosphere.

Mega-Damage: 2D6x1,000 M.D. each or 4D6x1,000 M.D. for a combined volley.

Rate of Fire: Once per melee.

Payload: Effectively unlimited.

**2. Magnetic Photon Array (16):** Similar to the MP arrays on the Yannar, these secondary cannons give the Zhokil an incredible punch against larger capital ships, and can hull smaller sub-capitals in just a few volleys.

Primary Purpose: Anti-Ship.

Secondary Purpose: Defense.

Weight: Not applicable, part of the ship's hull.

Range: 32 miles (51.2 km) in space, or 10 miles (16 km) in an atmosphere.

Mega-Damage: 3D6x100 M.D. each.

Rate of Fire: Each array may fire up to 3 times per melee round.

Payload: Effectively unlimited.

**3. Nezsam Torpedo Launching System (8):** Mounted three to a side and two forward on the ventral side of the bow, these launchers deliver the powerful Altess Nezsam torpedoes. These weapons alone allow the Zhokil to tangle with, and easily outpunch, ships twice their size.

Primary Purpose: Anti-Ship.

Secondary Purpose: Anti-Installation.

Weight: Not applicable, the launchers are part of the ship's hull. Each torpedo weighs 10 tons.

Range: 1,000 miles (1,600 km).

Mega-Damage: Anti-matter warheads do 4D6x100 M.D. each.

Rate of Fire: Singly or in volleys of 2 or 4.

Payload: 100 Nezsams per launcher. An additional 1,600 torpedoes are held in armored magazines for ease of reloading.

**4. Short-Range Missile Launchers (32):** These recessed turrets are used for point defense against enemy fighters, for hulling craft that attempt to board, and to shoot down incoming cruise missiles.

Primary Purpose: Anti-Fighter.

Secondary Purpose: Anti-Missile.

Weight: Not applicable, the launchers are part of the ship's hull. Each missile weighs around 400 pounds (180 kg).

Range: 10 miles (16 km).

Mega-Damage: 2D6x10 M.D. per K-HEX missile.

Rate of Fire: One at a time, but usually in volleys of four or eight.

Payload: Each launcher carries 16 missiles at the ready, with an additional 32 in an armored magazine. The ship carries four reloads.

**5. Ship's Systems of Note:** Tactical life support, escape pods for all crew, IFF/command and control systems.



# Consortium of Civilized Worlds Consortium Armed Forces

The Consortium Armed Forces (CAF) is the largest collective space fleet in the recorded history of the Three Galaxies. The Consortium of Civilized Worlds (CCW) is, itself, made up of 231 different spacefaring races, and consequently there is no set design or united theme for their ships. Instead, the influences of the founding races can be seen in several of the CAF's ships.

For example, the *Scorpion Attack Fighter*, the CAF Assault Shuttle, and the *Warshield* are very obviously of human design; they are square, chunky constructions with no aerodynamics or sleek outlines. *The Scimitar*, the *Black Eagle Fighter*, and the *Explorer* are heavily influenced by *Noro* building techniques. The Hunter-class Destroyer and the *Packmaster Carrier* are clearly Wulfen in nature.

The only real collaboration between the founding members was the construction of the *Protector*-class battleships, whose unique shape shows elements of all three races' shipbuilding abilities. It was assumed that from now on, all new CAF ships would be of similar shared design, but the unveiling of the *Emancipation*-class Super Carrier has shown that the *Human Alliance* is either acting on its own behalf, or trying to cement control of the Consortium. Only time will tell.

## CCW Disposition of Fleets

Half of the Consortium of Civilized Worlds's space fleet is dedicated to *non-combat* profiles. These ships are used by the *Discovery Corps* for exploration of the Three Galaxies and peaceful first contact with new species. While these ships are still heavily armed with HI-Lasers, missiles and rail guns, their crews are not comprised of soldiers, but rather of Fleet Officers, CAF Scientists, and even Colonists. The Discovery Corps uses sub-capitals exclusively.

The other half of the fleet, some 19,000 capital ships and 193,000 sub-capitals, are designated ships of the line. These ships are broken down into three Task Forces, one for each galaxy. The Task Forces are then further divided into Battle Groups, with one Group per each sector of Consortium space.

Since a "sector" is a spatial cube 500 light-years to a side, the *Corkscrew Galaxy* has many more ships than the tiny *Anvil Galaxy*. In fact, the Corkscrew is patrolled by 240 Battle Groups, two of which are permanently stationed within the Human Alliance. The *Thundercloud Galaxy* has 48 Battle Groups, while the Anvil has only 13.

The problem with the CAF Fleet is that even with all its tens of thousands of starships, it is still spread very thin. The CAF is so big that the Admiral of the Fleet can never be sure where all of its ships are at any one time. This leaves many critical decisions in the hands of *Sector Admirals* who, although encouraged to take the initiative, may not always have the best grasp on big-picture galactic politics. The Consortium was formed as a direct answer to the expansionist Kreeghor Empire, and the threat of war is ever present. All that is needed is for one misguided, but well meaning officer to take matters into his own hands and the Three Galaxies (or some sector of it) could be plunged into chaos.

## Consortium Ship Technology

The Consortium Armed Forces (CAF) have fairly advanced starships. Some races might have greater force field capabilities, and others may have incredible weapon range, but overall, CCW vessels are even across the board. This is mostly thanks to the numerous different races in the CCW and their influence on shipbuilding technology. The ships of the CAF are generally of better quality and have better fit and finish than their counterparts in the Transgalactic Empire (TGE), though not all of them are ships of war.

The one area where the CAF might be said to be *behind* the tri-galactic average is in *starship computer control*. Since humans have power over the Consortium Congress, they dictate just how smart the machines are that go into each and every ship of the line, and humans like their computers dumb and basic. This is not to say that starship A.I.s are slow in terms of informational processing speed or storage capacity, far from it. It is

just that living in the aftermath of the **Automaton Wars**, the *Human Alliance* has vowed to *never* give machines the chance to lord over them again. And that means no self-aware, super-intelligent A.I.s capable of learning.

In game terms, there are really no negative modifiers to be applied to CAF ships. Game Masters should just keep in mind that the main computer core of any Consortium vessel will be markedly inferior to many others in the Three Galaxies. It will not be able to formulate a *theory* out of bare facts, and it most certainly will not be able to run the ship in the event the crew is killed or incapacitated.

## CAF Ranks

The ranking system of the Consortium Armed Forces (CAF) can be a bit confusing. This is because it tries to combine the traditions of over 200 species into one, coherent fleet. However, since humans are still the dominant force within the CAF, the Noro, Wulfen, and Seljuk have largely abandoned their own ranks and commonly go by the human equivalent.

<u>Fleet</u>	<u>CAF Marine Corps</u>	<u>Monthly Pay</u>
Captain-General	—	25,000 per month
Captain	General	16,000 per month
Commander	Colonel	8,000 per month
Lieutenant Commander	Major	5,500 per month
Lieutenant	Captain	3,500 per month
Ensign	Lieutenant	2,800 per month
Petty Officer	Sergeant	2,000 per month
Specialist	Corporal	1,800 per month
Recruit	Private	1,700 per month

The supreme command of the CAF lies in the hands of the **Admiral of the Fleet**, which is a governmental position within the office of the Consortium Prime Minister. Beneath him is a confusing array of Admirals, Vice Admirals, Rear Admiral Upper Halves, and Rear Admiral Lower Halves. Each of the Galactic Task Forces is commanded by a **Grand Admiral**. Each group within that Task Force will be headed up by a panel of regular Admirals. As with most things, the CAF drowns in its own bureaucracy.

Inside a Consortium starship, there is further confusion between the officers who command and pilot the ship and the many CAF Marine Troopers who might also be on board. As a rule, these two branches just stay out of each other's way. The notable exception is the rank of **Captain-General**, which is unique to the CCW and its Fleet. A Captain-General has ultimate authority over *all* personnel aboard his ship, both Fleet and Marine Corps. This rank has replaced that of Commodore, and is usually only given to a Captain who is in charge of an armada of ships. Even a Marine General must yield to the authority of a Captain-General.

## CAF Uniforms and Colors

The enlisted men and women of the fleet wear “working blues” consisting of either a hard wearing work shirt and pants bloused into combat boots or coveralls. Their name is displayed on their chest above their left breast pocket, and their rank is

displayed on their collar. The shirts are typically either gray or light blue, and the pants are dark blue. Coveralls are color-coded by job. There is an enlisted dress uniform that consists of a uniform similar to the Fleet Officer's uniform save that the jacket is blue with white trim and of a slightly different cut.

Officers of the Consortium Fleet wear a two piece uniform consisting of a long, single-breasted jacket and pants. The pants are bloused into comfortable, knee-high boots and the jacket is cinched at the waist by a pistol belt. Officers jackets are white with dark blue trim, and the pants are dark blue. Name and commendations/medals are displayed on the left breast, and rank is displayed on the collar. Gloves are issued with this uniform, but they are rarely worn.

Officers have a dress uniform that resembles their standard uniform, except that both the jacket and pants are white, and the pants have a blue stripe down the leg. This is the uniform that officers wear to official functions and photo opportunities, and usually displays all of the officer's commendations and is accessorized with a short cape and a ceremonial saber.

CAF Marine enlisted men and officers both wear a two piece combat utility uniform with a utility/pistol belt and combat boots. The trousers are bloused into the boots, and the jacket's sleeves are cuffed over the elbows. These uniforms come either in dark gray for ship duty, or in a variety of camouflage for different environments. The marine's name is displayed over his left breast pocket, and rank is displayed on the collar. Marines have a dress uniform in dark gray and blue with red trim that resembles the CAF officer uniform.

## A Notable CAF Facility

### Ryan's Landing

#### Planet Goldielox, Corkscrew Galaxy

**Goldielox** was the first extra-solar planet colonized by humans, first settled over 4,000 years ago. Covered by vast, shallow oceans and tropical islands, it was an unheard of miracle for mankind to find so habitable a planet right in their own backyard. Goldielox was named, jokingly, by astronomers who found the planet to be “just right” – just the right distance from its star (not too hot, not too cold, just right), just right for human habitation and colonization, and just right for the Human Alliance's needs at the time.

It was once home to a wide array of marine life, but the low depth of the world's oceans made it easy to set up huge mining facilities on the seabed, and most of the sea life was killed or irreparably harmed by industrial pollution. The capital city, *Ryan's Landing*, became the launching pad for an even greater push out into the *Corkscrew Galaxy*. Incredible shipyards were built in orbit, connected to mines and refineries below by means of titanic space elevators. By the beginning of humanity's fourth millennium in space, Goldielox produced nearly 25% of all spacecraft in the Human Alliance.

The planet suffered horribly during the **Automaton Wars**. When the computer mainframe, Network, assumed control of Terra Prime, it next set its sights on its nearest neighbors. Network uploaded itself into a tachyon data packet, and arrived in the Goldielox central computers within two and a half minutes (the system is only four light-years from Terra Prime).

Goldielox Network then took complete control of the factories, the mines and the shipyards. It killed most of the humans, and then began retooling the planet to make robotic starships that would carry on its mission of domination to the rest of the human colonies. Then it sent a copy of itself to the next-nearest human world and infected those computers as well. The entire Human Alliance, 1,000 light-years across, was taken over by Network in the span of 10 hours.

Mankind fought back, and the wars against Network lasted over two hundred years, and devastated as many worlds as they liberated. The fighting for Goldielox was especially brutal, since the system was so heavily fortified, and the human rebels wished to capture the construction sites for use in the final assault to retake Terra Prime. In the end, prolific use of low-yield nuclear weapons destroyed the machines, but poisoned the planet as well. Today, the oceans of Goldielox are all but dead, their once emerald color now a rusty brown.

Goldielox is still the largest single production center in the Consortium of Civilized Worlds (CCW). The orbital shipyards of Ryan's Landing are equal to a city-sized space station (see **Dimension Book 6: The Three Galaxies**, page 8), and are capable of fixing and/or building up to 800 ships at a time. The planet itself is one of the most heavily defended worlds in the Consortium, second only to Terra Prime. At any given time, there are at least 42 *Protector*-class battleships, 300 *Warshields*, and 2 *Emancipation*-class dreadnoughts in orbit, or within the system.

## A Notable CAF Commander

### Captain-General Horace Shaw

#### Altess Dynasty, Anvil Galaxy

Horace Shaw is a man out of time. He is a capable leader of men, an excellent strategist, but is handicapped by the fact that the Consortium that he faithfully serves has not gone to war in over five centuries. Indeed, even though the CCW fought the Transgalactic Empire (TGE) Armada 20 years ago in the Anvil Galaxy, the action was kept low-key and limited for fear of igniting a full-scale conflict. It has been Consortium policy since the *First Great War* against the Kreeghor the TGE to avoid a total war scenario at any cost.

Commander Captain-General Shaw, who can trace his heritage back to those who fought against the machines in the *Automaton Wars*, has on several occasions, claimed that this course of action is producing a weaker CCW rather than a stronger one. There is now no one in the entire CAF who has seen mass combat, leaving the Fleet with a disturbing lack of veteran commanders and captains. Shaw has made numerous public statements on this matter, but sadly, they have been mostly dismissed as reactionary and warmongering. Finally, embarrassed by this "raving old man", Fleet Command sent him to patrol the one sector of space where he was certain not to get himself into any trouble – *The Altess Dynasty*.

Although not currently part of the Consortium of Civilized Worlds, the CCW would dearly love to have the Altess back in the fold one day. The CCW maintains a small fleet near Altess Prime just in case they should have to come to the Dynasty's rescue. This has never happened, and is impossible to imagine



ever happening, making this assignment the closest thing to exile that the CAF Fleet can come up with. Even if Altess Prime were attacked by an especially audacious enemy, the Altess would simply buy them off, or failing that, annihilate them with the robot armies of the Armoria.

Captain-General Shaw is fully aware that he has been swept under the political rug, but as an officer, he carries out his duty with honor and efficiency. His tiny fleet – one *Protector*, *CSS Restoration*, 4 *Packmasters*, 10 *Warshields*, and 30 *Scimitars* – keeps tabs on everything happening within 500 light-years of the Altess homeworld. They have seen no action in the two years since Shaw arrived, as was expected.

The joke may soon be on the CAF, however. **The Golgan Argosy**, newly refitted thanks to their *Tachyonic Antitelephone*, have set their sights on Altess Prime. They seek revenge for the last rebuffing the Altess gave the Republik some 300 years ago. *Gaus Binjo* is certain that with correct timing, the Altess Dynasty can be crippled and captured. As for the Armoria, while it is true that they have tens of billions of robotic defenders to unleash, most of these robots are in storage on Novus IX. Unknown to nearly everyone, the entire world is about to disappear in a chonal distortion (see **Anvil Galaxy**, page 116), breaking the backbone of the Armoria in one flash of light. When that happens, the Gulgans will see that the time is right, and attack the Dynasty. The Gulgans cannot be bought or bargained with, and the Altess will have no other choice but to call for assistance. Captain-General Shaw, ever ready for war, will be put in charge of the defense of one of the most valuable pieces of real



estate in the Anvil Galaxy, and lead the charge into the first real war the Consortium has seen in centuries.

## Horace Shaw – Quick Stats

**Alignment:** Principled.

**O.C.C./Experience Level:** 14th level CAF Fleet Officer.

**Attributes:** I.Q. 15, M.E. 11, M.A. 20, P.S. 18, P.P. 11, P.E. 13, P.B. 13, Spd 11.

**Hand to Hand:** Expert.

**Notes:** Horace Shaw is a fairly average-looking human in his mid-120s, though he looks to be in his 50s. Although on the political outs, he is charming, a natural leader, a skilled strategist and tactician, and can be quite persuasive in his arguments. He's on the outs within the CAF military because Captain-General Shaw pressed his unpopular opinion and pushed the wrong people. A man of high principle, Shaw is convinced he did the right thing and has no regrets.

The Captain-General has a thick handlebar mustache, a shaved head and a cybernetic right eye. He enjoys brewing his own alcohol and has turned one of his ship's cargo bays into a distillery. His only family, a great-granddaughter named Alicia, lives with him on board the *Restoration*. She is 15, having come to live with the Captain-General two years ago when her parents died.

# Notable Ships of the Consortium Armed Forces

## CAF *Araneae*-Class

### Interdictor

The Araneae-class Interdictor is a new style of ship recently encountered in the Galaxies. Smaller than the Protector-class battleship, but with a similar silhouette, the Araneae was designed to carry the newly developed Gravimetric Interdiction Field Generator. The *I-Field Generator* creates a heavy gravity well centered around the ship that allows the Araneae to temporarily disable the FTL drives of other nearby spacecraft. Araneae battlecruisers are incredibly fast for a capital ship, and with their I-Field Generators and thick armor, they excel at raiding, space blockades, and anti-piracy missions, but also perform well as troop and cargo haulers.

**Model Type:** Interdiction Battlecruiser (BCI).

**Class:** Araneae Class (Air-ay-nay).

**Ship's Complement:**

Ship's Crew: 1,673 (502 officers, 1,171 enlisted).

Bridge: Ship's Captain (1), Ship's Executive Officer (1), Helm (5), Navigation (5), Comms/Sensors (10), FTL Ops (10), Security (10 CAF Security Corpsmen in light CAF battle armor and armed with HI-50 laser rifles).

Combat Information Center (CIC): Interdiction Systems Officer (1), Interdiction Systems Ops (15), Comms (10), Ship's Weapons and Fire Control (15), Security (10 CAF Security

Corpsmen in light CAF battle armor and armed with HI-50 laser rifles).

General Operations: Engineering (180), Medical (200), Flight Operations (250), Ship's Security (125), Internal Communications (75), General Enlisted (750).

Embarked Troops: 164 (85 officers, 79 enlisted).

CAF Fleet Aviators: 114 combat ready pilots with 50 in reserve.

CAF Marine Corps Aerospace RPA Pilots: None.

CAF Marine Corps Ground Forces: None.

### Aerospace Group:

Aerospace Fighters: 42

SF-101 Black Eagles: One squadron (24 ships).

SF-69/SF-69B Scorpions: None.

LRF-25 Proctors: One half-squadron (12 ships).

SAS Assault Shuttles: One half-squadron (6 ships).

Aerospace Robots: None.

BR-CCW Battlerams: None.

SH-CCW Silverhawks: None.

### Planetary Assault Group:

MBT-35 Phalanx Tanks: None.

IFV-100 Maniple Infantry Fighting Vehicles: None.

AR-20 Bombard Assault Robots: None.

PA-10 Ground Pounder Powered Armor Suits: None.

### M.D.C. by Location:

Interior Bulkheads per 10 feet (3 m) – 60

Interior Hatches – 50 each

Exterior Hatches – 60 each

Ventral Launch Bay – 9,500

Ventral Recovery/Large Ship Hangar Doors (2) – 1,800 each

Thruster Array – 6,000

Torpedo Batteries (4) – 900 each

Point Defense HI-Laser Batteries (16) – 200 each

Point Defense Mini-Missile Batteries (8) – 200 each

Forward Hull Section (1/3) – 25,000

\* Midships Hull Section (1/3) – 25,000

\*\* Aft Hull Section (1/3) – 32,000

\*\*\* Hull per 40 feet (12.2 m) – 125

Variable Force Fields – 6,000 per side (24,000 in total)

\* Destroying the midships hull section destroys the CIC and eliminates all weapons and fire controls. This renders the ship flyable but unable to fight. Inflicting more than 60% M.D.C. damage to the midships section has a 50% chance of knocking out the Interdiction Field Generator.

\*\* Destroying the aft hull section destroys the engines, setting the ship adrift.

\*\*\* Punching holes in the hull causes the damage control system to automatically seal off whatever compartment has been exposed to vacuum.

### Speed:

Atmosphere: Araneae are trans-atmospheric, and can maintain an atmospheric cruising speed of 3,424.5 mph (5,479.2 km or Mach 4.5).



FTL: 8 light-years per hour.

Sub-Light: Built for speed, Aranea-class Interdictors can maintain an impressive 8,066.6 mph (12,907 km or Mach 10.6) in space.

Range: Limited only by supplies. The anti-matter reactors carry enough fuel to operate the ship at full readiness for 50 years, but shipboard stores are only good for twelve months of constant deployment with full crew and complement.

**Statistical Data:**

Length: 2,263.7 feet (690 m).

Beam: 400 feet (122 m).

Height: 700 feet (213.3 m).

Mass: 180,000 tons fully loaded.

Cargo: 78,000 tons of cargo.

Power System: Two interlinked, capital-class anti-matter reactors powering two banks of three-nozzle capital-class thruster arrays and one two-nozzle capital-class thruster array.

Market Cost: 120 billion credits.

**Weapon Systems:**

**1. Long-Range Anti-Ship Torpedo Launchers (4):** Along the forward ventral side of the hull are four massive, forward facing torpedo tubes, two port (on the left side) and two starboard (the right side). These tubes typically fire heavy-yield anti-matter torpedoes and are the Aranea's primary anti-ship weapons.

Primary Purpose: Anti-Ship.

Secondary Purpose: Anti-Installation.

Weight: Not applicable, the torpedo launchers are part of the ship's hull. The torpedoes themselves are 21 feet (6.4 m) long and weigh 12 tons each.

Range: 1,400 miles (2,240 km).

Mega-Damage: 4D6x100 M.D. per missile.

Rate of Fire: One at a time or in volleys of 2, 4, 8 or 16. Aranaes can fire a volley of torpedoes every other melee round.

Payload: 16 torpedoes in each tube mounted in an armored, auto-loading magazine for a total of 64. The ship can carry an additional 128 torpedoes for reloads.

Bonus: These torpedoes are considered smart munitions, and are +5 to strike.

**2. Double-Barreled Rapid-Fire HI-Laser Turrets (16):** One half of the ship's point defense system, these turrets are mounted four to a side (dorsal, ventral, port, starboard) and can lay down an impressive and deadly fire screen to keep enemy fighters, shuttles and missiles at bay.

Primary Purpose: Anti-Fighter.

Secondary Purpose: Anti-Missile.

Weight: Not applicable, part of the ship's hull.

Range: 5 miles (8 km) in atmosphere and 16 miles (25.6 km) in space.

Mega-Damage: 2D4x10 M.D. per double-barreled blast. Multiple turrets can be brought to bear on an enemy ship depending on its position.

Rate of Fire: Equal to the number of hand to hand attacks of the gunner (usually 4 or 5).

Payload: Effectively unlimited.

**3. Point Defense Missile Launchers (8):** The other half of the ship's point defense system, these turrets are mounted close to each pair of the HI-Laser turrets and are used mainly to take down incoming missiles and assault shuttles.

Primary Purpose: Anti-Missile.

Secondary Purpose: Anti-Fighter.

Weight: Not applicable, part of the ship's hull.

Range: 2 miles (3.2 km) in space, half in an atmosphere.

Mega-Damage: Varies by warhead. Typical load is fragmentation, 5D6 M.D. to a 20 foot (6 m) area (triple the area in space).

Rate of Fire: One at a time, or in volleys of 2, 4 or 8 missiles.

Payload: 64 missiles per launcher (512 in total). The ship can carry an additional 1,024 missiles in an armored magazine.

**4. Interdiction Field Generator:** The true power of the Araneae class, and the thing that makes these ships among the most feared in the Galaxies, is the high-output Gravimetric Interdiction Field Generator. The Araneae can generate a mobile, *super-heavy gravity field* much like a planet's gravity well.

The Interdiction Field *prohibits the use of FTL drives* within its area of effect, and can even *pull* an enemy ship out of FTL travel! With this field, an Araneae can "lock down" a fleet of sub-capital and capital ships in preparation for a strike from its fleet, or set ambushes for pirates or fleeing enemies.

The down side of the Interdiction Field is that it is extremely energy intensive, and draws power from all ship's systems during times when it is operational.

Primary Purpose: Anti-Shipping.

Secondary Purpose: Capture and Containment.

Weight: Not applicable, part of the ship's hull.

Range: The Interdiction Field creates a 60 mile (96 km) sphere of influence, with the ship itself at the center. All FTL drive spacecraft within the 60 mile (96 km) diameter of influence cannot engage FTL drives.

Mega-Damage: While the I-Field does no damage to other spacecraft, it causes incredible stress on the Araneae itself. Every 13 times the I-Field is used, there is a chance of a catastrophic failure within the ship's systems. This could be anything from losing internal gravity to the ship being pulled apart at the seams! Roll on the Catastrophic Damage Table presented earlier to see exactly what happens.

Rate of Fire: The I-Field needs one round to warm up, then is constantly active until deactivated or the ship is destroyed.

Payload: Effectively unlimited.

Penalties: When the Interdiction Field is active, all sensors and energy weapons see their range reduced by 75%, and the ship's speed is reduced by half.

**5. Ship's Systems of Note:** Tactical life support, launch/recovery and traffic control systems for aerospace craft, IFF/command and control systems, escape capsules for all crew.

## *Emancipation-Class* **Dreadnought**

Until about a quarter century ago, Consortium scientists and engineers commonly believed that the *Packmaster* was as big as one could build a ship and still have it able to travel faster than light. Then came the shocking discovery of the Kreeghor *Doombringer-class* dreadnoughts, and suddenly the rules changed. Many members of the Consortium Congress panicked. Their fear was that the Transgalactic Empire (TGE) could have only one reason for building such a vessel: to be a massive, mobile fortress from which to launch surprise attacks into Consortium space. They immediately drew up legislation to approve development of their own *super-capital ship* in order to bridge the "dreadnought gap."

The first hurdle in building a Consortium of Civilized Worlds ship larger than the *Packmaster* was the creation of an entirely new contra-gravity engine. This new engine, called the *Balanced Hammond Drive*, was one of the first pieces of military hardware in millennia developed with the help of artificial intelligences. Development of the Balanced Hammond Drive eventually increased the maximum possible mass of a starship into the range of 160 million tons. This meant that the CCW could finally design a ship that would equal the Kreeghor monstrosity. This new ship would be a super-carrier and forward command ship, leading fleets of thousands of ships into battle and going toe-to-toe with the TGE's *Doombringer dreadnoughts*. The first dreadnought built by the CCW, the CAF *Emancipation*, left the slips at the Goldielox drive-yards 20 years ago.

These massive, lumbering space vessels have a silhouette like that of a four-bladed broadhead arrow, and look like the letter X when viewed from the stern. CAF Spacers and Marines have humorously observed that the ship looks like two oversized Protector-class battleships caught in a very compromising position. There is a raised, heavily armored command tower at the aft of the ship in the space formed by the two top arms of the hull, and the ship's engines are mounted in the arms themselves, close to the central spine of the vessel.

The four primary HI-Laser cannons run the length of the ship in the valleys formed by right angles of the dreadnought's hull, and the rest of the secondary, tertiary and point-defense systems are spread liberally around the hull. The layout of the weapons provides 360 degree coverage, and allows the ship to bring an impressive amount of fire to bear on an enemy from nearly any angle. The ship's robot and fighter hangars and launch/recovery bays are in the two ventral arms of the hull, along with a secondary traffic control tower to augment the CIC (Combat Information Center; basically the combat command deck or "war deck").

It is interesting to note that development of the *Emancipation-class* was vehemently opposed by the Noro, the Catyr, the Strata, the In'Valians, and the Iborians, all of whom feared that the building of such a massive and deadly spacecraft would only inflame the Kreeghor to top it. Such an escalation in arms, they argued, was not why the Consortium of Civilized Worlds had been founded. But the Wulfen, the Faustians, and the humans



argued otherwise, insisting that such ships would enforce the peace, not break it. The Seljuk and Oni delegates were oddly neutral during the debate.

These ships have never been fully tested in combat. By the end of the last border war with the Transgalactic Empire (TGE), only one had been completed, and it was rushed to the front to be paraded near the disputed zone for all the Kreeghor commanders to see. As a symbol of Consortium might, the Emancipation-class dreadnought is unsurpassed. But as an effective instrument of war, they have yet to prove their worth.

**Model Type:** Dreadnought (DRD).

**Class:** Emancipation Class.

**Ship's Complement:**

Ship's Crew: 8,668 (2,600 officers, 6,068 enlisted).

Bridge: Ship's Captain (1), Ship's Executive Officer (1), Helm (10), Navigation (10), Comms/Sensors (20), FTL Ops (10), Security (20 CAF Security Corpsmen in light CAF battle armor and armed with HI-50 laser rifles).

Combat Information Center (CIC): CAF Marine Corps General (1, in charge of troop deployment, strategy and tactics), Military Advisory Team (10), Commander of Aerospace Group (1, CAG, commander of ship's aerospace wing), Ground Forces Commander (1, commander of ship's planetary assault group), Comms (10), Ship's Weapons and Fire Control (30), Security (20 CAF Security Corpsmen in light CAF battle armor and armed with HI-50 laser rifles).

General Operations: Engineering (500), Medical (430), Flight Operations (1,200), Ship's Security (250), Internal Communications (150), General Enlisted (5,993).

Embarked Troops: 18,060 (6,636 officers, 11,424 enlisted).

CAF Fleet Aviators: 2,520 combat ready pilots with 1,260 in reserve.

CAF Marine Corps Aerospace RPA Pilots: 3,120 combat ready pilots with 1,560 in reserve.

CAF Marine Corps Ground Forces: 9,600 combat ready Marines (Infantry, Armor, Mechanized Infantry).

**Aerospace Group:**

Aerospace Fighters: 1,560 total.

SF-101 Black Eagles: Four wings (960 ships, 40 squadrons of 24 ships each).

SF-69/SF-69B Scorpions: One wing (240 ships, 10 squadrons of 24 ships each).

LRF-25 Proctors: One wing (240 ships, 10 squadrons of 24 ships each).

SAS Assault Shuttles: One wing (120 ships, 10 squadrons of 12 ships each).

Aerospace Robots: 2,160 total.

BR-CCW Battlerams: One battalion (960 units, 6 companies of 160 units each).

SH-CCW Silverhawks: One battalion (1,200 units, 10 companies of 120 units each).

**Planetary Assault Group:**

MBT-35 Phalanx Tanks: 480

IFV-100 Maniple Infantry Fighting Vehicles: 360

AR-20 Bombard Assault Robots: One battalion (960 units, 80 companies of 12 units each).

PA-10 Ground Pounder Powered Armor Suits: One battalion (1,200 units, 100 companies of 12 units each).

**M.D.C. by Location:**

Interior Bulkheads per 10 feet (3 m) – 80

Interior Hatches – 70 each

Exterior Hatches – 80 each

\* Command Tower – 5,500

Ventral Launch Bays (6) – 9,500 each

Ventral Recovery/Large Ship Hangar Doors (2) – 8,500 each

Thruster Array – 25,000

Main Laser Batteries (4) – 5,000 each

Secondary Laser Batteries (8) – 1,200 each

Cruise Missile Batteries (4) – 900 each

Point Defense Batteries (48) – 400 each

Forward Hull Section (1/3) – 80,000

\*\* Midships Hull Section (1/3) – 80,000

\*\*\* Aft Hull Section (1/3) – 92,000

\*\*\*\* Hull per 40 feet (12.2 m) – 150

Variable Force Fields – 15,000 per side (90,000 in total).

\* Depleting the M.D.C. of the command tower destroys the bridge. With the bridge destroyed, the ship can still be operated from the CIC.

\*\* Destroying the midships hull section eliminates the CIC and all weapons and fire controls. This renders the ship flyable, but unable to fight.

\*\*\* Destroying the aft hull section knocks out the engines, setting the ship adrift.

\*\*\*\* Punching holes in the hull will cause the damage control system to automatically seal off whatever compartment has been exposed to vacuum.

**Speed:**

Atmosphere: Emancipation-class dreadnoughts are incapable of atmospheric flight.

FTL: 6 light-years per hour.

Sub-Light: Mach 7.5 in space.

Range: Limited only by supplies. The anti-matter reactors carry enough fuel to operate the ship at full readiness for 50 years, but shipboard stores are only good for two years of constant deployment with full crew and complement.

**Statistical Data:**

Length: 15,000 feet (4,572 m).

Beam: 2,000 feet (609.6 m).

Height: 2,000 feet (609.6 m).

Mass: 100 million tons fully loaded.

Cargo: 30 million tons.

Power System: 2 super-capital anti-matter reactors powering 2 four-nozzle super-capital thruster arrays and the newly designed Balanced Hammond Drive.

Construction Cost: The Balanced Hammond Drive cost over 800 trillion credits to refine. The first of these ships cost 32 tril-

lion credits to develop. Now that the process has been refined, the *Emancipation*-class can be built for about 350 billion credits.

## Weapon Systems:

**1. Main Laser Batteries (4):** The main weaponry for the *Emancipation*-class consists of four 80-inch HI-Lasers. They are arranged two per side, on the crosspiece of the front hull. These cannons were designed and built by the top weapon engineers in the Human Alliance, and are capable of inflicting 25% more damage than the main guns of the *Protector*. They may be fired two at a time (port or starboard), or as a devastating volley of four.

Primary Purpose: Anti-Planet/Anti-Installation.

Secondary Purpose: Anti-Ship.

Weight: Not applicable, part of the ship's hull.

Range: 120 miles (192 km) in space, or 60 miles (96 km) in an atmosphere.

Mega-Damage: 2D6x1,000 +3,000 M.D. per cannon.

Rate of Fire: Each cannon may fire once every other melee round.

Payload: Effectively unlimited.

**2. Secondary Laser Batteries (8):** The horrific amount of damage this vessel can throw out only becomes apparent when you consider that the secondary lasers of the *Emancipation* are in fact, the same 40-inch cannons that form the main armament of the *Protector*. Four are mounted on each side of the ship, with each in a ball turret. Thus, the *Emancipation*-class can actually fire each of these weapons for 360 degrees in a 90 degree arc.

Primary Purpose: Anti-Ship.

Secondary Purpose: Anti-Installation.

Weight: Not applicable, part of the ship's hull.

Range: 100 miles (160 km) in space, or 30 miles (48 km) in an atmosphere.

Mega-Damage: 2D6x1,000 M.D. per each cannon.

Rate of Fire: Each cannon can fire twice per melee.

Payload: Effectively unlimited.

**3. Cruise Missile Launchers (4):** Like the *Protector*, the cruise missile launchers are found on the front and mid-section of the ship (2 on each). They can each volley as many as 32 torpedoes simultaneously. With all four firing, that's a maximum possible 128 missiles per round.

Primary Purpose: Anti-Ship.

Secondary Purpose: Anti-Installation.

Weight: Not applicable, the launchers are part of the ship's hull. Each missile weighs 10 tons.

Range: Over 1000 miles (1600 km).

Mega-Damage: Per warhead, varies by type.

Rate of Fire: One at a time, or volleys of 2, 8, 16 or 32. Per launcher.

Payload: 32 missiles per launcher. Reloads are automatically brought up from the cargo holds (takes 2 melee rounds). Standard missile complement is 2,560 warheads; that's 20 complete reloads for each launcher.

**4. GR-Gun/Missile Batteries (48):** Spread around the hull, these rapid-fire point-defense batteries are deadly against fighters and shuttles, and create a very effective screen against these small ships.

Primary Purpose: Anti-Fighter/Anti-Shuttle.

Secondary Purpose: Anti-Missile.

Weight: Not applicable, part of the ship's hull.

Range: 16 miles (26 km) in space, one third that in an atmosphere. Missiles have a range of 2 miles (3.2 km) in space.

Mega-Damage: A burst is 20 rounds and inflicts 4D6x10 M.D.

Missiles are always plasma: 1D6x10 M.D. each.

Rate of Fire: Equal to the number of hand to hand attacks of the gunner (typically 5). Missiles can be launched one at a time, or in volleys of two or four.

Payload: 200 bursts for the gun, and 32 in the launcher. Both can be reloaded from the cargo bay in about 3 minutes.

**5. Ship's Systems of Note:** Tactical life support, escape pods for all crew, launch/recovery and traffic control systems for aerospacecraft and robots, IFF/command and control systems.

# The Dominators

Fifty thousand years ago, the Three Galaxies were entirely transformed by a war. It was so destructive and so vast in scope as to make it the single most devastating conflict in the history of the Megaverse. The war theater wasn't limited to a single continent, or even a particular world. It spanned over 90,000 light-years, consumed hundreds of millions of star systems, and involved weapons of such unimaginable ferocity that a single one of them all but sterilized an entire galaxy. For this was a war waged by the god-like *Elder Races*. This was the **War against the Dominators**.

In order to fully appreciate the War's impact on galactic history, one must first understand the ones who precipitated it: the Dominators themselves. The actual name for the thirty foot (9.1 m) tall warmongers' species has been forever lost. The other Elder Races simply called them "the Dominators." From the moment they first left their homeworld, the Dominators seemed fanatically driven to subjugate and enslave every other race in Creation. What no one truly knows, even to this day, is why the Dominators decided to wipe out all life in the Three Galaxies, and why they felt they had no choice but to do so. The Elven historian *Sarhon Witstaff* perhaps described them most aptly: "Their name is what they are."

## The Second Era

The **War against the Dominators** is the defining event of the Second Galactic Era, if only because modern researchers know little else about it. Everyone agrees that the Second Era ended 50,000 years ago with the destruction of the Dominator homeworld, but there is debate as to when it actually began. Most historians use the arbitrary starting date of five million years ago, coinciding with the assumed construction of *Center*, on Phase World. A smaller group uses the creation of the

*Monro-Tet Obelisks*, carbon dated back a million years. Regardless of when it began, the beings that lived during the Second Era were light-years more advanced than any species alive today, with cultures that had endured for millions of years. It was a time when godlike beings ruled the universe. There was no distinction between technology and magic, because both were so advanced as to be indistinguishable. What little machinery the Elder Races have left behind gives only tantalizing hints as to how they lived, and of what they were capable. Perhaps the greatest testament to their deific abilities lies in the fact that, in going to war, they unleashed weapons whose might was great enough to erase all traces of both their makers and their victims.

There is no surviving record that lists all of the Elder Races, but a few of them are mentioned by name in a 100,000 year old document that once belonged to the *Star Elves*. Called **The Lay of Treenen**, this fragment is part of an epic poem of unknown total length. In it are mentioned eight specific Elder Races: the nebulous *Boiaw*, the *Moochay*, the winged *Rothamril*, the *Promethai*, the *Ferothold Gardeners*, the *Irdra-orm*, the young *Astralfein* (who later became known as the Star Elves), and one other. The Lay also makes mention of “fleets of shape-shifting dreadnoughts,” leading many to presume that the aforementioned Promethai are, in fact, the Prometheans of Phase World.

The eighth Elder Race mentioned, though indirectly, are the “*Bar-aldack Kelger-est*.” If translated into Trade One, this phrase literally means: “those who would dominate”.

## Is there no Fate but what we make?

At some distant point in the past, the Dominators became obsessed by a prophesy. The oldest Promethean Second Stagers are certain that this dark prediction came from an alien species, since the Dominators have no oracular powers, and they suspect the culprits to be the mysterious *Lords of Entropy*. It may be that, as gods, they were always obsessed with it, as the Norse pantheon has always believed that it would come to an end during Ragnarok. Regardless of how it came to them, this prophesy became the single motivation for all of the Dominators’ actions.

It was foretold that the Dominators would be wiped out completely by the other species in the Three Galaxies. To deific beings that were immortal, the concept of death was so frightening as to be almost inconceivable, and the extermination of their entire race even more so. It caused the Dominators to panic, and they dedicated their lives to ensuring that this turn of events would never come to pass. For, much like the Norse gods, the Dominators believed in Fate. They were certain that time flowed in only one direction; that the past ceased to exist as soon as it became the past, and that future events were set in stone. So, they came to the conclusion that the only way to outwit the prophesy was to destroy every other species in the universe. After all, how could the Dominators be destroyed if they killed off all of their enemies first?

Contrary to what the younger races of the Third Era believe, the time of the Elder Races was one of unprecedented peace. The Three Galaxies had not known war for a hundred million years. Thus it came as a total surprise when the Dominators began what they called “the great work.” The other Elder Races were completely unprepared for what was to transpire next.

The first to suffer were the **Boiaw**, who had existed for eons as clouds of nebular gasses, light-years in size. They spent centuries at a time developing complex mathematics, and formulating theories. Having little in common with the more solid Elder Races, the Boiaw had never fought with anyone. The Dominators fell upon them, and enslaved them, for the Boiaw were greatly needed. Compacting them into tight containment fields, the Boiaw were to become the *power cores* and *central computer minds* that would drive the Dominators’ Star Fortresses – the chariots that would carry them triumphantly across the Three Galaxies. The Dominators cared little for the agonies of the Boiaw, who, used to the vastness of interstellar space, were now as close to being in Hell as they could have ever thought possible. The Dominators knew that had they not subjugated the Boiaw, they would have paid dearly for it sometime in the future. Better that some other species should suffer, rather than be given the chance to make the prophecy come true.

The Dominators then began their drive in earnest. Spreading out from their homeworld in the *Thundercloud Galaxy*, they eliminated hundreds of species before they encountered any resistance. Thousands more were turned into dust before the remaining Elder Races finally joined together to stop the carnage. *The Dominators* saw the powers aligning against them as proof that the prophesy was indeed true, the other species in the universe were out to destroy them. They couldn’t see that they were victims of a pre-destinational paradox, that in trying to avoid their fate, they had in fact set events in motion that would ensure their downfall.

## The End of Everything

Not all of the Elder Races joined the fight to stop the Dominators. A few of them decided that this war marked the end of everything they had ever known, and either fled or hid themselves away. **The Astralfein**, for example, used powerful magic/technology to make their planet invisible. Other races collectively traveled through time to the distant future, bypassing not only the end of the Second Era, but the Third as well. Several races, such as the vampiric **Sadut**, dug bunkers miles beneath the surface of their worlds and went into a state of suspended animation that continues to this day. In the *Corkscrew Galaxy*, the **Architects** built a giant defensive sensor net, and then tried to hide behind it (they were ultimately exterminated anyway).

Those who chose to unite and make a stand unleashed such weapons and magic/technologies as should never be seen again. The Elder Races fought back with a terrifying ferocity, but this only seemed to drive the Dominators on still stronger. It was then that the *first* of the **Cosmo-Knights** began to appear. In retrospect, many **Star Elf** scholars believe that the war against the Dominators was causing such a loss of life that the nature of the *Cosmic Forge* itself was in danger. The **Promethean Second Stagers** fear that this was the intent all along, for the **Lords of Entropy** to instigate such strife that the *Cosmic Forge* would have no choice but to step in and reveal itself. The *Cosmo-Knights* eventually helped turn the tide, and after thousands of years of fighting, the Dominators had been forced to retreat back to the core of the *Thundercloud* from whence they had come.

It should also be noted that around this time many “younger races” were beginning to develop throughout the Three Galaxies as well. The Elder Races, who were now very few in number, knew that they would not be around long enough to protect these newer species should the Dominators regroup and begin their campaign of genocide all over again. If they were going to pass into oblivion, then they were determined to take the Dominators with them. However, their home solar system was so heavily defended that everyone feared to attack it.

So it was that the Elders most powerful creation, the **Black Hole Projector**, was built. The weapon was only fired once, but it was enough. In an instant, the Dominators’ solar system, and everything around it for one hundred light-years, imploded. A hundred thousand stars collapsed in on each other in the time it takes a heart to beat. A shock wave that was part Ley Line Storm, part gamma ray burst roared outwards from the center of the *Thundercloud Galaxy* at the speed of light. Everywhere the blast front passed, it scoured planets of life, killing hundreds of emergent younger races and millions of animal species. Those who survived its passing had their evolution set back by millennia.

Only a few hundred Dominators survived, and many of those sank into an indescribable despair. The prophecy had come true, and their people were all but extinct. As for the few remaining Elder Races, many of them, seeing the destruction that the war had wrought, willed themselves to exist no more, and vanished. The Second Galactic Era was over. It would be forty thousand years before another one would begin.

## The Third Era

During the Interim, while the Three Galaxies became filled with demons, Splugorth, and Alien Intelligences, the surviving Dominators remained very quiet. They disassociated themselves from one another, and considered what they should do next. Being a divine race, they did not have children or procreate as we might understand it. Their remaining numbers were all that were left of their species.

A few of them eventually shook themselves out of their despair, and took up the *Great Work* once again. Only by this time the galaxies were populated by scores of tiny, mortal creatures. The other Elder Races were nowhere to be seen, save for the bothersome Astralfein, and the Promethai, who had cloistered themselves on Phase World never to leave it again. These younger races would be easy prey, the Dominators figured, provided they were never allowed to unite together on a grand scale, which seemed unlikely, given how much they fought with one another. When they were all destroyed, the prophecy’s grip would finally be broken.

To the younger races, which live such tragically short lives, the Dominators’ attacks seem almost random, but they are not. Since they are immortal, a Dominator’s sense of time is quite different from that of humans, Kreeghor, or even Altess. They can afford to move at a slow but determined pace, striking when and where they want. In the past one thousand years, there have been *three documented* Dominator attacks. **The first** was in 8997 TE, when the, then-unified, Wulfen Empire was ravaged by a fleet of three Star Fortresses. Whether the Dominators were cooperating, or just all happened to attack the same region of

space at roughly the same time, is unknown (most people pray the latter is the truth). This attack was rebuffed by the Wulfen Empire, who destroyed one of the three massive starships and forced the other two to retreat. However, the fighting left the Wulfen weakened and easy prey for the Kreeghor.

**The second** Dominator attack took place in 9612 TE, in the *Anvil Galaxy*, and resulted in the total destruction of the *Asu* people. This battle took place inside the Golgan Republik, but saw limited action on behalf of the Argosy. The Kouncil Politik thought it better to sacrifice one planet to satiate the Dominators, rather than send millions of good soldiers to fight in what was obviously a lost cause. Seven Cosmo-Knights were involved in this fight, which is most likely the only reason that the lone attacking Dominator was destroyed.

**The most recent battle** took place in the *Thundercloud Galaxy*, in 9880 TE. A single Star Fortress was heavily damaged (but not destroyed) during a protracted fight with the *Splugorth Kingdom of Dyssleth*. The Kittani were eventually ordered to fly suicide missions, crashing their ships at top speed into the hull of the Dominator Fortress, and detonating their engine cores. According to stolen reports, the Star Fortress was so tough that even the Kittani “Slicer” cannons could not cut through it. The Dominator eventually *retreated* from the combat zone.

It is now generally accepted by every major power bloc that the Dominators represent one of the gravest threats the Three Galaxies have ever known. Should the Dominators organize or band together for a coordinated attack, their intended target is doomed. As it is, it would take a fleet of ships to counter the power of a single Star Fortress. TGE and CAF officers both have “unofficial” orders to fight at each other’s sides should a Dominator ship appear in their domain of space.

## Dominator Magic/Technology

As members of one of the Elder Races, the Dominators have a level of technical achievement that borders on the metaphysical. Regrettably, almost all of this knowledge has been channeled towards waging war. Even then, the Dominators do not concern themselves with things like space fighters, giant robots, and fleets that number fifty ships or less. Their goals are grandiose, and so their weapons are tailored to the destruction of huge fleets, massive capital ships, moons, and entire planets.

A writer from Terra Prime was once quoted as saying that any sufficiently advanced technology would be indistinguishable from magic. To take his analogy further, any technology built by deific beings **is** magic. All of the weapons used by the Dominators, from their handheld weapons to the massive cannons on their planetoid-sized starships, are considered to be magic in nature. This means their weapons inflict damage to beings that are affected only by magic (vampires take half damage). *Phase fields* are still quite effective protection, but they are rare and comparatively few. Only the **Cosmo-Knights** are largely unaffected by Dominator energy weapons and take only 1/100th damage from all Dominator energy attacks. Many point to this as proof that the Cosmo-Knights were indeed sent by the Cosmic Forge specifically to stop the Dominator threat. Note that although the Knights take no damage whatsoever from beams of *Cosmic Energy*, they can still be grievously injured by the blade of a Dominator’s *Star Splitter*.



**Life-Force Reactors:** The Star Fortresses are powered not by anti-matter or nuclear reactors, but by *living beings*. Each ship is built around a *Boiaw* who has been forced to live for all these long ages trapped in a temporal stasis chamber. This process is very similar to the Bio-Wizardry or Rune Magic employed by the Splugorth, and somehow provides all the energy the Dominators need to power their world-sized vessels. Since a Star Fortress is mystically tied into the Boiaw's life force, given enough time, the hull of the fortress automatically regenerates damage as if the incredible spacecraft were healing.

**Cosmic Energy Weapons:** The Dominators are the only race in the entire universe known to have developed weapons that can fire directed cosmic energy. Even defining "cosmic energy" is difficult. Scientifically, it is a mixture of protons, alpha particles, and heavy atomic nuclei. It behaves like a laser, but has similar wave mechanics to a particle beam. It affects magical constructs, and shares many of the supernatural attributes of *sunlight*, even though it contains no photons. Cosmic energy has absolutely no radioactive signature or aftereffects. Cosmo-Knights can generate it by will alone, making many think it is somehow related to the phenomenon called *zero-point energy*. In short, no one knows what it is or where it comes from.

**Electric Reactive Armor:** Both the hulls of the Dominator starships and their personal body armor are built to greatly lessen the impact from explosive and kinetic attacks. The armor is made up of multiple conductive plates separated by insulating materials. A charge is then sent through the plates, creating a high-power capacitor. When an incoming body (like a missile or rail gun burst) tries to penetrate the plates, it closes the circuit and discharges the capacitor. This dumps a great deal of energy into the penetrator, causing it to vaporize or even turn into a plasma. **In game terms**, Dominator armor, whether on their person or on their ships, takes *half damage* from all kinetic and explosive attacks, including nuclear and anti-matter warheads.

**Quantum Wormhole Drives:** The Star Fortresses of the Dominators use a method of propulsion as fantastic as their weapon systems. Again, because no Dominator ship has ever been captured intact, the exact nature of their engines is a matter of conjecture. It is most widely accepted that they use some kind of wormhole drive to tunnel under realspace and move about at fantastic speeds. When a Star Fortress needs to relocate in a hurry, it opens a massive tear in the fabric of the universe, and drops down into it. Once under normal space, the ship can traverse a multitude of "hyper-pipes," subway-like tunnels in hyperspace that crisscross the entirety of the Three Galaxies. While traveling within a wormhole, the ship is not subject to many physical laws, and can reach a top speed of 300 light-years per hour!

## A Dominator Star Fortress

Among the most terrifying sights in all the Three Galaxies is the approach of one of these planetoid-sized vessels, for it can only mean death and destruction on an unprecedented scale. A Star Fortress is a titanic sphere, 30 miles (48 km) in diameter.

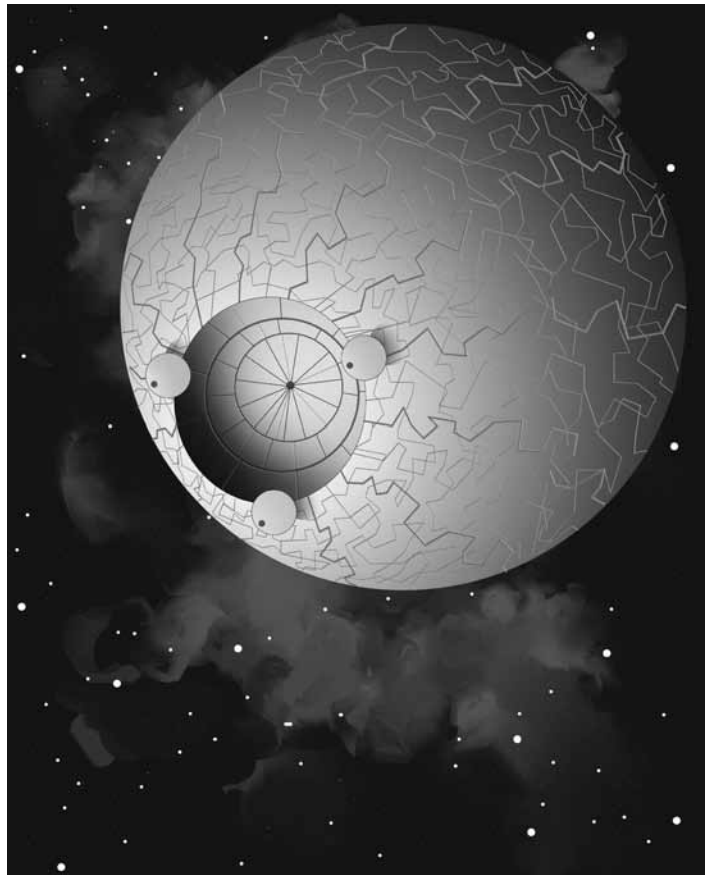

On its forward-facing hemisphere is a circular indentation seven miles (11.2 km) across, surrounded by three round weapon ports, each a mile (1.6 km) wide in themselves. Its surface is almost totally smooth, broken only by gun turrets the size of small mountains that evenly cover its outer hull. It has no apparent engines, it just glides along in deadly silence.

The outer hull of the ship is a mile thick. If one were to concentrate enough firepower to blast a hole through it and look inside, one could see a second, smaller sphere resting inside, connected to the outer hull by a spider web of massive catwalks, pipes, and arcs of electricity. Nestled safely in this internal core can be found the ship's lone occupant, one of the ancient Dominators. It is believed that there are fewer than two hundred Star Fortresses left in the Three Galaxies, but no one is certain.

**Class:** Mobile planet.

**Crew:** One Dominator.

**Troops:** None. But Inner Core may have 2D6 slaves or playthings of diverse races.

**M.D.C. by Location:**

Anti-Matter Cannons (3) – 200,000 each

Heavy Beam Weapons (100) – 15,000 each

Retractable Beam Turrets (5,000) – 1,200 each

Inner Core Hull per 40 foot (12.2 m) square section – 200

\* Internal Core – 3 million

Outer Hull per 5000 square foot (464.5 m) section – 7,500

\*\* Main Body (Outer Hull) – 20 million

\* Destroying the Internal Core kills the Dominator, and triggers the destruction of the entire ship. See self-destruct at the end of the description for details.

\*\* Depleting the M.D.C. of the Main Body renders the Star Fortress a floating wreck. It is not be able to move or fire weapons, but provided that the Inner Core is still intact, it begins *healing* itself.

#### **Speed:**

FTL: Can travel 300 light-years per hour via a hyper-pipe wormhole.

Sub-Light: Mach 4 in space. The ship is far too large to enter an atmosphere.

Range: Unlimited. The Dominators don't require supplies.

#### **Statistical Data:**

Height: Outer shell – 30 miles (48 km). Inner core – 10 miles (16 km).

Length: Outer shell – 30 miles (48 km). Inner core – 10 miles (16 km).

Width: Outer shell – 30 miles (48 km). Inner core – 10 miles (16 km).

Mass: Estimated at 9 trillion tons.

Power System: One Boiaw compressed in a temporal stasis bio-reactor.

### **Weapon Systems:**

**1. Anti-Matter Cannons (3):** Each of these weapons works by accelerating a dense stream of frozen anti-hydrogen to near light speed. These weapons are very cumbersome, and can only be used against targets that are capital class or larger. They are relatively slow in their firing, but they are capable of completely devastating planetary targets such as entire cities. All of these weapons are located in the front-facing hemisphere of the Star Fortress. They can be fired separately, or volleyed together against one target. Each weapon has an arc of fire of 60 degrees, and creates a beam of energy a mile (1.6 km) wide.

Primary Purpose: Anti-Planet.

Secondary Purpose: Anti-Ship.

Weight: Not applicable, part of the mobile planet's hull.

Range: 200,000 miles in space.

Mega-Damage: Fired singularly, each cannon inflicts 1D6x1 million M.D. If combined, the blast destroys **everything** in its path of fire, regardless of M.D.C. Against a planet, a combined volley will inflict 2D6x1 million M.D. to a ten mile area (16 km).

Rate of Fire: Each cannon may fire once every 8 minutes (32 melee rounds).

Payload: Unlimited.

**2. Heavy Beam Weaponry (100):** Spaced evenly around the outer surface of the ship are a series of beam weapons far more powerful than anything currently produced in the Three Galaxies. These weapon mounts are placed miles apart, so generally, they cannot be combined into volleys, unless the target is very large, like a planet, moon or massive, city-sized space station. Each weapon may adjust its arc of fire by ten degrees.

Primary Purpose: Anti-Capital Ship.

Secondary Purpose: Anti-Installation.

Weight: Not applicable, part of the mobile planet's hull.

Range: 200,000 miles in space.

Mega-Damage: 1D4x10,000 M.D. per blast.

Rate of Fire: Each cannon may fire once per melee round (15 seconds).

Payload: Unlimited.

**3. Retractable Beam Turrets (5,000):** The lightest of the Star Fort's armaments. They are the Dominators' idea of point defense, which is laughable considering that they are the same size as the main guns on several modern battleships. These beam emitters are spaced evenly around the surface of the Fortress to cover it from every attack vector. The average distance between turrets is less than a mile, and so they can be easily volleyed together in groups of four or more. Each gun can rotate 360 degrees, and has a 180 degree arc of fire.

Primary Purpose: Anti-Ship.

Secondary Purpose: Anti-Fighter/Anti-Missile.

Weight: Not applicable, part of the mobile planet's hull.

Range: 200,000 miles (320,000 km) in space.

Mega-Damage: 1D4x1,000 M.D. each.

Rate of Fire: Each weapon may fire twice per melee round (15 seconds).

Payload: Unlimited.

**4. Plasma Shockwave:** The Dominators are far from stupid, and despite their near total reliance on overwhelming firepower to win battles, they are excellent tacticians. They fully understand that their enemies will try to overwhelm them with swarming attacks of space fighters and torpedoes, as well as try to bring their battleships into point-blank range for mass nuclear volleys or kamikaze attacks.

To counter this, the Star Fortress can vent plasma gas from its power core. The gas fills space with burning vapor, destroying all incoming missiles, fighters, and combat shuttles that enter the vapor cloud (roll to dodge at -2). Cosmo-Knights take no damage from the plasma shockwave. Firing the plasma disrupts the temporal shielding of the Star Fortress for one minute (4 melee rounds).

Primary Purpose: Anti-Ship /Anti-Missile.

Secondary Purpose: Area Denial.

Weight: Not applicable.

Range: Radius of 300 miles (480 km).

Mega-Damage: 1D6x1,000 M.D.

Rate of Fire: Once every five minutes (20 melee rounds).

Payload: Unlimited.

**5. Temporal Shielding:** The Star Fortress does not have force fields as we might understand them, but can erect a large area of distorted time around itself. This *temporal shielding* plays havoc with Cosmo-Knights, fighter pilots, and starship crews, which often gives the Dominator the initiative in a battle.

The shield is a bubble 600 miles (960 km) in diameter, with the Star Fortress sitting in the middle. Any person pass-

ing through the field must make a saving throw against magic of 17 or higher to avoid the effects of the field. Robots and A.I.s must also roll to save.

**Effects:** Passing through the shielding destroys a live person's perceptions of time, causing him to feel tired, confused, and to believe he has been busy – fighting, working, etc. – for much longer than he actually has been. Characters who fail their saving throws are -10% on all skills; -60% if the skill requires the measurement of time or the setting of timers. They are also -2 to strike, parry, and dodge, -3 on initiative, and lose one melee action. **Note:** Robots and artificial intelligences (A.I.s) are similarly affected, and though penalties are half (round down), the duration is double.

**Duration:** Those who become affected by the temporal field remain sluggish and confused for 10 minutes (40 melee rounds)!

**Range:** 285 miles (456 km) out from the surface of the Star Fortress; it is a bubble.

### Additional Systems of Note:

- 1. Sensors:** The Dominator Star Fortress has all the standard sensor systems found on starships. In addition, it can track 15,000 separate targets to a distance of 500,000 miles (800,000 km). It should be noted that the Star Fortress itself is a non-reflective object which is very difficult to spot visually until it is right on top of its target. The Wormhole drive means that it does not produce a gravity wake that can be easily detected.
- 2. Regeneration:** Since it is connected to a living being, the Dominator Star Fortress can regenerate damage inflicted to it in the same way as a person might *heal* from a cut or burn. For game purposes, the ship recuperates 30,000 M.D.C. per hour, but in order to do so it cannot be involved in combat or any other action during that time. It simply sits quietly and regenerates. If pressed, it can heal 6,000 M.D.C. per hour and continue fighting or flying.
- 3. Self-Destruct:** The Dominators refuse to let any part of their Fortresses fall into enemy hands. The stasis chamber that contains the Boiaw is tied directly into the brain waves of the Dominator onboard. If he is killed, then the stasis chamber collapses, and the Boiaw inside, now free from its millennia of suffering, gleefully commits suicide by blowing the ship to ribbons. This explosion inflicts enough damage to destroy everything within a one hundred mile radius (160 km). If the battle took place over a planet, which is most likely, then 1D4x10 giant pieces of flaming debris rain down, each impacting with the same force as a mass driver, the planet being saved from the Dominator only to suffer lasting ecological damage.

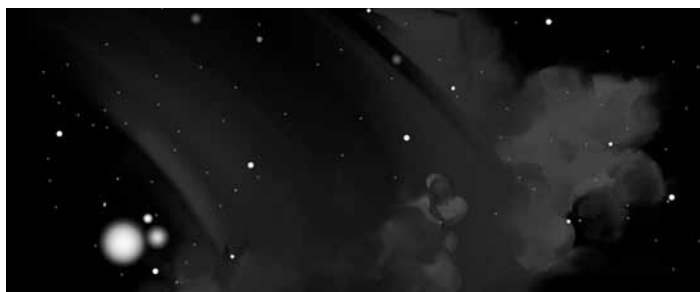

# Golgan Republik

## Golgan Republikan Argosy

The ships of the Golgan Republik are dismissed by the other power blocs in the *Anvil Galaxy* as being outdated, underpowered, and ineffective. Until recently, this was a fairly accurate assessment.

The Republik began its long decline over three centuries ago when the planet *Ulmore* decided to secede. **The Argosy and Replikan Guard** responded in full force, decimating the planet and waging a protracted civil war that cost millions of lives on both sides. Thereafter, the Golgans concluded that bringing planets back into the fold by force was an utter waste, and so they never again did so. Instead of strengthening their allegiance to the Republik, however, more and more worlds, knowing there would be no reprisal, broke away and declared their independence.

From then on, the Golgans' buffer zone, along with the once mighty Argosy Fleet, atrophied from inactivity and secession. When a member planet broke away, it tended to take any and all Republikan ships in its system with it. As the empire shrunk, so too did its coffers. Despite some calls to rebuild and re-strengthen the remaining ships of the Argosy, the Council Politik could never approve funding for such a massive upgrade. As the years went on, and the threat of Golgan hostility grew more and more remote, the other power blocs came to accept the fact that the Republikan Argosy could never pose a real threat, nor could the Republik bridge the ever-widening technological gap between it and its neighbors.

This opinion about Golgan decline has held pretty true for decades, but things have *changed* in the Republik, and the *Anvil Galaxy* is about to be proven wrong.

Ten years ago, select members of the Golgan military and government joined together and staged a bloodless coup. They gained control of both the *Argosy Kommand* and the *Council Politik*. They then granted the *robots of Mekanik* full member status, and set the *Kultural Revolution* in full motion. New weapon systems were designed, and the fleet was completely upgraded. Now ready to make its move, the Golgan fleet promises to restore the former glory of the Republik. Plans are underway to re-conquer the *Central Alliance*, liberate *Kablinka* from the Transgalactic Empire (TGE) and, when the timing is right, utterly *destroy the Altess*. The only power in the Anvil Galaxy they do not yet want to fight is the CCW. Not out of cowardice, however, but because they already have their hands full.

## Disposition of Golgan Fleets

For most of the past three centuries, the sad remnants of the Argosy have been stationed around the core planets of the Republik, protecting their precious homeworlds from an attack that would never come. They've sat on their hands and painted their bulkheads and taken part in endless "training exercises" and done little else aside from watching large portions of the fleet defect with seceding planets. With attrition from secession, defection and plain wear and tear, the once proud Argosy had

been reduced to just over 50,000 ships. These ships are mostly antiques, remnants of a time when the Argosy spread throughout the *Anvil Galaxy* and the Republik had the strength of over 2,000 member worlds. Their weapons, sensors and computer systems lag generations behind the rest of the galaxy, and they seemed to be on the brink of utter collapse until the coup and the advent of the *Tachyonic Antitelephone* (see below). The addition of new systems and new shipbuilding technologies from the distant future has breathed new life into the once moribund Argosy, although it remains to be seen if the Gulgans actually have the spirit and drive to make anything out of this technological wind-fall.

Since the majority of their ships are more antiquated and fragile than most, Gulgans fleet doctrine is based on the idea of overwhelming force. There is security in numbers, and this doctrine ties directly into the innate Gulgans fear of being attacked. One will *never* find a lone Gulgans cruiser and even their patrol craft travel in groups of three or more. A typical defensive formation includes *1D4 Bindas* cruisers and *1D6 patrol ships* per enemy ship of destroyer class or larger. An attack formation, which hasn't been seen or used in 300 years, is composed of *2D6 Bindas*, each with an escort of *2D6 Auntins*. There may or may not be one of the new *Slynor Command Ships* in the mix, depending on the size of the attack.

## Gulgans Republik Ranks

The ranks of the Argosy and of the Republikan/Auxiliary Guard are starkly divided along racial lines. Simply put, Gulgans are officers and everyone else is not. Non-Gulgans can never rise higher in rank than that of *Torno*, a position best described as "departmental supervisor." With their innate ability to lead and organize others, the Gulgans see this as the most natural arrangement in the world. Those dissatisfied with the way the Republik is being run see it as the pinnacle of Gulgans arrogance.

It should also be noted that the Republikan Guard, which is composed entirely of Gulgans, is a very poor fighting force. Even though they are armed with the very best of *Naruni weaponry*, the Gulgans, as a race, are poor warriors. It is the **Auxiliary Guard**, made up of all other manner of races, which does the actual fighting. It is also the Auxiliary Guard that is armed with older, somewhat outdated weapons and equipment, which means they have to fight twice as hard as most other armies in the Three Galaxies to make up for the technological gap.

<u>Gulgans Rank</u>	<u>Human Equivalent</u>
Gaus	General/Captain
Jelia	Colonel/Commander
Per	Major/Lt. Commander
Frias	Captain/Lieutenant
<u>Non-Gulgans Rank</u>	<u>Human Equivalent</u>
Torno	Supervisor
Verron	Specialist
Tya	Worker

The ranks of Torno, Verron, and Tya are best considered to be *noncoms* or *enlisted men*, and they will always be of a non-Gulgans species. A **Torno** is about equal in rank to a Ser-

geant; they are trusted and experienced specialists in some particular field of work, such as engineering, communications, weapon systems, sensor reading, and the like. If involved in ground combat, a Torno will be in charge of a platoon of soldiers.

A person who is a **Verron** is roughly the same as a Corporal. The rank of Verron means that this person is a specialist in some particular field, much like a Torno. A Verron does not have the authority to oversee a large group, nor can he make reports to a Gulgans of *Frias rank* or higher. In the event that a Torno is killed or incapacitated, the Verron assumes the rank of Torno. *Zebuloid* gunners and pilots always begin at this rank because of their value to the Republik.

Finally, there are the **Tya**, the lowest of the enlisted ranks, roughly equivalent to a recruit or private, although "worker" is actually the best translation of the word. They are raw recruits, fresh out of basic training, and essentially do all the grunt work and heavy lifting that the higher enlisted ranks can't be bothered with.

## Gulgans Uniforms and Colors

The predominant color scheme of the Argosy seems to be yellow and black. Gulgans officers usually wear gold colored, segmented plate armor over a light M.D.C. material uniform. Large, baroque rank insignia and commendation pins are prominently displayed on the right breast. As an officer gains in rank, and his value to the Republik increases, extra shoulder plates and thicker back-pieces are added for each promotion. Gulgans Gauses can have so many plates on their backs and shoulders that they resemble heavily armored turtles.

**Members of the Auxiliary Guard** wear colors similar to those of the Republikan Guard, but their armor is saffron colored and always lighter and of lesser quality than that of their Gulgans superiors. Their rank insignia are small, and commendations are few and far between for this mostly overlooked and underpaid fighting force.

## Gulgans Republikan Technology

The Gulgans Republik is currently an odd mix of cutting edge weaponry and antiquated technology. The newer ships, such as the *Slynor* and the upgraded *Bindas*, fly side by side with vessels like the *Auntin*, a ship which is the same today as it was *300 years ago*. Argosy ships tend to have organic silhouettes, vaguely resembling manta or sting rays, with soft lines and rounded corners. Xenologists and shipwrights from other races suggest this is due to the Gulgans' aquatic ancestry. The ships are heavily armored, which takes away somewhat from their graceful curves, and are typically painted in dark, flat shades of mottled greens and blues with white highlights.

The Argosy's energy and projectile weapons are mostly equal to the galactic standard. Projectile weapons are the typical rail and GR cannons, but for energy weapons, Gulgans use a variation on the HI-Laser that they call a "Disruptor Cannon." Disruptors seem to be a combination of laser and plasma weaponry, and instead of burning precise holes in armor they tend to disintegrate large patches of material around the point of impact. This makes for an ugly and difficult to repair hole, as the

disruptor tends to weaken materials directly around the disintegrated area.

Republik missile technology is woefully outdated, and the Argosy fields no smart munitions. They will have the standard +3 to strike, but the Republik lacks the ability to build anything more accurate. Likewise, their computer systems are like something from another age (imagine a spaceship built today, but run on a 386 processor). Automated gunnery programs are all but non-existent. Instead, the Golgan space fleet has evolved to encompass manpower whenever and wherever possible, and postings aboard a Golgan ship are very specialized and typically decided by a spacer's race.

## A Notable Argosy Facility

### Tachyonic Antitelephone

#### Mekanik

As the *Kultural Revolution* begins attacking its list of targets, the other power blocs in the *Anvil Galaxy* are all wondering the same thing, how in the hell did the resource-poor Gulgans manage to upgrade their fleet with so much new technology in such a short period of time? The Gulgans' natural paranoia means that, ultimately, they trust only their own race, which rules out a technological alliance with some other power. No intelligence agency has yet uncovered the truth, and few would believe it even if the answer was revealed. The technology is, in fact, entirely of Golgan design, from *four hundred years in the future*. The key to this knowledge was the invention of the Tachyonic Antitelephone.

The mathematics that allow the **Tachyonic Antitelephone** to work were developed almost entirely by the robots of *Mekanik*. Their theory goes like this: when you jiggle an electron it makes a radio wave. That wave then travels outwards into space. As it travels through space, it is also traveling outwards in time, leaving its source and traveling to a receiver in the future. If, as physics dictates, there is an equal and opposite reaction for everything in the universe, then that jiggled electron is also sending a kind of *inverse wave*. The inverse wave does the opposite of the original, it travels backward through time, carrying with it a message from the future. This allows a weapon schematic completed four centuries from today to be "faxed" *back in time* and used by the Gulgans living in the present.

The very idea of gaining information and intelligence from the future is something that, until the advent of the Antitelephone, has been the stuff of fantasy. It is generally accepted as a fact, even by the magic-using cultures of the Three Galaxies, that the past *cannot* be altered. One cannot travel *back* in time, nor change what has already happened. With the Tachyonic Antitelephone, however, the Gulgans seem to have found a loophole in the physics of the universe. They are not changing the past, but merely altering the future to one more preferable to the Republik.

The *Antitelephone* is not without its limitations. First, the conversation is decidedly one sided, the present-day Golgan get whatever the future Gulgans feel like sending. Second, although they should be able to receive messages from any point in the future, they seem to have been doing almost all of their "talking" with the same Gulgans 400 years away. These future

Gulgans have not been very forthcoming with descriptions of what their life is like. The directors of the Antitelephone believe that four centuries from now, the Republik is either in complete shambles or does not exist at all. They suspect that the future Gulgans are directing the present-day Gulgans in ways to avoid this fate.

The future Gulgans often send intelligence of things that have happened to them, but have yet to occur in the present. This allows the Argosy to prepare for large battles before they are fought. However, with every altered present event, the future is also altered. Thanks to this, the information is not always correct, as it might have applied to an event that will no longer happen. Furthermore, since many of the Golgan combat operations are taking place far from Mechanik, any intelligence gained through the Antitelephone can take days to reach far-flung troops. By the time the future information arrives to those fighting on the front lines, it may be too late to alter events for the better. Either that, or the field commanders may have already undertaken action that renders the information useless, as a new future has already been created.



## A Notable Argosy Commander

### Gaus Elia Binjo

**First Citizen of the Republik,  
Leader of the *Kultural Revolution***

Gaus Elia Binjo is finally doing what he was groomed his entire life to do, leading the Republik to a new era of greatness and security. When he was born, Elia Binjo was immediately identified as having all four heightened Golgan senses. For the first fifty years of his life, he was educated in the finest state-run private schools, and trained in the art of rhetoric and political maneuverings. It was assumed by all that he would eventually serve on, and perhaps even lead, the Council Politik. It was a shock to people in his elevated circles then, when he joined the Republikan Guard at his mother's urging.

His education and ability to command others should have allowed him to quickly rise to the rank of Gaus. Commendations and promotions came painfully slow however, for when an army never sees any action, promotions are hard to come by. Therefore, Elia and a dozen select others were organized into a special “investigative task force” by his mother, the head of the *Council Scientifik*, and placed under the command of that august body. Binjo’s task force was sent on missions of study and exploration far from the borders of the Republik, bringing them into contact with all manner of friendly and hostile alien races. By the time he turned 90, Binjo had seen more combat than any member of the Republikan Guard, and he and his underlings were a small, but finely honed fighting force.

Upon returning to the Republik, Binjo’s group came to see that the Republik was disintegrating through its own apathy and inaction. With every world that left, the buffer zone around Gologo Maxus grew smaller and smaller. Binjo came to believe that action must be taken to save the Republik from itself, even if it meant a complete societal overhaul. It was then that the *Kultural Revolution* was born.

Binjo’s colleagues, now calling themselves **the Assemblage**, began to seek out like-minded Gulgans to help them in their cause. Their numbers quickly grew into a well-organized underground movement. When the robots of Mekanik surprised everyone by presenting themselves to the Council, Binjo saw his chance. It was Binjo and the Assemblage who secretly entered into talks with the robots, asking what they could provide in return for full membership and protection. One hundred days later, with construction of the Tachyonic Antitelephone already underway and the Council Politik still unsure what to do, the Assemblage quietly and bloodlessly overthrew the Council and announced that they were now taking over as the ruling party.

So far, the Revolution has made great strides in shaping up the Republik and her armed forces. Using the future information from the Antitelephone, Gaus Binjo has delivered on what he promised, that the Republik would rebuild its crumbling buffer zone and regain its lost glory. The majority of Gulgans see this as a new golden age, and are going along with the militocracy for the time being. However, Binjo is playing a desperate gamble of which few are fully aware. The coffers of the Republik have been almost entirely emptied with the construction of the enhanced Argosy, and should the Revolution be somehow thwarted, their entire society will collapse into economic anarchy. Binjo knows that the Republik was doomed anyway, and that he only has this one shot to save it. He has become increasingly dependent on the information and intelligence provided him by the future Gulgans, to the point where he often cannot make an important decision by himself. His overreliance on the Tachyonic Antitelephone may well prove to be the Revolution’s undoing.

## Guas Binjo – Quick Stats

**Alignment:** Scrupulous.

**O.C.C./Experience Level:** 10th level Republikan Officer (equal to the Scholar O.C.C.).

**Attributes:** I.Q. 17, M.E. 13, M.A. 15, P.S. 13, P.P. 8, P.E. 11, P.B. 6, Spd 10.

**Hand to Hand:** Basic.

**Special Powers:** Has all four enhanced Golgan senses (see **Dimension Book 6: Anvil Galaxy**, page 57).

**Notes:** Can often be found living aboard one of the new Slynor Command Ships, and is growing ever more dependant on the Tachyonic Antitelephone to direct the course of the Republik. If the situation continues, the Republik will become a *chronocracy* that is, in effect, ruled by Gulgans from 400 years in the future. Gaus Binjo enjoys music, even though he cannot sing a note and is totally tone deaf.

# Notable Argosy Ships

## RAJCF-V4.5 *Jesstra*

### Multi-Role Aerospace Fighter

Never ones to dirty themselves with the actual *act* of war, the Gulgans built the *Jesstra* fighter for use by their multi-tasking *Zebuloid* allies. Designed from the ground up to take advantage of the *Zebuloids*’ unique physiology and lightning reflexes, the light and agile *Jesstra* is the primary force projection fighter of the Golgan fleet. Light and agile with a delta winged, lifting body fuselage, a well piloted *Jesstra* is, on average, four times more lethal and efficient than an equivalent fighter from the CAF or TGE. These fighters are still relatively new, and hideously expensive due to their specialized controls and avionics. As such, they’ve been a rare sight so far in the Three Galaxies.

**Model Type:** RAJCF-V4.5 *Jesstra*.

**Class:** One seat, multi-role aerospace fighter.

**Crew:** One.

#### M.D.C by Location:

Pulse Disruptors (2) – 40 each

Missile Bays (4) – 25 each

Reinforced Pilot’s Compartment – 125

\* Fusion Turbines (2) – 120 each

\*\* Wings (2) – 150 each

\*\*\* Main Body – 300

\* Destroying one turbine reduces the fighter’s performance by 50%. If the fighter is in an atmosphere, it can no longer achieve escape velocity.

\*\* Destroying a wing causes the vehicle to crash from loss of control if it is flying in an atmosphere. Destroying one or both of the fighter’s wings in space means the fighter cannot enter an atmosphere, and imposes a -2 penalty to dodge per wing.

\*\*\* Depleting the M.D.C. of the Main Body destroys the aerospace vessel.

#### Speed:

Atmosphere: 3,805 mph (6,088 km or Mach 5).

Sub-Light: 11,415 mph (18,264 km or Mach 15).

FTL: None, *Jesstra* fighters are not FTL capable.

#### Statistical Data:

Height: 7 feet (2.1 meters).

Length: 20 feet (6 meters).

Wingspan: 40 feet (12 meters).



Weight: 16.5 tons.

Cargo: A small compartment for a survival kit and a side arm.

Power System: One light fusion reactor powering two fusion turbines that deliver thrust through vectored thrust nozzles and numerous attitude thrusters.

Construction Cost: 8 million credits.

### Weapon Systems:

**1. Linked Pulse Disruptors:** Mounted as a pair along the dorsal side of the fuselage and pointing forward above the wing roots, these are the Jesstra's main anti-fighter weapons. They fire rapid pulses of unique HI-Laser energy and give the Jesstra excellent offensive abilities.

Primary Purpose: Anti-Fighter.

Secondary Purpose: Anti-Missile.

Weight: Not applicable, part of the fighter's fuselage.

Range: 2 miles (3.2 km) in space, half in an atmosphere.

Mega-Damage: 1D6x10 M.D. per single blast, 2D6x10 M.D. for a dual blast at the point of impact, then one quarter the damage to everything within 10 feet (3 m).

Rate of Fire: Equal to the number of hand to hand attacks of the Zebuloid pilot, that's 10-14 times per melee!

Payload: Effectively unlimited.

**2. Missiles:** Each of the Jesstra's wings mounts two recessed hardpoints close to the wing roots. These hard points can carry four medium-range or eight short-range missiles per wing.

Primary Purpose: Anti-Fighter.

Secondary Purpose: Anti-Ship.

Weight: Not applicable, the hardpoints are part of the fighter's fuselage. Missiles vary in weight per short- or medium-range missiles.

Range: 40 miles (64 km) for medium-range missiles.

Mega-Damage: Varies by warhead, short- or medium-range missiles.

Rate of Fire: One at a time, or in volleys of 2, 4 or 8.

Payload: Four medium-range missiles, or eight short-range.

**3. Bonuses:** Thanks to the specialized avionics and maneuvering system of the Jesstra, the Zebuloid pilots are +2 to strike and +3 to dodge while flying.

## Haelra-Class Troop Shuttle

Even with the Argosy's astounding new upgrades, the Republican Guard still sees itself as being out-manned and out-gunned by its opponents. As such, it tends to overcompensate for this non-existent but perceived weakness by overwhelming targets with far more men and materiel than is necessary. The Haelra is a good example of this thinking, a combat shuttle designed to carry *150 soldiers* and a *Naruni Juggernaut* with the ability to outrun and outgun most other shuttles.

The Haelra is heavily armored, but lightly armed and must be escorted by fighters when breaching a planet's atmosphere. When fighter support is not available, the landing zone is first blasted from orbit to eliminate anti-aircraft sites and other opposing forces. Like most combat shuttles, the Haelra is shaped roughly like a box to maximize internal volume. The corners of

the hull are rounded, as is the Golgan style, and each mounts a massive and powerful frigate-class fusion engine. These four, side-mounted thrusters give the Haelra enormous lifting power, and it can reach escape velocity in just a few short minutes. While the engines give the shuttle incredible straight-line speed, the ship is not particularly agile and isn't much for turning.

**Model Type:** RAHCTS-V2.9 Tactical Troop Transport (Combat Shuttle).

**Ship Class:** Haelra Class.

**Ship's Complement:**

Ship's Crew: 11

Bridge: Six: Ship's Captain (1), Helm (1), Navigation (1), Comms/Sensors (1), Security (2).

General Operations: Five: Engineering (1), Cargo Masters (2), Weapon Systems (2).

Embarked Troops: 150 with an embarked Juggernaut tank, or 300 without.

Embarked Armor: One Naruni Juggernaut tank (optional).

**M.D.C. by Location:**

Disruptor Cannons (4) – 100 each

Reinforced Pilot's Compartment – 200

Door-Ramp (back) – 400

\* Engines (4) – 200 each

\*\* Main Body – 2,500

\* Destroying even one engine cripples the Haelra, as its design requires all four engines working in balance. The loss of one thruster requires a piloting roll at -12% to either hover sta-

tionary or land. The loss of more than one engine means the shuttle crashes! -36% on piloting skill to make a successful crash landing.

\*\* Depleting the M.D.C. of the main body knocks out propulsion and all systems, setting the shuttle adrift in space or causing it to crash if flying in an atmosphere. Even one point below zero completely destroys the vessel. If destroyed while approaching a planet, the shuttle's passengers and crew are destroyed upon entering the atmosphere!

**Speed:**

Atmosphere: 1,200 mph (1,920 km or Mach 1.5).

FTL: Haelra shuttles are not FTL capable.

Sub-Light: 4,566 mph (7,305.6 km or Mach 6).

Range: Limited only by supplies. The fusion reactor carries enough fuel to operate the ship at full readiness for 50 years, but shipboard stores are only good for about six days of constant deployment with full crew and complement.

**Statistical Data:**

Length: 240 feet (73 m).

Beam: 50 feet (15.2 m).

Height: 70 feet (21.3 m).

Mass: 1,200 tons fully loaded.

Cargo: Either 150 combat ready troops with equipment and a Naruni Juggernaut tank, or 300 troops without. Optionally, the Haelra can carry 500 tons of palletized cargo.

Power System: Nuclear fusion engines; life of about 5 years.

Market Cost: 90 million credits.

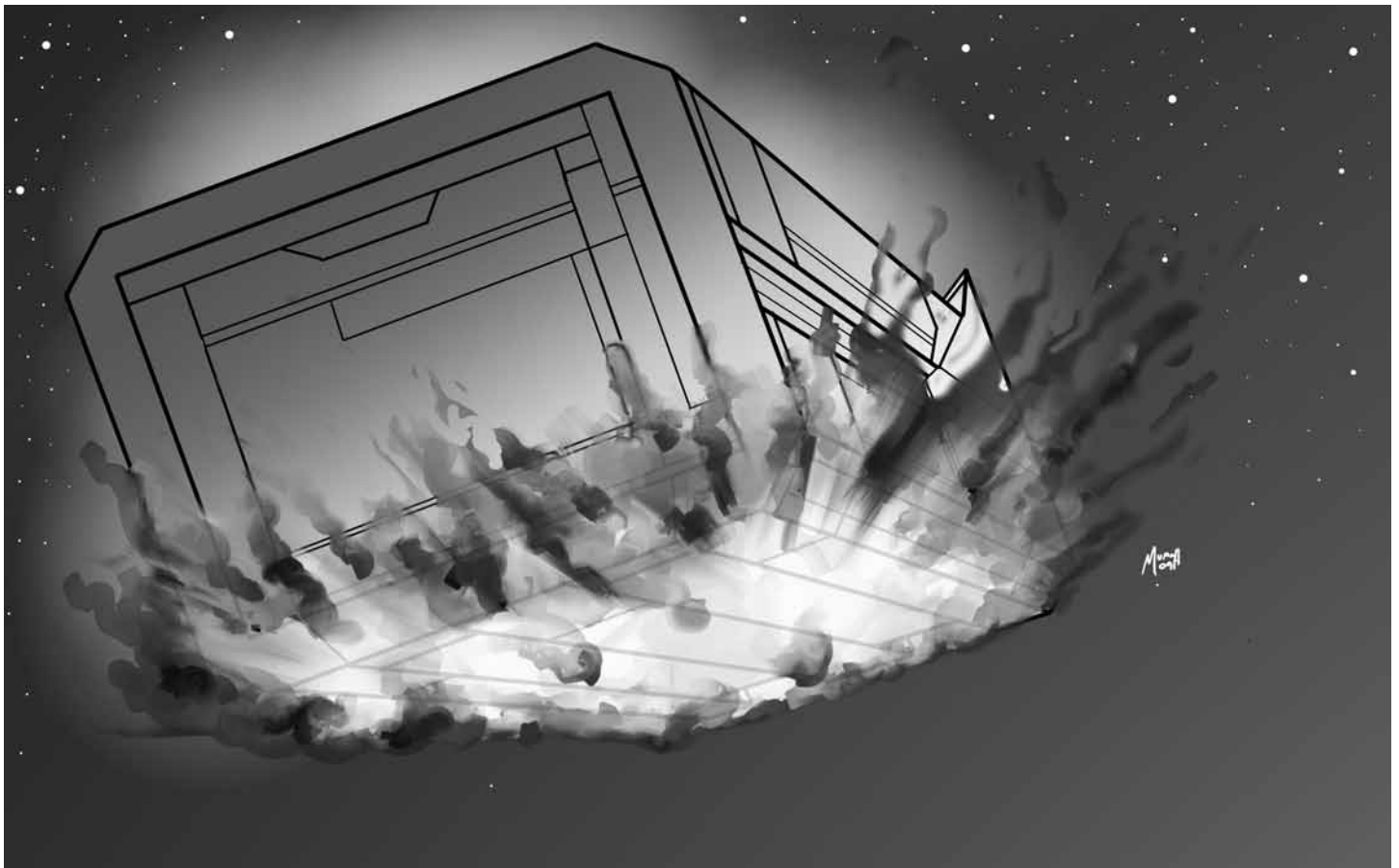



## Weapon Systems:

**1. Disruptor Cannons (4):** These weapons are mounted amidships in retractable ball turrets, two dorsal, and two ventral. The turrets have a 180-degree arc of fire.

Primary Purpose: Anti-Fighter.

Secondary Purpose: Anti-Missile.

Weight: Not applicable, part of the ship's hull.

Range: 2 miles (3.2 km) in space, or 4,000 feet (1219 m) in an atmosphere.

Mega-Damage: 1D4x10 M.D. per single blast at the point of impact, then 25% damage to everything within 6 feet (1.8 m). Multiple turrets can be brought to bear on single targets.

Rate of Fire: Equal to the gunners' number of attacks (usually 4-5).

Payload: Unlimited.

**2. Ship's Systems of Note:** Tactical life support, escape capsules for all crew and embarked troops.

## Bindas-Class Cruiser

Bindas-class cruisers are the workhorses of the Golgan Navy. Tried and true, the Bindas is a ship that has been in service in one form or another for nearly 1,000 years. It carries six banks of HI-Laser disruptors as its primary cannons, and a single, aft mounted, high-powered disruptor cannon for discouraging pursuers. Many Xenologists find it interesting that the Golgan ships have been built with some of their most potent weaponry firing aft. The prevailing theory is that, on some subconscious level, the Golgans expect they will have to retreat, and want their greatest firepower in a position to cover their exit from the field of battle. If so, they are unique among the major cultures in the Three Galaxies for this kind of thinking.

**Model Type:** RABCC-V8.0 Heavy Cruiser (CH).

**Class:** Bindas Class.

**Ship's Complement:**

Ship's Crew: 770 (220 officers, 550 enlisted).

Bridge: Ship's Captain (1), Ship's Executive Officer (1), Helm (5), Navigation (5), Comms/Sensors (5), FTL Ops (5), Security (10 Republikan Guard in light battle armor and armed with NE-300 Stutterers).

Combat Information Center (CIC): Golgan Jelja (1), Comms (5), Ship's Weapons and Fire Control (15), Security (10 Republikan Guard in light battle armor and armed with NE-300 Stutterers).

General Operations: Engineering (180), Medical (100), Ship's Security (125), Internal Communications (75), General Enlisted (227).

Embarked Troops: 375.

Zebuloid Aviators: None.

**M.D.C. By Location:**

Interior Bulkheads per 10 feet (3 m) – 50

Interior Hatches – 65 each



Exterior Hatches – 95 each

Mega-Disruptor Cannon (1, aft) – 1,000

Siege Disruptor Cannons (6 batteries of 2 each) – 600 each battery

Nuclear Torpedo Launchers (2; 1 forward, 1 aft) – 800 each

Particle Beam Cannons (4) – 150 each

Forward Hull Section (1/3) – 5,000

\* Midships Hull Section (1/3) – 5,000

\*\* Aft Hull Section (1/3) – 8,000

\*\*\* Hull per 40 feet (12.2 m) – 85

Variable Force Fields – 6,000 per side (36,000 in total)

\* Destroying the midships hull section destroys the CIC and eliminates all weapons and fire controls. This renders the ship flyable but unable to fight.

\*\* Destroying the aft hull section destroys the engines, setting the ship adrift.

\*\*\* Punching holes in the hull causes the damage control system to automatically seal off whatever compartment has been exposed to vacuum.

#### **Speed:**

Atmosphere: Bindas cruisers, despite their bulk, can muster an impressive 850 mph (1,360 km or Mach 1.2) in atmosphere.

FTL: 6 light-years per hour.

Sub-Light: 9,132 mph (14,611.2 km or Mach 12).

Range: Limited only by supplies. The fusion reactors carry enough fuel to operate the ship at full readiness for 30 years, but shipboard stores are only good for fourteen months of constant deployment with full crew and complement.

#### **Statistical Data:**

Length: 1,220 feet (372 m).

Height: 190 feet (58 m).

Beam: 630 feet (192 m).

Mass: 250,000 metric tons.

Power System: Two Golgan GG Mk. VII sub-capital fusion reactors powering one bank of four thrusters.

Cargo: Up to 50,000 tons of cargo in addition to standard complement of stores and ammunition.

Market Cost: 6.5 billion credits to construct.

#### **Weapon Systems:**

**1. Mega-Disruptor Cannon (1, aft/rear):** Mounted in a heavily shielded ball turret between the thruster cones, this massive, double barreled disruptor cannon fires directly aft and provides strong covering fire for rapid withdrawals. The turret has a 360-degree rotation and the barrels have a 60 degree arc of fire.

Primary Purpose: Anti-Ship.

Secondary Purpose: Defense.

Weight: Not applicable, part of the ship's hull.

Range: 70 miles (112 km) in space and 6 miles (9.6 km) in an atmosphere.

Mega-Damage: 1D4x1000 M.D. at the point of impact, then 25% damage to everything within 60 feet (18.3 m).

Rate of Fire: Maximum of two times per melee.

Payload: Effectively unlimited.

**2. Siege Disruptor Cannon Batteries (6):** These powerful energy weapons are the primary anti-ship weapons of the Bindas. The double-barreled batteries are mounted in heavily armored turrets with a 180 degree rotation, and the barrels have a 60 degree arc of fire. This weapon system has half the normal penalties to hit fighters and small targets.

Primary Purpose: Anti-Ship.

Secondary Purpose: Anti-Installation.

Weight: Not applicable, part of the ship's hull.

Range: 14 miles (22.4 km) in space, 5 miles (8 km) in an atmosphere.

Mega-Damage: 2D4x100 M.D. per cannon or a double blast that does 4D4x100 M.D. at the point of impact, plus 25% damage to everything within 30 feet (9.1 m).

Rate of Fire: Each battery can fire four times per melee round.

Payload: Effectively unlimited.

#### **3. Nuclear Torpedo Launchers (2, 1 forward and 1 aft):**

Mounted fore and aft along the ventral hull of the ship, these multi-tube torpedo launchers have an incredibly high rate of fire, and can saturate a large area of space with warheads in a matter of minutes.

Primary Purpose: Anti-Ship.

Secondary Purpose: Anti-Installation.

Weight: Not applicable, the launchers are part of the ship's hull. Each torpedo weighs roughly 12 tons.

Range: 1,000 miles (1,600 km).

Mega-Damage: Ion Torpedoes (Fusion warheads): 2D6x100 M.D. each.

Rate of Fire: One at a time or in volleys of 20 per launcher, per melee, for a maximum of 40 torpedoes per melee round. Launchers are reloaded in the same melee and can be fired again on the next.

Payload: 2,000 torpedoes (1,000 per launcher), with an additional 2,000 torpedoes carried aboard in an armored magazine.

**4. Particle Beam Cannons (4):** These rapid-fire particle cannons make up the Bindas' point defense system. They are mounted port and starboard, along the center line of the ship, and have an incredible rate of fire and respectable stopping power.

Primary Purpose: Anti-Fighter.

Secondary Purpose: Anti-Missile.

Weight: Not applicable, part of the ship's hull.

Range: 3 miles (4.8 km) in space, or one mile (1.6 km) in an atmosphere.

Mega-Damage: 2D4x10 M.D. per blast.

Rate of Fire: Equal to the number of hand to hand attacks of the gunner (usually 4-5). One or two Zebuloids usually share this job, in which case the number of blasts per melee (per cannon) is anywhere from 3 if a lone gunner, to 7 if two Zebuloids share the job, or 10-14 if a dedicated gunner is used in each turret.

Payload: Effectively unlimited.

**5. Ship's Systems of Note:** Tactical life support, IFF/command and control systems, escape capsules for all crew.

## **Sylnor-Class Command Ship**

The imposing Sylnor-class battleship is the newest addition to the Golgan Argosy. Other navies who encounter the Sylnor for the first time have trouble accepting that it is a Golgan ship at all. It looks too new, its weapons are too powerful, and its hull is too tough. The Sylnor is indeed a fully Golgan design, built using information and technology gained through the Tachyonic Antitelephone. In essence, it is a ship from 400 years in the future.

In appearance, the Sylnor is just a large Bindas, wide and flat, and looks vaguely like a manta ray. The new ship is easily six times the size of the Bindas cruiser, having nearly the same mass as the CAF Protector-class battleships. Its weapons are very advanced, and include multiple banks of siege disruptors, as well as the ability to lay down obscene numbers of nuclear



torpedoes. Like the Bindas, its most powerful weapon is mounted in the rear.

Thanks to their allies on *Mekanik*, the Republikan Argosy is set to unveil over 5,000 of these vessels. Without the assistance of vast numbers of robots, the fleet would never have been able to assemble so many ships in such a short span of time. But the achievement has not been without great cost. Now that the fleet is fully upgraded and ready to re-conquer those planets lost to the secessionists, the Rebulik is almost totally out of cash. Should the *Kultural Revolution* not work out in the Golgans' favor, the Rebulik will be utterly bankrupt.

The Sylnor were first deployed against a *Naruni Repo Fleet* that came to collect on some overdue bills, and in the liberation of *Kablinka* from the TGE. Both operations were phenomenal successes, with the tradeoff being that both the TGE and Naruni Enterprises have now become openly hostile towards the Republik.

**Model Type:** RASBS-V1.0 Battleship.

**Class:** Sylnor Class.

**Ship's Complement:**

Ship's Crew: 3,500 (1,500 officers, 2,000 enlisted).

Bridge: Ship's Captain (1), Ship's Executive Officer (1), Helm (10), Navigation (10), Comms/Sensors (20), FTL Ops (10), Security (10 Republikan Guard in light battle armor and armed with NE-300 Stutterers).

Combat Information Center (CIC): Golgan Jelja (1, in charge of troop deployment, strategy and tactics), Military Advisory Team (10), Commander of Aerospace Group (1, CAG, commander of ship's aerospace wing), Ground Forces Commander (1, commander of ship's planetary assault group),

Comms (10), Ship's Weapons and Fire Control (30), Security (10 Republikan Guard in light battle armor and armed with NE-300 Stutterers).

General Operations: Engineering (300), Medical (400), Flight Operations (500), Ship's Security (250), Internal Communications (150), General Enlisted (1,775).

Republikan/Auxiliary Guard: 3,500 (850 officers, 2,650 enlisted).

Zebuloid Aviators: 264, with 132 in reserve.

**Aerospace Group:**

Aerospace Fighters: 132 total.

RAJCF-V4.5 Jesstra Multi-Role Fighters: 96 (4 squadrons of 24 ships each).

RAHCTS-V2.9 Haelra Assault Shuttles: 36 (6 squadrons of 6 ships each).

**Planetary Assault Group:**

Naruni J-2 Juggernaut Tanks: 50

**M.D.C. by Location:**

Interior Bulkheads per 10 feet (3 m) – 50

Interior Hatches – 65 each

Exterior Hatches – 110 each

FM14 Super-Cannon (mounted aft) – 5,000

Mega Disruptor Cannons (4) – 1,000 each

Siege Disruptor Cannons (12 batteries of 2 each) – 600 each battery

Nuclear Torpedo Launchers (6, 3 forward / 3 aft) – 800 each

Particle Beam Cannons (24) – 150 each

Forward Hull Section (1/3) – 70,000

\* Midships Hull Section (1/3) – 70,000

\*\* Aft Hull Section (1/3) – 90,000

\*\*\* Hull per 40 feet (12.2 m) – 150

Variable Force Fields – 15,000 per side (90,000 in total)

\* Destroying the midships hull section destroys the CIC and eliminates all weapons and fire controls. This renders the ship flyable but unable to fight.

\*\* Destroying the aft hull section destroys the engines, setting the ship adrift.

\*\*\* Punching holes in the hull causes the damage control system to automatically seal off whatever compartment has been exposed to vacuum.

### Speed:

Atmosphere: Thanks to their mass, Slynor-class battleships cannot enter atmosphere.

Sub-Light: 7,610 mph (12,176 km or Mach 10).

FTL: 6 light-years per hour.

Maximum Range: Limited only by supplies. The fusion reactors carry enough fuel to operate the ship at full readiness for 30 years, but shipboard stores are only good for two years of constant deployment with full crew and complement.

### Statistical Data:

Length: 4,000 feet (1,219.2 m).

Height: 600 feet (183 m).

Beam: 800 feet (244 m).

Mass: 20 million tons fully loaded.

Power System: Four GG-Mk. IX capital-class fusion reactors powering four banks of four capital-class thrusters.

Cargo: The Slynor can carry 500,000 tons in addition to standard complement of stores and ammunition.

Market Cost: 200 billion credits to construct.

### Weapon Systems:

**1. F-Mk. 14 Super-Cannon:** The Super-Cannon fires an intense beam whose particles are in such a state of excitement that they break down into heavy protons. When the beam comes into contact with other matter or energy fields, it causes them to dissolve into subatomic components, essentially atomizing them. Observers aren't certain if this weapon is some kind of new disruptor cannon, which the Golgans are famous for, or a highly advanced plasma weapon. Both suppositions are largely correct, as the F-Mk. 14 is a heavy disruptor that has the benefit of 400 years of technological advancement. Having been the first to face it in combat, the *Kreeghor* of the TGE have dubbed this weapon "a disintegration beam." It is mounted in an aft ball turret, in much the same position as the smaller one mounted on the Bindas, and can fire at any target under, above, or directly behind (aft) of the ship.

Primary Purpose: Anti-Ship.

Secondary Purpose: Defense.

Weight: Not applicable, part of the ship's hull.

Range: 1,000 miles (1,600 km) in space and 33 miles (52.8 km) in an atmosphere.

Mega-Damage: 3D6x1,000 M.D. at the point of impact, plus 25% damage to everything within 120 feet (36 m).

Rate of Fire: Maximum of once per melee.

Payload: Effectively unlimited.

**2. Mega-Disruptor Cannons (4):** These weapons are the Slynor's primary anti-ship weapons, and can hull most small sub-capitals in one or two shots. Unlike those mounted on the Bindas cruisers, these weapons are made to fire at targets in front of, and to the sides of, the ship. Again, they are in ball turrets, with two on the dorsal and two on the ventral sides of the ship. All four can be fired at one target provided it is big enough, cruiser-size or larger, and that it is directly in front of the Slynor.

Primary Purpose: Anti-Ship.

Secondary Purpose: Anti-Installation.

Weight: Not applicable, part of the ship's hull.

Range: 70 miles (112 km) in space and 6 miles (9.6 km) in an atmosphere.

Mega-Damage: 1D4x1,000 M.D. per cannon at the point of impact, plus 25% damage to everything within 60 feet (18.3 m).

Rate of Fire: Maximum of two times per melee per cannon.

Payload: Effectively unlimited.

**3. Siege Disruptor Cannons (12 batteries of 2 each):** The Slynor carries twice the number of disruptors as the Bindas. Both cannons in a battery can be linked or can be fired separately (usually linked). This weapon system has half the normal penalties to hit fighters and small targets.

Primary Purpose: Anti-ship.

Secondary Purpose: Anti-Installation.

Weight: Not applicable, part of the ship's hull.

Range: 14 miles (22.4 km) in space, 5 miles (8 km) in an atmosphere.

Mega-Damage: 2D4x100 M.D. per cannon or a double blast that does 4D4x100 M.D. at the point of impact, then ¼ damage to everything within 30 feet (9.1 m).

Rate of Fire: Each battery may fire up to four times per melee.

Payload: Effectively unlimited.

**4. Nuclear Torpedo Launchers (6):** The Slynor mounts six torpedo launchers, three forward and three aft, and like the Bindas, can fill space with deadly Ion Torpedoes in a matter of seconds.

Primary Purpose: Anti-Ship.

Secondary Purpose: Anti-Installation.

Weight: Not applicable, the launchers are part of the ship's hull. The torpedoes weigh 10 tons each.

Range: 1,000 miles (1,600 km).

Mega-Damage: 2D6x100 M.D. per Ion Torpedo.

Rate of Fire: One at a time or in volleys of 20 per launcher, per melee round, for a maximum of 120 torpedoes per melee. Launchers are reloaded in the same melee and can be fired again on the next.

Payload: 6,000 torpedoes in total (1,000 per launcher).

# Naruni Enterprises

**5. Quantum Tracking Mine Dispenser:** Mounted in the aft of the ship below the engines, these two letter-box style launchers are configured to deploy special Quantum Tracking Mines. QT mines resemble small torpedoes and are essentially a miniaturized Contra-Gravity engine, a crude guidance system and CG sensor package and a high-yield ion warhead. Once deployed, the mines will sit in space, silently scanning their surroundings until they detect a ship powered by a CG drive. Once the CG wake is detected, the mines become active and immediately home in on their prey. The mines have a sensor range of 1,000 miles (1,600 km), fly at 7,610 mph (12,176 km or Mach 10), are +2 to strike and have two attacks per melee.

Primary Purpose: Area Denial.

Secondary Purpose: Anti-Ship.

Weight: Not applicable, the mine dispensers are part of the ship's hull. Each mine weighs 12 tons.

Range: QT Mines are powered by a small anti-matter battery with a life of about five years. They can wait nearly the entire 5 years at full readiness, and will fly until they hit their target or are shot down.

Mega-Damage: 2D4x100 M.D. to everything within the first 200 feet (61 m) of impact, and 2D4x10 M.D. to an additional 200 feet (61 m) beyond the initial blast site.

Rate of Fire: The mine dispensers can lay a mine every 7.5 seconds.

Payload: 2,400 mines.

**6. Particle Beam Cannons (24):** These point defense particle cannons are spread around the ship's hull and provide an adequate screen against incoming fighters, shuttlecraft and missiles.

Primary Purpose: Point Defense.

Secondary Purpose: Anti-Missile.

Weight: Not applicable, part of the ship's hull.

Range: 3 miles (4.8 km) in space, or one mile (1.6 km) in an atmosphere.

Mega-Damage: 2D4x10 M.D. per blast.

Rate of Fire: Equal to the number of hand to hand attacks of the gunner, typically 4-5, but if a dedicated Zebuloid gunner is used in each turret, the weapon has 10-14 attacks per melee.

Payload: Effectively unlimited.

**7. ECM Scrambling Field:** The Slynor are equipped with a kind of ionized hull shielding that interferes with conventional scanners. Attempts to read sensors or fix weapon systems on the ship suffer a penalty of -15%, and guided missiles are -2 to lock onto the ship.

**8. Ship's Systems of Note:** Tactical life support, IFF/command and control systems, escape capsules for all crew.

**Naruni Enterprises (NE)** doesn't play by the same rules as anyone else, nor do they function like any of the other trans-galactic powers within the Three Galaxies. Arguably, that is exactly how they got to become a Megaversal power, and how they remain one in the face of intense competition.

Unlike other galactic civilizations, the ultimate goal of the True Naruni – the supernatural beings who founded, own and run Naruni Enterprises – is to make money, which in itself is very unusual for supernatural beings. They only peripherally care about power or conquest, and acquisition of territory is only a means to make more money. Indentured servants and slave labor are quickly put to work in the company's factories, where their insultingly low wages help to improve NE's bottom line. The only reason to engage in scientific research is to create the best product possible, thereby burying the competition. Why the True Naruni are so mercenary and driven, and seem to feel the need to amass incalculable sums of money is unknown, but it is the motivation behind most everything they do.

The instrument they have built over millennia so that they may achieve this goal is the intergalactic conglomerate known in the Three Galaxies – and in many other galaxies and dimensions – as **Naruni Enterprises (NE)**. The company itself is so vast that it has evolved beyond being a mega-corporation, beyond being even a mundane political entity. In the Three Galaxies, Naruni Enterprises is a power bloc. In terms of technological ability, economic strength, and military might, it stands among giants like the *Consortium of Civilized Worlds (CCW)* and the *Transgalactic Empire (TGE)*, and actually, NE is probably several times larger and more technologically advanced. However, NE is NOT a political power and its leaders have no desire to be one. Naruni Enterprises maintains complete neutrality and is willing to work with EVERYONE – sort of.

You see, **Naruni Enterprises (NE)** is a cosmic retailer without peer. They specialize in arms dealing and are famous for the slogan, "Naruni Enterprises, we make war better," and only slightly less famous for the slogan, "Naruni Enterprises, we supply the Megaverse." Indeed, NE goods are practically omnipresent throughout the Three Galaxies. NE weapons, robots, power armor, spacecraft, vehicles, force fields, and much, much more, are found everywhere. Spacers, pirates, mercenaries, private armies, corporations and galactic nations all buy Naruni weapons and gear.

Looking to start a war? Naruni Enterprises can help you make that happen fast.

Need defense against an aggressor? Naruni Enterprises can provide what you need, when you need it.

Caught in an arms race? Let Naruni Enterprises help you cross the finish-line first.

Need tanks or giant robots to defend your border?

Looking for personal protection?

Do you want to build a space fleet?

A cargo fleet?

Need robots to work your factory?

No? Your needs are simpler? You need firearms and combat gear to supply your fledgling army or more powerful guns?

Naruni Enterprises can fill all your needs, and much more. “You can dream big when you have Naruni Enterprises at your side.” Another well known slogan.

Sometimes a purchaser will buy because Naruni technology is superior to their own. Sometimes they buy because Naruni Enterprises is expedient and the purchaser needs X *now*. Sometimes they buy just to supplement their own equipment and because NE are willing to sell to absolutely anyone. In fact, it is not uncommon to see both sides of a conflict armed with Naruni gear. This is still not enough for the True Naruni who run the company, and they continue to expand into new markets, growing larger every year, with no plans to stop until it has become an unstoppable intergalactic monopoly, even should that process take millennia.

It is important to stress that Naruni Enterprises does NOT offer mercenaries for hire, never takes sides and is happy to sell to both sides (and subdivisions within) any conflict. They never talk politics or take a side, not even to make a sale. NE sales representatives (mostly Uteni) are friendly, charming, but strictly business and supply weapons and equipment, regardless of who wants the gear or why, it’s just what Naruni Enterprises does. They have no concern for who might get hurt, that the status quo is shattered, or that millions of lives may perish as a result of their sale. They only seek to serve their client’s material needs, nothing more. Strangely enough, that has worked well for NE, because the people being attacked with NE weapons and starships can simply give Naruni Enterprises a call, and purchase their own arsenal of weapons and spacecraft to defend themselves or strike back. “Nothing personal, it’s only business” is not just a saying, it’s an axiom by which the company and its sales force live.

**Naruni Enterprises** is the framework under which a myriad of smaller companies and subsidiaries are found. “Smaller” is a subjective term, since these divisions make more annual profit than many planets. These subsidiaries are owned and controlled by the True Naruni, and include not just weapons and military hardware (although that is the “bread and butter” of the company), but also consumer electronics, music, videogames, tri-vision shows, children’s toys, clothing, domestic vehicles like hover cars and personal spacecraft, as well as commercial and military vehicles and spacecraft. From its top secret factory worlds, Naruni Enterprises manufactures and ships *whatever* people want and delivers to *wherever* they need it, and for that they need a space fleet.

## Pan-Galactic Consignment Fleet

The actual name for the NE shipping division is **Pan-Galactic Consignment**, but it is never called that. The fleet is synonymous with Naruni Enterprises, and consists of 5,000 massive vessels that are part battleship and part super-cargo carrier. The True Naruni do not feel the need to build anything smaller to move their wares, and it wouldn’t make any sense for the company to do so. Naruni Enterprises likes to sell huge volumes of goods to planetary governments. The more you buy, the steeper

the discount. Their stores and showrooms are massive complexes, filling several city blocks to the entirety of a space station. Each facility has an equally large storehouse attached to it, and entire worlds dedicated to manufacturing. Naruni doesn’t bother with little shops, or chains of modest stores in the local strip mall, they think big, deal big and sell big. To give you an idea, NE has leased one half of an entire level of Center to use as just one showroom. They think big because they are big.

This also makes the Naruni fleet the end-all and be-all target for ambitious pirates and raiders. **The Commodity-class super-cruiser**, fully loaded, can move 200,000 tons of merchandise; if transporting nothing but plasma cartridge rifles (15 million of them), that’s a cargo worth 640 billion credits! As a result, a Naruni cargo hauler is one of the most heavily armed single vessels in all the Three Galaxies.

## Technology Notes

Yet another thing that sets the True Naruni aside from other monstrous supernatural beings is their technological capability. They are quite comfortable in a high-tech setting such as Phase World. Although to the general public the Naruni corporate security forces use equipment that is of high quality, one only has to encounter a single **Repo-Bot** to realize that the company’s actual level of technological achievement is very much higher than the products they sell. The upper echelons of the company are smart enough to keep all the best technology for themselves, and out of the hands of the common customer. That way, they always have the advantage, even during those unpleasant moments when they must fight opponents who are themselves armed with Naruni weapons.

**Plasma Beams:** Plasma is an ionized gas, which is excited to such a degree that the atoms which compose the gas actually lose their electrons, and begin to dissolve into sub-atomic particles. The gas is usually contained within a magnetic field, and then heated by a fusion laser. When it comes into contact with other matter, it transfers its heat, and the target also begins to lose atomic cohesion. This makes it a devastating battlefield weapon commonly used by ultra-tech societies throughout the Megaverse.

Plasma weapons have a serious drawback, however, and that is their reduced range. When the super-hot plasma energy leaves the barrel of its weapon, it immediately begins to cool, solidifying back into atoms. In theory, the range of plasma weapons could be greatly extended if only one could devise a stronger magnetic field that would surround the plasma all the way to its intended target. So far, this breakthrough has eluded most technological civilizations.

The True Naruni, on the other hand, have managed to develop a means of producing inexpensive long-range weapons of this type called “plasma beams.” This technology is almost entirely kept for the company’s private use. The Repo-Bots, for example, use a hand cannon that fires plasma beams for a range of 4,000 feet (1,219 m), with twice as much destructive energy as the heaviest commercially available ejector. These weapons are also mounted on all Naruni starships. The only version of these guns available for common sale is the *unmodified NE-1000 Plasma Rifle* (which is a hidden gem: cheaper than the NE-10, with a bigger ammo load and longer range too!).

**Repo-Bot Direct Interface:** All of the computer systems on board a Naruni starship are built so that the Repo-Bots can link to them directly. This cuts down on the reaction time of ship systems such as shields, targeting, and weapons fire. It also allows Repo-Bot pilots greater control over the vessel. This system only works for Naruni Repo-Bots and automatically locks out any other types of cyborgs or intelligent robot users.

A Direct Interface is installed on *every* piece of “corporate use” military hardware. It provides the Repo-Bots with an *additional* +1 on initiative, +1 on Perception Rolls, +1 to strike, +1 to dodge, and +1 attack/action per melee when piloting or using the weapon systems of a corporate vessel.

**Neural Override:** This is a closely guarded Naruni secret that involves uploading the memories and skills of highly experienced employees, then combining them into one skill set. The skills and abilities are then programmed into a series of data-chips. When these chips are surgically implanted into an *organic brain*, the programming wipes it clean and takes over completely. This is how Repo-Bots are made, and explains why they are all so equally skilled and equally experienced. Since all the ‘Bots have this feature, they can, if they need to, gain wireless access to the nearest Naruni mainframe, and upload required information right into their brains. Groups of Repo-Bots, called a Master-Matrix, can also share information with each other over a tactical internet using this same set of chips so that what one of them knows, *all* the others also know. The range of the network connection in both cases is 125 miles (200 km).

## Naruni Uniforms and Colors

Naruni salesmen are predominantly (98%) the famous *Uteni aliens*. They function as the “face” of Naruni Enterprises and are so well known that many people mistake them to be “Naruni.” These natural born salespeople have a simple philosophy: “When in Center, do as the Prometheans.” What this means is that, in order to win the confidence of the consumer, a Naruni sales representative dresses and acts exactly like the culture he or she is selling to. For example, when dealing with the *Human Alliance*, the Uteni shift their appearance to something that looks human, they speak the human language: Trade Four, dress in human clothing, and use human mannerisms, slang and customs. The corporation has a veritable army of *xeno-culturalists* on staff to study the behavior of the major races in the Three Galaxies. Naruni sales staff must regularly attend training sessions to familiarize themselves with the languages, customs and behaviors of humans, Wulfen, Noro, and many other races.

As a result of being social chameleons, there is no “standard uniform” for Naruni salespeople off on a selling mission; they wear whatever the locals are wearing to make their potential customers feel comfortable and at ease. However, if the fleet is going into combat, or when working off the sales floor, Naruni employees wear a brown and blue, two-piece uniform with heavy boots. The material is tough, but flexible, and gives the wearer 15 M.D.C. worth of protection.

Clothing is incompatible with both Repo-Bots and Moloch Enforcers. The monstrous True Naruni, with their long, snakelike snouts, prefer expensive, loose clothing and love capes and cloaks with deep hoods that hide their hideous appearance.

## A Notable Naruni Facility

### “Hydrosphere”

#### System NE 324-6829, Thundercloud Galaxy

At the end of the Great War, the Consortium of Civilized Worlds (CCW) and the Transgalactic Empire (TGE) agreed, as part of a sub-set to the Lanator Accords, that the *Thundercloud Galaxy* would be divided into vast zones, each earmarked for colonization by a specific power bloc.

The idea was to establish rough boundaries over this, the least explored and least settled galaxy in those days, so that the two super powers wouldn’t come to blows for a second time. The Kreeghor then set about rebuilding their defenses in the Corkscrew Galaxy, but the Consortium began a rush to civilize the stars. This included a mass colonization of the Thundercloud. Although exploration is not really their thing, a token force of the *Naruni Social Studies Branch* was sent to the Thundercloud Galaxy, looking for interesting planets to add to the corporation’s holdings.

**In 9552 TE** (450 years ago), the Naruni discovered a slightly remarkable world in system 324-6829. Orbiting a yellow star, the planet was a water world, with a standard atmosphere, standard gravity, and an over-rich natural biosphere. The odds of such a place developing naturally were calculated at 1.08 million to 1, so the Naruni laid claim to it, called it “Hydrosphere,” and moved on.

Fifty years later, massive explosions on the independent world of *Kazematt* led to the discovery of *Killaryte*. With that, Naruni interest in the Thundercloud suddenly perked up, and hundreds of survey teams were dispatched. It did not take long for them to discover that this bizarre crystalline formation was almost entirely native to the Thundercloud Galaxy. Naruni Research and Development quickly came up with a method for safely refining the crystals, turning them into a component to enhance the power of explosives. *Killaryte* became big business almost overnight, and the mad dash to settle and exploit the Thundercloud went into overdrive.

Naruni again turned their attention to Hydrosphere in 9970 TE, when they learned that the massive underwater reefs which formed the basis of the planet’s biosphere were composed of a substance called *Killaryte-B* or “Kill-B.” This new variation of *Killaryte* had all the same properties as “Kill-A,” but was not explosive when under salt water. This made it easier to mine and transport, and Naruni began strip-mining the oceans with gleeful abandon. Environmental impact study . . . what’s that?

With the raping of the *Killaryte-B* reefs, all indigenous life on Hydrosphere are suffering. So much so that the local intelligent life forms are organizing to drive Naruni off their planet (not an easy proposition). At the top of the Hydrosphere food chain are the *Horned Whales*, giant, armored mammals with some magical powers over water. The Horned Whales normally abhor violence, but cannot abide the rampant destruction of their home environment. So far, two Naruni ocean floor bases have been destroyed, but at great cost to the whales. For their part, Naruni considers the actions of the Whales a nuisance, but one that is growing more serious by the day. The whales are beginning to realize that they are not powerful enough to beat Naruni, and that they need help.

Not long ago, a Cosmo-Knight named *Naladan* arrived on the planet, driven to Hydrosphere by visions from the Cosmic Forge. Naladan wishes to help the Horned Whales, but knows he cannot fight a war alone. Thus, he has contacted the *Hartigal Combine* in hopes of raising an army of liberation. He is, in doing so, coming very close to a position of leadership which could cause him to Fall. The Hartigal Combine wouldn't mind getting in on the Scramble for the Thundercloud's Killaryte, and is currently considering their options for removing Naruni and taking over Hydrosphere. Normally, there would be no cause to extricate the Naruni from a previously unclaimed world. However, the Combine (or other galactic power) can claim NE didn't have rights to take a planet already inhabited by intelligent life forms, and they are interceding on the behalf of the indigenous people, at their request. Naruni can argue the case in intergalactic court, but they will lose. Of course, such a court case, with all the legal wrangling Naruni Enterprises can afford, could take 1D6x10 years to resolve, and the inhabitants of the planet don't have that long at the rate NE continues mining Kill-B like they are, and polluting their oceans. Since "possession" is nine-tenths of the law, the most effective approach is to forcibly remove Naruni and let them argue their (unwinnable) case in court. But who has the guts to challenge and battle Naruni Enterprises?



## A Notable Naruni Commander

### Repo-Bot #400264550

#### Bushi Federation, Thundercloud Galaxy

For more than thirty years now, Naruni has been engaged in a campaign of espionage and industrial sabotage with **Bushido Industries**. The True Naruni are secretly envious of the Oni, because their technology was gifted to them by their goddess, *Ameratsu*, whereas the True Naruni had to work hard to develop their tech. In short, the Naruni feel that the Oni have *cheated* their way into the galactic weapons market.

NE has, so far, avoided an all-out war, because the Naruni consider war a waste of time and resources, and bad for busi-

ness. Naruni Enterprises may manufacture every type of weapon imaginable, but they never use them, themselves. Industrial espionage, sabotage, stealing secrets, smear campaigns, and even assassination, on the other hand, are all perfectly acceptable practices, especially if there is no evidence linking it back to NE. As a result, Naruni agents are constantly trying to steal secrets and blueprints from the data banks of the Bushi Federation as well as undermine their manufacturing and sales operations. On rarer occasions, the Naruni have deployed Repo-Bots for direct commando action against Bushido factories and offices, but always covertly, and always to sabotage Bushi operations. One of the most successful of these teams is Matrix 12-31-66, under the command of **Repo-Bot 400264550**.

This combat group has been operating inside Oni space for twenty years now. Their mission is to study Oni security in detail, and devise a time and means of assassinating the *Celestial Emperor*. Such an action, it is hoped, would throw the Bushi Federation into chaos, and might even, in a best-case scenario, cause the Oni to go to war against the Naruni. In the event of such an attack, the Naruni could claim to be the defenders, and could then openly fight the Oni without losing face in the courts of public opinion.

So far, no weakness has been found in the security of **Hoshino**, the Oni homeworld, and especially of the Imperial Fortress. So, in order to penetrate deeper into the data networks, Matrix 12-31-66 moved their *Audit ship* into the Oni core star system, avoiding detection by using their camouflage and moving at sub-light velocity. At such slow speeds, the Audit ship has been inbound for eighteen years, with only one of the Repo-Bots, 400264550, actually up and running. The others have been powered down and are standing silently in their alcoves.

When the ship came within close enough range, 400264550 used his onboard neural computer to hack into the datasphere of Hoshino and root around. However, while his consciousness was moving around in Oni cyberspace, 400264550 came into contact with the *rosuto kihaku*, the spirits of dead Oni who have been placed into cybernetic half-life.

**The Oni** believe that when they die, both the good and the evil go to dwell in a shadowy realm called *Yomi*. Things changed when *Ameratsu* departed, leaving the Oni with a vast technological library. The Oni, believing that their beloved sun goddess had given them a way to avoid going to *Yomi*, developed an advanced system that combined computers with cryogenics. Now when Oni pass away, they are placed into a deep freeze container, and hooked up to a computer. In this state of "half-life," their minds remain close to their bodies, and do not cross over into the terrifying lands of the dead. Relatives can activate a speaker system on the outside of the dead Oni's capsule, and even engage them in conversation to a limited degree. This is a lot like the psionic ability of Commune with Spirits, as the *rosuto kihaku* don't seem to be fully aware of their state of being.

What the Oni have yet to discover is that a few of the disembodied minds of their relatives have broken out of half-life, and are running around like *ghosts* in the planetary data sphere. They exist as pulses of energy, unable to really connect with the outside world, except for a very limited ability to enforce their will over machines linked to the network. Stories of computers



sending phantom emails, televisions suddenly flickering to life showing bizarre or terrifying images, and dead voices coming through speaker systems are simply labeled as urban myths. However, they are real and are happening with increasing frequency. Could it be that the dead are building their own *virtual afterlife* in Oni-cyberspace?

**Repo-Bot 400264550** is currently trying to explore this mystery in more depth before activating his comrades. However, his probing is stirring the ghosts into a more coherent state of mind. Likewise, he has not taken into consideration that, while jacked into half-life, there is the risk that one of these lost souls might actually be able to infect his neural chips, as a virus would a computer system. Since the Naruni brain implants are designed to absorb new information, this would be no different (or difficult) than standard Entity possession. Worse yet, since all the Repo-Bots in a given Matrix can instantly share information over their tactical internet, a group of dead Oni could, in theory, take over the whole group. If some particularly malevolent Oni spirits manage to organize themselves, the Bushi Federation just might be facing a technological *Dawn of the Dead*, with everyday computer users being taken over by the angry spirits of their ancestors.

## Notable Naruni Ships

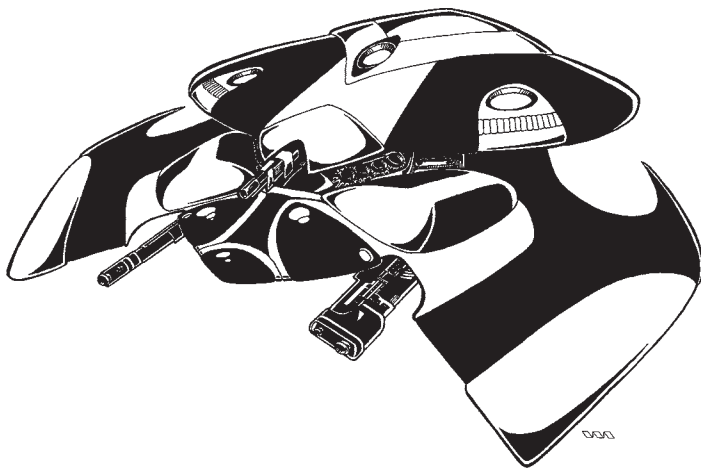

### “Fire-Spitter” Attack Ship *NCD-02 Naruni Corporate Design*

Whenever it goes to war against another conglom, or must respond in force to collect on an outstanding debt, the Security Forces of Naruni Enterprises unleash this advanced space fighter. The main chassis is that of the *Fire-Eater Attack Ship* sold commercially throughout the Three Galaxies. HOWEVER, *this version* carries very different weapons and has upgraded armor and force field. The plasma cartridge auto-cannons of the Fire-Eater have been replaced by long-range plasma beams, giving the Fire-Spitter an unlimited payload. The bomb/missile bays remain unchanged, but the light laser has been removed. The upgrade of this fighter has an enhanced engine for greater speed, handles like a dream, and is completely transatmospheric, which the Fire-Eater is not.

Typically, these corporate fighters are only found onboard the *Commodity-class Super Cruisers*, but they may also be stationed to protect important Naruni R&D bases and key manufacturing facilities.

**Class:** NCD-02 “Fire Spitter” Space Fighter.

**Crew:** One; combat pilot.

#### **M.D.C. by Location:**

Missile Compartment (underbelly) – 150

Side-Mounted Plasma Beams (2) – 150 each

Reinforced Pilot’s Compartment – 250

\* Main Body – 650

Variable Force Field – 300 per side (1800 total)

\* Depleting the M.D.C. of the main body destroys the propulsion system and causes the escape pod/reinforced pilot’s compartment to eject.

**Speed:** Mach 15 in space. Maximum atmospheric speed is Mach 5.

**Range:** Limited only by life support (keeps one person alive for up to two weeks).

#### **Statistical Data:**

**Height:** 12 feet (3.65 m).

**Width:** 30 feet (9.1 m).

**Length:** 40 feet (12.2 m).

**Weight:** 17.5 tons fully loaded.

**Cargo:** Bomb bay can be filled with up to five tons of cargo or bombs.

**Power System:** Nuclear; average energy life of 20 years.

**Market Cost:** Normal customers would be shocked to learn that the ship only costs Naruni 10.5 million credits to build. Would go for over 7 times that if it ever hit the market . . . which it will not. Corporate use only.

#### **Weapon Systems:**

**1. Plasma Beam Cannons (2):** So that they don’t have to worry about conserving their ammo, the plasma cartridge guns have been replaced by powerful plasma beams. The beams are always fired together, and cannot target separate enemies.

**Primary Purpose:** Anti-Fighters and Spacecraft.

**Secondary Purpose:** Anti-Missile and Defense.

**Weight:** Not applicable, part of the ship’s hull.

**Range:** Four miles (6.4 km) in space, 1.5 miles (2.4 km) in an atmosphere.

**Mega-Damage:** 2D6x10 M.D. per single blast, 4D6x10 M.D. per simultaneous blast at the same target when the two cannons fire together. Single or simultaneous dual blast counts as one melee attack.

**Rate of Fire:** Each blast counts as one melee attack. Equal to the number of hand to hand attacks of the pilot (usually 4-6).

**Payload:** Effectively unlimited.

**2. Missile/Torpedo Launcher & Bomb Bay(1):** The bottom of the ship is a missile and bomb bay that can fire either long-range missiles or self-guided bombs.

**Primary Purpose:** Anti-Ship.

**Secondary Purpose:** Anti-Installation.

**Weight:** Not applicable, the missile launchers are part of the ship’s hull.

**Range:** Missiles: 1,400 miles (2,240 km). Bombs: 200 mile (320 km) range.

**Mega-Damage:** 4D6x100 M.D. per missile/torpedo; typically K-HEX enhanced warheads.

Smart bombs are special thermite napalm explosives found only within Naruni Corporate Security and inflict 1D4x100 M.D. to a 150 foot (45.7 m) blast radius.

**Rate of Fire:** One at a time or in volleys of 2 or 4 missiles/torpedoes. Bombs can be released in volleys of 2, 4, 8 or 16. The NCD-02 can fire a volley of torpedoes twice every melee round.

**Payload:** 16 long-range torpedoes or 32 bombs.

**Bonus:** Torpedoes/missiles are fitted with an enhanced smart targeting system providing a bonus of +5 to strike, +4 to dodge, and have two actions per melee round.

Smart bombs are +3 to strike and dodge, and have two actions per melee.

**3. Enhanced Performance:** The NCD-02 Fire-Spitter features additional micro-thrusters for greater movement, and some of the best controls in all the Three Galaxies. **Bonuses:** +2 on initiative, +1 to strike, +3 to dodge, and bestows a +10% on all piloting skill rolls. Furthermore, *Repo-Bots* can directly interface with the fighter giving them *double the bonuses* (above) and +1 attack per melee round!

## Naruni Audit Ship

Most people in the Three Galaxies pray that they never see one of these ships. That's because they only show up when there is an outstanding debt to be collected.

The *Audit ship* is a small, but powerful transport. Its main function is to ferry *Repo-Bots* around the universe, but since it is fully trans-atmospheric, it can also be used as a mobile bunker

or forward command post. The ship possesses all the features of Naruni camouflage armor, plus it has advanced holographic imagers built into the hull. When standing perfectly still, it can be made to look like anything; a grove of trees, rocks, part of a hill, even an innocuous building if it happens to be in an urban area.

The *Audit's* profile is uniquely Naruni. It is long and flat, with no sharp corners or edges. In fact, it looks like the barrel of a plasma cartridge rifle lying on its side. The ship comes in only one color: black, just like the *Repo-Bot's* armor.

**Class:** Shuttle/small cruiser.

**Crew:** Four; 1 pilot, 1 co-pilot, 1 gunner, and 1 communications *Repo-Bot*, plus two squads of *Repo-Bots*, 16 total, stored in small alcoves until activated for combat.

**M.D.C. by Location:**

Plasma Beam Cannons (4) – 600 each

Cruise Missile Launcher – 1,500

Medium Missile Launchers (2) – 360 each

Reinforced Pilot's Cabin – 500

\* Main Body – 3,500

Variable Force Fields – 500 per side (3,000 total)

\* Depleting the M.D.C. of the main body means the ship is in tatters, with life support and contragravity systems knocked out, and unable to fight or move under its own power except for launching missiles. If the ship is reduced to -200 M.D.C., it explodes, doing 1D4x100 M.D. to all other ship components and any target within 1,000 feet (305 m).

**Speed:**

**Atmosphere:** Fully trans-atmospheric; speed in the air is Mach 5.



Sub-Light: Mach 15.

FTL: 5 light-years per hour.

Range: Limited only by supplies. The anti-matter reactors carry enough fuel to operate the ship at full readiness for 150 years. Shipboard stores are good for 32 months of constant deployment with full crew and complement. Minimal supplies on board since Repo-Bots need almost nothing to survive.

#### **Statistical Data:**

Height: 20 feet (6 m).

Length: 150 feet (45 m).

Width: 50 feet (15 m).

Mass: 800 tons.

Cargo: Room for about 100 tons of weapons and equipment. The cargo bay itself is 40 feet by 30 feet, with a height of 20 feet (12 m x 9 m x 6 m).

Power System: Advanced anti-matter reactor with 150 year life.

Cost: The cost to Naruni Enterprises is about 35 million credits to build. Would sell for ten times that if it ever found its way onto the open market . . . which it will not. Corporate use only.

#### **Weapon Systems:**

**1. Plasma Beam Cannon Turrets (4):** These are the ship's main weapons. Each plasma beam is mounted in a double-barreled, retractable turret, and has a 360 degree firing radius with a 90 degree arc of fire. Two are mounted on the top of the ship, and two on the bottom. The weapons may fire on separate targets, or be volleyed together in one searing blast against large targets of sub-capital size or bigger.

Primary Purpose: Anti-Spacecraft.

Secondary Purpose: Anti-Missiles and Defense.

Weight: Not applicable, part of the ship's hull.

Range: Four miles (6.4 km) in space, 1.5 miles (2.4 km) in an atmosphere.

Mega-Damage: 2D6x10 M.D. per single-barrel blast, 4D6x10 M.D. per simultaneous double-barrel blast (standard) per turret. When two or more turrets can fire on a large target, increase damage accordingly.

Rate of Fire: Each blast counts as one melee attack. Equal to the number of hand to hand attacks of the gunner (usually 4-6).

Payload: Effectively unlimited.

**2. Cruise Missile Launcher (1):** Located on the underside of the ship, and towards the front, is a simple cruise missile launcher. The housing only holds six anti-matter torpedoes, but that is more than enough to cause serious damage to a ship of frigate size or larger. The cruise missiles are usually reserved for engagements with larger spacecraft and bombarding large installations like factories, bunkers and small towns.

Primary Purpose: Anti-Ship.

Secondary Purpose: Anti-Installation.

Weight: Not applicable, the launchers are part of the ship's hull. Each missile weighs 10 tons.

Range: Over 1000 miles (1600 km).

Mega-Damage: Per warhead, varies by type, but standard issue is anti-matter: 4D6x100 M.D. each to everything in a 75 foot

(22.8 m) radius (triple the blast radius in an atmosphere – 225 feet/68.5 m).

Rate of Fire: One at a time, or volleys of 2, 4 or 6.

Payload: Six pre-loaded into the launcher.

**3. Medium-Range Missile Launchers (2):** Mounted on either side of the ship is a medium-range missile launcher. These are primarily used against space fighters and other small targets. These missiles all feature Naruni Smart Targeting: +5 to strike, +4 to dodge, and have 2 actions per round. Each launcher holds eight missiles.

Primary Purpose: Anti-Ship.

Secondary Purpose: Point Defense.

Weight: Not applicable, launchers are part of the ship. Missiles vary in weight per short- or medium-range missiles.

Range: 40 miles (64 km) for medium-range missiles.

Mega-Damage: Standard issue missiles are K-HEX enhanced warheads that inflict 2D6x10 M.D. to a blast radius of 30 feet (9.1 m).

Rate of Fire: One at a time, or in volleys of two, four, or eight per launcher.

Payload: 16 missiles in total, eight per launcher.

**4. Other Vehicles:** Depending on the nature of the mission, the cargo bay on the *Audit ship* can be left empty (for taking all that outstanding money back to the corporation), or loaded up with machines of war and destruction. There is enough room for 100 tons of gear, but the following are the most common loads:

- 16 OMAV Combat Pods, each with a full complement of drones, and Direct Interface. Plus, there's enough room for 150 additional drones (varying types).
- 4 Carnivore Light Hover Tanks. (Corporate upgrade – uses a CG hover system and K-HEX missiles. Also has Direct Interface).
- 1 Ovoid Combat Robot (with K-Hex missiles and Direct Interface).
- 1 Fire-Spitter Attack Ship.

**5. Additional Features:** Remember, thanks to a Direct Interface, the Repo-Bot pilots and gunners get the following bonuses: an *additional* +1 to initiative, +1 to strike, +1 to dodge, and +1 melee action!

## *Commodity-Class*

# Naruni Super Cruiser

This vessel nearly defies classification. In its identification papers it is called a "cargo cruiser," yet it is so large, and so well armed, that most authorities in the Three Galaxies consider it to be a *battleship*. In truth it is both, and is the epitome of Naruni technical ability and business sense.

The Commodity is one of the few ships in the known universe that is wider than it is long or high. It has nearly the same dimensions as seven battlecruisers sitting side by side. Its overall profile is rounded, with a flat bottom. Two massive, glowing engines curve around the aft section, but do not protrude outward from the hull. The port and starboard ends of the ship are



massive cargo doors, from which giant ramps can protrude, and the vessel is perfectly trans-atmospheric.

The *Commodity* is designed for two main roles: as a transporter of cargo, and as a transporter of troops for debt collection. As a cargo carrier, it can move close to 200,000 tons, giving it one of the heaviest lift capacities in the known universe. If filled with military units, it is an invasion force in a can. Like the *Audit*, the *Commodity* is coated with camouflage polymers and advanced holographics (destroyed when the M.D.C. of the ship is reduced by half). If landing on a planet or moon, it can be easily made to look like an innocuous structure or landmark.

**Class:** Flagship (Battleship or Heavy Cruiser).

**Crew:** 1,700, but can be run by as few as 60 crew members in an emergency. 1D4 True Naruni overseers are also on board.

**Troops:** Four Repo-Bot companies (568 Repo-Bots; 142 in each company) are always active on board, even when the ship is operating as a straight cargo hauler. This is in addition to any space fighters and tanks that it normally carries.

**M.D.C. by Location:**

- Main Cargo Doors (2) – 20,000 each
- High Energy Plasma Beam Turrets (12) – 1500 each
- Secondary Plasma Beam Turrets (6) – 1000 each
- Cruise Missile Launchers (3) – 800 each
- Point Defense Auto-Cannons (60) – 300 each
- Outer Hull per 40 feet (12.2 m) area – 200
- Inner Hull per 40 feet (12.2 m) area – 150
- \* Main Engines (2) – 15,000 each
- \*\* Main Body: 160,000

\* Destroying the engines eliminates all FTL travel, and reduces sub-light speeds by half.

\*\* Depleting the M.D.C. of the main body leaves the ship a twisted, floating wreck with no systems operating. Crew members may still evacuate in lifeboats, and fighters and power armor troops may force their way out of the ship. Otherwise, it and crew members without space suits or EVA Body Armor are dead in space.

**Speed:**

Atmospheric: Mach 2. The ship is fully trans-atmospheric.

Sublight: Mach 20.

FTL: 8 light-years per hour.

**Statistical Data:**

Height: 100 feet (30.5 m).

Width: 1300 feet (396 m).

Length: 300 feet (91.5 m).

Mass: 800,000 tons.

Supplies: Enough to keep the crew alive for one year.

Cargo: Can carry up to 200,000 tons of cargo in the internal bays. Usually stored in 7600 shipping cans.

Power Source: Anti-matter reactor with a 200 year life span.

Cost: 12 billion credits to produce. Never available for commercial or private sale.

**Weapon Systems:**

**1. High Energy Plasma Beams (12):** The main weaponry of this ship is a series of devastating heavy plasma beams. These weapons are arranged all along the periphery of the vessel: one at each of the top corners, one at each of the bottom corners, and one turret above and below each of the side

cargo doors. The maximum number of beams that can be volleyed against a single target is six, firing either above the ship or below it.

Primary Purpose: Anti-Capital Ship and Anti-Planet.

Secondary Purpose: Anti-Installation and Defense.

Weight: Not applicable, part of the ship's hull.

Range: 70 miles (112 km) in space, or 17 miles (27.2 km) in an atmosphere.

Mega-Damage: 1D6x1000 M.D. per turret.

Rate of Fire: Each turret may fire twice per melee.

Payload: Effectively unlimited.

**2. Secondary Plasma Beams (6):** Three of these beam weapons are found on the top portion of the ship, and three are mounted on the bottom. They are primarily used as a backup for the main weapons, but can be used against large to sub-capital sized spacecraft and large missile volleys.

Primary Purpose: Anti-Ship.

Secondary Purpose: Anti-Sub-Capital Ship and Defense.

Weight: Not applicable, part of the ship's hull.

Range: 34 miles (54.4 km) in space, but only 4 miles (6.4 km) in atmosphere.

Mega-Damage: 1D6x100 M.D. per turret.

Rate of Fire: Equal to the number of hand to hand attacks of the gunner (typically 4-5 per melee).

Payload: Effectively unlimited.

**3. Cruise Missile Launchers (3):** Two launchers are located on the top portion of the ship, and one on the center bottom. Each of the cruise missiles fired from the ship is equipped with a Naruni smart targeting array, making them +5 to strike, and with 2 actions per melee.

Primary Purpose: Anti-Ship.

Secondary Purpose: Anti-Installation.

Weight: Not applicable, the launchers are part of the ship's hull. Each missile weighs 10 tons.

Range: Over 1000 miles (1600 km).

Mega-Damage: Per warhead, varies by type, but standard issue is anti-matter: 4D6x100 M.D. each to everything in a 75 foot (22.8 m) radius (triple the blast radius in an atmosphere – 225 feet/68.5 m).

Rate of Fire: One at a time, or in volleys of 2, 4, 8 or 12, per launcher. Each launcher can fire once per melee.

Payload: 600 total, 200 per launcher.

**4. Point Defense Auto-Cannons (60):** Naruni has opted to use heavy rail guns for use against incoming missiles and space fighters. Each of these point defense turrets is automated, driven entirely by an independent targeting computer, and is +5 to strike and has eight attacks per melee round.

Primary Purpose: Anti-Space Fighter.

Secondary Purpose: Anti-Missile Volley and Defense.

Range: 2 miles (3.2 km) in space, or 4000 feet (1219 m) in an atmosphere.

Mega-Damage: 2D6x10 M.D. per 20 round burst.

Rate of Fire: Each automated turret can fire 8 bursts per melee.

Payload: 70,000 rounds (3,500 bursts) per cannon emplacement.

**5. Additional Vehicles:** The Commodity carries 4 wings of Fire-Spitter Attack Ships (NCD-02 corporate upgrade model) with 11 fighters per wing. For ground assault, it carries 30 Juggernaut Heavy Tanks (also a corporate upgrade that uses an anti-matter power reactor, CG hover system, K-HEX missiles, and the main gun has no recharge time).

**6. Possible Cargos:** In a cargo role, the ship can hold as many as 7,600 standard Cans. A few examples of its cargo capacity are as follows:

- 15 million cartridge rifles but with no ammunition.
- 7 million cartridge rifles and 215,000 cases of ammo (about 150 million rounds).
- 10,000 space fighters (some assembly required).
- 9,000 Carnivore Hover tanks.
- 1,000 Juggernaut Heavy Hover tanks.
- 143,000 suits of Enforcer power armor.
- 523,000 "suits" of infantry body armor.

If it is being used exclusively for troop transport, then nearly any mix of men and machines imaginable can be used. At its maximum, it can transport 99,400 Repo-Bots (roughly 650 companies), but the robots are powered down, and stacked up like cordwood until the ship arrives at the combat zone.

# The Splugorth Kingdoms

## Splugorth Repression Fleets

The space fleets of the Splugorth Kingdoms are a plague on all free peoples of the Three Galaxies. They arise from out of the galactic interiors without rhyme or reason, seemingly picking targets at random. They strike fast and hard, and then vanish almost as quickly as they came. Most other civilizations hate them, yet are afraid to fight them wholesale. There have only been nine full-fledged wars against any or all of the Splugorth Kingdoms in the past ten millennia. The Splugorth have lost every one of those engagements, but not before inflicting such damage to their attackers that the victory was pyrrhic at best. Furthermore, many believe that in every case, the victors were *allowed to win* either because the Splugorth didn't care to win, or some yet, unseen, ulterior reason.

The most famous of these conflicts was the **War against Rynncryll** in the *Anvil Galaxy*, and the destruction of *Yytheryss* – an amazing victory secured when the UWW Warlock Navy destroyed one of the Splugorth's sprawling, galactic Kingdoms and freed the enslaved populations of numerous worlds.

Exact numbers for the Splugorth Repression Fleets remain a matter of conjecture and flat-out guesswork. During the **War against the Rynncryll Kingdom** (see **Dimension Book 5: Anvil Galaxy**, page 124), Consortium Armed Forces battle groups came under constant fire by a *single cruiser-class ship* and one *supporting combat shuttle*, which were given the reporting names "Servitude" and "Raider" respectively. Of course during

that same conflict, the bulk of the Splugorthian assaults were leveled against their former slaves, the *Kreeghor*. The Transgalactic Armada suffered heavy losses under attacks from *tens of thousands of Kittani space fighters*. Based on this information, CAF Fleet officials remain certain that the Splugorth must therefore field some kind of heavy carrier. If so, however, it has yet to be encountered by anyone who has survived to talk about it.

## Disposition of Fleets

The Splugorth Repression Fleets are relatively small, with an estimated 1,000 ships in both the Anvil and Thundercloud Galaxies, and nearly 2,000 in the Corkscrew.

Despite this, the Splugorth are feared as ancient, dark and dangerous supernatural beings with immense, some would say god-like power, and demonic malevolence. The Splugorth are known to have enslaved countless worlds and people in other parts of the Megaverse and dabbled in magic and mysteries known to few other beings. While some people take solace in the fact that the Splugorth have a small presence in the Three Galaxies, currently laying claim to only three worlds, others are concerned the monsters have any presence at all. Even a toehold by the Splugorth harkens to a troubling and foreboding future.

## Kittani Starship Technology

It is often asked “why, if the Kittani have a technological culture dating back over thirty millennia, are their weapons and equipment so comparatively weak?”

What isn’t understood is that the **Kittani**, for all their seeming independence, are still *disposable minions* in the eyes of their demonic Splugorth masters. Thus, the Kittani technological level has been forcibly limited and held back by their alien masters/saviors for most of that time. After all, one cannot have the “lesser races” gaining too much power lest they begin to think for themselves and entertain thoughts of independence and rebellion. That’s the kind of thing that led to disaster with the *Kreeghor*. No, it is best if you keep your inferior servants under your thumb, vulnerable, humble and dependent upon their masters.

The Splugorth themselves are Alien Intelligences of incredible power. Thus, they don’t easily relate to any humanoids in the Megaverse and have difficulty appreciating the mortal condition, except areas where they can exploit it. The Splugorth only grudgingly acknowledge the need to travel through space. They would much rather use their considerable abilities to travel the *Astral Plane* to discover new worlds, then use dimensional portals to send a raiding force directly into the heart of their enemies or targets of new conquest, and strike without warning. Their monumental failures against the Prometheans, however, and the inability to defend themselves against space-borne opponents have forced the Splugorth to acquiesce. So, when it came time to construct space fleets, the various Splugorth Intelligences finally allowed *their servants* to rebuild the warships and giant weapons once found in the **Kittani** armadas before they were vanquished by the Splugorth. **The Kydians** also contributed, mostly in terms of physical labor, the management of slave labor and fleet construction.

These collaborative designs are almost identical to their ocean-going vessels, so the ships that sail the seas of *Rifts Earth* look a lot like the starships that prowl the dark regions of the Three Galaxies. Although the Splugorth fleets are tiny in number when compared to the other power blocs in the Three Galaxies, the ancient and advanced technologies of the Kittani, combined with Splugorthian magic, make the Repression Fleets dangerous in the extreme.

## Splugorth Fleet Hierarchy

The normal Splugorthian hierarchy is a little different when the four Kingdoms go into space. *Normally*, **Kydians** (i.e., the famous Overlords and Powerlords) have authority over the Kittani and most other Minions of Splugorth, as well as the multitude of slave races. However, the Kydians are *great followers*, not leaders. Moreover, they lack all but the most basic technical knowledge. Therefore, *in space*, it is the **Kittani** who have power over the Kydians. A **High Lord** or **Conservator** is still the master of both races, and all other minion races are subservient, but make no mistake, this is an important step forward for the *Kittani*, who have longed for the day when they would be allowed to conquer enemies the way they did 38,000 years ago: all by themselves.

A **Kittani** can be any Fleet rank up to and including Captain, and as such, their word on the ship is law. However, they can be overruled by a *High Lord*, *Conservator*, or *Splugorth Intelligence* with no questions asked. The Kittani only have so much free rope to play with, and should they try to overstep their authority, the Conservators on board kill the offenders immediately. While the Splugorth are willing to admit that, in the Three Galaxies at least, they need to have a space fleet, and are even willing to let their *minions* have the run of things, they will not tolerate insubordination or rebellion in the least.

**Most of the Kittani are happy with this seeming compromise.** They get to determine their own destiny (to a degree) and, at the same time, are practically saving the Splugorth Kingdoms in the Three Galaxies from annihilation. However, there are a growing minority of Kittani officers who have now had a taste of freedom and want more. They are smart enough to know they cannot yet throw off the shackles of the Splugorth, but hope and plan for the day when the Repression Fleets will wipe their tentacled masters from the face of the universe. That having been said, the overwhelming majority live to serve their immortal and monstrous masters. The Kittani (and Kydians) have served as the premier slave race for so many millennia that most completely accept their lot in life. All Kittani are born into slavery and the Splugorth culture and society is all they truly know. In this regard, they tend to see themselves not as slaves, but as “the chosen” appointed to serve their living gods, the Splugorth. All other beings are generally viewed as a) inferiors, b) the enemies of their masters, and c) people to conquer or exploit as their Splugorth masters dictate. As a result, most of the billions of Kittani who serve the Splugorth across the Megaverse are haughty and proud of the elite position they hold within the tyrannical power structure of the Splugorth. Compared to most other slave races, the Kittani are practically (but are not) free citizens who serve as the right hand – or fist – of the Splugorth Kingdoms, particularly in the reaches of outer space.

## Kittani Fleet Hierarchy is as follows:

Splugorth Intelligence

High Lord

Conservator

Kittani

Upov (Captain)

Oziru (Commander)

Iyuzobi (Lt. Commander/specialist)

Zobi (Lieutenant)

Idadahe (Kittani Warrior)

Powerlords/Overlords/Splugorth Slavers

All other minions

**Upov** is a title that would best translate as “Captain,” but to the ape-like Kittani, it is *much more*. Within the confines of a given starship, the Upov is the leader of the group, both socially and militarily. He is given the best food, the best quarters, and can mate with any female of his choosing, whether or not she already has a mate.

The role of the **Oziru** is to act as a bodyguard. This is always a Kittani male many years younger than the Upov, but one who has been chosen by him. The Oziru may or may not be one of the Upov’s offspring. In combat, the Oziru leads the other Kittani fighters in general, while command of specific units will go to the Iyuzobi. The Oziru fights any and all battles for the Upov, who is considered too important to risk in trivial matters of combat. The only exception to this is if an aspiring young Iyuzobi wishes to fight the Upov for leadership of the group. In this case, the Oziru must stand aside, and the Upov must fight his own battle. If the old Upov is killed (the only way an Iyuzobi can win the leadership), he usually also kills all of the old Upov’s offspring who are under the age of three. He may then replace these children with ones of his own lineage.

The **Iyuzobi** are young males and females who serve as specialists in technical matters and all things espionage. Only males may challenge for leadership of the group (see above), as the Kittani are still a rigidly patriarchal society. They are generally of middle age, and have total authority over the younger Zobi.

The **Zobi** are the youngest members of a Kittani ship’s crew, but are old enough and experienced enough to lead small groups of warriors. Zobi can be both male and female. Even if they remain dedicated fighters and do not branch off into a military specialty, a Zobi who lives to age 50 is automatically elevated to the standing of Iyuzobi. As such, he may challenge the Upov for control of the group, should he ever wish to do so.

## Kittani Uniforms and Colors

If the Kittani display an actual system of rank insignia it is completely unknown outside of the Repression Fleets. It is *believed by most outsiders* that the number of spiny attachments on a given Kittani’s power armor suit is an indication of his or her standing, so a Kittani of high rank will have many more spines on his Serpent armor than one of low rank. In truth, the situation is quite the opposite. Kittani leaders have others to fight for them, and so they have *less* adornment than underlings. However, the various intelligence agencies for the other power blocs continue to believe otherwise.

**Outside of their armor**, the approximate age and experience of a Kittani can be discerned just by looking at them. Young males have black hair on their heads and bodies, while females of the same age seem to have red or brown fur. As Kittani age, their hair turns deep silver. A Kittani who is very old and powerful may be almost completely bald from having so many others groom him, a sign of affection and respect.

**Kyidian Powerlords and Overlords** are always found wearing their flat gray bio-power armor as it is both their uniform and sense of identity. They also wield staves of authority or other Bio-Wizard weaponry.

**Conservators and High Lords** are above such mundane trappings as clothing and uniforms, though some do adorn themselves with ornate helms, mantles and jewelry. They may also wield any weapon, magic or technological, in the Splugorth’s arsenal.

**Note:** See **Rifts® World Book Two: Atlantis** for more information about the Splugorth, Kittani, Kydians, vehicles, power armor, tech and magic weaponry, magic, symbiotic organisms, and some Splugorth slave races. **Rifts® World Book 21: Spynn Dimensional Market** provides more information about Bio-Wizard weapons, Bio-Borgs and additional slave races (at least those found on Rifts Earth).

## Notable Splugorth Facilities

The locations of the Splugorth fleet yards are currently *unknown* to all of the major power blocs. It is assumed that there is at least one major construction facility in orbit of each of the four Splugorth Ruling Worlds, but again, this is more speculation than fact.

## A Notable Splugorth Commander

### Upov Esunawey

#### Kingdom of Rasstynnth, Corkscrew Galaxy

For the past few months, the **Kingdom of Rasstynnth**, in the Tail of the Corkscrew Galaxy, has been steadily losing contact with the planets on the edge of its territory. The pyramids that connect them to the other planets in the Kingdom suddenly went “off the grid,” and no one could teleport there anymore. When Kydian Overlords were sent to investigate, they found the entire planet utterly devoid of life. No structure was left standing. There were no plants, no animals, and most importantly, no slave stock. A Repression Fleet, under the command of **Upov Esunawey**, was dispatched to investigate further. The fleet was not long out of their home port when they came into contact with the aliens now known as **the Intruders**. Given the destructive technology used by these beings, it has been surmised that the Intruders are the ones responsible for the destruction of the Splugorth worlds in the Kingdom of Rasstynnth. The size of Upov Esunawey’s fleet was expanded, and he has been given orders to track down and destroy every last Intruder.

That was nearly six months ago, and the battle has not gone well. Every time the Intruders are thought destroyed, more seem to appear from out of nowhere. The solid energy ships are likewise resistant to Kittani weapons (they do not take extra damage from the Slicer Cannons or Neutron weapons). The number of



warriors who have died during this conflict is staggering, and is reminding many of the horror stories told during their youth about another race of planet destroyers whose name has been forbidden to be spoken.

Slowly but surely, however, the Kittiari have fought the Intruders backwards through space. Currently, the Repression Fleet is approaching the outer limits of an eight planet star system. Long-range probes have shown that the inner system is heavily fortified not only by thousands of *UFO ships* and *Spinnerettes*, but also by huge orbital structures that can only be habitats or space stations. Upov Esunaway is not certain that his fleet can attack the system and win, but *Lord Rasstynnth* wants complete revenge, and is ordering his minions to purge the system. The Intruders have their collective backs to the wall, and will fight like an angry hornets nest, so it's all up to the Splugorth. If they carry the day, the Intruder threat could be driven from the *Corkscrew Galaxy* altogether. If the Repression Fleet is destroyed, the Intruders will rally, and make an unobstructed dive straight for *Lord Rasstynnth's throne world*.

If ever there was a time for a Kittiari faction to attempt a break from Splugorth dominion, this might be it. They are not a cowardly race, but the savage attacks of the Intruders have stirred a deep fear in many of the younger warriors unaccustomed to facing such a resilient and powerful foe. Even the older Kittiari are having trouble accepting that their Splugorth master may be sending them to the slaughter. Whispers of a mutiny are beginning to spread, and it remains to be seen if Upov Esunaway will endorse it and save his people, or crush it and choose to attack the Invaders even if it means the total destruction of his fleet, his own life, and every last soldier under his command. This would not be the first time in the history of any people that a leader was faced with such a choice. The lot of the professional soldier is all too often to follow orders and pray they can achieve victory even against overwhelming odds.

## Upov Esunaway – Quick Stats

**Alignment:** Anarchist.

**O.C.C./Experience Level:** 10th level Kittiari Warrior.

**Attributes:** I.Q. 22, M.E. 24, M.A. 15, P.S. 26, P.P. 11, P.E. 20, P.B. 14, Spd 19.

**Hand to Hand:** Martial Arts.

**Psionic Powers:** Mind Block, Sixth Sense, Speed Reading, Total Recall, Object Read, and Telemechanics. 115 I.S.P.

# Notable Ships of the Splugorth Repression Fleets

## Splugorth “Raider”-Class Combat Shuttle

Raider-class combat shuttles are the primary planetary assault craft of the Splugorth Repression Fleets. Carried by the dozen by the larger ships of the fleet, these shuttles are relatively heavily armed for their size and can carry off hundreds of slaves and tons of loot from unsuspecting planets. As a single unit, the Raider poses a great threat to a target world. Its small size and speed allow it to slip by or outfly most planetary defenses and make the ship well suited for lightning strikes and terror tactics. Launched en masse from larger sub-capital and capital ships, coordinated squadrons of Raiders can clean a whole planet of viable slaves within a matter of hours.

**Model Type:** Assault Shuttle (KS-TAS).

**Class:** Raider Class.

**Ship's Complement:**

Ship's Crew: 31

Bridge: Ship's Captain (1), Helm (2), Navigation (2), Comms/Sensors (4), Security (2 Kittiari in K-U light power armor and armed with K-30 ion pulse rifles).

General Operations: Engineering (2), Cargo Masters (4), Slave Tenders (4), Ship's Security (10).

Embarked Troops: 148

Kittiari Armored Troops: One company (64 Kittiari).

Splugorth Slavers: 12 (each commands a magic, Slave Barge).

Altara Blind Warrior Women: 72 (divided evenly to serve the Slavers).

**M.D.C. by Location:**

Prison Cells (100) – 600 per wall

Neutron Cannons/Particle Beams (2) – 200 each

Missile Launchers (2) – 120 each

\* Bridge – 600

\*\* Hull/Main Body – 3,600

\* Destroying the Bridge effectively cripples the ship, leaving it with two attacks per melee, -5 to strike and all combat bo-





nuses, and no long-range communications or sensors of any kind. Individual power armor troops can continue fighting, of course.

\*\* Depleting the M.D.C. of the Main Body destroys the ship.

### Speed:

Atmosphere: 5,372 mph (8,595.2 km or Mach 7).

Sub-Light: 11,415 mph (18,264 km or Mach 15).

FTL: None, the Raider is not FTL capable.

Range: Limited only by supplies. The Kittani anti-matter reactor carries enough fuel to operate at full readiness for 50 years, but shipboard supplies are only good for planetary assaults and short, in-system trips of two weeks or less.

### Statistical Data:

Height: 65 feet (19.8 m).

Beam: 65 feet (19.8 m).

Length: 220 feet (67.0 m).

Weight: 5,000 tons.

Cargo: Raider shuttles can carry up to 800 slaves and 500 tons of loot.

Power System: One K-AM-220 frigate-class anti-matter reactor powering one bank of two frigate-class plasma thrusters.

Market Cost: Nearly impossible to find. Would cost 500 million credits fully armed and loaded.

### Weapon Systems:

**1. Neutron Cannons (2):** A variation on the particle beam, the Neutron Cannon fires a deadly stream of unstable charged

neutrons as opposed to the protons of a standard particle cannon. Neutrons have the same devastating effect on materiel as their proton-based cousins, with the added bonus of inflicting double damage to *organic targets*. The Raider's Neutron Cannons give the little ship an incredible punch.

Primary Purpose: Anti-Ship.

Secondary Purpose: Anti-Fighter.

Weight: Not applicable, part of the ship's hull.

Range: 6,000 feet (1,829 m) in an atmosphere. 2 miles (3.2 km) in space.

Mega-Damage: 3D6x10 M.D. per cannon, double damage to *organic targets*.

Rate of Fire: Equal to gunner's hand to hand (usually 4 or 5).

Payload: Effectively unlimited.

**2. Missile Launchers (2):** Mounted aft between the engines on the dorsal and ventral hulls of the ship, these long-range, retractable missile launchers give the Raider excellent stand-off capabilities. These weapons are commonly used to bombard an area to soften it up before landing.

Primary Purpose: Anti-Ship.

Secondary Purpose: Anti-Installation.

Weight: Not applicable, part of the ship's hull.

Range: 500-1800 miles (800 to 880 km).

Mega-Damage: Varies by warhead. Typical loadout is proton torpedoes – 6D6x10 M.D. to a 50 foot (15 m) blast radius.

Rate of Fire: One at a time or volleys of 2, 4, 6, 8, 12 or 16.

Payload: 64 missiles in each launcher for a total of 128. The ship can carry an additional 512 missiles in the hold.

**3. Alchemical Stealth Coating:** Instead of variable force fields, the Raider's hull is coated in a special TW material that renders it almost impossible to detect via conventional sensors. It is technically invisible to radar and ladar, and anyone trying to locate the ship on sensors suffers the following penalties: -80% if the ship is standing still, and -40% if the ship is moving. It is not equipped with any kind of cloaking field.

**4. Ship's Systems of Note:** Tactical life support, escape capsules for all crew and embarked troops, slave containment systems.

## Splugorth

### “*Servitude*”-Class Cruiser

The Splugorth's *Servitude*-class heavy cruiser pushes the upper limit for what can be considered a “cruiser” by most navies. Much like all Kittani designs, this massive and awkward looking ship takes its design cues from nature. It resembles a giant, armored form of a common and ubiquitous water-strider indigenous to the Kittani homeworld, with three defined hull/body sections and six spindly legs that serve both as docking stations for smaller ships and as landing skids. Usually deployed with a dozen Raider-class shuttles, these ships form the core of the Splugorth Repression Fleets, and just the sight of them dropping out of FTL above a planet can cause hysteria among a populace.

**Model Type:** Heavy Cruiser (KS-CH).

**Class:** *Servitude* Class.

#### Ship's Complement:

Ship's Crew: 465 total (115 Officers, 350 Enlisted and Slaves).

Bridge: Ship's Captain (1), Ship's Executive Officer (1), Helm (5), Navigation (5), Comms and Sensors (5), Security (2 Kittani in K-U light power armor and armed with K-30 ion pulse rifles).

Combat Information Center (CIC): High Lord (1, in charge of troop deployment, strategy and tactics), Military Advisory Team (3), Overlord (1, commander of ship's planetary assault group), Slaver (1, in charge of all slave collecting operations), Comms (5), Ship's Weapons and Fire Control (15), Security (5 Kittani wearing K-U light power armor and armed with K-30 ion pulse rifles).

General Operations: Engineering (35), Medical (20), Flight Operations (15), Ship's Security (100), Cargo Masters (30), Slave Tenders (100), Internal Communications (15), General Enlisted and Slaves (100).

Embarked Troops: 2,270 total (450 Officers, 1,640 Enlisted and Slaves).

Kittani Ground Forces: 1,334

Kittani Aviators (Raider shuttle pilots and crews): 186

High Lords: 10

Overlords: 240

Powerlords: 60

Splugorth Slavers: 60

Altara Warrior Women: 360

Conservators: 10

Metzla: 10 (Murex or Volute. Described in detail in **Rifts® World Book Two: Atlantis**, pages 54-57).

#### Aerospace Group:

KS-TAS Raider Assault Shuttles: One squadron (12 ships).

**Planetary Assault Group** (see **Rifts® World Book Two: Atlantis** for complete descriptions:

K-MPA Manling Powered Armor: 360 (45 squads of 8 units each).

K-SEP Serpent Powered Armor: 60 (5 squads of 12 units each).

K-EPA Equestrian Powered Armor: 60 (5 squads of 12 units each).

K-FPA Flying Fox Powered Armor: 120 (10 squads of 12 units each).

Overlord Powered Armor: 300

#### M.D.C. by Location:

Interior Bulkheads per 10 feet (3 m) – 50

Interior Hatches – 65 each

Exterior Hatches – 110 each

Main Missile Batteries (6) – 2400 each

Gravimetric “Slicer” Cannons (4) -1400 each

Fusion Beam Cannons (4) – 700 each

Neutron Cannons (16) – 200 each

Holding Cells (1000) – 400 per wall (reinforced)

Support Legs (6) – 6800 each

\* Forward Hull Section/Head (1/3) – 15,000

\*\* Midships Hull Section/Thorax (1/3) – 15,000

\*\*\* Aft (rear) Hull Section/Abdomen (1/3) – 20,000

\*\*\*\* Hull per 40 feet (12.2 m) – 150

Variable Force Fields – 54,000 total (9,000 per side)

\* Destroying the Forward Hull Section/Head obliterates the bridge and primary comms and sensor suite. The ship can still be flown and fought from the CIC, but all sensor ranges are reduced by half. The loss of the forward section also destroys the forward pair of landing legs.

\*\* Destroying the Midships/Thorax Hull Section eliminates the primary launch bays, weapons fire control, midships landing legs and the CIC, rendering the ship flyable but unable to fight.

\*\*\* Destroying the Aft Hull Section/Abdomen destroys the rear engines and engineering sections, setting the ship adrift.

\*\*\*\* Punching holes in the hull causes the damage control system to automatically seal off whatever compartment has been exposed to vacuum.

#### Speed:

Atmosphere: Designed to land and disgorge its ground forces, the *Servitude* is fully trans-atmospheric and can maintain a speed of 1,200 mph (1,920 km or Mach 1.5).

FTL: 6 jumps of 5-20 light-years or 120 light-years per day.

Sub-Light: 7,610 mph (12,176 km or Mach 10).

Range: Limited only by supplies. The anti-matter reactors carry enough fuel to operate the ship at full readiness for 30 years, but shipboard stores are only good for eighteen months of constant deployment with full crew and complement.



**Statistical Data:**

Length: 1,650 feet (503 m).

Beam: 800 feet (244 m).

Height: 400 feet (122 m).

Mass: 300,000 tons.

Cargo: These huge ships have four whole deck levels dedicated to holding the living cargo brought by the slave ships. Up to 20,000 slaves can be carried in the 1,000 reinforced cells (20 humanoids in a cell under cramped conditions).

Power System: One K-AM-330 anti-matter reactor powering two banks of three nozzle cruiser-class thruster arrays and a P.P.E. generator to power the R-Drive.

Market Cost: Never sold; it would go for 100 billion credits or higher!

**Weapon Systems:**

**1. Splinter Missile Batteries (6):** Similar in practice to the TGE’s Singularity Missile, each Splinter Missile carries a number of self-guided submunitions within a larger missile. While they are of a lower yield than the secret Singularities, Splinters are no less dangerous, and are the primary assault weapon system of the Servitude.

Primary Purpose: Anti-Planet.

Secondary Purpose: Anti-Installation.

Weight: Not applicable, part of the ship’s hull. Each missile is 28.2 feet (8.5 m) long and weighs 30 tons.

Range: 1,400 miles (2,240 km).

Mega-Damage: 2D6x100 M.D. per submunition. (2D6x1000 M.D. if all ten hit their target.) Blast radius is 100 feet (30.5 m).

Rate of Fire: Each launcher can fire a single missile once per melee.

Payload: Each launcher carries one missile in the tube and five at the ready for 36 missiles. An additional 64 missiles are kept in an armored magazine.

Note: Splinter Missiles are considered smart missiles, and are +5 to strike.

**2. Gravimetric “Slicer” Cannons (6):** Mounted at the top of each support leg, these weapons are incredibly powerful and can hull all but the very largest ships in minutes. The system uses controlled gravity waves, and due to the deep penetration of the weapon, it has a much better chance to do critical damage to its target. The weapons have the standard penalties to hit fighters and other small targets.

Primary Purpose: Anti-Ship.

Secondary Purpose: Anti-Installation.

Weight: Not applicable, part of the ship’s hull.

Range: 18 miles (28.8 km) in space, half that in an atmosphere.

Mega-Damage: 2D4x1000 M.D. per beam. Several beams can be combined into a volley, if the ship is positioned correctly.

Rate of Fire: Once every other melee.

Payload: Effectively unlimited.

Note: Slicer cannons inflict critical damage (double) on the roll of a Natural 19 or 20 to strike due to their high penetration.

**3. Fusion Beam Cannons (4):** Mounted on the aft/abdomen part of the hull, these secondary energy turrets are used to engage other sub-capital ships and small space stations.

Primary Purpose: Anti-Ship.

Secondary Purpose: Anti-Installation.

Weight: Not applicable, part of the ship's hull.

Range: 10 miles (16 km) in space, half that in an atmosphere.

Mega-Damage: 3D6x100 M.D. per fusion gun blast.

Rate of Fire: Each may fire up to 4 times per melee round.

Payload: Effectively unlimited.

**4. Neutron Cannons (16):** A variation on the particle beam, the Neutron Cannon fires a deadly stream of unstable neutrons as opposed to the protons of a standard particle cannon. Neutrons have the same devastating effect on materiel as their Proton cousins, with the added bonus of dealing double damage to organic targets. These are the same weapons found on the Raider-class shuttles, used here as point defense weapons.

Primary Purpose: Anti-Fighter.

Secondary Purpose: Anti-Missile.

Weight: Not applicable, part of the ship's hull.

Range: 6,000 feet (1,829 m) in an atmosphere. 2 miles (3.2 km) in space.

Mega-Damage: 3D6x10 M.D. per cannon. These weapons inflict double damage to *organic* targets.

Rate of Fire: Equal to the gunner's hand to hand (usually 4 or 5).

Payload: Effectively unlimited.

**5. Splugorthian Warding:** The Servitude has a built-in TW electronic countermeasures system. Attackers from major tech powers such as the Transgalactic Empire (TGE), the Gulgans, or the Consortium of Civilized Worlds (CWW) find their sensors slightly scrambled when trying to lock weapons on the ship. Such gunners have penalties of -3 to strike beyond visual range. Missiles are somewhat more effective: at first engagement, missiles have a 60% chance of being unable to achieve a lock (if they are smart bombs, they can try for another pass). After that, the jamming can be fully adjusted to and the missile achieves lock normally. The warding guarantees the Servitude the all-important first strike.

**6. Ship's Systems of Note:** Tactical life support, launch/recovery and traffic control systems for aerospace craft and robots, IFF/command and control systems.

## Splugorth

### “Taskmaster”-Class Carrier

Thus far, only the Transgalactic Empire has had any serious contact with this strange and dangerous vessel, and they refuse to share what they know with any other galactic power. Imperial Security agents have given this Carrier the Kreeghor code name “*Kom-Kasdyak*,” a word that roughly translates into Trade One dialect as “Taskmaster.”

**The Taskmaster** is a *command, communication and control* (C3) ship that acts as the heart of a massively powerful Splugorth invasion fleet. In actions against Rynncryll, a Task-

master was protected by an inner screen of six *Servitude-class heavy cruisers*. Beyond this was an outer screen of up to twenty *Dragon Dreadnoughts*, which seem to fill the role of destroyers in the Repression Fleets. *Kittani transformable fighters* were found out on the picket.

In appearance, the ship is shaped like a massive yet graceful bird of prey. The Kittani philosophy of merging natural and machine forms comes through quite obviously in its avian silhouette. A long, slender neck extends from the main body, ahead of massive wing-like structures that nestle the main engines beneath them. Two curving talons are found on the ship's ventral side, facing forwards, and contain the ship's hangar bays and launch and recovery systems.

**Model Type:** Carrier (KS-CV).

**Class:** Taskmaster Class.

**Ship's Complement:**

Ship's Crew: 2,800 total (560 Officers, 2,240 Enlisted and Slaves).

Bridge: Ship's Captain (1), Ship's Executive Officer (1), Helm (10), Navigation (10), Comms/Sensors (20), FTL Ops (10), Security (10 Kittani wearing K-U light power armor and armed with K-30 ion pulse rifles).

Combat Information Center (CIC): High Lord (1, in charge of troop deployment, strategy and tactics), Military Advisory Team (12), Overlord (1, commander of ship's planetary assault group), Slaver (1, in charge of all slave collecting operations), Comms (15), Ship's Weapons and Fire Control (30), Security (20 Kittani wearing K-U light power armor and armed with K-30 ion pulse rifles).

General Operations: Engineering (250), Medical (200), Flight Operations (900), Ship's Security (250), Slave Tenders (250), Internal Communications (150), General Enlisted and Slaves (658).

Embarked Troops: 9,436 total (2,336 Officers, 7,100 Enlisted and Slaves).

Kittani Aviators: 1,224 combat ready pilots with 612 pilots in reserve.

Kittani Ground Forces: 1,600

Kyidian Ground Forces: 6,000

**Aerospace Group:**

K-TRF-M Transformable Aerospace Fighters: Two wings (480 ships, 20 squadrons of 24 ships each).

KS-TAS Assault Shuttles: Four squadrons (24 ships, 6 in each squadron).

**Planetary Assault Group:**

K-MPA Manling Powered Armor: 880 (110 squads of 8 units each).

K-SEP Serpent Powered Armor: 180 (15 squads of 12 units each).

K-EPA Equestrian Powered Armor: 180 (15 squads of 12 units each).

K-FPA Flying Fox Powered Armor: 360 (30 squads of 12 units each).

Overlord Powered Armor: 3,000 (300 squads of 10 units each).



**M.D.C. by Location:**

- Interior Bulkheads per 10 feet (3 m) – 80
- Interior Hatches – 70 each
- Exterior Hatches – 80 each
- Mass Driver – 12,000
- Fusion Beam Cannons (8) – 700 each
- Neutron Cannons/Particle Beams (40) – 200 each
- Cruise Missile Launchers (4) – 1000 each
- Talon Hangars (2) – 22,000 each
- \* Forward Hull Section (1/3) – 45,000
- \*\* Midships Hull Section (1/3) – 45,000
- \*\*\* Aft Hull Section (1/3) – 50,000
- \*\*\*\* Hull per 40 feet (12.2 m) – 150
- Variable Force Fields – 15,000 per side (90,000 in total)

\* Taking out the Forward Hull section destroys the bridge and primary comms and sensor suite. The ship can still be flown and fought from the CIC, but all sensor ranges are reduced by half.

\*\* Destroying the midships section eliminates the primary launch bays, weapons fire control, and the CIC, rendering the ship flyable but unable to fight.

\*\*\* Destroying the Rear/Aft Hull Section takes out the engines and engineering sections, setting the ship adrift.

\*\*\*\* Punching holes in the hull causes the damage control system to automatically seal off whatever compartment has been exposed to vacuum.

**Speed:**

Atmosphere: None. While they have a relatively aerodynamic shape, Taskmaster carriers are too large to enter a planet’s atmosphere.

FTL: 6 light-years per hour.

Sub-Light: 6,088 mph (9,741 km or Mach 8).

Range: Limited only by supplies. The anti-matter reactors carry enough fuel to operate the ship at full readiness for 50 years, but shipboard stores are only good for eighteen months of constant deployment with full crew and complement.

**Statistical Data:**

Length: 5,000 feet (1,500 m).

Beam: Main Spine – 700 feet (213 m). Wingspan – 3,500 feet (1,066 m).

Height: 1,200 feet (360 m).

Mass: 60 million tons.

Cargo: 5 million tons.

Power System: Two K-AM-440 anti-matter reactors powering two banks of four-nozzle capital thruster arrays and a K-CG-080 Contra-Gravity FTL drive.

Cost: Unknown, estimated to be in the hundreds of billions of credits.

## Weapon Systems:

**1. Mass Driver:** The mass driver is a terror weapon, plain and simple. Using the same principles as rail guns, the mass driver consists of a long barrel that runs the entire length of the ship along the ventral side. Instead of flechettes or armor piercing slugs, the mass driver fires huge, steel-reinforced stone blocks that weigh ten tons each. While this weapon does incredible damage to space stations and other capital ships, its true power lies in its ability to devastate planets. When fired into a planet's atmosphere, the stone block essentially becomes an asteroid, and causes the kind of wholesale destruction that an actual asteroid impact would make. The Splugorth use this weapon to destroy major population centers in anticipation of landing slavers and assault teams on a planet.

Primary Purpose: Anti-Planet.

Secondary Purpose: Anti-Installation.

Weight: Not applicable, the mass-driver is part of the ship's hull. Each stone block weighs 50 tons.

Range: 500 miles (800 km) in space. Cannot be fired from within an atmosphere.

Mega-Damage: 1D6x1,000 M.D. in space.

When fired at the surface of a planet it does 1D4x100,000 M.D. to everything within the five mile (8 km) diameter impact epicenter, and 1D6x100,008 M.D. from the shockwave and firestorm to the subsequent five mile (8 km) secondary blast diameter and 4D6x10 M.D. to everything for the next 10 miles (16 km). This attack leaves a crater that is 1000 feet deep (305 m) and 4 miles (6.4 km) wide.

Rate of Fire: One shot every fifteen minutes (60 melees).

Payload: Four.

**2. Fusion Beam Cannons (8):** Mounted in forward-facing turrets along the leading edge of the wings, a combined volley from these particle accelerators can destroy most sub-capital ships in one blow. Each weapon may also be aimed at separate targets. Each fusion beam cannon has a 180-degree arc of fire.

Primary Purpose: Anti-Ship.

Secondary Purpose: Anti-Installation.

Weight: Not applicable, part of the ship's hull.

Range: 10 miles (16 km) in space, half that in an atmosphere.

Mega-Damage: 3D6x100 M.D. per fusion gun blast.

Rate of Fire: Each may fire up to 4 times per melee round.

Payload: Effectively Unlimited.

**3. Neutron Cannons (40):** A variation on the particle beam, the Neutron Cannon fires a deadly stream of unstable neutrons as opposed to the protons of a standard particle cannon. Neutrons have the same devastating effect on materiel as their proton cousins, with the added bonus of inflicting double damage to organic targets. These are the same weapons found on the Raider-class shuttles, used here as point defense weapons.

Primary Purpose: Anti-Fighter.

Secondary Purpose: Anti-Missile.

Weight: Not applicable, part of the ship's hull.

Range: 6,000 feet (1,829 m) in an atmosphere. 2 miles (3.2 km) in space.

Mega-Damage: 3D6x10 M.D. per cannon. These weapons inflict double damage to *organic* targets.

Rate of Fire: Equal to the gunners' hand to hand attacks (usually 4 or 5).

Payload: Effectively unlimited.

**4. Cruise Missile Launchers (4):** The Taskmaster carries standard anti-matter cruise missiles with a range of 1,000 miles (1,600 km). They will always be smart missiles however, with +5 to strike, +4 to dodge, and 2 actions per round. All four launchers are mounted aft, two on the dorsal side and two on the ventral. Each launcher can volley as many as ten missiles at once.

Primary Purpose: Anti-Ship.

Secondary Purpose: Anti-Installation.

Weight: Not applicable, part of the ship's hull. Each missile weighs 10 tons.

Range: 1,000 miles (1,600 km).

Mega-Damage: 4D6x100 M.D. per anti-matter warhead.

Rate of Fire: One at a time or in volleys of 2, 4, 6, 8 or 10 per launcher, per round.

Payload: 50 per launcher for a total of 200 missiles. An additional 400 missiles are kept in an armored magazine.

**5. Ship's Systems of Note:** Tactical life support, launch/recovery and traffic control systems for aerospace craft and robots, IFF/command and control systems, slave containment systems.

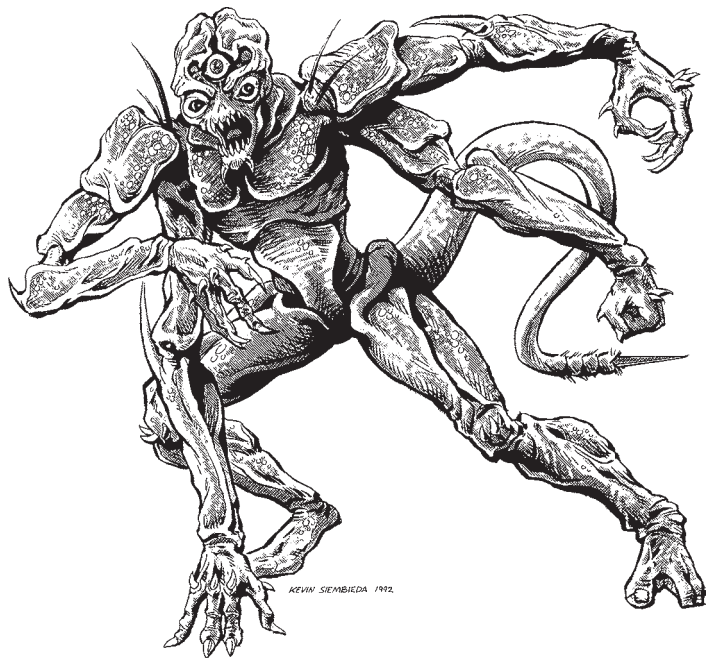



# The Transgalactic Empire

## The Imperial Armada of the Transgalactic Empire

It is a rare thing when the power of one species forces so many others to unite together for mutual defense, and that fact alone speaks volumes of the Imperial Armada of the Transgalactic Empire (TGE). So fearsome and destructive is the Imperial Armada that it toppled the ancient *Wulfen Empire*, and forced the creation of the *Consortium of Civilized Worlds (CCW)*. The Armada has existed for over 5,000 years, since the day the Kreeghor finally overthrew their Splugorth masters. It has undergone many changes in that time, and each revision has been a direct result of changes in the *Kreeghor* way of thinking.

As slaves, the Kreeghor never had a real society to call their own. When freed from subjugation however, they were forced to invent one. Freedom became their driving motivation: freedom from oppression. Unfortunately, the Kreeghor felt that the only way to ensure that they never again fell under the power of another species was to *wipe out all the other races* living in the Three Galaxies. In the beginning, the Kreeghor tackled this in the same way that they had fought battles for their alien masters, by swarming an enemy with sheer weight of numbers. The ancient Kreeghor were the masters of “shock and awe,” and developed a fleet comprised of hundreds of thousands of shuttles, fighters and frigates. This policy of victory through attrition served them well for many thousands of years. The Kreeghor had been raised since birth to see themselves as *disposable*, and

they thought very little of throwing their lives away in battle so long as the mission objective was accomplished. That mission had now turned to eliminating the competition and potential threats, expanding the Kreeghor Dominion, and gaining new worlds and resources. They were also fortunate that there was little to no organized resistance to their expansion at the time. 5,000 years ago, the Three Galaxies was a very different place. The Human Alliance was in its infancy, the Noro had not yet developed interstellar travel, and the Oni were still barbarians.

However, the Kreeghor finally met a worthy foe when they pushed into Wulfen space. The Wulfen did not approach war with the same headfirst recklessness as the Kreeghor, and although smaller in numbers, the Wulfen were able to inflict great damage to the Kreeghor. By the time the war ended, and the Wulfen Royal Family had been overthrown by their own people, the Wulfen Republic had been cut in half. The Kreeghor then underwent a dramatic shift in thinking, mainly thanks to the so-called *Dark Tribes* who had allied themselves to the Kreeghor in a bid to achieve power. From the Dark Tribes, the Kreeghor learned that a space fleet which used several different classes of starships (not to mention tactics such as flanking, feinting, and distracting) could win the day without a horrific loss of life and machinery. And so, the makeup of the Armada changed to incorporate more destroyers and cruisers.

When the Kreeghor again began to expand their Empire, the results were devastating for any who opposed them. So much so that the remaining half of the Wulfen Republic was forced to

seek help from the newly formed Human/Noro partnership known as the burgeoning Consortium of Civilized Worlds (CCW). This marked the beginnings of the CCW, and an end to unfettered Kreeghor aggression.

**The First Great War** between the Transgalactic Empire (TGE) and Consortium of Civilized Worlds (CCW) raged for centuries, with the end result being stalemate. Neither side could secure an overwhelming victory against the other, and eventually a peace accord had to be signed, which was another first for Kreeghor society. In the aftermath, the Transgalactic Empire was again forced to revise its thinking, and developed an entirely different way of fighting its enemy, through a tense, non-shooting “Cold War.”

Instead of openly fighting the CCW, the Kreeghor learned how to fight using diplomatic maneuvering, economic pressure, selective aid, intimidation, propaganda, assassination, low-intensity military operations and full-scale proxy war. Moreover, they began to fight their enemy not through violence, but through the implied threat of violence. The Empire began building and stockpiling a massive number of ships and weapons, sending the signal to the CCW that resistance would be useless in the face of so much hardware. As a result, the Consortium began to increase their own weapon reserves. The Kreeghor would counter this by developing ever larger ships, faster FTL drives, and high-yield cruise missiles. An arms race that spanned the galaxies spiraled towards an uncertain future.

Eventually, the numbers of combat ships and volumes of firepower possessed by either side produced an unavoidable outcome: If the two parties ever engaged in full-scale war again, both sides would be annihilated. It was mutually assured destruction on a universal scale. The Imperial Armada, now bolstered by many member races who had helped to expand Kreeghor thinking, came to realize that they had lost all first strike capability. The precious CCW Core Worlds were now protected by buffer zones thousands of light-years across. Since standard sensors could detect a ship moving at FTL speeds out to a distance of 10 light-years, one could never launch a successful “decapitation strike” (an attack that aims to remove the command and control mechanisms of the opponent in the hope that this will severely degrade or destroy their capacity for retaliation). Simply put, the Kreeghor could think of no way that they could win.

So while TGE’s diplomats were speaking of arms limitation talks, and of weapons reductions for both sides, the top Royal Kreeghor strategists had an epiphany, if they couldn’t possibly chew through all the defenses of the Consortium, they had to get around them.

**A super-secret project was initiated.** The goal of this project was to build a first strike capable starship that was undetectable by conventional means. The Rebellion on Good Hope and the ongoing battles against the Free World Council have caused endless delays in this program, but at last the Kreeghor believe they now have the means to destroy, or at least cripple, the Consortium forever. Thanks to a cadre of *Prometheans* who all failed their Tests of Maturity, the Imperial Armada is almost set to begin testing a new, *Phase capable* sub-capital ship, a nearly invisible missile boat that, if successful, could spell certain doom for any who oppose the Kreeghor.

## Disposition of TGE Fleets

Despite years of shipbuilding experience and the addition of numerous, highly technical races like the *Machine People* into the ranks of the Transgalactic Empire (TGE), the Armada continues to use mainly small spacecraft as its primary ships of the line. Sub-capital ships, *frigates*, *destroyers* and *cruisers*, make up the bulk of the Armada, supported by legions of shuttles and space fighters. Capital and super-capital ships like battleships and dreadnaughts are incredibly uncommon, making up less than five percent of total warships in the TGE fleet.

There are six main Imperial Fleets operating in the Three Galaxies, with two fleets each based in the *Corkscrew*, *Anvil* and *Thundercloud Galaxies*, and **Fleet Command** is on *Kreeghor-tet*. Each of these fleets is comprised of four battle groups, and each battle group is centered around one of the massive *Doombringer dreadnoughts*. These battle groups are further broken down into numerous flotillas and task forces which take care of the workaday fleet duties like patrolling and escort.

There are currently four fleets operating in the Corkscrew: First and Second Corkscrew, Second Anvil and Second Thundercloud. This has left single undermanned and overextended fleets operating in the *Anvil* and *Thundercloud Galaxies*. Of the fleets in the Corkscrew, three are missing a dreadnought. *Nisbroloth*, rechristened *Hopebringer* by the rebellion, belonged to the Second Corkscrew Fleet, but was captured while docked for repairs during the *Rebellion of Good Hope*. Upon her capture, the First Corkscrew Fleet made for Good Hope while the Second Anvil and Second Thundercloud were dispatched to the Corkscrew to provide reinforcement and support. One battle group from First Corkscrew and its *Doombringer Niphal* were annihilated by *Hopebringer* and her ragtag fleet of pirates and Spacers within days of the rebellion, and in the intervening years, *Hopebringer* tangled with and destroyed *Choli*, one of Second Anvil’s *Doombringers*.

Obviously, the loss of three of their vaunted dreadnoughts has been a huge black eye for the Imperial Fleet. They are currently racing to complete replacements for the three lost *Doombringers*, and slowly returning their fleets to full strength. The Rebellion has dragged on longer than the Kreeghor ever expected, and it’s stretching both the resources and the patience of the Kreeghor Admiralty dangerously thin.

## Imperial Ship Technology

The human population of the Consortium constantly keeps their computer technology held back from its full potential, which has kept the TGE their equal in shipbuilding technology for many years. However, since the Empire incorporated the *Machine People* into its ranks of soldiers and civilians, things have changed. Thanks to these living machines, the TGE has made several stunning technological breakthroughs well ahead of the Consortium’s best minds.

Foremost among these discoveries was the creation of the **Kelthrot Harmonic Field**, the revolutionary, new contra-gravity engine that tripled the “mass limit.” Before this advancement, ships larger than 60 million tons could not be catapulted into faster-than-light speeds. Combat and exploratory ships had effectively “topped out.” However, the new engine



configuration of the TGE has raised the bar, and the Transgalactic Empire gleefully began building dreadnoughts. Meanwhile, it took some time for the Consortium to acknowledge that such ships were even theoretically possible, let alone build one of their own.

On the whole, Kreeghor ships are designed for combat first, and all other missions second. Smaller classes, such as destroyers and cruisers, are not as heavily armored as their Consortium counterparts, but skimping on extra plating saves the Empire money. Also, safety is not nearly as important to the TGE as it is to almost everyone else in the Three Galaxies. One can often find an Empire vessel in desperate need of repairs, its engine leaking anti-protons, and its crew sick from heavy ion poisoning. The TGE has no such thing as a workers' safety board, nor a governmental lobby group to demand change on the workers' or soldiers' behalf. This is not to say all Armada ships are floating deathtraps, but they are certainly a far cry from the clean, spacious and well run ships used by the Consortium Armed Forces (CAF).

## TGE Ranks

Even though there are five or six core races that comprise the forces of the Imperial Legion and the Armada, the Kreeghor force everyone to use their rankings and command hierarchy.

<u>Kreeghor Rank</u>	<u>Translation</u>	<u>Human Equivalent</u>
Tronton	Galactic Commander	Grand Admiral
Hadash Chulzak	Political Officer	—
Cressak	Fleet Commander	Commodore
Cren-Cressak	Dreadnought Commander	Independent Captain
Rylcus	Commander	Captain
Nolrak-Dirs	First in Front	Commander
Hapgar-Dirs	Second in Front	Lt. Commander
Craddar	Large Group Leader	Sergeant
Gun-Craddar	Small Group Leader	Corporal
Kulson	Warrior	Private

A **Tronton** is not placed in charge of a whole galaxy, as the CAF does with its Grand Admirals. The Emperor and his Royal Family refuse to put that much trust in a single officer. Rather, they are only given control over a single "Dominion." All other Armada officers within that Dominion must obey orders from that particular Tronton, with the exception of the *Invincible Guardsmen*, who are a Special Forces unit answerable only to the Emperor, and of a Hadash Chulzak – a political officer.

The **Hadash Chulzak** is an officer appointed by the Royal Family to oversee a unit of the military. They have the authority to override any decision of military officers, and can remove them from command if necessary. Sometimes the Chulzak usurps the functions of a regular military commander, but this is almost never necessary. Their mere presence usually ensures that commanders follow their directives. The day-to-day duties of the political officer generally involve propaganda work, rooting out dissidents and boosting the morale of the other troops. A Hadash Chulzak must obey any orders given him by members of the Invincible Guard, but otherwise he is free to act as he sees fit.

When a fleet of two or more ships is involved together, one of the captains – a **Rylcus** – will assume the rank of **Cressak**. This honor usually goes to the Kreeghor with the most experience (highest level), but a younger Rylcus may elect to fight to the death for the title. There is no limit to the number of ships a Cressak might have control over, but he cannot give orders to the captain of a Doombringer.

The rank of **Cren-Cressak**, literally meaning "other fleet captain," was created when the first Doombringer left the Feydra-Beta shipyards. In his paranoia, the Emperor does not trust any Cressak enough to include one of the dreadnoughts in his command. Instead, the Rylcus of a Doombringer is allowed to act independently and to take action guided by his training and personal discretion. If this means opening fire on a disobedient Cressak or abandoning a fleet to be slaughtered by enemies, then so be it. Thus, a Doombringer can be seen as a fleet unto itself, or a fleet within a fleet. A Cren-Cressak is likewise forbidden to assume the rank of Cressak, and lives in constant fear of the several political officers stationed on his ship.

A **Nolrak-Dirs** is generally the first officer of a given ship. It is interesting to note that the translation of this rank, "first in front," relates to a Kreeghor tradition that the highest ranking officer goes last in a marching formation. This way, his second in command cannot stab him in the back and take his place.

## TGE Uniforms and Colors

Gray and black with blue or red trim are the dreaded colors of the TGE and its Legions. While serving aboard an Imperial starship, any and all officers wear their Legionnaire combat armor which is gray with black edging. Kreeghor wear matte black and silver-trimmed armor to separate themselves from the non-Kreeghor races. Rank insignia are worn on the right shoulder, with campaign ribbons also running down the right arm.

*Invincible Guardsmen*, should they be serving on board, are easily identified by their shining silver armor, which is worn regardless of race.

*Political officers* are very conspicuous aboard ship, always dressed in a steel gray uniform and a long, red overcoat with gold trim.

## A Notable Armada Facility

### The Array

#### Corkscrew Galaxy

Like so many of the mysterious ruins and artifacts found across the Three Galaxies, no one is certain who constructed the Array or when, exactly, it was built. A series of 200 massive and ancient communications satellite-stations and their defense systems, the Array stretches 25,000 light-years from end to end. It runs for a full third of the length of the Corkscrew Galaxy, through its entire thickness, and cuts right through the middle of Kreeghor space. The original purpose for the Array is unknown, but most scholars assume it to be the remnants of some sort of early warning system.

The TGE has never figured out how to use the Array to its full potential. All they know is that it can apparently listen in on every kind of communication traveling through it. **Imperial Security** has engineered the routing of the majority of the Em-

pire's communications through the Array, and they use it to monitor private communications of Imperial citizens. Every phone call, every hypernet download, every tach-line transmission that passes through the Array is recorded and analyzed. If certain keywords show up ("rebellion," "assassination," "terrorist," "democracy," etc.), the person who said them can expect a knock at their door, and several heavily armed Security Agents asking them to come in and answer a few questions.

While the Array is an excellent propaganda tool, in reality most of the messages it records become garbled and fragmented to the point of uselessness. The computers in each node are now so old that they often do not work properly, and they are so alien in design that no one is sure how to fix them. Still, the Imperial propaganda specialists have made certain that everyone living in the Empire knows about the Array, so that everyone is afraid to say anything that might be used against them, because one never knows who is listening.

**The Free World Council** has an express interest in destroying the Array, or better yet, using it for their own purposes. *The Cadre*, the elite military group that leads the Rebellion from Good Hope, would be quite interested in gaining access to the recording logs of the nodes and collecting information on Imperial Fleet movements and plans.

Each node in the Array is the size of a small space station, with enough space to dock four sub-capital class or smaller ships, and has 40,000 M.D.C. (a 100 foot/30.5 m area of the hull has 200 M.D.C.). It has built-in automatic repair systems that repair light damage (less than 25% of total M.D.C.) in about 1D4x10 minutes and heavy damage (more than 60% of total M.D.C.) within 6D8 hours. Its sensors (light, heat, gravity, motion) and communications (radio, tach-line, language translators) are beyond anything produced by current societies and have a range of roughly 500 light-years. It is interesting to note that the Array can also detect temporal distortions, such as might occur if the *time-line* were changed, and it is the only known method of detecting *Dominator Star Fortresses* at long range. Each node is also armed with six automated, medium HI-Lasers (2D4x100 M.D. per blast, 8 mile/12.8 km range, with 8 attacks per melee round). The nodes were unmanned when they were first discovered by the Kreeghor, but now each have a staff of about 150 personnel.

## A Notable Armada Commander

### Rylcus Yarrl Adan

#### Veripin System, Thundercloud Galaxy

Rylcus Yarrl Adan is an accomplished and well respected Wulfen Armada officer who has served the Empire faithfully for over fifty years. He is a veteran of thirty-two different military campaigns, has been wounded in action five times and has received some of the highest combat honors that non-Kreeghor can win. Now, in the autumn of his career, he is about to throw it all away and betray everything he believes in.

Yarrl Adan grew up in Imperial occupied Wulfen space and joined the Legion as soon as he was old enough. Young and impressionable, he wanted more from life than his impoverished parents could offer, and he saw a career in the Legion as a means to get it. He bought into the state propaganda completely,



and never doubted that the Imperial way of life was the best that there was. He underwent technical training and became Gun-Craddar of Engineering on a *Smasher*-class cruiser.

When he was 40, he fought in the border wars against the CCW. During one particular engagement, the main bridge of the ship he was serving aboard was completely destroyed, and the engineering teams had to assume command. Adan served as an acting Nolrak-Dirs for six months until such time as the ship could be repaired and a new command crew installed. For his service to the Transgalactic Empire, he was awarded the distinguished *Mult Joyech* medal for meritorious service. He was allowed to keep his rank as First Officer when the *Smasher* was repaired, and served out the rest of the conflict in that position where he continued to exhibit impressive leadership skills and composure under fire.

Years later, Adan was transferred to the *Doth Ledroth Fleet Yards* orbiting Veripin 7. It was there his technical expertise could be best put to use. His primary assignment was to keep a close eye on the station's four new Promethean weapon developers. Although the actual workings of the *Phase Engine* were quite beyond him, he fully appreciated the destructive power of the *Etherium*. So much so, that when he was awarded the honor to become the Rylcus of the vessel, Adan declined. To his superiors, Yarrl Adan had passed the final test. If he had immediately accepted the command, he would have been seen as being overeager, and would have been executed as a potential traitor or an ambitious rival to those already in power. Instead, his polite declining of the offer showed reserve, caution and responsibility. Of course, that meant the Kreeghor leadership insisted that he take command of the new Phase Ship and take it through

its final testing sequences. Yarrl Adan had little recourse but to agree, but that was okay, for by this time he had formulated a plan of his own.

Rylcus Adan is planning to take the *Etherium* prototype Phase Ship on its test run, then make a break for the closest Consortium world and plead for asylum. If he arrives safely, the Wulfen intends to turn the ship over to the CAF for study so that they can come up with a way to detect such vessels in the future. Despite appearances, Yarrl Adan is not a traitor. Although he is sure to be branded one, the Wulfen commander completely supports the TGE in every way. However, he is quite certain that as soon as the Consortium of Civilized Worlds or other enemy of the Empire learns about the existence of this spacecraft at the business end of its energy cannons, it will create such fear of the unknown that it will compel *everyone* else in the Three Galaxies to unite in an effort to destroy the TGE. Adan is smart enough to realize that the once the *Etherium*-class Phase Ships attack that their existence will negate the mutual safety brought by *deterrence* between the TGE and the CCW. However, if the CCW has the vessel in their hands before it is actually used against them, they can respond politically while studying the vessel and finding ways to detect it and neutralize it, thus maintaining deterrence and an uneasy peace.

The biggest initial problems of this daring plan are securing the allegiance of the crew, and killing the Kreeghor Political Officer who is going along for the ride.

When the ship goes AWOL, the Transgalactic Empire will throw everything they have in the area on a search and destroy mission. The prototype *Etherium* is rigged with monitoring equipment that the rest of the Armada can use to track it. Since it moves so slowly in Ghost Mode, it will take the ship *weeks* to reach CCW space.

In the meantime, the Consortium has recently discovered, through its own agents in the Free World Council, that a century ago the Empire had some kind of laboratory on Good Hope. A facility that was destroyed in the initial fighting, but that was apparently trying to develop a new kind of cloaking device for Kreeghor ships. The agents of the GSA know that this project was relocated after the Rebellion, and that in all likelihood it was moved to Veripin 7. They are even now trying to get an operative team onto the station. If they are lucky, they (or some other group of intrepid adventurers) might be able to *help* Rylcus Adan get the Phase Ship to the Consortium. If they fail to help the erstwhile Wulfen, the Kreeghor are likely to recapture the *Etherium*. If that happens, total galactic war seems inevitable. Consequently, it is imperative that Rylcus Adan gets the *Etherium* into the hands of the CCW. (Game Masters, this could be a wild adventure where the fate of the Three Galaxies may hang in the balance.)

## Yarrl Adan – Quick Stats

**Alignment:** Scrupulous.

**O.C.C./Experience Level:** 15th level Imperial Legionnaire.

**Attributes:** I.Q. 15, M.E. 17, M.A. 9, P.S. 25, P.P. 15, P.E. 13, P.B. 13, Spd 24.

**Hand to Hand:** Expert.

**Notes:** Yarrl Adan is a Wulfen from the Blackstep lineage. He is of heavy build, with a bushy tail. He is 71 years old, and

has graying fur around his ears and snout. His family have been citizens in the TGE since the Wulfen Republic was first divided over 700 years ago. He has never married and so has no family of his own, but does have three other siblings from the same litter. Since smoking is forbidden on starships as it fouls up the life support systems, he chews tobacco.

# Notable Ships of the Imperial Armada

## TGE *Etherium*

### Prototype Stealth

### Guided Missile Destroyer

*Etherium* is the brainchild of a cadre of four Promethean outcasts currently working under contract for the Transgalactic Empire. These mercenary shipwrights and aerospace engineers have been wandering the Three Galaxies for centuries, unlocking forbidden technologies and violating weapons treaties for whomever can pay their exorbitant fees. Their current project is the result of a lucky find during a raid on the *Repository of Tyedaisun*, the great Elven library on *Magestar*. During their raid, the rogue Prometheans came across plans for an experimental, ship-sized phase field generator that had been proposed during the war against the Dominators. Knowing they'd found something explosive and potentially very lucrative, the Prometheans sat on their discovery and began to make inquiries as to who among the major powers in the Three Galaxies would be willing to pay for such a technology. The TGE was the first to bite. The outcasts were selling the potential ability to make starships completely invisible to standard technological sensors, and the Kreeghor were buying.

With a nearly unlimited budget and access to the best scientists and facilities the Empire could provide, the outcasts spent two decades unlocking the secrets in the plans they pilfered from *Magestar*. Finally, two years ago, they made their breakthrough and *Etherium* was born. When flying in stealth mode, all of *Etherium's* typical fins and protrusions fold in together to give her a long and narrow profile. All of her weapons are recessed into the hull and protected behind retractable, delicate looking armored plates. This provides clean lines and a shape that defeats most technological sensors. Unlike the Star Ghost fighter, *Etherium* is covered in a sensor absorbing coating that gives it a slightly iridescent, dun colored finish.

While *Etherium's* stealth systems are both technologically and magically light-years ahead of the CAF's, her real strength lies in her weapons. During the vessel's development, TGE scientists were working on a new style high-yield, multi-warhead anti-matter missile for use in planetary bombardment and station sieges. It was decided by TGE brass that *Etherium* would be the first ship to carry these lethal new missiles, and the programs were merged into *Project Singularity*. All of *Etherium's* weapon systems are optimized for the carrying and deployment of the new *Singularity* missiles. TGE War Ministers envisioned small squadrons of *Etherium*-class destroyers warping undetected into

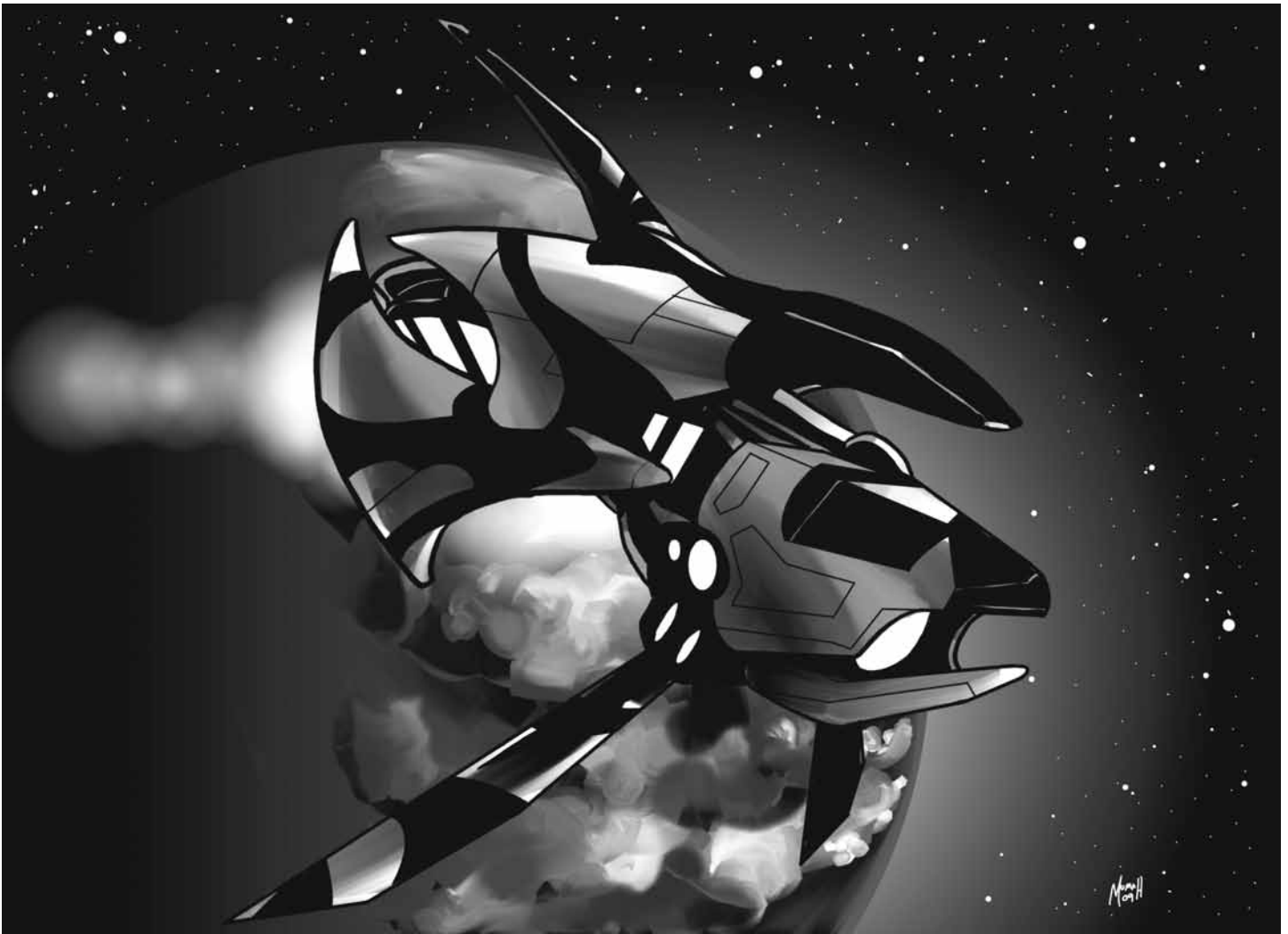

a planet's orbital space and unleashing dozens of Singularity missiles in advance of an invading fleet. This new ship and its deadly cargo would give the TGE nearly unmatched *first strike* capabilities, and allow the Empire to engage in a campaign of expansion and conquest with near impunity.

At this time, *Etherium* is the only ship of her class active and is currently conducting space trials in the far reaches of TGE space. If all goes well and she meets her performance goals, there are plans to begin production of at least two dozen of these ships.

**Model Type:** Experimental Guided Missile Destroyer (TIV-DDGX).

**Class:** Etherium Class (Experimental).

**Ship's Complement:**

Ship's Crew: 200 total (20 Officers, 180 Enlisted and Conscripts).

Bridge: Ship's Captain (1), Ship's Executive Officer (1), Hadash Chulzak (1, Political Officer), Helm (2), Navigation (2), Comms and Sensors (2), Security (2 Invincible Guardsmen in Imperial Legionnaire's armor and armed with EPR-8 pulse rifles).

Combat Information Center (CIC): Legion Nolrak-Dirs (1, in charge of weapons deployment), Military Advisory Team (2), Comms (2), Ship's Weapons and Fire Control (15), Se-

curity (4 Invincible Guardsmen in Imperial Legionnaire's armor and armed with EPR-8 pulse rifles).

General Operations: Engineering (18), Medical (10), Ship's Security (25), Internal Communications (8), Enlisted and Conscripts (104).

**M.D.C. by Location:**

Interior Bulkheads per 10 feet (3 m) – 50

Interior Hatches – 65 each

Exterior Hatches – 95 each

Laser Cannons (2) – 1,200 each

\* Launcher Bay Doors (40) – 350 each

Singularity Missile Launchers (40) – 1,000 each

Mini-Missile Launchers (8) – 300 each

Forward Hull Section (1/3) – 2,600

\*\* Midships Hull Section (1/3) – 2,800

\*\*\* Aft Hull Section (1/3) – 3,800

\*\*\*\* Hull per 40 feet (12.2 m) – 85

\* Destroying the launcher bay doors exposes the Singularity missiles to attack.

\*\* Destroying the midships hull section eliminates the CIC and all weapons and fire controls. This renders the ship flyable but unable to fight. There is also a 10% chance that destroying the midships section damages the missile magazine and causes

any remaining Singularity missiles to detonate. Should that happen, the missiles annihilate the ship and inflict 2D6x1,000 M.D. to anything within 500 miles (800 km).

\*\*\* Destroying the aft hull section eliminates the engines, setting the ship adrift.

\*\*\*\* Punching holes in the hull causes the damage control system to automatically seal off whatever compartment has been exposed to vacuum.

### Speed:

Atmosphere: The *Etherium* is transatmospheric, and can maintain a cruising speed of 3,805 mph (6,088 or Mach 5) in atmosphere.

FTL: 6 light-years per hour.

Sub-Light: Relatively fast for a ship her size, the *Etherium* can muster an impressive cruising speed of 9,132 mph (14,611.2 km or Mach 12).

Range: Limited only by supplies. The anti-matter reactors carry enough fuel to operate the ship at full readiness for 40 years, but shipboard stores are only good for eighteen months of constant deployment with full crew and complement.

### Statistical Data:

Length: 574 feet (175 m).

Beam: 75 feet (22.8 m).

Height: 60 feet (18 m).

Mass: 48,000 tons fully loaded.

Cargo: Minimal. Interior space is taken up mostly by weapon systems and missiles.

Power System: One high-output sub-capital anti-matter reactor powering two, two-nozzle sub-capital plasma thruster arrays. The *Etherium* also has a Mk. IV interlinked Phase Engine.

Development Cost: Unknown. Likely to be in the hundreds of billions.

### Weapon Systems:

**1. Laser Cannons (2):** These massive HI-Lasers are the *Etherium's* main anti-ship weapons. Like all HI-Lasers, they have excellent penetration and stopping power, but suffer from high energy consumption and a relatively low rate of fire.

Primary Purpose: Anti-Ship.

Secondary Purpose: Anti-Installation.

Weight: Not applicable, part of the ship's hull.

Range: 100 miles (160 km) in space, or 30 miles (48 km) in an atmosphere.

Mega-Damage: 1D4x1000 M.D. per cannon, or 2D4x1000 M.D. if fired together.

Rate of Fire: Each cannon may fire once per melee round (15 seconds).

Payload: Effectively unlimited.

**2. Singularity Missile Launchers (40):** These dreaded missiles are the creation of the Transgalactic Empire. The principle of these missiles is relatively simple. It's not the explosion that does the damage, but the micro-singularity (black hole) that is created by the missile's detonation. It only lasts for a few seconds (one melee round), but in those few seconds it causes massive damage. The black hole puts enormous

stresses on a ship's bulkheads, causing them to buckle and collapse, and the missile ends up causing more internal damage than one would expect.

Primary Purpose: Anti-Planet.

Secondary Purpose: Anti-Installation.

Weight: Not applicable for the launchers, as they are part of the ship's hull. Each Singularity missile is 32 feet (9.75 m) long and weighs 50 tons.

Range: 1,000 miles (1600 km), in an atmosphere.

Mega-Damage: 1D6x1,000 M.D. per missile to a radius of 500 feet (152 m); half damage for 500 feet (152 m) beyond that.

Rate of Fire: The missiles can be launched singly or in volleys of 2, 4, 8, 10 or 20.

Payload: The ship carries 40 Singularity missiles, one in each of the vertical launch silos.

Bonus: Singularity missiles are considered smart munitions, and are +5 to strike thanks to their guidance systems.

**3. Mini-Missile Launchers (8):** Spread around the hull of the ship, these missile launchers comprise the point defense system, and are placed such that they have complete coverage across the entire ship.

Primary Purpose: Anti-Missile.

Secondary Purpose: Anti-Fighter.

Weight: Not applicable, part of the ship's hull.

Range: 2 miles (3.2 km) in space, half in an atmosphere.

Mega-Damage: Varies by warhead. Typical load is fragmentation, 5D6 M.D. to a 20 foot (6 m) area (double the area in space).

Rate of Fire: One at a time, or in volleys of 2, 4 or 8 missiles.

Payload: 64 missiles per launcher (512 in total). The ship can carry an additional 1,024 missiles in an armored magazine.

**4. Etherium Stealth Field (ESF):** Essentially a ship-sized OP-field, the ESF enables *Etherium* to fly while out of phase, making the ship undetectable and invulnerable to technological sensors and weapons. To fight or deploy her Singularity missiles however, *Etherium* must drop the Phase Field. This makes the destroyer vulnerable for a short period of time. Duration: The massive Phase Engine gives the ship an unlimited number of "charges," so it can run in Phase-mode indefinitely. Activating the ESF counts as an attack, and can be used as a dodge to avoid incoming attacks.

**5. Ship's Systems of Note:** Tactical life support, escape pods for all crew, IFF systems.

## TGE Executioner-Class Battleship

The Executioner represents the missing link between the *Smasher*-class cruiser and the *Doombringer Dreadnought*. It was first built 650 years ago for use in the First Great War. Executioners were initially developed to counter the heavily armed and armored cruisers of the Human Alliance, which had proven more effective than the frigates and light cruisers that the TGE was fielding at the time. There are currently just fewer than 17,000 of these massive ships in the Imperial Armada.



The Executioner was the first Kreeghor starship built so large that it couldn't safely land on a planet, but it would not be their last. The Consortium soon trumped the TGE's battleship by building the *Protector*-class and the Kreeghor, always ones to think that bigger is better, were determined to build a superior ship. They did so with the *Doombringer*-class dreadnought, which reigned as the largest ship in the Three Galaxies until recently. Since the Kreeghor dreadnought was constructed using many of the same weapon systems found on the Executioners, many historians consider this ship to be a precursor to the monstrous Doombringers.

**Model Type:** Battleship (TIV-BB).

**Class:** Executioner Class.

**Ship's Complement:**

Ship's Crew: 3,974 total (398 officers, 3,572 Enlisted and Conscripts).

Bridge: Ship's Captain (1), Ship's Executive Officer (1), Hadash Chulzak (1, Political Officer), Helm (5), Navigation (10), Comms and Sensors (10), Security (4 Invincible Guardsmen in Imperial Legionnaire's armor and armed with EPR-8 pulse rifles).

Combat Information Center (CIC): Legion Nolrak-Dirs (1, in charge of troop deployment, strategy and tactics), Military Advisory Team (10), Dil-Oldyt (1, Supreme Pilot, commander of ship's aerospace wing), Dil-Kuzkin (1, Supreme Soldier, commander of ship's planetary assault group), Comms (10), Ship's Weapons and Fire Control (30), Security (10 Invincible Guardsmen in Imperial Legionnaire's armor and armed with EPR-8 pulse rifles).

General Operations: Engineering (100), Medical (200), Flight Operations (100), Ship's Security (600), Internal Communications (75), Enlisted and Conscripts (2,800).

Embarked Troops: 2,940 total (308 Officers, 2,632 Enlisted and Conscripts).

Imperial Oldyt (Aviators): 240

Imperial Kuzkin (RPA Pilots): 900

Imperial Legionnaires: 1,800 combat ready Legionnaires.

**Aerospace Group:**

Aerospace Fighters:

FF-100 Flying Fangs: 60 (6 squadrons of 10 ships each).

TIV-TT1 Rain of Death Assault Shuttles: 30 (3 squadrons of 10 ships each).

**Planetary Assault Group:**

IAF-95 Dark Slayer Tanks: 100 (20 platoons of 5 units each).

KT-1 Kartuhn-Terek "Doomsday Machines": 30 (15 platoons of 2 units each).

IAR-500 Imperator Robots: 100 (20 platoons of 5 units each).

IPA-WI-K Warlord Power Armor: 500 (10 platoons of 50 units each).

**M.D.C. by Location:**

Interior Bulkheads per 10 feet (3 m) – 50

Interior Hatches – 65 each

Exterior Hatches – 110 each

Hangar/Recovery Bay – 12,000

Launch Tubes (2) – 6,000 each

\* Command Tower – 10,000

Laser Cannons (2) – 2000 each

Particle Beam Cannons (4) – 1,200 each

Cruise Missile Launchers (2) – 900 each

GR Gun Emplacements (8) – 600 each

Forward Hull Section (1/3) – 50,000

\*\* Midships Hull Section (1/3) – 50,000

\*\*\* Aft Hull Section (1/3) – 65,000

\*\*\*\* Hull per 40 feet (12.2 m) – 100

Variable Force Fields – 8,000 per side (48,000 in total)

\* Destroying the command tower eliminates the bridge. With the bridge destroyed, the ship can still be run from the CIC.

\*\* Destroying the midships hull section eliminates the CIC and all weapons and fire controls, rendering the vessel flyable but unable to fight.

\*\*\* Destroying the aft hull section wipes out the engines, setting the ship adrift.

\*\*\*\* Punching holes in the hull causes the damage control system to automatically seal off whatever compartment has been exposed to vacuum.

**Speed:**

Atmosphere: Executioners are slow and awkward in atmosphere, and can manage only a paltry 250 mph (400 km). Additionally, the helm is -20% to all control and piloting skill rolls in atmosphere.

FTL: 6 light-years per hour.

Sub-Light: Mach 9.

Range: Limited only by supplies. The anti-matter reactors carry enough fuel to operate the ship at full readiness for 40 years, but shipboard stores are only good for eighteen months of constant deployment with full crew and complement.

**Statistical Data:**

Length: 3,000 feet (914.4 m).

Beam: 600 feet (183 m).

Height: 500 feet (152.4 m).

Mass: 25 million tons fully loaded.

Cargo: Can carry 300,000 additional tons of cargo.

Power System: Four TGE capital-class anti-matter reactors powering two, five-nozzle capital-class thruster arrays and a standard TGE Contra-Gravity FTL system.

Market Cost: These ships cost roughly 35 billion credits to build. None have made it to the black market, and they are exclusive to the Imperial Armada.

**Weapon Systems:**

**1. Laser Cannons (2):** These huge and highly accurate laser cannons run half the length of the ship. They are the ship's main cannons, and allow the Executioner to dish out incredible volumes of fire.

Primary Purpose: Anti-Ship.

Secondary Purpose: Anti-Installation.

Weight: Not applicable, part of the ship's hull.

Range: 100 miles (160 km) in space, or 30 miles (48 km) in an atmosphere.

Mega-Damage: 1D4x1,000 M.D. per cannon, or 2D4x1,000 M.D. if fire-linked.

Rate of Fire: Each cannon may fire once per melee round (15 seconds).

Payload: Effectively unlimited.

**2. Particle Beam Cannons (4):** These medium energy weapons are intended for use against other capital ships, but are effective against most sub-capital vessels as well. The four turrets are mounted two to a side on the ship, so usually only two cannons can be trained on a single target at once. Each gun may fire on a separate target if so ordered.

Primary Purpose: Anti-Ship.

Secondary Purpose: Anti-Installation.

Weight: Not applicable, part of the ship's hull.

Range: 4 miles (6.4 km) in space, or 1.5 miles (2.4 km) in an atmosphere.

Mega-Damage: 1D4x100 M.D. per single blast, 2D4x100 per simultaneous dual blast at the same target.

Rate of Fire: Equal to the number of hand to hand attacks of the gunner (typically 4-5).

Payload: Effectively unlimited.

**3. Cruise Missile Launchers (2):** The name pretty much says it all.

Primary Purpose: Anti-Ship.

Secondary Purpose: Anti-Installation.

Mega-Damage: Varies by warhead.

Rate of Fire: Singly or in volleys of 2, 4, 8 or 10.

Range: 1,000 miles (1,600 km). Point-blank range is 1-3 miles (1.6-4.8 km), and cannot be fired at a closer range than that.

Payload: 50 cruise missiles at the ready and an additional 50 in an armored magazine. The ship carries an additional 400 missiles, enough for four reloads per launcher.

**4. GR-Gun Emplacements (8):** A series of heavy gravitonic guns are maintained for point defense. They are especially good for shooting at incoming enemy missiles and Cosmo-Knights.

Primary Purpose: Anti-Fighter/Anti-Robots/Powered Armor.

Secondary Purpose: Anti-Missile.

Weight: Not applicable, part of the ship's hull.

Range: 3 miles (4.8 km) in space, or 1.5 miles (2.4 km) in an atmosphere.

Mega-Damage: 4D6x10 M.D. per burst.

Rate of Fire: Equal to the number of hand to hand attacks of the gunner (typically 4-5).

Payload: 8000 rounds per turret for 200 40-round bursts.

**5. Ship's Systems of Note:** Tactical life support, launch/recovery and traffic control systems for aerospacecraft and robots, IFF/command and control systems.



# United Worlds of Warlock

## The Warlock Navy

Approximately 50,000 years ago, at the end of the last Galactic Era, the majority of cultures living in the Three Galaxies were utterly destroyed in the **War against the Dominators**. Those precious few species who survived intact, did so either by fleeing the Three Galaxies altogether, or by somehow hiding themselves until the fighting was over. *The Star Elves* of planet Alfheim chose the latter. Instead of joining the battle to stop the renegade gods, the Star Elves hid. They collected all their knowledge into the massive *Repository of Tyedaisun*, and then shrouded their entire planet in a magical invisibility field.

**The Second Galactic Era was ending.** From behind their mystic cloak of invisibility, the Star Elves watched with sorrow as the Three Galaxies burned. Although the Second Era was over, they knew a Third Era would someday begin. All they had to do was wait out the eons in between. Called "the Interim" by the Star Elves, this period lasted nearly 40,000 years. During the Interim, the Three Galaxies became populated by monsters, Alien Intelligences and all sorts of unsavory and horrible creatures. Foremost among these monstrous races were the



Splugorth, who established seven enormous kingdoms throughout the Three Galaxies. Four of these were in the *Corkscrew Galaxy*, one was located in the *Thundercloud* and the last two, the realms of Yythcryss and Rynncryll, sprawled across the *Anvil Galaxy*.

**The Third Galactic Era.** Eventually, the third and current Galactic Era began as the younger races like *humans* and *Noro* left the cradles of their civilizations and took to the stars. It was during the dawn of this new era that the Star Elves encountered the *Warlocks*. This motley collection of mages and Techno-Wizards formed an easy alliance with the Star Elves, who were pleased to see that the secrets of magic had not been forever lost in the aftermath of the Dominator War. Together, the two groups continued to explore the galaxy and settle new worlds. Then they ran headlong into *Splugorth Lord Yythcryss* and his legion of minions.

Yythcryss instantly sought to absorb the Warlock worlds, steal their secrets, and enslave their populations. War between the parties was immediate and devastating. The Star Elves, who wanted to rely on their tried and true policy of hiding until the danger had passed, were pressured by the Warlocks to take an active hand in the fighting. So it was that the first combat spacecraft of the Star Elves were built, their giant colony vessels now transformed into crystalline battleships.

Even this was not enough, and Lord Yythcryss continued to grind the Warlock and Elven armies beneath his mighty heel. In desperation, the Star Elves sent a call for help through the cosmic ley lines. A call answered by the *Anvil Dwarves*. The re-strengthened fleet was finally able to turn the tide of battle, and proceeded to rout the Splugorthian hordes. Every world the Warlocks liberated from Yythcryss' kingdom bolstered their ranks, as freed slaves of the Splugorth turned on their alien overlords and happily joined the battle against them. Finally, during the *Battle of Therackhon*, the Warlock Navy destroyed the last strongholds of Yythcryss and the Splugorth Lord, nearly destroyed in the battle, fled.

The war was over, and though none realized it at the time, the foundation for the **Untied Worlds of Warlock** had been laid.

Following the defeat of Lord Yythcryss, the Warlock leaders held a summit on Alfheim to discuss the future of their fledgeling galactic nation. *High King Silverlight* of the Star Elves was in attendance, as were several of the Warlock Lord Magi, and six representatives of the Anvil Dwarves. Together they had won a hard and bitter war, and now had to decide what was to be done with the liberated Splugorth worlds as well as the armed forces that had been assembled to free them. One of the Anvil Dwarves, *Master Smith Hacori Darksteel*, had come to them with a plan and proceeded to lay it out for all involved.

Darksteel told the assembled leaders that they had won the war only because their combined navy was superior to that of their enemy. Indeed, the astounding defeat of *Lord Yythcryss* was even now forcing the other Splugorth Kingdoms in the Three Galaxies to build larger and better space fleets for themselves. If the Star Elves, Anvil Dwarves and Warlocks were to survive a future act of aggression, they *all* needed to *unite* for mutual defense and support, for it was only together that they were able to win this hard-fought victory. In what soon became known as the **Darksteel Doctrine**, Master Smith Hacori Darksteel stated that the *new United Worlds* should not go look-

ing for trouble, but should be prepared when trouble inevitably came to their doorstep. They should therefore follow a policy of neutral relations with the other power blocs of the Three Galaxies, but destroy any and all trespassers and aggressors without pause.

Darksteel's model is still followed to this day. The Warlock Navy is not a fleet of conquest, and it almost never engages in first strikes, pre-emptive strikes, decapitation strikes, or any other kind of outright and unprovoked acts of aggression. Instead, it specializes in crippling surgical strikes meant to deter attackers from entering the domain of the United Worlds of Warlock. Such aggressors usually include *space pirates*, the *Splugorth* and their minions, and the *Star Hives*. The fleet of the Warlock Navy is smaller in number than the CAF, the Transgalactic Armada and even the Golgan Argosy, mostly because their incorporation of magic and Techno-Wizardry built into their spacecraft and weapons takes longer to produce and is more difficult to make en masse than the equipment of their enemies and allies.

**The primary mission of the Warlock Navy** is to guard the cosmic ley lines and nexus points, and defend the United Worlds from invasion, raids, and destruction. The **Warlock Marines** also take part in exploratory missions, searching the cosmos for long-lost artifacts of historical and magical significance, as well as other types of magic items, rare components used in magic, and new spells and alien forms of magic. Other agents of the United Worlds of Warlock do intelligence work, going undercover to collect information and keep tabs on the other galactic powers. Whenever possible, the UWW tries to ensure that space battles take place along *cosmic ley lines* and *nexus points*, where the enhanced ambient magic *supercharges* their weapons and spells. If a Warlock fleet has to fall back from an engagement, it always tries to flee to the nearest Lagrange or Saddle point (the latter being a natural nexus point found an equal distance between two stars). The Darksteel Doctrine also means that, more than anyone else, the UWW uses orbital defense satellites, and listening posts positioned far out in deep space.

## The Minion War

The United Worlds of Warlock's protective and paranoid nature, defenses, listening posts and ties to the mystical and supernatural, made them one of the very few galactic powers (the Splugorth and Naruni Enterprises being two others) to have an inkling about the escalating conflict between Demons and Deevils. Though the UWW took some simple precautions and put their fleet on alert, they, like others aware of the brewing **Minion War**, *NEVER* imagined the war between demons and infernals would explode as it has. And they certainly never expected the Minion War to spill across the dimensional divide, across the Megaverse and into the Three Galaxies.

The infamous demons of **Hades** and notorious infernals of **Dyval** had been at each other's throats long before most of the races of the Three Galaxies came into being. These two supernatural races live in their own hellish dimensions beyond the realm of mortals and constantly dabbled in the affairs of sentient beings, but in small, insidious ways. Evil supernatural beings, both enjoyed tormenting humans and other mortals, they served dark lords and evil gods, and frequently clashed over winning

the hearts and minds of their mortal pawns and victims. These clashes turned into an increasingly bitter rivalry that spanned countless millennia. Born from violence and wickedness, the rivalry and squabbles between demon and Deevil often led to brutality, backstabbing and treachery. On occasion, such conflicts spiraled into bloody skirmishes and even all-out war, but such violence was always isolated and very limited. At worst, an entire world might suffer in the wake of their rivalry, but even that was rare. More often than not, demon and Deevil struck at each other covertly and through games of deception, manipulation, and sabotage. Never full-blown war. And never a war that spilled across the Megaverse. That has all changed with the *Minion War*.

**Phase World, the Three Galaxies, Rifts Earth,** and many **other worlds** and their people have become either the unwitting pawns or unwanted fields of battle for demons and Deevils. Some are recruited by demons or infernals to join their battle as soldiers, henchmen or elite special forces. Others are recruited to be worshipers in order to provide P.P.E. and raw power to their dark masters. Still others are seen as a resource to be captured, conquered, plundered or tricked and manipulated. Powerful magic items and mystic artifacts across the Megaverse are being purchased or taken (stolen and taken by force) by one side of the Minion War or the other. Mercenaries, mages, dragons, supernatural beings, and other opportunists lured by the promise of earning a king's ransom are joining the campaign to "acquire" magic artifacts for one side or the other. These "opportunists" have no personal interest in the war, nor allegiance to either supernatural force, but they intend to profit from them if they can. Even if it is, literally, a deal with a devil.

Already, worlds across the Megaverse are finding their halls of magic looted and sacred artifacts missing. That includes the United Worlds of Warlock. Worse, in some cases, the loss of such a powerful, legendary and/or sacred artifact(s) causes political or religious turmoil and civil unrest for that world or civilization. In other cases, it shifts the balance of power, leaving their mystical defenses weakened and their people vulnerable to attack by their own rivals and enemies. The havoc the Minion War is causing on countless worlds is only starting to be felt, and it is only the beginning. What lasting and earth-shattering impact the Minion War may indirectly or directly have on individual worlds and galactic communities is yet to be realized, but if the war last for years, decades or centuries it could be devastating. Likewise, one cataclysmic event could have dramatic repercussions for one or countless worlds. For example: Both the demons of Hades and the Deevils of Dyval scour the Three Galaxies in search of the *Cosmic Forge*. While it seems unlikely, even the thought of what might happen if the Cosmic Forge fell into the hands of such an evil force is unthinkable.

As bad as all that may be, the Minion War is having an impact in other ways. Hell-spawned raiding parties and entire fleets of demon and infernal spacecraft now also travel the space-ways of the Three Galaxies in search of booty, forced labor, slave stock and ships to be commandeered to become part of their demon fleets. Demon worshipers, cults, covens and evil brotherhoods are popping up everywhere. Deevils and demons are instigating planet-wide rebellions, support the rise of demonic and monstrous kingdoms, encourage insurrection and the practice of dark magic in their name, as well as work to under-

mine existing governments so that the new regime that replaces it may require its people to worship demons or infernals.

It doesn't stop there, as both spawns of Hell know no limits, and are willing to go so far as to cause the destruction of entire civilizations and worlds so that they may tap the P.P.E. at the moment of mass death for their own dark and deadly purposes. It is horrific, and the horror is spreading.

As the chaos and violence of the Minion War stirs things up across the Three Galaxies, it encourages other evil supernatural beings and malevolent forces to take advantage of the situation. Many wonder and fear if this shakeup will encourage the Dominators, Star Hives, Splugorth and others to take action against old enemies or cut a deal with the participants of the Minion War – or bide their time until they sense a weakness and then strike.

**Phase World, the United Worlds of Warlock (UWW) and other people who use magic** or are attuned to the supernatural world, or possess powerful magic artifacts coveted by the dark forces of the Minion War, are among the first to feel the shock waves and repercussions of the brutal feud. Moreover, since the forces of Hades and Dyval seek each other's absolute conquest or, failing that, total obliteration, those who side with one side or another, or are *perceived* to have sided with their rival, are marked for retribution, conquest or destruction as well. This may even apply to those who are unwitting pawns or take some action to protect themselves, but in so doing, inadvertently hurt one of the two factions of the Minion War.

## Disposition of UWW Fleets

Due to their largely non-centralized government and non-expansionist policies, the bulk of the Warlock Navy is based in, and directly around, the *Anvil Galaxy*.

There is only one fleet in the Warlock Navy, **the First Warlock Fleet**. The First Warlock, comprised of nearly 30,000 vessels, is based out of *Alfheim*, where Warlock Fleet Command is located. The fleet is further broken down into numerous small *Kampfgruppen*, a Dwarven word that roughly translates as "battle group." Each battle group contains a number of smaller task forces and flotillas. The ships of the Warlock Navy are predominantly of sub-capital class and smaller, and these vessels make up the bulk of the navy's *Kampfgruppen*. The few capital ships they do have, such as the powerful Elven *Brightwander*-class ships, are usually held in reserve or stationed at important planets, space stations and strategic locations throughout the Anvil Galaxy. To this date, the Warlock Navy has never deployed any super-capital ships, nor do they have any plans to do so.

## Warlock Ship Technology

There are few guiding design philosophies that tie together the ships of the Warlock Navy. Each race that contributes spacecraft to the Navy puts its own strong cultural stamp on their contributions.

**The spaceships of the Star Elves** tend to be constructed of shimmering alloys and enchanted crystal. The shapes and designs of these vessels have a graceful and highly organic look to them. Their holds, passageways and quarters are large and airy, with muted pastels and earth tones predominant in their color schemes.

**Dwarven spacecraft** are sturdy and rough-hewn, designed with an eye more toward practicality and hard use than style or comfort. They tend to resemble vessels from the early days of steel-hulled ships, with lots of thick armor plating and exposed rivets. Their shipboard spaces are cramped and dark, due to the Dwarves' physiology, small stature, ability to see in darkness, and natural proclivities. Thus, Dwarven ships are typically painted dark blue or gray and crew quarters are simple and Spartan.

**Human and Warlock space vessels** tend to be sleek and modern, with magical systems that rival anything from the highly technical nations like the Transgalactic Empire (TGE) or Consortium of Civilized Worlds (CCW). They have clean, aggressive lines and fast looking hulls packed to the gunwales with all manner of magical and technological weapons, sensors and equipment. They are thoroughly modern ships with built-in efficiencies and passable shipboard crew quarters. Color schemes are commonly light gray and silver to brilliant white with red, gold, blue, black or silver trim.

If anything could be said to tie these varying design philosophies together, it is the Warlock Navy's reliance on magic and Techno-Wizardry. Unlike the Techno-Wizardry of Rifts Earth, which is a relatively new science, the peoples of the United Worlds of Warlock have been fusing magic and technology for thousands of years. Techno-Wizard (TW) devices from Rifts Earth often look clunky, exotic and even silly. By comparison, the TW machines built by the Techno-Wizards of the UWW are indistinguishable from any other tech and science based device or machine. The Techno-Wizardry of the UWW has none of the obvious signs that it is a magic-technology hybrid. There are no crystals or knobs sticking out at ungainly angles, no pieces that seem out of place. Instead the magic components of a given machine are built seamlessly into the whole, and are unnoticeable in much the same way that circuitry and microprocessors blend into whatever they are powering.

Over the years, the Warlock Navy has developed several new magic technologies. Some of these, such as the *Rift Projector Cannon* and the *Bottled Demon missiles*, are well documented. Some are not so well known or are considered to be "classified" information or secret weapons.

**Emulative Throwback Shielding:** Based on the spell House of Glass, this feature is found only on the *Brightwander*-class ships. Whether this is because the massive transports are made of crystal or because the other Warlock ships are too small for the enchantment to work is not known by those outside the UWW. Throwback Shielding wraps the *Brightwander* in a glimmering energy cocoon, and any strikes that hit the ship then inflict the same amount of damage to the one who inflicted it! For example, if a Splugorth spaceship hits a *Brightwander* for 1,000 points of damage, the Splugorth ship also takes 1,000 points of damage as the magic throws back the same amount of force and damage at its attacker. Note that the magic shielding only deals out an *equal amount of damage* and does not replicate any special effects, such as extra radiation damage or dimensional displacement.

Throwback Shielding is very costly to maintain, and can only be up and running for 12 minutes, three times daily. The ship may fire any and all weapons while the shielding is up, but

fighters or shuttles that are launched do not have the protective effect of the Emulative Throwback Shielding and are vulnerable to incoming attacks. **Note:** Throwback Shielding takes the place of any other kind of force field.

**Regenerative Hulls:** Several of the most important ships and space stations of the Warlock Navy have a version of the Metropolis spell cast upon them. This legendary enchantment allows the hulls of such ships to regenerate damage. They can also be repaired by normal means, but will completely restore themselves if given enough time. Only the exterior armor of the ship grows back, not the internal walls of the hull nor engines or machinery. If a vessel or installation with a Regenerative Hull suffers grievous damage and is knocked down into Catastrophic Damage levels (has lost 75% or more of its M.D.C.), then the spell is broken. Damage is "healed" at a rate of 2D6x100 M.D.C. per 30 minutes; 4D6x100 per hour until the outer hull is completely restored.

**TW Force Field:** This is not a variable force shield, but the Armor of Ithan spell expanded and augmented to cover the entire ship and, in effect, function as a force field. It has a duration of 60 minutes/one hour per activation or until all M.D.C. is reduced to zero, whichever comes first. It can be activated three times daily, but each activation takes one minute and costs 5,000 P.P.E. This enchantment cannot run concurrent with the Emulative Throwback Shielding, only one or the other can be used at a time. P.P.E. is drawn from the crew, which is two points per activation from the crew of big ships and space stations. **Note:** Often reserved for the capital ships; see *Brightwander*, described elsewhere in this section.

**Techno-Wizard Missiles** are widely used by the Warlock Navy. The Negate Mechanics mini-missiles are especially popular, and anti-magic missiles have wreaked havoc on the Splugorth Repression Fleets in the past.

The United Worlds of Warlock (UWW) developed these missiles to affect other vessels and space stations whose weapon systems and defensive systems were, themselves, magical in nature. While this may seem odd since the majority of the UWW's own vessels are magically powered, other powerful enemies such as the Splugorth also utilize magic to some degree in their space vessels, making an anti-magic defensive arsenal a must. A typical tactic is for a retreating fleet to lob several dozen to a hundred of these missiles to make good their escape. They also come in handy when trying to capture an enemy vessel rather than destroy it. This also means the Warlock Navy is well equipped to handle the fleets fielded by demons and infernals in the **Minion War**. Thus, while the warring factions in the Minion War may raid the UWW for magic artifacts and such, both sides are generally giving the United Worlds of Warlock a wide berth when it comes to invasion or serious acts of aggression. In short, the magic wielding UWW is too dangerous to tackle.

Due to the mystical nature of constructing these weapons, they are only available in the following missile types: *medium-range*, *long-range*, or *cruise missile*.

The main purpose of TW missiles are to knock out specific magic weapons and ship systems. The effects are cumulative, so multiple missiles can disable a vessel such as any of the demon spaceships, a Dwarven Iron Ship, and others.

## AMM-Mark 12, TW Anti-Magic Missile

For every hit with an Anti-Magic Missile, the receiving vessel gets a saving throw versus an Anti-Magic Cloud. If the ship fails the saving throw, one random system is disabled for one hour.

This missile also has a secondary purpose: It can be set to detonate in a given area, producing the effects of an Anti-Magic Cloud spell. The duration is for one hour. All magic based spacecraft that enter the area of effect get a saving throw. A successful save means the ship's magic systems are only partially affected and operate at *half power, half damage and half range* for 30 minutes (the same is true of handheld magic weapons used by the crew or troops).

If the ship fails to save, all of its magic systems are disabled for one hour. However, the vast majority of magically constructed vessels have some sort of conventional backup weapon systems in case something like this happens. The Anti-Magic Missiles are equal in strength to a 12th level spell caster.

Primary Purpose: Anti-Starship.

Secondary Purpose: Defense.

Range: Standard as per missile type; *medium-range, long-range, or cruise missile*.

Mega-Damage: Medium-range missile: 2D4x10. Long-range missile: 2D6x10. Cruise missile: 6D6x10 M.D. plus magic effect.

Duration of the Anti-Magic Effect: One hour. Only a saving throw reduces the effects and duration by half.

Cost: Medium-range cost 750,000 credits, long-range cost 900,000 per missile and TW cruise missiles cost one million.

## TW Hull-Breacher Missiles

This is one of the few weapons that the UWW uses as a last resort. Unlike other missiles whose main purpose is to destroy or cause major damage, these missiles hardly leave a scratch. They are designed to momentarily open ship compartments to outer space. This is caused by a *Mystic Portal* that activates when the missile impacts on the hull of the ship. Anyone caught in the compartment where the missile hits is at risk of being blown out into space, or at the least, suffering from a sudden decompression. This weapon can also be used to create an opening for combat troops to enter and board an enemy vessel without actually blowing or cutting a hole in the hull and inflicting any long term damage. When the duration ends, the portal disappears and the hull has minimal damage and no sign of a breach.

Primary Purpose: Anti-Personnel.

Secondary Purpose: Defense.

Range: Same as medium-range missiles.

Mega-Damage: 4D6 M.D. plus magical effect.

Duration of the Mystic Portal: Five minutes or until the magic is dispelled.

Countermeasures: A *Negate Magic* spell instantly dispels any one open *Mystic Portal*, while a *Close Rift* spell closes every *Mystic Portal* on the ship, simultaneously. The *Negate Magic Barrier* spell does not work, because the *Mystic Portal* is an opening, not a barrier.

Cost: 600,000 per missile.

## NM-Mark 20,

### TW Negate Mechanics Mini-Missiles

This missile works in a similar fashion to the anti-magic missile, except it affects non-magical ships as well as vessels that utilize magic in their design.

The missile causes one random mechanical system to stop functioning. It can range from a weapon system to an engine, to a non-essential system, to a critical system like life support. The effects should be based on where the missile struck (weapon turret, sensor cluster, communications tower, radar, bay door, engine, etc.). The effect from a random hit is left up to the G.M. or may be rolled on the following table. Multiple missile hits have an accumulative effect, each knocking out more systems aboard the spacecraft. The duration is only 15 seconds per missile, though repeated or successive, multiple missile strikes may extend the duration. But even a mere 15 seconds can seem like an eternity when your weapons are out. The missile is only effective on spacecraft equal to or smaller than a space shuttle, or an individual weapon system (turret, sensor cluster, bay door) of a sub-capital or capital ship.

Limited to mini-missiles for precision, targeted, surgical strikes. However, recently, the Warlock Navy has been considering building a larger, heavier version of the missile (medium-size and/or cruise missile) for use against larger vessels and space stations. One drawback of the missiles is that first the shields of the target must be breached in order for the missile to work; it must impact on the hull itself.

Primary Purpose: Anti-Star Fighter/Power Armor.

Secondary Purpose: Defense.

Range: 1 mile (1.6 km) in an atmosphere, 5 miles (8 km) in space.

Mega-Damage: 4D6 M.D.C., mainly impact damage.

Duration: One melee round (15 seconds).

Cost: 10,000 per missile.

Random effects of being hit by an NM-Mark 20:

**01-15%** Lucked out! Deactivates a non-vital system.

**16-25%** Deactivates propulsion system. The ship can still maneuver with directional thrusters; all bonuses to dodge are reduced by half.

**26-45%** Helm control is lost! The pilot cannot steer or maneuver. No bonuses to dodge, only luck and a natural roll.

**46-55%** One weapon system is deactivated. G.M., determine which.

**56-75%** Sensors are deactivated. The pilot is blind for the melee round and must rely on his own senses and bonuses. All bonuses from Sensory Equipment and Space Fighter Elite, plus the vehicle's bonuses may be lost if all sensors are affected.

**76-80%** Life support is deactivated in a portion of the ship. Although this may not seem all that bad for a few seconds, if the life support goes down for more than four minutes the pilot and/or crew in the affected area may go unconscious. This is due to carbon dioxide poisoning and the air not being recycled. Roll a save versus poisons/toxins every minute after the first four. Also, heat dissipates very quickly. After four minutes those in the affected area suffer 1D6 S.D.C. damage every me-

lee from the freezing cold unless in environmental suits or armor.

**81-85%** Targeting systems are down. No bonuses to strike, natural rolls only.

**86-90%** Air locks and bay doors are down; will neither open nor close.

**91-99%** All communications are down.

**100%** Main power goes off line. The vehicle is momentarily dead in space!

## Ranks of the United Worlds of Warlock

The ranking system of the UWW is broken down into three major departments: Engineering, Fleet Command, and the Warlock Marines. This came about because of the specialized talents of the United Worlds' founding races. The Anvil Dwarves brought unparalleled Techno-Wizardry and smithing skills. The Star Elves, with their deep connection to the ley lines of space and knowledge of astronomy, made excellent "maginavigators" and "nexus sailors." The Warlocks, being the ones who convinced the Star Elves to fight rather than hide, formed the basis of a dedicated and trained Marine Corps.

Each department therefore uses a different system of ranks, and each rank is derived from the most influential race.

### Engineering (Dwarves)

<u>Warlock Rank</u>	<u>Translation</u>	<u>CCW Equivalent</u>
Leiter	Master Smith	Chief Engineer (Lt. Cmdr)
Facharbeiter	System Specialist	Lieutenant
Lehrling	Apprentice	Ensign

### Fleet Command (Star Elves)

<u>Warlock Rank</u>	<u>Translation</u>	<u>CCW Equivalent</u>
Taroahas Ahheat	Master of the Ship	Captain
Henolreld Onalhied	The One Who Aides	Commander
Atelteut Isuhabiad	Guider of the Path	Lt. Commander
Olalneud Tehrals	Sailors in the Void	Lieutenant

### UWW Marines (varied, mostly Human)

<u>Warlock Rank</u>	<u>CCW Equivalent</u>
Jenol	General
Kern	Colonel
Mahj	Major
Kapit	Captain
Eltee	Lieutenant
Korul	Corporal
Sar	Sergeant
Jarhe	Private

**In the Navy Engineering corps**, the Dwarven method of designating superiors is used. Everyone who joins the engineering team is considered to be in apprenticeship to someone who has been there longer. Therefore, if your specialty is fixing the Rift Drive, you would begin tutelage under the Rift Drive Facharbeiter. Just before the Facharbeiter retired or died, he would name his successor. The remaining Lehrlings would then

continue to learn under their new Facharbeiter, or get transferred to a new posting. One can only become a Leiter by mastering every single engineering system on a ship. This means apprenticing for decades, learning each and every nuance of the ship and its enchantments. Only then is someone ready to be in charge of all the vessel's mystic machinery.

**The Star Elves** are the ones who do most of the actual flying, as it appeals to their continuing quest to explore the universe. A Henolreld Onalhied is like a ship's First Officer, answering directly to the Master of the Ship. The piloting and navigation of the vessel lies in the hands of the Guider of the Path, the Atelteut Isuhabiad.

**The ranks of the Warlock Marines** are derived from an obscure dialect called *Nomaijorb*. Nomaijorb was developed centuries ago during the war against Yythcryss as a sort of lingua franca to assist communications between the varied worlds of the Union. Its use has waned over the years, but the Warlocks keep it around as a secret language, and to anyone outside of the UWW it sounds like gibberish.

## Uniforms & Colors of the UWW

The three differing departments of the Warlock Navy all wear differing styles of clothing, suited to the tastes and traditions of their founding races. For the Star Elves, this means rich fabrics and long, flowing floor-length robes. These robes are of bright, natural colors, such as blue, yellow, red, silver, and gold, and are embroidered with silver and gold thread. The proliferation of robes, soft lighting and subtle magicks can make the bridge of a typical Warlock starship look like a monastery. The Star Elves do not display any kind of rank, they are simply expected to know who is who aboard ship.

Engineers wear goggles, hard-wearing coveralls, heavy boots and gloves and an ever present tool belt. Their rank is displayed on their left sleeve and tools, as well as tattooed on their left forearm. Their coveralls are color coded by job, with the colors tending to be bright so that an engineer's post can be easily identified in the dim confines of a ship's engineering decks.

The Warlock Marines always wear their magical powered armor, which is a deep burgundy color with gold accents. Their armor magically displays their rank insignia in the center of the chest and the back of the helmet. It cannot be painted over or blasted away. As a Marine progresses higher in rank and responsibility, the number of plumes on his or her helmet is also increased.

## A Notable UWW Navy Facility

### Planet Ghenhey, System UWW-785

#### United Worlds of Warlock, Anvil Galaxy

Ghenhey is the sixth planet in a system of eight that orbits a dying red dwarf star on the fringes of the UWW. It is an average-sized terrestrial planet with standard gravity and a thick and heavy atmosphere composed mainly of large amounts of carbon dioxide, methane, nitrous oxide, ozone and chlorofluorocarbons. The planet seems to be the victim of runaway greenhouse effects, with an average surface temperature of 665 degrees Fahrenheit (352 degrees Celsius). It has no indigenous life, but is home to nearly 80,000 colonists.

The planet is covered in ruins that apparently date back to before the War against the Dominators. The latest scanning equipment and dating techniques place the construction of the alien cities that litter the landscape at nearly 100,000 years, making them some of the oldest known ruins in the Three Galaxies, third only to Center and the Monro-Tet Obelisks. Who built them is a total mystery, but the research teams who live there with their families have dubbed them “the Time People.” There is strong evidence that the original inhabitants of Ghenhey were magic users with a strong preference for *Temporal Magic*. They were also devout followers of the *Cosmic Forge*, and some romantics would like to believe they may have actually known the whereabouts of its secret location. Unraveling the mysteries of this bleak planet has been an ongoing project for the past 150 years. The Time People left very little hard information behind, and the atmosphere makes working a challenge, to say the least. The Warlock researchers are very excited by what they have uncovered so far however, including three previously unknown Temporal Magic incantations.

Unfortunately, Ghenhey sits right on the edge of the *Coleopteroid Quarantine Zone* – the space infested by the **Star Hives**! For the past forty years, the bugs have been laying constant siege to the planet and her colonists. So far, it’s been nothing the Warlock Marines can’t handle, but the numbers of attacking space insects are increasing, as is the frequency and ferocity of the assaults. The Marine General in charge of the planet, *Ranaut Faircutter*, has come to believe that a planet-sized Star Hive is entering the system. Since such an object is presumed to be non-reflective and traveling at sub-light speeds, it would be all but impossible to detect until it was, galactically speaking, right on top him.

Indeed, the Marine forces on Ghenhey will soon find themselves in the battle of their lives. The General is correct, and millions of rampaging giant insects will soon swarm into the system. Already, several patrol ships have gone missing out beyond the *Oort Cloud*, and General Faircutter fears the worst. The problem is that the General will have to decide shortly whether or not to fight for control over this important archaeological site, or to abandon it completely. Staying means almost certain death, but falling back means having to destroy the Ghenhey Tangent, lest the UWW risk the Star Hives gaining the means to teleport right into the heart of the Warlock Worlds.

## A Notable UWW Navy Commander

### Kern Haze Pennington

**Human Warlock Marine, Commanding Officer,  
Commission 49**

In order to better combat the threat posed by the **Dark Covens**, the leaders of the Warlock Navy assembled *49 Special Forces teams* called “Commissions.” Their mission was to locate and destroy these terrorist cells by any means necessary. The Warlocks have a thing for numerology, and so it was thought that the number of Commissions – 7x7 – would prove to be lucky. In a way they were right, though not as they had expected.

Since their inception, most of the **Commissions** have met horrible fates, having been eaten by monsters, transformed into



vampires and then exterminated by other Commissions, sucked into hellish dimensions, or turned into zombies. The members of the forty-ninth Commission, however, have had phenomenal success. Whether this is because of their excellent teamwork or because they are numerically blessed is open for debate.

The leader of **Commission 49** is *Kern Haze Pennington*, a human Warlock Marine and a veteran of several engagements against the Splugorth. He is a decorated hero, and has killed more enemies of the United Worlds of Warlock than he can count. He is a staunch believer in the cooperative spirit of the UWW, which is ironic considering his background.

Haze Pennington is a *sleeping agent*. He was born and raised in Splugorthian captivity, and was trained for a life of combat in the arenas of Gylcrdd. Then, just before the Rynncryl Kingdom declared war on the Anvil Galaxy, the High Lords hatched a devious plan to place *controllable human spies* into all of the other major power blocs. Pennington was one such agent, mentally conditioned by the Splugorth so that he could slip effortlessly into the UWW. Once there, he was to join the Warlock Marines. The High Lords of Rynncryl had planned that one day they would “reactivate” their slaves, who would then return to the Kingdom with all kinds of useful intelligence, but the war went very badly for the Splugorth, who found themselves fighting both the CCW and the TGE. In the chaos, these secret agents were forgotten about.

So for 24 years, Haze Pennington has lived a lie of which not even he is aware. As far as he is concerned, he was born on Alexandria and worked as a shopkeeper. Then, he joined the War-

lock Marines so that he could adventure and see the galaxy. His previous training as a gladiator served him well, even though he consciously remembers nothing of his past life, and he quickly came to the attention of the Marine commanders.

Commission 49 is now the bane of the Dark Covens. The group itself consists of only six members: **Pennington**, who is the leader, **Teuddo**, a Ratanoid sniper, **Ckar**, a Minotaur heavy weapons specialist, **Dutilad Shadowlock**, a Star Elf Magic Specialist, and two Dwarves, **Daffo Minecutter** and **Tiav Stonebeard**, both of whom are good, old fashioned Warlock Marines. The group has their own Arcane Patrol Ship loaded with everything they might ever need, including several Greataxe tanks.

However, on their last mission it seems that their luck ran out. While infiltrating a group of *Splugorth Sunaj Assassins* that had set up shop on Rhilith, Kern Pennington was “reactivated.” It seems that these particular Sunaj were on a mission to gather all the lost spies planted around the Anvil Galaxy so many years ago (the assassins want the agents’ information so that they can take over Rynncryyl). Pennington was on their list, and so the assassins set the whole operation up just to reawaken his dormant self.

Kern Pennington is now back on board the Commission’s ship. The Sunaj got away during the fight, and Commission 49 has orders to pursue them, which means going into Splugorth space. The question is, what happens when they arrive there? Will their commander betray them, turning them (and their Warlock combat armor) over to the Sunaj, or can Pennington rise above the brainwashing, break his mental conditioning and remain an independent and free-willed officer in the UWW? And if he does manage that, what old, locked away memories of his past might help him in future struggles with the Splugorth and their minions?

## Kern Haze Pennington, Quick Stats

**Alignment:** Unprincipled.

**O.C.C./Experience Level:** 8th level Warlock Marine.

**Attributes:** I.Q. 13, M.E. 11, M.A. 9, P.S. 22, P.P. 19, P.E. 14, P.B. 10, Spd 19.

**Hand to Hand:** Martial Arts.

**Notes:** Armed with GC-55 gravity cannon in addition to his Warlock Marine armor. Pennington is about six feet tall, with a clean-shaven head and green eyes. During the past 24 years while undercover, he has married a True Atlantean woman named Kynthia Theophilus. The two have a son, Rhodes, aged 17, who dreams of joining the Marines like his father. Now that Pennington has been reactivated by the assassins, he is unsure what to do about them and how he should proceed from this point forward. He genuinely loves his family and his life in the UWW, but he feels conflicted and tainted about his past life and service to the Splugorth and questions his own loyalty to his family and the UWW.

# Notable Ships of the United Worlds of Warlock

## Brightwander-Class Multi-Role Capital Ship

Originally built over 5,000 years ago as colony ships, the first Brightwanders were designed to bring Elven civility and civilization to the Three Galaxies after the dark ages of the Interim. Massive, glittering crystalline constructs that resemble a sharp-edged teardrop, these ships represent the pinnacle of Star Elf ship design. Since they were built as colony ships, their hulls are modular, with internal decks and bulkheads that can be re-configured for a number of uses. When they were first constructed, they were built with no standard sub-light drives, just a mystical generator and a Rift Drive. When the Star Elves made contact with the Warlocks, the ships were upgraded with drives and weapon systems for use in the fight against Yythcryss.

Thanks to their modular design they fill a number of roles in the Warlock fleet, from troop and cargo transport, to hospital ship to straight-up battleship.

**Model Type:** Multi-Role Capital Ship (MRV).

**Class:** Brightwander Class.

**Ship’s Complement:** (The following stats are for a Brightwander fitted for combat as a *general purpose battleship*).

**Ship’s Crew:** 2,400 (480 officers, 1,920 enlisted).

**Bridge:** Ship’s Captain (1), Ship’s Executive Officer (1), Helm (8), Navigation (8), Comms/Sensors (10), FTL Ops (10), Security (5 Warlock Marines wearing non-powered Warlock Marine Armor and armed with PB-85 Blast Rifles).

**Combat Information Center (CIC):** Warlock Marine Corps General (1), Military Advisory Team (4), Commander of Aerospace Group (1, CAG, commander of ship’s aerospace wing), Ground Forces Commander (1, commander of ship’s planetary assault group), Comms (5), Ship’s Weapons and Fire Control (10), Security (5 Warlock Marines wearing non-powered Warlock Marine Armor and armed with PB-85 Blast Rifles).

**General Operations:** Engineering (250), Medical (200), Flight Operations (450), Ship’s Security (250), Internal Communications (100), General Enlisted (1,080).

**Embarked Troops:** 4,208 (1,568 officers, 2,640 enlisted).

**UWW Fleet Aviators:** 324 combat ready pilots, with 120 in reserve.

**Warlock Marines:** 3,764 (1,124 officers, 2,640 enlisted).

**Aerospace Group:**

**WF-F15 Shadow Bolt Strike Fighters:** One squadron (36 ships).

**ARC-XV “Breacher” Assault Shuttles:** One wing (24 ships, 4 squadrons of 6 ships each).





ARC-II Arcane Patrol Frigates: 2 squadrons (12 ships, 6 in each squadron).

### **Planetary Assault Group:**

W-1/W-F1 Warlock Combat Armor: 1,200

WIFV-99 Greataxe Infantry Fighting Vehicles: 220

### **M.D.C. by Location:**

Interior Bulkheads per 10 feet (3 m) – 50

Interior Hatches – 65 each

Exterior Hatches – 95 each

Secondary Prism Cannons (8) – 800 each

Tertiary Prism Cannons (24) – 600 each

Main Hangar – 70,000

\* Forward Hull Section/Main Prism Cannon (1/3) – 30,000

\*\* Midships Hull Section (1/3) – 30,000

\*\*\* Aft Hull Section (1/3) – 45,000

\*\*\*\* Hull per 40 feet (12.2 m) – 85

\*\*\*\*\* Armor of Ithan (magic force field) – 35,000

\* Destroying the forward third of the ship also destroys the Main Prism Cannon.

\*\* Destroying the midships section eliminates the primary launch bays, weapons fire control, midships landing legs and the CIC, rendering the ship flyable but unable to fight.

\*\*\* Destroying the aft hull section takes out the engines and engineering sections, setting the ship adrift.

\*\*\*\* Punching holes in the hull causes the damage control system to automatically seal off whatever compartment has been exposed to vacuum.

\*\*\*\*\* The TW force field is not a variable shield and has a duration of one hour. It can be activated three times daily, but each activation takes one minute and costs 5,000 P.P.E. This enchantment cannot run concurrent with the Emulative Throwback Shielding, only one or the other can be used at a time. Duration is one hour or until M.D.C. of the shield is reduced to zero. When that happens damage comes off the ship itself until a new TW force field can be erected.

### **Speed:**

Atmosphere: 1,522 mph (2,435 km or Mach 2).

FTL: The Brightwander's R-Drive is capable of jumps of up to 20 light-years. The P.P.E. generators can power five jumps per 24 hour period.

Sub-Light: The conventional drives can move the Brightwander along at a respectable 5,631 mph (9,010 km or Mach 7.4).

Range: Limited only by supplies. The fusion reactors carry enough fuel to operate the ship at full readiness for 40 years, but shipboard stores are only good for 18 months of constant deployment with full crew and complement.

### **Statistical Data:**

Length: 3,333 feet (1,016 m).

Beam: 600 feet (183 m) around at its widest point.

Height: 1,111 feet (338.6 m).

Mass: 10 million tons, plus troops and cargo.

Cargo: Aside from standard ordnance and stores, the Brightwander ships can carry an additional 100,000 tons of cargo.

Power System: Conventional power is provided by a series of four O&T capital-class fusion reactors powering two banks of three capital plasma thrusters. The Rift Drive is powered by a series of P.P.E. jump generators.

Development Cost: Estimated into the trillions of credits.

### **Weapon Systems:**

**1. Prism Laser Cannon (1)**: This energy beam is fired directly from the ship's bow, where it seems to spring from the hull itself like a searing, white-hot lance. Since the beam is composed of magical light rather than a standard laser beam, it inflicts full damage to other vessels and force fields that utilize magic, as well as any creature vulnerable only to magic attacks. It inflicts half damage to vampires and Vampire Intelligences and full damage to Splugorth and most other Alien Intelligences.

Primary Purpose: Anti-Ship.

Secondary Purpose: Anti-Installation.

Weight: Not applicable, part of the ship's hull.

Range: 90 miles (144 km) in space, or 14 miles (22.4 km) in an atmosphere. Range is doubled if the ship is on a ley line or nexus point.

Mega-Damage: 3D6x1,000 M.D. per blast; 50% greater damage when on a ley line and double if the ship is at a nexus point.

Rate of Fire: Twice per melee round (15 seconds).

Payload: Effectively unlimited, tied to the mystic generator.

**2. Secondary Prism Cannons (8)**: These weapons are arranged in a ring around the mid-section of the ship. Each beam emitter has a 180 degree rotation and a 90 degree arc of fire. As the Brightwander tapers towards its bow, all eight of these weapons can be brought to bear on a single target, provided that target is directly in front of the ship and the size of a capital ship or larger. Standard attacks fire a volley of two, four or eight cannons in conjunction with a shot from the main cannon. Affects magic spacecraft, creatures of magic and vampires as noted above.

Primary Purpose: Anti-Ship.

Secondary Purpose: Anti-Installation.

Weight: Not applicable, part of the ship's hull.

Range: 14 miles (22.4 km) in space, or 3 miles (4.8 km) in an atmosphere. Range is doubled if the ship is on a ley line or nexus point.

Mega-Damage: 1D6x100 M.D. per beam; 50% more damage if on a ley line and double when the ship is located on a nexus point. Can be combined into a volley of up to 8 beams.

Rate of Fire: Equal to the number of hand to hand attacks of the gunner (usually in the neighborhood of 4 or 5).

Payload: Effectively unlimited, tied to the mystic generator.

**3. Tertiary Prism Cannons (24)**: Scattered around the ship at various points, these weapons are intended for use against space fighters and incoming missiles. As usual, it inflicts half damage to vampires and full damage to creatures vulnerable to magic.

Primary Purpose: Anti-Fighter.

Secondary Purpose: Anti-Missile.

Weight: Not applicable, part of the ship's hull.

Range: 3 miles (4.8 km) in space, or 1 mile (1.6 km) in an atmosphere. Range is doubled if the ship is on a ley line or nexus point.

Mega-Damage: 1D6x10 M.D. per blast, increase by 50% when on a ley line, and double damage when the ship is at a nexus point.

Rate of Fire: Equal to the number of hand to hand attacks of the gunner (typically 4 or 5).

Payload: Effectively unlimited, tied into the mystic generator.

**4. Ship's Systems of Note:** Tactical life support, launch/recovery and traffic control systems for aerospacecraft, IFF/command and control systems. The Brightwander ships also feature Emulative Throwback Shielding, Regenerative Hulls and TW Force Field.



## Tangent Space Station

Found in orbit of all major United Worlds, as well as some moons, the Tangent is an incredible achievement. It is a pyramid in space, carved and molded from a single asteroid. It joins with other Tangents across the light-years to form a web of teleportation portals, instantaneous communication relays, and definitive orbital platforms. The Tangents are constructed on a Lagrange point to take advantage of these natural “space nexus points” to provide the station with unlimited power. It also serves to increase the damage and range of its Techno-Wizard weapons by a factor of two.

A Tangent looks like a four-sided crystalline pyramid lying on its side, with the point of the pyramid pointing in the same

direction as the planet’s rotation and the flat, square bottom facing the opposite direction. This featureless area of the space station is where the interlinking *Rift portals* are created so that when a ship jumps from one Tangent to another, it automatically travels in the right direction when it orbits its destination.

Weapons are mounted on all five points of the pyramid. There are three airlocks on each face, allowing up to 12 ships to hard dock. There are quarters on board the Tangent to accommodate as many as 100,000 people, as well as a basic sick bay, and a few small businesses. Each Tangent has a detachment of Warlock Marines that act as station police, as well as being equipped with some of the best magical security systems around. Tangents are built with Regenerative Hulls that automatically repair themselves.

**Model Type:** “Tangent” Gateway Station.

**Class:** Techno-Wizard space station.

### M.D.C. by Location:

Airlocks (12) – 400 each

Concealed Defense Turrets (20) – 200 each

Weapon Hardpoints (5) – 2000 each

\* Main Body – 300,000 (outer hull has 450 M.D.C. per 100 foot/30.5 m area).

\* Depleting the M.D.C. of the Main Body destroys the station.

**Speed:** Usually orbits a planet at a speed of 10 miles (16 km) per second. Otherwise immobile.

### Statistical Data:

Mass: Over 160 million tons.

Power System: Special power plant that converts Ley Line energy.

Production Cost: Estimated in the trillions of credits.

### Weapon Systems:

**1. TW-HI Laser Emplacements (5):** Mounted at each point of the pyramid, these TW converted HI-Lasers look like something from a battleship, which they are. These 38 inch guns are updated versions of an old Warlock design used during the Yythcryss conflict. They have excellent range and penetration, and thanks to the Lagrange point, their performance is essentially doubled.

Primary Purpose: Anti-Ship.

Secondary Purpose: Anti-Intelligence.

Weight: Not applicable, part of the station’s hull.

Range: 200 miles (320 km).

Mega-Damage: 3D6x1,000 M.D. per blast.

Rate of Fire: Twice per melee.

Payload: Effectively unlimited, tied to the station’s power system.

**2. Heavy Prism Laser Batteries (10):** Similar to the weapons found on the Brightwander ships, these batteries are excellent against smaller capital and sub-capital ships. These weapons are mounted two to a corner, and work in conjunction with the TW HI-Lasers.

Primary Purpose: Anti-Ship.

Secondary Purpose: Defense.

Weight: Not applicable, part of the ship's hull.

Range: 28 miles (44.8 km).

Mega-Damage: 2D4x100 M.D. per beam.

Rate of Fire: Equal to the number of hand to hand attacks of the gunner (typically 4 or 5).

Payload: Effectively unlimited, tied to the mystic generator.

**3. Point Defense Batteries (24)**: A combination TW GR-gun/missile launcher battery, these weapon systems are frighteningly effective against small ships like fighters and shuttles, and can seriously damage even the smaller sub-capitals like destroyers and frigates.

Primary Purpose: Anti-Aerospacecraft/Anti-Robot.

Secondary Purpose: Anti-Missile.

Weight: Not applicable, part of the station's hull.

Range: 32 miles (51.2 km) for the TW GR-guns. Missiles have a range of 10 miles (16 km).

Mega-Damage: A burst from the TW GR-guns is 20 rounds and inflicts 4D6x10 M.D. Missiles can be any conventional or magic type, and damage varies by warhead.

Rate of Fire: Equal to the number of hand to hand attacks of the gunner (typically 4-5). Missiles can be launched one at a time, or in volleys of two or four.

Payload: 1,000 bursts per each gun, and 32 missiles per launcher. Additional ammo and missiles are held aboard the station in armored magazines.

**4. Space Fighters**: To deal with enemy bombers and similar small targets, each Tangent also fields 10 wings of 12 Shadow Bolt space fighters (120 ships in total). These pilots are some of the best in the Navy, and are at least 5th level or higher.

### 5. Additional Features:

The Tangent is warded to be impervious to energy. Actually, magic based energy attacks inflict half their normal damage, but ordinary energy weapons do no damage. (Explosives and other non-energy weapons do full damage.) This effect is permanent. The mystic protections also offer everyone on board protection from *Alien Intelligences*, including the Splugorth, providing everyone a +5 bonus to save against the Horror Factor, insanity, possession, and psionic powers of such creatures.

Sensors on the station allow it to detect conventional contra-gravity engine wakes to a distance of ten light-years. It can also *read* any ley lines it is connected to in the same way a Ley Line Walker can, and will know if any ships using Rift Drives are traveling along them.

Instantaneous communication with all other Tangents in the United Worlds of Warlock – means that reinforcements can be teleported in from anywhere. This process takes 5-10 minutes.

If in dire need, the station's Rift Portal can be turned into a *Rift Projector Cannon* with a 150 mile (240 km) range and unlimited payload (see **Phase World®**, page 155, for details).

Self-Destruct – the Tangent can be destroyed by speaking the proper power words (only three Star Elves in the court of

King Siverlight know what they are). A Rift to the Elemental Plane of Fire appears on the Lagrange Point within 2D4 minutes, and swallows the entire station and everyone still on it.

## Sentinel-Series

### UWW Orbital Weapon Platform

The Sentinel is a standard planetary defense satellite commonly found orbiting most major Warlock worlds. It is composed of four cannons attached to a TW battery, with maneuvering thrusters and a basic targeting computer. Each satellite can identify and track 48 separate targets out to a range of 300 miles (480 km), and is +1 to strike with its particle cannons. If the satellite is orbiting at a Saddle or Lagrange Point, then its range and damage are doubled!

**G.M. Notes**: In a two-body system, such as Terra Prime and her moon, there are only five possible Lagrange points, and two of them are unstable and unusable. Also, at the time of writing there were nearly 9,000 satellites in orbit around Terra Prime. This can be used as a measure for just how many *Sentinels* there might be over any given UWW planet.

**Model Type**: Sentinel Mk. 6.

**Class**: Autonomous Defense Satellite.

#### M.D.C. by Location:

Sub-Particle Cannons (4) – 200 each

Attitude Thrusters (8) – 100 each

Solar Collectors (2) – 200 each

\* Main Body – 400

\* Depleting the M.D.C. of the Main Body destroys the satellite.

**Speed**: A maintained planetary orbit of approximately 10 miles (16 km) per second.

#### Statistical Data:

Mass: 15 tons.

Power System: Solar collector and P.P.E. Generator.

Production Cost: 80 million credits.

### Weapon Systems:

**1. Sub-Particle Cannons (4)**: These cannons fire TW beams composed of magically accelerated charged particles. Due to their magic nature, these weapons do full damage to creatures that are immune to energy, but are hampered by anti-magic fields and creatures that have a natural magic resistance.

Primary Purpose: Anti-Ship.

Secondary Purpose: Anti-Fighter.

Weight: Each cannon weighs 1.5 tons.

Range: 15 miles (24 km).

Mega-Damage: 5D6x10 M.D. per single blast from one barrel. A four-barrel volley does 2D4x100 M.D.

Rate of Fire: Each cannon may fire three times per melee round (15 seconds).

Payload: 40 shots before requiring a recharge period of 1D6x10 minutes.

# Some Notable Space Weapons & Equipment

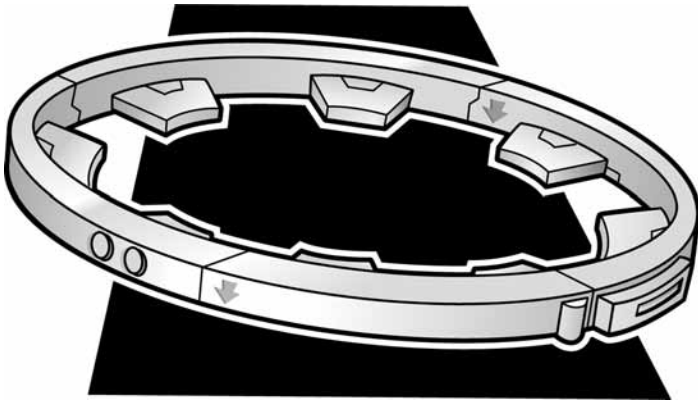

## Burning Ring

### Ship Boarding/Rescue Tool

Originally designed as a search and rescue tool, burning rings are made by a number of manufacturers throughout the Three Galaxies. They use a continuous, high-output plasma cutter to burn quickly through a ship's hull. A burning ring consists of an alloy ring roughly six feet (1.8 m) in diameter, with eight heavy tabs spaced around the inner circumference. When placed on a ship's or space station's hull, the tabs attach the ring via electromagnets or an extremely powerful adhesive. Once attached, the plasma cutter is activated and proceeds to cut a perfectly round plug out of the ship's hull. They are one-use items with their own internal power source, and burn until out of power or until deactivated remotely. For ease of transport, the whole thing can collapse to the size of a large briefcase. Care must be taken when cutting into a ship, as the pressure inside the hull ejects the plug along with the escaping atmosphere.

Weight: 17 lbs (7.65 kg).

Range: 5 feet (1.5 m).

Mega-Damage: 1D4x10 M.D. per melee round (15 seconds) to cut through a Mega-Damage hull. 1D4 M.D. if hit by the rocketing hull plate cut from the vessel.

Payload: Burning rings have enough power to burn for 10 melee rounds (two and a half minutes).

Cost: 45,000 credits.

Note: Use of a burning ring requires the skill *Demolitions*, *Mechanical Engineer*, or *Weapons Engineer*, or *Field Armorer* or *Basic Mechanics* (the latter two suffer a -10% skill penalty) to operate the burning ring properly. If the character does not possess one of these skills, the burning ring is not likely to complete the opening in the hull. *Roll percentile dice* to determine how much of the ring was cut. Under 50%, hardly any air escapes and the attempt to board may not be noticed by the ship's crew

(30% chance). Any greater percentage is likely (70% chance) to register on ship sensors and alert the crew that someone is attempting to board the ship, as well as the exact location where the breach is being made. If 88% or more is completed, the cut plate of the hull pops partially out and air gushes out, but the hole is not completely cut and the plate is held partially in place. The character(s) trying to board *may* be able to pry the mostly cut ring plate wide enough to board the spacecraft. However, it will take some time (1D4 melee rounds/15-60 seconds) and a response team may be rushing to the location of the breach to engage them.

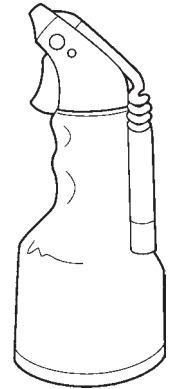

## Breaching Gel

### Ship Boarding/Rescue Tool

Breaching gel, much like the burning ring, was initially designed as a search and rescue tool. It is a stable chemical compound that becomes extremely caustic when exposed to an electric charge. It is sold in pressurized cans, and is dispensed as a thick, extremely sticky, clear gel coating two electrical wires. When placed around an object on a ship's hull, say an airlock latch, and connected to a power supply like an E-Clip or power pack, the gel quickly burns through the surface, making a clean hole. It is typically used to cut small holes (4-6 feet/1.2 to 1.8 m in diameter) in thin surfaces like view ports or airlock doors. Each breaching gel can contains 50 feet (15.2) of gel coated wire.

Mega-Damage: 2D6 M.D. per melee, and an application will burn for 2D6 melees or until the power is cut.

Weight: A can of breaching gel weighs 3.4 pounds (1.53 kg).

Cost: 75,000 credits per canister.

Note: Use of breaching Gel requires the skill *Demolitions* or *Weapons Engineer*, or *Electrical Engineer* or *Basic Electronics* (-15% skill penalty for the latter two) to correctly apply the gel and wire it. If the character does not possess one of these skills, the breaching gel is not likely to slice the surface completely open. *Roll percentile dice* same as described under the Burning Ring, above, to determine how much was cut.

## Cruise Missiles

The ships of the major spacefaring navies of the Three Galaxies are armed with an incredible array of weapons, including heavy GR artillery and massive focused energy weapons, but some special notice must be taken of cruise missiles. Cruise missiles, sometimes called torpedoes when referring to missiles deployed from a starship, are super-heavy, long-range missiles similar to the modern-day Tomahawk and BhraMos. They are specifically designed to pack as much destructive power into as small and agile a package as possible, and are typically used en

masse against starships and space stations. While numerous warhead technologies have come and gone over the centuries, there are mainly two different types of warheads used today: *nuclear* and *anti-matter*.

Nuclear cruise missiles have an average explosive power of 500 kilotons. They work through a *fusion* reaction in which hydrogen atoms are turned into helium. They are dirty and destructive, with massive blast areas and terrible aftereffects thanks to fallout and radiation. While considered an old and second-rate warhead technology among the more technologically advanced powers like the CAF and TGE, they are easy to make and cheap to produce, leading to their common use among poorer or lower-tech powers like the Golgans.

Anti-matter torpedoes are built using anti-hydrogen suspended in a perfect vacuum, which itself is wrapped in a magnetic field. When an anti-matter cruise missile strikes its intended target, a small conventional explosive goes off, collapsing the magnetic field. The anti-hydrogen then comes into contact with normal matter, and starts a process called *annihilation*. This releases tremendous amounts of energy, equal to one megaton. These weapons are considered state of the art, and while destructive in the extreme, their aftereffects tend to be lighter and more contained than the older fusion warheads.

These kinds of weapons behave very differently depending on where they are used. In the vacuum of space they inflict a large amount of damage to a confined area, and may emit a brief but intense electromagnetic pulse (EMP). Cruise missiles can therefore quickly deplete the integrity of even the largest battleships and dreadnoughts, although most military computers and circuits on board these ships are shielded against the EMP (only a 20% chance being overloaded or wiped clean). However, they are far more damaging when deployed in an atmosphere. Not only does the missile's warhead go off, but the detonation causes many secondary effects, such as overpressure, dynamic pressure, and radioactive fallout. In every way, anti-capital ship torpedoes that are detonated within an atmosphere behave like real-world nuclear missiles.

For this reason, cruise missiles are considered weapons of mass destruction by most of the major power blocs in the Three Galaxies. It is generally accepted that they are allowable in space battles, but their use against planetary bases and population centers is considered barbaric by the likes of the Consortium of Civilized Worlds (CWW) and United Worlds of Warlock (UWW).

The *Lanator Accords*, signed by the CCW and the TGE, specifically prohibit the use of cruise missiles, both nuclear and anti-matter, within the atmosphere of any inhabited world. Heavy directed energy weapons, lasers, particle beams and the like, also fall into this category. They are fine for use in space, but are considered illegal if used against a planet. Unfortunately, there are many galactic powers that are not bound to observe this agreement, and so planetary "slagging" is a terrifying fact of life, again illustrating the point that one needs to have a space fleet, even if only for defensive purposes.

### **Nuclear Cruise Missile**

Primary Purpose: Anti-Ship.

Secondary Purpose: Anti-Installation.

Weight: 3,000 lbs (1,350 kg).

Range: 1,000 miles (1,600 km).

Mega-Damage: 2D6x100 M.D.

Blast Radius (space): 150 feet (45.7 m).

Blast Radius (atmosphere): 450 feet (137 m).

Length: 18 feet (5.4 m).

Top Speed: Mach 9 in space, half in an atmosphere.

M.D.C. of Missile: 45

Market Cost: 180,000 credits each.

### **Anti-Matter Cruise Missile**

Primary Purpose: Anti-Ship.

Secondary Purpose: Anti-Installation.

Weight: 2,000 lbs (900 kg).

Range: 1,000 miles (1,600 km).

Mega-Damage: 4D6x100 M.D.

Blast Radius (space): 75 feet (22.8 m).

Blast Radius (atmosphere): 225 feet (68.5 m).

Length: 20 feet (6 m).

Top Speed: Mach 9 in space, half in an atmosphere.

M.D.C. of Missile: 45

Market Cost: 480,000 credits.

## **Emergency Hull Patcher**

The Emergency Hull Patcher is little more than a canister of quick-set M.D. resin with a carrying handle. Simply place the patcher over the small hole or crack, release the resin, and it clings to the hull on a molecular level, filling the crack or hole in a matter of 4D6 seconds. In the alternative, the patches can be used like a super-adhesive applied to the edges of a plate of M.D.C. material and quickly pressed against the hull to quickly (4D6 seconds) and firmly glue the patch plate over a breach; suitable for holes up to three feet (0.9 m) in diameter for plating, but recommended best for small patch plates 6-12 inches (15 to 30 cm) in diameter. Can fill a hole up to six inches (15 cm) in diameter and cracks of any length up to one inch (2.5 cm) wide. Ideal for filling small and medium size cracks and holes in decks, hatches, view ports and bulkheads. Good for at least 1D6+6 applications (half that if the use is heavy).

Weight: A can of Hull Patch weighs 3 pounds (1.3 kg).

Cost: 18,000 credits per canister.

## **Environmental Body Armor**

### **Features Common to Environmental Body Armor of the Three Galaxies**

All spacefaring people have some type of environmental body armor or EBA suit that enables the wearer to survive and function in the cold, hostile environment of outer space. Also functions in inhospitable atmospheres and underwater at depths up to 1,000 feet (305 m; double for heavy armor).

- Complete environmental battle armor suitable for use in all hostile environments, including space.

- Computer controlled life support system.
- Internal cooling and temperature control.
- Artificial air circulation systems, gas filtration, humidifier.
- Computer controlled, independent oxygen supply and purge system that automatically engages in low oxygen or contaminated air environments. Five hour oxygen supply.
- Insulated, high temperature resistant shielding for up to 300 degrees Centigrade (572 F). Normal fires do no damage. Nuclear, plasma, and magic fires do full damage.
- Radiation shielded.
- Polarized and light sensitive/adjusting tinted visor/face plate.
- Built-in loudspeaker; 80 decibels.
- Directional, short-range radio built into the helmet. Range is 5 miles (8 km) in atmosphere, 150 miles (240 km) in outer space.
- Removable helmet and face plate or visor.
- Handheld Mini-Computer: A multi-purpose miniature computer and display that is either built into the forearm near the wrist or can be removed from a compartment on the forearm, shoulder or hip and used as a handheld device. Roughly the size of a modern Earth cell phone. The computer is linked to the systems and sensors of the suit and indicates system errors within the armor, damage levels, power levels, radiation levels, outside temperature, oxygen supply, and other vital signs of the wearer and his armored suit, as well as direction (compass), time, and date.
- Ammo and supply waist belt, shoulder belts, and shoulder holster. Pilots and officers have their choice of shoulder or hip holster and side arm.
- Clamps and modular hook-up ports in the back for most standard EVA Packs.
- Boot survival knife or Vibro-Blade for officers and military specialists, Multi-Purpose Tool for engineers, scientists and repair personnel.
- M.D.C. varies with the requirements of the species, level of technology and preference of materials, but usually falls within the following ranges, listed by general category. The advanced technology of many people in this part of the universe provides a considerable amount of M.D.C. protection.

Light Environmental Armor: Typically made of light, flexible M.D.C. material with no movement penalties.

Helmet: 25-35  
 Arms: 12-20  
 Legs: 20-30  
 Main Body: 25-50

Medium Environmental Armor: Typically made of a combination of padding, flexible M.D.C. material, and light plating. Modest movement penalties of -5% to -10%.

Helmet: 35-40  
 Arms: 20-35  
 Legs: 35-45  
 Main Body: 60-80

Heavy (Hard Plate) Environmental Armor: Typically made of combination inner flexible M.D.C. material, padding and heavy

exterior plating. Movement is restrictive even in the weightlessness of space and has penalties of -12% to -25% to physical movement and skills such as Acrobatics, Climbing, Gymnastics, Prowl, Swimming, and similar.

Helmet: 50-80  
 Arms: 40-60  
 Legs: 50-90  
 Main Body: 100-200

Cost: Varies dramatically with the level of M.D.C. protection, requirements of the species and manufacturer. Generally 35,000 to 300,000 credits.

## EVA Packs

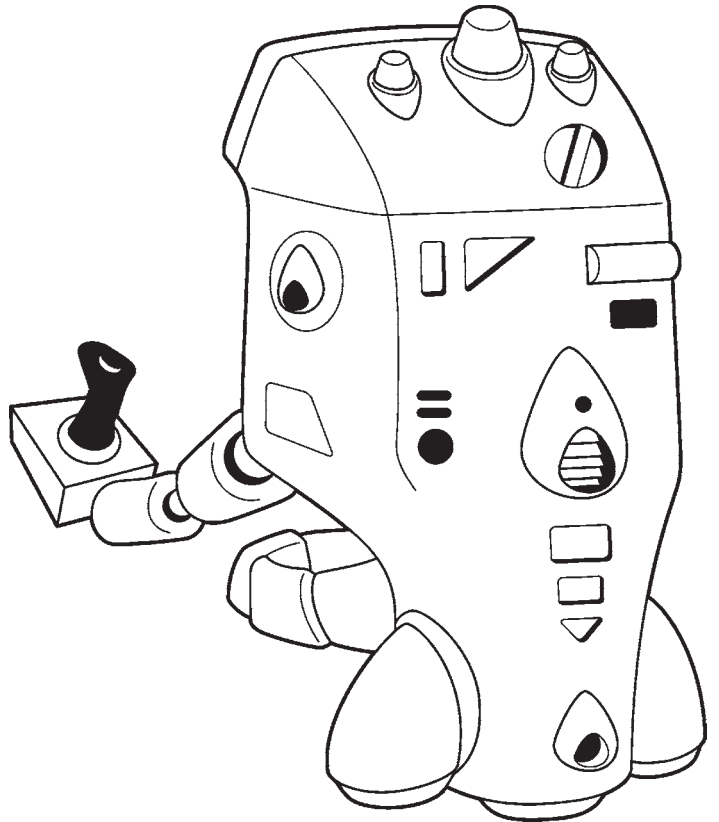

### All-Purpose Maneuvering EVA Pack

The APM-EVA Pack was designed to give people operating in outer space control and maneuverability in zero and micro-gravity environments. The EVA Pack uses an array of xenon-fueled, gridded ion thrusters to produce sufficient thrust to move a fully equipped operator. EVA Packs are used by anyone who needs to function outside a spacecraft, from scientists, engineers, repair people and rescue parties to fully armed soldiers, pirates, raiders and boarding parties.

Speed: 300 mph (480 km) in space only. The EVA Pack cannot be used in atmosphere.

Range: Fully fueled, the EVA Pack is good for seven hours of constant use.

M.D.C.: 25

Bonus: +1 to dodge in space.

Cost: 50,000 credits.

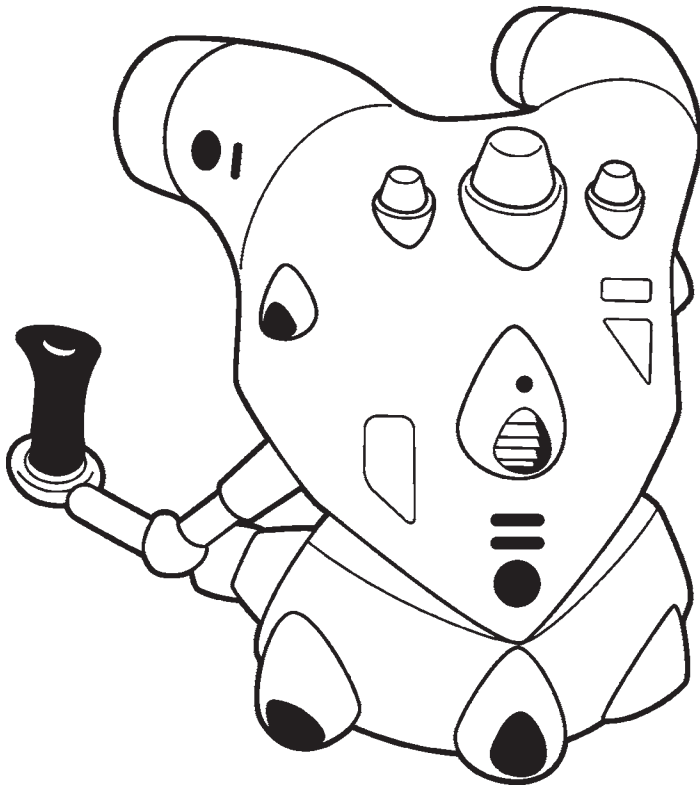

## Emergency EVA Pack

The Emergency EVA Pack is a smaller and more compact version of the EVA Pack. Issued to the pilots and crews of fighters and small spacecraft, the EEVA Pack is a last ditch emergency vehicle for pilots set adrift in space. Using smaller versions of the Xenon fueled, gridded ion thrusters used in its larger sibling, this pack is relatively slow but using one is seen as preferable to floating aimlessly through hostile space. The pack also includes an emergency beacon that broadcasts an encrypted signal up to 125,000 miles (200,000 km) in space to assist in rescue operations.

Speed: 80 mph (128 km) in space only.

Range: Fully fueled, the Emergency EVA Pack is good for three hours of constant use. The beacon has its own battery good for 96 hours.

M.D.C.: 15

Cost: 30,000 credits.

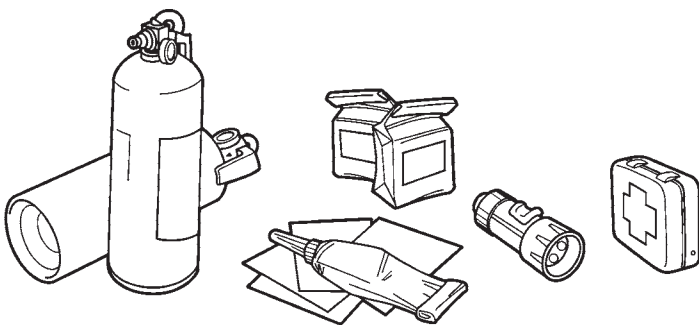

## Pilot's Survival Pack

Issued in every space fighter, assault shuttle and small troop transport, this pack contains everything a stranded pilot could need to exist in the cold vacuum of space. Each kit includes the following items:

M.D.C.: 10

Cost: 15,000 credits.

Special Features:

- Flashing beacon light; can be turned off and on by the user.
- Emergency beacon that broadcasts an encrypted signal up to 50,000 miles (80,000 km) in space. The beacon has its own battery good for 192 hours.
- Hand-fired signal flare/beacon.
- Clock calendar.
- Audio recorder with 24 hours of recording space available.
- Two small oxygen bottles with 12 hours of air apiece. Each bottle is the size of a large thermos, and comes with a handful of adapters that allow the bottle to connect to the life support systems of most major brand EVA suits (80%).
- One EVA suit patching kit. This kit contains four patches and a tube of strong adhesive. It's good for temporary repairs of small tears and holes.
- One small, impact resistant flashlight.
- One miniature PSE-7000 Portable Scanner (**Dimension Book 6: Three Galaxies™**, pages 104-106) with a bio-unit add on.
- One "Spacer's Friend" multi-tool.
- Three days worth of freeze dried rations and water (for crash landings on a planet).
- One miniature first aid kit (for crash landings on a planet).

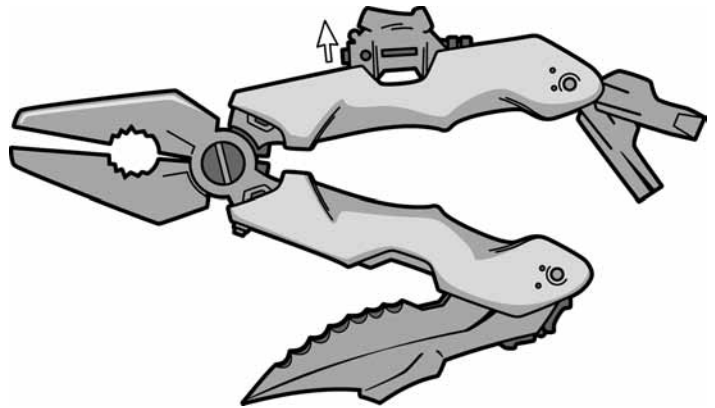

## "Spacer's Friend" Multi-Tool

This rugged multi-tool is specifically designed with the needs of the Spacer in mind. It is made of a high-strength ferrous alloy, is oversized for ease of use by gloved hands and contains the following tools:

- One small, serrated Vibro-Knife (1 M.D.).
- Pliers with wire cutters.
- One flathead and one square-drive screwdriver.
- Laser Distancer.
- Micrometer.
- High-intensity LED light that shines red or white light.

The power for the light, distancer and Vibro-Knife comes from a small solar cell and internal capacitor. The capacitor carries enough power to run all three for two hours, and takes ten minutes to recharge one hour's worth of power.

Weight: 2 lbs (0.9 kg).

Cost: 8,500 credits.

# Altess Armoria Equipment

## Officer Jump Suit

The Armoria Officer Jump Suit is an individually tailored, skintight, one-piece, long-sleeved, coverall type garment worn by all members of the Armoria. The suit is made from hand-some, high thread-count ballistic fabric interwoven with a matrix of high-tensile foil-fibers. It is reinforced with integral gel inserts at the elbows, shoulders, spine, lower back, hips and knees, and comes issued with a pair of knee-high boots, gloves and a helmet. When sealed to the boots, gloves and helmet, the jump suit acts as a mechanical pressure suit, and is treated to protect the wearer from nuclear, biological and chemical exposure. This suit is always issued in matte dark gray or black with purple and white highlights, and has nickel-plated hardware (zippers, buckles, etc.).

### M.D.C. by Location:

Helmet – 50

Arms (2) – 35 each

Gloves (2) – 12 each

Legs (2) – 45 each

Boots (2) – 15 each

Main Body – 75

Gel Inserts (11) – 10 each

### Standard Features:

- 1. NBC Shielding:** Through a combination of embedded materials and chemical coatings, the Officer Jump Suit provides excellent protection against nuclear, biological and chemical agents. When sealed to the boots, gloves and helmet, the suit grants a +6 to save vs lethal and non-lethal poisons to resist chemical and biological agents. It also reduces damage dealt by radiation, chemical and biological agents by 50%.
- 2. Passive Temperature Control:** The Officer Jump Suit is insulated, waterproof and designed to wick away sweat and moisture. It is also woven with tiny channels that contain a stable liquid compound similar to anti-freeze. The passive temperature control system keeps the wearer up to 20 degrees Fahrenheit (11.2 degrees Celsius), warmer than ambient temperature.
- 3. Heat and Fire Resistance:** The Jump Suit takes no damage from normal fires, and reduces the damage from M.D. fires like plasma weapons and ship fires by 40%.
- 4. Oxygen Supply:** An oxygen tank with a 10 hour capacity can be connected to the helmet, allowing the suit to be used as an EVA or emergency rescue suit.

**Weight:** 12 lbs (5.4 kg) with boots, gloves and helmet.

**Cost:** This armor is unique to the Armoria, and is unavailable to the market.

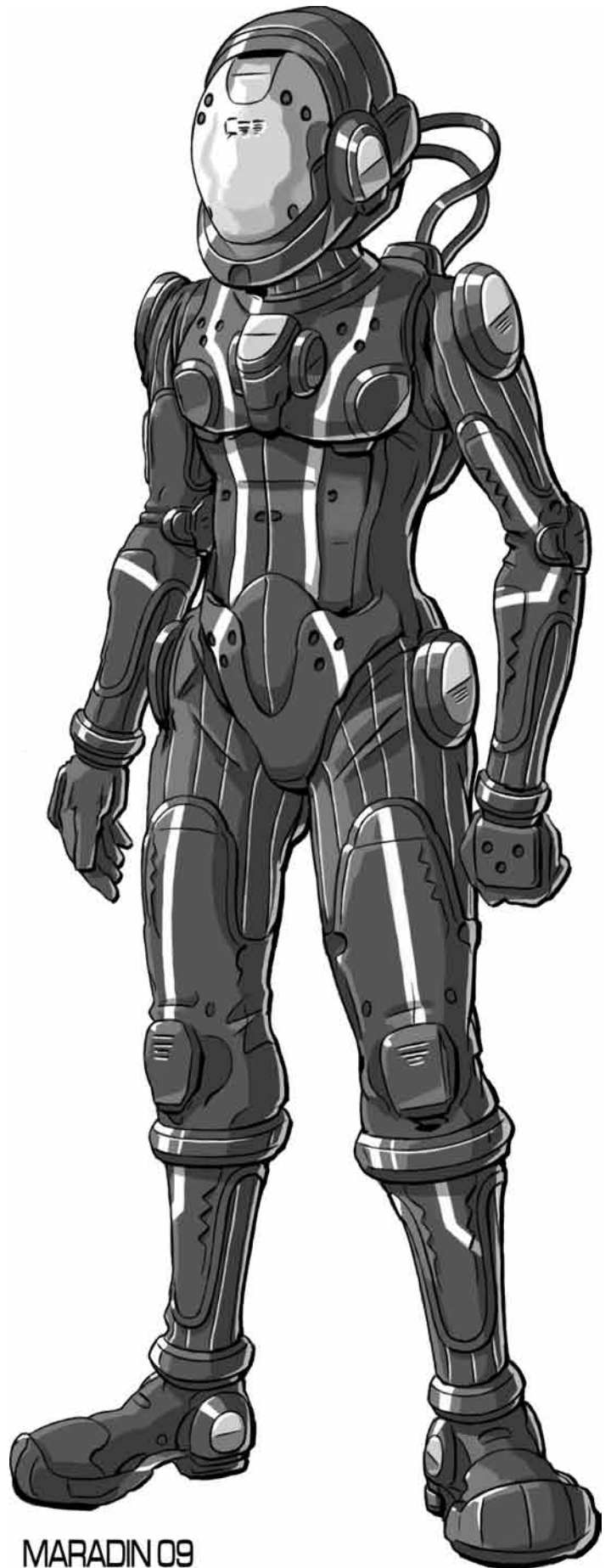

**MARADIN 09**  
vulne pro



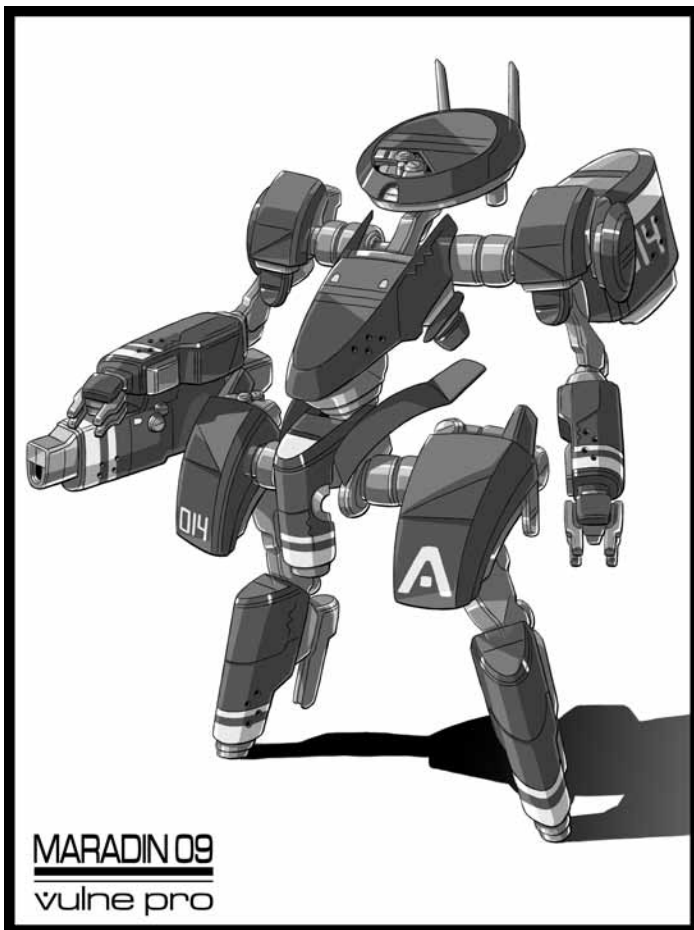

## Altess Advocate Robot

Due to the role they play in the Armoria, the robots that crew the starships of the Armoria deserve a special mention. The Advocate robot is a neural-type intelligence that can learn and adapt to new situations, make leaps of logic, and draw conclusions from incomplete or sketchy evidence. Its computer brain is loaded with every skill it could ever need to act as a front-line soldier or crew member aboard any of the Altess starships. Since the Armoria hasn't seen actual combat in centuries, many of the Advocates are sitting in warehouses on Novus IX, powered down and waiting for the day that they are again called to serve.

When acting as pilots and gunners, the Advocate jacks in and links directly to the various computer controls, giving it an additional +2 to strike with the ship's weapons (in addition to bonuses from a Weapon Systems roll and target's size).

The Altess Advocate Robot can adjust its shape and size to better accommodate its environment, enabling it to reduce its width and height by 30%, folding up its legs, and it has a pair of smaller, lighter, highly articulated hands and arms that come out of the forearm housings to handle intricate equipment and perform delicate operations. There are also a number of jacks and cables located in the arms and hips/upper legs to link directly into the controls of machines, equipment and computers. The Advocate Robot can also attach a wide range of modular tools to its forearms to build and make repairs.

**Model Type:** AD-88

**Intelligence Type:** Neural.

### M.D.C. by Location:

Concealed Arms and Hands (2; fine work) – 15 each

Utility Hands (2, main) – 35 each

Arms (2) – 70 each

Legs (2) – 125 each

\* Head – 105

\*\* Main Body – 250

\* Destroying the head of the robot eliminates all optics and sensory systems. In most cases, the robot shuts down as a safety feature. However, about 20% of the time it continues to fight or function as best it can, striking blindly until it is destroyed. Under these conditions, the robot has no initiative and no combat bonuses, and is -9 to strike, parry, and dodge. **Note:** The head is a small and difficult target to hit, especially on a moving target. Thus, it can only be hit when a character makes a "Called Shot" and even then the attacker is -2 to strike.

\*\* Depleting the M.D.C. of the main body effectively destroys the robot, causing it to detonate its hidden self-destruct mechanism, leaving nothing to salvage.

### Speed:

**Running:** 120 mph (192 km) maximum. Note that the act of running does NOT tire the robot, and speed can be maintained indefinitely.

**Leaping:** The robot legs are strong and well suited for leaping. Leaps are limited to approximately 20 feet (6 m) high or lengthwise. A running leap at speeds in excess of 40 mph (64 km) enables the robot to leap an additional 10 feet (3 m).

**Flying:** Possible only by use of a contra-gravity pack.

**Range:** The nuclear power pack gives the Advocate approximately 20 years of life, even under the most strenuous and constant amount of use.

### Statistical Data:

**Height:** 6.5 feet (1.9 m).

**Width:** 3.9 feet (1.1 m).

**Length:** 3.2 feet (0.9 m).

**Weight:** 800 lbs (360 kg).

**Physical Strength:** Equal to a Robotic P.S. 40.

**Cargo:** None.

**Power System:** Nuclear: energy life is 20 years.

**Cost:** Available only within the Altess Dynasty. Might go for 4-5 million credits apiece in the open market.

### Standard Features:

**1. Can use any other type of handheld weapon:** There are no specific weapon systems built into these robots. They can, however, use just about any type of energy weapon, light rail gun, handheld weapon or tool a humanoid can use. If the utility hands are too bulky for the weapon, it can be used by the extendible arms and hands concealed in the robot's forearms. Standard issue weapon for all of the Armoria is the unaltered *Naruni Plasma rifle, the NE-1000* (1D4x10, 30 shot clip, 3000 foot/914 m range).

**2. Combat & Bonuses:** Six hand to hand attacks/actions per melee. Skill is about equal to eighth level Hand to Hand: Expert. **Bonuses:** Including sensor and W.P. bonuses (standard): +2 on initiative, +1 on Perception Rolls, +5 to strike, +6 to parry and dodge, +2 to disarm, +2 to roll with impact, critical strike on a Natural 18 or higher, paired weapons, kick, and judo flip. +3 to strike using handheld weapons/guns of all types.

Attribute Equivalents of Note: I.Q. 16, P.S. 40 (Robotic), P.P. 20, Spd 264 (120 mph/192 km).

**3. Modular Tool Attachments:** There are dozens of modular tools that can be attached to the forearm. They range from a variety of electric drills, saws, nail gun, power wrench, air guns, jackhammer, spotlights, and other utilitarian tools to laser and plasma torches and Vibro-Blades.

**4. Sensors of Note (in the head):**

Optics: Basic optical system, including the visible light spectrum, infrared, ultraviolet, and polarization, as well as passive light amplification (nightvision 500 feet/152 m), telescopic (6000 feet/1829 m), and targeting. Plus a microscopic magnification lens for detail work.

Amplified Hearing: Can hear sounds as quiet as 10 decibels as far away as 500 feet (152 m). Can also hear in the ultrasonic range of high-frequency sound. The computer is programmed to recognize 60,000 different mechanical sounds, from the sound of a car engine to the hum of a generator. Adds to alertness and attacks.

Speech: Full vocal capabilities. Speaks and is literate in Altess, Trade One, Trade Three, and Trade Four at 98%.

**5. Skill Program:** Programs include Communication, Electrical, Mechanical, Pilot, Pilot Related, plus Appraise Goods, Chemistry, Chemistry Analytical, all Computer skills, all Demolitions skills, Firefighting, Math: Basic and Advanced (both at 98%), Recycling, and Salvage, all at 90% (unless stated otherwise), as well as basic combat and weapon skills (W.P. Rifles, W.P. Energy Pistol, W.P. Energy Rifle, W.P. Heavy M.D. Weapons, W.P. Blunt, W.P. Knife, and W.P. Sword), all at 7th level proficiency. **Note:** Pilot skills include Starship, Contra-Gravity Pack and Space Fighter, all at 90% proficiency.

## Golgan Argosy Equipment

### Republikan Guard Armor

Worn by the Republikan Guard and Golgan Argosy officers, this suit of heavy, segmented, environmental plate armor consists of cera-alloy plates backed by thick ballistic fabric woven with high-strength foil-fibers. Like much of Golgan design, the armor has a distinct aquatic theme, and looks like the chitinous plates of a lobster. The most unique feature of this armor is the modular back pieces. As a Republikan Guardsman or Argosy officer advances in rank, more and more plates are added to the back and shoulders of the armor, eventually coming to look like

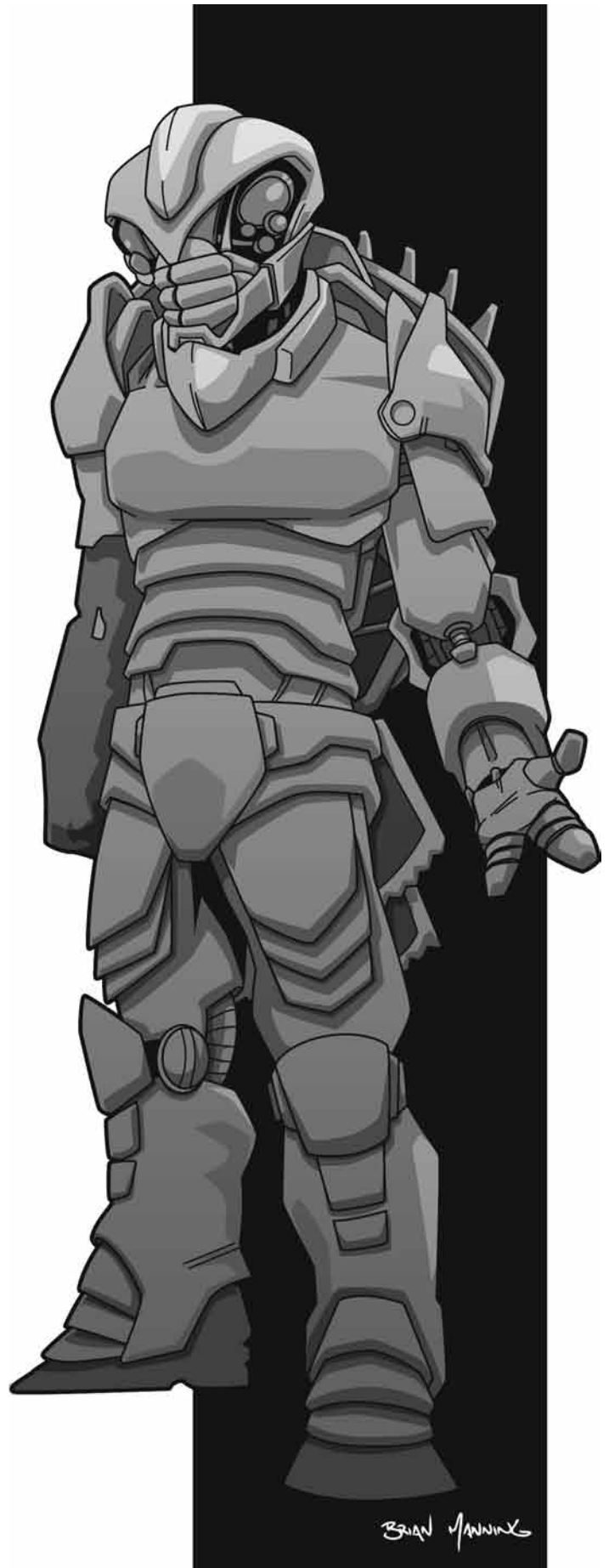

a crab or turtle shell. This is a manifestation of the Golgan thinking that retreat is always imminent, and a strong rear defense will be needed when running away. This armor comes in yellow and black, the colors of the Argosy, and is unsuited for other races due to its tailoring for the unique frames of the Golgans.

**M.D.C. by Location:**

Helmet – 50

Arms (2) – 35 each

Legs (2) – 55 each

Main Body (front) – 95

Main Body (rear) – 110 (\*starting base)

\* The higher the rank, the greater the protection; add 12 M.D.C. for each additional plate layering due to rank.

**Standard Features:** Republikan Guard armor has all features common to environmental armor and can be used as an EVA suit in an emergency.

**Weight:** 35 lbs (15.7 kg). RG Armor is heavy and stiff, and imposes a movement penalty of -15%. Each additional back plate layer weighs 5 lbs (2.25 kg) and imposes an additional -1% movement penalty.

**Market Cost:** This armor is unique to the Argosy, and is unavailable to the open market.

## Golgan Auxiliary Guard Armor

AG Armor is the standard issue armor suit for units of the Auxiliary Guard. While it shares many stylistic cues with the finer Republikan Guard armor, AG armor is nowhere near as good quality. It is noticeably lighter and of poorer fit and finish, and lacks the ability to stack on additional back and shoulder plates.

**M.D.C. by Location:**

Helmet – 35

Arms (2) – 20 each

Legs (2) – 30 each

Main Body – 65

**Standard Features:** AG armor has all features common to environmental armor and can be used as an EVA suit in an emergency.

**Weight:** Typically 20 lbs (9 kg) and imposes a -5% movement penalty.

**Market Cost:** This armor is unique to the Argosy, and is unavailable to the market.

## Argosy G-44 Disruptor Pistol

This bulky, long-barreled side arm is issued to high ranking Golgan Gauses and is as much a symbol of rank as it is a weapon. It fires the same brilliant purple disruptor beam as the G-88 rifle, but at a lower intensity. It also suffers from the same low range and high energy consumption as the G-88 rifle.

Weight: 2 lbs (0.9 kg).



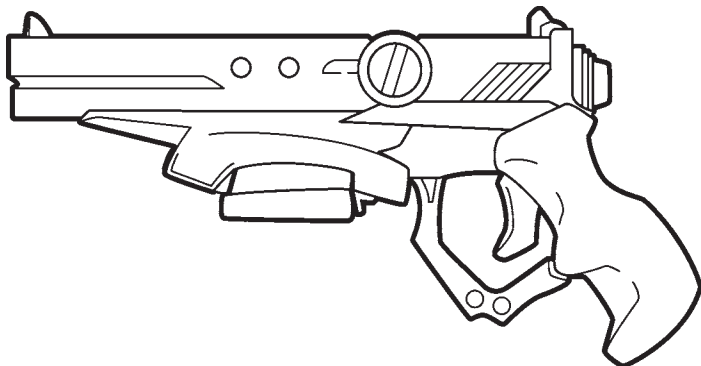

Range: 450 feet (137 m).

Mega-Damage: 2D6+2 M.D. per single shot to the point of impact, plus 25% damage to everything within a one foot (0.3 m) diameter around the impact point.

Rate of Fire: Single shot only. Each shot counts as one attack.

Payload: 9 blasts.

Market Cost: None of these pistols have made it to the market yet. If they ever do, they could fetch somewhere around 17,000 credits.

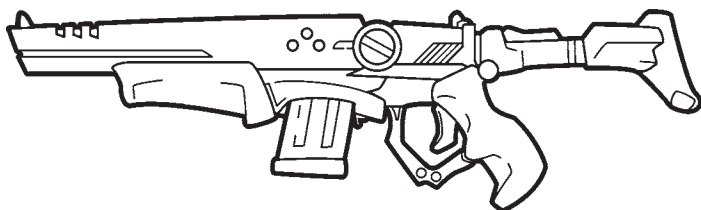

## Argosy G-88 Disruptor Rifle

The G-88 is a long, bulky looking, select-fire rifle similar in profile to the CAF's HI-80 Combat Laser Rifle. It is issued solely to the Republican Guard and fires brilliant purple disruptor beams that have excellent penetration and tend to leave ugly, ragged holes in whatever they hit. The down side of all this destructive power is high energy consumption and relatively short range for an energy rifle.

Weight: 7 lbs (3.2 kg).

Range: 1,700 feet (518.2 m).

Mega-Damage: 4D6+4 M.D. at the point of impact for a single shot and 2D4x10+5 M.D. for a five pulse burst, plus 25% of the damage to a 1.5 foot (0.5 m) diameter around the impact point.

Rate of Fire: Single shot or five round burst. Each shot or burst uses one melee attack.

Payload: 20 single shots or 4 five blast rapid-fire pulses.

Market Cost: None of these rifles have made it to the open market yet. If they ever do, they would fetch somewhere between 42,000-54,000 credits.

# Common Auxiliary Ships

## Bullock-Class Orbital Tug

Bullock-class tugs are representative of a number of different vessels found in and around planetary space all throughout the Three Galaxies. Tugs are generally small, hardy ships of roughly frigate size with oversized power plants and incredibly powerful engines. They are chiefly used to maneuver large cargo and warships into and out of places where navigating on their own would be difficult or hazardous, like busy orbital ship-yards or dry docks. They also tow vessels and satellites that have lost power or have suffered damage and cannot maneuver under their own power, as well as cargo barges and large pieces of debris. To do this, tugs work in teams, depending on the size and mass of the ship or object they're moving. They come along side a ship to be moved and "tie-up" to her using mechanical or magnetic grapples, then slowly guide the larger ship to its destination.

Tugs can be fitted for other duties as well, and the Bullock is no exception. Bullock tugs make excellent search and rescue craft, and are often sent with a team of medics and soldiers to retrieve stranded or heavily damaged ships and render aid to their crews. Bullock tugs are used by both military and civilian entities, and thousands of them are in use by both the CAF and the TGE.

**Model Type:** Heavy Orbital Tug (OTH).

**Class:** Bullock Class.

**Ship's Complement:**

Ship's Crew: 17-25: One Captain, one Pilot, one Executive Officer/First Mate, one Cook, Five Engineers and 8-16 general crewmen.

**M.D.C. by Location:**

\* Engine Section – 500 each

\*\* Grapples (4) – 250 each

Interior Bulkheads per 10 feet (3 m) – 50

Interior Hatches – 15 each

Exterior Hatches – 45 each

Main Body – 1,800

\*\*\* Hull per 40 foot (12.2 m) section – 40

\* Destroying the engines sets the ship adrift.

\*\* Destroying one grapple reduces the ship's towing capacity by 25%. Destroying two grapples reduces towing capacity by half and destroying three makes the ship unable to tow.

\*\*\* Punching holes in the hull causes the damage control system to automatically seal off whatever compartment has been exposed to vacuum. Ships are highly compartmentalized to prevent decompression of the whole ship.

**Speed:**

Atmosphere: Bullock tugs are rarely, if ever, sent into a planet's atmosphere. If forced to enter atmosphere, the ship could manage 400 mph (640 km).

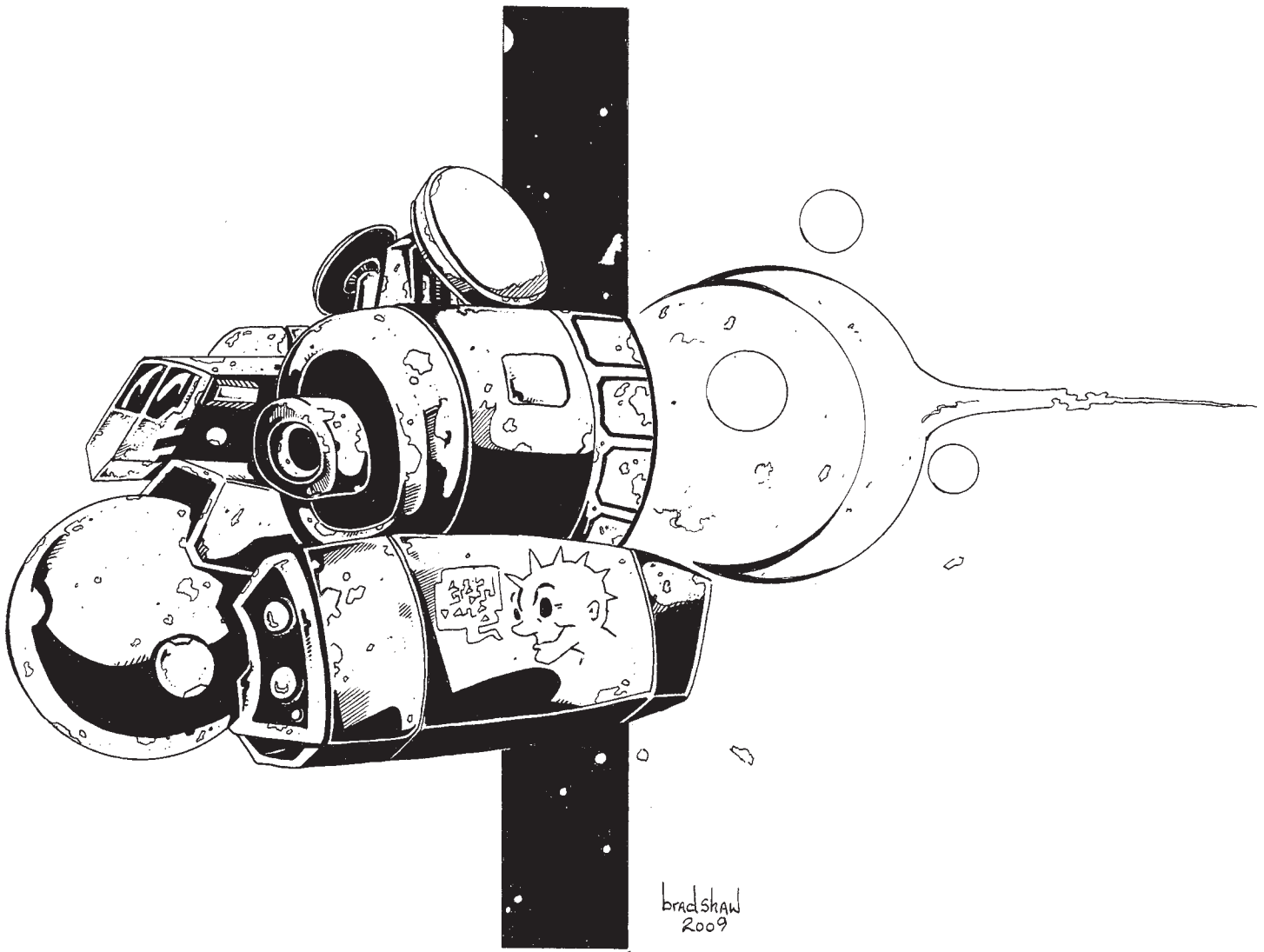

Sub-Light: 3,424 mph (5,479 km or Mach 4.5).

FTL: Bullock tugs are not FTL capable.

Maximum Range: Limited only by supplies. The anti-matter engines have a lifespan of 30 years, but shipboard stores are only good for about two weeks deployment with a full crew.

**Statistical Data:**

Length: 480 feet (146.3 m).

Beam: 230 feet (70.1 m).

Height: 160 feet (48.7).

Mass: 7,800 tons.

Cargo: Bullocks can carry 8,000 tons of cargo, or a mixture of soldiers (one platoon) and a medical team with all of their weapons and equipment. Bullocks have a towing capacity of 65,000 tons.

Power Source: One sub-capital class anti-matter reactor powering one bank of four sub-capital class sub-light engines.

Cost: 16-20 million credits.

**Ship's Systems of Note:**

**1. Magnetic Grapples (4):** These grapples are mounted two to a side, two port and two starboard, and allow the Bullock to tie-up to larger ships. The grapples themselves are huge electromagnets, about ten feet (3 m) across, attached to 350 feet

(106.6 m) of high-strength cable. The grapples are fired at the larger ship, then the Bullock reels itself in and proceeds to move its charge at will.

Primary Purpose: Towing

Secondary Purpose: Salvage

Weight: Each magnet weighs three tons.

Range: 350 feet (106.6 m).

Mega-Damage: None.

Rate of Fire: Firing a grapple takes one action.

Payload: One grapple.

**Cargo Runabout**

The EVR-150 cargo runabout is one of the most common vehicles found in and around space stations and orbital shipyards. This small spacecraft has a boxy, pressurized cabin that can seat 3-4 and a long cargo bed full of anchors and tie-downs. They are easy to fly, cheap to maintain and can take an enormous amount of abuse. The EVR comes in a variety of variant sizes, with the main variation being the size of the cargo bed.

**Model Type**: EVR-150a-d.

**Class**: Three seat orbital cargo runabout.

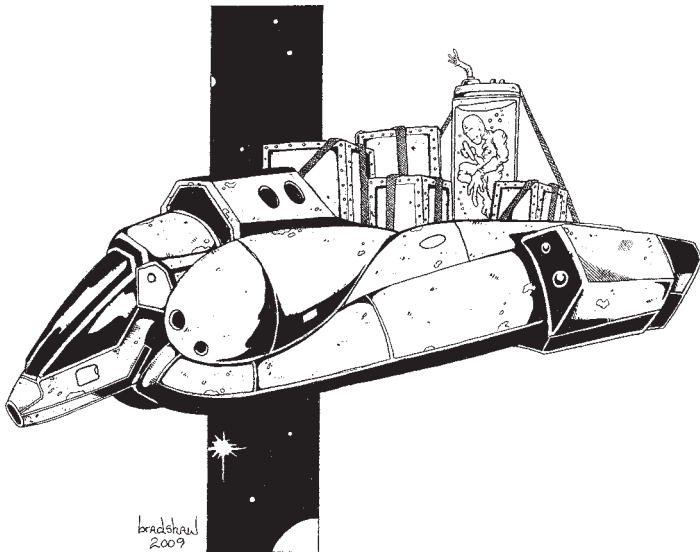

**Crew:** One pilot, plus 3-4 passengers can fit in the cabin along with the pilot.

**M.D.C. by Location:**

- \* Pressurized Cabin – 200
- Hatches (2) – 35 each
- Cargo Bed – 400
- Optional Hardtop for Cargo Bed – 225
- \*\* Thrusters (4) – 125 each
- Lights (4) – 18 each
- Main Body – 780

\* Breaching the cabin vents the atmosphere and has a 15% chance of killing the occupants.

\*\* Destroying the thrusters sets the little ship adrift.

**Speed:** The EVR-150 can jet along at nearly 100 mph (160 km).

**Statistical Data:**

- Height: 8-10 feet (2.4 to 3 m).
- Length: 20-30 feet (6.1 to 9.1 m).
- Width: 7-12 feet (2.1 to 3.6 m).
- Weight: 3-6 tons.

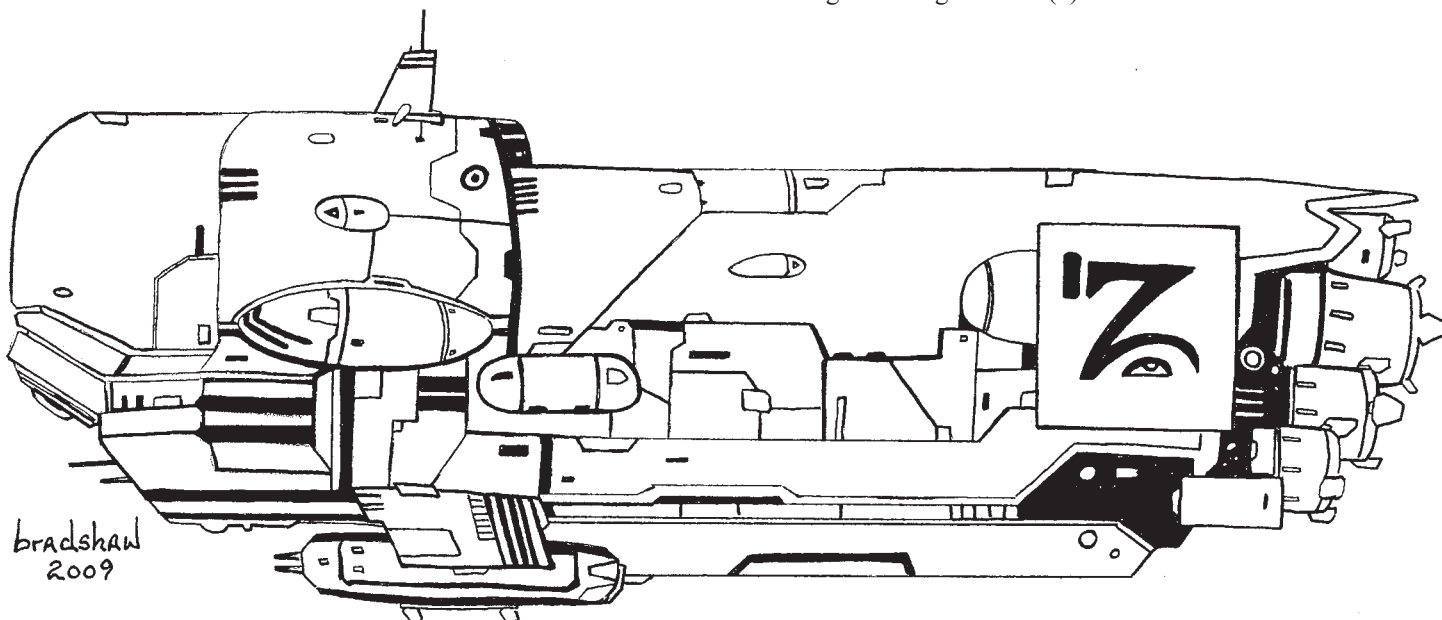

**Cargo:** The EVR-150 can carry up to 10-18 tons.

**Power System:** Two high-thrust ion thrusters fueled by xenon gas and numerous low-thrust vernier thrusters. Electrical power is provided by a bank of rechargeable batteries. The batteries can hold an 18 hour charge.

**Cost:** 1.2 to 2 million credits each.

**Special Equipment:** Life support, radiation and heat shielding, polarized canopy, two xenon floodlights, two infrared floodlights.

## Dray-Class Fleet Tender

Dray-class fleet tenders are massive, cruiser sized cargo vessels used by many commercial and navy fleets to haul cargo and deliver supplies and support or “tend” far-flung battlegroups throughout the Galaxies. Almost twice the size of the CAF’s Warshield-class cruiser, these heavy lifters are designed to carry hundreds of thousands of tons of palletized and containerized cargo within their cavernous holds. They carry food, water, medical supplies, spare parts, ordnance, fresh troops and all manner of necessary materiel to wherever it is needed.

Since they are highly automated and mostly cargo space, Drays have a small crew in comparison to other ships of the same size. Being essentially an up-armored freighter, Drays are relatively fragile and fare poorly in military engagements. While they have a very good point-defense system, these ships are usually deployed under heavy escort by other sub-capital ships.

**Model Type:** General Fleet Tender (TSG).

**Class:** Dray Class.

**Ship’s Complement:**

**Ship’s Crew:** 300: One Captain, one Executive Officer, two Pilots, two Navigators, 100 Engineers, one Load Master, one Quartermaster and 192 general hands.

**M.D.C. by Location:**

- Interior Bulkheads per 10 feet (3 m) – 50
- Interior Hatches – 25 each
- Exterior Hatches – 50 each
- Cargo Loading Hatches (2) – 850 each

Point Defense Batteries (24) – 150 each

\* Forward Hull Section (1/3) – 3,500

\*\* Midships Hull Section (1/3) – 3,700

\*\*\* Aft Hull Section (1/3) – 4,500

\*\*\*\* Hull per 40 foot (12.2 m) section – 65

Variable Force Fields – 1,500 per side (9,000 total)

\* Destroying the forward hull section reduces the total carrying capacity by one third, and has a 35% chance to destroy any and all cargo stored in the forward holds.

\*\* Depleting the M.D.C. of the midships hull section reduces the ship's carrying capacity by two-thirds and has a 45% chance of destroying any and all cargo carried in the midships holds.

\*\*\* Depleting the M.D.C. of the aft section of the hull destroys the engines and engineering decks, setting the ship adrift.

\*\*\*\* Punching holes in the hull causes the damage control system to automatically seal off whatever compartment has been exposed to vacuum. Ships are highly compartmentalized to prevent decompression of the whole ship.

### Speed:

Atmosphere: Dray-class tenders are ill-suited to atmospheric operations, and, at best, can muster a speed of 700 mph (1,120 km).

Sub-Light: 3,805 mph (6,088 km or Mach 5).

FTL: 4.3 light-years per hour.

Maximum Range: Limited only by supplies. The anti-matter reactors carry enough fuel to operate the ship at full readiness for 40 years, but shipboard stores are only good for sixteen months of constant deployment with full crew and complement.

### Statistical Data:

Length: 1,470 feet (448 m).

Beam: 345 feet (1025. m).

Height: 607 feet (185 m).

Mass: 100,000 tons.

Cargo: Dray-class tenders can carry 400,000 tons of palletized and containerized cargo, and up to 250 passengers or troops.

Power Source: Three sub-capital class anti-matter reactors powering two banks of four sub-capital class thrusters.

### Weapon Systems:

**1. GR-Gun/Missile Batteries (24):** Point-defense batteries mounted four to a side, port, starboard, dorsal and ventral, as well as in the bow and stern of the ship. They are the Dray's only weapons, but give the ship excellent protection against small attack vessels such as fighters and shuttlecraft commonly used by pirates, raiders and Spacers.

Primary Purpose: Anti-Aerospacecraft/Anti-Robot.

Secondary Purpose: Anti-Missile.

Weight: Not applicable, part of the ship's hull.

Range: 16 miles (26 km) in space, one-third that in an atmosphere. Missiles have a range of 2 miles (3.2 km) in space.

Mega-Damage: A burst is 20 rounds and inflicts 4D6x10 M.D.

Missiles are always plasma: 1D6x10 M.D. each.

Rate of Fire: Equal to the number of hand to hand attacks of the gunner. Missiles can be launched one at a time, or in volleys of two or four.

Payload: 200 bursts per GR-gun, and 32 missiles in the launchers. Both can be reloaded from the cargo bay in minutes and can be reloaded 1D4+2 times.

**2. Ship's Systems of Note:** Tactical life support, lifeboats for all crew and passengers, cargo handling systems.

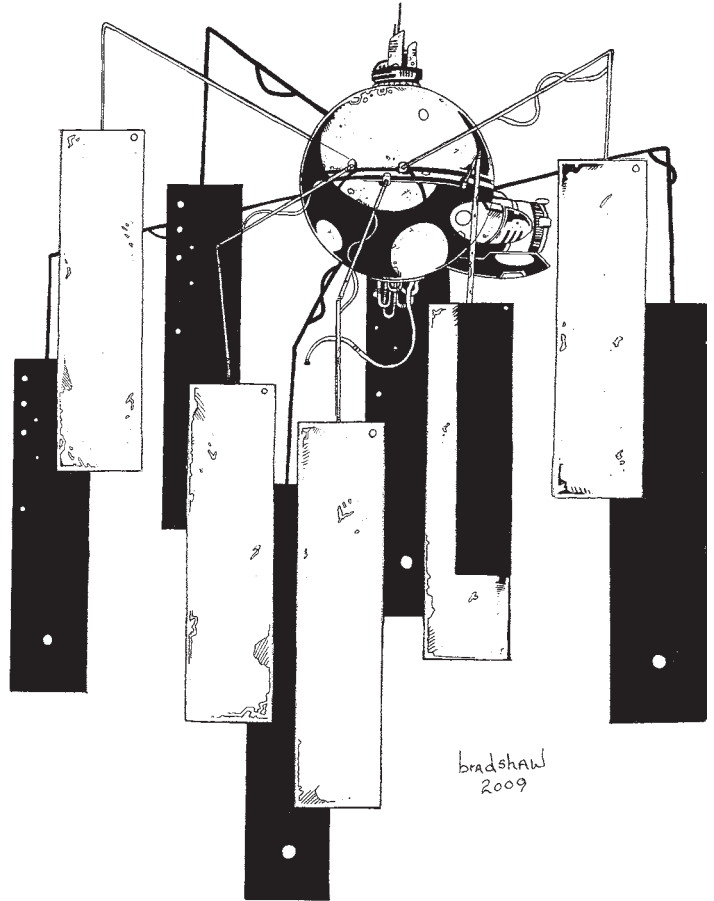

## Artisan-Class Mobile Deep-Space Dry Dock

Artisan mobile dry docks are one of the stranger, and more useful, ships in the Three Galaxies. Essentially a massive, free-roaming shipyard, Artisans are used by all three major powers (CAF, TGE and UWW) in support of their interstellar fleets. These ships are composed of ten modular docks, or *slips*, mated to a huge engineering and command module that houses the command center, reactors and drives. Pressurized hangars, barracks and utility buildings litter every side of the ship, and cranes dot the landscape around the slips. There's even a comprehensive magnetic rail car system for moving men and parts between the slips.

With a workforce of nearly 3,000, Artisans can handle nearly any job. The modular nature of their dock sections allows them to handle a wide array of ships. The slips can handle 16 sub-capital ships, eight capital ships or any mix thereof. The ship itself has full production and fabrication capabilities, and

carries enough parts and raw material to rebuild large capital ships like carriers from burned out hulks. Since Artisans are fully FTL capable, they are typically deployed close to the front lines of a major conflict to provide maintenance, resupply and repair for ships of the line.

Tours of duty aboard these ships are tedious, cramped and largely thankless. Work shifts are typically long, and the work is hard and potentially dangerous. Despite this, a posting to an Artisan is coveted by many engineers, as it's seen as the ultimate test of one's skill, training and stamina.

**Model Type:** Mobile Deep-Space Dry Dock (MD).

**Class:** Artisan Class.

**Ship's Complement:**

Ship's Crew: 2,800 engineers, technicians and general hands.

Troop Complement: 750 armed troops (Marines, Legionnaires, etc.) for security.

Aerospace Complement: 6 shuttles, 12 Bullock-class tugs, numerous small cargo runabouts and personal spacecraft.

**M.D.C. by Location:**

\* Modular Dock Sections (10) – 6,500 each

Living Quarters/Equipment Buildings/Hangars – 4,000 each

Pressurized Catwalks – 450 each

\*\* Engineering/Command Section – 8,000

Interior Bulkheads per 10 feet (3 m) – 60

Interior Hatches – 35 each

Exterior Hatches – 45 each

\*\*\* Hull per 40 foot (12.2 m) section – 110 each

\* Destroying a modular dock section makes that section unusable, and has a 40% chance of seriously damaging any ship moored there.

\*\* Destroying the engineering/drive section sets the ship adrift.

\*\*\* Punching holes in the hull causes the damage control system to automatically seal off whatever compartment has been exposed to vacuum. Ships are highly compartmentalized to prevent decompression of the whole ship.

**Speed:**

Atmosphere: Artisan-class mobile dry docks are unable to enter atmosphere.

Sub-Light: 2,739 mph (4,383 km or Mach 3.6).

FTL: 3 light-years per hour.

Maximum Range: Limited only by supplies. The anti-matter reactors carry enough fuel to operate the ship at full readiness for 40 years, but shipboard stores are only good for twelve months of constant deployment with full crew and complement.

**Statistical Data:**

Length: 3,217 feet (980.5 m).

Beam: 2,940 feet (896 m).

Height: 338 feet (103 m), not including slips.

Mass: 13 million tons.

Cargo: 700,000 tons

Power Source: Four capital-class anti-matter reactors powering all repair and maintenance systems, as well as two banks of four capital-class thrusters.

## Weapon Systems:

**1. GR-Gun/Missile Batteries (48):** These point-defense batteries are scattered around the Artisan, and give it excellent protection against fighters and shuttlecraft.

Primary Purpose: Anti-Aerospacecraft/Anti-Robot.

Secondary Purpose: Anti-Missile.

Weight: Not applicable, part of the ship's hull.

Range: 16 miles (26 km) in space, one-third that in an atmosphere. Missiles have a range of 2 miles (3.2 km) in space.

Mega-Damage: A burst is 20 rounds and inflicts 4D6x10 M.D. Missiles are always plasma: 1D6x10 M.D. each.

Rate of Fire: Equal to the number of hand to hand attacks of the gunner. Missiles can be launched one at a time, or in volleys of two or four.

Payload: 200 bursts for the gun, and 32 in the launcher. Both can be reloaded from the cargo bay in about 3 minutes.

**2. Other Weapons:** While not typically sanctioned by their navies, enterprising Artisan commanders have been known to mount medium-sized anti-ship weapons on their platforms before going into a hostile area of space. The Artisan-class mobile dock can mount six medium-sized weapons (see **Rifts® Dimension Book 2: Phase World®**, pages 154-155, and **Rifts® Dimension Book™ 6: Three Galaxies™**, pages 128-129).

**3. Ship's Systems of Note:** Tactical life support, complete ship repair and dry dock facilities, lifeboats for all crew and troops.

## Lifeboat/Escape Capsule

Every ship built by the major spacefaring people is equipped with a number of escape capsules or lifeboats capable of evacuating the ship's entire complement. Escape capsules are all pretty similar, have a number of standard features, and are capable of prolonged exposure to and travel through space. They usually carry 10 passengers, with a seat and safety restraint for each. They are slow, cramped and uncomfortable, but preferable to the alternative of being stranded in space in only an EVA suit. The stats below are for a typical capsule, Game Masters are free to modify them as they see fit.

**M.D.C. by Location:**

\* Viewports (3) – 25 each

\* Hatch – 55

\*\* Engine Array – 200

\*\*\* Main Body – 400

\* Destroying the viewports or hatch immediately vents the internal atmosphere into space. Unless sealed quickly, all will die.

\*\* Destroying the engines sets the escape capsule adrift.

\*\*\* Destroying the main body shreds the capsule and kills everyone inside.

**Speed:**

Atmosphere: Capsules are shielded against reentry, but atmospheric operations are limited to controlled, safe landings.

Sub-Light: 1,400 mph (2,240 km or Mach 1.8).



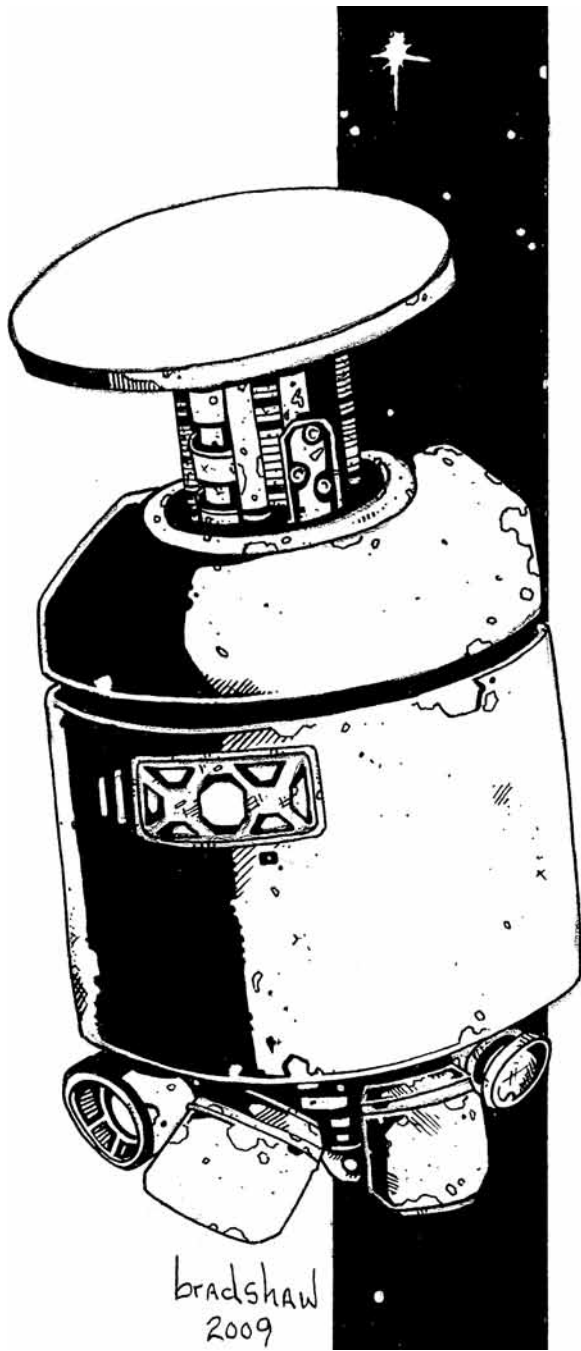

FTL: 1 light-year per hour. UWW capsules with a Rift-Drive can jump 5 light-years 5 times a day.

Maximum Range: Limited only by supplies. While the anti-matter battery has enough power to last for 15 years, on-board emergency rations, air and water are only good for about a month of deployment with 10 passengers.

**Statistical Data:**

Length: 20 feet (6 m).

Beam: 12 feet (3.6 m).

Height: 12 feet (3.6 m).

Mass: Typically around 10 tons.

Cargo: Limited to emergency supplies and small items carried by the passengers.

Power Source: Escape capsules are typically powered by a small anti-matter battery with a life span of about 15 years. Those used by the UWW will have a P.P.E battery with a comparable life span. This battery powers the ship's life support, sub-light drives and a small CG or Rift FTL drive.

Cost: 5-9 million credits each.

**Standard Features:**

- 1. Life Support Systems:** The capsule is equipped with the typical chemical and radiation shielding, oxygen scrubbers and water filters.
- 2. Onboard Computer:** The capsule is equipped with a rudimentary navigation computer and autopilot. With guidance from a human or other sentient being, the computer can plot a course for the nearest friendly planet and pilot itself there. The computer essentially has the *Pilot: Spaceships* skill at 70%, has two attacks/actions per melee and is +4 to automatic dodge (the act of dodging does not count as a melee attack/action).

# Space Magic

By Kevin Siembieda & Carl Gleba

A section talking about *magic* might seem a little unexpected in a book entitled **Fleets of the Three Galaxies** that is predominantly about spaceships, but not when you stop and think about it. The Three Galaxies is an environment where *magic is real*, fairly commonplace and is regarded as an exotic type of technology. The United Worlds of Warlock (UWW), the Splugorth Fleets, the Dominators, Demon Fleets, pirates and others all use magic. Furthermore, the use of magic or incorporation of *magic* built right into any given spacecraft can give the pilot and crew an unexpected edge, at least in certain circumstances. In fact, magic is an accepted part of spaceship construction and space combat in most intergalactic communities.

Can Teleportation and Mystic Portal be used to board a spacecraft? Is there a defense against Teleportation or Mystic Portal to stop would-be boarding parties? Can magic be used as a defense of a vessel? Can magic be used to attack, disable or capture a spaceship? Can magic be used to survive and travel in space without a spacecraft? The answer to all of these questions is yes.

The Three Galaxies has had spacefaring races for hundreds of generations. Many different types of spells and magic were specifically created either by necessity or design to help magic cultures survive and explore the depths of space. The following spells might be considered exclusive to the Three Galaxies, but could be known to any spacefaring race whose technology is at least partially based on magic. The Game Master *may* wish to impose a penalty of double the P.P.E. cost for those spell casters who are not native to the Three Galaxies or familiar with the environment of outer space. It should also be noted that many of these spells can only be cast *in the vacuum of space*.

# Level One

## Communications Booster

**Range:** One communications system or radio per spell by touch or up to 20 feet (6.1 m) away.

**Duration:** Five minutes per level of the spell caster.

**Saving Throw:** Not applicable.

**P.P.E.:** Four

Turns short-range radio transmissions into long-range, and boosts long-range radio systems by 300x. Works only in the vacuum of space.

## Detect Leak

**Range:** Area effect that covers a 20 foot (6.1 m) radius per level of the mage.

**Duration:** One minute per level of the caster.

**Saving Throw:** Not applicable.

**P.P.E.:** Four

When cast, the spell amplifies the sound of the leak (sometimes they are almost undetectable) and pinpoints the source of the leak with a magical white smoke that by either flowing toward it or emanating from it, depending on which side of the leak the spell caster is on. If the leak is sealed before the duration of the spell ends, the spell automatically ends and the smoke disappears, indicating the leak is fixed. If the spell is cast in an area where there is no air leak, nothing happens. The spell is capable of detecting up to two leaks per level of the spell caster.

**Note:** This spell can also be used to detect other types of leaks, involving other gases than air, chemicals, fuel, energy, radiation, heat, water, and so on, on board spacecraft and other vehicles, as well as environmental suits, body armor and power armor. In all cases, the leak is pinpointed by a column of white, odorless smoke.

## Magnetic Boots

**Range:** Self or two others by touch, or one up to 50 feet (15.2 m) away.

**Duration:** 10 minutes per level of experience.

**Saving Throw:** Standard, but applicable only if the spell is unwanted.

**P.P.E.:** Two

This spell enables the mage or recipient to resist the effects of zero gravity and cling to the surface of space stations and the hull of spaceships as if his boots were magnetic. The enchanted character remains subject to the effects of zero gravity, but will not float away as long as one foot is touching a magnetic surface (most spaceship and space station hulls are some type of metal). Speed is half in zero gravity.

## Propulsion Blast

**Range:** Self or two others by touch, or one up to 50 feet (15.2 m) away.

**Duration:** One melee round. Each blast counts as one melee attack or melee action.

**Saving Throw:** Standard, but applicable only if the spell is unwanted.

**P.P.E.:** One

A simple spell that creates a light burst of air capable of propelling the mage or recipient of the magic through space at a slow speed (1D4 mph/1.6 to 6.4 km). It may also be used to change direction, float back to the surface of a spacecraft or its hatch, and similar needs.

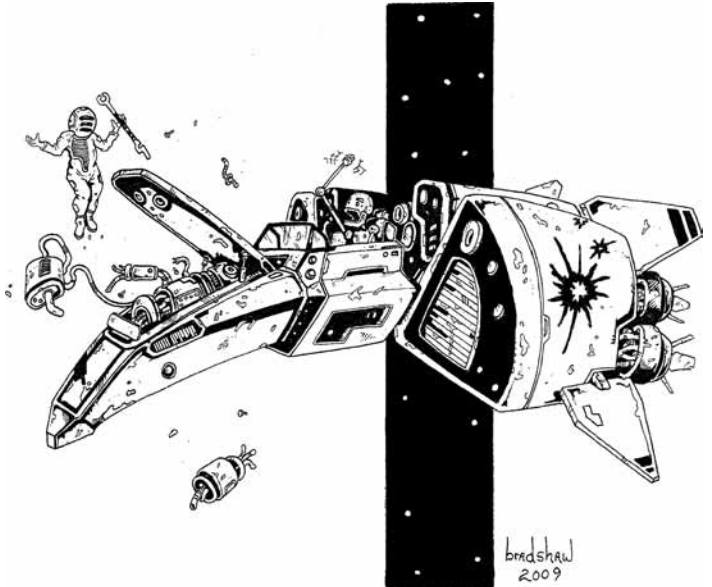

## Zero Gravity Movement & Combat

**Range:** Self, two others by touch or one other up to 30 feet (9.1 m) away.

**Duration:** Three minutes per level of the spell caster.

**Saving Throw:** Standard, but applicable only if the spell is unwanted.

**P.P.E.:** Four

The spell imbues the character with the ability to function and fight without penalty; same as if the character had the *Zero Gravity Movement & Combat* skill at 75% proficiency. **Note:** Characters without the skill or enchantment float around helplessly, bounce around and are completely disoriented: -15% on skill performance, -1 attack per melee, -2 on initiative, and Spd and all combat bonuses are reduced by half.

# Level Two

## Magic Homing Beacon

**Range:** Self or up to two others by touch.

**Duration:** One day per level of the spell caster.

**Saving Throw:** +2 to save if the magic is unwanted.

**P.P.E.:** Five

This spell gives the recipient a magical homing beacon that is activated the moment the spell is cast. The homing signal is imperceptible by ordinary technological means. Only characters who can have the magic ability to Sense Homing Beacon or Lo-

cate Life Signs can hear, sense and locate the source(s) of the Magic Homing Beacon.

## Sense Magic Homing Beacon

**Range:** Self or one other by touch. Range of detection is one light-year radius per level of the spell caster.

**Duration:** Ten minutes per level of the spell caster.

**Saving Throw:** Standard if unwanted.

**P.P.E.:** Eight

This spell enables the recipient to sense, follow and locate the source or sources of Magic Homing Beacons within his sensing range.

## Space Walk

**Range:** Self or two others by touch.

**Duration:** Ten minutes per level of experience.

**Saving Throw:** Standard if the magic is unwanted.

**P.P.E.:** Five

This spell does not protect the recipient from the hazards of space, so a spacesuit or other means of protection is necessary, but it does give the character the ability to “walk in space.” This is just like it sounds, the character can walk along the hull of a spaceship, space station, asteroid, etc., without fear of drifting off into space. Likewise, the character can walk along sensory arrays or any protrusions sticking out from the vessel, leap to a nearby tug, platform or piece of debris and ride on the outside, provided speed of travel is a slow 70 mph (112 km) or less. This means the character can ride debris and walk along any spaceship, be it along the sides, upside down or topside.

## Vacuum Speak

**Range:** The spell can be cast on oneself or as many as two others by touch. Range of the radio transmission in space is limited to one mile (1.6 km).

**Duration:** 10 minutes per level of experience.

**Saving Throw:** Standard.

**P.P.E.:** Six

Sound waves cannot travel in a vacuum, so this spell enables the mage to cast spells and talk by transforming his voice into radio waves that can be used in space, and picked up by conventional radios and listening systems. Furthermore, any characters using Vacuum Speak can be heard by other characters also enchanted with the same magic spell, thus allowing communication between two or more individuals without a radio in space. **Note:** The practitioner of magic still requires a spacesuit, environmental body armor or additional magic protection, such as Impervious to Vacuum, to survive in space.

## Level Three

### Recycle Air

**Range:** Self or one or two others by touch.

**Duration:** Instant transformation. How long the air lasts depends on how much was available in the first place, with a 12

hour maximum before another spell needs to be cast to cleanse and replenish the air again.

**Saving Throw:** Not applicable.

**P.P.E.:** Five; double the P.P.E. to double the duration.

**Limitations:** An entire spacecraft or sealed section of a larger spaceship as large as a shuttlecraft, provided there is an air supply (even a stale or spoiled one) to begin with.

This spell requires an existing atmosphere/air supply that it can purify and regenerate similar to a technological air purification and recycling system. Thus, it can instantly transform foul or stale air into a clean, breathable atmosphere, in effect, refreshing and renewing the existing available air supply. This means the air contained in an escape capsule, sealed chamber inside a spacecraft, airtight vault, environmental body armor, or similar enclosure can be magically purified and restored, renewing and extending an existing air supply every time the spell is cast.

## Radiation Shielding

**Range:** Self or one other by touch or up to 60 feet (18.3 m) away.

**Duration:** Three minutes per level of the spell caster.

**Saving Throw:** Standard if the spell is unwanted.

**P.P.E.:** Six

This spell protects the character and anything on him from dangerous and deadly levels of radiation for a short period of time. It also provides limited protection (half damage) from heat caused by radiation.

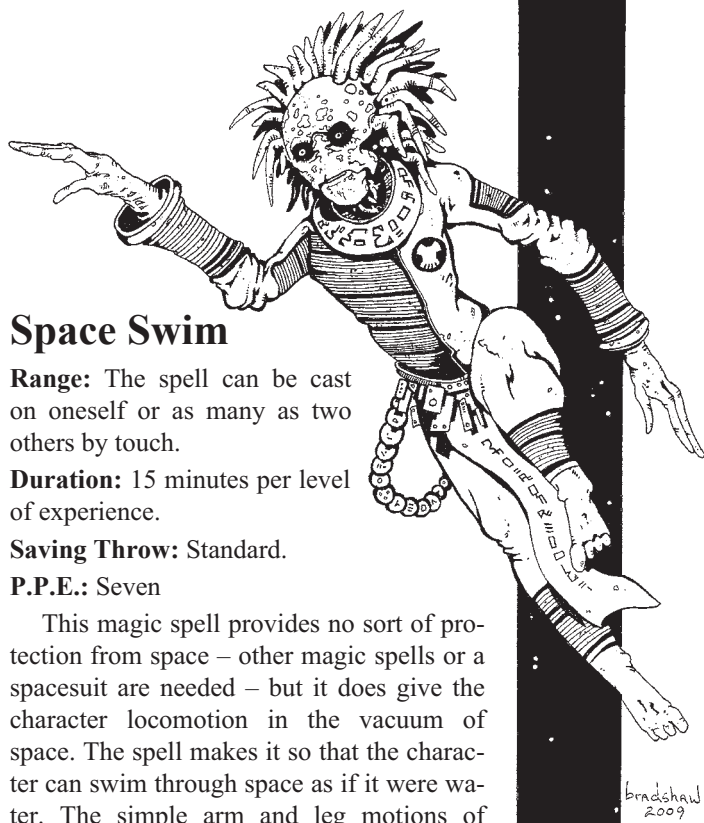

## Space Swim

**Range:** The spell can be cast on oneself or as many as two others by touch.

**Duration:** 15 minutes per level of experience.

**Saving Throw:** Standard.

**P.P.E.:** Seven

This magic spell provides no sort of protection from space – other magic spells or a spacesuit are needed – but it does give the character locomotion in the vacuum of space. The spell makes it so that the character can swim through space as if it were water. The simple arm and leg motions of swimming propel the recipient of the magic

through space with grace and ease. It also provides the character with the *Zero Gravity Movement & Combat skill* at 95% proficiency and provides the following bonuses while “swimming” in space: +1 to strike, parry and disarm, +2 to dodge and +2 to roll with impact. Maximum speed is double the character’s running speed. Ideal for working outside a spaceship or space station, boarding parties and recreation.

## Level Four

### Detect Teleportation & Magic Breaches

**Range:** Self only; sense magical breaches and teleportation up to 100 feet (30.5 m) away per level of experience.

**Duration:** Two melee rounds (30 seconds) per level of the spell caster.

**Saving Throw:** Not applicable.

**P.P.E.:** Eight

This enchantment enables the spell caster to detect and pinpoint locations where one or more magic breaches via *Mystic Portal*, *Teleportation*, *Dimensional Rift* and similar magic have occurred within the last 1D4+1 minutes, or are occurring at the moment, on or within the space vessel. This magic also tells the mage exactly where the Teleportation, Mystic Portal or other magic breach occurred, and enables him to initiate defensive action, dispatch defenders or cast magic to counter, engage or impede the boarders.

### Distress Call

**Range:** Two light-years per level of the spell caster.

**Duration:** Repeats 10 times an hour for two hours per level of the spell caster.

**Saving Throw:** None, although the spell could be negated with Negate Magic or an Anti-Magic Cloud.

**P.P.E.:** Twelve

This spell creates a small sphere the size of a grapefruit that floats near him for the duration of the spell. The sphere transmits a universal distress signal plus, if so desired, a recorded message up to 15 words may be transmitted. The distress call is repeated every six minutes for one hour per level of the spell caster. The message is broadcast on multiple frequencies and can be picked up and heard by a wide range of modern communication systems as well as those using Vacuum Speak and Detect Homing Beacon. As a distress call, the signal can be traced to the location of the magic sphere by both technological and magic means.

### Hide in Space

**Range:** One individual or spacecraft of any size up to Capital sized spacecraft.

**Duration:** One minute per level of the spell caster.

**Saving Throw:** Not applicable.

**P.P.E.:** Varies with the size of the vessel. Man-sized (under 12 feet/3.6 m): 10 P.P.E., shuttle or smaller spacecraft: 30 P.P.E.,

sub-capital ships: 75 P.P.E., or capital: 145 P.P.E.; cannot conceal anything larger.

The spell folds space and time around the individual or space vessel to make it invisible to normal vision, optic systems, and all other means of detection, including advanced EWAR systems.

The magic is negated and the individual or spacecraft becomes visible the instant he/it uses any of its systems to see outside the magic concealment, e.g. activates its radar, sends out a sensor probe, tries to communicate to the outside world, activates engines, sends a radio transmission, initiates a targeting system, attacks or moves. While magically concealed, those inside the vessel can only rely on their own line of sight and senses and must remain stationary or adrift. Ideal for hiding only.

### Impervious to Vacuum

**Range:** Self or two others by touch, or one other cast up to 90 feet (27.4 m) away.

**Duration:** Five minutes per level of the spell caster.

**Saving Throw:** Standard.

**P.P.E.:** Ten

An enchantment that makes the individual impervious to exposure to vacuum, outer space and sudden decompression. It insulates the individual from the cold of space, cosmic radiation, and provides the recipient with the ability to *breathe without air* for the duration of the enchantment, however the recipient still cannot speak because sound waves do not travel in space. Ideal for use when exposure to space without a protective spacesuit or other gear is imminent. **Note:** Although not affected by the vacuum of space, the character has no means of movement through space and remains vulnerable to physical damage and attacks. Additional means of protection and movement are advised. This spell only works in space, but can be combined with other space spells.

### Magic Tether

**Range:** 40 feet (12 m) +10 feet (3 m) per level of experience.

**Duration:** Three minutes per level of the caster.

**Saving Throw:** Dodge of 16 or higher.

**P.P.E.:** Ten in space and 15 in an atmosphere.

The spell conjures forth a rope composed of magic fibers that has the strength of a steel cable. One end of the tether is anchored to the spell caster and the other fires towards a single target and either wraps around it or attaches upon a soft impact (no damage). Latching on to an inanimate object or spacecraft, the mage can let himself be pulled along as it moves through space, or he can pull himself along the length of the tether to the surface of whatever it is attached to. A magic tether can also be used to snare objects and people floating in space to be pulled toward the mage. This is ideal for rescue and salvage operations provided the target does not weight more than a ton. When used on inanimate objects and unconscious people, the Magic Tether always hits its intended target, provided it is within range, but alert and hostile or unwilling sentient beings and robots may try to dodge being tethered. A roll of 16 or higher (bonuses apply)

is necessary to successfully avoid the tether. The Magic Tether only has 4 M.D.C. and can easily be cut, or snapped with a Supernatural Strength of 24 or higher, or Robotic P.S. of 40+. Tethering oneself to a powerful, hostile being can have the opposite effect of the spell caster being pulled to it! The spell is good for conducting rescues and is commonly built into various Techno-Wizard gadgets and even TW Space Tugs. It should be noted that when used against other living beings, the tether does NOT entangle, tie up or incapacitate the target in any way.

The Magic Tether spell can be used in an atmosphere, but costs a little more P.P.E. to cast it and defenders only need a 14 or higher to dodge. The magic tether has a strength of 600 pounds (270 kg), plus 100 pounds (45 kg) per additional level of experience. In the weightless vacuum of space, the Magic Tether can pull objects three times its tensile strength.

## Stellar Navigation

**Range:** Self or one other by touch.

**Duration:** 10 minutes per level of the caster.

**Saving Throw:** Standard for unwilling victims.

**P.P.E.:** Eight

The magic imbues the character with an innate sense of direction when in space and the ability to read space charts and plot a course at 96% skill proficiency as if he had the *Navigation: Space skill*. If he fails his roll he is 2D4 light-years off course.

## Level Five

### Seal Leak

**Range:** 10 feet (3 m).

**Duration:** Two hours per level of the spell caster.

**Saving Throw:** Not applicable.

**P.P.E.:** Eleven; double the P.P.E. to double the duration.

Once an air (or other) leak is located, this spell creates a strong seal over the hole(s). The seal is temporary, lasting hours, which is hopefully enough time to make proper repairs. This spell can seal holes up to one foot (0.3 m) in diameter per level of the spell caster or a number of small leaks/breaches along the same hull or fitting. Thus, the repair can be a single hole or multiple tiny leaks if they fit in the diameter of the spell or run along the same length of pipe or conduit.

The spell has found numerous applications, from sealing hull breaches to plugging leaks in air hoses, pipes, and lines, to sealing small ruptures in spacesuits. The UWW often incorporates this spell in certain types of spacesuits, as well as their own TW version of a *patch kit*. The seal has 100 S.D.C. (1 M.D.) per level of the spell caster. It should be noted that this is only a temporary repair and disappears at the end of the duration, and the patch is susceptible to S.D.C. damage. **Note:** This spell can also be used to seal leaks involving other gases, chemicals, fuel, energy, radiation, heat, water, and so on, on spacecraft and other vehicles, as well as environmental suits, body armor and power armor.



### Magic Escape Bubble

**Range:** A magical sphere that can hold the spell caster and one additional passenger per level of experience.

**Duration:** One hour per level of the spell caster.

**Saving Throw:** Not applicable.

**P.P.E.:** Fifteen

If no physical escape capsule or lifeboat is available, the Magic Escape Bubble is a good, though very temporary, measure for escape and survival in outer space. The bubble, regardless of size or the number of passengers, has only 50 M.D.C., but it insulates those inside from the hazards of space (cold, radiation, provides breathable air, etc.). If the bubble is “popped” (M.D.C. reduced to zero), anyone inside the Escape Bubble without a spacesuit, environmental armor, or other magical protection is exposed to the vacuum of space, and dies in a matter of 1D6x10+40 seconds. Although not affected by the vacuum of space while inside the bubble, the character has no means of movement through space and the bubble remains vulnerable to physical damage and attacks. Additional means of protection and movement are advised. **Note:** May be combined with magic spells such as Homing Beacon, Hide in Space, any of the spells that provide propulsion/movement in space, and others that seem applicable (use common sense). This spell only works in space.

## Magic Hull Patch

**Range:** By touch or up to 30 feet (9.1 m) away.

**Duration:** Instant and permanent results.

**Saving Throw:** Not applicable.

**P.P.E.:** Twelve

A simple spell that, in effect, magically bonds a sheet or plate of metal to the hull to patch it. The plate may be an actual plate intended for patch work, or any available plate of metal, including a piece of floating debris that was snagged by some means (Magic Tether?). The patch is limited to 100 lbs (45 kg) per level of the spell caster, and it provides only whatever M.D.C. it has available to it (typically 1D6+4 M.D. per square foot/0.092 square meter). Although the patch is permanently bonded to the hull, it looks exactly like what it is, a patch. Furthermore, the light M.D.C. means the patch is a weak spot, and a large one may be an easy place for an enemy to breach and board the ship.

## Level Six

### Create Breathable Air

**Range:** The area around the mage, approximately a 10 foot (3 m) area.

**Duration:** One hour per level of the spell caster.

**Saving Throw:** Not applicable.

**P.P.E.:** Eighteen

This spell creates enough breathable air for two people per level of the spell caster to last one hour per level of the mage. The air is not contained, so if there is a leak this air will also leak out. The only other restriction to this spell is that there must be a small amount of air to begin with, as the spell is completely negated in a vacuum. A leaky environment reduces the duration of the spell as the air leaks away. In any case, the mage can cast the spell multiple times to increase the amount and/or duration of the air supply, or shortly before the previous spell literally runs out of air to continue it.

### Create Drinkable Water

**Range:** Up to 10 feet (3 m) away.

**Duration:** Instant results; requires a container to hold the fluid.

**Saving Throw:** Not applicable.

**P.P.E.:** Sixteen

This spell draws moisture and converts it into purified drinking water. The mage can create 10 gallons (37.8 liters) per level of his experience, but he will need something to hold the water in. The containers can be anything from a bathtub or steel drum, to plastic bottles or anything that can hold water without it leaking. To keep the water clean, it is best if the container, whether it be one large container or several smaller ones, can be covered and sealed.

### Magic Reentry Bubble

**Range:** Self or two others by touch.

**Duration:** Ten minutes per level of experience.

**Saving Throw:** Standard if the magic is unwanted.

**P.P.E.:** Twenty

A magic spell that creates a magic environmental bubble that can survive the heat, stress and turbulence of reentry into an atmosphere without burning up or tearing apart. The speed is blistering and the experience harrowing, but as the bubble approaches the planet's surface it automatically slows down and lands softly on solid ground (unless none is available). There is no way to pilot or direct the bubble as it is meant to be a survival mechanism and simple means to go from space to the surface of a planet, moon or similar large body with an atmosphere. Thus, the Magic Reentry Bubble lands at the nearest ley line, nexus point or other place of magic.

### Shooting Star

**Range:** 500 feet (152.4 m) per level of the spell caster in space; half that range in an atmosphere or on a space station or spacecraft.

**Duration:** Instant.

**Damage:** 1D6+1 M.D. per level of the spell caster.

**Saving Throw:** Not applicable except as a dodge.

**Bonus:** The spell caster is +2 to strike with a Shooting Star.

**P.P.E.:** Eighteen

A spell that is common to most Space Warlocks, the Shooting Star is a burst of blue magical energy that shoots from the outstretched hand of the mage. Halfway to its target the magical bolt separates into a dozen smaller sparkling stars that pepper an area like a mystic shotgun. Everything within the 10 foot (3 m) radius takes full damage. This spell can be cast anywhere, but is most effective in space, where it has the greatest range.

### Space Flight

**Range:** Self, up to two by touch, or one up to 200 feet (61 m) away; line of sight required.

**Duration:** 30 minutes per level of experience.

**Speed:** Mach One per level of experience. Only works in space. Double speed when flying along a space ley line.

**Saving Throw:** Standard, but only if the enchantment is unwanted.

**P.P.E.:** Fifteen

The spell caster is able to soar through space with ease as if he were rocket propelled. The enchanted individual has excellent speed and mobility in space and can maneuver, dodge, and change direction with but a thought. Speed is Mach One per level of experience, so a 5th level spell caster can achieve Mach 5 in space. The magic does not work in an atmosphere, so a character cannot fly from a spaceship to a location planetside or from the surface of a planet to his spaceship in orbit. The moment he enters an atmosphere the spell is negated. As long as the character is in a spacesuit to protect him from the vacuum of space or has other magical protections in place, and has a breathable air supply, he can fly through space as long as the spell is in place. **Note:** If encapsulated by an Air Bubble or Create Air spell, or when on board a spaceship with an artificial atmosphere/air supply, the spell remains in force, it is not negated.

# Level Seven

## Intuitive Xeno-First Aid

**Range:** Self.

**Duration:** Five minutes per level of the spell caster.

**Saving Throw:** Not applicable.

**P.P.E.:** Twenty-Two

This spell give the recipient an intuitive and temporary understanding of alien physiology sufficient to perform helpful and competent treatment equal to First Aid (Paramedic skill level if the character has the Paramedic or M.D. skill) even if he has no actual medical skill or knowledge. Base skill is 70% +2% per level of experience.

If the character has skill knowledge that involves Xenobiology or Xeno-Medicine of any kind, he can actually function as if he were a Medical Doctor familiar with the species and perform surgery and other complex treatments equal to a skill of 60% +1% per level of his experience.

In both cases, these abilities apply to even completely unknown *humanoid alien species* he has never seen before. Reduce skill ability by half if the subject is not humanoid.

## Locate Life Signs

**Range:** 100 mile (30.5 m) radius per level of the spell caster.

**Duration:** One minute per level of the spell caster.

**Saving Throw:** Not applicable.

**P.P.E.:** Twenty

A magic scan that searches for signs of life in the void of space. Ideal for search and rescue operations. Only detects large animal life forms from guinea pig to humanoid or larger, not bacteria or other small life forms. Only works in outer space or the surface of moons and planets that are otherwise devoid of life. If the spell caster knows the missing person, he can calibrate the search for life signs to that one person or two or three specific people. **Note:** This spell can also be tuned to find all Magic Homing Beacons within the search radius with absolute ease; 98% success rating.

## Magic Tug Tether

**Range:** 100 feet (30.5 m) +10 feet (3 m) per level of experience.

**Duration:** Three minutes per level of the spell caster.

**Saving Throw:** Not applicable except as a dodge of 14 or higher.

**P.P.E.:** Twenty-Two in space; does not work in an atmosphere.

The spell conjures forth a rope line composed of magic fibers that has the strength of a steel cable. One end of the Tug Tether is anchored to a space barge, platform, cargo container, hunk of debris, or damaged or derelict spaceship as large as a frigate, and the other end is anchored to an active spacecraft, ideally a tug or cargo hauler. The active spacecraft can then pull its "cargo" as if it were a tug boat. This spell is ideal for cargo hauling, salvage, rescue and tugboat operations, as well as clearing away debris from shipping lanes, or towing a damaged vessel. Cannot be used on living beings or capital-class vessels, and this spell does not work in an atmosphere. **Note:** A single Magic

Tug Tether can pull up to 30,000 tons +10,000 tons per level of the spell caster. If 2-3 tethers are used, increase the weight capacity by 50% (double when riding along a space ley line).

## Space Fire Stream

**Range:** 100 feet (30.5 m) per level of the spell caster, double along a space ley line, and triple at a nexus point.

**Duration:** Instant.

**Damage:** 1D8x10 M.D. and +1 to strike.

**Saving Throw:** Not applicable, except as dodge.

**P.P.E.:** Twenty

A flamethrower-type stream of fire that burns, even though there is no air to feed it in space. Only works in space.

## Space Push

**Range:** By touch or up to 30 feet (9.1 m) away.

**Duration:** Instant.

**Saving Throw:** Not applicable as the force is invisible and effects a wide area.

**P.P.E.:** Sixteen

A personal offensive spell that, without moving the spell caster, creates a blast of force that pushes anyone within in a 6 foot (1.8 m) radius of the blast away from him. The jolt sends the victim(s) tumbling in space away from his attacker at a speed of 35 mph (56 km). Unless the victim(s) has some means of *space flight*, he loses initiative and half his attacks per melee, and is -5 to all combat maneuvers (strike, parry, etc.) and skill performance is -35% while tumbling. There is also a 01-40% chance the character lets go of whatever he was holding and it drifts away. However, a victim with maneuvering capabilities (EVA pack, magic flight, etc.) can stop his tumbling in 1D6+4 seconds to return to battle.

However, if the character has *no space flight* capabilities, he suffers all the penalties above as long as he is tumbling away, has a 01-60% likelihood of letting go of whatever he was holding (it floats away) and he continues to tumble, head over heels, until rescued by someone else or he collides with something bigger (suffers 1D4 M.D. from impact). If he isn't rescued or doesn't collide with something, the victim tumbles into space at a slow speed forever. **Note:** This spell only works in a vacuum and is only effective against humanoids and relatively small objects weighing less than one ton.

## Vacuum Fire

**Range:** 100 feet (30.5 m) +20 feet (6.1 m) per level of the spell caster, double along a space ley line, triple at a nexus.

**Duration:** 1D4 melee rounds per level of the spell caster or until available combustible materials are burned up.

**Damage:** 2D6 S.D.C. to S.D.C. material, or 1D6 M.D. to M.D. materials.

**Saving Throw:** Not applicable, except as dodge.

**P.P.E.:** Twenty-Eight

A spell that causes one combustible material item, like clothing and other fabrics, spacesuit, plastic, rubber, wood, leaking fuel, and so on, to burst into flame similar to spontaneous combustion. The fire continues to burn, spread and grow as long as

there is combustible material to burn even though there is no oxygen to feed the flames. The fire is fed by magic energy and consumes all combustible material until the fire is extinguished, there are no more combustible materials left to burn, or the spell duration ends. Only burns in the vacuum of space, does not work in an atmosphere, but otherwise behaves and travels like a normal fire.

## Level Eight

### Anti-Gravity Flight

**Range:** Self or one other, or an object, platform or vehicle, by touch or up to 10 feet (3 m) away.

**Duration:** Ten minutes per level of the spell caster.

**Saving Throw:** Standard when applicable.

**P.P.E.:** Thirty-Five P.P.E. when used on a living being under 20 feet (6.1 m) tall, 60 when used on a vehicle, space fighter or shuttlecraft no larger than 100 feet (30.5 m) long; larger targets are not possible.

Limited to one individual, small fighter or shuttlecraft per spell cast, but may also be cast on ordinary cars and engineless platforms to give them flight capabilities. Anti-Gravity Flight can be used to fly silently through an atmosphere (and space) without an engine or jet propulsion, hug the ground or sides of buildings (often escaping detection by broad radar systems), to stop from falling, hover in midair (any altitude), and otherwise float above the ground, as well as slip the bonds of a planet's gravitational pull to get into outer space and fly through space or get to a spacecraft. The spell caster, or other sentient being who is the recipient of this magic, controls the speed and direction of travel as well as the altitude.

Speed in an atmosphere: 70 mph (112 km).

Speed in space: 100 mph (160 km).

**Bonus:** The spell also provides the equivalent skill and bonuses of the *Zero Gravity Movement and Combat* skill at 85% proficiency.

**Note:** To survive in outer space, the character needs an air supply and protection from the hazards of space (cold, radiation, lack of air, etc.) via a space-worthy vehicle, spacesuit or additional magic spells. This spell can NOT be combined with other space flight spells to increase its speed.

### Cosmic Ray

**Range:** 30 feet (9.1 m) per level of the spell caster.

**Duration:** Instant.

**Damage:** 3D6+3 points direct to Hit Points per melee to most living beings. The ray passes through conventional M.D.C. body armor (half damage if wearing magic armor or force field).

2D6+2 M.D. to mortal Mega-Damage creatures, 5D6+5 M.D. to supernatural beings including demons and Deevils, as well as creatures of magic. NO damage to spaceships, artificial constructs, body armor, or beings made of pure energy, rock or minerals.

**Saving Throw:** -1 to save. A successful save means the victim suffers half damage.

### P.P.E.: Thirty-Five

The spell creates a white beam of light that passes harmlessly through thin walls of solid matter such as body armor or the walls of a car, and inflicts damage direct to Hit Points. It also affects Mega-Damage creatures, and has an even greater effect on supernatural beings and creatures of magic. See damage above.

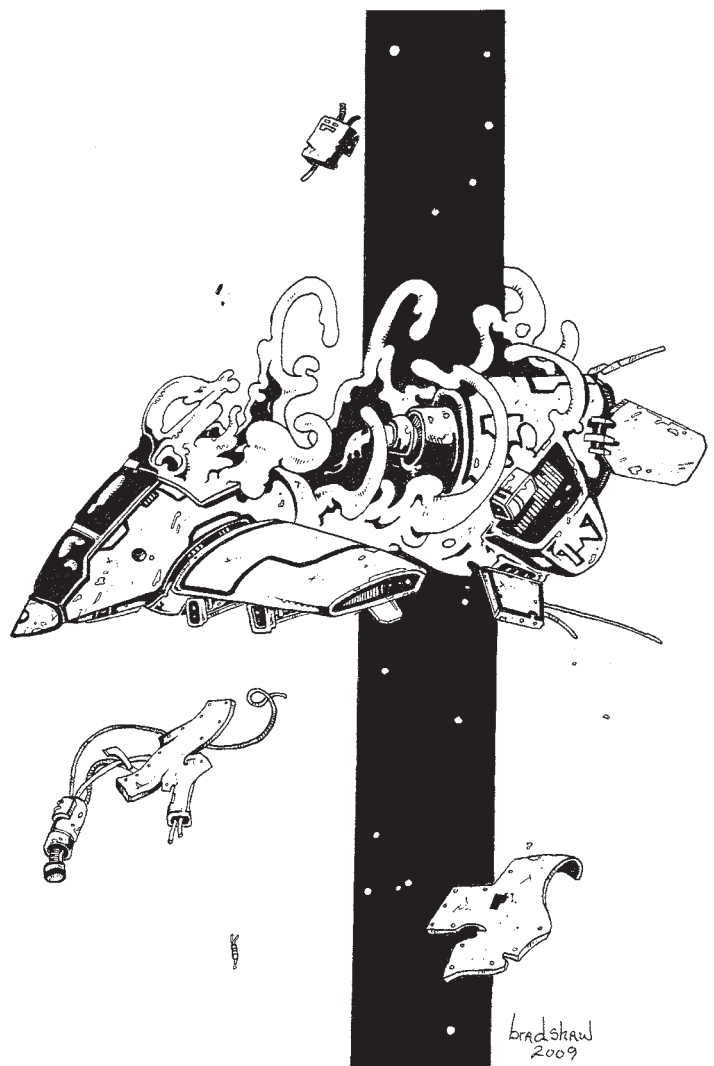

### Hull Regeneration

**Range:** By touch or up to 100 feet (30.5 m) away; line of sight.

**Duration:** Temporary or permanent; varies with P.P.E.

**Saving Throw:** Not applicable.

**P.P.E.:** Twenty-Five P.P.E. per 5% of the hull that is temporarily rebuilt. The temporary construct lasts for one hour per level of the spell caster. Triple the P.P.E. cost to make the reconstruction permanent. **Note:** Limited to small spacecraft like fighters, shuttles and frigate sized vessels; cannot rebuild the hull of anything larger than a frigate.

A powerful spell that magically rebuilds and reforms a spacecraft's hull out of star dust and mystic energy. As much as 5% of a ship's hull can rebuilt per 25 P.P.E. expended. The spacecraft can be no larger than a frigate, and only replaces the hull walls, not gun turrets, sensor arrays, engines, machine parts, force fields, etc. The replaced hull has *half its original M.D.C.* and this magic does not work on body armor or power armor,



but does apply to space capsules, barges and other small spacecraft and platforms.

## Magic Long-Term Escape Pod

**Range:** Self or one other by touch.

**Duration:** Six months per level of the spell caster.

**Saving Throw:** Not applicable.

**P.P.E.:** Thirty-Five

This spell *requires* a cargo container of some sort. The container must be large enough to hold at least one person (i.e. the size of a coffin or larger), and must be able to be sealed tight. Once the spell is cast, the person is put into a state of suspended animation and the box is magically made airtight and protects and preserves the person inside from the dangers of space as well as slows the aging process.

*Suspended animation* lasts as long as the duration of the spell or until the container is opened, whichever comes first. If near a planet or moon with an environment conducive to the life form inside, the escape pod lands, opens and the passenger(s) awakens.

**Note:** A single container/Magic Escape Pod may be small or large. If large, it can contain many more people than one, but the spell must be cast separately on each person contained within it for them to be in a state of suspended animation. May be combined with other magic space spells such as Homing Beacon, flight spells, etc.

## Level Nine

### Cosmic Armor

**Range:** Self, or one other by touch.

**Duration:** 10 minutes per level of the spell caster.

**Saving Throw:** Standard for unwilling recipients.

**P.P.E.:** Forty-Five

Cosmic Armor is as close as one comes to a *magic, armored combat spacesuit*. It appears as a form fitting suit of EBA body armor that covers the wearer from head to toe in what looks to be a silver or chrome colored, metallic material with a faint blue tint to it. The head is covered in an ornate, chrome helmet with a tinted, polarized visor, and the entire armor resembles something akin to a Cosmo-Knight.

Cosmic Armor is an enhanced version of Armor of Ithan that also provides complete protection from all the negative effects of outer space (cold, radiation, lack of air, etc.) as well as provides basic flight capabilities.

#### Features of Cosmic Armor:

- The character can breathe for as long as the spell is in place.
- Enjoys a constant comfortable internal temperature and is protected from cold, radiation and extreme blasts of heat.
- Cosmic Armor can hover, and flies at a speed of Mach One.
- Armor has 50 M.D.C. per level of experience!
- Magic and M.D. cold and heat/fire/plasma attacks do half damage to the Cosmic Armor.

- Spells may be cast and psionic powers used while wearing Cosmic Armor, and additional magic may be combined with it, such as other methods of flight, communications, etc.

**Limitations:** Reduce flying speed by *half* in an atmosphere. The armored protection also restricts movement a bit, and inflicts a penalty of -5% to all Physical skills such as Acrobatics, Climbing, and similar, and -10% to Palming, Pick Pocket, Prowl, Safe-Cracking, Seduction and most Medical and highly technical skills that require a delicate touch.

### Magic Decoy Vessel

**Range:** Can be cast up to 500 feet (152 m) away per level of experience; line of sight required.

**Duration:** Three minutes per level of experience.

**Saving Throw:** Standard vs illusion.

**P.P.E.:** Forty

An illusionary spell that creates the image of a small spacecraft, such as an escape capsule, space fighter or shuttlecraft. The illusion is always wrapped around a piece of wreckage or space debris and not only fools the natural eye, but registers on radar/ladar and fools most sensors into believing it is really there. It does not register life signs, but that in itself is not unusual as the crew could be dead and the ship a derelict, abandoned, or piloted by robots or an A.I. system. The illusionary vessel just sits in one place and doesn't move, and makes a wonderful decoy. Pirates, Spacers and most other space travelers are unlikely to be able to resist investigating further. Likewise, the illusionary vessel may appear to be a potential attacker, scout or guard ship, and if there is a person with portable equipment like a radio hiding among the debris within the illusion, that individual will register and so will any active equipment he might have on him.

### Micrometeorites

**Range:** 1,000 feet (305 m) per level of experience to a 10 foot (3 m) radius per level. The exact area of effect can be controlled by the mage to be narrow or large.

**Duration:** One melee round (15 seconds).

**Damage:** 2D6x10 M.D., +5 M.D. per to level of experience to everything/everyone in the area of effect. Against large targets like sub-capital spaceships, the damage is to the main body or a particular section or specific target (gun turret, sensor array, engines, etc.) on the vessel.

**Saving Throw:** Not applicable except as a dodge. Sub-capital ships and larger are -5 to dodge, smaller vessels are -3 to dodge and characters in space are -1 to dodge.

**P.P.E.:** Fifty-Five

The spell summons from the depths of space meteorites the size of marbles and propels them at targets with the strength of rail gun rounds. What makes this spell so effective is that the meteorites pepper a 10 foot (3 m) area per level of the spell caster and the barrage lasts one full melee round (15 seconds). Characters in space who see the attack coming are likely to break off their own attack or operation, flee for cover, and stay there the full melee. To stay in or enter the area of effect means to take full damage even if it is for a moment. The spell last for one full melee and the mage is able to hurl the meteorites at a

specific target. This spell can only be cast in the vacuum of space, never in an atmosphere.

## Nova Blast

**Range:** 1,000 feet (305 m) +300 feet (91.5 m) per level of the spell caster in space. In an atmosphere, range is 500 feet (152 m) +100 feet (30.5 m) per level of experience.

**Duration:** One melee round per level of the caster.

**Damage:** In space: 1D4x100 M.D. In an atmosphere: 1D4x10 M.D.

**Saving Throw:** Not applicable, other than a dodge, people are -2 to dodge, fighters and shuttles are -3 to dodge, larger ships are -4 to dodge.

**P.P.E.:** Thirty

The spell caster is able to hurl bolts of super-hot plasma summoned from the heart of a star. The mage actually appears to be throwing the plasma (use normal strike bonuses to throw) and when it leaves his hand it hurls through the air like a fiery rocket and it expands as it goes. Range and damage are reduced when cast in an atmosphere on a planet, but full range and damage do apply when in space, which does include being in a space station or spacecraft.

## Star Light

**Range:** Self or spacecraft by touch. The Star Light covers a 200 foot (61 m) diameter per level of experience.

**Duration:** Two minutes per level of the spell caster.

**Saving Throw:** Standard for unwilling recipients.

**P.P.E.:** Forty-Five

The mage or his spacecraft glows with the intensity of a miniature sun. So bright is the light that he cannot be seen within it, nor can anyone or anything else within the radius of effect be seen. Furthermore, radar and other sensors are only able to read the sphere of Star Light as a single object, thus everyone or every spacecraft bathed in the Star Light is unseen and undetectable. However, the mage and anyone inside the area of Star Light can see just fine and their sensor equipment is completely operational. Ideal to cover an escape (teleport, warp, etc.) or conceal the appearance of incoming fighters or small spacecraft, to conceal one's true number of small spacecraft, and temporarily blind an opponent.

**Note:** Vampires, most undead and any other being vulnerable to sunlight, and exposed directly to Star Light takes 2D6x10 damage (S.D.C. or M.D. depending on the nature of the undead being). Vampires and the like inside a spacecraft are protected, but they will not want to attack or go near the light, and are likely to desire to flee the area altogether as the radius of Star Light has a *Horror Factor of 19* for their kind.

## Level Ten

### Anti-Gravity Zone

**Range:** Can be cast up to 500 feet (152 m) away; line of sight.

**Area of Effect:** Temporarily negates gravity within a 20 foot (6.1 m) radius per level of the spell caster.

**Duration:** One minute per level of the spell caster.

**Saving Throw:** Not applicable. Zero Gravity skills minimize the penalties of this spell, so does Anti-Gravity Flight and Space Swim.

**P.P.E.:** One Hundred and Ten

This spell negates gravity within a limited zone of influence. Victims caught in the anti-gravity zone are helpless, floating, bobbing, and slowly spinning without control. Shooting any firearm or using any power that has a "kick" causes the character to fly in the opposite direction and across "the zone." Upon reaching the end of the Anti-Gravity Zone, the victim bounces and floats back the other way as if he hit an invisible line or wall (no damage). Victims within the zone of Anti-Gravity are stuck inside of it unless they are physically pulled outside of it (and fall to the ground), or until the spell duration ends. **Penalties:** All those inside the zone see speed reduced to 10%, attacks per melee reduced by half, they have no control of their movement, and are -8 on initiative, -6 on Perception Rolls, -20 on skill performance, and -5 to strike, parry, dodge, disarm and entangle. **Note:** Only characters with Zero Gravity training/skills do not suffer these penalties because they are trained to operate in zero gravity and behave accordingly. Instead, they function as their Zero Gravity skill(s) allow, but even they lose initiative and one attack upon entering or being hit by the Anti-Gravity Zone. This spell works only where gravity is present, typically on a planet, moon, or inside a spaceship or space station.

## Block or Seal Against Teleportation & Mystic Portal

**Range:** Can cast the spell up to 50 feet (15.2 m) away per level of experience, and affects a 30x30 foot (9.1 x 9.1 m) area per level of the spell caster.

**Duration:** Three minutes per level of the spell caster.

**Saving Throw:** Not applicable.

**P.P.E.:** One Hundred and Twenty

The spell prevents magic wielding invaders from Teleporting into the area of enchantment. Anyone trying to Teleport into the protected area expends half the usual P.P.E., vanishes and reappears a second later exactly where he was standing a moment before. When this happens, the mage knows he has been blocked by this spell.

Similarly, this spell can be cast along the walls of a spacecraft to prevent the use of Mystic Portal to breach and enter the ship. However, when this is done, the magic applies only to the walls to stop Mystic Portal and does not prevent Teleportation. When a Mystic Portal spell is cast against the protected surface, half the P.P.E. to cast the spell is used up and nothing happens.

## Create Vacuum

**Range:** Can be cast up to 130 feet (39.6 m) away; line of sight.

**Area of Effect:** Covers a 6 foot (1.8 m) radius per level of the spell caster.

**Duration:** 2 melee rounds per level of the caster.

**Damage:** The first melee round: 2D6 points direct to Hit Points to mortal beings per melee round, and 4D6 M.D. to

Mega-Damage creatures that breathe. Subsequent melee rounds: Double the damage each following melee round.

**Saving Throw:** See below.

**P.P.E.:** Seventy

This spell creates a vortex around an area that becomes instantly devoid of atmosphere. Anyone not wearing sealed body armor, a spacesuit or imbued with magical protection from space/vacuum has all the air sucked out of their lungs and they begin to suffocate. It is very debilitating and shocking to the body, especially the loss of atmosphere, and the blood slowly begins to boil and gas in the blood causes the veins to swell and, eventually, burst.

**Roll to save vs exposure to decompression and vacuum:** 16 to save.

*A successful save* means the character suffers half damage, but can feel his body tightening and responding badly. He is disoriented, can't tell up from down, can't tell direction, loses sense of time, Spd is reduced by half, skill performance is -50%, has no initiative, -6 on Perception Rolls, and attacks per melee and all combat bonuses are reduced by half!

*A failed roll to save* means the victim takes full damage, cannot tell up from down, cannot tell direction, loses all sense of time, Spd is reduced to a crawl (10% of normal), skill performance is reduced to zero, has no initiative, no Perception Roll, no combat bonuses, and one attack/action per melee round.

Unless characters caught in the vacuum can get out of the area of effect (perhaps pulled, pushed or teleported out by another character if he can't do it on his own), the character will die a painful death in a matter of a minute or two.

## Sub-Light Space Flight

**Range:** Self or one other character by touch, or spacecraft by touch.

**Duration:** One hour per level of experience.

**Saving Throw:** Standard for unwilling victims.

**P.P.E.:** Sixty

This spell gives the spell caster or his spacecraft the ability to travel at Mach 16 or greater regardless if he or the actual ship is normally capable. Speed is Mach 16 + Mach One per level of experience.

## Ley Line Speed Doubler

**Range:** Depends on the length of the ley line.

**Duration:** Instant.

**Saving Throw:** Not applicable.

**P.P.E.:** Seventy-Five

The spell doubles the vessel's usual rate of speed for one hour per level of the spell caster when flying along a space ley line. Whatever the mode being used (Mach speed, sub-light, FTL/light-years, etc.), the speed is doubled when riding along a space ley line.

## Negate Mystic Portal

**Range:** Area effect that covers a 20 foot (6.1 m) radius per level of the spell caster.

**Duration:** Instant.

**Saving Throw:** Not applicable.

**P.P.E.:** Sixty-Six

A magic spell that instantly negates and closes any and all Mystic Portals within its area of effect. Affects only Mystic Portals, which are often used to board ships without doing any permanent damage to the vessel's hull.

# Level Eleven

## Gravity Field

**Range:** The spell can be cast up to 10 feet (3 m) away per level of the caster. The area of effect is as follows: for 1 G it is a 50 foot (15.2 m) radius per level of the caster, or as an offensive spell for more than one gravity level the area of effect is reduced to a 5 foot (1.5 m) radius per level of the spell caster.

**Duration:** Special, see below.

**Saving Throw:** Dodge!

**P.P.E.:** One Hundred and Eighty

This spell can be very useful if a ship's gravity generator is offline. The first option the mage has is to create one standard gravity (1 G) to a 50 foot (15.2 m) radius per level for one hour per level of his experience.

The second option for this spell is an offensive attack. The mage can affect a five foot (1.5 m) radius per level of experience, and create up to 2 Gs per level. This only lasts for fifteen seconds per level of the spell caster and affects everyone in the radius of effect, even the mage! The only way out is to dodge with a natural 16 or a modified 20 or greater, or, perhaps, to crawl out. **Note:** The listed effects are for S.D.C. creatures that live in roughly one gravity. Supernatural creatures don't feel the effects until 6 Gs. This spell also affects cyborgs and those in power armor, and robots, all of whom start to feel the effects at 4 Gs.

**The effects of being caught in a heavy gravity field are as follows:**

**At 2 Gs** the character's Spd, combat bonuses and attacks per melee round are reduced by one third; skill performance is -10%.

**At 3 Gs** the character's Spd, combat bonuses and attacks per melee round are reduced by half; skill performance is -25%.

**At 4 Gs** the character cannot remain standing on his feet, must get on all fours and crawl slowly; Spd, combat bonuses and attacks per melee round are reduced by 75%; skill performance is -50%.

**At 6 Gs** the character is pinned to the ground and can barely manage to pull himself along inch by inch. Spd is reduced to only 5%, the character has only one attack/action per melee round, has no combat bonuses whatsoever, and furthermore, is -5 on all base rolls. Skill performance is likewise, barely possible at -90%, takes three times as long to do and is a Herculean effort. **Note:** Mega-Damage beings suffer the effects of 2 Gs.

**At 8 Gs** the character is pinned to the ground and cannot move. The body feels tremendous pressure, as if a great weight were crushing him, and takes 1D6 S.D.C. damage per melee round. The individual remains conscious for the number of min-

utes equal to his P.E. attribute. **Note:** Mega-Damage beings suffer the effects of 3 Gs.

**At 10 Gs** the damage is 4D6 S.D.C./Hit Points per melee round (1D6 M.D. to Mega-Damage beings) and the character remains conscious for a number of melee rounds equal to his P.E. attribute number. **Note:** Mega-Damage beings suffer the effects of 4 Gs.

**At 12 Gs** and beyond, all mortal/S.D.C./Hit Point creatures suffer 1D6x10 S.D.C./Hit Points per melee round (2D6 M.D. to Mega-Damage beings) and the character remains conscious for a number of seconds equal to his P.E. attribute number. **Note:** Mega-Damage beings suffer the effects of 6 Gs.

## Cosmic Force Field

**Range:** Self or others up to 1000 feet (305 m) away. Range is doubled at a space ley line and tripled at a ley line nexus point.

**Area of Effect:** The Cosmic Force Field places a dome-like bubble over a 50 foot (15.2 m) diameter plus 15 feet (4.6 m) per level of experience. In the alternative it can be cast as a "wall" along a line that is 10 feet tall (3 m) and 50 feet (15.2 m) long (+15 feet/4.6 m per level of experience).

**Duration:** Three minutes per level of the caster.

**Saving Throw:** None.

**P.P.E.:** Two Hundred

A spell that creates a strong magic force field that can be used to cover a large area to protect people and property. It can be used on the surface of planets and moons, in and on spacecrafts as well as to encapsulate people, cargo, or small spacecraft such as fighters as a protective containment bubble. While the force field protects from physical damage, it does nothing to protect people from the hazards of space (does not hold or create air, and cold, radiation, etc. goes right through it). The spell caster can scale the force field to be as small or large as required within the mage's limitations.

**M.D.C. of Force Field:** 250 M.D.C. per level of experience (325 S.D.C. per level and an A.R. of 19 in S.D.C. worlds). The protection is doubled on a ley line and tripled at a nexus. Vulnerable to all attacks including physical, magic, and psionics, all do full damage.

**Limitation:** The Cosmic Force Field is immobile and stays in one place, vanishing only when the duration ends, the field is destroyed or the mage cancels the magic.

**Note:** This spell is commonly built into a TW dome mounted on the tops of most UWW spacecraft where most of the Space Warlocks can cast their spells with a degree of protection.

## Triangulated Teleportation

**Range:** The spell may include the spell caster only, or two others by touch, or the spell caster and two others by touch. Teleportation range is 100,000 miles (160,000 km) per level of the spell caster. Or for double the P.P.E., one light-year per level of the spell caster!

**Duration:** Instant.

**Saving Throw:** Not applicable.

**P.P.E.:** One Hundred and Sixty

The spell requires a homing signal to triangulate upon to make a perfect Teleportation. The destination of the Teleport spell is the exact location of the beacon. The beacon or signal can be magical in nature or technological. In either case, the spell locks in on its coordinates and sends those being teleported to that exact location. The spell does not work without a steady signal to home in upon. If the signal is weak or intermittent, the spell could deposit those being teleported in the middle of nowhere, anywhere between the starting point and the destination, and in space that's a huge area.

If the destination is magically "blocked" for Teleportation, the travelers are "bounced" back to their starting point, the P.P.E. is expended and the Teleportation travelers are dazed, -8 on Perception Rolls and all combat actions (strike, parry, etc.), -30% on skill performance and reduce Spd by 30% for 1D6+2 melee rounds.

## Level Twelve



## Meteor Swarm in Space

**Range:** Up to 1200 feet (366 m) away per level of the spell caster.

**Area of Effect:** A swarm of slow moving meteors fills a 1000 foot (305 m) diameter of space per level of the spell caster.

**Duration:** Two melee rounds per level of experience.

**Damage:** 2D4x10 M.D. per level of the spell caster per melee round to shuttle size and smaller spacecraft or space stations,

*double damage* to sub-capital and larger spaceships, multiply damage by 10x if the vessel *tries to navigate through* the Meteor Swarm rather than try to go around it or stay still and let it pass.

**Saving Throw:** Not applicable. Sub-capital and smaller spacecraft are -4 to dodge and -25% to applicable piloting skill rolls. Larger vessels suffer double the penalties, while individual characters and spacecraft smaller than 30 feet (9.1 m) suffer half the penalties (round down).

**P.P.E.:** Two Hundred and Ninety

The spell creates a swarm of medium-sized meteors (e.g. the size of a sedan to that of a house) that suddenly appear out of nowhere. They are moving, as a group, at a relatively slow 1D4 Mach speed, but represent a genuine danger and an obstacle, especially to large spacecraft. The Meteor Swarm always appears just ahead or behind the target, giving the potential victim two melee actions to take evasive action and get out of the way before the swarm hits (roll to dodge), provided the spacecraft has the time, speed and mobility to get out of harm's way. This spell may also be used as a means to momentarily block, barricade or defend an area of space with a Meteor Swarm.

**Note:** This spell cannot be cast while traveling at light speed, FTL speed, hyperspace or while Rifting/using a Rift Drive or wormhole. Nor can it be cast against a planetside target as it only works in outer space.

## Space Dust

**Range:** Up to 500 miles (800 km) away, and has an area effect of a 100 mile (160 km) radius.

**Duration:** One hour per level of the spell caster.

**Saving Throw:** Not applicable.

**P.P.E.:** Three Hundred

Space Dust renders all sensors, scanners and tracking systems of those inside the dust cloud inoperable. Likewise, sensors and scanners of those outside the dust cloud are unable to penetrate the Space Dust cloud. Thus, a spaceship on the run becomes invisible to sensors and space probes while it is within the dust cloud, giving a fugitive a place to hide and/or a chance to make good an escape. Likewise, Space Dust can be used to hamper rescue and salvage operations when cast over the search area, or can impair the abilities of an incoming fleet, set up an ambush, and so on. Note that Space Dust affects EVERYONE who enters the dust cloud, including the spell caster, and those outside the dust cloud cannot see, track or scan what is contained inside of it.

## Summon Ion Storm

**Range:** Can be cast up to 1 mile (1.6 m) away per level of experience.

**Duration:** Varies per the intensity of the storm summoned.

**Saving Throw:** None per se, vehicles can attempt to move out of the storm's way.

**P.P.E.:** Three Hundred

The spell conjures a magnitude one ion storm. The magic energies cause the loose ions to converge on each other causing an ion storm. The intensity of the storm can be increased once the mage reaches third level of experience. At third level the mage can create a magnitude two ion storm. Every two levels after

that the intensity can be increased to the next magnitude level. A fifth level mage can create a magnitude 3, at seventh level a magnitude 4, and so on.

The mage can also choose to control the storm's direction or let it run its course. If the storm is left to run its course it will go in a direction opposite the mage and travels at Mach 10 for the duration of the spell. Should the spell caster choose to control the storm, it will require his full concentration with no other actions or spell casting possible for the duration of the spell. If the mage lets go of his control to cast another spell or take some other action, the storm runs its course as above.

**Damage, Duration** and other aspects of the storm are as per its level of intensity. See the description of Ion Storms in **Rifts® Dimension Book Six: Three Galaxies™**, pages 16-17, for details, duration and damage caused by Ion Storms (as well as other stellar phenomena).

**Limitation:** In order to cast this spell the mage must be in direct contact with the vacuum of space.

## Summon Meteor Shower

**Range:** 3 miles (4.8 km).

**Area of Effect:** Hits one large target (sub-capital ship or larger) or everything in a 100 foot (30.5 m) radius.

**Duration:** One minute per level of experience.

**Saving Throw:** Not applicable, except as a dodge. -3 to dodge for sub-capital ships, -5 to dodge for capital ships, and space stations and moon bases cannot dodge.

**P.P.E.:** Three Hundred, plus fifty for every increased level of intensity (e.g. 300 for a Type One shower, 350 for a Type Two, 400 for a Type Three, 450 for a Type Four and 500 for a Type Five Meteor Shower).

This spell summons a meteor shower of varying intensity.

**Damage, Duration** and other aspects of the storm are as per its level of intensity. See the description of Meteor Showers in **Rifts® Dimension Book Six: Three Galaxies™**, pages 21-23, for details and damage caused by Meteor Showers (as well as other stellar phenomena). Duration is as per the spell caster, though he can end the spell anytime he desires.

**Limitation:** In order to cast this spell the mage must be in direct contact with the vacuum of space. Cannot be summoned to strike a planet or moon with an atmosphere.

## Superluminal Speed (FTL)

**Range:** Self or one other by touch.

**Duration:** Two hours per level of the caster.

**Saving Throw:** Standard for unwilling victims.

**P.P.E.:** Two Hundred and Fifty

This powerful enchantment enables the spell caster or another character, or a small spacecraft (no larger than a shuttle), to travel faster than the speed of light. The recipient of the magic is transformed into pure energy and able to travel at a speed of two light-years per hour, per level of the spell caster. This spell can only be cast in the vacuum of space. The only drawback to this spell is the size limitation and that the spell caster has no means of true navigation unless used in conjunction with the Stellar Navigation Spell while traveling FTL in en-

ergy form. The spell is typically reserved for in-system travel. It takes only one melee round (15 seconds) to attain top speed, but one minute to slow down to a dead stop.

## Level Thirteen

### Asteroid Strike

**Range:** 600 feet (183 m) per level of the spell caster.

**Damage:** 1D6x1000 M.D.

**Duration:** Instant (about 4 seconds).

**Saving Throw:** Not applicable, except as a dodge with a +1 to dodge for shuttles and smaller vessels, -3 for sub-capital spaceships and -5 to dodge for capital vessels. -10 to dodge for space stations, super-capital ships and dreadnoughts.

**P.P.E.:** Five Hundred and Fifty

A directed attack that is leveled against one, specific, large target such as a sub-capital or larger spacecraft. The attack can only be performed in *outer space*, NOT in an atmosphere nor against the surface of a planet.

### Solar Flare

**Range:** Up to 1,200 miles (1920 km) away, and has an area effect of a 300 mile (480 km) radius.

**Duration:** 1D6 hours +30 minutes per level of the spell caster.

**Saving Throw:** Not applicable.

**P.P.E.:** Five Hundred

The magic causes a solar flare to erupt, sending cosmic rays, fire and radiation into space. The flare affects a specific area of space and plays havoc with communications, radar, sensors and navigation equipment. The following effects and penalties apply:

- Reduce all communications and sensor range by 2D4x10%.
- Any video/camera/surveillance systems are knocked out for the duration of the solar flare.
- Targeting computers and radar systems randomly blink on and off. Roll percentile dice every time either is used: 01-50% means the system is on and working fine. 51-00% means the system is off, unavailable, and any bonuses it provided are momentarily gone.
- Navigation systems are off target by 1D4x10%.
- All sensor data is scrambled, contradictory and unreliable; -40% skill penalty to read.
- All computer programs and operations are sluggish and take twice as long as usual.
- Weapon systems are sluggish, reduce the number of attacks per melee by one.

## Level Fourteen

### Create Nebula

**Range:** Two miles (3.2 km) away per level of experience.

**Duration:** One hour per level of experience.

**Saving Throw:** Not applicable.

**P.P.E.:** One Thousand

This spell conjures forth all the loose matter in a given area, multiplies it and turns it into a nebula five miles (8 km) in diameter (spherical area of effect) per level of the spell caster's experience. Being caught inside it cause the following problems:

- Visibility is poor, one mile (1.6 km), as if flying through a light fog.
- Defensive shields fail! Force field systems are inoperable while inside the nebula, and though magic force fields remain functional, they are at half their usual M.D.C.
- Ship sensors and targeting computers are inoperable while inside the nebula. No combat bonuses. Flying and fighting via line of sight and human reaction.
- Navigation and communications are reduced by 33% their usual range and operators are -30% on their skill rolls, and -60% to Sensory Equipment skill due to interference and unreliable data readings, glitches and momentary freezing of images and data.
- Turbulence inflicts a -20% to piloting and navigation skills.
- Mega-Damage from bursts of heat and/or caustic gas inside the nebula inflict 1D4x10 M.D. every minute to all spacecraft trapped inside the nebula (damage is usually to the main body of the vessel).
- Going into FTL or warp drive while inside a nebula sends the vessel 2D4x10 light-years off course.

**Note:** Robots and A.I.s suffer all the above penalties as well.

**Limitation:** In order to cast this spell the mage must be in direct contact with the vacuum of space. Cannot be summoned to strike a planet or moon with an atmosphere.

### Create Wormhole

**Range:** Can be cast one mile (1.6 km) away per level of experience.

**Duration:** One melee per level of experience.

**Saving Throw:** Not applicable.

**P.P.E.:** Nine Hundred

This spell opens a micro-wormhole to be used as a means of escape. However, as it is a desperate form of transportation, the spell caster cannot designate where the wormhole spits him or the vessel out. It can send its passengers in any direction from the starting point and 1D6 light-years away per level of the spell caster's experience. Can be used on any size ship.

**Limitation:** In order to cast this spell the mage must be in direct contact with the vacuum of space or inside a spacecraft in space, but in the latter case, the entire vessel is wormhole shifted, not just the mage. Cannot be used against a planet or moon.

### Phoenix Light

**Range:** Touch only.

**Duration:** Two hours per level of the spell caster.

**Saving Throw:** Not applicable.

**P.P.E.:** One Thousand

This spell is used as an alternative to the Rift Drive. When activated, this powerful spell envelops the spell caster's ship

(any size short of a space station) with magic fire that slowly takes the shape of a giant bird-like creature. The ship can travel at a speed of two light-years per level of the spell caster, per hour. This spell requires the full concentration of the spell caster for the entire duration to maintain it. An added benefit is the spell caster is granted temporary Stellar Navigation at 88%. The spell caster does not need to be directly exposed to a vacuum to cast this spell, but it only works in spacecraft designed for interstellar travel.

## Summon Comet

**Range:** Five miles (8 km) per level of the spell caster and the size of the comet is one mile (1.6 km).

**Duration:** Two minutes per level of experience.

**Saving Throw:** Dodge! Sub-capital ships are -3 to dodge and larger vessels are -6 to dodge.

**P.P.E.:** Two Thousand

The spell summons a comet to be used as a large projectile that the mage can control! The comet can be directed at any large object (sub-capital ship or larger) in space and is +5 to strike targets within five miles (8 km) of the spell caster. Beyond the five miles (8 km) the comet is +2 to strike.

**Damage:** 2D4x1000 M.D. +200 M.D. per level of experience with a direct hit, but *every* spacecraft to which the comet comes within a half mile (0.8 km) suffers 1D6x100 M.D. from its vapor cloud and space particles. Note that any ships smaller than sub-capital that get in the direct path of the comet take 2D6x100 M.D. and are pushed out of its path as the comet continues toward a larger target. The comet does not stop until it strikes something the size of a sub-capital spaceship or larger.

Other damage: If the comet collides with a ship, crew members not strapped down will be tossed around, taking 6D6 S.D.C. for each comet strike. Even those strapped into a chair will take 1D6 S.D.C. If the crew is prepared for the impact, and have at least one melee's warning, they only take 3D6 S.D.C. and if they can roll a 15 or higher with impact/fall they can further reduce the damage by half.

The advantage of this spell is its range, size and collateral damage the comet inflicts on its path to its intended target. Due to the size of the comet, smaller ships are swept aside like leaves in the wind and the comet continues on its course for the duration of the spell, damaging everything in its path until it strikes something big. **Note:** This spell does not work in an atmosphere and cannot be sent against a planet or moon with an atmosphere.

## Nexus Space Warp

**Range:** Varies.

**Duration:** Instant.

**Saving Throw:** Not applicable.

**P.P.E.:** Seven Hundred and Fifty-Five

The spell enables the space vessel to pop from one space nexus point to the next nearest space nexus in 1D6 minutes. Given enough P.P.E., the ship can hop light-years away, from one nexus point to the next, nearest nexus in a matter of 1D6 minutes. It is also a great way to escape an enemy, fast.

# Level Fifteen

## Create Gravity Well

**Range:** Can be cast up to 400 miles (640 km) away, and affects everything within a 100 mile (160 km) radius.

**Duration:** Five minutes per level of the spell caster's experience.

**Saving Throw:** Not applicable.

**P.P.E.:** One Thousand One Hundred

This powerful spell is used to trap and contain enemy spacecraft by creating a super-heavy, artificial gravity well. The gravity well pulls any vessel traveling at FTL speed within a 100 mile (160 km) radius of the gravity well *out of warp* and prevents it and all other vessels in the area of effect from being able to engage FTL systems. Furthermore, the influence of the gravity well reduces the speed of all other space travelers by half! With this field, the mage can "lock down" a fleet of sub-capital and capital ships in preparation for a strike from his own fleet, stall an attacking fleet, or set up an ambush.

## Metamorphosis: Creature of Light

**Range:** Self or one other by touch.

**Duration:** One hour per level of the spell caster when just flying, three minutes per level when engaging in combat or other interaction with the physical world.

**Saving Throw:** Standard

**P.P.E.:** Two Thousand Five Hundred

This powerful spell transforms the spell caster into pure light energy. This makes the mage an M.D.C. creature with P.E. times 10 in M.D.C. (Mega-Damage creatures add 500 M.D.C.) and he can fly in space at a speed of 2 light-years per hour per level of the spell caster. Sub-light Speed is Mach One for each Spd attribute, so a character with a Spd of 9 can fly at Mach 9, a character with a Spd of 24 can fly Mach 24. As a Creature of Light, the mage is impervious to energy attacks of all kinds, including radiation, heat, fire, lasers, plasma, particle beams and others. However, explosives, magic, and psionics do full damage. Also, the mage gains the ability to fire lasers that inflict 1D6 to 6D6 M.D. per blast (the exact amount of damage is up to the character, he is +2 to strike with the blast, and range is 1,000 feet/305 m +300 feet/91.5 m per additional level of experience). Strength and Physical Endurance become Supernatural, +1 attack per melee, +2 on initiative, +1 to strike, +5 to auto-dodge (the act of dodging does not use up a melee attack) and can see all spectrums of light for the duration of the spell.

# New Temporal Magic

## Double Paradox

**Range:** Self or one other by touch.

**Duration:** Two melee rounds per level of experience.

**P.P.E.:** Ninety-Five

**Level:** Considered a 10th level spell.

**Saving Throw:** Standard for those choosing to resist. Also note that the time-stream automatically resists this spell and gets a saving

throw at +1, so each time it is cast, there is a chance of it not working. If the flow of time (the G.M.) makes a successful saving throw, the spell does not work.

**Note:** This is one of the new spells uncovered in the ruins of Ghenhey.

For a few brief moments the spell caster exists in two places at once! The stats, clothing/appearance and equipment are identical for each, as of the moment the spell was cast. However, Hit Points and S.D.C. (M.D.C. for Mega-Damage beings), P.P.E., and I.S.P. are divided in half. While co-existing at the same time in two different places, the character remains linked to his other self, has a clear idea of what he is doing in both places and suffers identical injury. Thus, if wine is spilled on his shirt at one location, it appears on his shirt at the other. Likewise, if the character is wounded at one location, a duplicate wound appears on him at the other, and both selves feel the pain and suffer the same damage, effects, penalties and stat modifications.

The spell caster has all the advantages of being in two places at once, and the character can fight two foes simultaneously, do various tasks at the same time, and even cast spells at the same time. However, both are using up the same P.P.E. (or I.S.P.) reserve, and falling under attack and suffering damage at *both locations* could kill him fast. The spell can be ended at will, causing one of his selves to vanish at one location and appear, for an instant, and merge with the other. This is disorienting, and the sudden spatial shift and merging leaves the character dazed for 1D4 melee rounds in which attacks per melee, all combat bonuses, Spd and skill proficiencies are reduced by half.

## Resistance to Time Warps/Stop Time

**Range:** Self or another by touch.

**Area of Effect:** 5 foot (1.5 m) diameter +2 feet (0.6 m) per additional level of the mage.

**Duration:** One minute per level of the spell caster.

**Saving Throw:** Not applicable.

**P.P.E.:** One Hundred and Twenty

**Level:** Considered an 11th level spell.

**Note:** This is one of the new spells found in the ruins of Ghenhey.

If the spell caster fears he may be attacked with any time distortion spell, he can cast this preventative invocation on himself. Then, if such a spell is used against him by an enemy, the mage has a good chance of escaping its effects. If this spell is in place when a Time Stop spell is cast, the character is impervious to it and is NOT stopped in time. However, he will realize what magic is being sent against him, and may *pretend* to be affected/stopped. Against all other Time Warp magic, including Temporal Blast, a character protected by this spell is +3 to save (in addition to any other save vs magic bonuses he might have), and even if he fails to save, the duration, damage and effects of the magical attack are *HALF*.

## See Temporal Anomaly

**Range:** Self.

**Duration:** Three minutes per level of the caster.

**Saving Throw:** Not applicable.

**P.P.E.:** Thirty

**Level:** Considered an 8th level spell.

This spell works well in conjunction with Sense Temporal Anomaly and makes the character able to *see the flow of time* as if he were traveling down a huge river. Temporal disturbances stick out like large rocks in a river. Where the water is disturbed by the rocks, so is the flow of time when temporal anomalies occur. They also cause ripples, which can be clearly seen with this spell.

The mage is also able to see *time holes* (the river flows around these), *tears in time* (where the flow of time may be diverted such as at a Temporal Nexus) and if someone cast a *Time Jump* spell. The character literally sees the time traveler going through time. He will appear to be way down the “river” (going with the flow) if going forward in time and up the “river” (going against the flow) if going back in time. The mage can even estimate how long of a Time Jump another spell caster made. Base skill is 32% +4% per additional level of experience. If successful, he is accurate within 1D4 minutes. If unsuccessful, he has no clue and will have to wait at least an hour to try the spell again. This is because time is constantly flowing and the mage will need a different reference point in time to tell.

## Sense Temporal Anomaly

**Range:** Self.

**Duration:** Three minutes per level of the spell caster.

**Saving Throw:** Not applicable.

**P.P.E.:** Thirty

**Level:** Considered an 8th level spell.

The spell caster can sense when the flow of time has been disturbed in a given area and can tell if someone did a Time Jump (backward or forward) or if any other Temporal Magic spell has been recently used and what it was. He can also sense any sort of dimensional Rift, teleportation, or time distortion and whether it is a natural occurring phenomenon or the result of magic. Temporal spells leave a very distinctive mark in the flow of time, and those that alter time create a “ripple” that lasts one hour for every 5 P.P.E. spent. So if a Temporal Warrior did a Fast Forward spell the ripple effect would last for fourteen hours (70 P.P.E.). This can give the spell caster a significant advantage when trying to determine when events took place and who might be responsible. The spell caster also gains the following abilities:

- Sense the opening and closing of Temporal Rifts. Note: These are very rare and an uncommon phenomenon. They only occur where the temporal/dimensional fabric is weakest, which is most likely at super nexus points or even magic triangles. Timing is also a key factor. Big events such as planetary alignments, winter and summer solstice, and lunar eclipses are the only known times they occur. Range is 50 miles (80 km).
- Sense the use of Time Warp spells within a one mile (1.6 km) radius.
- Sense Temporal Raiders within a 1,000 foot (305 m) radius. Only knows if they are close or far and the general direction is vague.
- Can tell if he has traveled through time unknowingly and a general idea of how far he has traveled.
- Can determine the duration of a Time Barrier roll: If successful the caster knows exactly, if unsuccessful the caster is unsure until the duration is elapsed. 35% +5% per additional level of experience.

## Sense Time

**Range:** Self or 2 by touch.

**Duration:** 5 minutes per level of experience.

**Saving Throw:** Standard.

**P.P.E.:** Twenty

**Level:** Considered a 7th level spell.

A very useful spell created by Temporal mages, it first was developed to negate the effects of a Time Deprivation spell (T-Dep), providing the afflicted person with another saving throw at +3. *The second effect* of the spell allows the the recipient of the enchantment to know the exact time, down to the second, without the need for an actual timepiece.



## Temporal Blast

**Range:** 100 feet (30.5 m) +50 feet (15.2 m) per level of experience.

**Damage:** 2D6 direct to Hit Points to mortals, 2D6 M.D. to Mega-Damage beings.

**Duration:** Duration of side effects and penalties is two minutes per level of experience.

**Saving Throw:** Standard.

**P.P.E.:** Twenty

**Level:** Considered a 7th level spell.

The spell caster fires a bolt of Temporal Energy directed at a specific limb of the intended target; typically an arm or leg. Roll to strike at +3 when the target is under 100 feet (30.5 m) away and +1 to strike when the subject is at a greater distance. The beam of Temporal Energy rapidly ages the limb to the maximum of that race's life expectancy, effectively rendering it weak and impaired; *reduce* P.S., P.P., and when applicable, Spd, by 90%. The arm and fingers become withered, wrinkled, stiff and achy, the fingernails grow long and curled, the hands become gnarled, while legs atrophy, stiffen and are barely able to support the weight of the body.

**If one arm is affected, the penalties are:** -1 on initiative, all other combat bonuses are -2, and the strength in that one arm and hand are vastly diminished, which may make using heavy weapons and tools, as well as the performance of certain skills, impossible or very difficult with that arm; at best the affected arm and hand suffer a -35% skill penalty.

**If both arms of a humanoid are affected, the penalties are:** -2 on initiative, all other combat bonuses are -3, and the strength in both arms and hands is vastly diminished, making it impossible to use any weapon or tool weighing more than seven pounds (3.1 kg), and the performance of most skills are very difficult, at best -70% skill penalty.

**If one leg is affected, the penalties are:** -1 attack per melee round, -1 on initiative, -3 to dodge, -2 to all other combat bonuses and Spd is *reduced by half*. The character can move, but his good, young leg handles most of the load and he walks with a noticeable limp, dragging the aged, weak leg behind him.

**If both legs of a humanoid are affected, the penalties are:** Reduce attacks per melee by half, -2 on initiative, -6 to dodge, and -3 to all combat bonuses, and Spd is *reduced by 90%*. The character can barely stand straight or hobble along at a crawl. It is best if the character can find some sort of support to brace himself with in order to stay standing.

**Random Hit Location (Optional):** 01-20% right arm, 21-50% right leg, 51-70% left arm, and 71-100% left leg.

**Note:** This spell does not fully affect creatures of magic or supernatural beings, however they are still subject to the damage. While the Temporal Blast may not age them, it is still a blast of Temporal Energy and it hurts.

## Time Warp: Causality Loop

**Range:** 100 feet (30 m) plus 20 feet (6.1 m) per level of experience to a 10 foot (3 m) area per level.

**Duration:** 15 minutes and repeats one time plus once per additional level of the spell caster. Repeats once at level one, twice at level two, three times at level three, etc.

**Saving Throw:** Special.

**P.P.E.:** Two Hundred and Fifty

**Level:** Considered a 12th level spell.

**Note:** This is one of the new spells uncovered in the ruins of Ghenhey.

The spell caster creates a Temporal *Causality Loop* which makes time repeat the last fifteen minutes once per level of the spell caster. This spell affects all people in the area of effect. Those who are caught in the loop repeat the last 15 minutes of their lives, completely unaware that events are repeating. They simply have an odd sense of *deja vu*. Should it repeat again, all characters get to make a saving throw, but at -3 to save. If it repeats again, they get to save but with a penalty of -2. The penalty goes down each time until the saving throw is standard.

**Example:** A 4th level Temporal Wizard casts the spell on a group of pursuers. At the point of the spell being cast, those in the affected area go back in time and repeat the last 15 minutes. Because the Wizard is 4th level, the group repeats the last 15 minutes FOUR times, giving the spell caster up to an hour head start. On the first loop, no one saves and time repeats until the point of the spell being cast, and 15 minutes has passed. The second loop, people start to realize something is wrong, but they are -3 to save. The third loop, they are -2 to save. By the fourth loop, they all realize they are caught in a time loop, but are -1 to save. If a saving throw was successful, that individual character pops out of the loop, but some or all of his companions may still be going back in time to relive the experience. And because they are actually going back in time and reliving the exact experience, even characters who make their saving throw are with them because they were with them when it all first happened. However, the character free from the loop can take action, but at least 15 minutes have passed, and his attacker may be long gone or up to no good, anywhere. When the spell ends and the characters are all free of the time loop, it is as if they just lost the time they were caught in the Causality Loop.

Any mage familiar with Temporal Magic will sense a temporal anomaly after the first Causality Loop, and immediately know what is happening. He can also try to take measures to cancel and stop the magic loop. *Negate Magic* can work, but suffers a penalty of -5, *Dispel Magic Barriers* is -8, *Anti-Magic Cloud* has a standard saving throw, and *Time Maelstrom* is +3 but the characters all suffer the effect of that spell.

## Time Warp: Stop Time

**Range:** Up to 10 feet (3 m) away per level of the spell caster.

**Area of Effect:** 5 foot (1.5 m) diameter +2 feet (0.6 m) per additional level of the mage.

**Duration:** One melee round (15 seconds) per level of the spell caster.

**Saving Throw:** Not applicable.

**P.P.E.:** Seventy

**Level:** Considered a 9th level spell.

This powerful Temporal Magic spell *freezes time* in the area affected. Everyone and everything caught in the area, stops as if time is standing still (and it is, in that area). At the end of the duration, all characters who were stopped in time have no idea what happened. For them, it is as if nothing happened and it is the very next second. The only way one might suspect is when they see that their watch is off by so many seconds or minutes. Anyone or anything that enters the area of effect, including the spell caster, is also stopped in time.

As a temporal distortion, no hostile action can be taken against anyone stopped in time, but while they are stopped, the spell caster (and company) may be able to take some quick action, snoop around, steal something *outside* the area of effect, make good their escape, and so on. Everything that happens around the characters while they are temporarily frozen in time is unseen and unknown to them, because it didn't happen in their time frame.

Teams of Temporal Warriors have been known to cast this spell at several strategic areas, stopping time around them, to provide a clear, quick path to a particular place, item or objective.



# RIFTS®

- Imagine Earth transformed into an alien landscape.
- Humans exist – barely. And we are not alone.
- Aliens and monsters emerge from the Rifts – holes torn in the fabric of space and time, connected to countless worlds and realities.
- Ancient gods, demons and magic have returned.
- Magic and technology clash.
- Hundreds of character classes, many inhuman.
- *Rifts® Ultimate Edition* is the core RPG rule book.
- Expansive world setting with 90+ sourcebooks to draw upon.
- Rifts®, your portal to endless adventure.
- Limited only by your imagination.

[www.palladiumbooks.com](http://www.palladiumbooks.com)

© 2014 Palladium Books. Rifts®, Megaverse®, Nightbane® and other titles, slogans and likenesses are trademarks of Palladium Books, Inc. Palladium Books - 39074 Webb Court, Westland, MI 48185 USA - 734-271-2903 order line.

## Other RPG Worlds from Palladium Books®:

- *Rifts®* – the ultimate role-playing experience.
- *Rifts® Chaos Earth®* – Play the apocalypse as it happens.
- *Splicers®* – Weird science. Bio-tech battles insane robot legions.
- *Robotech® RPG* – All eras of the TV show brought to life.
- *Dead Reign® RPG* – Can you survive the Zombie Apocalypse?
- *Palladium Fantasy RPG®* – Unique world, monsters as player characters, magic and more.
- *Heroes Unlimited™ RPG* – Play any hero; mutants, aliens, cyborgs, superhumans, mages, immortals and more.
- *Nightbane® RPG* – Conspiracy, magic, horror and monsters.
- *Beyond the Supernatural™ RPG* – Modern horror and suspense.
- *Ninjas and Superspies™*, and more.

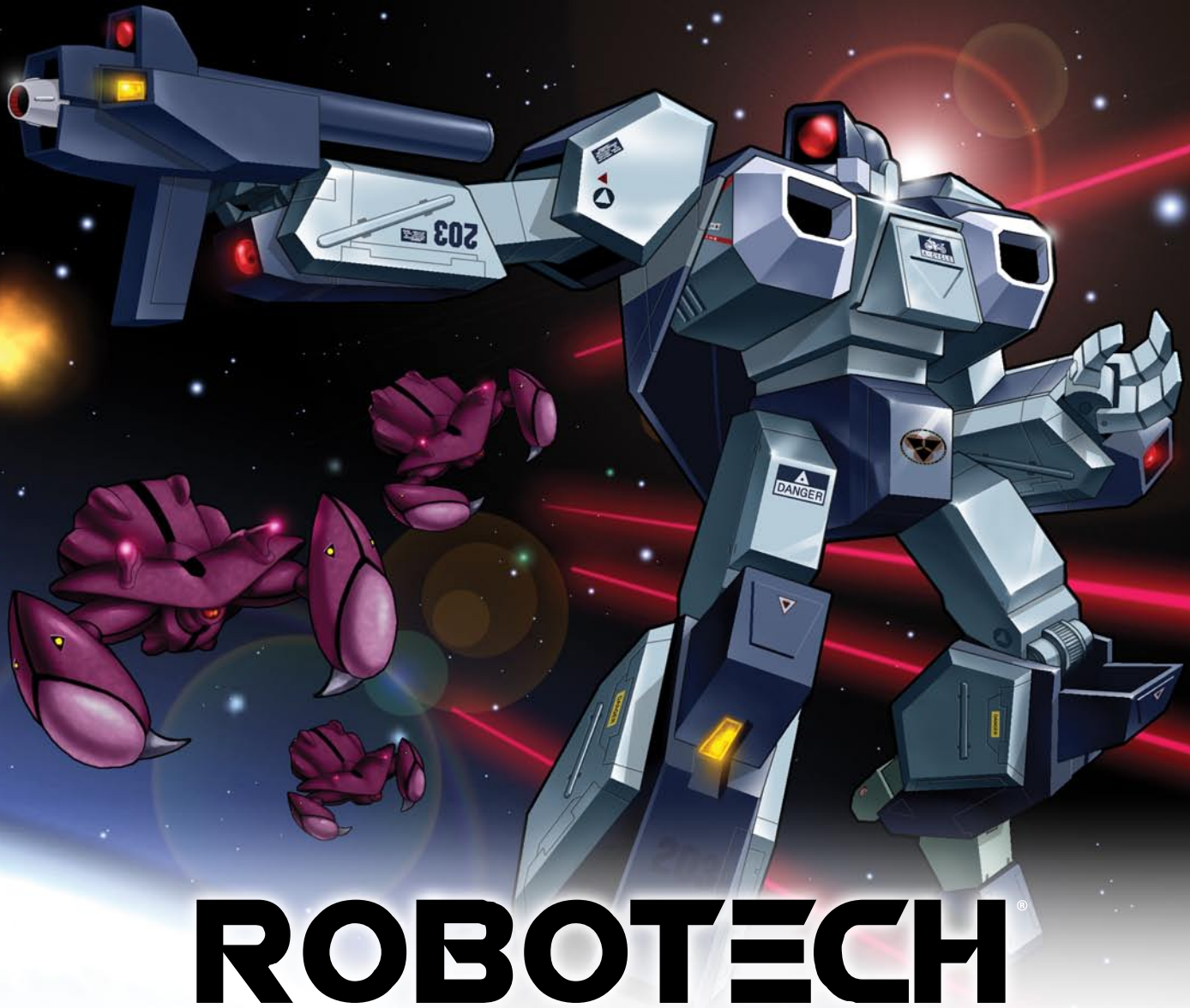

# ROBOTECH®

## Role-Playing Game and Sourcebooks

- **Four generations of heroes and mecha** • **Giant transformable robots** • **Alien invaders** • **Battle for control of the Earth** • **Combat takes to the stars** • **All presented in a core rule book and dynamic set of epic sourcebooks** • **Easy to learn** • **Fun to play** • **Quick character generation** • **Fast combat** • **Captures the action and adventure of the anime TV series** • **Isn't it time you joined the adventure?**

### Robotech® "Core Rules" – Shadow Chronicles® RPG Hardcover

All the rules and information a player needs to start a Robotech® role-playing campaign with Admiral Rick Hunter and the United Earth Expeditionary Force trekking across the galaxy.

- Human mecha: Alphas, Betas, Cyclones & much more.
- Five character classes. 25 different Military Specialties.
- Invid mecha, Haydonites, and alien enemies.
- Quick roll character tables. Make a character in 15 minutes.
- A complete, stand-alone RPG.
- 224 pages. Cat. No. 550HC. 8½ x 11 size, hardcover.

### Robotech®: The Macross® Saga Sourcebook – Cat. No. 551

A treasure chest packed with the iconic mecha, vehicles, weapons and characters that made Robotech® famous. Valkyries, Destroyers, ground vehicles, aircraft, spacecraft, weapons, Zentraedi soldiers, Zentraedi mecha, alien invaders, heroes, villains, and more.

- All the iconic Macross mecha, vehicles, weapons & characters.

[www.palladiumbooks.com](http://www.palladiumbooks.com)

### Robotech®: The Masters Saga™ Sourcebook – Cat. No. 552

Tons of never before seen stats and descriptions for the many weapons, armor, mecha and robots of the Army of the Southern Cross.

- The Army of the Southern Cross™ – all 15 branches and their mecha!

### Robotech®: New Generation™ Sourcebook – Cat. No. 554

The battle for the liberation of Earth starts here.

- Kit-bashed mecha combining parts from different mecha.
- Invid Hives, world overview, key characters and adventure ideas.

### Robotech®: Genesis Pits™ Sourcebook – Cat. No. 555

The Invid Genesis Pits, their purpose, function.

- Inorganics and other war machines of the Invid Regent.
- Genesis Pit mutations and monsters.

### Robotech®: Expeditionary Marines Sourcebook – Cat. No. 553

Join the UEEF (United Earth Expeditionary Force) led by Admiral Rick Hunter as they travel across the galaxy liberating planets from the bondage of the Invid Regent, the Robotech Masters and other tyrants.

- New mecha, weapons, and character classes of the UEEF Marines.
- New alien species and allies. Planet hopping and more.



# ROBOTECH

R P G T A C T I C S

## Main Boxed Game – Cat. No. 55100 – Available Now!

A fast-paced, strategy battle game that captures the speed and action of Robotech®. Play Earth defenders or Zentraedi invaders.

- Scalable from small squad skirmishes to mass battles.
- Turn-based system of play and uses D6. Two or more players.
- 34 highly detailed game pieces. 6mm scale.
- 112 page color rule book with paint guide and index.
- 53 laminated, color game cards.
- 24 custom dice, two decal sheets and more.
- Assembly and painting required. Glue not included.
- \$99.95 retail – Cat. No. 55100 – shipping now!
- Available in North and South America, the EU, Australia & New Zealand.

**Note:** Each product contains plastic game pieces requiring assembly and painting. Glue not included. This is not a toy. Small parts, not suitable for children under the age of 13. Adult supervision advised. Images shown here are not to scale.



### UEDF Valkyrie Wing™ – Cat. No. 55201

Build your fleet of Earth defenders with the Valkyrie Veritech Fighter; six game pieces total. **\$36.95 retail.**

- 2 Valkyries in Fighter mode.
- 2 Valkyries in Guardian mode.
- 2 Valkyries in Battloid mode.
- Multiple heads for making the VF-1A, VF-1J, VF-1R & VF-1S.



### UEDF Tomahawk/Defender Destroids™ – Cat. No. 55202

Expand your Destroid squad with these formidable walking tanks; four game pieces total. **\$32.95 retail.**

- 2 Tomahawk Destroids – the main battle tank of Destroids, brimming with powerful particle beam cannons for arms, and wielding a battery of missiles and an array of other weapons.
- 2 Defender Destroids – a long-range, anti-aircraft juggernaut capable of shooting down incoming Zentraedi Battlepods and Gnerl Fighters.



### UEDF Spartan/Phalanx Destroids™ – Cat. No. 55203

Add some long-range power and up-close punch to your army with these valuable Destroids; four game pieces total. **\$32.95 retail.**

- 2 Spartan Destroids – civil defense, riot control and deadly in hand combat.
- 2 Phalanx Destroids – a walking, long-range missile artillery unit.



### Zentraedi Regult Battlepods™ – Cat. No. 55401

Expand your Zentraedi forces with their main infantry battle mecha; six game pieces total. **\$36.95 retail.**

- 6 Regult Tactical Battlepods – the lightning quick Regults, armed with a pair of particle cannons and auto-cannons, attack in wave after wave.



### Zentraedi Artillery Battlepods™ – Cat. No. 55402

Give your Zentraedi legion greater firepower with these artillery and support Battlepods; four game pieces total. **\$36.95 retail.**

- 4 Zentraedi Support Battlepods, each of which can be made into:
    - Gluuhaug-Regult – Light Artillery Battlepod
    - Serauhaug-Regult – Heavy Artillery Battlepod
    - Telnesta-Regult – Experimental Particle Beam Battlepod
- Four game pieces total.**



### Zentraedi Glaug Command™ – Cat. No. 55403

This diverse pack provides your Zentraedi forces with greater tactical capabilities; three game pieces total. **\$36.95 retail.**

- 1 Glaug Officer's Battlepod – the fast and deadly mecha of Zentraedi field leaders.
- 1 Quel-Regult Scout Battlepod – the stealthy eyes and ears of your Zentraedi battle force; electronic warfare capabilities.
- 1 Quel-Gulnau Recovery Pod – enhances the Glaug's ability to bring in Battlepod reinforcements. **Note:** This figure has NEVER before been offered by any company.

# Can YOU survive the Zombie Apocalypse?



## The Dead Reign® RPG series

**Dead Reign® RPG – “Core Rules.”** It is the aftermath of the *zombie apocalypse*. The dead reign and the living fight against impossible odds. Can you survive? Find out with this fast-paced horror game. Easy to learn. Fast character creation and combat.

- **Zombie combat and survival rules, vehicles and equipment.**
- **6 iconic Character Classes plus Ordinary People (40+ occupations).**
- **7 types of zombies, plus the Half-Living.**
- **101 Random Scenarios, Encounters, Settings and other tables.**
- **\$22.95 retail – 224 pages – Cat. No. 230. Available now.**

## Civilization Gone™ Sourcebook

Civilization has crumbled to nothing. There is no army. No government. No help coming. What now?

- **Madmen, Psychopaths, villains, heroes and protectors.**
- **House, home and survivor camp tables, resources & encounters.**
- **\$12.92 retail – 64 pages – Cat. No. 231. Available now.**

## Dark Places™ Sourcebook

Travel the rails and urban underground to move about undetected by zombies.

- **Worm Meat, Bug Boy, Sewer Crawler & Impersonator Zombies.**
- **Traveling the rails, sewers and other dark places.**
- **Random encounter tables, boxcar content tables, and much more.**
- **\$12.92 retail – 64 pages – Cat. No. 232. Available now.**

## Endless Dead™ Sourcebook

The zombies grow in number and strangeness. Can humankind survive?

- **Zombie amalgamations, tables and encounters.**
- **New player characters & timetables for your campaign.**
- **Weaponizing vehicles, vehicle combat rules, and military bases.**
- **Creating survivor caravans, hideouts, Safe Havens & more.**
- **\$16.95 retail – 96 pages – Cat. No. 233. Available now.**

## Other horror titles from Palladium Books®

**Beyond the Supernatural™ RPG**      **Nightbane® RPG**

## Fear the Reaper™ Sourcebook

Heroes who, like knights of old, travel the highways fighting zombies and helping survivors.

- **Comprehensive background on the Road Reapers.**
- **Their code, missions, weapons, strategies and tactics.**
- **The Terror Zombie and more.**
- **\$12.95 retail – 48 pages – Cat. No. 234. Available now.**

## Graveyard Earth™ Sourcebook

The Zombie Apocalypse across the globe; provides a world overview and many adventure ideas.

- **Many tables for settings, encounters and adventure hooks.**
- **Random Safe Havens by region, and Survivor Leaders.**
- **How to get home from abroad, zombie threat levels & more.**
- **\$12.95 retail – 64 pages – Cat. No. 235. Available now.**

## Hell Followed™ Sourcebook

This big, 160 page sourcebook begins to redefine the zombie genre. It broadens the field of possibilities and expands upon the modern zombie mythos. It is full of twists and surprises you will not expect.

- **11 new types of terrifying zombies.**
- **7 player characters, plus Masked Lunatics – heroes or madmen?**
- **21 disasters to complicate survival, and urban survival.**
- **Government enclaves, conspiracy theories and more.**
- **\$20.95 retail – 160 pages – Cat. No. 236. Available now.**



# Palladium Books® Check List & Order Form

Dept. P-16, 39074 Webb Court, Westland, MI 48185

Name: \_\_\_\_\_ Address: \_\_\_\_\_

City: \_\_\_\_\_ State: \_\_\_\_\_ Zip/Postal Code: \_\_\_\_\_ Country: \_\_\_\_\_

Credit Card Number: \_\_\_\_\_ Expiration Date: \_\_\_\_\_  Visa  MasterCard

Telephone Number: \_\_\_\_\_ Signature: \_\_\_\_\_  AMEX  Other

## The Rifter® Series

- \_\_\_ 175 The Rifter® #75 – \$13.95
- \_\_\_ 176 The Rifter® #76 – \$13.95
- \_\_\_ 177 The Rifter® #77 – \$13.95
- \_\_\_ 178 The Rifter® #78 – \$13.95 (Spring)
- \_\_\_ 179 The Rifter® #79 – \$13.95 (Summer)

## Splicers® Note: Sourcebooks coming soon.

- \_\_\_ 200 Splicers® RPG – \$23.95

## Dead Reign®

- \_\_\_ 230 Dead Reign® RPG – \$22.95
- \_\_\_ 231 SB 1: Civilization Gone™ – \$12.95
- \_\_\_ 232 SB 2: Dark Places™ – \$12.95
- \_\_\_ 233 SB 3: Endless Dead™ – \$16.95
- \_\_\_ 234 SB 4: Fear the Reaper™ – \$12.95
- \_\_\_ 235 SB 5: Graveyard Earth™ – \$12.95
- \_\_\_ 236 SB 6: Hell Followed™ – \$20.95
- \_\_\_ 237 SB 7: In the Face of Death™ (coming)

## Rifts® Novels

- \_\_\_ 301 Sonic Boom™ – \$9.95
- \_\_\_ 302 Deception's Web™ – \$9.95
- \_\_\_ 303 Treacherous Awakenings™ – \$9.95
- \_\_\_ 304 Tales of the Chi-Town 'Burbs™ – \$12.95
- \_\_\_ 305 Rifts® Path of the Storm™ – \$12.95

## Weapons Books

- \_\_\_ 401 Weapons and Armor™ – \$8.95
- \_\_\_ 402 Weapons and Castles™ – \$8.95
- \_\_\_ 403 Weapons and Assassins™ – \$9.95
- \_\_\_ 404 Weapons & Castles of the Orient™ – \$9.95
- \_\_\_ 409 Exotic Weapons™ – \$9.95
- \_\_\_ 410 European Castles™ – \$9.95

## Palladium Fantasy RPG®

- \_\_\_ 450 The Palladium Fantasy RPG® – \$26.95
- \_\_\_ 4500HC Palladium Fantasy RPG® 30th Anniversary Hardcover – \$50.00
- \_\_\_ 451 Dragons & Gods™ – \$24.95
- \_\_\_ 453 Old Ones™ 2nd Ed. – \$24.95
- \_\_\_ 454 Monsters & Animals™ 2nd Ed. – \$24.95
- \_\_\_ 455 Adventures on the High Seas™ – \$24.95
- \_\_\_ 458 Island at the Edge of the World™ – \$20.95
- \_\_\_ 459 Yin-Sloth Jungles™ – \$20.95
- \_\_\_ 462 Western Empire™ – \$24.95
- \_\_\_ 463 Baalgor Wastelands™ – \$24.95
- \_\_\_ 464 Mount Nimro™ – \$20.95
- \_\_\_ 465 Eastern Territory™ – \$24.95
- \_\_\_ 466 Library of Bletherad™ – \$20.95
- \_\_\_ 467 Northern Hinterlands™ – \$24.95
- \_\_\_ 468 Land/Damned 1: Chaos Lands™ – \$24.95
- \_\_\_ 469 LoD 2: Eternal Torment™ – \$24.95
- \_\_\_ 470 LoD 3: The Citadel – \$24.95 (coming)
- \_\_\_ 471 Wolfen Empire™ – \$20.95
- \_\_\_ 472 Mysteries of Magic™ One: Heart of Magic – \$16.95
- \_\_\_ 474 Bizantium/Northern Islands™ – \$20.95
- \_\_\_ 475 Garden of the Gods™ – \$16.95 (coming)

## Heroes Unlimited™ / After the Bomb®

- \_\_\_ 500-2 Heroes Unlimited™, 2nd Ed. – \$26.95
- \_\_\_ 5000HC Heroes Unlimited™ 30th Anniversary Hardcover – \$50.00
- \_\_\_ 501 Villains Unlimited™ Revised – \$24.95
- \_\_\_ 503 After the Bomb® RPG – \$24.95
- \_\_\_ 505 Road Hogs™ (After the Bomb® II) – \$9.95
- \_\_\_ 507 Mutants Down Under™ (AB III) – \$9.95
- \_\_\_ 511 Mutants of the Yucatan™ (AB IV) – \$9.95
- \_\_\_ 513 Mutants in Avalon™ (AB V) – \$16.95
- \_\_\_ 514 Mutants in Orbit™ (AB VI) – \$16.95
- \_\_\_ 515 Aliens Unlimited™ – \$24.95
- \_\_\_ 516 Heroes Unlimited™ G.M.'s Guide – \$24.95
- \_\_\_ 517 Century Station™ – \$24.95
- \_\_\_ 518 Gramercy Island™ – \$24.95
- \_\_\_ 519 Aliens Unlimited Galaxy Guide™ – \$24.95
- \_\_\_ 520 Mutant Underground™ – \$16.95
- \_\_\_ 521 Powers Unlimited® One – \$16.95
- \_\_\_ 522 Powers Unlimited® Two – \$16.95
- \_\_\_ 523 Powers Unlimited® Three – \$16.95
- \_\_\_ 525 Revised Ninjas & Superspies™ – \$20.95
- \_\_\_ 526 Mystic China™ – \$24.95
- \_\_\_ 527 Armageddon Unlimited™ – \$20.95

## Robotech® RPG

- \_\_\_ 550 Robotech® The Shadow Chronicles® RPG (manga size) – \$16.95
- \_\_\_ 550HC Robotech® The Shadow Chronicles® Deluxe Hardcover RPG – \$30.95
- \_\_\_ 5500HC Robotech® The Shadow Chronicles® Gold Ed. Hardcover RPG – \$70.00
- \_\_\_ 551 Robotech® Macross® Saga Sourcebook – \$16.95
- \_\_\_ 552 Robotech® The Masters Saga™ Sourcebook (NEW in 8½ x 11) – \$20.95
- \_\_\_ 553 Robotech®: Expeditionary Force Marines Sourcebook – \$20.95
- \_\_\_ 554 Robotech® The New Generation™ Sourcebook – \$16.95
- \_\_\_ 555 Robotech® Genesis Pits Sourcebook – \$16.95

## Robotech® RPG Tactics™ (New!)

- \_\_\_ 55100 Robotech® RPG Tactics™ – \$99.95
- \_\_\_ 55105 Robotech® RPG Tactics™ Rulebook – \$20.00
- \_\_\_ 55101 UEDF Dice Pack – \$12.00
- \_\_\_ 55102 Zentraedi Dice Pack – \$12.00
- \_\_\_ 55201 UEDF Valkyrie Wing – \$36.95
- \_\_\_ 55202 UEDF Destroid Pack – \$32.95
- \_\_\_ 55203 UEDF Spartan Pack – \$32.95
- \_\_\_ 55401 Zentraedi Regult Battlepods – \$36.95
- \_\_\_ 55402 Zentraedi Artillery Battlepods – \$36.95
- \_\_\_ 55403 Zentraedi Glaug Command – \$36.95

## Rifts® Chaos Earth®

- \_\_\_ 660 Rifts® Chaos Earth® RPG – \$20.95
- \_\_\_ 661 Rifts® CE Creatures of Chaos™ – \$12.95
- \_\_\_ 662 Rifts® CE The Rise of Magic™ – \$12.95
- \_\_\_ 665 Rifts® Chaos Earth® First Responders™ – \$16.95 (coming)
- \_\_\_ 666 Rifts® Chaos Earth® Resurrection™ – \$20.95

## Beyond the Supernatural™

- \_\_\_ 700 Beyond the Supernatural™, 2nd Ed. – \$24.95
- \_\_\_ 702 Tome Grotesque™ – \$20.95 (coming)
- \_\_\_ 703 Beyond Arcanum™ – \$24.95 (coming)

## Nightbane®

- \_\_\_ 730 Nightbane® RPG – \$24.95
- \_\_\_ 731 Nightbane®: Between the Shadows™ – \$20.95
- \_\_\_ 732 Nightbane®: Nightlands™ – \$20.95
- \_\_\_ 733 Nightbane®: Through the Glass Darkly™ – \$20.95
- \_\_\_ 735 Nightbane® Survival Guide™ – \$20.95
- \_\_\_ 736 Nightbane® Dark Designs™ – \$20.95

## Rifts®

- \_\_\_ 800HC Rifts® RPG Ultimate Edition – \$39.95
- \_\_\_ 801 Rifts® Sourcebook One Revised – \$20.95
- \_\_\_ 802-E Rifts® World Book 1: Vampire Kingdoms™, Revised – \$24.95
- \_\_\_ 803 Rifts® Conversion Book One™ – \$24.95
- \_\_\_ 804 Rifts® WB 2: Atlantis™ – \$20.95
- \_\_\_ 805 Rifts® Sourcebook 2: Mechanoids™ – \$16.95
- \_\_\_ 807 Rifts® WB 3: England™ – \$20.95
- \_\_\_ 808 Rifts® WB 4: Africa™ – \$20.95
- \_\_\_ 809 Rifts® Dimension Book 1: Wormwood™ – \$20.95
- \_\_\_ 810 Rifts® WB 5: Triax™ – \$24.95
- \_\_\_ 811 Rifts® Pantheons of the Megaverse® – \$24.95
- \_\_\_ 812 Rifts® Sourcebook 3: Mindwerks™ – \$16.95
- \_\_\_ 813 Rifts® Mercenaries™ – \$20.95
- \_\_\_ 814 Rifts® WB 6: South America – \$20.95
- \_\_\_ 815 Rifts® WB 7: Underseas™ – \$24.95
- \_\_\_ 816 Rifts® DB 2: Phase World® – \$24.95
- \_\_\_ 817 Rifts® DB 3: Phase World® Sourcebook – \$16.95
- \_\_\_ 818 Rifts® WB 8: Rifts® Japan™ – \$24.95
- \_\_\_ 819 Rifts® WB 9: South America Two™ – \$24.95
- \_\_\_ 820 Rifts® WB 10: Juicer Uprising™ – \$20.95
- \_\_\_ 821 Rifts® WB 11: Coalition War Campaign™ – \$24.95
- \_\_\_ 822 Rifts® WB 12: Psyscape™ – \$20.95
- \_\_\_ 825 Rifts® WB 13: Lone Star™ – \$20.95

- \_\_\_ 826 Rifts® WB 14: New West™ – \$24.95
- \_\_\_ 827 Rifts® WB 15: Spirit West™ – \$24.95
- \_\_\_ 828 Rifts® Sourcebook 4: Coalition Navy™ – \$16.95
- \_\_\_ 829 Rifts® WB 16: Federation of Magic™ – \$20.95
- \_\_\_ 830 Rifts® DB 4: Skraypers™ – \$20.95
- \_\_\_ 831 Rifts® Index Volume Two™ – \$16.95
- \_\_\_ 832 Rifts® WB 17: Warlords of Russia™ – \$24.95
- \_\_\_ 833 Rifts® WB 18: Mystic Russia™ – \$20.95
- \_\_\_ 834 Rifts® WB 19: Australia – \$24.95
- \_\_\_ 835 Rifts® WB 20: Canada™ – \$24.95
- \_\_\_ 836 Rifts® WB 21: Splynn Dimensional Market™ – \$24.95
- \_\_\_ 837 Rifts® WB 22: Free Quebec™ – \$24.95
- \_\_\_ 838 Rifts® WB 23: Xiticix Invasion™ – \$20.95
- \_\_\_ 839 Rifts® Coalition Wars®: Sedition™ – \$20.95
- \_\_\_ 840 Rifts® Coalition Wars®: Coalition Overkill™ – \$16.95
- \_\_\_ 841 Rifts® Coalition Wars®: Sorcerers' Revenge™ – \$16.95
- \_\_\_ 842 Rifts® Coalition Wars®: Cyber-Knights™ – \$16.95
- \_\_\_ 843 Rifts® Coalition Wars®: Shadows of Evil™ – \$16.95
- \_\_\_ 844 Rifts® Coalition Wars®: Final Siege™ – \$24.95
- \_\_\_ 845 Rifts® Game Master Guide™ – \$26.95
- \_\_\_ 846 Rifts® Aftermath™ – \$24.95
- \_\_\_ 847 Rifts® DB5: Anvil Galaxy™ – \$20.95
- \_\_\_ 848 Rifts® Book of Magic™ – \$26.95
- \_\_\_ 849 Rifts® Adventure Guide™ – \$24.95
- \_\_\_ 850 Rifts® Bionics Sourcebook™ – \$16.95
- \_\_\_ 851 Rifts® DB 6: Three Galaxies™ – \$20.95
- \_\_\_ 852 Rifts® Dark Conversions™ – \$24.95
- \_\_\_ 853 Rifts® Chi-Town 'Burbs™ – \$9.95
- \_\_\_ 854 Rifts® The Tolkeen Crisis™ – \$12.95
- \_\_\_ 855 Rifts® The Black Vault™ – \$9.95
- \_\_\_ 856 Rifts® The Vanguard™ – \$9.95
- \_\_\_ 857 Rifts® WB 24: China One™ – \$20.95
- \_\_\_ 858 Rifts® WB 25: China Two™ – \$20.95
- \_\_\_ 859 Rifts® DB 7: Megaverse Builder™ – \$16.95
- \_\_\_ 860 Rifts® DB 8: Naruni Wave 2™ – \$16.95
- \_\_\_ 862 Rifts® WB 26: Dinosaur Swamp™ – \$20.95
- \_\_\_ 863 Rifts® MercTown™ – \$20.95
- \_\_\_ 865 Rifts® Merc Ops™ – \$20.95
- \_\_\_ 866 Rifts® WB 27: Adventures in Dinosaur Swamp™ – \$20.95
- \_\_\_ 867 Rifts® Mercenary Adventure Sourcebook – \$12.95
- \_\_\_ 868 Rifts® WB 28: Arzno™ – \$20.95
- \_\_\_ 869 Rifts® WB 29: Madhaven™ – \$16.95
- \_\_\_ 870 Rifts® John Zeleznik Coloring Book – \$5.95
- \_\_\_ 871 Rifts® Machinations of Doom™ – \$18.95
- \_\_\_ 872 Rifts® DB 10: Hades™ – \$24.95
- \_\_\_ 873 Rifts® DB 11: Dyval™ – \$24.95
- \_\_\_ 874 Rifts® WB 30: D-Bees of North America™ – \$24.95
- \_\_\_ 875 Rifts® DB12: Dimensional Outbreak – \$24.95
- \_\_\_ 876 Rifts® Megaverse® in Flames™ – \$24.95
- \_\_\_ 876HC Rifts® Megaverse® in Flames™ Gold Hardcover Edition – \$50.00
- \_\_\_ 877 Rifts® Heroes of the Megaverse® – \$16.95
- \_\_\_ 878 Rifts® Sourcebook: Shemarrian Nation™ – \$16.95
- \_\_\_ 880 Phase World®: Fleets of the Three Galaxies™ – \$16.95
- \_\_\_ 881 Rifts® WB 31: Triax™ Two – \$24.95
- \_\_\_ 883 Rifts® DB 14: Thundercloud Galaxy™ – \$20.95
- \_\_\_ 884 Rifts® Vampires Sourcebook™ – \$20.95
- \_\_\_ 885 Rifts® WB 32: Lemuria™ – \$24.95
- \_\_\_ 886 Rifts® Black Market™ – \$24.95
- \_\_\_ 886HC Rifts® Black Market™ Hardcover Gold Edition – \$60.00
- \_\_\_ 887 Rifts® WB 33: Northern Gun™ One – \$24.95
- \_\_\_ 888 Rifts® WB 34: Northern Gun™ Two – \$26.95
- \_\_\_ 889 Rifts® Sourcebook: Coalition States, Heroes of Humanity™ – \$20.95
- \_\_\_ 890 Rifts® Dimension Book 15: Secrets of the Atlanteans™ – \$24.95
- \_\_\_ 890HC Rifts® DB 15: Secrets of the Atlanteans™ Gold Edition – \$50.00
- \_\_\_ 891 Rifts® World Book: Sovietski™ – \$24.95 (coming)
- \_\_\_ 892 Rifts® Sourcebook: The Disavowed™ – \$16.95 (coming)
- \_\_\_ 893 Rifts® CS: Heroes of Humanity™ Arsenal Sourcebook – \$16.95 (coming)
- \_\_\_ 894 Rifts® Haunted Tech™ – \$16.95 (coming)
- \_\_\_ 895 Rifts® Living Nowhere™ – \$16.95 (coming)
- \_\_\_ 2510 Rifts® & The Megaverse® Art Book – \$22.95
- \_\_\_ 2510-HC Rifts® & The Megaverse® Art Book, Hardcover – \$50.00
- \_\_\_ 2510-CML Rifts® & The Megaverse® Art Book, Collector's Masterwork – \$125.00

### Miscellaneous Products

- \_\_\_ 600 Deluxe Revised RECON® RPG – \$22.95
- \_\_\_ 2537 Gamer Coffee Mug – \$10.00
- \_\_\_ 2539 Rifts® Dice Bag – Black – \$8.00
- \_\_\_ 2544 Dead Reign™ Coffee Mug – \$10.00
- \_\_\_ 2554 Palladium Bookmarks, Set One – \$5.00
- \_\_\_ 2555 Palladium Bookmarks, Set Two – \$5.00
- \_\_\_ 2561 Property of Chi-Town Library Pencil – \$0.50 each
- \_\_\_ 2562 Future Visions™ – The Artistry of Charles Walton II – \$13.95
- \_\_\_ 2566 Glitter Boy Mouse Pad – \$9.95
- \_\_\_ 2567 Old Ones Mouse Pad – \$9.95
- \_\_\_ 2568 Zombie Graveyard Mouse Pad – \$9.95
- \_\_\_ 2575 Rifts Poker Cards 1 (full color) – \$11.99
- \_\_\_ 2576 Rifts Poker Cards 2 (line art) – \$11.99

**Note:** T-shirts and other products can be found online: [www.palladiumbooks.com](http://www.palladiumbooks.com)

### Rifts® Miniatures

- \_\_\_ MI8002 Xiticix Pack – \$18.00
- \_\_\_ MI8004 Coalition Dog Pack – \$18.00

- \_\_\_ MI8005 Men of Magic Pack #1 – \$18.00
- \_\_\_ MI8006 Cyborgs Pack #1 – \$18.00
- \_\_\_ MI8007 Simvan & Ostrosaurus Pack – \$18.00
- \_\_\_ MI8008 Coalition Skelebots Pack #1 – \$18.00
- \_\_\_ MI8009 Coalition SAMAS Pack #1 – \$22.00
- \_\_\_ MI8010 Coalition Sky Cycle Pack – \$22.00
- \_\_\_ MI8011 Coalition Dog Pack #2 – \$18.00
- \_\_\_ MI8015 Damaged Skelebots Pack #1 – \$12.00
- \_\_\_ MI8016 Cyber-Adventurers Pack – \$18.00
- \_\_\_ MI8017 Rogues & Scout Pack #1 – \$18.00
- \_\_\_ MI8018 Brodkil & Witchling Pack – \$18.00
- \_\_\_ MI8019 Damaged Skelebots Pack #2 – \$18.00
- \_\_\_ MI8020 Psi-Stalkers & Scouts Pack #1 – \$18.00
- \_\_\_ MI8021 Shadow Beast – \$12.00
- \_\_\_ MI8022 Mystic Knight – \$6.00
- \_\_\_ MI8023 Lord Magus – \$6.00
- \_\_\_ MI8024 High Magus – \$6.00
- \_\_\_ MI8025 Coalition Psi-Stalker – \$6.00
- \_\_\_ MI8026 Coalition Dog Boy in DPM-D1 Armor – \$6.00
- \_\_\_ MI8027 Coalition Dog Boy #2 – \$6.00
- \_\_\_ MI8028 Coalition Dog Boy #3 – \$6.00
- \_\_\_ MI8029 Coalition Dog Boy #4 – \$6.00
- \_\_\_ MI8030 Coalition Dog Boy #5 – \$6.00
- \_\_\_ MI8031 Glitter Boy – \$20.00
- \_\_\_ MI8032 Glitter Boy Pilot – \$6.00
- \_\_\_ MI8033 Kydian Overlord – \$20.00
- \_\_\_ MI8034 Dragonsaurus – \$10.00
- \_\_\_ MI8035 Slaver and Slave (Atlantis) Set – \$10.00
- \_\_\_ MI8036 Crazy – \$6.00
- \_\_\_ MI8037 Juicer #1 – \$6.00
- \_\_\_ MI8038 Juicer #2 – \$6.00
- \_\_\_ MI8039 Cyborg #1 – \$12.00
- \_\_\_ MI8040 Cyborg #2 – \$12.00
- \_\_\_ MI8041 Cyborg #3 – \$6.00
- \_\_\_ MI8042 Coalition Officer – \$6.00
- \_\_\_ MI8043 Coalition Grunt #1 – \$6.00
- \_\_\_ MI8044 Coalition Grunt #2 – \$6.00
- \_\_\_ MI8045 Coalition Grunt #3 – \$6.00

**When placing an order by mail, please add money for shipping and handling.** Add \$5.00 for orders totaling \$1-\$50, \$10.00 for orders totaling \$51-\$95, and for orders totaling \$96-\$200 please add \$15.00 US. Double the amount for Canada, and *quadruple* it for overseas orders. For more shipping options, order online at [www.palladiumbooks.com](http://www.palladiumbooks.com).

Allow 2-4 weeks for delivery.

Make checks and money orders payable to: *Palladium Books*

**Check release dates for new products.** If the book you order has not been released yet, your order will be held as a backorder until the product is available. Please note that prices are subject to change without notice.

**Orders can also be placed by phone,** at (734) 721-2903 (order line only). Please have your credit card information when you call.

**[www.palladiumbooks.com](http://www.palladiumbooks.com)**

## Also from Palladium Books®

### Minion War™ Titles

- **Dimension Book 10: Hades** (Demon Hell described)
- **Dimension Book 11: Dyval™** (Deevil Hell described)
- **Dimension Book 12: Dimensional Outbreak™** (Phase World®)
- **Heroes of the Megaverse®** (Phase World®)
- **Armageddon Unlimited™** (Heroes Unlimited™ crossover)
- **Rifts® Megaverse® in Flames™** (Minion War™ for Rifts®)

### Robotech® The Shadow Chronicles® RPG

Robotech is back, redone and better than ever.

- Mecha, power armor, spacecraft, aliens & more.
- Quick-roll character creation takes 15 minutes.
- A complete role-playing game.
- The Macross® Saga Sourcebook – available now.
- The Masters Saga™ Sourcebook – available now.
- Robotech® Expeditionary Force Marines™ – available now.
- Robotech® New Generation Sourcebook™ – available now.

### Dead Reign® Role-Playing Game

The dead have risen to attack the living. Civilization has crumbled. Survivors are on their own. This is the Zombie Apocalypse.

- In-depth data on zombies; 7 different zombie types.
- Fighting zombies and human resources.
- Six character classes and ordinary people.
- Fast playing and easy to learn.
- 224 pages. A complete role-playing game.

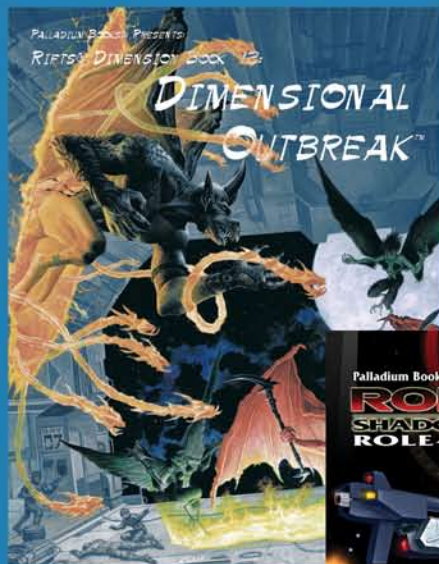

At stores  
everywhere

### Rifts® Dimension Book™ 13:

## Fleets of the Three Galaxies™

**Fleets of the Three Galaxies™** presents the more powerful fleets in the Galaxies, key figures, notable locations, brewing problems, avenues for adventure, new spacecraft, notable gear and Space Magic.

More than that, it helps to crystallize the politics and powers that be in the Galaxies as well as reveal long standing feuds, growing aggression and secret plots. Plus it can be used in conjunction with the battle between demons and Deevils as the *Minion War™* spills across the Megaverse®.

- 17 new major spacecraft, from fighters to dreadnoughts.
- Space tugs, lifeboats and special gear.
- Missiles and weapon systems.
- Classification of ships and common features.
- Spaceship creation guidelines and random ship damage table.
- History and insight to key fleets and races.
- Fleet ranks, background and notable figures.
- Common strategies and tactics in space combat.
- Fleet formations and notable spacecraft of the Dominators, Splugorth, Naruni, CCW, TGE and other key powers.
- Three Galaxies time-line.
- Space magic, many adventure ideas and more. 128 pages.

## Unleash your imagination and Explore the Megaverse®

\$16.95

Cat. No. 880

ISBN-10: 1-57457-147-8

ISBN-13: 978-1-57457-147-9

**Palladium  
Books Inc.**  
www.palladiumbooks.com