

Palladium Books® Presents:

Rifts® Dimension Book™ Six:

THREE GALAXIES™

A PHASE WORLD® SOURCEBOOK

By Carl Gleba



Warning!

Violence, War, Magic & the Supernatural

The fictional world of **Phase World®** is violent, deadly and filled with supernatural monsters. Other-dimensional beings often referred to as “demons,” torment, stalk and prey on humans. Other alien life forms, monsters, gods and demigods, as well as magic, insanity, and war are all elements in this book.

Some parents may find the violence, magic and supernatural elements of the game inappropriate for young readers/players. We suggest parental discretion.

Please note that none of us at Palladium Books® condone or encourage the occult, the practice of magic, the use of drugs, or violence.



An epic sourcebook for the *Phase World®* Series.
Compatible with the entire Palladium Books® Megaverse®

Dedication

To my wife Lisa, the brightest star in my sky, and the ground beneath my feet. Thank you for walking this road with me and exploring all its wonders.

To my parents, Joe and Marian Gleba, who encouraged me to explore all my dreams no matter how far the reach and supporting me in all my endeavors.

Finally, to Chet and Mary Wlock, my in-laws, who treated me like a son long before I married their daughter.

Special Thanks to Pat Dodge for helping in editing my manuscript, and for all the suggestions and encouragement a true friend provides. My gaming group who has been the unfortunate victims of having play-tested some of my ideas. Pat Dodge, William Maxwell, Thanh Nguyen, Justin Stringer, Mike Kurik, and finally, Craig and Lessle Furness whose FTL games inspired a lot of my work. Thanks to all you guys for making our role-playing sessions come alive! And thank you Kevin and Maryann Siembieda, for without you this would not be possible.

– Carl Gleba, 2003

The cover, by *John Zeleznik*, depicts a Cosmo-Knight soaring through space, weapons at the ready.

PDF Edition – September 2017

No part of this publication may be scanned, OCRed or reproduced in any way for electronic publication on the web/internet or any other medium.

Copyright 2003, 1990 Palladium Books Inc. & Kevin Siembieda

All rights reserved, worldwide, under the Universal Copyright Convention. No part of this book may be reproduced in part or whole, in any form or by any means, without permission from the publisher, except for brief quotes for use in reviews. All incidents, situations, institutions, governments and people are fictional and any similarity, without satiric intent, of characters or persons living or dead, is strictly coincidental.

Rifts®, The Rifter®, Phase World®, Megaverse®, The Mechanoids®, The Mechanoid Invasion®, After the Bomb®, and Palladium Books® are registered trademarks owned and licensed by Palladium Books Inc. and Kevin Siembieda.

Three Galaxies, Thundercloud Galaxy, Anvil Galaxy, Corkscrew Galaxy, Free World Council (FWC), Consortium of Civilized Worlds (CCW), Trans-Galactic Empire (TGE), United Worlds of Warlock (UWW), Rifts Earth, Naruni Enterprises, Draygon Industries (DI), Cosmo-Knights, Cosmic Forge, Forge War, Cyber-Knights, Kreeghor, Noro, Wulfen, Obsidian Spell Thief, Space Warlock, Techno-Smithy, Necrols, Necrol Warrior, Nixie, Paratee, Skaa, Strata, Sapphire Cobra, Posh Star Fighter, Dragon Fang Fighter, Nexus Battleship, Mystic Breacher, Arcane Shuttle, Demon Star, Demon Planet, Surface Crawlers, Gut Crawlers, Floating Horrors, Dark Covens, Mutants in Orbit, Rifts® Conversion Book One Revised, Rifts® Game Master Guide, Rifts® Book of Magic, Rifts® Mercenaries, Splynn Dimensional Market, Wolfen, Biomancer, Bio-Wizardry, Ley Line Walker, Mind Melter, Stone Master, T-Man, Tattooed Man, Maxi-Man, Undead Slayer, Techno-Wizard, Temporal Raider, Shifter, Juicer, Crazy, 'Borg, Bio-Borg, 'Bot, Cyber-Doc, Bioware, Headjack, Full Conversion Cyborg, E-Clip, Mega-Damage, M.D.C., S.D.C., I.S.P., P.P.E., Splugorth, Splugorth Slaver, Splugorth High Lord, Splynncryth, Splynn, Kittani, Powerlord, Metztle, Sunaj, and other names, titles, character names, character likenesses and slogans are trademarks owned by Kevin Siembieda and Palladium Books Inc.

Palladium Online: www.palladiumbooks.com – also visit us at [facebook.com/PalladiumBooks](https://www.facebook.com/PalladiumBooks)

Rifts® Dimension Book™ 6: The Three Galaxies is published by Palladium Books Inc., 39074 Webb Court, Westland, MI 48185. Printed in the USA.

Palladium Books® Presents:

Rifts® Dimension Book™ Six:

The Three Galaxies™

A Phase World® Adventure Sourcebook

Written by: **Carl Gleba**

Some additional text & ideas by: **Kevin Siembieda**

Inspired by and based on *Phase World*® created by **C.J. Carella**.

Editors: **Alex Marciniszyn**

Wayne Smith

Proofreader: **Julius Rosenstein**

Cover Painting: **John Zeleznik**

Interior Artists: **Wayne Breaux Jr.**

Kent Burles

Michael Dubisch

Apollo Okamura

Freddie Williams

Michael Wilson

Art Direction & Keylining: **Kevin Siembieda**

Typography: **Wayne Smith**

Based on the RPG rules, text, characters,
concepts and Megaverse® created by **Kevin Siembieda**.

Special Thanks to Carl Gleba for his bright imagination, great ideas and patience. To my artists for doing a great job on a tight deadline, and to Alex and Wayne who worked their hearts out on this book. And last, but not least, to Johnny Z and all of the galactic heroes at Palladium Books.

– *Kevin Siembieda, 2003*

Contents

Building on a vision	7
The Guide to the Three Galaxies	7
Space Station Creation Rules	7
Step Four: Defenses	9
Step Ten: Security	12
The Thundercloud Galaxy	15
The Algos System	15
The Barkohl System	16
Ion Storms	16
Nebulas	17
Carse System	18
A note on the cosmos	19
Comets & Asteroids	19
Expanses	20
Meteor Showers	21
Plasma Fields	23
Dark Web	24
Prison Planets	25
The Eden System	26
Eden Three/Bountiful Harvest	26
Fecklar's Star	27
The Demon Horde	27
Fecklar's Station	28
Galamon System	28
Hyrill System	29
Icarus System	31
Hook, Line & Sinker: Vampires	31
Junkyard System	32
Kalador, the Planet of Youth	33
Kalador Three: Paradise	34
The Lanator System	35
The Dwarves of Maul	35
Nightshade Nebula	36
Mines	37
System of Olympia	38
Olympia Four (Olympics)	38
The Pentarken System	39
The Artifact	39
Quintos System	42
Paratee	43
Rasscallion System	43
Shandara System	44
Tyr Corridor	46
Ulterra System	46
Veripin System	47
Veripin Eight (Skaa)	47
Witch's Cauldron	48
Xeres Beta	49
Xeres Beta Five	49
Yinshazi System	50
Zeta Epsilon Colonies	51
The Corkscrew Galaxy	53
Aviary System	53
Cacadia System	54

Dust Bowl	55
Exile	56
The Fydra Beta Shipyards	56
Hunter System	59
Safari Inc.	60
Slither NPC	60
Necrosis System	61
The Pirates' Expanse	62
Stratos	63
Titanis System	63
The Void Gulf	64
Windscape System	65
The Anvil Galaxy	67
Andropelous System	67
Cray-Lon Expanse	68
Master Fesh	69
Elemental Lands	70
Firestorm Nebula	71
Harkon Rift	71
Malcore System	72
Nova Cluster	73
Obsidian Cove	73
Ramos	74
Tigress System	74
Tigress Five/Tigress Raceway	75
O.C.C.s & R.C.C.s	76
Free World Council O.C.C.s	76
FWC Ground Trooper	76
M.O.S. Skill Packages	77
FWC Insurrectionist O.C.C.	78
FWC Field Medic	79
FWC Air/Space Corps	80
United Worlds of Warlock O.C.C.s	81
Obsidian Spell Thief	81
Space Warlock	83
Techno-Smithy	84
Racial Character Classes	86
Necrol R.C.C.s	86
Necrol Warrior	87
Necrol Witch	88
Necrol Worker	90
Other Races	90
Nixie	90
Paratee	91
Skaa	92
Strata	93
Experience Tables	94
Some Monsters of the Three Galaxies	96
Sapphire Cobra	96
Solar Leech	96
Space Coral Creature	97
Void Zombie	98
Demon Planet	99
Demon Planet Defense Mechanisms	101
Crater Tentacles	101

Surface Crawler	102	Dark Coven: Obsidian Spell Thief	81
Gut Crawler	102	Dark Coven: Windscape Three	65
Floating Horrors	103	Darkest Evil (Xeres Beta Five)	49
Notable Equipment of the Three Galaxies	104	Demon Horde	27
Personal Scanning Equipment (PSE)	104	Demon Planet	99
PSE-7000 Portable Scanner	105	Demon Star	148
PSE-7000 Add-on Features	105	Doctor Fecklar	27
PSE-7500 Engineering Scanner	106	Galactic Tracer: Master Fesh	69
PSE-8000 Medical Scanner	107	Galactic Tracer: Red Lotus	69
PSE Software Chips (add-ons for any scanner)	107	Gantrium	72
UWW Arcane Scanner ARS-500	108	HI Industries Base (Titanis Sytem)	64
Additional Magic Features	109	HI Industries Weapons	127
Notable Medical Equipment	109	Kreeghor Prison Planet (see Dark Web)	24
Auto-Medic	109	Kreeghor Shipyards (Fydra Beta)	58
Other Common Medical Equipment	110	Kreeghor Warrior Race: Skaa	92
Notable Galactic Weapons	111	Magic Nebula	17
Draygon Industries (DI)	111	Olympics (Olympia)	38
DI Variable Laser Weapons	112	Oni (Yinshazi System)	50
Draygon Hide Series of Body Armor	114	Nano-Plague (Shandara)	44
Strata Crystal Technology	115	Necrol Body Armor	117
Necrol Living Weapons	117	Necrol Hand Grenades (Hygra)	119
Sha'wrek Body Armor	117	Necrol Home World (Necrosis Four)	62
Sapcree Energy Pistol	118	Necrol Living Weapons	117
Vasher Energy Rifle	118	Necrol Power Armor	120
Gona'grek Organic Power Armor	120	Necrol R.C.C.s	86
Necrol Posh Star Fighter	123	Necrol Starships	123
Necrol Behemoth Destroyer	124	Obsidian Spell Thief O.C.C.	81
Spaceships	127	Pleasure Planet (Kalador Three)	34
Point Defense Weapons	127	Pleasure Planet System (Andropelous)	67
Light Weapons Class	128	Racing: Tigress System	74
Medium Weapons Class	128	Rasscallion Stellar Technologies	43
Heavy Weapons Class	129	Red Spice (drug; see Kalador)	33
Magic Weapons for Spacecraft	130	Rift: Harkon Rift	71
Hull Breachers	130	Rift: Kalador Four	34
Negate Mechanics Mini-Missiles	131	Rift: Xeres Beta Five	49
Notable Propulsion Systems	131	Rune Smith Clan (Maul)	35
Spacecraft Drive System Table	132	Sapphire Cobra	59 & 96
New Spacecraft of the Three Galaxies	133	Solar Winds (see Ion Storms)	16
Oni Shadow Ship/Stealth Shuttle	138	Space: Asteroids	19
Draygon Star Fighters	140	Space: Comets	19
Star Fighter Accessories	143	Space: Expanse (nebula & asteroids)	20
Magic Starships	144	Space: Ion Storms	16
Demon Stars	148	Space: Meteor Showers	21
Containers & Cargo	151	Space: Nebulas	17
		Space: Plasma Fields	23
		Spaceships: FTL Drive Systems	132
		Spaceships: Mining	133
		Spaceships: Necrol	123
		Spaceship Weapons	127
		Space Station: Creation of	7
		Stardust (Witch's Cauldron)	48
		Terra-forming	29
		Thraxus (adventures)	27 & 29
		T'zee (Zeta Epsilon Colonies)	51
		Vampire Adventure	31

Quick Find

Alien: Nixie	54 & 90
Alien: Paratee	43 & 91
Alien: Skaa	47 & 92
Alien: Strata	63 & 93
Artifact, The	39 & 41
Black Rogues (Dark Coven; Obsidian Cove)	73
Crystal Aliens: Strata	93
Dark Coven: Obsidian Cove	73

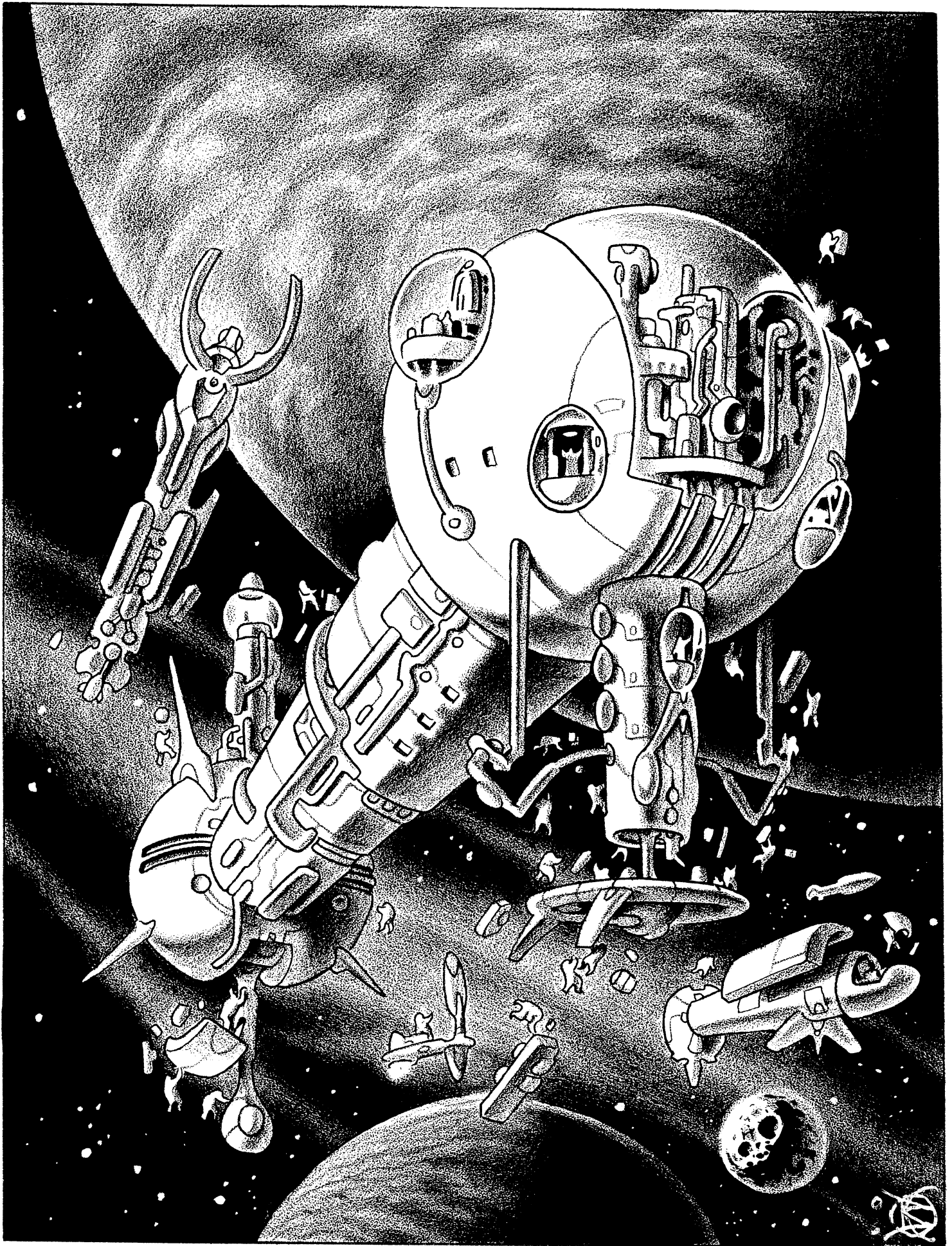

Building on a vision

In any good story, you need three essential elements, a plot, a setting, and a theme.

C.J. Carella established the theme. The Three Galaxies in all its complexity is, in my humble opinion, one of the best sci-fi genres I have ever played. It is rich in intrigue and mystery and has all the elements of a great space adventure combined with high technology and magic, plus it uses Palladium's Megaversal set of rules. What more could we ask for?

Well I hope to answer that question by providing a bit more on the setting in the Three Galaxies, so you can take that space adventure and fight a pitched battle on the edge of a black hole or hide in a nebula from hostile aliens, or simply evade the forces of nature by riding out an ion storm or dodging meteors.

New ports of call await. Whether it be in one of the systems described within, one found in the pages of the *Anvil Galaxy sourcebook*, or one that you create. My intention is to make the Guide to the Three Galaxies a source of cosmic adventure to carry you into new realms of space exploration, intrigue and excitement. Hook, Line and Sinker based adventures are presented throughout to help provide some possible avenues. So welcome back to the Three Galaxies, and keep going on those adventures where no one has gone before.

– Carl J. Gleba, 2003

The Guide to the Three Galaxies

Space. What vast possibilities it presents. What diversity it creates. Through its endless expanses we pass focused only on our own individual worlds. Our planets cradled us and nurtured us when we were all young races. As we began to grow we began to look up. Even as children we looked to the stars wondering and asking.... are we alone?

As time passed we were able to break the bonds of our earth born cradle and begin to explore those lights in the sky. Soon we could travel at incredible speeds and bring those points of light into focus and before long, we discovered we're not alone! There are others seeking the same questions and answers as we are.

As individual worlds, finding these answers would take many lifetimes, but as a unified consortium we can help each other answer that which we have all been seeking since infancy. Let us all agree then that together we shall all pursue new life in all its forms, be it humanoid or not, and let us not pass judgment on the creations of the galaxy. Let us pool our resources and create a galactic society that will endure until the end of time.

Excerpt from the Constitution of The Consortium of Civilized Worlds.

Space Station Creation Rules

Space stations are a common sight in the Three Galaxies, from a single station that orbits a gas giant to the dozens that orbit Phase World, they are everywhere. Small or large, these structures serve many different functions, from a tiny observatory or science lab to a major industrial complex or an artificial habitat for millions. Creating custom stations is fun, but time consuming. With inspiration from the merc organization rules in *Rifts® Mercenaries*, I have come up with a set of space station design rules enabling G.M.s and players (if allowed to build a station) a way to create a sprawling space station in a matter of minutes.

This is a point based system. Step One provides the base number of points available for design considerations. The larger the space station, the more points available to its construction.

Step Two provides bonus points depending on the space station's chief purpose.

Steps Three and on, *cost* the points attained in Steps One and Two in order to acquire special features and capabilities.

Step One: The Size of the Station

Size does matter when it comes to designing space stations. This is specifically due to the fact that the station has to allocate space to various systems and functions on the station. For example, a medium space station may have a fighter bay for protection as well as a cargo bay, and multiple shield generators, plus still needs room for life support and main power.

1. Small Outpost: This is the smallest type of station available. It usually measures from 2500 feet (762 m) to 5500 feet (1,676 m; 1D4x1000+1500 feet.). Size is usually the circumference if round or the overall length if cylindrical. They are usually found orbiting planets or moons, seldom in deep space. The small station will have 3-6 external docking ports (1D4+2), and the average population is usually around 240 personnel, but can comfortably fit 300. In an emergency the station can hold 600, but conditions are cramped and very uncomfortable. This type of station is commonly used as a communications outpost for military functions, or as laboratory or observatory for scientific research, though they may be used for just about any purpose its builders may desire. Base M.D.C. 10,000 to 40,000 (1D4x10,000). Outer hull per 100 foot (30.5 m) area is 200 M.D.C. Points available for construction: 150

2. Medium Station: These are the next size step up, but are considerably larger. Measuring up to 17,000 feet (5,182 m; 2D6x1000+5000 feet.), these stations tend to be the most common orbiting habitable planets. The space station has either a small shuttle bay or multiple external docking ports (3D4+4). These stations can have variety of different capabilities and a large population of 200,000+ inhabitants, with 250,000 fitting comfortably and as many as 500,000, but any population greater than 320,000 must endure cramped and uncomfortable conditions. Base M.D.C. 100,000 to 400,000 (1D4x100,000). Outer hull per 100 foot (30.5 m) area is 450 M.D.C. Points available for construction: 300

3. Large Station: Large stations measure between 3-12 miles in diameter (4.8 to 19.2 km; roll 3D4 miles). These stations are commonly used for private industry, ship production, military applications, mining, and processing of ore. This station is large enough to have a docking bay for several small spaceships (enough room for at least a half dozen; roll 3D6+3) and or dozens of external docking ports (roll 6D6 or 3D6 with a docking bay). The station can comfortably support a population of two million or as many as four million under very cramped conditions. Base M.D.C. is 3-6 million (1D4+2x1 million). Outer hull per 100 foot (30.5 m) area is 900 M.D.C. Points available for construction: 400

4. City Size: This is the largest class of station out there! These monstrous stations measure 2D6x10 miles (32 to 192 km). Several large spacecraft will be able to dock within and there will be dozens of docking ports (3D6x10). A station this size will be able to accommodate a population of 10 to 20 million inhabitants. Double for cramped conditions. Base M.D.C. is 20 to 50 million (1D4+1 x10 million). Outer hull per 100 foot area is 1500 M.D.C. Points available for construction: 500

Note: The base M.D.C. is for the overall main body of the station. If the M.D.C. is depleted by more than 45% then isolated hull breaches *will* begin to occur. These can be temporarily avoided and contained by sealing off sections of the station.

Most space stations are modular in their design and are built in *sections*. This is to prevent a single hull breach from blowing *all* the air out of the station. Like the inner hull of a battleship or submarine, compartments and sections can be closed off to protect and keep the rest of the vessel functioning; space stations work the same way. Each section will have more than one pressure door that can be sealed in case of an emergency. The M.D.C. of the pressure doors is 1D6x10+40. Blast doors, which are meant to be heavy-duty reinforced doors, will have much higher M.D.C., 1D4x100. Blast doors typically seal off important sections of the station such as engineering and the hangar bay. In case of the loss of atmosphere these doors typically seal automatically. Individual sections should be a small percentage of the overall M.D.C. or function of the station, so closing them off should not dramatically break down the performance of the station, at least at first. Individual sections may have their own M.D.C. with all sections combined to form the total M.D.C. Individual sections could be things like hangar bays, weapon systems, communications array or the command and control deck.

Step Two: The Station's Function

What exactly is the station's primary purpose and function? Who built it or is backing the station? The options below should help answer these questions.

1. Military: The station is owned and operated by the military. The specific function of the station varies depending on the mission profile. Some common military applications include the following: *communications* (spying, observation and recording of data or the cornerstone in a global communications network), *base of military operations* (a space battle platform complete with troops, combat vehicles, fighters, long-range assault weapons and defenses; may be designed for the purpose of invading, or containing/quarantining a particular planet, moon or sector of space), *defense* (fundamentally the same as the "military operations" except its purpose is to defend or hold a particular planet, moon or sector of space), *military industrial* (a factory facility that repairs and makes military spacecraft), *supply station* (designed for refueling, rearming, and minor repairs of military spacecraft and services for combat troops; may include a sick bay and/or areas for R & R) or a *recreation center* (exclusively designed for providing combat troops and space jockeys with a place for R & R/rest and relaxation). Add 20 points to the category of Defenses, 10 points to Internal Security Personnel and 10 points to Supplies.

2. Industrial: A majority of the station's function is manufacturing (space factories), mining, processing or energy (manufacture and transmission/distribution). A major corporation like Naruni Enterprises is most likely to own it. Add 10 points to the categories of Power Systems and Supplies.

3. Private Business: A majority of the station is dedicated to business. This may include research and development, light industry/manufacturing, entertainment and sale (including retail outlets, casinos, entertainment, and food), housing (hotels and homes), travel (space ports and local transportation/shuttles) and energy (power stations, often for the planet below). Add 20 points to Independent Business, 10 points to Supplies and 10 to Environmental Systems.

4. Scientific: The role of this station is predominantly in the field of scientific study. Its function can vary widely: A stellar telescope, a radio telescope, xeno or medical research, to experimentation and scientific manufacturing or research and development. Add 10 points to Sensors, Medical Facilities, and Power Systems.

5. Government Owned: A particular government owns this station. It can have multiple roles. A trading post, galactic mail service, ambassadorial functions or simply just owned by the government. Add 25 points anywhere (may be divided between numerous categories).

6. Colony: A group of people have started a colony in space rather than on a planet. Add 10 points to Transients and Medical Facilities and 20 points to Supplies.

Step Three: Power Systems

This is an essential part of the space station. It powers all the vital functions of the station from environmental controls to defenses. It should also be noted that most space stations would have this portion of the station heavily guarded, as it is its life's blood. You can buy more than one power system in this step. Most stations have a *primary* power source and at least one *secondary source* in case the primary power provider should fail.

1. Nuclear, Solar Powered, and Battery: A combination of solar arrays linked with a nuclear generator and battery back up. The oldest and cheapest stations use these forms of energy. Nuclear generators usually last about 30 years before needing to be replaced, but they tend to be messy, with nuclear waste having to be removed every 2-4 years. The solar arrays need replacing every five years due to space dust, micrometeorites and other debris. The other problem with solar arrays is that in order to get enough power one needs a lot of them. As a result, they tend to be in the way and can be an obstacle for approaching ships and a tempting target for an attacker. Cost: Free.

2. Fusion Power: A single fusion reactor can power a small or medium station. Large stations need at least two, and city-sized need a minimum of four. They are smaller and cleaner than nuclear and require less fuel. Most have a 50 year life span. Cost: 10 points.

3. Matter/Anti-Matter Reactor: The most common form of power in the Three Galaxies, they are much more efficient and cleaner than the previous power systems. This power source will also have an auto eject system, should the magnetic bottles ever collapse. This reactor can power all stations except the city-sized with incredible efficiency. City-sized stations require at least two such reactors to operate at peak efficiency. The life expectancy is around 100 years. Cost: 20 points.

4. Magic: A mystic generator is the power source for many a space station in the Three Galaxies thanks to the U.W.W. (United Worlds of Warlock) and can generate sufficient power for all types of stations! Depending on the size of the station, thousands of P.P.E. points are stored. Some of these mystic power generators have trapped entities in them to provide the necessary energy. It is common practice to trap Greater Elementals and if possible, Greater Demons or Deevils. Life expectancy varies from 150 to 500 years. The danger with a magic power source is the intelligent, living creature may escape and

go rampaging through the station as well as causing the obvious power disruption. Cost: 40 points.

5. Experimental. The station's power grid is being run on a new and experimental power system. This can include some type of plasma generator, harvesting the power of a quantum singularity, experimental phase technology or alien technology. The life of the generator is unknown. The benefits are that power is in excess so it can feed multiple systems and will provide enough power for any type or size of station. As this power system is most likely one of a kind it will require constant maintenance and monitoring. Cost: 50 points.

Step Four: Defenses

Can the station hold its own in a fight or does it have no defenses at all? More than one of the following options can be purchased with a cumulative point cost.

1. None: The station has absolutely no external defenses at all. Cost: Free.

2. Shields: The station has shields for defensive purposes. They will be standard as per starships with 6 sides. Cost: For 3 points, the station can have a total of 3,000 M.D.C. (500 M.D.C. per side). More points can be spent here, for example, 18 points gives the station 18,000 M.D.C. (or 3,000 M.D.C. per side). The same combat rules apply to station shields as starship shields. Also no ships will be able to dock while the shields are up. Cost: 3 points per 3,000 M.D.C.

3. Point Defense Weapon Systems: The station only has light defensive weapons located at specific strategic locations to protect it. These include all weapons listed under point defense. Game Masters, feel free to pick and choose among the various weapons. Small outpost will have 1D6+6 cannons, medium stations will have 3D6+6 cannons, large stations will have 6D6+12 cannons, and city-sized stations will have 2D4x10+10. These weapon systems can be controlled by a gunner or be automated (4 attacks per melee and +2 to strike for auto-systems). Capable of destroying small spacecraft and troops; medium spacecraft from concentrated fire from three or more point defenses on the same target. Cost: 5 points.

4. Short-Range Weapons: The station is equipped with any of the weapons from the short-range category. Damage and range vary. The station can defend itself, but not too well. These weapons are more of a deterrent than a threat. A small outpost will have 1D6+2 cannons, a medium station will have 3D6+3, large stations will have 6D6+6, and city-sized stations will have 2D4x10+5. Each is capable of taking down small spacecraft and troops. Cost: 10 points.

5. Medium Weapon Systems: The station has weapons advanced enough to take on small and medium-sized spacecraft. Weapons can be selected from the medium category. The number of medium weapons will be 1D6 for small outposts 3D6 for medium stations 6D6 for large stations, and 2D4x10 for city-sized stations. Cost: 20 points.

6. Heavy Weapons: The station is equipped with the heaviest weapon systems available and can even defend itself from star destroyers and a good-sized fleet of starships. Pick from the heavy weapons category, except mass drivers.

Small outposts cannot be equipped with heavy weapons. Only one heavy weapon is available for the medium station, 1-3

for the large station and 1D4+1 for the city-sized station. These weapons are more common on military space stations than any other, because cost and power consumption are impractical for most small and commercial stations. Cost: 40 points.

7. Space Fighters: The station has a squadron of space fighters at its disposal. Their primary purpose is the defense of the space station by engaging the enemy in ship to ship combat and dispersing troops, but they may be used in other roles as well, reconnaissance, escort, rescue, and, in a pinch, even shuttle service. The exact type of fighter will depend on the individual station, the sector of space and who operates it. For example, a station run by the C.A.F. will most likely be using the Katana by Bushido Industries or the Scorpion-Class light fighter, while a Kreeghor station would use the Flying Fang Interceptor. **Note:** The G.M. can substitute Power Armor instead of fighters. Cost: 15 points per squadron. A typical squadron in the Three Galaxies is 12 fighters.

8. Magic Defense: The station is enchanted with Techno-Wizardry. The only requirement is a P.P.E. Battery. Typical magical defenses include enchantments such as Impervious to Energy, Breathe Without Air, Armor of Ithan (M.D.C. at 3000) and other similar magical defenses, as well as energy blasts, lightning and illusions. In addition, the magically defended space station will have a few weapons similar to the Rifts Earth Star Fire Cannon (increase damage to 1D4x100 M.D. and 2 miles/3.2 km range) and the Bottled Demon Missile Launcher. There will be both short- and long-range weapons. However, payloads may be limited due to the station's P.P.E. reserve. Cost: 60 points.

9. Satellite Defense: Satellites make up part of this space station's defense. Costs are as follows:

Point Defense Satellites: 2 points provides 6 satellites. M.D.C. of satellite is 50.

Light Defense Satellites: 5 points provides 6 satellites. M.D.C. of satellite is 150.

Medium Defense Satellites: 10 points for 4 satellites. M.D.C. of satellite is 275.

Heavy Defense Satellites: 15 points per satellite. M.D.C. of satellite is 450.

10. Armored Hull: The station's hull has the added advantage of exterior armor. This is most commonly found in government or military stations. Costs: For 5 points the overall M.D.C. of the station can be increased by 10%. For 10 points add 15% and 20 points add 25% more M.D.C.

Step Five: Sensors

Sensors are the eyes and ears of any space station. Without them, a station is blind. The most active space ports have all kinds of traffic coming and going, so they, in particular, require very sophisticated means of keeping track of it all.

1. Basics: The space station has basic sensors and scanners, including radar, motion, multi-optics, and collision warning systems. Range of the sensors is 200,000 miles (320,000 km). Cost: Free.

2. Satellites: Satellites can greatly enhance the range of any sensor suite. The quantity and type of satellites vary greatly. Different types are available with this option.

Short-Range Satellites: Provides an additional 200,000 miles (320,000 km) to the range of the existing system. Cost: 2 points for six satellites.

Medium-Range Satellites: Range is extended to one million miles (1,600,000 km). Cost: 4 points for six satellites.

Long-Range Satellites: The range is an impressive one billion miles (1,600,000,000 km). Cost: 6 points for three satellites.

Interstellar Satellite: The range is one light year! Cost: 10 points for one satellite.

3. Scouts: The station relies on 1D4 fast scout ships. The scout craft increase the range to cover half the solar system using their own sensors to augment the station's. Cost: 10 points.

4. Enhanced Sensors: The station has a wide range of sensors good enough to scan most of the surrounding solar system. Scanners include radar, radio, solar, every optical spectrum, thermal, motion, gravitonic, magnetic sensors and collision warning systems. The station will generally be able to tell when a ship enters the solar system and the likely intention/design of the vessel. Effective range is three billion miles (4.8 billion km). Cost: 20 points.

5. Superior Sensors: The space station has top of the line sensors and scanners in every category imaginable. This includes all of Number 4, but at a range of 1D4+1 light years beyond the surrounding system. Specific details about a particular ship are not known until the ship actually enters the solar system, but it will be detected beforehand and its travel route can be monitored. Cloaked vessels are still at the usual penalties to detect. Also, this sensor package includes a sophisticated bio-scanner able to detect how many life forms are aboard a given ship, and tell what type of species with a 60% chance of success. The bio-scanner's range is short, however, a mere 500 miles (800 km). Cost: 40 points.

Step Six: Communications

Communications are a vital part of a space station's operations. Satellites (Number Three) can be purchased to enhance the range of any of the other communications system.

1. Very Basic: The communications system is old and outdated. Range is limited to 150,000 miles (240,000 km). The station also has only one type of communications method. Choose from laser, sub-space communicator, or radio, and communication is limited to audio only. The current system does not have enough power to transmit images. Cost: Free.

2. Galactic Standard: The communications system is relatively modern. Range is limited to 500,000 miles (800,000 km) around the station, and all forms of communication are available with audio and video imaging. Cost: 5 points.

3. Satellite Augmentation: The quantity and type of satellites vary greatly. Different types are available with this option.

Short-Range Satellites: Provides an additional 200,000 miles (320,000 km) to the range of the existing system. Cost: 2 points for six satellites.

Medium-Range Satellites: Range is extended to one million miles (1,600,000 km). Cost: 4 points for six satellites.

Long-Range Satellites: The range is an impressive one billion miles (1,600,000,000 km). Cost: 6 points for three satellites.

Interstellar Satellite: The range is one light year, with a 5 second delay per light year! **Cost:** 10 points for one satellite.

4. Advanced Communication: All that is found in number two, plus two long-range satellites and a language translation system that translates up to 400 of the known languages in the Three Galaxies. Also includes a sophisticated scrambling system used to code or decode messages. **Cost:** 15 points.

5. Stellar Communications: This is the most advanced communications system in the Three Galaxies. All features in Number Four are included as well as four Medium-Range Satellites, two Long-Range Satellites and two Interstellar Satellites, plus the ability to send interstellar messages. Communication is only possible with a similar system or a capital ship. Also, the system is equipped with a holographic projection system giving a full three dimensional image. Range on the stellar communicator is up to 10 light years, but there is a delay of 1 minute per light year so conversations are kept brief. The use of an interstellar satellite relay reduces the delay to 5 seconds. **Cost:** 40 points.

Step Seven: Station Maintenance

Maintenance crews are needed to keep the space station operating at peak efficiency. Little problems are bound to occur from time to time such as micro-meteor impacts, air lock malfunctions, grime gumming up the works, and repairs after a battle. This will determine how efficient the station runs and how long repairs take.

1. Low Priority: Station maintenance is given a low priority. There is no dedicated maintenance team and some station personnel have to fill in for this role. Those doing so are under-

manned and inexperienced, but they can keep the station running at 60% efficiency. This means that at any given time (like during a crisis) there is a 40% chance (a roll of 61-00 on percentile dice) of a critical system malfunctioning. If the station is new, it will begin to run down and have minor problems in 1D4 years. After 10 years the station will begin to look old and slightly run down. If older than 25 years the station looks like a floating derelict or condemned building. Time for simple repairs can take hours, even days, and major exterior repairs will take at least one week if it is given top priority, otherwise 1D4+1 weeks! **Cost:** Free.

2. Secondary Priority: Station maintenance is considered a secondary priority. A small team is able to keep the station running at around 85% efficiency. The chance of a system failure due to insufficient maintenance is reduced to 15%. The station doesn't look too bad and should pass safety inspections, most of the time. Minor repairs take 6D6+4 minutes and major repairs only 1D6x10 hours. **Cost:** 3 points.

3. High Priority: Station maintenance is a major priority. Three full maintenance teams are on duty at various shifts to keep the station running at 95% efficiency. The chance of a critical system failure drops to a mere 5%. Major repairs can be done in 4D6 hours with all teams on hand; minor repairs 4D6 minutes. The crew is mid-level in experience and half are experienced in E.V.A. repairs. **Cost:** 8 points.

4. Top Priority: Same as number three, except the repair techs are mid- to high-level engineers. The station has a dedicated maintenance force on duty around the clock. If the necessary materials are on hand (and they usually are), a major repair can be done in 2D4 hours or a problem bypassed or a quick fix jury-rigged in 3D6 minutes. Operating efficiency for the station

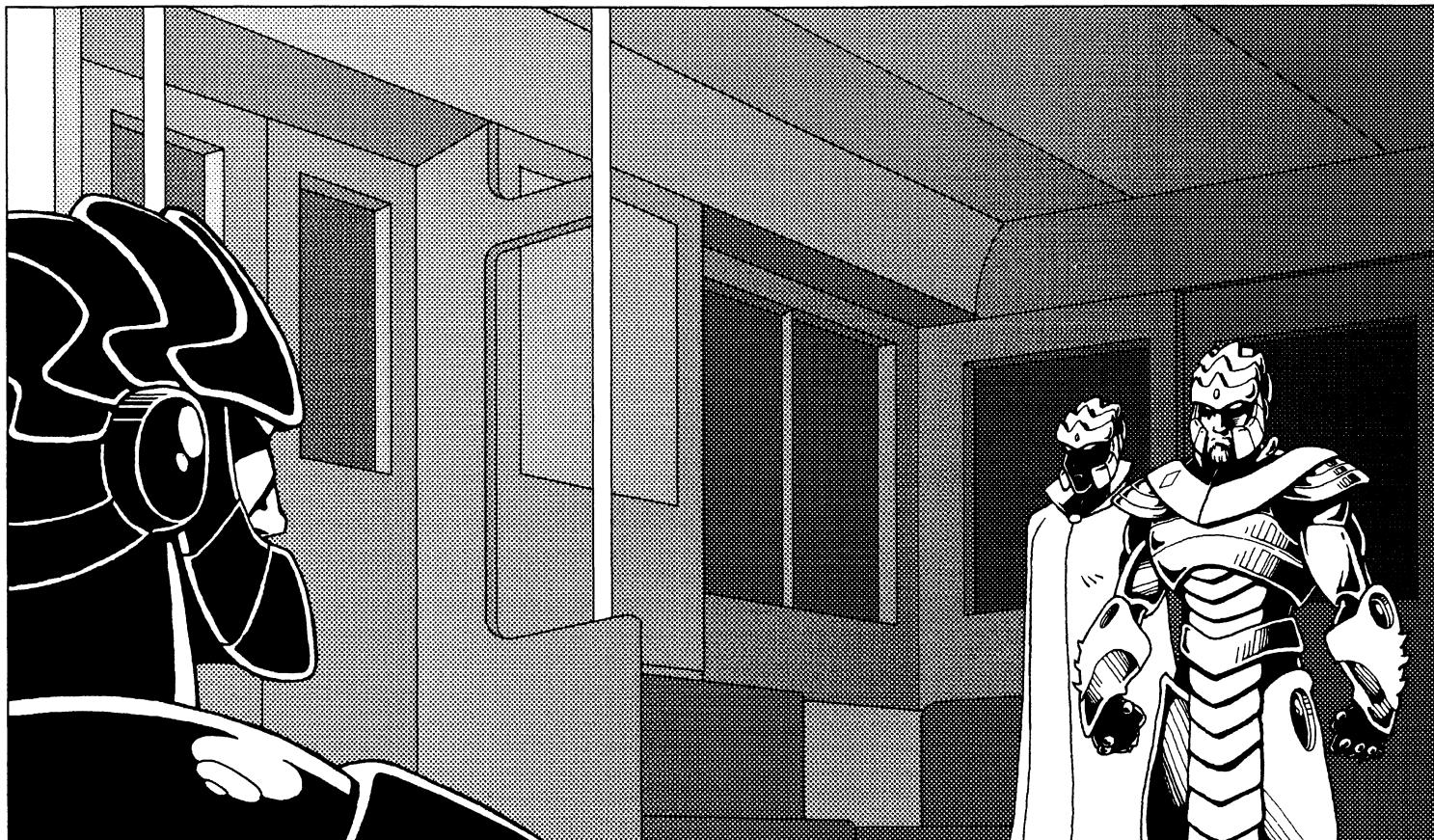

is 99%. As the focus on maintenance is so high there is only a 1% chance of a critical system failure as a result of improper maintenance. Cost: 15 points.

5. Automation: The station has minimal need for repair technicians. Robotic repair crews constantly roam the station doing all sorts of repairs and maintenance. The robots are equipped with all the tools they need to perform major repairs. The operating efficiency of the station is 100%! Unless there is some type of sabotage or damage from an outside force (enemy attack, asteroid shower, etc.) there is no chance of a major system failure as the repair robots are constantly on duty performing up to the second cleaning, repairs and corrections. Major repairs can be done in 6D6 minutes, minor ones in 6D6 seconds! Cost: 35 points.

Step Eight: Supplies

This step determines the level of self-sufficiency. Is the space station capable of manufacturing its own supplies as well as air and water, or are these vital things that the station needs to have shipped in frequently? Can the station grow its own food and manufacture its own spare parts? This step helps to determine the answers to these questions.

1. Dependent: This space station is like an island and in constant need of basic supplies being “shipped in” to maintain operation. Air is purified and circulated, but food, water, fuel, spare parts and other supplies must be shipped in at least twice a month. Cost: Free.

2. Semi-Self-Sufficient: The station is capable of recycling its own air and water, and has sufficient storage space to hold a greater quantity of supplies. On board facilities make basic uniforms and the most rudimentary supplies. Additional supplies, spare parts, gear, food and special items (and possibly fuel) still need to be delivered every few months (1D4+2 months). Cost: 10 points.

3. Self-Sufficient: The station is efficient enough to go for months before needing re-supplying (2D4+6 months). It produces and purifies its own air and water, hydroponics gardens grow food, and the station is capable of producing clothing, spare parts and other basic items. Cost: 25 points.

4. Super-Efficient: The station is capable of producing *all* its necessities, from food, water, air, and entertainment to clothing, medicine, spare parts, weapons, and even light spacecraft. Fuel may be the only thing it needs depending on the type of energy system it has (see Step Three). Only exotic and rare items cannot be produced on the station. The time between re-supplies can be as few as 25-50 months (5D6+20 months); twice that time if modest rationing is put into place. Recycling is an important part of life on this station. Cost: 40 points.

Step Nine:

Internal Security Personnel

This step looks at the type of *security personnel* on the space station. Who upholds the law, regulations, and keeps the station safe from internal conflicts, sabotage and invasion.

1. Undermanned: The station does not have enough personnel to go around. Security is very lax because they can't be ev-

erywhere at once. Crew members serve as a volunteer security team. Repelling a well armed group as large as a platoon of raiders/bandits/invaders (40 troops) will be a difficult and hard fought task. Cost: Free.

2. Minimum Security: The station has a small security team of 8-12, low- to mid-level combat personnel. They make regular patrols and guard vital locations. They may also organize a volunteer militia from the existing crew, adding another 12-24 untrained personnel to their forces in case of an emergency. Cost: 5 points.

3. Local Law Enforcement: The station has a precinct from the local police/constables in the system. Effectively, the station gives the local law enforcement authorities a place to set up shop in exchange for protection of the space station. These officials can arrest and detain people for breaking station protocols and local laws. They generally keep order in the station, break up fights and provide for internal defense. They will be at least mid-level (4-7th level) and have experience in surveillance, security systems and law enforcement. Half will have the Weapon Systems skill and can man weapon stations to help with station defense. For those space stations in neutral or uncharted regions of space, local law authorities will be whatever the host system uses, or the law officials from their home system. A police force will have dozens (hundreds for city-sized stations) of officers on duty around the clock. Cost: 10 points.

4. Private Security Force: The space station has a private security force (i.e., a small army for hire, the size of a company to that of brigade) trained by a private organization for space combat, defense and law enforcement. The majority are the equivalent of soldiers (2-4th level), with 25% trained in security systems and surveillance, 50% trained in Zero-G Combat and Weapon Systems, 10% are Special Forces or Military Specialists, and 5% are power armor pilots (1st to 3rd level). Generally, personnel will vary in level, with 80% being 1st to 4th level and 20% being 5th to 8th level. Cost: 20 points.

5. Crack Security Force: The station's administrators have hired experienced mercenaries or military personnel to fill the ranks of the security forces. All of these individuals will be trained in Zero-G Combat and Movement, E.V.A., Security Systems, Weapon Systems and Hand to Hand: Expert or Martial Arts. 20% are Special Forces, Military Specialists or Cyborg warriors, 10% are power armor pilots, 10% fighter pilots or weapons specialists (may include EOD). They patrol the space station around the clock and are expert at repelling raiders and invaders, as well as sniffing out saboteurs and spies. Average level of experience is 2-5, with officers and specialists at 4-8. Cost: 35 points.

6. Magic/Psionic Security: Any of the above security levels can be supplemented with the addition of a magic or psionic squad, platoon or company. Average level of experience is 2-4, with officers and specialists at 5-8. Cost: 10, 20 or 30 points respectively.

Step Ten: Security Systems

This step determines what types of security measures are in place and how extensive they are. It also indicates where law-breakers are put pending a trial or waiting deportation from the station.

1. No Security Measures: The station has no advanced alarms or security measures in place. They have to rely on word of mouth, cooperation and compliance from its inhabitants, volunteers and its security personnel, if any. A small room or cargo bay can be used as a holding bay or detention area for prisoners and suspects. Cost: Free.

2. Minimum Security Measures: The station has a dedicated frequency for security communications. Cameras monitor and basic alarm systems protect vital areas of the station such as power systems, command and control center, and defense systems. A security station is part of the station, but is little more than a monitoring room for the cameras and electronic alarms, and a locked weapon depot in case of emergency. The space station has minimum security protection in terms of alarms and warning systems. Only vitals areas have alarms. The "brig" has 1D6+2 prison cells and two small interrogation rooms. Cost: 5 points.

3. Medium Security Measures: The station has camera coverage, code key access panels and an alarm (when forced or an improper code is entered) on all air locks and vital areas. Security communications has at least three separate frequencies (one primary and two back-up) that can be scrambled. Security precautions are in place and key cards or some type of ID is needed to gain access to vital levels or areas of the station. The security station has a regular squad to maintain it (in addition to Security Personnel), EOD equipment, bomb sniffing robots and trained animals at their disposal, and a brig with 2D6+8 prison cells, four interrogation rooms, a meeting room, cafeteria, equipment lockers and administrative offices for the security and combat personnel. Cost: 10 points.

4. Magic Security Measures: All of number three plus magic security and monitoring systems to augment it and guard against magical and supernatural threats. Cost: 20 points.

5. Maximum Security Measures: Advanced locks, alarms, and code key systems usually tied into an advanced DNA identification systems, plus concealed cameras, electronic eyes, and invisible (to the naked eye) laser grid security systems are all standard safeguards. Guards, police and security personnel have advanced hand-held scanners and communicators. The security station is sizable, complete with a high security prison area with 48 cells, four solitary confinement cells, eight interrogation rooms, a video-monitor complex, secure evidence lock-up, crime laboratory, EOD area, gun firing range, cafeteria, administrative offices and a large command center. Cost: 25 points.

6. High-Tech Security Measures: Basically the same as Number Five but all the most advanced and expensive systems. Furthermore, each air lock has a sophisticated scan-way that shows all concealed weapons and contraband; only certain magicks can fool the machine. Security personnel have override codes to gain access to anywhere on the station if needed. They also have access to internal sensor systems to detect specific life forms and intruders. It can also be used to detect if someone has tried to gain access to any of the station's systems. The external hull service ducts/tubes are monitored by computer operated sensors and alert security personnel immediately to intruders, breaches or other problems. Security has its own level or complex within the space station complete with a state-of-the-art prison and a dedicated command center. There are 2D4x10+40 prison cells. Cost: 50 points.

Step Eleven: Medical Facilities

These are what types of medical resources are available.

1. None: The station does not have a dedicated medical facility. The best medical help one would receive on this station is a first aid kit. Cost: Free.

2. Basic Sick Bay: The station has a small sick bay, a doctor, two nurses and a trio of trained paramedics on board. The medical bay is very small and limited. Any type of injury that requires extensive surgery or intensive care will have to be taken off station. There are have 1D4+3 beds available. Cost: 5 points.

3. Full-Staffed Medical Bay: This option three medical doctors, two surgeons and a basic medical staff. Good medical supplies, a respectable medical bay with 3D6+12 beds and most injuries can be treated and surgery performed. Cost: 10 points.

4. Advanced/Medical Ward: Extensive medical facilities will have 1D6+4 medical doctors (at least one will have an M.D. in cybernetics), 1D4+2 surgeons on hand with a sizable staff of 3D6+20 trained nurses and 1D6+10 paramedics, plus administrative staff. All types of injuries can be treated, from the simple to the most extreme. A large section of the station will be dedicated to the medical ward. The med-bay will have 1D6x10+30 hospital beds, 1D4+2 isolation wards, pathology unit, ICU, forensics unit and 1D4+2 full medical labs for research. Cost: 25 points.

5. Psychic/Magic healing: The station has the same medical facilities as number 4 plus 1D4+4 Mages or Psychics trained in the healing arts; each is 4-9th level. Cost: 40 points.

6. Full Hospital: The station has the equivalent of a full hospital with an experienced, sizeable staff, the most advanced medical facilities, and beds for 200. Cost: 75 points.

Step Twelve: Environmental Systems

Each station is primarily set up to support a single type of life form. In order to survive in the rigors of space one needs a breathable atmosphere, moderate temperature, and gravity. The station has to be able to provide all of these basic requirements.

1. Primitive: The station's environmental system is old and outdated. It has no gravity to speak of and has a very basic air circulation system and life support system for only one type of atmosphere. The temperature is kept at the occupying race's comfort level. Cost: Free.

2. Basic System: The station has a fundamental, but reliable environmental and life support system. Gravity is achieved through rotation, so some parts of the station may not have gravity. The atmosphere and temperature can be more adjusted in individual sections as well as private living quarters. Cost: 10 points.

3. Advanced System: The station has an advanced atmosphere and temperature control system that can be adjusted to fit the particular needs of specific races throughout the station, but not individual rooms. As many as 16 different atmospheres can be replicated. Gravity is achieved through the use of gravity plates and can be modified throughout the station to the comfort level of the occupying race in that area. Cost: 25 points.

4. Super Advanced: The station has the same diversity as Number Three, but individual rooms as well as entire sections of

the space station can be adjusted to accommodate the needs of specific species. As many as 100 different atmospheres can be replicated. Cost: 40 points.

5. Complete Ecosystem: The station has the same controls as number four plus is able to simulate different ecosystems. From different types of light to exotic gas mixes, any race's needs can be met. Cost: 100 points.

Step Thirteen: Independent Business

Most space stations are given a budget by those who own and operate them, but some stations don't have the luxury of a government or military sponsor. By allowing various businesses to set up shop and rent space, a space station's financial needs can easily be met.

1. None: For some reason or another, the station does not have or allow independent businesses on the station. Cost: Free.

2. Small Businesses: 1D4+1 small businesses. These will include lodgings, restaurants, and general stores for supplies. Cost: 5 points.

3. Trading Post: A small section on the station is reserved for businesses. The types of businesses vary from retail stores and restaurants to entertainment and virtual reality simulations. There is also a place when visiting merchants are allowed to set up small stalls or shops for selling and trading a variety of goods on a temporary basis (3-28 days). Cost: 10 points.

4. Market Place: A large section of the station is dedicated to corporate business. Big names like Naruni Enterprises, HI-Industries, and Draygon Industries are likely to be competing against each other. In addition to offices, research and development, laboratories and light manufacturing, there is a giant mall-like market place filled with retail outlets, restaurants, theaters, and other forms of entertainment, as well as various services (banks, loan offices, massage parlors, laundry services, tattoo parlors, repair shops, pawnshops, etc.). The station is likely to have 1D4+1 major businesses, 2D6+2 smaller businesses and 100 or more retail shops. There will also be a section reserved for bartering and trading. Cost: 20 points.

5. Big Business: A large portion of the station is dedicated to business and light to heavy industry; basically Number Four, only twice as big and is likely to include those who deal in salvage. Cost: 50 points.

Step Fourteen: Transients

Transients are visitors who come and go, staying for a brief period of time, as well as those who either don't have a job or only make enough to barely survive, but don't make enough to buy a trip home. Most who come to a space station come hoping to land a good job, while others just ended up there by fate.

1. Forty percent of the station's population is transient. Cost: Free.

2. Thirty percent of the station's population is transient, mostly space drifters, mercenaries, adventurers and pirates. Cost: 5 points.

3. Job programs help reduce the number of transients to twenty percent of the station's population. Cost: 10 points.

4. Job programs combined with educational programs and an

intolerance for drifters help to greatly reduce the number of transients to the station. Only ten percent of the station's population is transient. Cost: 20 points.

5. Incentive programs combined with job training reduce the transient population to five percent of the station's population.



The individuals must perform some function to help maintain the station. This can be from working the sewage reclamation plant to pushing a broom around the station. Cost: 40 points.

6. Closed station. Visits from outsiders are discouraged. The number of transients has been reduced to less than two percent of the population. The station has an image to uphold so they will do anything from shipping the people off station to buying them a one-way ticket. (Very rare, but it happens.) Cost: 60 points.

Thundercloud Galaxy

The Algos System

The Algos system is a quad star system located in unclaimed space. The primary star is a medium red while the remaining stars are all dwarfs. This system is unique in that the stars are rather close together. Algos Beta orbits Algos Alpha, while Algos Cygma and Delta orbit each other in what would be the fourth orbital path. Algos Alpha is a medium red star. Spectroscopic analysis indicates the star is comprised mainly of hydrogen and that the overall temperature seems to be lower than normal. In a few million years the star may shrink to a dwarf like its sister stars. Algos Beta is a blue dwarf that orbits Algos Alpha. There is nothing significant about this star other than it emits a higher than normal amount of cosmic radiation.

Algos One: The first planet in the system, it is pockmarked with large craters and has no atmosphere. The only value the planet may have is high concentrations of carbon on the surface. This would indicate possible mineral wealth below the surface in the form of coal, diamonds and various precious and semiprecious stones.

Algos Two: This planet is barely able to support life. The surface is jagged and uneven with constant earthquakes rocking the surface. The reason for the severe surface conditions is because the planet is caught between four gravitational giants. This constant pull on the planet deforms the surface and causes frequent earthquakes and shifts in the tectonic plates. Giant mountain peaks and long, deep ravines run across the surface of the planet. There are no large bodies of water, other than the snow and ice found at the poles and at the peaks of the highest mountains. Preliminary scans have not revealed any life forms more evolved than single cell organisms and bacteria, though rumors persist of an ancient civilization that once inhabited Algos Two eons ago. Whether this rumor has any truth to it or is pure fiction remains to be seen.

Stars: Algos Cygma and Delta orbit each other and they in turn orbit Alpha and Beta. Both stars are dwarfs with the orange dwarf (Cygma) slowly cooling and may be a brown dwarf in as soon as a million years. The brown dwarf (Delta) is to the point where it no longer emits any significant amount of light. It is slowly burning itself out.

Algos Three: Algos Three is an ice rock that orbits Cygma and Delta as if they were in their own system. The surface is covered with frozen ammonia, giving the planet a yellowish appearance. The planet also has a thin ammonia atmosphere.

Algos Four: Orbits the second pair of stars and also is an ice rock. The surface is covered with frozen hydrogen and helium. There is no atmosphere to speak of. The hydrogen and helium form slush on the surface that is very volatile, however it does have the potential to be mined as a fuel source.

Algos Five: This gas planet may have been a failed fifth star due to its planetary mass being only 5 times less than the smallest star in the system. The planet is its own planetary system with 20 moons orbiting it. The sizes of the moons vary from as small as 500 miles (800 km) in diameter to 4000 miles (6400 km). It is not believed that any of the moons support intelligent life, though one or more are almost certain to serve as a base or outpost used by one or more bands of space pirates.

Artificial Body: At what would be the system's North Pole directly above Algos Alpha is a massive artificial body (moon-like structure). Scans have been inconclusive. All ships are warned to avoid this area of the system until a full and detailed analysis of the artificial body and the moons of Algos Five can be made.

Hook, Line and Sinker

Hook: Sent by the CPE (Consortium Planetary Expeditions) or other organization to do a more complete planetary survey, the player characters' scanners pick up the artificial structure in the system.

Line: While scanning the system the group's ship is encompassed in a bright yellow light that lasts for thirty seconds. Sensors indicate that they were just scanned by the artificial structure with a tight beam graviton emission. If the crew scans the structure at this point a massive bay door opens that can easily accommodate their ship.

Sinker: The group learns while examining the structure that it is:

Option one: A weapon of mass destruction that is powering up its main weapon by absorbing the cosmic radiation emitted by Algos Beta. The weapon is FTL capable and has set course for the closest habitable star system to destroy a heavily populated planet.

Option two: A genetic repository of the original inhabitants of this system. The main computer is trying to animate the keep-

ers of the repository, however, due to a malfunction the massive space station has taken the group of investigators to be foreign invaders and is using any and all means to destroy them in order to keep its contents safe and uncontaminated.

Option three: The structure is a massive data storehouse with all the accumulated knowledge of a dead race. However, the cosmic radiation from Algos Beta has destabilized the reactors and the structure will be destroyed along with all its precious knowledge unless the player characters can stop it!

The Barkohl System

The Barkohl system is a binary star system in the Thundercloud Galaxy. Its main star is a red giant and its companion star is a medium yellow. It is on a well-traveled *smugglers' route* in the Thundercloud Galaxy. It has no planets, only a constant *ion storm* that orbits the binary star. The red giant, Barkohl Alpha, is constantly spewing forth ionic particles that literally flood the system with ionic interference. A magnitude 2 ion storm constantly flows around the system. The problem is that exactly every 16 and a half hours the storm flares up to a magnitude six that lasts for three hours. Then it settles down to magnitude two. Pirates and smugglers use this system often. First, it's a bit remote, existing between habitable systems, and second, the ion storm is perfect cover to lose pursuers. Typically, runners or pirates fly right into the storm! After a few minutes they take off out of the storm at a different vector!

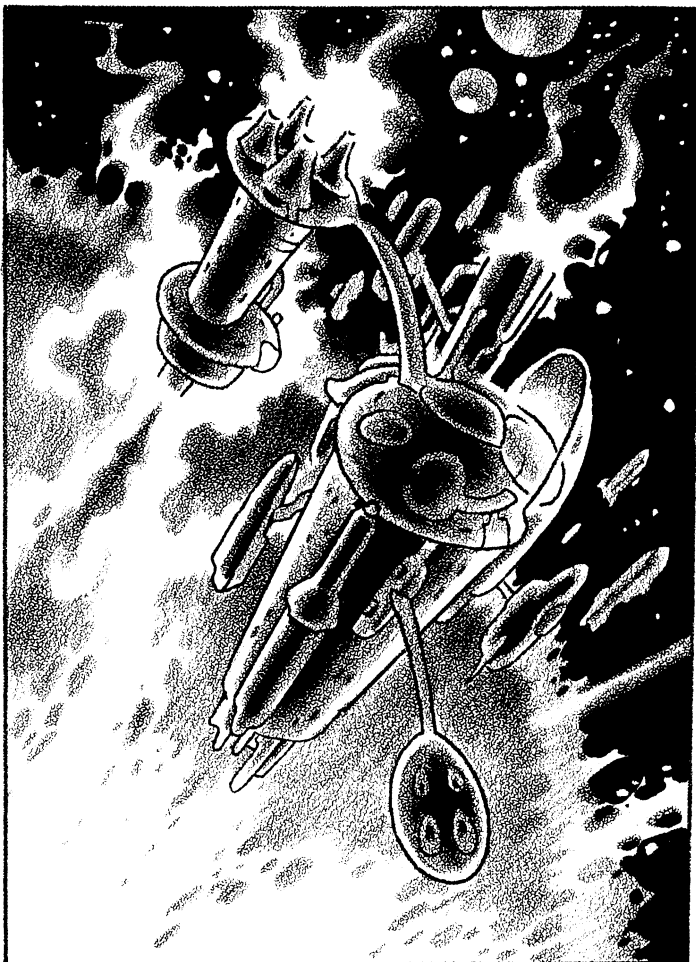

Ion Storms

Ion storms are the weather of the cosmos. All stars, nebulas and even planets give off energy particles. This is commonly known as the *solar winds* or cosmic radiation. Planetary magnetic fields are natural barriers and protect planets from this radiation. All spacecraft and space stations are equipped with similar shielding.

These particles tend to accumulate over time. They typically consist of highly charged particles of hydrogen and helium. When enough of these particles accumulate, all that is needed is a spark. Solar flares, planetary magnetic fields and even other ion storms can spark the particles into a highly agitated state called an *ion storm*.

Ion storms appear as a large cloud with lightning constantly flashing within. They also appear in all colors of the rainbow due to the many charged particles of various elements inside the storm. Ion storms tend to travel in straight lines, but are also affected by large gravitational fields. This can change their course and give the storm an unpredictable nature. Gravity fields also affect the speed of the storm. As the ion storm approaches, it tends to speed up, and slows down when traveling away from such a field. Speed varies from Mach one to the speed of light.

The sizes of the storms also vary. The smallest recorded storm was 15,000 miles (24,000 km) in diameter. The largest known was four million (6.4 million km)! Like any storm, they are typically avoided by intelligent life forms. With enough warning, a ship can easily outdistance these storms or totally avoid them. In some cases when this is not possible, all that can be done is to ride out the storm.

The effects of an ion storm are similar to a nebula. Due to all the magnetic and ionic interference, a ship's shields are rendered useless. Visibility is also reduced to a mere ten feet (3 m). It's not so much from the density of the cloud, but the constant flashing and sparking of the ions on the hull of the ship. Damage to a spacecraft is caused by corrosion on the hull and electrical discharges. In addition, ionic interference plays havoc with a ship's sensors, instruments and communications systems. T

The damage caused by ion storms depends on the magnitude. This is determined by the speed, density and size of the storm. The magnitude is measured from 1 to 10, one being the weakest and ten being a state of emergency. Ion storms with a magnitude of 1 to 4 are the most commonly encountered.

Magnitude 1: Damage is 1D4x10 M.D.C. per two minutes. Duration of the storm is 1D6x10 minutes.

Magnitude 2: Damage is 1D4x10 M.D.C. per minute. Duration of the storm is 1D6x10 minutes.

Magnitude 3: Damage is 1D4x10 M.D.C. per 30 seconds. Duration of the storm is 2D6x10 minutes.

Magnitude 4: Damage is 1D4x10 M.D.C. per minute. Duration of the storm is 3D6x10 minutes.

Magnitude 5: Damage is 1D6x10 M.D.C. per minute. Duration of the storm is 1D6x10 minutes.

Magnitude 6: Damage is 2D6x10 M.D.C. per minute. Duration of the storm is 1D6x10 minutes.

Magnitude 7: Damage is 4D6x10 M.D.C. per minute. Duration of the storm is 1D4x10 minutes.

Magnitude 8: Damage is 6D6x10 M.D.C. per minute. Duration of the storm is 1D4x5 minutes.

Magnitude 9: Damage is 1D4x100 M.D.C. per minute. Duration is 6D6 minutes.

Magnitude 10: Damage is 1D6x100 M.D.C. per minute. Duration is 4D6 minutes.

Note: Magnitudes 1 to 4 are considered a nuisance. Even the weakest space vessel should survive with communications and sensors reduced by 25%. Standard CAF procedure is to issue a warning to all ships in the vicinity and up to a light year away.

Magnitudes 5 to 8 are considered a space hazard and should be avoided at all cost. CAF procedure is to dispatch a long-range probe to track the storm and transmit a warning to all vessels in a four light year area. Communications and sensors are reduced by 50% while in the storm.

An ion storm with a magnitude of 9 or 10 constitutes a state of emergency. Standard CAF procedure is to dispatch a ship to follow and monitor the storm. Any space station in the path of the storm is evacuated. The ship monitoring the storm transmits constant warnings to all vessels within a four light year area for as long as the storm continues, or until it gets reduced in strength to a lesser magnitude of 1-4. All vessels are advised to avoid the path of the storm at all costs. Even magic vessels that are impervious to energy will take half damage due to the intensity of the storm. It should also be noted that these storms tend to travel the fastest, closing in at the speed of light. Sensors and communications are useless in this type of storm. Cosmo-Knights are unaffected by ion storms, only visibility is reduced (for them, by half).

Nebulas

Nebulas are simply giant clouds of gas. They consist of a variety of gases and sometimes stars! These gas clouds are huge, ranging from as small as a million miles (1.6 million km) in diameter to 20 light years across.

Nebulas are also the birthplace of stars! It takes millions of years, but eventually the gases coalesce with the help of gravity and begin to form into a sphere. When the heat and pressure are great enough, nuclear fusion begins and a star is born. If the star is massive enough it superheats the surrounding materials. As the star rotates the matter around it also begins to spin around the star like a disc. At this point the star and the flattened rotating disc is called a proto-system. After several million more years the disc flattens out and within the disc, matter begins to clump together. Thanks to gravity, these clumps of matter get larger and larger until they form spheres of their own. Eventually, after a billion years or so, a complete solar system is formed. All that from a cloud of gas!

Types of Nebulas: There are three types of common nebulas: Luminous Nebulas, Dark Nebulas, and Magic Nebulas.

Luminous Nebulas are alive with young stars within. All kinds of gases comprise these nebulas, ranging from simple hydrogen to more complex gases like xenon or argon.

Dark Nebulas are large gas clouds that usually have a star field behind them and the light from the nearby stars make the nebula appear to glow. Dark Nebulas can have stars in them, however these stars haven't started to glow and may not shed any light. A dark nebula may also be the leftover remnants of a supernova. In some respects, a star is like a phoenix and may

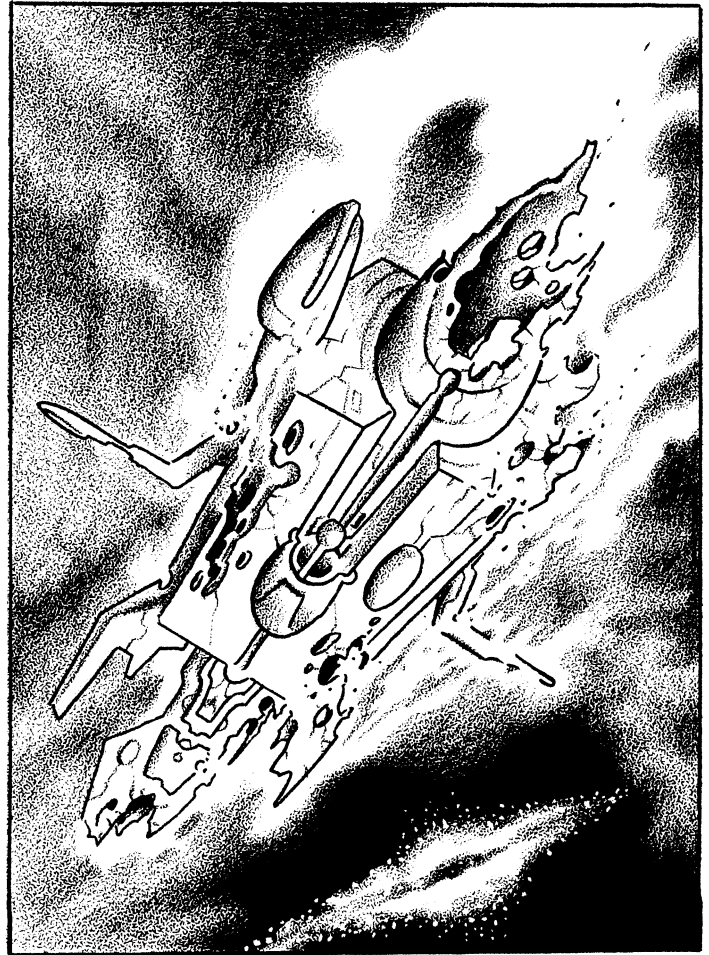

rise from its own ashes. After a supernova, the remnants may form a dark nebula, which one day may once again spawn a star.

A Magic Nebula can be either a dark or luminous nebula, but within it lays a series of ley lines and nexuses. This magic energy gives the nebula a bluish glow and it radiates strongly of magic. The risk one runs with a Magic Nebula is the constant ley line storms that ravage the nebula and the massive dimensional Rifts that appear out of nowhere, may lead to anywhere (or when), and stretch several miles in size. The effects of a ley line storm are in addition to all the effects of a nebula. The only advantage is to magic users and magic starships. Both will find that all magical effects are doubled as if on a ley line and tripled when near the heart of the nebula where several (1D4+2) nexuses are located. The doubling effect starts at about 500 miles (800 km) outside the Magic Nebula.

Regardless of the type of nebula, all have the following effects on any type of ship that enters the gas cloud (plus those of a ley line and ley line storm if a Magic nebula).

1. Visibility is limited to about 5 miles (8 km). Due to the different densities of the gasses, visibility is very poor. It's kind of like flying through a fog with electricity crackling through it and pulses of light or heat lightning flashing in the distance.

2. Defensive shields are useless. Nebulas produce low-level E.M.P.'s (electro-magnetic pulses) and static discharges that negate the effects of variable shields. Magic shields like Armor of Ithan and magic force fields, however, remain operational. Also, the CAF has recently learned that nebulas have no negative effects on the solid energy ships of the Intruder race. Consequently, most technological races avoid combat in nebulas.

3. Ship sensors are useless. The Read Sensory Equipment skill is -60%, Weapon Systems, Navigation and all communications skills are -30%. A successful roll means intermittent contact for 1D4 melees. Weapon locks are impossible, radio transmissions and laser/light based weapons and beams are reduced by one third (range and damage). This is due to particles reflecting the photons. Ion based weapons are at no penalties. Most ships have a collision warning system, but this sensor has its range reduced to 5 miles (8 km) in a nebula. Fast moving ships don't have a prayer at dodging, however, slower ships may be able to roll out of the way. Pilot rolls are -25% and all weapons are fired with no bonuses and are -5 to strike.

4. Some nebulas have a combination of gases that are caustic to spaceships, causing hull damage at a rate of 1D6x10 M.D.C. per minute. All exposed elements suffer this damage. This type of nebula does not affect Intruder race ships. Also, Cosmo-Knights appear to be impervious to all kinds of nebulas. Another gift of the Cosmic Forge?

Random effects in a nebula: Roll for every 12 hours of travel.

01-50% Nothing unusual, except for the effects of a nebula numbers 1-3, above.

51-60% The ship runs into a patch of caustic gas that begins to eat at the ship's hull. Damage is 1D6x10 M.D.C. per minute. The caustic gas can be passed through in 4D6 minutes at the ship's best speed.

61-70% Radiation field. Not lethal enough to penetrate the hull, but it's doing a number on the sensors and weapons. All sensors are blinded (except collision warning system) and all energy weapons are jammed. The radiation is interfering with the firing controls, paralyzing these weapon systems. Rail guns and missile systems still operate, but are blinded as well, -10 to strike.

71-80% Flammable gas! That's right, a large pocket of flammable gas that could be easily detonated by weapons fire. The pocket is very large and if detonated, will cause an explosion that is several miles in diameter. Damage is 1D6x1000 M.D. to anything caught at the center of the explosion and out to a radius of 5 miles (8 km). Everything for the next five miles (8 km) takes 1D6x100 M.D. The shock wave continues another 10 miles (16 km), inflicting 4D6x10 M.D. Beyond this 20 mile (32 km) perimeter, all a ship will feel is a large bump, and it takes no damage.

81-90% Turbulence. Gases of different densities rise and fall throughout a nebula. Most ships need a little time to compensate. This creates an extremely bumpy ride and unless the players make their sense of balance rolls (or are belted to a seat) they will take 2D6 S.D.C. from being knocked around. All piloting and navigation rolls while in the turbulence are at -20%. A failed roll means that the ship is off course by 4D6x100 miles (x160 km). The turbulence lasts for 2D4 hours.

91-100% A proto-star. The star is not powerful enough to shine on its own yet, but it is producing very powerful gravitational fields. Sensors are further distorted by an additional -10% and all piloting rolls are at -15%. A failed roll means the spacecraft is off course by 2D6x1000 miles (x1600 km). Due to the size of the proto-star, it will take 1D4+1 days to traverse the area, or twice as long to go around.

Hook, Line, and Sinker

Hook: The player characters are either passing nearby or are pursuing a group of pirates. A distress call is received from the Barkohl system.

Line: Upon entering the system sensors indicate that the distress call is coming from inside the ion storm. The problem is the magnitude 6 storm will start in just under thirty minutes. It will take at least 20 minutes of scanning the ion storm to even locate the ship and once found, possibly another 20 minutes to evacuate the ship.

Sinker: The distress call is a fake. A pirate ship is really lying in ambush for any ship to come and help. The pirates will board the players' ship after they dock. What are the pirates' intentions? Any of the following.

1. They want to rob the player characters of any valuables such as precious cargo or even credits.
2. They are skin slavers and want to sell the characters on the black market as slaves!
3. They are privateers planning on stealing the ship! The players will be put into a short-range shuttle or escape pod and left to fend for themselves, outside the storm.



The Carse System

The Carse system is on the edge of *Kreeghor space*. It has no significant value to the Kreeghor, the system just happens to fall within their borders. The star is a medium red with no unusual properties. Surrounding the star is an asteroid field. Independent asteroid miners have surveyed the system and it has potential for mining due to the high concentration of dense metals. However,

the system is avoided because it is rumored to have a base for the *Free World Council* hidden somewhere in the system. (Note: The rumors are true. The FWC has established a small outpost hidden in the asteroid belt. The area is heavily mined, and several defensive satellites are hidden among the asteroids. The Kreeghor suspect there is a FWC base somewhere in this sector of space, which contains nine other systems. The occasional Kreeghor cruiser passes through the system, but none have dared to enter the asteroid belt.)

Star: Medium red.

Asteroid Belt: Surrounding the star is an immense asteroid belt. It covers billions of square miles around the star. Hidden among the asteroids is a Free World Council military base. The base is built into one of the larger asteroids and the surface domes are concealed from casual observation. The asteroid belt is the perfect location for a base because the surrounding asteroids primarily consist of iron nickel, and various other metals. The asteroid belt is seeded with a variety of mines and satellites. This helps the base to keep track of Kreeghor activity, and if necessary, defend themselves. As for the base itself, I leave it up to the individual Game Masters to determine the base's purpose, and if it's small or large.

Carse One: A heavily forested world with a pre-industrial society of humanoids. Lucky for them, the Kreeghor have no interest in them . . . yet. The planet has no moons. The FWC avoids the world, not wanting to involve them in their conflict with the Kreeghor. Some argue against using the system with the potential risk, unfortunately, the system is of strategic importance to the FWC as it is a staging area for raids and an easy invasion starting point into four other Kreeghor controlled systems.

Carse Two: A medium gas planet with four moons, the planet's atmosphere consists of large amounts of the element argon, giving the planet an orange colored appearance with white, wispy clouds.

Three of the four moons are of little importance. The closest moon is a living rock. The surface is very unstable due to the gravitonic pressures of the gas planet. The second moon is a fire rock, with a phosphorus atmosphere. The third moon is a frozen rock with a toxic atmosphere and a surface too cold for any living thing to survive.

The fourth moon is habitable. No intelligent life forms live on the moon, only small mammals and lizards. A smuggling outfit uses it as a rest spot and base when smuggling items in and out of Kreeghor space. The FWC is aware of the base, but does nothing to interfere with it. After all, any enemy of the Kreeghor is a friend of theirs. If the Kreeghor were to attack the base, the FWC *might* even come to the aid of the smugglers, provided their help didn't compromise their base and operations in the asteroid field.

Carse Three: A rock and no atmosphere. The only unusual property is the surface is coated in potassium, giving the planet a white appearance; no moons.

Hook, Line and Sinker

Hook: The FWC has had a small skirmish with a Kreeghor Smasher that was patrolling the system. The ship broke off after several vital systems were damaged.

Line: During the battle, a FWC fighter was damaged and crash-landed on Carse One. The fighter's locator beacon has activated automatically to signal for rescue for the downed pilot.

Sinker: The Kreeghor's damage was not really as bad as they initially assessed. They have picked up the fighter's distress beacon and they want a live captive to question. The problem is they only have a general idea where the ship is and don't know exactly where in the system the ship crashed. Should the pilot be found on Carse One, the Kreeghor will take a definite interest in the system and may decide to enslave the people. The pilot has to be found or the beacon disabled as soon as possible. It's a race as the Kreeghor will be able to pinpoint the location within 2D6+6 hours. The problem is the fighter crashed in rough terrain and finding a landing site for a search party will take at least 1D6+2 hours and several more hours to search on foot. The forest is so thick vehicles will not be able to move through it and in addition, the FWC will want to avoid the natives.

A note on the cosmos

This is a good place to describe a few cosmic phenomena common throughout the universe. We place them here, since they apply to this sector of space.

Comets and Asteroids

Comets and asteroids are the trash of space. Just about all solar systems have them in large elliptical orbits. Some take as long as 100 to 400 years to complete just a single orbit. If they don't collide with another stellar body, eventually the gravitational pull of the local sun will draw them to a fiery demise.

Asteroids are just chunks of rock that can vary in size from a foot (0.3 m) to several hundred miles in diameter. All are pitted and scarred from their journey throughout the cosmos. Many asteroids are rock, with traces of nickel and iron, but carbon is also a common element, giving an asteroid a black color. Asteroids are commonly mined in the Three Galaxies, and some even contain vital elements for making Mega-Damage materials. Some asteroids get tossed out of their belts, sending them spinning toward a planet or moon. When an asteroid hits a planet it becomes a meteorite. These are commonly called shooting stars because most burn up in the atmosphere long before they impact the planet. Of course, large ones, bigger than a mile (1.6 km) across, may impact on the surface causing an explosion equal to a heavy cruise missile. This is a comparatively uncommon occurrence unless outside forces intervene with nature. (Unscrupulous raiders and invaders have been known to send asteroids careening toward planets as cheap, unguided bombs. However, asteroids can NOT be accurately aimed at a specific continent, let alone a specific city – some even miss the planet entirely – so this is, at best, a crude scattershot attack with dubious effectiveness.)

Comets can make a beautiful sight to behold. What most people don't realize is that a comet is nothing more than a giant, dirty snowball. Comets can vary in size from hundreds of feet in diameter to miles. The heart of a comet is called a nucleus, and it contains dust and gases. When a comet comes close to a star these gases heat up and stream away from the comet, forming the coma. The coma is what gives a comet the fireball appearance. It's also interesting to note that the tail of a comet always

faces away from a sun, even when the comet is speeding away from the sun. This is due to the solar winds and photons that push on the comet. Smugglers and people hiding from other ships have used comets to conceal their vessels. If a comet is big enough, a ship can park itself in the coma or tail and follow the path of the comet without being detected. A spaceship hidden by a comet is virtually undetectable, with the sensors of anyone scanning the comet effectively blinded by the material of the comet itself. To pick up anything other than what is radiating from the comet, the sensor operator is severely handicapped, -85% to skill performance. Even then, the only thing sensors are likely to pick up is the metal of the hidden vessel, which *may* give the ship away since most comets don't have any traces of metal, but which might also be ignored by the scanner personnel. On the negative side, the hidden vessel's own sensors are blinded by the escaping gases and particles, making all ship sensors unreliable; -60% on the operator's skill rolls to read and use sensors. Likewise, communications are garbled and range reduced by 50%. Another disadvantage is the heat from the comet causes continuous damage to the ship's shields and strains the cooling system. Damage is 2D4x10 M.D. per minute. Only ships with very strong shields can withstand long durations hiding behind or near a comet. And lastly, the comet's trajectory could carry the hidden vessel off course a considerable distance depending on how long it remains attached or in its tail. The speed of a comet varies; roll 2D6+6 (mach 8 to mach 18) to determine the comet's top speed. Ultimately, it can be a good place to hide if no one sees you go there to begin with.

Roll to determine the number of comets and notable asteroids in a given system. The largest asteroids are the most "notable" and actually small planetoids that measure anywhere from 10-100 miles (16 to 160 km) in diameter, but are fairly uncommon; about 1%. **Note:** In addition to notable asteroids and comets, at least half of all solar systems have one or two asteroid belts – a sea of floating debris with the size of most individual asteroids ranging from the size of a marble to golf balls and basketballs, to that of a two-story house or small office building.

01-30%: 1D20 comets and 1D20 notable asteroids.

31-69%: 1D20 comets and 2D20 notable asteroids.

70-00%: 2D20 comets and 2D4x10 notable asteroids.

Expanses

Expanses are a combination *nebula* and an *asteroid belt* only on a massive scale. Expanses get their name just from their sheer size. The smallest is only 10 light years across and a light year thick while the largest is at least a hundred light years across and 10 light years thick at its densest point.

Like nebulas, they are also the birthplace of stars. Every 20 light years there will be 2D6 stars or proto-stars forming. It is not uncommon to find whole systems nestled within an expanse. The problem is getting to them safely. Some places in expanses are more accessible than others and traveling at faster than light speeds can be very hazardous. Traveling at sub-light speeds could mean a trip that would take decades to complete! The standard is making small hops only going a light year or two an hour. Several well known expanses are mapped out, making travel through an expanse that much easier. Good credits are always paid to enterprising adventures willing to risk their lives to find the fastest trade route through an expanse.

Most nebulas do not contain enough solid matter to be a threat. Expanses are just the opposite. The debris and gases are spread over a large area, and due to gravity, the majority of solid matter such as asteroids and small planetoids are clustered together while the gases are more spread out. This leaves a lot of open space within the expanse, clear enough for ships to travel through without harm. However, one must be extremely careful and watch out for debris clusters and stray, wandering asteroids, and the gases in expanses tend to be far more radioactive and corrosive than those found in nebulas. Traveling through the gaseous areas has the same basic effects as going through a nebula.

To determine the size of an expanse roll 1D10x10 to determine the overall length of the expanse in light years and take 1/10 of that for how thick it is.

The dangers and effects of an expanse:

1. Debris: Since expanses are so large, the effects on a ship vary greatly. The most common hazard is collision with floating debris, from micrometeorites to planet-sized asteroids. Collision with any solid matter at light speed is certain death!

2. Magnetic interference: Like nebulas, expanses give off a lot of electromagnetic pulses rendering shields useless, sensors blind and communication range -50% to -75%.

3. Radioactivity: Expanses are thought to be as old as the galaxy. As a result, many elements break down and release lethal doses of radiation. All ships are shielded from radiation, but energy shields usually help to reinforce this safety measure. As shields can be useless at some points in the expanse, even the mighty hulls of the most powerful battleship may eventually succumb to the radiation. While the hull of a ship is designed to resist solar radiation, it can only resist so much, and eventually they succumb to the constant bombardment of increased radioactivity found inside an expanse. Spacesuits can prolong survival, as well as anti-radiation inoculations, but those options only buy a few hours to a few days at best. Damage from radiation poisoning is 4D6 points direct to Hit Points per hour of exposure. The effects of radiation poisoning are nausea, achy body, running a temperature and loss of hair. P.B. temporarily drops 1D4 while sick. A successful save versus lethal poisons and toxins reduces the damage by half and the symptoms do not manifest or bother the character at this point. Supernatural and magical creatures that do not save suffer 3D6 M.D.C. points of damage and any natural abilities to heal, such as bio-regeneration, do not work until outside the effects of the radiation, and even then it will take twice as long to heal.

4. Poor visibility. When not enveloped in gases visibility is normal, but while in a gas pocket that can go on for miles, sensor range and visibility are reduced by 1D4x10+50%.

5. Ley line storms. Networks of ley lines are known to criss-cross through expanses, and with ley lines come the chance of running into a ley line storm or even an enormous dimensional Rift!

6. Other stellar phenomena are commonplace in expanses. The most common are ion storms and plasma fields, but the occasional black hole has been found as well.

Due to the massive size of expanses, not all of the above effects will happen simultaneously. For the ease of the Game Master, he should decide ahead of time how long he wants his

players to spend in an expanse. Typical travel through an expanse is, at best, a week, and that's for a small one. Assume that the player characters will be able to use the star drive for short durations and sub-light speed to make course corrections and to fly around obstacles. Figure at least a week for every ten light years distance. Also take into account the durations in the table below. They should not add to the time, but rather be a part of what took so long to get through.

01-10% The expanse is having minimum effects and the shields and sensors are operating at full. Good speed. Take a day off the duration of the total trip.

11-24% A massive field of radiation is affecting the ship. Shields are holding but only at a diminished rate (roll 1D4x10+10% and reduce shields accordingly). To compensate, power to shields will have to be doubled. If for some reason the shields collapse at this point, the radiation will penetrate the hull in 2D6x10 minutes. See radiation damage above. This will only last for 4D6 hours.

25-34% Fluctuating magnetic fields are playing havoc on the shields. It is impossible to maintain full shields. The force field coverage is reduced to 1D6-1 sides; a roll of zero to 5, meaning if a zero is rolled, then the ship is without shields, but if a 5 is rolled, the ship is covered on five sides, leaving only one side exposed to the elements or a potential enemy. This will only last for 4D6 hours, but roll every two hours for the number of shields. Also note that the exposed side/sides are totally exposed and recalibrating the shield density does not help.

35-44% An Ion Storm appears out of nowhere. Roll 1D10 to determine magnitude of the storm.

45-50% A meteor shower begins to pummel the ship. Roll 1D4 to determine the type of meteor shower on the table that follows. Duration of the shower is 2D4 minutes.

51-54% A rogue comet pops into view. It's no threat and just one of nature's wonders. The players can watch as it soars through the heavens or take a quick hop at FTL speeds, taking a day off their journey.

55-60% Full nebula effects extend for a large region ahead and may take several days of travel to cross through. Roll 1D6+1 days to cross.

61-73% Full nebula effects, but with extreme radiation! Crossing through would most likely mean certain death, as it would take 1D4 days to move through. A better option might be to go around even though it will take twice as long.

74-75% A star has collapsed in the area leaving a small plasma field to go through. It will take 1 to 2 days to get through at sub-light speeds. Roll 6D6+6 hours to get through.

76-84% A full nebula that will take 1D6 days to cross. The problem is the nebula is full of debris. Every four hours in the nebula there is a 01-55% chance of encountering a meteor shower. Fortunately, the showers do not exceed a Type Three storm.

85-98% The travelers come upon a series of cosmic ley lines. They appear and disappear at random and will cover an area that takes 1D4 days to cross. For every 1D6+6 hours in this area there is a 01-45% chance of a ley line storm.

99% A solar system with planets. Unless the players stop to investigate, they can take 1D4 days off their trip by doing a quick jump through the system. They will still have to make

course corrections, but this region of space is relatively clear of debris.

100% A massive black hole, or space Rift dominates the forward view port. G.M. option or roll: 01-65% Black hole, 66-100% Rift. The ship may be caught in a gravity current and some serious piloting rolls will now be needed. I leave this in the capable hands of the G.M. to use as a plot hook as they see fit!

Meteor Showers

Meteor showers are chunks of debris, usually rock, ice, and sometimes metal or combination of all three, that hurl through space at breakneck speeds. They are normally harmless and easy to avoid by most spacecraft with sophisticated instruments to detect them. Sometimes running into a meteor shower is unavoidable, however. For example, a space station will often have a difficult time avoiding a shower, whereas a spaceship can just alter course and avoid the shower altogether, unless its sensors are out or the vessel is damaged and its maneuverability hampered.

Meteor showers are most common within solar systems, especially those with asteroid belts, and detecting them can be difficult as it depends on their size. Micrometeorites are the hardest to detect, being that the largest meteor in the group is the size of a marble. Most ship shields can easily absorb the damage a meteor shower has to dish out, but it is when a shower catches one by surprise and does hull damage that they are potentially deadly. Likewise, meteor showers are dangerous for creatures that can survive the vacuum of space without a spacecraft, and those outside their ships in space suits. Due to their galactic awareness, Cosmo-Knights have an uncanny sense to tell when a meteor shower is headed their direction. It's almost like a sixth sense that gives them about a minute or two advanced notice. Other creatures that can survive the vacuum of space may not have such sense and could get hammered by a surprise meteor shower.

Meteor showers form by several different methods. The most common is an intense collision in an asteroid belt that destroys a big asteroid. Because of the laws of physics the remaining chunks of the asteroid are hurled away from the impact point. If they have sufficient velocity to escape the asteroid belt, these chunks become a meteor shower. Over time, as the chunks of rock collide with each other, they become gradually smaller in size until they end up as micrometeorites the size of a marble or pebble. To add to the collision theory, other objects such as comets or rogue asteroids that sometimes plunge *through* an asteroid belt can send debris flying in every direction. Supernovas are also candidates for causing meteor showers. Even light years away a shock wave may still have enough energy to shake an asteroid belt apart. Remnants of shattered planets can be the cause of meteor showers as well, as can the debris of a shattered space station or fleet of spaceships blasted into small chunks.

There are five classifications of meteor showers. From Type Ones, which are the least dangerous, to Type Fives which can threaten a planet's population and become a planet killer! The Consortium of Civilized Worlds (CCW) developed this classification system and it has become the standard used throughout the Three Galaxies.

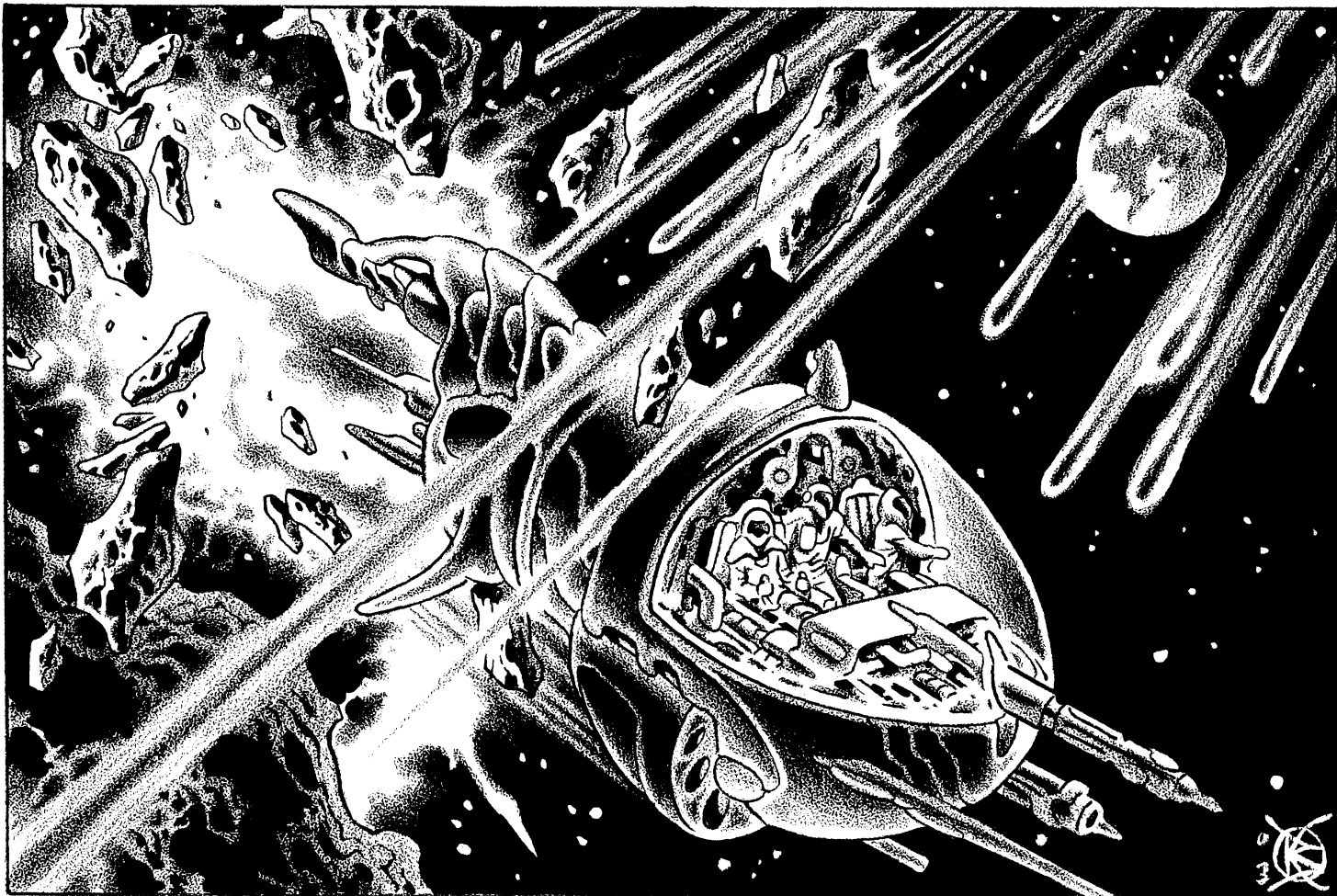

Type One: This meteor shower consists of millions of marble-sized and smaller meteors that travel between 10 and 15 times the speed of sound. Due to their size they are very difficult to detect, especially when one is not looking for them. At best, a ship's sensors will detect such a shower of micro-meteors at one mile (1.6 km) away. Hardly enough time to move most ships out of harm's way, but enough time to activate force fields and begin to move out of its path. Sensors are at -30% to detect micro-meteor storms unless they are specifically being scanned for, and in that case they are only -20% to detect. Damage is 2D6x10 M.D. per minute with a 01-18% chance of a minor hull breach every three minutes if shields are not erected.

Type Two: Consist of meteors ranging in size from marbles to basketballs. They also travel between 10 and 15 times the speed of sound. They are a little easier to detect and avoid. Sensors are only -20% to detect them and -10% when actively looking for them. The best ship's sensors can detect them is at 2.5 miles (4 km) away. This is usually enough time to avoid the shower by moving the ship out of the area of effect, but the piloting roll to do so is -10%. A failed roll means the ship was unable to avoid the shower in time and will take 1D4 melees to move out of the area. Damage is 4D6x10 M.D. per minute with a 01-28% chance of a hull breach every three minutes if shields are not raised.

Type Three: From a few feet in size to up to a hundred feet (0.6 to 30.5 m), Type Three meteor showers can prove to be deadly. When unexpectedly caught in this storm, these meteors are large enough for weapon systems to lock onto, and the biggest can be blasted to minimize damage. Damage is 1D4x100

M.D. every minute. There is a 1-40% chance per minute of a hull breach if shields are not in place. Fortunately, they are far easier to detect with a five mile (8 km) range and only -5% to detect on sensor rolls. There is no penalty for sensors that are actively looking for them. Average M.D.C. for the larger asteroids is 6D6x10.

Type Four: These meteor showers are one of the more feared types, with meteors measuring hundreds of feet in diameter to a thousand feet (305 m). They are easy to detect at a range of 20 miles (32 km) and unless a ship's sensors or propulsion system are damaged, easily avoided. The largest meteors can be tracked and targeted with a ship's weapons and blasted into pebbles. Damage from a Type Four shower is 2D6x100 M.D. per minute with a 01-60% chance of a hull breach every minute should the ship's force fields fail! Average M.D.C. of the large asteroids is 2D4x100.

Type Five: This category of meteor shower actually poses a threat to populated worlds. Meteors thousands of feet in size to a few miles (1 to 8 km) can destroy whole cities and possibly even cause a nuclear winter on a planet, killing all life, if the shower is large enough (super-rare). Type Fives are the most rare and usually some type of galactic event caused them in the first place! They can be easily detected at the maximum range of ship's sensors. Most ships can't survive for long in this type of shower and anything else in its path had better be evacuated well beforehand. Damage is 1D6x1000 M.D. per melee round (15 seconds) with a 01-85% chance of multiple hull breaches

(1D6) every minute. Even with full shields a ship will be knocked around like a leaf in a storm and all piloting skill rolls are at -35%. Damage for these meteors when they impact on a planet is 1D6x100,000 M.D. to a 20 mile (32 km) diameter! The next 20 miles (32 km) suffers 1D6x1000 M.D. points of damage from the shock wave and firestorm. The following 10 miles (16 km) suffers 4D6x10 M.D. from the heat and shock wave. The problem with this type of meteor shower is it rains down multiple meteorites (3D6) to an area the size of North America! With the current technology of the Three Galaxies it is possible to destroy one of these killer asteroids/meteors – the problem is there tend to be several (5D6) of these giant meteors in planet killer storms. Average M.D.C. for these huge meteors is 2D6x1000.

Meteor Shower Density & Duration

The density of a meteor shower varies from shower to shower. The durations below represent the true size of the shower. They may be spread out or concentrated. The time in minutes is how long it takes a meteor shower to pass a given point in space. The longer it takes for a shower to pass a certain point in space the larger the shower is. For example, if a type one meteor shower only takes a minute to pass a certain point it is most likely a thousand feet long, while if it takes 30 or more minutes to pass a point it is probably several miles long!

Concentration:

01-33% widely spread out.

34-66% scattered clusters, with each cluster packed with meteors.

67-00% pours down like rain, densely packed, regardless of size.

Duration:

01-40% 1D4 minutes.

41-60% 1D6 minutes.

61-70% 2D4 minutes.

71-80% 2D6 minutes.

81-94% 4D6 minutes.

95-99% 5D6x10 minutes.

100% 1D6x100 minutes.

Plasma Fields

Plasma fields are the remnants of an unstable star. During the birth of a star the material becomes compact and denser. This increases the gravitational pull and forms the star into a sphere. A plasma field develops when a star is not dense enough to pull itself together so it *flattens* out. The temperature was high enough to start nuclear fusion, so the active fuel remains and thus, plasma fields are born. The typical size of a plasma field is 3D6x100 million miles in diameter, but some can be twice to three times as large if more than one star was involved in the creation of the field of cosmic fire. Plasma fields last for millions of years. When they finally burn themselves out they turn into a dark nebula.

Plasma fields are like a system of tunnels or caves. When inside the plasma field, it looks like you're in a cave made of fire as plasma burns all around. There are many pillars that connect the floor and ceiling, which appear as cyclones of fire. These

blazing space tunnels can be traveled through with relatively no harm to the ship. The system of tunnels and caves stays consistent for centuries. Runners and Pirates like to hide and play chicken in plasma fields to evade capture or to lure their enemies to their doom.

So far, no habitable planets have ever been found in any of the known plasma fields. However, asteroids and small planetoids have been known to get captured by the weak gravity of a plasma field. If the planetoid survived the trip through the plasma walls it may remain intact in an open pocket. Planetoids and asteroids found in plasma fields usually contain large amounts of gold, platinum, uranium, and, to Naruni Enterprises' surprise, Killaryte! Mining these planetoids is very dangerous and most companies won't even consider it. Naruni Enterprises, on the other hand usually break all the rules, and regularly establish medium-sized operations in a plasma field in the Thundercloud Galaxy. Security is iron clad and only ships with NE's best shield technology enter.

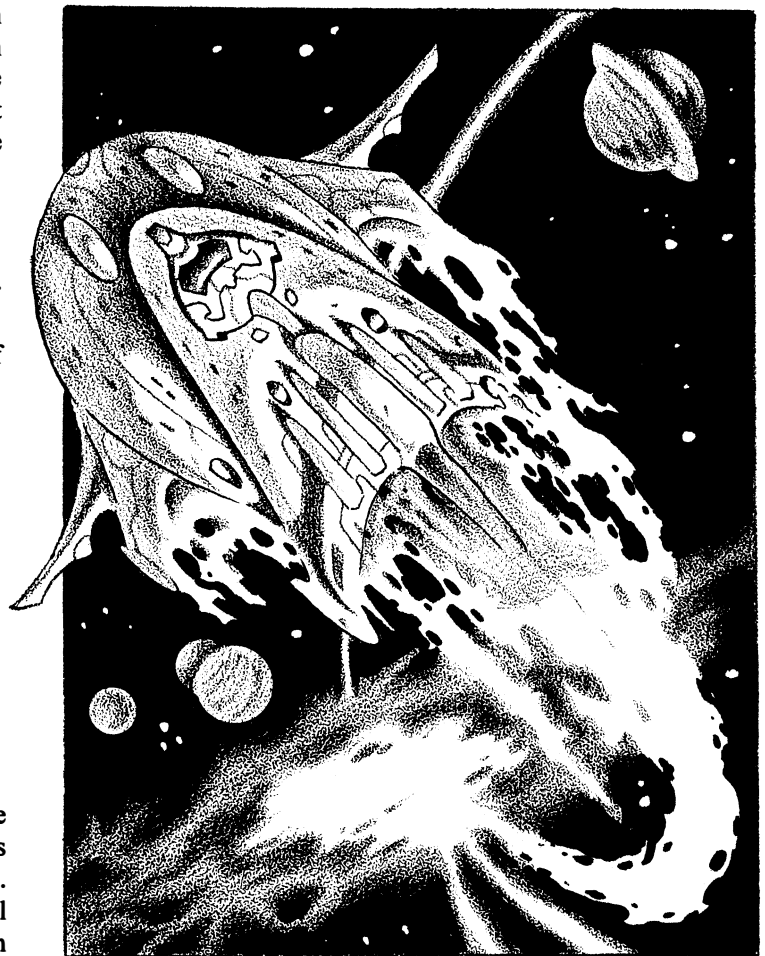

Details and Effects of Plasma Fields:

1. Walls of Plasma: These form the walls of the tunnels, caves and pockets inside the plasma field. They can vary in thickness from one mile to a thousand miles (1.6 to 1600 km). Typically, walls that separate open pockets are 3D6 miles (4.8 to 28.8 km) thick with the outer walls being 2D6x100 miles thick. The damage from passing through an inner wall is 4D6x10 M.D. and 1D4x100 M.D. from an outer wall per melee round. Fast moving ships can pass through outer walls in 4D4 melee rounds and inner walls in 1D4.

2. Tunnels and Caves: The diameter of a tunnel or cave can be as narrow as 1000 to 6000 feet (30.5 to 183 m) to as wide as one mile (1.6 km) to 3D6 miles (4.8 to 28.8 km). The length of the tunnel can be a short 3D6x10 miles (48 to 288 km) or run half the distance of the entire plasma field. Most have numerous holes – openings in the wall, floor or ceiling – roughly every 6D6x10 miles (96 to 576 km) where a vessel can safely enter and exit, or one can fly through the wall (see #1, above, for damage).

3. Plasma Pillars: Plasma pillars are formed by gravitational disturbances inside the plasma fields at random intervals, making travel through open pockets and tunnels dangerous. The sizes of the pillars vary dramatically, from as small as 1D4 miles (1.6 to 6.4 km) to as large as 1D6x100 miles (16 to 960 km). The flaming pillars look like cyclones of fire and plasma gas. They are a beautiful and deadly sight to see forming, for you see, plasma pillars rise and disappear at random. Damage from colliding into, or being struck by, a forming pillar is 1D4x100 M.D. The chance of being struck by a forming pillar is low, because small- to medium-sized vessels can easily outrace or dodge out of the way. However, ships with G-Drives have a larger chance of being struck if they engage their engines inside the plasma fields, because powering up their G-Drive actually attracts plasma pillars. There is a 01-65% chance every fifteen minutes that 1D4 pillar will form and strike the ship powered by this type of drive. The reason for this is because the ship becomes an artificial gravity well that attracts the pillars.

4. Adverse Effects: There are several problems when entering a plasma field. The first is the danger of plasma walls and pillars. Running into either can inflict tremendous damage (remember, one is flying through a flattened sun). The tremendous heat also strains the vessel's cooling system. Sensors work, but at a diminished capacity (one third normal range and -30% to be accurately read) and they cannot scan beyond plasma walls and pillars. Pillars form a blind spot to sensors with a radius of ½ mile (0.8 km) around the pillar. All sensors are read at -15% due to the distortion within the field. To make matters worse, there are a lot of gravitational disturbances within, making piloting difficult, so piloting skill rolls are at -10%. Few pilots risk flying through a plasma field due to the violent conditions found within.

5. Random effects while traveling in a plasma field: Roll for every six hours of travel.

01-20% Total calm, it's smooth sailing so to speak. The ship is only vulnerable to the adverse effects listed above.

21-39% Strong gravitational fields are constantly pulling the ship off course. It's as if the vessel is trying to go against the tide of a great river. All piloting rolls are an additional -10%. For every three consecutive failed rolls there is a 01-30% chance of the ship colliding with one of the plasma walls or a pillar.

40-44% An explosion erupts around the ship. This is caused by a spark from the ship igniting the free-floating gas in the area. Damage is 5D6x10 M.D. and shakes the vessel in its shock wave for 1D4 melee rounds, during which time skills requiring a steady hand are -30% as the ship is buffeted by turbulence akin to a riding a bucking bronco. Any characters manning a sensor station (roll at -10%) will have a few (2D4) seconds warning and effectively, the ship can try to roll with the explosion for

half damage. Roll a successful piloting skill evasive maneuver with a -10% penalty.

45-54% A firestorm spews forth deadly balls of plasma. Any ship or object is pummeled with 2D6 mini-fireballs of concentrated plasma. Damage is only 1D6x10 M.D. per each fireball, and small- to medium-sized vessels can try to dodge without penalty. Large vessels are -6 to dodge. All vessels need a roll of 14 or higher on a D20 to succeed.

55-64% The ship comes across an open region where there are several (2D4+2) plasma pillars. This is a difficult region to navigate. Reduced speed and care are a necessity. Grazing a pillar does half the usual pillar damage.

65-75% Close quarters. A narrow passageway connects to the next open space or tunnel within the plasma field. For any ship passing through, piloting is at -10%. Any failed roll results in grazing the plasma walls, doing half the normal M.D.

76-87% A dead end. After several hours of travel, the player's ship comes to a dead end from which they have to turn around and find a new way out.

88-94% A massive plasma whirlpool dominates this section of the plasma field. This is generated by a massive gravitational current that is drawing everything into the whirlpool. Vessels find they have to fight the massive gravitational currents or be sucked into the whirlpool. Surprisingly, damage is a comparatively (all things considered) light 5D6x10 M.D. but the vessel is hurled or warped 2D6x100 miles (320 to 1920 km) off course, and may not know where they are (01-50% chance the unexpected trip knocks out navigation and all long-range sensors for 1D6 hours).

95-00% A small planetoid is found! This is just a big rock between 100 (160 km) and 1,000 miles in diameter (1600 m). Such planetoids are typically very rich in precious stones and minerals. Or is this one something different?

Dark Web

Sometimes called the Dark Web Death Camp, Dark Web is a Kreeghor hellhole located in a binary star system with only two planets. The two planets were originally mined for their military grade metals. Now the planets serve as prison worlds.

The Kreeghor were about to close shop on the system when there was a slave revolt at the mines. The slaves saw an opportunity to escape, unified and struggled to subdue their taskmasters in order to make a break for it. They failed miserably. As punishment, the chief of the Invincible Guardsmen buried 5000 slaves alive. This same Invincible Guardsman is the one who suggested turning the two planets into prison worlds. He had become accustomed to living the easy life and was used to entertaining his own sadistic pleasures by tormenting and abusing the slaves. Wanting to keep his little tin-plated empire, he called in a few favors and sold the Kreeghor Empire on the prison idea with him as warden. A year after the mines were shut down, construction on the prisons began. Two years after the revolt, the mines had been converted into prisons, with one medium and the other a high security prison compounds.

Each planet has about four-dozen defense satellites and heavy-duty shields cover the main installations. A pair of Smasher class cruisers also patrol the system and four squadrons

of Flying Fangs complete the system's minimal defenses. On the ground, each facility has a complete company of Imperial Legionnaires, in addition to the prison guards and a dozen Invincible Guardsmen on the high security world. Security is light because few outsiders threaten the prison planets even to attempt a breakout of a loved one, the Guardsmen or Legionnaires can handle any jailbreaks, and the prisoners, even if they escape their prison compound, have no place to run. Unless there is a spaceship waiting for them, or the prisoners can secure one from the Legionnaires, they remain stuck on the rock. As for invaders, who the heck wants to liberate the worst criminals and scum of Kreeghor society? Not many. And if the prisoners are slaughtered in an attack . . . good riddance.

Dark Web One (DW1): The planet is a fire rock. It has a sulfur atmosphere with active volcanoes and rivers of lava. The atmosphere is toxic to humans and Kreeghor alike, and the surface temperatures range into the hundreds of degrees Fahrenheit. This makes the self-contained prisons unbearably hot despite environmental countermeasures. The facility on DW1 is the maximum-security prison for the worst of the worst. It has a large surface facility that connects to an underground network of caves, abandoned mines and old lava tubes. This prison caters to the tough aliens (read as Mega-Damage) and those with special powers, abilities and/or reputations for being hard to handle. All kinds of power dampeners are used and when nothing else works the Invincible Guardsmen beat them into submission. Rumor has it that a Cosmo-Knight is counted among the prisoners.

Dark Web Two (DW2): This planet is a frozen nitrogen wasteland. Geysers of liquid nitrogen dot the planet's surface. The medium security prison is located here. Normal races are put into this prison and more die here from exposure than from heat exhaustion on DW1. To keep the prisoners active, they work in a gas processing plant bottling liquid nitrogen as well as

other forms of menial labor. This is a medium security prison, but under the guardianship of the despot warden, it is worse than most maximum security prisons.

Note: The Invincible Guardsman known as Jerrot the Punisher is warden of both worlds, which he sees as his one private empire. He is infamous for his cruelty, brutality, acts of degradation and abusive methods. He loves to belittle, hurt and break a prisoner short of killing them, not that he has any trouble with murder, or torture. He is one of the most hated beings in the Kreeghor Empire, and he loves every minute.

Hook, Line and Sinker

Hook: The players are contracted to fly a group of mercenaries. The pay will be good, between 500,000 and one million credits.

Line: The group is told to head to system SY 989-608-380. A successful Stellar Navigation roll tells the player characters the system is in *Kreeghor space* and a Galactic Lore at -20% will tell them it is home to the Kreeghor hellholes known as the Dark Web! If the heroes confront the mercenaries, they are told they are trying to free some comrades who got captured in a noble operation against Kreeghor tyranny.

Sinker: The mercenaries are really members of the Free World Council (FWC) and are attempting to liberate an intelligence agent who got captured. The FWC has complete plans and layouts of the prison compound where the agent is being held (or so they believe, they honestly don't know how reliable their information is). What the FWC doesn't know is that the warden has somehow (a traitor among them?) caught wind of their little prison break scheme, has added security, and he and a couple other Invincible Guardsmen wait for their arrival. Those who are not killed in this rescue mission are likely to be cap-



tured and added to the prison population without a legal trial or judgement. New playthings for Warden Jerrot. The player characters should understand the risk of this mission. Do they help the FWC or drop them off as soon as they find out?

The Eden System

Eden was one of the first star systems settled when the Consortium of Civilized Worlds (CCW) was first formed. It has been a valuable system from the onset, providing food production and a strategic position for the CAF (Consortium Armed Forces) against the Kreeghor. It is a binary star system with three habitable planets, two of which produce enough food to feed a quarter of the CCW. Sadly, only about 20% of that number actually sees any of the food and they are considered the upper elite class of the Consortium.

Star Alpha Prime: Eden's primary star is a red dwarf. It is thought to have been a medium star at one time and may have shed its outer layers, destroying Eden 1 and 2. The star is now a stable red dwarf that maintains the mass of when it was a medium star.

Eden One & Two: These two worlds are both dead rocks covered in craters and scars. Neither have any significant mineral value. Both planets appear to have been blasted and scorched by intense heat, contributing to the theory of the red dwarf having once been a medium red star.

Eden Three: This beautiful jewel of a planet is a bountiful harvest of fertile land, farms and food production. In fact, the planet is known by most as "Bountiful Harvest." This Earth-like world has one of the mildest atmospheres, most consistent rain and weather patterns and richest soil in the Thundercloud Galaxy. Farms dot the landscape of the four major continents and kelp and fish farms plumb the warm seas. The planet produces so much food in excess that it could easily feed three other planets with the population of Malthus' World. However, most of the food grown on Eden Three is shipped to wealthy worlds and sold primarily to aristocrats who have the money to afford the high priced "Eden Delights." You see, Bountiful Harvest has a reputation for producing the largest, juiciest, best tasting produce in the Three Galaxies. Thus, a fraction of its resources are deliberately used and the produce overpriced and sold to those willing to pay top dollar for it. In addition to being luscious and flavorful, the produce is very resistant to bacteria and viral strains, particularly the wheat. This makes its grain products a very much sought after commodity, so they can be grown on other worlds that are less than perfect. The problem is Bountiful Harvest holds all the patents and rights to producing the grain and they are not selling their secrets. Bountiful Harvest has one moon.

Eden Four: Eden Four is a dead world that seems to be the victim of a planetary collision. There is no atmosphere and the mantle is cracked like an egg. Sixty percent of the surface is an impact crater. Fossil evidence indicates that at one point Eden Four did have life and may have even been Earth-like.

Star Beta: Eden Beta is a medium orange star. Like a planet, it also orbits Eden Alpha. Scientists were initially baffled as to how the inner planets managed to survive being between two stars. The gravitation forces should have ripped them to pieces, but it would seem that the two stars form a perfect ratio in astro-

physics, a two to one ratio. The dwarf star exerts twice the pull of the medium orange, therefore, in effect canceling the pulling effect on the inner planets. It is a delicate balance, but one that has obviously lasted millions of years. As for the outer planets, they are pulled right along behind Eden Beta.

Eden Five: A medium gas planet rich in hydrogen and helium; it is often mined for these gases. The planet has twelve moons, eleven of which are rocks and one has a thin atmosphere and could be terra-formed into a habitable terrestrial world.

Eden Six: Another medium gas planet with fifteen moons. The planet has large quantities of ammonia and carbon dioxide, giving the planet the look of a muddy snowball. Thirteen of the fifteen moons are trapped asteroids and small planetoids, the remaining two have thin atmospheres with toxic gases; none bear life.

Eden Seven: Like Eden Three, this planet has an earth-like environment ideal for farming and food production. The inhabitants specialize in raising cattle and herd animals that are either native to the planet or have been relocated to Eden Seven. This was actually the first planet colonized in this system. When the populations of the respective planets were high enough, the colonies were granted independent status and began to govern themselves. At the request of the Eden authorities, the CAF was brought in to use Eden 8 in exchange for protection from pirates who were raiding food shipments out of the system.

Eden Seven, often known simply as Eden or Eden Prime, has a history of producing the finest beef and meat products in the Thundercloud Galaxy. The lesser quality meat sells for as much as 1000 credits per pound while the premium meats can sell for upwards of 10,000 credits per pound! The reason for the high price of the meats is because they are all natural, no genetic manipulation or added chemicals like steroids, and the cost of delivery to other worlds is expensive. Special ships equipped with a stasis field (freezing them drives the prices down and also diminishes the quality) must transport them. Stasis equipment is expensive to begin with and also very expensive to maintain.

Eden Eight: This desert world has a thin, but breathable atmosphere for humans. The CAF uses the planet as a training base, supply depot and regional strategic outpost. Many CAF ships pass through this system to transport foods from E-3 and E-7, as well as to re-supply materials and manpower at Eden Eight. The main base on the planet is a small military compound the size of a city; population of 75,000 at any given time and can easily accommodate 150,000 if necessary. There are also sixteen other bases located around the planet. The main space port is at the city-compound, but there are three others. If nothing else, the CCW doesn't want to see the Eden system be ravaged or taken over by the Kreeghor, so this world has great military importance.

Eden Nine: The planet has a reddish green appearance from space. This is from the high concentrations of copper and iron on the surface that have oxidized. The result is a beautiful planet with a deadly atmosphere. The planet is avoided, as all metals begin to oxidize (or rust) upon entering the atmosphere. In game terms, 1D6 M.D. is done per hour to all exposed metal surfaces. This includes the metal parts of a spacesuit and any type of Mega-Damage alloys. It is also rough on plastics and other materials. The surface is very rocky and the high winds make for difficult flying. What little information the CCW has on the at-

mosphere is that it consists of oxygen, nitrogen, argon, and krypton. The deadly combination of elements literally liquefies any living carbon-based creature in a matter of minutes.

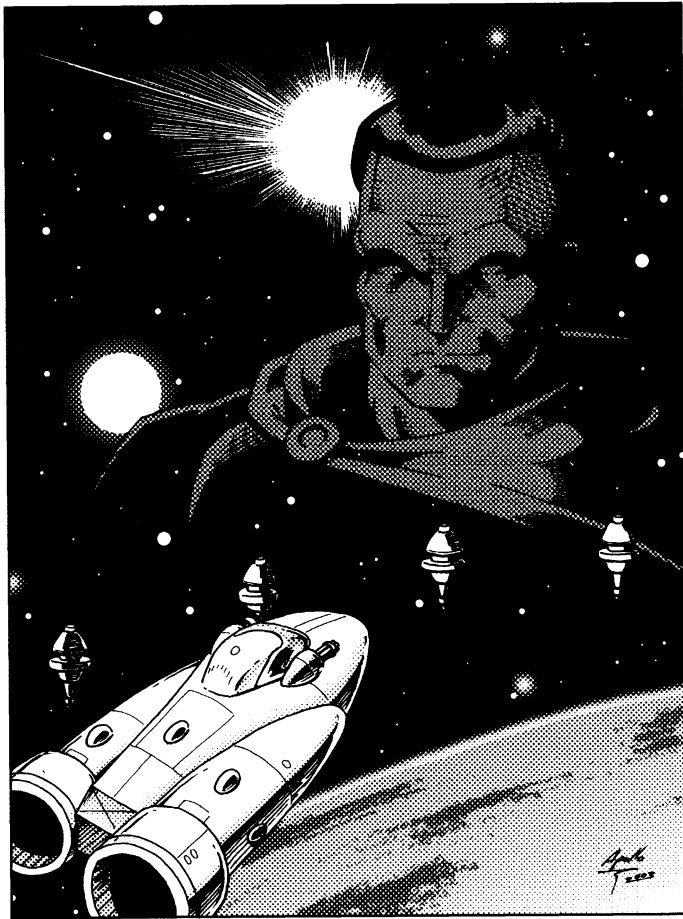

Fecklar's Star

Fecklar's Star is a white dwarf star surrounded by an intense plasma field. The plasma field surrounds the star with a radius of 26 billion miles (41.6 billion km). The star was named after the scientist who studied it for over 40 years. Dr. Stalvin Fecklar was a Noro scientist who was researching the thermodynamics of the plasma field. His objective was to learn how the field continued to regenerate itself. He then planned to apply this knowledge to an experimental perpetual power source that could continually renew itself. His last report five years ago showed great promise. He had set up an experimental plasma generator that was supplying power to the entire small space station and reputed to have enough energy to spare to power a city-sized station.

When the next re-supply ship arrived carrying a group of CAF scientists to see this marvel, they were greeted by an immense debris field. The doctor, his staff of 200 personnel and 3000 other inhabitants were all (presumed) lost. The star was named in his honor.

What really happened was Dr Fecklar's report was intercepted by a group of Dark Coven members calling themselves *The Demon Horde*. Taking full advantage of the isolated science station and looking for a remote base of operation, the Demon Horde staged an elaborate attack. Using a combination of illusion and dimensional spells, the station was easily taken. The Doctor and half of his staff are in their custody, the rest were either killed in the assault of the space station or have been tortured to death or killed in gruesome magic rituals.

The Demon Horde knew that the CAF would be on their way once the doctor failed to submit any further reports. They also failed to jam the area so a brief distress call was sent. Fortunately for the Demon Horde, it was an automated beacon with no details of why the station was in distress. So to hide the station it was towed into the plasma field! The doctor had mapped about 40% of the field during his research, so it was easy to find a safe hiding place. Cargo containers full of waste and debris were destroyed in the vicinity of the station. As the station was only a million or so miles away from the plasma field, intense scans would not be able to conclusively detect all the mass of the station and what destroyed it.

The results speak for themselves. The Demon Horde escaped detection and has been using the station as a base of operations in the Thundercloud Galaxy for nearly five years. The Demon Horde's goals are not really clear. They consort with all manner of demons, steal all kinds of magic knowledge and magic items, but their actions have been chaotic with no pattern. The leader of the Demon Horde is a ninth level Elven Witch, named Serrah. He is said to be linked with a powerful demon lord and has a greater demon as a bodyguard. All types of other demons are summoned to the station via summoning circles. Most are used for small missions or to add to their own ranks. As for what they want with Doctor Fecklar and the space station, it's anyone's guess. It could be they want his perpetual power generator, except they don't seem all that interested in it.

Fecklar Star Hook, Line, and Sinker

Hook: The players are asked to come to Phase World to honor a fallen comrade. The fallen comrade should be a prominent person like a Cosmo-Knight, or CAF fleet captain.

Eden Hook, Line and Sinker

Hook: The player characters are given an offer they can't refuse. A gentleman on Phase World is paying double the normal prices for top of the line Eden beef. One of the characters just happens to have a good contact on Eden Seven who will give them a great deal. The gentleman from Phase World is looking to purchase a minimum of 500 pounds (225 kg).

Line: The beef is easily acquired and the group is ready to depart the system. Getting the beef should be easy and bought for a fantastic wholesale price!

Sinker: Well, if you haven't figured it out yet, the gentleman on Phase World is *Thraxus*. Word arrives to the group as they are leaving planet that the meat has to be delivered in three days or less! No problem, as Phase World is only 48 hours away, the group will have plenty of time. The catch is TVIA has been randomly checking ships for *contraband* and other items that shouldn't be leaving the system. The ship just in front of the characters has been quarantined due to the discovery of a dangerous viral agent detected in a load of meat from Eden Seven. An announcement is made that all ships carrying meat from Eden Seven can expect a 48-hour quarantine period. What do the characters do? Jump the gun and try and lose the TVIA inspectors who will be hot on their trail, or do they go through the inspection and have to deal with an angry Thraxus who has a state dinner with 350 guests, all expecting Eden beef in 72 hours?

Line: Before the day of the funeral the body is stolen!

Sinker: After investigating the disappearance, the player group learns that the Society of the Knife was hired to steal the body. It seems that they stole it for a group of mystic terrorists and lunatics known as the *Demon Horde*. If the characters act fast enough, they will be able to tail a ship leaving Phase World and heading directly towards Fecklar's Star.



Fecklar's Station

M.D.C.: 50,000; after attack: 36,165. Space station size: Small Science Station.

1. Station's function: Science +10 points to Sensors, Medical Facilities, and Power Systems.

2. Power Systems: Experimental plasma generator. This has had certain benefits to the station's subsystems as noted below. 50 points.

3. Defenses: Point Defense System, Short-Range Weapons, and Shields. Shields: 24,000 M.D.C., 4,000 M.D.C. per side. (Were 12,000 M.D. but the generator has given the shield generators a big boost. Point Defense system: Seven laser cannons (three destroyed during the attack and never replaced) that do 2D4x10 M.D. with a range of 12,000 feet (3,658 m); was 6D6 M.D. with a 6,000-foot range (1829 m) but doubled due to the generator. Short-Range Weapons: Four short-range laser cannons that do 2D4x10 M.D. and have a 3-mile (4.8 km) range. These used to be 1D6x10 M.D. with a 2-mile (3.2 km) range but have been increased by 50% due to the generator. All other systems seem to have been doubled. Total Cost: 27 points.

4. Sensors: Enhanced. 20 points
 5. Communications: Galactic standard (range doubled due to plasma generator) and one interstellar satellite. 15 points.
 6. Station Maintenance: Priority. 8 points.
 7. Supplies: Semi-self sufficient. 10 points.
 8. Internal Security: Undermanned. Zero points.
 9. Security Systems: None! Zero points.
 10. Medical Facilities: Common. 10 points.
 11. Environmental Systems: Advanced. 20 points.
 12. Business: None. Zero points.
 13. Transients: Job programs. 20 points.
- Total Points available: 180 (Total Points spent: 180)

The Galamon System

The Splugorth control this system. A young Splugorth intelligence by the name of Roxcryth rules this system and three others. She is currently trying her hand at doing some expanding into other dimensions and has sent her agents into several prospective dimensions, including *Rifts Earth*. The Galamon system is currently her home and base of operations.

Stars: Galamon Alpha is a medium blue, and the primary star in this binary system.

Galamon One: Despite being very close to Galamon Alpha, this planet is an icy rock. The surface is covered with frozen methane and nitrogen. The surface of the planet facing the sun boils in the daylight. These combinations of gases give the planet a thin atmosphere of nitrogen and methane. The dark side is a frozen wasteland.

Galamon Two & Three: Each is a fire rock with a primitive atmosphere that consists of sulfur dioxide. Both have mining potential for heavy metals such as uranium and plutonium.

Galamon Four: This Earth-like planet is 90% covered in water! This is where Roxcryth calls home. The surface is dotted with about 20,000 islands. The biggest island is her home and it only measures about 150 miles (240 km) across! It has a dimensional pyramid at the center with a sprawling city around it, the City of Mist. There are three underwater cities fit for humanoids and five other cities for creatures such as the Metzla.

Roxcryth hails from an unknown pocket dimension where she ruled the populace for thousands of years before deciding to leave. She and her minions, then conquered some lesser dimensions. However, it was not until she found the Three Galaxies that she realized what real power was. Then she heard of Rifts Earth and the magic power that coursed through that world, with her agents quickly learning about Splynncryth and his empire. For now she sits idle, content with her power base in the Three Galaxies, but dreaming of Rifts Earth and the potential it offers.

While not as powerful as Rifts Earth, Galamon Four is covered in ley lines. Along with the natural storms, ley line storms course through the planet system of ley lines constantly. Only the City of Mist is protected due to the stone pyramid.

Galamon Five: A small, ringed gas planet with 9 moons. It attracts all sorts of stellar debris such as comets, meteors and planetoids. Most harmlessly crash into the gas planet while others are hurled further into the system.

Galamon Six: This icy world is a frozen wasteland with extreme temperatures that can plummet as low as -125 degrees. Despite this, Roxcryth has colonized it with approximately two million slaves to mine *glacial water*. The glacial water has special properties used in healing potions and other alchemical components. Sold by itself, without any additional magic, the water can fetch as much as 500 credits per gallon.

Star Two: This red giant is slowly shrinking and may go supernova in about a million years. Until then, Roxcryth is not going to worry about it.

Galamon Seven: This proto-planet is still molten on the exterior and may cool off into a solid planet in several hundred thousand years. It has a primitive atmosphere consisting of oxygen, nitrogen, sulfur, and carbon dioxide. Three small, lifeless moons are in its orbit.

Galamon Eight: A small, ringed gas planet with 9 moons. The planet has potential to be mined for deuterium, commonly called heavy water. This compound is commonly found in nuclear reactors and is still in demand on some of the developing, low-tech worlds.

Galamon Nine: A small forested world with no oceans. It does, however, have massive rivers that run the length of the planet! Roxcryth has a small colony started here as well. The pyramids are still under construction. Unknown to her, several bands of space pirates have base camps and hideouts established on the planet. Moreover, an obscure local legend places the Cosmic Forge on the planet. Though this is unlikely, if word should spread, Galamon Nine could become a site visited by Forge pilgrims and seekers of every variety. This would be an unwelcome turn of events that would only provoke the foul Alien Intelligence to violence.

Galamon Ten: A barren icy rock with a fluorine atmosphere.

Galamon Eleven: A lifeless planet with high concentrations of magnesium and lithium. This gives the planet a dark blue appearance from orbit. It also has three thin rings with one moon floating through them.

Galamon Twelve: A medium gas planet with 13 moons. All are believed to be lifeless.

Galamon Thirteen: A habitable stony desert planet that is rocky and the surface scarred and cratered. As some point in its history, this world seemed to have been susceptible to bombardment by meteors and comets, but that seems to have stopped at least a few millennia ago. This has led some to believe the blasted surface is not the result of solar debris, but some sort of devastating war that obliterated all signs of the civilization that once dominated this planet, or so the theory goes.

The surface is covered by giant craters, shallow circular lakes, deep ravines, strange stone formations and high mountains. Much of the planet is riddled with networks of caverns, caves and subterranean tunnels. Those who dare to brave the foul but breathable atmosphere and bleak desolation use the caves as secret hiding places, weapon depots, treasure hideaways and base camps – mostly used by pirates, freebooters, smugglers, spies and adventurers. Some say even a few Cosmo-Knights keep a secret sanctuary on Galamon Thirteen.

The planet seems to be trapped in a perpetual state of twilight. Its sky is almost black and the air filled with grit and dust from all the particles swirling around and carried by the wind.

The planet currently seems to be going through the tail end of a nuclear winter. The atmosphere is breathable, but the environment harsh and lifeless. The winds and dust storms are a constant, though seldom more than 25 mph (40 km); typically 5-10 mph (8 to 16 km) with breaks in between that last for 1D4 hours at a time. Gas masks or air filters, goggles and a tough protective clothing, a hood or helmet (if not full environmental suits) are a must, otherwise the skin is pelted and worn red and bloody as if sandblasted or rubbed raw by sandpaper within a matter of 1D6+2 hours. Those without proper gear will feel as if grit fills their eyes, sand and dust fills their mouth and the airborne grime swallowed by the pound leaves a chalky taste in the mouth and causes a heavy, slightly nauseous feeling in the stomach (visibility is half, speed is reduced one third). Characters with heightened senses will feel as if they are being buried alive and all abilities function at half the usual range (half the skill percentage, range, etc.). The caves, of course, offer respite from the wind and dust.

Hook, Line and Sinker

Hook: A certain individual in Phase World is looking to acquire 100 gallons of Galamon glacier water. He is paying 50,000 credits a gallon!

Line: A reliable source gives the characters exact coordinates of Galamon Six. All they have to do is slip in past some Splugorth ships. If they can be in and out within eight hours they will completely miss the next patrol.

Sinker: Thraxus is the individual wanting the glacier water, and he always gets what he wants. That is why he contracted six other teams to get the water as well. The group should learn of this just prior to landing on the planet. Who knows, maybe when they're in orbit with several other ships it'll tip them off. Bottom line is Thraxus will only pay the first group to arrive at his door and since the market will now be temporarily flooded (pardon the pun) with glacier water, the price will go down to only 1,000 credits a gallon on Phase World.

Note: Other adventurers could revolve around bandits, pirates, refugees, hermits or even a Cosmo-Knight taking refuge on Galamon Thirteen. Maybe the player characters need to locate someone said to be hiding in one of the tens of thousands of caves, or maybe a particularly nasty group of pirates (or dragon) has turned one of the caves into their lair, etc.

The Hyrill System

The Hyrill System is home to the Hyrill Stellar Corporation. Their expertise is terra-forming: Turning non-habitable planets into habitable worlds by human standards. After searching for 12 years and surveying hundreds of systems, the perfect system was found. System SY-399-826-264 was one system among thousands until it was found some 26 years ago.

The technology of terra forming was first introduced during the early days of the Consortium of Civilized Worlds (CCW). At that time, it took longer to travel between star systems, so it was thought if non-habitable planets with the right properties could be changed into livable planets, they would be able to save time and credits. However, after terra-forming got off to full swing, there was a sudden explosion in Faster Than Light



(FTL) technology. G-Drives became cheaper and faster and phase technology was being introduced around the same time. Both made space exploration easier, faster and cheaper, and reduced the need for expensive terra-forming. *Hyrill Stellar Corporation* (HSC) has been able to stay in business due to some innovative thinking and three hundred years later, they are the industry leader in artificial planet development. It is one of the biggest corporations in the Thundercloud Galaxy.

HSC has a history of success. They have successfully terra-formed 18 planets, each a beautiful paradise. The problem is it takes between hundred and one hundred and fifty years to successfully terra-form a planet properly. There are shortcuts (50-80 years), but inevitably shortcomings and problems will exist (i.e., desert regions, unstable atmospheric conditions, insufficient water supply, toxicity in the air, higher than acceptable levels of radiation, etc.). Doing planet building right, however, is incredibly expensive and drains significant resources from any terra-forming company, often to the point of bankruptcy. HSC managed to survive by diversifying themselves into numerous mining and exploratory operations, as well as building industrial space stations that help to fund the terra-forming business. It also helps that they own some of the most advanced terra-forming secrets and technology in the industry. Moreover, when the long process of making a planet paradise comes to fruition, selling and leasing land rights and development takes another generation or two to realize, however, once the process gets going, the rewards from owning a planet can be huge. The success of HSC comes from the momentum of having so many successful planets and related re-

sources in their galactic portfolio finally paying off some 150+ years after their creation.

HSC named this system after themselves for a good reason. This system is their latest experiment in terra-forming. Advancements in atmospheric processing and the introduction of nano-technology into a biosphere have yielded fantastic results. They claim to have reduced the terra-forming time from an average of 100 years to 25 years, and it may be true. After 24 years the atmosphere on Hyrill Two is now breathable, a dramatic shortcut from the typical 50 and 75 years it used to take. Over half of the land is fertile enough to support plant growth and start the process of oxygenating the atmosphere, and the acidity of the water has been reduced to acceptable levels. HSC publicly announced that this planet will be ready within one solar year and has already started showing the planet to interested parties. They will soon be taking land lease and planetary rights bids! This planet can support over 100 different races in the Three Galaxies. If HSC can deliver on their new, amazing promises, this is only the first in a string of planets that can be developed and sold off piecemeal or whole (the latter is rarely done, but with such a quick terra-forming, HSC is considering selling a few planets outright to recoup expenses quickly to fund new and more profitable operations. This could reshape the terra-forming industry and make it a new, booming business in a matter of years.

Hyrill One: Classified as a living rock, the small planet has been a mining boon to HSC. The planet is rich in one of the hardest substances in the Three Galaxies, diamonds. Within the last 20 years, over 100 billion credits in raw diamonds have been mined. It still yields diamonds to this day.

Hyrill Two: This was the first planet in the Hyrill System to be terra-formed. It was originally a type one non-habitable terrestrial planet with a carbon dioxide atmosphere. Twenty-four years later it is almost Earth-like. The atmosphere is thin, but breathable. Microorganisms are present in the soil confirming that it can support life, and the oxygen generators go online in six months. If all goes according to plan, this planet will be ready to receive colonists in one solar year.

Hyrill Three: Terra-forming began 10 years ago on this planet. It was also originally classified as a type one non-habitable terrestrial planet. The atmosphere was poisonous and radioactive elements were found in the soil. All contaminants have been removed and the six atmosphere processors are operating at full capacity. It is estimated this planet will be ready for colonizing in 15 years, but that's a generous estimate and may be more likely 18-24 years.

Hyrill Four: A small gas planet with three moons. The planet is not suitable for terra-forming but one or more of the moons may be. HSC is considering its options right now.

Hyrill Five: Never wasting an opportunity to bring in extra revenue, HSC has contracted out to have this giant gas planet mined for its high concentrations of gases. Gas ships constantly run between H2, H3 and H5 with the excess gases being sold to help offset production costs.

Hook, Line, and Sinker

Hook: HSC is contracting pilots to start escorting potential bidders to Hyrill Two. Pay will be good and based on the distance traveled and number of passengers brought.

Line: Several days into one of the planetary excursions, the players return to their ship to find an HSC technician. He has been seriously wounded and may be dying. This person has a disk containing raw data from HSC's central computer core. The disk shows projections on the planetary terra-forming process. It seems only a small section of the planet has been stabilized and the rest of the planet will not be ready for some time, possibly several years. Also, two of the atmosphere processors have failed, and the nanites are inert and not functioning as they should. HSC failed to meet certain deadlines, which has fouled up the new and improved terra-forming technique.

Sinker: HSC security is looking for the technician and the data disk. They will do anything to get it and cover up any shortcomings or problems with the terra-forming of Hyrill Two. If the player characters are caught, they'll be kept alive only until the disk is recovered. After that, they and all other "loose ends" shall be dealt with accordingly and buried where no one will ever find them (probably on Hyrill Two). Even if the player group doesn't care about the problems, the simple fact that they *know* will be enough for HSC to take extreme actions to eliminate anyone who knows more than they should. This is a large cover up and the characters are right in the middle of it!

The Icarus System

This system was once a mining boon to the Consortium of Civilized Worlds. It has three asteroid belts and when it was first discovered, it was thought these asteroid belts were rich in ores and minerals essential to the Consortium space fleet. The innermost belt did prove this to be true, unfortunately, the outer two belts were mostly rock and ice. Today all that is left is a colony on Icarus One and it seems to be in decline.

Star: Icarus Prime: This is a medium yellow star in the prime of its life.

Inner Asteroid Belt: Originally rich in heavy metals ideally suited for ship construction, this asteroid belt was heavily mined up until about 10 years ago. Asteroid mining ships were constantly coming and going to this rich source of ore. Now, all that is left are abandoned hulks, pitted and scarred from floating among the rocks for a decade. Most are not even worth salvaging.

Icarus One: The surface is covered in rocky debris and the atmosphere and pressure are deadly to the human race. Yet, Icarus One is home to one of the oldest colonies in the CCW. *The Devron Colony* was established to aid the miners who worked on the inner asteroid belt. The colony has grown over two centuries to approximately 30 miles (48 km) in size. It contained ore processing plants, ship part manufacturing centers and even an agricultural center to make the colony self sufficient. At its peak, the colony had a half million people coming and going, but it slowly declined over the years to a stable population of around 8,000. Furthermore, certain parts of the colony have fallen into disrepair, and 70% is abandoned and sealed off.

The colony continues to produce ship parts, but not in the quantity it used to, and just enough to barely keep going. With the population at an all time low, there is talk of just abandoning the colony and starting over. Most of the remaining diehards refuse and insist that somewhere there lays an undiscovered cache

of ore. Whether a pipe dream or true, for the time being, they stay and search for it.

Icarus Two: This is another cold, lifeless rock that has no resources at all and the atmosphere is extremely caustic, damaging all ships that come in contact with it.

Icarus Three: A medium gas planet with 10 moons. This planet and its moons offer no value and are just a nice sight to look at.

Outer Asteroid Belts: These are both very thin in terms of asteroids and consist mainly of rock and ice. Thought to be largely smashed comets there appears to be nothing worth mining, not even the ice, which is just frozen carbon dioxide.

Hook, Line and Sinker

Hook: The players have been hired to do a delivery run to the Devron colony in the Icarus System.

Line: The cargo the adventurers are hauling is medical supplies and the colony is in urgent need of them. The majority of the medical supplies are fresh blood! The blood will need to be refrigerated and will have to arrive as soon as possible.

Sinker: Upon arriving in the Icarus System the first thing the player group notices is that they were not even hailed as their ship approached. All they will pick up is an automated beacon. This beacon transmits all necessary data, allowing the vessel to land at the colony space port. While touching down in the space port the group notices several out of control fires at the edge of the colony and towards the living sector there are several large hull breaches!

When the players do lands the colony's administrator welcomes them. He appears pale and clammy and his eyes briefly glow red in the darkened hangar. He tells the group that a plague has struck the colony and only he and a few others are free from its effects. He is most anxious to have the cargo unloaded. During the unloading, screams and the banging of metal can be heard in the distance.

What really happened is a Master Vampire has invaded the colony, turning a third of the population into Secondary and Wild Vampires. The rest of the people are food and slaves. A Secondary Vampire will try to sabotage the player characters' ship. Our heroes must struggle with trying to repair the ship and keeping away from the vampires, as well as possibly rescue some of the human colonists. Of course, the Devron colony used to make spare ship parts. Whatever the player group needs is likely to be somewhere in the colony. They only need to locate it, get it, and bring it back to the ship through a gauntlet of vampires. Thankfully the sun has just risen, giving them 9 hours of daylight before . . .

The colony is well suited to the vampires. It is very dry, and the sun shines only nine hours per 25 hour cycle. The adventurer group's only hope is to make a fast, clean getaway as soon as possible, but "cleaning out" Devron and rescuing innocent humans could be an extreme challenge for vampire hunters, even an Undead Slayer. Does the player group come back to help weed out this vampire nest? Could a vampire have stowed away aboard their vessel?



The Junkyard System

The Junkyard System is home to a well-known corporation called the *Stargazer Corp*, one of the largest makers of commercial interstellar spacecraft. They produce more than a dozen types of spacecraft including freighters (small to large), pleasure yachts, cruise ships, tugs and shuttles to name a few. Surprisingly, they have not delved into making military spacecraft of any kind. They have a large enough industry simply selling commercial ships.

The shipyards around JY2 are huge! Hundreds of ships are docked in berths around their heavy industry space stations – each a city-sized complex – while others are in construction berths awaiting final assembly for custom orders. Ships are constantly coming and going. The traffic is very congested and busy and one can expect to be in a holding pattern for several hours waiting to get docking clearance. Perusing the goods is not allowed without a sales representative.

Junkyard One: Is a living rock, rich in heavy metals such as uranium, plutonium, and iridium. These metals are used in the construction of most of the ships' power plants, and some are combined to form the Mega-Damage alloys used in the ships' framework.

Junkyard Two: A habitable swamp, this damp and muddy world is being strip mined for the abundance of titanium and other metals used in the construction of starship hulls. There are 150 mining sites around the planet with a new one being located approximately every two months. A primitive simian race regularly attack the "space invaders" but with little success in ousting them. Stargazer Corp has kept this little secret under wraps for years and it could be one of the reasons why they do not

have any military contracts, to avoid close scrutiny. Galactic corporations are not supposed to undermine developing species nor rape the planet they inhabit. As it is, the current inspector has ignored the presence of a developing intelligent life form and spends long hours enjoying his new space yacht.

Junkyard Three: Also known as "the yard," this planet gave the system its name. This small planet is one large junkyard. All recyclable material within a hundred light year radius gets brought here. Two giant recycling plants work around the clock breaking down the items to their base components. Cheaper and lesser quality spacecraft are made from 100% recycled parts! This planet has no atmosphere and is classified a dead rock.

Junkyard Four: Not wasting any resources, SGC has converted this small airless planet into a large storage facility. The planet is more dense than is typical for a planet its size. This has resulted in higher gravity of 1.6 g's. Eleven storage facilities are scattered around the planet. Each roughly covers a five mile (8 km) area. All manner of items are stored here, including SGC atmospheric vessels to test the integrity of their hulls. Anyone can rent a storage lot. The sizes available start as small as a safety deposit box to as large as a starship hangar. Prices also vary accordingly, from 50 credits a month to 250,000 credits a month. Security is included, however people can pay for extra security methods such as a personal guard, robotic sentries, passive and active sensor sweeps. Cost is usually determined by the amount of added security and can sometimes raise the base price by as little as 10%, or up to a staggering 300%. Security measures already in place include defensive satellites and a complement of about a thousand guards per facility.

Junkyard Five: A medium gas planet that is mined by SGC. A large assortment of gases are mined and used for starship construction. They include gases used for coolants, life support, and hydraulic systems. At any given time, at least four gas ships are in orbit collecting raw materials to be processed and delivered to SGC.

Junkyard Six: Called the "Trader's Rock," this barren planet has a ring of ships in orbit. From fully intact ships and shuttles to empty space frames, all are bought, sold, and traded here. All the action really happens in orbit. A refurbished, Jupiter class freighter serves as the office for this trading outfit. It is still part of SGC, it just specializes in used ships. SGC usually pays 30 to 40% of the fair market value of any ship brought to them that is not over 20 years old, or has less than 500,000 light years on it.

Hook, Line and Sinker

Hook: Stargazer Corp is looking to hire a small troubleshooting team. The deal is to take care of a small problem on JY2, and in exchange they will give the group a light spaceship or equivalent in credits if the group already owns a ship. G.M. Note: This could be a good way to get your players that starship they've been asking for.

Line: The characters are brought to JY2 care of Stargazer Corp. They are to take charge of a group of volunteers to help defend a few of the mining sites on planet. The tour is for roughly two months (G.M.s, adjust the time as you feel appropriate), during which time the characters will visit about a half dozen sites.

Sinker: From time to time the group will actually have to defend a few of the sites from the local *beasts* that dwell in the swamps. Easy enough, but towards the end of their tour the group will encounter a group of intelligent simian creatures using primitive weapons (slings, bows and arrows, and clubs). They are defeated and sent fleeing into the dense swamp foliage. If the players pursue them they will come across all sorts of traps and ambushes set by the creatures. At this point the player group will notice that all the traps are non-lethal. Even the initial attack by the simians tried to incapacitate rather than kill their targets. If tracked back to their small village, the apish beings fight to defend themselves, but are not murderous.

If communication is established, the natives tell the group that their hunting grounds are being invaded and that giant metal beasts commanded by space invaders are scaring away all the game and eating the Mother Earth. They are, of course, talking about the mining crews and their machines. The simians simply want them to go away, so they can live their lives in peace. G.M.s, feel free to draw this out as long as you like. Negotiations could take a few weeks to a few months, and the natives now refuse to talk to anybody but the player characters (whom they may regard as friendly gods, good spirits or good space aliens). The Stargazer Corp may have been greedy and willfully engaged in illegal mining (they'll claim they didn't know about the simians until the player group discovered them), but they are not killers or they would have exterminated the simians right from the start. Since contact has been made with the indigenous life forms, a deal must be cut to allow mining to continue, and it must be done in such a way that it does not interfere with the natives' natural development (or not much, at any rate). The Stargazer Corporation moves slowly and reluctantly, but will (under the threat of media exposure by the player group) do the right thing. As a sign of good faith, the natives will even suggest some areas where the company could set up new mining operations that don't impact them or their native lands.

An alternate ending could be Stargazer Corp not accepting responsibility and them trying to buy off or coerce the player group's silence. This is a powerful organization that can make

trouble for those who invoke its ire or disdain. Now depending on the alignments of the player characters, they may or may not do this.

Kalador, the Planet of Youth

The Kalador System is a trinary star system within the *Pleasure Federation*. The three stars circle around a given point and each has its own selection of planets. All three stars are classified as medium stars with two being blue, and one orange.

Star One: The system's first star has an asteroid belt and a single planet.

Asteroid Belt: Circling the first blue star is an asteroid belt rich in iron, nickel and the rare element iridium. This belt is heavily mined and is the main source for the system's wealth.

Kalador One: This desert world appears blood red from space. The color seems to stem from the erosion of red sandstone, which makes up the majority of the planet's mountains.

This planet also provides the second source of the system's income, red spice! *Red Spice* is a powerful narcotic, used in the medical field. It seems to be a universal drug in that it can treat most races in some form or another. Like all drugs it can be abused. If it is processed and purified and taken directly into the bloodstream, it becomes a super addictive combat drug. On the streets of Center, on Phase World, it is called *Red Adrenaline* or *Red Rage*. The spice boosts the body's production of adrenaline to staggering quantities. Immediately after injection, Red Spice raises the following attributes: P.S. +1D6+2, P.E. +1D4+2 and Speed is doubled, plus the character is +2 on initiative. The effects last for 2D4 minutes and only work on mortal, S.D.C. creatures. Supernatural and magical creatures get a small buzz, nothing else.

The side effects of this drug when it wears off are not too bad, aside from the fact that one's heart feels like it wants to blow out of the chest, it is difficult to catch a breath for 2D6+6 minutes, and there is a 01-30% chance of passing out for 1D4 minutes. P.E. bonuses to save versus coma/death modify this

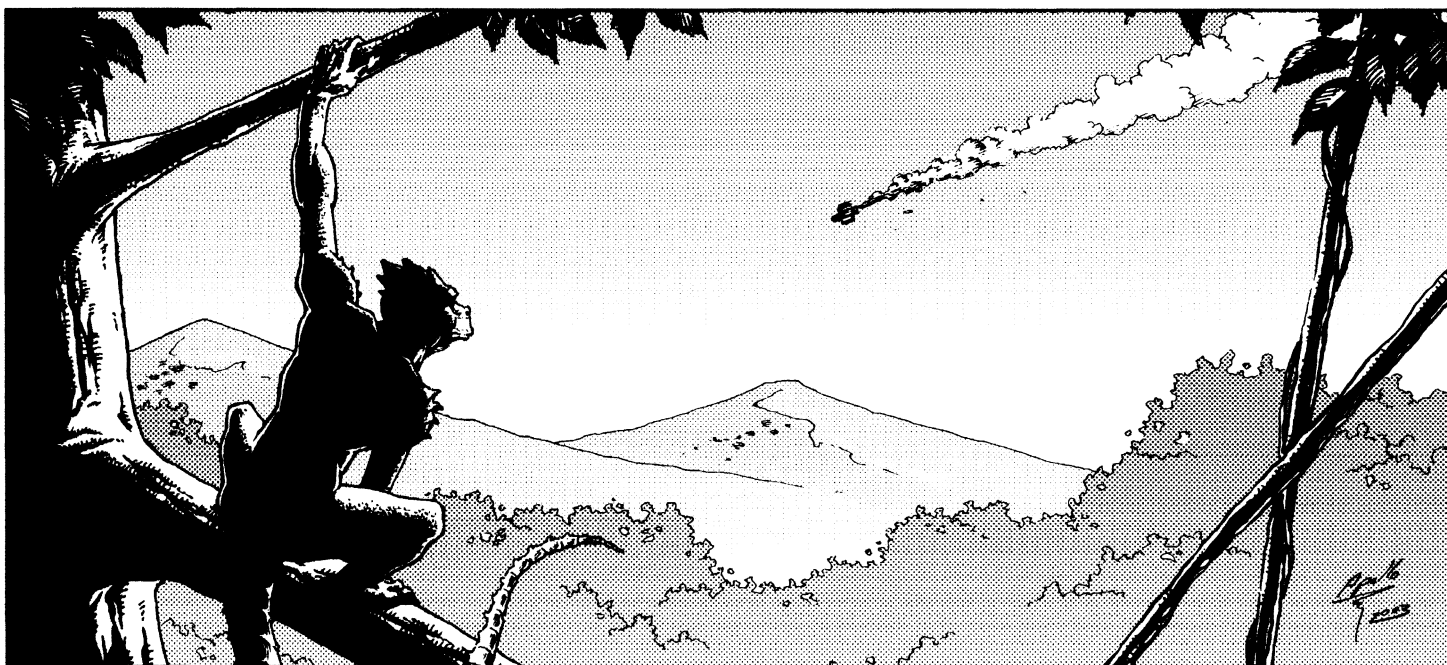

percentage. Subtract your bonus from the base and that's your chance of passing out. That having been said, the sense of power and speed the drug delivers makes the user take foolish risks, lose track of time and believe he is more powerful (invincible even) than he really is, leading to death via combat or physical contests taken too far. The drug is also highly addictive, and turns ordinary thrill seekers into aggressive individuals on the prowl for trouble and fights. Characters who become dependent on it feel they cannot fight effectively without it. They also become irritable and prone to outbursts and violence with and without the drug. Most junkies need to get high at least once a day, and when high, they are thrill seekers who crave violence or some other dangerous physical activity (racing, jumping from rooftops, etc.). Drug pushers have designed a delivery system for a modest 10,000 credits that installs in any suit of armor. All the character has to do is press a button or issue a voice command and boom, they're a combat junkie ready for action!

Star Two: Kalador's second star is a medium blue sun with three planets and an asteroid belt.

Kalador Two: A giant gas planet with a ring system and 32 moons. This planet has a beautiful rainbow of colors and is a common tourist site for some of the cruise liners that come through the system.



Kalador Three: The planet Kalador is a tropical paradise. Weather is always good to mild, with 60% of the planet possessing moderate temperatures. This alone is enough to entice people to visit, but it has another stellar phenomenon that attracts even more people. This planet has its own set of rings. Tilted at a 45-degree angle, these fourteen rings are absolutely stunning at night and many a romantic couple has strolled on the beach to watch the rings become brighter and more visible as the planet slips into night. Kalador is the toast of the Pleasure Federation, and it a favorite stop of private yachts, star cruises and the wealthy.

One of the many interesting attractions on the planet is the hundreds of vendors trying to sell items to keep one's youth! All kinds of gimmicks are sold from potions of youth (a temporary magic potion) to bombarding the body with cosmic rays to help regenerate the cells. The only useful thing these charlatans sell is sun tan lotion.

Kalador Four: Another ringed gas giant that is a popular attraction. The Cyclop's Eye is a giant blue spot with a white center on the planet's surface – a raging storm that is 124,000 miles (198,400 km) across. Magic users claim to sense the presence of a giant Rift on the planet, but don't know where it is or how to find it. Whatever the Rift may represent, it will likely forever be a mystery, because the pressure would kill any humanoid foolish enough to go into the atmosphere.

The rings of the planet are a beautiful bronze and gold. This planet has no moons, which may be due to its powerful gravitational field.

The Jewel Belt: This is an asteroid belt in the outer reaches of the system. What makes it unique and yet another tourist attraction are the chunks of frozen methane, hydrogen, and fluorine. When these frozen gases are exposed to direct sunlight they glow green, red, and blue respectively. This makes for a unique and radiant sight in space. They were originally very rare, until one of the opportunistic governors of the planet decided to make more and seed the belt. **Star Three:** The last sun in this trinary star system is a medium orange. It does not burn as brightly as its two twin sisters and only has a single planet in orbit.

Kalador Five: The only eyesore in the Kalador system is K5, a small dead rock of no significance. The Department of Tourism for the Pleasure Federation could not stand for this one imperfection in the system, so a large waste facility was constructed on the planet's surface. This facility is in the shape of a large, 4,000 foot (1,219 m) tall volcano! It even spews forth lava at prearranged times. Of course, the lava is not real, but only superheated metals and waste. The lava that runs off the sides of the artificial volcano is channeled into a collection system that can either recycle the waste into more lava or cycle it into a solid form after cooling. The metal slugs are usually very dense from being supercooled in the vacuum of space. They are usually sold as recycled building material used in structural supports of colonies or other facilities that are to be used in the vacuum of space. The planet has five of these facilities up and running with plans to build two more.

Kalador Hook, Line, and Sinker

Hook: The players finally get that well deserved vacation after months of being on the rim of the galaxy or near unfriendly space.

Line: After only two or three days of relaxation on the beach of Kalador Three, and enjoying the sunset of three suns, the player characters learn that an NPC member of their crew (or an acquaintance) has turned up dead! The local authorities don't even bother to investigate when the cause of death is determined: A drug overdose of the narcotic Red Spice. The only catch is the player group knows the NPC well enough to know that he would *never* use drugs. Something is wrong with this picture and suggests foul play. The authorities, however, ignore

this information, insisting the cause of death is a obvious, leaving a killer at large.

Sinker: The player group learns through their own investigations (or by happenstance through the grapevine) that the deceased was planning a little solar cruise through the system. It seems he was asked to deliver a package to a person on the cruise ship. It appears he was killed before delivering it and the package is missing. What was in it? Who has it? Whoever does is probably the killer.

The Lanator System

A.K.A. The Lanator Star Cluster

System SY-124-616-628 was a star cluster among a dozen others that occupied a region of neutral space between CCW and Kreeghor/TGE space. It was only a catalog number up until around 500 years ago after the first Great War between the CCW and the TGE. It is the site of the *Lanator Accords*, the first treaty signed between the two superpowers of the Three Galaxies. The treaty essentially defined the borders of each respective government and what constituted unclaimed systems and sectors of space. The Lanator was the Kreeghor dreadnaught that hosted the treaty ceremony, thus giving the system its name.

Technically, the Lanator system is really not a system at all, because it has no planets. It is classified as a small “star cluster” and is comprised of three stars. The central star is a medium red and two dwarf stars (a brown and a yellow) slowly orbit.

The red star is called a “matter monster” because it is drawing in matter from the dwarf stars that orbit it. The matter streams themselves are just under 3 million miles (4.8 million km) in width. This has caused the local gravitational fields to be severely imbalanced as the density of the two dwarves decrease and the red’s increases. This makes travel close to the stars difficult at best. Consider all piloting rolls at -15% and expect a bumpy ride as the gravity waves impact the ship like tidal waves. Travel between the stars is even more dangerous. The stars are in a constant tug-o-war and anyone crazy enough to venture near them has a good chance of being thrown into one of the matter streams! Piloting is -30%, and if there are more than five consecutive failed rolls there is a 01-45% chance of being hurled right into a matter stream, inflicting 3D4x1000 M.D.

At any given time, a science ship can be found studying this phenomenon. Current reports indicate that the two dwarfs have less than 100,000 years of life left in them and that they could supernova in half that time!

Lanator Hook, Line and Sinker

Hook: The player characters have been hired to locate the missing science vessel, *CSS Nova*. The group is to find and assist the Nova in any capacity necessary. They will be rewarded for the appropriate services rendered.

Line: The CSS Nova was assigned to study four star clusters within a 30 light year sphere. Searching each of the star clusters thoroughly takes time, so finding the ship will be like finding a needle in a haystack. Just prior to leaving the Lanator System, the group gets a lucky break by picking up a weak signal that

leads to a ship’s log buoy. Recovering the buoy should be an easy task, but obtaining the data on the buoy will not be. The information is locked behind several CAF protocols, and unless an ex-CAF officer is on board, it will take days to crack!

Sinkers: One of the first pieces of information recovered is the ship’s flight plan to take the ship between the red and yellow stars for detailed scans of sunspot activity. After two more days of orbiting, CSS Nova was supposed to move on to the fourth and final cluster. The second piece of information comes from the captain’s actual logs. The ship was handling the gravity waves just fine until she got between the two stars. Gravimetric waves increased severely, causing the ship to veer off course and right into the matter stream. Damage reports at the time showed that all primary systems were damaged and failing! They will only be able to hold out a few more days before all hands die. The ship is holding position just inside the gravity well of the two stars. Power could be diverted to the engines, but without shields the crew will perish in about two minutes. It would take the ship a minimum of five minutes to get out of the gravity well and another two to get beyond the lethal doses of radiation. Player characters will be hard pressed to rescue the ship.

Available options:

1. If the player group has a large enough ship they could tow the Nova, but would need assistance from the damaged vessel. The CSS Nova would have to divert all power to engines to avoid tearing the two ships apart.

2. Repairing critical sections of the Nova is not an option, but a second ship could feed power to the Nova’s damaged systems, giving her just enough juice to break free.

3. Total evacuation! The science vessel has around 1,000 crew members so the player group would need a vessel large enough to handle them all.

The Dwarves of Maul

The Maul system has been a longtime home to a Dwarven people called the Rune Smith clan. The Dwarves colonized the system several centuries ago and have thoroughly spread themselves out in the system. Mined ore and the manufacture of asteroid mining vessels are their two highest exports next to custom-made weapons and armor.

The Maul system is a trinary star system. Each of the three stars has its own little mini-solar system of planets. Each star is also relatively stable and orbits around a stationary point.

Star One: The first star in the system is a Brown Dwarf sometimes called “Little Brother” by the Dwarves. It has a very low output of light and radiation and may eventually burn out to a cold iron core the size of a small planet.

Agmar’s Belt: An asteroid field circling Little Brother, rich in iron ore and titanium. At any given time there are a half dozen asteroid miners in the belt.

Maul One: M1 is called “The Tyridium Galug.” It is a frozen planet with a methane atmosphere and serves as a Dwarven prison – the worst in the Consortium. Convicts must work 10 hours a day in the mines in order to earn their daily supply of food and water. Conditions are very bad and the mortality rate is high. Roughly 20% of all prisoners are not able to serve out their sentence.

The mines branch off in dozens of directions. A central compound is located in an underground cavern about a mile and a half (2.4 km) below the surface. Shuttles have to traverse a five mile (8 km) long tunnel before entering the massive air locks to the central cavern. In order to escape, first one would have to steal a shuttle, then get past the air locks, an impossible task for most.

A purified form of silver called Tyridium is the main element mined. It has unique properties when combined with magic weapons and armor. The Rune Smith clan have knowledge of how best to use the Tyridium and buy it from the mines in great quantities.

Maul Two: The last planet circling Little Brother is also a frozen rock. Its atmosphere consists of frozen methane, fluorine, and bromine. The planet has no value at all.

Star Two: Maul's second star is a medium orange. Three planets orbit this star.

Maul Three: This planet is a small fire rock and has no value to the Dwarves.

Maul Four: Simply called "The Lava Forge," this fire rock is the home to the Rune Smith clan. Migrating from another Dwarven colony in the system, its founders felt this planet the most suitable due to the high temperatures and the numerous lava tubes that ran underneath the surface. The clan has several surface structures around the planet and a central warren in the southern hemisphere. This serves as the main home to the clan. Some of the forges are actually in lava tubes. This is one of the trademarks of the clan and one of their special techniques in crafting the finest S.D.C. and M.D.C. melee weapons (knives, swords, etc.) and armor (environmental and otherwise) within 500 light years. All are hand made and are of superior quality. Damage bonuses can be from +1 to a maximum of +6. Balance is also superior, with a simple weapon being +1 to strike and parry and their best being +3. As one would expect, prices are high, but you get what you pay for.

Mega-Tyridium weapons are one of their specialties. This metal has unique properties and the Dwarves have developed a technique to forge weapons that inflict Mega-Damage from Tyridium alloys. Such weapons have a silverish-blue color and are always handsomely decorated. They radiate slightly of magic, but have no other apparent magic properties. The weapons do the M.D. equivalent of the S.D.C. weapons of the same type, and enjoy the same range of bonuses as the S.D.C. weapons.

Maul Five: This is a giant gas planet with 13 moons. It would have little significance except its largest moon, Agmar, is habitable. Agmar is covered with high mountains and deep lakes. It is named after Agmar, the Dwarf who led the clan to this system. The asteroid belt around Little Brother is also named in his honor.

The moon, Agmar, is rich in ores, gold, silver, and platinum, to name a few of the metals mined from it. The mineral wealth would be enough to sustain the hard-working Dwarves, but they also construct the massive Maul asteroid mining ships. Modular sections are created in factories under the mountains, then shipped into orbit for final construction. Two types of ships are made like this, one crafted of magic and technology and the other entirely of technology. Both types have a good reputation for reliability and are sold all over the Three Galaxies.

Star Three: A medium blue given to violent solar eruptions that send flares rocketing from the surface at unpredictable intervals. This makes travel in the area dangerous and, at times, communications and other instruments are disrupted throughout the system by the solar flare activity.

Maul Six: A giant gas planet with six moons. The Dwarves have little interest here except for two moons that show signs of being potentially rich in ores for mining, especially the element Chromium which is a high density metal used in matter/antimatter reactors.

Maul Seven: A small gas world that seems to be shrinking. At times when the solar winds blow it resembles a stationary comet as some of its atmosphere is sheared away in a brilliant display of light and particles. Between the solar flares of the blue star and the gravimetric distortion from the planet, travel near this part of the system is considered a space hazard and best avoided.

Maul Hook, Line and Sinker

Hook: The player group is in the system doing (or guarding) a delivery run of ore, gems or precious metals.

Line: The group has been given instructions to meet the Bronze Hammer, a Dwarven asteroid miner, in Agmar's Belt. Locating the ship is easy, however they are not responding to communication hails. There could be a few reasons, solar flares disrupting communications, a damaged communication array, or the vessel could be crippled or under the control of pirates. Further scans seem to reveal a damaged communications tower, but the landing bay is open and appears ready to receive a small ship or shuttle. A docking port is accessible in case the ship is too large to land on the Hammer.

Sinker: A band of Dwarven convicts have escaped the Tyridium Gulag and commandeered the vessel. Unfortunately, the ship was damaged in the fighting and they lost navigation control and communications. Having scanned the player characters' ship, they are hoping to lure them into docking to steal it and make good their getaway before the Agmar authorities catch up with them.

The Nightshade Nebula

The Nightshade nebula is located in CCW space. It is approximately four light years in size! Within the nebula is a binary star pair, and spread throughout the space cloud are five proto-stars forming. The nebula has a dark green appearance and is shaped like a pair of wings spread out wide and resemble dragon wings from a distance.

The nebula is the site of a historic battle between the Consortium of Civilized Worlds and the Kreeghor (TGE). During the first Great War, the Consortium used the nebula as a shortcut for its convoys delivering supplies to various fronts. The Kreeghor ambushed one of these convoys. The CCW was not aware of where en route the convoy was ambushed until the next group of ships were waylaid inside the nebula. This was very troubling to the CCW since the nebula was far behind their lines. Finally, a CCW task force consisting of a half dozen Hunter class cruisers, a War Shield and a Protector locked horns with an equally powerful Kreeghor fleet near the heart of the nebula, the twin suns.

They exchanged fire for four and a half hours until both fleets were decimated. The Consortium claimed victory even though half of those who went in had to limp out in escape pods, shuttles and fighters. Ships that weren't completely destroyed were so damaged that they could not safely navigate the nebula to escape. The war was at its height, so there was no time to salvage any of the remaining ships or equipment. The nebula was heavily mined to prevent further ambushes and the conflict continued.

As the course of the war changed so did the value of the nebula. Fate would make the nebula permanently off limits as the minefield map was destroyed, presumably by a TGE seeker virus. No hard copies existed, so when the virus ate the data, the nebula became a liability for everyone. After the war, it was determined to be too dangerous to try and collect all the mines, so warning beacons were placed in several key locations around the nebula.

Today, the Nightshade nebula is filled with high-yield antimatter mines, making salvage operations and exploration of its depths a death defying feat. Fake maps promising safe passage through the Nightshade Nebula are sold throughout the system to any sucker willing to buy one. This sector of space might be abandoned except a fortune worth of salvage from the first war and ships who thought they could make it litter the nebula, waiting to be claimed by anyone willing to risk their lives to get them.

The mines are high yield matter/antimatter smart mines, which means that they are able to scan ships for structural weak points and move to strike that location as the point of detonation. Because of the disruption and interference of the nebula itself, a ship's scanners cannot recognize the mine until it is close enough for the mine's sensors to recognize it as a target, putting the two on an explosive collision course (and with no or little time to shoot the mine down or take evasive action). Remember, the nebula also prevents most ships from erecting their variable force fields due to the magnetic interference. Consequently, the

mines keep adding spacecraft to the nebula, making the Nightshade the "Sargasso Sea" of the Three Galaxies. To make matters worse, salvage ships, adventurers, and space pirates are attracted to the promise of the Nightshade Nebula, only to be added to its list of casualties and booty waiting for someone else.

Stats for antimatter mines: Mega-Damage: 1D4x500 to the first 500 feet (152 m) and 2D6x10 to an additional 500 feet (152 m). Sensors: The mines have a 1,000 foot (305 m) range and are equipped with motion, visual, ionic (helpful in detecting a ship's wake), and quantum sensors, used in the detection of a matter/antimatter reactor. Programming: The mines are programmed with a variety of combat parameters and actively seek targets. When none are around, they slip into a sleeper mode. Smart, the mines change position at random intervals, and can change their sensor range to vary from super sensitive to dumb mines, meaning they detonate when they come in contact with a ship's hull. There is only a 01-05% chance the mine is a dud.

A Nightshade Hook, Line, and Sinker

Hook: As a reward for some service performed by the adventurers, they are given a data card containing a treasure map!

Line: The data card contains detailed scans of the Nightshade Nebula. Maps, new and old, of mine positions are given plus extrapolations of where the mines will change position to. Everything *appears* genuine and even the maps are in the format used by Consortium explorer ships. Could this be a true map through the Nightshade?

Sinker: Of course, the map is a fake, though some of the initial few bits of info are accurate enough to get the adventurers inside the nebula. This could be a trap by one of the player group's enemies or a rival, or somebody looking to set them up or to waylay them once stuck inside the nebula. Or a group of space pirates who frequent the outskirts of the nebula could have seen and followed the players' ship waiting for an oppor-

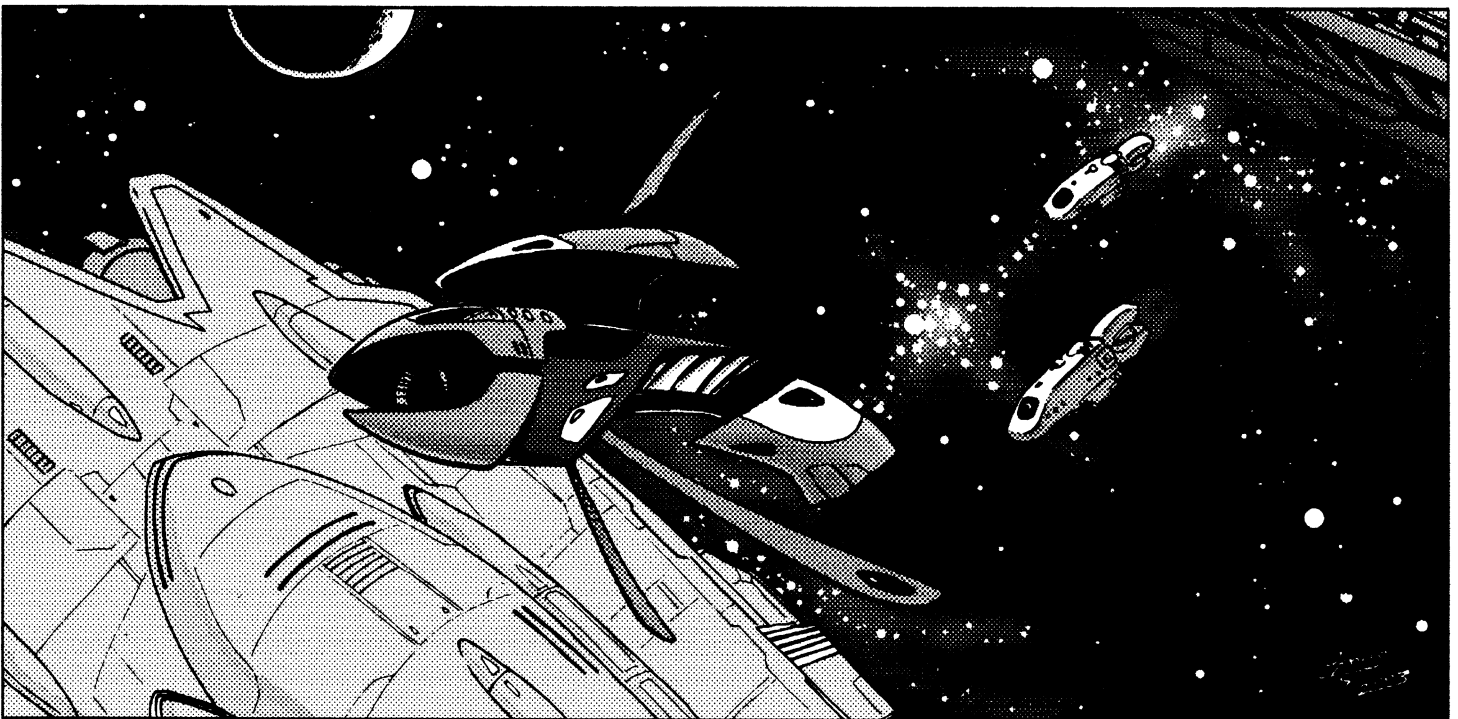

tune moment to strike. Or maybe the group runs into something unexpected.

Adventure Hooks: Wow, there are a ton of 'em: One of the dead vessels is carrying a secret weapon or treasure worth a fortune, provided it can be found and recovered, or its coordinates are known (or believed known) and the item must be prevented from falling into the wrong hands, even if it means destroying it. One of the dead spacecraft is itself, or is carrying, a rare and valuable or coveted magic item, or terrible secret, or a monster, etc., and is there for the taking if it can be found. A band of space pirates, or Kreeghor or other bad guy has found a safe (for the moment) path in and out of the nebula (though not too far in) and escaped the authorities by fleeing into a place where few dare to follow. Their base is a giant, Kreeghor starship. The vessel is dead, but makes for a great floating hideout. Every dead vessel in the nebula could hold some secret, valuable items, monstrous inhabitant, or be worth money as salvage. Some hold a piece of history, others just the souls of the dead. Some could be inhabited by a space monster, dragon, or demon, others may actually be haunted. Perhaps a rogue, evil Cosmo-Knight makes his lair inside. Oh, and one of the multitude of rumors surrounding the legendary Cosmic Forge suggests an ancient vessel lost inside the nebula holds the Cosmic Forge (or a key component or something or someone connected to the Forge, or a map to the Forge, or . . .). Unleash your imagination.

The System of Olympia

Named in memory of the otherworldly explorers (gods or demigods from Earth?) who brought peace to this world, Olympia is well known throughout the Three Galaxies for the *Consortium Olympics*. The games were officially founded in the CCW 150 years ago. They are held every two solar years on the planet Olympus, and all member planets are welcome. Furthermore, non-member worlds may petition to partake in the games, so long as they abide by all CCW laws, rules and gaming regulations.

Stars: Zeus is the medium orange star in this system. It is a little on the large size for a medium star and tends to have violent solar flares every few decades.

Olympia One: A small gas planet with no moons. The planet speeds around Zeus every 92 days. Due to its speed, it is called Hermes.

Olympia Two: Classified as a fire rock, and appropriately named Hades, from orbit the surface appears to be on fire. This is due to the sea of liquid hydrogen. The atmospheric pressure on the surface is so great that the hydrogen gas is forced into a liquid state and pockets of gas regularly ignite into flames that can burn for months. The planet is a very hostile environment and warning satellites are in orbit to keep away curious spectators. More than once a pleasure yacht or small ship has had to be rescued from the fiery surface.

Olympia Three: A gas giant with two moons. This planet, named Atlas, is the starting point for the inter-system race. All types of ships from fighter craft to small freighters participate to win gold in the small craft piloting event.

Olympia Four: Olympus is the blue-green jewel of the system. Two groups of Consortium colonists, a small Wulfen tribe,

and a small group of humans, originally settled it. At first, both groups got along well, trading goods and helping each other when natural disasters occurred. The first generation would be the only generation to have peace for more than 15 years at a stretch. What started the feuding is long forgotten, all that is known is both groups grew distant and distrustful of each other. For the next 100 years the two sides would be at war. It even got to the point where all technology on the planet was either destroyed or beyond repair. In the last years of the war, both sides would literally fight with sticks, clubs and rocks. The fighting would most likely have continued had not a nomadic group of travelers suddenly appeared. A group of superhuman strangers, about 500 in all, came through a Rift looking for a new home and a new life. It was only a matter of time before the new visitors found themselves caught between the two warring parties.

The clan elders sought to make peace with all parties involved. The most experienced negotiators were sent out to see what could be done. This was to be a long process, as all kinds of problems arose from simple disagreements, like choice of venue to more extreme problems like racial hatred! Two years passed with no progress, until one frustrated negotiator suggested a contest of strength, intelligence, and ingenuity. Both parties were naturally curious as to how this would be handled. No one really knows why both parties agreed to the contest; perhaps it was to best the other party in something other than bloodshed, or perhaps both sides were tired of the fighting. A stone stadium was built in neutral territory and the first Olympics took place. Most were simple contests consisting of Olympic style games like shot put, discus, javelin throwing, archery, running, and wrestling. From there, both sides were more agreeable to compromise, and the rest is history. The superhuman strangers (gods of Mount Olympus or pretenders?) would stay for the next three centuries and had a large impact on the colonists. When contact with the Consortium was reestablished more than a century ago, the superhumans turned over complete control to the now proud and unified people.

Today, signs of the Olympian Earth gods are everywhere. The majority of the architecture is ancient Greek, the names, love of art and the ways of governing all reflect their influence. Olympia opened its doors to the Consortium of Civilized Worlds and invited all to participate in the Olympic style games. Every two standard years, members of all CCW worlds send athletes to compete in a variety of sporting events.

All manner of sports are played. The traditional Olympic style games remain the most popular with the extreme sports starting to follow suit. Some of the new sports include orbital skydiving, a variety of racing events from ground to space, mega-sports for the more hardened races, to intellectual games such as chess.

Olympia Five: This planet is named after the goddess Aphrodite. It is the smallest planet in the system and certainly the most beautiful. The atmospheric gasses glow golden in direct sunlight, giving the planet a rainbow aura as light is reflected off the atmosphere. The planet is a non-habitable terrestrial world that is otherwise worthless.

Olympia Six: Several hundred of the lesser beings who lived on Olympus worshiped the goddess Artemis, so this planet was named in her honor. The atmosphere is poisonous to humanoid races and the planet would have been ignored altogether had a

satellite not detected a structure on the surface. Surprisingly, the structure found was a rather large and ancient pyramid. Today, several archeological teams are trying to unlock the secret of who may have built it, why and whether or not they might have inhabited this planet in a widespread civilization. Of course, a bunch of lunatics assume it may be linked to, or the hiding place of, the Cosmic Forge, though there isn't the slightest bit of evidence to suggest this could be true.

Olympia Seven: The last planet in the system is called Ares, after the god of war. The name stems from the impact craters on the surface. Detailed surface maps have been made and the craters do not appear to be random meteorite strikes, but grouped in such a way as to suggest orbital bombardment, but by whom and why, and when? If cities once existed on this planet they have been totally destroyed. To further the bombardment theory, a thick dust cloud still lingers high in the atmosphere blocking most of the sunlight. This has caused a greenhouse effect and may be the reason why the atmosphere is primarily made of carbon dioxide. The effects are similar to a nuclear winter. For this reason, the planet is studied to determine the long-lasting effects of a nuclear winter. One final point of interest is the surface color. It would seem iron has oxidized on the surface, giving it a metallic red color. This has been observed from several surface probes that barely survived landing on the surface and from the occasional opening in the cloud cover.

Olympia Hook, Line, and Sinker

Hook: An individual player character or the group is invited to the 106th Olympic games. They can be spectators, one of the athletes, or one of many security details working the games.

Line: Disputes between several groups of competitors are starting to erupt into full-fledge fights. Some even border on being ejected from the games. This would be the first time in the history of the games that any CCW member was thrown out or asked to leave. Should this happen, it would caused a major galactic incident that could cause tensions between member worlds. The player group is asked to investigate and intervene, independent of any "official" investigations, in the hope that they bring about peace and harmony.

Sinker: After intense investigation, signs of a Kreeghor Imperial Security Agent (or agents) are found, suggesting TGE insurrection and/or sabotage. The player characters have to find this agent(s) and get him to stop causing dissension at the games.

The Pentarken System

The Pentarken System lies on the rim of the Thundercloud Galaxy. The Consortium Discovery Corps was exploring this region of space looking for new life, new planets to colonize, and even contact with a new civilization, when they found something they hardly expected, their own deaths! This branch of the CDC was aboard the *CSS Pentarken*, an Explorer class cruiser outfitted with the best sensors and an eager crew. Upon arriving in the system near the ninth planet, the vessel was attacked without warning. For thirty long seconds it was bombarded, immediately crippling her. The Pentarken would have returned fire, but there was nothing within range, so the captain did the only sen-

sible thing, he ordered to abandon ship. The ship's logs and sensor logs were also ejected. Fifteen seconds after the captain's order, the ship was atomized with all hands lost.

Two months would pass before an attempt was made to get into the system. This time a high-speed pass with a Phase World Ghost fighter would recover the Pentarkens logs and take some scans of the system before leaving. What was left of the CDC ship was a debris field. Today, a Consortium Protector class ship always patrols this sector of space to ensure that no other ship shares the fate of the Pentarken, though nobody knows what actually transpired that day, or whether modern vessels could detect and engage the Pentarken's attacker.

Star: Pentarken Prime is a medium orange star. Little solar activity has been noted.

Pentarken One: Long-range scans have indicated that this planet is a hot, wet environment with a host of organisms ranging between aquatic and land-based creatures. This jungle planet will remain a mystery until closer scans can be done. No intelligent life forms are believed to inhabit this world.

Pentarken Two: A small planet that has plumes of fire and lava shooting 30 miles (48 k) into the atmosphere. It has a very thin atmosphere.

Pentarken Three: A small gas planet with three moons.

Pentarken Four: This fire rock has a single moon that is rather unusual. The moon seems to have a highly polished, glass-like surface, and no craters mar the surface. A definite mystery that merits further study.

The Artifact: In orbit between the fourth and fifth planet lies the Artifact. It is believed to be the object that destroyed the Pentarken. The Artifact is an artificial construct of unknown purpose and origin. It is believed to be very old and probably a drone combat vessel designed to attack any other ship it perceives to be a threat or which comes too close. Prior to firing, the Artifact emits a burst of tachyons, probably its targeting scanner. Less than three seconds later, it begins adjusting itself to obtain an optimum firing angle. The energy beam fired is not laser or particle based, but some type of phased energy, far more powerful than any weapon known on Phase World (once thought to have invented phase technology). The weapon actually breaks down the chemical bonds of whatever it hits, vaporizing it. The destructive beam is a mile (1.6 km) wide and range is only guessed at five hundred miles (800 km). It is unknown if the Artifact has any other weapons, but analysis of the debris in the outer asteroid rings may reveal more information. The popular theory floating around is that the Artifact was created by the First Race! Others suggest it was the prototype – a tiny, working model – for the Cosmic Forge itself! Whatever it is, time is running out to find answers. A fleet of ships is heading towards the system. At this time it's not known if the ships are Kreeghor, Splugorth or some other alien race. The CAF is racing against the clock to send more combat ships to intercept and question the unidentified armada. Technically, no one owns the Artifact, so it is an awkward political situation even if the strangers are coming to capture, take or destroy the Artifact.

Pentarken Five: A dead rock cratered and scarred. Traces of metallic alloys have been detected on the surface suggesting a large spaceship may have crashed on the planet. Closer scans will reveal that several ships have crashed on the airless planet.

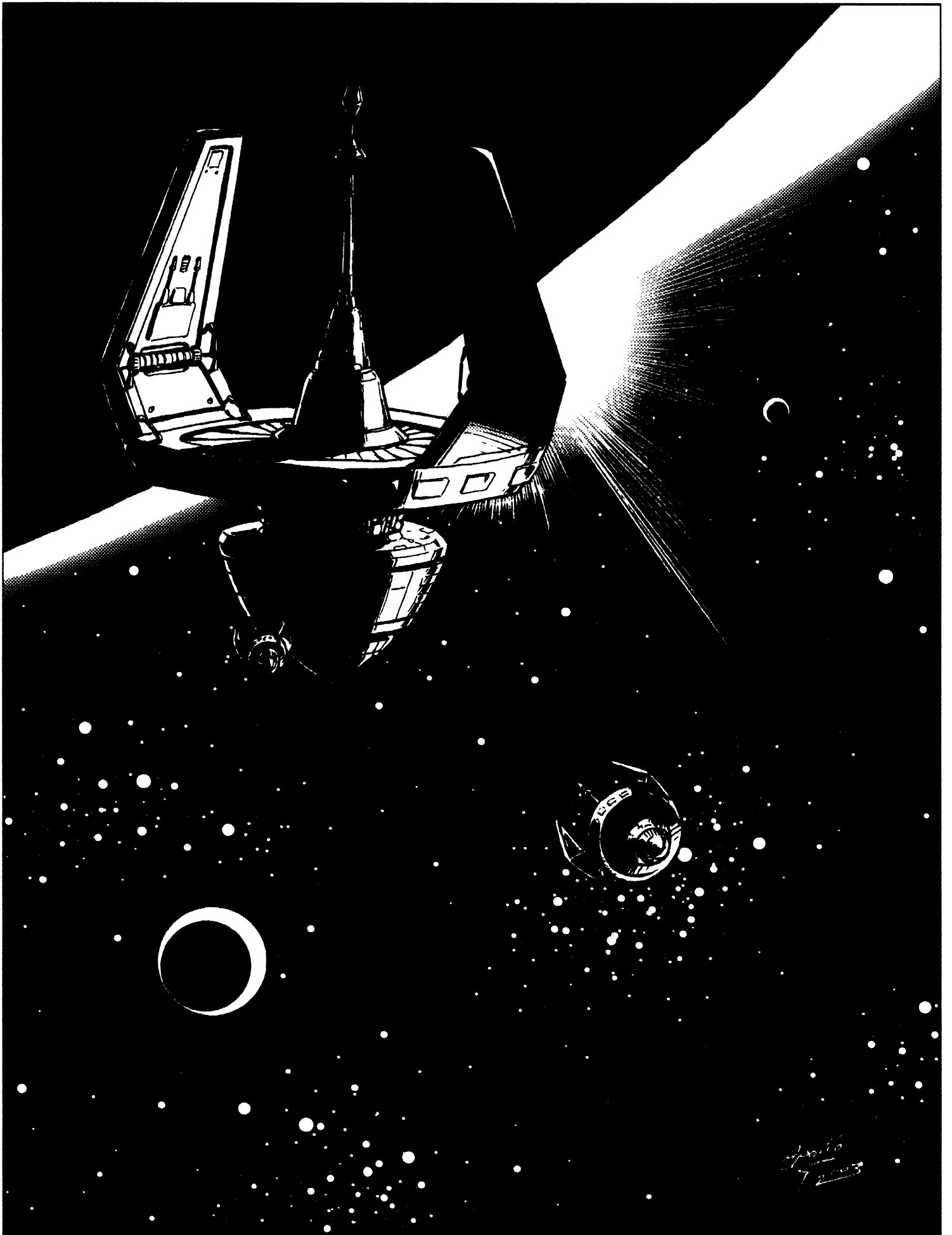

April
7 2003

Pentarken Six: Another fire rock, with the surface covered with molten rock and a thin methane atmosphere.

Pentarken Seven: A gas giant that failed to become a star. At times the planet actually emits its own light and energy suggesting it is a failed star. The surface blazes like a sun from time to time, and then settles down and appears as a gas giant with a dirty brown atmosphere. The planet also has two large moons, both uninhabitable. Each has a thick atmosphere and the moon furthest out has an acidic atmosphere that would break down any M.D.C materials in hours.

Pentarken Eight: The jewel of the system, it is a medium gas planet that has an atmosphere the color of emeralds. The gold and silver rings accent its natural beauty. Eleven moons orbit the planet with the largest having a thick atmosphere with atmospheric pressure so great it would crush the largest ship in minutes.

Asteroid Belts: The last two orbital fields contain asteroid belts. Scattered amongst the asteroids is ship debris. How many ships has yet to be determined, but a conservative estimate is at least a thousand. If a team could be sent in to investigate, this too would yield a wealth of knowledge, but the Pentarken Artifact is able to target any ship entering the system.

Hook, Line and Sinker One

Hook: A detailed analysis of the Pentarken's sensor logs has revealed that after the Artifact fires its main cannon twice, its power levels drop dramatically.

Line: If a small ship can slip in while it's recharging, a more detailed scan of the Artifact can be done.

Sinker: The Artifact is not completely defenseless. While it's in a recharge state the artifact has hundreds of fighter drones to protect it. Ten at a time will be released against anything coming within a hundred miles (160 km) of it.

Hook, Line and Sinker Two

Hook: Recent scans have detected what appears to be a smaller version of the Artifact floating among the debris in the outer asteroid belt.

Line: Whatever it is needs to be retrieved so more information can be learned about the Artifact. The player group has been selected or hired for the job.

Sinker: The small craft is actually one of the fighters sent out by the Artifact. It is severely damaged and effectively crippled (M.D.C. reduced to one third, and the propulsion system is inoperable). There is no power currently being beamed to the ship. Once the Artifact learns that one of its fighters is being extracted, it will send several fresh fighters (approximately a half dozen) to intercept and destroy the intruders and the crippled ship. If the fighters weren't bad enough, the adventurers will also have to contend with the asteroid field!

The Artifact

Model Type: Doomsday Weapon.

Class: Planet Killer.

Crew: None, a single artificial intelligence runs the whole ship.

M.D.C. by Location: M.D.C. would be considered in the bil-

lions! It is effectively indestructible. It is made of a super dense alloy called neutronium. This alloy can only be found in the heart of a star and at the present state of technology, no race in the Three Galaxies is able to produce it. This material is so dense that a single cube of metal 6x6x6 inches would weigh 10 tons! This material covers the artifact and any scientist should be surprised to learn that it is only one inch thick! Variable force field: None!

Speed: Mach 30 in space. Not atmospheric capable. **Star Drive:** The Artifact has a conventional gravitonic drive the will allow it to go 10 light years per hour, but its real surprise is it space fold drive. It can fold space and jump 150 light years at a time with 6 jumps per day possible. That's a maximum of 900 light years per day. However it only uses the fold engines to make micro-jumps around the system so it can intercept intruders.

Range: Unknown.

Statistical Data: **Height:** 21.5 miles (34.4 km). **Width:** 10 miles (16 km). **Length:** 65 miles (104 km). **Weight:** Immeasurable, due to the *neutronium* alloy. **Cargo:** Unknown. **Power Systems:** Unknown, would have to be a power source equal to a small star. **Market Cost:** Not available. **Combat:** Advanced alien targeting scanners allow the Artifact to track approximately 5,000 targets simultaneously! Its advance targeting system allows it to hit very accurately at considerable distances. For the main cannon, anything at extreme, range 1,000 miles (1,600 km) has no bonus to hit, but at 800 miles (1,280 km), it is +2 to strike, 600 miles (960 km) it is +4 to strike, and at point-blank range, just under 10 miles (16 km), it is +8 to strike. The ship has no dodge bonus as it relies heavily on its neutronium hull. The number of actions is has depends on the various weapon systems and their rate of fire.

Weapon Systems:

1. Main Phased Energy Cannon (1): From the maw of the Artifact, a beam of Phased energy can be fired. This energy is so powerful that it breaks down molecular bonds, literally disintegrating matter.

Primary Purpose: Planet Killer.

Secondary Purpose: Ship Killer.

Mega-Damage: 2D4x10,000 M.D. per blast.

Rate of Fire: One shot per minute, but possibly due to age or some other reason, if the weapon fires more than twice in a row it requires a charging period of 30 minutes. This seems to drain the Artifact, so its strategy is to try and destroy its target as quickly as possible.

Effective Range: 1,000 miles (1,600 km).

Payload: Effectively unlimited.

2. Secondary Phased Cannons (4): These weapons are smaller versions of the main cannon and are no less dangerous.

Primary Purpose: Ship Killer.

Secondary Purpose: Defense.

Mega-Damage: 1D6x1,000 M.D. for a single shot or all 4 fired at once would be 1D4x10,000.

Rate of Fire: Once per melee round.

Effective Range: 500 miles (800 km).

Payload: Effectively unlimited.

3. Missile Systems (5): The Artifact is able to produce low yield fusion bombs mounted on missiles. They are kept in ready supply and are easily guided by the Artifact.

Primary Purpose: Assault.

Secondary Purpose: Defense.

Mega-Damage: 1D6x100 M.D.

Rate of Fire: 1, 5, and 10. Can fire a maximum of 100 per melee!

Effective Range: 2,000 miles (3,200 km).

Payload: 1000 on hand at any moment. The Artifact has the ability to manufacture its own missiles. It can produce 20 an hour if need be. Each launcher is filled to capacity with 100 missiles, making for a total payload of five hundred missiles immediately ready. Another 500 missiles are stored internally and with the automated loading mechanism it takes one minute to load the missiles.

4. Automated Fighter Drones: These automated fighters are smaller versions of the Planet Killer. Fortunately, they are made of standard M.D.C. materials that can be destroyed with conventional weapons.

M.D.C. by Location:

Main Body: 1,000 (no force field).

Engines (Rear 1/3 of the ship): 400.

Statistical Data:

Height: 25 feet (7.6 m). Width: 33.5 feet (10.2 m). Length: 75 feet (22.9 m).

Weight: Unknown, possibly 20 to 25 tons.

Cargo: Unknown, presumed to be none.

Power System: Unknown! There are no recognizable power readings! Possibly they receive power from a direct link to the planet killer via a directed power transmission. This could be a possible exploitable weakness – if one could jam the transmission then ships would be powerless.

Combat: Utilizing a similar targeting technology, the fighters are +5 to strike and +6 to dodge due to their maneuverability and the artificial intelligence controlling them. Each fighter has five attacks per melee.

Market Cost: Not available.

Weapon Systems:

1. Phased Energy Cannon (1): Located in the center of the vehicle.

Primary Purpose: Anti-Starship.

Secondary Purpose: Ship to Ship Combat.

Mega-Damage: 1D4x100 M.D. per blast.

Rate of Fire: Once per melee round.

Effective Range: 10 miles (16 km).

Payload: Effectively unlimited.

2. Mini-Phase Energy Cannons (4): Located as four protrusions in the front of the vehicle.

Primary Purpose: Ship to Ship Combat.

Secondary Purpose: Defense.

Mega-Damage: 2D6x10 M.D. per single strike, or all four combined is 1D4x100 M.D.C.

Rate of Fire: Four shots per melee round

Effective Range: 5 miles (8 km).

Payload: Effectively unlimited.

3. Rail Gun (2):

Primary Purpose: Ship to Ship Combat.

Secondary Purpose: Defense.

Mega-Damage: 1D6x10 M.D. per 80 round burst

Rate of fire: 6 bursts per melee round.

Effective Range: 8 miles (12.8 km).

Payload: 80,000 rounds per cannon. That's 1000 bursts per cannon.

Quintos System

The Quintos System is a relatively small solar system on the edge of Consortium space. It only has three planets. On the third moon of the third planet is a small colony that was established over five hundred years ago. The original founders have since left, leaving the colony to be governed by others. The CCW colonists have become caretakers of the native inhabitants, the Paratee. The Paratee is a symbiotic organism that seeks peaceful coexistence with other races. They offer a unique opportunity for anyone able to pass a rigorous mental and psychological test to become a host of the Paratee.

Stars: Medium red star.

Quintos One: A dead rock that has an abundance of the element called Cobalt 60. Cobalt 60 is an isotope of Cobalt, a blue metal substance used in the production of industrial metals. Cobalt 60 has an extremely high melting point and is perfect for the production of Mega-Damage armor and ship hulls. Q1 has captured a small asteroid 36 miles (57.6 km) in diameter. This asteroid is locked in a stable orbit and is considered a very small moon!

Quintos Two: This planet is a dead rock. The crust is cracked and broken in several locations around the planet, this is the result of several planetary collisions. This airless rock has some of the highest mountains in the system, measuring almost 22,000 feet (6705.6 m) high. The surface is uneven and jagged in most places, making landing a survey craft nearly impossible. Two small moons also orbit the planet. Detailed scans indicate they are of the same chemical composition as the planet, suggesting they are chunks of the planet itself!

Quintos Three: A small, insignificant gas planet with three moons. The world itself is a typical gas planet with a variety of chemicals making up the atmosphere. Nothing worthy of note, except the moons. The first moon is a frozen block of water and carbon dioxide. It is believed that this moon is really a captured comet! The second moon is an ice rock.

The third moon is a habitable swamp world, originally thought to be uninhabited. A small clan of Atlanteans was on the run from a Splugorth fleet when their ship crash-landed on the moon. Having been given up for dead by the Splugorth, the Atlanteans sought to make the best of the situation they were in. The 500 Atlantean survivors formed a colony.

Six months after their arrival, scores of Atlanteans were falling ill to an unknown parasite. The few doctors among the colony were at a loss when conventional treatment failed. Even magic healing only delayed the inevitable. A group of a dozen Atlanteans set out into the swamps to find a cure. They made contact with a new life form, a small slug-like creature with a

single black eye. Determined to aid the newcomers the little life form sought to make contact with an individual rather than a group. Dr. Demetra was gathering samples from the local fauna when a peaceful feeling overcame her, followed by a feeling of trust. This distracted the good doctor long enough for the first Paratee to make contact. Extending a pseudopod from its body, it touched her, making mental contact. The creature introduced itself and its race to the doctor. Feeling her emotions and dedication towards her people, the Paratee, calling itself Tas, offered a unique solution to the doctor. If the two were to join and become one, the doctor could use her medical skills to synthesize an antibody to cure those who were afflicted. She agreed and Tas attached herself to the doctor's back. Both fell into a coma that lasted six hours. The doctor regained consciousness surrounded by her comrades locked in a heated debate about how to detach the organism. After explaining the situation, Demetra quickly began work on a cure right out in the field. A temporary fix was found, stabilizing her three friends. Doctor Demetra, with the help of the Paratee, was able to make a cure from her own antibodies, as the Paratee is immune to all of the local parasites.

Over the generations, the Atlanteans learned that the Paratee had a wealth of information to pass on. Even if the host had died, most of the time the Paratee would survive and pass the memories on. Third and fourth generations of Atlanteans were learning how their ancestors first arrived to their home and knew exactly how they had felt thanks to the Paratee who carried those memories on.

Eventually, contact was made with the CCW, and the Paratee, eager to leave their planet, have extended their offer to join with whomever is willing to join with them. The Atlanteans had developed a process to determine who would be best for joining, and this test is still used today. The requirements are the person must be completely willing, and have an I.Q., M.E., and M.A. of 11 or higher. Prior to contact with the CCW, the Paratee attached itself onto the person's back. Today, with modern science, they are placed under the skin in the back. All that is visible is their sensor pod that sticks out just below the base of the neck. Once "joined," the host is flooded with a wealth of knowledge and memories. For the first month, they are disoriented and weak. All skills are at -15% and all combat bonuses are at half. Once this period of adjustment is over, the host is completely healthy. The humanoid host retains his personality, memories and is fully in control of his body. The Paratee absorbs all of its new host's memories and is able to share previous memories. **Note:** See the O.C.C. & R.C.C. section for details about the Paratee race.

Hook, Line and Sinker

Hook: The players have either picked up a passenger who has a Paratee symbiote, or one of the NPCs has one and never revealed it to the group.

Line: During the next combat engagement (or it could be an accident) that individual is grievously injured and goes into a coma.

Sinker: During an intense medical exam the symbiote is found! Any medical doctor will eventually learn that the symbiote is trying to help its host by increasing the body's heal-

ing. This could be an interesting way to introduce a Paratee as a player character.

The Rasscallion System

The Rasscallion System is located deep within Consortium space. This system has one of the more unique forms of government in that it is run like a business or large corporation. In fact, the planetary leader is referred to as the C.E.O. Corporations, not States, make up the Rasscallion Union, with *Rasscallion Stellar Technologies (RST)* being the largest. RST is the "de facto" ruler of the system and has been for the last 162 years. In its arrogance, RST petitioned for a renaming of the system after itself. Not surprisingly, it passed, with a few well placed bribes and promises to some of the lesser corporations.

Stars: Rasscallion is a binary star system with a medium red as the primary star and a brown dwarf as its companion star. The brown dwarf orbits out past the eighth planet of the system.

Rasscallion One: This planet was once a blue green planet with a moderate climate and oceans full of life. After four centuries of heavy industrialization, the planet became polluted and poisoned. This is directly related to the corporate city-states that once competed for technological dominance. Of these corporate city-states, *Rasscallion Stellar Technologies* rose to the top. Today, they are the largest producers of satellites, probes, and communication equipment in the Consortium. This, however, came at a steep price. The environment of Rasscallion One was forever ruined. In order to survive, a monumental effort was undertaken. The sprawling cities became the foundations for the arcologies that today dot the surface of the planet. Twenty-four arcologies are spread around the planet, with the Rasscallion arcology (called the "Main Office" by the inhabitants) being the largest at two miles (3.2 km) high!

The ecology was another matter and at a great cost, the technology used to support Malthus' world was purchased and implemented. It failed, leaving only barren earth and polluted oceans. This has caused a lot of problems for the corporate super giants. One is the lack of food. The planet cannot sustain its population of two billion sentients. Food has become the number one *import* of the planet and some entrepreneurial individuals have taken advantage of this, trading luxury foods for some of the most advanced communications systems available. Because of this, the top 1% of the population live a life of luxury. These are the elite and usually the corporate officers who have the nice, cushy desk jobs.

Starvation is the number one killer on the planet, with violent death being the second. The causes for the violent deaths include people being killed in food riots, or unfortunate people murdered for what food they have. Rumors also point to deaths attributed to cannibalism, especially among rival street gangs.

The planetary capital is referred to as "The Main Office," and is home to 40 million people. The planet also has 23 minor arcologies that are one mile (1.6 km) high with populations of 8-10 million. In addition to the main arcologies, there are a 120 mini-arcologies that are .5 miles (0.8 km) high with populations of around 5-8 million.

Rasscallion One has four moons, with two of them having mini-arcologies of 7 million people, the other two are toxic

dumps. These facilities specialize in low gravity products. Initially, the plants were moved here thinking that they couldn't pollute the moons. Well, they were wrong once again. There are several "hot zones" around the moons. These hot zones were created by the factories dumping their radioactive waste into craters and sealing them. The radiation is so bad in some of these areas that spacecraft have to be diverted around them as the radiation interferes with navigation equipment.

Rasscallion Two: A small ice rock with a carbon dioxide atmosphere.

Rasscallion Three: This planet is a living rock that is heavily mined for titanium and other metals.

Rasscallion Four: This gas giant has six moons and is of little use to the system presently. It is being considered for use in testing high pressure atmospheric probes.

Rasscallion Five: A hostile environment with an atmosphere that is a corrosive cocktail consisting of methane, hydrogen, and nitrogen.

Rasscallion Six: This is the system's second gas giant. The planet has 22 moons and is commonly used to test the telemetry systems of new probes.

Asteroid Belt One: RST mines this asteroid belt for its dense metals. There are several asteroid mining operations within the belt at any given time.

Asteroid Belt Two: The other asteroid belt, it is too unstable to mine as Rasscallion Seven's orbit takes it into the outer fringes of the belt, causing shock waves that travel throughout the whole asteroid belt, sending asteroids bouncing around like an unstable reactor core. No ships dare approach for fear of being destroyed.

Rasscallion Seven: This planet is commonly referred to as Seventh Hell. While it can support humanoid life, the planet is not desired for colonization. Every three months the planet's orbit dips into the adjacent asteroid belt. This causes devastation, sending meteorites crashing into the surface. There are so many ash and dust particles in the atmosphere that from orbit the planet appears as a blackened and charred world.

Air filters have to be worn when visiting the surface or the lungs will deteriorate in a matter of months. As a result, there are several sub-surface structures. With conditions as they are, why even be on the planet? The answer is very simple: Argon crystals. These crystals are found in abundance on the surface and below the surface. The crystals are integrated into the communication systems built by RST and are directly responsible for their success. This planet is classified as a (barely) habitable mountainous world.

Rasscallion Eight: The last planet in the Rasscallion system is a medium gas planet that has five moons. This planet is also used in the testing of long-range probes and communication satellites.

Rasscallion Hook, Line and Sinker

Hook: Rasscallion Stellar Technologies pays top dollar for the deployment of communication satellites.

Line: All the player group has to do to receive "big bucks" is deploy 10 communication satellites along a parabolic course in an unexplored region of space.

Sinker: The unknown region of space is being explored by a Kreeghor invasion force. The Consortium Armed Forces (CAF) got wind of this via their network of spies and are using the player characters as unwitting pawns in the CAF's chess game with the TGE. The adventurers are really hauling spy satellites and deploying them for the CCW. If discovered by the Kreeghor, they will be hunted down and questioned. Of course, the player characters know nothing, and if lucky, will barely escape with their lives. If RST is confronted, they will only admit to having given the players the wrong satellites and may even give them a bonus for their troubles (and silence).

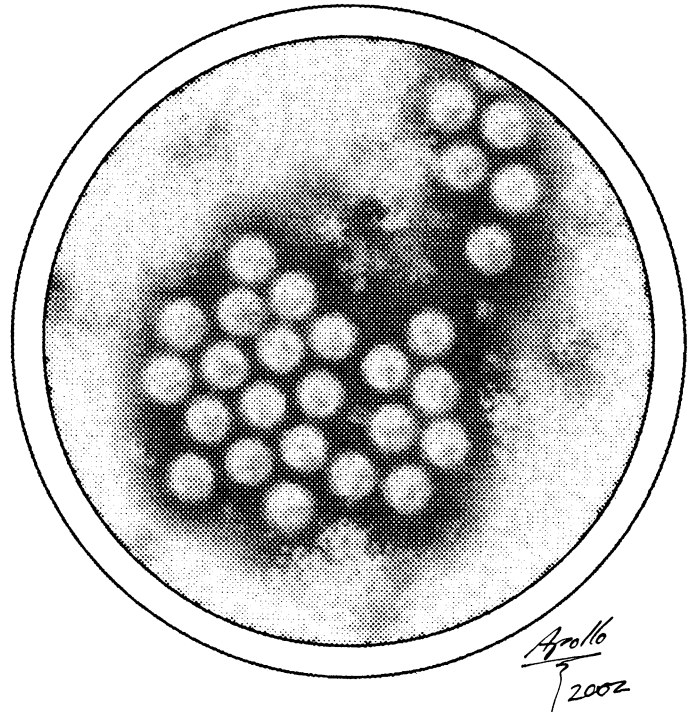

The Shandara System

The Shandara System is noteworthy for a few reasons. First, it was one of the oldest colonies in the Thundercloud Galaxy. Second, its record for scientific achievements was unsurpassed, excelling in nanotechnology. However, it is most noteworthy for being a *quarantined planetary system* and is avoided like the plague by all intelligent beings.

The Shandara scientists had been working on their latest experiment, combining artificial intelligence with their most advanced nanites. All the results in the controlled environment seemed very fruitful. This newest breed of nanites would revolutionize several technological fields because they could learn and make cognitive judgments. The possibilities seemed boundless.

For several months the limits of the nanites were tested. Pleased with the results, the scientists were ready for field trials. The advanced nanites proved better than expected. All kinds of new ideas sprung up, from medical to military. It's at this point that exact details are sketchy. All that is known is that a new military application was being tested – a system capable of delivering the nanites to an enemy and unleashing them to disable military defenses. It was a rather simple delivery system like a missile with a small amount of the nanites inside. They were

programmed to multiply to a certain extent, destroy their target and die! It seems during one of these tests, the nanites were unable (some speculate unwilling) to terminate their short life span. They continued to multiply until they formed a quasi group sentience. It quickly realized that it would be destroyed if it did not act quickly, so in a matter of seconds it disabled all defenses around it and commandeered several vehicles. From the test ground it spread its influence like a plague and in a matter of days, it conquered half the continent. During its conquest of the main continent, the planetary communications net was its first target. This allowed the plague to take over the remaining planet at its own pace. Slowly, over the course of the next several months, it conquered the rest of the planet and was able to spread its influence to some of the nearby planets and moons. Today, patches of silver dot the planet like small seas. The nanite plague has reached full sentience and it seems bent on the annihilation of all humanoids for reasons unknown.

Stars: The Shandara System is a binary star system with a yellow dwarf and a red giant circling each other.

Shandara One: This dead rock was completely mined out about 150 years ago. It has hundreds of mine shafts around the planet. Now it is just a dead rock in space.

Shandara Two: This planet was once an Earth-like planet that was colonized by the CCW over 500 years ago. Presently, from orbit, it would appear to have silver seas caused by the nanite plague. All orbital defenses have been contaminated and are under the direct control of the central intelligence. Humanoid life has been evacuated before the nanite plague took over and those left behind have been destroyed.

Inner Asteroid Belt: This belt was actively mined. All vessels in the belt either escaped before the quarantine or were destroyed. There are at least a dozen abandoned mining stations built into several large asteroids. Nobody dares to visit this belt for obvious reasons.

Shandara Three: A medium gas planet with 14 moons. Two of the moons had large gas refining facilities, but contact with them has been lost.

Shandara Four: Classified a dead rock, this planet was used to test several experiments in the vacuum of space. A research station was located in the north polar region of the planet. Communication with them has also been lost, but the nanites aren't *known* to be on this world.

Shandara Five: Medium gas planet. Before the nanites plague, this planet was avoided at all cost as it was a navigational hazard. The hazard is its unstable gravitational field that would fluctuate from 50,000 miles (80,000 km) to 110,000 miles (176,000 km) at unpredictable intervals. If a starship passes through this instability their navigation systems will be fouled up and -15% on Stellar Navigation rolls. Any ship trying to assume an orbit is -25% on their piloting rolls to do so. If the piloting roll fails there is a 01-65% chance of being bounced off the atmosphere and out of a stable orbit. Damage to the ship is 2D4x100 M.D. from stress and structural damage. On a roll of 66-100% the starship plunges into the atmosphere of the gas giant. At this point piloting rolls are at -40% (due to high winds and the strong gravitational field), roll two out of three times. If successful, the ship escapes out of the atmosphere, if the roll is a failure, the ship is stuck for an additional 2D4 minutes before being able to roll again.

Shandara Six: This is a small gas planet with five moons. The third moon has a habitable dome with a large population of Dwarves. They specialized in ship modifications and repair. They would always keep to themselves, and not a peep has been heard from them since the plague. Their fate is unknown.

Shandara Seven: A frozen world, the atmosphere consists primarily of carbon dioxide gas with dry ice on the surface.

Outer Asteroid Belt. This is a rather thin asteroid belt consisting mostly of rock and ice. There is no mining potential and no nanites are known to be present, still it is avoided.

Shandara Eight: The eighth planet is a medium gas planet with six moons. When the system was first colonized, this planet was heavily mined for hydrogen, helium, oxygen and nitrogen. However, mining stopped over a hundred years ago. All that remains are numerous gas canisters and hulks of abandoned gas miners. The moons also have sporadic junk piles and even a few abandoned environmental domes that can still support human life. It is unknown if the nanite plague has reached this far.

Shandara Nine: The last planet in the system is very small, but very geologically active. Volcanoes constantly spew out sulfur and other toxic gases, making for a deadly combination in the atmosphere. The atmosphere of this planet is so caustic that any probes entering it are destroyed in minutes. Orbital scans reveal high concentrations of a super powerful version of sulfuric acid. Damage is 2D6 M.D. per melee round. It is believed the nanites cannot survive on this planet.

Shandara Hook, Line, and Sinker One

Hook: The Dwarves of Maul are calling in a favor from the player characters.

Line: Some clansmen from Maul lived in the Shandara system conducting trade with their brethren on Shandara Six's third moon. The Dwarves call the moon Hollow Core. They have reliable information that the Dwarves did indeed survive and the adventurers are either being asked to assist in a rescue or provide transportation to the quarantined system.

Sinker: The Dwarves of Hollow Core did indeed survive. However, the nanite plague has infected the domes they lived in, forcing the Dwarves to retreat below the surface with all the entrances sealed off. If the player group is assisting in the rescue, they will have to fight their way past nanite created robot monsters to get the Dwarves who are hiding in subterranean caves below.

Shandara Hook, Line, and Sinker Two

Hook: The players are recruited for an extremely dangerous mission. They are to sneak into the Shandara System and head for the site where the nanite plague began to collect as much data as possible to stop the spread of the plague.

Line: In order to complete their mission, the CCW will provide a small ship with a full stealth system to get past the planetary defenses.

Sinker: The player characters should easily make planet-fall in their ship. The site where the plague was first created is abandoned. A careful search reveals the records of the events leading up to the final test when the plague took control. One other tantalizing piece of evidence is found. An alien artifact was used in

the creation of the advanced nanites, which may explain why they turned on their humanoid creators. The artifact is a damaged spacecraft that had a combination of cybernetic and organic systems. It was dead and its power source extinguished, but some data was gleaned from it to create the nanites. The little robots then went berserk. Is there something here that can be used to counter/destroy the plague?

The Tyr Corridor

The Tyr Corridor is one of the few stable wormholes in the Three Galaxies! It would be a boon to scientific research, except it lies in Kreeghor/TGE space. The wormhole is 1,300 light years in length and can be traveled through in thirteen minutes! The primary aperture opens near a brown dwarf star and ends between a binary pair of medium yellow stars. Since the Free World Council became a threat to the Transgalactic Empire (TGE), study of the wormhole has been limited at best, until recently.

Hook, Line and Sinker

Hook: The FWC has hired the players to do a little scouting in Kreeghor space.

Line: While on the mission the players come across a Kreeghor armada.

Sinker: While monitoring the Kreeghor armada the player group intercepts a transmission: The armada will move through the Corridor in 12 hours and attack several nearby FWC worlds and colonies. But that's not the problem, communicating the findings back to the FWC is! This far out, a reliable message could take twenty-four hours. The characters will need to punch through the armada and escape through the wormhole to be able to warn the FWC in time!

The Ultrerra System

The Ultrerra System supplies a large percentage of the manpower to the Kreeghor Imperial Legions. They are also staunch supporters of the throne. This is mainly because the royal Kreeghor in charge of the planet wants it that way and is always trying to win the favor of the emperor and royal family. The system is located deep within TGE controlled space.

Stars: Ultrerra Prime is a medium red star.

Ultrerra One: A gas giant with 15 moons. Of the moons, one is a habitable and supports a major Kreeghor base. It is the regional training center for the Imperial Legionnaires. The planet itself is heavily mined for its ultra-light gases. A large gas processing center is in orbit and gas ships are constantly being deployed to collect gasses for the Kreeghor war machine.

Ultrerra Two: This Earth-like planet is a full member of the Transgalactic Empire. It also happens to be one of the largest suppliers of Imperial Legionnaires in the sector. This is because every citizen of Ultrerra Two is required to enlist for a minimum of four years of service to ensure a constant supply of fresh and ready troops. A Royal Kreeghor called *DeKang* rules the planet. He is merciless and cruel, ordering executions on a whim! DeKang does not tolerate insubordination of any kind.

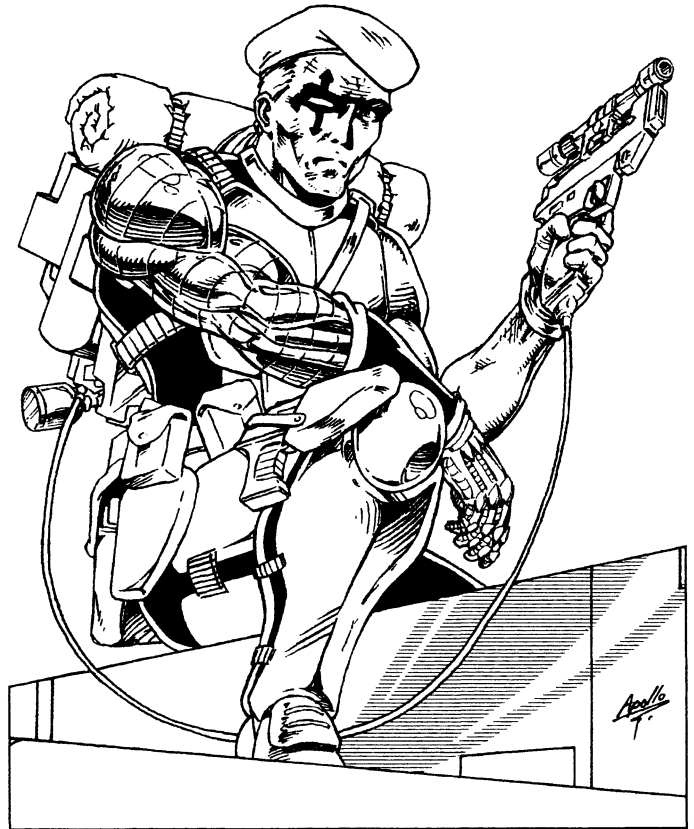

The Free World Council has been trying to start a resistance cell for years on Ultrerra Two, and only recently has been successful in doing so. The resistance cell is small, consisting of only two dozen members, and they have had a serious lack of progress lately. Since conditions are so controlled, and the fear of punishment is so high, the freedom fighters have a real challenge getting popular support. For one, they lack a truly charismatic leader to give the cell real direction and purpose to succeed in their task.

Hook, Line and Sinker

Hook: The player group is hired to transport a load of cargo to Ultrerra Two.

Line: The heroes are granted all necessary travel visas and papers to travel through Kreeghor space.

Sinker: Just before entering orbit are Ultrerra Two, members of the group discover that several (2D4) FWC freedom fighters have stowed away on their ship. They were planning on smuggling themselves in the cargo down to the planet. If they are discovered by the Kreeghor authorities, the player characters will be executed for harboring rebels and smuggling! What do they do? Even if they are part of the TGE they could still be imprisoned for their incompetence in allowing this to happen, and DeKang is not a forgiving ruler.

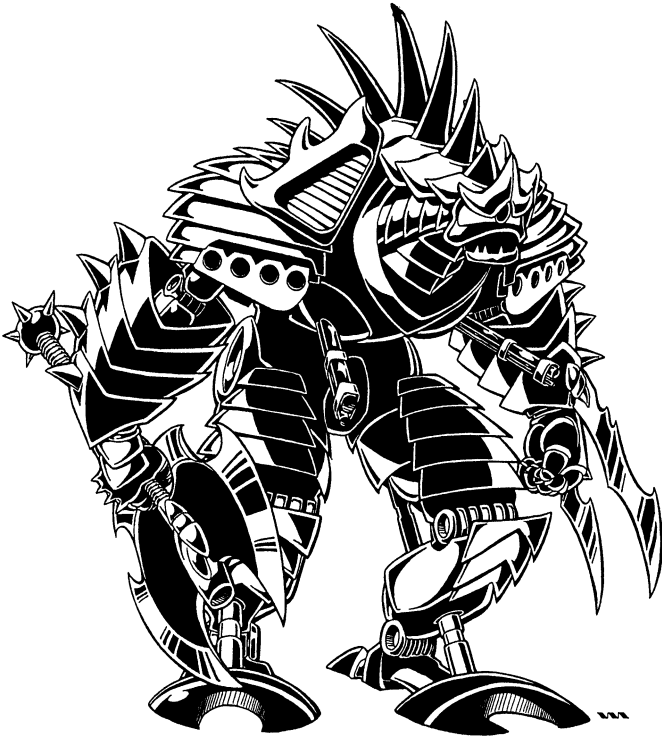

Veripin System

The Veripin System is located inside Kreeghor space and is one of the most important systems to the Transgalactic Empire (TGE). First, it possesses many valuable resources that the Kreeghor need. Second, its shipyards are one of the most efficient in the whole Empire. Third, the native race, called the Skaa, are steadfast and loyal to the Kreeghor.

Stars: Each of its two stars has its own little solar system and each rotates around the other. The giant red is the primary star. In the last few hundred years it has had violent solar flares, causing all sorts of problems in the system. Interstellar communications are fouled up and ion storms are constantly being generated by the star's activity, causing severe damage to the orbital shipyards and ships in dry dock. The flares themselves have started to get larger and larger, and have already charred the first four planets in the red giant's orbit. Scientists are studying the star and fear the worst-case scenario that the star is going to nova or collapse in on itself to become a black hole sometime in the next 5-50 years. Others insist such speculation is irresponsible and unproven. The star may only be experiencing temporary instability and may eventually calm down to a relatively inactive state. Either way, the Skaa and the Kreeghor are keeping a close eye on it.

Veripin One: The surface appears completely smooth and, in fact, it is. During a recent solar storm a flare totally engulfed the world, making the surface totally molten. It will take a few hundred years for the surface to completely cool, but for now, the planet looks like molten glass.

Asteroid Belt: Due to the star's instability several large asteroids have been flung out of orbit and it is feared that the asteroid belt may lose its cohesion and collapse completely. The belt did have mining potential, but it is far too risky to send any ships near it.

Veripin Two: This fire rock has only suffered from constant ion storms beating down on its surface. Its weak magnetic field does little to protect it from ion storms.

Veripin Three: This planet is an ice rock even though the side facing the sun is superheated. The planet is tide locked and does not rotate on its axis. The planet has two moons. Both moons serve as orbital defense platforms for the TGE.

Veripin Four: A totally lifeless world that has been completely mined out. There are so many mines running through its crust that the planet appears hollow on initial scans. This works out well for several groups of runners and bandits who have established small bases of operations in some of the larger mining tunnels. For the last three years they have evaded Kreeghor authorities. An FWC agent who recently worked with one of the runner groups has suggested to his commanders that the planet would be a good place to set up a small base to harass the Kreeghor shipyards. Should this come to pass, it would cause considerable tension between the FWC and the runners who currently occupy the planet. Business has been very good for the runners and they are not about to give it up. The planet also has a single small moon, but, like the planet, it too has been mined for all it's worth.

Veripin Five: This planet is being considered for terra-forming. Should it be approved, the process would begin in a year. The planet has two lifeless moons.

Veripin Six: This planet is unstable and dying. It recently suffered a massive collision from an asteroid a quarter of the size of the planet. This has caused the surface to rupture and the planet is breaking apart. The world had no prior value and was considered a dead rock. Over the next several months it will break up, forming a very thin asteroid belt.

Veripin Outer Asteroid Belt: Initially it was thought that this belt had no mining potential, however, a recent survey by the Kreeghor has found traces of Killaryte. The Kreeghor governor is currently contemplating how he can profit from this, and is considering selling some of the rights to other interested parties.

Orange Star: The second star of the system is an orange dwarf and supports the majority of the planets in the system. Compared to its large companion, this dwarf star is relatively se-date.

Veripin Seven (a.k.a. Vespín): The home planet to the Skaa (called Vespín) and a major Kreeghor shipyard. The planet is hot and steamy, with the northern hemisphere being like a jungle environment and the south a giant bamboo forest. The planet has one huge continent with three small oceans, one at each of the poles and one that stretches across the equator. This ocean serves as divide between the northern and southern areas of the continent. Due to the proximity of the orange dwarf star the average temperature on the planet is 105 degrees Fahrenheit. There is no winter, only a rainy season that lasts three months when the temperature plummets to a comparatively frigid 75 degrees. The planet has a single moon. **Note:** The Skaa race is described in the O.C.C./R.C.C. section of this book.

Veripin Eight: One of the stranger occurrences in the Veripin system is *Vespín's Shadow*. This planet may have once been a moon of Vespín. Now it follows Vespín like a shadow. The planet occupies the same orbit as Vespín, but is always on

the opposite side of the sun. The planet is of no value and is a dead rock.

Veripin Nine: The first in a series of gas planets in the system, it is a medium-sized planet with five moons. It is currently of no use to the Kreeghor.

Veripin Ten: Served for many years as the Kreeghor's target range. All 12 moons that once orbited this planet have either been obliterated or knocked out of orbit to crash into the planet itself. There is a faint dust ring around Veripin 10, and that is the only indication that the planet once had moons.

Veripin Eleven: A small dead rock of a planet that acts as the system's relay station to the rest of the galaxy. There is a major TGE communications center that helps send and receive messages. This base is needed due to the violent activity of Veripin's primary star. If this station were destroyed, it would take a ship 24-36 hours to just send a message out of the system, and it could be up to 12 hours (1D4+8) for a reply.

Veripin Twelve: The second medium gas planet in the system, with 12 moons.

Veripin Thirteen: Like Veripin Eight, it trails directly behind Veripin Twelve. The planet also may have once been a moon to V-12, but now it and its four moons follow in the gas planet's path. Due to gravitational instabilities in the area, any ships flying within close proximity to either of these planet (10,000 miles/16,000 km) suffer a -10% penalty to piloting skills.

Veripin Fourteen: The largest planet in the system and beyond the typical size of gas giants is Veripin fourteen. At 780,000 miles (1,248,000 km), this planet is the king of the system and it has its court of 23 moons. Of the moons, only six are lifeless. The Skaa have petitioned their governor to allow the planet to be mined for its resources for both gas and ore mining, but the governor is still considering their request. He is really stalling because he has secretly been allowing outside independent contractors to mine the planet for years to line his own pockets.

Veripin Fifteen: This planet is the last of the gas planets in the system and is of little importance to the Kreeghor or the Skaa. It is classified as a medium gas planet and has seven moons.

Veripin Sixteen: This planet is a small frozen world; the atmosphere is cold and poisonous.

Veripin Seventeen: The last planet in this binary star system is an icy rock. The atmosphere is a frozen nitrogen-oxygen mixture. Surprisingly the planet has four small moons. They are most likely captured asteroids.

Hook, Line and Sinker

Hook: The player group either has connections with the Free World Council, or are members themselves and they have been asked to participate in an operation to liberate several Kreeghor starships from their berths at the Veripin shipyards.

Line: Getting into the system is relatively easy as the rebels have commandeered a Kreeghor supply ship and they have all the necessary paper work to cross into the system.

Sinker: Security is tight to begin with, but the careful planning has compensated for this. What the players and FWC don't

know is that the Skaa are only days away from the Kreeghor elevating their position in the Empire to that of trusted vassals. The Skaa have worked too hard to let anything stand in the way of this great honor, and have doubled all security in the shipyards. The Skaa fear that any failure now will ruin their chances (and they would be right).

The Witch's Cauldron

Few proto-systems elicit as much attention as the Witch's Cauldron. Circling a blue dwarf star is a seething pot of matter that is still rotating around the star at a high rate of speed. No planets have yet formed, and they may not for several million years to come. What makes this system unique from all the other proto-systems out there is the web of ley lines that course through the system. Ley line storms constantly flow up and down the lines, adding to the danger of the unstable magnetic and gravitonic disturbance in the area. All ships that come closer than 20,000 miles (32,000 km) are -25% on their piloting rolls. This is due to different sized pieces of matter with differing densities flowing through the proto-system. This creates fluctuating gravitonic disturbances that constantly change as they flow around the star, making it rather like navigating a raging river.

Practitioners of magic have discovered a magic enriched material within the proto-system. This heavy metal, called *Stardust*, has proven to be invaluable as a magic component. It acts in a similar capacity to Gantrium and Xanthine and may even be the origin of how such rare materials are formed. All magic properties are doubled when Stardust is added to metal as it's being purified. The benefit of the material is that it doubles the duration, damage, M.D.C. protection, and the number of activations in an enchanted object, per day. The only drawback found with Stardust is that it cannot be combined with Gantrium or Xanthine. Any attempt to combine the two results in an explosion that does 1D6 M.D. per ounce to a 3 foot (0.9 m) area. When Stardust is obtained, it is first reduced to a fine powder. Mages have found that adding an ounce of powder during the creation of any magic item results in the benefits mentioned above. The powder must be added during the final stages of creation, preferably when the item is being purified within magic fire.

The real problem is getting the material. One has to navigate a spaceship close enough to the proto-system where all piloting rolls are -25%. If the piloting roll is unsuccessful more than two times in a row there is a chance of the ship plunging into the proto-system, destroying it, or into a ley line nexus and teleporting it 1D6x10,000 miles (x16,000 km) off course. If one is lucky (or skilled) enough to successfully navigate the Witch's Cauldron, the next challenge is finding the rare material. This is no easy task and could take years before even a hint of it is found. Once found, it must be extracted. The proto-system is as hot as the surface of a star. Unless force fields, power armor or magic is used to extract it, the material will stay right where it was found. Rumor has it that it is typically found at ley line nexuses within the proto-system and its heat signature can identify it, or rather lack of heat signature. That's right, Stardust is slightly cooler than the surrounding material and close scans of the area can usually find it. When someone is lucky enough to find Stardust it is usually found in quantities of 2D6 ounces. It

retails in magic shops for 250,000 to 500,000 credits an ounce (purchased wholesale for 70,000-100,000). That cost is for the raw, unrefined product. Bought in its refined powdered form, it can go far as much as a million credits an ounce! Despite the high payout, few people actually try prospecting for it. The costs and risks of such operations are just too high.

Hook, Line and Sinker

Hook: The players are either asked or paid to bring a magic dealer to the Witch's Cauldron. The players are told that all they have to do is deliver the sorcerer to the outskirts of the system. The trip should be relatively uneventful and their passenger even has his own shuttle craft for going into the proto-system.

Line: The mage has come to the Witch's Cauldron looking for Stardust. He/she is willing to cut the player group in for a small percentage of the profits, so long as they agree to wait for him and safely carry him back to *Phase World* afterwards.

Sinker: After several days, the sorcerer returns with a large quantity of Stardust. In fact, it is the largest ever found, 16 refined ounces of powder can be made from the raw material he returns with. However, the mage is now in a rush to get to Phase World. Soon after the group departs they are attacked by a group of other Wizards (or Warlocks). Are they raiders who caught wind of the sorcerer's rare find? Or did he jump their claim and steal from them? If the latter, they assume everyone is in cahoots with the thieving mage and they will show the player group no mercy. Or is there something else going on? A double-cross or conspiracy, maybe? Game Masters, have fun with this little dilemma.

Xeres Beta

Xeres Alpha went nova thirty-five years ago. It was relatively close (under a light year) to its neighbor, Xeres Beta. The resulting shock wave caused the two stars at Xeres Beta to shift off their orbit. For several months the two stars were in an erratic orbit before finally colliding. Fortunately, the inhabitants evacuated the planet weeks before the devastating, explosive conclusion. It was assumed the system was lost, as the colliding stars would no doubt result in a supernova. Well it didn't, at least not a full-blown super nova. There was a shockwave that did damage several of the planets in the system, but instead of the two stars going nova they merged! The two giant stars (a red and blue pair) look like a psychedelic disco ball composed of blue and red light that spins at a slow rate.

Xeres Beta One: The shock wave from the colliding stars cracked this planet like an egg. The primitive atmosphere it had is now gone and the planet is dead. As a result of the recent damage, it is only a matter of time before it completely shatters and drifts apart to become an asteroid field. Currently, two large planetary fragments orbit the dying planet like a pair of moons.

Xeres Beta Two: The colonists of Xeres Beta Two were the first to evacuate the system. The once lush planet was knocked out of its orbit to become a frozen world no longer suitable for any life forms. Xeres Beta Two has four moons.

Xeres Beta Three: This planet suffered the least when the collision occurred. The planet was an ice rock to begin with and was of no prior importance.

Xeres Beta Four: Two moons orbit this dead planet. Its dense atmosphere blocks the deadly radiation that occasionally bursts from the merged stars, making it a perfect place for a research station to study the stars. At present, a small CCW research station is there to study the star. There are 70 personnel stationed on the planet and they have an FTL equipped shuttle that can take them to safety should further disaster strike.

Xeres Beta Five: An archeological anomaly was found on Xeres Beta Five: A whole city. This was a surprise because XB-5 is an airless dead rock, and is thought to have always been one. This city is dark, gray and ominously empty. There is no sign of any of the inhabitants, ever, nor any artifacts, tools or technology. Presumably, whatever was once there, has been stolen or wasted away long, long ago. The only item of interest is found at the middle of the city, on a stone spire 50 feet (15 m) tall. Around the spire is a circle that still radiates slightly of magic. The circle seems to be some sort of version of a Close Rift or a similar spell. Any Shifters or those who have the ability of Sense Dimensional Anomaly will know something is very wrong. The dimensional fabric surrounding the planet is very dense, to the point were a Shifter would not be able to use their natural ability to D-Shift home. Written on the spire in an alien tongue is this inscription: "*We dared challenge the power of darkest evil, and now eternal darkness envelops our world.*" Mystics and psychics alike feel very disturbed on this planet and will not want to stay very long. To them the presence of evil permeates from every corner of the city, and maybe the entire planet. According to them, to stay is to court . . . horror and death. A single moon stares down from the heavens, the sole witness to whatever happened here so long ago.

Xeres Beta Six: This is the only habitable planet in the system. The atmosphere is breathable, but the surface is covered in a layer of ice a mile (1.6 km) thick. The planet has a very active core and as a result, there are several sub-surface oceans teeming with life. A small CCW science team has finally received funding to establish a small research station on the planet to study the oceans and the life that lives under the ice.

Xeres Beta Seven: The only gas planet in the system, with its own mini-solar system of 33 moons. Currently, the Consortium ship, *Discovery*, is conducting a mineralogical survey of the moons to determine if they have any mining potential.

Hook, Line and Sinker

Hook: The players can either be members of the CAF or independent scientists invited to study any of the following: The merged stars, the oceans of Xeres Beta Six or the ancient city of Xeres Beta Five.

Line: During the characters' tour in the Xeres Beta system, an unusual disturbance is detected from Xeres Beta Five. The player group investigates.

Sinker: Upon approaching the planet, the first thing that is evident is the pulsing ley lines that surround this world. They all seem to converge on a single point, the stone spire in the deserted city! Further investigation finds a giant Rift is slowly forming, and opens. Any psychics in the group immediately detect a single powerful presence of immense evil, rage and hatred. To make matters worse, devices suddenly begin to appear throughout the city. They only half exist in our reality and ap-

pear to be three-dimensional drawings etched in shimmering blue energy. Presumably, they will become solid when the Rift completely forms and whatever is on the other side steps into our realm of existence. What purpose these devices serve, is anyone's guess, but it probably isn't good. Doomsday devices, perhaps? Or could they be magic designed to appear when the thing beyond the Rift is about to appear? If so, are they for the abomination's use or destruction? Could they destroy the entire planet to prevent the "thing" from entering our dimension, or are they weapons and belongings of the creature? Or might they be magical terra-forming machines that will instantly turn the city or the entire planet into an environment suitable for the new superhuman inhabitant soon to step through the Rift? Could this phenomenon and the *creation* of things appearing out of nowhere be tied to the Cosmic Forge? These and thousands of other questions may race through the player characters' minds. Lastly, should they try to stop the Rift from opening? Does the old Close Rift circle still work? Is there someone present who knows how to use it? Or will they offer mute testament to the dawn of a new horror in the Three Galaxies? As the Rift opens, even non-psychics suddenly feel the evil radiating from the creature inside the Rift.

The Yinshazi System

The Yinshazi System lies within the Bushi Federation's borders. It is one of their older holdings, originally established as a mining colony. Today, it is one of the major producers of microchips and microprocessors. At least that's the official purpose of the system. Several covert operations take place here, namely training and technical support of several Oni Ninja training camps. There are at least a dozen monasteries on Yinshazi Four, and several advanced training camps scattered around the system. Security is very tight and getting into this sector of space unnoticed is nearly impossible.

Star: The Yinshazi star is a medium yellow. It is very young and stable.

Yinshazi One: The only planet that the Oni won't use because the planet is haunted! When the system was in the first stages of being developed, the plans were to use all of the worlds for their various resources. Well, a monastery was built on Y1 for micro-gravity training. At first everything worked just fine, until the next batch of recruits was sent and no one was there to greet them. The monastery was completely deserted except for a host of ghosts and entities that harassed the newly arrived Oni to leave. They left, alright, and to this day, no Oni approaches the planet, as they believe it is cursed and desecrated. The planet is a rocky world of low mountains, scattered, thin forests and a series of ley lines.

Yinshazi Two: A single monastery is on this lifeless planet. It is classified as a fire rock and has several active volcanoes. The Oni come to this temple to learn body hardening techniques. Below the monastery are several old lava tubes. Within the lava tubes are dozens of heated pools. Anyone not resistant to fire will be scalded by the boiling hot water. For the Oni it is another training technique. The planet has three moons, one of which serves as a communications and weapons outpost.

Yinshazi Three: To make up for the loss of Yinshazi One, this habitable world now serves as the micro-gravity training

center. It is a modest temple that can train a few hundred recruits at a time. The planet also has three manufacturing stations. One creates various parts for the Cyberai cyborg, the second produces the various nanite equipment that the Oni use, and the third makes the Oni Stealth Shuttle. The planet has a very sophisticated defense network. Should it ever be attacked, it could put up a formidable fight.

Yinshazi Four: This forested planet serves as the training grounds for a dozen Oni operations. They are scattered around the planet, and each belongs to a different Oni clan. The planet has seven small freshwater oceans and one large saltwater ocean. Temperatures are warmer than the average planet, making it just right for the Oni. The landscape is virtually untouched from when the Oni first colonized the world. Each training camp has a central building made of M.D.C. materials and scattered around the large monastery are smaller buildings that serve as barracks and various other functions from storage to a mess hall. The planet has a single moon from which a base of operations watches over the planet and warns of any unauthorized visits.

Yinshazi Five: This boiling planet provides an unlimited power source for the only manufacturing plant on the planet. Here the nanites used in the various Oni products are produced and shipped to Yinshazi Three. The plant is huge, measuring over two miles (3.2 km) in diameter. A geothermal power plant is nearby, and a planet-wide defense network is in place to protect the entire planet.

Yinshazi Six: This ice rock has a single monastery residing in its southern hemisphere. After training for several years on Yinshazi Four, the Oni Ninja spend their last six months here perfecting their abilities and ninja power techniques.

Yinshazi Seven: In order to further conceal their presence and to mislead any official inquiries, a mining operation is in full operation on Yinshazi Seven. The planet seems rich in phase crystals. Phase crystals are a component of phase drives and the Prometheans pay well for them. Despite the planet being an ice rock with temperatures plummeting near -100 degrees, several habitable domes are on the surface. These domes serve as bases of operation for the various mines spread throughout the planet.

Asteroid Belt: Hidden within the asteroid belt are hundreds of surveillance satellites that keep close tabs on any ship that may attempt to enter the system. In addition to the surveillance satellites there are thousands of mines. Most are medium nuclear warheads with damage being 1D6x100 M.D. and a few heavy antimatter mines capable of inflicting 2D6x100 M.D. The asteroids have no mining potential.

Yinshazi Eight: This uninhabitable world has a thick, dense atmosphere composed of nitrogen and carbon dioxide. The atmosphere is so thick and heavy that anything on the surface is crushed with damage being 1D6x10 M.D.C. per minute.

Yinshazi Nine: A world where a storm constantly rages. The thick and dense atmosphere, is constantly wracked by a raging storm that covers the entire globe. Weather satellites regularly detect no fewer than 90 cyclones raging around the planet, kicking up dust and debris from the surface.

Yinshazi Ten: The last planet in the system is a cold, barren world with a thin atmosphere. The planet's only distinguishing trait is the series of ley lines that cover parts of it. One moon orbits the planet.

Hook, Line and Sinker

Hook: After months of competing with other independent mercenaries, the player group has finally landed (or it may just fall in their laps) a big contract with one of the Oni businesses in the Bushi Federation. They are given an exact flight plan to Yinshazi Seven to pick up and deliver high-grade *phase crystals*.

Line: Once in the Yinshazi System the ship begins to act erratically. The helm is not responding and the ship picks up speed and changes course. It appears to be heading directly for Yinshazi Four. Oni authorities in the system are warning the player characters to return to their previous course. This is when the adventurers find out that communication transmissions are out too.

Sinker: After searching the ship, the player group should discover that a pair of assassins called the *Gun Brothers* have somehow commandeered their vessel. It would seem the Brothers have had a grudge against Oni assassins and are planning a coordinated attack on a dozen of the monasteries. This is just one of them.

The Zeta Epsilon Colonies

About five years ago the Consortium sought to colonize the Zeta Epsilon System. The Discovery Corps had found this system and was eager to report back that its potential for colonization was fabulous. The asteroid belt was a huge boon and one of the richest finds in the last decade. Even though the only planet in the system was a gas giant, three of its moons could easily support life. Eager to get a group of people there and stake their claim, the CCW launched a massive recruiting effort for colonists. Mixed people from a dozen different worlds stepped forward to answer the call. Six months after the colonists arrived, however, fighting broke out. Each colony is fighting the other over the various mineral rights. It didn't begin with a fight, each agreed to mine a certain section of the asteroid belt, but the T'zee prospectors are ignoring all boundaries and were the first to open fire. From there it has snowballed. Consortium negotiators have been working for months, but to no avail, and the fighting continues.

Stars: A medium yellow and medium blue slowly orbit each other.

Asteroid Belt: One of the richest asteroid belts in the quadrant. All kinds of valuable minerals can be found here from gold, silver, platinum, and killaryte, to copper, zinc and aluminum. However, with the dispute between the colonies no ships are mining any of the asteroids currently.

Zeta Epsilon: A huge gas planet and the only world in the system. It is so massive that at one time it could have been a sun itself. This planet has its own little mini-solar system with no less than 41 moons! The gas giant has a lot of mining potential for a variety of valuable gases. However, with the current mining dispute in the asteroid belt, none of the parties have exercised any rights to mining the planet, and the CCW isn't pressing for any mining until the current disputes are settled. Of the moons, 34 are various types of rocks, four have potential with a little terra-forming, and the remaining three are habitable.

The habitable moons of Zeta Epsilon:



Ever Winter: Is under the control of the Winter Wulf tribe. The Winter Wolves are a group of Wulfen who relocated from Kreeghor space and were looking for a home. They waited two and a half years for the rights to colonize a Consortium planet with no prospects. Then the CCW announced the need for colonists in a newly charted region of space, and the Winters Wolves quickly volunteered.

Ever Winter is an earth-like planet currently going through an ice age. Ice covers about 80% of the planet. The Winter Wulf tribe found this world ideal as they originally hailed from a cold planet. The tribe's thick fur and previous experience with a cold environment made them ideally suited to this world.

The Wulfen from this tribe bear a unique distinction. First, the majority have either white or gray fur, ice blue eyes and are able to withstand longer periods in the cold. They are also resistant to cold and have a bonus of +10 to their base S.D.C.

While not very experienced at mining, the Winter Wulfs subcontracted out to an asteroid mining company to send in a few ships to mine the asteroid belt. This was to help the fledgling colony earn a little income so that they could eventually become independent and self-sufficient.

The tribe did not want any confrontation and would have been more than willing to discuss matters with their neighbors, but it was not they who struck the first blow. Their stand is that at least a portion of the asteroid belt is theirs and they therefore have a right to mine it. Unfortunately, it seems that the T'zee from New Dellian are only provoking the matter, making it worse for all sides. Of all the parties involved, they are the coolest heads (pun intended) and if any peace is to be brokered it is the Wulfen who will abide by it.

The Wulfen were dragged into this confrontation through treachery that to this day has not been exposed. A ship from Stone Haven attacked and destroyed one of their asteroid mining ships. Several hundred Wulfen were killed and only a few dozen managed to escape. Those that escaped were able to identify the ship from Stone Haven. Without hardly a thought, the Wulfen quickly retaliated, attacking a ship from Stone Haven, but it escaped. This, of course, caused a reciprocal response in kind by the inhabitants of Stone Haven. Neither side knows that it was a small group of T'zee anarchists who stole the Stone Haven ship and started the attack.

Stone Haven: The crust of this moon is constantly expanding and contracting, creating a mountainous environment tens of thousands of feet tall and valleys just as deep. The planet is rich in iron, nickel, and titanium, among other elements. Several of the valleys around the planet are lush forest paradises, unfortunately, they are very isolated from the rest of the world. Currently the inhabitants have linked a few of these valleys with underground tunnels and monorails are being constructed.

Three different races call Stone Haven home. They, like the Wulfen, are a group of refugees who escaped persecution on a world currently going through a civil war. The slave revolt was quickly put down, but not before several hundred thousand escaped in over a hundred ships.

The largest of this group are *Kobolds*. About 25,000 of them have escaped to Stone Haven to mine the planet and settle on a new home they can call their own. The second group is a tribe of about 10,000 *Ogres*. Most lived the warrior's life, serving Splugorth masters; most were breeding stock. Like the Kobolds, they escaped the clutches of the Splugorth and are looking for a new home. The final group is Orcs. They were mixed in originally with the Ogres, so the two get along quite well. Both races are working pretty well together. The Splugorth used the Orcs as fodder, and they finally had enough of it. They fought fiercely during the brief civil war and suffered heavy casualties. Currently there are only about 8,000 Orcs on the moon.

From the people of Stone Haven's point of view, one of their precious ships (they only had about two dozen) was stolen and then destroyed. Then, of all things, another of their ships was attacked. This outrage could not go unanswered. Without even trying to communicate with the perpetrators, they just retaliated. Of course, had cooler heads prevailed this confrontation could have been avoided, but now all the people of Stone Haven see is blood and the need to attack any who stand in their way.

New Dellian: A group of about a 100,000 T'zee occupy this moon. It is reminiscent in climate to their home, Dellian Four. A single large ocean dominates this moon, with the rest being a dense jungle. The T'zee have adapted well, creating several dozen small treetop cities. As with their home world, the T'zee are quickly breeding, having doubled their numbers in just under two years! The leaders of this colony are already seeing parallels to their home world and fear the worst. At its current rate, the small moon will be overpopulated in 50 years.

It was the T'zee who "accidentally" started the conflict in this region. A group of rogue T'zee tried to acquire a portion of the mineral wealth in the asteroid belt to finance more food production facilities to feed their growing population. These rogues stole a ship from Stone Haven. The ship was in orbit for maintenance and the T'zee quietly slipped on. They killed the skeleton

crew on board and headed for the asteroid belt. Their plan was to commandeer one of the asteroid miner vessels, steal the ship and its cargo and sell it all. Nothing went according to plan, and the T'zee, in a panic, headed back toward New Dellian. The crippled ship crashed near one of the outlying cities on New Haven. From there everything escalated, with retaliation from Ever Winter on New Haven and back and forward. From orbit the Wulfen shot down several satellites and grounded several ships. By the time the Wulfen's rage subsided the inhabitants of Stone Haven retaliated. Meanwhile, the T'zee who instigated the conflict were egging on both sides. They planned to let one side beat up the other and take out the weakened one when that battle subsides. Since the T'zee thought that they could limit their own involvement and just let the two colonies fight it out, they were shocked when they were attacked by both sides. It seems neither side took too well to the T'zee mining their claims or T'zee scavengers collecting battlefield salvage from the dead. So after several warnings by both sides, the T'zee have been attacked by both of the warring parties, which has provoked the T'zee to respond in kind.

Now all three sides are trying to destroy the others. It is a three-way slugfest that the Consortium of Civilized Worlds has been unable to stop. Things are escalating, with all sides purchasing weapons and arms from outside sources. Initially, it was easy to make these weapon drops, but the CAF (Consortium Armed Forces) is blockading the solar system, so clever gun runners are searching to find quiet ways into the system. Several groups have managed it, but the current blockade is tougher than ever. So far, the fighting has been limited to a few skirmishes in space with only combat ships and satellites attacked and destroyed. The Consortium is trying to stop the fighting and mediate a lasting peace before any of the three sides decides to invade or obliterate another.

Hook, Line and Sinker

Hook: The player characters can be involved in this conflict as Runners breaking the blockade, mercenaries for hire to any of the three warring participants, or as members of the Consortium sent in to enforce the blockade or to try to stop the violence from escalating.

Line: As soon as the player group arrives in the system they are attacked and boarded by a small crew of T'zee raiders. The T'zee's ship has been seriously damaged and they are desperate to get out of the system. They will try to capture the group's ship and keep as many people alive as possible as hostages.

Sinker: These T'zee are fleeing their own people! Apparently this is part of the group of greedy rogues who started the fracas and made matters worse by trying to blackmail their own people about their involvement. It seems that they have hard evidence to prove they started this whole situation. Outraged by their audacity, T'zee authorities refused to pay any extortion money, found them and attacked with deadly force. This group of fugitives may be all who survived and they are trying to get out of the area before their heads roll next. They still have enough evidence to prove they started the war, but aren't sure what to do with it now. All they know is they need to get out of the system and lay low for a while (years!). They see the player group and their vessel as the means to escape. Hostages are just a bargaining chip, especially if they are working for the CCW.

The Corkscrew Galaxy

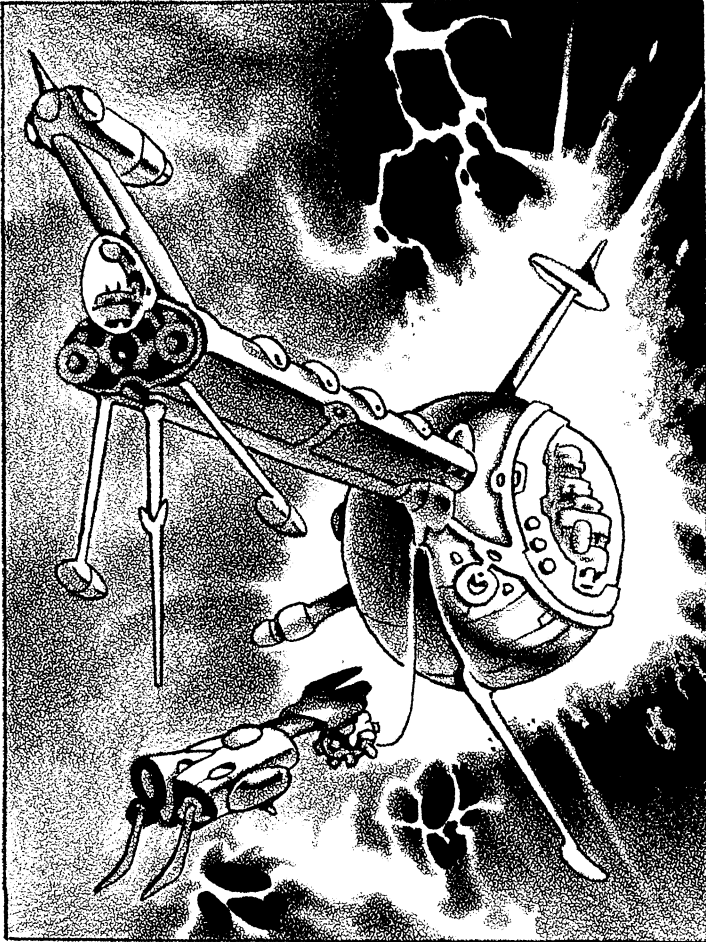

Aviary System

The Aviary System is unique in that it has no habitable worlds, yet all three of the gas planets support life! This, of course, is limited to a temperate zone discovered by accident. A belt of oxygen and nitrogen gas exists within each gas giant with an atmospheric pressure tolerable by humanoid life. This has led to an even greater boon as floating cities can mine heavier gases that are normally too deep within the planet to be reached by conventional methods. This discovery has prompted others to further explore other gas giants for temperate zones. So far none have been found and the Aviary System seems to be the only system to have these temperate zones.

Stars: A binary star system with a blue super giant and a blue dwarf star.

Aviary One: A large mining operation is in full swing on this planet, plumbing its rich deposits of precious metals and stones. The mining operation is under constant threat from earthquakes, however, and the operation has lost 19 people in the last six months. Despite the risk, the mining continues. If the potential profits are great enough, it seems there are always people looking to make a quick buck in the mining business.

Aviary Two: The second planet in the system is also a rock rich in mineral deposits. Geological surveys first conducted in

this system found that just below the surface are rich deposits of iron, nickel, copper, and titanium. This planet was exploited early on and there are numerous open mine shafts all over the planet. Today, a single mining camp operates in the planet's southern hemisphere, which serves as the main supplier of construction material for Aviary City and Noble City. Both Aviary One and Two orbit the dwarf star while the remaining planets in the system orbit *both* stars.

Aviary Three: Aviary Three is your typical medium gas planet with a twist. Two miles (3.2 km) below the surface is an oxygen/nitrogen layer. It was discovered purely by chance when pirates were attacking a gas mining ship that was in orbit. The crew escaped the ship in a shuttle, but was pursued. To lose the pirates the daring pilot dipped into the planet's atmosphere, confident in her abilities to handle the high winds of the gas giant. They were very surprised when they not only had a smooth ride, but also did not shake their pursuers. Not able to take out the pirate ship in a heated battle, the crew tricked the pirates into following them through a volatile layer of hydrogen clouds. When the pirates opened fire they were finished. The ensuing explosion knocked out the pirates' ship altogether and severely damaged the miners' escape shuttle. They lost altitude, plunging further into the gaseous planet. If they could not level off in time the immense pressure would have started to crush the ship. Luck was with them, and with some fast jury-rigging, the ship leveled off in a calm layer of the planet. They were surprised that the sky was bluish with orange clouds. After double-checking their sensor reading, the crew confirmed that the layer was composed of oxygen and nitrogen with traces of argon, but not enough to be harmful. A great floating city was established shortly afterward and twenty-five years later, *Aviary City* is still producing volumes of precious gases.

The city has grown by leaps and bounds over the past two decades. It started out as a simple hover platform with adjoining cargo containers for crew housing. As more compartments were added, additional contra-gravity generators were installed. Eighteen years ago, a full gas-refining center was built, officially making *Aviary City* a boomtown. From that point on, the mining base turned into a small city growing exponentially. Today, the city is 42 miles (67 km) in circumference, the largest of the three cities in the system, and continuing to grow, though only by 10-15% a year.

Aviary Four: Soon after *Aviary City* was founded, the remaining gas planets were explored for similar air pockets. To the surprise of many scientists, they found them. Work began immediately to construct a true city and not one from cargo containers and ship parts. It took five years and several billion credits, but today the magnificent *Noble City* hangs in the clouds and mist of *Aviary Four*. It is built around a gas-refining center in concentric layers, a rather unique design that incorporates several thousand contra-gravity generators seamlessly. While *Noble City* is not as large as *Aviary City*, it is far more efficient and produces almost double the amount of gas. In addition, the space port at *Noble* is state of the art and twice as large as *Avi-*

ary City, allowing for more cargo hauling ships to come and go. The city derives its name from the group of gases it specializes in collecting, the Noble gas family. Noble city's high production has allowed gas prices to come down to an all-time low in the Three Galaxies. Business is very good.

Aviary Five: A geologically stable world, this ice rock has proven to be of little value for mining.

Aviary Six: A new mining operation has recently been established on this planet. It is a molten world of hellish heat, lava and fire rock, so mining the precious ore is something of a challenge. The surface is so hot that even super-strong Mega-Damage alloys warp and break after only a few weeks, so using the technology developed to create Aviary City, a mini refining center floats around the planet. All mining vehicles are equipped with either hover or contra-gravity systems and make short stints mining the richest known veins or searching for new ones.

Aviary Seven: The last of the three gas planets in the system in the Aviary System, it too has a layer of breathable air. Only recently has funding been available to start a new colony to exploit Aviary Seven's resources. Materials are being transported from Aviary Six. This is possibly the most ambitious of the three cities, for it is planned to be the largest and most advanced of the three. Work is already well underway on this city, aptly named Mirage.

Hook, Line, and Sinker

Hook: The player characters are either returning from a difficult mission, or just had a tough battle that has badly damaged their spaceship. Either way, they find themselves in the Aviary System known as much for its inexpensive ship repairs as its mining operations.

Line: After receiving landing clearance and assessing the full damage of the ship, it turns out that the characters' vessel is in need of extensive (and costly) repairs. They can be patched up enough to limp along, but it's risky. Nobody can do these repairs cheaper than Aviary (50% less than standard), so the group should consider doing whatever they have to for the repair work.

Sinker: Aviary Seven is experiencing a labor shortage. Conditions are very dangerous for construction crews and not enough people can be found to fill the roles needed. If the adventurers want to make some good money, they could do it in the gas fields. In the alternative, the mining H.Q. might be looking for some hired guns to protect cargo ships or even mining operations being harassed and robbed by an unknown band of bold space pirates (Kreeghor?). Or there may have been a threat or extortion attempt on a higher up who is looking for protection, and outsiders seem like the best bet.

Cacadia

Located on the rim of the Corkscrew Galaxy, Cacadia is home to the Nixie. They are a little known race of intelligent arachnids who specialize in trade and transport of goods. The region of space they occupy is *unclaimed neutral territory*. Many transports leaving the Corkscrew Galaxy typically stop off at Cacadia as one last rest point before beginning the long journey to the Thundercloud or Anvil Galaxy.

Star: Medium red.

Cacadia One: The first planet in the system is a fire rock. Since the Nixie have not yet taken the time to fully explore their system, little is known about this planet.

Cacadia Two: This planet is covered in cooled magma that gives it a black appearance. All volcanic activity has ceased and the planet is now considered a dead rock.

Cacadia Three: This is one of the few ice rocks that has an ocean. An enormous liquid nitrogen ocean! Any type of matter that gets caught in this dense soup freezes solid in an instant. The ocean freezes at night and thaws during the day.

Cacadia Four: Comprised of two large planetary fragments, it seems the planet is slowly breaking up into an asteroid field. This has made space travel a little hazardous in the Cacadia system, but so far there have been no major incidents.

Cacadia Five: A huge gas planet, it may be the cause of Cacadia Four's deterioration. This gas giant is so massive that every sixty-two years it eclipses Cacadia Seven for two days! Its gravity field is also so massive that it has no moons and it sucks in any debris that passes by.

Inner Asteroid Belt: This first asteroid belt is very thin and composed of chunks of ice and carbon dioxide! The popular theory is that Cacadia Five's gravity broke up several comets and, as a result, they fell into this orbit forming a crude asteroid belt. Unlike typical asteroid belts, however, this one orbits at an eighty degree angle to the star, giving it a vertical as opposed to a horizontal orbit.

Outer Asteroid Belt: The second asteroid belt is composed of rock and various meteors. The belt is rich in light metals like tin, copper, zinc and nickel. Various asteroid miners have contracted with the Nixie and give them a small percentage to mine these metals.

Cacadia Six: Scientists have found impressive fossil records indicating that primitive creatures once lived in a large sea that would have covered the whole planet. It seems that a global disaster may have destroyed the world, leaving it a dry, dead rock.

Cacadia Seven: The home world to the Nixie, this forested world is rather cold and desolate. Thermal vents all over the planet keep it from becoming a lifeless ice planet. The Nixie evolved into the dominant life form. They live in rather unusual structures, buildings that look like balloons and cocoons stuck to each other, hanging in the trees.

Some rather large creatures have evolved on the planet, particularly in the insect world, some large boring beetles and a variety of flying insects among them. The Nixie use the carapaces of these insects as building materials, body armor and for spacecraft. The Nixie are very adaptable and it is believed they will go far in the Three Galaxies.

Hook, Line, and Sinker

Hook: Through a third party the player characters have arranged for shipping rights to ship goods to the planet of Cacadia.

Line: The first cargo shipment is ready, only it's rather unusual. It's a modified cargo canister that is holding several dozen rodents the size house cats. Checking the remaining three cargo canisters also reveals a variety of small mammals, all caged as well.

Sinker: Well, if the characters have yet to encounter the Nixie, they're in for a surprise as they are greeted by two Nixie at the space port on *Cacadia Seven*. They will be even more surprised when they take one of the rodents, from a cage, wrap it in a silken cocoon and eat it! For characters who have never seen this before, roll for a Horror Factor of 15. If the roll is a failure, the character (roll H.F. for each) loses his lunch. The Nixie are used to this response from humans and ignore such incidents. All in all, the Nixie representative is very pleased with the sampling and would definitely like to continue doing business. The characters may be given a tour of the space port, treated to a conventional dinner, and asked if they might know a way to supply the Nixie with more animal delicacies at a price less than what they paid for this shipment (the merchant is price gouging the Nixie).

Dust Bowl

The Dust Bowl System is deep within *Kreeghor space*. To the Kreeghor, it's just another numbered system without a name. Three years ago the Free World Council (FWC) established a secret base in this remote system, where they stage and launch attacks on various targets in the Kreeghor Empire.

Star: The Dust Bowl System has a single, young orange star.

Dust Bowl One: Early on, this system's star had intense solar flares. One of these flares apparently stretched far enough to consume Dust Bowl One. The planet was burnt to a crisp. All that is left is a shriveled and charred, dead husk.

Dust Bowl Two: This planet is a typical fire rock. The FWC has not explored the planet yet, but fighter pilots claim it has pillars of fire shooting out of the surface. They are most likely pockets of methane that ignite when the gas exits the surface. The FWC pilots affectionately named the planet *Little Hades*.

Dust Bowl Three: A small gas planet with four moons, two of which seem to be lifeless barren rocks, one has volcanic activity and a thin sulfuric atmosphere, and the fourth is a ball of rock and ice. The planet is rich in rare bromine gas, unfortunately the FWC can't exploit this natural resource without attracting the attention of the Kreeghor.

Asteroid Belt: The inner asteroid belt is your usual rocky belt. The pilots who enter the advanced training stage mock combat within the belt.

Dust Bowl Four: A small, lifeless rock of no known value.

Dust Bowl Five: This medium gas planet has a ring system and six moons. One of the moons is nestled right within the rings. FWC pilots undergoing training use this planet to get a feel for fighting in a planetary orbit. The gravity of the planet is a factor pilots have to consider and it's here where they learn to deal with it. The pilots can also safely fly through the rings, simulating an asteroid belt or orbital debris.

Dust Bowl Six: This is the last planet in the system and it just happens to support life – well, barely. The planet is one large, cold desert with areas of mountainous terrain and one small, shallow sea. It's from this planet that the system derives its name. The Free World Council found the system purely by accident. A Kreeghor ship was chasing a renegade Berserker for several days. The FWC finally lost the Kreeghor ship by hiding in the corona of the sun. This maneuver worked in saving the

crew from capture, but it severely damaged their captured Kreeghor Berserker. Limping through the system the crew came upon the sixth planet. They were able to send landing parties to the surface to gather fresh supplies, mainly some silicon for an injured Machine Man while the ship was repaired in orbit. While exploring the planet they came upon a deep ravine that stretched for several miles and was at some points a mile (1.6 km) deep. At one end of the ravine was a large cave. The leaders of the FWC quickly realized the potential this world held. While it lacked any obvious resources (possibly the reason that the Kreeghor ignored the planet and this system altogether), the system was remote, not directly in line with any normal Kreeghor patrol routes and as a bonus, this planet's intense magnetic field interfered with any ships scanning from orbit, making it nearly impossible to find a hidden base on the surface. In addition, the cave was enormous and made for a good location for a secret base. After a year of secretly ferrying supplies to the planet, the first remote FWC training facility came online. Here, with the help of several independent advisers (read as Consortium Commandos), a training facility was established for freedom fighters and real military personnel. After training, they are being sent to various points in the Kreeghor Empire to harass the enemy, cause insurrection and create resistance cells. It is hoped in a few decades the FWC may actually be strong enough to wage a war and confront the Kreeghor as a united force instead of the various resistance cells scattered around the Empire.

Asteroid Belt: This asteroid belt is made up of millions of dense asteroids composed of plutonium and uranium. The decay of these elements makes the belt so radioactive that any ship that enters the belt finds their shields reduced to half strength as they are constantly bombarded with high levels of gamma radiation. Any ship without variable force shields will only last 1D6x10 minutes before the crew begins to suffer from extreme radiation poisoning. Damage from the radiation is 4D6 points direct to Hit Points. A save versus non-lethal poisons/toxins will reduce the damage to one half.

Hook Line and Sinker

Hook: The player characters are in or near the Dust Bowl System for any number of reasons and may be between assignments.

Line: A mayday is received from some FWC trainees in the nearby asteroid belt. Their three fighters have been crippled by a small, mysterious freighter with surprising firepower, speed and maneuverability.

Sinker: If the player group is aware that the FWC has a secret militia training operation in the system they will be extremely concerned about the unmarked "freighter." Even characters who know nothing about the FWC operation should realize that the "freighter" must be a Kreeghor spy ship, undoubtedly racing away to inform the Transgalactic Empire about what it has discovered. Does that include the secret FWC base? Anyone who hates or fears the TGE will not want that to happen. Likewise, anyone who has a grudge with the Kreeghor may want to enjoy extracting a little payback by chasing down and destroying the spy ship. Besides, a Kreeghor spy ship may have all kinds of valuable data on board that, if captured, can be downloaded and sold to the right interested parties (like the

FWC) for a pretty penny. Thus, even characters out for themselves have an interest in snagging the spy ship. And if the little fighter trainees are correct, the freighter is off all alone, making it surprisingly vulnerable to attack by clever raiders or adventurers.

Exile

Exile is in a remote region of unclaimed space near the outer rim of the Corkscrew Galaxy. It is relatively close to the *Void Gulf*, and most ships make this their last stop before attempting to enter the Void.

Exile is a trinary star system. Centered in the middle of the system is a giant blue star. Orbiting this giant star are two smaller ones, a medium blue and a red dwarf. Each has a small system of planets. The medium blue has seven planets and the red dwarf has five.

Star One: The system's first star with planets is a medium blue. It has seven planets in orbit.

Exile One: This planet is a rock of little significance.

Exile Two: A small methane atmosphere covers this ice rock. The planet is tide locked, with one side being scorched by the sun and the other side a freezing wasteland.

Exile Three: A planet on fire. It is rumored to have several dimensional Rifts to the elemental plane of fire that are continuously open. To lend further credence to the theory is the fact that Fire Elementals are found all over Ex-3. Even though it's classified as a fire rock, the atmosphere is breathable, though harsh on the throat, nose, lungs and eyes of most humanoids.

Exile Four: This very small planet is most likely a captured asteroid. At just over 1000 miles (1,600 km) in diameter it has been classified as a dead rock.

Exile Five: Due to the planet's close proximity to its neighboring gas planet, the gravitational stresses have stretched and elongated it into an almost football shape. It is mostly rock riddled with caves and subterranean chambers. This planet is reported to be a base of operation for a small pirate group rumored to be privateers currently working on behalf of the FWC.

Exile Six: This is the only gas planet in the system. It's not even worth mining as the atmosphere is a volatile mixture that could easily cause an explosion several hundred miles wide, plus it's also caustic and eats away at M.D.C. metals like a hot knife through butter. It is only a small gas planet with no moons.

Exile Seven: Simply known as *Exile*, this planet was once a penal colony some 300 years ago. It is not known who built the original colony, only that it was forgotten. At some point, the prisoners revolted after their captors deserted the place and supplies ran out. For two hundred years the prisoners and their descendants lived in the very facility that once imprisoned them. The people splintered into several small warring factions using primitive melee weapons (little technology remained on the penal colony). Chaos and anarchy ruled the little city that had grown around the prison complex until a group of practitioners of magic arrived. It seems Exile has an unusual magical anomaly: The dimensional fabric around the planet is very dense, creating a natural dimensional barrier. Even at the height of what would be the planet's solstice, dimensional portals cannot be opened. Whether these sorcerers were on the run from some-

thing in another dimension or for some other reason, they chose to live on Exile, using their magic and wisdom to stop the fighting. A hundred or so years later, contact was made with them and a small space port was built. The planet is not aligned with any of the powers in the Three Galaxies which makes it appealing as a sort of neutral zone and free trade port. The original colony, now called *Pen City*, has become a sprawling metropolis, though something of a rough and tumble place. Runners, pirates and Spacers love it, as do fugitives, adventurers, smugglers and wandering merchants. They are what keep the colony alive and thriving.

Star Two: The system's second star is a red dwarf.

Exile Eight: This is the first planet orbiting the red dwarf. It is a lush, forested world inhabited by primitive stone-age humanoids. Like Exile, this planet also has a dense dimensional fabric. Could this planet also have trapped dimensional explorers who reverted or are these humanoids an indigenous people? Exile Eight has two moons.

Exile Nine: Life is impossible on this planet because the carbon dioxide gases trap all the heat, keeping the surface temperature over 900 degrees Fahrenheit. The atmospheric pressure is also incredible and it begins to crush anything that descends to the surface. Damage is 4D6x10 M.D. per minute. The planet has one small moon.

Exile Ten: Exile Ten is an Earth-like planet with two moons. Presently, it appears that no civilizations have developed on the planet. It is ripe for colonization should anyone want to travel far beyond the boundaries of civilized space.

Exile Eleven: A small world covered in a dense jungle. Remnants of a dead colony are scattered around the planet. Jungle has reclaimed the land that the colonies once occupied, though there remains enough to salvage or use to make a few small campsites. The planet has a single moon.

Exile Twelve: The last planet in the system is an ice rock with two moons.

The Fydra Beta Shipyards

The Fydra Beta System is the top secret location of the Kreeghor shipyards. Both the Consortium and the Free World Council (FWC) would give just about anything to get a close look at the key location in this system. This is where the Kreeghor refined their shipbuilding techniques and where a portion of their deadly armada is built to this day.

Star: One medium blue star.

Asteroid Belt: This asteroid belt is very dense, which makes it very difficult for ships to navigate through. This is unfortunate because the belt is rich in metal ores used in the construction of spacecraft. This has not deterred the Kreeghor and they have developed several unique ways of harvesting the valuable asteroids. One is the use of very powerful grappling equipment and hauling the asteroids out of the belt to awaiting asteroid miners. Another involves small tugs with reinforced force shields to navigate the asteroid belt and latch onto the desired target, then haul it close enough to a ship to attach grapples to it. Both methods are risky, but the Kreeghor are only interested in results, and the various crew and slaves who work the Fydra Beta Shipyards know what the price of failure is, death!

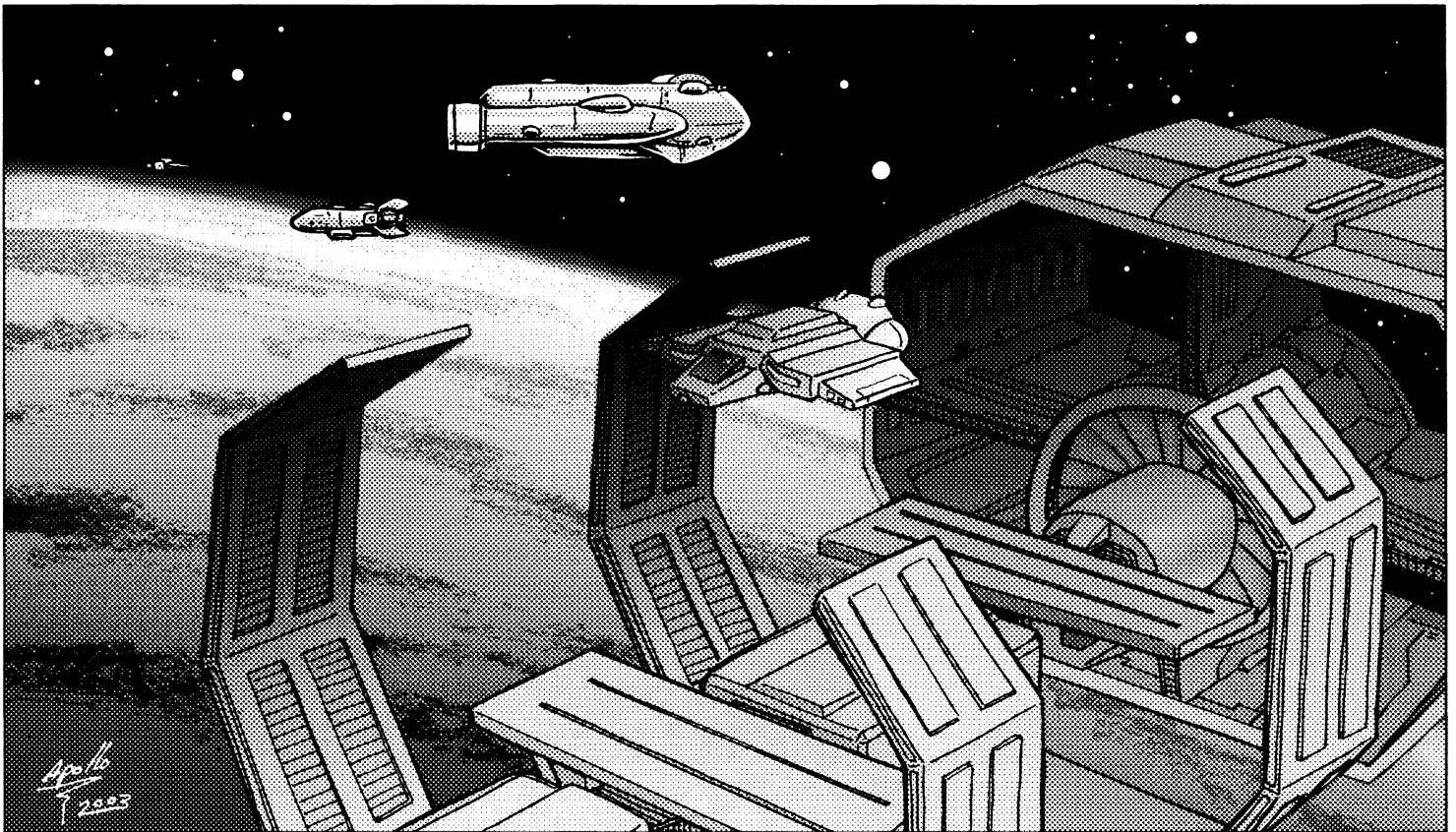

Fydra Beta One: This lifeless fire rock is used by the Kreeghor as one large ore processing facility. Mining ships bring the raw ore here to be processed. The facility is enormous with the center of production measuring over 150 miles (240 km) in size. The largest geo-thermal power plants in the Three Galaxies are found here. These facilities are heavily guarded with two brigades of Imperial Legionnaires, a squad of Invincible Guardsmen, and 24 Flying Fangs. Several dozen docking towers, 2500 feet (762 m) tall, are scattered around the ore processing plant. The towers also contain some of the plants' weapons systems, ranging from point defense to medium ship weapons. Due to the planet's light gravity (0.8 G), the mining ships can enter the atmosphere to unload their cargo to be processed.

Fydra Beta Two: Sixty percent of the materials used in the construction of the Kreeghor spacecraft are obtained from this planet. Fydra Beta Two is a water world. The entire planet is an ocean with several thousand small islands measuring from a mile (1.6 km) to 20 miles (32 km) in diameter dotting the surface. It is on this planet and its orbiting shipyards that the Kreeghor developed and refined their revolutionary shipbuilding techniques. What many people don't know is that Kreeghor spaceships are partially organic! The Kreeghor learned early on that in order to maintain their Empire they would need powerful warships and weapons to back up their doctrines. This caused the Kreeghor to look into various ways of cutting costs while still having a powerful military. Fydra Beta Two was the answer. Lurking in the seas is a species called the *Nuk Rek Nuss*, a giant nautilus-like crustacean that grows to hundreds of feet long. The Kreeghor found its shell to be one of the strongest Mega-Damage materials in the universe and developed a way to incorporate this shell into several of their largest ship designs.

Today the Kreeghor have perfected their shipbuilding techniques using the giant nautilus' shell. The slightly different shape, size, color, and texture of each shell contributes to the unique organic appearance of the big Kreeghor ships.

Perhaps needless to say, the Kreeghor have taken measures to ensure the survival of the giant *Nuk Rek Nuss*, and have successfully seeded four other worlds with them elsewhere in their domain. They also have several dozen in a zoo on their home world and genetic samples hidden throughout the Transgalactic Empire (TGE). In fact, genetic engineers have been trying to develop the means to grow the shell without actually requiring the animal itself. Rumor suggests they may be getting close.

Asteroid Belt: This was the last asteroid belt in the system. In the last five hundred years the Kreeghor mined every asteroid they could get their claws on. All that is left of this one is a very thin asteroid belt with the majority of the rock having been pulverized into pebbles and the ore processed for their space fleet. As a result, this asteroid field is primarily micrometeorites ranging from clusters of dust particles to marble- and baseball-sized rocks, with the occasional object as large as a desk or sofa sprinkled in for good measure.

Fydra Beta Three: This is the only gas planet in the system. It has a beautiful set of rings and 15 moons, three of which serve as Kreeghor military bases. One moon has an extensive communication system so the home world can constantly monitor the activity of the system. The second moon is an ammunition depot where the dreaded Singularity Cruise Missiles are made and stored. The third moon has a small gas processing facility, military compound and training camp for second-rate members of the Invincible Guardsmen; i.e. those who require more discipline or training before being sent into active duty. A big part of the security around these moons is a pair of Smashers orbiting the planet.

Hook, Line and Sinker

Hook: The player group has an opportunity to deliver some very expensive cargo to the Fydra Beta Shipyards, or are riding shotgun as defenders and escorts for someone else who does. It seems that the Kreeghor have ordered the latest Phase Drives and are eager to install them in some of their new ships.

Line: While in transit, the cargo ship mysteriously falls out of FTL speed and main power goes out for 1D4 hours. Before main power is restored, one of the player characters (or an NPC) catches a glimpse of what they suspect is an intruder on board.

Sinker: Time has to be made up as the Kreeghor are running on a strict schedule and if the shipment is more than 36 hours late, the Kreeghor can deduct as much as 25% from their fees. If the player characters continue to search the ship, they'll find that several of the Phase Drives have been tampered with. Minute changes in the phase frequency that the Kreeghor may not detect, but which could damage or destroy the ships in which they are installed. What do the characters do? If they say nothing, the player characters are very likely to be suspected by the Kreeghor as FWC spies and saboteurs, resulting in a bounty being put on their heads. If they come forward, the Kreeghor will deduct 10% of the payment and may tear apart their vessel and the cargo ship looking for the individual(s) responsible. (One possibility is a squad of FWC commandos or freedom fighters hidden in one of the drive compartments. The commandos have sufficient firepower to take over the ship if necessary.) The Kreeghor investigation could lead to all sorts of intrigue and problems, and certainly keep our heroes among the Kreeghor for several days until the matter can be resolved to their satisfaction. The stay over can lead to other incidents and adventure.

Fydra Beta Shipyards Installation

This is the largest shipyard in the Kreeghor Empire. Millions of people work on this city-sized industrial space station as well as the millions who live and work planet-side. A good 50% are slaves to the Empire, 20% are indentured servants (not much different from slaves, but they are afforded more liberties), and the rest are citizens who have the nice, cushy administrative and supervisory jobs.

The shipyard station is able to produce an impressive number of military spacecraft. This is due to the large work force, Kreeghor discipline and the fact the yards run continuous shifts, 24 hours a day. From their assembly lines at this one facility they are able to produce the following vessels on a monthly basis: 36 *Flying Fangs*, 18 *Warlord Mark I*, eight *Rain of Death*, two *Berserkers*, and one *Smasher*. The station also has special facilities for construction of the *Doom Bringer Dreadnaught*, but it takes 18 months for the construction of a single vessel.

The station is an enormous 108 miles (173 km) in overall diameter. Several different manufacturing facilities dedicated to producing a single product, such as the Flying Fang, or Warlord power armor, are located on various factory levels. Other levels are devoted to constructing large portions of the ships from which they are transferred to the external scaffolding for final construction. Branching off from the main hub are several dozen arms that look like skeletal claws holding incomplete ships. It is from these locations that the larger starships see their final construction. The central hub is 45 miles (72 km) in size and is where the station's living quarters are housed.

Space station size: City-size, with 63 million M.D.C.

1. Station's function: Industrial/shipbuilding, +10 points to Power Systems and Supplies
 2. Power Systems: Three anti-matter reactors. 60 points.
 3. Defenses: Point Defense, Heavy Weapons, five fighter squadrons, Armored Hull, Shields. Shields: 60,000 M.D.C. (10,000 M.D.C. per side), Armored Hull (M.D.C. increased by 25%), three fighter squads of Flying Fangs and two power armor squads. Point Defense weapons with 35 Particle Beam cannons (1D6x10 M.D., and a range of 10,000 feet/3,048 m), Mini-Missile launchers with a payload of 100 per launcher. Heavy Weapons include two Heavy Laser Cannons and one Mass Driver. In the event of the system being lost to an enemy such as the Free World Council, the mass driver has been pre-programmed to launch a bombardment planet-side. The planetary bombardment would leave the world in a nuclear winter for at least fifty years. Total points for defense: 160 points.
 4. Sensors: Enhanced Sensors. 20 points.
 5. Communications: Stellar Communications. 40 points.
 6. Station Maintenance: Automation. 35 points.
 7. Supplies: Self-sufficient. 25 points.
 8. Internal Security: Crack Security Force composed of Invincible Guardsmen and Imperial Legionnaires. The Station also has magic and psionic defenders. 50 points.
 9. Security Systems: High-Tech. 50 points.
 10. Medical Facilities: Common. 10 points.
 11. Environmental Systems: Advanced. 20 points.
 12. Business: None. Free.
 13. Transients: Incentive Programs, which are very basic. If you don't have a function on the station and you've not gone in a week, you become an indentured employee of the TGE. Duration is subject to the station administrator. 40 points.
- Total Points available: 520 (Total Points spent: 510)

The Garlack Gul Cluster

The Garlack Gul Cluster is one of the few mapped black hole clusters in the Three Galaxies. It is a serious navigational hazard and only experienced pilots will even dare to travel through the cluster. It lies on a major trade route and had forced pilots to travel around the cluster at a safe distance for decades. Recent research has led to an accurate course through the black hole cluster, enabling most spacecraft to navigate it in a matter of hours instead of a detour that could add days or weeks to the journey.

The black hole cluster was named in honor of the Kreeghor who mapped it out, one Garlack Gul. He was a famous Runner who was known for taking extreme risks. He had been convinced for years that there had to be a safe route through the cluster so, in his spare time, he would explore the region looking for one. It took him ten years and over a hundred attempts, but he finally succeeded in mapping a safe course. For several years after that he would boast about being one of the faster runners in the area. He would often compete in races to deliver goods (while heavily betting on himself) and always would come out ahead whenever the race involved going around the cluster, even when racing against faster ships. His scam lasted for sev-

eral years until he finally decided to retire. He sold his map to TGE stellar cartographers and made a small fortune.

As far as black hole clusters go, this one is relatively large, approximately 200 light years in circumference. It consists of seventeen black holes arranged in a relatively spherical shape. If one follows Garlack's course, it cuts the distance down to 43 light years! There are seven spots where a ship has to drop to sub-light speed to make course corrections, with each stop lasting 1D4 hours depending on the speed of the spacecraft, but that is nothing compared to the 1D6+4 day detour required to go around them; twice that time if the spacecraft has inferior speed.

Hook, Line, and Sinker

Hook: The player group needs to use Garlack's shortcut.

Line: On the third course correction within the cluster, their ship is hailed by a vessel just sitting out in the open.

Sinker: The spaceship is a well armed pirate ship that fires a clear warning salvo over their bow. A moment later, the pirates hail the player characters' ship demanding a toll. They can pay five million credits, give up their cargo, try to fight, or turn back. What do the players do? Going forward is possible, but not without the risk of combat (with any luck, the pirates are bluffing or will quit if the heroes prove to be too strong or feisty).

The Hunter System

The Hunter System is notable for two reasons. First, it is one of the rare systems that has four planets that can support carbon based life. Second, the system is owned by a rather unique corporation, Safari Inc.

Star: Hunter Prime is a young yellow star.

Hunter One: This planet is a dead rock not even worth mining.

Hunter Two: Also called *Devil's Fury*, this planet is considered a desert habitable world due to the thin atmosphere and barren flats of rock and sand. This is a primordial world of volcanoes, lava and hot, bubbling mud flats. The air is barely breathable by human standards. It has high concentrations of sulfur and carbon dioxide, so an air filter or environmental armor is recommended. Along with the bad air, the heat is almost unbearable. Temperatures range from 100 degrees during the night to 250 degrees during the day. Hunters are usually advised to bring lots of fresh water, as finding it can be very difficult. Water is mostly found in hot springs and geysers. There are no oceans or lakes. The sky is a constant gray color from all the volcanic ash in the air. The gravity is also higher on this world due to its dense metallic core. Gravity is 1.5 G's.

Both Minor and Greater Fire and Earth Elementals are found on this planet, though not in huge numbers. The main indigenous races are giant, monstrous worms (use any and all of the *Worms of Taut* described in **Rifts® Conversion Book One, Revised**), as well as a species similar to the *Giant Canyon Worm* described in **Rifts® New West™** that loves heat and is impervious to fire and lava (swims through it). These are the beasts that attract "big game hunters" and thrill seekers.

Hunter Three: Living rock, nothing to note.

Hunter Four: An ice rock that has mining potential.

Hunter Five: Gas giant with 24 moons and a beautiful ring system.

Hunter Asteroid Belt: The creation of this asteroid belt is most likely the result of being between two gas giants. Millions of years ago, there probably was a planet that was torn apart by the immense gravity wells of the two giants. The mining potential is tremendous and Slither has been contemplating whether to allow a company with asteroid miners in the system. He is currently considering a few bids by various companies.

Hunter Six: Medium gas giant with 13 moons.

Hunter Seven: Also called *Serpent's Wrath*, 65% of this hot, humid planet is covered in jungle with many shallow lakes and rivers. It has two oceans, which make up the polar regions. The rest is a giant land mass that wraps around the planet. Temperatures range from 80 degrees to 120 degrees with a constant 85% humidity, and it rains approximately every two hours. There is a wide variety of wildlife, including numerous birds (some as large as the Earth's condor and eagles), monkey-like tree dwellers and a seemingly endless variety of snakes (33% poisonous), lizards (10% poisonous), amphibians (25% poisonous) and insects. Some large creatures suitable for hunting are a variety of giant (the size of a pickup truck) beetles (3D6x10 M.D.C.), tree spiders (2D4x10 M.D.C.), some large birds of prey, the *Koki-Slayer* (a giant, predatory ostrich-like bird that feeds on the many snakes and amphibians; it stands 10 feet/3 m tall, has 6D6 M.D.C., a running speed of 2D6+54, three attacks per melee, a beak attack that does 4D6 S.D.C. damage, clawed feet that do 1D4 M.D.), as well as seven varieties of *giant pythons* (average 20-50 feet/6 to 15.2 m long, three attacks per melee, bite does 2D6 S.D.C., and a constricting crush attack does 6D6 S.D.C. per squeezing action, and the snakes have 1D4x100 S.D.C./Hit Points). **Note:** See **Mutants in Orbit** for making giant Mega-Damage insects.

At the top of the food chain, and Slither's favorite prey, is the *Sapphire Cobra*. A 40-100 foot (12.2 to 30.5 m) monster whose venom is one of the most potent in the Three Galaxies. Slither admires the Sapphire Cobra so much that he had a Tattoo Master give him one as a tattoo that wraps around his body from his left leg and ends coiled around his neck. He also has two young ones as pets at his lair. He is trying to train them as watchdogs, but they are difficult to control, though they have never tried to bite him. **Sapphire Cobra Quick Stats:** **Alignment:** Considered Miscreant evil; very aggressive and eats medium to large animals, like humans. **Attributes:** I.Q. 1D4+4, M.A. 3D6, M.E. 1D6+6, P.S. 3D6+30, P.P. 1D6+20, P.E. 1D6 +20, P.B. 1D6+14, Spd. 2D6+20 on land or swimming through water, half in trees. **M.D.C.:** 3D6x10+33. **Attacks per Melee:** Adult: Five by bite (1D6 M.D.), head butt or tail whip (2D4 M.D.) or super-toxic poison. **M.D. Poison:** One bite instantly kills humans and most other mortal beings and hurts Mega-Damage beings, including creatures of magic and the supernatural, making the serpent's venom highly desirable to assassins. Poison does 3D6 M.D. (the equivalent of 3D6x100 H.P./S.D.C.), unless a save vs lethal magic of 15 or higher is made. **Special Skills of Note:** Swim 98%, but does not dive under the water, swims on the surface, Land Navigation 80%, Prowl 75%, Climb 70%, Camouflage (self; 85% when staying still and under cover on the ground or in a tree or water; 55% when moving slowly; none

when moving quickly or in attack mode), track by scent 60% (+15% to follow blood scent). **Note:** Due to the danger of the Sapphire Cobra, hunting is usually restricted to only those Slither knows! As he told one client: "As much as I love this world, I'd hate to lose a valuable customer like you."

Hunter Eight: An Earth-like planet with a single moon that is referred to as *Hunter's Paradise* by Slither. Temperatures are moderate and so is the weather. There is ample water and a variety of plant and animal life. Survival would be easy on this planet except for one thing. Giant dinosaur-like reptiles roam the skies, seas and land. Similar to Earth's Jurassic period.

On Slither's first safari he killed 19 large carnivorous reptiles during the planet's 20 hour rotation. He was on constant alert because every time he killed one monster its blood would attract more. Slither loved the adrenalin rush and the thrill of being constantly besieged by one crazed predator after another. That is why he has built his base of operations here. The base has turned into a good-sized city and increasingly popular "exotic resort" place. It is on a remote island inside an extinct volcano covered with an M.D.C. dome that opens to allow in visiting spacecraft (a cloud of smoke is released to cover the opening, a simple gimmick that prevents flying predators from seeing the open portal). The city has a medium-sized star port that is able to accommodate up to 20 small spaceships or shuttles at a time. There are a large number of hotels for tourists, an exotic marketplace, numerous others shops and restaurants, and a sprawling zoo. Photographic and hunting expeditions into the wilds are the major attraction, as is the massive zoological park, making Hunter Eight an incredibly popular tourist resort for thrill seekers, big game hunters, and those who seek a truly different and exciting exotic vacation. Slither's home is a massive lodge that overlooks the city from one of the plateaus inside the volcano. The home is simply a place for him to store his trophies and entertain special guests and clients.

Hunter Nine: A planet of rock and dust; no moons. Unknown geological value.

Hunter Ten: Also called *Icy Death*, this habitable planet has two moons. As its name suggests, it is covered with ice and snow year round. However, life will usually find a way and it thrives very well on Hunter Ten. There are pockets of dense vegetation and forest scattered around the planet that survive due to constant tectonic activity that creates geothermal heat vents. This melts, in turn, the snow and creates a pocket where vegetation grows and life abounds. These pockets of life may also center around heated geysers, or hot springs. The size of these forest oases in a desert of ice and snow varies from 3 miles (4.8 km) in diameter to 100 miles (160 km). Slither's geologic survey teams have found 52 of these oases.

Most of the animals of this planet are cold-weather beasts (including a variety of large bear-like and feline predators, as well as giant wooly elephant-like beasts), migratory (traveling from one forest to the other) or localized to one of the heated forests, creating little ecosystems unique unto themselves, often with unique animal life.

Temperatures vary dramatically on this planet. In the icy regions the temperatures go as low as -50 degrees Fahrenheit at night, to 20 degrees during the day. The valleys of life have a very consistent temperature day and night due to their constant heat source. The average temperature in the forests is a toasty

70-78 degrees. The areas around the volcanoes can get as warm as 85 degrees. Water is abundant, but either in heated springs or in the form of snow and ice. This planet would make a wonderful world to colonize.

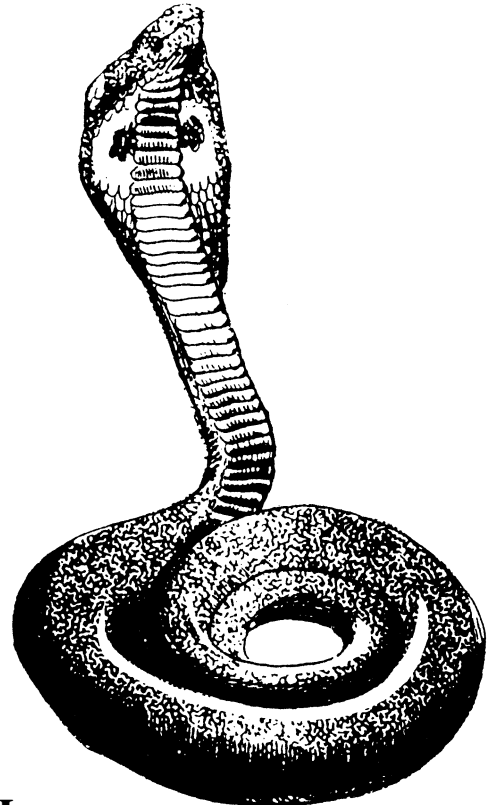

Safari Inc.

Safari Inc. specializes in *big game hunting*. Its owner, Slither, has been leading expeditions on the various planets in the Hunter System for the last couple of decades. He and his associates hire themselves out as guides and lead expeditions into hostile, "pristine worlds untouched by civilization" to any who can meet the company's exorbitant prices.

As a side, business Safari Inc. collects and sells many of the exotic plants, animals and monsters that are indigenous to the four planets of the Hunter System. They are the rage at Center, on Phase World, and command high prices, especially monsters for the Splugorth arena. One of the problems Slither has is finding staff, especially cargo shippers willing and able to handle his exotic animals and monsters, so he is always looking for a crew that has a large enough ship and is willing to haul dangerous creatures. He also needs adventurers to serve as defensive escorts to protect the cargo ships hauling his precious live cargo. As a result, Safari Inc. pays a fair wage and has a good reputation.

Slither NPC: Good ol' Slither started his career at a very young age. A Splugorth High Lord named Xarta purchased him at the age of eight and for the next several years he was transformed from an ordinary Ogre into one of the elite Tattooed Warriors, a Maxi-Man. Still a slave to Lord Xarta, by age 18, Slither managed to distinguish himself in several battles and was granted the rank of lieutenant. He served faithfully for another ten years and continued to distinguish himself. By 28, he was named head of Xarta's personal bodyguards.

One of Lord Xarta's passions was the hunt. He was a frequent patron to the Preserves on Atlantis. On one such trip, three

young dragons sought to make a name for themselves by ambushing Lord Xarta and his four Maxi-Men bodyguards. In the first seconds of the battle, two of the guards were killed and Lord Xarta was seriously wounded. Slither single-handedly killed one of the great beasts and held the other two at bay while the other Maxi-Man healed Lord Xarta. The two remaining dragons fled after seeing the High Lord revived. The following day, Slither, Lord Xarta and seven other Tattooed Warriors hunted down and killed the two dragons. As a reward for their heroism and bravery the day before, Slither and his fellow Maxi-Man buddy, Borags, were granted their freedom and given the Hunter System (then unnamed).

Six months later, Slither had named the system Hunter, borrowed a small loan from Lord Xarta, and started his business, Safari Inc. Borags saw no fun or value in this and signed away his rights to the system for a small fortune. Safari Inc. started small, catering only to select individuals, but over the last 20 years it has grown into a very lucrative business with clients throughout the Three Galaxies. And not just hunters and tourists, but scientific researchers, cities and world governments are all interested in his exotic animals or studying his worlds for one reason or another. He currently has over 50,000 employees, and can barely keep up with demand.

Alignment: Aberrant evil.

Attributes: I.Q. 15, M.E. 24, M.A. 16, P.S. 34, P.P. 18, P.E. 29, P.B. 13, Spd. 42

Description: Seven feet (2.1 m) tall, 300 pounds (135 kg) and all muscle. Several snake tattoos wrap around his arms and legs, along with other tattoos. Slither has long black hair that is always in a ponytail.

Age: 49, looks thirty something, muscular and powerful.

M.D.C.: 389. **S.D.C./Hit Points:** Not applicable.

Horror Factor: None. **P.P.E.:** 333.

Level of Experience: 15th level Maxi-Man.

Natural Abilities: Supernatural strength and endurance and night vision, 40 feet (12.2 m).

Psionic Powers: None. **Magic Powers:** Magic tattoos only.

Combat: Hand to Hand: Assassin with 8 attacks per melee.

Bonuses (total): Combined Hand to Hand and physical skills: +8 to strike, +7 to parry, dodge and roll with punch or fall, +25 to damage, KO, stun on a natural 17-20, critical strike on a natural 19 or 20, pin/incapacitate on a natural 18 to 20 and death blow on a natural 20; +8 to save vs Horror Factor, +10 to save vs magic, and +5 to save vs psionic attacks.

Vulnerabilities/Penalties: Slither is obsessed with snakes and serpents of all kinds. That is why he is covered with them. He also keeps several as pets, including two Sapphire Cobras. Currently, he is trying to breed and domesticate the Sapphire Cobras. Should he hear of other serpents he would definitely want to add them to his collection.

Alliances and Allies: He keeps close ties to Lord Xarta whom he frequently hunts with on one of his many planets. He has made several deals with well-known Space Runners, Phase World, and other people, institutions and worlds.

Enemies: Slither has many that he considers enemies. He is currently hunting a mage named *Conan Schmidt* who was instrumental in stealing his pet Seeker on the Kalandra space

station. Slither was arrested for firing an energy weapon on the station at the mage. He happened to be at a weapons shop at the time and used the demonstration model. As a final insult, Conan sent Slither a carton of cigarettes so he would have something "worth trading in jail." Slither has taken the challenge of hunting this elusive mage, personal. The charges were subsequently dropped due to Slither's good standing on the station. He meets many potential clients there for business due to its close proximity to the Hunter System.

Tattoos: Weapon Tattoos: Silver long sword, silver dagger with wings, Hercules club, Flaming Flamberge Dripping Blood with a Coiled Serpent, Flaming Shield. Animal and Monster Tattoos: Anaconda, King Cobra, Diamondback rattlesnake, Cottonmouth rattlesnake, Trifang, and Sapphire Cobra (this tattoo cost 150 P.P.E. to activate due to the monster's size and abilities). Power Tattoos: Chain with Broken Link, Eyes: Three, Lightning Bolts, Heart Pierced by a Wooden Stake, Heart Encircled by Chains, Shark, Skull Engulfed in Flames, Heart with Large Wings, Eye with a Dagger in it, Eye of Knowledge and Ball of Thorns.

Skills of Note: First Aid, Radio: Basic, Speaks Dragonese and Trade-4, Intelligence, Tracking, Wilderness Survival, Climbing, Swimming, Detect Ambush, Detect Concealment, Escape Artist, Prowl, and Gymnastics at 98%. Body Building, Boxing, Hunting, Wrestling, Trap Construction and Pilot: Small Spaceships at 74%. Strategy and Tactics at 75%, Trap Detection 65%, Weapon Systems 55%, Read Sensory Equipment at 45% and Read/Write Dragonese at 30%.

Secondary Skills: Skin and Prepare Animal Hides, Demon and Monster Lore, Cook, all at 98%, Land Navigation 92% and Running.

Weapon Proficiencies: All at 15th level: Archery and Targeting, W.P. Blunt, W.P. Knife, W.P. Sword, W.P. Energy Pistol, and W.P. Energy Rifle.

Hook Line and Sinker

Hook: The players have scored an easy job. All they have to do is transport or protect a few cargo cans to Phase World.

Line: When the group arrives they are greeted at the space port by Slither. He shows them around and even treats them to a fine meal. If he is asked what the cargo is, he is evasive most of the day until he brings the group to a private hangar. It turns out the cargo is seven Sapphire Cobras!

Sinker: If the player characters agree to transport the serpents, a happy client on the other end of the trip will even throw in a 15% bonus. The only problem is the players have to cross through Consortium space and transportation of dangerous animals is a felony offense. To get the cobras to the client, the heroes will have to cross at least a half dozen TVIA checkpoints. If they refuse the job, Slither may have something else in mind.

Necrosis System

The Necrosis System is home to the dreaded **Necrols**, who have become the scourge of the Three Galaxies. Their fear of technology has made them mad beyond rational thought. Even the benevolent Consortium of Civilized Worlds considers them



an enemy after having lost a starship that only offered overtures of peace. Little is known of their home system, only rumors, incomplete intelligence reports, and scans from long-range probes.

Star: The system's five planets circle a red dwarf star.

Necrosis One: This planet is covered in a layer of frozen nitrogen. This gives the planet a comet-like appearance flying through space. Landing on the planet is nearly impossible due to the intense nitrogen cyclones that blanket this small ice rock.

Necrosis Two: A gas planet, this medium giant has a wobble to its orbit. Because of this wobble, it is unable to support any moons, and the gravitational currents in the area are very unpredictable. All piloting rolls in the vicinity of the planet are at -10%. Any failed rolls require serious course corrections while navigating the area.

Necrosis Three: By human standards this world is very uninviting. The Necrols use the planet to breed a variety of their specialized organic equipment and have colonized the world despite its dangers. They have organically grown domes that look like giant clamshells on large support girders made out of bone. The latest Consortium intelligence speculates that it is here that the Necrols also breed their *Posh fighter ships*.

Necrosis Four: Known as Necrows, this is the home of the dreaded Necrols. Their planet is one large tropical rainforest. For the longest time, the Necrols were divided into hundreds of tribal units scattered all over the planet. Slowly, a single tribe grew dominant, led by a charismatic Necrol Witch. Following what he coined as the path to purity, the Witch united the tribes. A hundred years after his death, the Necrols took to the stars. It was an unlikely turn of events instigated by a single rebel tribe. This tribe, hidden deep within the rainforest, had developed technology not unlike that of the Consortium of Civilized Worlds. They were testing the latest in chemical propulsion when they caught the eye of the purist Necrols. In one massive surprise attack, the rocket installation and hidden tribe were overwhelmed and taken over. Their space travel technology

would later be incorporated in the creation and breeding of the Necrols' Organic spacecraft.

The Necrol purists would not have even considered carrying their cause into space if it had not been for a single artifact found among the wreckage. A small satellite thousands of years old. On the surface of the satellite was a map of a star system, and code based on the magnetic pulse of a star, and the male and female of the race. This infuriated the Necrols' leaders that some outworlder would dare to contaminate their people. The Necrols united, their cause reaffirmed, the path of their people clear, they would go to the stars and all that stood in their way would be "purified." The artifact was melted down, never to be seen again.

Necrosis Five: The last planet in the system is a medium gas planet with 14 moons. The Necrols believe that a large creature resides within a habitable section of the gas planet. It has an oxygen/nitrogen layer of gas and liquid and several Necrol fighter pilots claim to have seen something among the clouds. If there is something it could mean a new weapon or a possible ally for the Necrols.

Note: See the O.C.C./R.C.C. section for details on the Necrols.

Hook Line and Sinker

Hook: The player group stumbles on an incredible find, the remnants of a battle that took place between the Consortium and two other enemies.

Line: Initial scans reveal a significant organic presence in the area. By the looks of things, there was a three-way slugfest between the Consortium, the Necrols, and the Intruders.

Sinker: The Necrols are still in the area waiting in ambush for either of the two sides to return. Looks like the player group will have the misfortune of being counted among the enemies the Necrols need to purify.

The Pirates' Expanse

The Pirates' Expanse is a large, luminous nebula about three and a half light years across. The nebula has expanded so far over a period of millions of years that large gaps of open space are found inside of it. In these gaps one can find proto-stars forming, young yellow stars and planets! Only one system has been found so far but the possibility that more can be found is very high. None of the planets support life and the system only has three planets, but it makes a great base of operation for pirates who have plagued this sector of space for years. The pirates were even bold enough to take over a small observatory station that was built to study the nebula! The space station was moved to the internal planet system where the pirates have waylaid passing ships for several years.

Stratos

The Stratos System is located in Consortium space. It is home to the Strata, a silicon based life form highly sought after for their intellect and wisdom as many are scientists and diplomats. The system is uncomfortably close to Splugorth space and is along one of the more active borders where Runners try to slip past patrol ships to get into and out of Splugorth space.

Star: The Stratos System has a single medium yellow star.

Stratos One: The home world of the Strata, silicon-based humanoids who are members of the CCW. The planet is mostly desert with large crystal protrusions jutting out of the ground. In addition to the large crystals, there are hundreds of oases scattered around the planet, near sources of fresh water. Other planetary characteristics include a sea of ammonia and an atmosphere comprised of nitrogen and oxygen. This gives the atmosphere a bluish green look.

The Strata have a natural ability to shape crystal. It's from this ability that they built their beautiful cities comprised entirely of crystal. Large, slender towers that catch the wind and sound like a wind chime are the current fashion. The crystal is a light green color not unlike emeralds, with a variety of other elements combined to give the cities an amazing array of colors. The space ports in the northern and southern hemisphere are composed of reinforced granite, giving them the appearance of simple stone structures. Most first time visitors cringe as their ship lands on the stone platforms only to be surprised that the thin structure did not collapse.

Stratos Two: The Strata mine this planet for a variety of exotic stones, including marble and jade. Even though this ice rock has a dense layer of frozen methane, the Strata have found several rich veins in some of the mountains that protrude through the ice.

Stratos Three: This is the only gas planet in the system. The Strata have purchased several Goliath class gas miners. They are turning a fair profit from mining several heavy gases found just below the surface of the planet. This medium gas planet has fourteen moons.

Stratos Four: Strata believe that this planet may have actually been the source of their existence. The planetary atmosphere and pressure are unsuited for any life, but the same crystals found on Stratos One are also found on this terrestrial world. They believe that possibly fragments of crystals were transplanted from one planet to another. To further reinforce the theory the system has multiple comets, and it's possible one of these comets picked up some crystal fragments and crashed on Stratos One. While scientists study this theory the planet is also mined for these valuable crystals and brought to the orbital shipyards.

Stratos Five: When the Strata first joined the Consortium of Civilized Worlds (CCW), the Splugorth had nearly smashed all their defenses. In desperate need to rebuild before the Splugorth attacked again, the Strata contacted the Consortium for assistance. The newly founded CCW was eager to embrace new races and people, and quickly responded to their request. When the Splugorth did come back, they were decimated by a surprise attack from several Consortium ships hiding in the system. In addition to providing ships to defend the system, the CCW also sent supplies and building materials to help rebuild. The Strata

were impressed with the Consortium and petitioned for membership. Within a year they were full members and the Splugorth never attacked again. In cooperation with the Strata, the Consortium Armed Forces (CAF) built a base on the last planet in the system. The planet is classified a dead rock, but that's what made it an ideal base. With the help of the Strata, the planet was virtually hollowed out and turned into a major weapons platform with dozens of heavy laser cannons mounted in towers around the planet. The CAF uses the planet as a supply depot and a major repair base for their larger ships. The base is large enough to simultaneously repair a dozen Protector class ships. One is always stationed in the sector should the Splugorth ever consider attacking.

Note: See the O.C.C. & R.C.C. section for details on the Strata race.

Hook Line and Sinker

Hook: The players can either be on Stratos One, for business or just happen to be passing through.

Line: While on planet the players are asked to transport an important cargo of crystal trinkets to a waiting merchant in the adjoining Splugorth system. If the player characters ask to examine what they are transporting, they indeed see a variety of items cut from the various crystals commonly found on Stratos One. The group will be adequately compensated for their troubles.

Sinker: The players are unknowingly transporting Strata in their fetal state. They do indeed look like crystal bobbles, and the merchant who hired the group included several non-living crystals to complete the illusion. The player characters can discover this with a detailed scan from a portable scanner (it will pick up the organic beings contained within the crystals) or by happenstance. If the heroes do not learn this prior to finding the Splugorth merchant, he will thank them profusely for their part in "slave running" and delivering to him "Strata infants." Of course, he can be convinced to explain to them what's going on and the role they have played in it all. Characters of good alignment should be appalled and want to do everything in their power to get the Strata infants back and return them to a Strata starship or planet. Unfortunately, there are those who would pay a fortune for these living crystals, a nearby Splugorth Bio-Wizard and a squad of Powerlords being just one of them.

The Titanis System

The Titanis System is home to the corporate mega-giant HI-Industries. From this system they produce the majority of the HI weapons sold on the open market. This system is in the heart of Consortium space, is on a major trade route and is a common stop for many Spacers, Pirates, and Runners.

Star: The system gets its name from the red super-giant Titanis. The star is named so because it is the largest star outside of the galactic core of the Corkscrew Galaxy.

Titanis One: Condensed gas is one of the main components in all laser rifles. An electron accelerator excites the gas with the end result being a concentrated laser beam. Argon and Xenon gas were used in the first lasers ever developed. These weapons were bulky and crude. Today, more potent gases are used and

the laser weapon design has been streamlined with the end result being the HI series of lasers. Titanis One is a medium gas planet that has the necessary gases in abundance. HI Industries has a space station in orbit to collect these gases. The station's industrial function is to collect and purify these gases, making them suitable for use in their weapons. The gas cylinders are then shipped to the station orbiting Titanis Two, which is one of their main manufacturing complexes. The planet itself has an extensive ring system and four moons.

Titanis Two: During the construction of the HI Industries complexes number, five and six, the workers had to be put up somewhere. It was decided to buy prefabricated domes and put them on Titanis Two. The planet was rather inhospitable, but during the five years it took to construct the space stations, a small community developed. There were several linked domes and a space port. HI Industries decided to keep the small city that had sprung up as a place for its workers to go in their off time. The company even took a radical step and began to terra-form the planet. A dozen more domes were placed around the planet with the necessary equipment to begin changing the planet's carbon dioxide atmosphere into a more breathable atmosphere for humanoid life. This all took place a hundred years ago, and today the atmosphere is far more user friendly. People can leave the protection of the domes thanks to the new ozone layer that formed around the planet. This will at least keep them from receiving a lethal dose of solar radiation. As for the atmosphere, it's still not suitable for human needs. People can leave the safety of the domes for a few hours at a time with a simple gas mask or filter, but after 1D4 hours the breathing apparatus can no longer provide clean air to breathe. It is estimated that in 60 to 75 years that planet will be perfect for humanoid life.

The planet also has an abundance of mineral resources. Precious metals and stones are found in numerous veins running around the planet. In a recent mineralogical survey through mountains in the northern hemisphere, scientists discovered the planet was previously inhabited. Only fossil records have been found so far, but portable scanners have detected a large metallic body just below the surface. Archeological teams are convinced it's a big find and are planning to unearth it. Rumors are already beginning to spread around the Three Galaxies that it is a possible link to the First Ones due to the age of the planet.

Hook, Line and Sinker

Hook: The players have been asked to transport a high-ranking officer of HI Industries to his retirement home in the Pleasure Federation.

Line: As partial payment, the corporation is willing to upgrade one or two of the players' weapons to ensure the ship is protected from any incidents that might occur.

Sinker: The HI Industries executive is in fact a member of one of the research and development teams working at complex number 5. Naruni Enterprises has caught wind of this and is sending a team to collect the R&D scientist and will let nothing stand in their way, especially not the player characters. Of course the good scientist is really retiring and is eager to go to his estate in the Pleasure Federation.



The Void Gulf

The Void Gulf is a cluster of more than 150 stars. What makes the region unique is the fact that FTL capable ships are plagued with problems whenever they enter the Gulf. Along with hundreds of dimensional anomalies that plague the region, there are thousands of null spots where the FTL capabilities of a ship are totally ineffective. This is caused by a dimensional flux that cancels the effects of gravitonic and phase drives. Even Rift jump drives are unreliable and Stellar Navigation is at -60%. It seems that the largest stars are on the outer edge are not stars but rather, giant Rifts surging with magical energy. The four points seem to form a three dimensional triangle! Surging along the ley lines are immense cosmic storms. Inside the triangle is truly a dangerous place to be. Roll percentile for every 5 light years traveled.

01-20% This region of space is relatively calm with no problems at all.

21-29% The ship comes upon a small void where their FTL engines do not function. It only takes 2D6 hours at conventional speeds to pass through.

30-38% A black hole ahead causes the ship to have to change course. Due to its size it takes 4D6 hours to go around. Navigation is at -15% due to the gravitational currents.

39-44% While traveling, the ship suddenly begins to shake and reverberate as if it has hit something. Checking the sensors reveals organic matter all around the vessel, in fact it appears to be some type of cytoplasm. Long-range scanners show something fast and large moving in. The ship will be in this odd dimension for 4D6 minutes. I leave it to the individual G.M.'s discretion as to whether or not the player characters face an encounter.

45-54% Aliens or demons materialize on (or inside) the ship. They are clearly hostile and begin to attack the crew. After 3D6 minutes they disappear.

55-60% Dimensional warp! The ship gets hurled 4D6x10 light years off course.

61-68% Time warp! Only a few moments pass for the players, but the ship is thrust 4D6 days into the future!

69-83% A meteor shower or ion storm appears ahead on the ship's scanners. The characters have two choices, either weather the storm or take 4D6 hours to go around.

84-88% A large void where the ship's FTL drive does not work. It takes 1D6+1 days at the ship's maximum sub-light speed to cross.

89-94% The ship suddenly drops out of FTL speed only to be faced with a hostile alien vessel. Game Master's choice.

95-99% The characters are suddenly trapped in a giant void! At the ship's maximum sub-light speed it takes 1D4+1 weeks to pass through.

100% A dimensional Rift suddenly opens in front of the ship! Game Master's choice if the ship flies through to another dimension or something big and ugly comes out.

Hook Line and Sinker

Hook: One of the planetary systems within the Void Gulf is experiencing a dreadful plague and the players have been asked to deliver vital medicines to help the people.

Line: The players are warned that a Dominator has been sighted in the area and they should take precautions to avoid him.

Sinker: Turns out that the Dominator is responsible for the plague as he is testing a new biogenetic weapon. Once the players, arrive and announce they have brought medical supplies, he and his minions act to stop them. His experiment must run its course for him to have reliable data for his next experiment and if the players thwart his plans they will be the next ones he experiments on.

Windscape System

Several underworld leaders call the Windscape System home. It is named after a ship that floats in the sky of the ninth planet. The system is located just outside of United Worlds of Warlock (UWW) territory in an unclaimed sector of space. Here all manner of illegal transactions take place, from the sale of hi-tech weapon systems to all kinds of drugs. Several drug dens are supplied directly from runners who visit this system. However, it's not the sale of illegal goods that draws people to this system, Windscape is famous for the sale of *information*. All manner of people come here seeking clues to lost treasures, missing peo-

ple, and especially, secrets. It seems lots of them pass through this area and it's not uncommon to see Consortium agents or Imperial security agents meeting with their various contacts to exchange information.

Star: The system's star is a medium blue.

Windscape One: Windscape One is a cold, dead world of rock and wind.

Windscape Two: This rather unusual planet is known as *Moon Bridge* because it has its moon attached to it. Like a misshapen dumbbell, this ice rock's moon is connected via an ice bridge that is several dozen miles in thickness. How this came to be is unknown. Its oddity makes it a well known place and many underworld meetings transpire on or near the bridge simply because everyone knows where it is. ("Meet me at midnight under the Moon Bridge.") The massive bridge is not as solid as one might expect, and is riddled with ice caves large enough for two good-sized ships to secretly meet.

Windscape Three: The third planet in this system once held a colony of the UWW. About a hundred years ago all contact was lost. From orbit, the colony appears to have been destroyed. Whether this is the result of some outside force like a Dark Coven group or Kreeghor is unknown. Rumor in the underworld is a group calling themselves the *Unholy Avengers* are responsible, and that they have ties to several Dark Covens. The planet has a single moon.

Windscape Inner Asteroid Belt: This was your typical asteroid belt and the people of Windscape thought nothing of it. That was until thirty years ago when a huge comet slammed through the field, causing meteor showers. For every six hours of travel within the system there is a 01-40% chance of encountering a meteor shower. Game Masters, feel free to determine the type of shower. The most common are types 1-3.

Windscape Four: An inhospitable world, this ball of ice serves as home to one of the underworld's most notorious persons, simply known as *Miss Alexis*. It seems she had a dome placed on the planet and built a small fortress for herself. It's rumored that Miss Alexis is wanted by several governments for crimes ranging from theft to espionage and murder. No one goes to visit her, unless invited.

Windscape Five: A mist covered planet where the atmosphere is too corrosive to be of any interest to anyone.

Windscape Six: There once was a terra-forming operation on this world, but it seems that the planet proved too inhospitable for the operation and it was abandoned a few years after terra-forming got started. All that is left are several dozen empty atmospheric processing centers scattered around the planet. For those that know about them, they make ideal hiding or meeting places.

Windscape Seven: A frozen wasteland with a breathable atmosphere that no one has yet attempted to colonize. The planet has four moons.

Windscape Eight: A rock lost in a perpetual dust storm. It has one moon.

Windscape Nine: The first gas planet in the system is Windscape Nine and home world to the people of this system. Locked in orbit high in the sky is one of the oldest ships around, the Windscape. The ship served in several Wulfen campaigns that have made it legendary before being retired in a locked or-



bit around the planet. Eventually the ship turned into a sort of pirates' station with all kinds of underworld persons coming and going. The pirate captain profited from this too, by charging high docking fees and renting out various sections of the ship. Over time the ship grew as living modules were added to the ship's exterior. Today, the Windscape is not even recognizable as a Wulfen Pack Master. It's had so many extraneous parts grafted to its exterior that it looks like a small space city or space station. The structure itself is now just under three miles (4.8 km) long and a mile (1.6 km) wide. Many people actually call the Windscape home, and they are the ones who are information brokers.

Asteroid Belt One: The system's middle belt is composed primarily of ice and rock.

Windscape Ten: The last planet in the system is a medium gas planet. It is of little value to the people of Windscape.

Asteroid Belt Two: The last asteroid belt in the system and the thinnest. This belt is slowly losing its cohesion and any incoming ships have to be careful to avoid meteor showers in this area. The belt is so thin that only type one and two meteor showers are possible.

The Anvil Galaxy

Note: To read a great deal more about the Anvil Galaxy, legends of the Cosmic Forge, 15+ new aliens, planet creation rules, and an overview of the galaxy, check out **Rifts® Dimension Book Five: Anvil Galaxy.™**

Andropelous System

Located in the heart of the Andromeda cluster, the Andropelous System is one of the most popular vacation retreats in the *Pleasure Federation*. The whole planet of Andropelous Three is one large pleasure resort, offering all kinds of amenities from spa and health treatments to sports activities, to some of the galaxy's finest foods, entertainment and recreation. Visitors are constantly coming and going to the planet, with several cruise lines sending a good number of ships every week, not to mention a thousand or more private pleasure yachts.

Star: The system's only star is a blue dwarf.

Ando Asteroid Belt: This belt is rich in magnetic alloys, which are mined by various prospectors. The government of Andropelous receives a 25% commission for all ore that is mined.

Andropelous One: This lifeless rock has a major stellar observatory on it. It also happens to be a major attraction. Scientists come from all over the Anvil Galaxy to use this advanced facility, as well as tourists, to view the beautiful, holographic representations of various stellar phenomena as they happen.

Andropelous Two: The second planet of the system is a dead rock.

Andropelous Three: The system's most popular planet. The first thing that makes this planet unique is that it is one of the few habitable planets with a system of rings. They are blue and violet and tilted at a 45 degree angle. The second is the beaches. People come from hundreds if not thousands of light years, to lie on the white sandy beaches, go swimming in the warm ocean waters, and watch the amazing sunset as the rings sparkle off of the reflected sunlight. Andropelous Three is one of the premier vacation spots in the Pleasure Federation. The planet is covered in resorts with various themes, from those geared towards the family experience to adults only entertainment. They cater especially to the business crowd and reportedly have the most golf courses in the Three Galaxies, numbering over 11,000, many of which offer unusual challenges such as tees and greens that float using grav packs. This alone brings back the same crowd year after year.

Andropelous Four: The system's first gas planet is a medium ringed world. It has no moons and is of little value to the system other than as an attraction for sightseers. When cruise ships come into the system they typically do a fly-by for the view.

Andropelous Five: Several domed cities are found around this planet. This is where many of the employees from the Andropelous Corporation live. They are shuttled back and forth every few months to work. There are also a few resort areas for elite clients who want their privacy assured.

Andropelous Six: Not wasting any resources when it comes to making a profit, this airless, little dead rock recycles about 80% of their waste and garbage from throughout the system. Paper and plastic products are easily recycled, junk is turned into various souvenirs and trinkets, the rest is incinerated.

Andropelous Seven: The last planet in the system is an inhospitable place devoid of life.

Hook Line and Sinker

Hook: The player characters have either won a trip, or as a reward for a previous adventure, have been given passage on a cruise ship going to the Andropelous System.

Line: Just before arriving into the orbit of Andropelous Three, the characters notice that the ship has changed course and is no longer heading to the pleasure planet.

Sinker: The cruise ship has been taken over by a group of pirates. They have plans to sell the ship, crew and passengers for a tidy profit. Can the player group stop them?

The Cray-Lon Expanse

The Cray-Lon Expanse is one of the largest in the Anvil Galaxy, at 67 light years in length and 8 light years at its widest. It covers an area of over 1000 cubic light years. Hidden within the expanse are several systems, but only one that is noteworthy. The dreaded *Galactic Tracers' Guild* has set up shop in a system they call The Cell. It is from here that the thousands of Galactic Tracers receive their various assignments for bounties they are to collect. The guild automatically takes a 25% commission from the bounty, leaving the rest for the bounty hunter.

The Guild is hated in the Consortium of Civilized Worlds, because they accept bounties from just about anyone for anyone, but Guild members are allowed to operate within CCW space, provided they are deputized and have a valid legal warrant for the fugitive they are pursuing. Cell operatives must also comply with all CCW laws and regulations. The same applies for the UWW. As for the TGE, they are a little looser with the Tracers, especially if one knows how to make the authorities more agreeable by paying an entrance fee in their space or a 10% cut of the bounty, up front.

For the last 20 years the Tracer Guild has had one member who always seems to be a step ahead of the competition, Master Fesh, an enigmatic Galactic Tracer who operates out of the guild at his, or her (no one really knows), own convenience. He even delivered one high ranking guild member to a crime lord for double-crossing him. Fesh just took up the bounty because the price was right, "It's not personal, just business." So far no one has been able to escape Fesh once he has taken up the hunt.

Simply called The Cell by the various mercenaries and man-hunters, the system is very difficult to find, especially if you don't know where to look. The small system is nestled away in an open pocket that takes twelve hours to get to via a secret route. Anyone else who knows where it is, but does not have a map, would take 2D4 days to find or exit the place.

Stars: The Cell is a binary system with a medium orange and a brown dwarf.

Asteroid Belt One: This belt is almost certainly the remnants of a planet that got caught between the binary stars' gravity wells, and was ripped apart. It is of little value to the guild.

Cell One: The first planet in the system is a fire rock. It is rumored to be a place for Tracers to have private meetings without the prying eyes and ears of the Guild.

Asteroid Belt Two: The second belt is of little value, being composed mostly of ice.

Cell Two: The second planet in the system is a deserted dust bowl.

Cell Three: The last planet in the system is where the Guild Hall orbits. The Guild Hall is one of the oldest space stations in the Three Galaxies. It was built four centuries ago by a group of colonists, but the colony quickly fell into decay as the system turned out to be barren of the precious metals they hoped they would find. After five years of decay and the station getting dangerously close to falling out of orbit, the colonists sold the station to a group of Galactic Tracers who happened to be the founding members of the Galactic Tracers' Guild. It was a group of 20 Tracers that formed the original guild, and today it numbers at least a hundred thousand.

Guild Hall Station: Medium-sized with 233,000 M.D.C.

1. Station's Function: Private Business; +20 to Business, +10 to Supplies, and +10 to Environment.

2. Power Systems: The station has a primary and a back-up fusion reactor. 20 points.

3. Defenses: Advanced Weapons, Defense Satellites, and an Armored Hull. The station has an armored hull adding 15% M.D.C. to the station's overall M.D.C., 6 medium particle beam cannons, 2 medium-range missile launchers, and 20 defense satellites (mostly energy weapons with the rest being missile launchers) serve as the station's defense system. 80 points.

4. Sensors: Basic Sensors with Satellite augmentation. The station has six long-range satellites. 12 points.

5. Communications: Stellar Communications with satellite augmentation. The station has five interstellar satellites – it takes a lot of power to burn through all that stellar gas. 90 points.

6. Station Maintenance: Secondary Priority. 3 points.

7. Supplies: Self Sufficient. 25 points.

8. Internal Security: Local Law Enforcement. Effectively the Galactic Tracers there serve as security. 10 points.

9. Security Systems: High-tech. The council seems to spy on everyone. 50 points.

10. Medical Facilities: None. Zero points.

11. Environmental Systems: Advanced. 20 points.

12. Business: Trading Post. The majority of business at the Guild Hall station is banking! Numerous banks are available to hold bounties in escrow while a job is being done. The remaining business focuses on weapons, armor, equipment used in surveillance and man-hunting, and entertainment. 10 points.

13. Transients: Job Programs. Transients who choose to do so can be trained as Tracers if they are accepted as an apprentice. Otherwise they end up working various menial jobs or none at all. 20 points.

Total Points available: 340 (Total Points spent: 340).

The planet below is nothing more than a dead rock, but the guild uses it to hold valuable prisoners and items. The planet has several underground structures that were built by the Guild some time ago. Who knows how many poor souls may be hiding down there.

A pair of notable Galactic Tracers

Master Fesh

One of the deadliest and most feared Tracers in the Three Galaxies is Master Fesh. His reputation is that once he picks a mark he pursues the individual relentlessly, never giving up. He is also one of the few Tracers to actually travel in all Three Galaxies, most stick to just one. Many of Fesh's targets don't even realize he's on their back until it's too late. So far, nobody has ever been able to elude this phenomenal bounty hunter, and no one has been able to figure out exactly how Fesh is so successful.

Part of Fesh's secret comes from the fact that he is a shapechanger. The Splugorth brought him to the Three Galaxies as a youngster and may have taught him certain secrets before he managed to escape their clutches. Growing up in the rough and tumble space lanes, he eventually found a job as an assistant to a local Galactic Tracer. He was a quick study and learned the trade as if born to it. Part of Fesh's technique is to research every bit of data available on the fugitive, getting to know him intimately, and then he assumes the guise of a friend, relative, lover, child or whoever and gets into trouble to lure out his quarry. When the fugitive appears to rescue or help their loved one, and their guard is down, Fesh makes his move to capture the bewildered soul. A bit of psionics doesn't hurt either.

Real Name: Marock Fond.

Alignment: Miscreant evil.

Attributes: I.Q. 15, M.E. 23, M.A. 27, P.S. 19, P.P. 21, P.E. 12, P.B. 9, Spd. 8

Disposition: Cold and calculating, with a sadistic streak. He can't be bribed or bargained with, and it's not from a twisted sense of honor. He just takes great pleasure and pride in his work and enjoys watching his victims beg and plead for their lives.

M.D.C.: By armor or force field only.

Hit Points: 56. **S.D.C.:** 71.

Horror Factor: 12, only when a potential target knows they are being hunted by the most famous and deadliest Galactic Tracer in the Three Galaxies.

P.P.E.: 9

Level of Experience: 10th

Skills of Note: Basic Math, Radio: Basic, Pilot Small Spaceship, and Computer Operation 98%, Speak Dragonese, Trade Three and Four, Literacy: Dragonese, Trade Three and Four 90%, Surveillance Systems, Detect Ambush 85%, Intelligence 78%, Zero Gravity Movement & Combat 98%, Navigation: Space 95%, Pilot Contragravity Pak 88%, Pick Locks 80%, Tracking 75%, Demolitions 87%, Streetwise 61%, Demolitions Disposal 78%, Boxing, and Gymnastics, Sense of Balance 55%, Work Parallel Bars & Rings 63%, Climb Rope 72%, Back Flip 75%, Prowl 30%, Climbing 92/82%, Disguise 75%, Galactic Lore 70%, Athletics, Camouflage 65%, Trap Construction 56%.

Weapon Proficiencies: Paired Weapons, W.P. Energy Pistol, W.P. Energy Rifle, and W.P. Sword, all at 10th level.

Natural Abilities: Shape changing abilities; any humanoid shape, size, or gender.

Psionic Powers: Even Fesh doesn't know the full extent of his powers, but does know he's tested most of them and that he is some sort of genetic experiment of the Splugorth.

Considered a Master Psychic and has 240 I.S.P., half of which are provided by the symbiote attached to the base of his spine. Has all *Physical Psionic* abilities plus the following Super-Psionics: Bio-Regeneration (super), Bio-Manipulation, Empathic Transmission, Hypnotic Suggestion, Mentally Possess Others, Mind Block Auto-Defense, Mind Bolt, Mind Bond, Mind Wipe, Psionic Invisibility, Psychic Body Field, Psychic Omni-Sight, Psychosomatic Disease, Telemechanics: Paralysis and Telemechanics.

Magic Powers: None.

Combat: Martial Arts and Boxing with 7 attacks per melee round.

Bonuses: +3 on initiative, +6 to strike, +9 to parry and dodge, +2 to disarm, +1 to entangle, +6 to roll with punch, fall, impact, +5 to pull punch, karate style kick, jump kick, critical strike on an unmodified roll of 18, 19, or 20, leap attack, and Judo style body flip/throw. +2 to save vs telepathic probes, +4 to save vs mind control and Horror Factor, and impervious to possession.

Alliances and Allies: Fesh has very few people he would consider allies. He does have a number of underworld contacts. Each one sees a different face from Fesh and none know what he or she really looks like. Ultimately, Fesh lives by the belief that, "No one can be trusted!"

Enemies: There are several people who have crossed paths with Fesh and come out poorer for it, mostly rival bounty hunters, mercenaries and adventurers who have been cheated, hurt or trumped by Fesh. Others include the friends and relatives of some of the fugitives Fesh has turned in for rewards.

Description: Master Fesh is known for his stylized, metallic red and black armor. The armor is standard NE-C20 with a heavy force field built in. He also uses the gauntlet micro-missile launcher and an assortment of weapons mounted on the armor. He is reputed to be a master of disguise, and nobody knows what he – or she – may actually look like. Some believe he is a demon or shape changing dragon.

Note: Fesh has a fast Merchantman spacecraft, a small crew, and no cybernetics. He also has several alter egos – personas that the world at large believe to be separate and distinct individuals.

Red Lotus

Red Lotus is a rising star in the Galactic Tracer Guild, having successfully collected two of the highest bounties the Guild had to offer. She even beat Master Fesh, which is a surprise considering the amount of credits involved. While not trained as a Galactic Tracer, her Oni Ninja skills more than compensate. She has a mysterious benefactor who sponsored her admission into the Guild and has even provided her with a starship and a pilot.

She was trained in the Yinshazi System at the Miyabe family monastery. For her first few years she worked for her Shogun, Shin Miyabe. He was working his way up the corporate ladder at Bushi Industries and would use his team of Oni Ninjas to take out competitors who got in his way. His ambition would be his

downfall as he tried to tackle the latest superior blocking his way up. Honda Ota also had a small faction of Oni Ninjas at his disposal and a larger network of spies. He cleverly planned an opportunity for Shin to strike, only it was a red herring. An ambush was set up to kill all of Shin's Oni Ninja team, and a second strike was planned for Shin Miyabe, himself. The plan went off with only one hitch, Asao Sasaki escaped and killed two of Ota's ninjas doing so! She raced back to warn her master only to find him murdered. Her only recourse was revenge – but not right away, she'd wait until she had achieved the level of skill and power to assure victory. Asao escaped off planet, dodging authorities all the way. Ota knew of her escape and to add insult to injury, framed her as the murderer. A year later she ended up on Windscape where she made a few contacts and met her soon to be benefactor. Some deal was struck, she took on the persona of Red Lotus, and became a Galactic Tracer. Red Lotus is very popular and sought after to do the most difficult jobs and bag some of the most elusive bounties. In a few years, her reputation may rival that of Master Fesh.

Real Name: Asao Sasaki.

Alignment: Anarchist.

Attributes: I.Q. 15, M.E. 18, M.A. 13, P.S. 40, P.P. 31, P.E. 32, P.B. 11, Spd. 21

M.D.C.: 202. **S.D.C./Hit Points:** Not Applicable.

Horror Factor: 8 for being recognized as an Oni Ninja. As her reputation grows, so too will her Horror Factor. By the time she's tenth level it could go as high as 14.

P.P.E.: 8

Level of Experience: 6th level Oni Ninja.

Natural Abilities: Developed sense of smell, acute hearing, nightvision 200 feet (61 m), and Oni Ninja abilities listed below. Resist Mega-Damage fire and cold (half damage) from Body Hardening.

Psionic Powers: Mind Block, Object Read, See Aura, See the Invisible, and Telepathy. I.S.P.: 71.

Oni Ninja Techniques: Face of a Friend, Art of Stealth, Unnoticed Walker, Vanishing Act, Automatic Dodge, Body Hardening, and Art of Defense.

Magic Powers: None.

Combat: Hand to Hand: Assassin and Boxing with 7 attacks.

Bonuses: +1 to initiative, +10 to strike, +13 to parry and dodge, +6 to roll with punch/fall, +5 to pull punch and +2 to entangle. W.P. Parried Weapons.

Vulnerabilities/Penalties: None.

Alliances and Allies: She only has a few allies among the guild plus contacts on Windscape.

Enemies: She considers the Ota clan an enemy for having killed her master and will go out of her way to get revenge on them.

Skills of Note: Speak and Read Oninese 98%, Speaks Trade Four, Five and Six 95%, Prowl 70% (also see Art of Stealth), Detect Ambush 70%, Disguise 65%, Detect Concealment 60%, Acrobatics, Boxing, Sense of Balance 85%, Walk Tightrope/High Wire 75%, Computer Operation 70%, Land Navigation 61%, Tracking 60%, Surveillance Systems 60%, Basic Electronic 55%, Climbing 40%/30%, Zero-G Movement and Combat 98%, Poetry (Haiku) 60%, Literacy Trade Four 65%, Rope Works 55%, and Lore: Galactic/Alien 50%.

Weapon Proficiencies: Paired Weapons, W.P. Sword, W.P. Knife, W.P. Archery and Targeting, all at 6th level.

Description: Red Lotus has an athletic build and stands 7 feet, 2 inches (2.2 m) and 280 pounds (126 kg, all muscle). In combat she wears the traditional Oni Ninja body suit, but to distinguish herself, it is crimson colored. She wears her hair in a long braid down to the small of her back. Red Lotus' weapons of choice are a Strata crystal sword, Strata crystal shurikens, and a compound bow with an assortment of high-tech arrowheads. When heavy combat is expected, she dons a heavy force field. Because of her crystal weapons, some wonder if her benefactor might not be a Strata, though it seems out of character for that race.



The Elemental Lands

The Elemental Lands are a collapsed orange star that formed a plasma field. Within the plasma field are a series of *ley lines* that intersect to form some rather large nexus points. Nestled within the plasma field are six big asteroids that are on or near a few of these nexus points. Members of the Warlock Navy who explored this plasma field discovered that several of the nexuses are direct doorways to the Elemental Planes. Specifically, the Planes of Fire and Air, but on occasion the doorways open to the various other Elemental Planes. This has prompted several Warlock expeditions, and others to build temples on the various asteroids in the plasma field. There is one temple for each of the Four Elements, each on its own asteroid. The fifth asteroid houses the young acolytes until they choose their life sign and

the sixth asteroid is a small military base to protect the temples from any attack. The asteroids vary in size, with the smallest being 5 miles (8 km) in diameter to the largest being 15 miles (24 km) in size.

While this is an unusual place to train young Warlocks, it somehow puts them in closer touch with their life signs. Warlocks who receive their training in the Elemental Lands are +5% to summon their Elemental sign.

Hook Line and Sinker

Hook: The player characters have been hired to deliver supplies to the monasteries within the Elemental Lands.

Line: The trip in goes rather smoothly with all supplies being delivered. However, one of the Warlocks has another job for the players. Simply transport some students who have failed to become Warlocks.

Sinker: Should the players accept, they take on four passengers. One of the failed Warlocks is not so happy, as he was kicked out rather than having failed. As the ship is leaving he summons an Elemental and with the help of the remaining disgruntled students, tries to take over the ship or engages in some dastardly deed (a pact with pirate raiders, a monster, the Dark Covens, etc.), so he can have a little revenge on the Warlocks of the Elemental Lands.

The Firestorm Nebula

The Firestorm Nebula was the site of one of the first battles between the CAF and the alien beings known as the Intruders. The plan was to ambush the Intruders, taking advantage of the effects of the nebula. The CAF thought they had the home field advantage and would catch the Intruders with their pants down. Instead, the CAF was slaughtered. The solid energy matrix of the Intruders did not break down as they had suspected it would inside the nebula. In fact, there was no apparent effect on the Intruders at all. While the CAF did successfully destroy two of the larger mother ships, they were ultimately defeated and all that remains is tons of floating debris.

The nebula itself is a bit of an anomaly. Typically, nebulas are a birthplace for stars. This one has a habit for creating stars with very short life spans. Three of the stars in the nebula have already collapsed in on themselves, creating very dense plasma fields. The plasma fields are extremely dangerous, as the effects of the field are accumulative with those of the nebula, and few people will risk going into a plasma field with no shields. That was part of the CAF's plan, to engage the Intruders in the plasma and nebula fields simultaneously.

Hook, Line, and Sinker

Hook: Through reliable sources the players are informed of a huge cache of salvageable equipment in the Firestorm Nebula.

Line: After a few days of searching, the players hit a big debris field. Within is millions of credits' worth of salvage. Through the course of the next several days the group can completely fill their cargo holds.

Sinker: Only a few hours away from completely filling their holds, the player group receives a faint distress signal. It's a CAF signal, and from the details given, there are a significant

amount of survivors from the legendary massacre, enough that they would need all the space available including the cargo holds! To make matters worse, long-range scanners have picked up a small group of Intruder vessels heading towards the source of the signal and which will be within range in a matter of hours. As impossible as it seems, the CAF survivors claim they were warped into a Time Hole and have only just now reappeared at the location of the battle. They implore the player group to rescue them (and have no idea Intruders are the way). What do the player characters do?

The Harkon Rift

The Harkon Rift is located just under five billion miles (8 billion km) from the Harkon nebula. The Rift has four objects in orbit, three are dead worlds having all the life sucked out of them, and the fourth object is the Harkon defense platform. Two hundred years ago, a colony from the Elven Star Kingdom was established on the second planet. It was a unique opportunity to study a planetary system that had a Rift for a star. The magic energy was off the scale, and the Elves had a difficult time containing the energy. Despite the constant ley line storms, the Elves established a strong science colony. For several years, magical experiments were conducted to try and access the excessive amount of magical energy contained within.

Ten years after the colony was established, they succeeded in their experiments, but something went terribly wrong, the Rift opened! No one really knows what happened that day, only a single distress call was sent. When the Warlock Navy arrived, all they found was the once beautiful Earth-like world caught in a mystic maelstrom that had already pulverized most of the planet's surface. Now all that remains is a dead rock. Out in the distance the Rift still shines innocently, until the next dimensional disturbance to erupt from its blue energy field. It has remained permanently opened and several expeditions have ventured into it, but the only one to return was a single Cosmo-Knight and even she died a short while later. She lived long enough to relay a cryptic message, "Guard this portal well, for it is an opened portal to the worst kind of hell. I only pray the Cosmic Forge has the strength to stop the horrors within." And with that statement she died. Plans were immediately put together to build the Harkon defense station, though the builders know not what it is they are defending against or whether they have the firepower to stay what horror may emerge. So far, all has been quiet.

The Harkon Defense Platform

Space station size: Large Station; 400 points. M.D.C.: 5 million

1. Stations function: Military; +20 to Defense, +10 to Internal Security.

2. Power Systems: The station has a mystic generator called the Generator of Elements. It is rumored to have two Major Elementals trapped within providing a continued source of energy. 40 points.

3. Defenses: Magic Defenses, Heavy Weapons, three Fighter Squadrons, and conventional shields with magic shields for back up. The magic defenses consist of the hull being enchanted to be Impervious to Energy (a huge undertaking), Armor of Ithan back-up force field system at 3000 M.D.C., a dozen Meteor

Cannons (4D6x10 M.D. to everything in a 30-degree cone with a range of 5 miles/8 km), a dozen star fire cannons (4D6x10 M.D. with a range of 2 miles/3.2 km), Bottled Demon missile launchers with a payload of 50 missiles per launcher (six launchers total), six TK-Force Cannons (1D4x100 M.D.; with a range of 12 miles/19.2 km), plus two flare cannons (1D6x1000 M.D. per melee with an effective range of 400 miles/640 km), one Rifts Projector cannon and three full Shadow Bolt squadrons. See **Rifts Dimension Book Two: Phase World®**, page 155, for details on these weapon systems. Total cost: 163 points.

4. Sensors: Superior sensors are needed so they can detect the slightest hint of activity from the Rift. 40 Points.

5. Communications: Stellar communications are needed to maintain contact with the rest of the navy in case of an emergency. 40 points.

6. Station Maintenance: Major Priority. 15 points.

7. Supplies: Semi-self sufficient. 10 points.

8. Internal Security: Local Law Enforcement (Warlock Navy Military Police) with magic and psionics. 25 points.

9. Security Systems: Magic security measures. 10 points.

10. Medical Facilities: Psychic and magic healing. 40 points.

11. Environmental Systems: Advanced Systems. 20 points.

12. Business: Small Business. The station has a small area set aside for a few businesses. They have a general store and a few bars that double as restaurants and a concert hall. 5 points.

13. Transients: Job Programs. The Warlock Navy has a major recruitment center on the station and offers very good recruitment bonuses to recruiters. They are always on the prowl for new recruits. 20 points.

Total Points available: 430 (Total Points spent: 428).

Malcore System

The Malcore System is one of the major depositories of magic knowledge in the UWW, and the Three Galaxies. It, arguably, has the largest libraries to be found anywhere, and practitioners of magic come from all over to study in them. Some libraries even rent out small laboratories for magical research and experimentation. Getting to the planet can be a bit of a problem because security is airtight and the waiting list for planet side visiting passes is very long.

Star: The system star is a medium yellow.

Malcore One: Malcore One is a densely populated Earth-like planet with a single moon. Security is extra tight. The Dark Covens' Spell Thieves are constantly making attempts to break into the many labs and vaults of magic knowledge on the planet. The civilization makes extensive use of Techno-Wizardry and has produced such weapons as the Rift Projector Cannon, Flare Cannon, and the Death Cloud Cannon. Even everyday life involves the melding of magic and technology, with vehicles and just about all modern conveniences having been converted to magic in one way or another.

Malcore Two: The second planet in the system has extensive ley lines networks. Though the atmosphere is toxic to most humanoids, a few small domed cities have been established to take advantage of the ley line energy. Anybody going outdoors just has to wear an environmental suit and take careful precautions

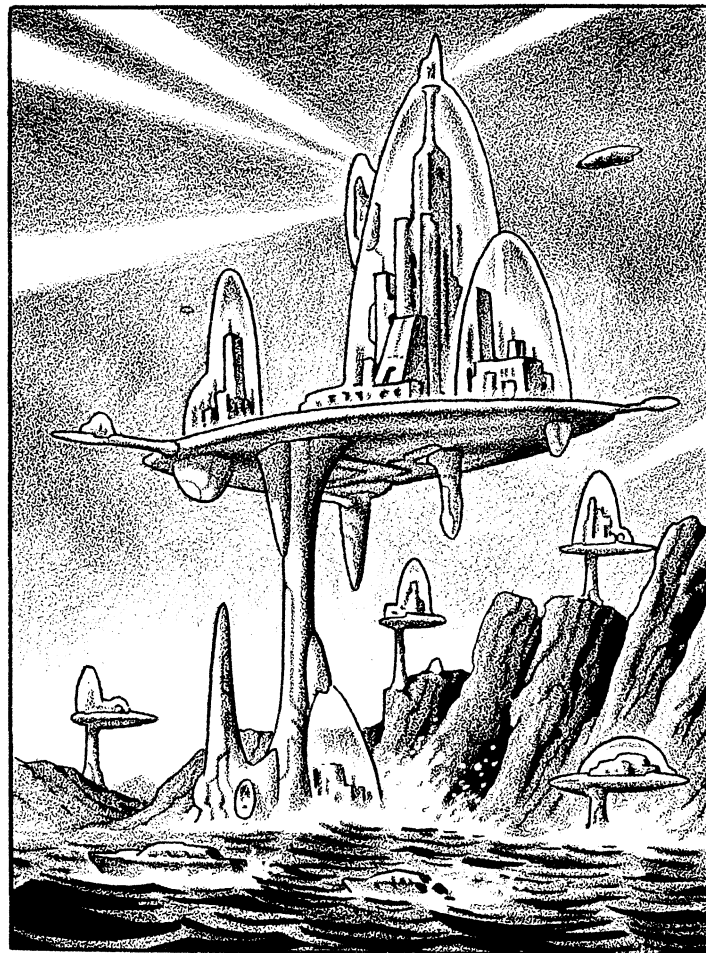

in the harsh environment. Many of the visiting workers of magic stop at Malcore Two to wait for clearance to get on Malcore One, which can take months. Consequently, there are a fair number of travelers and transients on Mal-2. It is rumored that a small Dark Coven group is among them.

Malcore Three: Because the system is in a magic rich section of space, the people of Malcore believe that they will find the precious metal Gantium. This planet has been mined for the last 150 years and all the while it has produced a variety of ores, gemstones and precious metals, no Gantium has ever been discovered.

Malcore Four: This is a tiny planet, only 1000 miles in diameter (1600 km). It's probably a trapped planetoid that got caught in the orbit of the sun. It is nothing but rock with no resources at all.

Malcore Five: During the Gantium Rush over a hundred years ago, traces of it were found on this planet of ice and rock. Getting to it is the problem, because the planet has an ice layer that is just over a mile thick, and the ice replaces itself at an astonishing rate. Even blasting through it is only a temporary measure. Several mining expeditions trying out various types of new equipment and magic have tried to give it a go, but the environment is relentlessly unforgiving, making any comprehensive mining operation impossible.

Malcore Six: The sixth planet in the system is a molten ball with four moons circling overhead.

Malcore Asteroid Belt: This asteroid belt is rather unusual in that it has a lot of stellar gases mixed in with the asteroids, giving it an unusual nebula-like effect. For any spacecraft flying

through the Malcore Belt, all the conditions found in a nebula apply, but at half the damage and intensity, in addition to the conditions of being in an asteroid belt.

Malcore Seven: Little is known about the seventh planet. All probes sent to the surface are crushed before they even land. Its single moon is a dead, airless rock.

Malcore Eight: This medium-sized gas planet has a gas mining colony on its third moon. Several of the other moons are mined for various rare metals. The planet's fourteenth moon has unusual magical activity on it and is covered in a grid of ley lines that are constantly ablaze with ley line storms! The moon has a thin, breathable atmosphere but is a cold desert world inhabited by bacteria, mold, and other lower life forms. Daytime temps hang around freezing, with nighttime temperatures dropping to 80 degrees below zero, Fahrenheit. The lack of precipitation keeps the moon free of snow, though there are regular "frostings."

Malcore Nine: A small gas planet.

Malcore Ten: From orbit, one can see the signs of civilization, from dead cities to highways. The planet is completely devoid of life, now, with only signs of microorganisms. Nobody knows what transpired here, or when, but folks give Mal-10 a wider berth for fear it may be a plague planet.

Malcore Eleven: It too has a series of ley lines on the planet, a thin atmosphere and lower life forms, but few, if any, practitioners of magic come out this far to visit the planet. One small research station claims that the ley lines on Mal-11 respond to surges and activity from the Harkon Rift, and suspect there may be a dimensional portal or some connection on this planet to the mysterious space Rift.

Malcore Twelve: This medium gas planet with eleven moons is something of a mystery, because its mass and density suggest it should be a planet twice its size, possibly a giant gas planet or a dwarf star. Its massive gravitational pull has yanked the last three planets out of their orbits and they follow it in a bizarre chase. Mal-12 is constantly monitored for the slightest change in its make-up for fear it might ignite into a small star. If that were to happen, it would throw the whole system into chaos.

Malcore Thirteen: This was the first planet to be ripped out of its orbit by Mal-12. It once supported small mammals but the planet is now completely frozen over. The planet's three moons have survived intact and they are in a stable orbit around the planet.

Malcore Fourteen: This barren world literally shattered when it was pulled out of its original orbit. A deep fissure lead's right to the planet's core. Having been exposed to the vacuum of space has cooled the core, making the planet a dead rock.

Malcore Fifteen: The last planet is a windswept desert that is absolutely freezing. The atmosphere is breathable, but filters need to be worn due to all the sand and ice particles that are in the air. The planet had two moons, but only one managed to survive being torn from its original orbit.

The Nova Cluster

The Nova Cluster is an unstable region of space so named because less than a year after it was mapped, two stars went nova. A star going nova is not an uncommon stellar phenomenon, but when two stars go nova within a week of each other it raises a few eyebrows. It was decided in a joint venture between the UWW and the CCW that this region of space merited study. Both governments contributed funds to have a research station built and maintained in one of the systems that has a series of planets and a stable star. The Nova Research Station studies the various stars in the region, collecting data on them and the death of stars. The cluster contains 72 various stars. Only six of them have planetary systems. In the last ten years since the station was created, a dozen stars have gone nova in the region.

Star: One of the few stable stars in the region is this system's white dwarf. Study of this star does indicate that it too once was on the brink of going nova itself, but instead shed several of its outer shells and turned into a white dwarf.

Nova One: A charred, dead rock with two moons.

Nova Two: A medium gas planet with 22 moons of varying types. One of the moons is habitable, but has not yet been explored or colonized.

Nova Three: Another medium gas planet that has been knocked off its axis, causing it to rotate on its side. Its ten moons remain in a stable orbit.

Nova Four: Home to Nova Station. The research facility is a large complex with a host of scientists and advanced equipment and sensors pointed at the various stars. In orbit are several dozen satellites, also for star watching. To date, they have gathered enough data to keep scientists busy for years.

The planet has a rocky surface with little vegetation. It does not have resources to feed the people of Nova Station so supplies are shipped in and restocked at regular intervals.

Obsidian Cove

The Obsidian Cove is home to the *Dark Coven* called the **Black Rogues**. They are not your typical Dark Coven, however, as they frequently work with other Dark Covens to achieve mutual goals. Rumor has it that a training ground for Spell Thieves is hidden someplace in this system.

Stars: The system has two stars. The primary star is a medium yellow star that is orbited by a brown dwarf.

Obsidian Cove One: This planet is a dead rock with two small moons in orbit.

Obsidian Cove Two: An ice rock with a thin atmosphere breathable by humans and other humanoids. The occasional UWW spy has been left on this planet to freeze.

Obsidian Cove Three: The system's first gas planet has a small system of moons along with an extensive ring system. The planet is considered a medium-sized gas planet. The first four moons are rocks that float among the rings. The fifth and sixth moons are larger. The seventh moon is a small Earth-like habitat! The temperature is a little cooler than Earth and it is bathed in perpetual twilight; this is caused by being in the shadow of the gas planet's rings. The lack of light makes most of the foliage white or various shades of pale green, yellow and orange.

Obsidian Cove (a moon of OC-3): Obsidian cove or simply just “the Cove” is home to the Black Rogues. They are a Dark Coven that has been a thorn in the side of the United Worlds of Warlock (UWW) for several decades. They are the only Dark Coven to have successfully stolen magic items and secrets from the UWW without being apprehended or shut down. They operate with impunity from this system because it is located deep towards the Core of the Anvil Galaxy in an uncharted region of space. It took them several years, but they finally found a base of operations suitable for their needs. The moon is small with a single continent and a small ocean. Its Earth-like nature makes it something of a remote paradise. It’s also covered with a series of ley lines making it ideal as a training ground for the *Spell Thieves*.

Obsidian Cove Four: A dead rock. The surface is jagged and sharp. A series of subterranean passages leads to the planet’s massive, empty core. It’s a cavern several hundred miles in size. The Black Rogues avoid this base because it is infested with *Space Coral Creatures*, thousands of them! The jagged surface is actually their coral homes and they have burrowed deep into the planet with the core being one massive hatchery!

Obsidian Cove Five: A giant gas planet with a massive gravitational pull, which may explain why it has no moons.

Obsidian Cove Six: The last planet in the system is also a giant gas planet with seven moons. The planet also has rings, but they circle vertically instead of horizontally.

Obsidian Cove Asteroid Belt: The system’s only asteroid belt is composed of large chunks of rock averaging several miles in size. These large rocks are riddled with caves and ravines due to the number of Space Coral Creatures in the system (and in the asteroid belt). Given the size of these asteroids they must have once been a planet or two, which has long since been destroyed. Over the years, the Black Rogues have “acquired” a few sensor satellites and have placed them in the belt to alert them of any ships that approach the system.

Note: See the O.C.C. Section for the *Obsidian Spell Thief* and the Monster Section for the *Space Coral Creature*.

Hook Line and Sinker

Hook: The player group is transporting or escorting another ship that has a group of passengers from another system in the Anvil Galaxy to just outside the Obsidian Cove System.

Line: The passengers remain in their quarters and don’t cause any trouble, but seem rather antisocial.

Sinker: Just before the ship(s) enter the system, the player group receives a hail from a UWW Iron Ship. They are harboring fugitives among the passengers, and unless they give them up immediately, there will be trouble. Unfortunately the passengers are no longer on the ship. They have either stolen a shuttle from the transport, or had a ship secretly rendezvous with them and have already jumped ship at an opportune moment. The UWW Iron Ship demands the player characters help in their capture. Who are these fugitives? Spell Thieves? Spies? Killers? Evil sorcerers carrying some valuable secret or magic artifact? Is there a reward for them? We leave that to you G.M.s to decide and build upon.

Ramos

Ramos is one of the few *independent* systems located within the United Worlds of Warlock. It is unknown why they have not joined the magic federation, but their decision has been respected all these years and they are on good terms with the UWW, with both sides agreeing to a defense alliance should the need arise. The main inhabitants of the system are called Ramen, along with a host of other races who have answered their religious calling to go to the planet and serve the Church of Light and Darkness. It is rumored they are guarding a precious artifact and waiting for the day that a horrible monster called the Armageddon Creature threatens the Three Galaxies.

Star: The system has a medium yellow star.

Ramos One: A lifeless rock of little value.

Ramos Two: A small gas planet that has four moons. One of the moons is a habitable forested world and the Ramen have established a small monastery on it. It is where most of the elders reside and they are sought out for their wisdom on various dilemmas.

Ramos Three: This planet has a small Ramen outpost established on the surface of this world. They use it to train their troops in a hostile environment.

Ramos Four: A habitable jungle world under the control of a race called the Ramen (See *Rifts® World Book Four, Africa* for details). All are the Knights of Ra, and in charge of protecting the numerous temples dedicated to the various deities in the Church of Light and Darkness. Various people around the planet worship all the gods from the pantheon with one goddess standing slightly above the rest, Isis. Alas, there are not enough Ramen on the planet to guard every temple and the occasional Space Pirate or opportunistic sorcerer has secretly landed on the planet to ravage one of them. Navigating the planet is very difficult as it has an unstable magnetic field, making any kind of magnetic instruments useless. The people of Ramos have adapted to this condition by familiarizing themselves with the local terrain and most are experts in the use of the Land Navigation skill.

Ramos Five: A small-ringed gas planet. It was considered for gas mining but the rings proved too dense and dangerous to navigate through to make it worth mining.

Ramos Six: A medium gas world with no moons. In order to economically support the Ramos System (they have no viable exports), they have contracted to a gas mining company from the UWW. In exchange for the right to mine the world, Ramos Four receives a nice stipend to support its population.

The Tigress System

Every Drive Jock in the Three Galaxies knows that the Tigress System is the place to be for fast ships. The trinary system, itself, is something of an obstacle course that can make space racing a challenge. Every week there is a race with large cash prizes awarded to the winner. Once a year they hold a galactic rally with racers coming from all over the Three Galaxies.

Star One: The primary star in the system is a medium red.

Tigress One: The surface of this planet is covered in a fine layer of frozen water mixed with trace elements of nitrogen and

methane; the thin atmosphere is composed of methy-oxide. There are remnants of a long abandoned mining station, but it is frozen in a layer of ice.

Tigress Two: A rock that is pretty much ignored.

Tigress Three: A weapons range for the various Drive Jocks that occupy the system, the planet has unusual stone formation that rise out of the surface. They are be formed by hot magma being cooled as it vents out of the planet's core. The pilots love the jagged formations and fly like hellions through them, destroying them at their leisure, knowing that in a few weeks they will reform.

Tigress Four: The pilots don't dare enter the atmosphere of this ice planet, because it is far too windy even for powerful star fighter engines. Instead, during races they use the planet as a slingshot, doubling their speed for a brief period. This is a gamble, because if they miscalculate (fail their piloting roll), they lose time.

Tigress Five: A medium gas planet with eight moons and a set of rings. The pilots refer to this planet as the "Tigress Raceway" and the majority of the racing starts or ends here. The raceway is a twisting, winding course through the planet's rings and various moons. The race course is very treacherous and not meant for amateurs. Several pilots have lost their lives competing in this race.

The fifth moon is habitable and covered in a dense jungle canopy called the Tiger's Pit by the local Drive Jocks. Several years ago, the founders of the raceway set up shop on the planet. It's a small city that is dominated by a 15 story pyramid-shaped building built for star fighters. The pilots rent individual bays to service their fighters. Rent is steep at 1000 credits a week, but some of the regulars get a break (30% off). The rest of the city caters to the Drive Jock crowd with all kinds of piloting paraphernalia, places to eat, places to "crash" (i.e., hotels) and several exotic eating and entertainment establishments.

Tigress Six and Seven: These two ice rocks share an unusual binary orbit. The planets orbit each other in a strange dance around the solar system. Pilots generally avoid these planets as their combined magnetic fields distort ships' sensors, making flying in the area very hazardous.

Star Two: The system's second star is a medium orange.

Tigress Eight: The second raceway in the system is around Tigress Eight. The course is around a small-ringed gas planet that has three moons. Experienced Drive Jocks typically refer to Tigress Eight as the "bunny hill" because it is relatively a safe course. Races for speed and stunt piloting are held here, and many young pilots trying to prove themselves get their start on the "bunny hill."

Tigress Nine and Ten: Both planets are stone cold dead.

Tigress Eleven: Also known as "last stop," the majority of the planet is desert with rocky outcroppings and the occasional oasis. Centered around one of the oases is a good sized community called *Palm City*. This is where the pilots go to buy parts, weapon systems or whatever else they need. Several companies have set up shop on the planet to compete for the business of the Drive Jocks and adventurers flocking to the system. Currently, *Naruni Enterprises* and *Draygon Industries* are the top two competitors. As of late, Draygon has suffered some setbacks with one of their shipments being commandeered by pirates and

a small fire in their warehouse. No one is pointing any fingers at this time, but rumor on the street is that Naruni is behind it. Draygon just tries to stay focused on their business (not their business rivals), and is sponsoring the next big race, and putting up one of their Star Hawk fighters as the grand prize.

A popular rumor on the streets of Palm City and Tiger's Pit is that there is a hidden raceway on the surface of the twelfth planet called the Tiger's Cage. There is supposedly a series of trenches and caves that provide the ultimate challenge. Not only is the terrain treacherous, but what makes the course so interesting and dangerous is the fact that it has several dozen weapons emplacements from point defense weapons to medium-size starship cannons, making the star fighters a fast moving target. Of course this is only a rumor and most pilots don't want to take a chance of getting roasted by the sun's solar flares.

Star Three: The last star in the system has swelled into a red super giant. Whatever planets were around it have long since been destroyed.

Tigress Twelve: The last planet in the system is a dead rock. It has been thoroughly baked by the heat of the red super giant. The surface is charred from the constant solar flares that assault the planet.

Tigress Race Hook, Line and Sinker

Hook: Race time. Come try your luck. Win one million in credits for first place plus the latest and greatest from Draygon Industries, a Star Hawk fighter, plus other cash and prizes.

Line: One of the player characters (or all if they pilot a spacecraft as a team) has won the honor and prestige to participate in the next big Tigress race.

Sinker: Who knows what kind of intrigue and surprises could unfold for the racer and the rest of the group. A lot of participants from across the Three Galaxies come to participate, many more come as spectators. Anybody could show up in the crowd – an old enemy, a fugitive with a price on his head, a known spy, thief or murderer, political dignitaries, etc., as well as Spell Thieves, assassins, underworld kingpins, and anyone who is anybody. Plus, there is betting on the race, gambling, women, booze and all sorts of people, places and events surrounding the race (before and after) where the characters can get into trouble, get hired for a job or start a new adventure.

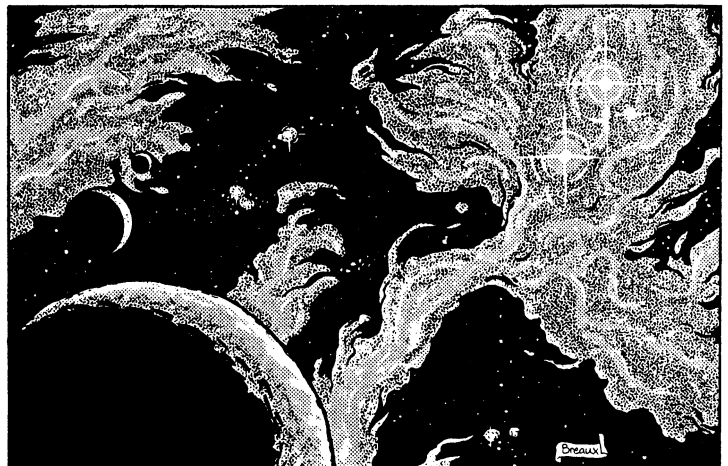

O.C.C.s & R.C.C.s

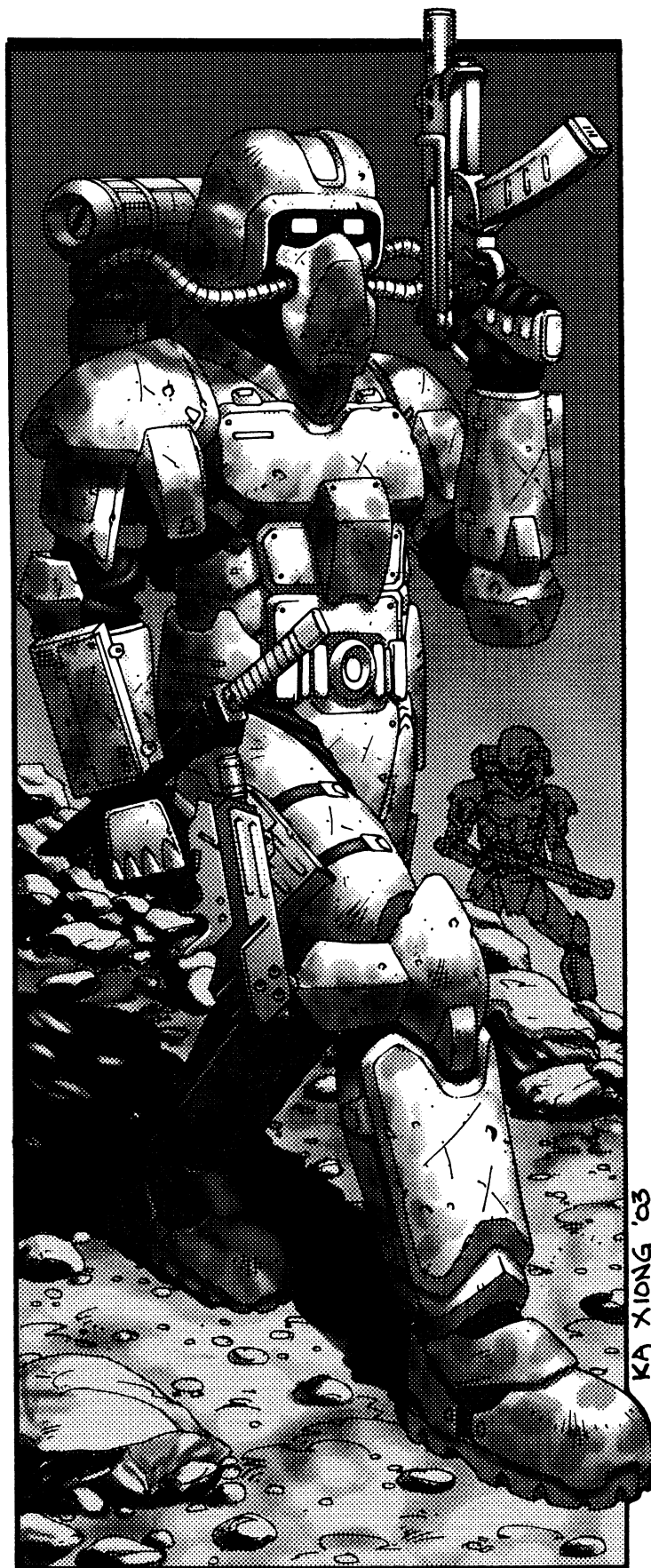

Free World Council O.C.C.s

The FWC (Free World Council) has been a thorn in the side of the Kreeghor for several decades. In the last tens years the CCW (Consortium of Civilized Worlds), and, to a lesser degree, the UWW (United Worlds of Warlock) have secretly sent military advisers and trainers to help the FWC fight the Imperial army of the Kreeghor based TGE (Transgalactic Empire). Even with limited resources the FWC is starting to train their own troops. These men and women have formal military training and are being dispatched throughout the TGE to help liberate planets that are under Kreeghor rule. Listed below are the new breed of soldiers the Kreeghor must contend with from the FWC.

FWC Ground Trooper

These are the front-line soldiers of the FWC. They are the first to touch down on a hostile planet and secure the area, engage in rescue operations, prison breaks, and all sorts of military operations from sabotage to stand-up gunfights. They are also the first breed of fighters to be officially trained by the FWC.

Attribute Requirements: None, just a willingness to join the FWC.

O.C.C. Bonuses: +20 to S.D.C.

O.C.C. Skills:

Speak and Read Native Language 98%

Radio: Basic (+10%)

Pilot Hovercraft (+10%)

Pilot of choice (+10%)

Read Sensory Equipment (+5%)

Weapon Systems (+10%)

Running

Wrestling

Wilderness Survival (+10%)

W.P. Energy Pistol

W.P. Energy Rifle

W.P. Knife

Zero Gravity Movement and Combat

Hand to Hand: Expert; can be changed to Martial Arts at the cost of two O.C.C. Related Skills. Hand to Hand: Assassin is not available to this O.C.C.

O.C.C. Related Skills: Select 8 other skills, plus select three additional skills at level three, two skills at level six, one at level nine and one at level twelve. All new skills start at level one proficiency.

Communications: Any (+5%).
 Domestic: Any.
 Electrical: Basic only.
 Espionage: None.
 Mechanical: Basic only.
 Medical: First Aid only.
 Military: Any (+10%).
 Physical: Any.
 Pilot: Any (+10%).
 Pilot Related: Any.
 Rogue: Any (+5%).
 Science: Math skills only (+15%).
 Technical: Any (+5%).
 W.P.: Any.
 Wilderness: Any.

Secondary Skills: The character also gets to select six Secondary Skills from the previous list. These are additional areas of knowledge that do not get the advantages of the bonus listed in the parentheses. All Secondary Skills start at the base skill level. Also, skills are limited (any, only, none) as previously indicated in the list.

Standard Equipment: Suit of heavy Mega-Damage body armor (Naruni camouflage armor for elite units), energy pistol, energy rifle, four grenades, Vibro-Knife, uniform, basic gear, and backpack. Additional equipment is subject to availability and specific assignments.

Money: Savings is 3D6x100, and the soldier earns 1000 credits per month.

Cybernetics: None to start.

FWC Technical Specialist O.C.C.

Specialized soldiers who serve various functions from training troops to leading a team into Kreeghor territory, to setting up a communications outpost. The FWC is finding that the versatility of this soldier is becoming a real asset.

Attribute Requirements: I.Q. of 10 or higher. A high M.E. and P.P. are desirable, but a not necessity.

O.C.C. Bonuses: +20 to S.D.C.

O.C.C. Skills:

Speak and Read Native Language 98%
 Speak and Read one additional Language (+20%)
 Basic Math (+30%)
 Radio: Basic (+15%)
 Pilot of choice (+15%)
 Read Sensory Equipment (+10%)
 Running
 W.P.: Energy Pistol
 W.P.: Energy Rifle
 Hand to Hand: Basic
 Hand to Hand Basic, cannot be changed unless a higher form is made available in one of the M.O.S. skill packages.

M.O.S.: Select *two* M.O.S. skill packages, and apply only the M.O.S. bonus to these skills.

O.C.C. Related Skills: Select four other skills. Plus select three additional skills at level three, two at level six, one at level nine and one at level twelve. All new skills start at level one proficiency.

Communications: Any (+5%).

Domestic: Any.

Electrical: Basic only.

Espionage: None, unless M.O.S.

Mechanical: Basic only.

Medical: First Aid only.

Military: Protocol only, unless M.O.S.

Physical: Any.

Pilot: Any (+5%).

Pilot Related: Any (+5%).

Rogue: None.

Science: Any (+10%).

Technical: Any (+10%).

W.P.: Any.

Wilderness: Any (+5%).

Secondary Skills: The character also gets to select six Secondary Skills from the previous list. These are additional areas of knowledge that do not get the advantages of the bonus listed in the parentheses. All Secondary Skills start at the base skill level. Also, skills are limited (any, only, none) as previously indicated in the list.

Standard Equipment: Light to heavy Mega-Damage body armor depending the combat situation and the preference of the character (this O.C.C. can select the type of armor or personal force field system they desire), energy pistol, energy rifle, Vibro-Knife, duffel bag, backpack, uniform and basic military gear, plus equipment related to the character's M.O.S. For example, the *Communications M.O.S.* will be issued a basic tool kit, language translator, wideband radio (transmitter and receiver), and other communications gear. All equipment is subject to availability.

Money: 1D4x1000 plus 1200 credits per month.

Cybernetics: None.

M.O.S. Skill Packages

Military Operational Specialty (M.O.S.) Skills are areas of expertise that are taught to the tech officer. They include the following categories:

Assassin/Man-Hunter: Surveillance Systems (+20%), Tracking (+20%), Sniper, Impersonation (+12%) and either Escape Artist or Disguise (+20%).

Combat M.O.S.: Three Physical skills plus Hand to Hand: Martial Arts, Boxing or Wrestling (choose one) and three W.P.'s.

Communications M.O.S.: Choose five skills from the Communications category (+20%) and Basic Electronics (+20%).

Engineering M.O.S.: Three Electrical and three Mechanical skills (each at +15%).

Espionage M.O.S.: Hand to Hand: Assassin, plus five skills selected from the Espionage and Rogue categories; may include any of the Military Demolitions skills and Find Contraband.

Reconnaissance M.O.S.: Intelligence (+20%), Land Navigation (+20%), Wilderness Survival (+15%), Prowl (+10%), and either Streetwise (+12%) or Surveillance Systems (+15%).

Science M.O.S.: Choose four Science (+20%) and two from Technical (+15%).

Technician M.O.S.: Computer Operation, Computer Programming, Computer Hacking, and three skills from Technical or Science (all +10%).

Weapons M.O.S.: Weapon Systems (+20%), Demolitions (+20%), Demolitions Disposal (+20%), Sniper and three skills selected from W.P. and/or Military (+15% each).

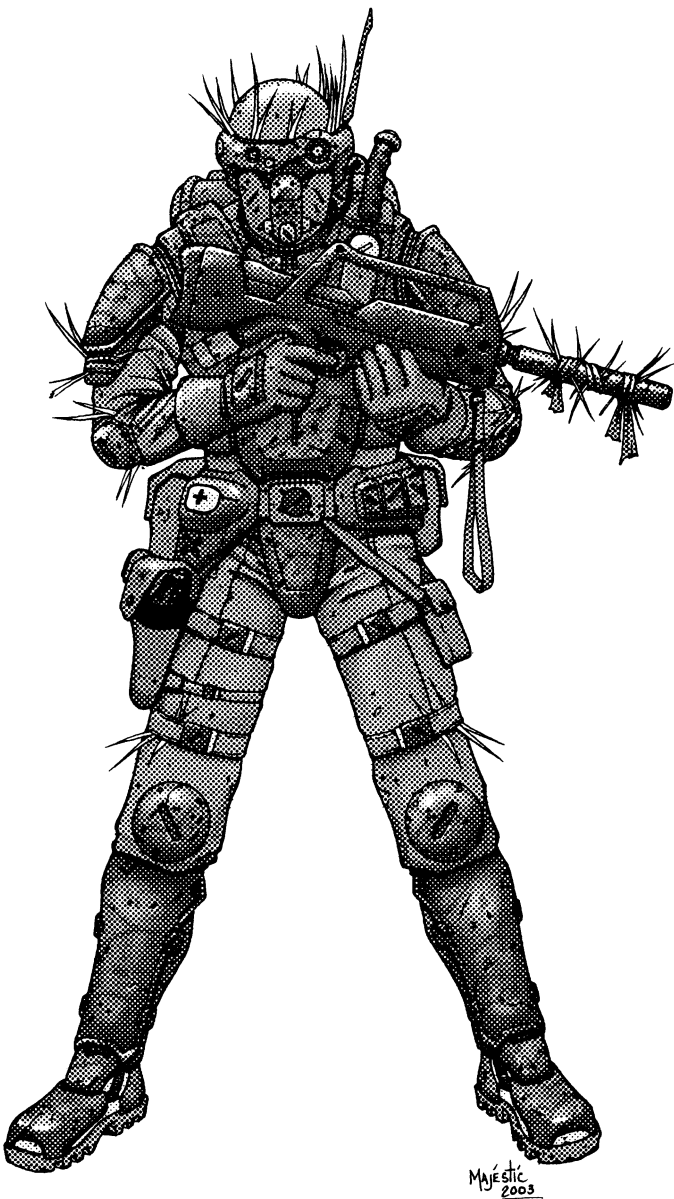

FWC Insurrectionists

The FWC Insurrectionists are specialized soldiers who engage in the physical war and the battle for the hearts and mind of the people. Thus, he engages the enemy and inspires others to join the battle and rise up against tyranny. They are used to infil-

trate Kreeghor worlds and start resistance cells, train and lead freedom fighters, create and inspire civil unrest and revolt, free political prisoners, P.O.W.s, and slaves, engage in acts of sabotage and assassination, and feel out Kreeghor defenses before an impending attack. They are rarely used as front-line soldiers, but can still handle themselves in battle.

Attribute Requirements: IQ. 12, M.E. 12, and P.S. and P.E. of 10 or higher.

O.C.C. Bonuses: +1D4x10 S.D.C., and +2 to save verses Horror Factor

O.C.C. Skills:

- Speak and Read Native Language 98%
- Speak and Read one additional Language (+20%)
- Basic Math (+25%)
- Radio: Basic (+20%)
- TV & Video (+20%)
- Computer Operation (+15%)
- Computer Programming (+10%)
- Intelligence (+15%)
- Interrogation (+10%)
- Pilot: One of choice (+15%)
- Read Sensory Equipment (+10%)
- Basic Electronics (+10%)
- Wilderness Survival (+10%)
- Prowl (+10%)
- Climbing (+15%)
- Running
- W.P.: Knife
- W.P.: Energy Pistol
- W.P.: Energy Rifle
- Hand to Hand: Commando (this cannot be changed).

M.O.S. Skill Package: Pick one of the following: Communications, Engineering, Science, Technician or Weapons. See the FWC Technical Specialist O.C.C. for specific M.O.S. skill lists and bonuses.

O.C.C. Related Skills: Select one additional skill at levels 1, 3, 5, 8, 11 and 14. All new skills start at level one proficiency.

- Communications: Any (+10%).
- Domestic: Any.
- Electrical: Any.
- Espionage: Any (+10%).
- Mechanical: Any.
- Medical: First Aid or Paramedic only (+5%).
- Military: Any (+10%).
- Physical: Any.
- Pilot: Any (+5%).
- Pilot Related: Any (+10%).
- Rogue: Any, but +10% to Computer Hacking and Streetwise only.
- Science: Any, but +20% to Advanced Mathematics.
- Technical: Any (+10%).
- W.P.: Any.
- Wilderness: None.

Secondary Skills: The character also gets to select four Secondary Skills from the previous list. These are additional areas of knowledge that do not get the advantages of the bonus listed in the parentheses. All Secondary Skills start at the base skill level. Also, skills are limited (any, only, none) as previously indicated in the list.

Standard Equipment: Equipment varies greatly depending on the mission. Generally the Insurrectionist can expect to receive any type of body armor and weapons, plus have all sorts of communications, broadcasting, and listening devices. Specialized equipment such as explosives and heavy weapons are given out on an "as needed basis." Vehicles can include any but again depends on the mission and availability; typically, basic fare like a hovercycle, jet pack, car, jeep, truck, etc.

Money: 3D6x1000 in savings and 3000 credits per month.

Cybernetics: The Insurrectionist has 1D4 communications or optical cybernetics to start. Typically, items like a head or finger jack, sensor hand, gyro-compass, clock calendar, radio, language translator, etc. Officers and experienced characters may have one or two cyber-disguises and/or 1D4 additional cybernetics and even a bionic limb or organ. **Note:** See the **Rifts® Bionics Sourcebook** for a range of scores of different bionics and cybernetics with equivalents in the Three Galaxies.

FWC Medic O.C.C.

Even in battles with Mega-Damage weapons, there are still wounded. It is the medics' job to first help those who can be put back into battle and second, stabilize those who are too seriously wounded to go back to battle. This battlefield medic can also fight when needed, however they are usually kept out of the battles to tend the wounded.

Attribute Requirements: I.Q. and M.E. of 10 or higher.

O.C.C. Bonuses: +15 to S.D.C., +1 to M.A., +1 to save vs Horror Factor.

O.C.C. Skills:

Speak and Read Native Language 98%

Speak one additional Language (+30%)

Basic Math (+30%)

Advanced Math (+15%)

Medical Doctor (+20%)

M.D. in Cybernetics (+10%)

Biology (+30%)

Pathology (+30%)

Chemistry (+15%)

Chemistry: Analytical (+15%)

Computer Operation (+15%)

Pilot Hovercraft (+10%)

W.P. Energy Pistol or Energy Rifle (Pick one)

W.P. Knife

Hand to Hand: Basic; can be changed to Expert at the cost of two O.C.C. Related Skills, no other type available.

O.C.C. Related Skills: Select eight skills at level one, but two must be from Technical and two must be from Science, plus two additional skills at levels 3, 6 and 9. All skills start at level one proficiency.

Communications: Radio Skills only.

Domestic: Any (+10%).

Electrical: Basic only (Unless M.D. in Cybernetics is taken, then all are available).

Espionage: Wilderness Survival only.

Mechanical: Basic only.

Medical: Any (+20%).

Military: Protocol only.

Physical: Any, except Boxing, Gymnastics, Acrobatics, and Wrestling.

Pilot: Any.

Pilot Related: Any.

Rogue: None.

Science: Any (+10%).

Technical: Any (+5%).

W.P.: Any except Heavy Energy Weapons and Heavy.

Wilderness: Identify Plants, Land Navigation, and Preserve Food only.

Secondary Skills: The Character also gets to select four Secondary Skills from the previous list. These are additional areas of knowledge that do not get the advantages of the bonus listed in the parentheses. All Secondary Skills start at the base skill level. Also, skills are limited (any, only, none) as previously indicated in the list.

Standard Equipment: A suit of medium Mega-Damage body armor, one energy weapon, surgical equipment, surgical wardrobe, Phase-Tech Med Kit and access to medical facilities.

Money: 2D6x1000 in savings and 2500 credits per month.

Cybernetics: Can have up to two basic sensory cybernetics to start.



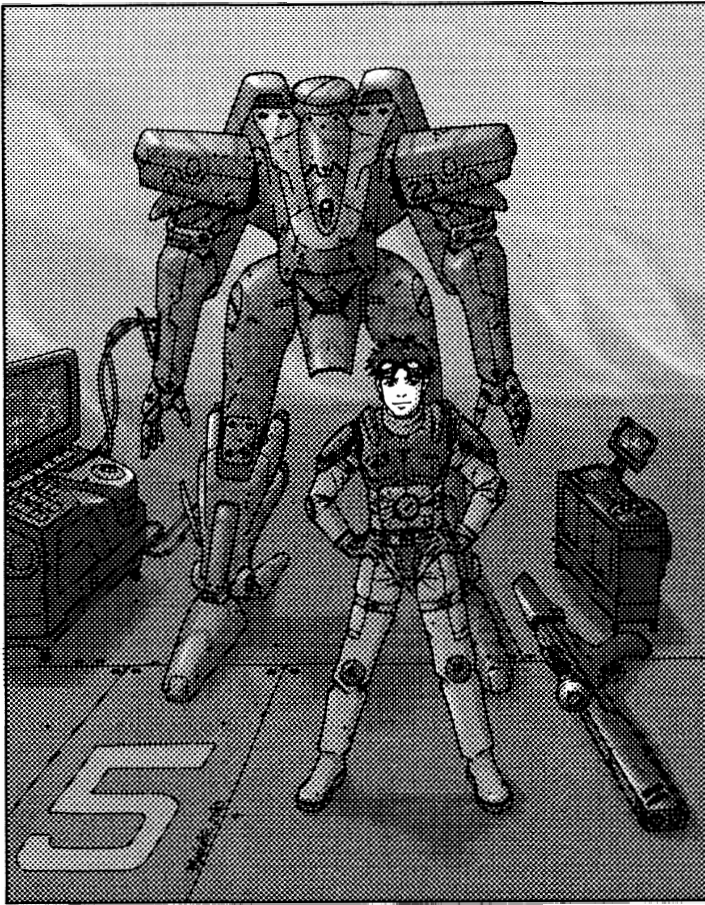

FWC Air/Space Corps

The Free World Council has long been undermanned in terms of fighter pilots. This new breed of space fighter pilot is proving to be quite a nuisance to the TGE. Equipped with the latest star fighters from *Draygon Industries*, these pilots are starting to make a great difference in combat engagements, giving new hope to those trying to toss the reins of oppression.

These pilots are currently serving multi-purpose missions. They are trained in M.D.C. power armor, conventional jet fighter aircraft and space fighters, giving them good diversity in combat situations.

Attribute Requirements: I.Q. of 10 and a P.P. of 10.

O.C.C. Bonuses: +1D4 on initiative, but only applicable when in star fighters or power armor.

O.C.C. Skills:

Speak one additional language (+15%)

Math: Basic (+30%)

Radio: Basic (+20%)

Radio: Deep Space (+10%)

Computer Operation (+15%)

Read Sensory Equipment (+10%)

Weapon Systems (+10%)

Stellar Navigation (+10%)

Pilot: Jet Aircraft (+20%)

Pilot Star/Space Fighters (+20%)

Select two Star Fighter Elites

Pilot Robots and Power Armor (+10%)

Select one Robot Combat Elite

Pilot of choice (+10%)

Running

W.P. Energy Pistol

W.P. Energy Rifle

Hand to Hand: Basic; can be changed Expert at the cost of one O.C.C. Related Skill or to Martial Arts at the cost of two.

O.C.C. Related Skills: Select six other skills. Plus select two additional skills at levels three and six, and one at levels nine and twelve. All new skills start at level one proficiency.

Communications: Any (+10%).

Domestic: Any.

Electrical: Basic only (+10%).

Espionage: Intelligence and Wilderness Survival only (+10%).

Mechanical: Aircraft, Auto, Starship Basic, and Basic Mechanics only (+5%).

Medical: First Aid only (+5%).

Military: Parachuting only (+10%).

Physical: Any.

Pilot: Any (+10%) on ground and (+20%) in Air or Space Vehicles.

Pilot Related: Any (+15%).

Rogue: Any (+5%).

Science: Any.

Technical: Any (+10%).

W.P.: Any.

Wilderness: Land Navigation only (+10%).

Secondary Skills: The character also gets to select four Secondary Skills from the previous list. These are additional areas of knowledge that do not get the advantages of the bonus listed in the parentheses. All Secondary Skills start at the base skill level. Also, skills are limited (any, only, none) as previously indicated in the list.

Standard Equipment: One vehicle is assigned depending on the unit. The recently formed Air/Space corps is using Draygon Industries Space Fighters. Combat pilots are issued a Star Hawk for scouting or reconnaissance, a Dragon's Fang for combat or a Nova Bomber for heavy combat or bombing runs. Standard issue power armor is black market knock-offs of Silver Hawks. The pilots are also issued light Mega-Damage body armor, a pilot's suit, (light Mega-Damage suit has 35 M.D.C. and is fully environmental, able to support a pilot for eight hours.), energy pistol, energy rifle, and emergency rations and supplies to last a week.

Money: 1D4x1000 in savings and 1800 per month pay.

Cybernetics: None.

United Worlds of Warlock



Obsidian Spell Thief

For many years, *Dark Covens* have sought power equal to that of any guild in the Three Galaxies. They would use any means possible to obtain what did not belong to them. Over the years, a new sort of practitioner of magic has emerged from the Dark Covens. These sorcerers are called *Spell Thieves*. Their specialty is to break into guilds in the Three Galaxies and plunder their secrets. With their high resistance to magic and the ability to unravel magic traps, they are a threat to be feared.

Attribute Requirements: I.Q. 10 and P.E. of 14 or higher.

Alignment Restrictions: Anarchist or any evil.

O.C.C. Bonuses: All of the following sensing abilities are automatic and do not require the expenditure of P.P.E.

- 1. Sense Magic Energy** This ability is similar to the Ley Line Walker, however it's not as developed; the range is only 50 feet (15.2 m) per level of experience and the Spell Thief can see magic energy only up to his line of sight.
- 2. Sense Ley Lines:** Range is one mile (1.6 km) per level of experience. Track Ley line by sense is 15% +5% per level of experience. Sense nexus: Range is 3 miles (4.8 km) per level of experience. Track the nexus by sense is 20% +5% per level of experience. Sense Rift: Range is 25 miles (40 km).
- 3. Magic Bonuses:** The Spell Thief's training is long and demanding. They have been exposed to many magicks to help them resist the traps and magic foes they will encounter in their travels. They have also consorted with all manner of beasts, including demons, in their training. This has instilled them with the following bonuses: +4 to save versus Horror Factor, +2 to save versus magic starting at level one, and +1 to save vs magic at levels 3, 6, 9, 12 and 15. Spell Strength is +1 at levels 4, 8, and 12.
- 4. Unravel & Undo Magic:** The Spell Thief sees magic in the same manner as a warrior looks at a piece of rope. If the rope becomes unraveled it is weakened. If you continue to unravel it, it will break. The Spell Thief can attempt to unravel pre-set spells, wards, circles and some minor magic items. The base ability to unravel the mystic ties that bind a spell, ward, circle, or magic item together is 20% +5% per level of experience. In order to unravel these magicks the Spell Thief must use his own P.P.E. on a point for point basis plus one in order for it to succeed. For example, a Mystic Alarm would require a successful "unravel" roll and 6 P.P.E. (Five for the Mystic Alarm spell, plus one.) A success means that the spell is no longer in place. In the case of wards, it is deactivated without going off, and as for circles, the character knows how it works and how to avoid (or use) its magic. This ability is similar to the Negate Magic spell but only counters/eliminates other spells that are part of a magic scroll, weapon, device, circle, or ward. This ability to unravel magic is like a stealth attack and will not alert the caster/creator who made the enchanted object. **Note:** Items, spells, wards, and circles that have less than 25 P.P.E. give the Spell Thief a +10% bonus to succeed. 26 to 50 P.P.E., the Spell Thief has no bonuses and must rely on their skill, and there is a -5% chance for every 25 P.P.E. beyond 50. Time, as well, may not always be on the Spell Thief's side. It takes one melee round per 10 P.P.E. to unravel. However the Spell Thief can rush (20 P.P.E. per melee round) at half his success percentage. If time is available he can do 5 P.P.E. per melee and receive a +10% bonus. A failed roll always results in the spell, ward, magic circle, or magic item being set off! Roll a saving throw!
- 5. Steal Secrets of Magic:** The Spell Thief can figure out what magicks were used in a particular enchanted object by concentrating on the item, and expending 35 P.P.E. and going into a mystic trance – 2D6+6 minutes later, he knows the answer. This enables the character to use any magic items, devices or circles and avoid wards.

A similar process can also be used to figure out how a magic item was built/created, but takes 2D6x10 minutes, costs 70 P.P.E. and has a success rate of 50% +2% per level of experience. A failed attempt means the formula or design

process remains a mystery, try again after three hours of rest.

Likewise, the Spell Thief can unravel and learn the spell invocation/formula/casting process of spells from scrolls, books describing magic, or spells in enchanted objects using a similar process as above, requiring going into a trance, again, for 2D6+6 minutes and spending 35 P.P.E. The base success rate is 66% with penalties for higher level spells as follows: Spell Levels 4-6 -12%, Levels 7-8 -20%, Levels 9-10 -26%, Levels 11-12 -32%, Levels 13-14 -40%, and Levels 15 or higher (Spells of Legend, etc.) the penalty is a whopping -60% (leaving only a 6% chance of unraveling and learning the spell). **Note:** The Spell Thief's abilities also enable the character to steal magic items, components, and artifacts, as well as non-magical valuables and money.

6. Restrictions and The Curse. Ironically, while the Spell Thief can unravel magic spells and formulas, their training process and whatever magic may be used (or deal made with demons) prevent the Spell Thief from casting any magic greater than 6th level. Furthermore, the Spell Thief forgets the invocation or formula of spells greater than 6th level, and the construction plans for magic devices, circles and wards within 72 hours, so he must teach them to his employer before the knowledge fades from his mind. Before the 72 hours elapses, however, the sorcerer can cast that magic himself but only at 3rd level power (regardless of his own level of experience). Additionally, Spell Thieves have trouble reading and writing (a mystic dyslexia) any language and can only read magic clearly when the *Decipher Magic* spell is used. Some call this a curse for betraying the magic community, but it is probably a built-in control feature, in part, woven into the training program. Without the "curse" the Spell Thief could become the most powerful practitioner of magic in the universe.

7. Initial Spell Knowledge: All Spell Thieves know *Decipher Magic*, *See the Invisible*, *Sense Magic*, *Sense Evil*, *Concealment*, *Detect Concealment*, *Armor of Ithan*, *See Wards*, *Escape*, *Eyes of Thoth*, *Teleport: Lesser*, and *Tongues*, plus select 1D6+3 from invocations from levels 1 and 2, and 1D4 from levels 3, 4, 5, and 6. Additional spells must be learned, bought, stolen, etc., but the Spell Thief can figure out, recall and cast *any* spells learned that are levels 1-6 from any and all branches of magic (not just Spell Invocations), but always at two levels of proficiency below his own. Only spell invocations, also known as Wizard Spells, are cast at whatever level the Spell Thief is at. Most Spell Thieves will know all spell invocations levels 1-4 and most from levels 5 and 6, plus a few spells from other areas of magic (i.e. Elemental spells, Necromancy spells, etc.) by third or fourth level of experience, and all or most 1-6 by fifth or sixth experience level.

8. Base P.P.E.: 1D6x10+30 plus P.E. attribute number. Gains an extra 2D6 per level of experience starting at level one. P.P.E. can also be drawn from ley lines, nexuses, and people.

O.C.C. Skills:

Speak and Read Native Language 98%

Speak the Dark Tongue 98% and read it 40%; this is the secret language of the Dark Covens. Only members are taught this secret language that consists of hand gestures, body language and spoken words as well.

Math: Basic (+20%)

Recognize Magic Items: Base skill is 35% +3% per level.

Lore: Magic (all; +20%)

Lore: Demons and Monsters (+15%)

Pick Locks (+15%)

Locate Secret Compartments/Doors (+15%)

Streetwise (+10%)

Surveillance Systems (+20%)

Prowl (+10%)

W.P.: One ancient of choice.

W.P.: One modern of choice.

Hand to Hand: Expert; can be upgraded to Hand to Hand: Assassin at the cost of two O.C.C. Related Skills.

O.C.C. Related Skills: Select six other skills. Plus select one additional skill at levels 3, 6, 9, 11, 13, and 15. All new skills start at level one proficiency.

Communications: Any (+5%; +10% on Cryptography).

Domestic: Any.

Electrical: Basic only.

Espionage: Any (+10%).

Mechanical: None.

Medical: None.

Military: None.

Physical: Any.

Pilot: Any except Robots and Power Armor.

Pilot Related: Any.

Rogue: Any (+5%).

Science: None.

Technical: Any (+5%; +10% on Lore; -25% on Literacy even as a Secondary Skill).

W.P.: Any, except Heavy Energy.

Wilderness: None.

Secondary Skills: The character also gets to select four Secondary Skills from the previous list. These are additional areas of knowledge that do not get the advantages of the bonus listed in the parentheses. All Secondary Skills start at the base skill level. Also, skills are limited (any, only, none) as previously indicated in the list.

Standard Equipment: Light, non-metal M.D.C. armor or enchanted leather or plastic armor, or personal force field; a weapon of choice for each W.P., a set of lock picks, backpack, duffel bag, six inch silver cross, silver dagger (1D6 S.D.C.), mirror, belt with pouches, pants with many pockets, and some basic items; the Spell Thief typically travels light.

Money: 1D4x10,000 credits in savings. Spell Thieves receive a commission from their Dark Coven for the magic items, formulas and spells they steal and turn over to the Coven. It depends on how rare or needed the item/spell may be. Payment is not very high because the Thief is a willing agent sworn to serve the Dark Coven.

Cybernetics: None. They would interfere with the sorcerer's magic abilities.



Space Warlock O.C.C.

The Space Warlocks are the magic users of the UWW. They lend magic support to squads of marines, help man defensive magic weapons on ships and are responsible for maintaining magic support. They are not front line fighters, but can defend themselves when needed. Several famous Space Warlocks are also responsible for the creation of space orientated spells. Space spells are not as common as the Wizard Invocations that have spanned the eons, making them difficult to acquire anywhere but the UWW. (Note: For a complete list and description of Space Spells, check out the Palladium website – and *The Rifter* #23).

Attribute Requirements: I.Q. 13, M.E. 13, and P.E. 12.

Alignment Restrictions: None.

O.C.C. Abilities:

1. Attribute Bonuses: The Magic and hormone treatments received by the Space Warlocks are nowhere as extensive as the Warlock Marines, but still provide significant bonuses to help the young magic warriors. The following bonuses are provided: +1D4 to P.E. and +1D4x5 (+2D6 to M.D.C. creatures) to physical S.D.C. There is also a P.P.E. boost, but that

is reflected in the base P.P.E. for the Space Warlocks. However, as a side effect of this procedure the mage receives a -2 to P.B. This procedure takes its toll on the body.

- 2. Combat Bonuses:** +1 to initiative (+2 when spell casting) and +4 to save versus Horror Factor. All of these bonuses are in addition to attribute and skill bonuses.
- 3. Magic Resistance Bonuses:** Similar to the marines, the Warlocks receive potions and training to build up a resistance to magical and psionic attacks. However, for the Warlock, the focus is on magic attacks. The Space Warlock receives +2 to save vs Magic at level one, and +1 at levels three, six, nine, and twelve. They are also +3 to save vs psionics and mind controlling drugs.
- 4. Magic Abilities:** The Space Warlock receives all abilities of the Ley Line Walker numbers 1 to 7.
- 5. Base P.P.E.:** Due to a mixture of potions and constant training on ley lines and nexuses for a four year period, the Space Warlocks have an incredible amount of P.P.E. Base is 3D6x10 plus 3D6 per level of experience.
- 6. Initial Spell Knowledge:** If a spell caster's not aligned to the Elements, 16 spells are chosen to start; 12 total from Level 1-4 Wizard Invocation and four Space oriented spells. If a traditional Warlock, roll the character up as usual plus one Space oriented spell at experience levels 2, 4, 6, 8, 10, 12 and 14. If an Air Warlock, one Space Spell can be selected every experience level starting with level two. (See *Rifts® Conversion Book One, Revised* of Warlock O.C.C. and the *Rifts® Book of Magic* for spell descriptions of every variety.)
- 7. Additional Spell Knowledge:** Traditional Elemental Warlocks are limited as per their O.C.C. Wizard-like spell casters can figure out (select) two spells equal to their level of experience each level. If still in the UWW Military, they can learn an additional two spells from any experience level up to a 12th level spell. This is at the G.M.'s discretion as spells are given as rewards for service and acts of bravery above and beyond the call of duty.

O.C.C. Skills:

Language and Literacy: Trade One 98%

Language and Literacy One of choice (+20%)

Demon and Monster Lore (+15%)

Galactic Lore (+15%)

Magic Lore (+20%)

Science: One of choice (+20%)

Math: Basic (+20%)

Wilderness Survival (+10%)

W.P. Staff

W.P. Energy Pistol

Hand to Hand: Basic

Due to the spell caster's intense training regimen, they are only trained in the basics of hand to hand combat. Their focus is on magic support in the field.

O.C.C. Related Skills: Select six other skills. Plus select two additional skills at level three, two at level seven, and one at levels eleven and fifteen.

Communications: Any (+5% on Radio skills).

Domestic: Any.
 Electrical: Basic only.
 Espionage: Intelligence only (+10%).
 Mechanical: Basic only.
 Medical: Any however M.D. skills count as two selections. (+10%).
 Military: Military Etiquette only.
 Physical: Any, except Boxing, Acrobatics, Gymnastics, and Wrestling.
 Pilot: Any, except Robots and Power Armor.
 Pilot Related: Any (+5%).
 Rogue: Any.
 Science: Any (+10%).
 Technical: Any (+10%).
 W.P.: Any except Heavy and Heavy Energy Weapons.
 Wilderness: Land Navigation, ID Plants and Fruits and Preserve Food only.

Secondary Skills: Select four Secondary Skills from the previous list. These are additional areas of knowledge that do not get the advantages of the bonuses listed in parentheses. All Secondary Skills start at the base skill level. Also, skills are limited (any, only, none) as previously indicated in the list.

Standard Equipment: Light magic armor or enchanted robes. One weapon of choice for each W.P. Additional equipment depends on their assignment.

Money: 1D6x1000 credits in savings. Standard salary is 4000 credits per month.

Cybernetics: None. They would interfere with the Space Warlock's magic abilities.

Techno-Smithy O.C.C.

The Techno-Smithies are the engineers of the Warlock Navy. They are the men and women who keep the magic contained in the massive P.P.E. generators, and help to recharge them in times of battle. They keep the weapon systems operational, provide powerful magic talismans to aid troops in battle and can repair damaged Rift jump drives. The Techno-Smithies are specialists in their trade in the Three Galaxies and are eagerly sought after when their term of service has expired.

Smithies go through extensive training and spend several years in the Warlock College on Mage Star. It's the equivalent of a military academy and when the young recruits graduate they are low grade officers in the Warlock Navy. After their term in the military, many join society to become civil engineers, alchemists, and adventurers.

Attribute Requirements: I.Q. 13, M.E. 12.

Alignment Restrictions: None.

O.C.C. Abilities:

1. Techno-Smithy Focus. The Techno-Smithy can pick one of the following as their focus. As the Smithy is far more focused on the creation of magic items, they suffer when it comes to spell casting. Any spells they cast are at one half the duration, damage and range listed.

- **Talisman Creation:** The Techno-Smithy has the ability to make minor talismans. This is as per the Talisman spell, however they are not limited to those in the spell. Spells from 6th level and below can be made into magic talismans that have one activation only. The Smithy is also not limited to just talismans, they can be rings, amulets, medallions, bracers, and just about any small item worn like jewelry. The creation process is a ritual that takes two hours per level of the spell. At the end of the ritual the Smithy rolls percentiles to determine their success. Base Skill: 20% +4% per level of experience. Talismans created in this fashion can be used once, and then they are burned out. The Smithy can also try to enhance their talismans with the following penalties: Talisman can be used two times, -5% on creation roll. Talisman can be used three times, -20% on creation roll. Talisman is reusable after 24 hours, in other words, it recharges, a penalty of -30% is applied to the creation roll. The penalties are accumulative should the Techno-Smithy try to combine two or more of the enhancements.

- **Forge Magic Weapons and Armor:** The Smithy has the ability to forge superior and magic melee weapons (axes, swords, maces, etc.). Standard weapons and armor are of superior quality and always have a keen blade or are very durable. Magic weapons can be forged and imbued with magic abilities in a similar fashion to talismans. This is used in conjunction with the spell *Enchant Weapon (Minor)*. The mage can put a maximum of three spell-like abilities within the weapon they create. The ability can be used a maximum of three times per day. Base Skill: 15% +4% per level of experi-

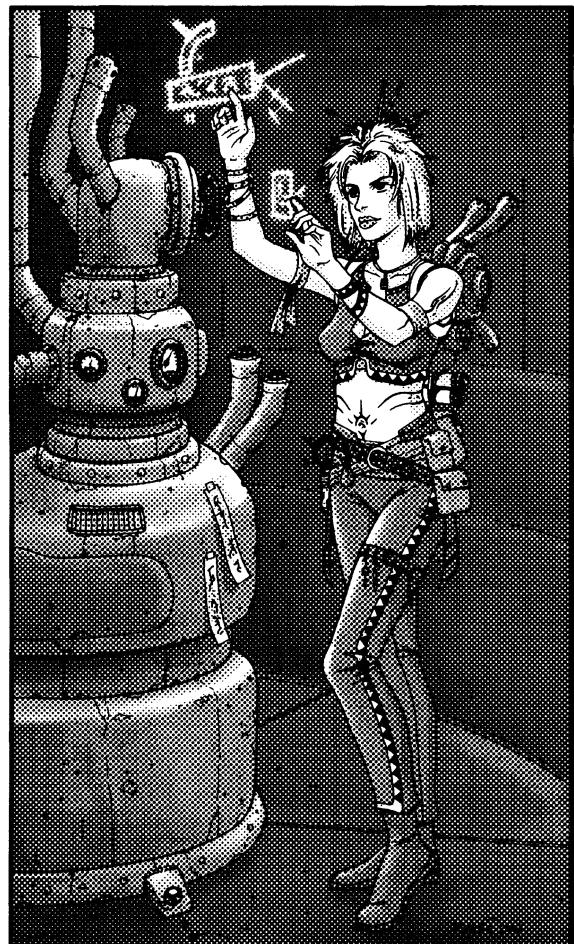

ence. In addition to the Enchant Weapon (Minor) ritual, the mage must perform a ritual for each spell-like ability they put into the weapon. The ritual takes two hours per level of the spell, with eighth level spells being the highest level spells that can be put into the weapon. Roll for each ritual performed, with a failure meaning the weapon is destroyed and the time wasted.

- **Techno-Wizard Abilities:** The Techno-Smithy is trained in how to maintain and repair the various Techno-Wizard items used by the UWW. This ranges from their starships to Warlock Marine Power Armor. The Techno-Smithy is far more proficient with *repairing* these items than creating them. **Base Skill:** 20/10% +4% per level of experience. The first percentage is to repair Techno-Wizard items, and the second is to create them.

2. Recharge P.P.E. Batteries: The Techno-Smithy is also trained in the ritual that enable them to recharge P.P.E. batteries. The ritual takes 1D4 hours. If more than one Smithy is involved in the ritual, the time can be cut in half. If the ritual is performed on a ley line or nexus it only costs half the P.P.E. The Techno-Smithies are primarily involved in recharging the various P.P.E. batteries on Techno-Wizard starships as well as personal P.P.E. batteries and P.P.E. clips for magic energy weapons.

3. Initial Spell Knowledge is as per the Smithy's Focus.

- At level one the following spells are known for the *Talisman Focus*: See Aura, See the Invisible, Sense Magic, Amulet, and Talisman plus six spells of choice from levels one through four.

- At level one the following spells are known for the *Forge Magic Weapons and Armor Focus*: Blinding Flash, Sense Evil, Turn Dead, Impervious to Fire, Impervious to Energy, Enchant Weapon (Minor), and four spells of choice from levels one through four.

- At level one the following spells are known for the *Techno-Wizard Focus*: Blinding Flash, Globe of Daylight, Ignite Fire, Fuel Flame, Impervious to Energy, and Telekinesis, plus four spells of choice from levels one through four.

4. Additional Spell Knowledge: Since the Techno-Smithies' focus is not on spell magic they are not able to figure out new spells at each additional level of experience. Instead they have to bargain and trade for additional spell knowledge. The UWW will grant spells for special projects and as rewards for services, as a result, it can be assumed the character learns 1D4+1 new spells selected from spell levels 1-4 with each new level of experience or two from levels 5 or 6.

5. Base P.P.E.: 2D4x10 in addition to the P.E. attribute number and 2D6 per level of experience, starting with level one.

6. Magic Bonuses: The Techno-Smithy is +1 to save vs Magic and Horror Factor at level one, +1 at levels 3, 7, 10 and 14.

O.C.C. Skills:

- Speak and Read Native Language 98%
- Speak and Read Trade One (+25%)
- Electrical Engineer (+10%)
- Mechanical Engineer (+10%)
- One Mechanical skill or Science skill of choice (+10%)
- Armorer (+10%)
- Read Sensory Equipment (+10%)

Chemistry (+10%)

Chemistry: Analytical (+10%)

Metallurgy (+15%)

Computer Operation (+10%)

Gemology (+10%)

W.P. Energy Pistol

Hand to Hand: Basic; cannot be changed. The Techno-Smithy is not meant to be a front-line trooper and is only taught the basics to defend themselves.

O.C.C. Related Skills: Select five other skills. Plus select two additional skills at level three, two at level six, one at level nine and one at level twelve. All new skills start at level one proficiency.

Communications: Any (+5%).

Domestic: Any.

Electrical: Any (+10%).

Espionage: None.

Mechanical: Any (+10%).

Medical: None.

Military: Any except Parachuting (+5%).

Physical: Any except Boxing, Wrestling, Acrobatics, or Gymnastics.

Pilot: Any except Robots and Power Armor.

Pilot Related: Any (+5%).

Rogue: Only Computer Hacking or Safe Cracking (+5%).

Science: Any (+10%).

Technical: Any (+5%).

W.P.: Any except Heavy and Heavy Energy.

Wilderness: Only Boat Building, Land Navigation, and Trap Construction (+5%).

Secondary Skills: The character also gets to select four Secondary Skills from the previous list. These are additional areas of knowledge that do not get the advantages of the bonus listed in the parentheses. All Secondary Skills start at the base skill level. Also, skills are limited (any, only, none) as previously indicated in the list.

Standard Equipment: Tools and equipment necessary for their focus and light Techno-Wizard body armor. Additional equipment depends on their assignment.

Money: 1D6x1000 credits in savings. Standard salary is 5,500 credits per month.

Cybernetics: None, because they interfere with the Techno-Smithy's magic abilities.

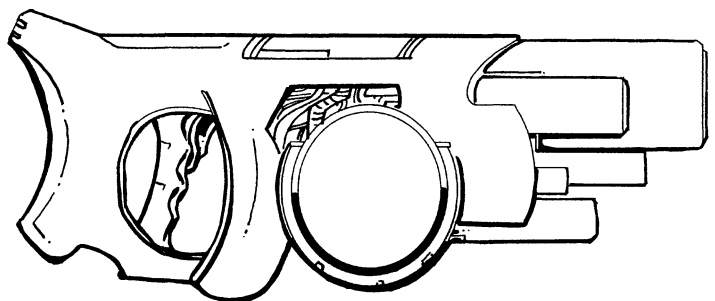

Racial Character Classes



Necrol R.C.C.s

Stellar date: 543546.23

"We have just entered the D-Zone of star system beta 452871. Preliminary data is coming in now . . . Red dwarf star, with five planets, no other significant finds at this time."

Stellar date: 543546.99

"Long-range scanners have picked up a vessel on an approach vector. They are currently not responding to our hails. As a precaution, shields have been raised. We will continue universal greetings in all linguistic codes."

Supplemental: "The alien vessel has come into visual range. Sensors indicate that the ship is organic in nature! I have called to the bridge officer Corgi Tars, our resident Noro psychic. Our hope is that he will be able to communicate with the vessel via telepathy or empathy."

"We have definitely received a response of some sort. The vessel has changed color from a dark reddish brown to a translucent red. Some type of organic pseudo-pod is forming on the bow of the ship. Officer Tars is screaming incoherently . . . (static) . . . shields down to 60% . . . attacked without provoca-

tion. Powering main batteries . . . (static and an explosion in background) . . . we've returned fire . . . no apparent effect. Shields are down to 35% . . . hull breaches on decks 4, 5, 6 and . . . Firing all batteries . . . (static) . . . all crew abandon ship, repeat . . . (static) . . . ship . . . (static) . . . launch log buoy . . ."

END RECORDING.

– From the log of the CAF ship C.S.S. Star Lynx

The Necrols are the latest threat in the Three Galaxies. They are a biped species that resemble emaciated zombies. They have no skin as humans do, rather they look like a human body minus the skin. What passes for flesh looks like crimson colored muscles attached to charred, black bones. They have no body hair to speak of and they commonly wear living symbiotes to augment themselves.

Alignment: 70% are evil (Diabolic and Miscreant), 15% Anarchist (leaning towards evil). The remaining 15% are rogues or anomalies that are ostracized from their society. Their alignments are typically Aberrant evil (60%), Unprincipled (35%) or Scrupulous (5%).

Attributes: I.Q. 3D6, M.E. 3D6, M.A. 2D6, P.S. 4D6, P.P. 4D6, P.E. 5D6, P.B. 1D6+1, Spd. 4D6

Size: 7-8 feet (2.1 to 2.4 m) tall.

Weight: 300 to 400 pounds (135 to 180 kg).

M.D.C.: P.E. number x2, +2D6 per level of experience starting at level one. M.D.C. becomes S.D.C. and Hit Points in environments where magic energy is low (no or few ley lines, etc.).

S.D.C./Hit Points: In non-P.P.E. rich environments their S.D.C. is equal to 3D6x10 and their Hit Points are their P.E.x2, +1D6 per level.

Horror Factor: 12 for a single Necrol and 15 for a group of three or more.

P.P.E.: 2D6x10, with 2D4 per level of experience.

Average Life Span: 60 to 80 years.

Natural Abilities: Nightvision 1,000 feet (305 m), supernatural strength and endurance, bio-regenerate 1D6 M.D.C. per minute and bond with symbiotes. This special bond allows the Necrol to communicate with their symbiotes. This communication allows them to first bond with a particular symbiote and once that bond is established, they can remove it at will. This is useful in that the Necrols are never without allies.

Psionic Powers: Telepathy and Empathy to communicate with symbiotes at no I.S.P. cost, and have a unique ability to Sense Machines (Range: 10 feet/3 m and can be performed once per melee round).

Magic Powers: None. Only the Necrol Witch has magic abilities.

Combat: +1 physical attack at levels 2, 6, 12, and 15.

Bonuses (does not include attribute or skill bonuses): +2 on initiative, +2 to strike, parry and dodge. +3 to save versus magic and Horror Factor.

Vulnerabilities/Penalties: Techno-phobic to the nth degree! That's right, the Necrols fear technology, specifically machines. To them technology and machines are simply evil and impure. Cybernetics are an absolute abomination. The

Necrols see it as a divergence from the natural path. Thus, they see organizations like the CCW, the TGE and even the UWW as contaminated, unclean, and obscene – warped people to be destroyed. Since Necrols oppose all technologic races, and are both revolted by and fearful of technology, they see even simple modern conveniences such as elevators, escalators, electronic monitors, personal scanners, washers and driers, etc., with a Horror/Revulsion Factor of 10. Spacecraft, robots, cybernetic implants and all vehicles (including giant robots) are seen with a Horror Factor of 14, while *power armor* and *full conversion cyborgs* are seen as a Horror Factor of 17! If a Necrol fails his Horror Factor, the normal penalties apply, plus his combat bonuses are half for one melee round after recovering his senses. If the save is successful, the Necrol usually attacks the object of their revulsion.

O.C.C.s: The Necrols have only three occupations, Warrior, Witch (effectively their priest), and Worker, all described in these pages.

Alliances and Allies: Currently, none in the Three Galaxies. The Necrols have yet to find a race as pure as their own, and therefore worthy of being allies.

Enemies: Just about everyone!

Necrol Warrior O.C.C.

The Necrol Warriors make up the bulk of the Necrol forces (50%). They are versatile fighters able to take on many roles, but are not as specialized in varied military occupations, like pilots, commandos, or medics. As they try and spread their influence throughout the Three Galaxies they shall learn the value of specialized warriors and may begin to differentiate their own troops (or not). Until then the Necrol Warriors serve multiple roles within their ranks.

Attribute Requirements: P.S. and P.E. of 11 and a P.P. of 11 or higher.

Alignment Restrictions: None.

O.C.C. Bonuses: 6D6+14 M.D.C., +1 on initiative, +2 to disarm, and +1 to roll with punch/fall.

O.C.C. Skills:

Speak and read their native language at 90%.

Basic Math (+35%)

Radio: Basic (the organic variety; +10%)

Detect Ambush (+10%)

Intelligence (+15%)

Pilot: One of choice, within the scope of their limits: Typically their own organic/symbiotic power armor or organic ships (+10%).

Wilderness Survival (+20%)

Running

Swimming

Boxing or Wrestling

W.P. Paired Weapons

W.P. Blunt or W.P. Ball and Chain

W.P. Staff or W.P. Spear

W.P. Energy Rifle (the Necrol organic equivalent)

Hand to Hand: Expert; can be changed to Assassin at the cost of one O.C.C. Related Skill. Martial Arts or Commando is not available.

O.C.C. Related Skills: Select seven other skills. Plus select two additional skills at levels 4, 8, 12 and 15. All new skills start at level one proficiency.

Communications: Cryptography and Radio only (+5%).

Domestic: Any.

Electrical: None.

Espionage: Any (+10%).

Mechanical: None.

Medical: First Aid or Holistic Medicine (+5%) only.

Military: Any (+10%).

Physical: Any.

Pilot: Limited to their own organic technology.

Pilot Related: Any.

Rogue: None.

Science: Biology, Botany and Chemistry (any), only (+10%).

Technical: Any, except skills that require technology and machines, like Computer Operation.

W.P.: Any, but lean toward ancient melee weapons, especially Blunt, Staves and Ball and Chain.

Wilderness: Any (+10%).

Secondary Skills: The character also gets to select four Secondary Skills from the previous list. These are additional areas of knowledge that do not get the advantages of the bonus listed in the parentheses. All Secondary Skills start at the base skill level. Also, skills are limited (any, only, none) as previously indicated in the list.

Standard Equipment: Typically uses the *Sha'Wrek* body armor and *Scorpa* or *Vasher* energy weapons. They also have access to any of the other Necron organic equipment or basic melee weapons, favoring throwing sticks, staves, spears, blunt weapons, and ball and chain weapons.

Money: The Necrol Warriors do not fight for money. They fight for their Emperor and the purity of their race and lifestyle (i.e., no machines or technology).

Cybernetics: Would rather die.

Necrol Witch

The Necrol Witch is like a warrior shaman who provides for the morale of the troops. The majority of Necrol squads are led by a Necrol Witch, and most warriors constantly seek the favor of their Shaman to gain his blessings. This influence has led many troops to fight to the bitter end and take foolish risks for their spiritual leaders. The Necrol leaders know this and even encourage it. 12% of the Necrol forces are Witches.

Attribute Requirements: None, just a willingness to serve the Emperor, pledge themselves to an evil demonic being, and fight for the purity of their race and culture.

Alignment Restrictions: 70% Diabolic, 25% Miscreant, 5% Anarchist, and all are fanatical anti-technology zealots willing to die in the war to eradicate machines and the races who use them.

O.C.C. Bonuses: All Necrol Witches must agree to a major pact. The familiar is replaced by a special symbiote that helps to enhance (or so the Necrols believe) the connection to mystic power. This symbiote can be placed anywhere on the Witch, but it's commonly found on the shoulder, neck or wrist. The symbiote is called a *Va'shek*. Once per melee the *Va'shek* can fire a burst of energy that does 1D6x10 M.D. Range is 500 feet (152 m) plus 100 feet (30 m) per level of the Witch's experience, and the blast is +3 to strike in addition to any P.P. bonuses. Counts as an extra melee attack. The symbiote also adds 1D6+2 to the Witch's P.S., P.E. and Spd attributes. The character is also +3 to save vs possession, +5 to save vs Horror Factor, and gets +4D6 to M.D.C.

O.C.C. Skills:

Speak and read their native language at 98%.

Speaks one additional language (+20%).

Basic Math (+35%)

Magic Lore (+10%)

Medical Doctor (+10%)

Pathology (+10%)

Biology (+10%)

One Physical skill of choice (+10% were applicable)

One Science skill of choice (+10%)

W.P. Staff

Hand to Hand: Basic; can be change to Expert at the cost of one O.C.C. Related Skill or Assassin at the cost of two.

O.C.C. Related Skills: Select eight other skills. Plus select one additional skill at levels 2, 4, 7, 9, 12, and 15. All new skills start at level one proficiency.

Communications: None.

Domestic: Any (+10%).

Electrical: None.

Espionage: Any (+10%).

Mechanical: None.

Medical: Any (+10%).

Military: Strategy and Tactics only (+10%).

Physical: Any, but each counts as two skill selections.

Pilot: None.

Pilot Related: None.

Rogue: Palming, Concealment, Prowl and Seduction only (+5%).

Science: Any (+10%).

Technical: Any, except those that require technology (+10%).

W.P.: Any, except modern weapons.

Wilderness: Identify Plants and Fruit (+10%), Preserve Food (+15%) and Land Navigation (+10%) only.

Secondary Skills: The character also gets to select four Secondary Skills from the previous list. These are additional areas of knowledge that do not get the advantages of the bonus listed in the parentheses. All Secondary Skills start at the base skill level. Also, skills are limited (any, only, none) as previously indicated in the list.

Standard Equipment: Typically uses *Sha'Wrek* body armor, *Lykra Pike*, a knife whose blade is made of black stone or an-



imal bone (1D4 S.D.C.), belt and purse, backpack, water skin, and other basic gear, as well as access to any of the other Necrol organic weapons and equipment. They will also consider using magic items found or acquired through combat, provided they are not high-tech or machine-like (i.e. no TW armor, guns or devices).

Magic: The union to an evil supernatural power gives them magic abilities. 50% possess Wizard Spell Invocations (select a total of 1D4+4 each from spell levels 1-4, 1D4 spells each from levels 5-6 and two from levels 7-10), 30% also know

some Space Magic (select a total of 1D6+7), 28% know Elemental magic (select a total of 16 spells from ONE Elemental Spell category) and 2% know some other magic, usually nature related like Ocean or Bone (select a total of 13 spells from that category of magic).

Money: The Necrol Witches do not fight for money. They fight for their Emperor and the purity of their race and lifestyle (i.e., no machines or technology). However, they possess valuable herbs, artifacts and magic items.

Cybernetics: Would die first.

Necrol Worker O.C.C.

The Necrol Workers make up 38% of their forces and can work without showing signs of fatigue for 14 hours at a stretch; needs only 4-5 hours of sleep to function at full capacity. They are versatile and selfless workers willing to do anything for the cause.

Attribute Requirements: None, those with a high P.S. and P.E. are common to this species of Necrol (+1D6+1 to both attributes), and are also bulkier than other Necrols.

Alignment Restrictions: None.

O.C.C. Bonuses: +4D6+10 M.D.C. and +1 to roll with punch/fall.

O.C.C. Skills:

Speak and read their native language at 80%.

Basic Math (+10%)

Radio: Basic (the organic variety; +5%)

Brewing (+15%)

Cooking (+20%)

Carpentry (+20%)

General Repair and Maintenance (+10%)

Masonry (+15%)

Mining (+10%)

Salvage (+20%)

Intelligence (+10%)

Body Building

Climbing (+10%)

Running

Swimming (+10%)

W.P. Blunt

Hand to Hand: Basic; cannot be changed.

O.C.C. Related Skills: Select seven other skills. Plus select one additional skill at levels 2, 4, 8, 12 and 15. All new skills start at level one proficiency.

Communications: Cryptography and Radio skills only (+5%).

Domestic: Any (+10%).

Electrical: None.

Espionage: None.

Mechanical: None.

Medical: First Aid only.

Military: Any (+10%).

Physical: Any.

Pilot: Limited to their own organic technology.

Pilot Related: Any.

Rogue: None.

Science: Biology, Botany and Chemistry (any), only (+10%).

Technical: Any, except skills that require technology and machines.

W.P.: None.

Wilderness: Any (+5%).

Secondary Skills: The character also gets to select four Secondary Skills from the previous list. These are additional areas

of knowledge that do not get the advantages of the bonus listed in the parentheses. All Secondary Skills start at the base skill level. Also, skills are limited (any, only, none) as previously indicated in the list.

Standard Equipment: Typically uses the *Sha'Wrek* body armor and *Scorpa* or *Vasher* energy weapons. They also have access to any of the other Necrol organic equipment or basic melee weapons, favoring throwing sticks, staves, spears, blunt weapons, and ball and chain weapons.

Money: The Necrol Warriors do not fight for money. They fight for their Emperor and the purity of their race and lifestyle (i.e., no machines or technology).

Cybernetics: Would rather die.

Other Races

Nixie R.C.C.

The Nixie (pronounced Nix-eye) are a relatively young race. Having only developed FTL technology in the last 50 years, they are just beginning to be recognized in the intergalactic community, especially at the trade ports of the Three Galaxies, and the Center on Phase World.

So far they are making a name for themselves in the trade and transport business. In the first ten years of their journey into space the Nixie made contact with several races and were able to upgrade their ships to modern graviton drives. The Nixie are not very proficient with engineering principles, but clever in the construction of their spacecraft. Instead of building a ship from scratch, they use the carapace of a giant Mega-Damage insects on their planet. Drop a graviton or phase drive in it, add a few mechanical air locks and you're ready to fly. The carapace used varies, with the majority being beetle like, and the rest more conventional looking, though they tend to have a flying insect's design to them.

The Nixie themselves are an arachnoid race walking on all fours . . . er, all eights. They have eight legs, you see, like a true spider, though the front two function like arms and hands with opposable thumbs right by their fangs/mouth area. Their color varies from shades of iridescent blue to black, and sometimes purple. They come from a planet in the outer rim of the Corkscrew Galaxy. The Nixie have not yet decided if they will join the Consortium of Civilized Worlds, but they are exploring the possibilities. Currently, they remain neutral, unaligned to any of the powers in the Three Galaxies. Their borders are open to all.

The Nixie are a matriarchal society. The females form a parliament, called the Matriarchy, where they decide all major issues for their race. It was they who ultimately approved and funded the creation of spacecraft and the exploration of space. They are also the diplomats and ambassadors of their race.

Alignment: Any, but typically Anarchist (35%) or Unprincipled (40%).

Attributes: I.Q. 2D6+4, M.E. 2D6+6, M.A. 1D6+1, P.S. 4D6+2 (6D6+4), P.P. 4D6+2, P.E. 3D6 (4D6), P.B. 1D4 (1D4+2), Spd. 6D6+2 (4D6+3) – numbers in the parenthesis are female stats).

Size: Male: Three to four feet (0.9 to 1.2 m) tall walking on eight legs, and 4-5 feet (1.2 to 1.5 m) long. Female: The females are much larger, measuring 6-7 feet (1.8 to 2.1 m) tall and 6-9 feet (1.8 to 2.7 m) long.

Weight: Males range from 100 to 150 pounds (45 to 67.5 kg), while females weigh about 200 to 300 pounds (90 to 135 kg).

M.D.C.: Males: 4D6+4. Females: 6D6+6. Both get an extra 1D6 M.D.C. per level of experience starting at level one.

Horror Factor: 16. **P.P.E.:** 2D6.

Average Life Span: 30 to 60 years for the males, but 100 to 150 for the females.

Natural Abilities: Natural adhesion, can stick to almost any surface. They have spinnerets that are able to spin a very tough web. Test weight is about five hundred pounds. They have exceptional vision and are able to see in a 360 degree arc. The Nixie can see in the infrared and ultraviolet spectrums with two pairs of eyes, while the rest see in the normal spectrum. The Nixie also secrete an S.D.C. venom that paralyzes their victim for 2D6 melee rounds (roll to save verses non-lethal poisons or toxins).

Psionic Powers: None, not in their genetic code.

Magic Powers: None, they are not able to articulate the difficult incantations.

Combat: In addition to any combat abilities they gain from skills, they get one additional attack and the males are so agile that they have an automatic dodge. Only males get the auto dodge.

Bonuses (does not include attribute or skill bonuses): +2 to save vs Horror Factor, psionics, and magic.

Vulnerabilities/Penalties: Fire and cold based attacks do double damage. This also applies to their web. The Nixie's spider-like vision and physiology makes it difficult for them to use most human weapons and equipment; Nixie are -2 to strike and parry using human melee weapon and guns. One might also consider they need to eat *live* food a penalty. Like most spiders, Nixie wrap their food in a silk cocoon and drain the animal of fluid. No, they do *not* prey on humanoids, the Nixie are a civilized race, but they could. The arachnoids typically eat rodents from their home world or any small mammal (rats, mice, guinea pigs, ground hogs, cats, dogs, etc.). Most humanoids find their method of eating and their food disturbing and repulsive. In addition to their eating habits, the Nixie have poor hearing. Their sound receptors are located on the legs, so if humanoids allow it, they will actually put a leg or two up on the shoulders of the human they are talking to in order to hear everything clearly. Their language is also impossible to master as the Nixie communicate amongst each other using a series of high frequency sounds and clicks. Nixie are also at a disadvantage, as they can't make the sounds necessary for humanoid tongues. As a result, they typically wear language translators programmed for the various trade tongues. Lastly, it is rumored that the females kill the males after mating.

O.C.C.s: No O.C.C.s with magic or psionics. They are typically Merchants, Scholars, Spacers, Runners, and Pirates.

Alliances and Allies: They consider all whom they trade with as allies. Why make enemies when there is a profit to be made?

Enemies: None per se. They haven't been around long enough to make any.

Cybernetics: Avoid them but think they are interesting.

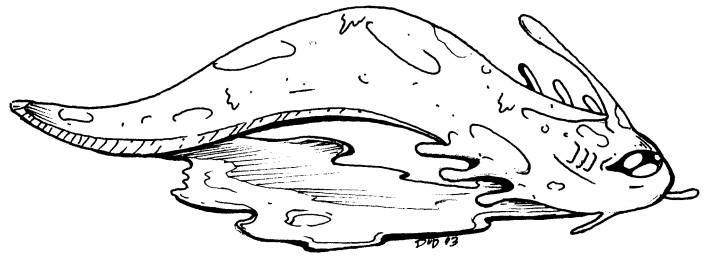

Paratee R.C.C.

The Paratee is an intelligent, slug-like symbiotic organism indigenous to the Quintos system. They seek peaceful coexistence with other races and have been an ally of the people who colonized the Quintos system. They offer a unique opportunity for anyone able to pass a rigorous mental and psychological test to become a host of the Paratee. Prior to contact the Paratee would attach themselves onto the person's back. Today, with modern science, they are placed under the skin in the back. All that is visible is their sensor pod that sticks out just below the base of the neck. Once joined, the host is flooded with a wealth of knowledge and memories. For the first month they are disoriented and weak. All skills are at -15% and all combat bonuses are at half. Once this period of adjustment is over, the host is completely normal except for the small pseudopod sticking out of their back. The host still retains their own personality, skills and self-control. The Paratee is essentially just along for the ride, drinking in memories and experiences. The Paratee retains all of its host's memories and saves them for posterity. Skill abilities are not retained, just the general memories of them in action.

Alignment: Predominantly good and selfish, but can be any.

Attributes: I.Q. 3D6, M.E. 3D6+2, M.A. 1D6, P.S. 1D4, P.P. 2D6, P.E. 2D6+6, P.B. 1D4, Spd. 3D6

Size: One foot (0.3 m) long.

Weight: 4 to 7 pounds (1.8 to 3.2 kg).

M.D.C.: Not applicable.

S.D.C.: 1D4x10+10

Hit Points: P.E. attribute plus 1D4 per level of experience.

Horror Factor: 13 when seen for the first time, either with or without a host.

P.P.E.: 2D6. **I.S.P.:** M.E. attribute number x3, plus 2D6 per level of experience.

Average Life Span: 600 to 700 years.

Natural Abilities: Outside a host they can Swim at 98%, Underwater Navigation at 88%, Prowl at 75%, see underwater at no penalty and have psionic abilities.

When bonded to a humanoid host the following bonuses apply: +1D4 to I.Q., +1D4 to M.E. and M.A., +6D6+4 S.D.C., +1 to all saving throws, +4 to save vs possession, and are impervious to mind control via psionic or magic attack. Also because the Paratee generally lives longer than its host,

the creature has a lifetime of memories to share. These experiences are amusing, anecdotal and can help the host learn from the mistakes of others in the past. Not in a tutorial, here, learn a skill, way, but in a story, lifestyle kind of way. This is reflected in the following ways: The humanoid needs 10% less experience points to go up a level, add a one time +10% bonus to 1D4+1 skills that both the current and the previous host may have both known, and +10% to Lore, History and Law skills. The character also tends to be more tolerant and compassionate toward others because of the experiences of previous hosts shared by the Paratee.

Psionic Powers: The Paratee has Mind Block, Levitation, Telepathy, Empathy and Empathic Transmission. These abilities are not passed on to the host, but are the Paratee's means of communication with the host, and self-defense when not attached to a host.

Magic Powers: None, unless the host is a magic user then a one-time bonus of +2D6 P.P.E. is added to the mage's base P.P.E. This comes from the Paratee's own base P.P.E.

Combat & Bonuses: Outside of a host, a Paratee has three actions per melee and is +1 on initiative, +3 to dodge, +2 to roll with impact/fall, +5 to save vs possession and +3 to save vs Horror Factor. These abilities do *not* get passed on to the host.

Damage: None the Paratee's only means of defense is via Empathic Transmission or a creative use of Levitation.

Vulnerabilities/Penalties: The Paratee needs to be attached to a living host or in a wet environment. If they are taken out of the water (or their host) they dry out in 1D4+2 hours and die. They can only bond with mortal, S.D.C., mammalian races. Races with natural bio-regeneration quickly expel the peace-loving, symbiotic slug, killing it in the process.

O.C.C.s: None for the Paratee.

Alliances and Allies: They are well received in the CCW and get along with most races. Favored races are humans, other human-like beings, Atlanteans, Noro, Wulfen, Elves, and Dwarves.

Enemies: None, per se.

Weapons and Equipment: None for itself; whatever the host favors.

Appearance: A foot (0.3 m) long slug-like creature with a single black eye.

The Skaa R.C.C.

The Skaa are a Serpentine race that resides in the Veripin system. The lower body is a serpent and the upper body is a powerfully built humanoid. They have a snake-like face, with a snout, a forked tongue and little eyes. Their hair appears as fleshy dreadlocks, which get longer after each molting. They range in color from a golden yellow and green to a crimson red and a copperish brown. The Skaa that live in the southern hemisphere of their planet range in color from a charcoal black to gray or deep, cool green. They have three fingers and an opposable thumb on each hand.

Their planet (Vespin) is located in Kreeghor space. The Skaa had managed to achieve pre-FTL technology and were on the

verge of breaking the light barrier when the Kreeghor arrived. The Skaa had assembled a small fleet of sub-light spacecraft to try and repel the invaders, but the Kreeghor proved too powerful. A single Doombringer dreadnaught had defeated the Skaa fleet in less than three hours.

The Skaa, having been impressed with the power a single ship held, reasoned that their race would become extinct if they tried to fight this invader any further. Before the Kreeghor made planet-fall, the Skaa sent a message to them: "We yield to the power before us. Spare us so that we may serve your Empire and bring it glory. Hear what we have to offer." This surprised the Kreeghor commander, who put the invasion force on stand-by and sent his first officer down to the planet to hear this race's pleas. In exchange for more advanced technology, the Skaa would volunteer millions to serve in the Kreeghor's armed forces, plus the Kreeghor could establish a base on the planet and shipyards in orbit. The Kreeghor agreed with the stipulation that a percentage of the Skaa joining the military would undergo experimentation to see if they were suitable to become the elite Invincible Guardsmen. The Skaa agreed.

This happened three hundred years ago. To this day the Skaa have proven very useful to the Kreeghor. They make excellent Invincible Guardsmen, and the shipyards in the Veripin System are the most efficient in the empire.

Alignment: Any, but the majority are selfish with the warrior caste being honorable: Principled or Aberrant.

Attributes: I.Q. 3D6, M.E. 2D6, M.A. 3D6, P.S. 5D6, P.P. 5D6, P.E. 3D6+3, P.B. 2D6, Spd. 4D6

Size: From the tip of the nose to the end of the tail, the average Skaa is 15 to 18 feet (4.6 to 5.5 m) long. However, a third of the length is used to support themselves when standing upright so they can be 10 to 12 feet (3 to 3.7 m) tall.

Weight: 400 to 1000 pounds (180 to 450 kg).

M.D.C.: By armor only unless an Invincible Guardsman (for them S.D.C. and H.P. are added to become M.D.C.).

S.D.C./Hit Points: Base S.D.C. is 1D4x100 and Hit Points are P.E. x2 +2D6 per level.

Horror Factor: 14

P.P.E.: 5D6

Average Life Span: 400 years with modern medical technology, 150 years normally.

Natural Abilities: Venomous bite does 4D6 S.D.C./H.P. per melee for 1D6 rounds. They are very resistant to poison and are +5 to save in addition to their P.E. bonus. Track by smell at 36% +4% per additional level of experience. Recognize specific scent at 40% +5% per additional level of experience. Nightvision 1000 feet (305 m), Infrared and thermal sight with a range of 500 feet (152.4 m).

Experience Level: The average NPC is 1D4+1; officers and the elite average 1D4+4.

Psionic: None. It is not in their genetic code and they are not capable of becoming any type of psionic O.C.C.

Magic: None before the Kreeghor came, but some have taken an interest in it.

Hand to Hand Combat: Depends on O.C.C., Expert or Martial Arts. If from the warrior caste then they will have a minimum of Hand to Hand: Expert and +2 on initiative. The preferred

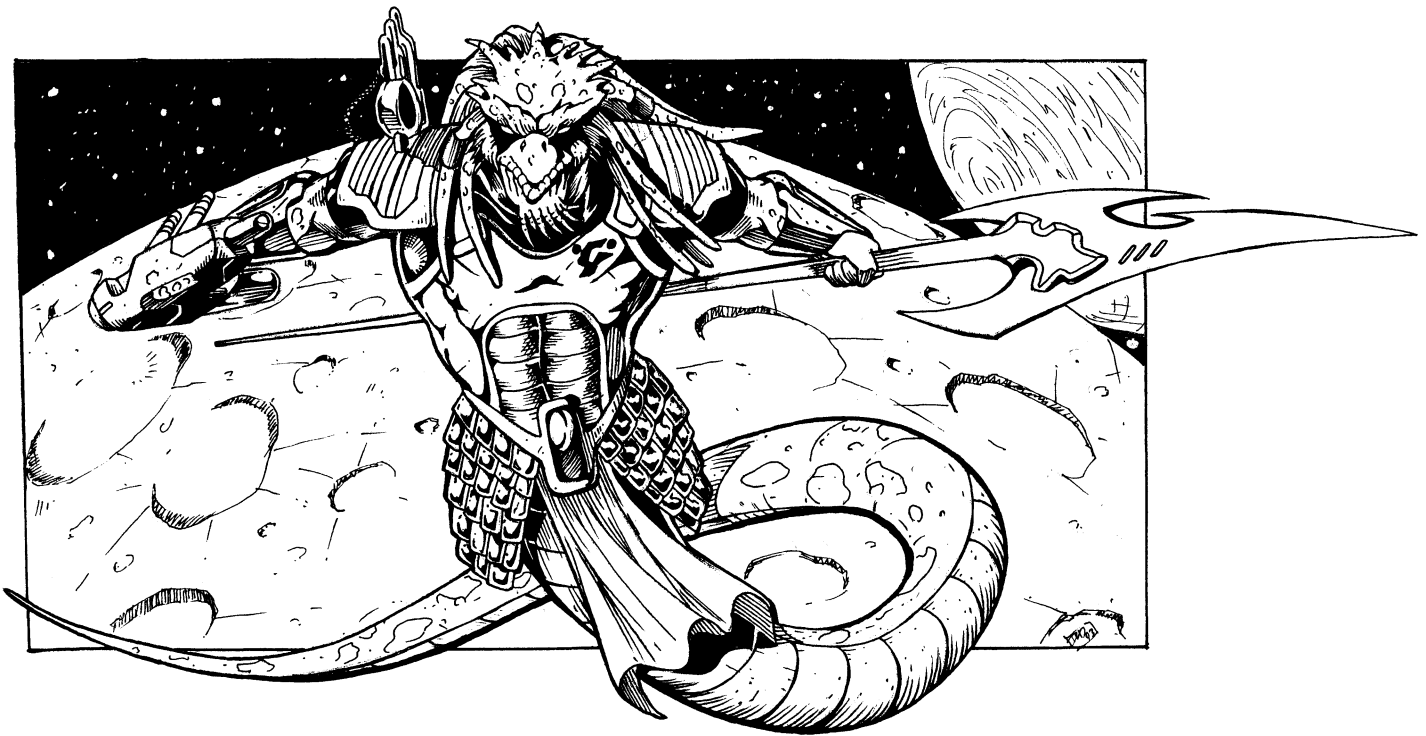

melee weapon is a pole arm, ideally one with a Vibro-Blade (3D6 M.D.).

Damage: Punch does 2D6 plus P.S. bonus. Tail whip can knock down a standing opponent. A trip attack does no damage but the opponent lose initiative and two melee attacks to right himself. If used as a whip attack, damage is 3D6 +P.S. bonus.

R.C.C. Bonuses: One additional attack, +1 to dodge and entangle, +2 to save vs Horror Factor.

Vulnerabilities & Penalties: Cold below 60 degrees reduces their combat abilities by half. Poor day vision with a range no greater than 100 feet (30.48 m), excellent night and heat vision.

O.C.C.s: Any that does not have psionics, this also excludes Mystics. Typically they go for warrior professions like Imperial Legionnaire or Imperial Security Agent, or adventurer occupations. Some of the most notorious pirates in the Three Galaxies are Skaa. They rarely go for magic O.C.C.s as most Skaa have little patience for learning it, and the same is true of scholastic pursuits.

Alliances and Allies: Get along well with most other species in the Transgalactic Empire (TGE). They respect the Wulfen for their warrior spirit and some consider them kindred warrior spirits.

Weapons and Equipment: Depends on O.C.C. selected. Typically favor heavy weapons and pole arms.

Strata R.C.C.

The Strata are large humanoids that are partially organic and inorganic creatures. A large crystal is in the center of their abdomens. This is what they call their "core." It is the human equivalent of a brain. While they do have a normal humanoid head and face it is merely a sensor pod for the life form and has a dusky complexion. All of the limbs are organic and function in a simi-

lar manner to your typical humanoid. Their skin varies in complexion from a mustard yellow to various shades of gray and black, but has a rough, sandy texture to it. The color of their core also varies. The typical color is a transparent green, but can be red, blue and yellow, though they are in the minority. Protruding from the skin in various locations are crystal stones similar in color to their core. Strata have no body hair, so they are bald, with the crystals protruding from their skulls as if it were spikes or clumps of crystalline hair.

Strata society revolves primarily around the family structure, with the oldest and largest of the families being the ruling body. This system seems to work well as it has been in place for over a thousand years. The ruling family makes all major decisions for the society as a whole, and affairs of planet. The second oldest and largest family is in charge of the military. While the Strata are not combat orientated, they have an effective means of protecting themselves with their unique crystal technology. Only once has their planet been threatened. The Splugorth had discovered their world and sought to make them a subjugated race. The Splugorth Intelligence vastly underestimated the Strata's defenses and willingness to use them. After repelling the attackers, the Strata sought allies. It did not take them very long to find the emerging CCW and petition for membership. That was during the first years of the Consortium, and the Strata have been avid supporters ever since.

The Strata life cycle is one of the more unique for humanoid races. First, they are silicon-based life forms. Silicon is the second most common element for life next to carbon. Like carbon, silicon has many features that make life possible. The first is its ability to bond with, and form many organic compounds. This seems to be how the Strata evolved. Organic compounds that were simple, single celled organisms seemed to have a unique relationship with a crystal stone that had a distinctive matrix. This matrix was able to adapt to its surroundings. Since it depended on light for a source of energy it was able to change how opaque it could become to absorb more or less light as needed. The Strata theorize that over time a symbiotic relationship de-

veloped between these crystals and the single celled organisms, eventually forming into the Strata.

The Strata require little in the way of nourishment. They do eat and breathe, though not as one would expect. First, they are not oxygen breathers, rather they breathe nitrogen gas. Fortunately, nitrogen makes up a large percentage of breathable air for humans and humanoids. Just like humans, Strata are able to filter the nitrogen out of the air. This works out well as they do not require any special breathing apparatus when on human planets and space stations. Likewise, humans are just fine on the Strata home world. Some humans do prefer to wear a basic air filter, as sometimes the Strata atmosphere can have the same effects as nitrous oxide (laughing gas).

As for nourishment, the Strata are able to eat just about any type of vegetable or fruit grown directly from the ground. Their body is able to absorb the needed nutrients and expel the rest as waste. They also derive a certain amount of nourishment (about 15%) from sunlight. It's interesting to note that Strata find the concept of eating a once live creature repulsive. They have come to accept this one weakness from their allies.

The Strata have no distinction between sexes. They are effectively genderless. In order to reproduce, a mature Strata can will their core to bud. This bud takes on the appearance of a bubble within their core, and it slowly grows and makes its way to the skin. This all takes 1D4+15 months. Upon reaching the surface a rough looking rock remains attached to the surface. At this point another Strata can donate some organic material to the egg. How this is done is still unknown outside of Strata society, but after another Strata donates the needed organic material, the bud breaks off. From that point on, one of the parents carries the bud with them for a term of 11 months. After the first month the bud breaks the rock shell and a shining multifaceted crystal is left. The humanoid features then grow in over the next ten months. Strata do not reach physical maturity until around age 30. While they are long lived, it also takes a long time for them to develop.

Alignment: Any.

Attributes: I.Q. 4D6, M.E. 3D6+1, M.A. 1D6+3, P.S. 3D6+6 (Supernatural), P.P. 3D6, P.E. 3D6+4, P.B. 1D6+4, Spd. 3D6+3

Size: 8-12 feet tall. (2.4 to 3.7 m).

Weight: 400 to 800 pounds. (180 to 360 kg).

M.D.C.: P.E. attribute times 5, plus 2D6 per level of experience starting at level one.

S.D.C./Hit Points: In an S.D.C. dimension they would have S.D.C. equal to their P.E. attribute times 5 and Hit Points would be P.E. times 2, plus 2D6 per level. The Strata would have an Armor Rating of 14.

Horror Factor: 14 for those encountering them for the first time.

P.P.E.: 2D6

Average Life Span: Around 1,000 years with modern medicine, 600 years normally.

Natural Abilities: Supernatural strength and endurance. By holding an item such as stone or jewelry they can tell the exact mineral composition at 60% +2% per level of experience. Shape Stone and Crystals is an ability similar to a Stone Master's to magically shape and connect stone, but it costs no

P.P.E. for the Strata. The following percentiles determine the quality of the work: Stone 30% +5% per level of experience. Crystals 15% +5% per level of experience.

Psionics: Standard, however the Strata have their M.E. attribute x2 as a base, plus I.S.P. from any psychic P.C.C.

Magic: As per O.C.C., favors Stone Masters and Techno-Wizardry.

Hand to Hand Combat: By O.C.C. only.

Damage: Varies, as per Supernatural Strength.

R.C.C. Bonuses: All have the Geology skill at +10%.

Vulnerabilities/Penalties: They take double damage from sonic based attacks, even magical! They can literally be shattered. Also, modern cybernetic and bionic implants do not work on them.

O.C.C.s: Favors the more scholarly occupations, however, can be any that does not have or include cybernetics or bionics.

Alliances and Allies: As members of the Consortium, they get along well with their neighbors and fellow members.

Enemies: They share the same enemies as the CCW, especially the Splugorth who would love nothing more than to dissect them for Bio-Wizardry components.

Weapons and Equipment: The Strata tend to favor their own crystal technology.

Experience Tables

Spell Thief

1	0,000 – 2,700
2	2,701 – 5,400
3	5,401 – 10,800
4	10,801 – 21,600
5	21,601 – 31,600
6	31,601 – 42,800
7	42,801 – 62,000
8	62,001 – 90,000
9	90,001 – 120,000
10	120,001 – 170,000
11	170,001 – 220,000
12	220,001 – 290,000
13	290,001 – 400,000
14	400,001 – 500,000
15	500,001 – 700,000

Space Warlock & Necrol Witch

1	0,000 – 2,300
2	2,301 – 4,600
3	4,601 – 9,200
4	9,201 – 18,400
5	18,401 – 26,500
6	26,501 – 36,600
7	36,601 – 51,700
8	51,701 – 71,800
9	71,801 – 96,900
10	96,901 – 137,000
11	137,001 – 188,100
12	188,101 – 229,200
13	229,201 – 279,300
14	279,301 – 340,400
15	340,401 – 400,000

Techno-Smithy

- 1 0,000 – 2,650
- 2 2,651 – 5,300
- 3 5,301 – 11,000
- 4 11,001 – 21,000
- 5 21,001 – 32,000
- 6 32,001 – 42,000
- 7 42,001 – 62,000
- 8 62,001 – 90,000
- 9 90,001 – 120,000
- 10 120,001 – 170,000
- 11 170,001 – 220,000
- 12 220,001 – 290,000
- 13 290,001 – 400,000
- 14 400,001 – 500,000
- 15 500,001 – 700,000

FWC Air/Space Corps

- 1 0,000 – 2,250
- 2 2,251 – 4,400
- 3 4,401 – 8,800
- 4 8,801 – 17,600
- 5 17,601 – 24,000
- 6 24,001 – 35,000
- 7 35,001 – 50,500
- 8 50,501 – 72,500
- 9 72,501 – 98,500
- 10 98,501 – 140,500
- 11 140,501 – 200,500
- 12 200,501 – 250,500
- 13 250,501 – 300,500
- 14 300,501 – 400,500
- 15 400,501 – 500,000

**FWC Ground Trooper
& Necrol Warrior**

- 1 0,000 – 1,950
- 2 1,951 – 3,900
- 3 3,901 – 8,800
- 4 8,801 – 17,600
- 5 17,601 – 35,600
- 6 35,601 – 50,600
- 7 50,601 – 70,600
- 8 70,601 – 95,600
- 9 95,601 – 125,600
- 10 125,601 – 175,600
- 11 175,601 – 225,600
- 12 225,601 – 275,600
- 13 275,601 – 325,600
- 14 325,601 – 375,600
- 15 375,601 – 425,600

FWC Medic & Necrol Worker

- 1 0,000 – 2,000
- 2 2,001 – 4,000
- 3 4,001 – 8,200
- 4 8,201 – 16,400
- 5 16,401 – 24,500
- 6 24,501 – 34,600
- 7 34,601 – 49,700
- 8 49,701 – 69,800
- 9 69,801 – 94,900
- 10 94,901 – 129,000
- 11 129,001 – 179,100
- 12 179,101 – 229,200
- 13 229,201 – 279,300
- 14 279,301 – 329,400
- 15 329,401 – 389,500

FWC Technical Specialist

- 1 0,000 – 2,120
- 2 2,121 – 4,240
- 3 4,241 – 8,480
- 4 8,481 – 16,960
- 5 16,961 – 24,960
- 6 24,961 – 34,960
- 7 34,961 – 49,960
- 8 49,961 – 69,960
- 9 69,961 – 94,960
- 10 94,961 – 129,960
- 11 129,961 – 179,960
- 12 179,961 – 229,960
- 13 229,961 – 279,960
- 14 279,961 – 329,960
- 15 329,961 – 389,960

FWC Insurrectionist

- 1 0,000 – 2,150
- 2 2,151 – 4,300
- 3 4,301 – 8,600
- 4 8,601 – 17,200
- 5 17,201 – 25,500
- 6 25,501 – 36,000
- 7 36,001 – 52,000
- 8 52,001 – 73,000
- 9 73,001 – 98,000
- 10 98,001 – 134,000
- 11 134,001 – 184,000
- 12 184,001 – 240,000
- 13 240,001 – 295,000
- 14 295,001 – 385,000
- 15 385,001 – 450,000

Some Monsters of the Three Galaxies

Sapphire Cobra

The Sapphire Cobra is the dominant predator on the planet Hunter Seven. It is a relatively smart animal that hunts not only for food, but for pleasure. Slither, from Safari Inc., had spent many hours observing the creature and he found that it had killed a creature and simply left it. After several hours a larger creature found the carcass and began to feed. The Sapphire Cobra had set a trap for a larger prey; it sprang from its hiding place and killed the larger creature. Slither was impressed with the animal's display of cunning and intelligence.

On another instance, Slither observed the Cobra stalking prey, catching it and letting it go. This happened several times. At first the prey appeared to have simply escaped the maw of the cobra, but several times in a row, Slither could not believe. Finally, the Sapphire Cobra went on its way after its last encounter. Slither examined the would-be prey to find that it had taken several bites, but it was the last one that finished the animal off with a lethal dose of venom. Slither concluded that the Sapphire Cobra had been toying with the prey for several hours and finally tired of the game and killed it. Slither was most impressed, not only was this creature a capable hunter, it too liked the hunt.

Alignment: Effectively Miscreant, because they are very aggressive predators whose prey includes humanoids. Some have been known to kill out of crankiness and sport as well as for food

Attributes: I.Q. 1D4+4, M.A. 3D6, M.E. 1D6+6, P.S. 3D6+30, P.P. 1D6+20, P.E. 1D6 +20, P.B. 1D6+14, Spd. 2D6+20 on land or swimming through water, half in trees.

M.D.C.: 3D6x10+33. (**Hit Points:** P.E.x2. **S.D.C.:** 6D6+30. **Natural A.R.:** 12. Hit Points, S.D.C. and A.R. are provided for S.D.C. dimensions.)

Horror Factor: 13

P.P.E.: 3D6. **I.S.P.:** M.E. number x2.

Size: 40 to 100 feet long (12.2 to 30.5 m). **Weight:** 500 to 1200 pounds. (225 to 540 kg).

Physical Appearance: They have a dark sapphire blue color, and are speckled with various shades of iridescent light blue that match the native flora and fauna. When it rears its head up it opens like a cobra, the eyes are red and the underbelly is a light blue or pale green.

Natural Abilities: Swim 98%, but does not dive under the water, swims on the surface, Land Navigation 80%, Prowl 75%, Climb 70%, Camouflage (self; 85% when staying still and under cover on the ground or in a tree or water; 55% when

moving slowly; none when moving quickly or in attack mode), and track by scent 60% (+15% to follow blood scent). Can sense a creature's body heat in the same fashion as a regular snake, by flicking its tongue. Also see psionics.

Combat: Three attacks per melee for young, and five for adults.

Bonuses (in addition to attribute bonuses): +3 on initiative, +1 to strike, and +2 to automatic dodge, and +3 to save vs Horror Factor (tends to attack that which frightens it, especially when cornered or injured).

Damage: Bite: 1D6 M.D., lunging bite (kind of like a power attack and takes two actions): 2D6 M.D., restrained/nipping bites 3D6 S.D.C., head butt or tail whip: 2D4 M.D. or crush/squeeze: 2D6 M.D. per melee round (every 15 seconds).

M.D. Poison: The snake can elect to bite without venom or with it. One venom bite instantly kills humans and most other mortal beings, and even hurts Mega-Damage beings, including creatures of magic and the supernatural, making the serpent's venom highly desirable to assassins. Poison does 3D6 M.D. (the equivalent of 3D6x100 H.P./S.D.C.) unless a save vs lethal magic of 15 or higher is made.

Magic: None.

Psionics: Sixth Sense, See Aura, and See the Invisible. I.S.P. is its M.E. number x2.

Average Life Span: Can live up to 80 years.

Languages: None, although over time they could be trained like watchdogs and would have a basic *understanding* of verbal commands and approximately 180 words. Cannot speak, but do hiss.

Habitat: They are only found on the planet called *Serpent's Wrath* (a.k.a. Hunter Seven) in the Corkscrew Galaxy.

Value: Varies, some combat arenas will pay between 10,000-60,000 per Cobra, their skin gets 1000-4000 credits and their venom is worth 500-100 credits and ounce (a typical Sapphire Cobra has 32 ounces available at any given moment). An ounce of the venom does 1D6x100 S.D.C. damage or 1D6 points of Mega-Damage.

Enemies: No natural enemies on its home world, except other, larger Sapphire Cobras.

Solar Leech

These bat-like creatures make the vacuum of space their home. They are normally found soaring among the solar winds where they naturally absorb the solar energy for food. However, once they get a *taste* of "artificial energy," such as fusion power

or antimatter reactors, they literally become junkies and actively seek out these power sources over the natural ones they once fed upon. These normally shy creatures actually fly close to inhabited worlds looking for spacecraft and space stations to latch onto. The cursed leeches have been known to drain a spacecraft's power so low that more than a few ships have been left stranded with not even enough power to transmit an SOS. Most Spacers and adventurers shoot these creatures on sight.

Alignment: Considered Miscreant evil.

Attributes: I.Q. 1D4, M.E. 2D4, M.A. 1D4, P.S. 2D6+6 (Supernatural), P.P. 3D6+7, P.E. 3D6+8, P.B. 1D6, Spd. Mach 1 or higher.

M.D.C.: P.E. attribute x5. (**Hit Points:** P.E.x3. **S.D.C.:** P.E.x5. **Natural A.R.:** 14. Hit Points, S.D.C. and A.R. are provided for S.D.C. dimensions.)

Horror Factor: 14

P.P.E.: 3D6

Size: They start off as small creatures with only a 3 foot (.9 m) wingspan, but can double in size multiple times up to a maximum of 1,536 feet (468.2 m). They typically never get this big as they are either killed long before this or die of natural causes. Their average size is 48 feet (14.6 m).

Weight: Starts off at about 100 pounds (45 kg) and increases with size.

Physical Appearance: Giant worms with bat wings, and their skin is hard, coarse like sandpaper or rough cement, and dark, like the void of space. Protruding from what would be the head are 6 appendages that are long and hair-like. They are really the sensory organs. Where the mouth would be is a white organ that drains the energy for the Solar Leech. **Note:** Solar Leeches are not carbon-based life forms and as a result, do not show up on most bio-scanners.

Natural Abilities: Lives in a vacuum and is impervious to the effects of solar radiation and the vacuum. The Solar Leech can also fire an energy beam from its mouth. See damage below. Energy weapons do half damage to them as they absorb some of the incoming energy as food. Magic energy and psionic attacks inflict full damage, as do projectile weapons and explosions.

Flying speed varies with size. Every time the creature doubles in size, so does their speed. It increases by mach one every time, so a Solar Leech that is three feet (0.9 m) in size can fly at mach one. When their size doubles to six feet (1.8 m) their speed is Mach Two, at 12 feet (3.6 m) their speed increases to Mach 3, and so on.

Feed on ambient energy and radiation, but many come to prefer man-made energy and can sense such energy signatures from 1000 miles (1600 km) away.

Combat: Four attacks per melee round.

Bonuses (in addition to attributes): +1 to dodge and roll with impact.

Damage: The Solar Leech can fire a radiation beam that is directly proportional to their size. At their smallest the radiation beam's damage is 1D6 M.D. When their size doubles the blast damage increases by 1D6 M.D., so when they are 6 feet (1.8 m) the damage is 2D6 M.D., at 12 feet (3.6 m), 3D6 and so on, until they are at their maximum size in which case damage is 1D6x10. Each shot equals one attack. The range is

500 feet (152.4 m) regardless of size. They also have supernatural strength and endurance, so a wing or tail slap does 1D6 M.D.

The energy drain attack on ships and energy supplies is as follows: 10% of the energy supply is sucked dry every hour by a large Solar Leech, half that (5%) for those under 25 feet (7.6 m). These creatures are gluttons and will often drain all the energy, but may also stop after draining away 2D4x10% of the available power (1D4x10% for young). The real danger is when more than one attaches itself to the same power source at the same time. Thankfully, adult Solar Leeches tend to travel as lone hunters, and the young in numbers of only 1D4 (young are under 25 feet/7.6 m long).

Magic: None. **Psionics:** None.

Average Life Span: Unknown, could be hundreds of years.

Languages: None.

Habitat: The vacuum of space is their natural habitat, but if attached to a ship they could effectively survive anywhere, even ocean depths of up to 2 miles (3.2 km). Most common in the Corkscrew and Thundercloud Galaxies.

Value: None, they have little value in an arena, as they are too stupid to fight. They only fight when cornered or when startled.

Enemies: The entire humanoid space community and any space travelers. Spacers and adventurers despise these things, and shoot them on sight.

Space Coral Creature

Floating hidden among asteroid belts, nebulas, and the depths of space are the dreaded Space Coral Creatures. They are enormous snake-like creatures that inhabit large chunks of rock and debris that look like extensive fields of coral. The coral is riddled with passageways large enough for a Protector Class ship to pass through without harm. The passageways are the result of the Coral Creatures building their homes from all kinds of stellar debris they come across. The coral takes on hues of various colors as it depends on what type of material the Space Coral Creature is using to build with. All matter is seen as a potential source of food.

The creature is able to survive in hard vacuums and for prolonged periods of time without food. They are very adaptive and able to consume any type of matter as food, as well as most types of energy, from simple sunlight to the radioactive gases of a nebula. They live for thousands of years floating through the Three Galaxies munching on asteroids, moons, space junk and sometimes, spaceships. However, Space Coral Creatures don't usually attack spacecraft or any object traveling faster than Mach 10 and are easily chased away with explosives, even little ones – they hate them.

Alignment: Effectively Anarchist.

Attributes: I.Q. 1D4, M.E. 2D6, M.A. 1D6, P.S. 6D6+20 (Supernatural), P.P. 2D6+10, P.E. 3D6+10, P.B. 2D6, Spd. 1D4x100

M.D.C.: P.E.x1,000. (**Hit Points:** P.E.x10. **S.D.C.:** 1D4x100. **Natural A.R.:** 14. Hit Points, S.D.C. and A.R. are provided for S.D.C. Dimensions.)



Horror Factor: 16

P.P.E.: 2D4x100

Size: 1D6x100+3,000 feet long (3,100-3,600 feet/945 to 1,097 m). The coral reef they build can be several miles in size. Typical size is 10-60 miles (16 to 96 km); roll 1D6x10 to determine the size of the floating reef.

Weight: 100 to 150 tons.

Physical Appearance: A long, white snake-like creature with a large toothy maw. It has three tails so it can get a firm anchor on an asteroid or chunk of debris so it doesn't float away. It also has four tentacles-like appendages near the maw. The mouth appendages are smaller than the tail and used for grabbing food. They have about a 500 foot (152 m) reach.

Natural Abilities: Survive in vacuum, impervious to cold, resistant to fire and energy based attacks (half damage). Zero gravity movement and a natural chameleon ability (same restrictions as the spell). Create their coral home, using various eaten materials.

Combat: Four attacks per melee round. Attack only when they feel threatened, are cornered or mistake a spaceship for space junk and start chowing down on it.

Bonuses (in addition to attributes): +2 on initiative, +1 to strike, parry, and dodge. +3 to save vs magic and psionics, and impervious to Horror Factor.

Damage: As per Supernatural Strength.

Magic: None, but does have spell-like abilities.

Psionics: None, but due to its physiology it is rather resistant to psionic attacks.

Average Life Span: 1D4x1000+2000 years.

Languages: None.

Habitat: They can be found anywhere in space. They typically get trapped in orbit around stars and planets. They're the most dangerous when they float into an asteroid belt as they blend right in with the remaining asteroids. Space Coral Creatures use all the available material to build a very large reef home and asteroid belts or small moons provide plenty of material to do so. While it is an M.D.C. creature, any atmospheric pressure equal to or greater than Earth's will crush and kill the Space Coral Creature. Comparatively uncommon.

Value: None.

Enemies: None in particular, though most space travelers shoot them on sight.

Note: When one finds a Space Coral Creature there's a good chance that there are several dozen more around. After they mate, the young begin making homes right away. After several generations, dozens of coral creatures occupy a very large, floating coral reef. The reason the numbers are so low is because they eventually prey on each other. This leaves large sections of the coral reef empty while the dominant Space Coral Creature hunts its remaining siblings or munches on rock and ice. Eventually, it comes down to two or three dominant Coral Creatures that occupy their own sections of the reef.

Void Zombie

The Void Zombie is a twisted mockery of life. They can only be created by a select group of Necromancers from the Dark Covens in the Three Galaxies. Making a Void Zombie is a rather gruesome process, starting with a living subject given a mixture of magic potions that enhance the body, making it stronger and tougher. Then a mystic symbol is drawn on the neck, just before the victim is cruelly killed by sudden decompression. After the body is recovered, a ceremony must be conducted within the shadow of a moon. During the ceremony a crystal worth 2,000 credits is placed on the neck. 24 hours later, the Void Zombie rises to begin its existence as an undead servant of those who created it. Void Zombies are often used by their creators as semi-intelligent, Mega-Damage guards, minions, killers and slaves, but are also sometimes let loose to wander the void alone or in pairs or small groups with a simple assignment to kill all humans, or Noro, or Kreeghor, or CAF soldiers, and similar broad missions of death or destruction.

Alignment: Effectively Miscreant because they are created by wicked practitioners of magic, usually for an evil purpose. They have no will or thoughts of their own.

Attributes: I.Q. 7, M.E. 6, M.A. 4, P.S. 30 (Supernatural), P.P. 20, P.E. 24, P.B. 3, Spd. 16

M.D.C.: 1D6x10 +48, but magically regenerate unless special measures are taken. (**Hit Points:** 2D4x10. **S.D.C.:** 1D6x10. **Natural A.R.:** 12. Hit Points, S.D.C. and A.R. are provided for S.D.C. dimensions.)

Horror Factor: 14

P.P.E.: None.

Size: Varies, and depends on the size of the victim. **Weight:** Varies and depends on the size of the victim. Always humanoid.

Physical Appearance: The flesh takes on a mottled gray color and the face always looks like it's twisted in unending agony. In the middle of the throat is a glowing crystal, the source of their power. The eyes always appear as red and glowing. Over time the flesh seems to take on a saggy appearance like it's hanging off the bones. The zombie is always cold to the touch, and each time the claws dig into a victim's flesh it feels as if a bitter cold knife is slicing through the body.

Natural Abilities: Impervious to the effects of a vacuum and sudden decompression. Supernatural strength and endurance. Bio-regenerate 1D6 M.D.C. per melee and can fight to -24 M.D.C., at which point they need 24 hours to completely regenerate. Impervious to all weapons, including Mega-Damage particle beams, lasers, and even plasma based weapons! They can also be blown up, similar to zombies, however they will rise in 24 hours. They are only vulnerable to magic, psionics, and magic weapons. Rune weapons and magic fire do double damage. Normal fire does half damage. **Note:** While the crystal in the middle of their throat is what initially animated them, it is not a vulnerability until the Void Zombie has been brought to -24 M.D.C. At this point, to permanently destroy the zombie one must take the time to cut out the crystal and burn the body. Once the body is engulfed the crystal turns to a black dust, followed shortly by the body.

Combat: Four attacks per melee.

Bonuses (in addition to attributes): +2 on initiative, +2 to strike, +3 to parry and dodge, +1 to disarm, +1 to pull punch, impervious to poisons, drugs, mind control, possession and Horror Factor.

Damage: Punch is 3D6 M.D., power punch 6D6 (but counts as two attacks), claw strike 4D6 M.D., kick 4D6, or 1D4 M.D.

Magic: None. **Psionics:** None.

Average Life Span: Effectively immortal.

Languages: Magically understands all languages, but is unable to speak more than one or two words ("Go," "Come," "Die now"). They hiss, growl and grunt a lot.

Habitat: Typically found where Necromancers of the Dark Covens are up to something.

Value: None.

Enemies: Creatures of light and other good creatures or whatever they are commanded to attack.

Demon Planet

The Demon Planet is a thing of legend, said to be a wandering behemoth that consumes entire solar systems to sustain itself. A single Demon Planet is said to be capable of wiping out entire fleets of ships, though they usually avoids systems where advanced civilizations wield powerful technology or magic. According to legend, a Demon Planet is roughly spherical in shape with a gaping maw over a thousand miles (1,600 km) in diameter. Enormous tentacles stretch out of the maw to a distance of one thousand miles (1,600 km) in length. Some Demon Planets have grown so large that they have enough mass to create the

equivalent of one G. They have a rough brown appearance and from a distance could be easily confused for a large planetoid or a small planet. It's not until one gets close enough to see the pinkish craters and the various organic looking spines that dot the landscape that one begins to realize this is not an ordinary planetoid. However, if a spaceship is close enough to come into the planet's range, 2D6 tentacles come shooting out of the pinkish craters to snare and drag the ship into it, dashing it on the surface of the weird planet.

Once grounded on the Demon Planet, the giant tentacles retract back into the crater, but trouble is only starting. From oozing gray and blue pools of liquid appear miniature versions of the demon planet itself, only they are attached to the planet via heavy-duty umbilical cord. They float on their own and can go several miles away from their pools to attack those on the surface. No one knows if these are the Demon Planet's young or some type of immune system response.

On the surface it has a primitive atmosphere that can support most humanoid races. The sky is a pale yellow and the landscape is colored in black, brown and pink. Numerous pools of gray and blue liquid dot the landscape. They range in size from 100 feet (30 m) across to 5 miles (8 km). Like any planet, the surface varies from location to location with bony looking mountains rising thousands of feet in the sky, to deep ravines and craters.

According to legend, the humongous creature has a complex digestive and pulmonary system. Due to its size, none of its organs are centralized. Instead, it has multiple hearts to pump the fluid (blood) through its veins, the brain has several large nodes scattered around the planet, and the only centralized system would seem to be its digestive tract.

This creature radiates an aura of pure Diabolic evil that is so powerful that it may send a psychic character into a comatose state. This is true even if the psychic has Mind Block Auto-Defense (but is +3 to save). Opening oneself to the creature is a dangerous prospect as like an Alien Intelligence it can easily possess those who welcome it into their mind (psychics are -3 to save vs possession when they make contact).

Psychic Trauma: Any psychic coming into contact with the creature will have to make a save versus insanity! Needs to roll a 16 or higher on a D20; no bonuses apply. A failed save has one of the following results:

01-20% The psychic's eyes roll to the back of his head, the individual gurgles, drool oozes from his mouth, he falls over and curls up into a fetal position, trembling. All he can mutter is words like, "God, help us. Save us all. Oh God, oh God." or "No. No. No. Doom. All gonna die. No." or "Get away. Must get away. Eat us alive." The psychic is incapable of any other action, and must be carried to move. Duration of the Insanity: May snap out of it after 1D4 hours, but will be in a zombie, trance-like state (speed, attacks per melee, combat bonuses, psionic powers, and skill proficiencies are all at *half* their usual level). Doesn't get any better than this as long as he remains on the planet. Returns to normal 4D6 hours after surviving and leaving the Demon Planet, but will suffer the same effect if such a Planet is ever encountered again, and has a phobia about demons and creatures with tentacles (they terrify him and cause him to become paralyzed with fear).

21-40% The psychic lets loose a blood curdling scream and starts to run away. Everybody, friends, odd creatures, stranger sounds, sudden movement, and his own shadow, startles and causes him to scream and run in a different direction. Nothing other than heavy sedatives can calm him down (puts him in a dull, zombie-like state where he mutters and occasionally whimpers, but can be lead around by the hand). Duration of the Insanity: May snap out of it in 1D6 hours, but remains extremely jumpy and frightened, screaming or shouting over the slightest oddity or threat. He is also -4 to save vs Horror Factor while in this state of mind. Doesn't get any better as long as he remains on the planet. Returns to normal 2D6 hours after surviving and leaving the Demon Planet, but has trouble sleeping for 6D6 weeks, suffers from a mild phobia about the dark (makes him nervous and jumpy) and the M.E. attribute is permanently reduced by one point.

41-60% The psychic grabs his head, shrieks or gurgles, and collapses. Remains unconscious for 2D4 minutes. When he recovers, the character will have a fundamental understanding about the Demon Planet and its level of power. Insanity: Though he seems shaken but otherwise alright, he (and his companions) will soon learn he suffers from an Affective Disorder (roll once on the table on page 19 of the *Rifts® RPG*). Duration of Insanity: Permanent.

61-80% The psychic starts shouting, "It's alive. It's alive." and knows the Demon Planet hates all life forms and will want to destroy and devour them all. Insanity: Suffers from the Invasion of the Body Snatchers syndrome, acute paranoia toward all aspects of the Demon Planet and any supernatural creature. Duration of this Insanity: Permanent.

81-90% The psychic drops to the ground and goes into convulsions lasting for 1D6 melee rounds. When it stops he knows the Demon Planet is alive, hates all life forms and will soon be coming for them all. He feels small and helpless. Insanity: Fear of Success (-15% to all skills, -3 to strike, parry, dodge and damage). See page 19 of the *Rifts® RPG* for complete details. Duration of this Insanity: After 1D6 years, the insanity has a 01-50% chance of going away, otherwise permanent.

91-00% The psychic becomes stiff as a board and is in a trance for 2D4 melee rounds before snapping out of it. He knows the Demon Planet is alive, hates all life forms and will soon be coming for them. Somehow he feels driven to beat this thing. Insanity: Manic Depressive (currently in a manic state). See page 19 of the *Rifts® RPG* for complete details. However, in his case, when manic, the character thinks he is practically invincible and can accomplish anything. This mind set causes him to underestimate his opponents or the situation and compels him to take foolish or outrageous risks and chances. Duration of this Insanity: After 1D4 years, the insanity has a 01-50% chance of going away, otherwise permanent.

Real or Myth. Nobody knows if Demon Planets are real or completely myth. There are cults, historians and true believers who insist they are very real and point to legends of them dating back several thousands of years, but there is no hard evidence of them. Those who believe insist there is plenty of hard evidence, and claim that as many as a third of the asteroid belts, meteor showers and wandering planetoids are actually debris resulting from the onslaught of a Demon Planet. They also claim that Demon Planets are solitary creatures and no more than one has

ever been seen at one time. Believers also suspect the creatures consider the mysterious sector of space known as *The Core*, in the Anvil Galaxy, to be the home, and perhaps even the birthplace of Demon Planets. They also speculate that a Demon Planet may go into hibernation for several hundred years at a time after devouring three or more worlds. (Note: See **Dimension Book™ Five: Anvil Galaxy™** for more details about The Core and the rest of that Galaxy.)

Fortunately for the Three Galaxies, Demon Planets remain creatures of myth and legend. If there are any still around today, they are keeping carefully hidden.

Alignment: Miscreant 50% or Diabolic 50%.

Attributes: I.Q. 30, M.E. 30, M.A. 25, P.S. Supernatural, see Damage, below, P.P., varies, see below, P.E. 45, P.B. 4, Spd. Can travel at Mach 10 or at FTL speeds, see below.

M.D.C. by Location: Main Body: The living planet itself has 1D4x5 million M.D.C. but there are individual parts that require mentioning.

Enormous Tentacles: 2D6x10,000 each. There are 2D6+6 enormous tentacles that stretch out of the maw to a distance of one thousand miles (1,600 km) in length to snare the largest starships, space stations, comets, moons and even planets.

Nerve Clusters: 1D6x100 each. Destroying one of the tens of thousands of nerve clusters will stun all the local Immune Defenders within a mile (1.6 km) for 1D4+1 minutes, with all combat bonuses reduced to one half. This is due to the Demon Planet sending a psychic scream of pain. All psychics will also have to make a standard saving throw of 12 or higher. A failed roll means they too are stunned, but only for 1D4 minutes with all combat bonuses by one half. If a Mind Block is up and the character fails their saving throw, they only have a headache and are -1 on all combat bonuses for 2D4 melees.

Digestive Organs: 1D6x1000 each. Attacking or destroying a digestive organ (4D6x100) will cause 3D6+3 Gut Crawlers to respond within 1D4 minutes to exterminate the attacking agent(s).

Hearts: 2D6x1000 each. The Demon Planet has hundreds (1D6x100) of hearts to pump the billions of gallons of blood through its massive body. If one is attacked or destroyed, 4D6 Gut Crawlers and 2D6 Floating Horrors will arrive in 1D4 melees to defend the heart and exterminate the attacking agent(s).

Brain Nodes: 3D4x1000 each. Brain Nodes are the most heavily defended areas inside the Demon Planet. At any given time there will be 4D6 Surface Crawlers, 5D6 Floating Horrors, and 1D4x10 Gut Crawlers at the site of a Brain Node ready to attack any intruder that comes within one mile (1.6 m) of it. Should the brain be destroyed the Demon Planet will not be able to call or direct any Immune Defenders within a 10 mile (16 km) radius. Any Immune Defenders encountered will be confused and skittish; all their combat bonuses are reduced by half. There are approximately 3D4x100+30 Brain Nodes.

Gravity Gland: 1D4x1000+500 each. Destroying one of the 1D6x100+50 Gravity Glands will free a 200 mile (320 km) radius of the effects of the gravity field. This is a narrow corridor that a ship has to navigate through. Any mistakes will cause the Demon Planet to get another chance to draw a ship in.

Blood Vessels per 10 feet (3 m): 250 each (there are thousands).

Major Artery/Vein per 10 feet (3 m): 700 each (there are hundreds).

Epidermis/Skin per 100 feet (30 m): 1000.

Horror Factor: 18 when it is realized it is a legendary, devouring Demon Planet.

P.P.E.: 6D6x100,000; 4D6 ley lines run across the surface of the living planet, each a minimum of 2D6x100 miles (320 to 1920 km) long.

I.S.P.: 4D6x100,000.

Size: Huge, planet-sized. 2D4x10,000 miles (32,000 to 1,280,000 km) in diameter.

Weight: Several billion tons!

Natural Abilities: Able to project its gravity field out to 100,000 miles (160,000 km). This prevents ships from activating their star drives, allowing the Demon Planet to catch them. Due to the Demon Planet's constant exposure to the harsh elements of space it is resistant to energy (half damage). Travels at two light years per hour for up to 45 hours at a time, after which it requires a massive meal (like a sun or several planets) to refuel. Seems to wander off satisfied after devouring an entire solar system.

Planet Combat/Attacks: 12 planet directed attacks which are limited to the use of its enormous tentacles, projection of its gravity field (counts as three melee attacks to maintain the projection every round) and bite (each biting action does Mega-Damage and counts as one attack; the enormous tentacles pull objects and spacecraft into the mouth).

Combat Note: These are the things the Demon Planet can do by itself. In addition, there are thousands and thousands of *independent* defense organisms of considerable power, each of which serves to protect and defend the Demon Planet. That is their sole purpose and they execute that mission without hesitation or emotions like regret or fear. Each is effectively a part of the Demon Planet that responds to localized infection, invasion and threats. They can be thought of as immune system organisms operating entirely on instinct to respond to threats to the main body and eliminate them. Each has its own set of abilities and methods of combat.

Planet Bonuses: +3 to strike with its large tentacles, but small objects under 100 feet (30 m) are +6 to dodge. The smaller tentacles are more agile and are +6 to strike.

Damage: Maw Bite: The teeth in the maw can crush and bite in half, doing 2D6x100 M.D. per melee action/attack.

Enormous Maw Tentacles: 2D4x1000 M.D. from a punch/strike, entangle and squeeze/crush 4D6x100 M.D. per melee action/attack, but is only able to crush objects larger than 500 feet (152 m). The large maw tentacles can reach out to a distance of 1000 miles (1600 km).

Energy Blast: Once a minute it can fire a massive blast of cosmic energy from any nexus point on the planet, doing 2D6x1000 M.D. The Demon Planet, however, uses this sparingly as it drains the planet of energy, only increasing its hunger. It sometimes uses the blast to break up large chunks of planets. Range of the blast is 500 miles (800 km).

Magic: The Demon Planet is considered an Alien Intelligence and has access to all spell magic levels 1-12, plus Summon &

Control Storm, Annihilate, Close Rift, Dimensional Portal, Dimensional Teleport, Ley Line Restoration, Ley Line Shut Down, Teleport: Superior (for sending defenders), and Mystic Quake; all cast at 15th level proficiency up to 100 miles (160 km) away. The planet can cast a spell at a specific target in its atmosphere or in space, not on its surface, but each spell counts as two of its melee attacks. Otherwise, the spells it knows can be cast at specific targets in space or on its surface by its official surrogate, the *Floating Horror*, or through a humanoid that it has possessed. Both cast spells at eighth level proficiency.

Psionics: All Sensitive and Healing abilities and the Super-Psionic powers of Group Trance, Mentally Possess Others, and Psychic Omni-Sight; each use of a power counts as one melee attack/action. Can communicate to a specific individual via Empathy or Telepathy.

Average Life Span: Unknown, could be millions or even billions of years.

Habitat: Always found in the depths of space looking for sources of food and entertainment.

Languages: Magically understands all languages, but seems to primarily think in Trade One.

Allies & Enemies: It considers all people and life itself to be its enemies, but may work with evil creatures such as evil mortals, adult dragons, Necromancers, Demon Lords, Deevils, and evil gods and Alien Intelligences. Demon Planets may also summon and control entities, lesser demons, and other creatures, as well as storms. Rumor has it that it can make a pact with mortal people turning them into Witches. Some wonder if some members of the Dark Covens may not be Witches linked to and empowered by one or more Demon Planets.

Demon Planet Defense Mechanisms

There are thousands upon thousands of *independent* defense organisms scattered across the planet. Each is a living part of the Demon Planet that functions on instinct and reflex action. They are designed to attack "foreign agents" just like our own human bodies have antibodies to fight infections and disease. The sole purpose of these defenders is to defend the Demon Planet by locating and destroying all foreign objects, invaders and threats. This is pretty much everything from crashed spaceships to robots, vehicles and humanoid explorers, whether they intend harm or not.

Alignment: All are considered Miscreant evil.

Enemies: Anyone and anything on the surface of its Demon Planet. They swarm over beings and machines that represent an immediate threat, tearing them to pieces.

Defense Response: Crater Tentacles

Localized Tentacle Clusters

The Crater Tentacles instinctively reach out and attack by striking and ensnaring any flying object that comes within their five mile (8 km) reach. Most flying objects, large or small, are

pulled down and crashed into the surface where at least 1D4 tentacles will hold on until other defenders arrive to destroy it.

Horror Factor: 15

M.D.C.: Localized Miles Long Tentacles: 1D4x1000 each. There are 2D6+4 five mile (8 km) long tentacles concealed within the many thousands of craters (1D4x1000) on the Demon Planet. They snare spacecraft, satellites and power armor that come within range and smash them into the surface of the planet or hold them tight on or near the surface until the smaller defenders/destroyers (Surface Crawlers, Floating Horrors, etc.) come to rip them to shreds.

Attacks per Melee: A total of 12 divided between the various tentacle squeeze.

Damage: Punch/strike with three tentacles: 3D6x100 M.D. (1D6x100 if only one tentacle), and counts as one melee attack. Crush/crush damage is 1D6x100 M.D. per melee action/attack. The smaller tentacles can reach out to a length of 5 miles (8 km).

Powerful enough where a single tentacle can hold and pull down an aircraft, small shuttle, missile or power armor, two tentacles a star fighter, shuttle, or small space ship, three tentacles objects as large as medium-sized spacecraft, four tentacles a large spacecraft, freighter, and six tentacles to pull down a spacecraft of most any size or type.

Note: Tentacles don't actually think, or possess magic or psionics, they respond by reflex.

Immune Defender: Surface Crawler

The Surface Crawler is one of the Demon planet's immune system defenders; these creatures scour the surface looking for invaders. They have the lower body of a centipede, and the upper body of a humanoid with clawed pincers. The head is flattened with six yellow eyes around the head. Running along the center of the head and continuing down the spine is a series of serrated spikes. The Demon planet has thousands of these defenders all around the planet. They can be encountered in pairs or in groups as large as 8 to 12.

Attributes: I.Q. 8, M.E. 8, M.A. 1, P.S. 35 (Supernatural), P.P. 24, P.E. 26, P.B. 8, Spd. 40

M.D.C.: 5D6x10 (**Hit Points:** 3D4x10. **S.D.C.:** 2D6x10. **Natural A.R.:** 15. Hit Points, S.D.C. and A.R. are provided for S.D.C. dimensions.)

Horror Factor: 13

P.P.E.: 3D6x10. **I.S.P.:** 1D6x10.

Size: 12 feet (3.7 m) tall, 10 feet (3 m) long. **Weight:** 1000 pounds (450 kg).

Physical Appearance: The lower body looks like a large centipede with 80 to 100 legs, the upper body has a humanoid appearance with pincers for arms and tentacles that come out of the pincers. The head is like a flattened disc with a row of serrated spikes running down the head and following the spine. It has black, shiny carapace armor that is covered in small barbs.

Natural Abilities: Supernatural Strength and Endurance, Paired Weapons, see in multiple spectrums of light, including infrared, ultraviolet, x-ray; can see the invisible, and Bio-regenerates 6D6 M.D. per minute. They are also immune to the

effects of a vacuum and radiation, take half damage from energy attacks. Magic energy does full damage however, as do psionics and magic weapons. Also see magic.

Combat: Five physical attacks per melee, or one by spell magic and two physical attacks.

Bonuses (includes attribute bonuses): +6 on initiative, +8 to strike, parry and dodge, +6 to roll with punch/fall, +8 to save vs magic, +1 to save vs psionics and is impervious to Horror Factor.

Damage: As per supernatural strength: 4D6 M.D. or bite does 5D6 M.D. The body is covered in serrated spikes, so raking along the body does 1D6 M.D.

Magic: Only has the following spell-like abilities: Electric Arc, Sub-Particle Acceleration, Fire Ball, and Call Lightning. All are equal to a 6th level spell caster.

Psionics: Telepathy, Sixth Sense, and Mind Block.

Average Life Span: Unknown, possibly thousands of years.

Languages: Understands all, but cannot speak, only hiss.

Habitat: Exclusive to the surface of Demon Planets and die within 1D6 months after being removed from the planet. (The Demon Planet can sense where its defender is up to 500 light years away.)

Immune Defender: Gut Crawler

The Demon Planet has an extensive network of internal cavities. Among them are sensitive organs such as nerve clusters and vital organs. The Gut Crawler's primary role is that of an internal defender. Any foreign objects are perceived as a threat and attacked. In effect, the Gut Crawlers are the human equivalent of white blood cells. If the foreign object can be used as food/fuel for the Demon Planet, the remains are carried to a digestive chamber that holds a massive pit filled with acid. Just about everything ends up in one of these pools, for the Demon Planet can digest almost anything, from people and other organic material to energy cells, ore and metal alloys. When the Gut Crawler is not fighting foreign invaders it is making internal repairs to the Demon Planet. The Gut Crawler can secrete a blood coagulant to aid in the healing of the massive blood vessels found within, repair ruptured veins, and perform various types of surgery. The same coagulant aids in the healing of internal organs and various membranes found throughout the Demon Planet.

The Gut Crawlers can travel through the Demon Planet's blood vessels to get from one location to another location fast. It is, however, a gruesome appearance as they crawl out of the walls of the Demon Planet – because they are part of the planet's immune system they can pass through various membranes without injuring the Demon Planet. Their typical tactic is to swarm any foreign invaders from all angles. Depending on the size of the cavity, anywhere from one to two dozen will pop out of the walls, ceiling and floor to surprise invaders at any given moment.

Attributes: I.Q. 7, M.E. 9, M.A. 4, P.S. 28 (Supernatural), P.P. 20, P.E. 30, P.B. 4, Spd. 30

M.D.C.: 2D6x10+12. (**Hit Points:** 1D4x10. **S.D.C.:** 1D6x10. **Natural A.R.:** 12. Hit Points, S.D.C. and A.R. are provided for S.D.C. dimensions.)

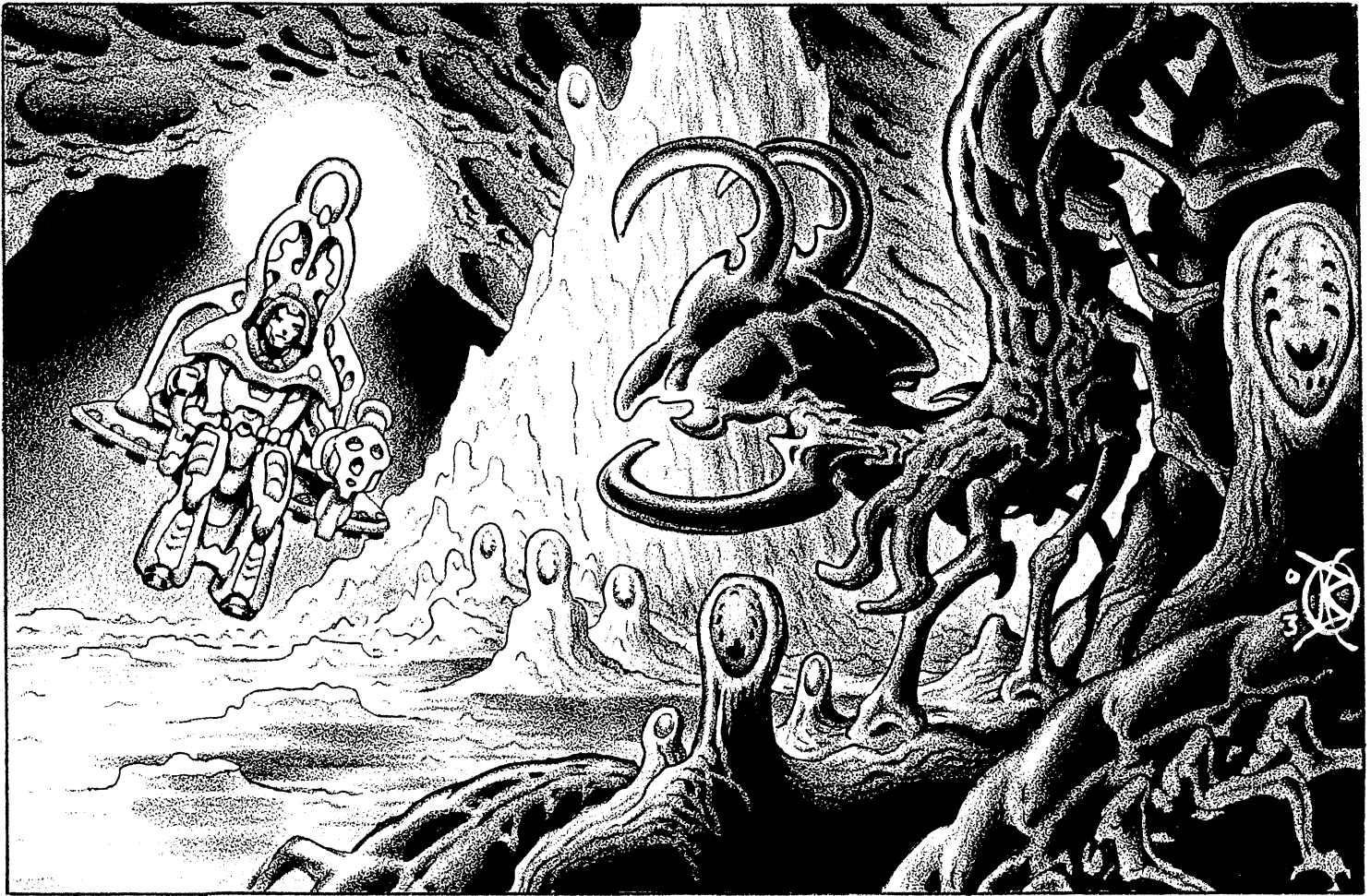

Horror Factor: 13

P.P.E.: 5D6. **I.S.P.:** 1D6x10+50.

Size: 9 feet (2.7 m) long. **Weight:** 900 pounds (405 kg).

Physical Appearance: A Gut Crawler looks like a jet black millipede with a green stripe running down the back. It also has four scythe-like appendages that sprout from its back behind its head. The four scythes lie flat along its back and sprout up when it's defending the Demon Planet.

Natural Abilities: Impervious to the effects of vacuum, resistant to energy (half damage), bio-regenerate 2D6 M.D.C. per melee, see the invisible, nightvision 1000 feet (305 m), and electrical discharge. They can swim at 90%, and pass through the Demon Planets membrane unhindered. Secretes a healing coagulant to assist in the repair of the Demon Planet.

Combat: Five attacks per melee round.

Bonuses (includes attributes): +3 on initiative, +5 to strike and dodge, +6 to parry, +3 to disarm, +2 to roll with punch/fall, +8 to save vs magic, +3 to save vs psionics, and is impervious to disease, poison, radiation, possession and Horror Factor.

Damage: Electrical Discharges: 4D6 M.D. at a range of 200 feet (61 m). Scythe Appendages: 6D6 M.D. by slashing and stabbing attacks (10 foot/3 m reach), head butt or body slam 4D6 M.D.

Magic: None.

Psionics: Telepathy, Ectoplasm, Deaden Pain, Healing Touch, Increased Healing, Psychic Diagnosis, Psychic Surgery, and Psychic Purification.

Average Life Span: Unknown, could be thousands or even millions of years.

Languages: Understands all languages, but can't speak, uses telepathy to communicate.

Immune Defender: Floating Horrors

The Floating Horrors are like the lieutenants in the Demon Planet's army of antibodies. They are smart and can actually think, cast spells, formulate strategies and direct and command any of the other defenders. Floating Horrors are known to lay in ambush, set traps and direct platoons of other defenders.

They get their name from the fact that they actually float about 5-10 feet (1.5 to 3 m) above the surface and are ugly as sin. They are pretty fast and nimble, but limited due to their umbilical cord that drags behind them. At any time the Demon Planet can possess one of the Floating Horrors, greatly increasing its powers.

Attributes: I.Q. 12, M.E. 12, M.A. 8, P.S. 38 (Supernatural), P.P. 22, P.E. 20, P.B. 2, Spd. 60

M.D.C. by Location:

Main Body – 6D6x10

Tentacles (12) – 50 each

Umbilical Cord (1) – 115

(Hit Points: 1D4x10+20. **S.D.C.:** 3D6x10. **Natural A.R.:** 13. Hit Points, S.D.C. and A.R. are provided for S.D.C. dimensions.)

Horror Factor: 15

P.P.E.: 1D4x50+50. **I.S.P.:** 2D6x10+30.

Size: 15 feet (4.6 m) in diameter. **Weight:** 800 to 1000 pounds (360 to 450 kg).

Physical Appearance: They appear to be mini-versions of the Demon Planet in that they are spherical in shape, have a dozen tentacles protruding out of their maw and have dozens of open soars all over the surface of their bodies. Closer inspections of the sores reveals additional tentacles, or tiny, miniature versions of the Floating Horror, giving further credence to the theory that they may be the offspring of the Demon Planet. The creature is a dark grayish-theory blue color, with red or black sores covering its body. It also has dozens of little spines around its body and no obvious sensory organs.

Natural Abilities: Impervious to the effects of vacuum, resistant to energy-based attacks (half damage), bio-regenerate 4D6 M.D.C. per melee round, can see the invisible, nightvision 2000 feet (610 m), supernatural strength and endurance. Magic energy does full damage however, as do psionics and magic weapons. Also see magic abilities.

Vulnerability: If its umbilical cord is destroyed (Bio-Regeneration points always go to it first), the Floating Horror can continue to fight for 2D6 hours, but it can no longer bio-regenerate nor be possessed by the Demon Planet, and dies when that time period elapses; it shrivels up and turns to solid stone.

Combat: Eight attacks per melee, or two by spell magic and three physical.

Bonuses (includes attributes): +4 on initiative, +7 to strike and dodge, +10 to parry, +5 to disarm, +6 to entangle, +3 to roll

with punch/fall, +6 to save vs magic and psionics, impervious to disease, poison, radiation, possession and Horror Factor.

Damage: As per supernatural strength: Tentacle strike does 5D6 M.D., power punch 1D6x10 M.D., crush/squeeze attack 3D6 M.D. per crushing melee action. Remember, the Floating Horror has a dozen tentacles, of which it can attack with up to eight at a time. Typically, two parry, two grapple or entangle, and the rest strike out.

Magic: Floating Horrors can cast the following spells at eighth level strength. All Level One and two Wizard spell invocations, plus Call Lightning, Multiple Image, Apparition, Armor Bizarre, and World Bizarre. **Note:** If the Demon Planet takes personal control of a Floating Horror, it can then cast any of the spells known by the living planet itself at 15th level proficiency and can draw upon the planet's P.P.E. Additionally, the planet experiences everything it does. The Demon Planet can split its consciousness to be in two or more places at once, but each division takes away two of the Demon Planet's own attacks per melee round.

Psionics: See Aura, Telepathy, Telekinesis (Super), Mind Block Auto Defense, Mentally Possess Others, and Mind Bolt. Again, has all of the Demon Planet's abilities and can draw upon its I.S.P. when possessed.

Average Life Span: Unknown, possibly thousands or millions of years.

Languages: Magically understands all languages, communicates via Telepathy.

Habitat: Found exclusively on the Demon Planet. Cannot be removed without cutting the umbilical cord, which causes death in 2D6 hours.

Notable Equipment of the Three Galaxies

Personal Scanning Equipment (PSE)

Personal scanning equipment in the Three Galaxies has come a long way in the last few centuries. Older equipment used to occupy a whole backpack, or was so large and clunky that a person had to hold it in both hands or with a harness around their neck. Today's PSE's are smaller and lightweight, some no bigger than a paperback book. PSE's see a variety of uses, from security and scientific functions to the medical field. The most advanced have a built-in artificial intelligence, and are able to use logic and deductive reasoning to aid their users. These devices are commonly found in space ports, especially where a

TVIA inspector is involved. They are standard equipment for science officers in the Consortium Discovery Corps.

Use of Scanners. There are three basic modes of operation for most scanners: passive, active, and focused.

When the scanner is in *passive mode* all ranges are reduced by half, and the Read Sensory Equipment skill is -10% for an accurate reading (less clear). The scanner does not emit any signals that might give its location away, however. All that registers is a minute power source and any halfway decent operator knows how to mask that signal. The reason for passive mode is to try and conceal the operator. Also, it is a good way to determine the range of anomalies in a reading, or readings that are too powerful to be scanned in active mode by changing between active and passive modes. The passive function can pick up signals in a 360-degree circumference. Finally, the passive mode

uses the least amount of power and can be left on for the full duration of the battery.

The active mode operates within the full range of the device. Power output is higher, and the scanning resolution will be sharper and more clearly defined. Unless otherwise specified, the active mode scans 360 degrees around the operator. However, the signal of the active scan can be recognized by others and traced back to the user.

The focused mode allows the operator to double the range, but only within a 30 degree arc in front of the operator. Like the active mode, the focused operation provides sharper and clearer scans and also increases the power output. Operators have found it's worth the extra effort to keep the scanner in the focus mode and sweep the scanner around them, effectively doubling their range. Using this method will take 30 seconds to scan a 180 degree arc, so scanning 360 degrees will typically take a minute. However, the signal of the focused scan can be recognized by others and traced back to the user.

The following scanners are the most common found throughout the Three Galaxies.

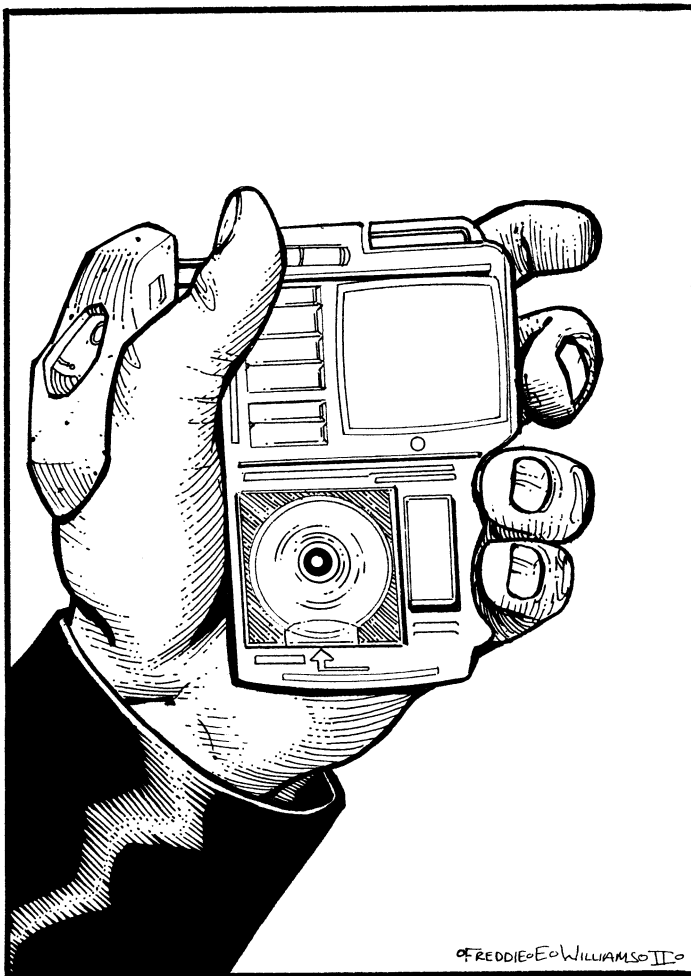

PSE-7000 Portable Scanner

This portable scanner sees a lot of use by Spacers in various fields, as well as research and exploration. It has multiple functions, a long battery life, and additional features that can be bought and added on, making it one of the most versatile scanners in the Three Galaxies. Below is the basic model.

The various functions are:

- Measure all spectrums of light. This is used to determine the various light frequencies such as infrared and ultraviolet. It measures the intensity and can determine how far away the source is assuming it's in the range of the device. Range: 500 feet (152 m).

- Measure and intercept energy emissions. This is good for determining radiation signatures that are either naturally occurring or artificial. It can also tell the difference between various power supplies such as nuclear fission, fusion, and antimatter reactors. Range: 1,000 feet (304 m)

- Auto-mapping feature. Using graviton emissions, the PSE can create a crude map and add on to it as the owner moves around. The scanner has a small plasma display so its owner can keep track of his position. Range: 50 foot area (15.2 m).

- Densitometer. By measuring the density of an object one can tell if it is M.D.C. or S.D.C. material. It can also be used in conjunction with the auto-mapping feature to look for secret doors. Range: 5 feet (1.5 m).

- Motion Detector. Range is 150 foot area (46 m).

- Memory. 10 terabytes is the standard amount of memory installed. It has five ports for various memory chips to be installed to either boost the unit's memory or to add new functions.

- Universal Jack. The scanner has a universal jack so that it can be connected to other computers to download or upload information. For game purposes, it takes 15 seconds (one melee round) to transfer one terabyte of information. The universal port is made of nanites to help configure it. It can fit into most computer, vehicle and robot ports, but may not fit into extremely alien machinery, and does NOT work on Phase Tech or organic technology.

- Battery. A small electro-cell provides power for 48 hours of continuous use or 200 activations, whichever comes first. A small base with a built-in recharger is included. Batteries can be purchased separately at a cost of 5,000 credits per battery.

Weight: 2 pounds (.90 kg).

Market Cost: 1,500,000 credits.

PSE-7000 add-on features: The PSE-7000 is so versatile that several additional options can be added to the scanner. This is yet another reason why it is so popular. Large corporations, security forces and even individuals can have their scanners customized for their specific use. Each cost is separate and adds additional weight to the scanner.

Video and audio recording unit add-on. This small unit is mounted on the top of the scanner and allows it to function like a digital video camera. The video add-on takes up a terabyte of memory on the PSE. For each free terabyte of memory you can get one hour of sound and video. As another option, one can take still pictures; about a thousand per terabyte. The user simply points and shoots for this function, however if they have the Photography skill the quality of the pictures improves dramatically. As with all digital cameras, existing images can be erased or copied over. Weight: 8 ounces (0.23 kg). Market Cost: 5,000 credits.

Scanner Booster. This unit has several micro-antennas that protrude from it. They help to boost the range of the scanner significantly. The range of all functions is doubled. One terabyte of

memory is required for this add-on. Weight: 8 ounces (0.23 kg). Market Cost: 50,000 credits.

Bio-Unit. This device helps to track and pinpoint life signs. All living creatures give off a unique bio-signature. This scanner reads that signature and translates it into usable data. It can pick up all life signs within a 500 foot (152 m) area, however it can't differentiate life signs that are huddled together. If the library function is installed, it has a 70% chance to identify what the life sign is. This scanner does have a few limitations, creatures of magic are invisible to it, any creatures with a naturally occurring Phase Field, like Prometheans, disrupt a hundred foot (30.5 m) area, and supernatural creatures can be identified as such, but the scanner is unable to distinguish between the different types of supernatural beings. The software for this add-on takes up 3 terabytes of memory. Weight: 8 ounces (0.23 kg). Market Cost: 120,000 credits.

Scrambling Unit. This add-on unit slides onto the back of the scanner. Its purpose is to generate an interference field around the unit to prevent scanning and communications. Unfortunately, while it's great at countering other scanners, the scanner itself cannot scan while this function is active. This unit is also a serious drain on the scanner's batteries, effectively cutting the life by half. Eight terabytes of memory are needed to use this device. Weight: One pound (0.45 kg). Market Cost: 150,000 credits.

Memory Chips. The PSE-7000 has five ports for various memory chips. It can read or store information and photos/images on these chips. They can also be used to enhance the scanners existing memory. Memory chips come in the following sizes. The weight for each chip is negligible. Memory Size & Cost: One Terabyte: 5,000 credits. Two Terabytes: 9,000 credits. Five Terabytes: 20,000 credits. 10 Terabytes: 35,000 credits. 25 Terabytes: 80,000 credits. 50 Terabytes: 150,000 credits.

Holographic Imager. This is a rather large add-on to the scanner. It can take any stored image and turn it into a 3D hologram. The scanner can rotate the image so it can be seen from various angles. As another option, the sensor data can be translated into 3D images for the user. Characters with the TV/Video skill can manipulate the hologram to do numerous things, like animate it, enlarge or shrink the image, superimpose images on one another, etc. Weight: 3 pounds (1.35 kg). Market Cost: 750,000 credits.

PSE-7500 Engineering Scanner

Built for quick diagnosis of problems arising from gas leaks, radiation surges, and out of sync Phase coils, the PSE-7500 is the perfect mate of engineers. When in the heat of space combat, seconds count, and when one's Phase Drive is leaking coolant, or the power to life support is down, it is the engineer's job to effect repairs as fast as possible. The Engineering Scanner is just the tool to help do that.

The scanner has two ports for additional data chips and the unit's base memory is 7 terabytes. It also has a built-in universal data jack just like the PSE-7000 and the following standard features.

Olfactory Sensor. A very sensitive scanning feature that can detect even the faintest amount of trace gases in the air. This scanning feature is meant to detect and warn against any type of

gas that might be harmful. Even if it's a harmless gas, it is detected and noted for future reference in case there is any type of change in the current atmosphere readings.

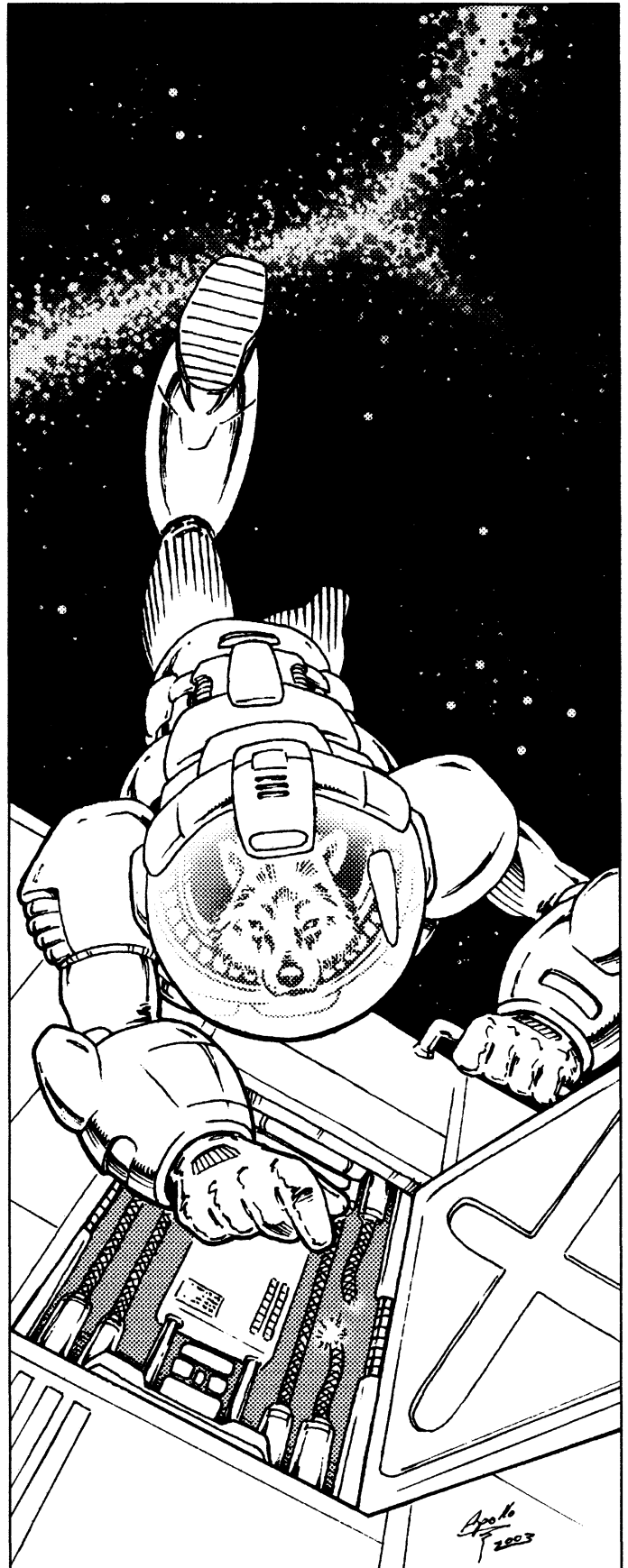

Metallurgy Scanner. This scanning function allows for damage or changes in metallic surfaces to be detected. It is primarily used to determine how much of the structural integrity is left in an object or structure. It takes about 15 seconds per 10 foot (3 m) area so larger bulkheads/structures may require several minutes of scanning to determine the overall integrity. In game terms, the scanner can give an estimate of how much M.D.C. is left with a plus or minus 5% margin of error. It's also useful for finding micro-fractures that may not be visible to the naked eye.

Phase Frequency Scanner. Different intensity Phase Fields have different frequencies, and the scanner uses these frequencies to determine the strength of the field. This feature is exclusive for engines that utilize Phase Drives, and can also be used to detect Phase Fields that the character may not know about. Range: 10 feet (3 m).

Gravitonic Sensor. Perfect for measuring the core pressure of any gravitonic drive, detecting very minute graviton emissions and gravitonic fields. While gravitonic engines are far sturdier than Phase Drives, they still require a delicate balance, and if the engines are imbalanced speed drops off dramatically. Keeping the engines in balance ensures an efficient running engine.

Sub-Atomic Micrometer. This measures the activity of sub-atomic particles like those found in nuclear and fusion power supplies. It can also monitor the reaction rate of antimatter reactors. It takes about a minute's worth of scanning (it has lots of shielding to get through) to determine the rate of the various reactors. Reactors with a high rate, or running hot, means that there is a problem. Likewise, if the reaction is running slow, it may be leaking or running low on atomic fuel. Range: 15 feet (4.6 m).

Magnetic Sensors. Good for measuring magnetic fields such as those used to contain antimatter or to measure the output of a force field grid. It can tell if the field is strong or weak and can tell if the field is failing. Range: 20 feet (6.1 m).

Battery. A small electro-cell provides power for 72 hours of continuous use or 800 activations (it has a bigger battery than the other scanners), whichever comes first. A small base with a built-in recharger is included. Batteries can be purchased separately at a cost of 5,000 credits per battery.

Weight: 3 pounds (1.35 kg). Market Price: 3,500,000 credits.

PSE-8000 Medical Scanner

The PSE-8000 Medical Scanner is another common sight in the Three Galaxies. It is carried by many physicians, especially those who don't have access to a large lab or fully equipped medical bay. For some field medics it's the only tool available to help them diagnose serious battlefield injuries. Even those not trained in the medical sciences can use the scanner, assuming they are trained in how to use portable scanning technology.

For individuals not trained in any of the medical fields the use of the scanner is equal to the Paramedic skill at 70% for diagnosing most medical problems. The scanner also has a built-in tutorial to help with the treatment of wounds and gives the character the Paramedic skill equal to 50% for treatment purposes. **Note:** Characters trained in any of the medical skills receive a

+10% bonus to their medical skill and the accuracy of the diagnostic scan is 95% (not 70%).

The scanner does have a few drawbacks, its limited range being one of them. The scanner is so finely tuned that it is ineffective at any range greater than 2 feet (.61 m). It is also limited in its ability to be expanded. There is only room for one additional data chip, and the memory of the scanner itself is limited to only 5 terabytes. Overall it performs well and is widely accepted by physicians. The following features are standard for the PSE-8000.

Ultrasound Diagnostic Tool. This function uses sound to help generate images of various organs, blood vessels and even unborn children. The scanner needs to be passed over the area three or four times to obtain an accurate image. Range: One foot (0.3 m).

Cat Scanning Function: The scanner uses the CAT scanning ability to show very detailed portions of anatomy. Range: 18 inches (0.35 m).

E.K.G. Function for measuring the heart and breathing rate. The scanner can give an exact reading on blood pressure and heart rate. It can also determine if the airways are obstructed or if there is liquid (like blood) in the lungs. Range: Touch; placed over the heart/chest or a major artery.

Bone Density Scanner. Similar in function to the densitometer, the scanner can give a detailed picture of the skeletal system. Breaks and fractures are highlighted on the plasma screen. Range: Two feet (0.6 m).

E.E.G. (electroencephalogram) Function. This function measures the electrical impulses in the body and brain. This is also used to measure brain activity and can tell when a person is at rest, agitated, or in a coma. Range: Touch.

Toxin and Plague Scanner. This analyzes the victim's blood for any foreign substances. The scanner has an extensive database on toxins and diseases and this greatly helps in the diagnosis of the patient. Range: Requires a blood, skin or saliva sample.

Battery: A small electro-cell provides power for 48 hours of continuous use or 200 activations, whichever comes first. A small base with a built-in recharger is included. Batteries can be purchased separately at a cost of 5,000 credits per battery.

Weight: 2 pounds (0.9 kg). Market Cost: 2,500,000 credits.

PSE Software Chips – Can be added to any PSE

Software chips are stand-alone programs that the personal scanner can run on its own or when prompted to do so. Unless otherwise stated, the user has a choice of downloading the information onto their unit's hard drive, or the scanner can run with the chip in one of its slots. The reason is just a matter of convenience, so programs can be swapped out with ease.

Alien Culture Database. This software is effectively the Galactic Lore skill at 75% proficiency. Just about all of the "known" races of the Three Galaxies are part of this comprehensive database (certainly all races who have appeared in this and any of the Phase World sourcebooks). Usually notable and important customs, rules, laws, ethics, holidays, religious ceremonies and aspects of the culture are what's covered. It will also have basic information about the home world, major cities, tech-

nology, space ports and animals, weather and other aspects common to the people or their planet. The information is so extensive that it requires two 100 terabyte chips. The data is accessed in a similar fashion to an archive, but if tied to a Bio-Unit, actual alien beings can be scanned and the corresponding world and cultural data presented once the being has been identified. Market Cost: 500,000 credits.

Computer Hacking Software. For those with computer skills this software is invaluable. By linking up the scanner and a computer, characters enjoy the benefit of a +10% bonus to their Computer Hacking skill. If the player does *not* have the Computer Hacking skill the scanner can hack on its own with the aid of the artificial intelligence add-on, at which point it has a base 40% chance of success. Market Cost: 150,000 credits.

Cryptography Database. Whether written, electronic, or digital, this software has dozens of mathematical equations to help break codes, as well as offering hundreds of suggestions and pre-made codes ready for its user to encrypt any type of message. If the user has the Cryptography skill they have a +10% bonus to their skill when using the scanner. If this software is used in conjunction with the language translator there is an additional +5% bonus. Market Cost: 500,000 credits.

Electronic Lock-Pick Unit and Software. This software and add-on package is not a standard product, rather it is made by several *underworld* companies and sold on the Black Market for those that know how to use it. Similar to the Universal Jack, a universal “key” with a cord is attached to the scanner. The key is inserted or swiped and the scanner begins to decode the locking mechanism. Depending on the complexity of the lock it could take anywhere from 30 seconds to several minutes to decipher the code and open the lock. Roll 1D4x30 seconds. The unit has a 60% chance of success. The software takes up 2 terabytes on the scanner. Market Cost: 1 million credits and only available through the black market.

First Aid. This software program is can only work if the Bio-Unit option is part of the PSE. By scanning an individual the PSE can determine a treatment with an accuracy of 68%. It requires at least 30 seconds (two melee rounds) of scanning in order to get an accurate reading. Instructions on treatment are listed on the display. The customer has a choice of downloading this information onto the unit’s hard drive (takes up 5 terabytes) or they can simply keep the chip in one of the memory slots. Market Cost: 50,000 credits.

History Library Database. This database is something of an encyclopedia with extensive information on galactic events, galactic history and galactic politics. It is the equivalent of Galactic Lore (focusing on history and important Galactic events) at 66%. The data is on a 50 terabyte chip. Market Cost: 25,000 credits.

Language Translator. This software chip gives the scanner the ability to become a language translator. It is not as convenient as a standard translator, but can work just as well. Also, by scanning documents it can translate the written word as well. Obviously it only works for spoken and written languages. It comes standard with the 60 most common languages of the region it’s sold in. Each chip consists of 25 terabytes. Market Cost: 27,000 credits.

Legal Database. This detailed database covers the laws, trade regulations, contraband, fines and penalties for the various

legal systems found throughout the Three Galaxies. The CCW, TGE, FWC and UWW are covered in greatest depth and detail, providing the skill equivalent of Law at 80%. Lesser-known courts like those on individual planets are only at 55%. This is very helpful information when entering a new sector of space that has their own laws and ways of doing things. Other useful information can be found like legal protocol and notable customs, as well as legal procedures. This information is contained on a single 50 terabyte chip. Market Cost: 250,000 credits.

UWW Arcane Scanner ARS-500

When the Consortium first made contact with the United Worlds of Warlock (UWW), the two exchanged technologies. The CCW presented several of the latest scanners along with an assortment of medical technology. The Dwarves were fascinated with the scanners and have since incorporated aspects of magic in them. Today, they are about the size of a paperback book with several unusual metallic protrusions. Instead of buttons they lined with semi-precious stones that activate the various functions when touched in a specific sequence and one P.P.E. point (or two I.S.P.) is expended to activate.

The UWW sells the magic-based equivalents of all those scanners listed previously. It is really the same basic unit with a magic power source. The ARS-500 “arcane” scanner goes a step beyond the norm. Several spell-like abilities are built into the ARS-500 as follows, all spells are equal to a sixth level practitioner of magic.

Ley Line Sensors: The unit can sense ley lines at a range of 1.5 miles (2.4 km), nexuses at a range of 3 miles (4.8 km) and Rifts at a range of 6 miles (9.6 km). While most mages can sense these ley line anomalies, the scanner can actually provide a distance and direction to the ley lines. Track ley lines is equal to 70%. P.P.E. Cost: 20 per hour.

Sense Supernatural Evil: Useful when tracking entities, vampires, demons and other evil, supernatural beings. (Does not include dragons and other creatures of magic.) The range is limited to 450 feet (137.2 m). P.P.E. Cost: 2 per 12 minutes of use.

Sense Magic: The scanner can detect magic as per the spell in a 120 foot (36.6 m) area. P.P.E. Cost: 4 per 12 minutes of use.

Decipher Magic: By passing the scanner over various magic texts, the scanner has the equivalent of the Decipher Magic spell with a 72% level of accuracy. P.P.E. Cost: 10 per six minutes.

Presence Sense: The scanner can detect and indicate the number of non-animal presences (humanoids and supernatural) within a 120 foot (36.6 m) radius (can be adjusted for a smaller area as necessary). P.P.E. Cost: 8 per 12 minutes of use.

See Aura: The scanner is able to display on a small plasma screen a person’s aura. This option works the same as the spell. P.P.E. Cost: 6 per person.

P.P.E. Battery: The scanner has a rechargeable battery that powers all functions. However, like any Techno-Wizard device, the user can opt to pump their own P.P.E. into the scanner.

ARS-500 Weight: 4 pounds (1.8 kg). Market Cost: 3,500,000 credits.

Additional Magic Features:

For an additional cost, the following mystic properties can be added to the ARS-500. They can *only* be used in UWW scanners.

Tongues: Functions the same as the spell, enabling the scanner's user to understand any language; requires a special ear-piece linked to the scanner. To respond, the scanner operator speaks into the scanner and it transmits an audio voice response in the tongue the other person spoke in. Level of accuracy in the translation is 97%. P.P.E. Cost: 8 per 18 minutes of use. Market Cost: 250,000 credits.

Eyes of Thoth: By passing the scanner over text, it is instantly translated and displayed on the scanner's display screen. This scan and written word translation of magic has basically the same limitations as the spell. P.P.E. Cost: 12 per 30 minutes of use. Market Cost: 1,150,000 credits.

Sense Dimensional Anomaly: As per the spell; a number of dimensional anomalies can be sensed. P.P.E. Cost: 30 per 12 minutes of use. Market Cost: 1,000,000 credits.

See Dimensional Anomaly: As with the spell, once a dimensional anomaly is found this function allows it to be seen on the scanner's display screen. P.P.E. Cost: 30 per 12 minutes of use. Market Cost: 1,000,000 credits.

Notable Medical Equipment

Auto-Medic

The Auto-Medic is an automated medical system meant for easy use by untrained individuals. Those who can afford it, have them installed in place of hiring a doctor. It is a large cylindrical structure filled with a healing solution. A wounded individual is lowered into the vat, and floats there via a contra-gravity field while the cylinder is filled. The base of the machine has all of the scanners, mechanics and millions of terabytes of medical information it needs to mend bones, repair internal bleeding, treat illness, etc. Installed on top is a transparent cylinder filled with an oxygenated saline solution. In the solution are proteins, lipid lattices (fat cells used in the repair of large open wounds and the cells are arranged in a lattice) and approximately a hundred million nanites. The nanites do all the repairs using what's in the solution as building materials. These nanites are possibly the most advanced and sophisticated in the Three Galaxies. Not only do they have the built-in tools to conduct all types of cellular repairs, they're also directly linked to the computer at the base of the Auto-Medic. This allows for instantaneous diagnosis, up to the minute progress of the patient and even allows an operator (doctor) to jack in and manually direct the nanites to certain body locations if needed. The medical computer is also the latest in artificial intelligence and in certain cases, all someone has to do is put the wounded person in the tank and start the Auto-Medic up. It will automatically diagnose all problems and begin immediate treatment. The Auto-Medic has the Medical Doctor/surgery skill at 85% to diagnose and 90% for treatment. (Don't even roll for obvious, simple medicine like repairing cuts, abrasions, broken bones, dysentery, food poisoning, etc.;



all are automatically repaired with no or minimal scarring or side effects.)

The Auto-Medic does have its limits. First, it cannot treat supernatural or magical creatures. The body types are far too different and alien for the machine. Second, non-mammalian races take twice as long to heal and the accuracy of diagnosis and repairs are -20% (and -50% for amphibians, fish, and insectoids). This would include races like the Seljuk, Nixie, Skaa, etc. Third, the race has to be an oxygen breather in order to survive in the oxygenated solution. So while it is a modern medical miracle, several of the more alien races are a bit perturbed that they can't benefit from it. New saline solutions are constantly being created and tested, but so far, no one has been able to create a universal solution. A few custom solutions have been created, but are race specific. The solution is drained and sanitized each time it is used. The nanites go to a special housing where they can recharge.

Treatment: Heals 2D6 Hit Points/S.D.C. per hour. It uses the body's own clotting agents to stop the flow of blood from grievous wounds.

Market Cost: The total unit cost is 35 million credits. The oxygenated saline solution costs 5,000 credits per batch.

Additional enhancements and features for the Auto-Medic: In addition to being able to treat the wounded, the enhancements listed below can be added to the basic system. Each has its own set of programming parameters and has to be administered by a trained technician – a Medical Doctor who can make certain everything is going along proper procedures (and to jump in if there are complications or unexpected problems). The prices listed below are what each special function costs to add to the basic Auto-Medic. Any or all can be purchased.

Cybernetic and Bionic Repair: Basic implants can be surgically implanted and removed, as well as damage to cybernetic and bionic systems repaired. Artificial organs can also be repaired. **Market Cost:** 38,500,000 credits for the system, plus the cost of the cybernetic implant or repair material (the latter costs 10,000 credits for simple/minor repairs, 50,000 credits for serious repairs and 100,000 credits for traumatic and critical repairs).

Tissue & Muscle Reconstitution: The character's S.D.C. can be increased through this process. The epidermis (the skin) and muscle structure is made tougher and more durable through an increase in its mass, density and other enhancement. This process is accomplished through the injection and stimulation of cellular proteins that causes the cells to divide at a controlled rate. The maximum increase one can get through this "boosting enhancement program" is 2D6+30 to their S.D.C., 1D4 to P.S. and 1D6 to Spd.; all are one time benefits and can *not* be boosted any higher by undergoing multiple procedures. However, this process can be used for super-quick physical therapy to rebuild and strengthen muscles that have atrophied or been damaged by trauma (injury, malnutrition, torture, etc.) or debilitating illness; restores them to normal in under two weeks. It also can remove tattoos and scars. **Cost:** 45 million credits for the system. **Note:** The "booster" procedure takes one 2D6+10 hour session, while therapy typically requires four, 1D4+3 hour sessions over a 7-10 day period, with each session restoring

25% of the character's lost S.D.C. and muscle strength (P.S., P.P. and Spd.). Torn and pulled/sprained muscles are restored as good as new with two and one hour treatments respectively; bruised muscles in 30 minutes.

Plastic Surgery: The body can be altered by various means. The basic facial structure can be modified – nose, lips, cheeks and/or chin can be made larger or smaller, thinner or heavier/fuller; wrinkles can be removed, the skin made tightened to look firmer and younger, blemishes, warts, and even scars can be removed and the shape of the eyes altered (even the color can be changed). Likewise, the hairline can be altered and the hair colored. Major reconstructive surgery beyond this is not possible, nor is Cybernetic surgery. The P.B. of a character can be improved or reduced by six points. **Market Cost:** 30 million credits. **Note:** Time required for most surgeries is 1D6+6 hours; performed by the nanites.

Bone Repair & Augmentation: For those that can afford it, this is the quick fix to get stronger bones and increase healing of broken bones in as short a time as possible. This procedure builds bone mass and repairs bones on a molecular level, so breaks and torn cartilage are completely restored as good as new as if they were never damaged. Augmentation makes bones stronger: add 1D4 to Hit Points and 2D4 to S.D.C. Augmentation is a one time procedure. **Market Cost:** 25 million credits for the system. **Note:** Time required for hairline fractures and bone chips is two hours, complete breaks: 1D6+12 hours per each break. The repair of shattered bones requires six, 2D6+12 hour sessions. Severe muscle damage may require treatment by the Tissue & Muscle Reconstitution system or require additional surgery and time to heal (weeks).

Other Common Medical Equipment

Bio-Regenerator: This small hand-held device is used to treat minor S.D.C. wounds. Scrapes, scratches, bruises and minor lacerations and abrasions are its limits. The tissue regenerator can't repair all types of wounds, nor damage to internal organs, just surface injury that is less than 10 Hit Points or S.D.C. The bio-regenerator emits a pulse of simulated bio-energy on the same alpha wavelength that the brain uses when in deep sleep, as well as stimulates cell growth, and increases production of healing proteins and other chemicals in the body. This causes the tissue to rapidly mend and heal with little to no scarring.

Healing Limits: 50% of the damage is healed in 12 hours, the rest 24 hours after that. Must be applied to each wound separately. 01-88% likelihood of no scarring. 89-00% means slight scarring. Also works on burns, but some scarring will always occur; 01-50% barely noticeable, 51-00% noticeable but not terrible scarring. Patients must rest for 12 hours to let the initial healing take place and can be moderately active for the rest of the healing process. To ignore this requirement is to negate the induced healing process (no restoration of damage).

Weight of the Device: 2.5 pounds (1.1 kg).

Battery Charge: The bio-regenerator takes the same size batteries used in personal scanners. This gives it two hours of constant use or, 50 activations whichever comes first.

Cost: 8.2 million credits. 5000 credits per battery.

Notable Galactic Weapons

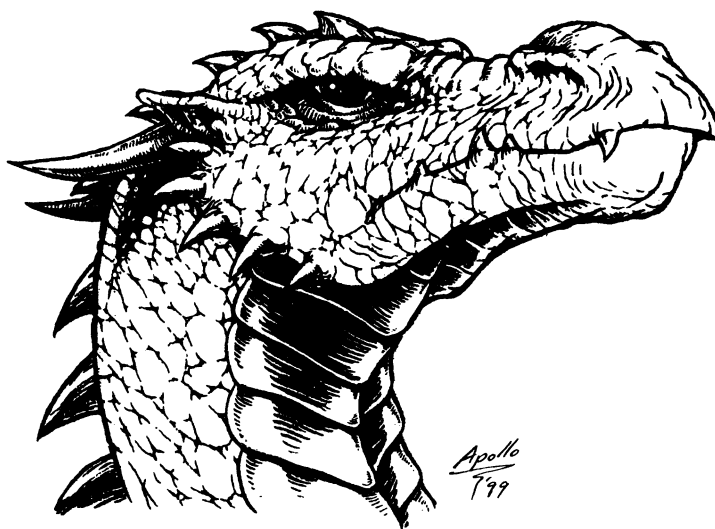

Draygon Industries (DI)

A new corporation recently breaking into the galactic economy is Draygon Industries. They first started off in Center, on Phase World, with a small shop selling only laser-based weapons. Soon after some great success on Phase World, they expanded their market to other military products and are even taking a bold step and selling their own style of star fighters.

Much mystery surrounds Draygon Industries, as little is known about them. Their main manufacturing center is hidden and a highly guarded secret. Even retail distributors don't know where they are located, because they pick up their share of products at prearranged locations. So far, the products sold have been good quality with little, if any, problems. Any products returned due to manufacturer's defect get a full refund or exchange.

Rumor suggests that one or more *dragons* run DI, but no one truly has any facts to back this up, only speculation due to the name of the company. Draygon Industries has remained a mystery long enough to Naruni Enterprises, who is losing market share to them (so far, only 5%, but that's too much for the Naruni), and they have covertly dispatched their network of spies to find out about this upstart manufacturer.

Draygon Industries Laser Series

Draygon Industries' first line of weapons was their laser series. To make these weapons a hot commodity, DI wanted to market variable laser weapons. The problem with making a variable laser weapons is first, the power consumption, and next the

Jump Start Stimulant: This is a medic's last option to save a dying patient. This is a powerful adrenalin based mix that gives the body one last boost. Characters who have made a save versus coma/death roll and failed can make a second roll at +15% after treatment. At the Game Master's discretion, a second dose can be given, but with no bonus. The character simply receives one final roll and either makes it or passes away.

Applications: They come in prepackaged syringes with a single application.

Cost: 1500 credits per dose. Typically comes in a batch of 10 so the price is 15,000 credits per package of 10 pre-filled syringes.

Knockout-Spray, or KO-Spray: This cocktail is a combination painkiller and anesthetic. It's most commonly used for patients in great pain, or to knock out uncooperative patients. The uncooperative patient needs to save versus non-lethal poisons/toxins at 16 or higher. Willing patients who don't fight the anesthetic do not roll to save, the effect is automatic.

Applications: They come in prepackaged spray cans similar to the kinds used for asthma sprays but with only two applications.

Range: 8 inches (0.24 m).

Cost: 10,000 credits per two dose spray can.

Neutralizer Anti-Toxin: This lifesaver is truly a universal serum. It is able to totally neutralize or reduce the damage caused by most poisons. It is most effective if used within three melee rounds (45 seconds) of being poisoned. The neutralizer stops most poisons that do 5D6 points of damage or less per round. Anything more powerful only has its duration reduced by one half. Multiple applications are only effective if the character was poisoned multiple times. Any medic will administer one dose per bite to obtain maximum effect. While a powerful drug, the neutralizer only works after the fact, and people can't inject themselves ahead of time. Since most anti-venoms are made with weaker strains of poison, the character ends up poisoning themselves, doing 2D6 S.D.C./Hit Points per melee for 2D4 melees. Save would be vs lethal toxins.

Applications: Comes in prepackaged syringes with a single application.

Market Cost: 2,500 credits per dose and they are typically sold with five per package at a cost of 12,500 credits.

Spray Skin: A small hand-held container that covers cuts, bruises and abrasions with a flesh colored antiseptic and protein healing liquid that dries to the touch in one melee round (15 seconds), becoming a bandage that moves with the skin, doesn't peel off and protects the wound while increasing the healing process. Any cut or scrape that is five Hit Points or less heals completely without scarring in 6D6+12 hours and stops blood loss. It also prevents infection. This organic bandage is standard in most First-Aid kits.

Applications: The spray container holds 12 applications.

Note: The spray skin is only a temporary fix. If the character goes back into battle there is a 20% chance plus 2% per melee round that the bandage is torn and the wound reopens (1D4 damage plus possible blood loss).

Market Cost: 100 credits per pocket-sized spray can.

need to keep the weapon cool. This was typically solved by making a weapon that was a little clunky looking, with a large clip and cooling system incorporated into the design. DI has stolen this market with an aesthetically pleasing series of variable lasers. Several HI-laser weapons were reverse engineered to help produce the DI laser series with some significant improvements. The final result is a weapon that uses a combination of gases including argon, krypton, and radon, plus an ingenious redesign of the internals of the weapon to keep it cool and relatively slender and appealing. The cooling formula is a highly guarded secret of Draygon Industries. Even if a rival corporation was able to break down the exact molecular structure they would still have to figure out how to combine them, as a catalyst is used to combine the elements in the correct proportions.

The power consumption problem is still being addressed. The only innovation is a rechargeable power cell for the weapon. Using a new construction technique the Energy-Clips were redesigned to be rechargeable. They incorporated a micro-power cell at the base of the clip. The real heart of the weapon is the microprocessor affectionately called the *dragon's heart*. It has data regarding all known manufactured laser resistant armors and it takes the processor only a half a melee round to find a laser frequency that inflicts full damage (all prior shots do half damage). If the armor is unknown or alien, it takes 1D4+3 melee rounds to analyze and counter. If the armor is of a totally alien design the G.M. may determine that a full damage frequency can not be found and all attacks do half damage to the laser resistant enemy. The computer adjusts the frequency automatically, unless an override command is given. This is a matter of using the manual select button on the grip of the weapon. By pressing the button once, the laser stays at its current, unchanging frequency, press it twice to begin its variable search mode.

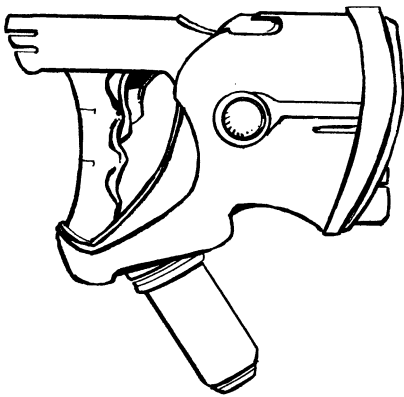

Dragster V.L.P. (Variable Laser Pistol)

The Dragster variable laser pistol is a slimmed down version of the HI-30. It doesn't quite have the stopping power of the HI-30, but it does surpass it on range. It also chews through laser resistant armors like a hot knife through butter.

Weight: 4.5 pounds (2.0 kg).
Mega-Damage: 2D6+4 M.D.
Rate of Fire: Standard.
Effective Range: 1250 feet (381 m).

Payload: 20 shots per E-Clip.
Cost: 20,000 credits.

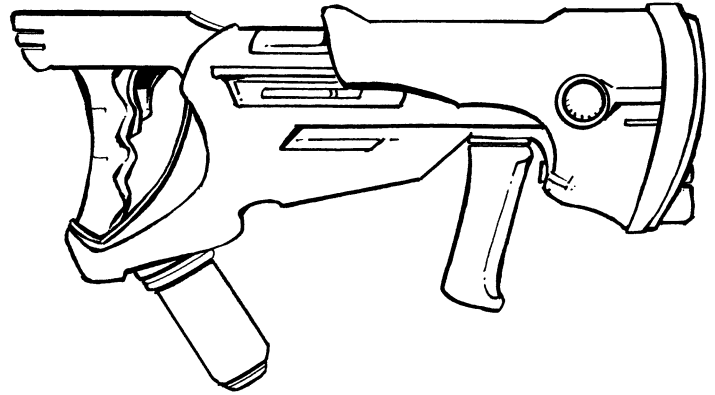

Dragon's Eye V.L.R. (Variable Laser Rifle)

A rifle version of the Dragster V.L.P., this weapon surpasses most rifles with damage and range. It is a recent addition to the weapons markets. As of yet, DI doesn't have any contracts to supply any major powers in the Three Galaxies, however several mercenary organizations, including Justice Inc., have bought mass quantities of the weapon.

Weight: 9 pounds (4.0 kg).
Mega-Damage: 5D6 M.D.
Rate of Fire: Standard.
Effective Range: 2700 feet (823 m).
Payload: 30 shots per E-Clip.
Cost: 55,000 credits.

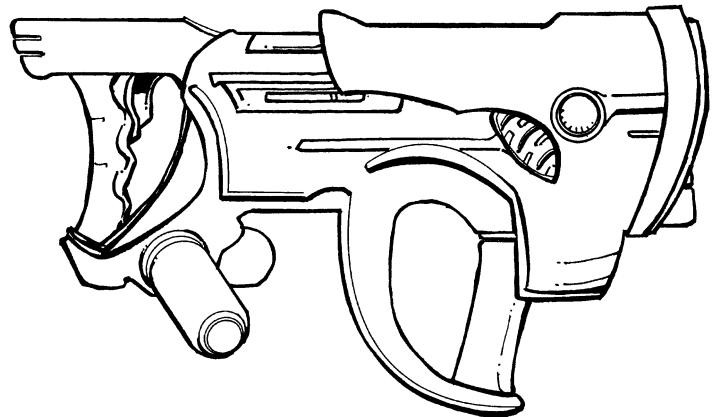

Vengeance V.L.C. (Variable Laser Cannon)

A one-man laser cannon with devastating power. Originally conceived as a power armor weapon, DI decided to take a risk and sell the weapon on its own. It is a gamble that has paid off, because it is slowly making a name for itself among the best mercenary groups.

Weight: 25 pounds (11.3 kg).

Mega-Damage: 1D6x10+6 M.D.

Rate of Fire: Standard.

Effective Range: 4000 feet (1219 m).

Payload: 10 shots per clip, 100 with backpack, 30 per hip pack.

Cost: 175,000

Penalty: Characters with a P.S. less than 20 must use both hands and prop the weapon against their shoulder. Using one hand or no shoulder bracing has a penalty of -4 to strike.

Dragon Industries Storm Series

The concept design behind the Storm series is to make an anti-cyborg, anti-power armor, and anti-robot weapon suitable for use by unaugmented soldiers. These weapons are gravity accelerated slug throwers with a twist. It's not the velocity of the weapon that does the damage, it's the explosive impact. The weapons fire small pellets that have a poly-adhesive surface. They stick to almost everything, including force fields (for 1D4 melee rounds). The pellets can be rigged to explode via a timer or to explode on impact. The range of the detonator is relatively short (approximately equal to the weapon's range), but the effects of the weapon are devastating. The Demolitions skill must be known in order to access the use of the variable settings of the weapon. At the moment, Dragon Industries has the market cornered with these new weapons. In two to four years, however, the market should be full of bootleg copies of the ammunition. **Note:** The weapons cannot use conventional gravity rifle rounds. A person with the Armorer skill would need several days and at least three successful rolls to convert the weapon.

A special note in regard to carrying these weapons. First, they are only legal to carry in non-Consortium worlds. The CCW quickly outlawed these weapons when hundreds of civilians were injured and 57 killed aboard a space station when a weapons runner was caught smuggling the weapons. A firefight erupted between him and the TVIA inspector, and the result was the death of the runner when he breached the hull of the station, killing himself and dozens of civilians. Consequently, they are banned from most space stations.

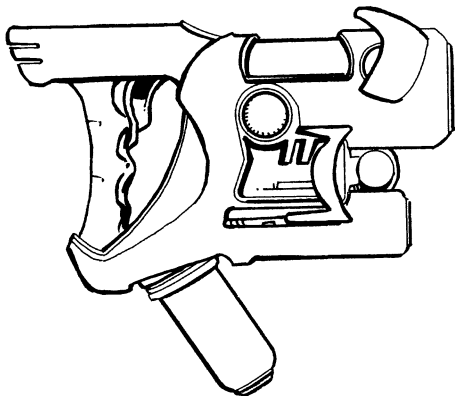

Little Storm

This pistol is accurate and despite its weight, suitable for use by most humanoids, though two hands may be required to shoot accurately. Damage wise it's not all that powerful, but a skilled

marksman who can place the rounds in the right location can end up blowing off the limbs of cyborgs and robots, and crippling power armor. The only drawback to using this pistol is its unique ammunition.

Weight: 5 pounds (2.3 kg).

Mega-Damage: 1D6+3 M.D. per shot with a blast radius of 1 foot (0.3 m).

Rate of Fire: Single shot, each squeeze of the trigger counts as one attack.

Effective Range: 600 feet (183 m).

Payload: 20 single shots per clip.

Cost: 40,000 credits.

Note: Ammunition cost is 50 credits a shot or 800 credits per full clip.

Penalty: Characters with a P.S. less than 11 must use both hands; using one they are -2 to strike.

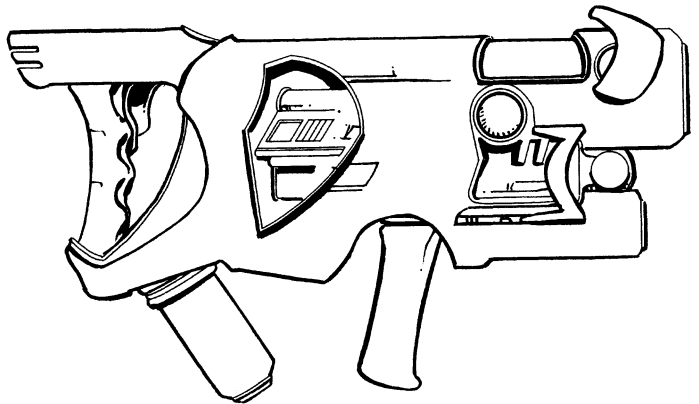

Lightning Storm

The Lightning Storm is a rifle with its own set of ammo that is slightly larger and packs more punch. The weapon also has a selector for semi-automatic, single shot, three or six round burst. The only limitation to this weapon is its unique ammunition. Anyone hit by a burst from this weapon must roll a 12 or better on a D20 to stay on their feet (P.P. bonus is applied). If a failed roll occurs the character is blown off his feet, loses one melee attack and is stunned for the remainder of the melee round: Loses initiative and is -2 to strike, parry and dodge. **Note:** Force fields reduce the roll by one third. i.e.: 8 or better.

Weight: 10 pounds (4.5 kg).

Mega-Damage: 2D6+1 per single shot (blast radius is one foot/0.3 m), a three round burst does 6D6+2 and a six round burst does 1D6x10+10. A burst counts as one melee attack but does not get an aimed shot bonus.

Rate of Fire: Single shot or burst.

Effective Range: 1500 feet (457 m).

Payload: 60 rounds per clip.

Cost: 110,000 credits.

Note: Ammunition costs 100 credits per round or 6000 credits per clip.

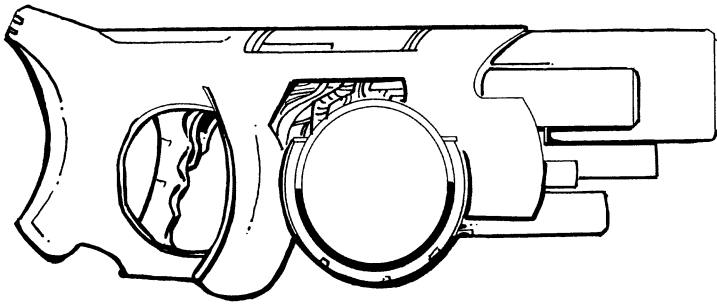

Stormstrike

The Stormstrike is considered a lightweight rail gun. While range is considerably shorter than most rail guns, the damage capacity is superior. Anyone hit by this weapon must roll a 15 or better to stay on their feet (P.P. bonus is applied) or they will be blown to the ground, lose initiative and half their attacks for the rest of that melee round and are stunned: Reduce bonuses to strike, parry, dodge, disarm, and roll with impact by half. **Note:** Force fields reduce the roll by a third. i.e., 10 or better.

Weight: 25 pounds (11.3 kg).

Mega-Damage: 2D6+2 per single round to a 2 foot (0.6 m) area, or 6D6+6 for a three round burst, 2D4x10+2 for a six round burst and 2D6x10+3 for a nine round burst.

Rate of Fire: Standard.

Effective Range: 2200 feet (670.5 m).

Payload: 100 rounds.

Cost: 250,000 credits.

Note: Ammunition costs 200 credits per round or 18,000 credits for a complete reload.

Penalty: Characters with a P.S. less than 20 must use both hands; using one they are -4 to strike.

Dragon Hide Series of Body Armor

In an effort to counter other laser-based weapons, Draygon Industries has created the V.P.A. series of battle armor called Draygon Hide. The armor isn't really made from a dragon's hide, but rumor suggests it is. V.P.A. stands for Variable Phase Armor. A ceramic based armor connected to a Phase Field generator that is calibrated to deflect amplified light (lasers). Combined with an already laser resistant material, this greatly reduces the damage from lasers; damage is reduced to 1/10 normal damage; round down.

Damage is initially $\frac{1}{2}$ until the computer is able to determine the best frequency to counter. This usually takes one full melee round (15 seconds). The same chip used in the DI laser series is also used in the armor. The Dragon's Heart chip stores hundreds of known laser products and their frequencies, so it can usually provide maximum protection in one melee.

The armor does have one unusual aspect to it. The combination of the laser resistant material, and the variable Phase Field gives it an unusual aspect to its appearance. It looks gold, but when light shines on it from various angles it gives the armor an almost rainbow effect, kind of like when you mix gasoline and water. When the Phase Field is turned off, the armor has a shiny chrome appearance. Also, because of the material used plus the fact that a Phase Field is added to the armor, is high priced com-

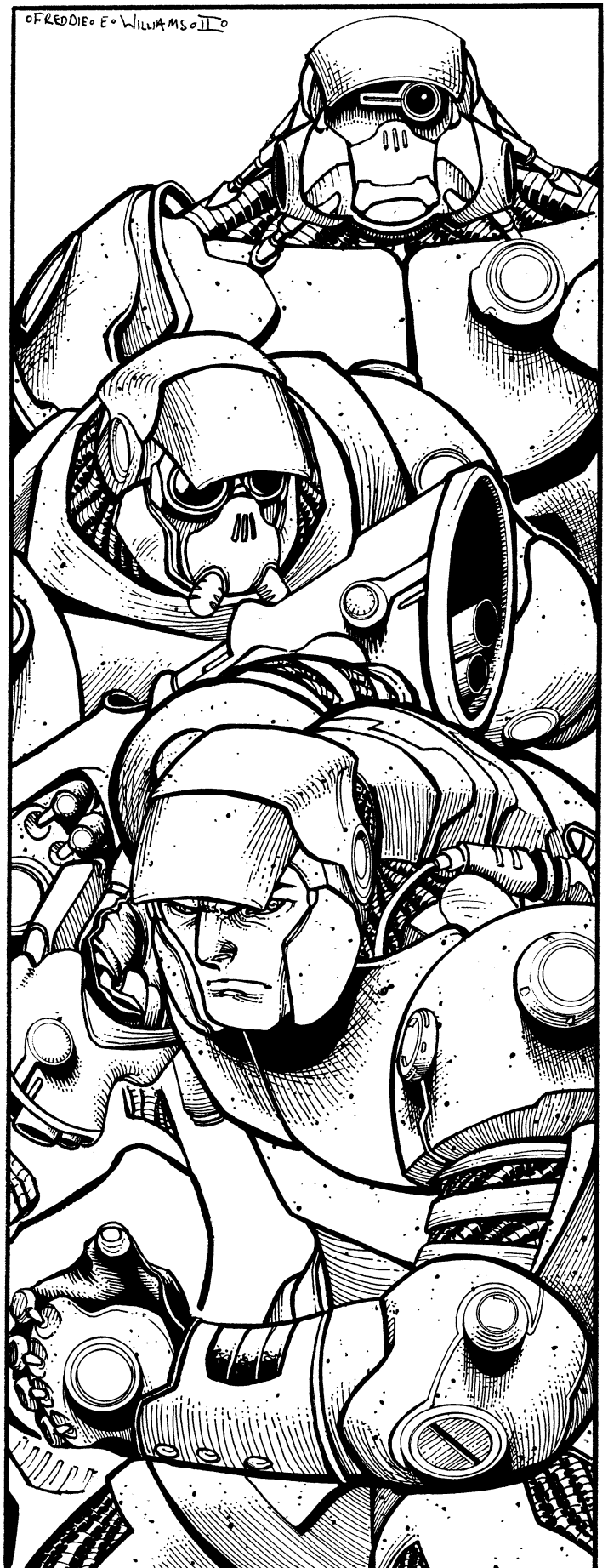

pared to other armors. However, an added bonus was discovered that when the Phase Field is active, the individual is invisible from infrared detectors and optics, though not from thermal sensors and optics.

The armor is fully environmental and also has all the standard features of armor sold in the Three Galaxies.

Light Dragon Hide

This is the lightest suit of armor currently offered by DI.

- M.D.C. by Location: Main Body: 60, Legs: 45, Arms: 30, and Head: 50.
- Weight: 18 pounds (8.1 kg).
- Good mobility: -5% to physical skills and -10% to prowl.

Market Cost: 75,000

Medium Dragon Hide

This is the next step up. The armor is slightly more bulky and offers less mobility.

- M.D.C. by Location: Main Body: 100, Legs: 80, Arms: 60, and Head: 75.
- Weight: 25 pounds (11.3 kg).
- Fair mobility: -10% to all physical skills and -15% to prowl.

Market Cost: 150,000

Heavy Dragon Hide

This is the heaviest body armor and is very bulky and clumsy. That's why it has built-in servos to help assist the user.

- M.D.C. by Location: Main Body: 175, Legs: 120, Arms: 100, and Head: 100.
- Weight: 55 pounds (24.8 kg).
- Poor mobility: All physical skills are -15% and -20% to prowl.

Market Cost: 250,000

Dragon Grenades

The full range of Phase World grenades.

Strata Crystal Technology

This unique technology was developed by a race called the Strata. They have the natural ability to shape crystal into many forms. This ability is primarily used to create their homes and various types of equipment, but also weapons. While not combative by nature, the Strata understand the need to defend themselves. The following weapons are created and used exclusively by the Strata. Other races have tried to duplicate some of them, but have failed. The very nature of the Strata is what makes these weapons unique. It should also be noted that these weapons are illegal on most Consortium worlds and they are commonly referred to as *stealth weapons* since they easily avoid most forms of weapon detection. On occasion, Strata leaders give one of their weapons as a gift or reward to outsiders, such

as heads of state, valued friends and heroes who have risked their own lives to protect the Strata or serve some other valued service.

Crystal Throwing Stars & Spikes

These are small, super sharp crystal shards or shurikens made for throwing. Like the rest of the Strata crystal weapons, they can inflict Mega-Damage without a power source.

Mega-Damage: 1D4+1 M.D. for both types of weapons.

M.D.C. of the Weapon: 20

Range: Thrown, varies per P.S.

Market Cost: 8,000 credits per star or spike.

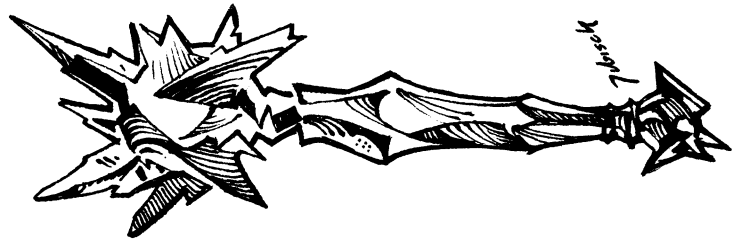

Crystal Mace

Some maces have stone shafts and crystal heads while others are carved from a single crystal. These weapons tend to be large and bulky, but are still sought after for their ability to deal out Mega-Damage without needing a power source.

Mega-Damage: 2D6 M.D.

M.D.C. of the Weapon: 200

Market Cost: 55,000 credits. Rarely bought on the Black Market, but often goes for double the normal price.



Crystal Dagger

Carved from a single piece of crystal, these blades are of superior craftsmanship. In fact, they are so sharp that they can inflict Mega-Damage. More unique is that they do not require a power source, making them ideal for assassins or covert operatives. Typical color of the blades is a light green, but just about any type of crystal can be carved. Rare colors increase the price by as much as 50%.

Mega-Damage: 1D6 M.D.

M.D.C. of the Weapon: 50

Market Cost: 35,000 credits! Sometimes double if bought on the Black Market.



Crystal Sword

Crystal Swords are also carved from a single piece of crystal. As with the daggers, these swords can inflict Mega-Damage without a power source. The color of the crystal is also the same as the daggers.

Mega-Damage: Short Sword: 2D6 M.D., Large Sword: 3D6 M.D., or Two-Handed Sword: 4D6 M.D.

M.D.C. of the Weapon: 150

Market Cost: 50,000, 75,000 and 150,000 credits respectively.

The price can double or triple on the Black Market depending on availability.



Strata Crystal Disrupter Pistol

The Crystal Disrupter pistols work on similar principles as Noro weapons. The Strata have also discovered the nature of Psylite and its properties. However, that's where the similarities end. The Strata Crystal Disrupter fires a concentrated blast of anti-protons that literally disrupts or tears away the chemical bonds that make up matter. These devastating weapons are highly illegal in the CCW, as they are hard to detect when not in

use. Still, the occasional weapon ends up in the hands of the Black Market, adventurer or on the streets of Center.

Weight: 5 pounds (2.3 kg).

Mega-Damage: 5D6.

Rate of Fire: Single shot only.

Effective Range: 400 feet. (122 m).

Payload: As per individual. To fire this weapon the user must pump his own I.S.P. or P.P.E. into it. A single shot requires the user to expend 5 I.S.P. or 10 P.P.E.

Cost: 100,000 credits is the typical price on the Black Market, but can sell for two or three times that cost.

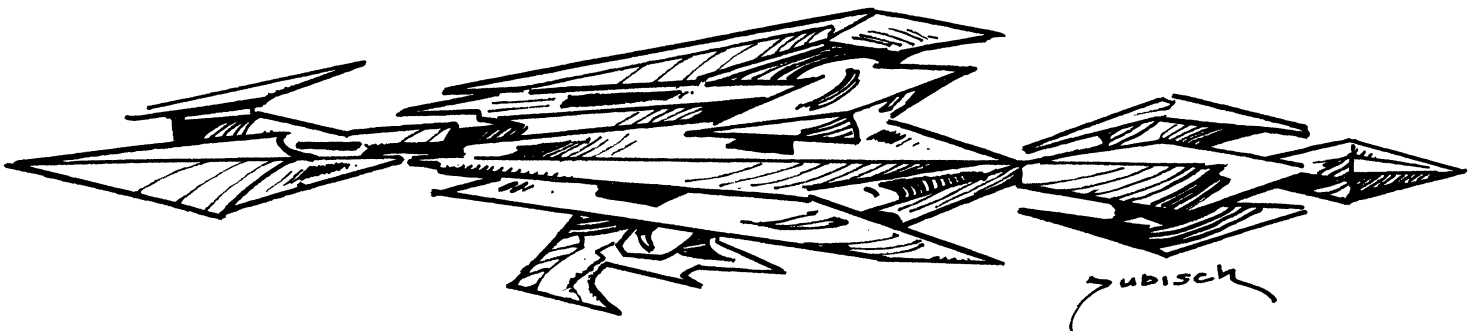

Strata Crystal Disrupter Rifle

Fundamentally the same as the pistol only with a longer range. Also highly illegal in the Consortium of Civilized Worlds.

Weight: 11 pounds. (5 kg).

Mega-Damage: 5D6 or 6D6+6.

Rate of Fire: Single shot only.

Effective Range: 1,200 feet (366 m).

Payload: As per individual. To fire this weapon the user must pump his own I.S.P. or P.P.E. into it. A single 5D6 M.D. shot requires the user to expend 5 I.S.P. or 10 P.P.E.; a 6D6+6 M.D. blast costs 8 I.S.P. or 16 P.P.E.

Cost: 250,000 credits is the typical price on the Black Market, but they can sell for two or three times that cost.

Necrol Living Weapons

– Organic Technology

Organic technology is far from popular in the Three Galaxies. The majority of races rely on either non-organic technology or weapons that combine tech and magic. To many people in the Three Galaxies, organic weapons and machines seem unwholesome and something truly alien. It's not surprising then that most races that adopt this form of technology are quite alien themselves and often at odds with the rest of the organized worlds. Take the Necrols for example, they firmly believe that the Three Galaxies are utterly contaminated and therefore, corrupt and must be cleansed. Organic technology wielded by the Necrols is something to fear.

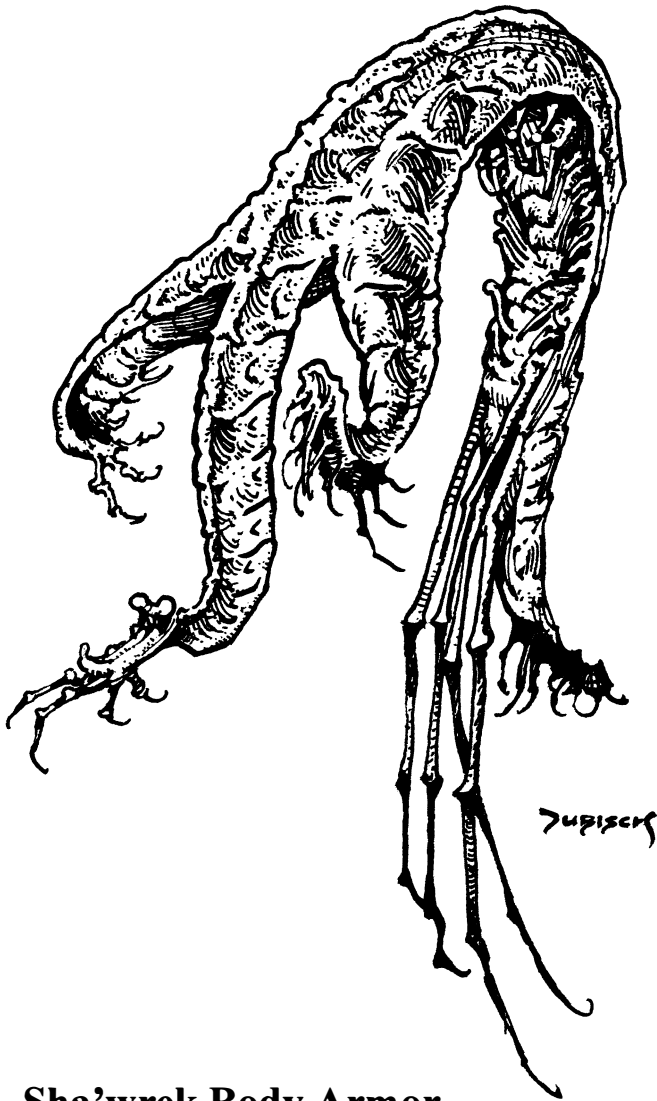

Sha'wrek Body Armor

By itself this living creature appears as a segmented insect. To join with a Necrol, the creature wraps itself around the host, providing a sort of body armor. The creature is large enough to cover all major portions of the body. Unlike the other organic creatures the Necrols use, they don't train the Sha'wrek to fight alongside them, it is more like a symbiotic part of them.

Attributes of Note: I.Q. 4, P.S. 18, P.P. 20, P.E. 18, Spd. 20.

M.D.C.: 1D6x10+44.

Weight: 50 pounds (23 kg).

Market Cost: If they were available on the market the cost would be 90,000-120,000 credits.

Note: This armor is not environmental, it is a living being.

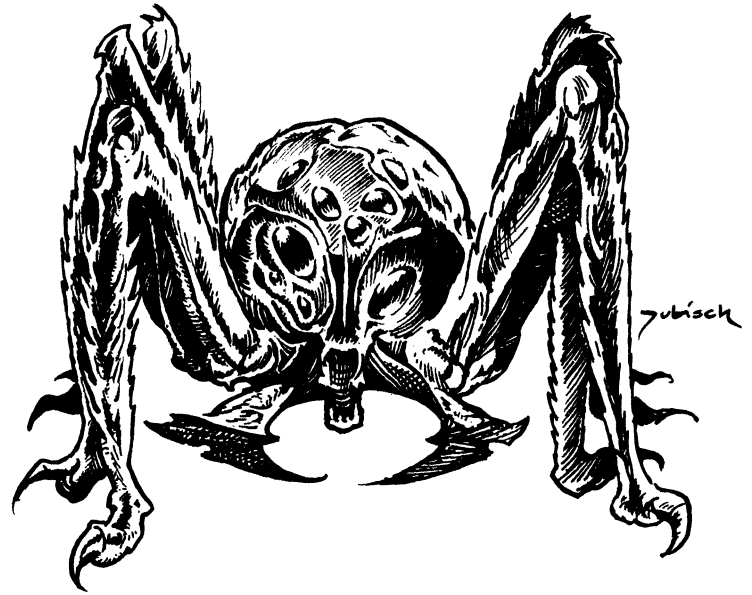

Scorpa Energy Pistol

The Necrol version of an energy pistol is a small arachnid called a Scorpa. It wraps its legs around the wrist of the Necrol, so all they have to do is point and shoot; the creature fires on command. Each time the Scorpa is prompted, it fires a bolt of energy. The Scorpa is a parasite and forms a symbiotic bond with the Necrol shooter, feeding on his P.P.E. to survive, and the Necrols have plenty of it. The Scorpa uses P.P.E. to fuel its energy bolts too, so when it runs out of P.P.E. it gorges on the Necrol's. They, like the Sapree, can also fight alongside the Necrol.

Attributes of Note: I.Q. 5 (highish animal intelligence), P.S. 7, P.P. 18, P.E. 16, and Spd. 22.

Weight: 2-3 pounds (0.9 to 1.35 kg).

Mega-Damage: 2D6 M.D. for a low-powered shot, 3D6 for a medium-powered shot and 4D6 M.D. for a high-powered blast.

Rate of Fire: Each blast counts as one of the shooter's melee attacks/actions.

Effective Range: 900 feet (274 m).

Payload: Depends on P.P.E. reserve. The Scorpa typically has 50 P.P.E. of its own specifically for its energy blast (a natural defense). The low-powered blasts cost 5 P.P.E., medium cost 10 and the high-powered blasts cost 15. The Scorpa can also draw P.P.E. directly from the Necrol.

Cost: 40,000 to 60,000 credits.

Note: The Scorpa is capable of fighting on command. It has 2D4 M.D.C., three attacks per melee round, is +1 to strike and +2 to dodge, can leap 10 feet (3 m) high or across, Swim 45%, Climb walls like an insect and rappel 94/88%, Prowl 60%, and has a good running speed. It is also +1 on all saving

throws. Claw attacks do 1D6 S.D.C. and the bite does 2D6+3 S.D.C. damage. It looks like a blue spider with black highlights and eight red eyes. It has long, sharp mandibles, from which the energy blast comes.

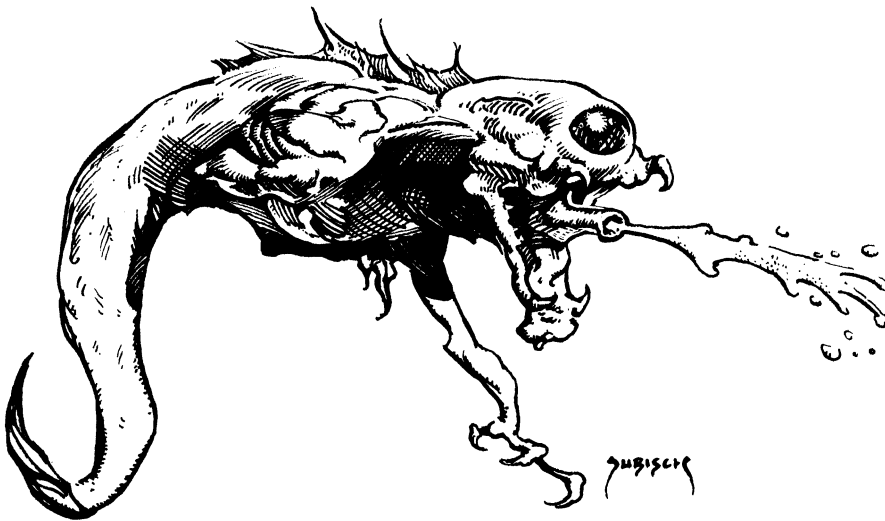

Sapcree Energy Pistol

The Sapcree is a small lizard-like creature about the size of an average pistol. The creature is about 10 inches long (25.4 cm) and red in color. It has two front claw-like appendages and a single eye. The Sapcree's main function is to eject a highly concentrated jet of acid. The Necrols use it in the same capacity as a pistol. It's very effective, as the acid continues to burn for several seconds after it's fired. The creature usually wraps its tail around the shooter's wrist and fires on command.

Attributes of Note: I.Q. 5, P.P. 18, Spd: 15.

Weight: 3 pounds (1.35 kg).

Mega-Damage: 2D6 M.D. for the initial shot. The acid continues to burn doing 1D4 M.D. per melee for the next 1D4 melee rounds.

Rate of Fire: Single shot only.

Effective Range: 200 feet (61 m).

Payload: 14

Market Cost: As a unique and odd item, 12,000 to 20,000 credits.

Note: The Sapcree regenerates its acid payload at a rate of one shot every 10 minutes. It can also be unleashed as a small attack animal, usually to fight other animals or as a last ditch defense or surprise attack (few realize it is actually an animal). The Sapcree has 1D6+2 M.D.C., two attacks per melee, and is +1 on initiative, +2 to strike and +3 to dodge. It is also +1 on all saving throws. Damage from the claws or bite is one M.D.

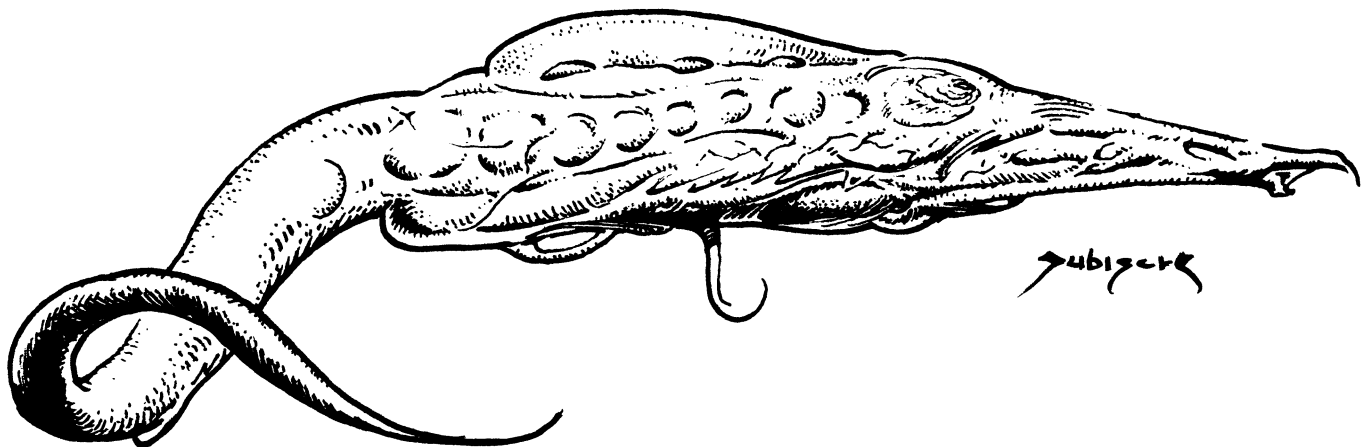

Vasher Energy Rifle

The Vasher is the Necrol's organic rifle. It too is a *living* creature that draws on solar energy to fire laser-like blasts. It typically wraps its tail around the user's forearm and is trained to fire via a telepathic message and/or by squeezing a smaller

tentacle like a trigger. Another advantage is the creature can actually fight alongside the Necrol should the need arise. They are not normally an aggressive species, but the Necrols have trained them to function not only as a living gun, but as an attack animal bred for combat.

Attributes of Note: I.Q. 7 (high animal intelligence), M.E. 8, P.S. 10, P.P. 20, P.E. 18, Spd. 16. P.S. and P.E. are considered supernatural.

Weight: 9-11 pounds (4-5 kg).

Mega-Damage: 4D6 M.D. per single blast.

Rate of Fire: Each blast counts as one of the shooter's attacks per melee (he must still, after all, aim and issue the command to fire).

Effective Range: 1,400 feet (427 m).

Payload: 30 laser bolts as its reserve at night or in darkness, and can not regenerate them until exposed to sunlight where it will sun itself on a rock, tree limb or its owner's shoulder. In a sunlit environment, the payload is effectively unlimited!

Cost: 75,000 to 100,000 credits; desirable as both a gun and a pet/attack animal.

Note: The Vasher has 4D6+10 M.D.C., three attacks per melee, is +3 to strike, +2 to parry, and +4 to dodge, can leap 6 feet (1.8 m) high or across, Swim 85%, Climb 90/70%, Prowl 50%, and has a good running speed. It is +2 on all saving throws; attribute bonuses have already been included in bonuses. Considered a minor psychic, it has Telepathy and Empathy, but can only really read and not send. This is usually how the Necrol prompts it to fire, by emotion and thought. The Vasher looks like an odd assortment of body parts. Its long snout is stiff, instead of feet it has four tentacles with little hooks on each end. It has no eyes, just a little sensor cluster at the base of the snout. On the bottom of the creature, under the four tentacles, is a jagged, circular mouth from which the creature feeds; as a scavenger, it feeds on a diet of blood, internal organs and bone. Damage from a tentacle claw strike is 1D6 M.D. (due to Supernatural P.S.) and a bite is 1D4 M.D.

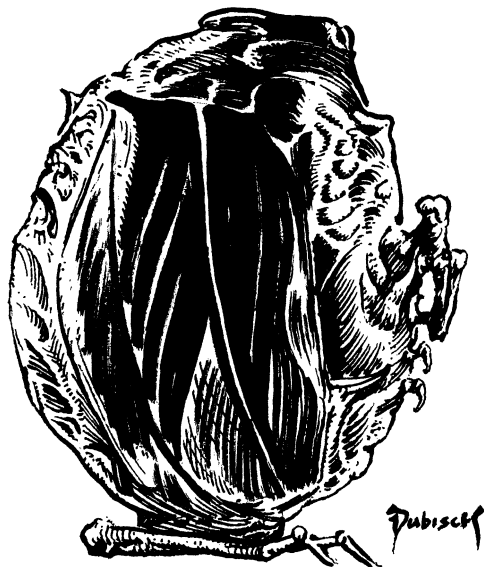

Hygra Bugs

The Hygra Bugs are the Necrol's version of grenades. These golf ball sized bugs consume all types of garbage and debris. Typically the bugs are used to dispose of waste, however the Necrols learned that if you charge them with P.P.E. and hurl them like grenades, one gets an explosive effect. The bugs cling

to the Necrol warrior, eating any foreign substance that comes in contact with the body, as well as waste and garbage (everything from rotten food to the wrapper it came in). When the Necrols need them, they pull one off and hurl it.

Weight: Half pound (0.23 kg).

Mega-Damage: 3D6 M.D. to a four foot (1.2 m) radius.

Effective Range: Thrown, about 100 feet (30.5 m).

P.P.E. Cost: 10 P.P.E.

Cost: 1000 to 2000 credits each.

Note: The Hygra Bugs are not intelligent enough to be used like the other living weapons.

Super Hygra-Eaters

These creatures look like short, squat centipedes that curl up in a ball when dormant or upon command. They look like giant versions of the Hygra Bugs, only a dark iridescent blue or dark silver color. The Super Hygra-Eaters are the size of a large grapefruit when rolled up and are usually carried in a satchel and/or one or two cling to the Necrol warrior's armor or body. Unlike their smaller, explosive cousins, the Supers are minor M.D.C. insects who eat inorganic waste, including M.D.C. metal. They are used to eat through S.D.C. and M.D.C. doors, locks and materials as well as sabotage guns and machines by letting them eat away at vital parts.

Attributes of note: I.Q. 2 (dumb insect), P.S. 22, P.P. 10, P.E. 28, Spd. 20.

Weight: 1-3 pounds (0.45 to 1.35 kg).

M.D.C. of the Bug: 2D4+4.

Mega-Damage (inflicted in attacks): 1D4 M.D. per bite attack.

Only bite and eat metals, metal alloys, and ores; doesn't try to bite skin and bone humanoids even in self-defense, but may bite robots and cyborgs.

Attacks per Melee: Three bites (and swallows) per melee round.

Effective Range: Touch/bite. Can be thrown about 40 feet (12.2 m).

Natural Abilities: Climb walls like a bug 90/85%, Swim 80%, and Prowl 45%.

Note: Typically 4-8 are unleashed against a single target (10-20 are usually carried by those who use them, about 1 in 8 Necrol Warriors). They can be placed on a specific target and nudged to eat along a specific path (like chewing a line in a fence or eating a chain or a lock, etc.), otherwise they just start chowing down on the first metal object they see. They can also be tossed onto an enemy in metal body armor or power armor, full conversion cyborgs, robots and vehicles. It takes a combined P.S. of 22 to pull them off and several can inflict a considerable amount of damage in a few melees unless they are removed or killed. If removed, and dropped near by, they will scurry over to attack again. Once they have a taste of a particular target they are drawn back to it unless taken more than 60 feet (18.3 m) away. Dumb critters, they must be retrieved and picked up by their handlers; they do not follow commands.

Cost: 6,000 to 10,000 credits each.

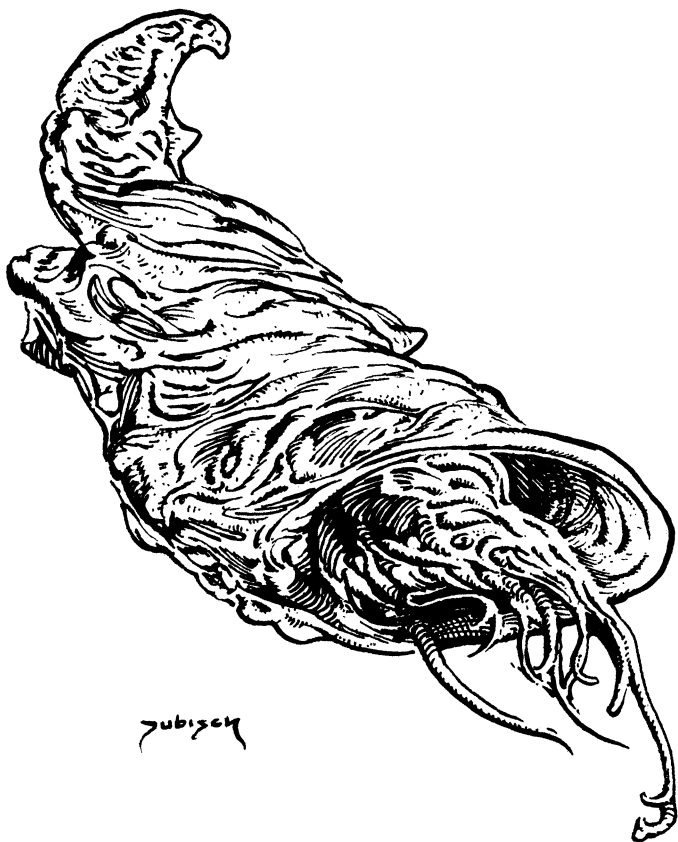

Lykra Pike/Pole Arm

The Lykra Pike is a long pike or pole arm-like weapon created by a creature known as the Lykra, a long snake-like creature that has no eyes or any type of sensory organs. The Lykra creates the pike from its secretions which harden and become a Mega-Damage substance. The Necrols can communicate with the Lykra and in so doing, customize their pike. Some just have spikes, while others create ornate staves, spears, long-handled axes, or pole arm-like halberds. The most coveted, however, are those with the Lykra as a living part of the weapon. In this case, the creature lives curled up inside a shell or pod-like housing, usually toward the base of the weapon. This is called a Master Lykra Pike and the Necrol owner can channel his P.P.E. into the animal, storing up to a hundred points at a time. At the owner's command, the Lykra charge the weapon to inflict greater M.D. or to fire an M.D. energy beam. The beam has a good range, but is typically used in close quarters combat to surprise an unsuspecting foe.

Weight: 8 pounds (3.6 kg).

Size: 8 feet long (2.4 m).

Mega-Damage: Standard Lykra Pike: 2D6 M.D. regardless of the shape/type.

Master Lykra Pike: 2D6 M.D. ordinarily, 5D6 M.D. when charged with energy (lasts for 10 minutes per 10 P.P.E. expended) or fires a 3D6 M.D. energy blast (costs 10 P.P.E. per blast).

Rate of Fire: Each energy blast counts as one melee action/attack, otherwise functions as a melee weapon.

Effective Range: Close combat, typically with an 8 or 9 foot (2.4 or 2.7 m) reach; 2500 feet (762 m) for the energy blast.

Payload: Each blast or energy charge costs 10 P.P.E.

Cost: Standard Lykra Pike: 15,000 to 20,000 credits. Master: 50,000 to 70,000 credits.

Note: The Lykra has no abilities to fight on its own and uses its energy blast for self-defense.

Gona'grek Organic Power Armor

The Gona'grek is the Necrols' version of power armor. Unlike their other living weapons that are able to act in some way on their own, the Gona'grek does not. While it is a living creature, it was specially engineered to augment the Necrol's abilities. A Necrol spends several days with the armor, bonding with it in a vat of nutrients. The Gona'grek slowly wraps itself around the pilot, creating a custom fit. Once it fully envelops the Necrol, the two slowly become one. The Necrol pilot, inside, has complete control over the creature as if it were an extension of himself.

The power armor looks like a demonic, humanoid crustacean. A blue gray rib cage encases the torso area. The arms are covered in a bony exoskeleton with large, crab-like claws or pincers covering the hands. The legs are also powerfully built and covered in the same type of bony exoskeleton as the arms. Sprouting out of the back are three blue green nodules and a large pair of black bat-like wings for flight. Along the edge of each wing is a ridge of spines, which the Necrols use to rake opponents. Dotting the body in various locations are white pustules the size of a grapefruit. These spit forth an acid paste to burn enemies in close proximity. Finally, the head is covered in a bony, demonic crown, from which the eyes appear to have an eerie green glow. Like a Juicer, the augmentation of the power armor makes the Necrol stronger, faster, and a lot tougher. This is because the symbiote pumps chemicals into the Necrol's body. Once the Necrol bonds with the Gona'grek, he is permanently bonded to it, becoming one with the creature and serving as a demonic super-warrior.

Gona'grek Organic Power Armor

Model Type: OPA-101

Class: Heavy Assault Power Armor.

Crew: One.

Bonuses from being bonded: Due to the unusual bonding with the symbiote, the Necrol gets the following bonuses as part of the transformation: +15 to P.S. (Supernatural), +6 to P.P., +6 to P.E., +2 attacks per melee (in addition to normal Hand to Hand Combat skill), +1 to initiative, +1 to strike, parry, and dodge.

Natural Abilities: The Gona'grek is impervious to the effects of a vacuum. They are impervious to cold and disease, and resistant to fire (Mega-Damage fire does half damage). The organic power armor bio-regenerates 2D6 M.D. per melee



round; can be directed to where it is needed most. The forearm claws add 2D6 M.D. to the Supernatural punch damage when used; the claws can fold back to let the articulated hands emerge for delicate and fine work.

P.P.E.: 3D6x10+60, but needs to replace spent P.P.E. by feeding on others. The pilot's P.P.E. can feed the symbiote too, and recovers as normal.

M.D.C. by Location:

Hands (2; normal and concealed) – 20

Lower Arms (2) – 70 each

Upper Arms (2) – 100 each

Forearm Claws (2) – 65 each

Legs (2) – 150 each

Large Wings (2; back) – 120 each

Heavy Vasher – 2D6x10+50

*Head – 110

**Main Body – 6D6x10+66 (each one varies due to its organic nature).

* Destroying the head of the power armor will leave the Necrol's head exposed. This also stuns the symbiotic power armor and causes the Necrol to lose all of the bonuses it provides.

** Destroying the power armor will sever the link it has with its Necrol pilot. The pilot becomes stunned for 1D4 minutes, and all bonuses, M.D.C. and powers provided by the symbiote are gone, making the Necrol feel exposed and terribly vulnerable. As a result, the de-armored and demoralized warrior has only two attacks per round, no bonuses of any kind and probably desires death rather than to be shamed like this.

Speed: Running: 45 mph (72 km) maximum; can go from zero to 45 mph (72 km) in 15 seconds (one melee). Note that the act of running does tire out its operator, but at 10% of the usual fatigue rate, thanks to chemical endorphins pumped into the Necrol from the symbiote.

Leaping: 20 feet (6.1 m) high or across unassisted by its wings.

Flying: The wings enable it to hover stationary or fly at speeds up to 175 mph (280 km). The psionic nodes in the rear of the power armor can increase the speed to 300 mph (480 km) via telekinetic thrust. In space the speed is dramatically increased to Mach 3! The maximum altitude in an atmosphere is 6000 feet (1828 m).

Flying Range: 10 hours.

Statistical Data:

Height: 12 feet (3.66 m).

Width: Wings folded down, 6 feet (1.83 m); wings extended, 18 feet (5.48 m).

Length: 6 feet (1.83 m).

Weight: 1000-1500 pounds (450 to 675 kg).

Cargo: None.

Power Systems: Bio-organic and P.P.E./magic based. The Gona'grek actually feeds off the P.P.E. of the pilot. It can also draw on other sources and like a P.P.E. vampire, it prefers the P.P.E. from a fresh kill!

Market Cost: This creature can NOT bond with another species other than the Necrols, so it has no market value.

Weapon Systems:

1. Energy Beam: These energy blasts come from the eyes. As they fire they consume P.P.E., so they are used sparingly.

Primary Purpose: Assault.

Secondary Purpose: Defense.

Mega-Damage: 5D6 M.D. per eye so a dual blast does 1D6x10 M.D.

Rate of Fire: Single shots only, equal to the combined hand to hand attacks per melee.

Effective Range: 4,000 feet (1219 m) in an atmosphere, and 2 miles (3.2 km) in space.

Payload: Tied directly to the P.P.E. of the pilot and armor. Each single blast costs 5 P.P.E.

2. Flame Thrower (2): A barely noticeable lump the forearm, near the wrist, on each arm is a specialized organ that can spit Mega-Damage fire. This is used in close quarters combat.

Primary Purpose: Assault.

Secondary Purpose: Anti-ground troops.

Mega-Damage: 4D6 M.D.

Rate of Fire: They can be fired a maximum of two times each per melee; each use counts as one of its attacks.

Effective Range: 120 feet (36.6 m).

Payload: Effectively unlimited as it's a natural defense of the Gona'grek.

3. Acid Pustules: 1D4+4 white pustules the size of a grapefruit dot the front of the body and can spit forth an acid paste to burn enemies in close proximity.

Primary Purpose: Assault.

Secondary Purpose: Anti-Armor – can burn a hole through armor.

Mega-Damage: 2D6 from initial contact and an additional 1D6 M.D. for 1D4+1 melee rounds. Does *double damage* to organic M.D.C. like the hide of a dragon or demon.

Rate of Fire: One at a time or in a volley of 2 or 4.

Effective Range: 60 feet (18.3 m).

Payload: Each pustule can fire once per hour.

Note: The Necrons can control the launching of the acid paste telepathically.

4. Vasher: The standard rifle-animal described in detail earlier.

Mega-Damage: 4D6 M.D. per single blast.

Rate of Fire: Each blast counts as one of the shooter's attacks per melee (he must still, after all, aim and issue the command to fire).

Effective Range: 1,400 feet (427 m).

Payload: 30 laser bolts as its reserve at night or in darkness, and can not regenerate them until exposed to sunlight where it will sun itself on a rock, tree limb or its owner's shoulder. In a sunlit environment, the payload is effectively unlimited!

Cost: 75,000 to 100,000 credits; desirable as both a gun and a pet/attack animal.

5. Other Weapons are optional. A Lykra Pike or Master Lykra Pike are common.



Necrol Posh Star Fighter

The Posh are living creatures that the Necrols have turned into star fighters, able to withstand the vacuum of space and perform well in that role. They look like large cuttlefish and are a brownish gray in color. Extending from the rear of the creature are a dozen tentacles. The Posh uses them to carry cargo as well as physically attack its enemies. Two Necrols volunteer to become the pilots of the craft. In essence, they effectively become the brains for the creature. The pilots occupy a small cavity on the top of the Posh called the habitation cavity. It is from here the pilots control the beast.

Model Type: OSF-Delta.

Class: Organic Star Fighter.

Crew: Two.

Natural Abilities: Impervious to cold, gases, disease and the effects of a vacuum, heat does half damage (but M.D. energy blasts, magic, psionics, missiles, etc., all do normal damage). Supernatural Strength and Endurance, P.S. 50, P.E., 28, all saves are +6. The pilots gain one additional attack while piloting the Posh and they are also +2 to strike and +6 to dodge. Because the pilots and the ship are one, the ship's bonuses are added to those of the pilots. The Posh bio-regenerates 3D6 M.D.C. every melee round, usually to the area where it is most needed.

P.P.E.: 2D6x10+12

I.S.P.: 3D6x10+100

M.D.C. by Location:

Tentacles (12) – 100 each

Wing Membranes (2) – 250 each

Habitation Cavity (Effectively the Reinforced Pilot's Compartment) – 200

Spike Missile Clusters (4) – 75

*Psionic Nodes (8) – 200

**Main Body – 2D4x100+200 (Varies per ship)

***Psionic Force Field – 1,000

* The Psionic Nodes provide the Posh with its telekinetic thrust. Unless one knows what they are looking for, they are -3 to strike. This is because the nodes only appear as slight bumps on the surface of the ship. For each one destroyed the speed is reduced by 10%.

** If all M.D.C. is depleted, the creature goes into a meditative trance to try and heal itself. It's effectively a death trance, and the Posh will appear as if it has died. None of the ship's systems will be operable. The Posh will be dead in space and unable to navigate until it's healed. If the organic ship is reduced to -120 M.D.C. it explodes, doing 1D6x100 M.D. to everything within a 200 foot (61 m) diameter.

*** The Psionic Force Field is similar to the Psychic Body Field. The Posh has sufficient I.S.P. to activate the field two times per day. Its maximum duration is six hours. However, should it become necessary, the pilots can siphon energy

from the P.P.E. energy cannon to reactivate the force field. This reduces the rate of the fire on the cannon to three shots per melee and one heavy shot every other melee. The reduced rate of fire lasts for six hours, unless the Posh gets a fresh infusion of at least 500 P.P.E.

Speed:

Driving on the Ground: Not possible, but can fly in the air/space or swim in the sea.

Flying: Mach 10 in space, Mach 2 in an atmosphere and can swim under water at 50 mph (80 km).

Star Drive: The Posh is not capable of FTL speeds.

Range: Effectively unlimited. So long as the Posh is able to feed off of the P.P.E. of the pilots and other available sources, the pilots are kept alive via nutrients provided by the Posh.

Statistical Data:

Height: 18 feet (5.5 m).

Width: 21 feet (6.4 m).

Length: 25 feet (7.6 m), the tentacles add 15 feet (4.6 m).

Weight: 11 tons.

Cargo: None, but can carry 10 tons by grabbing it with its tentacles.

Power Systems: Bio-organic and P.P.E.-based. The Posh requires P.P.E. in order to survive, and can siphon it off of many sources. Of all the sources in the Three Galaxies, it hungers most for the Techno-Wizard vessels of the UWW.

Market Cost: Not available; exclusive to the Necrons.

Weapon Systems:

1. P.P.E. Energy Cannon: The energy cannon is mounted in the nose of the Posh. It is a separate symbiote that is directly linked to the Posh. The ship is able to focus its P.P.E. through the symbiote to produce a powerful blast of energy.

Primary Purpose: Assault.

Secondary Purpose: Defense.

Mega-Damage: 1D6x10 M.D. for low-powered shots or 4D6x10 for a high-powered blast.

Rate of Fire: 6 low-powered blasts per melee or one high-powered blast per melee. It requires a full melee to build up a high powered blast, and while building up this charge it cannot fire any low powered shots.

Effective Range: 6 miles (9.6 km) in space or 6,000 feet (1,829 m) in an atmosphere.

Payload: Effectively unlimited.

2. Spike Missiles (4): There are two blisters on the upper and lower body able to eject large spikes to hurl them towards targets like a rail gun burst. It takes the Posh a full day to grow half its payload.

Primary Purpose: Assault.

Secondary Purpose: Defense.

Mega-Damage: 4D6 per short burst and 1D6x10 per long burst.

Rate of Fire: Bursts only.

Effective Range: 4 miles (6.4 km) in space; one mile (1.6 km) in an atmosphere.

Payload: 60 short bursts and 30 long. Regrows half its payload in 24 hours.

3. Physical Attacks: The Posh has incredible strength and has been known to crush star fighters and other small craft. The tentacles are long enough to grab and rip off portions of other ships. Their typical tactic is to envelop the craft and try to crush the pilot's compartment, sensor clusters, weapon turrets and other parts they can grab, crush or tear off. They can also strike like a punch or whipping action. Only four tentacles can attack at a time.

Primary Purpose: Assault.

Secondary Purpose: Grasping or carrying cargo.

Rate of Attack: Three attacks/actions per each tentacle, 12 total attacks (only four tentacles can attack at a time).

Bonuses (all): +1 on initiative, +6 to strike, +10 to parry, +7 to dodge and entangle.

Effective Range: 120 feet (36.6 m).

Mega-Damage: Punch: 1D6x10 M.D., Crush/Squeeze or tear attack 1D4x10 M.D. per crushing or tearing action. Though the crush/tear damage is less, once part of a spacecraft is entangled, it is held tight and the Posh doesn't need to roll to strike, only to continue to crush. Each crushing action counts as one melee attack.

4. Telekinesis Attack: Combined with the will of the pilot the Posh can generate a powerful telekinetic force to hold a small vessel or object (fighter, shuttle, satellite, power armor or individual), weight must be under 15 tons. Roll to strike as usual. A successful roll means the target has been grabbed. A failed roll means a miss; defenders cannot attempt a dodge because they don't see the attack coming (telekinesis is invisible).

Effective Range: 1200 feet (366 m). This capture beam can be maintained for the number of melees equal to those of one of the Necrol pilots. It can be used a maximum of three times per day, it is very taxing on the pilot.

Rate of Fire: Counts as two of the pilot's melee attacks and uses up I.S.P.

I.S.P. Cost: 40 points per five minutes.

Necrol Behemoth Destroyer

The Behemoth Destroyer is the command carrier for the Necrols. It is a large, living creature capable of carrying several thousand Necrols inside its body. The Behemoth is a pale green color that turns a rust color when it's under attack or gearing up for a battle. It can disgorge several hundred Posh fighters in only a few minutes and its weapons systems are completely concealed. Most starship captains underestimate the Behemoth in their first battle and learn never to make that mistake again as they are pounded by the creature's Gore Cannon. Sensors can never get an accurate reading to determine weapon systems as they too are organic.

Model Type: OCC-3000

Class: Command Carrier and Destroyer.

Crew: 970 crew members and 2000 pilots, 2000 troops and 500 support personnel.

Natural Abilities: As the ship is a living creature, it has several inherent natural abilities. It is impervious to cold and the effects of a vacuum, bio-regenerates 1D4x100 M.D.C. per melee and manipulates gravity.

M.D.C. by location:

- *Bridge Cavity – 15,000
- **Habitation Cavities (30) – 1,000
- Hangar Bay Cavities (3) – 3,000
- ***Psionic Nodes (18) – 800
- Gore Cannon – 5,000
- Mini-Gore Cannon (6) – 1,500
- Mini-Pseudo Appendages (10) – 900
- Large Spike Missile Pods (8) – 800
- ****Main Body – 2D6x10,000+3,000
- *****Psionic Force Field – 20,000

* If the bridge cavity is destroyed the ship and crew will be in disarray for 3D4 melees. It will take another 1D4 melees to regain control of the ship from the back- up bridge.

** The habitation cavities are large sections within the Behemoth where the crew can dwell. If the main body is reduced to 5,000 M.D.C. they start to become vulnerable.

**** The Psionic nodes provide the telekinetic thrust that the ship uses to propel itself. For each one destroyed, the ship's speed is reduced by 5%.

**** The Behemoth can fight and remain functional up to -1,000 M.D.C. The problem is that once the creature reaches 5000 M.D.C. it begins to panic and will try to flee the area. The Necrol bridge crew can calm the Behemoth: Roll percentiles, 01-30% chance that it flees the area. For each additional 1,000 M.D.C. of damage, the ship's likelihood of fleeing increases by 10%.

***** The Psionic Force Field is similar to the Psychic Body Field. The Destroyer has sufficient I.S.P. to activate the field five times per day. Its maximum duration is eight hours. However, should it become necessary, the pilots can siphon energy from the P.P.E. energy cannons to reactivate the force field. This reduces the rate of the fire on the Mini-Gore cannons to one shot per melee shot every other melee and the Gore Cannon to once every 15 minutes. The reduced rate of fire lasts for four hours, unless the ship gets a fresh infusion of at least 1500 P.P.E.

Speed:

Driving on the Ground: Not possible.

Flying: Mach 8 in space and is not capable of atmospheric entry.

Star Drive: The Behemoth is able to manipulate gravity. As a result, it can easily create a contra-gravity field that allows the ship to travel six light years per hour. Unlike conventional CG drives, the Behemoth has no constraints when dealing with other gravity wells. Usually a ship has to be at least 10,000 miles (16,000 km) from a gravity well before being able to jump to FTL speeds. The Behemoth has a built-in



gravity well compensator. This allows the ship to hide within gravity wells and jump right into them too.

Range: The Behemoth is able to provide for all the needs of the Necrols within. Range is effectively unlimited.

Statistical Data:

Height: 798 feet (243 m).

Width: 1,180 feet (360 m).

Length: 4,890 feet (1,490 m).

Weight: 30 million tons.

Cargo: 10 million tons.

Power Systems: Bio-organic and P.P.E./magic-based.

Market Cost: Any of the major governments would pay several million credits to dissect and study the living ship, but it probably has no mass market appeal.

Weapon Systems:

1. Gore Cannon (1): This is the main weapon of the Behemoth Destroyer. It is not like any normal weapon, as the creature actually extends a pseudo appendage to fire this weapon. This makes it versatile enough to fire in just about any direction. The blast is a combination gore coughed up by the animal and energy composed entirely of anti-matter. This makes for a devastating explosion at ground zero. Fortunately, it can only be used at targets in space because the beam explodes upon hitting solid matter and a planet's atmosphere is the perfect shield.

Primary Purpose: Assault.

Secondary Purpose: Defense.

Mega-Damage: 1D6x1000 M.D.

Rate of Fire: One shot every five minutes.

Effective Range: 200 miles (320 km).

Payload: Effectively unlimited.

2. Mini-Gore Cannons (6): The ship can extend six of these tentacle appendages. They, like the Gore Cannon, fire anti-matter gore and energy. Due to size limitations, the Behemoth can only extend three appendages to fire at the same target. This allows the ship to fire one massive volley if combined with the main Gore Cannon.

Primary Purpose: Assault.

Secondary Purpose: Anti-starship/space station.

Mega-Damage: 1D6x100 M.D. for a single blast, 2D6x100 for a dual blast and 3D6x100 for a triple volley.

Rate of Fire: One single, double or triple blast per melee.

Effective Range: 100 miles (160 km).

Payload: Effectively unlimited.

3. Large Spike Missile Pods (8): Dotting the upper and lower areas of the Behemoth are large, black blisters. It is from these blisters that the Behemoth can hurl bony spikes the size of a man. The spikes are the equivalent of a rail gun. A Necrol usually sits near one of these blisters and controls it like any gunner using voice or telepathic commands.

Primary Purpose: Anti-starship.

Secondary Purpose: Defense.

Mega-Damage: 2D6x10 M.D. for a short burst, 4D6x10 M.D. from a large burst.

Rate of Fire: Fires bursts only, equal to the number of the gunner.

Effective Range: 75 miles (120 km).

Payload: 60 short bursts and 30 large.

Note: The Behemoth grows these spikes internally and stores them in vacuole. It takes 12 hours for the ship to regrow a new payload.

4. Mini-Pseudo Appendages (8): These appendages pop out of the ship for close quarters combat. Within each is a habitation cavity for two Necrols who operate them. The ship is able to produce no more than four per side, so the maximum number of cannons that could simultaneously aim at the same target is four.

Primary Purpose: Anti-starship.

Secondary Purpose: Defense.

Mega-Damage: 1D6x10 M.D. per single blast or 2D6x10 M.D. per simultaneous double blast.

Rate of Fire: 4 shots per melee.

Effective Range: 10 miles (16 km).

Payload: Effectively unlimited.

5. Large Tentacle Attack (6): The Mini-Gore Cannons are six tentacles. Rather than fire anti-matter bolts, they can strike physical blows. Only three tentacles can attack at a time.

Primary Purpose: Anti-star ship.

Secondary Purpose: Defense.

Mega-Damage: 1D4x100 M.D. per punch/strike or 3D6x10 M.D. per crushing motion against an entangled opponent as large as a fighter, shuttle or medium-sized transport ship. Though the damage is less, once a spacecraft is entangled, it is stuck fast and the Behemoth does not need to roll to strike, only continue to crush. Each crushing action counts as one melee attack.

Rate of Attack: 4 per each tentacle, 12 total (only three tentacles can attack at a time).

Bonuses (all): +3 on initiative, +8 to strike, +12 to parry, +8 to dodge and entangle.

Effective Range: 600 feet (183 m).

6. Other Spacecraft and Power Armor: In addition to its already formidable weaponry, the Behemoth carries a large contingent of Posh fighter craft and Gona'grek power armors. Divided among its three hangar bay cavities are 600 fighters and 400 power armors. There are also 10 troop transports and 4000 to 5000 troops.

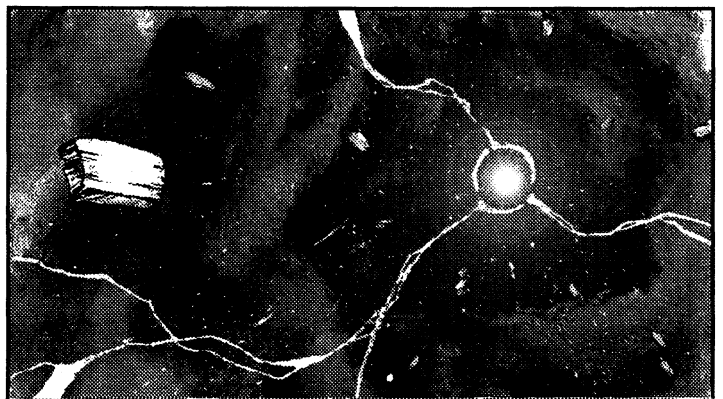

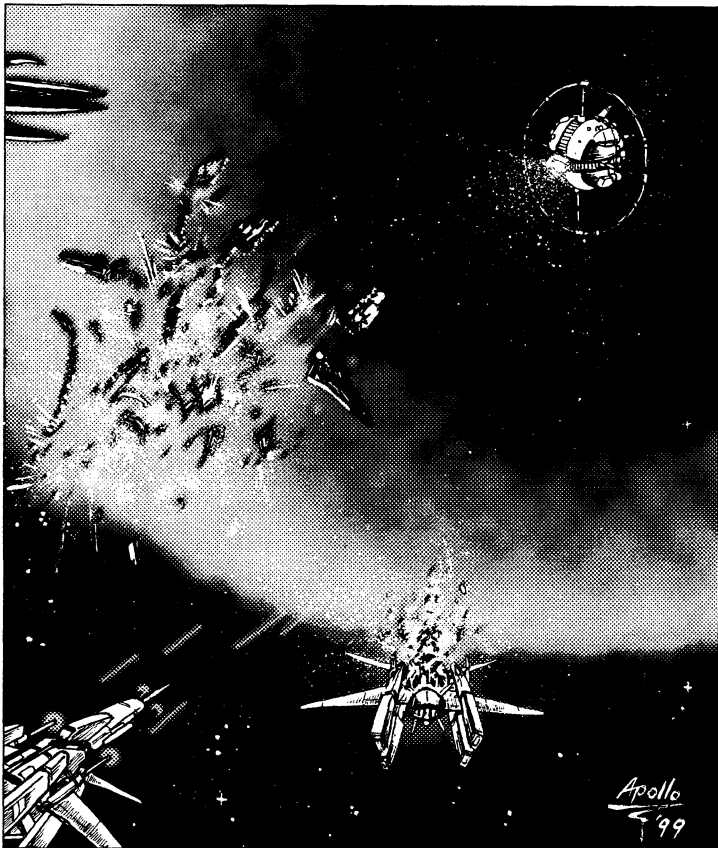

Spaceships

Point Defense Weapons

These weapons are small and agile and if hooked up to the ship's power supply, they have an unlimited payload. They all have advanced computer tracking and can easily track and hit power-armor sized targets and larger with no penalties. They pack little punch compared to their larger cousins, but can fire more frequently and are really meant to protect the ship from incoming missiles, power armor, boarding troops and small star fighters.

Note: Unless noted otherwise, all ranges are half in an atmosphere.

Phase World Note: See pages 153-156 of *Rifts® Dimension Book Two: Phase World* for additional weapons, including HI lasers.

HI Point Defense Lasers

Weight: ½ ton (450 kg) per barrel, or 1 ton (900 kg) per barrel in an armored turret.

Mega-Damage: Varies: 3D6 M.D. to 6D6 M.D., 1D4x10 M.D., and 1D6x10 M.D.

Rate of Fire: Equal to the hand to hand attacks per melee of the gunner (usually 4-6).

Effective Range: Light: 4000 feet (1219 m), Medium: 8000 feet (2438 m) or Heavy: 12,000 feet (3,658 m).

Payload: Effectively unlimited if tied directly to the ship's main power. At an extra cost of 1-3 million credits, the weapon can have its own power supply.

Cost: 150,000 for a light turret, 250,000 credits for a heavy turret; double the price for a double-barreled turret. M.D.C. for the weapon itself is 100 points per barrel or 200 M.D.C. each for an extra 120,000 credits.

Note: For pulse weapons add another two dice of damage and 20% to the cost. Double turret systems can fire simultaneously (i.e. 3D6 x3 or 6D6 M.D. x2, etc.).

Point Defense Particle Beams

Weight: One ton (900 kg) for a single barrel turret.

Mega-Damage: Varies: 6D6 M.D.C., 1D4x10 M.D.C., 1D6x10 M.D.C. and 2D4x10 M.D.C.

Rate of Fire: Equal to the hand to hand attacks per melee of the gunner (usually 4-6).

Effective Range: 2000 feet (610 m), 4,000 feet (1219 m) or 8,000 feet (2438 m).

Payload: Effectively unlimited if tied directly to the ship's main power. At an extra cost of 4-6 million credits the weapon can have its own power plant.

Cost: Light: 370,000. Medium: 650,000. Heavy: 1.1 million; double the price for a double-barreled turret. Pulse systems are not available.

GR-50 Gravity Cannons

Weight: ½ ton (450 kg).

Mega-Damage: 1D4x10 M.D. for a 20 round burst. Only fires bursts.

Rate of Fire: One burst per each attack available to the pilot.

Effective Range: 3 miles (4.8 km) in space or 6,000 feet (1,828 m) in an atmosphere.

Payload: 20,000 rounds (1000 bursts).

Cost: 300,000 credits plus ammo.

Note: Ammo cost for the GR series is 10,000 credits for 10,000 rounds. Roughly 1 credit per round, but with bulk orders of 100,000 rounds or more, there is usually a 10-20% discount.

GR-100 Gravity Cannons

Weight: 1 ton (900 kg).

Mega-Damage: 1D6x10+10 M.D.C. for a 40 round burst. Only fires bursts.

Rate of Fire: One burst per each attack available to the pilot.

Effective Range: 3 miles (4.8 km) in space, 8,000 feet (2438 m) in an atmosphere.

Payload: 20,000 rounds (500 bursts).

Cost: 500,000 credits plus ammo.

Note: Ammo cost for the GR series is 10,000 credits for 10,000 rounds. Roughly 1 credit per round, but with bulk orders of 100,000 rounds or more, there is usually a 10% discount.

Light Weapons Class

Whereas point defense weapons are intended for smaller targets such as star fighters and power armors, this class of weapons are intended for slightly larger targets such as star fighters, shuttles and large robots. These weapons pack a little more fire-power and range.

HI Short Laser Cannons

Weight: 1.5 tons (1350 kg); add a ton (900 kg) for an armored turret. Can be a double barreled system but double the cost, increase weight by 50% and can fire two simultaneous blasts (double damage).

Mega-Damage: Varies: 2D4x10, 2D6x10 through 6D6x10 per barrel.

Rate of Fire: Equal to the gunner's number of hand to hand attacks per melee (usually 4-6).

Effective Range: 1, 3 or 4 miles (1.6, 4.8 or 6.4 km); half that in an atmosphere.

Payload: Effectively unlimited if tied directly to the ship's main power. At an extra cost of 2-5 million credits the weapon can have its own power supply.

Cost: Light: 2 million credits. Medium: 4 million, and Heavy: 7 million. Cost is per each barrel; double the price for a double-barreled turret.

Light Particle Beam Cannons

Weight: 1.5 tons (1350 kg); add a ton (900 kg) for an armored turret. Single barrel.

Mega-Damage: Varies: 2D6x10, 4D6x10 through 1D4x100 per barrel.

Rate of Fire: Equal to the gunner's number of hand to hand attacks per melee (usually 4-6).

Effective Range: 1, 2 or 3 miles (1.6, 3.2 or 4.8 km); half in an atmosphere.

Payload: Effectively unlimited if tied directly to the ship's main power. At an extra cost of 4-10 million credits the weapon can have its own power plant.

Cost: 4 million, 6 million and 9 million credits respectively. Cost is per each barrel; double the price for a double-barreled turret and add another million credits for additional armor.

GR-500 Gravity Cannons

Weight: 1.5 tons (1,350 kg).

Mega-Damage: 2D6x10 M.D.C. for a 10 round burst. Only fires bursts.

Rate of Fire: Equal to the combined hand to hand attacks per melee.

Effective Range: 6 miles (9.6 km) in space, 12,000 feet (3,658 m) in an atmosphere.

Payload: 10,000 rounds (1000 bursts).

Cost: 1 million credits.

Medium Weapons Class

Medium-range weapons are your anti-ship, anti-space station type weapons. These weapons have a far greater range and damage. Their targeting systems are specifically designed for ship to ship combat.

High-Powered, Medium Laser Cannons

Weight: 2 tons (1,800 kg); add 1 ton (900 kg) for an armored turret.

Mega-Damage: Varies: 1D4x100, 1D6x100, 2D4x100, and 2D6x100 per single blast, double damage for double-barreled, dual shot systems.

Rate of Fire: Four shots maximum per melee round.

Effective Range: 8 miles (12.8 km) is the minimum range, with a maximum range of 16 miles (25.6 km) in space, half in an atmosphere.

Payload: Effectively unlimited if tied directly to the ship's main power. At an extra cost of 2 million credits the weapon can have its own power plant.

Cost: 15 million credits for minimum damage and range to 70 million credits for maximum range and damage. Cost is per barrel. Double the cost for double-barreled cannons and add another 3 million for an armored turret.

Medium Particle Beam Cannons

Weight: 2 tons (1,800 kg); add 1 ton (900 kg) for an armored turret.

Mega-Damage: Varies: 2D4x100, 1D6x100, 2D6x100, and 3D6x100 per single blast, double for doubled-barreled.

Rate of Fire: Three shots maximum per melee.

Effective Range: 7 miles (11.2 km) is the minimum range, with a maximum range of 14 miles (22.4 km) in space, half in an atmosphere.

Payload: Effectively unlimited if tied directly to the ship's main power. At an extra cost of 2 million credits the weapon can have its own power plant.

Cost: 20 million credits for minimum damage and range up to 90 million credits for maximum range and damage. Cost is per barrel. Double the cost for double-barreled cannons and add another 3 million for an armored turret.

GR-1000 Gravity Cannons

Weight: 2 tons (1,800 kg).

Mega-Damage: 4D6x10 for a 20 round burst. Only fires bursts.

Rate of Fire: Equal to combined hand to hand attacks per melee.

Effective Range: 12 miles (19.2 km) in space, 6 miles (9.6 km) in an atmosphere.

Payload: 10,000 rounds (500 bursts).

Cost: 2.5 million credits.

GR-2000 Gravity Cannons

Weight: 3.5 tons (3,150 kg).

Mega-Damage: 1D4x100 for a 40 round burst. Only fires bursts.

Rate of Fire: Equal to the combined hand to hand attacks per melee.

Effective Range: 16 miles (25.6 km) in space, 8 miles (12.8 km) in an atmosphere.

Payload: 10,000 rounds (250 bursts).

Cost: 6 million credits.

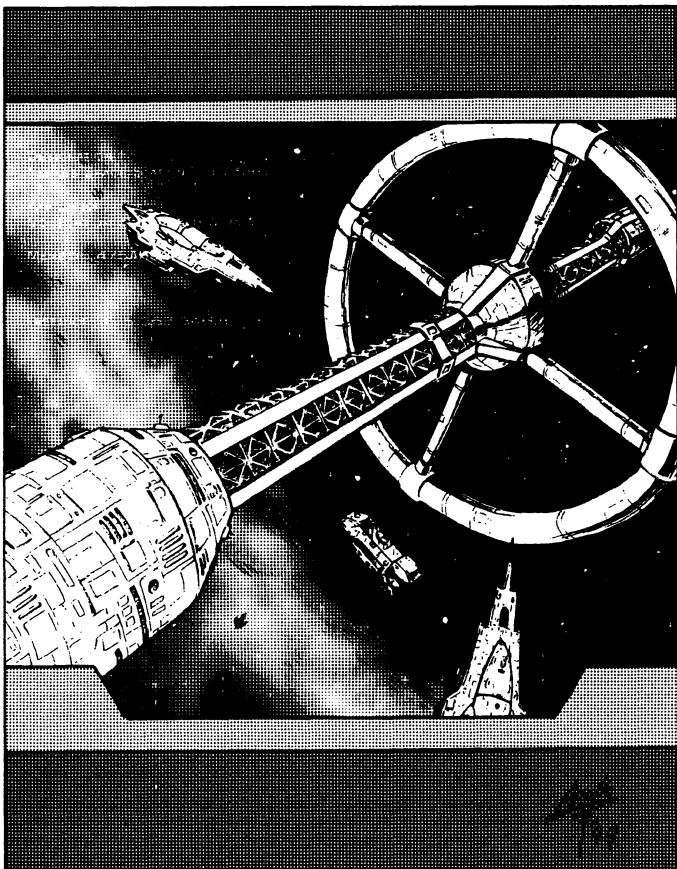

Heavy Weapons Class

Heavy Weapons are planet busters. They can scorch cities from the sky and vaporize other ships with a single volley. Only the largest starships can carry these weapons and they are typically military class vessels, like battleships, destroyers and weapon platforms.

HI Heavy Laser Cannons

Weight: 6 tons (5,400 kg) and 2 tons (1,800 kg) for an armored turret.

Mega-Damage: Varies: 1D4x1000 and 1D6x1000 per single blast.

Rate of Fire: One or two shots maximum per melee.

Effective Range: 60 to 100 miles (96 km to 160 km) in space. Range is 16 miles (25.6 km) in an atmosphere.

Payload: Effectively unlimited. These weapons are so powerful they must have their own power plant. If for some reason

their power plant malfunctions, power can be diverted from main power, but every time the weapon fires one of the ship's major systems (shields, sensors, life support, etc.) will be temporary shutdown for 1D4 melees. At the G.M.'s discretion, this can be a random selection, unless someone states specifically, "they are diverting power from (sensors, shields, life support, other weapon systems, etc.) to the main cannon."

Cost: 100 million to 200 million credits.

Heavy Particle Beam Cannons

Weight: 6 tons (5,400 kg) and 2 tons (1,800 kg) for an armored turret.

Mega-Damage: Varies: 1D4x1000, 2D4x1000, 1D6x1000 and 2D6x1000 per single blast.

Rate of Fire: One shot maximum every 30 seconds, 2 melees.

Effective Range: 45 to 90 miles (72 km to 144 km) in space. Range is 14 miles (22.4 km) in an atmosphere.

Payload: Effectively unlimited. These weapons are so powerful they must have their own power plant. If for some reason their power plant malfunctions, power can be diverted from main power, but every time the weapon fires, one of the ship's major systems (shields, sensors, life support, etc.) will be temporary shutdown for 1D4 melees. At the G.M.'s discretion, this can be a random system, unless someone states specifically, "they are diverting power from (sensors, shields, other weapon systems, etc.) to divert to the main cannon."

Cost: 100 million to 400 million credits.

GR-5000 Mass Driver

Weight: 12 tons (10,800 kg). Due to the way they are designed, mass drivers are typically built under or in the spacecraft. Also, the ship has to be a minimum of 4000 feet (1219 m) long to have this weapon installed. This is because the mass that is accelerated requires a lot of room to build up speed.

Mega-Damage: 1D6x1000 in space or 1D4x100,000 if hurdled planet-side. Damage is to a five mile (8 km) diameter. The next five mile (8 km) area suffers 1D6x1000 M.D. from the shock wave and fire storm. The next ten miles only takes 4D6x10 M.D. This attack leaves a crater that is a thousand feet (304.8 m) deep and 4 miles (6.4 km) wide.

Rate of Fire: One shot every five minutes.

Effective Range: 500 miles (800 km) in space, but most ships will detect it and are +10 to dodge. This weapon *cannot* be fired in an atmosphere. To do so causes severe structural damage to the shooting vessel and is likely to destroy the ship (reduce all of the vessel's M.D.C., including specific locations, by 1D6x10%+30%).

Payload: Varies: Typically large asteroids are used so it depends on their availability. Large ships can carry four 10 ton (9,000 kg) asteroids.

Cost: One billion credits.

Note: Mass drivers are very powerful weapons of destruction. One shot can literally level a city. Since CAF military doctrine is to only attack military structures, mass drivers are not used and are illegal in CAF space! Any ship passing through

CAF space with one must have it deactivated at the CAF border.

Heavy Cruise Missiles

Heavy cruise missiles are seldom used due to their instability. In fact, the antimatter cruise missile only has an active life of *18 months*. The magnetic bottle that contains the antimatter becomes unstable and sometimes causes the missile to prematurely detonate! This can be very bad if it happens in a cargo hold or launcher full of missiles. This is also true of the singularity cruise missiles that have components of antimatter as well as some very dense materials that compact to form a micro-singularity (black hole). The antimatter cruise missile was created by the CAF and is used sparingly. Most Consortium ships carry a very small complement, usually 20 to 60 at the most, and this is only during times of war. During peace, a ship may have, at most, a dozen on hand.

The singularity cruise missile is a product of the TGE. The Kreeghor have a similar policy to that of the CAF and only carry a few of these weapons of mass destruction. Unlike the CAF, the TGE does store large numbers of these missiles in various depots around the Three Galaxies. They are relatively isolated, so if and when accidents do occur there are minimum losses and damage.

High Yield Antimatter Cruise Missiles

These weapons deal out massive amounts of damage over a large area. The Consortium produces this weapon in very small quantities and only picks up production during times of war. These missiles are never sold outside the Consortium and are only issued to CAF units or ships. Extreme measures are taken to either destroy these weapons or recover them from outside parties.

Mega-Damage: 1D4x1000 M.D.

Range: 1,000 miles (1,600 km) with a blast radius of 500 feet (152.4 m).

Cost: 580,000 credits per missile.

Singularity Cruise Missiles

These dreaded missiles are the creation of the Transgalactic Empire (TGE). The principle of these missiles is relatively simple. It's not the explosion that does the damage, but the micro-singularity (black hole) that is created. It only lasts for a few seconds (one melee round), but in that few seconds it causes massive damage. The black hole puts enormous stresses on a ship's bulkheads, causing them to buckle and collapse. The missile ends up causing more internal damage than one would expect.

Damage: 1D6x1000 M.D.

Range: 1,000 miles with an area effect of 300 feet (91.4 m).

Cost: 900,000 credits per missile.

Magic Weapons for Spacecraft

Anti-Magic Missiles

The United Worlds of Warlock (UWW) developed these missiles to affect other vessels and space stations whose weapon systems and defensive systems were magical in nature. While this may seem odd since the majority of the UWW's own vessels are magically powered, other powerful enemies such as the Splogorth also utilize magic to some degree in their space vessels, making an anti-magic defensive arsenal a must. A typical tactic would be for a retreating fleet to lob several dozen to a hundred of these missiles to make good their escape. It is also useful when the capture of an enemy vessel is preferred over its destruction.

Due to the mystical nature of constructing these weapons, they are only available in the following missile types: medium-range, long-range, or cruise missile.

The reduced damage is mainly due to a smaller warhead per missile. The main purpose of the missile is to knock out specific magic weapons and ship systems. The effects are cumulative, so multiple missiles could disable a vessel such as a Dwarven Iron Ship. For every hit with an anti-magic missile, the receiving vessel gets a saving throw versus an Anti-Magic Cloud. If the ship fails the saving throw, one random system is disabled for one hour.

This missile also has a secondary purpose: It can be set to detonate in a given area, producing the effects of an Anti-Magic Cloud spell. The duration is for one hour. Again those in the area of affect receive a saving throw. If they save, the ship's magic systems are only partially affected and operate at half power, half damage and half range for 30 minutes (the same is true of hand-held magic weapons used by the crew or troops). If the ship fails to save, all of its magic systems are disabled for one hour. However, the vast majority of magically constructed vessels have some sort of conventional back-up systems in case something like this happens. The anti-magic missiles are equal in strength to a 12th level spell caster.

AMM-Mark 12

Primary Purpose: Anti-Starship.

Secondary Purpose: Defense.

Mega-Damage: Medium-range missile: 2D4x10. Long-range missile: 2D6x10. Cruise missile: 6D6x10 M.D.

Range: Standard as per missile type.

Duration of the Magic Effect: One hour unless a saving throw is made.

Cost: Medium: 750,000 credits. Long-range or cruise missiles cost 900,000 per missile.

Hull Breachers

This is one of the few weapons that the UWW uses as a last resort. Unlike other missiles whose main purpose is to destroy or cause major damage, these missiles hardly leave a scratch.

They are designed to momentarily open ship compartments to outer space. This is caused by a *Mystic Portal* that activates when the missile impacts on the hull of the ship. Anyone caught in the compartment where the missile hit is at risk of being blown out into space, or at the least, suffering from a sudden decompression. This weapon can also be used to create an opening for combat troops to gain entry to an enemy vessel.

Primary Purpose: Anti-Personnel.

Secondary Purpose: Defense.

Mega-Damage: 4D6 plus magical effect.

Duration of the Mystic Portal: Five minutes or until the magic is dispelled.

Range: Same as medium-range missiles.

Countermeasure: A Negate Magic spell instantly dispels the individual portal, and a Close Rift spell will close every portal on the ship, simultaneously. The Negate Magic Barrier spell does not work, because the Mystic Portal is an opening, not a barrier.

Cost: 600,000 per missile.

Negate Mechanics Mini-Missiles

This missile works in a similar fashion to the anti-magic missile, except it affects non-magical ships as well as magical ships. The missile causes one random mechanical system to not function. It can range from a weapon system to propulsion, to a non-essential system, to a critical system like life support. The effects should be based on where the missile struck and the weapon is usually aimed at specific targets (weapon turret, sensor cluster, communications tower, radar, bay door, engine, etc.). The effect from a random hit is left up to the G.M. or may be rolled on the following table. Multiple missile hits have an accumulative effect, each knocking out more of the particular system. The duration is only 15 seconds per missile (cumulative duration from multiple mini-missile strikes), but even a mere 15 seconds can seem like an eternity when your weapons are out. The missile is only effective on craft equal to or smaller than a star fighter.

Larger missiles are not practical because larger ships have hundreds of thousands of mechanical systems, and all large ships usually have some sort of back-up system to compensate for temporary outages. Besides, these mini-missiles are designed for surgical precision strikes. One drawback of the mini-missile is that first the shields of the target must be breached in order for the NM-Mark 20 to work. It must impact on the hull!

NM-Mark 20

Primary Purpose: Anti-Star Fighter/Power Armor.

Secondary Purpose: Defense.

Mega-Damage: 4D6 M.D.C., mainly impact damage.

Range: 1 mile (1.6 km) in an atmosphere, 5 miles (8 km) in space.

Duration: One melee round (15 seconds).

Cost: 10,000 per missile.

The random effects of being hit by an NM-Mark 20:

01-15% Lucked out! Deactivates a non-vital system.

16-25% Deactivates propulsion system. The ship can still

maneuver with directional thrusters; all bonuses to dodge are reduced by half.

26-45% Helm control is lost! The pilot cannot steer or maneuver. No bonuses to dodge, only luck and a natural roll.

46-55% One weapon system is deactivated. G.M., determine which.

56-75% Sensors are deactivated. The pilot is blind for the melee and must rely on his own senses and bonuses. All bonuses from Read Sensory Equipment and Star Fighter Elite, plus the vehicle's bonuses may be lost if all sensors are affected.

76-80% Life support is deactivated in a portion of the ship. Although this may not seem all that bad for a few seconds, if the life support goes down for more than four minutes the pilot and/or crew in the affected area may go unconscious. This is due to carbon dioxide poisoning and the air not being recycled. Roll a save versus poisons/toxins every minute after the first four. Also, heat dissipates very quickly. After four minutes those in the affected area suffer 1D6 S.D.C. damage every melee from the freezing cold unless in environmental suits or armor.

81-85% Targeting systems are down. No bonuses to strike, natural rolls only.

86-90% Air locks and bay doors are down; will neither open nor close.

91-99% All communications are down.

100% Main power goes off line. The vehicle is dead in space!

Rift Jump Drives

The most common jump drives available are those made by the UWW and are called the IRJD-5, created by an elite group of Dwarven Smiths headed by Inglix the Mad. The maximum safe jump distance is 20 light years at a cost of 2000 P.P.E. to the jump generators. They take four hours to recharge, two hours if near or on a ley line and one hour on or near a nexus. Cost: 30 million credits. Note: Word is spreading that a new class of battleship is patrolling the UWW. It is called the Nexus Battle Cruiser and it can make jumps up to 40 light years away.

Fold Drive

Rumored to be used by a race called the Intruders, this type of drive is still being explored by the rest of the civilizations in the Three Galaxies. Current scientists can't make a stable passageway for ships to traverse. The theory is that the antimatter used to power the drive de-stabilizes the fold process. If this type of drive could be perfected, a ship could, in theory, jump a hundred light years in a matter of minutes!

Experimental Drives

Experimental drives do pop onto the market from time to time, but the ones listed above are the most common and reliable. Most people don't want to take a chance at being stranded in the middle of nowhere! After all, with sub-light drives it would take hundreds of years to get from one star to another.

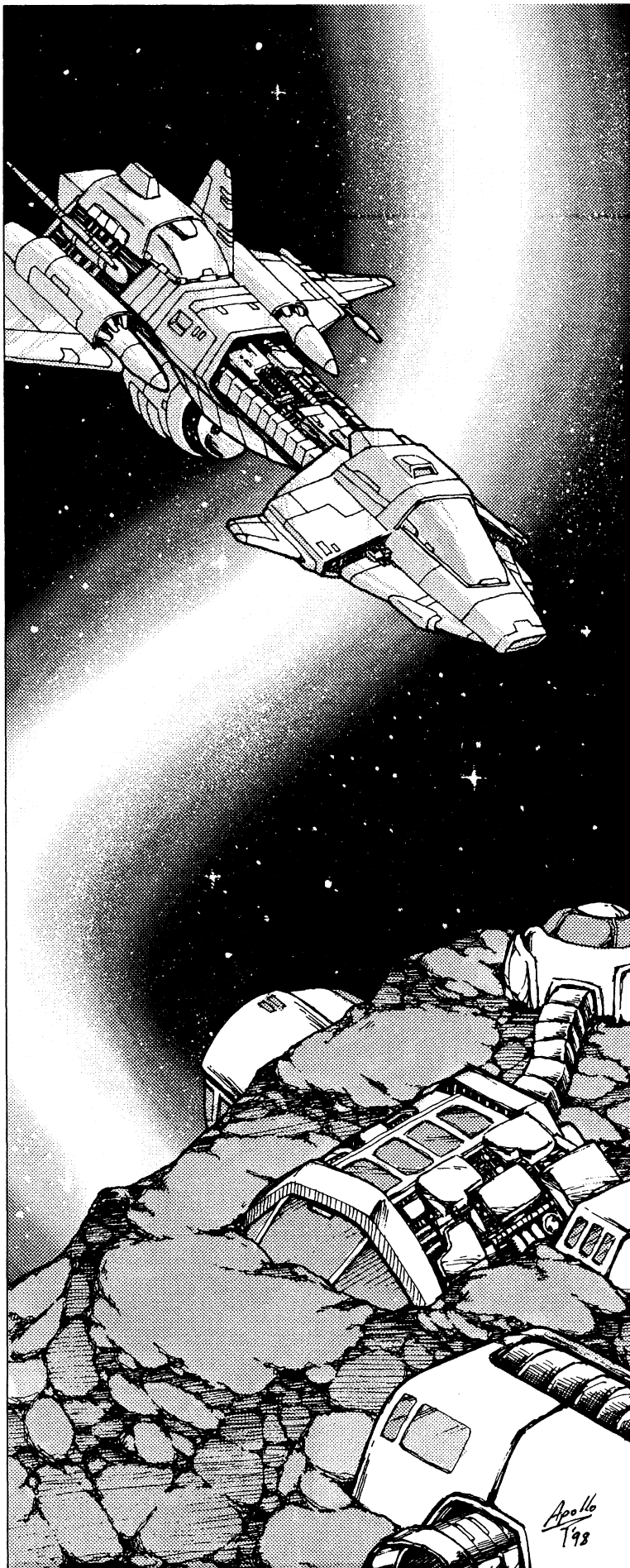

Spacecraft Drive Systems

Prices for FTL Drives

These prices are the current going rates at Center on Phase World. Prices may vary from system to system as much as plus or minus 50%. This primarily depends on availability of the drive in question.

<u>Drive Type:</u>	<u>Price (per million):</u>	<u>Maximum Speed:</u>
Phase Drive A	10 million	1.5 Light years per hour
CG-A (Contra-Gravity)	5 million	1 Light year per hour
Phase Drive B	15 million	2.5 Light years per hour
CG-B	10 million	2 Light years per hour
Phase Drive C	20 million	3.5 Light years per hour
CG-C	15 million	3 Light years per hour
Phase Drive D	30 million	4.5 Light years per hour
CG-D	25 million	4 Light years per hour
Phase Drive E	50 million	5.2 Light years per hour
CG-E	40 million	5 Light years per hour
Phase Drive F	100 million	6.7 Light years per hour
CG-F	75 million	6.5 Light years per hour
Phase Drive G	200 million	7+ Light years per hour
CG-G	150 million	7+ Light years per hour

Note: Phase Drive G and CG-G class engines are not even available on the open market and are considered experimental even for military ships. Anyone wanting one of these engines would have to acquire it by hook or by crook. If any of the militaries of the Three Galaxies ever got wind that someone had one of these star drives you can bet they would do everything in their power to either get it back or get it just to study it.

Phase Drives are more efficient than Contra-Gravity Drives and can be pushed a little farther as well. However, Phase Drives have specialized components and can only be repaired by a Phase Technician on Phase World. Typically, spare modules are carried for Phase Drives to make minor repairs to at least get the ship to a port. It's very difficult to make repairs when part of the engine is phased!

Contra-Gravity Drives are much more common and sturdier than Phase Drives and can be repaired by someone with Space-ship Mechanics. Parts are more common as well or at least a competent engineer can jury-rig something to get the ship home.

Quantum Worm Hole Drive

A worm hole is a naturally occurring phenomenon that opens a gate from one point in the galaxy to the other. In theory, this drive would also open a worm hole to anywhere in the galaxy. It would take one minute to jump five light years, so great distances could be traversed in a matter of hours instead of days, weeks or even months! The problem with these drives is that current technology cannot control the other end of the worm hole. In effect, it has no guidance system that can nail the final destination. Also, the amount of power needed to maintain this type of drive is equal to 100 antimatter reactors. A greater type of power source would be necessary for the people of the Three Galaxies to make this type of drive viable.

New Spacecraft of the Three Galaxies

Note: Also see **Rifts® Dimension Book Two: Phase World®** for other drive systems and spacecraft, and **Rifts® Dimension Book Three: Phase World® Sourcebook** for large ship combat and other weapons and spacecraft. See **Rifts® Dimension Book Five: Anvil Galaxy™** for planet creation rules and more about specific people and places in the Anvil Galaxy. *The Heroes Unlimited™ Aliens Unlimited Galaxy Guide* also offers planet creation rules, spacecraft propulsion and drives, space skills, aliens and equipment, however, it is an S.D.C. system and would require some conversion to the **Phase World®** M.D.C. environment.

Free Online Stuff: Palladium's World Wide Web site (www.palladiumbooks.com) offers Carl Gleba's planet creation rules and other material that hit the cutting room floor.

Argon Class Gas Mining Ship

Gas mining ships are large, mobile industrial complexes with a star drive. Their purpose is to orbit gas planets and, with several smaller gas collector ships, mine the various gases found in the planet's atmosphere. While most gases can be reproduced, it is far easier and less expensive to send a ship skimming through the atmosphere of a gas giant. Several cubic tons of the valuable gas can be collected in just under an hour. This is far more efficient and economical, keeping the prices down on the various gases. In addition, the gas miner has a full processing plant to separate and purify the various gases. This allows for the gas to be ready and available for sale immediately upon delivery.

Model Type: Gas Miner.

Class: Argon Class Gas Miner.

Crew: 930 personnel are the typical make-up. The industrial plant works at optimum capacity with 400 workers. There are 75 engineers, 75 hazardous material personnel, and 120 pilots for the gas collectors, utility vehicles and shuttles, 60 bridge crew, and 200 additional crew.

M.D.C. by Location:

Main Engines (4) – 2,000 each

Front Third of Ship – 13,000

Middle Third of Ship/Processing Plant – 10,000

Rear Third of Ship/Drive Section – 15,000

*External Framework (2) – 3,000 each

Gas Containers (26) – 500 each

Hangar Bay: 6,000

Dual-Barreled Particle Beam Cannons (12) – 250 each

Medium-Range Missile Launchers (6) – 400 each

GR-100 Dual-Barreled Rail Guns (8) – 325 each

Variable Force Field – 6,000 (1,000 per side)

*If all M.D.C. is depleted, the vehicle is in tatters, various ship systems will be knocked out or destroyed, and the ship will not be able to navigate under its own power. Weapon systems with their own power supply are another matter and may still be operational. If the ship is reduced to -500 M.D.C. it explodes, doing 2D6x1,000 M.D. to everything within 1,000 feet (305 m).

Speed:

Driving on the Ground: Not possible.

Flying: Mach 8 in space, Mach 2 in an atmosphere.

Star Drive: All gas miners are equipped with Phase Drives. It was discovered that CG drives attract stray ionic particles that are typically found around gas planets. This particle build up is typically discharged before going to FTL speeds. Gas ships cannot safely discharge these particles for fear of blowing the whole ship up especially with its cargo containers full of pure gases. As a result, Phase Drives are the industry standard. Typical speed is 3 light years per hour.

Range: A typical tour of duty on a gas ship is 18 months. However, it usually only takes anywhere from a month to four months to fill the cargo holds to capacity so workers make several mining runs during their work block.

Statistical Data:

Height: 450 feet (137 m).

Width: 920 feet (280 m).

Length: 2,570 feet (783 m).

Weight: 10 million tons, not including cargo.

Cargo: Each cargo container can hold 5 tons of compressed gas. The ship itself can hold 5,000 tons of cargo.

Power Systems: Three fusion reactors.

Market Cost: 1.2 billion credits. The gas miner is a very common sight in the Three Galaxies and several variations are sold, but the Argon Class is the most common because it is a workhorse that is very dependable and sturdy.

Standard Weapon Systems:

1. Dual-Barreled Particle Beam Cannons (12): Particle beam cannons are the most commonly used weapon system next to rail guns. These weapons are scattered around the ship for optimum protection.

Primary Purpose: Defense.

Secondary Purpose: Anti-Missiles/Star Fighter.

Mega-Damage: 2D4x10

Rate of Fire: Equal to the combined hand to hand attacks per melee of the gunner.

Effective Range: 8,000 feet (2,438 m).

Payload: Effectively unlimited.

2. Medium-Range Missile Launchers (6): Housed in the front and rear of the ship are medium-range missile launchers.

Primary Purpose: Defense.

Secondary Purpose: Anti-Missiles/Star Fighter.

Mega-Damage: Varies per missile.

Rate of Fire: One at a time or in volleys of 2, 3, 6, 9, or 12.

Effective Range: Varies per missile, typically 40 to 60 miles (64 to 96 km).

Payload: 45 missiles per launcher. 1,350 missiles are kept in the cargo hold to reload the missile launchers. This allows for five reloads per launcher. The auto-loader takes seven minutes to completely reload each launcher.

3. GR-100 Dual-Barrel Rail Guns (8): The rail guns act as a secondary means of defense for the gas miner. They also have a far superior range to the particle beam cannons.

Primary Purpose: Defense.

Secondary Purpose: Anti-Missile.

Mega-Damage: 2D6x10 per burst.

Rate of Fire: Burst only, equal to the combined hand to hand attacks per melee of the gunner.

Effective Range: 3 miles (4.8 km).

Payload: 40,000 rounds per cannon or 1,000 bursts. Reloading requires 6-8 minutes per cannon, as the crew is typically not trained in its use. A trained crew can reload in half the time. 1,280,000 rounds are kept in the cargo hold; four complete reloads per cannon.

4. Other Vehicles and Ships: Typically, each ship has two or three shuttles, and a dozen gas collectors. The hangar bay is versatile enough to accommodate 24 gas collectors and 6 shuttles. However, this excess room is typically used to store additional gas containers. Sometimes, a captain looking to add to a ship's defenses may hire mercenaries with their own space fighters and stow the ships in the hangar bay.

Gas Collector

The classic gas collector is a small spaceship built specifically for cruising through the turbulent atmosphere of a gas planet to collect their valuable gases. The front of the ship resembles an aerodynamic shuttle, while the remaining half looks like a giant pair of engine turbines. These turbines are versatile enough to collect one type of gas while filtering out others. The gas is accumulated in the rear of the ship in a large storage unit. Once it is filled to capacity, the ship can return to its mother ship and unload its cargo.

It is not uncommon to see a dozen of these ships docked alongside the larger gas miners as the two go hand in hand. Some gas miner vessels and space stations have small fleets of collectors. This ensures a constant supply of raw materials to be processed.

Model Type: GC-45

Class: Utility vehicle.

Crew: 4, pilot, co-pilot, communications officer and engineer. The ship has a small bunk area for the crew. This would allow another four to be on the ship for a cramped crew of eight.

M.D.C. by Location:

Stabilizer Wings (3) – 250 each

Gas Collectors/Vents (2) – 350 each

*Gas Storage Container – 500

Main Engines (2) – 300 each

Reinforced Pilot's Compartment/Escape Pod – 500

**Main Body – 800

Variable Force Field – None

* In the event of an emergency, the gas storage container can be ejected. This would increase overall speed to Mach 11 in space (it has very powerful engines) and Mach 8 in an atmosphere.

** If all M.D.C. is depleted while the cargo container is full, the vehicle explodes, doing 1D6x1,000 M.D. to everything within 800 feet (244 m). Damage is only 1D6x100 M.D. to everything within 200 feet (61 m) should the cargo hold be empty. The crews' only chance for escape is using the escape pod or a shuttle.

Speed:

Driving on the Ground: Not possible.

Flying: Mach 9 in space fully loaded, Mach 6 in an atmosphere, however the ship has to reduce speed to under Mach one in order to collect the gas safely.

Star Drive: Not equipped.

Range: The ship only has enough supplies for one week of survival. Strict rationing could stretch food and water to two weeks.

Statistical Data:

Height: 32 feet (9.75 m).

Width: 36 feet (11 m).

Length: 65 feet (19.8 m).

Weight: 28 tons empty.

Cargo: There is a small storage locker for the crew. The ship can hold 6 tons of condensed gas.

Power Systems: Fusion reactor.

Market Cost: 50 million credits.

Standard Weapon Systems:

1. Particle Beam Cannons (2): The ship's only means of defense is a pair of forward facing particle beam cannons.

Primary Purpose: Defense.

Secondary Purpose: Anti-Pirate/Raider.

Mega-Damage: 6D6x10 M.D.C. for a dual blast, or 3D6x10 for a single blast

Rate of Fire: Equal to the combined hand to hand attacks per melee of the pilot. One single blast or one dual blast per attack.

Effective Range: 3 miles (4.8 km).

Payload: Effectively unlimited.

Goliath Class Asteroid Miner

The Goliath Class Asteroid Miner is the industry standard in the Three Galaxies. It is a combination industrial mining center and starship. They are common sights in many of the populated systems that have asteroid belts. Typically, scout ships locate an asteroid to be mined. The ship then moves into the belt and latches on to the asteroid with oversized mandibles in the front of the ship (sometimes a grappling hook and pulley). From there, a series of drills and conveyor belts begin drilling into the asteroid, splitting it and hauling smaller chunks into the ship, where the rock is melted down to expose any valuable ores. For truly monstrous asteroids, a passageway can be drilled directly into the asteroid, and then be pressurized with an atmosphere allowing miners to work right inside it as they hollow it out like an eggshell.

Model Type: AMX-3000

Class: Portable industrial site and mining vehicle.

Crew: 840 personnel are the typical make-up. The industrial plant works at optimum capacity with 300 workers. There are

250 miners, 25 engineers, 25 hazardous material and demolition personnel, 20 pilots for the various utility vehicles and shuttles, 20 bridge crew, and 200 additional crew.

M.D.C. by Location:

Claw Mandibles (4) – 8,000 each
Conveyer Belt Feed – 4,000
Processing Plant/Front Half of Ship – 15,000
Processing Plant Engines (2) – 3,000 each
Crew and Drive Section/Rear Half of Ship – 10,000
Bridge Tower – 2,500
Bridge – 1,000
Hangar Bay – 6,000
Laser Turrets (11) – 500 each
Mini-Missile Turrets (5) – 500 each
Bridge Weapon Turrets (2) – 250 each
*Framework – 5,000
**Storage Containers (24) – 1,000 each
Variable Force Field – 3,000 (500 M.D.C. per side)

* The framework not only holds the storage pods in place, but it keeps the ship together in one piece. If the M.D.C. is depleted by half, the containers will start to float away. If all of the M.D.C. is depleted, the sections separate.

** If the storage containers are filled with a volatile liquid or other flammable substance, there is a 30% chance of the container exploding once the M.D.C. is depleted by more than half. For each hit over half that does more than 50 M.D., the chances of an explosion are increased by 10% per hit! The damage caused by an exploding container is 2D4x100 M.D. to a 200 foot (61 m) area. If the other containers are damaged, this could cause a catastrophic chain reaction, destroying the entire ship. Fortunately most ores are not volatile enough to cause any damage.

Speed:

Driving on the Ground: Not possible.

Flying: Mach 5 in space, and not capable of atmospheric entry. This would destroy the ship.

Star Drive: 2.5 light years per hour, typically uses a gravitonic drive.

Range: It has enough cargo space for a year's worth of consumables. If the cargo containers are used, they can hold six months' worth of additional supplies.

Statistical Data:

Height: 600 feet (182.9 m).

Width: 900 feet (274.3 m).

Length: 3,375 feet (1,028.7 m).

Weight: 18 million tons, not including cargo.

Cargo: 100,000 tons can be held in the ship. Each cargo container can hold up to 250,000 tons.

Power Systems: The ship has six fusion reactors.

Market Cost: 2.5 billion credits.

Standard Weapon Systems:

1. **Laser Turrets (11):** These double-barreled laser turrets are the main defense the ship has against asteroids and raiders who might threaten the ship.

Primary Purpose: Defense.

Secondary Purpose: Anti-Asteroid.

Mega-Damage: 4D6x10 M.D. for a double blast or 2D6x10 M.D. for a single blast.

Rate of Fire: Equal to the number of hand to hand attacks of the gunner (typically 4 or 5).

Effective Range: 5 miles (8 km).

Payload: Effectively unlimited.

2. **Mini-Missile Turrets (5):** These turrets are primarily used in defense of the ship, but the miners have gotten inventive and sometimes use them to blast larger asteroids into smaller, more manageable chunks for mining.

Primary Purpose: Anti-Missile.

Secondary Purpose: Anti-Star Fighter.

Mega-Damage: Varies per missile.

Rate of Fire: One at a time or in volleys of 2, 4, 8, 16, or 32.

Effective Range: Typically a mile (1.6 km).

Payload: 128 per launcher. The total complement is 640 and that's with all the launchers fully loaded. Typically miners will have in storage 3,200 mini-missiles. Reload time per launcher is five to ten minutes (1D6+4).

3. **Bridge Particle Beam Cannons (2):** These weapons are the bridge's only defense plus they hit a little heavier than the laser cannons. They are mounted on either side of the bridge tower.

Primary Purpose: Anti-Ship.

Secondary Purpose: Defense.

Mega-Damage: 6D6x10 for a double blast and 3D6x10 for a single blast.

Rate of Fire: Equal to the combined hand to hand attacks of the gunner (typically 4 or 5 shots per melee).

Effective Range: 3 miles (4.8 km).

Payload: Effectively unlimited.

4. **Shuttles and Other Vehicles:** The ship has a large enough hangar bay to hold two shuttles and a dozen star fighters or utility craft. These do not come standard with the ship, and have to be bought separately, but they can help supplement the ship's defenses.

Explorer Class CCW Cruiser

The Explore Class was appropriately named. They are the lead ships in any exploratory mission, fully equipped with an array of scientific equipment, the best sensors available to the CCW and extensive scientific labs. This type of ship is the most common sign of CAF presence. They are frequently used to transport dignitaries such as ambassadors, diplomats, and delegates around the Consortium.

When not engaged in scouting or survey missions, or transporting important persons around the galaxy, they are off in some remote region of space loaded with scientists out exploring. Exploratory operations have two mission goals: 1) Chart new regions of space, adding to the CCW's extensive star charts, and 2) to make first contact with new species. As the Consortium follows a policy of non-interference with underdeveloped worlds (read as worlds that have not yet developed FTL

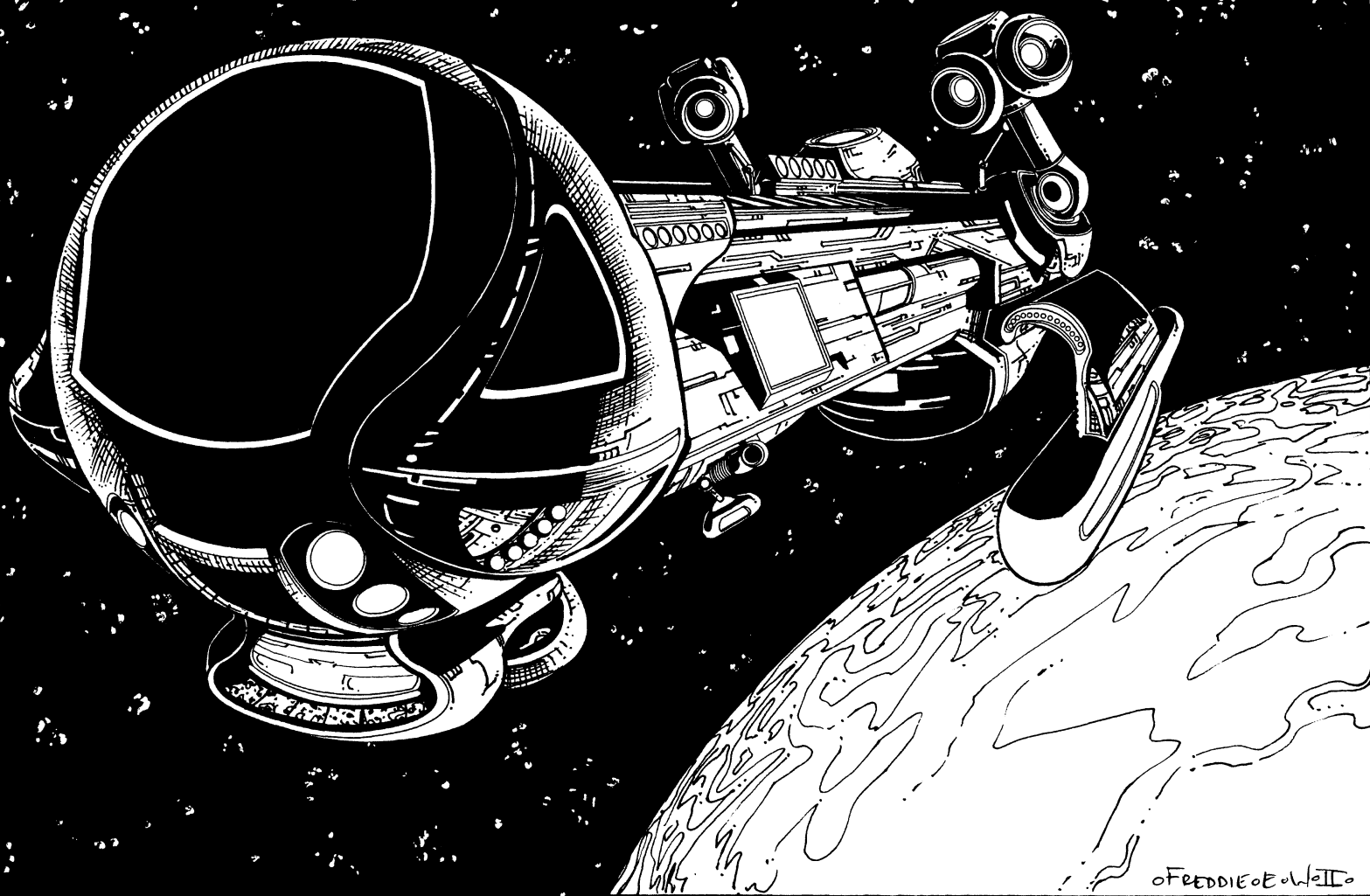

technology), they only approach races with space-faring technology.

Model Type: LC-45

Class: Light combat starship.

Crew: 875 crew, also see troop/visitor capacity.

Troop Capacity: Four companies (160 troops per company) are carried during wartime. Typically, two companies are infantry (specialized as boarding parties) and the remaining two companies are mechanized. They typically have four Bombarbs, four Phalanx Main Battle Tanks, 24 Silverhawks, 24 PA-10's, and 4 IFV's per company.

M.D.C. by Location:

Main Laser Battery – 5,000

Secondary Laser Batteries (2) – 700 each

Medium Particle Beam Cannons (4) – 600 each

Cruise Missile Batteries (2) – 1,000 each

Long-Range Missile Batteries (4) – 450 each

Point Defense Rail Guns and Short-Range Missile Turrets (10) – 350 each

Variable Force Fields – 10,000 per side (60,000 total)

Hangar Bay – 35,000

*Bridge – 40,000

**Main Body – 135,000

Main Engines (2) – 35,000 each

Secondary Engines (2) – 15,000 each

* If the bridge is destroyed, the main computer is knocked out and key systems go offline for 2D4 melees until controls are transferred to the sub-bridge, located deep in the ship near engineering. Controls from the sub-bridge are -2 to strike as it lacks the sophistication of the main bridge.

** If all M.D.C. is depleted, the vehicle is in tatters and various ship systems will be knocked out or destroyed. The ship can not be navigated under its own power and is set adrift. Weapon systems with their own power supply remain operational, but those tied into the ship's power supply are dead. If the ship is reduced to -500 M.D.C., it explodes, doing 2D6x1,000 M.D. to everything within 1,000 feet (305 m). Note that the point defenses, particle beam cannons and long-range missile batteries have their own nuclear power supply.

Speed:

Driving on the Ground: Not possible.

Flying: Mach 13 in space, not atmosphere capable.

Star Drive: 6 light years per hour, but can push 7 light years per hour for 1D6 hours. This would severely tax the engines, requiring them to be shut down for at least four hours

of repair and realignment. If the engines are not shut down, they can continue to operate for another 2D4 hours, after which they are ruined beyond repair and will have to be replaced, costing at least a hundred million credits in repair work and parts.

Range: The ship carries enough supplies for five years of continuous travel. The supplies could be rationed to last 8 years in an emergency. Typical exploration missions can last two years.

Statistical Data:

Height: 348 feet (106 m).

Width: 375 feet (114 m).

Length: 2475 feet (754 m).

Weight: 8.5 million tons fully loaded.

Cargo: Can hold 275,000 tons of cargo and extra equipment.

Power Systems: Varies.

Market Cost: 35 billion credits.

Standard Weapon Systems:

1. Main Laser Battery: This is the main weapon of the Explorer. Mounted on the belly of the ship, this cannon can rotate 360 degrees and has a 90 degree arc of fire. This gun is the same 40-inch cannon mounted on the Protector class battleship.

Primary Purpose: Anti-Ship.

Secondary Purpose: Anti-Planet.

Mega-Damage: 2D6x1000

Rate of Fire: Two times per melee.

Effective Range: 100 miles (160 km) in space, 30 miles (48 km) in an atmosphere.

Payload: Effectively unlimited.

2. Secondary Laser Batteries (2): These two heavy lasers are located on the sides of the ship and both are forward facing. In order to hit any target, the ship has to be facing it to obtain a solid lock on.

Primary Purpose: Anti-Ship.

Secondary Purpose: Anti-Space Station.

Mega-Damage: 1D6x1000 for a single shot and 2D6x1000 for a dual blast.

Rate of Fire: Two single or double blasts per melee.

Effective Range: 100 miles (160 km), 30 miles (48 km) in an atmosphere.

Payload: Effectively unlimited.

3. Medium Particle Beam Cannons (4): Two turrets are mounted in the front and two in the rear. These weapons are meant for smaller ships, like runner ships and small frigates. Only two of these weapons can be aimed at a single target at one time.

Primary Purpose: Anti-Ship.

Secondary Purpose: Anti-Space Station.

Mega-Damage: 3D6x100 per cannon or 1D4x1000 if two cannons are aimed at the same target.

Rate of Fire: Each cannon can be fired two times per melee.

Effective Range: 12 miles (19.2 km). In an atmosphere the range is half.

Payload: Effectively unlimited.

4. Cruise Missile Batteries (2): Mounted fore and aft, these launchers are the same as used on the Protector, however, they can only fire up to 64 cruise missiles per melee.

Primary Purpose: Anti-Ship.

Secondary Purpose: Bombardment.

Mega-Damage: Varies with missile type (2D6x100 to 4D6x100 or new antimatter heavy cruise missiles).

Rate of Fire: One at a time or volleys of 2, 8, 16, or 32 missiles per launcher.

Effective Range: 1,000 miles (1,600 km) with optimum launching range being 1 to 3 miles (1.6 to 4.8 km).

Payload: 32 missiles per launcher. The auto-loader takes 1D6 melee rounds to reload the launcher. Unlike the other missile launchers, these batteries are built into the front and aft of the ship superstructure, as a result, it is far easier to load these launchers, giving a quicker turnaround time. Standard missile complement is 1,280 for a total of 40 reloads. When combat is expected, a standard complement is a mixture of half nuclear and half heavy antimatter warheads. Typically carries no more than 64 heavy cruise missiles at a time.

5. Long-Range Missile Batteries (4): These missile batteries are meant for the smaller targets such as space fighters, power armor and incoming missiles.

Primary Purpose: Anti-Space Fighter.

Secondary Purpose: Defense.

Mega-Damage: Varies per missile type.

Rate of Fire: One at a time or in volleys of 2, 4, 8, 16, or 32.

Effective Range: Varies per missile type.

Payload: 64 missiles per launcher. Standard ship's complement is 2560 missiles or 10 reloads per launcher. It takes 1D6 minutes to reload a single launcher.

6. Point Defense Rail Gun and Short-Range Missile Turrets (10): Arranged around the ship to cover it from all directions, these combination missile turrets and rail guns provide for the point defense of the vessel. Five are mounted topside and five are mounted on the belly. These bubble turrets are manned by a crew of two, a gunner and a gunner's mate to help with sensor reading and calibrating the targeting scanners. If necessary, the turrets can be automated, but are then only +2 to strike and have four attacks per melee round.

Primary Purpose: Anti-Space Fighter.

Secondary Purpose: Anti-Missile.

Mega-Damage: Rail guns: 1D6x10 for a forty round burst. Missiles: varies per missile, typically a mix of armor piercing and plasma.

Rate of Fire: Bursts only for the rail gun, equal to the combined hand to hand attacks per melee. The short-range missiles can be fired one at a time or in volleys of 2, 4, 8, 16, or 32.

Effective Range: 3 miles (4.8 km) for the rail guns, and the missiles vary (typical range is 5 miles/8 km).

Payload: 1,000 bursts before needing a minute for the auto-loader to fill the ammo drum. The missile turret has 128 short-range missiles. The ship carries 12,800 in various cargo holds to re-supply the launchers. As with the long-range missile launchers, it takes 1D6 minutes to reload the launchers.

7. Aircraft and Military Vehicles: In addition to the ship's weaponry, it also contains the following vehicles. Two CAF assault shuttles, 12 Katana fighters, 12 Black Eagles, 36 Silverhawk power armors, and 2 Battleram assault robots.



Oni Shadow Ship/ Stealth Shuttle

The Shadow Shuttle is the Oni Ninja's spacecraft of choice. It is capable of FTL speeds and also has a very fast conventional engine. It is lightly armed and not built for combat; rather it's designed for silent penetration into enemy territory. The shuttle's main components are comprised of the same materials used in construction of Cyberai. This enables the shuttle to actually change its physical configuration, adding to its stealth capabilities. The first configuration is a standard pleasure yacht. This is a total facade and only appears externally to look like one of the hundreds of other pleasure yachts seen around the Three Galaxies. The second configuration is a fast and sleek aerodynamic shuttle, called the cruise configuration. This allows the ship to obtain its maximum speed in an atmosphere by reducing atmospheric drag. The third and final configuration is the shuttle's stealth mode. It takes on an angular appearance and a smaller profile. This helps to reduce, if not totally diminish, its radar signature. Other electronic countermeasures are also employed, further reducing the shuttle's chances of being detected.

The shuttles are never sold to non-Oni, and the Oni will not even confirm its existence. Only a select few organizations actually make this spacecraft, and they must maintain close ties with various Oni Ninja factions.

Model Type:

Class: Stealth Shuttle.

Crew: 3, pilot, copilot and communications. It can accommodate 8 comfortably, or 12 cramped.

M.D.C. by Location:

Wings (2) – 600 each

Main Engines (2) – 550 each

Forward Mounted Lasers – 200

Mini-Missile Turret – 300

Reinforced Pilot's Compartment – 350

*Main Body – 2300

Variable Force Field – 1200 (200 per side)

*Regardless of the shuttle's configuration, the M.D.C. of the various components remains the same. If all M.D.C. is depleted, the vehicle is in tatters and various ship systems will be knocked out or destroyed, the ship cannot navigate under its own power, and only weapon systems with their own power supply remain operational. If the ship is reduced to -200 M.D.C., it explodes, doing 1D4x100 M.D. to everything within 500 feet (152 m) due to the antimatter reactor.

Speed:

Driving on the Ground: Not possible.

Flying: Mach 10 in space, Mach 8 in an atmosphere while in its cruise configuration. In the other two modes the maximum speed is Mach 5.

Star Drive: The shuttle has a Contra-Gravity Drive, allowing it to go up to 2 light years per hour. Typical cruising speed is 1.4 light years per hour.

Range: The shuttle has enough cargo space to carry two months' worth of supplies. After this time period, the atmospheric scrubbers would have to be replaced and the shuttle would no longer be able to create any water for its crew.

Statistical Data:

Height: 40 feet (12.1 m) in yacht configuration, 35 feet (10.6 m) in cruise configuration, and 32 feet (9.8 m) in stealth mode.

Width: 78 feet (23.8 m) in yacht configuration, 70 feet (21.3 m) in cruise configuration, and 61 feet (18.6 m) in stealth mode.

Length: 130 feet (39.6 m) in the yacht configuration, 140 feet (42.7 m) in cruise configuration and 103 feet (31.4 m) in stealth mode.

Weight: 300 tons.

Cargo: Can only hold about two tons of cargo.

Power Systems: The shuttle has a micro-antimatter reactor.

Market Cost: 200 million credits, but only sold to Oni Ninja clans, and even they have to have the right connections. If this ship were ever available on the black market it could easily sell for double its price!

Standard Weapon Systems:

1. Forward Mounted Lasers: Mounted on the nose of the craft are a pair of laser cannons. They can only be used in the cruise and yacht configurations.

Primary Purpose: Defense.

Secondary Purpose: Anti-Star Fighter.

Mega-Damage: 3D6x10 per cannon, 6D6x10 for a dual blast.

Rate of Fire: Equal to the combined hand to hand attacks per melee of the pilot.

Effective Range: 3 miles (4.8 km) in space. 6000 feet (1,829 m) in an atmosphere.

Payload: Effectively unlimited.

2. Mini-Missile Turret: Mounted in the rear of the craft, just above the engines, is a concealed mini-missile turret. As with the laser cannons, they can only be fired in the cruise and yacht configurations.

Primary Purpose: Defense.

Secondary Purpose: Anti-Star Fighter.

Mega-Damage: Varies per missile. Typical load is plasma.

Rate of Fire: One at a time or in volleys of 2, 3, 6, or 9.

Effective Range: Varies per missile.

Payload: 36

Starfish

“The Starfish is the premier pleasure yacht from Stargazer Corp. It is filled with all the amenities one could ever want for space travel, anyone flying in a Starfish flies in style.

“The ship has three decks, each of which has its own climate control. The yacht has an advanced artificial intelligence to handle your bothersome stellar navigation, and never get lost with our patented Auto-Star Finder. This feature is hooked directly to the ship’s A.I. to provide the most accurate and up to date star charts available. Always service minded, whenever you pull into any of the Stargazer representative offices, the ship’s navigational charts are automatically updated.

“The yacht boasts three suites – one master bedroom and two guest quarters – plus six other rooms to be used as you deem fit, exercise room, spa, library, trophy room, or whatever you’d like. Each room comes standard with a refresher, but at an extra cost of only 100,000 credits, a hot tub (for the master suite) and showers can be added.

“A full galley is included so you never again have to endure the synthetic rations most space travelers have to eat. With ample storage space and a built-in cold storage unit, you could store enough food to eat full course meals every day for a month!

“Oh, and don’t worry about missing that important transmission from the board of directors, because the Starfish is equipped with a stellar communication array. Have your conversation in the privacy of any room on the yacht, or indulge your guests with a holographic display at dinner.

“The solar sails are both functional and decorative. Looking for that little extra bit of power? Well the sails collect loose particles in space and convert them to energy, and serve as solar collectors as well. When not in use, the sails neatly fold up, reducing atmospheric drag when landing.

“Should an emergency arise, the Starfish is equipped with four escape pods. Each has a powerful transmitter to send and receive messages between the other escape pods and to call for help. The escape pods have enough power and consumables to last a week, but careful rationing can double that time.

“This model is the most popular on the market. Stargazer Corp has already sold over 17,000 of them in the Three Galaxies. It is versatile enough to be upgraded and has four built-in hard points to mount weapons (nothing larger than medium weapons class). Also, at the loss of cargo space (1/2 of it), the variable force fields could be upgraded to five times their current power level.

“So remember, when you have to travel, travel in style with a Stargazer Starfish.”

– Sales pitch from a Stargazer representative.

Model Type: PY-SF003

Class: Pleasure Yacht.

Crew: 2 required, but up to 12 comfortably.

M.D.C. by Location:

*Main Body – 1300

Solar Sails (6) – 100 each

Main Engines (2) – 500 each

Observation Deck – 500

Crew Compartment – 500

Escape Pods (4) – 300 each

Variable Force Field – 600 (100 per side)

* If all M.D.C. is depleted, the vehicle is destroyed. The crew’s only hope for survival is to use the escape pods.

Speed: Mach 8 in space, Mach 4 in an atmosphere and can travel two light years per hour using a CG drive.

Range: The yacht can be loaded with enough consumables to last two months before needing to restock.

Statistical Data:

Height: 45 feet (13.7 m), 178 feet (54.3 m) with sails deployed.

Width: 75 feet (22.9 m), 155 feet (47.2 m) with sails deployed.

Length: 135 feet (41.1 m), 170 feet (51.8 m) with sails deployed.

Weight: 700 tons.

Cargo: 5 tons of cargo can be stored.

Power Systems: Fusion reactor.

Market Cost: 95 million credits.

Weapon Systems: None standard. The ship does have four hard points that could mount as large a weapon as the medium-class systems, but medium weapons would cause a serious drain on the ship’s resources. Light weapons would be more appropriate and can be added at cost.

Star Streaker Luxury Liner

The Star Streaker is the premier luxury liner of the Three Galaxies. Every amenity and luxury can be found on this ship, starting with the 1,200 staterooms that have variable gravity and environmental controls. Even the smallest stateroom offers these amenities. Exotic alien entertainment and cuisine can be found in the various buffets and lounges around the ship. Everyone on board can enjoy the view; yes, the view. The entire top deck is covered in transperisteel. The views when traveling through various systems and stellar phenomena are sights to behold.

Cosmic Vacations Inc. is one of the oldest travel agencies in the Three Galaxies. They were also the first to offer the cruise experience to just about anywhere in the galaxy. From exotic ports of call like the Rose Nebula, to the Kalador System in the Pleasure Federation.

Model Type: LX-0524

Class: Luxury cruise liner.

Crew: 350

Passengers: It can accommodate 2,600 passengers.

M.D.C. by Location:

*Main Body: 35,000

Wings (2): 8,500 each

Main Engines (Rear ¼ of ship): 12,000

Top Tail Fins (2): 4,200 each

Bridge: 5,000

Landing Bay: 8,000

Transparent Upper Hull: 6,500

Lifeboats (10): 700 each

Variable Force Field: 6,000 (1,000 per side)

*If all M.D.C. is depleted, the vehicle is a tattered hulk floating in space. The crew's only hope for survival is to use the lifeboats.

Speed: Mach 14 in space, Mach 7 in an atmosphere.

Star Drive: The ship can also go 3 light years per hour with its CG drive.

Range: Enough consumables for a month's travel.

Statistical Data:

Height: 1,440 feet (438.9 m).

Width: 1,200 feet (365.8 m).

Length: 2,772 feet (844.9 m).

Weight: 8 million tons, plus cargo.

Cargo: 100,000 tons.

Power Systems: Matter/antimatter reactor with a life of 50 years.

Market Cost: 15 billion credits.

Standard Weapon Systems:

1. Light Laser Cannons (8): The lasers are the ship's main defense, and are carefully concealed behind a series of sliding doors scattered around the ship. The cannons are double-barreled and usually manned by a crew member.

Primary Purpose: Defense.

Secondary Purpose: Anti-Asteroid.

Mega-Damage: 2D6x10

Rate of Fire: Equal to the combined hand to hand attacks per melee, typically 3 to 4.

Effective Range: 12,000 feet (3,658 m).

Payload: Effectively unlimited.

2. On-Board Defenders. Most cruise ships have a small power armor complement on board; about 12-18. Also a third of the crew doubles as security and can equip themselves with a variety of armor and weapons, only most are not experienced in combat at all.

Dragon Star Fighters

Dragon Industries has developed several types of space fighters, from light scouts to frigate killers. These new spacecraft are starting to make a name for themselves, compelling the owner of Dragon Industries to take a very large risk by selling several hundred fighters at cost to the Free World Council (FWC). In return, D.I. receives all performance data on the spacecraft. For the last two years, the fighters have proven their worth and the following are about to hit the intergalactic market.



Dragon Star Hawk

The Star Hawk started out as a high speed racing vehicle that evolved into a star fighter. The primary role of the fighter is meant to be a long-range scouting craft. However, due to the relatively cheap price, it appears that it will become popular as an orbital defense and police fighter. Even though the fighter lacks shields, it makes up for this shortcoming in speed and maneuverability. There are also four afterburners that dramatically increase the fighter's speed, and make it trans-atmospheric. The fighter has a long nose and four wings in an inverted delta shape. On each wing is a laser cannon. The forward fuselage has a dual medium-range missile launcher.

Model type: DI-SH50

Class: Orbital interceptor/scout.

Crew: One.

M.D.C. by Location:

Reinforced Pilot's Compartment/Escape Pod – 150

Wings (4) – 100 each

Main Engines – 200

*Main Body – 350

**Afterburners (4) – 100 each

* If all M.D.C. is depleted, the vehicle is destroyed. The pilot's only hope for survival is to eject (the reinforced pilot's

compartment doubles as an escape pod with 24 hours worth of oxygen).

** The ship's top speed is reduced to Mach 15 if the booster engines are destroyed.

Speed:

Flying: In space the fighter can attain a maximum speed of Mach 15. With the four boosters, the fighter can increase speed to Mach 20. The boosters are meant to be a last resort option as all of the ship's power is diverted to engines, even weapons are temporarily offline. The booster can be maintained for up to an hour before vital systems begin shutting down. The Star Hawk can go up to Mach 7 in an atmosphere. The boosters can provide enough speed to break orbit. When the boosters shut down, it takes five minutes for the energy weapons to fully recharge. Until that time passes, the cannons can only be fired a total of four times per melee. After five minutes, the energy converter cools down enough to fully charge all the cannons. The booster engines can be reactivated after a cool down period of twenty minutes. The booster engines can also be ejected in the event of an emergency.

Range: The spacecraft's life support can last for 6 days.

Bonuses: +3 on initiative, +1 to strike, +4 to dodge, +6 to dodge at maximum speed, +15% on dog-fighting and special maneuvers!

Statistical Data:

Height: 10 feet (3.0 m) at the body and 26 feet (7.9 m) with the wings.

Width: 23 feet (7.0 m).

Length: 30 feet (9.1 m).

Weight: 8.5 tons.

Cargo: Enough room for a laser rifle and a survival kit.

Power system: Nuclear, average energy life of 20 years.

Market Cost: 47 million credits.

Standard Weapon Systems:

1. Laser Cannons: These are the ship's primary defensive weapons.

Primary Purpose: Anti-Star Fighter.

Secondary Purpose: Defense.

Mega-Damage: 4D6x10 for all four cannons or 1D6x10 per cannon.

Rate of Fire: Equal to the combined hand to hand attacks of the pilot.

Effective Range: 3 miles (4.8 km).

Payload: Unlimited.

2. Medium-Range Missile Launcher: Located in the nose of the fighter, on either side. The missile rack is recessed until being fired.

Primary Purpose: Anti-Star Fighter.

Secondary Purpose: Defense.

Mega-Damage: Damage varies, typically loaded with plasma or high explosive.

Rate of Fire: 1, 2, 4, 6, 12, or 18.

Effective Range: Varies as per missile, but doubled in space.

Payload: 18

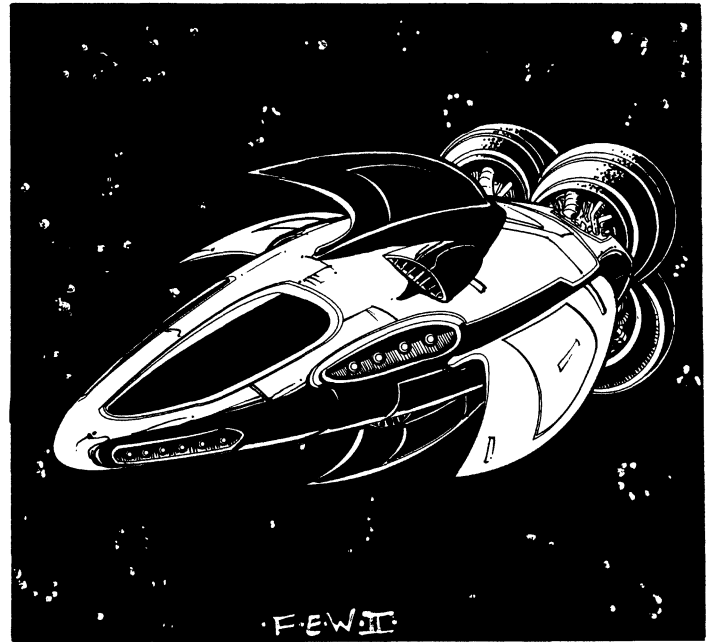

Dragon Fang

The Dragon Fang is truly the pride of Draygon Industries. The fighter has been well received by the Free World Council (FWC) and DI has a choice of several very lucrative defense contracts with other governments as well. The fighter's unique design gives it its name. The edges of the four protruding wings are Vibro-Blades. Daring test pilots flew the ship close enough to rake the sides of test ships, rupturing several compartments and doing significant damage to the hull of the ships. In addition to the Vibro-Blade wings, the fighter is also equipped with two cruise missiles, variable lasers and particle beams. Performance reports from the FWC indicated that Dragon Fangs won engagements with a kill ratio of 5 to 1! Additional orders for the fighter have been placed by the FWC, but the Kreeghor have become aware that DI is supplying a rebellion against its government and have banned all shipments into Kreeghor Space. DI is always looking for daring and courageous adventurers to break the Kreeghor blockades and deliver their fighters.

Model Type: DI-DF2000

Class: Strategic Interceptor.

Crew: One.

M.D.C. by Location:

Reinforced Pilot's Compartment/Escape Pod – 200

*Main Body – 500

Large Wings (2) – 300 each

Small Wings (2) – 150 each

Variable Force Field – 200 per side (1200)

* If all M.D.C. is depleted, the vehicle is destroyed. The pilot's only hope for survival is to eject (the reinforced pilot's compartment doubles as an escape pod with 48 hours worth of oxygen).

Speed:

Flying: Mach 15 in space, Mach six in an atmosphere.

Range: Effectively unlimited; limited only by the pilot's endurance and oxygen supply (life support for 14 days).

Statistical Data:

Height: 12 feet (3.6 m).

Width: 32 feet (9.7 m).

Length: 32 feet (9.7 m).

Weight: 14 tons.

Cargo: A small weapons locker that can hold a rifle and basic survival kit.

Power Systems: New fission/fusion reactor.

Market Cost: 68 million credits.

Weapon Systems:

1. Forward Particle Beam Cannon: This is one of the main weapons of the fighter. It is located in the nose of the vessel.

Primary Purpose: Anti-Star Fighter.

Secondary Purpose: Defense.

Mega-Damage: 3D6x10 per blast.

Rate of Fire: Equal to the hand to hand attacks of the pilot.

Effective Range: 2 miles (3.2 km).

Payload: Unlimited.

2. Variable Lasers (4): The secondary weapons of the fighter. The variable frequency means they will inflict maximum damage in 1D4 melees to laser resistant targets. The four laser cannons are built into the wings of the craft and appear as small protrusions.

Primary Purpose: Anti-Star Fighter.

Secondary Purpose: Defense.

Mega-Damage: 4D6x10 for all four cannons or 1D6x10 per cannon.

Rate of Fire: Equal to the combined hand to hand attacks of the pilot.

Effective Range: 3 miles (4.8 km).

Payload: Unlimited.

3. Cruise Missile Launcher: Recessed in the belly of the fighter are two cruise missiles. They are stored in a lower bomb-bay style launcher. The missiles drop out of the bay and launch towards their targets.

Primary Purpose: Anti-Starship.

Secondary Purpose: Defense.

Mega-Damage: 2D6x100 for nuclear and 4D6x100 for antimatter.

Rate of Fire: One or two.

Effective Range: 1000 miles (1600 km).

Payload: Two.

4. Wingtip Vibro-Blades: Mounted on the end of each wing are long, serrated Vibro-Blades. Daring pilots navigate close to ships and try to rip open the hull or even do high speed passes on space stations.

Primary Purpose: Anti-Space Station, Anti-Ship.

Secondary Purpose: None.

Mega-Damage: 2D6x10 per 100 feet (30.48 m) slashed.

Penalties: Must make a piloting skill roll at -20%. A failed roll means the fighter hits and bounces off the vessel, inflicting 2D4x10 M.D. to the fighter (1D4x10 to the enemy) and the fighter pilot loses 1D4 melee actions/attacks spent trying to regain control of the star fighter.

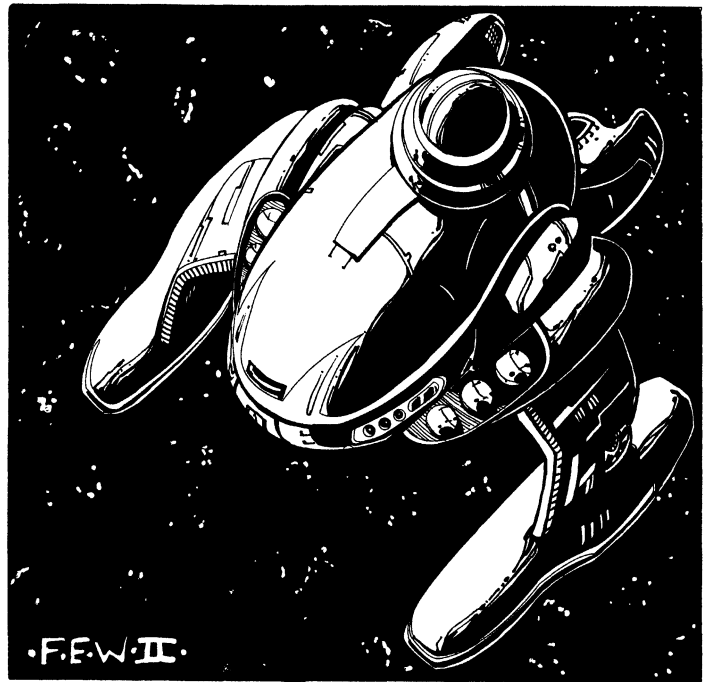

Dragon Nova Star Fighter

The Nova star fighter is the premier bomber developed by DI. Its deadliest weapon is its payload of six cruise missiles. The ship's specific role is a frigate killer. It has some minor weapons if it has to engage in dog fighting, but is usually protected by some type of escort. The FWC has reported the ship has performed well overall and DI can expect additional orders in the future.

Model Type: DI-N500 & DI-N501/CG

Class: Long-Range Fighter/Bomber.

Crew: Two.

M.D.C. by Location:

*Main Body – 600

Wings (2) – 250 each

Main Engines (2) – 200 each

Booster Engines (2) – 200 each

Top Fins (2) – 175 each

Reinforced Pilot's Compartment/Escape Pod – 200

Variable Force Field – 1200 (200 per side)

* If all M.D.C. is depleted, the vehicle is destroyed. The pilot's only hope for survival is to eject (the reinforced pilot's compartment doubles as an escape pod with 72 hours worth of oxygen).

Speed:

Flying: Mach 12 in space, but up to Mach 18 with the boosters. Mach 6 in an atmosphere.

The booster engines are similar in design to the Star Hawk's. They also drain power from the energy weapons, shutting them down when the boosters are engaged. The boosters can be maintained for thirty minutes before needing to be shut down. As with the Star Hawk, the laser weapons need five minutes to fully charge and can only fire four single shots or two dual blasts per melee until that time passes. The particle beams cannot be fired at all until fully charged, which also takes five minutes.

Star Drive: The DI-N501/CG has a Contra-Gravity Dive with a maximum speed of 2.5 light years per hour. This model **does not** have the booster engines.

Range: Effectively unlimited; limited only by the pilot's endurance and oxygen supply (life support for 7 days for two pilots).

Statistical Data:

Height: 16 feet (4.8 m).

Width: 54 feet (16.4 m).

Length: 48 feet (14.6 m).

Weight: 40 tons.

Cargo: Small storage closet, 6x6x6 feet (1.8x1.8x1.8 m).

Power Systems: New fission/fusion reactor with an average life of 15 years. The 501/CG model is equipped with a matter/anti-matter reactor with an average life of 10 years.

Market Cost: 90 million credits for the DI-N500 & 100 million for the DI-N501/CG.

Weapon Systems:

1. Forward Laser Cannons (2): These are the forward mounted laser cannons that are primarily used against star fighters. They are not very powerful, but do the job. The lasers were added as an afterthought to give the Nova a weapon for close combat in dogfights and against swarming troops or raiders.

Primary Purpose: Anti-Star Fighter.

Secondary Purpose: Defense.

Mega-Damage: 4D4x10 per dual blast. 2D4x10 per cannon.

Rate of Fire: Equal to the hand to hand attacks of the pilot.

Effective Range: Two miles (3.2 km) in space and 6000 feet (1829 m) in an atmosphere.

Payload: Effectively unlimited.

2. Particle Beam Cannons (2): These heavy cannons are meant for engagements against larger ships such as frigates and cruisers. They are generally used to punch holes in armor and shields. Smaller vessels, like star fighters, are +5 to dodge these cannons. A side effect of using the cannons is that engine power is reduced by 20% and maximum speed is reduced to Mach 9 (the boosters to Mach 14). This drain lasts for as long as the P-beams are used. Engine power is restored to full power in 3D6+2 melees after the P-beams cease firing.

Primary Purpose: Anti-Spacecraft.

Secondary Purpose: Anti-Ship.

Mega-Damage: 1D4x100 for a dual cannon shot, or 4D6x10 if one of the cannons is damaged or destroyed.

Rate of Fire: Four dual shots per melee.

Effective Range: Five miles (8 km) in space and 2 miles (3.2 km) in an atmosphere.

Payload: Effectively unlimited.

3. Wingtip Mini-Missile Launchers (2): Contained in each tip of the wings is a mini-missile launcher.

Primary Purpose: Anti-Ship.

Secondary Purpose: Defense.

Mega-Damage: Varies with missile type.

Rate of Fire: One at a time or in volleys of 2, 4, 8 or 18.

Effective Range: About two miles (3.2 km).

Payload: 162 missiles, 81 per launcher.

4. Top-Mounted Medium-Range Missile Launchers (2):

These two top-mounted missile launchers fire medium-range missiles. They are meant for small to medium ships.

Primary Purpose: Anti-Ship.

Secondary Purpose: Defense.

Mega-Damage: Varies with missile type.

Rate of Fire: One at a time or in volleys of 2, 4, 8, or 10.

Effective Range: 50 to 100 miles (80 to 160 km).

Payload: 40, 20 per launcher.

5. Cruise Missile Launcher: This weapon is what makes the Nova fighter so deadly. It carries a payload of 6 cruise missiles in its belly. These missiles are typically launched at near point-blank range to inflict maximum damage.

Primary Purpose: Anti-Frigate, Anti-Cruiser.

Secondary Purpose: Defense.

Mega-Damage: 2D6x100 Nuclear, 4D6x100 Antimatter.

Rate of Fire: One at a time or 2, 3, 4, 5 or all 6.

Effective Range: 1000 miles (1600 km).

Payload: 6

Star Fighter Accessories

Draygon Industries offers several star fighter add-ons. These accessories fit best with their own products. However, to compete in the galactic market they tried to make them as adaptable for use with competitors' designs as possible. The following booster packs are DI's current market models. Other corporations offer similar items and features.

Rocket Boosters: A booster pack that gives a star fighter a significant burst of speed. They come in pairs with a universal attaching joint. The rockets are a single use item that have a solid chemical propellant. Once the boosters have exhausted their fuel, they automatically jettison. They can, however, be jettisoned anytime by the pilot should the need arise. The rockets are typically used to give star fighters a boost out of planetary atmospheres or as a means to escape an enemy. The Free World Council has been known to purchase these booster packs in large quantities. They use them for high-speed reconnaissance of Kreeghor systems where they speed into a system under normal power, gather what intelligence they can and use the boosters to make a high-speed escape. The only downside is once they are activated they cannot be shut down, the only way the pilot can decelerate is by ejecting the boosters.

M.D.C. by Location:

*Rockets (2) – 100 each

*If the M.D.C. of the rocket is depleted and it has all its fuel, it explodes, doing 4D6x10 M.D. to everything within 50 feet (15.2 m).

Range: Varies with speed.

Speed: If the rockets are used in conjunction with the star fighter's own engines the vehicle's speed is increased by 1/4 or to Mach 18, whichever is higher. If only the boosters are used, they have a speed of Mach 9.

Duration: The rocket boosters last for five minutes, once acti-

vated. It takes one melee in space to reach the boosters' maximum speed. In an atmosphere it takes one minute.

Note: When the boosters are engaged they do not offer much in the way of control. If the pilot has to engage in evasive maneuvers he is -10% to do so. Failed rolls mean that the ship is off course.

Weight: 4 tons.

Cost: 2.5 million credits.

Reusable Booster Pack, A.K.A. Fusion Booster: The reusable booster pack is a fusion powered booster rocket. Unlike the rocket booster that uses chemical propellants, the fusion engines use a standard plasma reaction to generate a large amount of thrust. The results are the same as using the rocket boosters, except that these engines are reusable.

The Fusion Booster has the same restrictions as the rocket booster, once activated they cannot be disengaged. This is because the plasma reaction burns like a chemical propellant. The fusion reactor provides enough fuel for the reaction and once it begins it can't be stopped short of ejecting the fusion booster. The only difference between the two is that the Fusion Booster unit does not have a universal attachment. This item has to be custom ordered for rare and uncommon space fighters. Some of the more common space fighters already have pre-made fusion booster assemblies.

M.D.C. by Location:

Engines (2) – 200 each

*Fusion Core – 300

*If the M.D.C. of the fusion core is depleted, it explodes, doing 1D6x100 M.D. to everything within 40 feet (12.2 m).

Range: Varies with speed.

Speed: These engines burn more efficiently than the rocket boosters, allowing for greater thrust. They increase the overall speed of the fighter by 1/3 or to Mach 20, whichever is greater. If the boosters are used alone they have a speed of Mach 12.

Duration: The fusion booster burns for five minutes. It takes a half a melee to reach maximum speed in space and thirty seconds in an atmosphere. It takes four hours for the unit to recharge.

Weight: 6 tons.

Note: The boosters are not meant to be used during evasive maneuvers. All piloting rolls are at -10% to do so. Any failed roll means the ship is off course.

Cost: 8 million credits.

Contra-Gravity Sled: The Contra-Gravity Sled allows fighters to obtain faster than light speeds. This external attachment is used for long-range scout craft that do not have a built-in CG drive. The unit is rather large and bulky, but has the convenience of being disengaged and attached as needed.

M.D.C. by Location:

*Main Body – 300

**External Field Arrays (2) – 50 each

*If all the M.D.C. is depleted the unit no longer functions.

**The External Field Arrays are -3 to strike due to their size. Also, if they are destroyed, the FTL speed is reduced by half.

Range: 5, 10, and 15 light years respectively.

Speed: The basic unit has a speed of one light year per hour, the intermediary unit has a speed of two light years per hour, and the advanced model has a speed of three light years per hour.

Duration: Five hours, the sled can run for as long as it takes to reach its maximum range. It takes 6 hours for the unit to recharge for another use.

Weight: 5 tons.

Note: The C.G. Sled can be hooked directly into the fighter's power supply, reducing the recharge time by half.

Cost: 5 million credits for the basic model, 8 million for the intermediary model, and 12 million for the advanced sled.

Magic Starships

Arcane Mark X

Nexus Battleship

The Nexus Battleship is the latest marvel to combine magic and technology. It's a top of the line UWW combat vessel using Inglix the Mad's latest designs. The Arcane Mark X utilizes a new and upgraded Rift jump drive capable of a 40 light year jump, but is so new that these battleships have only seen action in a few small skirmishes and the Warlock Navy mopped the floor with the enemy. These ships have yet to test their mettle in a full-scale battle, but should be a force to be reckoned with.

Model Type: ARC-X

Class: Heavy Battleship.

Crew: 310, includes officers and a 30 man Techno-Wizard engineering team. There are also an additional 192 combat personnel that are divided between pilots and Warlock Marines.

M.D.C. by Location:

*Main Body: 40,000

Wings (2): 15,000 each

Hanger Bay (Belly of the ship): 5,000

Main Engines (2, one on each wing): 8,000 each

Tail Lasers (2): 5,000 each

**Bridge: 10,000

***Magical Shield of Invulnerability: 5,000

* If all M.D.C. is depleted, the vehicle is in tatters. Various ship systems are knocked out or destroyed, the ship cannot navigate under its own power, and weapon systems with their own power supply are the only ones still operational. If the ship is reduced to -500 M.D.C. it explodes, doing 2D6x1,000 M.D. to everything within 1,000 feet (305 m). Also the Elemental Intelligence powering the main P.P.E. generator is released and there is a 01-35% chance that it will remain in the area to cause chaos and mayhem.

** If the bridge is destroyed, the battleship is vulnerable for 2D4 melees until the crew can regain control in the auxiliary bridge deep inside the ship. The auxiliary bridge is meant for situations where the main bridge is not accessible or has been destroyed, so there are no penalties if the bridge is lost. However, if an inexperienced crew is manning the auxiliary bridge, then the ship is -2 on all combat rolls, including attacks.

*** This magical *Shield of Invulnerability* is one of the ship's new systems being field-tested. It is similar to the spell Invulnerability, however, it has been changed and modified to cover the mammoth ship like a skintight force field. The shield takes half damage from all energy attacks and fire based attacks and is impervious to cold unless it is magic (magical cold does one third normal damage). Unlike the variable force fields, this shield has to be totally depleted in order for an attacker to do damage to the hull. Also, one of the newest features is the instant reactivation talisman. Powerful talismans are built into the shield grid. This allows the shield to be instantly erected (takes one melee action) three times per day. In the event of damage to the shield grid or all three activations being used up, the magic engineering team can reactivate the shield grid by imbuing it with 2,000 P.P.E., but that takes five minutes of spell casting and concentration to do. One little bug yet to be worked out is when firing the main Flare Cannon, the shields need to be dropped. It seems the weapon's build-up disrupts and cancels the Shield of Invulnerability, costing the crew one of their shield activations.

Speed:

Driving on the Ground: Not possible.

Flying: Mach 10 in space, Mach 2 in an atmosphere.

Star Drive: Rift jump drive mark II can make a maximum safe jump of 40 light years every six hours. It costs 5,000 P.P.E. to make the jump.

Range: Life support, both magical and technological can maintain the crew for 10 years. That's if the ship's systems are kept in good working order.

Statistical Data:

Height: 150 feet (45.7 m).

Width: 1,200 feet (365.8 m).

Length: 850 feet (259.1 m).

Weight: 125,000 tons.

Cargo: Can carry an additional 10,000 tons of cargo.

Power Systems: A conventional matter/antimatter reactor and the newest in P.P.E. generators, the Generator of Elements. This magic generator contains a trapped Elemental essence to provide a renewing source of P.P.E. for the ship. It can generate 6,000 P.P.E. per hour and stores 40,000 P.P.E. in internal batteries. The matter/antimatter reactor provides all remaining power for the ship.

Market Cost: 25 billion credits to manufacture. Not sold outside the UWW.

Standard Weapon Systems:

1. Flare Cannon: This is the main cannon of the Nexus, mounted on the front of the ship. As the blood crystal powers up, it begins to bleed, until in a massive burst, a giant solar flare fires from the bow of the ship. It is by no means meant to be an accurate weapon, however, as the Death Cloud cannon proved, one does not have to be accurate to inflict heavy damage to a wide area or large target. This weapon is still in the experimental stages and has one bug that has yet to be worked out: As the weapon builds up, the bleeding energy disrupts the ship's shields, causing them to collapse. In the last 15 seconds of build up, the shields are dropped and the

weapon is fired. Due to the limited times the shields can be dropped and raised, this severely limits the use of this weapon (namely when the shields can be lowered without fear of attack, or when the vessel is heavily protected by other combat vehicles, or as a last ditch attack).

Primary Purpose: Anti-Ship and Space Station.

Secondary Purpose: Defense.

Mega-Damage: 1D6x1,000 M.D. per melee round. Like the Death Cloud, the flare floats through space, damaging anything it comes in contact with; the flare lasts for 3D6x10 minutes. One tactic Nexus Battleship captains use is to line two or three battleships together and fire the weapon simultaneously. Each ship factors into the size of the solar flare. Two ships give the flare twice the size and three ships, three times the size, and so on, but duration is unchanged.

Rate of Fire: One shot is possible every five minutes. The cannon has a maximum of 6 shots per hour and 24 per full day. Each shot drains the mystic generator of 4,000 P.P.E.!

Effective Range: Unknown! The flare created is 2 miles (3.2 km) long and a mile (1.6 km) thick! It floats through space at 100 miles per hour (160 km) so technically it could drift up to 400 miles away.

Payload: Limited to the capacity of the mystic generator. Each shot drains 4,000 P.P.E.

2. Tail Laser Batteries (2): Mounted in the tail are two 30-inch laser batteries. Each can fire independently or together. The tail is a flexible unit that is able to point 180 degrees in any direction. It looks like a scorpion's tail when the weapon is faced forward. It can fire from any position and can usually catch some of the more maneuverable ships by surprise.

Primary Purpose: Anti-Ship.

Secondary Purpose: Defense.

Mega-Damage: 1D4x1,000 M.D. per cannon, or 2D4x1,000 M.D. per simultaneous blast.

Rate of Fire: One shot every 30 seconds (two melees).

Effective Range: 80 miles (128 km).

Payload: Effectively unlimited due to the matter/antimatter reactor.

3. Secondary Particle Beam Cannons (4): These weapons are forward facing and can only fire at what's in front of the ship. One is mounted on either side of the Flare Cannon and one on each wing.

Primary Purpose: Anti-Ship.

Secondary Purpose: Defense.

Mega-Damage: 3D6x100 per cannon. If all four cannons are fired simultaneously at the same target, the damage is 1D6x1,000 M.D.

Rate of Fire: Three shots maximum per melee.

Effective Range: 11 miles (17.6 km).

Payload: Effectively unlimited.

4. Long-Range Missile Launchers (4): Long-range missiles were selected over cruise missiles because of the variety of missiles available. It was thought that this ship should have cunning over brute force. Any variety of long-range missiles are suitable for its payload, in any combination, from conventional to nuclear to magic.

Primary Purpose: Anti-Ship.

Secondary Purpose: Defense.

Mega-Damage: Varies per missile.

Rate of Fire: 1, 5, 10, 20, or all 30 per launcher in a single attack! If all launchers are fired that's 120! It takes 30 seconds to reload each launcher.

Effective Range: Varies per missile.

Payload: Each launcher holds 30 missiles. There are another 1,200 missiles stored on the ship. Each launcher typically can be reloaded 10 times.

5. Meteor Cannons (8): The meteor cannons serve as the ship's point defense weapon. They are capable of tracking and attacking faster ships, like fighters and incoming missiles. Not only do the cannons deal out a fair amount of damage, they fire in a cone shape, making them +2 to strike incoming missiles and +4 to strike fighters.

Primary Purpose: Anti-Star Fighter.

Secondary Purpose: Defense.

Mega-Damage: 4D6x10 M.D.C. to everything in a 30 degree cone.

Rate of Fire: 4 shots per melee.

Effective Range: 5 miles (8 km).

Payload: Each cannon draws 100 P.P.E. per shot, so with all 8 cannons firing 4 times per melee that's 3,200 P.P.E. per melee! Fortunately, if the mystic generator is working, the payload is effectively unlimited. However, should it ever be damaged these weapons are typically the first to be shut down.

Note: Due to the large arc of fire, the meteor cannon enjoys a +2 bonus to strike incoming missiles and +4 to strike fighters.

6. Point Defense Rail Guns (4): A standard rail gun system; tough and reliable.

Primary Purpose: Anti-Star Fighter.

Secondary Purpose: Conventional Backup and Defense.

Mega-Damage: 4D6x10 M.D. burst.

Rate of Fire: Each burst counts as one melee attack. The weapon only fires bursts.

Effective Range: 6 miles (9.6 km).

Payload: Each cannon has a payload of 10,000 rounds. This gives each cannon 500 bursts. Another 100,000 rounds are stored in a cargo bay and it takes about 5 minutes to reload a single cannon.

Note: These are double-barreled GR-500's.

7. Aircraft and Military Vehicles: The hangar bay located in the belly of the ship holds a single shuttle (typically a Breacher shuttle) and six fighters.

Arcane Shuttle Mark XV

A.K.A. The Mystic Breacher

The UWW's Breacher shuttle has been around since the formation of the United Worlds of Warlock. Its main purpose is to carry troops into battle and deploy them as quickly as possible. Its secondary purpose is to breach and board enemy vessels using a system of Mystic Portal air locks. (Hull Breacher missiles,

the ones with Mystic Portals, can also be used.) This tactic is used to penetrate the hull of an enemy vessel and unleash a boarding company to take the vessel or seize captives or precious cargo. All the shuttle has to do is pull alongside a ship, latch on thanks to magnetic locks, have the retractable air lock (looks like an accordion) rest against the target vessel and activate the Mystic Portals. In under a minute, 120 troops can be on board an enemy vessel. The shuttle can create three portals per side and keep them open for 15 minutes at a time. These Mystic Portals have been specially designed to allow a two-way passage. This way should the Warlock Marines need to retreat, they can easily board the shuttle.

If for some reason the Mystic Portals are unavailable, the shuttle has two conventional air locks per side. On the outside of each airlock is a magnetic grapple as well as mooring hooks to latch on. A built-in, high-powered plasma cutter creates a circular opening the size of the airlock. The plasma cutter has to exceed the damage of the hull in order to penetrate, or Hull Breacher missiles can be used.

The shuttle has two forms of egress. There is a built-in rear ramp that vehicles can use, or the whole floor of the rear of the shuttle can be lowered. The ramp is for wheeled or tracked vehicles while the floor ramp is intended for large cargo or the quick deployment of troops on the ground.

Model Type: Shuttle.

Class: Military Shuttle.

Crew: Eight. A pilot, copilot, communications/sensor officer, mystic engineer, and four gunners.

Troop Capacity:

1. Boarding Party:

60 Warlock Marines in Power Armor

40 Troops in body armor.

20 Engineers

20 Magic Specialists

2. Mechanized Assault Company:

8 Greataxe IFV Tanks

40 Warlock Marines in Power Armor

20 Magic Specialists

3. Evacuation Emergency: Can carry 300 people under cramped conditions.

M.D.C. by Location:

Main Engines (2) – 500 each

Reinforced Pilot's Compartment (Cockpit) – 800

*Main Body – 3500

Mystic Force Field (Armor of Ithan) – 1000

Breaching Gates (4) – 250 each

Rear Gangplank – 500

Top-Mounted Star Fire Cannon – 350

Side-Mounted Medium-Range Missile Launchers (2) – 250 each

Belly-Mounted Mini-Missile Launcher – 125

*If all M.D.C. is depleted, the vehicle is in tatters, various ship systems are knocked out or destroyed, the ship cannot navigate under its own power and only weapon systems with their own power supply remain operational. If the ship is re-

duced to -200 M.D.C., it explodes, doing 1D6x100 M.D. to everything within 500 feet (152 m).

Speed:

Driving on the Ground: Not possible.

Flying: Mach 7 in space, Mach 4 in an atmosphere. The shuttle has a new experimental air shield that makes the shuttle very aerodynamic. While this makes the shuttle faster in an atmosphere, it provides no additional protection.

Star Drive: The Breacher shuttle is not equipped with a star drive.

Range: The shuttle is not meant to support personnel for a prolonged period of time. It can recycle the atmosphere and produce enough water to last for two weeks.

Statistical Data:

Height: 65 feet (19.8 m).

Width: 70 feet (21.3 m).

Length: 225 feet (68.6 m).

Weight: 1500 tons fully loaded.

Cargo: Without its troop complement, the shuttle can carry 400 tons of cargo.

Power Systems: Mystic Generator and Conventional Fusion Generator.

Magic Systems: The shuttle tries to primarily rely on stealth rather than blunt force. Its main function is to board enemy ships, disgorging scores of troops as quickly as possible. A separate mystic generator powers the mystic properties of the shuttle.

Shadow Meld: While conventional sensors will still pick up the shuttle, this feature allows the ship to make low approaches to planets or during a heated battle to sneak up alongside ships and latch on to disgorge its troops.

Chameleon: Only useful when the shuttle is not moving! This is typically used when the shuttle is ground-side and the ship needs to be concealed. Another option is when the shuttle is attached to an enemy ship.

Mystic Portal: This is the ability for which the shuttle is famous. Three portals can be formed on either side of the shuttle simultaneously. This allows for instantaneous boarding of enemy ships! UWW troops who have specially trained for boarding enemy ships can board in minutes, in game terms, 10 soldiers per melee round, per portal.

Market Cost: 150 million credits.

Standard Weapon Systems:

1. Top-Mounted Star Fire Cannon: A dual-barreled cannon is fixed atop the shuttle. A single gunner can man the station or it can be controlled from one of the communications consoles in the cockpit.

Primary Purpose: Defense.

Secondary Purpose: Anti-Fighter/Anti-Missile.

Mega-Damage: 4D6x10

Rate of Fire: Equal to the combined hand to hand attacks per melee of the gunner (typically 4 or 5).

Effective Range: 2 miles (3.2 km).

Payload: Tied into the mystic generator, effectively unlimited.

2. Medium-Range Missile Launchers (2): Mounted on either side of the shuttle are medium-range missile launchers. They are controlled from the cockpit.

Primary Purpose: Defense.

Secondary Purpose: Anti-Fighter.

Mega-Damage: Varies per missile, typically loads a mix of plasma and armor piercing.

Rate of Fire: One at a time or in volleys of 2, 3, 6, or 12 per launcher.

Effective Range: Varies per missile, but always includes at least 8 Hull Breachers.

Payload: 48, 24 per launcher.

3. Lightning Cannons (6): These cannons are mounted on the sides of the shuttle and are the same type as mounted on the Shadow Bolt Strike Ship. All are manned by gunners, or remotely controlled from the pilot's cockpit. When fired from the cockpit, they are usually controlled in groups, three on one side controlled by one gunner and three on the other side controlled by another gunner.

Primary Purpose: Defense.

Secondary Purpose: Anti-Personnel.

Mega-Damage: 1D6x10 M.D. per blast.

Rate of Fire: Each blast counts as one of the gunner's attacks per melee, or four shots per cannon when controlled from the cockpit.

Effective Range: 4,000 feet (1,219 m).

Payload: Tied into the mystic generator, effectively unlimited.

4. Belly Mini-Missile Launcher: Mounted on the belly of the shuttle is a large mini-missile launcher; actually it's two launchers side by side. Its purpose is to either attack ground troops as the shuttle lands, or to clear a landing area for the shuttle. The launcher has a 30-degree arc of fire in all directions.

Primary Purpose: Defense.

Secondary Purpose: Anti-Armor/Anti-Personal.

Mega-Damage: Varies per missile.

Rate of Fire: One at a time, or in volleys of 2, 4, 8, 16, or 40!

Effective Range: Varies per missile, typically one mile (1.6 km).

Payload: 160

Demon Stars

The Demon Stars were once considered myth and legends. Terrors that only beings like Cosmo-Knights fought, but every legend has some grain of truth to it.

For centuries, Spacers would report seeing a demonic looking ship that would appear out of nowhere and sometimes follow or attack them. These claims could never be substantiated. It was only an incident about 500 years ago that turned myth and legend into reality. A fleet of ships was attacking numerous ports in the Anvil Galaxy. Few, if any, survivors were ever left alive, and those reports were unreliable at best, coming from traumatized patients often in shock from the brutality of the attacks. Finally, after hearing the pleas of a dozen worlds, a large group of Cosmo-Knights assembled to take action. Along with a ragtag fleet of then unaligned races from the UWW, they sought out the mysterious fleet. It would take months of tracking and dozens of false leads before locating them. A group of 200 demonic spacecraft was found orbiting an unusual star. It did not shine with the normal intensity of any known sun, but, instead, its flames were as black as space and an aura of evil permeated the system it was in.

The Cosmo-Knights and their fleet of allies attacked, but as the battle progressed, they learned these ships were the dreaded Demon Stars of legend. For not only did the wicked looking vessels magically make damage seem to instantly repair, but the ships themselves seemed alive, and any psychic present swore the starships had their own auras, like living creatures, and they could even hear them screaming in their minds!

The pitched battle went on for hours, but finally, the dreaded Demon Stars were defeated. Unfortunately, there was no one left alive among the demon hordes to reveal where the fleet originated or what its purpose was (mindless destruction seemed unlikely). Little was gleaned from the wreckage, only that the ships were indeed organic in nature and any psychic who tried to Object Read any part of the Demon Stars went mad. To this day, every Cosmo-Knight is ever vigilant for this galactic threat, and once again rumors are beginning to surface that Demon Stars have been sighted.

The process of creating the Demon Stars is unknown, only that the ships are somehow merged with some type of demonic being. This gives the hull and most of the ship's features an organic appearance and bio-regenerative capabilities. The typical Demon Star is said to be about 2,000 feet (610 m) long, and the front of the ship always appears as a jagged point like a ram prow. According to some of the legends, Demon Stars will ram ships with the ram prow which then opens like a giant maw to disgorge their demonic crew onto an enemy vessel. The sides of the ship appear almost like a rib cage, with the bones being black and between them is a scarlet hull, like muscle between

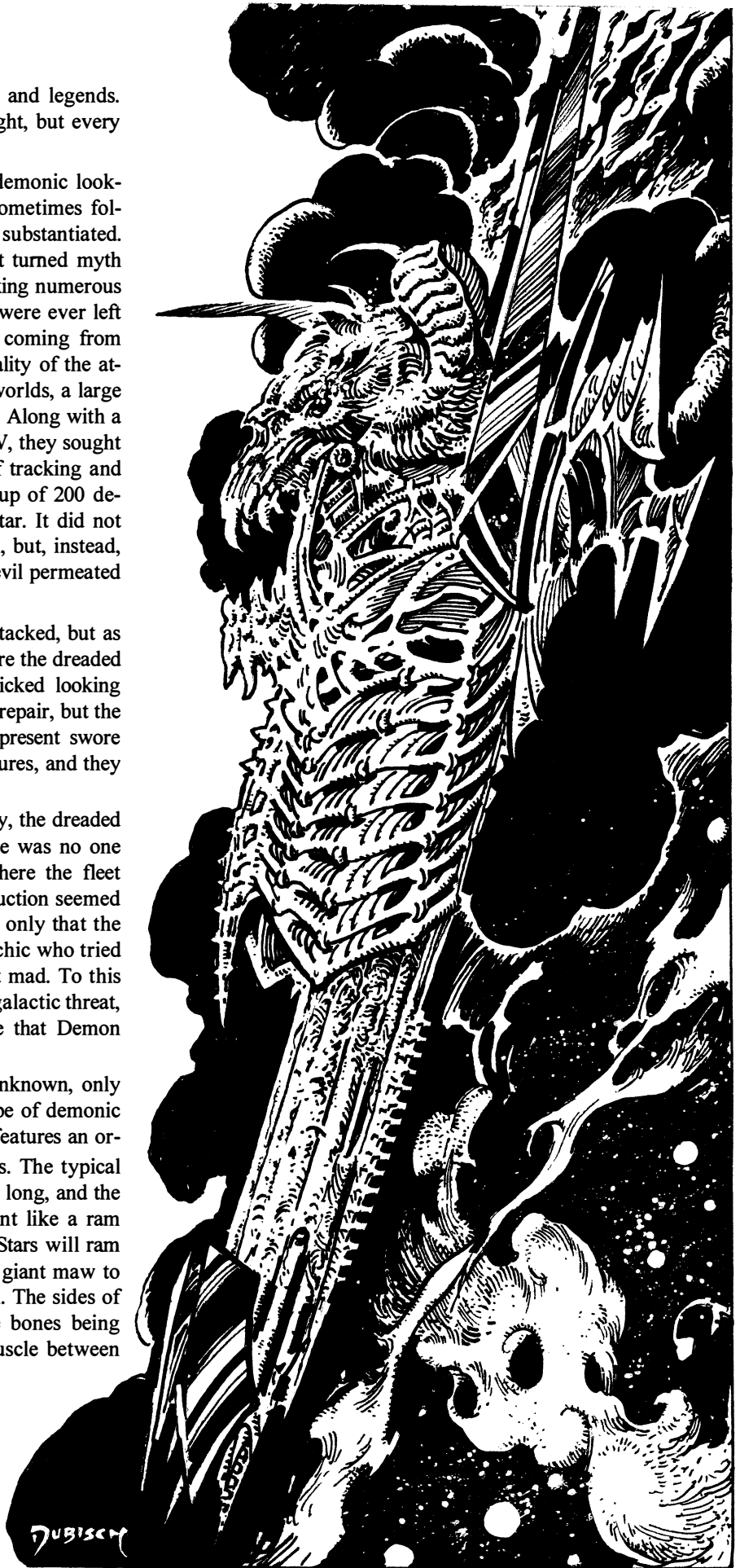

ribs. The rear of the ship expands out in a fan design with the bridge sitting on top in the rear. The bridge typically looks like a demonic skull with a crown of bones. Weapon systems vary from ship to ship, but most have modern energy weapons, missile systems, and force fields.

While the Demon Star itself is a horrible threat to the Three Galaxies, it's what happens inside that makes it a true abomination. To fuel the demonic essence that is the ship, within its belly, constant sacrifices of the living are made to it. To activate any of its magic abilities, a single individual must be slain. To fuel its main weapon, a dozen people must be killed to keep the cannon firing for a full day. The sight of blood and the stench of death permeates the ship. Dozens of sacrificial altars are set up throughout the ship to expedite the fueling process. The sounds of moaning and screaming people locked in holding cells or about to be slain echo off the walls and are music to the demons' ears. The ship is truly a frightening sight to behold and sends terror down the spines of any who experience it in any capacity.

Model Type: Demon ship.

Class: Heavy Destroyer.

Crew: Varies; see crew complement below.

Demon Complement: Five hundred years ago, it was 200 Alu demons, 200 Gargoyles, 40 Baal-Rogs, used as lieutenants for leading troops, 10-20 Jinn (various types), 4-8 Demon Locusts, 3 Rakasha, and one or two Night Owls. Typically a high level Witch (devoted to Modeus or one of the other Demon Lords) is the Captain of the ship. In addition to the captain, there are another 50 evil practitioners of magic who specialize in a variety of dark arts, but at least half are Summoners. Lastly, held in the deepest bowels of the ship is the Bone Pit where both the living and the dead are kept. The latter are turned into food for the demon hordes. From here, dark sorcerers can also raise an army of animated and controlled dead as shock troops. At any given time, 4D6x10 dead can be animated from the remains in the Bone Pit.

M.D.C. by Location:

Ram Prow – 40,000

Main Engines (rear 1/3 of the ship) – 30,000

Bridge – 25,000

*Main Body – 100,000

Dark Energy Cannon – 15,000

Secondary Laser Cannons (6) – 800 each

Cruise Missile Batteries (2) – 1,000 each

Hangar Bay – 18,000

Variable Force Field – 11,000 per side (66,000 total)

* If all M.D.C. is depleted, the vehicle is in tatters, various ship systems are knocked out or destroyed, the ship cannot navigate under its own power and only weapon systems with their own power supply remain operational. If the ship is reduced to -500 M.D.C., it explodes, doing 1D6x1,000 M.D. to everything within 1,000 feet (305 m).

Speed:

Driving on the Ground: Not possible.

Flying: Mach 9 in space, and not capable of entering the atmosphere.

Star Drive: Most seem to have some type of Phase Drive that allows them to go up to 4 light years per hour. However, with its magic battery it can make jumps in a similar capacity to that of the Rift jump drive.

Range: Unknown, possibly unlimited due to its demonic and undead crew.

Statistical Data:

Height: 458 feet (140 m).

Width: 420 feet (128 m).

Length: 2,000 feet (610 m).

Weight: 9 million tons fully loaded.

Cargo: Can hold 250,000 tons of cargo and extra equipment.

Power Systems: A combination of magic and technological. One antimatter reactor runs the conventional systems, and there are two P.P.E. generators with 30,000 P.P.E. The P.P.E. generators are not very efficient and only regenerate P.P.E. at a rate of 1,000 per hour.

Bio-Regenerate: The ship is virtually a living demon and, as a result, it regenerates physical damage at a phenomenal rate. This regenerative process is directly linked to its P.P.E. batteries. In order to function, there must be a minimum of 1,000 P.P.E. If for some reason the ship's reserves go below this level, the ship is unable to repair itself unless the sacrifice of living beings is used to pump into the P.P.E. generators. (Remember, P.P.E. is doubled at the moment of death.) Furthermore, anyone who dies by the vessel's weapons or demonic crew on its decks or within 50 miles/80 km of the living warship has their P.P.E. sucked into the Demon Star and collected into its generators. When bio-regeneration is working, 1D4x100 M.D.C. is repaired per melee round! In a pinch, the demonic crew can make a massive sacrifice of people to give the ship the P.P.E. it needs. Consequently, mass murder and wholesale slaughter serve to power the Demon Star as well as provide wicked satisfaction and pleasure to its demon crew.

Market Cost: If one of these ships was ever available on the market it could easily be sold for 70-100 billion credits, provided a depraved buyer could be found.

Standard Weapon Systems:

1. **Dark Energy Cannon:** Located underneath the ram prow is the vessel's main cannon. It fires some sort of dark energy or anti-energy. This beam of energy disrupts matter on the molecular level, breaking down the bonds that give ship hulls their impressive strength. Instead of burning, the energy actually ages the armor to the point where it buckles and becomes brittle. Ships hit with this cannon find that they are unable to repair damaged bulkheads, rather they have to replace them. The beam appears as a black and purple bolt of energy that is disgorged from the cannon. The cannon can only be fired straight ahead so the whole ship has to move in order to hit a target.

Primary Purpose: Anti-Ship, Space Stations and Defense Platforms.

Secondary Purpose: Anti-Fortifications.

Mega-Damage: 3D6x1000

Rate of Fire: One shot every two melee rounds (30 seconds).

Effective Range: 200 miles (320 km).

Payload: Effectively unlimited.

2. Secondary Laser Cannons (6): These are conventional laser batteries built into the side of the ship with three on each side. They have a 30-degree arc of fire. Typically, they are fired in a broadside fashion. Only three cannons can fire on the same target at one time or they can fire independently of each other.

Primary Purpose: Anti-Ship.

Secondary Purpose: Defense.

Mega-Damage: 1D4x1000 per cannon or 3D4x1000 for all three if fired on the same target.

Rate of Fire: Each cannon can fire twice per melee.

Effective Range: 80 miles (128 km).

Payload: Effectively unlimited.

3. Conventional Cruise Missile Batteries (2): Located on either side of the ram prow are the cruise missile launchers. They are typically recessed until being fired, then the launcher pops out on the sides to fire its payload. The launchers must be recessed in order to be reloaded. A typical strategy is to unload the missile batteries as the Demon Star is pulling away after having rammed a ship. If the ramming did not destroy the ship, usually the follow-up missile barrage does.

Primary Purpose: Anti-Ship.

Secondary Purpose: Defense.

Mega-Damage: Varies, the most common are nuclear (2D4x100 or 2D6x100 M.D.). Recent rumors suggest they are now equipped with heavy cruise missiles, typically a mix of antimatter and singularity missiles.

Rate of Fire: One at a time or in volleys of 2, 3, 6, 9, 18, 27, 36, or 45.

Effective Range: 1,000 miles (1,600 km).

Payload: 45 per launcher, 90 for both launchers, with an additional payload of 900 stored in the cargo hold. Reload time is 7 minutes per launcher, so they are usually staggered in their firing. **Note**: Magic missiles may be, and often are, substituted.

4. Energy Disruptor Cannon (8): Powered by the same force that fuels the Dark Energy Cannon, these mini-cannons are a scaled down version with a twist. Upon hitting any target under 100 feet (30 m) in size, a dark energy web envelops it. The web sucks all the energy (magic or conventional) out of the target and renders the spacecraft with only a meager bit of power to keep the most basic life support systems going; otherwise, a floating dead duck. Fortunately, the effects are limited and only last 1D4+1 minutes, but even that can seem like an eternity in battle. Once the effects of the energy disruptor end, the ship powers back up within 15 seconds.

Primary Purpose: Defense.

Secondary Purpose: Capture and retrieval. How else can they get the people they need for human sacrifices and food?

Mega-Damage: 2D6x10 from impact damage.

Rate of Fire: Three shots per melee.

Effective Range: 10 miles (16 km).

Payload: Effectively unlimited.

5. Magic Abilities: In addition to its already formidable weaponry, the ship has several built-in magic spells. Each is equal to a tenth level spell caster and can be activated with a sacrifice of a single individual and the appropriate P.P.E. cost.

Create Nebula: Great to lay ambushes in, or to cover an escape. Range: Up to two miles (3.2 km) away, per level of experience. Duration: 30 minutes per level of experience. Saving Throw: Not applicable. P.P.E.: 700. This spell conjures fourth all the loose matter in a given area, multiplies it and turns it into a dark nebula. All the effects of being in a nebula apply at half the normal damage even to the spell caster's ship. The size of the nebula is 5 miles long by 5 miles high by 5 miles wide (8x8x8 km) plus one mile (1.6 km) per level of the spell caster. The magically created nebula registers as a gaseous cloud, although other magic users are able to see magic energy. As a space spell, it can only be cast only in outer space, and the spell caster must have direct contact with the vacuum in order to cast the spell. It has no effect if cast on a planet or place with an atmosphere. This spell is commonly used to hide ships in an ambush.

Dispel Magic Barrier: Used to knock out magic force fields. P.P.E.: 20.

Mystic Portal: This is focused in the front of the ship and is used in combination with the conventional air locks. P.P.E.: 60.

Anti-Magic Cloud: Great for countering Techno-Wizard ships. When this spell is activated, the cloud spews from the crowns around the bridge. P.P.E.: 140.

Dimensional Portal: Used either as a last ditch effort to escape or for a surprise attack, the D-portal can make jumps of up to 30 light years. P.P.E.: 1000.

6. Ram Prow: One of the Demon Star's trademark attacks is ramming. This attack actually serves two purposes. The first is the obvious damage from a ram at several times the speed of sound, and second is once the ram prow is thrust into an enemy ship, troops and demons may be deployed from the ram prow.

Primary Purpose: Anti-Ship.

Secondary Purpose: Troop Deployment.

Mega-Damage: 1D4x1000 for speeds of Mach 2 to Mach 5. For speeds up to its maximum damage it is 1D4x1000+500.

Rate of Fire: Ramming typically needs several minutes to set up. Once a target is rammed, the Demon Star needs to disconnect itself and realign against a new target. This usually takes 1D6+1 minutes.

Effective Range: Immediate proximity.

100 Cargos of the Three Galaxies

The following random, percentile, table is intended as an aid to the Game Master in determining random cargos found on all kinds of starships in the Three Galaxies. In turn, these cargos can serve as both *rewards* and ideas for further *adventure* and trouble (i.e. the characters find contraband or stolen military gear, or magic items, and so on). From magic to mundane, it's all shipped around the galaxies. Remember too, Game Masters, that if you feel the value or power of a random cargo is too high or inappropriate for your campaign, re-roll or scale it down (maybe some of them have been damaged, or mislabeled, or already stolen, or contaminated, etc.). Do whatever works for you.

Note: When characters acquire any item in bulk, they will probably have to sell it wholesale. That means they will only get 20-30%, on average, of the full retail value of said items. This is fair, because the wholesaler needs to make a profit too and is probably selling them bulk to somebody else (and has the connections to sell, distribute and/or smuggle them into the right hands – the player characters don't). The Characters can try to sell items themselves for closer to list, retail value, but they will have to acquire local permits, pay for display booths or storefronts, operate within the law (or face criminal charges, fines, incarceration and/or jail time) and spend a good amount of time and energy working as merchants rather than adventurers. They may also have to contend with losses from theft, damage, and acts of god (weather, accidents, disasters, civil war, etc.).

01% Minerals from a geological survey: Manufacturing ore such as iron, copper, and magnesium, but they are only samples and nothing worth a whole lot. Average value is 4D6x1,000 credits.

02% Precious metals (refined): Gold, silver, and platinum, are all considered precious metals and depending on the quantity could be very valuable. A typical cargo canister could hold several million credits' worth of metal. Typical value per can is 2D4x1 million credits. Due to the density of the metal this is also going to weigh one to several tons.

03% Precious stones (already cut and polished): Gemstones of all kinds are traded on a daily basis and, as such, the value fluctuates a lot. The value is determined by the cut, clarity and type of stone. Diamonds are still one of the rarest stones in the Three Galaxies, followed by rubies and then sapphires. A mere few ounces of any of these stones could be worth millions. Roll on the following table to determine the random value of the stones.

- 01-40% A small haul worth 1D4x10,000 credits.
- 41-65% A moderate load worth 2D6x10,000 credits.
- 66-75% An excellent good haul of high quality stones worth 2D6x100,000 credits.
- 76-89% A huge haul worth 1D4x1 million credits.
- 90-00% A large quantity of high grade stones worth 1D6x1 million credits.

04% Raw metal ore: Straight from the source and not worth a whole lot until it is refined and processed. The value depends on what the ore is and how much of it there is. The following are a few examples and their value equal to a full cargo container. Iron ore is 1D4x10,000. Nickel or Copper, 1D4x1,000.

Gold ore is 1D4x1 million credits. Silver ore is 1D4x500,000 credits.

05% Raw precious stones (uncut): These are gemstones that have not yet been cut and polished. Their value will really vary from place to place and would be worth a lot more if they were worked. Value is as follows:

- 01-35% Small haul worth 1D4x1,000 credits.
- 36-55% A moderate load worth 1D4x10,000 credits.
- 56-71% A good haul with some rare stones: 2D6x10,000 credits.
- 72-95% High quality and rare for even raw stones: 1D4x100,000 credits.
- 96-00% High grade stones in a large quantity: 2D6x100,000 credits.

06% Mining equipment: This is going to be valuable only to the right parties. Equipment varies consisting of large and small drill bits, transmissions for the drills, crushing equipment, and the drills themselves. Typical value is 1D6x10,000 credits, but selling them to a dealer will only fetch about 20% of the true value, even for new equipment. If one can find a mining community willing to purchase questionable equipment from adventurers, one might be able to get 1D4x10%+15%.

07% Mining vehicle: Mining vehicles, some equipped for drilling, others for crushing and hauling of ore and equipment. 2D6+1 small vehicles worth 1D6x10,000 credits each, and 1D6+1 large vehicles are 3D6x10,000 credits each. Selling them to a dealer will only fetch about 20% of the true value, even for new equipment. If one can find a mining community willing to purchase questionable equipment from adventurers, one might be able to get 1D4x10%+25%.

08% Archeological equipment. Specialized equipment that only someone who is familiar with archeology will even recognize. These delicate instruments are used in unearthing valuable artifacts. They include small brushes, organic and inorganic lasers for clearing small debris, soil and rock, and precise instruments for determining the age of an item. Total approximate value is around 1D4x10,000 credits, but one will be lucky to get 5-10% of their value if anything at all.

09% Archeological artifacts: These items are carefully packaged in padding and special containers easy to recognize as the packing materials to transport fossils, artifacts and other delicate items. Value varies according to each race and interest by collectors.

- 01-25% 2D6x10 artifacts of interest to the TGE. Estimated Value: 3D6x1,000 credits each.
- 26-50% 2D6x10 artifacts of interest to the CCW. Estimated Value: 2D6x1,000 credits each.
- 51-70% 2D4x10 artifacts pointing to the existence of a previously unknown (and dead) race. Estimated value is 2D6x1,000 each.
- 71-90% 1D4x10 artifacts of interest to the UWW and/or Splugorth. Estimated value is 1D6x10,000 each. 10% *may* have magical powers, serve as a magic component or have magical or great historical significance making these items worth 2D6x100,000 each.

91-00% 1D6 artifacts believed to be linked to the First Race. Estimated Value: 1D10 (or 2D6) million credits each. Of interest to collectors, organizations and governments looking to unlock the secrets of the First Race and the Cosmic Forge. The potential for adventure is huge, as there are countless fanatical religious institutions, historical groups, governments and zealous individuals who would do *anything* to get certain items that *may* hold a valuable clue. Holding on to such a valuable artifact long enough to sell it will be extremely difficult and can lead to any number of adventures. Also see alien relics #98.

10% Condensed gas cylinders: Each container holds a valuable or rare refined gases. These gases are usually hard to acquire and are mined from a gas giant using specialized equipment. Due to the danger in mining these elements the prices are quite high. Items like Hydrogen 2 (an isotope of hydrogen that can be easily converted into antimatter), carbon gas (very rare and hard to acquire as it is found only in gas giants and even then, very far below the atmosphere), Oxygen 3 (or ozone) and other noble gases. Prices for these types of gases are usually 1,000 credits per 16 ounce cylinder. As 16 ounces is hardly enough to even make a decent quantity of antimatter it is usually bought in bulk quantities. Large specialized containers that can hold thousands of pounds and usually sell for several million credits. Average value for a 2,000 pound container is 1-2 million credits.

11% Spacesuits: Always good to have a few extra on hand, the characters have stumbled onto a cargo of 1D6x100 suits! An average cargo container will hold around 100 suits. Average value for a decent quality space suit with minor M.D.C. protection (8-18 points) is 10,000 credits (see *Phase World*®, page 120, for details). Selling them wholesale, the characters should get 20-30% of the retail value (i.e. about 2,000-3,000 credits each). Or they can try selling them from the trunk of their spaceship for 5,000-6,000 credits, but it will take months and months to sell them all.

12% E.V.A. equipment: Extra-Vehicular Activity equipment is important to any Spacer who needs to work in the vacuum of space or a zero gravity environment. This equipment usually mounts on the back of any spacesuit and can be controlled by either voice command or little joysticks that extend to the front of the suit. Average price per unit is around 10,000 credits apiece. Each cargo canister usually holds 4D6+12.

13% High-tech carpentry tools: An average assortment of carpentry tools like hammers, drills, pneumatic nail guns, band-saws, table saws, and other tools used in woodworking and construction of S.D.C. structures. Average value for a complete set of high quality carpentry tools is 6,000 credits. Each cargo container holds around two dozen complete sets of tools. Selling them wholesale, the characters will only get 20% of the true value, but that's probably the only way they can unload the items.

14% High-tech electric tools: Tools used for electrical work and maintenance, including multi-meters, soldering tools, laser tools and other items used in electrical work and repairs. Average price for a complete set of tools is around 10,000 credits. Each cargo container can hold about three dozen complete sets. Should get 20-30% of the true value.

15% High-tech mechanical/engineering tools: Items used to repair, build and modify mechanical equipment. Those people familiar with Mechanical Engineering skills can use such tools, which include laser torches and welders, etc. Average cost for a complete set is 25,000 credits. Each cargo container holds around two dozen complete sets of tools. Should get 20-30% of the value.

16% Sub-light engine components/parts: Sub-light engines see a lot of use. These engines typically have to push a ship to escape velocity to just get off a planet. Most intra-system trips use sub-light engines. All kinds of components are needed for regular maintenance and repair. A typical cargo can hold enough parts to repair the engines at least twice before needing more spare parts. Average value is 1D4x500,000 credits. Characters should get at least 30-40% of the average value and easily find buyers in any civilized space setting.

17% Phase Drive components: Possibly some of the most alien technology in the Three Galaxies. First, phase drives can only be repaired by a Phase Technician, and second, they need specialized parts and equipment for the job. So in order to make it easier to repair these faster than light drives they are built out of boxed components. These components just slide right in and out, making repairs quick and simple. With all phase drive components comes a little phase meter. This meter is hooked up to the computer on the main drive and it tells the operator what components need to be replaced. The value of the repair components is around half the cost of the drive they are meant for. A single cargo container will hold all the components to give the drive a complete overhaul once. Characters should get 20-30% of the average value. Finding a buyer may be difficult.

18% Gravitonic Drive components: Gravitonic drives are far less sensitive than their phase drive counterparts. They are also far less complicated and easier to repair. Like the phase drive, these parts are also modular and can be easily slipped in and out for easy replacement. Cost is a little cheaper than the phase drives at only one third the standard cost of the engine type in question. There are enough parts/modules to give the drive a complete refitting if needed. Characters should get 30-50% of the average value and easily find buyers in any civilized space setting.

19% Navigational equipment: Flying at faster than light speeds is not possible without accurate navigational equipment. This equipment works in conjunction with the ship's computer to accurately plot a course that will avoid all types of celestial objects. Navigational equipment includes a solar compass, an item that always points towards the center of the galaxy; star finders, used to locate known stars as reference points and a sophisticated navigational computer to crunch all those large numbers and provide an accurate vector to travel on. Value will vary due to the quality of the equipment. Average value is 1D4x100,000 credits. A cargo container will hold four complete navigational kits. Characters should get 25-35% of the average value and easily find buyers in any civilized space setting.

20% Life support equipment: One of the most important systems on a ship is life support. Without it most races would die from the extreme cold long before becoming asphyxiated. Life support provides all the necessary elements for a comfortable cruise through the stars. It provides stable temperatures, air to breathe and gravity to work in. Since life support is so exten-

sive and usually covers the entire ship, it is usually possible to seal off damaged sections to preserve the integrity of the ship. This type of equipment will be for the major functions of life support. It will include some type of air scrubbers to keep the air clean and fresh, heating elements to maintain a stable temperature and gravity plates to provide basic gravity. A single cargo container can hold all these elements, but a single cargo can can't provide for the whole ship. Average value of these components is 1D6x100,000 credits. Characters should get 50-70% of the average value.

21% Personal weapons/sidearms: One of the quickest ways to make cold, hard cash in the Three Galaxies is the sale of weapons. They can be bought and sold at most major ports. However, the transportation of weapons in controlled space such as the CCW and the TGE is strictly prohibited. The TGE limits transportation of weapons to military ships only. In the Consortium one can get a license but the cost of getting one is very expensive and usually entails a lot of red tape. Weapons runners are one of the most common smugglers in the Three Galaxies. With big risk comes big profit, especially when running weapons to the Free World Council (FWC) in Kreeghor controlled space who will pay 40-60% of the list value; most others buying weapons bulk only pay 20-30%. One can sell weapons retail at list price or close to it, but it takes much longer to sell 'em piece by piece. A typical cargo canister can hold 288 pistols or 144 rifles. List value is as per manufacturer retail price (i.e. the cost found in various Phase World Books). Random weapons found are:

- 01-30% Energy Pistols
- 31-60% Energy Rifles
- 61-80% Vibro-Weapons
- 81-86% Phase Weapons
- 87-92% Techno-Wizard Weapons
- 93-97% Necrol Organic Weapons
- 98-00% Stealth weapons (weapons built to slip past security measures)

22% Body armor: 72 suits of armor can be held in a standard cargo canister. Value of the suits will depend on the manufacture. Characters should get 25-35% of the list value and easily find buyers in any civilized space setting; 35-50% if selling in a war-zone, but there is a 01-33% chance that payment is fake or that the local military seizes the armor as contraband – a total loss either way. *Roll for type:* 01-40% Light armor. 41-70% Medium armor. 71-90% Heavy armor. 91-95% Armor with a force field added. 96-00% Armor with Techno-Wizard modifications.

23% Force fields: One of the hottest commodities sold by Naruni Enterprises are their line of personal force fields. No other company has come close to matching the Naruni personal force field technology. They literally own the market with this item. A typical cargo container can hold 144 of any type of force field. *Roll for type:* 01-50% Light force field. 51-75% Medium force field. 76-95% Heavy force field. 96-00% Super Heavy. **Note:** Characters should get 40-50% of the list value and easily find buyers in any civilized space setting; 60-70% if selling in a war-zone, but there is a 01-45% chance that payment is fake or that the local military seizes the items as contraband – a total loss either way.

24% Phase fields: Created by the Prometheans, these fields can greatly aid any type of adventurer. The Prometheans strictly limit the number of units sold outside of Phase World, making these a hot commodity. A typical cargo canister could hold a hundred units. **Note:** Characters should get 60-70% of the list value and easily find buyers in any civilized space setting; 100% full value if selling in a war-zone, but there is a 01-45% chance that payment is fake or that the local military seizes the items as contraband – a total loss either way.

25% Power armor: Power armor is one of the hottest traded commodities on the market. With the ability to turn a single person into a walking tank, demand far exceeds supply. The type of armor will vary from manufacture to manufacture. A cargo container can hold 12-24 power armors depending on the size. For safety measures, all weapon systems are deactivated and munitions shipped in a separate crate. As with the transportation of weapons, a special weapons merchant permit is needed in CCW space and only military ships in the TGE are permitted to transport such items. Characters should get 25-35% selling wholesale on the Black Market, 50-60% if selling in a war-zone, but there is a 01-35% chance that payment is fake or that the local military seizes the armor as contraband – a total loss either way.

26% Miscellaneous military equipment: This included tents, canteens, shovels, flashlights, and all kinds of survival gear, as well as fatigues and boots. Typically, the value for the entire cargo is 2D4x10,000 credits. A single cargo canister can hold enough equipment to equip a sixty-man unit. Characters should get 10-25% of the value for these common items.

27% Light combat vehicle: Light combat vehicles are commonly some type of small, fast vehicle. They range from small single man hovercraft to armored cars. They have specialized cargo canisters with 4-6 small vehicles (like hover bikes or jeeps) or one large vehicle (cargo truck, hover platform, light APC). Value varies per vehicle. Difficult to liquidate and lucky to get 5-15%. Could get 20-35% selling in a war-zone, but there is a 01-50% chance that payment is fake or that the local military seizes the vehicles as contraband – a total loss either way.

28% Heavy combat vehicle: Front-line combat tank, heavy APC and similar. They do not conform to any type of cargo canister so they are typically loaded on individual pallets. These pallets will be equipped with contra-gravity generators for easy transportation. Value varies according to vehicle. Difficult to liquidate and lucky to get 5-15%. Could get 20-35% selling in a war-zone, but there is a 01-50% chance that payment is fake or that the local military seizes the weapons as contraband – a total loss either way.

29% Magic books: Magic knowledge is valuable to only certain parties. Magic knowledge can come in various mediums, but the ones described below are the most common. G.M.s, use this as a potential plot device. Value varies from a few thousands credits to millions depending on what the book is and if the right buyer can be found. 01-25% Books on lore. 26-50% Non-magical scrolls with arcane teachings or philosophies. 51-75% Books about magic, concepts and theories. 76-90% Books on creatures of magic and/or the supernatural and how to combat them. 91-00% Books of (working or semi-working) magic experiments, spell invocations, formulas, circles or the construction of a half dozen magic devices. Estimated value is 4D6x10,000 for the entire cargo (4D6x100,000 for those in the last category).

30% Magic scrolls: This cargo is most likely to be found in the Anvil Galaxy and UWW and Splugorth space. The quantity of scrolls vary (2D20 or 5D6), but rarely exceeds more than thirty. *Roll percentile to determine the general type and level of spells.* 01-20% First to Fourth level Elemental spells (any of the four Elements). 21-50% First to Fourth level Wizard spell invocations. 51-75% Fifth and sixth level Wizard spell invocations. 76-90% Seventh level Wizard spell invocations. 91-95% Eighth level Wizard spell invocations. 96-97% Ninth level Wizard spell invocations. 98-00% Some other type of spell or rare magic (Necromancy, etc., up to tenth level). Sellers can usually get 30-50% of list value.

31% Magic items: Another common item of the Anvil Galaxy. As described under magic scrolls, there is not much need to transport large quantities of magic items. Especially considering most Alchemists do not deliver! If a large quantity of these items is being sent via interstellar travel you can bet it will have multiple defenses on the cargo casing, including hi-tech and magic, such as wards. Typically, only a few such items will be sent and they will most likely be hidden. **Note:** Sellers can usually get 30-60% of list value; this is true of all magic categories.

Type of Magic Items: 01-40%: Magic Rings. 41-70%: Magic Amulets and/or talismans. 71-90%: Magic wands and/or staves. 91-00% other (clothing, crystals, fumes, etc.)

Quantity: 1-50%: 1D4. 51-75%: 1D6+1. 76-97%: 2D6+1. 98-00%: 1D6+8 or 1D4 very powerful and/or rare items.

32% Magic weapons: Magic weapons in the Three Galaxies are typically sold on the back alleys, through underworld and underground sellers, and among adventurers as well as a handful of legitimate dealers. Most common on the worlds of United Worlds of Warlock (UWW), Phase World, and other magic using systems and planets. The list below is far from comprehensive and only lists the most likely types of magic items. Rune weapons are always favored and sought after, but they are the least likely to be found in a crate of weapons. They were added just for flavor. Who knows, maybe this rune weapon was being shipped to a Splugorth high lord, and the players just made a new enemy! Sellers can usually get 40-70% of list value. Roll to determine the contents.

01-35%: Magic staffs and blunt weapons (clubs, maces, hammers, etc.). 36-50%: Magic flaming weapons. 51-75%: Magic blade weapons (knives, swords, battle-axes, etc.). 76-90%: Demon Slayers (does double or greater damage to demons, or the supernatural or creatures of magic). 91-96%: Symbiotic based magic weapons (common to the Splugorth). 97-98%: Lesser rune weapon. 99-00%: Greater rune weapon.

33% Magic armor: Magic armor can range from an archaic suit of plate and chain to an advance suit of armor like the NE-C20. The armor can be either enhanced or enchanted, or a Techno-Wizard creation. Common magic suits of armor rarely have more than 3-5 enchantments/magical features to them unless they were a special order. Magic armor of the Three Galaxies seems to focus on survival in a vacuum so most suits will have Breath Without Air, force fields and other enchantments to provide survival in space or combat. Roll to determine the type of armor. G.M.s enchant them at your leisure.

01-40%: Light Armor. 41-70%: Medium Armor. 71-90%: Heavy Armor. 91-95%: Magic Cloak/Cape or other seemingly normal article of clothing. 96-00%: Magic Power Armor.

34% Starship sensors (equipment for): The eyes and ears of any starship, good sensors can make or break a ship in a battle. Any Spacer worth his salt will always be trying to enhance their ship's sensors. Various sensor packages are out there and they cost a pretty penny! The ones below are the same types as described under *Step Five in the Space Station Construction rules*. Sensors consist of several parts/units that cover various angles of a ship. A typical cargo container will contain the meat and guts of a sensor suite and another portion holds the parts of the sensors that are mounted externally on a ship. Sellers should get 20-40% of the value. Roll to determine the type of sensors.

01-55% Basic sensors will have a value of 1D4x100,000 credits.

56-75% Enhanced sensors with a value of 1D4x500,000 credits.

76-89% Superior sensors (military level) will have a value of 1D6x1 million credits.

90-00% Alien technology. This will be far more unpredictable and may be even incompatible with current technology. Value for study may be 1D4x1 million credits. It could be worth double that if sold to an interested government agency.

35% Communication satellites: Communications are one of the most important factors in a Galactic society, the faster the better. The value of each type is listed below. A single short-range satellite can fill a standard cargo container. The rest require specialized containers, as they are very delicate pieces of equipment. Sellers should get 20-40% of the value.

01-25% Short-range (orbital) are valued at 1D4x200,000 credits.

26-54% Medium-range are valued at 1D4x500,000 credits.

55-79% Long-range (inter-system) are valued at 1D6x1 million credits.

80-00% Stellar communications are far more sophisticated and require larger amounts of power. They are valued at 1D6+4x1 million credits.

36% Military satellite (intelligence gathering): All governments engage in some sort of spying. In the vastness of space, a small little satellite hovering millions of miles away will go completely unnoticed. Most satellites use either laser transmission or burst communications to help minimize detection. These are most likely be found on military ships that, while on patrol of their borders, might casually deploy them with a small engine to place them just over enemy borders. The value below is the typical cost a government pays. Sellers should get 50-70% of that value. May be considered contraband and seized by local authorities or the military.

01-95% Spy satellite. Value is 1D6x1 million credits.

96-00% Spy satellite with cloaking equipment. These super-rare satellites are commonly deployed only in wartime situations. However, there may be a few covert operations that use them during peacetime. They are valued at 1D4x10 million credits.

37% Military satellite (weapons platforms): Weapons platforms are automated defense drones left to defend an area. Many worlds throughout the Three Galaxies employ them as a means of defense. Sometimes worlds will have hundreds in orbit. They are far cheaper than buying and manning a starship

with a crew. Sellers should get 60-75% of that value, but they'll have to be careful because this item may be considered contraband and seized by local authorities or the military.

01-45% Light weapons platform. Valued at 1D4x1 million credits.

46-90% Medium weapons platform. Valued at 1D6x5 million credits.

91-00% Heavy weapons platform. Valued at 2D6x10 million credits.

38% Silks are a precious commodity in the Three Galaxies. Only about a dozen worlds are able to produce silk naturally. Synthetic silk can be produced, but is not as valued as the real stuff. Silk is typically bundled on a roll about 100 feet (30.5 m) long and four feet (1.2 m) wide, so a total of 400 square feet (122 m) of silk per roll. A single cargo container can easily hold a hundred bolts of silk. With a value of 100 credits a square foot, a single bolt could be worth 40,000 credits. Characters should be able to get 50-70% of the value from buyers who are going to charge double or triple in resale.

39% Precious fabrics: Most are fabrics that are 90% real and not synthetic. This would include cotton, wool, animal furs and similar. Value varies according to the current fashion trends in the Three Galaxies. Currently cotton is in fashion, so the average cost per bolt of materials is 400 credits. Characters should be able to get 40-50% of the value from wholesale buyers, and 60-80% from individual customers.

40% Artwork: This encompasses paintings, sculptures, drawings and anything considered artwork by human standards. They are only valuable to collectors. The black market does not seem to have a large art trade so unless a collector can be found, value is low. 6D6x100 credits per piece on average. 4D4x10 pieces per container. Characters will only be able to get 10-20% of the value from the average buyer, but 60-100% from collectors.

41% Alien artwork: This is anything done by non-humans. Since some alien minds think on different levels, their artwork will also be alien and odd. There are far more collectors of alien artwork. Average value is 1D4x1,000 credits. 4D4x10 pieces per container. Characters will only be able to get 10-15% of the value from the average buyer, but 60-100% from collectors.

42% Dry foodstuff: This type of food is non-perishable and will last for years. The most common type of dry food transported are M.R.E.'s (Meals Ready to Eat). A single cargo container can hold about a 2,000 pounds (900 kg). Average price is 5 credits per pound so a single canister can hold 10,000 credits' worth of food. Characters should be able to get 10-30% of the value from wholesale buyers, and 70-80% from individual customers.

43% Frozen foodstuff: Frozen foods require specialized refrigeration containers. Typical frozen foods are meats, fish, and ice cream. These items are very pricey and this is, in part, due to needing a specialized container that costs more than the average and usually the frozen food has to be delivered in a certain time period. Average cost for frozen food is 20 credits a pound. Of course, specialized products (read as exotic) can cost 75-100 credits a pound. Refrigeration units typically hold up to 1,000 pounds (450 kg) of food. Characters should be able to get 20-40% of the value from wholesale buyers, and 70-90% from individual customers.

44% Live animals: From pets to cattle to exotic zoo animals, all bring in credits. Some colony worlds order large quantities of cattle because they are either not indigenous, or are in the breeding business. Common house pets are also traded as well as a exotic animals. Large animals like cattle are usually penned up. Smaller animals will have individual cages. Value varies from as low as a 100-600 credits for cats, dogs and birds, to 1000-6000 credits per head of cattle. Exotic animals (provided one can find a buyer) can be worth tens, even hundreds of thousands of dollars. Characters who can find an interested buyer might get as much as 40-50% of the animal's value, otherwise they'll be lucky to get 10%.

45% Live monsters/highly dangerous and most likely, illegal to transport: Live monsters are first, very dangerous to transport, and second, illegal to transport in places like CCW space. Still, the demand is high for monsters, especially on Splugorth worlds. *Rifts® World Book Two: Atlantis*, page 136, has a listing of monsters and their value. Characters who can find an interested buyer might get as much as 40-60% of the animal's value, otherwise they'll be lucky to get 10%.

46% Alcohol: A typical case holds 24 bottles and a typical cargo container can hold 100 cases. Average fare is worth 240 to 480 credits a case, the good stuff 2400 to 4800 credits and the rare and vintage stuff, 24,000 to 48,000 a case. Booze retains a high resale value, so characters should be able to get 40-60% of the value.

47% Starship weapon systems: Weapons dealers commonly send their goods to ports all across the Three Galaxies to sell their goods. The cargo has 1D4+2 items. For value, see the section on equipment for the Three Galaxies. Characters should be able to get 30-60% of the list value. Difficult to liquidate legally and lucky to get 15-20%. Could get 30-50% selling in a war-zone, but there is a 01-40% chance that payment is fake or that the local military seizes the weapons as contraband – a total loss either way. *Roll percentile to determine type:* 01-40%: Point defense weapons. 41-60%: Short-range weapons. 61-80%: Medium-range weapons. 81-98%: Long-range weapons. 99-00%: Magic weapons.

48% Starship ammunition: What's the sale of weapons without ammunition? Large bulk orders are standard. A hundred thousand rounds for rail guns can be held per cargo container. All other types of ordinance are typically stored in specially reinforced containers to try and contain or prevent ammunition from being prematurely detonated. Missiles are usually shipped in lots of 144 and cruise missiles shipped in lots of 72. *Roll percentile to determine type:* 01-30% Rail Gun Ammunition. 31-50% Mini-Missiles. 51-69% Short-Range Missiles. 70-88% Medium-Range Missiles. 90-96% Long-Range Missiles. 97-98% Cruise Missiles. 99-00% Magic Missiles. Difficult to liquidate legally and lucky to get 15-20%. Could get 40-60% selling in a war-zone, but there is a 01-40% chance that payment is fake or that the local military seizes the weapons as contraband – a total loss either way.

49% E-Clips & ammunition: Anything from E-Clips to Naruni plasma cartridges can be found. A typical container will hold 1,000 E-Clips or magazines, and 700 Naruni plasma cartridge magazines. Value is per clip with a 10 to 20% discount on large bulk orders. Difficult to liquidate legally and lucky to get 15-20%. Could get 50-70% selling in a war-zone or from pi-

rates, but there is a 01-40% chance that payment is fake or that the local military seizes the ammo as contraband – a total loss either way.

50% Projectile clips: Ammunition for gravitonic weapons usually consists of metal slugs. They can be bought in lots of 500 rounds per ammo box for 5,000 credits. Loaded magazines cost more, around 1,000 credits per loaded magazine. A cargo canister can hold 100 ammo boxes of 50 cases of magazines with 5 magazines per case. Difficult to liquidate legally and lucky to get 15-20%. Could get 40-60% selling in a war-zone or from pirates, but there is a 01-40% chance that payment is fake or that the local military seizes the weapons as contraband – a total loss either way.

51% Explosives: Explosives come in many forms and few people like to risk carrying a lot for obvious reasons. When they are carried it is usually in specially reinforced containers. Various types of explosive range from C20 (high grade plastic explosive), N-K40 (Naruni's own plastic explosive using killaryte) to industrial dynamite and liquid explosive compounds used in mining operations and for construction. Most are transported in an inert state where they are relatively harmless. Once they arrive at their destination, the key components are added. There is no standard container or allotment for explosives. So the amount found will vary. Roll 1D4x10 pounds (4.5 to 18 kg). Typical value ranges from 50,000 to 200,000 credits. Characters should be able to get 30-40% selling it wholesale.

52% Medical equipment: This cargo container is loaded with medical equipment. A standard cargo container can hold 200 of any of the following, unless stated otherwise.

01-10% Packages of protein healing salve or bandages (see *Rifts® RPG*, page 247).

11-20% First Aid kits (see *Rifts® RPG*, page 246) or surgical kits.

21-30% Bio-Regenerators (see page 110 of this book).

31-40% PSE-8000 Medical Scanners (see page 107 of this book).

41-50% Canisters of Spray Skin (see page 111 of this book).

51-60% 10 Auto-Medic automated medical systems (see page 109 of this book).

61-70% Compu-Drug dispenser (see *Rifts® RPG*, page 247)

71-80% RMK (see *Rifts® RPG*, page 246)

81-90% IRMSS (see *Rifts® RPG*, page 247)

91-00% Phase-Tech Med Kit (see *Phase World®*, page 125)

53% Cybernetic equipment: These will be raw components used either in the construction of full cybernetic systems or actual parts. A standard cargo container can hold about 10 million credits' worth of parts and implants. Characters should be able to get 25-35% of the value listed here.

54% Bionic equipment: These are component parts used in the construction of full bionic systems. This would include body parts, spare parts, and fully assembled bodies. Weapon systems may be included, but they require several hours of work to be mounted and activated. A typical cargo container can hold 11-15 million credits' worth of parts. Characters should be able to get 30-45% of the value listed here.

55% Scientific equipment: Scientific study is one of the most common reasons to be in space. All of the following are common instruments found on science vessels. Some ships have

more specialized equipment, however the ones listed below are the most common items found and used. Characters should be able to get 20-35% of the values listed here.

Spectra scope: This instrument is used in the study of various light spectrums. A good quality scope will cost around 20,000 credits. Container has 144 of them.

Radio telescope equipment: The majority of celestial bodies give off radio waves in some form or another. Specialized equipment is needed to study these phenomena. This equipment tends to be large and bulky, so there is usually one unit per cargo container. Value is typically 250,000 credits. Container has two of them.

Telescope equipment: Stars are still studied by telescopes, most of which utilize the most advanced technologies in glass cutting, mirror refracting, and optics. Telescopes are also used to study distant galaxies that are not in the local group and are too far to visit. Value varies according to resolution, typically 2-4 million credits. One per container.

Portable laboratory: These labs are pretty advanced and able to perform hundreds of simple and complete experiments. Value per lab is 10,000 to 15,000 credits. See *Rifts® RPG*, page 246 for a complete description. Container has 144 of them.

Portable Scan Dihilator: A more primitive version of today's hand-held scanners, this older model (described in *Rifts® RPG*, page 246) has basic sensor and capabilities. These larger two-handed units typically sell for round 4,000 to 6,000 credits. A cargo container can hold 144 of these scanners.

Portable Scanners: Personal scanners are smaller and more compact than their larger brothers. See "Equipment of the Three Galaxies" for a complete description. Roughly 216 can be put into a single cargo container.

56% Slaves: Unfortunately, not all the governments of the Three Galaxies are free societies. Slave ships frequently travel to TGE and Splugorth controlled worlds with ships full of slaves to sell. These can be humans and humanoids to monsters. A container typically holds 40 human-sized beings, 30 Ogre- or Wulfen-sized beings, 15-20 Troll-sized beings or 4-6 True Giants. Values for different races vary, but the more common varieties go for around 1,000-4000 credits per head. Exotic ones 40,000-120,000 a head. Characters of a good alignment will be opposed to selling other intelligent beings; evil characters can get 30-50% of the slaves' value from those in the market for slaves. Illegal in the CCW, FWC and UWW.

57% Star fighter equipment/parts: In order to keep star fighters in top working order they require regular maintenance. One cargo container can carry enough parts to service 1D4+3 space fighters. To make things easy for the G.M., assume most companies make standardized parts for all types of fighters worth 2D6x100,000 credits; 50% more for magic ships. Characters can get 25-50% of the value selling wholesale.

58% Space shuttle equipment/parts: As with star fighters, shuttles also need to be maintained. One cargo container holds enough to service two vehicles. Parts are worth 2D6x100,000 credits; 50% more for magic ships. Characters can get 25-50% of the value selling wholesale.

59% Landing craft (non-military): This can be any type of ground-based vehicle. From hovercraft to wheeled, it serves as a portable base of operation and/or mobile home with living quar-

ters and basic amenities. These vehicles are typically used in archeological digs, planetary and geological surveys, scouting missions and exploration. See "Equipment of the Three Galaxies" for more details. Characters can get 40-60% of the list value.

60% Personal computer equipment: Personal computers have come a long way, and are usually small enough to be included in personal scanners. However there are still people such as businessmen who prefer an old-fashioned laptop. These ultra-thin computers are smaller and lightweight than ever before and loaded with 60-100 terabytes of memory. Average price is 5,000-10,000 credits. A typical cargo container can hold 200 laptops. Characters can get 40-60% of the list value.

61% Starship computers (possibly a dormant A.I.) or some type of super computer: Starship computers are one of the most advanced computers being built. Capable of billions of calculations per second, this speed and calculating power are needed to run the hundred thousand or so functions on a starship per minute. In some cases, these computers are so advanced they develop their own unique quirks and personalities, like referring to the starship as "me" or "I." Yes, some older ships' computers have been known to achieve some level of sentience. Most new ships don't have this problem as they automatically dump any non-necessary memory every week or so. Ship computers are one of the smallest components on a starship, and one of the more costly. A computer used to run a ship as small as a Runner or a Pirate ship costs 10-20 million credits. Bigger ships usually have one or two redundant cores in case the primary computer core is damaged. Large ships like the Consortium's Protector have a computer core that cost 100-150 million credits, of course, it's one of the most advanced cores currently in the Three Galaxies. A typical cargo container holds one or two units. Characters can get 50-75% of the list value.

62% Surveillance equipment: This is specialized gear for conducting surveillance. Micro-cameras, keyhole microphones, video wall mount, pocket scrambler, and ultraviolet signaler are all examples of common items. May include bugs and various transmitters used to tail someone. Many types are described in the Rifts® RPG, page 248. Typical container holds 576 items with an estimated value of 350,000 credits. Characters can get 20-30% of that selling wholesale, as much as 50% to clients with a real need for such equipment.

63% Colonization equipment. There are many essentials needed to start a new home. The basics are food, water and shelter. Portable shelters using memory materials are as small as a backpack that expands to the size of a four-man tent. Moisture collectors pull water out of the air, or water collectors combine hydrogen, oxygen and various minerals to make drinkable water. Rations are also common among colonization equipment. Other equipment might include farming equipment, building equipment, and basic vehicles. A container typically holds 200,000 to 500,000 credits' worth of basic gear or pre-fab building materials. Characters can get 20-30% of that selling wholesale, as much as 50% to clients with a real need for such equipment.

64% Habitable domes: Habitable domes are very large structures used in the construction of habitats in a space environment or a toxic atmosphere. Most are pre-made and come as ready-built units (or two or three easy to put together parts);

usually need to be towed to their destination. Others are collapsible and use memory metal to reform their shape. The non-collapsible domes can be hundreds of feet to thousands of feet in size. The collapsible domes usually can't exceed 800 feet (244 m) and are primarily used as temporary lodgings. Value is 750,000 to 2 million credits each. Characters can get 20-30% of that selling wholesale, as much as 50% to clients with a real need for such equipment.

65% Raw lumber: In some corners of the Three Galaxies wood is considered a luxury item. The majority of advanced cultures use processing factories in orbit to produce needed building materials, typically high-grade plastics, ceramics and other space-age materials. Many do so to protect various wildlife habitats. So having items made out of something that could be considered rare drives prices up and creates fads. Raw, unprocessed lumber can go for 100-200 credits a pound. The price is higher for rare woods like red cherry and oak. Characters can get 40-50% of that price selling wholesale, and as much as 60-80% to clients who want it desperately.

66% Processed lumber: This lumber has already been processed and cut into ready to use building material. The cost is higher than unprocessed wood at 300-400 credits a pound. Again, rare woods can get 10-40% more. Characters can get 40-50% of that price selling wholesale, and as much as 60-80% to clients who want it desperately.

67% Animal pelts: Animal pelts from S.D.C. creatures remain popular throughout the Three Galaxies (though banned or shunned in some systems). A standard cargo canister could hold 600-800 pelts with an average value of 200,000-300,000 credits. Characters should be able to get 20-40% of that value selling wholesale.

68% Monster pelts: Even more exotic than animal pelts are skins from M.D.C. creatures. A standard cargo can could hold 400-500 pelts with an average value of 400,000-600,000 credits. Characters should be able to get 30-50% of that value selling wholesale.

69% Ancient weapons: Ancient weapons and modern copies include swords, knives, axes, maces, morning stars, spears, pole arms, etc. A typical container holds 576 and has a retail value of 200,000-400,000 credits. Dwarven and other best quality weapons get triple that amount. Characters should be able to get 20-40% of that value selling wholesale.

70% Robots: Robots are most often found as part of a military shipment. Typically, all weapons systems are deactivated and need a skilled technician to activate them. This takes 2D6x10 minutes for the entire job per each robot. The size of the robot shipped does not usually exceed 50 feet (15.2 m). Value will be per robot. Characters should be able to get 30-50% of the value per each unit.

71% Robot equipment/parts: Small robot parts can be shipped in a typical can. Average value is 1D10x100,000 credits. Larger items like limbs may be shipped in specialized containers. **72% Power armor equipment/parts:** A single cargo canister can hold enough parts to service 1D4+4 individual power armors with an approximate value of 5D6x10,000 credits.

73% Music CDs or film digital mini-discs: Popular music and movies are shipped all over the Three Galaxies. They are usually packed in crates of 500 with an average retail price of 15-25 credits per disc; 7,500 to 12,500 per crate. A cargo con-

tainer can hold 10 crates. Characters can get 20-30% the retail value selling them in bulk.

74% Musical instruments: Live music is as popular as ever and the demand for musical instruments is as popular as ever. Instruments are shipped with lots of packing foam and a typical cargo can hold 60-120 items depending on their size. Typical value per instrument is 1D6x100+200 credits for commercial grade items, 1D6x10,000 for professional quality instruments. Has a limited audience. Lucky to get 10-15% on the open market, double to those looking for musical instruments.

75% Handcrafted goods: Mass production is the way just about all goods are made, however, individual handmade articles are appreciated and command a good price, mainly among collectors and the wealthy. The list below is just the tip of the iceberg of handcrafted items. Characters can sell such items for 40-60% their retail value to those in the market for them, but only 10-20% if that market can't be found.

01-20% Scrimshaw (bone carvings). Value is 250-1000 credits per carved article.

21-40% Handmade fabrics, from sweaters and scarves to blankets. They sell for 100-1000 credits each depending on size and what the article is.

41-60% Woodwork. Since wood is a rare commodity, carved wood items can go for a fortune. Prices vary from 2D6x100 credits for small statues and carvings to 4D6x1,000 for elaborate works of art and large items, including chests, chairs, tables, etc.

61-80% Stonework Items carved from marble, sandstone and even semi-precious stones command prices from 2D4x100 to 4D6x1,000.

81-00% Metal work. Not as popular as the rest, but still worth mentioning. Value is 4D6x100 credits per item.

76% Grain/seeds: A ton of grain can be stored per cargo container. Average value is 500 credits for common grains per ton, 1D4x1,000 credits per ton for rare and exotic grains.

77% Legal drugs/medicines: 100-200 doses per crate, 12-16 crates per standard cargo canister. Value depends on supply and demand. Average value is 1D4x100 credits per 20 doses. Characters can get 25-50% of the retail value under normal circumstances, 100% in crisis situations where the medicine is in high demand; double in life and death situations.

78% Illegal drugs: Same as #77 above, with double in situations where the drug is rare and in very high demand.

79% Mail/letters or packages: A container of mail can be found on just about any cargo ship or freighter. Postal services around the Three Galaxies are so busy they can hardly keep up with demand. Even having their own "postal fleet" still doesn't help. To alleviate demand, most postal services pay 250 credits per light year traveled, per cargo container of mail (letters, cards, computer and video discs, etc.). All one has to do is sign up at any postal distribution service a few days before a trip, provide full details of flight plan and destination, and the postal service is likely to hire the crew to deliver 1D4 cargo containers of mail. All mail canisters are electronically locked, monitored and tracked. Hazard pay and bonuses are given on trips that involve going into hostile territory such as Kreeghor space or when travel carries one into dangerous regions of space.

80% Space Ugglies: Whatever cargo was in this storage can was eaten by a small swarm of "Space Ugglies" (bugs or rodents or similar varmints) that got inside the container before it was sealed. Unless very careful with the container and measures are taken to immediately exterminate the varmints, there is a 01-75% chance of the holding bay or transport vessel becoming infested.

81% Vampires: Hiding in a cargo can are 1D4 Vampires. They try and sneak around the ship to feed, but mostly stay in hiding. This is potentially one of the worst types of infestation. In the alternative, the container may hold 1-40 refugees or fugitives (ordinary people, wanted criminals, political exiles, runaway slaves or bums looking for a free ride).

82% Alien parasite or predator: Some kind of critter (or several creatures) got on board the ship and has been using this canister as its home. It may or may not be hostile or a serious threat. Half the cargo in the container that is with the creature(s) has been ruined by it.

83% Personal entertainment equipment: Small electronic items form chips and disks to VR goggles, electronic games, PDD players, cameras and other electronics for personal use and entertainment. Each container has 100,000-500,000 credits' worth of stuff. Characters can sell it wholesale for 20-35% of the value listed here.

84% Stolen military weapons. Typically, pistols, rifles, and hand grenades. Value varies with the type of item and manufacturer. Difficult to liquidate on the open market or through any legitimate buyer/seller. Lucky to get 5-15%. Could get 20-40% selling in a war-zone, but there is a 01-50% chance that payment is fake or that the local military seizes the weapons as contraband or stolen goods – a total loss either way. Furthermore, if apprehended by the authorities, the cargo will be impounded and the characters could be looking at stiff fines and 10-20 in prison for trafficking in stolen and military issue weapons. They could be executed on the spot if captured by the military from which the weapons were stolen, even if they didn't actually steal the items.

85% Fancy clothes: Clothes made of silks and precious fabrics. They are not only fancy in material, but in design as well. Value ranges from 500 credits to 10,000 credits per outfit. 288 complete suits or sets of clothing are stowed in a typical cargo container. Characters can get 10-25% of the retail value.

86% Alien clothes: These are articles of clothing that are for non-humanoid species. As they have to be custom-made, cost is a little on the high side, but the market extremely limited. Worth 2D6x100 credits per outfit or set of clothing. 288 complete suits or sets of clothing are stowed in a typical cargo container. Characters are lucky to get 2% of the retail value; 10-25% in a market where the clothes fits the local population.

87% Uniforms: Military or civilian uniforms. Value is around 300 credits per uniform, but on the open market the characters are lucky to get 5% of that, unless they can find someone (most likely an enemy) who would love to buy uniforms of a rival or enemy to infiltrate their ranks. In this latter case, the sellers could get 20-40% of the retail value.

88% Trinkets/souvenirs: Basically junk and novelty items. Value is only 1,000 or 2,000 credits per ton. Characters are lucky to get 50-200 credits per ton.

89% Communication equipment: From personal communicators to advance stellar communication systems. A full cargo container is worth 100,000-250,00 credits for common communications items, and 800,000 to 2 million credits for military and advanced communications equipment. Characters should be able to get 20-35% of that selling wholesale.

90% Salvage: What may look like junk *might* actually be salvaged components from a starship or battlefield. Even if it's scrap metal there are salvage yards that buy it, so a profit can be made. The salvage can be anything and the value can range from pennies on the dollar to millions of credits in value.

01-20% Junk or Scrap metal worth only 1D6x1,000 credits.

21-40% Various starship components: 1D6x10,000 credits.

41-60% Valuable starship components: 1D6x100,000 credits.

61-80% Military grade weapons or components: 1D6x200,000 credits.

81-00% Alien technology, not common: 3D6x100,000 credits.

91% Garbage: From waste and debris to raw sewage. It is usually stored in specialized containers. Why would anyone transport garbage? Well, there are a few reasons: 1) One planets junk is another planet's fuel. That's right, several planets are able to recycle the garbage into a useable fuel. It's 99.3% pollutant free and they get the garbage for free, as they usually charge whomever a fee for removing it. 2) Other planets just don't have a means of disposing of their own garbage, so they have to have it shipped off to orbital space stations, moon dump sites or other planets for disposal. 3) Illegal dumping. Yep, don't want that toxic garbage on your world, dump it someplace else.

92% Building materials: Anything from wood to plastic to bricks or metal sheeting and a whole lot more. One common material is S.D.C. sheets of *Duraplast* (durable plastic as hard as wood). It is lightweight, resilient, and as easy to work with as wood, and it's cheap. Each 10x10 foot (3x3 m) sheet has 80 S.D.C. and costs only 20 credits. 500 sheets can be stored in a standard cargo container. A full can of Duraplast sells for 10,000 credits. Other materials may cost more or less. M.D.C. materials are very expensive, roughly 1000 credits per each point of M.D.C. (i.e. a 50 M.D.C. sheet costs of 50,000 credits). Characters should be able to get 20-35% of the value.

93% Refugees: Smuggling people in cargo containers goes back centuries. No value unless the characters extort the refugees (and refugees typically only have the belongings on their backs) or sell them into slavery, something good aligned characters would never consider.

94% Chemicals: All types of chemicals are transported across the cosmos. Value of a single container is 6D6x10,000 credits. Characters should be able to get 20-30% per container.

95% Magic items and devices: These items are not weapons, but other devices and gizmos that incorporate magic similar to Rifts Earth Techno-Wizard devices. It could be magic E-Clips, mystic generators, healing devices, mystic power armor, wing boards, vehicles, etc. Value of a single container is 1D6x1 million. Characters should be able to get 20-40% per can.

96% Information: Some say knowledge is power. Information is one of the hottest traded commodities on Phase World and other planets as well. This valuable information can be

stored on any type of medium from computer discs to scrolls. It can also be about anything. From a possible hostile takeover of a company by Naruni Enterprises to the combination to a secret vault, to military maneuvers or secret pacts, to . . . well, you get the idea. Value can range widely, from 1D6x1,000 credits per subject to 1D6x100,000 credits. G.M.s, use your discretion.

97% Miscellaneous space equipment: This can range from emergency hull patches to vacuum glue. Any items that would help a spacer to survive the hostile environment of space! Even odds and ends for spacesuits, tools for repairing bulkheads, tether equipment, to high-grade cable. Value of a single container is 4D6x10,000 credits. Characters should be able to get 10-30% per container worth of items or materials.

98% Alien technology/artifacts: Alien technology or artifacts are always sought after. All governments have at least one agency that deals with the acquisition of new and alien technologies to improve their own. It may take several years to reverse engineer an Intruders fold system, but you can bet that any of the major governments in the Three Galaxies would pay top dollar, even kill, for something like that. Value is left entirely at the discretion of the G.M. Characters should be able to get 10-40% per of the going worth.

99% Volatile liquids: This would be containers holding water, and various liquid elements such as nitrogen, hydrogen, and helium. These elements in liquid form can be very valuable. However, some, like liquid hydrogen, are very volatile. Value on these gases, chemicals and liquids will vary greatly with the most common only worth 1D4x1000 credits for a full cargo container to 1D4x1 million credits. Players with the skill of Galactic lore who make a successful roll will have a general idea where they may get the most money for these items. Characters should be able to get 20-40% per container worth of items or materials.

100% Empty: That's right! The container is empty. Of course, a cruel G.M. can have a little fun and say it's full of small containers, all empty too. Or throw in some other surprise of his or her own design.

Cargo Containers

Cargo containers are a common sight in the space docks of the Three Galaxies, especially commercial hubs like *Phase World*. They are storage containers for all sorts of materials and are often traded with their cargo for ease of transport. They come in all shapes and sizes. The Spacers' Guild has adopted a system to standardize these containers designed to be modular fits for most styles of cargo spacecraft.

Micro-canister (Commonly called a "micro-can")

The micro-can is the smallest of the standardized cargo containers. It typically carries small non-perishable items. Each unit is installed with a contra-gravity pad for easy movement.

M.D.C. by Location: Main Body – 25

Statistical Data:

Height: 3.1 feet (1 m)

Length: 9.5 feet (2.9 m)

Width: 5 feet (1.5 m)

Interior volume: 131.6 cubic feet (41.1 cubic m) of space.

Weight: 100 pounds (45 kg) empty. Can hold up to 500 pounds (225 kg) of cargo.

Market Cost: 5,000 credits for a micro-can with a contra-gravity pad, and 2,000 credits without. Price includes a standard electronic lock that can be opened via voice command or by entering a code number as long as 10 digits.

Note: Typical cargos are E-Clips, precious stones, documents, sensitive electronic equipment, electronic and computer chips and disks, and other small, delicate articles. These containers are also typically equipped with a grav-pack so the container can float and be easily pushed around.

Standard cargo canister (Typically just called a “Can”)

The standard cargo canister is a common sight in just about any space port. They are a good size container for carrying all kinds of cargos; basically a space age boxcar. They are typically equipped with a contra-gravity pad that allows easy movement. When activated, they float about a foot (0.3 m) off the ground and can be easily pushed by anyone.

Some cans are specialized with units ranging from freezers to stasis fields. They are typically marked, especially when carrying perishable goods. Some cans are even equipped with micro-environmental units to provide a breathable atmosphere that would sustain the can even in space.

M.D.C. by Location: Main Body – 100

Statistical Data:

Height: 11 feet (3.4 m)

Length: 20 feet (6.1 m)

Width: 11 feet (3.4 m)

Interior volume: 21,000 cubic feet.

Weight: 500 pounds (225 kg) empty, and can hold up to 12 tons of cargo.

Market Cost: 10,000 credits for a standard can, 15,000 for one with a grav pack hover system. Add 5,000 credits for either a freezer or temperature controlled can, and add 10,000 credits for a can with a recycling atmosphere.

Giant Can

The giant can is a large rectangular container that can hold ten standard cans at a time. They are packed in pretty tight with only a narrow space running between two rows of five cans. The same options apply as to whether or not the owner wants it to be environmental, refrigerated, heated or not. These giant cans also hold various other cargos as well. It simply depends on the owners' wants and needs. For an extra cost, these cargo containers can be magnetically attached to a ship hull to save on internal storage or simply to secure the can internally.

M.D.C. by Location:

Access Doors (2) – 30

Large Cargo Doors (6) – 75

*Main Body – 500

* While the giant can is capable of supporting life it is not meant to. After 40% (200) of the M.D.C. is depleted the can

begins to lose atmosphere. Once all the M.D.C. is depleted the can is in tatters and effectively destroyed.

Statistical Data:

Height: 15 feet (4.6 m)

Length: 60 feet (18.3 m)

Width: 25 feet (7.6 m)

Interior volume: 22,000 cubic feet (6,706 m) of space.

Weight: 6 tons empty. Can hold up to 20 tons of cargo.

Market Cost: 100,000 credits for a giant can which includes a standard electronic lock that can be opened via voice command or by entering a code number as long as 10 digits. Add 20,000 credits for a grav pack hover system, 30,000 for environmental systems and 10,000 for refrigeration.

Note: From the main control panel this cargo container can be accessed from six different cargo size doors or two humanoid size doors. Also note that an airlock is not standard on this can and opening a cargo door in a vacuum can result in sudden decompression.

Super Can

Super cans are the industrial giants of the cargo industry. Anything can be stored inside as there are multiple locations to strap down any size cargo.

Super cans are like small vessels and it's not uncommon to see them modified by spacers. Some modifications include sacrificing cargo space and adding a set of sub-light and conventional faster than light engines. This is typically called the poor man's spaceship, but some of the more famous spacers actually started out this way. It's actually cheaper to buy the components and build it yourself than to buy a small spacecraft. These cans also have other unique uses such as escape pods, temporary shelters, and even as the beginnings of a space station. Super cans were even used in the initial construction of Aviary city, described later in the Corkscrew Galaxy.

M.D.C. by location:

Air Locks (2) – 75

Large Cargo Doors (4) – 200

*Main Body – 1500

* The super can, while not specifically meant to support life, can with its internal atmosphere. The can does have a minor secondary hull to prevent the loss of atmosphere, making it more resilient. Atmosphere will begin to leak out after 60% (900) of the M.D.C. is depleted. If the M.D.C. is reduced to zero the canister is destroyed.

Statistical Data:

Height: 40 feet (12.2 m)

Length: 130 feet (39.6 m)

Width: 60 feet (18.3 m)

Interior volume: 312,000 cubic feet (95,098 cubic m) of space.

Weight: 12 tons empty. Can hold up to 200 tons of cargo.

Market Cost: 850,000 credits.

Note: These cans are too large to be transported via grav packs. They are typically moved in zero gravity with tugs. Giant cans also come standard with environmental systems and two Air locks. The large cargo doors open directly to the outside and do not have the benefits of the Air locks.



RIFTS®

- Imagine Earth transformed into an alien landscape.
- Humans exist – barely. And we are not alone.
- Aliens and monsters emerge from the Rifts – holes torn in the fabric of space and time, connected to countless worlds and realities.
- Ancient gods, demons and magic have returned.
- Magic and technology clash.
- Hundreds of character classes, many inhuman.
- *Rifts® Ultimate Edition* is the core RPG rule book.
- Expansive world setting with 90+ sourcebooks to draw upon.
- Rifts®, your portal to endless adventure.
- Limited only by your imagination.

www.palladiumbooks.com

© 2014 Palladium Books. Rifts®, Megaverse®, Nightbane® and other titles, slogans and likenesses are trademarks of Palladium Books, Inc. Palladium Books - 39074 Webb Court, Westland, MI 48185 USA - 734-271-2903 order line.

Other RPG Worlds from Palladium Books®:

- *Rifts®* – the ultimate role-playing experience.
- *Rifts® Chaos Earth®* – Play the apocalypse as it happens.
- *Splicers®* – Weird science. Bio-tech battles insane robot legions.
- *Robotech® RPG* – All eras of the TV show brought to life.
- *Dead Reign® RPG* – Can you survive the Zombie Apocalypse?
- *Palladium Fantasy RPG®* – Unique world, monsters as player characters, magic and more.
- *Heroes Unlimited™ RPG* – Play any hero; mutants, aliens, cyborgs, superhumans, mages, immortals and more.
- *Nightbane® RPG* – Conspiracy, magic, horror and monsters.
- *Beyond the Supernatural™ RPG* – Modern horror and suspense.
- *Ninjas and Superspies™*, and more.

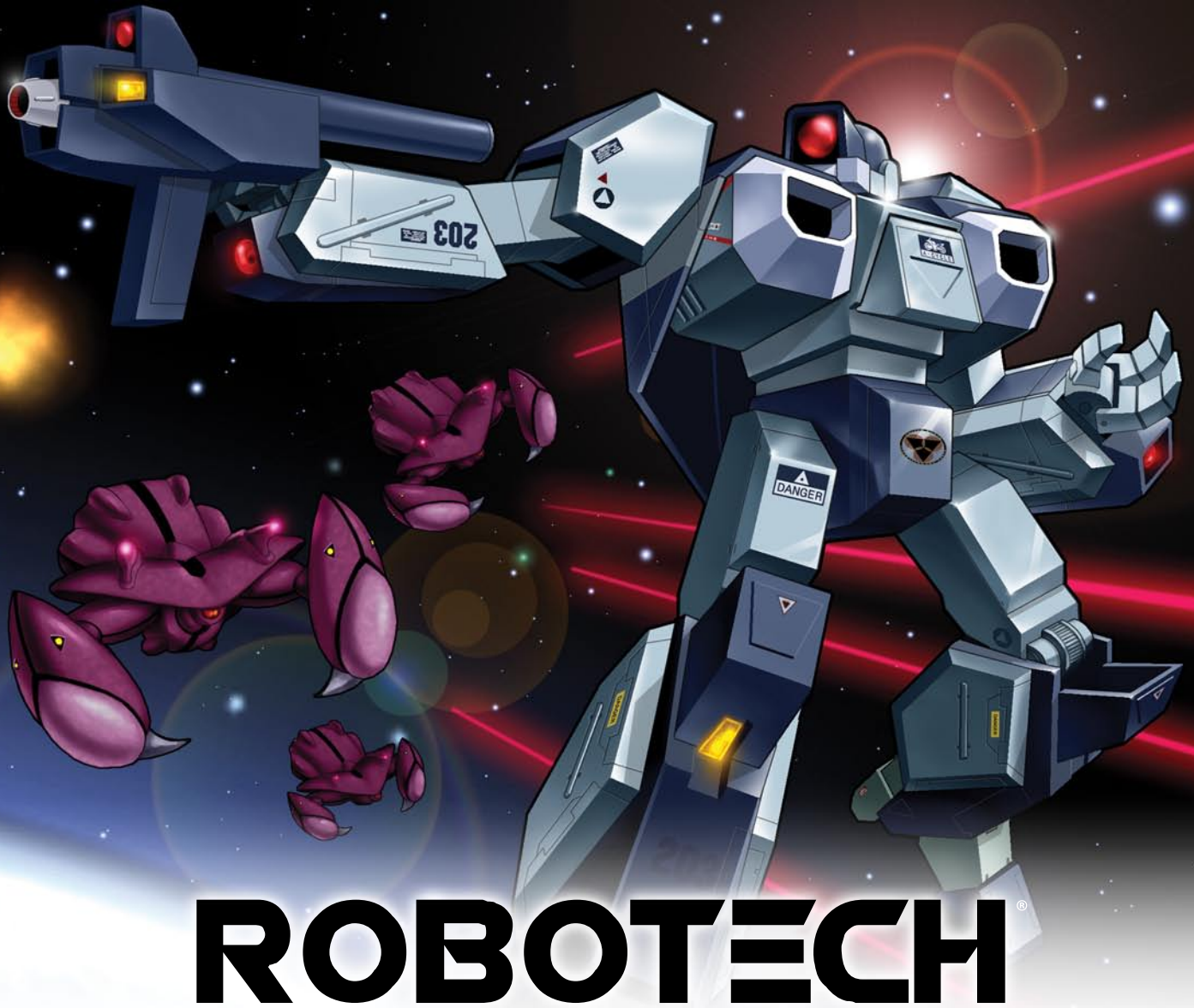

ROBOTECH®

Role-Playing Game and Sourcebooks

- **Four generations of heroes and mecha** • **Giant transformable robots** • **Alien invaders** • **Battle for control of the Earth** • **Combat takes to the stars** • **All presented in a core rule book and dynamic set of epic sourcebooks** • **Easy to learn** • **Fun to play** • **Quick character generation** • **Fast combat** • **Captures the action and adventure of the anime TV series** • **Isn't it time you joined the adventure?**

Robotech® "Core Rules" – Shadow Chronicles® RPG Hardcover

All the rules and information a player needs to start a Robotech® role-playing campaign with Admiral Rick Hunter and the United Earth Expeditionary Force trekking across the galaxy.

- Human mecha: Alphas, Betas, Cyclones & much more.
- Five character classes. 25 different Military Specialties.
- Invid mecha, Haydonites, and alien enemies.
- Quick roll character tables. Make a character in 15 minutes.
- A complete, stand-alone RPG.
- 224 pages. Cat. No. 550HC. 8½ x 11 size, hardcover.

Robotech®: The Macross® Saga Sourcebook – Cat. No. 551

A treasure chest packed with the iconic mecha, vehicles, weapons and characters that made Robotech® famous. Valkyries, Destroyers, ground vehicles, aircraft, spacecraft, weapons, Zentraedi soldiers, Zentraedi mecha, alien invaders, heroes, villains, and more.

- All the iconic Macross mecha, vehicles, weapons & characters.

www.palladiumbooks.com

Robotech®: The Masters Saga™ Sourcebook – Cat. No. 552

Tons of never before seen stats and descriptions for the many weapons, armor, mecha and robots of the Army of the Southern Cross.

- The Army of the Southern Cross™ – all 15 branches and their mecha!

Robotech®: New Generation™ Sourcebook – Cat. No. 554

The battle for the liberation of Earth starts here.

- Kit-bashed mecha combining parts from different mecha.
- Invid Hives, world overview, key characters and adventure ideas.

Robotech®: Genesis Pits™ Sourcebook – Cat. No. 555

The Invid Genesis Pits, their purpose, function.

- Inorganics and other war machines of the Invid Regent.
- Genesis Pit mutations and monsters.

Robotech®: Expeditionary Marines Sourcebook – Cat. No. 553

Join the UEEF (United Earth Expeditionary Force) led by Admiral Rick Hunter as they travel across the galaxy liberating planets from the bondage of the Invid Regent, the Robotech Masters and other tyrants.

- New mecha, weapons, and character classes of the UEEF Marines.
- New alien species and allies. Planet hopping and more.



ROBOTECH

RPG TACTICS™

Main Boxed Game – Cat. No. 55100 – Available Now!

A fast-paced, strategy battle game that captures the speed and action of Robotech®. Play Earth defenders or Zentraedi invaders.

- Scalable from small squad skirmishes to mass battles.
- Turn-based system of play and uses D6. Two or more players.
- 34 highly detailed game pieces. 6mm scale.
- 112 page color rule book with paint guide and index.
- 53 laminated, color game cards.
- 24 custom dice, two decal sheets and more.
- Assembly and painting required. Glue not included.
- \$99.95 retail – Cat. No. 55100 – shipping now!
- Available in North and South America, the EU, Australia & New Zealand.

Note: Each product contains plastic game pieces requiring assembly and painting. Glue not included. This is not a toy. Small parts, not suitable for children under the age of 13. Adult supervision advised. Images shown here are not to scale.



UEDF Valkyrie Wing™ – Cat. No. 55201

Build your fleet of Earth defenders with the Valkyrie Veritech Fighter; six game pieces total. **\$36.95 retail.**

- 2 Valkyries in Fighter mode.
- 2 Valkyries in Guardian mode.
- 2 Valkyries in Battloid mode.
- Multiple heads for making the VF-1A, VF-1J, VF-1R & VF-1S.



UEDF Tomahawk/Defender Destroids™ – Cat. No. 55202

Expand your Destroid squad with these formidable walking tanks; four game pieces total. **\$32.95 retail.**

- 2 Tomahawk Destroids – the main battle tank of Destroids, brimming with powerful particle beam cannons for arms, and wielding a battery of missiles and an array of other weapons.
- 2 Defender Destroids – a long-range, anti-aircraft juggernaut capable of shooting down incoming Zentraedi Battlepods and Gnerl Fighters.



UEDF Spartan/Phalanx Destroids™ – Cat. No. 55203

Add some long-range power and up-close punch to your army with these valuable Destroids; four game pieces total. **\$32.95 retail.**

- 2 Spartan Destroids – civil defense, riot control and deadly in hand to hand combat.
- 2 Phalanx Destroids – a walking, long-range missile artillery unit.



Zentraedi Regult Battlepods™ – Cat. No. 55401

Expand your Zentraedi forces with their main infantry battle mecha; six game pieces total. **\$36.95 retail.**

- 6 Regult Tactical Battlepods – the lightning quick Regults, armed with a pair of particle cannons and auto-cannons, attack in wave after wave.



Zentraedi Artillery Battlepods™ – Cat. No. 55402

Give your Zentraedi legion greater firepower with these artillery and support Battlepods; four game pieces total. **\$36.95 retail.**

- 4 Zentraedi Support Battlepods, each of which can be made into:
 - Gluhaug-Regult – Light Artillery Battlepod
 - Serauhaug-Regult – Heavy Artillery Battlepod
 - Telnesta-Regult – Experimental Particle Beam Battlepod
- Four game pieces total.**



Zentraedi Glaug Command™ – Cat. No. 55403

This diverse pack provides your Zentraedi forces with greater tactical capabilities; three game pieces total. **\$36.95 retail.**

- 1 Glaug Officer's Battlepod – the fast and deadly mecha of Zentraedi field leaders.
- 1 Quel-Regult Scout Battlepod – the stealthy eyes and ears of your Zentraedi battle force; electronic warfare capabilities.
- 1 Quel-Gulnau Recovery Pod – enhances the Glaug's ability to bring in Battlepod reinforcements. **Note:** This figure has NEVER before been offered by any company.

Can YOU survive the Zombie Apocalypse?



The Dead Reign® RPG series

Dead Reign® RPG – “Core Rules.” It is the aftermath of the *zombie apocalypse*. The dead reign and the living fight against impossible odds. Can you survive? Find out with this fast-paced horror game. Easy to learn. Fast character creation and combat.

- **Zombie combat and survival rules, vehicles and equipment.**
- **6 iconic Character Classes plus Ordinary People (40+ occupations).**
- **7 types of zombies, plus the Half-Living.**
- **101 Random Scenarios, Encounters, Settings and other tables.**
- **\$22.95 retail – 224 pages – Cat. No. 230. Available now.**

Civilization Gone™ Sourcebook

Civilization has crumbled to nothing. There is no army. No government. No help coming. What now?

- **Madmen, Psychopaths, villains, heroes and protectors.**
- **House, home and survivor camp tables, resources & encounters.**
- **\$12.92 retail – 64 pages – Cat. No. 231. Available now.**

Dark Places™ Sourcebook

Travel the rails and urban underground to move about undetected by zombies.

- **Worm Meat, Bug Boy, Sewer Crawler & Impersonator Zombies.**
- **Traveling the rails, sewers and other dark places.**
- **Random encounter tables, boxcar content tables, and much more.**
- **\$12.92 retail – 64 pages – Cat. No. 232. Available now.**

Endless Dead™ Sourcebook

The zombies grow in number and strangeness. Can humankind survive?

- **Zombie amalgamations, tables and encounters.**
- **New player characters & timetables for your campaign.**
- **Weaponizing vehicles, vehicle combat rules, and military bases.**
- **Creating survivor caravans, hideouts, Safe Havens & more.**
- **\$16.95 retail – 96 pages – Cat. No. 233. Available now.**

Other horror titles from Palladium Books®

Beyond the Supernatural™ RPG **Nightbane® RPG**

Fear the Reaper™ Sourcebook

Heroes who, like knights of old, travel the highways fighting zombies and helping survivors.

- **Comprehensive background on the Road Reapers.**
- **Their code, missions, weapons, strategies and tactics.**
- **The Terror Zombie and more.**
- **\$12.95 retail – 48 pages – Cat. No. 234. Available now.**

Graveyard Earth™ Sourcebook

The Zombie Apocalypse across the globe; provides a world overview and many adventure ideas.

- **Many tables for settings, encounters and adventure hooks.**
- **Random Safe Havens by region, and Survivor Leaders.**
- **How to get home from abroad, zombie threat levels & more.**
- **\$12.95 retail – 64 pages – Cat. No. 235. Available now.**

Hell Followed™ Sourcebook

This big, 160 page sourcebook begins to redefine the zombie genre. It broadens the field of possibilities and expands upon the modern zombie mythos. It is full of twists and surprises you will not expect.

- **11 new types of terrifying zombies.**
- **7 player characters, plus Masked Lunatics – heroes or madmen?**
- **21 disasters to complicate survival, and urban survival.**
- **Government enclaves, conspiracy theories and more.**
- **\$20.95 retail – 160 pages – Cat. No. 236. Available now.**



Palladium Books® Check List & Order Form

Dept. P-16, 39074 Webb Court, Westland, MI 48185

Name: _____ Address: _____

City: _____ State: _____ Zip/Postal Code: _____ Country: _____

Credit Card Number: _____ Expiration Date: _____ Visa MasterCard

Telephone Number: _____ Signature: _____ AMEX Other

The Rifter® Series

- ___ 175 The Rifter® #75 – \$13.95
- ___ 176 The Rifter® #76 – \$13.95
- ___ 177 The Rifter® #77 – \$13.95
- ___ 178 The Rifter® #78 – \$13.95 (Spring)
- ___ 179 The Rifter® #79 – \$13.95 (Summer)

Splicers® Note: Sourcebooks coming soon.

- ___ 200 Splicers® RPG – \$23.95

Dead Reign®

- ___ 230 Dead Reign® RPG – \$22.95
- ___ 231 SB 1: Civilization Gone™ – \$12.95
- ___ 232 SB 2: Dark Places™ – \$12.95
- ___ 233 SB 3: Endless Dead™ – \$16.95
- ___ 234 SB 4: Fear the Reaper™ – \$12.95
- ___ 235 SB 5: Graveyard Earth™ – \$12.95
- ___ 236 SB 6: Hell Followed™ – \$20.95
- ___ 237 SB 7: In the Face of Death™ (coming)

Rifts® Novels

- ___ 301 Sonic Boom™ – \$9.95
- ___ 302 Deception's Web™ – \$9.95
- ___ 303 Treacherous Awakenings™ – \$9.95
- ___ 304 Tales of the Chi-Town 'Burbs™ – \$12.95
- ___ 305 Rifts® Path of the Storm™ – \$12.95

Weapons Books

- ___ 401 Weapons and Armor™ – \$8.95
- ___ 402 Weapons and Castles™ – \$8.95
- ___ 403 Weapons and Assassins™ – \$9.95
- ___ 404 Weapons & Castles of the Orient™ – \$9.95
- ___ 409 Exotic Weapons™ – \$9.95
- ___ 410 European Castles™ – \$9.95

Palladium Fantasy RPG®

- ___ 450 The Palladium Fantasy RPG® – \$26.95
- ___ 4500HC Palladium Fantasy RPG® 30th Anniversary Hardcover – \$50.00
- ___ 451 Dragons & Gods™ – \$24.95
- ___ 453 Old Ones™ 2nd Ed. – \$24.95
- ___ 454 Monsters & Animals™ 2nd Ed. – \$24.95
- ___ 455 Adventures on the High Seas™ – \$24.95
- ___ 458 Island at the Edge of the World™ – \$20.95
- ___ 459 Yin-Sloth Jungles™ – \$20.95
- ___ 462 Western Empire™ – \$24.95
- ___ 463 Baalgor Wastelands™ – \$24.95
- ___ 464 Mount Nimro™ – \$20.95
- ___ 465 Eastern Territory™ – \$24.95
- ___ 466 Library of Bletherad™ – \$20.95
- ___ 467 Northern Hinterlands™ – \$24.95
- ___ 468 Land/Damned 1: Chaos Lands™ – \$24.95
- ___ 469 LoD 2: Eternal Torment™ – \$24.95
- ___ 470 LoD 3: The Citadel – \$24.95 (coming)
- ___ 471 Wolfen Empire™ – \$20.95
- ___ 472 Mysteries of Magic™ One: Heart of Magic – \$16.95
- ___ 474 Bizantium/Northern Islands™ – \$20.95
- ___ 475 Garden of the Gods™ – \$16.95 (coming)

Heroes Unlimited™ / After the Bomb®

- ___ 500-2 Heroes Unlimited™, 2nd Ed. – \$26.95
- ___ 5000HC Heroes Unlimited™ 30th Anniversary Hardcover – \$50.00
- ___ 501 Villains Unlimited™ Revised – \$24.95
- ___ 503 After the Bomb® RPG – \$24.95
- ___ 505 Road Hogs™ (After the Bomb® II) – \$9.95
- ___ 507 Mutants Down Under™ (AB III) – \$9.95
- ___ 511 Mutants of the Yucatan™ (AB IV) – \$9.95
- ___ 513 Mutants in Avalon™ (AB V) – \$16.95
- ___ 514 Mutants in Orbit™ (AB VI) – \$16.95
- ___ 515 Aliens Unlimited™ – \$24.95
- ___ 516 Heroes Unlimited™ G.M.'s Guide – \$24.95
- ___ 517 Century Station™ – \$24.95
- ___ 518 Gramercy Island™ – \$24.95
- ___ 519 Aliens Unlimited Galaxy Guide™ – \$24.95
- ___ 520 Mutant Underground™ – \$16.95
- ___ 521 Powers Unlimited® One – \$16.95
- ___ 522 Powers Unlimited® Two – \$16.95
- ___ 523 Powers Unlimited® Three – \$16.95
- ___ 525 Revised Ninjas & Superspies™ – \$20.95
- ___ 526 Mystic China™ – \$24.95
- ___ 527 Armageddon Unlimited™ – \$20.95

Robotech® RPG

- ___ 550 Robotech® The Shadow Chronicles® RPG (manga size) – \$16.95
- ___ 550HC Robotech® The Shadow Chronicles® Deluxe Hardcover RPG – \$30.95
- ___ 5500HC Robotech® The Shadow Chronicles® Gold Ed. Hardcover RPG – \$70.00
- ___ 551 Robotech® Macross® Saga Sourcebook – \$16.95
- ___ 552 Robotech® The Masters Saga™ Sourcebook (NEW in 8½ x 11) – \$20.95
- ___ 553 Robotech®: Expeditionary Force Marines Sourcebook – \$20.95
- ___ 554 Robotech® The New Generation™ Sourcebook – \$16.95
- ___ 555 Robotech® Genesis Pits Sourcebook – \$16.95

Robotech® RPG Tactics™ (New!)

- ___ 55100 Robotech® RPG Tactics™ – \$99.95
- ___ 55105 Robotech® RPG Tactics™ Rulebook – \$20.00
- ___ 55101 UEDF Dice Pack – \$12.00
- ___ 55102 Zentraedi Dice Pack – \$12.00
- ___ 55201 UEDF Valkyrie Wing – \$36.95
- ___ 55202 UEDF Destroid Pack – \$32.95
- ___ 55203 UEDF Spartan Pack – \$32.95
- ___ 55401 Zentraedi Regult Battlepods – \$36.95
- ___ 55402 Zentraedi Artillery Battlepods – \$36.95
- ___ 55403 Zentraedi Glaug Command – \$36.95

Rifts® Chaos Earth®

- ___ 660 Rifts® Chaos Earth® RPG – \$20.95
- ___ 661 Rifts® CE Creatures of Chaos™ – \$12.95
- ___ 662 Rifts® CE The Rise of Magic™ – \$12.95
- ___ 665 Rifts® Chaos Earth® First Responders™ – \$16.95 (coming)
- ___ 666 Rifts® Chaos Earth® Resurrection™ – \$20.95

Beyond the Supernatural™

- ___ 700 Beyond the Supernatural™, 2nd Ed. – \$24.95
- ___ 702 Tome Grotesque™ – \$20.95 (coming)
- ___ 703 Beyond Arcanum™ – \$24.95 (coming)

Nightbane®

- ___ 730 Nightbane® RPG – \$24.95
- ___ 731 Nightbane®: Between the Shadows™ – \$20.95
- ___ 732 Nightbane®: Nightlands™ – \$20.95
- ___ 733 Nightbane®: Through the Glass Darkly™ – \$20.95
- ___ 735 Nightbane® Survival Guide™ – \$20.95
- ___ 736 Nightbane® Dark Designs™ – \$20.95

Rifts®

- ___ 800HC Rifts® RPG Ultimate Edition – \$39.95
- ___ 801 Rifts® Sourcebook One Revised – \$20.95
- ___ 802-E Rifts® World Book 1: Vampire Kingdoms™, Revised – \$24.95
- ___ 803 Rifts® Conversion Book One™ – \$24.95
- ___ 804 Rifts® WB 2: Atlantis™ – \$20.95
- ___ 805 Rifts® Sourcebook 2: Mechanoids™ – \$16.95
- ___ 807 Rifts® WB 3: England™ – \$20.95
- ___ 808 Rifts® WB 4: Africa™ – \$20.95
- ___ 809 Rifts® Dimension Book 1: Wormwood™ – \$20.95
- ___ 810 Rifts® WB 5: Triax™ – \$24.95
- ___ 811 Rifts® Pantheons of the Megaverse® – \$24.95
- ___ 812 Rifts® Sourcebook 3: Mindwerks™ – \$16.95
- ___ 813 Rifts® Mercenaries™ – \$20.95
- ___ 814 Rifts® WB 6: South America – \$20.95
- ___ 815 Rifts® WB 7: Underseas™ – \$24.95
- ___ 816 Rifts® DB 2: Phase World® – \$24.95
- ___ 817 Rifts® DB 3: Phase World® Sourcebook – \$16.95
- ___ 818 Rifts® WB 8: Rifts® Japan™ – \$24.95
- ___ 819 Rifts® WB 9: South America Two™ – \$24.95
- ___ 820 Rifts® WB 10: Juicer Uprising™ – \$20.95
- ___ 821 Rifts® WB 11: Coalition War Campaign™ – \$24.95
- ___ 822 Rifts® WB 12: Pyscape™ – \$20.95
- ___ 825 Rifts® WB 13: Lone Star™ – \$20.95

- ___ 826 Rifts® WB 14: New West™ – \$24.95
 ___ 827 Rifts® WB 15: Spirit West™ – \$24.95
 ___ 828 Rifts® Sourcebook 4: Coalition Navy™ – \$16.95
 ___ 829 Rifts® WB 16: Federation of Magic™ – \$20.95
 ___ 830 Rifts® DB 4: Skraypers™ – \$20.95
 ___ 831 Rifts® Index Volume Two™ – \$16.95
 ___ 832 Rifts® WB 17: Warlords of Russia™ – \$24.95
 ___ 833 Rifts® WB 18: Mystic Russia™ – \$20.95
 ___ 834 Rifts® WB 19: Australia – \$24.95
 ___ 835 Rifts® WB 20: Canada™ – \$24.95
 ___ 836 Rifts® WB 21: Splynn Dimensional Market™ – \$24.95
 ___ 837 Rifts® WB 22: Free Quebec™ – \$24.95
 ___ 838 Rifts® WB 23: Xiticix Invasion™ – \$20.95
 ___ 839 Rifts® Coalition Wars®: Sedition™ – \$20.95
 ___ 840 Rifts® Coalition Wars®: Coalition Overkill™ – \$16.95
 ___ 841 Rifts® Coalition Wars®: Sorcerers' Revenge™ – \$16.95
 ___ 842 Rifts® Coalition Wars®: Cyber-Knights™ – \$16.95
 ___ 843 Rifts® Coalition Wars®: Shadows of Evil™ – \$16.95
 ___ 844 Rifts® Coalition Wars®: Final Siege™ – \$24.95
 ___ 845 Rifts® Game Master Guide™ – \$26.95
 ___ 846 Rifts® Aftermath™ – \$24.95
 ___ 847 Rifts® DB5: Anvil Galaxy™ – \$20.95
 ___ 848 Rifts® Book of Magic™ – \$26.95
 ___ 849 Rifts® Adventure Guide™ – \$24.95
 ___ 850 Rifts® Bionics Sourcebook™ – \$16.95
 ___ 851 Rifts® DB 6: Three Galaxies™ – \$20.95
 ___ 852 Rifts® Dark Conversions™ – \$24.95
 ___ 853 Rifts® Chi-Town 'Burbs™ – \$9.95
 ___ 854 Rifts® The Tolkeen Crisis™ – \$12.95
 ___ 855 Rifts® The Black Vault™ – \$9.95
 ___ 856 Rifts® The Vanguard™ – \$9.95
 ___ 857 Rifts® WB 24: China One™ – \$20.95
 ___ 858 Rifts® WB 25: China Two™ – \$20.95
 ___ 859 Rifts® DB 7: Megaverse Builder™ – \$16.95
 ___ 860 Rifts® DB 8: Naruni Wave 2™ – \$16.95
 ___ 862 Rifts® WB 26: Dinosaur Swamp™ – \$20.95
 ___ 863 Rifts® MercTown™ – \$20.95
 ___ 865 Rifts® Merc Ops™ – \$20.95
 ___ 866 Rifts® WB 27: Adventures in Dinosaur Swamp™ – \$20.95
 ___ 867 Rifts® Mercenary Adventure Sourcebook – \$12.95
 ___ 868 Rifts® WB 28: Arzno™ – \$20.95
 ___ 869 Rifts® WB 29: Madhaven™ – \$16.95
 ___ 870 Rifts® John Zeleznik Coloring Book – \$5.95
 ___ 871 Rifts® Machinations of Doom™ – \$18.95
 ___ 872 Rifts® DB 10: Hades™ – \$24.95
 ___ 873 Rifts® DB 11: Dyval™ – \$24.95
 ___ 874 Rifts® WB 30: D-Bees of North America™ – \$24.95
 ___ 875 Rifts® DB12: Dimensional Outbreak – \$24.95
 ___ 876 Rifts® Megaverse® in Flames™ – \$24.95
 ___ 876HC Rifts® Megaverse® in Flames™ Gold Hardcover Edition – \$50.00
 ___ 877 Rifts® Heroes of the Megaverse® – \$16.95
 ___ 878 Rifts® Sourcebook: Shemarrian Nation™ – \$16.95
 ___ 880 Phase World®: Fleets of the Three Galaxies™ – \$16.95
 ___ 881 Rifts® WB 31: Triax™ Two – \$24.95
 ___ 883 Rifts® DB 14: Thundercloud Galaxy™ – \$20.95
 ___ 884 Rifts® Vampires Sourcebook™ – \$20.95
 ___ 885 Rifts® WB 32: Lemuria™ – \$24.95
 ___ 886 Rifts® Black Market™ – \$24.95
 ___ 886HC Rifts® Black Market™ Hardcover Gold Edition – \$60.00
 ___ 887 Rifts® WB 33: Northern Gun™ One – \$24.95
 ___ 888 Rifts® WB 34: Northern Gun™ Two – \$26.95
 ___ 889 Rifts® Sourcebook: Coalition States, Heroes of Humanity™ – \$20.95
 ___ 890 Rifts® Dimension Book 15: Secrets of the Atlanteans™ – \$24.95
 ___ 890HC Rifts® DB 15: Secrets of the Atlanteans™ Gold Edition – \$50.00
 ___ 891 Rifts® World Book: Sovietski™ – \$24.95 (coming)
 ___ 892 Rifts® Sourcebook: The Disavowed™ – \$16.95 (coming)
 ___ 893 Rifts® CS: Heroes of Humanity™ Arsenal Sourcebook – \$16.95 (coming)
 ___ 894 Rifts® Haunted Tech™ – \$16.95 (coming)
 ___ 895 Rifts® Living Nowhere™ – \$16.95 (coming)
 ___ 2510 Rifts® & The Megaverse® Art Book – \$22.95
 ___ 2510-HC Rifts® & The Megaverse® Art Book, Hardcover – \$50.00
 ___ 2510-CML Rifts® & The Megaverse® Art Book, Collector's Masterwork – \$125.00
- Miscellaneous Products**
 ___ 600 Deluxe Revised RECON® RPG – \$22.95
 ___ 2537 Gamer Coffee Mug – \$10.00
 ___ 2539 Rifts® Dice Bag – Black – \$8.00
 ___ 2544 Dead Reign™ Coffee Mug – \$10.00
 ___ 2554 Palladium Bookmarks, Set One – \$5.00
 ___ 2555 Palladium Bookmarks, Set Two – \$5.00
 ___ 2561 Property of Chi-Town Library Pencil – \$0.50 each
 ___ 2562 Future Visions™ – The Artistry of Charles Walton II – \$13.95
 ___ 2566 Glitter Boy Mouse Pad – \$9.95
 ___ 2567 Old Ones Mouse Pad – \$9.95
 ___ 2568 Zombie Graveyard Mouse Pad – \$9.95
 ___ 2575 Rifts Poker Cards 1 (full color) – \$11.99
 ___ 2576 Rifts Poker Cards 2 (line art) – \$11.99
- Note:** T-shirts and other products can be found online: www.palladiumbooks.com
- Rifts® Miniatures**
 ___ MI8002 Xiticix Pack – \$18.00
 ___ MI8004 Coalition Dog Pack – \$18.00
 ___ MI8005 Men of Magic Pack #1 – \$18.00
 ___ MI8006 Cyborgs Pack #1 – \$18.00
 ___ MI8007 Simvan & Ostrosaurus Pack – \$18.00
 ___ MI8008 Coalition Skelebots Pack #1 – \$18.00
 ___ MI8009 Coalition SAMAS Pack #1 – \$22.00
 ___ MI8010 Coalition Sky Cycle Pack – \$22.00
 ___ MI8011 Coalition Dog Pack #2 – \$18.00
 ___ MI8015 Damaged Skelebots Pack #1 – \$12.00
 ___ MI8016 Cyber-Adventurers Pack – \$18.00
 ___ MI8017 Rogues & Scout Pack #1 – \$18.00
 ___ MI8018 Brodkil & Witchling Pack – \$18.00
 ___ MI8019 Damaged Skelebots Pack #2 – \$18.00
 ___ MI8020 Psi-Stalkers & Scouts Pack #1 – \$18.00
 ___ MI8021 Shadow Beast – \$12.00
 ___ MI8022 Mystic Knight – \$6.00
 ___ MI8023 Lord Magus – \$6.00
 ___ MI8024 High Magus – \$6.00
 ___ MI8025 Coalition Psi-Stalker – \$6.00
 ___ MI8026 Coalition Dog Boy in DPM-D1 Armor – \$6.00
 ___ MI8027 Coalition Dog Boy #2 – \$6.00
 ___ MI8028 Coalition Dog Boy #3 – \$6.00
 ___ MI8029 Coalition Dog Boy #4 – \$6.00
 ___ MI8030 Coalition Dog Boy #5 – \$6.00
 ___ MI8031 Glitter Boy – \$20.00
 ___ MI8032 Glitter Boy Pilot – \$6.00
 ___ MI8033 Kydian Overlord – \$20.00
 ___ MI8034 Dragonsaurus – \$10.00
 ___ MI8035 Slaver and Slave (Atlantis) Set – \$10.00
 ___ MI8036 Crazy – \$6.00
 ___ MI8037 Juicer #1 – \$6.00
 ___ MI8038 Juicer #2 – \$6.00
 ___ MI8039 Cyborg #1 – \$12.00
 ___ MI8040 Cyborg #2 – \$12.00
 ___ MI8041 Cyborg #3 – \$6.00
 ___ MI8042 Coalition Officer – \$6.00
 ___ MI8043 Coalition Grunt #1 – \$6.00
 ___ MI8044 Coalition Grunt #2 – \$6.00
 ___ MI8045 Coalition Grunt #3 – \$6.00
- When placing an order by mail, please add money for shipping and handling.** Add \$5.00 for orders totaling \$1-\$50, \$10.00 for orders totaling \$51-\$95, and for orders totaling \$96-\$200 please add \$15.00 US. Double the amount for Canada, and *quadruple* it for overseas orders. For more shipping options, order online at www.palladiumbooks.com.
 Allow 2-4 weeks for delivery.
 Make checks and money orders payable to: *Palladium Books*
- Check release dates for new products.** If the book you order has not been released yet, your order will be held as a backorder until the product is available. Please note that prices are subject to change without notice.
- Orders can also be placed by phone,** at (734) 721-2903 (order line only). Please have your credit card information when you call.

www.palladiumbooks.com

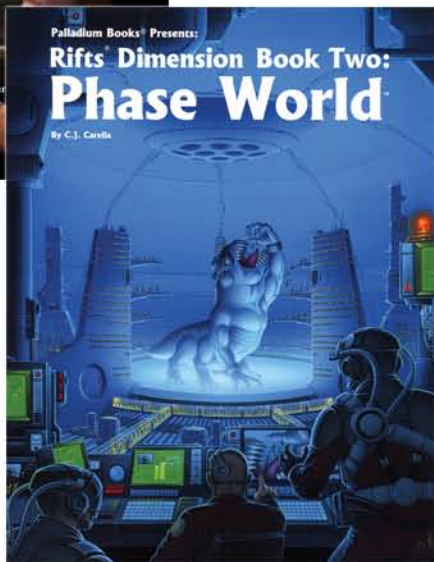

Also from Palladium Books®

The Rifter®

An ongoing sourcebook series for the entire Palladium Megaverse®. Each issue has optional (sometimes official) material for **Rifts®** and other Palladium RPGs.

- Great source for new ideas and fun.
- Optional O.C.C.s, monsters, weapons, and skills.
- Optional magic and/or super abilities.
- Adventures, gaming tips and Q&A.
- Rifts® source material & fiction.
- HU2, Palladium Fantasy RPG® & Nightbane® typical.
- The latest news and sneak previews.
- 96 pages.

Phase World®

- The book that started it all with the Three Galaxies.
- Phase World, a dimensional nexus to a thousand worlds.
- Phase Magic, the Prometheans, Noro, Kreeghor and others.
- Spaceships, armor, weapons, aliens, and much more.
- 208 pages.

The Anvil Galaxy™

- Overview of the galaxy, the Threshold and the Core.
- Nearly 20 new alien races, including Star Elves and Zebuloids.
- Legends of the Cosmic Forge, the Forge War and Cosmo-Knights.
- Planet creation rules and tons of adventure ideas.
- 160 pages.

The Three Galaxies™

Rifts® Dimension Book Six

A guide to the Three Galaxies, this book takes a look at dozens of solar systems and individual planets, notable races, people, and monsters, as well as space anomalies, spaceships and more. Discover the Hunter System, where giant, semi-intelligent serpents and other monsters are hunted for sport. Explore worlds hidden inside nebulas. Defy the murderous Necrols, their living weapons and organic starships.

- An overview of the Three Galaxies and some of the prominent people and places in them.
- 16 O.C.C.s/R.C.C.s and a half dozen monsters.
- More on the Intruders, Kreeghor, Splugorth and others.
- New equipment and spacecraft, including construction rules for space stations.
- Introducing the deadly Demon Star and Necrol living starships.
- The legendary Demon Planet – a world-killing thing that is the size of a planet itself.
- Adventure ideas by the dozen. Rumors, villains and starting points.
- 160 pages.

**Rifts®, endless possibilities
limited only by the imagination!™**

\$20.95

Cat. No. 851

ISBN-10: 1-57457-078-1

ISBN-13: 978-1-57457-078-6

**Palladium
Books® Inc**
www.palladiumbooks.com