

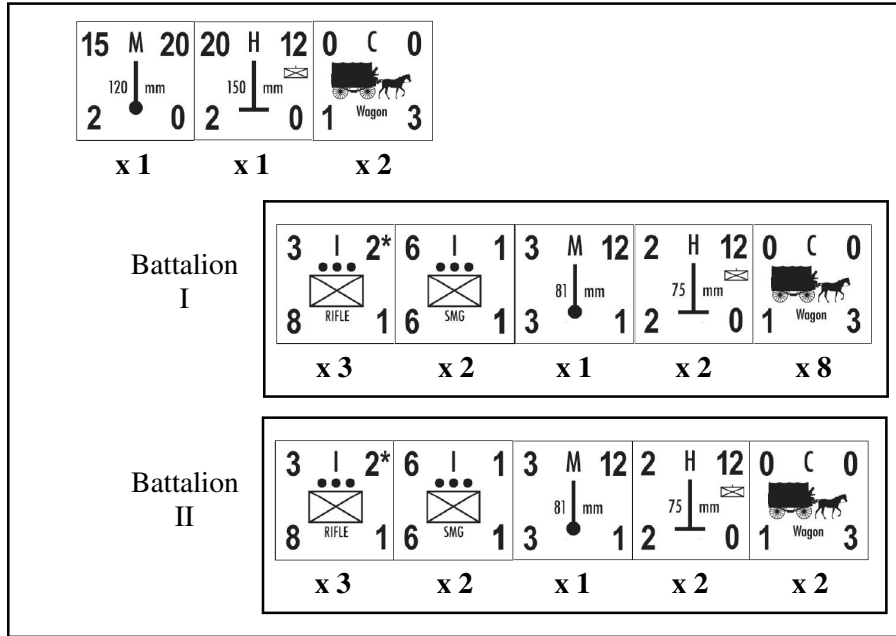

German 560th Volksgrenadier Div.

December, 1944

1128th Volksgrenadier Regiment



1129th Volksgrenadier Regiment

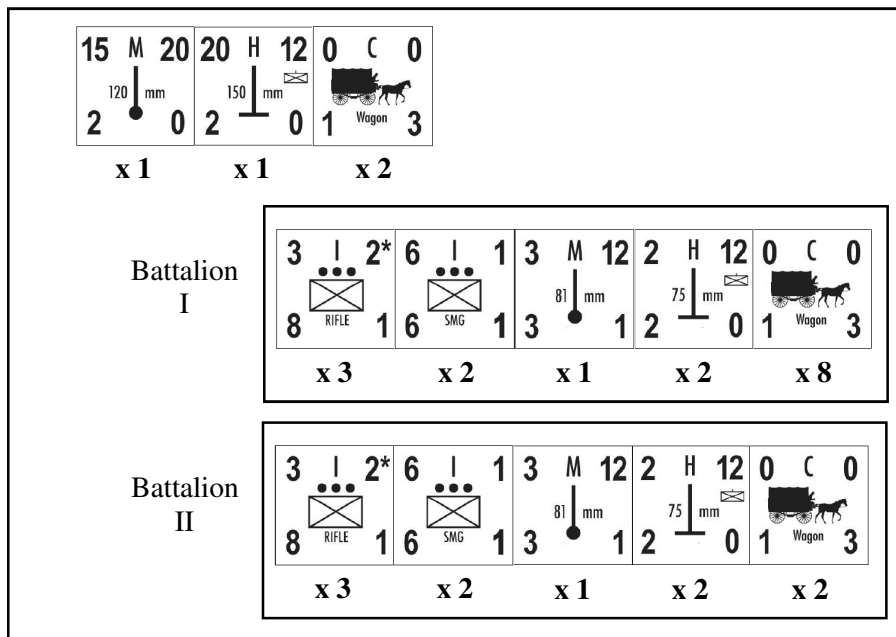

1130th
Volks-
grenadier
Regiment

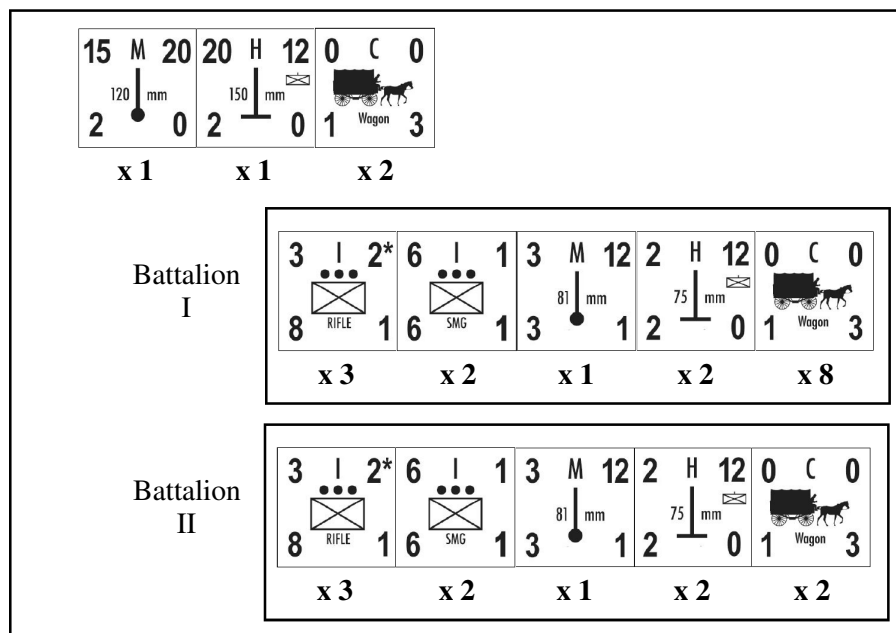

1560th
Volks-
Artillerie
Regiment

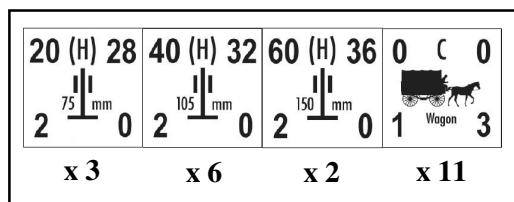

1560th
Volks-
PanzerJager
Battalion

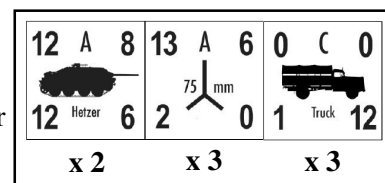

1560th
Volks-
Pioneer
Battalion

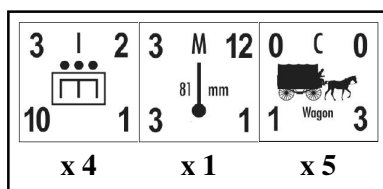

1560th
Volks-
Flak
Battalion

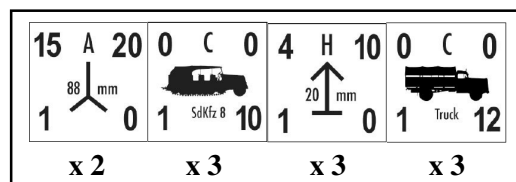

560th
Fusilier
Battalion

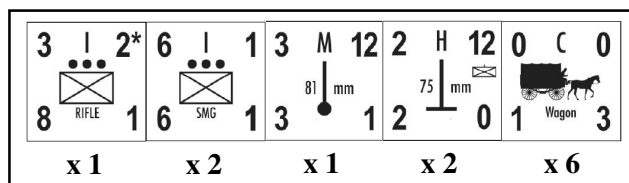

The 560th Volksgrenadier Division was the weakest division on the German side in this battle. It was a brand new division and had been recruited in Denmark and Norway only a few months before the battle. It was intended for the Russian front but was included in the Ardennes Offensive planning at the last minute. Because of this, many of its soldiers were still in route from Norway on December 16. Its strength has been reduced accordingly. The division also started the battle with its commander in the hospital. Despite all these problems, the 560th performed surprisingly well in the battle. It successfully attacked the U.S. 28th Infantry Division at the start of the battle and opened a hole for the 116th Panzer. The 560th then advanced and stayed on the flank of the 116th even though its total strength has been reduced to little more than a single battalion. The division almost reached Hotton but was too weak and had to fall back to Houffalize. The soldiers in transit finally caught up to the division just after the first of the year and the still badly depleted division ended the Battle of the Bulge fighting in the St. Vith area.