

SWORD & SORCERY

~~WURST~~
The Best of
GRIMTOOTH'S
TRAPS



CONTAINS TOO MUCH KNOWLEDGE
FOR MERE MORTALS!



THE ~~WURST~~ OF GRIMTOOTH'S TRAPS

Created by:

Rick Loomis, Steve Crompton, Liz Danforth and the staff of Flying Buffalo.

Additional

Content for Wurst Of...:

Scott Greene, Clark Peterson and Steve Crompton

Original Contributors:

Grimtooth the Troll with Paul O'Connor, Betty Kopf, Pat Mueller, Rick Loomis, S.S.Crompton, Scot Rhoads, Todd Diesen, Mike Stackpole, Michael Austin, Cliff Baird, Michael von Glahn, Greg Day, Michael Arner, Caroline J. Maher, Larry DiTillo, Charles Mollenhauer, Pat Mueller, Andy Beauchamp, Ted Rassieur, Matt Nadelhaft, Brandon Corey, Chris Andrews, Roy Cram, Todd Miller, Chris Alexander, Paul Ronkas, Brian Lawton, Chris Herborth, Andrew Bander, Joseph Yeager, Chris Hubbard, Dan Lambert, Bob Brown, David Stevens, Phil Dean, Barry Sullivan, Charles Scott Kimball, Maughn Matsuoka, David McConnell, Jason Lujan, Sefan Jones, J. Walker, John R. Greer, John T. T. Logenbaugh, Lara Abrash, Mark O'Green, Edward Schoonover, Pat Mueller, J.E. Todd, Brian Hammond, Mark Bassett, Dan Manning, Matt Nadelhaft, Fred Meyer, David Steven Moskowitz, P.D.J. Wright, Rick Bourgeois, Dr. Paul Ronkas, Chris Crotty, Brent Jones, Joe Formichella, Laurel Goulding, Andrew Bander, Brian Lawton, Dan Logans, George Andricopulos, David Stevens, Brian Moroz, John R. Greer, James Brazier, Oliver Fittock, Greg Day, Brandon Corey, Brent Halverson, Diana Harlan, Caroline J. Maher, Laurel Goulding, Drew Dietz, Norm Strange, Jersey Turnpike, Dr. E.L. Frederick, Ryan Scott, Dan Logan, Michael Von Glahn and Scott Jackson.

New d20 Content:

Scott Greene and Clark Peterson

Developer:

Bill Webb and Clark Peterson

Producer:

Clark Peterson

Layout and Design:

Mike Chaney

Interior Art:

Steve Crompton, Michael Von Glahn and Scott Jackson

Special Thanks:

To Rick Loomis, Steve Crompton and the folks at Flying Buffalo who were good enough to let us come over and play in the Dungeon of Doom! It was a pleasure to be able to bring Grimmy to the new edition of the rules.

Dedication from Necromancer Games:

To gamers everywhere who appreciate that it is cooler and more memorable to have your character die in a triple-spear-tilting-passage-reverse-gravity-springing-chair-giant-lobster trap than in a boring 60 foot deep pit with spikes.

Product Update Password for **The Wurst of Grimtooth's Traps**: Grimtina

This product requires the use of the *Dungeons and Dragons® Player's Handbook*, published by Wizards of the Coast®. This product utilizes updated material from the v.3.5 revision.



NECROMANCER
GAMES

THIRD EDITION RULES,
FIRST EDITION FEEL

©2005 Flying Buffalo, Inc., produced and distributed by Necromancer Games, Inc., under license. All rights reserved. Reproduction without the written permission of the publisher is expressly forbidden. Necromancer Games, Necromancer Games, Inc. and the Necromancer Games logo and The Wurst of Grimtooth's Traps are trademarks of Necromancer Games, Inc. All rights reserved. Grimtooth, Grimtina, Spike the Grim Dog, the names of the Original Grimtooth's Traps Books (Grimtooth's Traps, Traps Too, Traps Fore, Traps Ate, Traps Lite, Traps Bazaar, and the Dungeon of Doom) and the company name Flying Buffalo are trademarks of Flying Buffalo, Inc., and are used by permission. All characters, names, places, items, art and text herein are copyrighted by Necromancer Games, Inc. Dungeons and Dragons® and Wizards of the Coast® are trademarks of Wizards of the Coast, and are used in accordance with the Open Game License contained in the Legal Appendix. "d20 System" and the d20 System logo are trademarks owned by Wizards of the Coast and are used under the terms of the d20 Trademark License. Sword and Sorcery Studios and its logo, Creature Collection, Creature Collection II and Relics and Rituals are trademarks of White Wolf Publishing, Inc. All rights reserved. The mention of or reference to any company or product in these pages is not a challenge to the trademark or copyright concerned.

Reference to Kareem Abdul-Jabaar, Wilt Chamberlain, Shaquille O'Neal and/or any other sports teams or figures is for satirical purposes and does not imply any endorsement of this work by the person, team or organization.

This book uses the supernatural for settings, characters and themes. All mystical and supernatural elements are fiction and intended for entertainment purposes only. Reader discretion is advised.

Check out Necromancer Games online at <http://www.necromancergames.com>

And check out Sword and Sorcery Studios online at <http://www.swordsorcery.com>

Visit Flying Buffalo online at <http://www.flyingbuffalo.com>

Distributed for Sword and Sorcery Studios by White Wolf Publishing, Inc.

PRINTED IN CHINA

NECROMANCER GAMES

"THIRD EDITION RULES. FIRST EDITION FEEL"

Sword & Sorcery Studios
1554 Litton Drive
Stone Mountain, GA 30083

Dear Sword & Sorcery Studios:

Greetings from the Traps Bazaar! Wish you guys were here!

Our visit with Grimtooth is going great! Bill and I have been here for a few days now. (Bill wanted me to say hi for him; he's off with Spike the Grim Dog.) Grimtooth just can't seem to get enough of us. He sure is a nice guy for a troll. It was a great idea you guys had to send Bill and me to talk Grimmy into doing a book about traps! If anyone can bring the old passion back to traps, it's Grimtooth. Your idea to collect the best of his traps and compile them into a new book is pure genius! You guys really know your stuff. This book is going to be a big hit. I can feel it!

And it's not just me. We showed Grimmy the Third Edition trap rules and he just lost it. If I recall correctly, his rant went something like this:

"Search DC 20!?! Disable Device DC 20!?! That's it!?! That's all!?! That's what traps have been reduced to? Where is the artistry? Where is the evil? How in the *@%#! can you describe my favorite double tripwire, triple pressure-plate, poison gas-releasing, scything-bladed, corridor-shifting, delver-dropping, giant lobster cage trap with 'Search DC 20' and 'Disable Device DC 20'!?! Wait 'till I get my hands on those Coastal Wizards...!'"

It didn't get much better when we showed him the revised v.3.5 rules, either. We tried to calm him down — no easy task when you're talking about a carnage-loving troll! Still, tossing him a group of delvers to take the edge off (and a few elf maidens for dessert) seemed to do the trick. After all that, we finally got him to talk about his favorite subject — traps. But I'm getting ahead of myself... I forgot to tell you about how we met with Grimmy in the first place. The trip was great. (By the way, the map you gave us to the final resting place of Evinrood the Water Wizard was dead on!) We saw lots of interesting places. The Plain of Tomb-Mee. The Death Grange Cliffs. The Bjorni Sea. Bill drew some sketches; we'll try to send them along soon.

Anyway, after much toil and trouble, and a nasty rash, Bill and I stumbled on the place we had been searching for: Grimtooth's Traps Bazaar. And I do mean "stumbled." We'd been looking for a while with no results. Then I tripped over a strange capstone and one of our few remaining halfling hirelings got electrocuted. (Call it dumb luck, but as I always say "It's better to be lucky than smart.") Spotting a set of gates nearby distracted us from the halfling's death shrieks. Surely this was our destination! Bill recited the cryptic phrase, "Klaatu, Borata, Nikto" — along with dramatic gestures (he's good at that) — and the gates of the Bazaar opened. Bill thinks his phrase did it, but it might've just been the halfling's screams. Once the gates opened, who should step out from behind them but Grimtina, Grimtooth's little sister! I'll never forget her first words to us: "What the heck are you two idiots doing here? And what's with the halflings? I'm gonna tell my brother." We knew then that we'd done it! Here we were, at the famous lair of Grimtooth the Troll! Trap knowledge was right around the corner!



We got on Tina's good side by giving her some haughty elf boys to do with as she pleased and a few balloons (she loves balloons). Soon enough, she had invited us into the lair. She even showed us around Grimmy's workshop. Boy, we sure are learning a lot about traps! Grimtooth was with the Trollish Bikini Team when we arrived. So, it was a little while before we met the troll himself. What a great guy! He was really nice, and seemed to like us a lot! Well, there was that part where he talked to Tina over in the corner for a while, but then he came back and said hello. Er, well, maybe not "hello." Maybe more like, "Give me one reason why I shouldn't kill you two morons on the spot." That's when we sprung the Third Edition trap rules on him.

Well, I can't write any more now. Bill and I are supposed to meet with Tina. Hopefully we can get her to sneak us into Grimmy's study again so that we can look at some of his tomes about traps. Then we have to go meet up with Grimtooth over at the Dungeon of Doom. He says he has one final trap he wants to show us....

See you guys soon!
Clark Peterson and Bill Webb
Necromancer Games

PS: Bill said to tell Mike C. that he got a "special" drawing of Grimtina just for him!

PPS: We found this funny note on the back of some trap drawing. You probably should put it in the book.

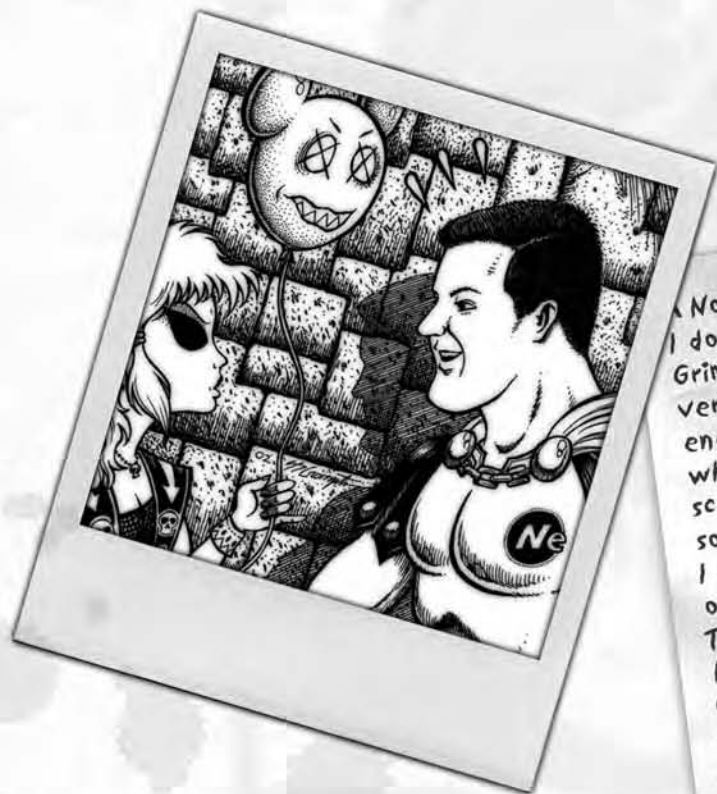

A Note From the Dungeon...
I don't get out much, chained as I am to this rock wall in Grimtooth's cavern complex. The old troll has kept me very busy working long months in the dark, drawing his endless designs of death and destruction. Every once in a while, I manage to smuggle a note up to the outer world, scribbled in code on the back of a piece of art. Hopefully someone has found this one and translated it...
I don't know how Necromancer Games managed to pull it off. In the many years I've been illustrating Grimtooth's Traps books, I've never heard Grimtooth say that any of his Mechanisms of Mayhem were less than the best. To Grimtooth, all his traps are the best!
Still, some lend themselves better to delving adventurers. So you can bet that the guys at Necro have searched high and low in the Grimtooth Traps tomes for perfect rooms, doors, corridors and other such character crushers. And now I hear that they even added gaming statistics to make them easier to use. Wow, back in my day, we had to count body parts to determine who survived a trap!
Anyway, Grimtooth and Grimtina have played me into adding a few more new drawings for this book. So hope you like them and all the rest of the great stuff the Necromancer guys have pulled together for your delving enjoyment.

Remember to duck!
S.S. Crompton

THE BEST OF GRIMTOOTH'S TRAPS

TABLE OF CONTENTS

Credits	1
Preface	2
A Word From Grimtooth	5
Trap Mechanics	7
Section One: Room Traps	12
Section Two: Corridor Traps	54
Section Three: Door Traps	108
Section Four: Traps Bazaar	126
Section Five: Dungeon of Doom	144
Last Trap	214
Index	216
Traps by Challenge Rating	219
Legal Appendix	222

WARNING!

Unauthorized disclosure of this material may contribute to the unjustified survival of adventurers, delvers, and player characters... and may result in serious damage to the deadly reputation of the Game Master.

A WORD FROM GRIMTOOTH



Greetings, and welcome to my book of traps — well, it will be my book of traps once I've taken care of those meddling Necromancer guys.

Assembled herein are some of my favorite traps, gathered from all my many previous books and presented for your approval. These traps are the work of a host of distinguished contributors — each a DM extraordinaire. In short, I feel that you'll find this to be the most entertaining collection of traps you've ever laid eyes on.

Besides, if you don't like my book, I'll rip your lungs out.

I have organized this volume into easy to distinguish chapters. This will better facilitate in setting traps into your own pits and tunnels. Plus, I've included my own special Traps Bazaar as well as a key to the most deadly trap filled dungeon of all time — the Dungeon of Doom!

To give you a general gauge by which to determine approximately how destructive a trap is, I've assigned to each trap a "Deadliness Rating": a

series of skulls printed with the trap in question. The more skulls you see, the deadlier the trap. Yeah, yeah, I know. "Third Edition" uses CRs for traps. Well, this is my book so we are doing it my way! No wussy CR's for this troll. Skulls. Get it? SKULLS!

You will find that the traps in this book range from wounding egos and broken fingers to causing almost certain death. In fact, I've heard that some of you think my traps are too deadly.

TOO DEADLY????!?!?

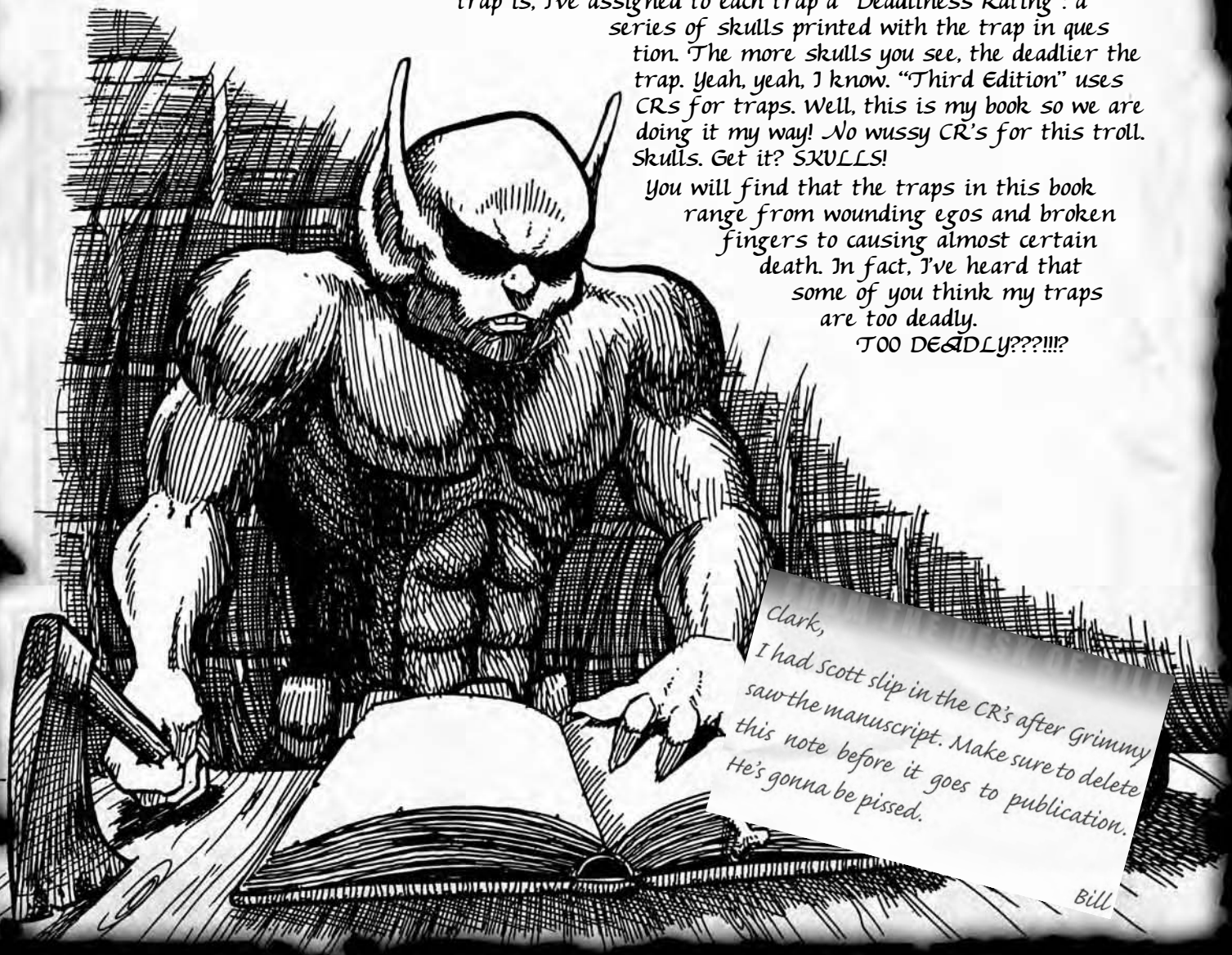

Clark,
I had Scott slip in the CR's after Grimmy saw the manuscript. Make sure to delete this note before it goes to publication. He's gonna be pissed.

Bill

What? How can a trap be too deadly? Most of these traps, having been designed by mere mortals, aren't deadly enough.

At times I am left to wonder why I even bother to share my wisdom with you, when you so callously ignore it.

All right, I'll accept the fact that some of you have twisted ideas about how to administrate a dungeon. Newfangled ideas about delvers actually escaping with their lives, and stuff like that. To each his own, I suppose, but if you're going to be a maverick, then you've got to blaze your own trails. Don't ask me to make my traps less deadly... change them yourself.

Now isn't that a fresh idea? Bet you can't find a rule for that in your hardbacks.

You see, these traps are now yours—you don't need special permission or a membership card to change them to your liking. You certainly don't need permission from those Coastal Wizards. Use your imagination. Use these traps any way you want to. That's right, you can increase or decrease the "punch" of a given trap by altering its consequences. This will depend upon your mood and circumstances, naturally. By filling a pit with an obnoxious-smelling green dye instead of boiling oil, you have altered the entire trap—yet the delivery system remains the same. With a modicum of monkeying around, you should be able to make any of the traps in this book leap through hoops for the edification and bemusement of delvers who journey through your dungeons.

I won't come after you if you do change some. But if I ever receive another letter about how my traps are "too deadly," I'm going to hand some wimp his head. Is that clear, human worms? Grimtooth will not be bothered again!

After all, my traps are perfect as is. You'd have to be some sort of pinhead to want to change them.

Besides, killing isn't really the point. Any fool can kill adventurers with incredible ease, and perhaps my traps have merely given them new and more complex weapons. If this is true, it is a pity. I have found that it's not nearly so much fun to kill as it is to terrify.

The most delicate and vulnerable part of any delver cannot be armored; it cannot be strengthened by magic or regrown after drinking a potion. I speak, of course, of the adventurer's ego. All too often it is forgotten and left unmarred by DMs who scarcely deserve such an honored title. It is to the pursuit of ego shredding that this volume of traps is dedicated.

Thus, without further ado, I hereby present my book of traps. Prepare to discover the joys of inflicting ethereal as well as physical damage! Steel cuts well, but ridicule cuts deeper, and the scars, while invisible, hurt nonetheless.

Enjoy it or die, mortal.

The Troll is Back!

~ Grint

Note About Arrangement of Traps:

I just got a note from the production department that complained the traps in this book weren't arranged in alphabetical order in each chapter.

I got that guy fired. Bye, bye Bates. Enjoy your new job cleaning the bathrooms in the Dungeon of Doom.

This is my book and I will arrange my traps how I choose. But for you more "sensitive" readers who are too clueless to use the index that I forced Clark and Bill to make, the reason I left them this way is because this is the order they are found in my original Traps books by Flying Buffalo. Sometimes a trap refers to one before its references get all jumbled and don't make any sense. Not like my traps need to make sense. They just need to kill.

TRAPS MECHANICS



FROM THE DESK OF CLARK

Bill and I convinced Grimtina to let us into Grimtooth's secret study. All we had to do was buy her some new clothes — oh, and a new chainsaw.

Let me tell you, you do not want to know what a troll keeps in his secret study. It isn't pretty. It still gives me nightmares.

Anyway, we got really lucky — Grimtooth's journal was open on his desk. That's right, out in the open! Can you believe it? If I didn't know better I'd think it was some kind of trap.

Anyway, I guess seeing the Third Edition trap rules got him so mad that he started jotting down notes on better ways to describe traps for the Third Edition rules. In fact, his last journal entry talks about how he's come up with something special for us! He must be talking about these rules!

We didn't have much time, but we managed to copy down most of what we found in Grimtooth's journal. Well, except the parts about one he planned for a certain "M.C." — we left that out because it was too graphic. Ugh. It still makes me shiver.

Bill dropped the candle at one point and got wax everywhere. We hustled to clean it up, and I think we got most of it. Grimtooth shouldn't notice anything... Anyway, I've enclosed the important stuff we got.

We're off to see Grimmy at the Dungeon of Doom. I'm sure he wants to say goodbye to us before we go.

Clark Peterson, Necromancer Games

FROM THE MIND
OF GRIMTOOTH

Wednesday

Met with those chowder heads Clark and Bill. They showed me the new Third Edition rules. Unbelievable!!! I'm not sure who these "wizards at the coast" are, but they don't know the first thing about traps! As if you can distill one of my masterpieces into "Search DC 20, Disable Device DC 20." I'll show those bozos!

Thursday

I just can't get Clark and Bill to leave me alone. Now they've showed me something they call "version 3.5." I don't really know what those idiots are talking about, but I do know this who ever wrote those rules needs to be boiled in oil!

Clark and Bill want me to help them stat out my classic traps for these silly new rules. Hah! That's too much knowledge for mere mortals!

Note to self: Talk to Tina about letting goofballs like those two into the lair.



Friday

I can't get that "Search DC 20" out of my head. I had to kill 20 delvers today just to be able to write this down.

Oh, for the good old days when all I had to do was assign a couple death heads to a trap and people knew what to do with it. But no, now it's "Reflex save" this and "Search DC" that. Surely even a dim-witted mortal could come up with something better. Maybe I will jot down a few ideas if it will get those Necro-numbskulls to leave me alone.

You'd think a little more complexity would mean that people could now understand my traps. Wrong! That's what happens when you let a bunch of coastal wizards do a troll's work.

On a more pleasant note, I think I came up with something "special" for those two meddling morons. Clark and Bill

Expanded Trap Rules

For some people, “Search DC 20; Disable Device DC 20” is all they need to describe a trap. The DM says they found the trap, the player rolls some dice and the DM says the trap is disabled. No roleplaying. No interaction. No fun. Just numbers and dice rolling. The trap is nothing more than a stat block.

For those of you who love the fiendish complexity and problem solving that goes along with traps, the current method of detailing traps in the Third Edition rules is insufficient for anything other than the most basic pit trap where the trap and the trigger and the effect all are in the same location and stem from one event. The v.3.5 rules are a bit better. But what about when the trigger and the trap are not located together? What if the trap has multiple effects and stages? How do you account for intelligent (or foolish) actions by the PCs? And what if your trap includes a spring-loaded chair and a giant lobster? That’s where Grimtooth comes in.

The following section contains a more detailed trap description system that allows DMs to describe and run complicated traps, such as many of the ones in this book. It builds on the trap information contained in v.3.5 of the *DMG*, Chapter 3, in the section entitled “Traps.” The most important additions and distinctions between this book and the *DMG* are detailed below.

Separating Trap from Trigger

The rules in the *DMG* provide one Search DC and one Disable Device DC for each individual trap. This doesn’t make sense for complex traps where the trigger is separate from the trap itself.

Sometimes, the trigger might be obvious but *what* it triggers may be deceptively difficult to find. For example, consider a tripwire on the floor that triggers darts that come from the opposite end of the room. The tripwire might be easy to locate, but the dart holes at the end of the room might be very difficult to find. These components warrant separate Search and Disable DCs. Things like this are detailed in this book’s various trap entries. See the sample Slider Spiker trap in the sidebar to see how the trap and the trigger are detailed separately.

Similarly, finding the trigger to a trap may make it easier to find the trap it triggers, or finding a trap and knowing one is there may make it easier to find its trigger. These factors are detailed under “Adjudicating Traps,” below.

Separating Components

As with triggers, traps may have separate components, depending on the actions of the PCs or the results of prior stages of the trap. With complex traps, each separate component should have a listed trigger, effect and save.

The way to determine if a trap should be split into multiple components is to ask if intervention could prevent one effect of the trap but not the other effect or effects. If so, the trap is divided into different components. Multiple components of the trap are listed as Primary, Secondary, Tertiary and so on until all the components are described. A separate trigger, trap effect and save are listed for each effect. In a sense, a trap with multiple com-

Example Trap: The Slider Spiker Trap



CR:	5
Type:	Combination (Magical and Mechanical)
Search:	Trap (DC 20), Trigger (DC 20)
Disable Device:	Trap (DC 20, 2d4 rounds); Trigger (DC 20, 2d4 rounds)
Primary Trigger:	Touch (touching the door)
Primary Trap Effect:	Stairs turn into a slide and sends PC down into 30-foot pit (3d6 falling damage).
Primary Save:	Reflex (DC 20) avoids
Secondary Trigger:	Location (teleport pad at bottom of pit)
Secondary Trap Effect:	30-foot fall onto giant spike (+20 melee; 3d6 falling damage, no save, plus 3d6 damage from spike if attack successful)
Reset:	Automatic (stairs reset after 1 minute)
Cost:	10,500 gp

The trap takes the form of a room with a staircase that goes up about 30 feet and ends in a door. The only other notable features in the room are a hole in the ceiling and, directly beneath it, a thin parchment target. The parchment conceals a long, sinister steel spike.

When a person touches the door at the top of the stairs, the steps fold down and the stairway converts into a slide. Unless the delver can somehow stop himself, he slides down the length of the stair and falls through a trap door hidden at its base. The trap door snaps shut immediately after and the character’s screams are heard receding into the depths...

...until they’re heard again from the ceiling. A *teleport* pad lies at the bottom of the trap door pit which transports anything that hits it to the hole in the ceiling above the target. Anyone falling through the trap door is thus teleported to fall through the hole in the ceiling, through the target, and onto the spike.

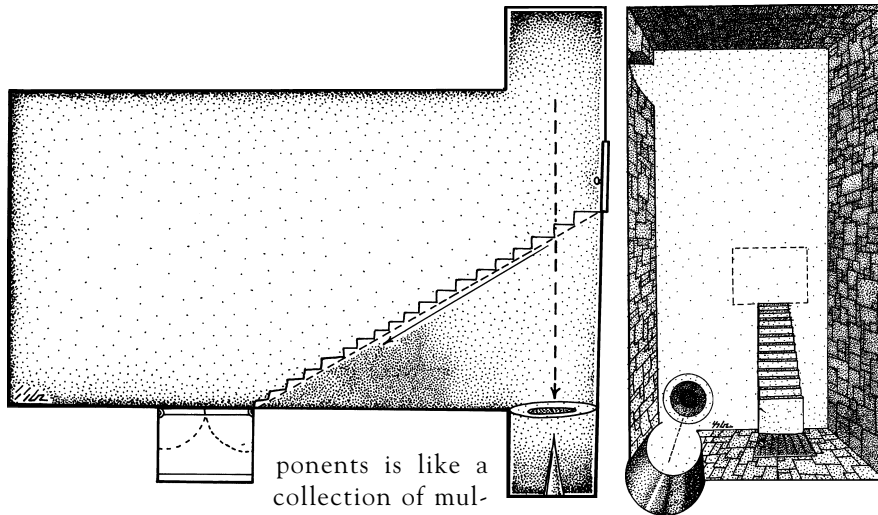

ponents is like a collection of multiple traps all in one. This is the key concept of a complex trap.

The Slider Spiker trap has several components: the stairs are a trap, the pit at the end is a trap, the *teleport* pad is a trap and the spike is a trap. But using the definition above, there are only two “components”: the stairs that turn into a slide dumping you into the pit and the teleporter that makes you fall onto the spike.

If a component does not list a save, there is none for that component. It is still considered a separate component of the trap even without a separate save because of the separate effect or trigger. For example, with the Slider Spiker trap, the second component (the *teleport* and fall on the spike) does not have a separate save. If you fell into the pit, you got teleported to fall onto the spike. But it is listed as a separate component because the teleporter could theoretically be detected and disabled before anyone slides down the ramp — rendering that second component ineffective. Or, similarly, someone could go into the pit without having slid down the ramp and could be teleported to fall onto the spike.

Trap Description

Each trap in this book has an expanded description, similar to a monster entry in the *MM*, detailed as follows:

Skulls: In addition to the standard CR for each trap, this book uses an additional way to measure the deadliness of a trap — skulls, like so: ?. The more skulls, the deadlier the trap. Traps range in deadliness from 1 to 5 skulls, with 5 being the most deadly. You may notice that the skulls do not always correspond to the equivalent CR from the Third Edition rules. The skull ratings come from the original Grimtooth products. It’s up to you to decide which one actually is a better reflection of trap deadliness.

Challenge Rating: The Challenge Rating, or “CR,” for each trap is listed in addition to its skull rating.

Type: The *DMG* says that traps come in two types, Mechanical or Magical. This book adds a new type: Combination, meaning that the trap is a combination of both magic and mechanics.

Search: Each trap entry lists a search DC for both the trap itself and the trigger for each of the trap’s components. Generally, the Search DC only applies to the

trap and trigger for the Primary component of the trap. Ordinarily, triggers and traps for secondary trap effects are not initially detectable. Use your judgment regarding what other components of the trap can be detected.

Disable Device: This entry provides a Disable Device DC for both the trap itself and the trigger. The entry also includes the normal amount of time it takes to disable the trap or the trigger. Generally, the Disable Device DC only applies to the trap and trigger for the Primary component of the trap. Ordinarily, triggers and traps for secondary trap effects are not subject to being disabled unless the PC has access to them. Use your judgment regarding what other components of the trap can be disabled.

Trigger: Unlike Search and Disable Device, each trap component has a listed trigger, indicating its type from the *DMG* as well as a parenthetical which provides additional details. The trigger types are: Location, Proximity, Sound, Visual, Touch, Timed and Spell. See the *DMG* for more on trigger types.

Trap Effect: Each component of the trap has a listed effect, including a text description and game mechanics in parentheses. The effect is what happens when the trap is sprung.

Save: Each component of the trap has a listed save type, save DC, and a description of the result of a successful save. If a save is not listed for a trap component, there is no save for that component. Normally, traps that have an attack as their trap effect do not also have a save.

Reset: Lists the conditions under which the trap can be made ready to trigger again, as per the *DMG*. Reset types are: No Reset, Repair, Manual and Automatic. See the *DMG* for more on trap resets.

Bypass: Some traps have a bypass. If so, they are listed. The entry provides text detail on what the bypass is, any game mechanic information such as a Search DC in parenthesis and then details on what the bypass does.

Cost: A cost to make each trap is listed using the guidelines from the *DMG*. See the *DMG* for more information. Cost is difficult to standardize and may vary widely. The listed cost is a suggestion and does not include expensive individual components or rare monsters that may be found within the trap that have to be provided separately. Use this cost entry as a suggestion and modify as needed to suit your campaign.

Adjudicating Traps

Adjudicating traps is one of the more difficult tasks for the DM. You could just let the rogue's player roll a d20 and say the trap is disarmed, but that takes the fun out of traps. You can't prevent rogues from using their abilities — after all, those abilities are key to the class. But you can increase the fun of a trap by allowing for creative and real world trap solving. If you don't do this, traps run the risk of being reduced to faceless obstacles and die rolls. Here are a few suggestions to make traps more interesting and fun to encounter. Oh yeah, and more deadly too.

Damage Variants for Damage from Traps: Traps are nasty. Trap damage is listed as part of each trap description. But many traps are not just damaging, they are debilitating. For that reason, we suggest that you use the *Variant: Massive Damage Based on Size* as well as the *Variant: Damage to Specific Areas* found in the *DMG*, Chapter 2. Long falls onto spikes should certainly trigger massive damage rolls. Similarly, traps that cause damage to specific parts of the body — hands, feet, legs, eyes, heads, whatever — should gain the additional benefit of doing what they are designed to do, which is injure those specific areas. Sometimes the trap descriptions list that such variants should be used. Still, feel free to use such variants any time you believe it is applicable. The fact that a trap entry in this book does not mention the use of the above variants does not mean that you should not use them. Use your common sense. Or your wicked desire to main delvers. Whichever you prefer.

Searching for Traps and Triggers: Remember that the trap and the trigger can be searched for separately

and discovered separately. Finding one (either the trap or the trigger) generally grants a +2 circumstance bonus to find the other as one alerts the rogue to the presence of the other.

Disarming Traps and Triggers: Triggers can be disarmed separately from the traps and vice versa. Depending on the degree of success, you could rule that the trap is bypassed only briefly if the success is marginal; or that the trap is permanently disabled until repaired if great success is achieved; or even that the rogue has managed to work in his own bypass to the trap depending on the result. Generally, marginal success means the trap is bypassed for 1d6 rounds or as determined by common sense. Great success (5 or more above the Disable DC) should allow the rogue to permanently disable the trap if he so chooses, or simply temporarily bypass it. Extreme success (8 or more above the Disable DC) gives the rogue the same choice as with great success, but also allows him to work in his own private bypass if he so chooses.

Destroying the Trap or Trigger: The key to a Grimtooth trap is to get away from the pure die rolling aspect of trap handling. If the delvers come up with a way to destroy or disable a trap or trigger, you should allow it. Frankly, half of the traps in this book are designed to get even *worse* for the delvers if they take this approach, but that is just part of the fun.

Using Real Solutions: An extension of destroying the trap or trigger discussed above, rather than just saying "roll a d20," encourage the group to actually try to solve the problem the trap presents. In fact, you could grant a +2 circumstance bonus (or more if you deem it appropriate) to a group that comes up with a good solution. Or you could just rule that the solution the characters come up with works and no die roll is needed. After all, once an adventurer finds a covered pit, wedging the cover shut shouldn't be that difficult. (Of course, that is where the invisible hinge, false lid, acid spraying trap gets sprung, spraying the delver in the face with acid...)

In short, the Third Edition rules took the fun out of traps and reduced them to die rolling. It's time to take the fun back!

SECTION ONE: ROOM TRAPS



I believe it was Napoleon's mother who first said, "Good things come in small packages," but she obviously had reason to lie. Many people view the height of creativity as being able to assemble a hideous engine of destruction and place it inside a tiny object — an object far too small to be able to cause any destruction at all. Those small minded individuals lack the imagination to conceive of havoc on such a massive scale that only an entire room could contain it.

Room traps are regimented death boxes about which the wheel of fantasy gaming rotates. They are the bread and butter, the meat and potatoes, of dungeons spiced with traps and tricks to ensnare the unwary. They are not to be dealt with lightly, for they fold, spindle, and mutilate dungeon delvers with more panache and malice than any other form of trap.

The necessary complexity of a trap that comprises an entire room delights me no end. What delver can ever feel safe when he knows that death lurks beneath the polished floor? What adventurer can ever truly relax when he expects the walls to open and mayhem undreamed of in his worst nightmares to explode all around him?

Care And Feeding of Room Traps

Use these traps carefully. An overabundance of room traps can slow your pacing to a crawl, and will disrupt the characters' interest in continuing the adventure. TPXs — total party kills — have a way of doing that. When used correctly, however, room traps can provide the finest of challenges.

To build a truly memorable room trap, remember Grimtooth's Three Rules:

1. **MAKE IT BIG!** How much can another few squares on the grid paper cost?
2. **MAKE IT WEIRD!** Never use an orc where a moose will do. Make sure your victims remember your trap, and have something to tell their pals when they're killing time in the afterlife.
3. **MAKE IT VIOLENT!** No half measures! Crack some skulls! It's a new century of gaming, and it's time to make it count!

Got it? Good. Now listen up and watch your hands and fingers.

~ Grimtooth



BOOKING OF

DUNGEON of DOOM
TRAPS BAZAAR
TRAPS LITE

TRAPS ATE
TRAPS FORE
TRAPS TOO
TRAPS

WURST of TRAPS

Infamous Wheel Trap



CR:	10
Type:	Mechanical
Search:	Trap (DC 25), Trigger (DC 25)
Disable Device:	Trap (DC 25, 2d4 rounds); Trigger (DC 25, 2d4 rounds)
Primary Trigger:	Proximity (when creature starts up slope)
Primary Trap Effect:	Large stone wheel (no attack roll needed; 16d6, crush; multiple targets in corridor)
Primary Save:	Reflex (DC 20) avoids (jump in trench or behind barrels)
Secondary Trigger:	Timed (after large wheel rolls free)
Secondary Trap Effect:	Small stone wheel (no attack roll needed; 8d6, crush; multiple targets in trench)
Secondary Save:	Reflex (DC 28) avoids
Tertiary Trigger:	Location (near barrels when wheel destroys them)
Tertiary Trap Effect:	Acid splash (5d6 acid damage)
Tertiary Save:	Reflex (DC 25) for half
Reset:	Manual (must put wheels back in place) and Repair (replace barrels and acid)
Cost:	80,000 gp

You can put this complex trap, created by Paul O'Connor, just about anywhere you have a lot of room. It works best when it is sprung upon a large number of delvers all at once — such as at a dungeon entrance.

The delvers walk through a door to find that they are standing at the base of a long ramp. The incline slopes up from them, ending in a wall with a door in it. A 5-foot trench is dug along the direct center of the incline from the base of the slope to disappear beneath the door at the top. The ceiling over the main-corridor part of this trap is quite high.

To the right and left at the base of the incline are two small, featureless rooms. Entrance to these rooms is blocked by several rows of sealed barrels, arranged to stand partially into the main corridor. Upon inspection, these barrels prove to be impossible to move or even to open. Banging

the sides vibrates the containers enough that faint sloshing is heard from within, suggesting that they are filled with some sort of liquid. With a bit of effort, delvers can scurry over the barrels and into the rooms beyond.

The trap is activated when someone starts up the slope. At this time, a steel curtain slides down from the ceiling to block the doorway through which the delvers entered. At the same moment, the wall at the top of the slope drops into the floor to reveal a large, black wheel that fills the width of the corridor. The wheel starts rolling down the slope immediately, rushing toward the party at an amazing speed!

The wheel reeks of strong anti-magic, and is indestructible. Thus, the party's options for evasion are limited to the less destructive methods. Delvers can scramble over the barrels into the small rooms or they may hunker down in the trench that runs up the slope and allow the wheel to pass by overhead.

Determine whether or not a character escapes the wheel however you like, but I suggest that you make the required rolls tougher and tougher as each character completes his evasive maneuvers. This ensures that those who think and act fastest have the greatest chance of survival. If you're feeling especially fiendish, you may rule that a character who fails to clear the barrels or make the trench blocks off any others from trying for the same spot.

The fun is just beginning. The wheel passes over anyone in the trench (unless they're absurdly large, like giants) — but those characters will be horrified to see that a *second* wheel, every bit as deadly as the first, is rolling down the *trench* just a few feet behind the first wheel. The only way to escape it is to leap back *out* of the

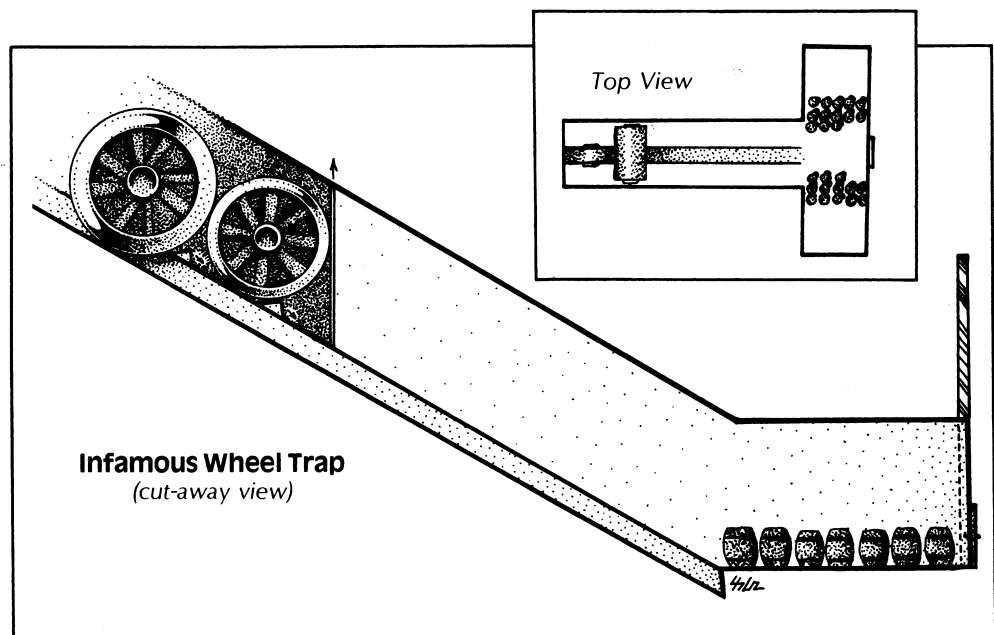

trench just after the first wheel passes — something that should prove considerably tougher than jumping down there in the first place.

Anyone who escaped the wheel(s) by rushing into the side rooms isn't out of danger yet, either. The barrels of liquid are crash-cushions to prevent the wheel from inflicting horrible, telltale damage to the room's back wall — however, the barrels collapse in the process, offering no protection to anyone who tried to hide between them and the back wall. Further, the liquid inside isn't water, but a burning, corrosive acid!

The acid sprays into the side rooms when the barrels collapse, almost certainly covering anyone standing within. Armor provides a certain amount of protection, but only at the expense of its future effectiveness — this acid is *corrosive*!

Getting the characters back into the flow of the dungeon after the destruction ends might prove a problem. You could design the room so that the splashing acid burns away the top layer of plaster within the small rooms, revealing secret doors. Or, you might place a door at the top of the incline, behind where the wheels were located originally. Suit yourself.

Not content with this design, Paul O'Connor has developed two more room traps — the Lobster Trap and the Slider Spiker Trap — described elsewhere in this chapter. Both are absurdly complex and go to great lengths to dispose of characters in bizarre ways. When confronted with the fiendish workings of his mind, I begin to suspect that Mr. O'Connor is a distant relative of mine....

Roman Amphitheatre Trap



CR:	10
Type:	Mechanical
Search:	Trap (DC 25), Trigger (DC 30)
Disable Device:	Trap (DC 27, 2d4 rounds); Trigger (DC 27, 2d4 rounds)
Primary Trigger:	Location (stepping on amphitheatre floor)
Primary Trap Effect:	Giant golden ball rolls down steps (no attack roll needed; 16d6, crush; multiple targets in a 10-foot wide line from steps)
Primary Save:	Reflex (DC 25)
Reset:	Manual
Cost:	66,000 gp

Designed by Betty Kopf, this trap hurls lethal objects at the unsuspecting party. This is a rather obvious trap, but it's great for visual effects and will almost certainly be triggered due to the treasure it offers.

The amphitheatre itself is dominated by a crouching statue that bears a huge golden globe upon its shoulders. The globe is roughly 5 feet in diameter, weigh in the neighborhood of five tons, and is worth approximately 50,000 gp.

The amphitheatre's floor is an enormous, finely balanced lever. Whenever a weight is set upon the floor (such as a party of adventurers), the lever shifts, causing the pole within the main amphitheatre structure to rise and dislodge the golden sphere. The ball bounces down the steps and into the midst of the party.

The globe itself makes quite a prize, but getting it out of the dungeon is tricky. Reducing it to a more manageable size would ruin the sphere's quality, likewise reducing its value.

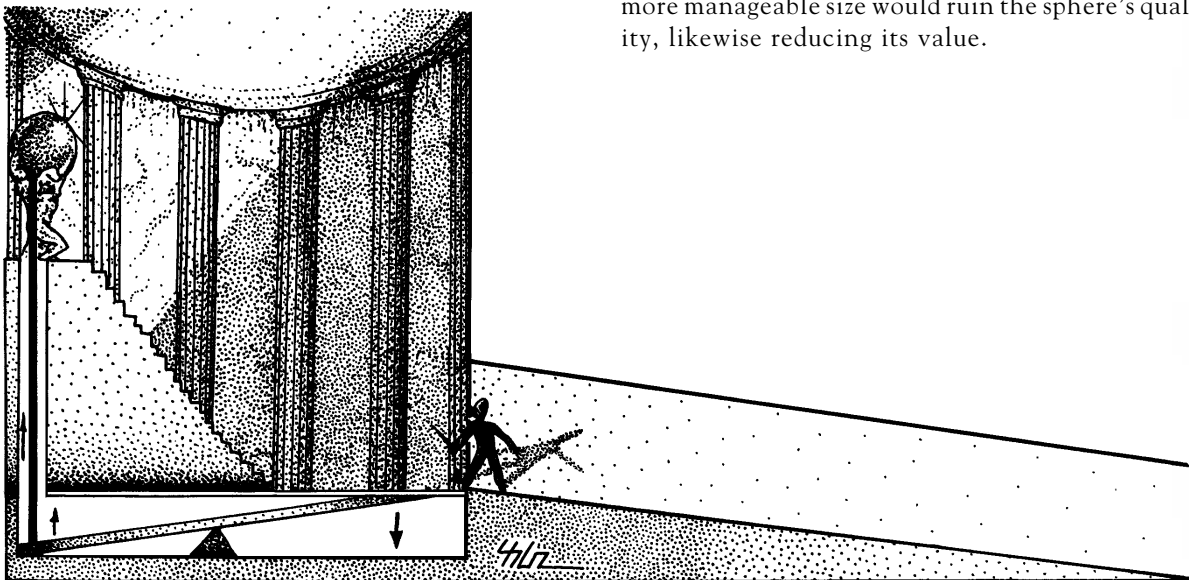

Illusions



CR:	2
Type:	Combination (Magical and Mechanical)
Search:	Trap (DC 20), Trigger (DC 20)
Disable Device:	Trap (DC 20, 2d4 rounds); Trigger (DC 20, 2d4 rounds)
Primary Trigger:	Location (pressure plates on either side of illusory pit)
Primary Trap Effect:	Spring-loaded floor slams PCs into ceiling spikes (+10 melee, 1d4 spikes per target, 1d4+2 each)
Primary Save:	Reflex (DC 20) avoids
Reset:	Automatic (floor resets immediately)
Cost:	2,100 gp

This fatally subtle room trap was designed by Pat Mueller. It presents the delvers with a room, the center of which is occupied by a spike-filled pit. The only way around the pit appears to be walkways to either side of the spikes. (See Figure A.)

The visible pit is an illusion, as is the section of roof above the walkways. In reality, the roof is covered with rows of spikes not unlike those in the pit. (See Figure B.)

So, walking across the “pit” is actually the safe way through. Using the walkways causes the springs beneath the floor to slam those sections against the ceiling. Ouch.

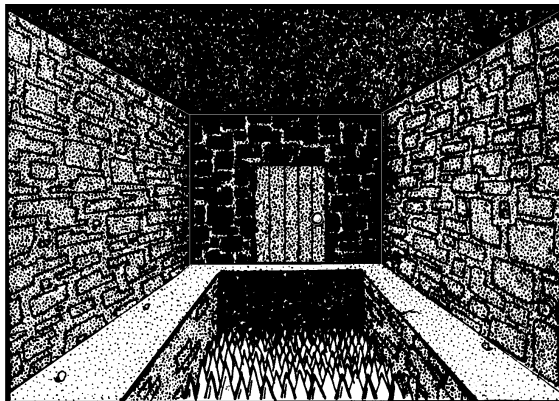

Fig. A (trap as it appears)

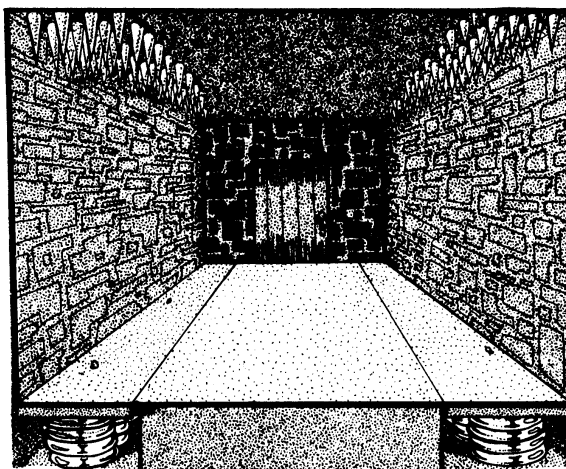

Fig. B (trap as it truly is)

Slider Spiker Trap



CR:	5
Type:	Combination (Magical and Mechanical)
Search:	Trap (DC 20), Trigger (DC 20)
Disable Device:	Trap (DC 20, 2d4 rounds); Trigger (DC 20, 2d4 rounds)
Primary Trigger:	Touch (touching the door)
Primary Trap Effect:	Stairs turn into a slide and sends PC down into 30-foot pit (3d6 falling damage).
Primary Save:	Reflex (DC 20) avoids
Secondary Trigger:	Location (teleport pad at bottom of pit)
Secondary Trap Effect:	30-foot fall onto giant spike (+20 melee; 3d6 falling damage, no save, plus 3d6 damage from spike if attack successful)
Reset:	Automatic (stairs reset after 1 minute)
Cost:	10,500 gp

Paul O'Connor designed this trap, but it's devious enough to have come from me! The trap takes the form of a room with a staircase that goes up about 30 feet and ends in a door. The only other notable features in the room are a hole in the ceiling and, directly beneath it, a thin parchment target. The parchment conceals a long, sinister steel spike.

When a person touches the door at the top of the stairs, the steps fold down and the stairway converts into a slide. Unless the delver can somehow stop himself, he slides down the length of the stair and falls through a trap door hidden at its base. The trap door snaps shut immediately after and the character's screams are heard receding into the depths...

...until they're heard again from the ceiling. A teleport pad lies at the bottom of the trap

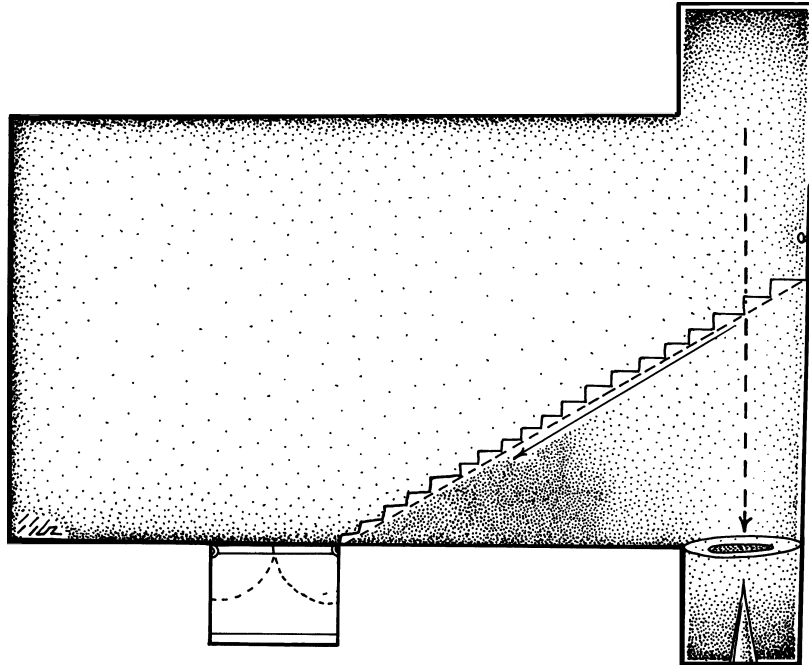
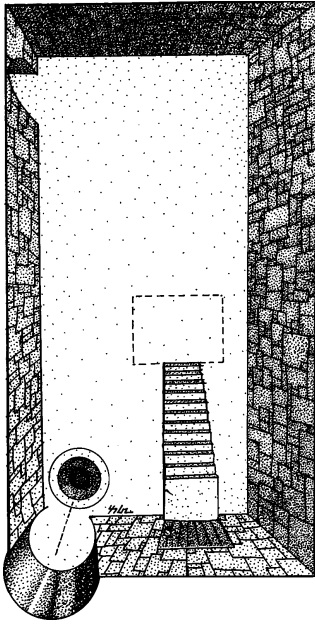

door pit which transports anything that hits it to the hole in the ceiling above the target. Anyone falling through the trap door is thus

teleported to fall through the hole in the ceiling, through the target, and onto the spike.

A usually fatal trap. And an incredibly confusing one.

The Lobster Trap



CR:	6
Type:	Combination (Magical and Mechanical)
Search:	Trap (DC 26), Trigger (DC 26)
Disable Device:	Trap (DC 26, 2d4 rounds); Trigger (DC 26, 2d4 rounds)
Primary Trigger:	Touch (handhold rings)
Primary Trap Effect:	Unless a Strength check (DC 25) succeeds, the cage doesn't slide all the way along the track and plummets into the room. The PCs take 3d6 falling damage and must now contend with at least one giant lobster (the <i>wall of force</i> keeps the other one at bay).
Secondary Trigger:	Touch (hidden lever in floor)
Secondary Trap Effect:	Suspends the <i>wall of force</i> (until manually reset) and allows all the lobsters to attack.
Reset:	Manual (cage must be reset); manual (suspended <i>wall of force</i> reinstated by speaking mystic command words "hot butter")
Cost:	25,000 gp

Paul O'Connor designed this trap for characters who have been captured and rendered unconscious elsewhere in the dungeon.

The characters find themselves in a precarious position when they come to. They are held captive in a cage suspended 50 feet above the sandy floor of a large, circular room with no obvious exits. The crate hangs by a chain from a winch, which is fixed into a track that runs across the room's ceiling to terminate in a blank wall some distance away. Hungry rock lobsters prowl the room, clacking their claws in anticipation of the feast to come. As the characters may learn if they get out alive, their weapons, armor and other possessions are in a small room beyond the only door out of this complex.

One trap door is in the floor of the cage and another is in the roof. Both are visible and unlocked. Opening the door in the floor reveals a rope ladder that dangles to the floor. Opening the roof door allows inspection of the winch device, which is equipped with two ring-like handholds.

There is more to this situation than meets the eye. First, an undetectable invisible wall (*wall of force*) projects from a stationary spot on the chamber floor to the cage's bottom trap door. This wall protects anyone climbing down the rope ladder from attack by the lobsters — but don't tell the delvers that! Second, a hidden hollow in the ground within the *wall of force* contains a treasure chest

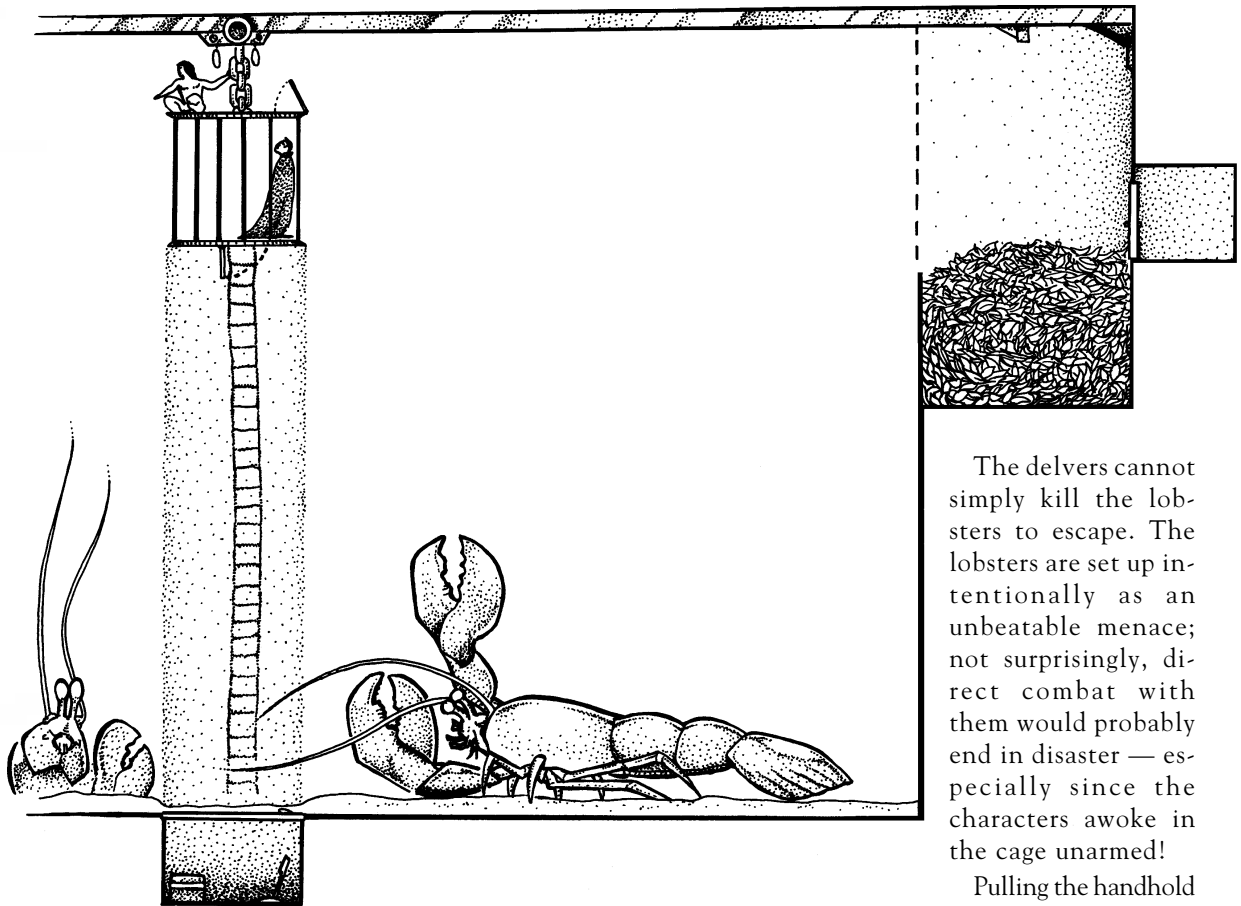

The delvers cannot simply kill the lobsters to escape. The lobsters are set up intentionally as an unbeatable menace; not surprisingly, direct combat with them would probably end in disaster — especially since the characters awoke in the cage unarmed!

Pulling the handhold rings causes the cage to slide along the track in the ceiling — however, it drops once it stops moving along the track! A character with sufficient Strength to make the required check pulls the winch enough so that the cage smashes through the false wall and into the bed of feathers beyond. Otherwise, the cage moves some distance along (how far depends on the check result as you prefer) before plummeting down to the chamber with the lobsters below. Too bad.

and an unmarked lever. Third, the portion of the chamber wall in which the ceiling track terminates is actually a thin section of painted parchment — the track continues straight on through. This obscured chamber has a door that leads out of the room.

Fearless characters who climb down the rope ladder may notice that the lobsters keep a respectable distance from them — this is thanks to the *wall of force*, of course, which gives the delvers an opportunity to discover its existence.

Any character who reaches the floor of the room has a good chance of finding the secret hollow. The hollow contains a chest full of treasure — plentiful or poor, depending on your whim. Beside the chest is a lever which has no obvious function.

Levers lead to doom for dungeon delvers. Pulling the lever suspends the *wall of force* instantly. The lobsters, being sensitive to such things, rush in greedily for the kill.

As previously noted, the characters' possessions await them in the room just off the chamber full of feathers. If you feel really mean, booby-trap the possessions.

Monstrous Lobsters: CR 2; SZL Vermin; HD 4d8+8; hp 26; Init +0; Spd 20 ft., swim 40 ft.; AC 15, touch 10, flat-footed 15; BAB/Grp +3/+10; Atk +5 melee (1d6+3, claw, 19-20/x2); Full Atk +5 melee (1d6+3 [x2], claws, 19-20/x2); SA improved grab (grapple bonus +10), squeeze; SQ improved critical (with claw), vermin; AL N; SV Fort +6, Ref +1, Will +1; Str 16, Dex 10, Con 14, Int —, Wis 10, Cha 2.

Skills: Hide +6, Spot +10.

The Deluxe Centerpost



CR:	10
Type:	Mechanical
Search:	Trap (DC 22), Trigger (DC 22)
Disable Device:	Trap (DC 20, 2d4 rounds); Trigger (DC 20, 2d4 rounds)
Primary Trigger:	Touch (staff in room)
Primary Trap Effect:	Collapsing ceiling (no attack roll needed; 16d6, crush; multiple targets in 10-ft.by 10-ft.room)
Reset:	Repair
Cost:	25,000 gp

This trap, by Rick Loomis, is a rather simple trap. In the center of a square room, a single, indestructible deluxe magic staff is wedged betwixt floor and ceiling. The staff, a coveted prize, supports the ceiling: a freestanding, 10,000-pound block of granite. Aside from this handicap, the staff is free for the taking.

Use whatever magical staff you want for the prize. Or, if you are feeling particularly nasty, give it no powers other than being indestructible. That is sure to make the delvers scream — if any remain alive afterward, that is....

The Dastardly Lava Room



CR:	10
Type:	Magical
Search:	Trap (DC 27), Trigger (DC 27)
Disable Device:	Trap (DC 27, 2d4 rounds); Trigger (DC 27, 2d4 rounds)
Primary Trigger:	Proximity (journeying into corridor)
Primary Trap Effect:	Lava (20d6 submersion or 2d6 contact; half damage for 1d3 rounds thereafter)
Reset:	Automatic
Cost:	50,000 gp

This elegantly simple trap was designed by Scot Rhoads. With this trap, delvers enter a standard dungeon room that contains several mounds of glowing (and imperceptibly growing) lava. Regular exits through standard doors are accessible from any point in the room.

A medium-sized tunnel leads from this room; at the end of this tunnel the delvers can see a sign. Exactly *what* the sign says, however, is impossible to tell from within the chamber itself.

A character who journeys down the tunnel to the sign is be greeted with the inscription, "You Blew It." The unfortunate delver discovers that the lava mounds moved in behind him to block the tunnel entrance, leaving him hopelessly trapped.

The Hoovermatic Trap



CR:	4
Type:	Mechanical
Search:	Trap (DC 25), Trigger (DC 25)
Disable Device:	Trap (DC 25, 2d4 rounds); Trigger (DC 25, 2d4 rounds)
Primary Trigger:	Location (pressure plate on floor)
Primary Trap Effect:	Air thins out. PCs begin taking suffocation damage after spending 6 minutes (60 rounds) in room.
Reset:	Automatic (after 30 minutes)
Cost:	20,000 gp

The devious dwarvish mind of Todd Diesen was responsible for this trap, which takes great pains to prove the effects of a partial vacuum upon dungeon delvers.

The delvers enter this room through its only door, which slides shut noiselessly and locks once the last party member is inside the room. The door fits flush into the wall and is very difficult to rediscover (Search DC 30).

The room itself is lit by a strobe light. The floor is 3 feet deep in gold coins. The walls are made of black basalt, smooth and featureless; the ceiling is difficult to see, due to the lighting.

Once the door locks, the ceiling starts pulling silently away from the floor. This causes the room pressure to change, making the air incredibly thin. After six to eight minutes of this treatment, characters begin to faint.



After ten minutes, the air is thin enough to kill the unconscious characters. Sputtering torches or lamps, the fainting of small animals the delvers might have brought along, a feeling of pressure in the ears, or the fact that characters are dropping dead right and left will tip off those who remain

conscious that something is amiss. Unconscious delvers bleed from the nose.

The trapped characters are well advised to search for the door they entered through. If they appeal to the Gods for something to breathe, feel free to fill the room with poison gas....

The Bigger They Are...



CR:	9
Type:	Mechanical
Search:	Trap (DC 20), Trigger (DC 20)
Disable Device:	Trap (DC 30); Trigger (DC 25)
Primary Trigger:	Proximity (entering cavern)
Primary Trap Effect:	Cavern fills with water in 4 rounds (see the Drowning rules in the <i>DMG</i>)
Secondary Trigger:	Touch (large boulder)
Secondary Trap Effect:	Crushing rock (no attack roll needed; 12d6, crush; multiple targets in a 20-ft. by 20-ft. area)
Secondary Save:	Reflex (DC 25)
Reset:	Manual (rock must be set in place) and automatic (water automatically drains from room)
Cost:	54,000 gp

Once more in his infinite generosity, Mike Stackpole has subjected delvers to another form of cliché doom in the form of this trap.

Delvers encounter the trap when they enter a large natural cavern. The entrance seals behind them quickly — a door slamming shut, falling rocks, or what-have-you. At the same time, the room begins to fill with water.

Somewhere near the ceiling, overhanging a ledge, is a large rock doing a credible imitation of a piton. Some smart delver may try to loop a rope around this rock so as to climb to safety. You can provide extra incentive by introducing sharks or similar nasties into the water.

In fact, the rock is balanced precariously. Any sort of tugging causes the rock to drop — usually onto the heads of those trying to rope it. And, the bigger it is, the harder the fall.

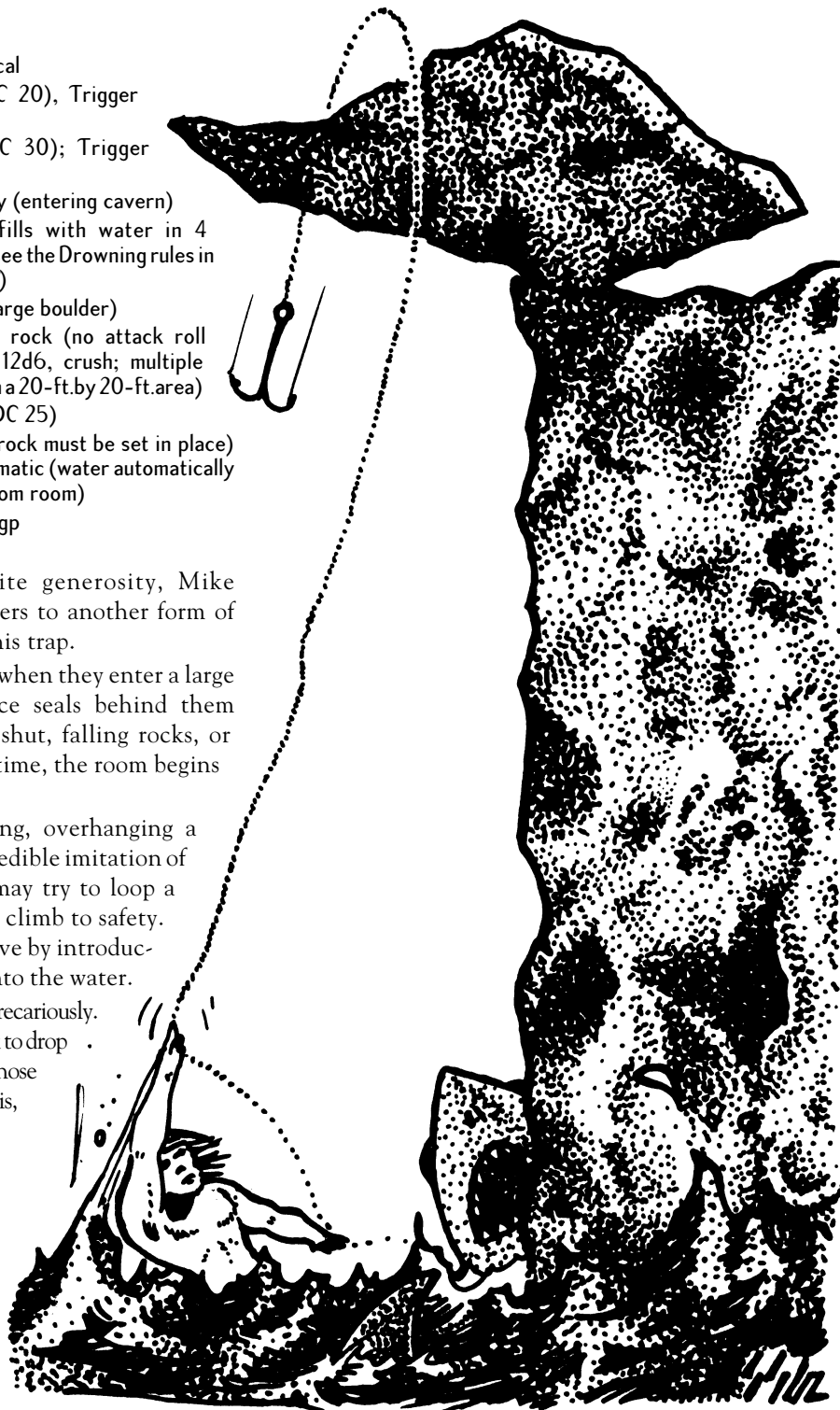

The One That Got Away



CR:	6
Type:	Mechanical
Search:	Trap (DC 25), Trigger (DC 25)
Disable Device:	Trap (DC 25, 2d4 rounds); Trigger (DC 25, 2d4 rounds)
Primary Trigger:	Location (chair seat)
Primary Trap Effect:	Spring-loaded seat catapults victim into either the stalactites if he lets go of the rod (3d6 points of damage and fall into water) or into the hidden reef if he hangs on to the rod (6d6 points of piercing damage)
Reset:	Automatic (the chair resets immediately)
Cost:	27,000 gp

Michael Austin designed this truly absurd room trap. It goes to such incredible lengths to be silly that I had no choice but to include it.

The room is formed from natural rock, complete with an array of menacing stalactites. Most of the

floor area is covered by a freshwater lake. Set out some distance onto this lake is a pier of sorts, upon which stands a fisherman's chair, complete with pole. Numerous hungry — and deadly — fish patrol the water. There is already some tension on the fishing line, which disappears into the water.

The chair is set upon a spring-loaded shaft; the spring releases when the fishing line becomes taut. Thus, when a character seats himself upon the chair and reels in the line, the trap is (quite literally) “sprung.”

The chair is hurled high, sending the character flying. If the character releases his grip on the fishing pole, his trajectory intersects with one of the ceiling's stalactites with a resounding splat. If the character hangs onto the pole for dear life, he clears the ceiling easily — and lands upon a hidden reef located just inches beneath the surface of the water.

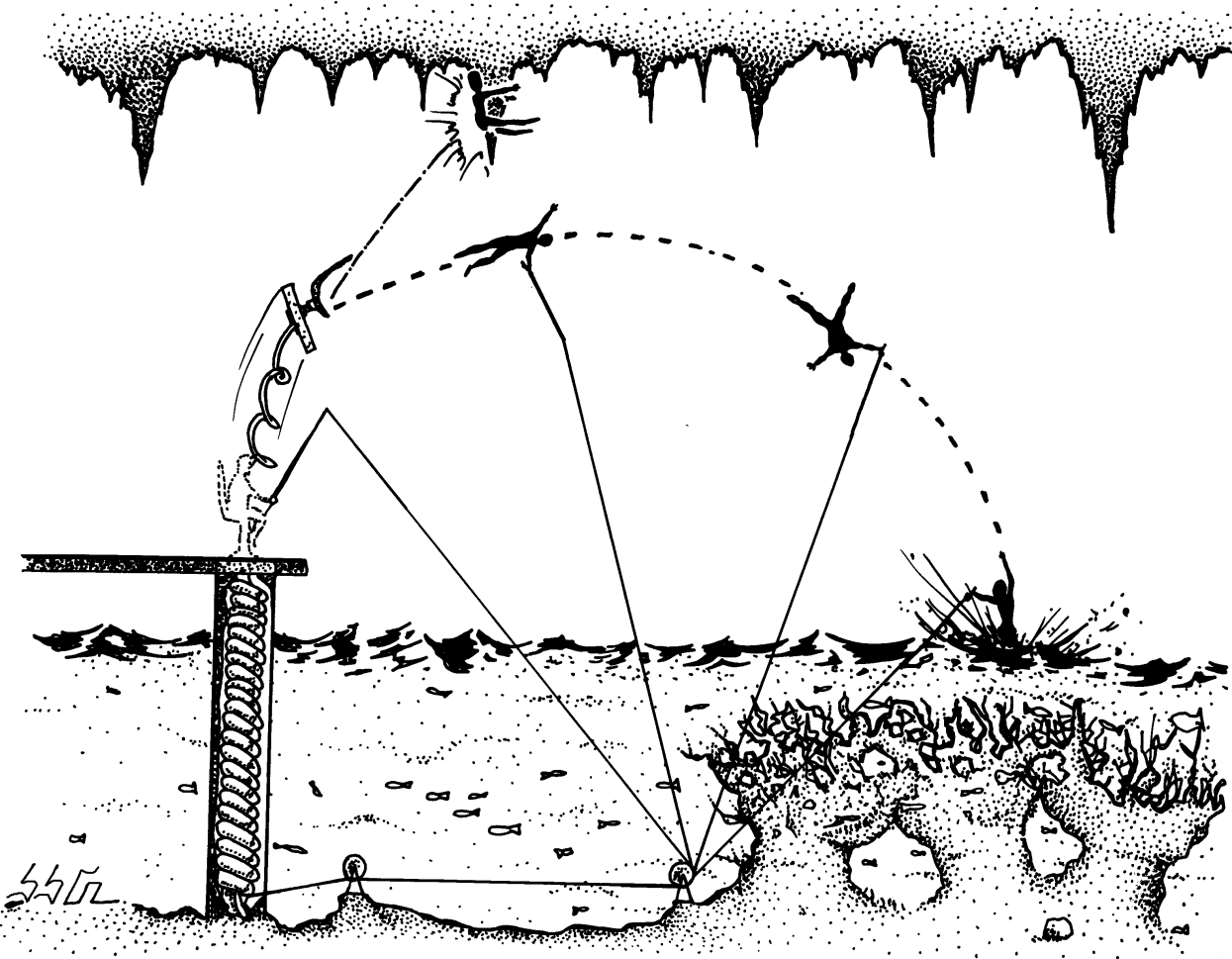

The Atlas Affair

	
CR:	10
Type:	Magical
Search:	Trap (DC 25), Trigger (DC 25)
Disable Device:	Trap (DC 25, 2d4 rounds); Trigger (DC 25, 2d4 rounds)
Primary Trigger:	Dispelling magical permanent <i>wall of force</i> cylinders (caster level 13th)
Primary Trap Effect:	Collapsing ceiling (16d6, crush; multiple targets in 50-foot by 50-foot room)
Reset:	Repair (ceiling), no reset (cylinders, permanent <i>wall of force</i> must be cast again)
Cost:	35,000 gp

Michael Austin developed this trap to deal with unnecessarily violent and/or greedy characters. The room is filled with exquisite Greek statues, each mounted upon a turntable that turns slowly to show the statue from a variety of angles. To enhance the beauty of the statues — and thus ensure the delver's doom — a valuable gem is set into the base of each figure. (Each gem is worth at least 700 gp.)

Each statue stands within a magical cylinder (permanent *wall of force*) that runs from floor to ceiling. In addition to protecting the statue, the cylinders also hold up the roof. Thus, if the delvers choose to loot the room by dispelling the magical cylinders, they end up bringing the roof down upon their heads.

The Bridge at Rue Vincent

	
CR:	6
Type:	Mechanical
Search:	Trap (DC 10), Trigger (DC 20)
Disable Device:	Trap (DC 20, 2d4 rounds)
Primary Trigger:	Location (standing on bridge requires a Balance check at DC 25; failure dumps character into wax)
Primary Trap Effect:	Falling into wax (10d6 points of scalding damage each round in wax; suffocation damage if head goes under)

Secondary Trigger:	Touch (attacking flint golem sends sparks into the air igniting the wax vapors)
Secondary Trap Effect:	Exploding wax vapors (5d6 points of fire damage to all within a 40-ft. radius, plus Reflex save DC 15 to avoid catching fire)
Reset:	No reset needed (unless golem is destroyed)
Cost:	18,000 gp

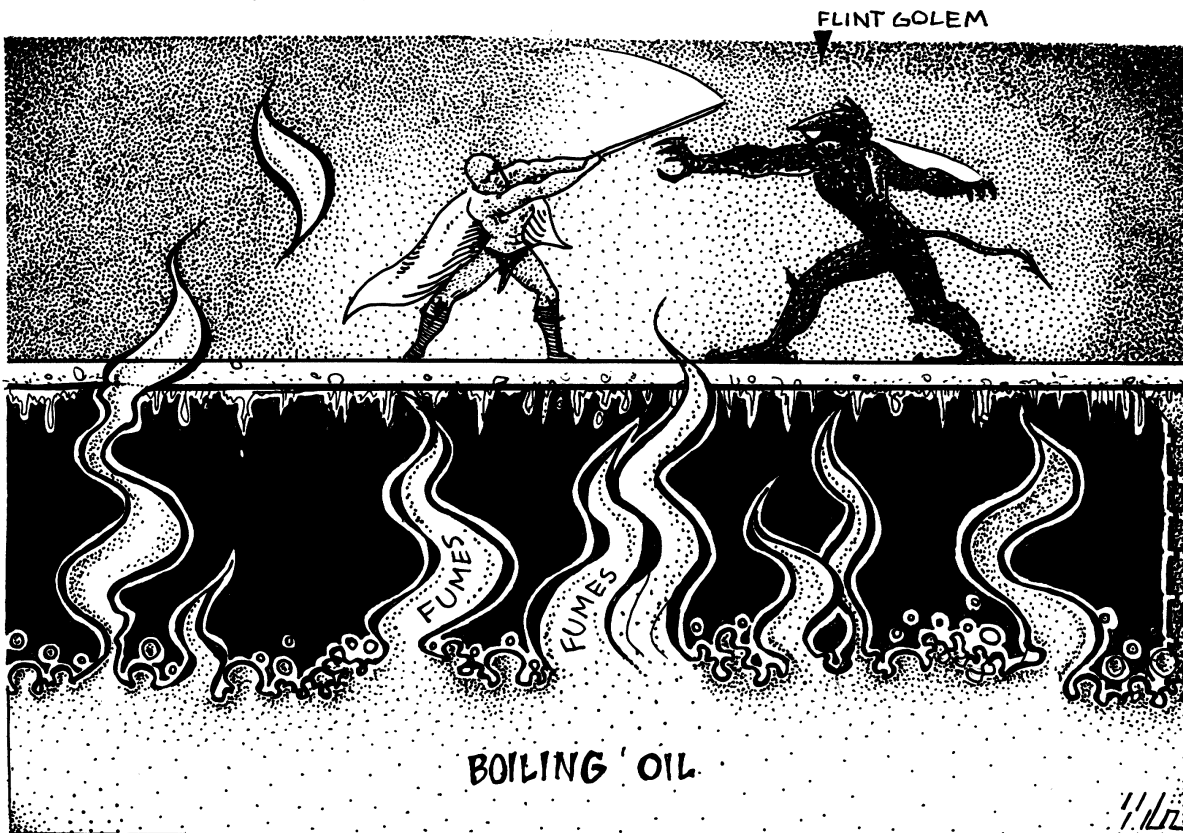

Michael Austin designed this trap as a room filled to a depth of ten feet with boiling wax. A narrow wooden bridge lacking guardrails — or safety measures of any sort — spans the wax. The air is laden with boiling wax vapors. Further, the wax has splashed up upon the bridge, making it quite slippery (DC 25 Balance check to remain standing). Guarding the bridge is a magical statue of living flint (see the flint golem below).

The characters can smell the wax in the air and feel it on the bridge — and begin to coat their clothing. A fall into the wax is likely to be fatal — if the fall doesn't kill the character outright, being suffocated in boiling wax probably will.

The flint statue is the crux of this trap. If the statue is attacked with steel weapons, the flint sends up a shower of sparks. Each time the sparks fly, there's a chance that the wax vapor ignites (determine however you like) setting fire to the bridge — and probably to a number of the characters as well.

Flint Golem: CR 3; SZ M Construct; HD 5d10; hp 27; Init -1; Spd 20 ft. (can't run); AC 15, touch 15, flat-footed 15; BAB/Grp +3/+4; Atk +4 melee (1d8+1, slam); Full Atk +4 melee (1d8+1 [x2], slams); SQ construct, resistances (+4 to saves against spells), magic immunity (as stone golem), damage reduction (10/magic); AL N; SV Fort +1, Ref +0, Will +1; Str 13, Dex 9, Con —, Int —, Wis 11, Cha 1.

The Teeter-Totter Room

	
CR:	2 (or higher)
Type:	Mechanical
Search:	Trap (DC 20), Trigger (DC 25).
Disable Device:	Trap (DC 25, 2d4 rounds); Trigger (DC 25, 2d4 rounds)
Primary Trigger:	Location (more than one-half the party crosses the pivot point under the floor in the center of the room)
Primary Trap Effect:	Floor tilts and balances like a see-saw. Each character in room must succeed at a Balance check (DC 20) if he attempts to move. A successful check allows the PC to move at one-half speed for one round. A failed roll means the PC can't move, and a failure by 4 or more means the PC slips and falls (perhaps sliding off the edge and into whatever is waiting underneath the floor)
Secondary Trap Effect:	No attack roll necessary; spring-loaded door sends creature into moving North wall (1d6 per 10 feet traveled).
Bypass:	A hidden trigger switch (Search DC 20) allows you to lock the floor in place so it doesn't swing on the pivot point
Reset:	Automatic
Cost:	7,000 gp (or more)



This is Cliff Baird's contribution to the genre of room traps. It wasn't designed to kill delvers; instead, it traps them (and in the process turns them into nervous wrecks).

Characters who enter this room may dance, jump up and down, or have a picnic between the door and the pivot point beneath the floor. However, when over half the weight in the room has moved to the other side of the pivot, the floor no longer rests on the support brace near the door. The brace falls away, and the floor becomes a great teeter-totter upon the pivot point.

It is up to you to decide what will happen to the characters if they fall off the floor. As an especially savage variation, have the floor slide off its pivot and follow the delvers into the pit if they blow it.

You can bump the CR of this trap seriously high or make it a multi-part trap (in Grimmy fashion) by placing a spike-laden pit or pit full of boiling oil or lava beneath the floor. Simply have the floor tilt on the pivot point and dump the PCs head first into whatever waits beneath the floor.

One Way Or Another



CR:	10
Type:	Mechanical
Search:	Trap (DC 20), Trigger (DC 25).
Disable Device:	Trap (DC 25, 2d4 rounds); Trigger (DC 25, 2d4 rounds)
Primary Trigger:	Location (pressure plate on walkway)
Primary Trap Effect:	No attack roll needed; crushing wall (16d6, crush); multiple targets in hallway. Those in front of doorway take 4d6 points of damage from the force of the wall and are catapulted into the room possibly hitting those on the walkway.
Secondary Trap Effect:	No attack roll needed; 40-foot pit (4d6 falling damage).
Primary Save:	Reflex (DC 25) for those against the walls in the hallway; Reflex (DC 20) for those in the doorway.
Bypass:	The bypass to this trap is to either avoid touching the chest or to step through the secret door in the North wall once the wall section begins moving.
Reset:	Automatic (and Manual for levers); the wall resets itself within 1 minute. If the PCs grabbed and broke the levers on the wall, they perhaps need to be replaced.
Cost:	40,000 gp

Michael von Glahn offers this as a possible ending to the search for that trap which will turn adventurers every which way but loose. While sinister in construction and implication, this beauty has certain humorous overtones in application.

The room is your normal type dungeon room. A walkway bisects the floor into two pits, running

from the door to a niche in the opposite wall that houses a chest. Each of the pits is covered by an illusion of normal flooring — obvious to even a casual glance. At either side of the niche, just barely out of easy reach from the walkway, is a lever.

In the corridor opposite the open doorway is a spring-loaded section of wall that is triggered by weight being dropped on a pressure plate in the walkway. The cautious delvers who stand in and around the doorway while someone walks out on the walkway, or while they throw the carcass of their latest victim onto the walkway to test the floor, are rammed by the wall into the room. Those not in the doorway are splattered against the wall. So much for those outside the room.

The delvers who have just been shot into the room like pinballs being blasted into action, must act quickly. It is not likely that they will fly straight and true at the chest, though you may wish to allow this if your thirst for blood has been quenched. Those who pitch off of the walkway fall through the illusory flooring into the pit below. Those who fly across the room and grab the levers to stay out of the pit find that the levers are fakes that detach from the wall, becoming nice souvenirs they can take with them as they fall.

As for any character lucky enough to survive this mayhem, Michael suggests something suitable in the chest to dispatch them. I suggest that DMs select carefully, for the thing in the chest should be like an aperitif after such a heavy meal. That is, small, aromatic, and packed with a big kick.

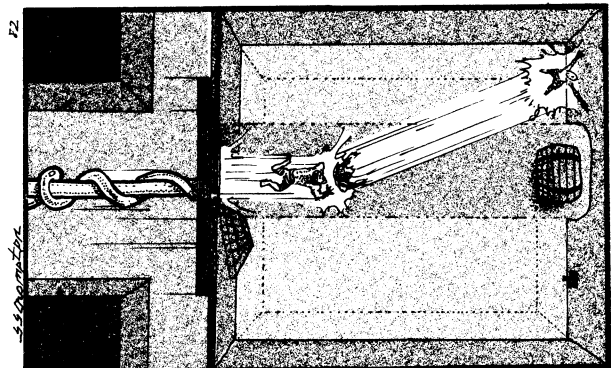
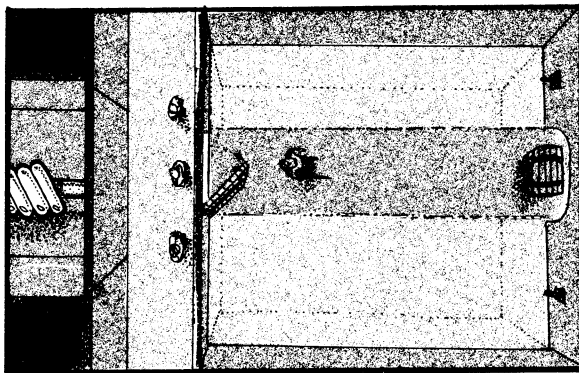

Toe Tickler



CR:	4
Type:	Mechanical
Search:	Trap (DC 20), Trigger (DC 20).
Disable Device:	Trap (DC 20, 2d4 rounds); Trigger (DC 20, 2d4 rounds)
Primary Trigger:	Location (pressure plate in front of doors)
Primary Trap Effect:	Small spears (+20 melee, 1d4 spears, 1d6+2 each spear). A character hit suffers a -2 penalty on all checks, saves, etc. that require the use of his legs. This penalty lasts until the delver heals naturally, magically or receives a Heal check (DC 15).
Bypass:	Perhaps a hidden switch (Search DC 20) or pressure plate keeps the trap from activating.
Reset:	Automatic
Cost:	15,000 gp

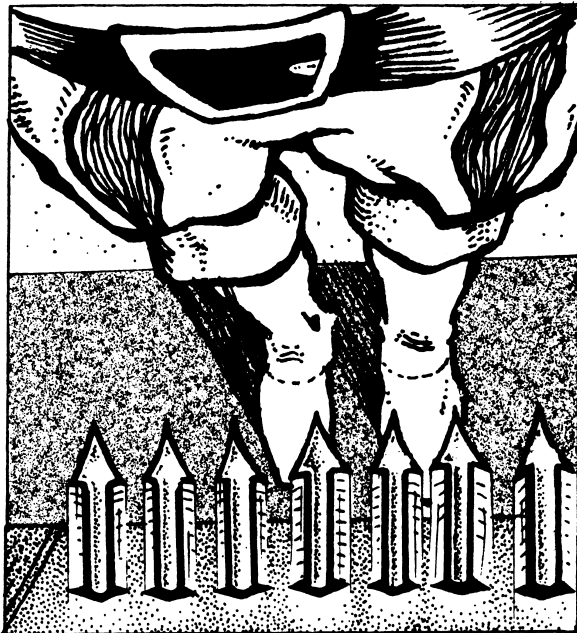

Greg Day has submitted an impairing room trap that is sure to wreak havoc among those delvers who think of greaves as old and useless.

The room can be entered without mishap — the trap is triggered when the delvers attempt to *exit* the room through either of its doors. The floor of the room drops one foot and the door-side wall of the pit is revealed to have a series of 2-inch holes running along it. From the holes come spears that should catch most characters in mid-shin, causing a painful wound if they do not break the shin outright. It should also slow a character significantly if being pursued....

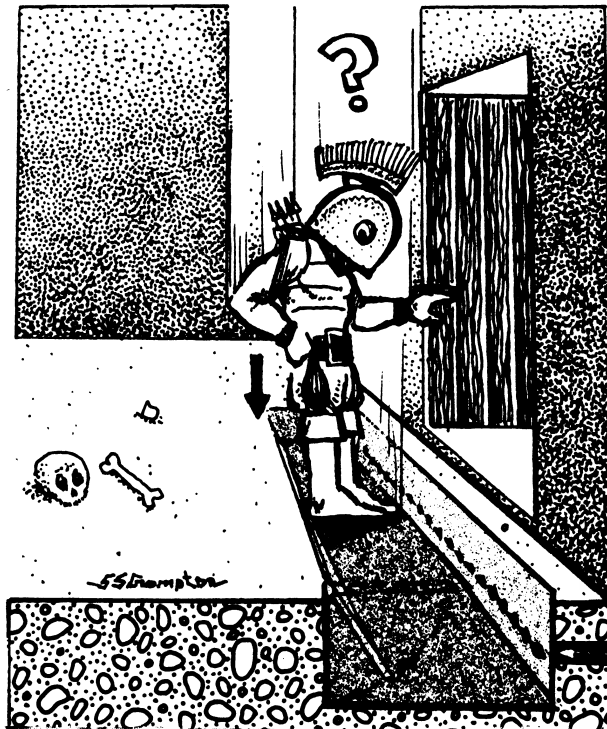

Fire and Ice



CR:	5
Type:	Mechanical
Search:	Trap (DC 20), Trigger (DC 25).
Disable Device:	Trap (DC 20, 2d4 rounds); Trigger (DC 20, 2d4 rounds)
Primary Trigger:	Touch (opening the silver door)
Primary Trap Effect:	Water fills room in 4 rounds (see the Drowning rule in the <i>DMG</i>)
Secondary Trap Effect:	No attack roll needed; 1d6 spikes each character, 1d4+2 each spike.
Tertiary Trigger:	Touch (opening the trapdoor in the ceiling)

Tertiary Trap Effect: No attack roll necessary; crystals immediately freeze the water. Characters trapped in the ice begin taking 1d6 points of cold damage each round they remain trapped. Characters unlucky enough to have their heads underwater when it freezes not only suffer cold damage but begin suffocating as well (see Suffocation in the *DMG*).

Reset: Manual (water tank must be refilled and crystals must be replenished)
Cost: 19,000 gp

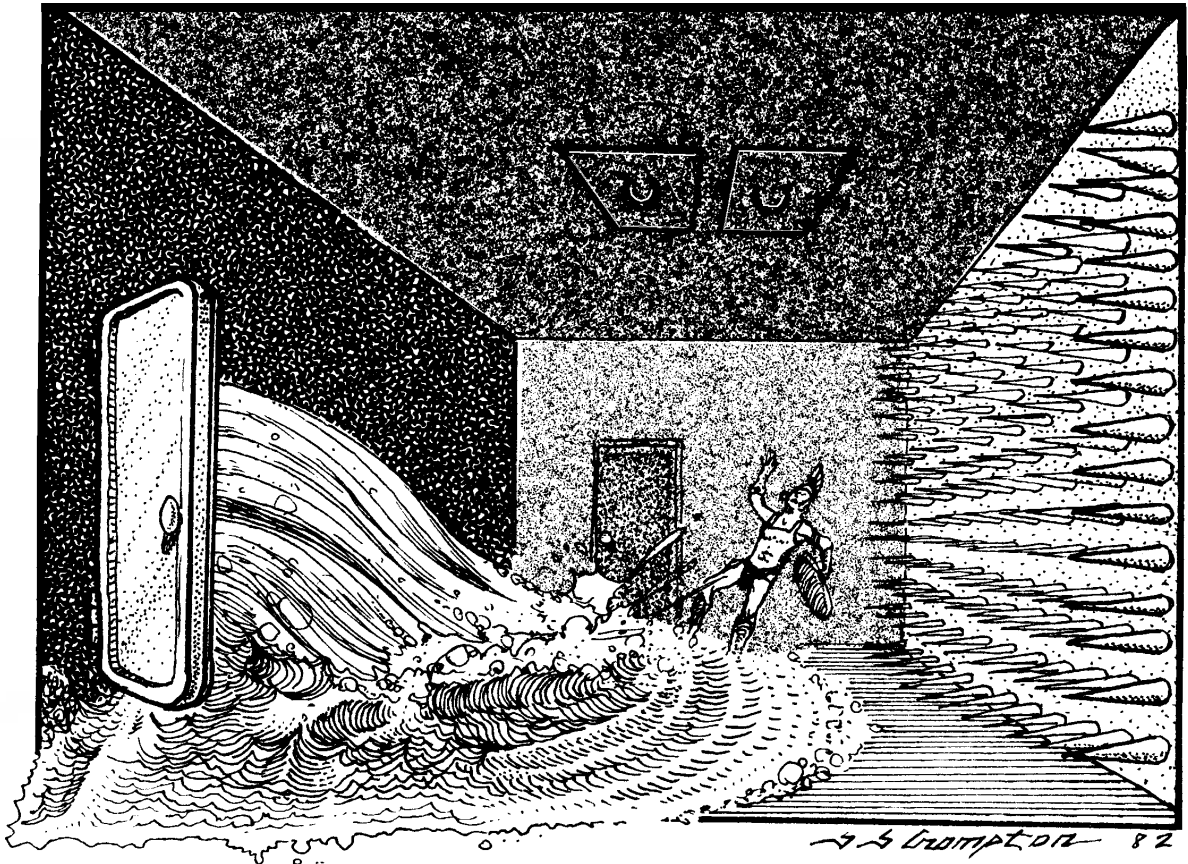

Michael Arner brings us this trap. Like many others in this section, it is harmless until some poor schmuck screws up and does (in his opinion) the sensible thing....

Rows of nasty-looking spikes cover one entire wall of a small room; in the wall opposite the spikes is a silver door. There is a trap door in the ceiling. Delves enter the room through a separate door on one of the unused walls; this door seals and locks itself behind the delvers (the door is Hardness 5, hp 20, Break DC 23).

If the party opens the silver door, they unleash a torrent of spring water that knocks them back against the spikes. The water continues to gush from the door and begins to flood the room. If the delvers survive the spikes, they find that they must drop most of their equipment to tread water. The room fills to a level dangerously near the ceiling (and the trap doors).

The safest thing to do is to sit tight. After about five minutes, the water drains away, allowing the delvers to exit through the now-dry silver doorway.

The delvers may panic, convinced that they will drown, and try to open the trap door — however, the trap door leads to doom! Behind the trap door is a chamber filled with crystals that freeze water. When the trap door is opened, the crystals dump into the water to cool things down....

Freezing Crystals: If somehow bypassed so that the crystals are obtained, the crystals fill the entire room above the trap door (a 10 foot by 10 foot room) and are enchanted so that when used together they have the effect of a strangely modified *ice storm* spell.

The entire roomful of crystals is needed to achieve the trap effect and are consumed when used.



Door-Lover's Room



CR:	5
Type:	Mechanical
Search:	Trap (DC 20), Trigger (DC 25).
Disable Device:	Trap (DC 20, 2d4 rounds); Trigger (DC 20, 2d4 rounds)
Primary Trigger:	Touch (the door at the top of the stairs)
Primary Trap Effect:	No attack roll needed; chute dumps characters into pit with spiders (2d6 points of falling damage for 20-foot fall from chute to pit)
Bypass:	A hidden switch (Search DC 20) perhaps extends a bridge or covers the pit thus allowing passage. Or perhaps the switch disables the trigger.
Reset:	Automatic
Cost:	17,000 gp

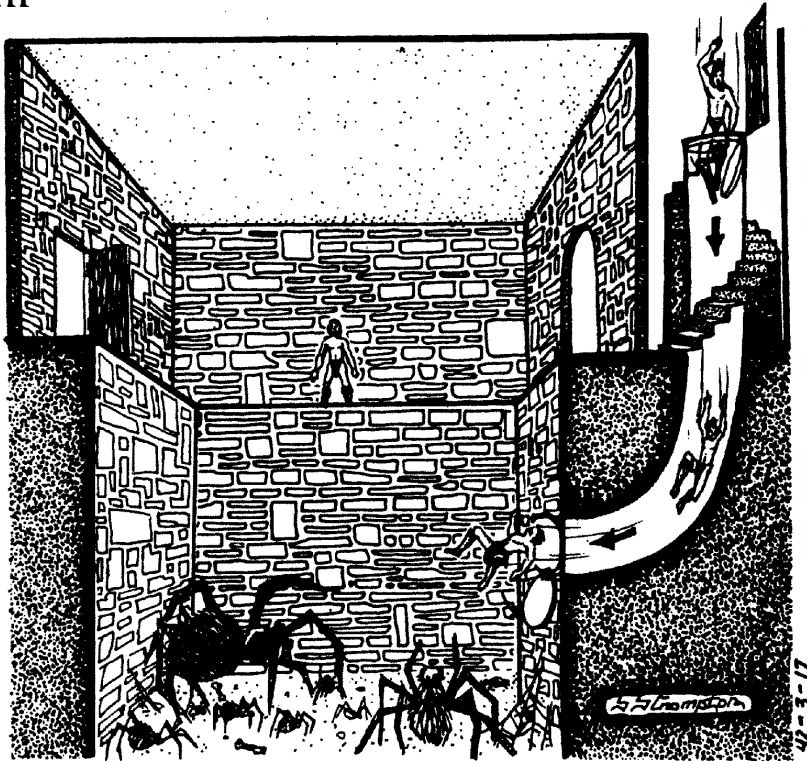

Caroline J. Maher designed this trap, which uses its own snare as a red herring for its intent. Interested? Read on....

Inside the room is a deep pit filled with ravenous, poisonous spiders (see below). Delves enter the room through a standard dungeon door. Narrow greased ledges lead around the pit to the apparent safety of a corridor on the other side of the pit. A DC 20 Balance check is required to negotiate the ledges safely.

When the characters reach the corridor beyond, they'll doubtless feel proud of avoiding the trap. So much the better... within the corridor is a spiral stair-

case that leads to a normal-looking door. When the delvers open the door, a trap door opens beneath their feet, sending them plummeting down a chute and into the spider-filled pit they've just negotiated! Never go forward until you're secure about what's behind you.

Spider, Large Monstrous (6): CR 2; SZ L Vermin; HD 4d8+4; hp 22 each; Init +3; Spd 30 ft., climb 20 ft.; AC 14, touch 13, flat-footed 11; BAB/Grp +3/+9; Atk +4 melee (1d8+3 and poison, bite); Face/Reach 10 ft./5 ft.; SA poison (Fort DC 16, 1d6/1d6 temporary Str), web (as per net attack); SQ vermin; AL N; SV Fort +5, Ref +4, Will +1; Str 15, Dex 17, Con 12, Int—, Wis 10, Cha 2.

Skills: Climb +14, Hide +6, Jump +2, Spot +7.

See-Saw Room



CR:	6	Secondary Trap Effect:	No attack roll needed; glass globes break spilling contents (see text below)
Type:	Mechanical	Tertiary Trap Effect:	Statues smash into delvers (+20 melee; 8d6, crush)
Search:	Trap (DC 20), Trigger (DC 25).	Reset:	Automatic (floor, 10 minutes) and Repair (the statues and globes must be replaced).
Disable Device:	Trap (DC 20, 2d4 rounds); Trigger (DC 20, 2d4 rounds)	Cost:	20,000 gp
Primary Trigger:	Touch (moving one of the statues)		
Primary Trap Effect:	No attack roll needed; room tilts and flings PCs into wall (1d6 points of damage).		

This trap from Larry DiTillo is a devious variation of the Teeter-Totter Room. The trap is tailored to deal with those inconsiderate delvers who like to play interior decorator and move every piece of furniture in a dungeon room.

The room is small and rectangular. Identical stone statues are set in opposite ends of the room; a series of glass globes supported on iron racks rest along the other pair of walls. Behind each statue appears to be a poorly-concealed secret door (DC 10 Spot check).

The entire room rests upon a central pivot; the statues secure small bolts that keep the room from tipping as soon as the first adventurer enters. If the statues are moved at all (presumably to gain access to the "secret doors"), the room's delicate balance is upset, tilting the entire chamber radically to one side or the other. The delvers are hurled toward one end of the room and the fragile glass globes are dislodged to

shatter on the floor, spilling their deadly contents (poison gas/flaming oil/scorpions/whatever you choose). Finally, the stone statue from the "up" end of the room plummets into the lower end of the room, pulping the delvers caught there. Oh, the fiendish wonder of it all!

This trap could also work as a corridor with a door at its midpoint and a statue at each end "hiding" a secret door. No matter how it is used, it is sure to be deadly.

The contents of the globes that shatter are left up to you, the DM. Suggestions include:

Burning Oil: 1d6 fire damage each round and the victim catches fire (see Catching on Fire in the DMG).

Burnt Othur Fumes: fills area in a 20-foot radius; Con 1 perm drain/Con 3d6.

Stinging Scorpions: 40 Tiny scorpions, see the MM.

You Rang?



CR: 2
Type: Mechanical
Search: Trap (DC 20), Trigger (DC 20).
Disable Device: Trap (DC 20, 2d4 rounds); Trigger (DC 20, 2d4 rounds)
Primary Trigger: Touch (touching the golden ball)
Primary Trap Effect: Room swings back and forth. Those standing on the floor must make a successful Balance check (DC 20) to remain standing. If the roll fails, the character is thrown down (1d6 damage) and slides into the wall (another 1d6 points of damage) as the room pitches about. Every round thereafter, the room shifts and

throws the characters against the opposite wall (1d6 points of damage).

A character on the bell must succeed at a Reflex save (DC 20) or fall from the bell to the floor (1d6 points of damage). If successful, the character maintains his grip but is munched against the wall (3d6 points of damage every other round as long as the hold is maintained).

Reset: Automatic; room resets after gonging 12 twelve times

Secondary Trap Effect: Fortitude save (DC 15) or deafened for 1d3 minutes. A successful save negates the effects for the remainder of the time in the room.

Cost: 2,000 gp

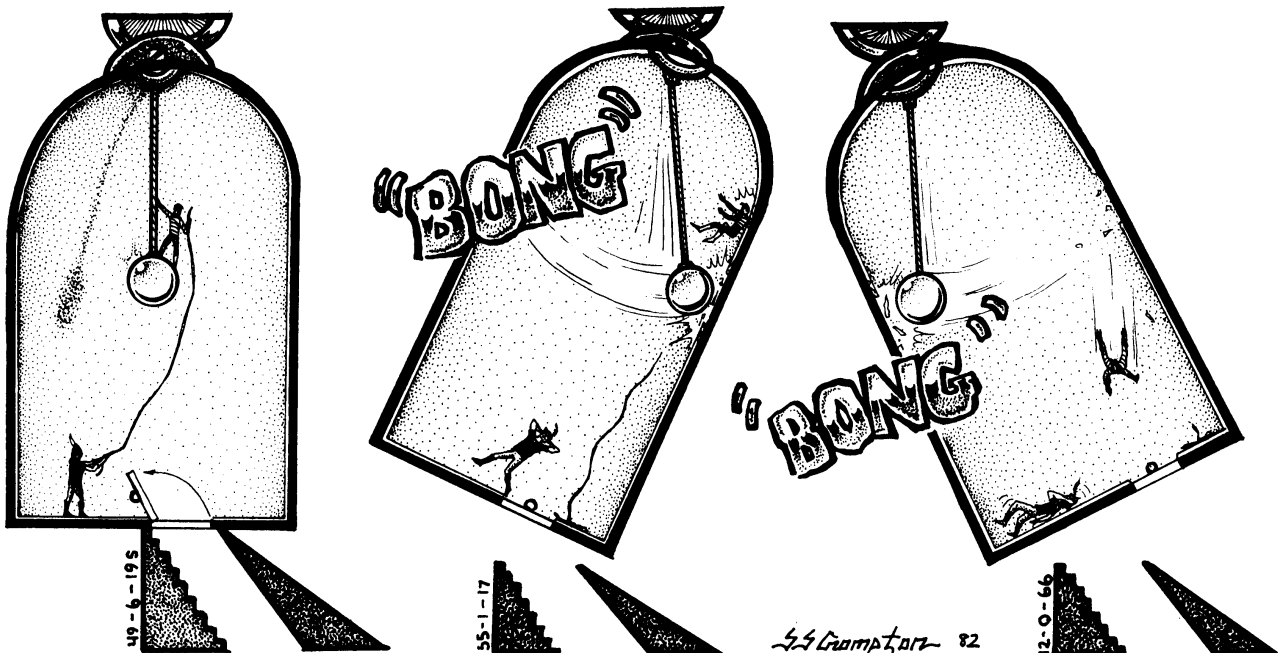

This trap, designed by Larry DiTillo, is a round room (10 foot diameter) with a 30-foot high domed ceiling. Hanging from the center of the ceiling, about 10 feet from the floor, is a golden ball about the size of a beach ball suspended on a silver rope. The room can be entered without mishap through a trapdoor in the bottom of the floor.

The party remains unharmed as long as no one fools around with the golden ball. However, doing *anything* to the ball and/or rope triggers a complex mechanism above the room, which starts swinging the entire chamber from side to side with the delvers trapped inside. The room is actually a giant bell!

The golden ball strikes against the walls (now revealed to be steel with a parchment-thin layer of stone), making an awful gonging din that should deafen the characters. Those delvers foolish enough to hang onto the ball are pulped against the walls; characters who merely stand in the swinging room should gather their share of bruises too.

The bell also serves as an alarm for monsters in the area. The room stops swinging after a few minutes — just in time to admit the hordes of hungry monsters who will have gathered nearby. The monsters should have no trouble dealing with the deafened and battered party within the room....

The Safe-Cracker's Nemesis



CR:	1 (or higher)
Type:	Mechanical
Search:	Trap (DC 20), Trigger (DC 20).
Disable Device:	Trap (DC 20, 2d4 rounds); Trigger (DC 20, 2d4 rounds)
Primary Trigger:	Touch (turning dial on safe)
Primary Trap Effect:	Floor slides 5 feet each time the dial on the safe is cranked. Falling into the pit is left to the DM (see below for suggestions)
Bypass:	If you decide there is a secret door behind the safe, allow the PC to disable the trap and find the door (but we don't suggest it. This just isn't the Grimtooth way).
Reset:	Automatic
Cost:	1,000 gp or higher

Picture a long room (20 feet) with a door at one end and a bank safe at the other. The safe is attached to the wall

permanently and cannot be moved. This is the setting for this trap designed by Scot Rhoads.

Delvers, being nimble-fingered little monkeys, will almost certainly attempt to pick the safe's lock by pressing their pudgy ears against the door and twirling the dial. To the safecracker's dismay, however, he soon finds that every mistake he makes while working the dial causes the floor of the room to slide one foot into the wall holding the safe — revealing a bottomless pit below. Too many mistakes, and the gap between the door and the floor will isolate the safecracker on the wrong side of the pit! You could be nice and include a secret passageway on the other side of the safe door if you wanted to give the delvers a way out....

The consequences of falling into the pit are left to you. The pit very well could be bottomless. Or it could magically *teleport* falling creatures anywhere from outside the dungeon to the middle of a cave full of pit fiends on the bottommost layer of Hell.

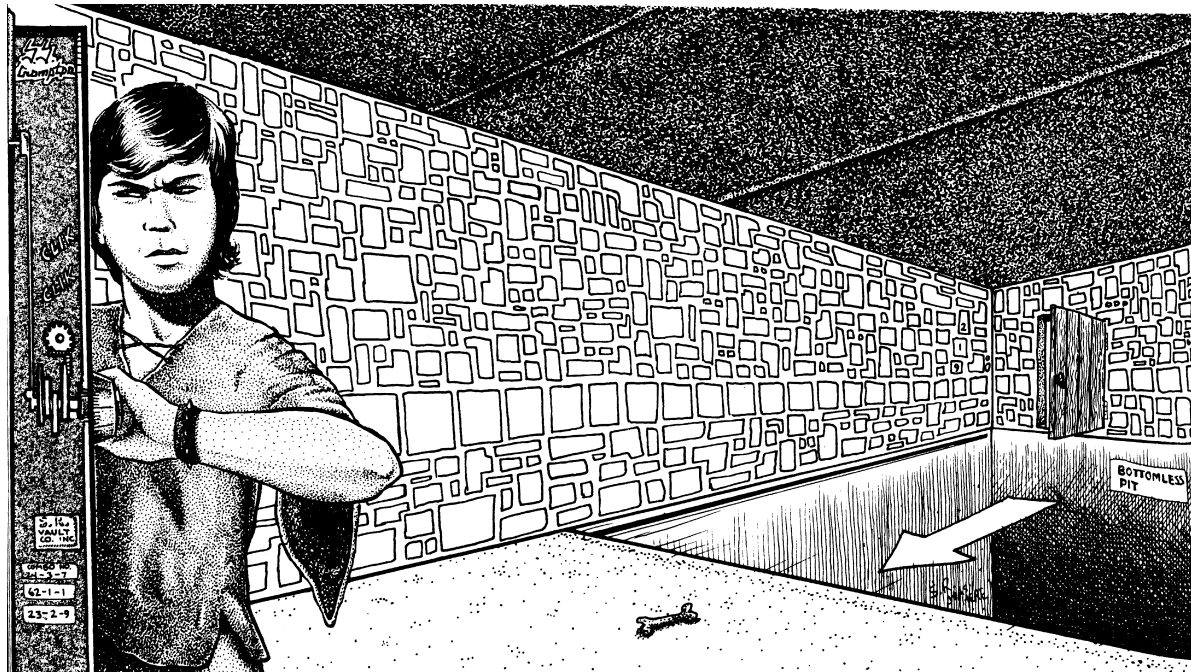

Troll's Bridge-Work

	
CR:	1 (or higher)
Type:	Mechanical
Search:	Trap (DC 20), Trigger (DC 20).
Disable Device:	Trap (DC 20, 2d4 rounds); Trigger (DC 20, 2d4 rounds)
Primary Trigger:	Location (pressure plate in center of bridge)
Primary Trap Effect:	Bridge folds up into a cage around the characters. The cage is Hardness 10, 40 hp, and Break DC 25.
Reset:	Automatic (but see below)
Cost:	1,000 gp or higher

Charles Mollenhauer brings us this trap. No, this isn't a denture for monsters, but rather a bridge over a chasm that quickly becomes a cage hanging over a chasm...

The trap works simply. Characters coming to the deep chasm see an easy way to cross it — a wide bridge suspended by wires from the ceiling. Stepping upon the pressure plate in the middle of this bridge causes the sides

of the bridge to fold up around the bridge middle, like a perverted drawbridge. The delvers are now trapped in a cage! You can leave them dangling over the chasm or lower the cage to the bottom of the pit (where, presumably, something horrible lies in wait)....

Adjust the reset time based on what happens after the bridge folds up into a cage. If it just traps the characters indefinitely, set the reset to "manual" and leave the PCs trapped until someone comes to save them. If the bridge-cage starts lowering them into a pit (boiling oil, acid, monster-filled), have it open once it hits bottom just enough to dump the PCs out. Then it slowly raises and resets itself.

Also, adjust the CR of the trap based on what happens. Just trapping the characters and leaving them suspended is CR 1. Lowering them into a pit of acid, lava, oil, etc. should bump the CR to 5 or 6 at least. If there is a monster (or monsters) in the pit, set the CR equal to the EL of the monsters.

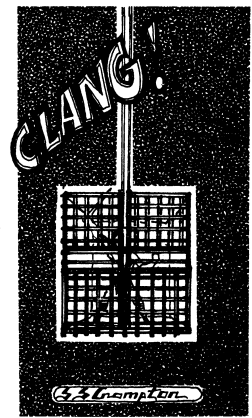
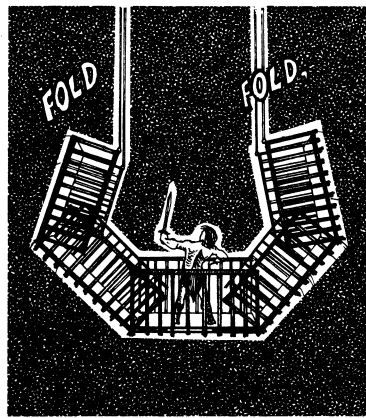
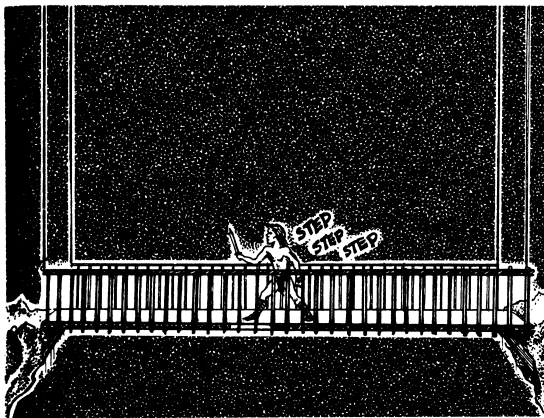

Cretin in the Circular Citadel

	
CR:	6
Type:	Magical (<i>geas</i>)
Search:	Trap (DC 31), Trigger (DC 26).
Disable Device:	Trap (DC 31, 2d4 rounds); Trigger (DC 26, 2d4 rounds)
Primary Trigger:	Touch (gem)
Primary Trap Effect:	The affected character can do nothing until he or she finds a corner in this perfectly round room. Once a corner has been found, then the character is released from the <i>geas</i> and may take the ruby without penalty.
Reset:	None (gem functions until a character breaks the <i>geas</i> on it by finding a corner)
Cost:	8,000 gp (includes cost of 5,000 gp gem)

From Pat Mueller comes this trap, whose intriguing construction should lead to the doom of many a delver.

The trap is a round room; entry is gained by a single door set flush with the wall. In the center of the room, on a raised circular dais, is a glowing ruby of great worth and obvious magical nature (5,000 gp value). Parading around the perimeter of the room are characters of all kinds and types. Each has a glazed, fixed expression and appears to be searching hopelessly for something. Several show signs of advanced malnutrition. There are a few dead bodies sprawled on the floor, as well.

The magical gem places a *geas* upon anyone who touches it (the spell is as the spell cast by a 15th-level sorcerer). An affected character can do nothing until he finds a corner... in this perfectly round room. Once a

corner is found, then the character is released from the *geas* and may take the ruby without penalty.

The various beings wandering around the room are all under the *geas*. Many have died (or are in the process of doing so) during their fruitless quest. None (obviously)

have discovered how to find the corner in a round room. The solution is simple enough: By knocking a small chunk out of the wall space (Hardness 5, 10 hp, Break DC 23), a corner is formed — thus ending the *geas*.

But there's no need to make it easy on the delvers and flat-out tell them that...

Death of 1000 Slices



CR:	3
Type:	Mechanical
Search:	Trap (DC 22), Trigger (DC 22).
Disable Device:	Trap (DC 20, 2d4 rounds); Trigger (DC 20, 2d4 rounds)
Primary Trigger:	Location (pressure plates on either side of the daggers in the floor)
Primary Trap Effect:	Collapsing wall staples character to it with spikes (+20 melee, 2d4 spikes, 1d4+2 each spike).
Bypass:	Perhaps a hidden switch (Search DC 20) keeps the trap from activating.
Reset:	Automatic
Cost:	15,000 gp

Andy Beauchamp brings us this room of dangerously positioned cutlery. This trap is so obvious, it's likely to claim many a life....

Two opposite walls in a square dungeon room are covered from floor to ceiling with thousands of sharp knives; the other two walls contain doors. Running along the floor, from one door to the other, is a row of knives. Running along the ceiling, exactly in line with the daggers on the floor, is a row of swords.

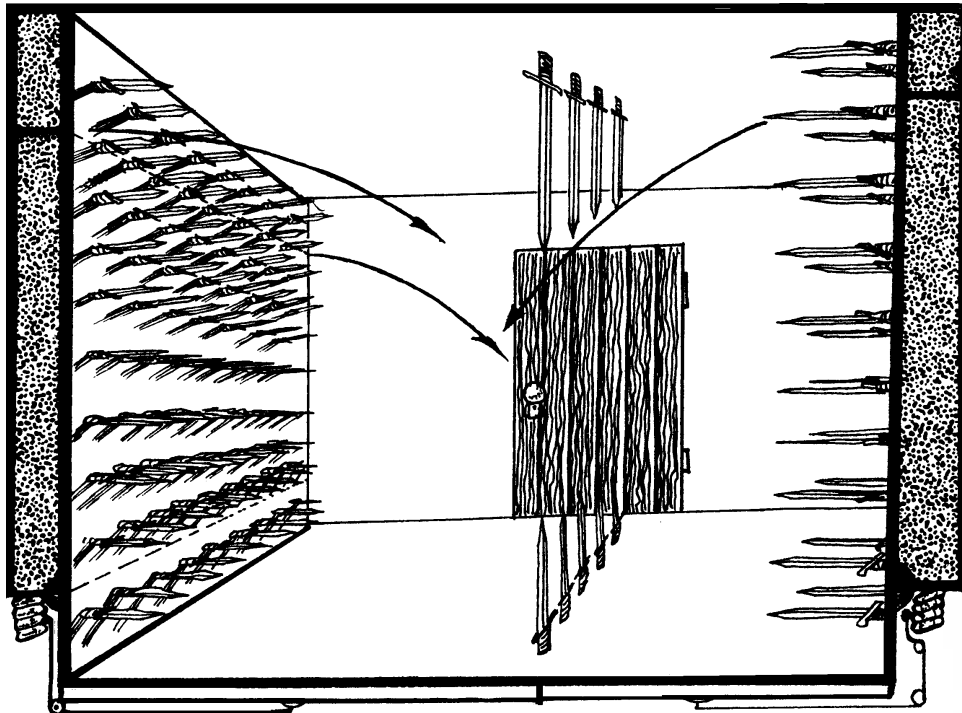

As soon as a character ventures more than 10 feet inside the room, the trap is sprung. If he has walked to either the right or the left of the row of daggers, then the nearest wall folds over onto the floor, mincing him horribly.

The only safe way to walk through this room is to straddle the daggers. This will cause both walls of knives to fall inward at the same time jamming together above the character.

If you want to make this trap even more deadly (a technique which I heartily approve), grease the floor around the row of knives. Thus, even if the delver avoids the walls, he might still slip and fall on the knives! An even nastier addition is to have a voice over announce, in the voice of the party's leader, "Hit the deck!"

I have often found that the key to catching the cleverest of characters in a trap is to provide a trap that is very simple, and provide the adventurers with the solution to it. They act upon that information and, well, see the next trap as an example.

The Ceiling Trap



CR:	10
Type:	Mechanical
Search:	Trap (DC 20), Trigger (DC 20).
Disable Device:	Trap (DC 25, 2d4 rounds); Trigger (DC 25, 2d4 rounds)
Primary Trigger:	Touch (opening either door)
Primary Trap Effect:	Crushing ceiling (no attack roll needed; 16d6, crush); multiple characters in either center of room or on each side of room depending on which door is touched.)
Bypass:	Perhaps a hidden switch (Search DC 20) keeps the trap from activating.
Reset:	Automatic
Cost:	25,000 gp

Ted Rassieur offers this trap. The room it is placed in is a normal room with one centrally-placed door in each of the east and west walls. The doors are placed directly across the room from each other, and the room is devoid of any furnishings.

When the east door is opened — both doors open out of the room — the ceiling area between the two doors slams down. It should be quite clear to the delvers that if they had been inside the room and opening the door, they would have been squashed. The ceiling then retracts after ten seconds.

When the west door is opened, the ceiling everywhere except between the two doors smashes down. What usually happens is that characters who enter through the east door stand out of the way to open the west door. By the same token,

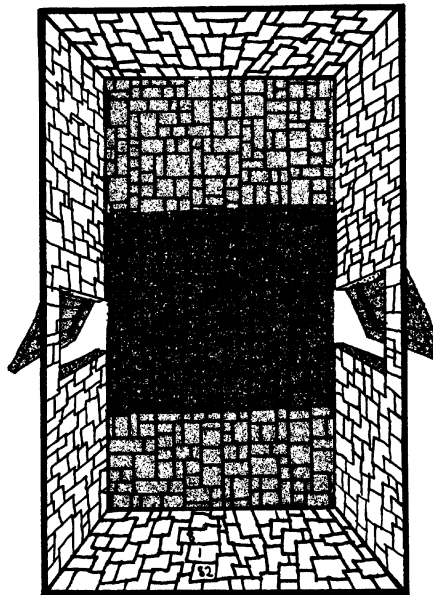
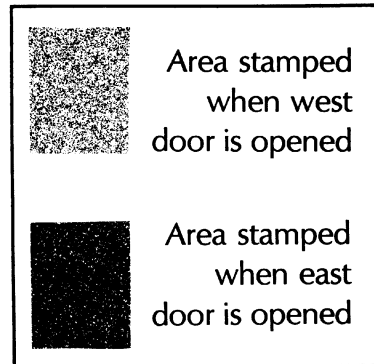

characters entering from the west know better than to stand away from the east door when they open it. Simple, but deadly....

Let Me At 'Em



CR:	10
Type:	Mechanical
Search:	Trap (DC 25), Trigger (DC 25).
Disable Device:	Trap (DC 25, 2d4 rounds); Trigger (DC 25, 2d4 rounds)
Primary Trigger:	Touch (releasing the button behind the bound man)
Primary Trap Effect:	Crushing wall (no attack roll needed; 18d6, crush; multiple targets [all creatures] in room)
Reset:	Automatic (wall resets in 2 rounds)
Cost:	30,000 gp

Mike Stackpole has retreaded a concept by Matt Nadelhaft to create this trap. All you have to get the characters to do is push the button....

The adventurers enter a small, dingy room through a door in the west wall. The north wall has a very strong-looking man bound to it by a steel band around his middle. As the adventurers enter the room, the captive taunts them with cries of "You sissies, I'll rip yer throats out. I'll smash ya all. I'll kill ya. I dare ya to release me; you ain't so tough." The south wall has a red button on it labeled "Release."

At the captive's back, within the band, is a button that his body keeps pressed in. If the release button is hit, the man is teleported away. This releases the button and allows the north wall to slam into the south wall. If the man has been killed, his body drops from the steel band — if the release button is pushed — accomplishing the same thing. A grim application of the "deadman switch" principle....

The Better Mousetrap



CR:	7
Type:	Mechanical
Search:	Trap (DC 5 [fairly obvious]), Trigger (DC 25).
Disable Device:	Trap (DC 20, 2d4 rounds); Trigger (DC 20, 2d4 rounds)
Primary Trigger:	Touch (the cheese loaded in the trap)
Primary Trap Effect:	If the snapping bar hits a character it deals 4d6 points of damage immediately and 1d6 points of damage each round the character remains pinned. The bar requires a Strength check (DC 30) to move. The snap-bar also triggers the secondary effect of the trap.
Secondary Trigger:	Location (pressure plate on edge of mousetrap). Only the snap-bar can release it. Characters standing on it will not trigger it.
Secondary Effect:	our cages spring open to release four dire lions (see dire lions in the <i>MM</i>).
Reset:	Manual
Cost:	16,500 gp

This trap could only have been born in the mind of Brandon Corey, and many adventurers will wish it had been stillborn. A huge mousetrap stands in

a room laid out in the shape of an L. The spring is the size of a man's thigh, and the bar that would break the neck of a mouse is fully 3 feet wide and 2 inches thick. On the trigger rests a pound of cheddar cheese that radiates good magic. The L-shape of the room is so that the characters cannot initially see what they are going to confront. No character with any sense would enter a room with that big trap.

Triggering the trap is simple: just toy with the cheese. As the bar snaps down, which it does when the bait is removed, it hits a pressure plate at its impact point. This activates the release catch on the doors to cages containing several big cats (lions, tigers, catamounts, and such).

As the characters examine the cheese, they note that the center of it contains a cat's eye gem (500 gp value). The magic is coming from the gem and attracts cats to the character with the gem. Of course, the cats will only wish to play with this character, and the game they seem to favor is ambush.

Just as an added surprise, you might have the characters meet the huge mice the trap was set for originally....



Kiss of Death



CR:	4
Type:	Mechanical
Search:	Trap (DC 25), Trigger (DC 25).
Disable Device:	Trap (DC 20, 2d4 rounds); Trigger (DC 20, 2d4 rounds)
Primary Trigger:	Touch
Primary Trap Effect:	Longsword blade springs out and hits victim in face or throat area (+20 melee, 1d8 plus automatic coup de grace attack)

Primary Save:	Reflex (DC 20) to avoid longsword and Fortitude (DC 10 + damage dealt) or die.
Reset:	Automatic
Cost:	18,000 gp

Brandon Corey designed this trap, which turns the joy of anticipation into the sour taste of reality with frightening swiftness.

The trap needs to be presented with a bit of preparation and is best served if the characters must ferret out information about it from many

and varied sources; make it a mystery. The basic rumor to be presented is that if the characters perform a certain ritual and kiss the Statue of the Goddess of Love at a nearby temple, they will become immune to swords and fear. Details of the ritual should be difficult to uncover, but they all should be available to the characters by some means or another.

The statue they must kiss is a huge head mounted on the wall of the temple, behind the main altar. The breadth of the lips must be easily as wide as a normal human head. The head and face are carved from unblemished white marble and are that of a woman who is inhumanly beautiful. The head radiates functional magic.

If the character attempting to gain the boon has completed the ritual correctly and kisses her on the lips, the boon is granted. Each DM must modify the promise to fit the reality of the campaign world being used.

If, however, the character failed some portion of the ritual or kisses a part of the statue other than the lips, the lips will part and a sword blade will lick out like a serpent's tongue. Anyone kissing the lips of the statue should be hit in the face and probably killed instantly. Characters kissing another part of the face would take the sword in the portion of the body at mouth level. The strange thing is, for those who complete the ritual and for those who blow it, the promise is kept.

Shock Treatment



CR:	4
Type:	Combination (Magical [<i>lightning bolt</i>] and Mechanical)
Search:	Trap (DC 28), Trigger (DC 28).
Disable Device:	Trap (DC 28, 2d4 rounds); Trigger (DC 28, 2d4 rounds)
Primary Trigger:	Location (pressure plates in bottom of fountain)
Primary Trap Effect:	Spear hits character on pressure plate (+5 melee, 1d8 damage)
Secondary Trap Effect:	Location (in water)
Primary Trap Effect:	Spear discharges electricity in water and deals 5d6 points of electricity damage to those in water or to those attempting to scrape gold from statue
Reset:	Automatic (spear resets after 3 rounds), no reset for <i>lightning bolt</i> (spell must be cast again)
Cost:	25,000 gp

This next little number is certain to surprise characters who believe themselves to be careful. Chris Andrews, the designer of this trap, has a knack for providing a new twist upon ordinary situations.

The adventurers find a room with a fifteen-foot diameter fountain in the center. The fountain features small jets of water from a stone pedestal in the center of the fountain. Upon the ped-

estal stands a beautiful figure bearing a twelve-foot long spear in an upraised hand. The statue is made of gold-plated steel, and a seam can be seen at the shoulder of the spear arm, as if the arm might be able to move down in a windmill action. The spear point is ten feet above the water level. The water is not poisonous, and the bottom of the fountain is dotted with treasure.

The adventurers will try to avoid the spear arm, fearing a stab in the back as they gather treasure. Indeed, standing upon one of the many pressure plates in the base of the fountain basin will cause the arm to fall, and only the clumsiest of characters will be hit with the spear. If the spear hits no one, it will dip into the water. This is when the large charge of electricity running through it will discharge into the water and any delvers in it as well... A similar thing will happen to the witless soul who tries to scrape the gold from the statue.

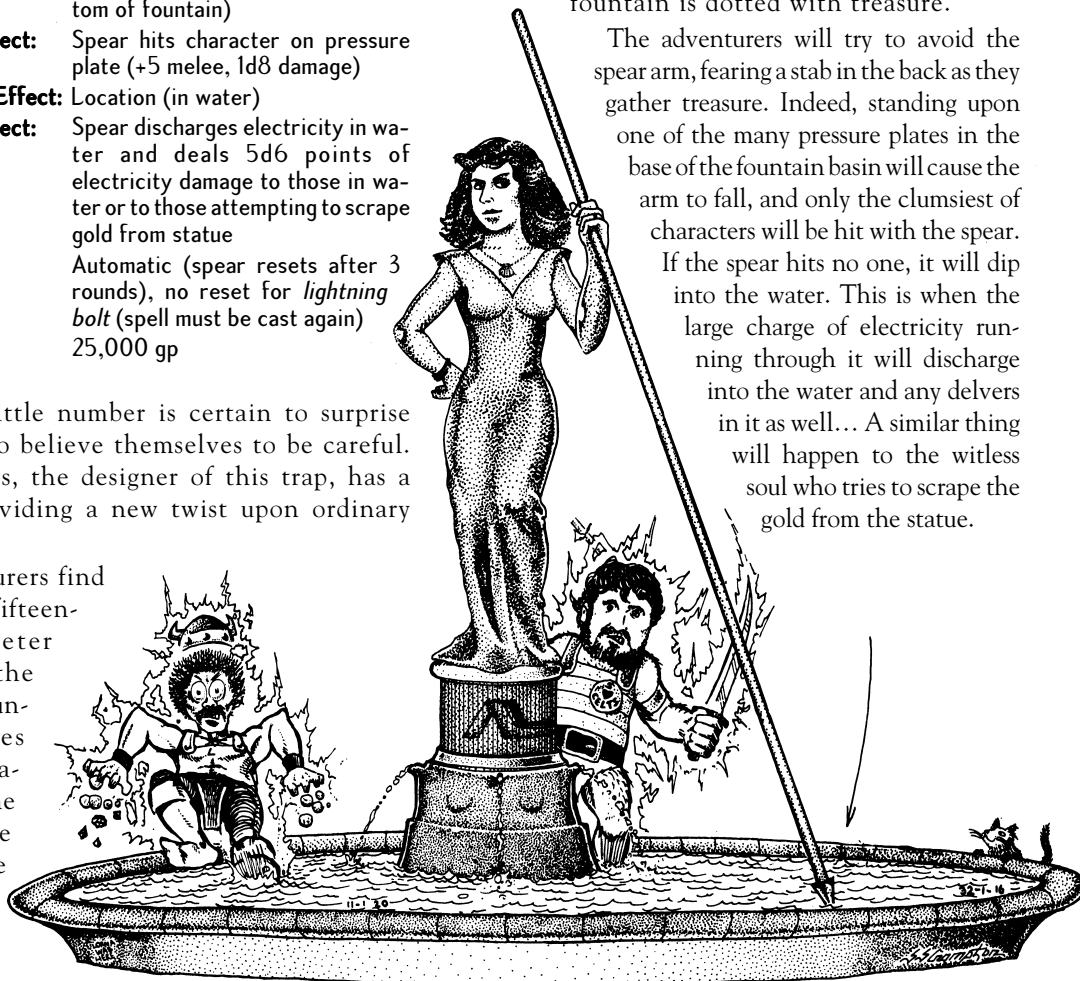

The Peerless Pillar Room



CR:	2 (or higher, much higher)
Type:	Combination (Magical or Mechanical or both)
Search:	Trap (DC 20); Trigger (DC 25)
Disable Device:	Trap (DC 15, 1d4 rounds each pillar)
Trigger:	Touch (Stepping on or hitting a trapped pillar)
Trap Effect:	Varies depending on the evilness of the DM, see below
Reset:	Repair (broken pillars must be replaced)
Cost:	2,000 gp or higher

Occasionally I'm sent a trap by someone passing himself off as "merely human." But I can tell a trollish design when I see one. That was the case with this room trap, submitted by a troll-kin masquerading under the nom de plume of Mad Roy Cram. Blood will out.

The room of pillars is meant to hamper tomb robbers, and it is well to locate it in a tomb because the survival rate of the robbers is not going to be very high. The room is large and deep, featuring five rows of five pillars in each row. The pillars are 30 feet high, at least, and only the cut-away tops

are at the party's level. The pillars that rise from shadow-shrouded depths are each three feet in diameter; there are four feet between each pillar and its closest neighbors. The pillars are polished and greased, so climbing or clinging to them is impossible. There are no exits from this room at the level of the pillars' bases, but there are seven doors around the room at the same level as the tops of the pillars. While every door has a 24-inch wide ledge before it, only one door leads deeper into the complex.

The appropriate task of jumping from one pillar-top to the next might seem simple. It is not. Any character in heavy armor will have difficulty with his or her momentum, and could tumble off the edge of any pillar if unlucky or clumsy. That, however, is likely to be the least of the possible problems. Roy has provided a sample of traps for the individual pillars, and with such inspiration, more can surely be invented as needed.

One pillar is made of fragile material that will crumble under 75 pounds of weight. A long fall. Another pillar, slightly similar, is hollow; its plaster top will break through with the sudden weight of a jumping character. The kicker to that pillar is

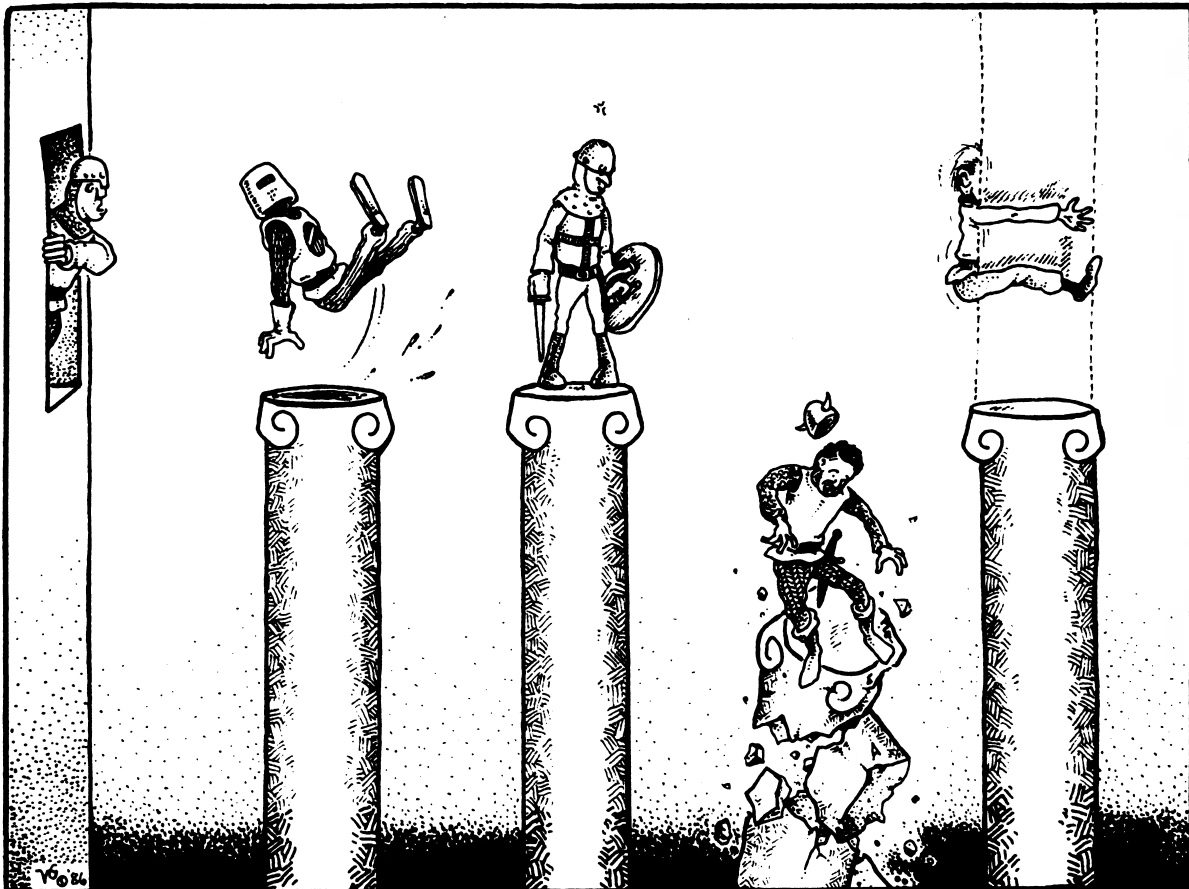

that the solid circumference of the pillar is metal, with a sharpened edge to sever ropes and quick fingers. Another pillar actually extends all the way to the ceiling — it just doesn't look it. Glass or a magically invisible wall will correct the assumptions of the character who "jumped to his conclusion." Another surprise in store is the pillar with a top that has been well greased. My favorite of all is the two-pillar trap: playing "follow the leader" is deadly when jumping on one pillar sends the last one flying up into the ceiling, provided there's at least 75 pounds worth of delver standing on it.

And do not forget there are six sham doors; any or all of them could have nasty things hiding behind...!

From the sample pillars given above the following can be used:

Crumbling Pillar: Breaks under 75 pounds or more of weight. Creature on pillar falls 30 feet or more to floor (or whatever) below. The creature takes 1d6 points of falling damage each 10 feet fallen.

Hollow Pillar: Plaster top breaks and character falls into pillar. A Reflex save (DC 20) allows the character to grasp the edge of the pillar where he

immediately takes 1d4 points of damage from the serrated and sharpened edges. The damage continues each round the character holds the pillar. Dropping into pillar not only traps character there, but he suffers 1d6 points of falling damage for each 10 feet fallen.

Illusory Pillar: The pillar extends to the ceiling but is magically (illusions) or mechanically (mirrors) made to look like it does not. Jumping "on to" the pillar results in 1d4 points of damage as the character connects with the very solid and real pillar. He also suffers 1d6 points of falling damage per 10 feet fallen as he plummets into the darkness below.

Greased Pillar: Character landing on pillar must succeed at a Reflex save (DC 20) or slip and fall off the edge of the pillar suffering 1d6 points of damage per 10 feet fallen.

"Follow the Leader" Pillar: After exiting a pillar the next creature weighing at least 75 pounds that steps on it is thrust straight up into the ceiling and takes 6d6 points of damage. Of course when the pillar resets (immediately) the character falls and suffers 1d6 points of damage per 10 feet fallen (don't forget this guy is falling from the ceiling to the floor rather than from the pillar to the floor, so more damage!)

Music To My Ears



CR:	2
Type:	Magical
Search:	Trap (DC 22), Trigger (DC 20)
Disable Device:	Trap (DC 20, 2d4 rounds)
Primary Trigger:	Event (playing the lute)
Primary Trap Effect:	A thunderous series of gongs deafens all within the room (as the <i>blindness/deafness</i> spell) for 1 hour. Also, all random/wandering monster encounter chances are doubled (and immediately make a roll for wandering monsters).
Bypass:	Don't play the lute!
Reset:	Repair (if the lute is damaged)
Cost:	1,000 gp

Some adventurers make outrageous claims as to their main profession — they don't loot tombs and slay troglodytes, they're musicians. Todd Miller has designed a room trap that snares these would-be minstrels with a catchy special effect, and the result is Music To My Ears.

The bait to this trap is a beautifully crafted lute, decorated with gold inlay, studded with winking gems and equipped with platinum strings. Doubtlessly the characters faced sharp difficulties before coming to this place, and even in



this room there some minor (and silent) obstacles to overcome before the would-be virtuoso could lay hands on this princely instrument.

One good strum across the platinum strings by the arrogant bardling, and the acoustics of the carefully-designed room will make him wish he'd never twanged a note of music in his life! "In tune" with the lute, the walls of the room amplify and

distort the sound, creating vibrations that sound like hundreds of gongs resounding on either side of one's head. It will be several minutes before the lute's last reverberations die away. At that point not only will all the adventurers in the room be temporarily deafened, but all the tunnel inhabitants will know exactly where to find easy pickings. What else is the dinner gong for?

Wimp's Revenge



CR:	2 (or higher)
Type:	Mechanical
Search:	Trap (DC 20), Primary Trigger (DC 20)
Disable Device:	Trap (DC 20, 2d4 rounds), Trigger (DC 20, 2d4 rounds)
Primary Trigger:	Touch (the chest)
Primary Trap Effect:	Dais rotates and shuts the chest and the creature touching the chest in another room whilst revealing what was on the other side of the rotating wall.
Bypass:	Don't touch the chest or perhaps a hidden switch (Search DC 25) doesn't allow the wall to rotate.
Reset:	Automatic or Manual (a hidden switch allows the wall to rotate perhaps; Search DC 20)
Cost:	2,000 gp or higher

With this trap, Chris Alexander reminds us that not all who wear the title "hero" deserve it. Too often a smaller, weaker character (even stupider than his tormenter) is bullied into taking risks for which the "hero" takes the credit — and the goodies.

A 15-foot long corridor comes to an end in an open doorway that leads into a large room. The room is bare except for a large, ornate,

enticing chest on a raised dais against the far wall.

True to his style, the "hero" will send in the wimp to investigate, while the "hero" remains a few feet outside the entrance where he or she can see what happens.

When the brave but bullied wimp touches the chest, the entire dais rotates, swapping the wimp and the chest for — what's waiting on the other side. At the same time as the dais rotates, a steel plate shuts off the corridor behind the "hero." This forces the character to prove whether or not he wears the title honestly. Of course, if the corridor is clear and the "hero" runs away, he leaves no doubt as to the veracity of the title!

What's waiting on the other side of the wall? A very big ogre with a very big club might give our "hero" very big trouble. For variety, a keg of explosive material (fuse activated when the dais turned) could be promising if there's a whole party of "heroes" hiding in the corridor.

What about the wimp and the chest? If you're the kind hearted (fie!), put some legitimate treasure in the chest. However, an easy exit from the dungeon, even empty-handed, would probably be best.

It is really up to the DM as to what is actually located on the other side of the rotating wall. If using explosives, allow the explosives one round after the wall rotates before they detonate. At detonation, the explosives deal

4d6 points of damage to all within a 30-foot spread. If an ogre with a big club is chosen, see the MM.

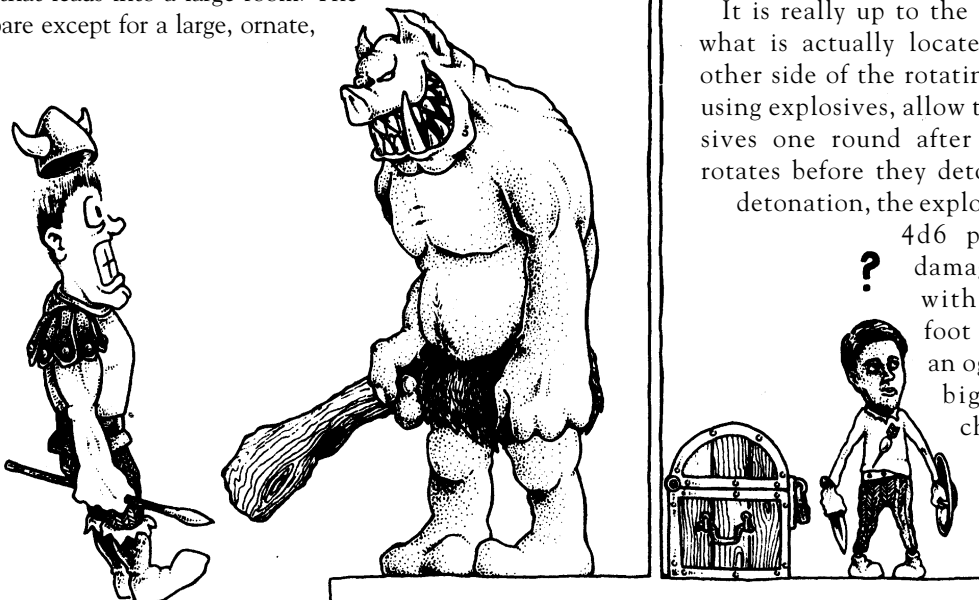

© 2006

Sauna



CR:	5
Type:	Combination (Magical [waterbreathing] and Mechanical) Trap (DC 21), Primary Trigger (DC 25) Trap (DC 25, 2d4 rounds), Trigger (DC 25, 2d4 rounds)
Search:	Trap (DC 25), Primary Trigger (DC 25)
Disable Device:	Trap (DC 25, 2d4 rounds), Trigger (DC 25, 2d4 rounds)
Primary Trigger:	Touch (touching water)
Primary Trap Effect:	Bestows <i>waterbreathing</i> on character for next 15 minutes.
Secondary Trigger:	Timed (10 minutes after first character enters pool)
Secondary Trap Effect:	Water begins freezing, dealing 1d6 points of cold damage each round to any character in water.
Reset:	Automatic (after 1 hour, the sauna resets itself)
Cost:	15,000 gp

Most characters avoid live steam like the plague, but the idea of a warm bath after a long day in a cold, damp dungeon complex is something few can resist. What better than a sauna, for example, to burn the cold from chilly bones? The Mad Doctor, Paul Ronkas, has devised a ghastly room trap that warms my heart, but will chill the delvers' blood.

This room trap could be a deceitful shelter in arctic wastes or simply a magical room in a cold, dank dungeon. The adventurers discover an elegant public-style bath, about 10 feet across and a full 20 feet deep. It is heated to just the right temperature by an underground hot spring. Anyone entering the water will shortly discover two things: while they are in the water they are gifted with the ability to breathe water (wouldn't want any accidental drownings here, would we?); and on the bottom of the pool they can find scattered coins, gems, weapons or whatever treasure you see fit. A very observant swimmer might notice there is no wood, cloth, bones or other organic material — just glass, stone, or metal. Delvers may also notice small, helpless snails throughout the pool, busily cleaning algae growing in the tepid waters.

Swimmers remain pleasantly comfortable for about ten minutes after the first person enters the pool. That should be enough time for your average delver to discard his aimless paranoia and hop in for a good hot soak. When the ten minutes are up, the hot springs stop flowing into the pool, and the water immediately gets colder — much colder. If the water-breathing delvers (remember the “gift”) swim quickly up from the bottom where they've been gathering goodies, they'll find an ice crust already formed across the top of the pool; the crust gets rapidly thicker.

Those who remained out of the pool won't be able to shout warnings to those below the ice. Those who choose to just soak their feet should be up to their ankles in ice. The delver below the water, after their initial panic, will

probably settle down and wait to be chopped out. After all, they can breathe under water, right?

Right. For another five minutes.

Five minutes after the ice covers the pool, the first person into the water can no longer breathe water. His buddies underwater with him can only watch him drown, knowing their own fate is creeping up behind them. Of course, with the speed the water is turning solid, they might freeze to death first.

If some party members remain outside they can work at chopping or burning a hole in the ice with some hellacious spell. The ice has Hardness 0 and 24 hp, though the ice gains 3 hp every round as the water quickly freezes. But unless the spell or the ice chopper is powerful, it'll take time. And time is something the swimmers are notably short on.

If the worst occurs, the snails will clean up afterward. They won't get everything, though, because even the most voracious snail has no taste for metal, stone or glass...

If the ice-crusting water isn't to your liking, you can be equally diabolical by making the water-breathing spell permanent after about ten minutes. That's “permanent” as in “fish” or “snail” — either a full transformation or perhaps the swimmers simply discover that breathing air will suffocate them as it would a fish.

If this room (in its basic form) is located deep inside a monster-populated dungeon, and you're seeing to the monsters' health and welfare, dispense with the snails. Stack some fishing poles, gaffing hooks, and large spoons nearby. Several hours after the delvers have “investigated” this room — or whenever feeding time rolls around — turn the hot springs back up to “simmer” and provide your chilly monsters with a good hot

meal... soup is good food! Come 'n get it!

Hmm...kills delvers and cuts costs. **Brilliant!**



The Danger Room



CR:	10	Tertiary Trap Effect:	+15 ranged (1d8, multiple spears); each creature in a 5-foot square is subjected to 1d3 spears.
Type:	Mechanical	Area of Effect:	Creatures in a 5-foot by 40-foot area in front of the spears; crushing trap affects any creature in any square adjacent to the treasure chest.
Search:	Trap (DC 20), Trigger (DC 20), Secondary Trigger (DC 35).	Quaternary Trap Effect:	Flame gout released by pressure plate (under the treasure chest) when the crushing block falls melts the wax façade on the wall opposite. This immediately releases a swarm of wasps (see below). Should any creature be in the path of the flames, they take 1d6 points of fire damage and must make a Reflex save (DC 15) to avoid catching fire.
Disable Device:	Trap (DC 20, 2d4 rounds); Trigger (DC 20, 2d4 rounds); secondary trigger (DC 25, 2d4 rounds)	Bypass:	There is no bypass for this trap, other than avoiding the pressure plate in front of the door.
Primary Trigger:	Location (pressure plate located by main door to chamber)	Circumstance Bonuses:	Placing a shield over the spear holes grants total cover against the spear attacks.
Secondary Trigger:	Location (pressure plate located underneath the treasure chest)	Reset:	Manual reset for spears, jam, and wasps; Automatic reset for crushing block.
Primary Trap Effect:	+15 ranged (1d8 [x 1d3], multiple spears); each creature in a 5-foot square is subjected to 1d3 spears.	Cost:	80,000 gp
Area of Effect:	Creatures in a 5-foot by 40-foot area in front of the spears; crushing trap affects any creature in any square adjacent to the treasure chest.		
Secondary Trap Effect:	No attack roll needed; 15,000 pound lead weight drops from ceiling (1d6, crush); multiple targets in a 5-foot area around the treasure chest.		
Secondary Save:	Reflex (DC 30) avoids		

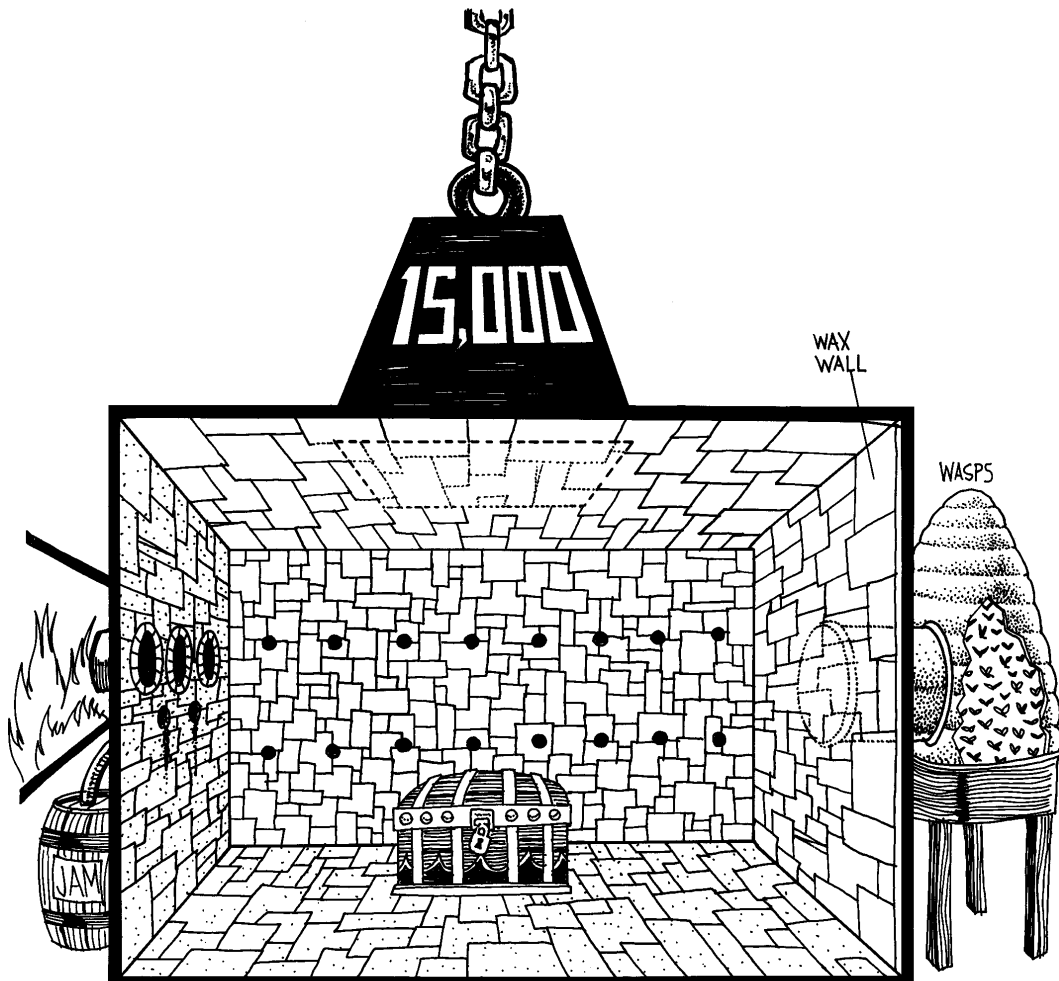

Brian Lawton identifies himself both as “Thorgrim Ghastlybeard” and the “Homicidal Bugbear of the Year” when introducing his submission. I’m afraid there is nothing I can do for you, Brian. Perhaps having your trap published will bring you great fame in your native land of Scotland, and help you raise funds to purchase the spare parts your head requires.

Brian calls this trap The Danger Room, a title with which I have no problem. It wouldn’t do to call this “The Rumpus Room,” or “The Dining Room,” or whatever-Brian’s title is understated, but it works. What it is, Brian.

As with so many room traps, this place screams “trap” to anyone with half a brain in their skull, which means most delvers will blunder right into it. Characters are presented with a room containing the ubiquitous treasure chest. Observant individuals will notice rows of holes on the walls directly behind and to the right of the treasure.

The fur begins to fly when a pressure plate located just inside the door is activated. A shower of spears then flies from the upper row of holes opposite the door. A standard dungeon delver drop drill will dodge the spears, but the characters aren’t out of the woods yet. When the spears hit the wall surrounding the door through which the charac-

ters entered the room, a concealed 15,000-pound lead weight is released to crash through the ceiling and land on the treasure chest (and maybe on a greedy delver or two). Simultaneously, a second volley of spears is released from the lower row of holes, which should upset anyone who avoided the first volley by dropping to the ground.

Brian’s not done. The lead weight oh-so-subtly triggers yet another pressure plate, causing great gorgs of raspberry jam to eject from holes on the left wall... the room should shortly be sticky with the stuff. This is followed by goutts of flame also issued from the left wall, the purpose of which is to melt the wax façade on the right wall — behind which is a tank of killer wasps.

Thus speared, crushed, gorged, and stung, the characters should be about done. Brian suggests that if anyone survives this treatment, they find the treasure consists of a single gold coin guarded by something small and gruesome and toothy. Those Scots are crabby, aren’t they?

Basically, if you want to off your players, use this trap. It serves that purpose very well.

Killer Wasps (200): AC 14, sting for 1 point of damage per round; each attack against the wasps kills a number of wasps equal to the damage dealt.

Thief Squasher



CR:	8
Type:	Mechanical
Search:	Trap (DC 20), Trigger (DC 25).
Disable Device:	Trap (DC 20, 2d4 rounds); Trigger (DC 20, 2d4 rounds)
Primary Trigger:	Touch (the chest)
Primary Trap Effect:	No attack roll needed; crushing wall (moves 5 feet per round; 1d6; crush); multiple targets in room.
Secondary Trigger:	Touch (opening the South door)
Secondary Trap Effect:	No attack roll needed; spring-loaded door sends creature into moving North wall (1d6 per 10 feet traveled).
Bypass:	The bypass to this trap is to either avoid touching the chest or to step through the secret door in the North wall once the wall section begins moving.
Reset:	Automatic; once the North wall touches the south wall (remember it moves 5 feet per round), it operates in reverse and moves 5 feet in the opposite direction until it reaches its original starting point; at the same time the chest rises from the floor and resets itself.
Cost:	27,000 gp

Anyway, dying is easy. Escaping from a trap is hard. Chris Herborth’s Thief Squasher is an old fashioned type of trap. This is a rectangular room containing a treasure chest. The party enters through the door in the west wall, while a similar door in the south wall promises escape. Inspection will reveal the south door is locked, however, as is the treasure chest. Especially sharp characters might locate the secret door in the north wall, but will find that it opens onto a blank wall — there is not room or corridor beyond.

The fun starts when someone tampers with the chest. First, audible clicks will be heard from the west and south doors. The west door is now locked, while the south door is unlocked. Next, the treasure chest slowly sinks into the floor. The chest is itself made of solid wood, so there’s not way someone can open the chest and hide inside. Simultaneously, the north wall begins to ever so slowly inch toward will drop all the way into the floor seconds before the wall passes above, meaning there’s no chance the characters can use the chest to somehow jam the approaching wall.

Opening the south door just makes things worse. The entire door is in fact a spring-loaded ram that will pulp anyone trying to open it against the

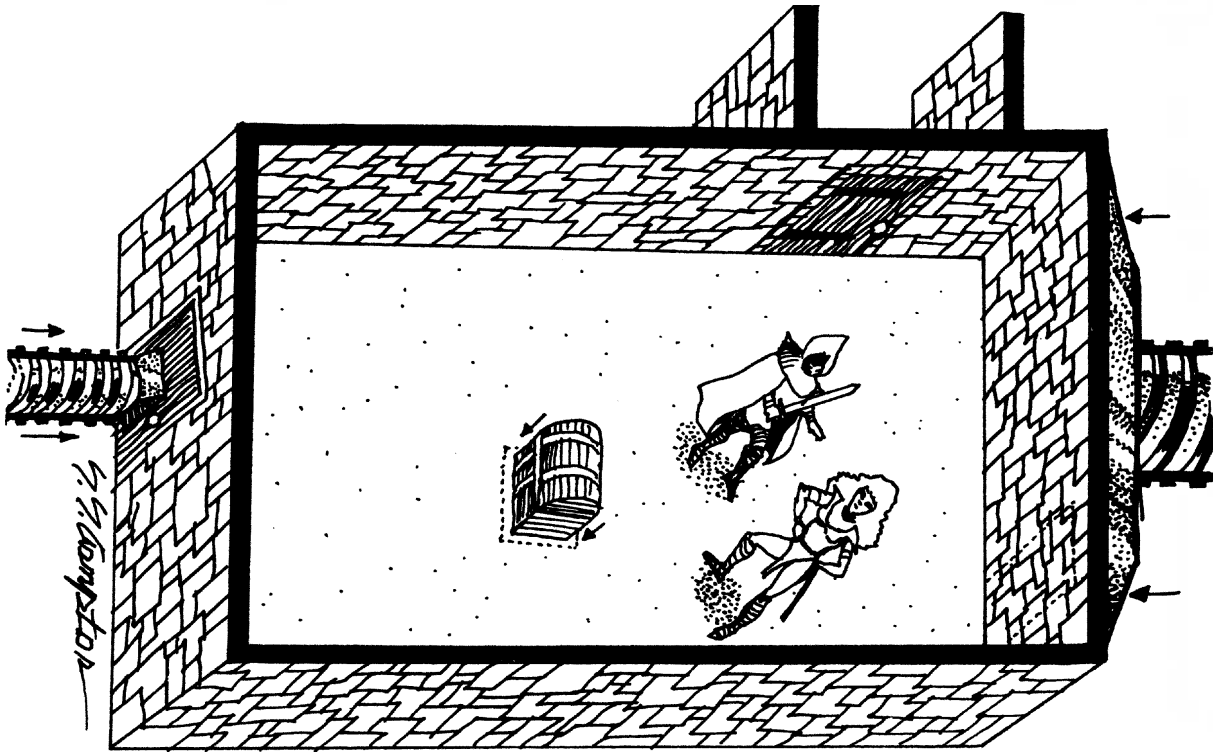

approaching north wall. The only way to escape is through the secret door in the north wall, which itself now no longer backs up against a wall.

Once through the secret door, the party will notice two things. First, the treasure chest has risen from the pit to resume its original position. Second, the secret door is one of the one-way variety — characters can pass through it from the south, but it doesn't exist at all from the north. Observant characters will also note the west door is once again unlocked.

If the party wants to leave now, they are free to do so. I know it hurts to let them get away, but there are lots of fools in the sea, and you'll have another chance to get them if your dungeon is worthy of the name. If, however, the party gets

greedy, and tries to mess once more with the treasure chest they already know is a trigger, then they deserve what next.

No proper trap is without a means of resetting itself. After pressing against the south wall (and thus resetting the ram in the south wall, if it was sprung), the screw powering the north wall will operate in reverse after someone mucks with the chest. The treasure chest will once again sink into the ground to allow the wall to pass above, but this time there is no escape. Without the secret door to scuttle through, the party will be crushed to death by the north wall as it returns to its original position. Try this one and see if you don't agree a trap is all the more insidious when it offers a whiff of freedom, then takes it away again.

Permanent Rope Burn



CR:	2
Type:	Mechanical
Search:	Trap (DC 20), Trigger (no trigger detection)
Disable Device:	Trap (DC 20, 2d4 rounds)
Primary Trigger:	Touch (grabbing the rope releases the barbs)
Primary Trap Effect:	No attack roll necessary; multiple barbs deal damage to creature touching the rope (1d4 barbs each character, 1d4 each barb). Each round the PC holds on to the rope he suffers additional damage. A Fortitude save (DC 10 + cumulative damage inflicted) is required to continue holding onto the rope. Regardless of the amount of damage taken, the PC is treated as having suffered damage to his hands as detailed in "Variant: Damage to Specific Areas," as detailed in Chapter 2 of the <i>DMG</i> .
Area of Effect:	Creature touching or grabbing rope.
Bypass:	Avoiding the rope altogether or perhaps wrapping something around the PC's hands avoids or reduces the damage dealt by this trap. Letting go of the rope prevents continued damage, but the PC falls (which brings its own consequences)
Circumstance Bonuses:	A PC that wraps his hands in thick cloth, leather, or the like takes 1 point less damage per barb. A creature wearing metal gauntlets or the like suffers only half damage from the barbs.
Reset:	Repair; must cover the barbs in thin rope or else the Search DC is reduced by one-half.
Cost:	1,600 gp

Andrew Bander offers this trap as a means to foil would-be Tarzans in any dungeon party. Place a room or chasm placed somewhere in your dungeon athwart the likely line of advance. Hang-

ing over the abyss is a rope. The most obvious way to cross the chasm is to leap out and grab the rope, but those who do are in for a nasty surprise. The rope is in fact tightly wound around a barbed steel cable. The barbs stick up at a 90-degree angle, and the rope sheath surrounding the cable is very loose and thin. The results for anyone trying to hang onto this horrible thing should be obvious. If this trap is placed in a sufficiently dark location, you may not even need to disguise the cable. From a distance, it will be impossible to spot the barbs until it is too late.

Of course, you can let go of the rope at any time. But that means the character falls to the floor below. We leave it up to your individual cruelty to determine how nasty a fall that is and what particular beastie might be residing there in the darkness....

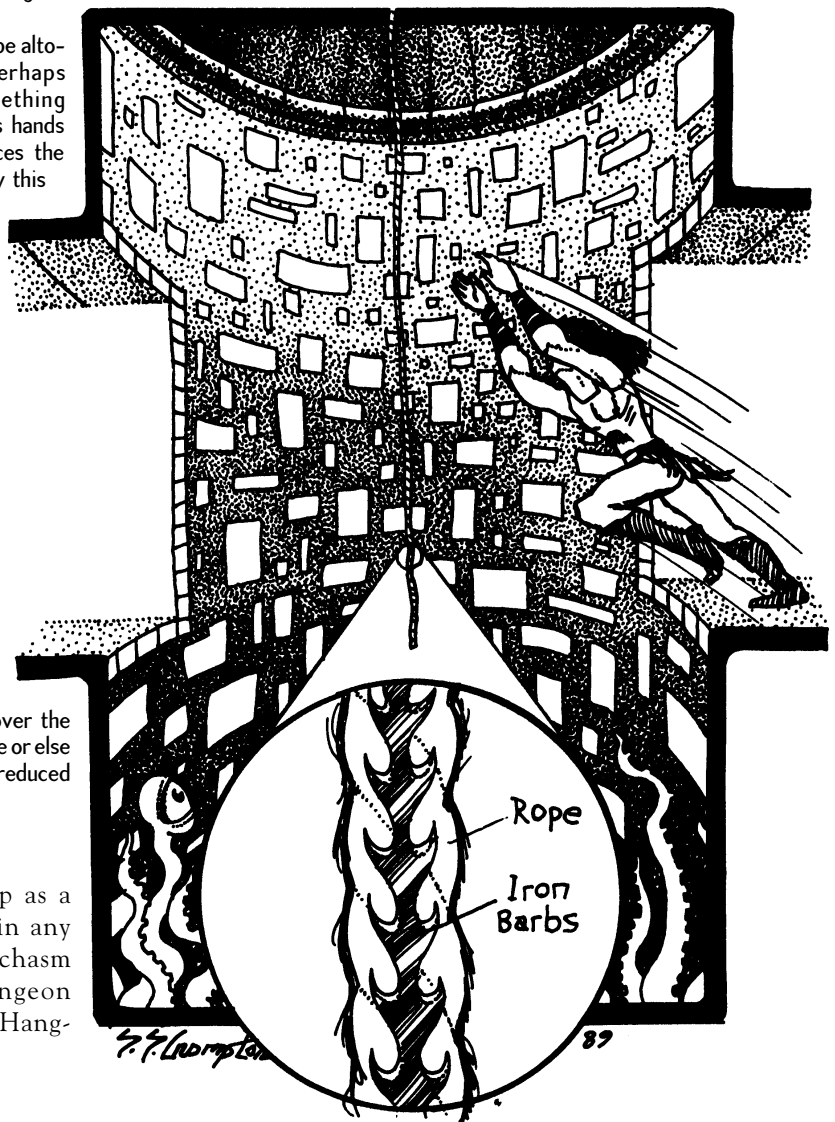

The Sands of Time



CR:	5
Type:	Mechanical
Search:	Trap (DC 25), Trigger (DC 25)
Disable Device:	Trap (DC 30, 2d4 rounds); Trigger (DC 20; 2d4 rounds)
Primary Trigger:	Touch (pulling the rope in the second chamber)
Primary Trap Effect:	No attack roll needed; sand fills the lower chamber in 4 rounds and suffocates those in it (see Suffocation in the <i>DMG</i>).
Area of Effect:	All within the second chamber.
Bypass:	Don't pull the rope!
Reset:	Repair (someone has to get all the sand back up into the first chamber).
Cost:	17,500 gp

This trap, by Joseph Yeager, is a classy room trap that properly foreshadows what will happen to anyone caught in its deadly embrace.

The trap is a two-story room entered from the top through a trap door. The floor of the upper room is filled with fine sand, and should seem slippery and treacherous enough to make the party feel this sand is in fact the entire trap. Perceptive characters may notice this chamber is shaped something like the inside of a bell,

but with the floor of the chamber covered in sand, the exact dimensions are impossible to determine. A careful search will reveal a secret door at ground level, behind which is a slick slide spiraling down. Anyone traveling down this slide will be disoriented, and should have a hard time determining exactly where they end up. In fact, the slide lets out into a dark bell shaped room directly beneath the first — a room that forms the lower half of a huge hourglass. The only feature of this room is a rope hanging from a cork in the ceiling. Pulling the rope frees the cork, and permits sand from the room above to flow into the lower chamber, suffocating anyone within.

While this may at first seem a painfully obvious trap, remember tumbling down the slide will disorient most characters, and few will understand they are in fact directly beneath the sandy room. Furthermore, never underestimate a delver's curiosity. Someone is bound to pull on the rope, even if only to see what it does.

Note: The Search DC to find the secret door is DC 15 (it is supposed to be found in order to spring the trap). Sliding down the slide disorients a creature for 1d3 rounds (-1 to attack rolls, saves, and

checks). Creatures standing in the top chamber when the rope is pulled begin sinking in the sand

and must hold their breath or begin taking suffocation damage. When a creature falls through to the second chamber it suffers 2d6 points of damage from the fall.

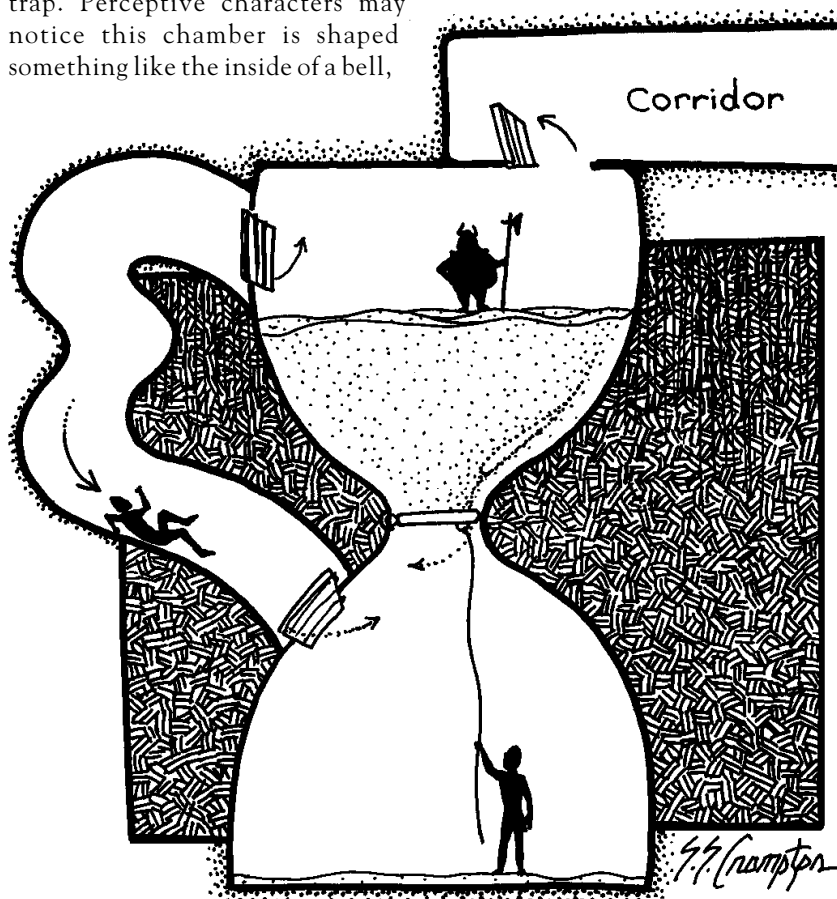

Free Fall Room

CR:	1
Type:	Mechanical
Search:	Trap (DC 20), Trigger (DC 22)
Disable Device:	Trap (DC 30, 2d4 rounds); Trigger (DC 15, 1d4 rounds)
Primary Trigger:	imed (after 1 minute, the door slams shut)
Primary Trap Effect:	No attack roll needed; the room drops to a random level in the dungeon.
Bypass:	Keeping the door from shutting prevents this trap from triggering.
Reset:	Automatic (after 5 minutes the room resets itself)
Cost:	2,000 gp

Jersey Turnpike's Free Fall Room is one of those wimpy traps that plays hob with map-making attempts and disorients delvers, when it really should be busy breaking heads. To each his own.

The party finds a normal dungeon room at the end of a featureless corridor. Within the room is a sign reading, "Warning! Room subject to periodic bouts of anti-gravity!" The floor is heavily padded, and the walls are supplied with a number of

handholds. Padding and handholds? What is this, Jersey, a filthy pleasure cruise?! I bet you sanded all the corners off your table when your baby sister started to walk, too.

Anyway, the "action" in this place is something as follows. Sensible delvers will either flee the room altogether or ready themselves for a bout of "anti-gravity." Sure enough, within a few minutes the door to this room slams shut, and the entire room drops down a shaft to the next level of the dungeon, although to delvers isolated in the room it may very well seem that gravity has abruptly gone away.

Put away any images you may cherish of elevators plummeting out of control. Mr. Turnpike, weenie that he is, has even designed a shock absorbing spring for the bottom of the drop shaft to cushion the room's fall. The delvers are now free to leave the room through a corridor every bit as featureless as the one through which they entered, although they will now unknowingly find themselves on a new dungeon level.

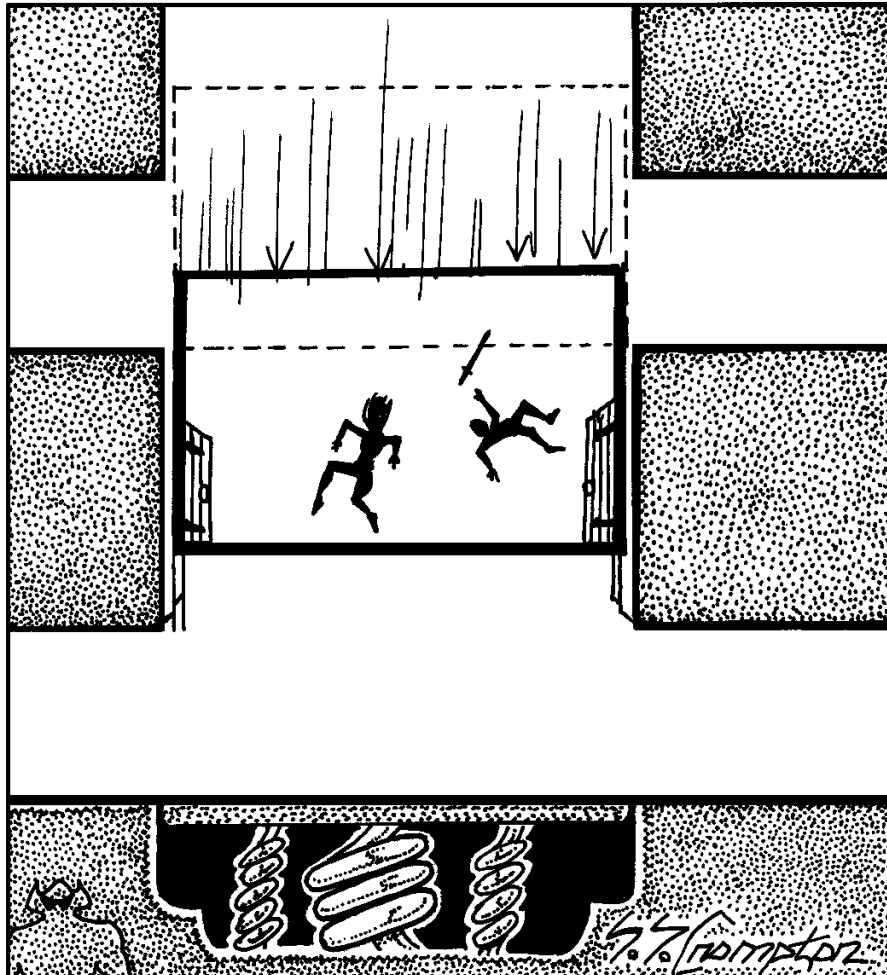

Cyclone the Deadly May-Pole



CR:	3
Type:	Mechanical
Search:	Trap (DC 20), Trigger (DC 20)
Disable Device:	Trap (DC 20, 2d4 rounds); Trigger (DC 25, 2d4 rounds); jamming the door prevents the maypole from rising from the floor.
Primary Trigger:	Timed (door slams shut as soon as someone enters the room)
Primary Trap Effect:	Spinning weights (+15 melee, 1d8 damage, spinning weight); multiple weights. After 5 rounds, the centrifugal force lifts the weights above the PC's heads; no further attacks.
Secondary Trigger:	No trigger; automatic (spinning maypole and weights ignite the oil that gets dumped in the room)
Secondary Trap Effect:	No attack roll needed; weights create sparks that ignite oil that has been dumped into room. Each creature in the room must succeed at a Reflex save to avoid catching fire (see Catching on fire in the <i>DMG</i>).
Secondary Save:	Reflex save (DC 15) to avoid catching on fire.
Bypass:	Don't enter the room!
Reset:	Automatic (after 10 minutes, the oil drains from the room and the maypole and weights sink back into the floor ready to go again).
Cost:	7,000 gp

Molly Ringworm has insomnia, and one night when she was unable to sleep she conceived of this trap. Some of the best traps flow directly from the subconscious when the mind hovers between dreams and waking, as this design clearly attests.

A tall circular room is accessed through one or more corridors. The floor is vaguely slippery, as if oil has recently been spilled on the flagstones. High up on each wall are continuous bands of black stone that look something like flint. The bands are regularly spaced and run all the way around the room as they march toward the ceiling. There appears to be some sort of circular depression directly in the center of the floor.

When anyone enters the room, all the doors slam shut and lock. A tall maypole then rises from the circular depression mentioned above. Hanging from the maypole at several different levels are long chains, at the end of which are heavy steel weights.

No sooner do the characters take all this in than the maypole begins to rotate. Centrifugal force causes the steel weights to fly up and away from the maypole, and in short order the chains and weights are whirling around the room perpendicular to the pole. Unless the party hits the deck in a hurry, someone is going to lose their head.

When the maypole reaches its top speed, the steel weights are brought level with the multiple bands of flint running around the room. Great showers of sparks appear where the weights strike the flint. Then, just when things seemingly can't get any worse, flammable oil begins to gush

from the top of the maypole, showering everyone and everything in the room. Combine the oil with the sparks and the lethal motion of the steel weights, and you have a May Day celebration to remember!

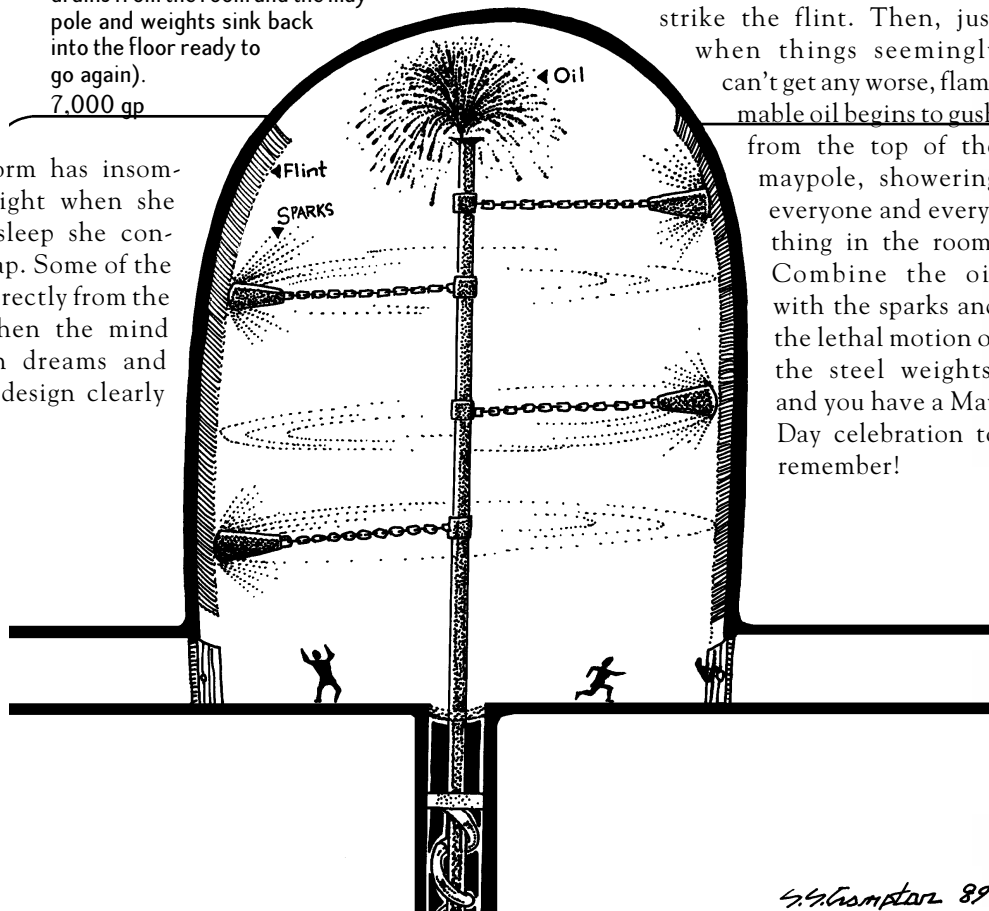

The Kareem Abdul-Jabbar Memorial Sky Hook Trap



CR:	3
Type:	Mechanical
Search:	Trap (DC 22), Trigger (DC 20)
Disable Device:	Trap (DC 22, 2d4 rounds); Trigger (DC 20, 2d4 rounds)
Primary Trigger:	Touch (the doorknob to exit the room springs the trap)
Primary Trap Effect:	No attack roll needed; creature in front of door is tossed 50 feet into net across the room; 5d6 points of damage (2d4 if victim stays calm and recognizes that the skyhook is a gentle shot).
Area of Effect:	Creature standing in 5-foot space directly in front of door.
Primary Save:	Reflex save (DC 20) halves the damage.
Reset:	Automatic
Cost:	3,000 gp

This trap by Molly Ringworm is kind of a weak design, but it is dedicated to one of my all-time favorite humans, and thus deserves a place in my book. Most dungeons already have a gymnasium in the lower levels, so it shouldn't be hard to include this well-deserved tribute somewhere in your tunnel complex.

This room trap takes the form of a basketball court completely filling a room. Door access the court through walls directly under each basket. There is nothing dangerous about the court. If you like, roll out a ball and let the delvers shoot some hoop... maybe even some full court action with a squad of giants is in order.

After the game, any delver trying to exit the room via the door opposite that through which he entered is in for a rude surprise. Turning the doorknob triggers a spring-loaded arm hidden beneath the floor. The arm will quickly shoot from the floor, gently catch the delver in the palm of its mechanical "hand," and launch its victim toward the basketball net on the far side of the gym. The hand is painted gleaming gold and has the cryptic number "33" inscribed in the palm.

Anyone who has ever seen Kareem shoot the Skyhook knows it is the most gentle of shots, and if the character doesn't panic he'll land on the basketball rim with minimal damage (or even pass all the way through, if he's tiny enough). Most characters will thrash about as they fly through the air, however, which will lead to a painful encounter with the backboard. If your victims complain about their treatment at the hands of this trap, you can always threaten them with the Wilt Chamberlain Memorial model—the one that reproduces Wilt's powerful slam dunk from the night he scored 100 points in a single game or perhaps the Shaquille O'Neal Free-throw model, which causes substantially more damage (and then flees to another mysterious plane known as "Miami").

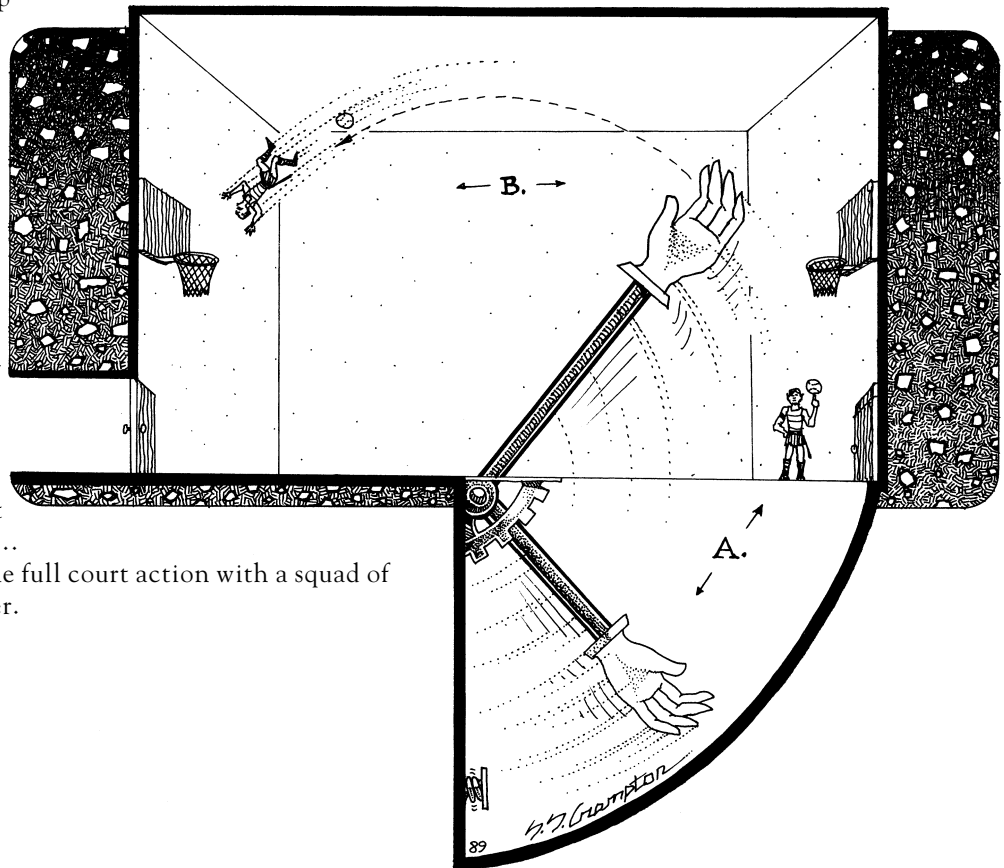

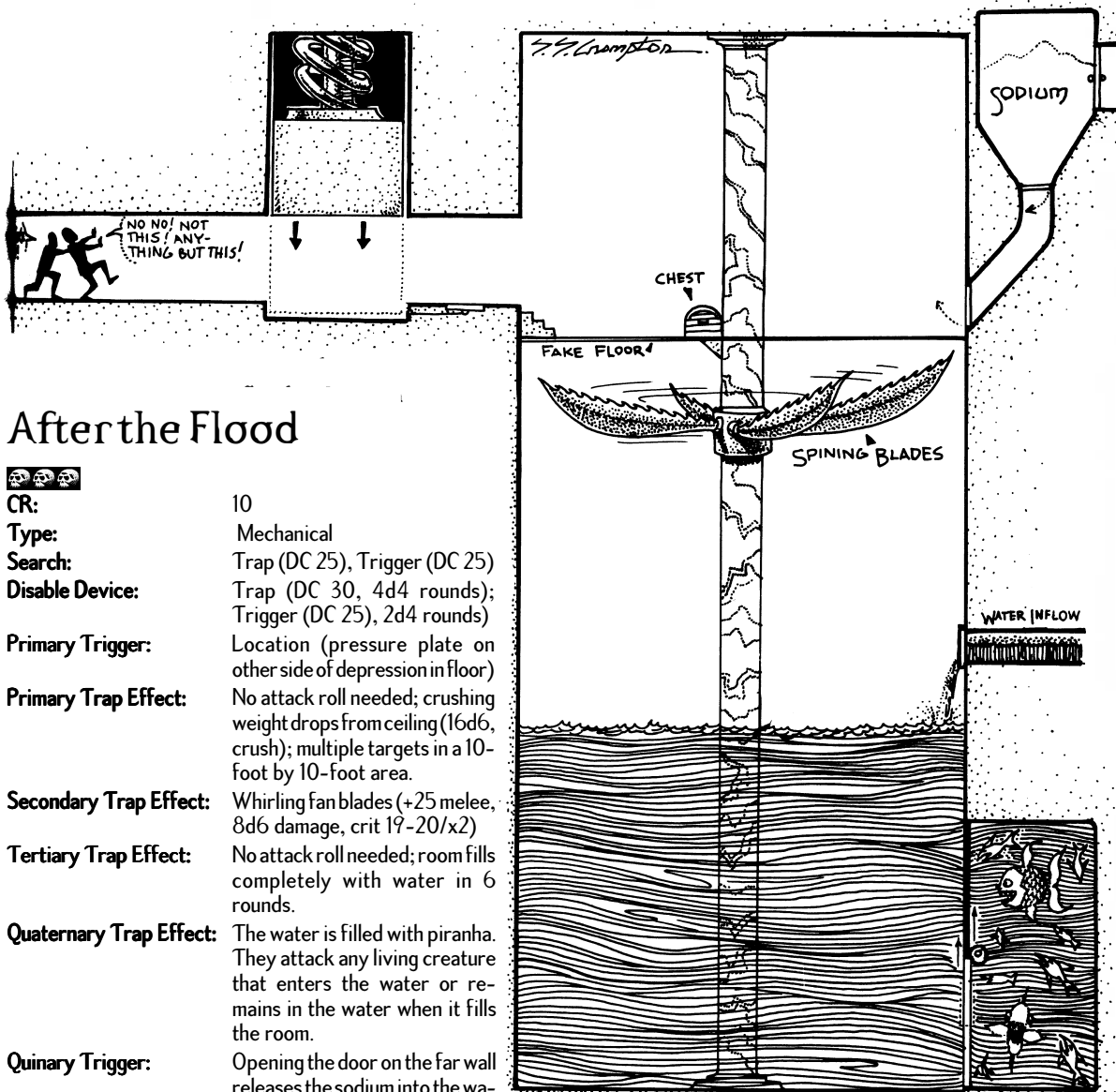

After the Flood



CR:	10
Type:	Mechanical
Search:	Trap (DC 25), Trigger (DC 25)
Disable Device:	Trap (DC 30, 4d4 rounds); Trigger (DC 25), 2d4 rounds
Primary Trigger:	Location (pressure plate on other side of depression in floor)
Primary Trap Effect:	No attack roll needed; crushing weight drops from ceiling (16d6, crush); multiple targets in a 10-foot by 10-foot area.
Secondary Trap Effect:	Whirling fan blades (+25 melee, 8d6 damage, crit 19-20/x2)
Tertiary Trap Effect:	No attack roll needed; room fills completely with water in 6 rounds.
Quaternary Trap Effect:	The water is filled with piranha. They attack any living creature that enters the water or remains in the water when it fills the room.
Quinary Trigger:	Opening the door on the far wall releases the sodium into the water.
Quinary Trap Effect:	No attack roll needed; the sodium reacts with the water and results in a violent explosion; 9d6 points of damage to all those in the room.
Bypass:	Jamming the fan blades allows passage through the blades. This does nothing for the piranha, sodium, or crushing ceiling block however.
Reset:	Repair (floor and sodium); Automatic (ceiling block rises after 1 hour; water recedes after 1 hour)
Cost:	50,000 gp

If you just want to punch the party members' tickets, sink your teeth into this trap, by Chris Hubbard. The trap is obvious from a distance, so if the party gets wiped out they have only themselves to blame.

Locate this trap at the end of any long corridor. Just past the room's threshold the party will see a

shallow trench in the floor.

On the far side of the trench is a trigger mechanism. Stepping on the trigger causes a huge section of wall to fall from the ceiling and settle into the trench, crushing anyone standing there, and ensuring the bulk of the party is not trapped in the room.

The room itself seems featureless save for a single treasure chest. Alert delvers might detect a faint humming, as if a machine were operating near by. The machine is in fact a huge fan blade that whirled into motion when the trigger was activated.

The chest actually sits in the middle of a false floor. The floor can be an illusion, but is less expensive to build it from thin wood or cloth. The chest is supported by a long column that reaches down to the actual floor of this room. The column is also the axle for the fan blade, which whirls about just beneath the false floor.

Anyone entering the room is bound to make this discovery first hand, and in the most painful way possible. After a delver or two has been diced by the blade, everyone will turn their attention to escaping this awful place. There's no getting past that big wall behind them, so the only exit will prove to be a door in the wall across the room... and on the far side of the fan blade.

Anyone waiting around long enough learn the bottom of this room is actually filled with water, and that the water level is rising. The water should be near the level of the chest about the time someone figures how to jam the fan and make it safe to swim across the room.

Safe, that is, provided the predatory fish in the water pose no threat to whoever has to swim across to the door. And even if someone should make it to the door, all they'll find behind it is a chute full of sodium, which will

produce an explosive chemical reaction when it hits the water. After the flood, there should be little left of the party, and all you need to do is replace the false floor to make this trap ready for the next batch of suckers.

Piranha (10): CR 1/4; SZ F Animal; HD 1/2d8; hp 2; Init +2; Spd swim 30 ft.; AC 20 (+8 size, +2 Dex), touch 20, flat-footed 18; BAB/Grp +0/-18; Atk +10 melee (1d2-2, bite); SA frenzy; SQ low-light vision, keen scent; AL N; SV Fort +0, Ref +2, Will +1; Str 6, Dex 15, Con 10, Int 1, Wis 12, Cha 2.

Skills: Listen +6, Spot +6. *Feats:* Weapon Finesse (bite).

SA—*Frenzy (Ex):* If a piranha detects blood in the water, it and all other piranhas within a 90-foot radius go into a frenzy gaining a +2 bonus to attack rolls for 10 rounds.

SQ—*Keen Scent (Ex):* A piranha can notice creatures by scent in a 90-foot radius and detect blood in the water at ranges of up to 500 feet.

The Lighthouse Gem

	CR:	3
	Type:	Combination (Mechanical and Magical)
	Search:	Trap (DC 20)
	Disable Device:	Trap (no disable DC, light must be blocked from touching creature or gem must be removed from light, i.e., knocked or removed from pedestal)
	Primary Trigger:	Location (in path of light beam) and Touch (touching light beam)
	Primary Trap Effect:	No attack roll required (permanent blindness)
	Area of Effect:	Creature touching light beam is permanently blinded (as by the blindness spell).
	Primary Save:	Reflex (DC 25) avoids
	Bypass:	Knock the gem from the pedestal or block natural light from touching the gem
	Circumstance Bonuses:	Placing a shield in front of your eyes or covering your head with a solid metal object (such as a bucket) provides total cover against the trap
	Reset:	Manual (gem must be placed on pedestal if removed and light must be able to touch gem)
	Cost:	5,000 gp (base cost not including cost of gem)

This trap by Dan Lambert is one of those neat theme room traps, where the room is centered on a treasure that is itself a trap. Put this one high up in your dungeon, near the surface where you can get lots of light. A vertical shaft above the room will do the trick, although you could put this one in a genuine lighthouse and it would work just fine.

In the center of a circular, domed room rises a pedestal. Atop the pedestal is a valuable magic ruby. The ruby is silvered on six facets, and slowly turns clockwise. Sunlight entering the chamber from above is reflected through the ruby and stabs out across the room in six arms of slowly turning light. The light appears gentle, but is actually a low-intensity laser. Being struck by one of the beams is enough to damage the optic nerve in the eye, even if your eyes are held tightly shut. Elves and others with acute vision are especially vulnerable.

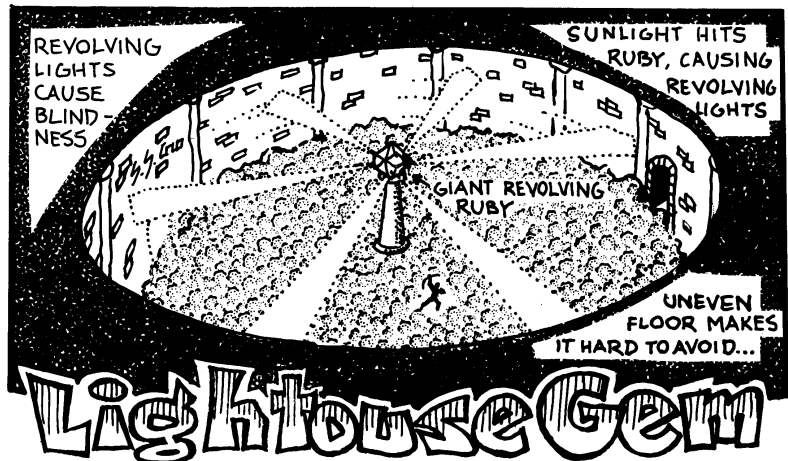

To steal the gem, a thief must enter the room at just the right time, then synchronize his movement with the gem's rotation. An uneven floor makes this more difficult than it might seem. A smart delver might also consider knocking the gem from the pedestal from a distance, or might try to block sunlight from entering the room. If you choose to use this trap, remember to guard

the room at night... unless you elect to make the gem run on moonlight, as well.

The actual value of the gem is set by the DM, but a gem of not less than 1,000 gp is suggested. (Not by Grimtooth however. If it were up to him, he would make the gem nothing more than a fancy piece of glass that looks like a gem.)

A Bridge Too Far



CR: 3

Type: Magical
Search: Trap (DC 27), Primary Trigger (DC 25)

Disable Device: Trap (DC 27, 2d4 rounds), Primary Trigger (DC 25, 2d4 rounds)

Primary Trigger: Touch (press buttons)

Primary Trap Effect: Illusory bridge spans pit. Those stepping onto bridge fall into fire (see below)

Primary Area of Effect: Those that step on illusory bridge

Secondary Trigger: Touch (pressing buttons a third time)

Secondary Trap Effect: Ledge characters are standing on begins retracting into wall and is completely gone in three rounds.

Secondary Area of Effect: Anyone standing on ledge.

Bypass: Press the three buttons again and the bridge is genuine and allows passage.

Reset: No reset

Cost: 6,000 gp

Phil Dean invites us to enjoy a trap for which he cheerfully admits no solution exists. Says Phil, "Can the delvers survive? What, do I have to think of everything?" Attaboy, Phil!

A door lets into a vast room divided by a pit of fire. The party can stand on a ledge just inside the door. A similar ledge projects in front of what is presumably an exit door on the far side of the room, and on the other side of the flames. Accessible from the ledge on which the delvers must stand are three buttons, each identified by a different arcane symbol.

Flying characters find it difficult to cross the pit of fire. Thermal updrafts disrupt flight, while smoke and heat further complicate the process. Even if a flyer makes it across the pit, he'll smack into the permanent *wall of force* protecting the exit door, probably resulting in a dip into the fire. Earth-bound characters will concede their only way across the pit lays in manipulating the buttons.

Each button, when pushed, goes flush into the wall and glows. The sequence is not important, although the delvers will certainly believe it is. Encourage this belief. After any three buttons are pushed, a magic bridge appears, spanning the pit of fire.

The bridge is an illusion. Anyone stepping on the illusory bridge winds up in the fire. Simulta-

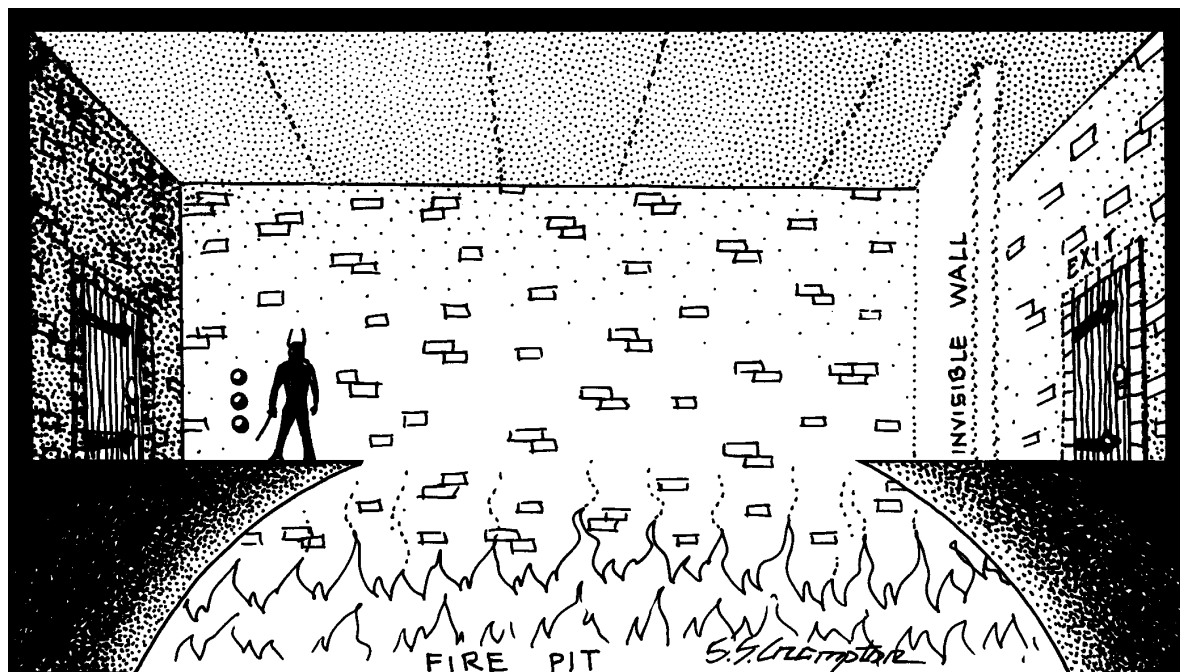

neously, all three buttons on the wall pop out, encouraging a different sequence.

The next time the three buttons are pushed, another bridge appears. This time the bridge is genuine. For half distance. Then it becomes an illusion again, meaning someone is headed for the flames, and the buttons pop out once more.

Anyone left? There won't be if the delvers press the three buttons again. This time the entry door locks and the ledge on which the party stands retract slowly into the wall, threatening to tumble everyone into the pit. Simultaneously, the *wall of*

force guarding the exit door vanishes, meaning delvers can now fly or maybe even leap to safety... though you needn't tell them that. They may well be convinced there's no way across the pit, and that you've stuck them in an inescapable and unfair deathtrap. Oh, boo hoo. I'm really broken up. Honest.

Note: Anyone attempting to fly over the fire takes 1d6 points of heat damage while anyone taking a "fire bath" suffers 2d6 points of fire damage each round and automatically catches fire (see *Catching On Fire* in the *DMG*).

Trollette Talk

Hello? Grimtooth's like, been in a bad mood since the Raiders traded John Gruden for some draft picks. Don't let him bother you. He acts all tough, but he's just a big pussycat. Or maybe

he eats big pussycats. I get confused sometimes.

Oh, wait a minute. We haven't been, like, properly introduced, though you probably saw my picture earlier in the book when I was telling one of those guys from Necromancer Games all about my brother's traps and stuff.

My name is Grimtina. I'm Grimtooth's kid sister. Some of you probably remember me from a book called *Grimtooth's Traps Ate*. I was the 102nd Trap. You don't remember? You didn't call me on my toll-free, uninhibited "900" number? Oh well, your loss. I disconnected my chat



line months ago. Grimtooth made me. He said it wasn't fair to tease boys like I do. He said it wasn't right to demand my suitors mail me their ears as a token of devotion. What's so bad about that? Van Gogh did it, and he's famous, even if he's crazy and mutilated and dead these days. His paintings are still worth a lot, and its money that matters, right?

Anyway, seeing as how Big Brother has stalked off saying he had something to cook up for those idiots from Necromancer Games, I guess it's my job to keep this thing going. Don't worry, I've been watching Grimtooth for years, and there's nothing to this job. Besides, I have a feeling Grimsie will return when he learns the Trollish Bikini Team is helping me present some of the traps. If he doesn't come back then who needs him? You've got little old me and that should be all you silly boys really need.

Stick together and hold hands! Boy, girl, boy, girl. All right, boy, girl, it, boy, girl, it, if you must. Don't mind the invisible chainsaw. I don't use it on my friends.

Grimtooth loves room traps, because he works with an unlimited budget and only a

room trap lets him exercise his unhealthy love of giant lobsters. I know Grimsie said think big, but I prefer to think small. You should see my room. It's in a zillion shades of crimson, decorated with posters of the Dead Kids on the Block and teen idols savaged by wild beasts for Tiger Beat centerfolds. I have my very own Bone Phone, a wardrobe of the cutest mini-skirts and of course more wizards and unicorns than you could shake a stick at. The real thing, of course. No pewter miniatures for THIS girl! If you are very good, maybe I'll let you see my room sometime. But don't count on it. And we'll have to leave the door open, no matter what.

In the mean time, here are a couple of my favorite room traps. Oh, and I didn't want my rooms to have any of those silly skulls. I was thinking of using black hearts or maybe unicorn stickers but I went to find the artist and Big Brother had already fed him to a giant lobster. Oh well, I'll just have to use the skulls. But we can all pretend they are the skulls of dead haughty elf boys who teased me, can't we?

Hole and the Wall Bang

	
CR:	3
Type:	Mechanical
Search:	Trap (DC 20), Trigger (DC 20, door knob)
Disable Device:	Trap (DC 20, 2d4 rounds); Trigger (DC 15, 1d4 rounds or use of <i>universal solvent</i>)
Primary Trigger:	Touch (doorknob)
Primary Trap Effect:	No attack roll necessary (stuck to door as if by an application of <i>sovereign glue</i>)
Secondary Trap Effect:	No attack roll necessary, 1d6 damage from door; 1d4 spikes from wall (1d4+2 each spike)
Reset:	Automatic, 5 rounds; door closes, if victim is not removed, the door slams into the wall spikes again in 1 minute. This cycle repeats itself until the victim is removed from the door or the trap is disabled.
Cost:	9,000 gp

The designer of this next submission signs his letters, "I'm Bob Brown and I'm English." I promise not to hold it against you, Bob, because you sound kind of cute. Besides, I like your trap.

This room belongs on the second or lower level of your dungeon. Upon entering a room, the delvers

will notice four things. First, the north wall of the room is covered with cruel metal spikes. Second, the floor of the room is etched with grooves and scrape marks running north/south, making it seem that the spike wall is mobile. Third, the south wall is pitted with holes such as the spikes might cause, and is bloodstained besides. Finally, there is a hole in the ceiling leading through which delvers stumbling into a pit on an upper level would tumble. Putting it all together, the party will reason victims fall through the hole in the ceiling, and are then crunched against the south wall by the moving wall of spikes. "Fortunately" they avoided the pit when they passed above, and now get to laugh at this crude trap because they've entered through the service door.

Let them laugh. I always get even with boys who laugh at me. Especially haughty elf boys.

Whoever tries to open the door leading out of this room is in for a shock. The doorknob is coated with adhesive, which will bond with whatever touches it. Hopefully, this will be the victim's naked hand. Next, the door is battered open from the north by a powerful spring. The door will slam into the victim, who will be unable to release the doorknob, then bang him against the wall of spikes. That should end the laughter.

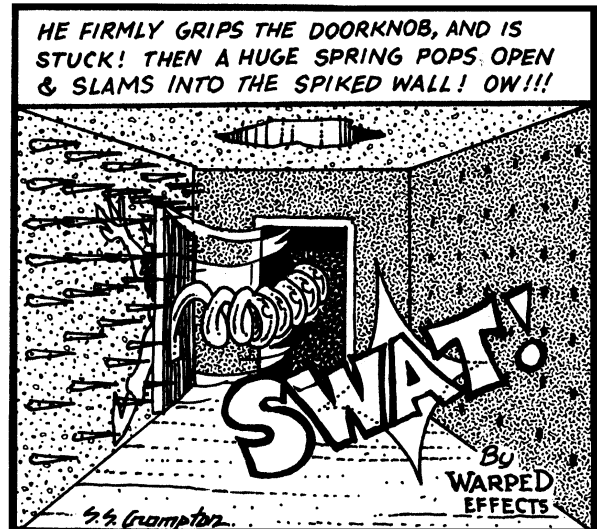
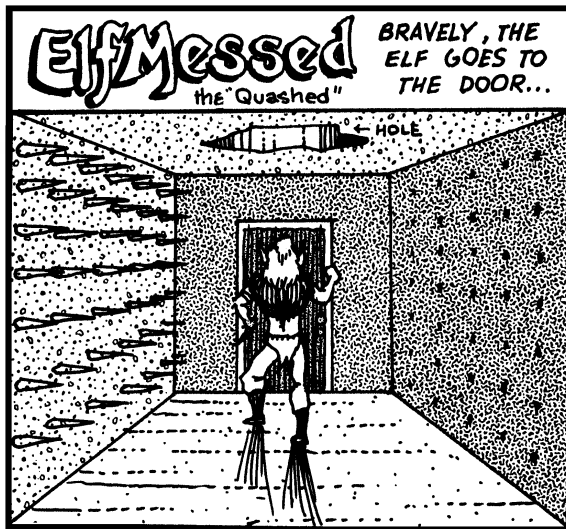

Note: Touching the door with a gloved or otherwise covered hand offers no protection. However, touching it with a hand or item coated in an application of *universal solvent* dissolves the adhesive and does not spring the trap nor stick the victim to the door.

A variant of this trap (if you are feeling particularly evil because Grimtooth is whispering nastiness into your ear) has the spikes coated with poison (most often black adder venom, Fort DC 12, 0/1d6 Str). The CR for this variant is 6.

Oh What A Tangled Web We Weave

	
CR:	3
Type:	Mechanical
Search:	Trap (DC 25), Trigger (DC 10), Bypass (no bypass DC needed, but creatures must deduce that they can use the atomizer to spray the webs and travel safely through room).
Disable Device:	Trap (DC 25, 2d4 rounds); Trigger (DC 20, 1 round if atomizer is used; otherwise 2d4 rounds)
Primary Trigger:	Touch (touching webs releases crossbow bolts)
Primary Trap Effect:	+12 ranged (1d8, crossbow bolt)
Area of Effect:	First creature touching a strand of web in the room releases a crossbow bolt in the area where the webs were touched
Bypass:	Atomizer on shelf outside room
Reset:	Repair
Cost:	6,000 gp

David fills a room with spider webs. Yuck! I hate spiders! Excluding those spiders I've dated, of course. Sitting on a shelf just outside the door to this room is an atomizer. I know what you're thinking — "Guy, not more science! I never pay attention in science!" Well, I felt the same way, but then I found out an atomizer is really just a fancy name for a perfume spritzer. Science guys call them atomizers because they create a fine spray of mist from a reservoir of liquid, like spraying perfume from a bottle. David doesn't say if the atomizer is bejeweled or of precious glass or anything, but in my dungeon you can bet it will be!

Okay, so we got this room full of webs and a handy atomizer on the outside. What's it all mean? Is this going to be on the test? Tripping any of the webs releases a crossbow bolt from hiding, designed to strike whoever triggered the web. If someone blunders about in the web room, they're going to look like a pincushion. If some bright boy hits on the standard notion of burning out the spider webs with a torch, all they'll do is release a wave of crossbow bolts. What to do, what to do?

This is where the atomizer comes in. If sprayed with a fine mist of water, the webs,

David Stevens calls his next trap Oh What a Tangled Web We Weave, which I think is a quote from Shakespeare or maybe President Clinton but I asked the teacher if it would be on the test and he said no so I didn't bother remembering it. I mean, if it's not going to be on the test, why bother learning it, right?

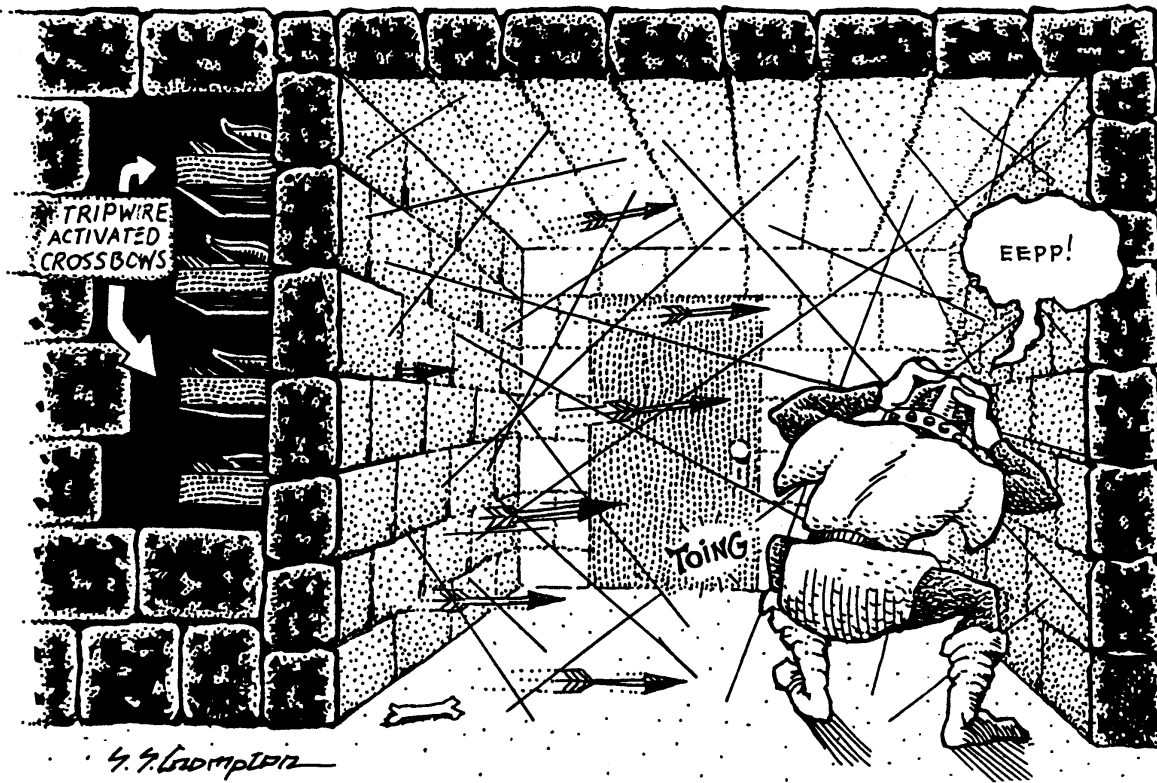

previously near invisible, will now glisten with reflected light. With the webs now clearly visible, the party can make their way through the room without triggering any of the crossbow bolts. If you want to work a giant spider

into this routine, it's up to you, but since I just broke up with one I'm not really in the mood.

Note: Burning or running through the webs releases a hail of 4d6 crossbow bolts (each attacks at +12 ranged).

SECTION TWO: CORRIDOR TRAPS



All right, I'm back. Those troll girls got to me, I must admit. And the lobsters. But don't think for a minute you've found a weakness in Grimtooth's armor! I may be mellowing with old age, but I'm still a mean cuss when I want to be.

Stop sniggering!

Right. What's next? I can't read Grimtina's handwriting. Let's see... Hmmmm. Looking past all the stickers and the black hearts and the "i's" dotted with big open circles, I think I can make some sense of my sister's notes. If this next chapter is a mess, blame Grimtina. What a scatterbrain. Remind me to scatter her brains on the floor when she comes back.

I think this is the corridor chapter. Bear with me. Why? Because I said so, beanhead!

It's all the fault of those morons Clark and Bill from Necromancer Games. If they hadn't showed up poking their noses into things I wouldn't have had to leave Grimtina in charge while I... uh... while I... prepared a "special surprise" for them.

Enough of that, let's get to corridor traps.

Perhaps I was a tad harsh when I suggested that the old saw, "Good things come in small packages," was a lie. Small, after all, is a relative term and can be used to describe anything from a "small" weapon like a stiletto to a "small" disaster, such as two empty seats on a wagon full of wizards going off a cliff. And a "package" is merely something that contains an item or items.

A corridor, therefore, could be considered a "small package" of sorts. If you think about it, it is often filled with delvers packed more tightly than tenpins. If delvers thought of corridors as the passages of death that they are rather than a way to get between one treasure room and the next, they'd never consider cramping themselves so into such a tiny space. One of the main reasons traps work so well in corridors is the fact that, due to the tunnel's dimensions, you have a fairly good idea where the party will be walking, and can plan your horrible devices with a high degree of directional accuracy. Where else can you expect your victims to line up in a neat little row like a sequence of pop-up targets?

So, "small packages" — corridors — can contain "good things" — delvers. And, as another proverb has it, "all good things must come to an end." To achieve that end, herewith, then, are the corridor traps.

No running in the halls!

~ Grimt



DUNGEON of DOOM
TRAPS BAZAAR
TRAPS LITE

TRAPS ATE
TRAPS FORE
TRAPS TOO
TRAPS

WURST of TRAPS

Hop, Skip and a Jump



CR:	10
Type:	Combination (Magical and Mechanical)
Search:	Trap (DC 30), Trigger (DC 30)
Disable Device:	Trap (DC 30); Trigger (DC 30)
Primary Trigger:	Location (jumping over pit and hitting wall)
Primary Trap Effect:	Victim bounces off of a <i>wall of force</i> , glass, or what have you and plummets into lava pit (20d6 submersion damage; 10d6 fire damage for 1d3 rounds after getting out of lava).
Reset:	No reset needed (unless using a glass wall and it happens to get broken or the spell is dispelled)
Cost:	7,000 gp

A popular form of corridor trap is the variety that obstructs or otherwise impedes the party's path of travel. With this in mind, Barry Sullivan developed the Hop, Skip and a Jump trap. The construction is simple. Present the party with a typical trench perhaps 4 or 5 feet across and filled with some disagreeable substance. Tell them that they could probably jump across the pit with a certain amount of effort, but that falling into the substance would be fatal. Do *not* tell them that a permanent *wall of force* stands on the opposite side of the pit!

The first character to attempt the jump is almost certainly doomed. The *wall of force* has nothing to grab onto, and

thanks to gravity and surprise the incident should happen so quickly that the remaining party members won't have a chance to save him before he splashes into the pit. The only way to defeat this trap is to dispel the wall and then jump, or to *teleport* across to a spot beyond the wall.

If you think this trap is too deadly, you can apply a number of variations. For instance, a sheet of heavy glass can go in place of the *wall of force*. This removes all magic from the trap, thus eliminating the chance of a magic-user sensing that there's something on the other side of the pit. Also, the first character to jump the pit may leap with enough force to smash through the glass instead of simply bouncing off it (glass has Hardness 1 and 1 hit point per inch of thickness). The delver suffers 1d4 points of damage per inch of thickness upon crashing through (a Reflex save halves the damage — use whatever DC you feel is appropriate); still, he's in better shape than if he'd fallen into the lava.

If you want to make the trap more insidious (and those nasty delvers certainly deserve whatever abuse you can dish out upon them), you can cover the pit with a trap door designed to give way when a delver treads upon it. Thus, the same pit might get two delvers — the first when the lead character falls in the pit, and the second when the remaining party members attempt to jump over the trench.

Note: If you opt to use something other than a *wall of force* to bounce the characters into the pit (such as a sheet of glass) change the Type to Mechanical only.

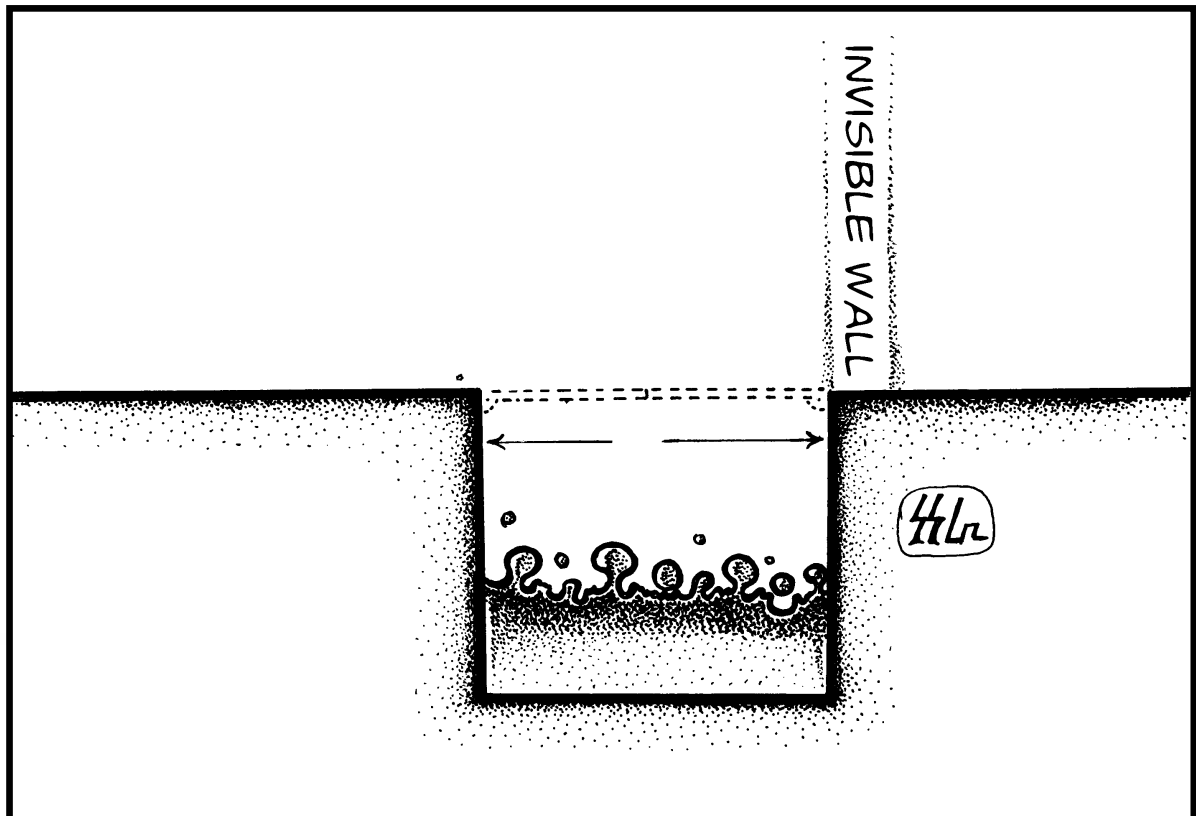

Sectioning Corridor



CR:	1 (plus CR of monster released)
Type:	Mechanical
Search:	Trap (DC 20), Trigger (DC 20)
Disable Device:	Trap (DC 20, 2d4 rounds); Trigger (DC 20, 2d4 rounds)
Primary Trigger:	Location (pressure plate on floor)
Primary Trap Effect:	Walls rotate perpendicular to each other isolating each member of party in a separate section.
Bypass:	Perhaps a hidden switch (Search DC 20) disables the pressure plate
Reset:	Automatic (walls reset after 10 minutes)
Cost:	2,000 gp

Delvers often seek safety in numbers. They walk close together, fight back-to-back, and navigate dangerous locations while roped together. Some of the most interesting combats are those which match individual delvers against one or more monsters. Rick Loomis developed this trap to set up these sorts of one-on-one situations.

The trap is triggered by a pressure plate concealed within the corridor floor. When this plate is stepped upon, the walls of the corridor turn perpendicular to

themselves, isolating each member of the party in a separate section (this can be 5-foot sections or whatever you prefer). You can then release monsters into the separate sections.

Delvers walking side by side when this trap activates will probably wind up in the same section together. That's fine if you like to give delvers a break. If you're properly fiendish, however, narrow the corridor to a width of 5 feet, ensuring that the party must be in single-file formation. In any event, be sure to provide a means of re-setting the trap, allowing the corridor to form up again and provide a way for the party to continue their journey.

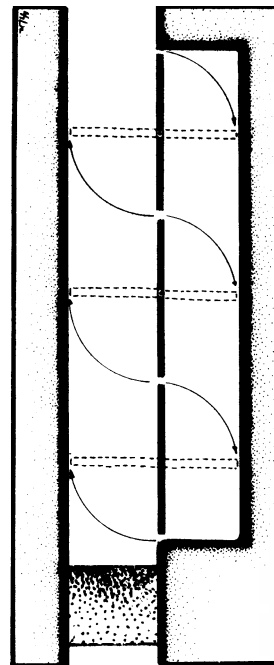

Archer's Tunnel



Charles Scott Kimball offered up a corridor obstruction trap with a twist, to put interest back into vertical ladder chambers.

Originally designed for a dungeon with three or more levels, the trap works best when the party comes upon it from the middle level. The structure of the trap is composed of a ladder shaft, complete with a pit or boiling lava (or some other horrible substance) at its bottom. The ladders may be sturdy or secured only loosely, depending upon how malevolent you feel.

At the top of the shaft stands an archer, his weapon ready. Determine his stats to best suit your needs, but make him fairly accurate. The archer shoots at anyone climbing the ladder (or flying up the chute). Once the adventurers start up, they'll find themselves in a sticky situation — especially if the archer waits until they are midway between levels before shooting, so as to strand his targets between routes to safety. Hard-pressed to retain their grip upon a possibly unstable ladder, the party members will find it hard to return fire or undertake extensive spell casting in their defense.

Notes: Simply use an NPC or monster with a lot of archery feats (Far Shot, Manyshot, etc.) and give it a composite longbow.

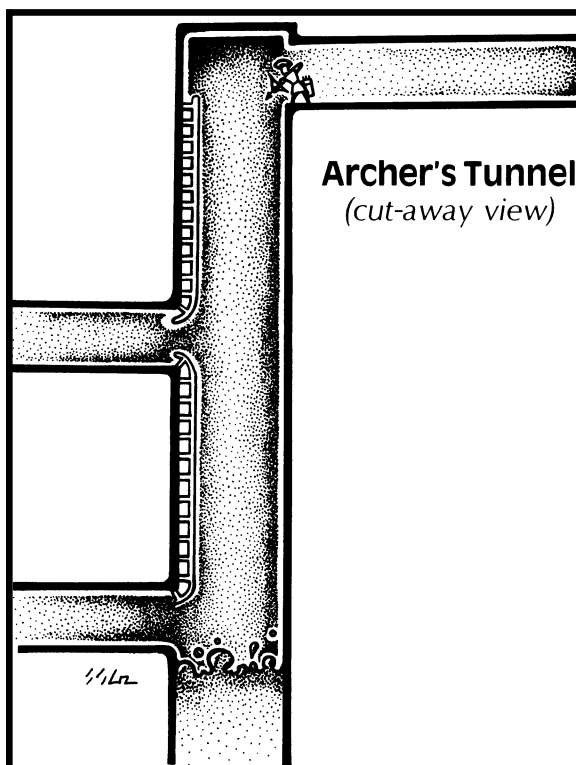

Mirror, Mirror, and the Fall



CR:	8
Type:	Mechanical
Search:	Trap (DC 20); Trigger (DC 20)
Disable Device:	Trap (DC 25, 2d4 rounds)
Primary Trigger:	Touch (touching molten gold)
Primary Trap Effect:	Molten gold (12d6 points of fire damage for submersion; 6d6 points of damage 1d3 rounds after extraction)
Reset:	Noresetneeded(unlessmirrorisbroken)
Cost:	16,000gp(includescostofmoltengold)

This clever trap was designed by Maughn Matsuoka. With the use of a single mirror, it lures characters to their doom.

The delvers enter at one end of a 50 foot long corridor. From what they can see, side passages extend from the left and right a short way in, but it's impossible to determine how long those passages go. The most direct route to the next door is at the other end of the 50-foot corridor. The problem is, the entire expanse — up to a few feet from each doorway — is filled with molten gold. The delvers must find a way to cross the gold before they can continue their journey.

In fact, the far end of the corridor has no door — it's molten gold all the way to the far wall. This little detail is obscured by a mirror that crosses the main corridor diagonally at a *second* set of side passages. Thanks to how the mirror is set, it reflects a side passage to suggest that the characters are looking at a continuation of the main corridor.

Adding to the challenge, a permanent *wall of force* (or perhaps just a normal plate of

metal made invisible by a permanent *invisibility* spell) is placed halfway down the corridor; it stands between the party and the mirror.

The suggestion that there is a door a mere 50 feet straight ahead may encourage some to *dimension door* across. Of course, this lands the caster in the gold. Anyone who doesn't go along sees the unfortunate character or characters vanish, but no one reappears at the other “end” — remember, they're actually looking at a reflection of the side passage! Though they see nothing, they'll surely hear horrible screams as the molten gold does its worst.

A *teleport* spell will take the characters safely to the door shown in the mirror. However, the door is a fake, opening on a stone wall. In fact, *all* the doors are fake — except for the one first used to enter the corridor and the one in the side passage hidden by the mirror. If the party is split at this point, the delvers see each other reflected in the mirror, seemingly at opposite ends of a straight corridor. An alert character may realize that those on the opposite side are shown in reverse (weapons hanging on the “wrong” side of a character's belt, etc.), but the reason for this is not immediately apparent.

The characters must find a way to breach the *wall of force*, then realize that there's something behind the mirror and break it (Hardness 1, 3 hit points) before reaching the only door out. At that point, you might surprise them with some troops awaiting on the landing, making it quite sticky for the delvers to get out safely.

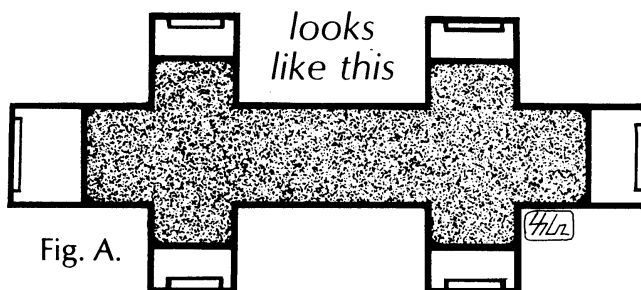

Fig. A.

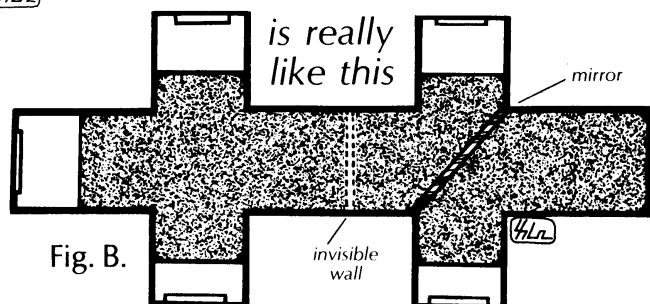

Fig. B.

Magnificent Marble Misadventure



CR:	1 (or higher)
Type:	Mechanical
Search:	Trap (DC 20), Trigger (DC 20)
Disable Device:	Trap (DC 20, 2d4 rounds); Trigger (DC 20, 2d4 rounds)
Primary Trigger:	Touch (disturbing the curtains)
Primary Trap Effect:	Oil-coated marbles (Balance check DC 25 to remain standing on marbles; each round)
Secondary Trap Effect:	Pit trap (1d6 falling damage each 10 feet fallen)
Reset:	Repair
Cost:	1,000 gp or higher

David McConnell submitted this vicious obstruction trap which is sure to slow even the most confident party to a crawl.

The trap is first encountered as a simple, unadorned set of curtains hanging across the dungeon corridor. When these curtains are disturbed or parted, a large door swings down from the ceiling behind the party, releasing a supply of oil-coated marbles onto the floor. The characters will probably have a hard time keeping their footing at this

point, and might even end up falling into the pit on the opposite side of the curtains. (A Balance check at DC 25 to remain standing on marbles each round.)

At the same time the marbles are released from the ceiling, a hopper on the opposite side of the corridor opens, spilling still more marbles onto the floor. The characters may or may not notice this, depending upon how alert they are (Spot or Listen check DC 20).

The delvers are now faced with the problem of getting across the pit, as the door that dropped behind them cannot be budged. The safest way of crossing is for the party to push all the marbles on their side of the pit down into the hole, and then attempt a running jump for the opposite side of the trench. Of course, the marbles on the far side of the pit won't provide much traction for someone attempting to land upon them...

This trap was designed to function regardless of the direction of the party's travel. Thus, by strict function, the trap should spring itself all over again when the party passes the curtain on the far side of the pit. You can ignore or implement this as you please.

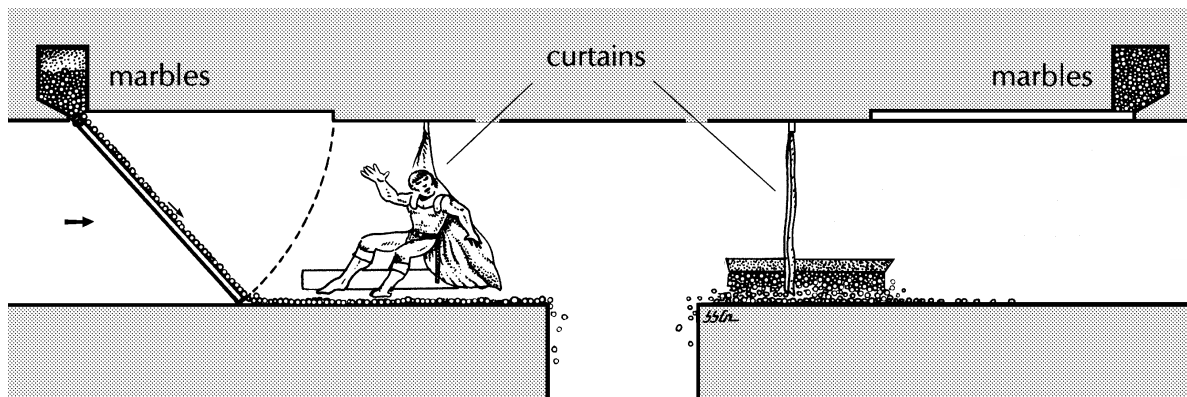

Look Before You Leap



This trap combines magic and monsters to a terrible end. Inform the delvers that they sense magic coming from the corridor ahead of them. A detection spell will reveal a pit beneath the floor, hidden from view by an illusion spell.

The delvers, not wishing to be surprised by whatever lurks in the pit below, will probably cast some sort of magic to dispel the illusion. Lurking inside the pit is a gorgon or some other appropriate monster with a gaze or breath weapon that can be immediately used against the PCs. If you are feeling really evil consider using a bodak....

Gorgon, Medusa or Bodak: See the MM for details.



Trip Wire That Isn't



CR:	1 (or higher)
Type:	Mechanical
Search:	Trap (DC 20), Trigger (DC 20), Bypass (DC 5)
Disable Device:	Trap (DC 20, 2d4 rounds); Trigger (DC 20, 2d4 rounds); Bypass (DC 25, 2d4 rounds)
Primary Trigger:	Location (tilting floor)
Primary Trap Effect:	Floor tilts and dumps characters into whatever evilness the DM has in store (pit, monster pit, cages, etc.)
Primary Save:	Reflex (DC 20)
Bypass:	Tripping the trip wires secures the floor in place
Reset:	Automatic (floor resets in 1 round)
Cost:	2,000 gp

This trap, designed by Mike Stackpole, uses “well-worn” and “common” situations in new and unique ways sure to cause problems for those “seen-it-all-before” delvers.

The main feature of the trap is a standard hinged section offloor, balanced upon a central fulcrum. The floor will give in to the slightest weight; the flipping floor section lets down into a pit, a cage, or to some other horrible fate.

Strung across the corridor on either side of the floor section is a highly visible trip wire. (However, glowing neon lights and flashing arrows would be a bit much.) The wire, when broken, causes two spring-loaded steel spikes to fire into the floor section from the corridor walls, thus securing it for safe passage. If the wire is left intact, of course, the floor section will freely tip as designed.

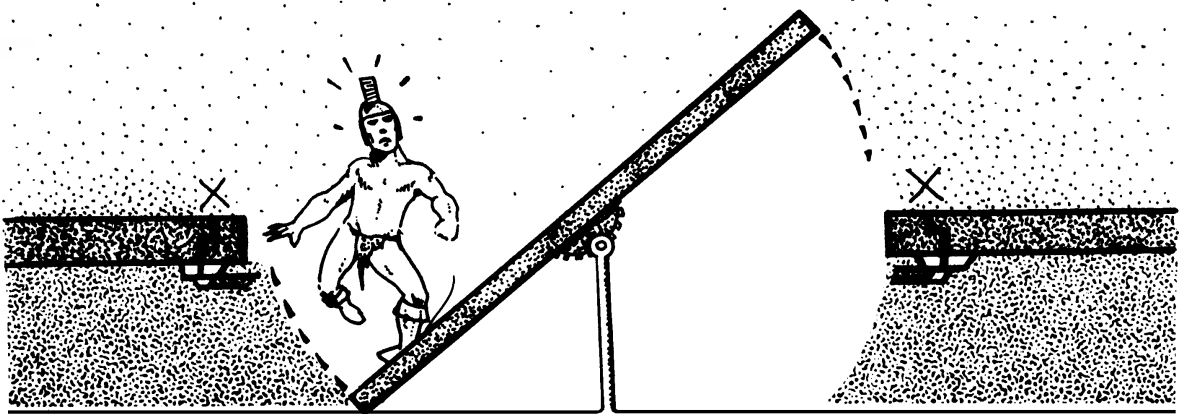

Last Laugh Trap



CR:	10
Type:	Mechanical
Search:	Trap (DC 27), Trigger (DC 27)
Disable Device:	Trap (DC 27, 2d4 rounds); Trigger (DC 27, 2d4 rounds)
Primary Trigger:	Location (pressure plate in ceiling)
Primary Trap Effect:	Crushing ceiling (16d6 crushing damage; multiple targets in 10-foot by 20-foot area)
Reset:	Automatic (ceiling resets immediately)
Cost:	29,000 gp

This Mike Stackpole special punishes eagle-eyed delvers. The basic construction is designed around a tilting section of floor. The floor section operates in the standard way, but the device opens into a pit filled with the debris of former victims — damaged armor and weapons, bones, perhaps a bit of treasure, and maybe even a magical item or two.

The hinged slab of floor should be fairly easy to locate — either by sight or by the fact that it moves when poked with a staff. Thus, the party can “luckily” locate the trap before it’s too late, and (they hope) decide to attempt to recover some of the treasures below.

The actual trap is located in the ceiling, and is activated when the hinged section of floor is tilted at an angle drastic enough to touch the roof of the corridor (as would be caused by some idiot falling into the trap, or by eager delvers who attempt to wedge the floor section into place so as to better recover the treasures below). When the floor section hits the ceiling in this manner, it depresses a pressure plate, causing the roof of the ceiling opposite it (where the bulk of the party is probably standing) to smash down to the floor.

Once the party has been reduced to paste, a clean-up crew will arrive to sweep the delvers’ remains into the pit where they can serve to lure another group to their doom. Tidy traps are the best traps.

Between a Rock and a Hard Place



CR:	9
Type:	Mechanical
Search:	Trap (DC 25), Trigger (DC 25), Secondary Trigger (DC 30)
Disable Device:	Trap (DC 25, 2d4 rounds); Trigger (DC 25, 2d4 rounds), Secondary Trigger (DC 25, 2d4 rounds)
Primary Trigger:	Location (pressure plate on floor)
Primary Trap Effect:	30-foot pit trap (3d6 falling damage)
Primary Save:	Reflex (DC 20) avoids
Secondary Trigger:	Timed (acid burns through rope)
Secondary Trap Effect:	Crushing block falls into pit (no attack roll needed; 12d6 points of crushing damage; multiple characters in 10-foot by 10-foot area inside pit)
Reset:	Repair (rope must be replaced; block must be hoisted back in place)
Cost:	15,000 gp

This trap is a clever variation on the common pit-in-the-corridor trap, and will ensure that characters keep on their toes at all times — or they will lose their toes!

The trap begins with a standard pit in the floor, activated by whatever method you choose. When a character falls to the bottom of the pit, he will find that he is in too deep to climb out on his own.

When the trap door slams down against the side of the pit, it pushes a button recessed into the wall. This button causes a vial of acid to shatter, which rapidly dissolves a wire that runs up through the dungeon wall to secure in place the section of roof above the pit.

The wire dissolves within seconds. As long as weight remains on the floor of the pit, however, the pressure plate therein will ensure that the block of ceiling remains in place. If all the weight is removed, then the ceiling drops into the pit, almost certainly crushing anyone who still remains within.

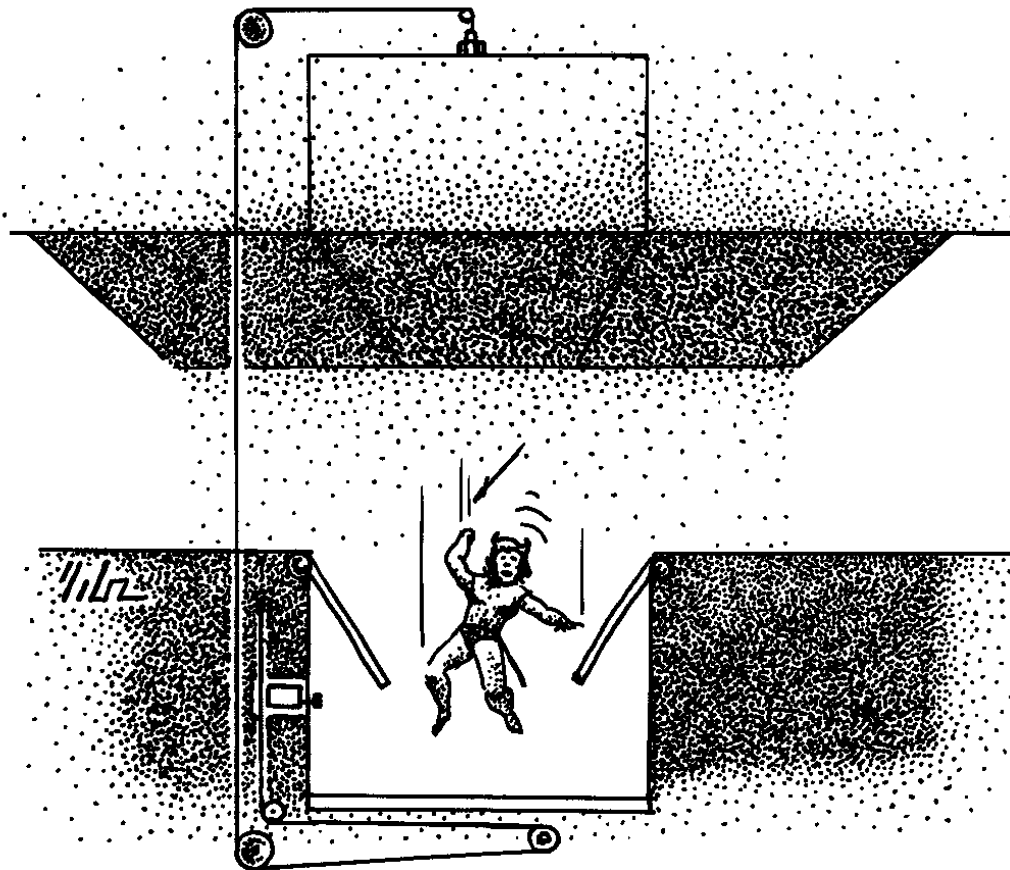

The Greystoke Memorial



CR: 10
Type: Mechanical
Search: Trap (DC 26), Trigger (DC 26)
Disable Device: Trap (DC 26, 2d4 rounds); Trigger (DC 26, 2d4 rounds)

Primary Trigger: Location (swinging across chasm on rope)

Primary Trap Effect: PC slams into pit wall (5d6 points of damage) and triggers secondary effect.

Secondary Trigger: Location (pressure plate on pit wall)

Secondary Trap Effect: Crossbow (+20 melee; 1d4 bolts, 1d6 damage each)

Tertiary Trap Effect: Lava pool (no attack roll necessary; 20d6 points of damage each round from submersion; 10d6 points of damage 1d3 rounds after extraction)

Reset: Repair (must be replaced fired crossbow bolts)

Cost: 60,000 gp

Brandon Corey has designed this trap in answer to the question, "What's a chasm doing in the Death Star, anyway?" I'm not sure what this Death Star is — although it sounds great! — but I am sure that I understand the reason for Brandon's residence in a local mental ward.

The corridor is broken by a huge pit filled with something nasty — monsters, disgusting fluids, or what-have-you. There appears to be no way to cross the pit. Characters may panic at this point if they're being pursued.

Diligent observation will reveal a block-and-tackle device in the ceiling over the approximate center of the pit. With a bit of luck, a delver might be able to cast a rope to find a secure purchase, to allow the party to...

How sickeningly heroic. Anyway, this is where the trap comes into play. The block and tackle itself isn't actually attached to the ceiling — in fact, it's attached to a rope-and-pulley system that will come loose from the ceiling if the full weight of your average dungeon delver hangs from it. The whole tackle assembly will dip sharply down from the ceiling, altering a swinging character's trajectory. Instead of casually clearing the far side of the pit, the delver will slam into the pit wall itself.

To add insult to injury, Brandon has added a battery of crossbow bolts that fire along the delver's projected angle of flight when tension is applied to the tackle device. Mindless overkill, true, but certainly more fun than watching yet another idiot delver act like Douglas Fairbanks.

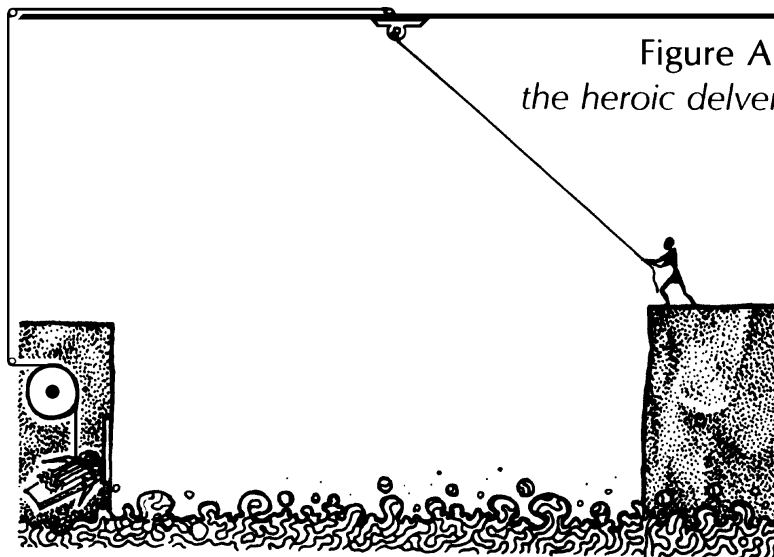

Figure A.
the heroic delver

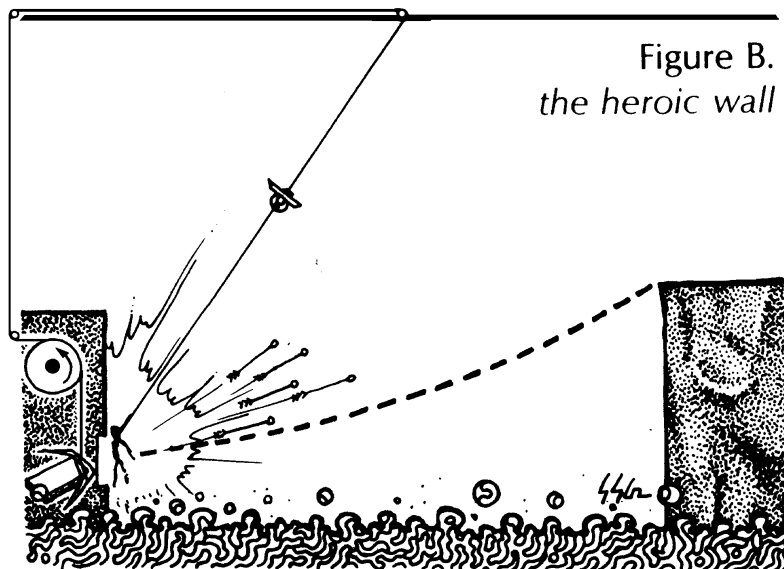

Figure B.
the heroic wall

Ball Bearing Corridor



CR:	2
Type:	Mechanical
Search:	Trap (DC 18), Trigger (DC 18)
Disable Device:	Trap (DC 18, 2d4 rounds); Trigger (DC 18, 2d4 rounds)
Primary Trigger:	Location (stepping on chamber floor)
Primary Trap Effect:	Floor tilts and dumps characters into 40-foot pit (4d6 points of falling damage).
Primary Save:	Reflex save (DC 20) avoids
Reset:	Repair
Cost:	2,200 gp

We can all “thank” Mike Stackpole for this devilish trap. Watch out for that first step...

The trap is a section of corridor that has been hollowed out to form a perfect sphere. A spherical

section of stone has been set within this cavity, balanced upon fine rollers that allow it to spin within the sphere.

As might well be expected, the fitting of the ball within the cavity is tight enough to ensure that the junctions with the hallway will be difficult to detect. The ball is delicately balanced, and a character who steps into it will cause it to tip. You might wish to increase the tension on the rollers so that more than one character can enter the trap before it rotates.

When the sphere rotates, the characters will fall into the pit below. For added effect, place spikes at the bottom of the pit. If you wish to be especially cruel, install automatic crossbows in the upper half of the trap to further bedevil characters trapped in the pit below. Escape can be provided through a trap door in the upper half of the trap.

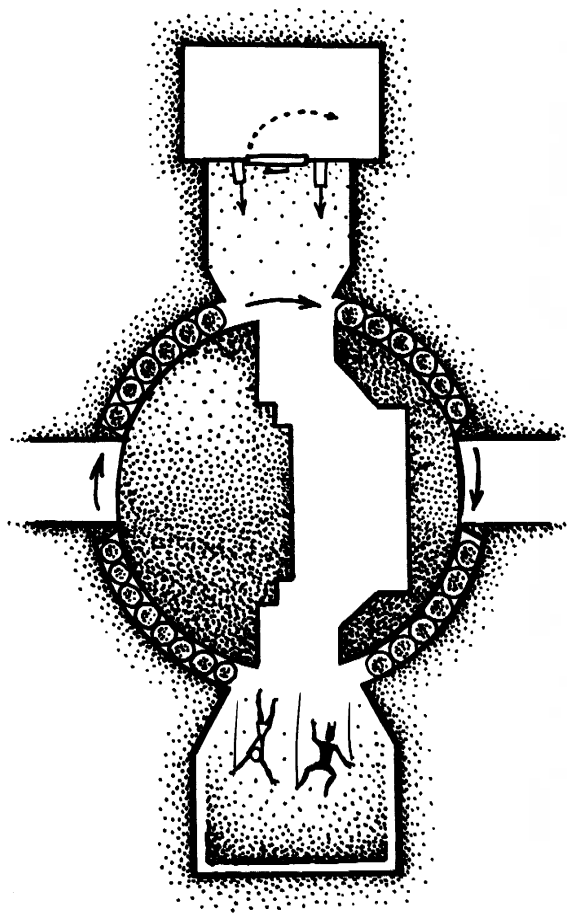
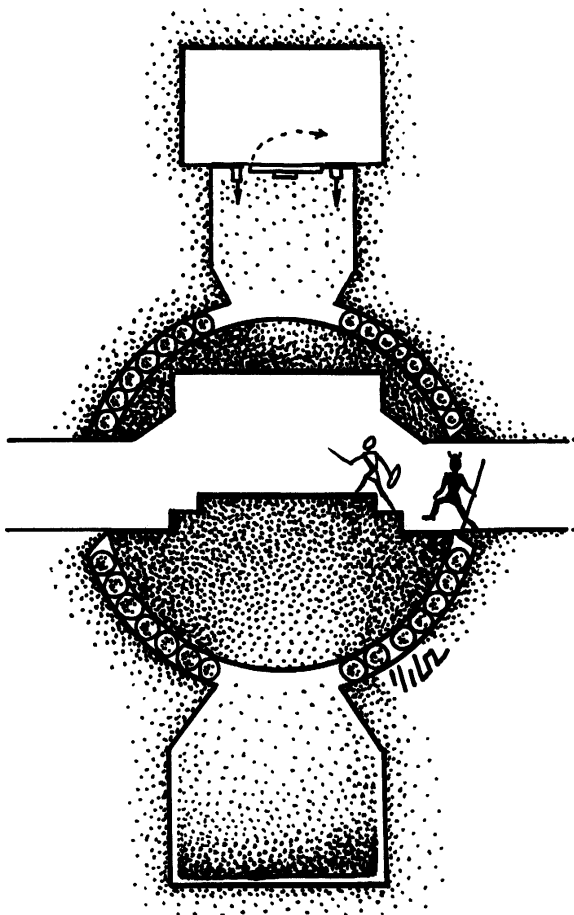

Which Way to the Front?



Another common type of corridor trap is the detour device, which forces the party off their line of advance and on to some alternate pathway against their will. These traps can be especially useful in dungeons where the floor plan allows the characters to wander around aimlessly while avoiding the provided encounters. Traps such as these ensure that the party will “get involved” — whether they want to or not.

A typical example of this trap was provided by Paul O'Connor. Using a simple set of sliding walls (triggered by either a pressure plate or a trip wire), this trap swiftly changes a bare stretch of corridor into a room. Such a room can be occupied by almost anything, but if you should choose to place

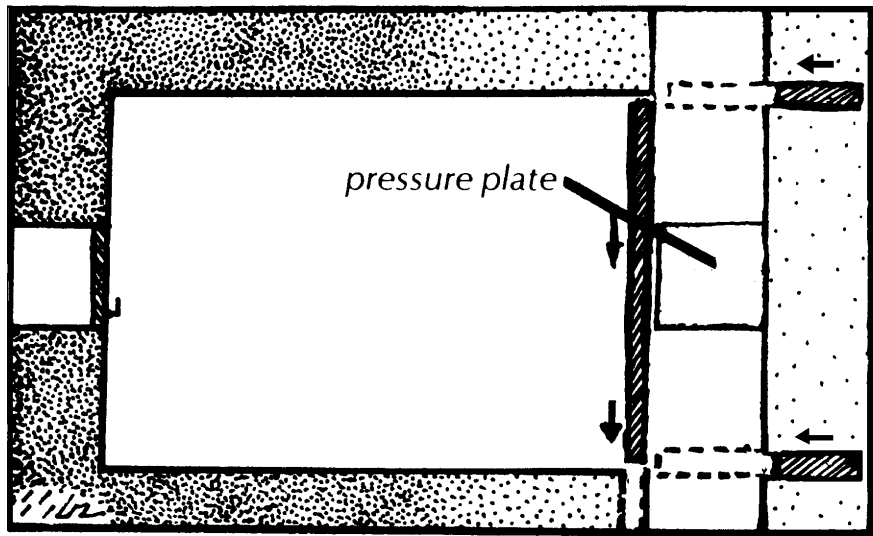

a monster inside, remember that there's an excellent chance the party could be caught flat-footed by the sudden situation change, with potentially fatal consequences. After the party has dealt with the room situation, they are allowed to leave through the door — along a different path than the one they wished.

Chute and Hammer Trap



CR:	2
Type:	Mechanical
Search:	Trap (DC 20), Trigger (DC 20)
Disable Device:	Trap (DC 20, 2d4 rounds); Trigger (DC 20, 2d4 rounds)
Primary Trigger:	Location (pressure plate on pivoting floor)
Primary Trap Effect:	Hammer (2d6 points of damage)
Primary Save:	Reflex (DC 20) avoids
Reset:	No reset needed
Cost:	2,000 gp

A rather violent method of sending delvers to lower dungeon levels against their will was designed by Jason Lujan. The trap activates when the party walks past the pivot point on a plate hidden in the floor. The plate will then tilt down at a 45-degree angle, dumping almost anyone standing upon it into the aluminum chute below. This chute is very narrow; positioned within it is a hammer designed to strike characters in the forehead with considerable velocity as they slide

by. The smaller races might be able to avoid being bashed, but human-sized characters are in for a whopper of a headache.

To make this trap even more deadly than it already is, you could make the chute narrower — ensuring that the characters will fall flat. Then, turn the hammer around so the claw end faces up the chute — this will catch a character under the jaw if he's falling feet-first on his back, or at the base of his skull if he's skidding down on his face. If anyone should survive this treatment, they're free to continue their journey through the lower levels.

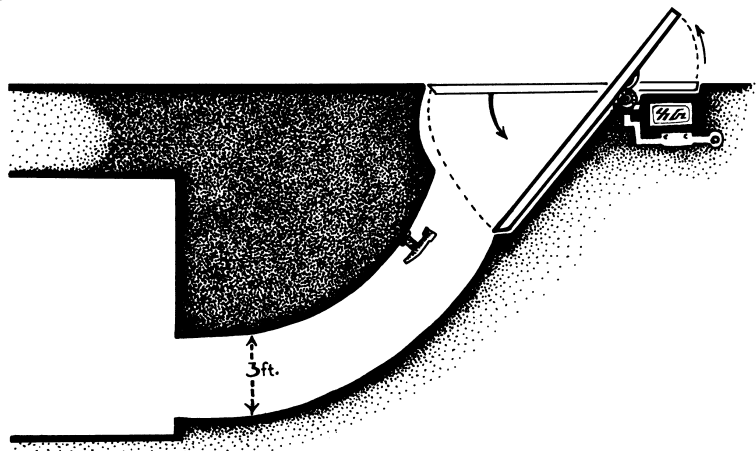

Orfile's Slide of Delver Dumping



CR:	1 (or higher)
Type:	Mechanical
Search:	Trap (DC 20), Trigger (DC 20)
Disable Device:	Trap (DC 20, 2d4 rounds); Trigger (DC 20, 2d4 rounds)
Primary Trigger:	Touch (opening door)
Primary Trap Effect:	Eel oil splashes out and coats floor, ceiling, and wall (Balance DC 50 to remain standing)
Secondary Trap Effect:	Floor tilts and dumps delvers into whatever the DM desires (pit, another room on a lower level, etc.)
Reset:	Repair
Cost:	1,800 gp

Sefan Jones has developed an even more elaborate means of sending dungeon parties plummeting toward the lower levels against their will. This trap is set up in a side tunnel, off the main corridor, and can be located on almost any dungeon level but the deepest.

In its normal state, the slide appears to be a standard side corridor, leading from the main route at a slight incline and ending in a door. When this door is opened, gallons of eel oil (or some other suitable substance) are released. The oil splashes down the length of the corridor, coating the ceiling, floors, and walls, rendering them nearly frictionless (Balance DC 50 to remain standing).

At the same time, a large spring concealed beneath the corridor uncoils, lifting the entire tunnel upwards at a sickening angle. Delvers thus find

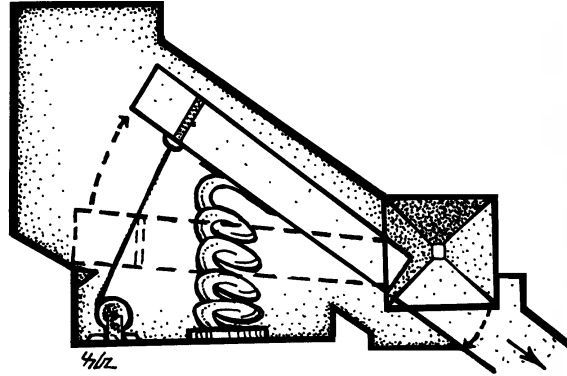

themselves skidding down the length of the corridor at a dismaying speed.

The delvers aren't out of the woods yet. A trapdoor located in the main corridor snaps open when the spring uncoils, forming an expressway to the lower dungeon levels. Characters might have a chance to save themselves by grabbing at the rim of the main corridor as they shoot by — but the effectiveness of this move is left to the DM's discretion. Remember to account for the possible actions of any characters who might be standing in the main corridor, out of harm's way, when all this happens.

Dungeon monsters with a sense of neatness can reset this trap by using the hand winch provided. However, I doubt the characters caught by the trap will even notice this bit of consistency, as this ride usually proves to be a one-way journey.

Mapper Maddener



J. Walker developed a corridor detour trap designed to give mappers fits. The trap is located in a corridor intersection, and is composed of a number of sliding wall sections. The sections are designed to rearrange themselves into various positions, altering the basic shape of the intersection into a "T," a straight section, or even a corridor or dead end. Each time the characters pass by, the configuration will be different, playing hob with any maps the party may be making. Of course, the trap will only

change the intersection when the delvers are out of seeing or hearing range, thus assuring their confusion.

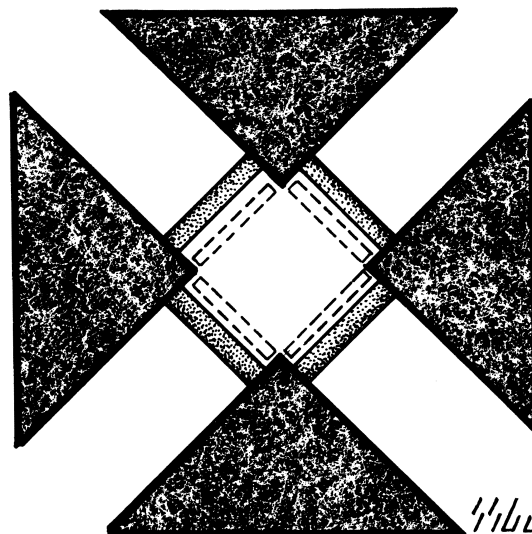

Mapper Maddener

= wall section positions

= pressure plates

Pilum Pacifier



CR:	3
Type:	Mechanical
Search:	Trap (DC 25), Trigger (DC 20)
Disable Device:	Trap (DC 20, 2d4 rounds); Trigger (DC 20, 2d4 rounds)
Primary Trigger:	Location (pressure plate)
Primary Trap Effect:	Spears (+20 melee, 3 spears, 1d8+1 damage each spear, range 200-ft max range). Regardless of the amount of damage taken, the PC is treated as having suffered damage to his feet or legs as detailed in "Variant: Damage to Specific Areas," as detailed in Chapter 2 of the <i>DMG</i> .
Reset:	Repair
Cost:	2,800 gp

The inherent danger presented by a flight of stairs is well illustrated in this trap from John R. Greer. The trap is activated when the lead character in the party steps upon a pressure plate concealed within the trigger step, causing three pilums (spears) to spring forth from the stairs to a distance of 8 to 10 feet. The pilums strike three

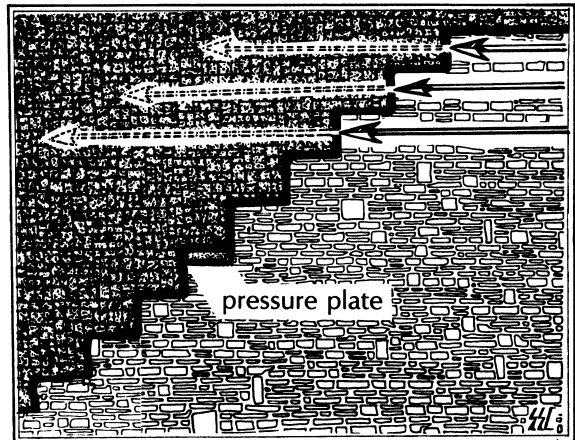

specific area: 3 or 4 feet above the trigger step, an equal distance above the step below the trigger step, and about 4 feet above the step below that. Thus, if a pilum doesn't strike the lead delvers, it may still hit the character who stands next in line. The DM should determine the extent of any damage done to the characters on the stairs, and should take into account exactly where the delver was hit. The construction of this trap, combined with the wildly varying heights of dungeon delvers, makes it possible for a characters to be struck *anywhere* by a pilum.

Folly Flight



CR:	1 (or higher)
Type:	Mechanical
Search:	Trap (DC 18), Trigger (DC 18)
Disable Device:	Trap (DC 20, 2d4 rounds); Trigger (DC 20, 2d4 rounds)
Primary Trigger:	Location (pressure plate)
Primary Trap Effect:	Stairs tilt and dump characters into whatever the DM has awaiting them.
Primary Save:	Reflex (DC 20)
Bypass:	A hidden lever or switch (Search DC 20) locks the stairs in place
Reset:	Automatic
Cost:	1,700 gp

This trap from John R. Greer takes its toll upon parties who venture up a flight of stairs, utilizing a deceptively simple construction to devastating effect.

The section of stair that comprises the trap perfectly matches the rest — but is in reality a carefully balanced ploy. If enough weight is placed on these stairs uphill of the fulcrum, the entire device will swing downward, dumping the party to whatever unkind fate the DM has waiting below.

Exactly when this trap is triggered is a matter of logic and discretion. If a single character navigates the stair, he might feel a shifting beneath him as a forewarning when he crossed the fulcrum. Depending on his speed, he might actually recover in time to retreat back over the

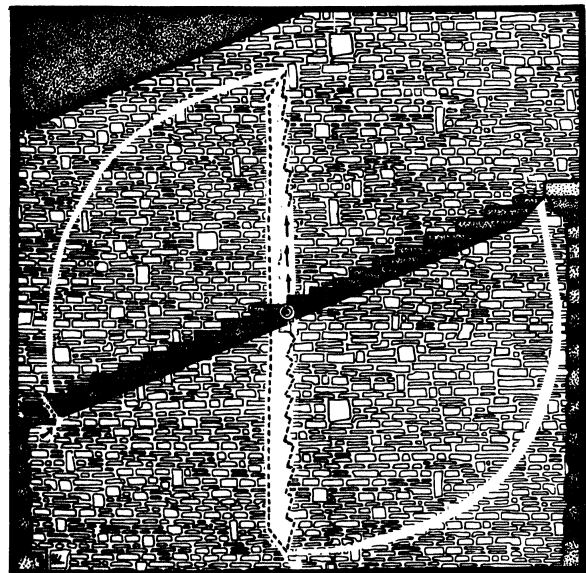

pivot point. If the character was running, the chances of his doing this are very slim.

If an entire party moves along the stair, the weight won't begin to shift until the bulk of the procession has crossed the pivot point. How radical the shift of weight is will determine the speed with which the stairs drop away.

Note that the stairs are supported only at their down-stairs end. Thus, a character who sets foot upon the trap from upstairs would instantly trigger this device.

See-Saw Corridor



CR:	6
Type:	Mechanical
Search:	Trap (DC 21), Trigger (DC 21)
Disable Device:	Trap (DC 21, 2d4 rounds); Trigger (DC 21, 2d4 rounds)
Primary Trigger:	Location (pressure plate in floor)
Primary Trap Effect:	Corridor tilts and drops PCs 60 feet into spiked wall (now floor); 6d6 falling damage, +20 melee, 1d4 spikes, 1d4+5 each spike
Primary Save:	Reflex (DC 25) avoids and allows character to jump clear before corridor tilts
Bypass:	A hidden switch perhaps locks the corridor in place (Search DC 20)
Reset:	Manual (hidden switch resets the corridor)
Cost:	5,000 gp

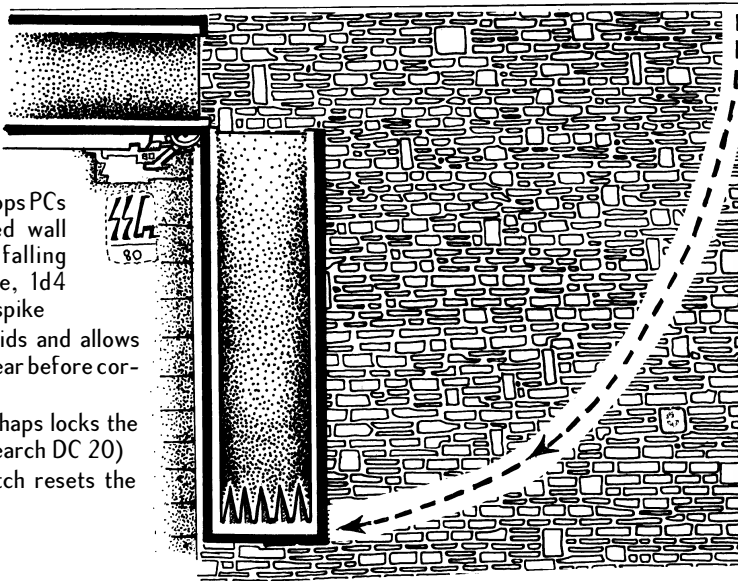
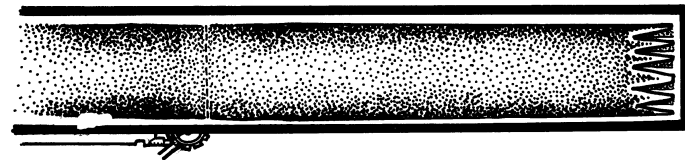

An especially fiendish corridor trap by John T. T. Logenbaugh could prove to be the death of even the toughest characters.

The trap works best in unlit corridors, to conceal the spikes that will eventually lead to the delvers' doom. The trap is similar to "Folly Flight" in that a significant amount of weight must move past the pivot point to trigger it, but the consequences are a bit more sinister. In a matter of seconds, the corridor that had provided safe

passage becomes a deadly drop-shaft! The specifics of the damage cause by this trap are, of course, left to the Game Master, but the compounded menace of a long fall and impalement will probably do most characters in. If you really want to be vicious, increase the length of the tilting portion of the corridor so that the spikes at the end are beyond the average range of darkvision or magical light.

Supercharger Crawlway



CR:	4
Type:	Mechanical
Search:	Trap (DC 25), Trigger (DC 22)
Disable Device:	Trap (DC 25, 2d4 rounds); Trigger (DC 25, 2d4 rounds)
Primary Trigger:	Touch (touching rubber wheels)
Primary Trap Effect:	Wheels fire victim into wall of spikes about 20 feet away (2d6 damage; +20 melee, 1d6 spikes, 1d4+6 damage each spike)
Reset:	No reset needed
Cost:	20,000 gp

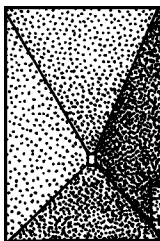

The crawlway is just large enough to permit passage of a normal-sized human being. The fit will be very tight, and the delver will find it impossible to turn around. Near the end of the crawlway, the character will discover a number of rubberized wheels that barely protrude into the passage through the ceiling and floor.

If the character continues, his pressure upon the wheels will trig-

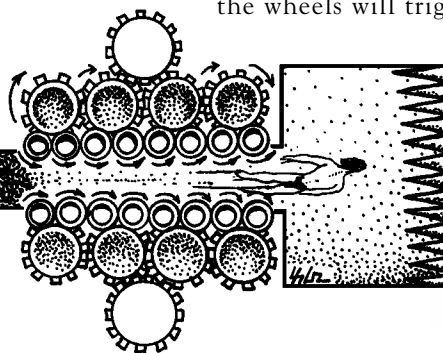

Paul O'Connor has designed a corridor trap that uses spikes to grim effect. Located in a low crawl space off the main dungeon corridor, this trap should provide a fatal surprise for anyone foolish enough to venture within.

ger the trap. The primary gears begin to turn at a terrific rate, shooting the helpless character through several feet of corridor and into the room beyond. Traveling at a speed of approximately 60

miles per hour, the character bursts into the room and encounters a wall of spikes. If there lives a character who could withstand such ghastly punishment, I certainly wouldn't want to meet him.

The Rolling Stone



CR:	2
Type:	Combination (Magical and Mechanical)
Search:	Trap (DC 20), Trigger (DC 20)
Disable Device:	Trap (DC 20, 2d4 rounds); Trigger (DC 20, 2d4 rounds)
Primary Trigger:	Location (pressure plate)
Primary Trap Effect:	Illusory ball released from wall in corridor
Secondary Trap Effect:	Poisoned wallspikes (no attack roll necessary; 1d6 spikes, 1d2 damage plus poison [1d2 Dex/1d2 Dex] each spike)
Primary Save:	Fortitude save (DC 15) resists poison
Reset:	No reset
Cost:	2,000 gp

Rick Bourgeois is fond of this corridor-murder trap. It presents the party with an enormous stone ball bouncing down the center of the corridor. To avoid this threat, the delvers will (naturally) throw themselves flat against the corridor walls.

Unfortunately for the delvers, the corridor walls are covered with many small, poison-coated spikes. Such a surface can prove very uncomfortable to an unarmored character.



The only way to defeat this trap is to either wear clothing of sufficient thickness to thwart the spikes, or to step into the stone ball. The ball, after all, is simply an illusion, and will vanish upon contact.

The Smashing Floor Trap



CR:	9
Type:	Mechanical
Search:	Trap (DC 26), Trigger (DC 26)
Disable Device:	Trap (DC 24, 2d4 rounds); Trigger (DC 24, 2d4 rounds)
Primary Trigger:	Location (pressure plate in floor)
Primary Trap Effect:	Spring-loaded floor slams into ceiling (no attack roll necessary; 12d6 crushing damage)
Primary Save:	Reflex (DC 25) avoids
Reset:	Automatic
Cost:	12,600 gp

A distinguishable sub-class of the "corridor murderers" type of trap is the "step and die" variety. Traps of this type are uniformly activated when someone treads upon their trigger mechanism. These traps respond directly to the delver — usually through a direct extension of the trigger mechanism itself, rather than a mundane caving in of the ceiling upon the party's heads (or some similar fate).

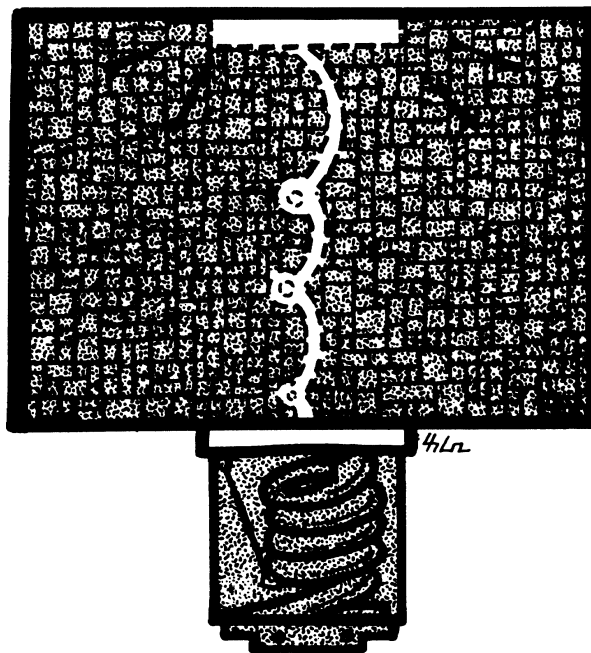

Due to their construction, traps such as those, which follow, lend themselves well to a variety of locations beyond corridors and tunnels. With little or no modification, the step-and-die traps will function as well within rooms or treasure chambers.

This trap by John T.T. Longenbaugh is a basic example of the step-and-die trap. The trap is acti-

vated by a pressure plate, designed to cut loose when at least 75 pounds of pressure is put upon it.

When the trap is sprung, a tightly coiled spring sends the entire floor section slamming against the ceiling. Most anyone caught by this trap is a goner — or, to quote John: “The person can be mailed to the funeral using only one stamp.” Of course, John made this comment before the postal rate increase...

Whirling Blade Boot Bloodier



CR:	2
Type:	Mechanical
Search:	Trap (DC 20), Trigger (DC 20)
Disable Device:	Trap (DC 20, 2d4 rounds); Trigger (DC 20, 2d4 rounds)
Primary Trigger:	Location (pressure plate)
Primary Trap Effect:	Slicing blade (+15 melee; 1d4 points of damage); victim takes a –2 circumstance penalty on all checks requiring the use of his legs until he heals naturally, receives magical healing, or receives a DC 15 Heal check. See Variant: Damage to Specific Areas in Chapter 2 of the <i>DMG</i> .
Reset:	Repair
Cost:	2,000 gp

Using the classic principle of transforming a child's toy into an engine of death, Mike Stackpole developed this trap. Propeller toys were never so cruel.

The trap is activated when a delver steps upon a pressure plate. Set below the plate is a long iron screw. Set at the base of the screw is a spring-loaded razor-edged device that looks very much like a wing nut.

For this trap, the flooring should be of tile or flagstone. The length of each of the wings on the

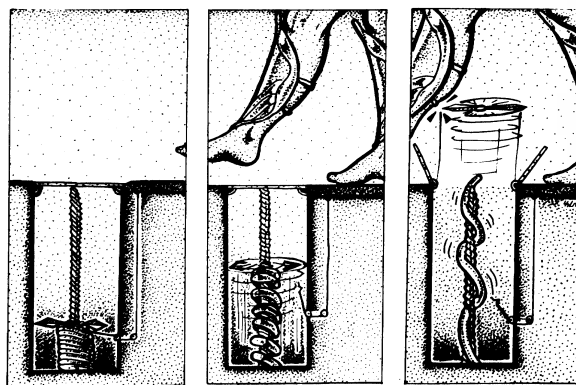

Figure 1

Figure 2

Figure 3

wing nut should be just short enough to allow the knife to spin freely inside the hole without striking the sides of the shaft.

When the trap is activated, the spring forces the whole nut assembly up the length of the screw with split-second precision. The nut completes its flight by bursting through the false tile above it and (with any luck) cutting into the character who stands above.

The consequences of this trap are almost certain to be crippling. After being hit by this device, a character will probably find it impossible to walk.

First Step Trap



CR:	5
Type:	Mechanical
Search:	Trap (DC 22), Trigger (DC 22)
Disable Device:	Trap (DC 22, 2d4 rounds); Trigger (DC 22, 2d4 rounds)
Primary Trigger:	Location (pressure plate)
Primary Trap Effect:	Keen-edge razorblades (+20 melee, 1d4+4 damage; crit 19–20/x2). Use Variant: Damage to Specific Areas in Chapter 2 of the <i>DMG</i> .
Reset:	Automatic
Cost:	20,000 gp

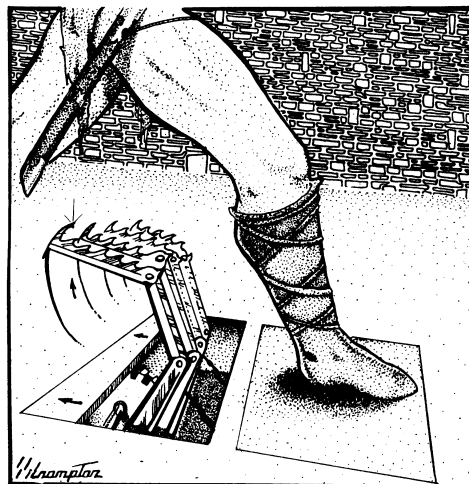

Another device that should prove rough on legs comes from Lara Abrash. This trap is sure to make character look before they leap.

The traps' construction is as simple as it is devastating. When a character steps upon a

pressure plate, the tile slides away. A rack of barbed, razor-sharp blades flips forward, cutting into the back of the leg and heel — perhaps even severing the foot entirely.

Crossbow Thirteen



CR: 6
Type: Mechanical
Search: Trap (DC 24), Trigger (DC 24)
Disable Device: Trap (DC 28, 2d4 rounds); Trigger (DC 24, 2d4 rounds)
Primary Trigger: Location (pressure plate)
Primary Trap Effect: Giant crossbow (+20 melee, 3d8+4 damage)
Secondary Trap Effect: 12 crossbows (+20 melee, 1d8 damage; multiple targets within a 10-ft radius of giant crossbow)
Reset: Manual (crossbows must be reloaded)
Cost: 36,000 gp

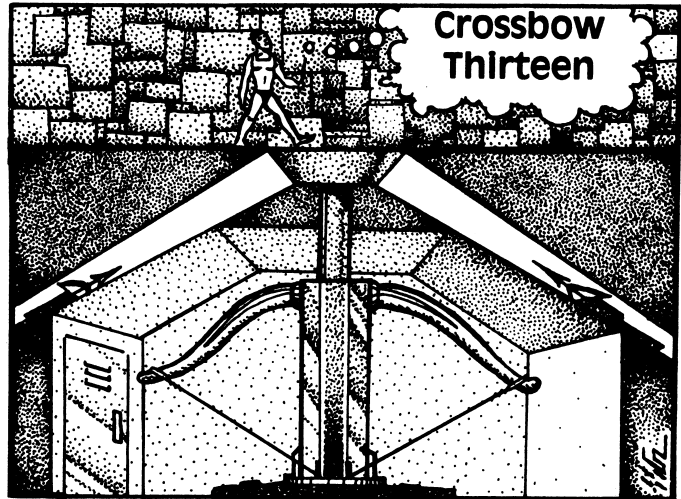

floor will fire, launching its quarrel (and the chunk of flooring at its head) up toward the ceiling. This may or may not clip the character who actually stepped on the “mine,” but it will almost certainly hit the next delver in line.

The worst is yet to come. After the main crossbow has fired, twelve standard cranequins open up from a sequence of shafts placed in a circle about the main quarrel. This “shrapnel” flies north at about a 17-degree angle to the floor. These arrows might strike anyone standing within 12 feet of the trap.

Another evil corridor trap was developed by John R. Greer. This devilish device is so named because it employs no less than 13 individual crossbows to achieve an effect roughly equivalent to an exploding land mine. This trap is a wonderful example of the kind of outrageous overkill and ruthless violence found in some of the most delightful traps.

When a delver steps upon a designated section of floor, the giant, loaded crossbow beneath the

Stair Snare



CR: 2
Type: Mechanical
Search: Trap (DC 20), Trigger (DC 20)
Disable Device: Trap (DC 20, 2d4 rounds); Trigger (DC 20, 2d4 rounds)
Primary Trigger: Location (pressure plate)
Primary Trap Effect: Spikes (no attack roll necessary; 1d8 spikes, 1d2 points of damage each spike). The real damage comes when the victim attempts to dislodge his foot from the trap (1d8 spikes, 1d4 damage each spike). Use Variant: Damage to Specific Areas in Chapter 2 of the *DMG*.
Reset: Repair
Cost: 1,600 gp

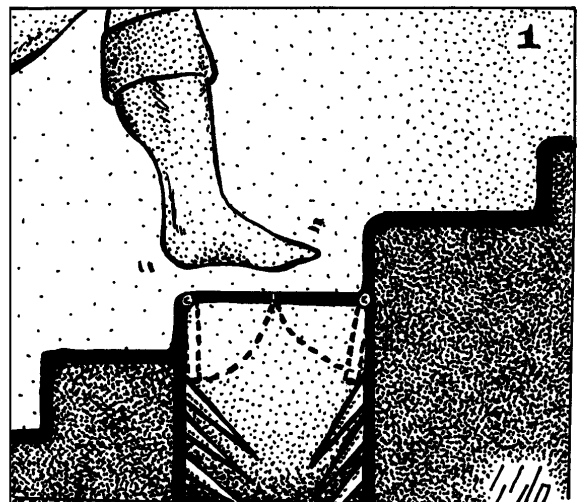

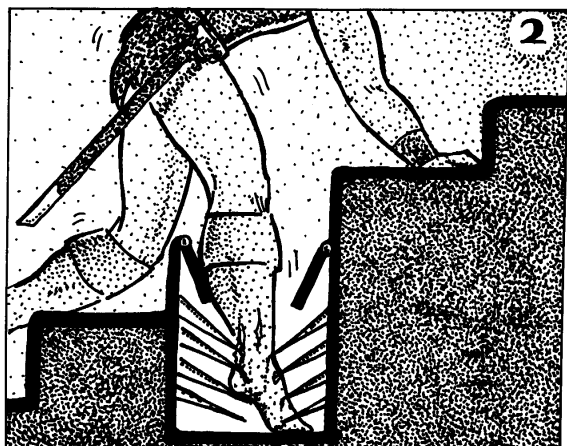

This is a simple trap submitted by Mark O'Green and Edward Schoonover. It works especially well if placed in a location frequented by wandering monsters, or within a room that is filling rapidly with water. The character, probably trapped, will thus have even more to deal with than the pain that the snare offers.

The trap is encountered when a character set foot upon a false section of stairway. The step gives way, allowing the foot to pass through to become ensnared in the barbs below. While the foot will probably pass into the step without suffering excess damage, pulling it out again is another story altogether — especially if the character is in a hurry.

Hero Sandwich



CR:	2
Type:	Mechanical
Search:	Trap (DC 20), Trigger (DC 20)
Disable Device:	Trap (DC 20, 2d4 rounds); Trigger (DC 20, 2d4 rounds)
Primary Trigger:	Location (pressure plate)
Primary Trap Effect:	Floors swing up into victim's head (+15 melee; 4d6 points of damage). Use Variant: Damage to Specific Areas in Chapter 2 of the <i>DMG</i> .
Reset:	Automatic
Cost:	4,000 gp

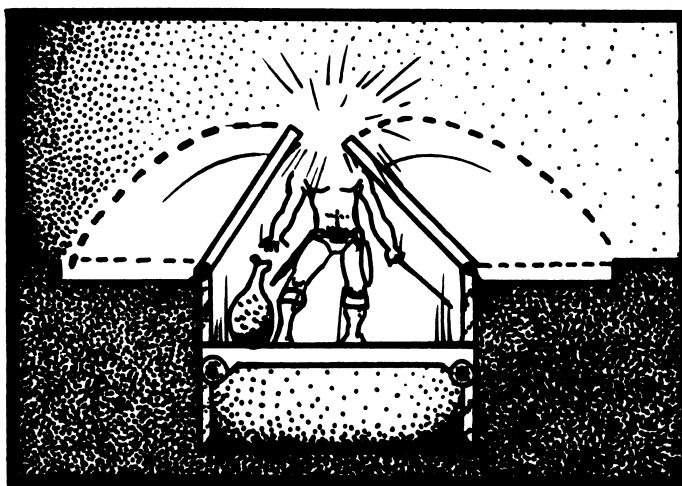
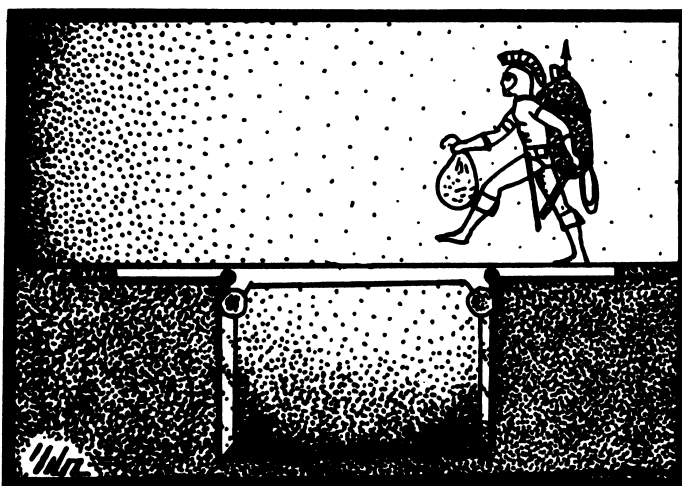

Mark O'Green and Edward Schoonover developed this trap. It's really very simple. Cover a shallow pit with a pressure plate. When a delver steps upon this plate, his weight causes the plate to fall, bringing hinged sections of the same plate together in a slapping motion in the approximate region of the delver's head. Add a tomato, a pickle, and perhaps a bit of lettuce, and you're ready for lunch. Pass the ketchup.



Piano Floor



CR:	2
Type:	Mechanical
Search:	Trap (DC 20), Trigger (DC 20)
Disable Device:	Trap (DC 20, 2d4 rounds); Trigger (DC 20, 2d4 rounds)
Primary Trigger:	Location (floor)
Primary Trap Effect:	Keen-edge razorblades (no attack roll necessary; 1d4+2 damage, crit 19–20/x2). Use Variant: Damage to Specific Areas in Chapter 2 of the <i>DMG</i> .
Reset:	Automatic
Cost:	6,000 gp

This trap, by Liz Danforth, is a scream.

Place between the slats of a tile or wooden-slat floor a number of extremely sharp, long razors. Beneath each slat should be placed a spring that will depress when the corresponding floor section is stepped upon. The result is a painful one.

For best effect, this section of floor should be located in an area that's likely to accept a sudden, great weight: at the base of a balcony (where someone is likely to land if he jumps), or in a section of hallway through which someone is likely to run (as if pursued).

The Flesh Pot



From Pat Mueller, this technically isn't a "step-and-die" trap; more accurately, it's a "step-and-stick" device. This trap is simply a pot of sticky goo. Place the mouth of the pot in most any convenient place, where it will receive a limb—beneath a false section of floor, or deep within a hole that someone is likely to reach into. The goo adheres to the delver's flesh instantly. The pot can be pulled from its hiding place, but the limb cannot be pulled from the pot!

Flesh Pot: Treat the adhesive as an application of *sovereign glue*; only removable by an application of the universal solvent.

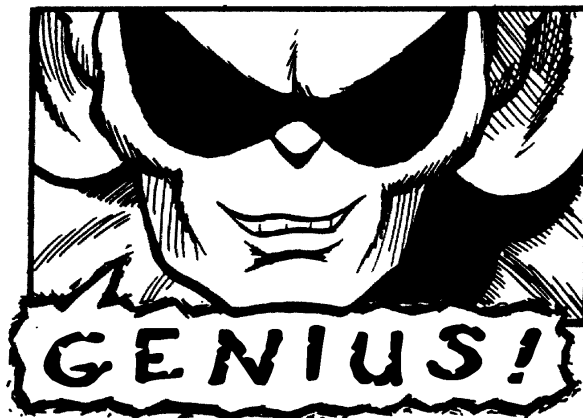

Shower of Gold



CR:	10
Type:	Mechanical
Search:	Trap (DC 25), Trigger (DC 25)
Disable Device:	Trap (DC 20, 2d4 rounds); Trigger (DC 20, 2d4 rounds)
Primary Trigger:	Event (pulling the release lever)
Primary Trap Effect:	Floor tilts and spills characters into pit (1d6 points of falling damage). Gold coins rain down on characters in the pit. Characters hit by the shower (those failing a save) take 16d6 points of crushing damage.
Primary Save:	Reflex (DC 25) to avoid falling in pit

Reset:	Repair
Cost:	30,000 gp (does not include the cost of the gold coins)

As Mr. J.E. Todd points out, most delvers kill the monsters and then take their treasure. This trap turns the tables on this familiar scene, letting the treasure kill the delvers and then the monsters take their bodies....

The trap is actually quite simple. In the wall of the corridor is set a lever; posted nearby is a sign that clearly reads "Treasure Vault Release." The

trap is set in motion when some fool actually pulls the lever.

Pulling the lever releases the catch-pins that secure this section of corridor, allowing it to split in two and collapse into the pit below. This forms a sort of funnel, which will neatly channel the

4620 cubic feet of gold coins that were hidden in a hollow above the corridor. Assuming gold weighs about 1000 pounds per cubic foot, we're talking about 4,620,000 pounds of gold here...

Of course, all this gold has to flow through a 4-foot by 4-foot opening, which just *might* give the hapless delvers a chance to avoid the shower.

Acid Rain



CR:	1
Type:	Mechanical
Search:	Trap (DC 20), Trigger (DC 20).
Disable Device:	Trap (DC 20, 2d4 rounds); Trigger (DC 20, 2d4 rounds)
Primary Trigger:	Location (floor over pit)
Primary Trap Effect:	Stepping on floor over the pit causes the floor to tilt and dump PCs into pit (1d6 falling damage for 10-foot fall). The chest flips over and spills acid on the PCs (1d6 points of acid damage).
Primary Save:	Reflex (DC 20) avoids tilting floor
Reset:	Automatic and Repair (floor resets when PCs step off of it but the chest of acid must be replaced)
Cost:	1,000 gp

Brian Hammond has developed a grim tropical trap. It centers on a dead-end section of corridor that balances upon a fulcrum. A false chest stands in the dead end; it is attached to the floor at its base by a hinge. When a delver enters the corridor, his weight will cause it to shift on the fulcrum, dropping down into the pit below. This causes the false chest to flop over on its hinge, releasing its deadly content — acid! — onto the slope. The acid should neatly spill down the sloping corridor and splash all over the unfortunate delver below.

Note: If you want to be cruel, up the intensity of the acid to, perhaps, 2d8 damage. Or change the acid to some nasty type of slime or ooze that could pour on the helpless delver.

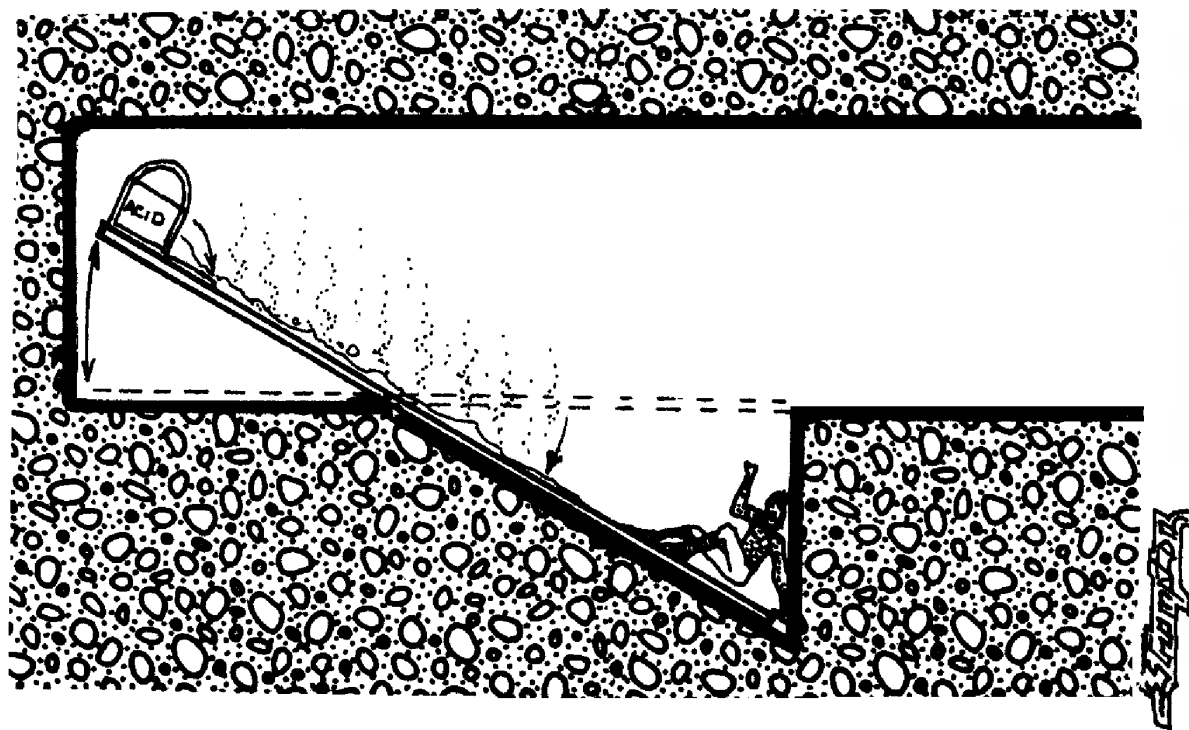

Wet Pit



Mark Bassett does interesting things with this pit trap. This is a simple pit that opens beneath the feet of a delver. As soon as the delver is trapped inside the pit, it begins to fill with water, bars spring across the top, and its walls begin to creep together. However, just before the delver is

drowned and pulped, the trap resets itself — the water drains out, the walls return to their original positions, and the bars withdraw.

A handy ladder then pops out of the pit wall; at the top of the ladder is a sign that reads, “You Have Been Warned. The Next Trap Will Be Fatal. Go Home.” Never underestimate the power of psychological damage.

Whipped-Cream Pit



CR: 1
Type: Mechanical
Search: Trap (DC 20), Trigger (DC 20).
Disable Device: Trap (DC 20, 2d4 rounds); Trigger (DC 20, 2d4 rounds)
Primary Trigger: Location (pressure plate on floor)
Primary Trap Effect: Victim falls 10 feet but suffers no damage as he lands in whip cream. Attempts to climb out (using the walls or ropes) require a Balance check or Climb check (either at DC 20 because the whip cream makes everything slippery)
Reset: Automatic
Cost: 2,000 gp

Mark Bassett developed this trap for those DMs who are tired of adventurers charging into your dungeon just for the glory of it all. Just see how brave a tale they can tell about drowning in a vat of whipped cream.

The Whipped-Cream Pit functions like a normal pit trap — but instead of containing spikes or acid to finish the clods off, it's full of whipped cream. Whipped cream is too airy to float on, too thick to paddle in, and too slippery to allow anyone caught within to grab a rope easily.

And don't forget the fun you can have, needling a player over the fact that you killed his character by submerging him in whipped cream....

Now You See It, Now You're Dead!



CR: 2
Type: Mechanical
Search: Trap (DC 20), Trigger (DC 20).
Disable Device: Trap (DC 20, 2d4 rounds); Trigger (DC 20, 2d4 rounds)
Primary Trigger: Touch (pulling lever)
Primary Trap Effect: Spring-loaded floor sends delver crashing through the mirrors (1d4 damage) and into spikes (1d4 spikes, 1d4 damage each spike). The delver also suffers 3d6 points of damage from the force that shoots him skyward.
Reset: Automatic and Repair (floor resets after 1 minute, but the mirrors must be replaced)
Cost: 4,000 gp

Dan Manning has developed a trap that only a chump would fall for. That means it works like a charm on your average delver. Dan calls his trap Now You See It, Now You're Dead!, but I prefer the alternate onomatopoeic title of *Splat!*

This is a homely trap that smashes a delver into several rows of spikes. The trap keys upon the claustrophobic

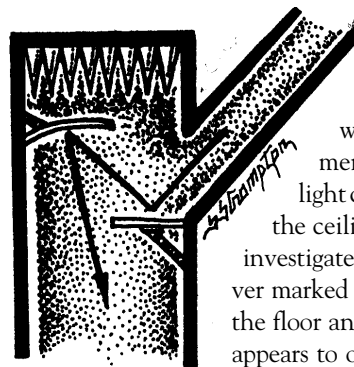

anxiety of a delver who's been trapped underground for a while. When the aforementioned delver sees light coming from a hole in the ceiling, he will doubtless investigate — and discover a lever marked “UP” sticking out of the floor and a ceiling vent that appears to open onto a patch of clear daylight sky 30 feet above.

In reality the “sky” is merely an image produced by a cleverly aligned series of mirrors. Behind the mirrors is a bank of spikes. And when the delver pulls on the lever, the spring beneath his feet uncoils...slamming him through the mirrors and into the spikes. Splat! No more delver!



Suspension Ladder



CR:	3
Type:	Mechanical
Search:	Trap (DC 20), Trigger (DC 25).
Disable Device:	Trap (DC 20, 2d4 rounds); Trigger (DC 25, 2d4 rounds)
Primary Trigger:	Location (middle of third ladder)
Primary Trap Effect:	Ladder drops vertically. Touching any rung but the one the character is hanging on causes the rung to break and drop the victim roughly 55 feet to the ground (5d6 points of falling damage)
Reset:	Manual (switch against wall near third ladder resets the ladder).
Cost:	6,000 gp

This trap by Mike Stackpole is designed to force characters to think — if they want to stop hanging around. A character finds himself in a vertical tunnel, a chimney of sorts. There is a ladder running up the side of the chimney and light at the top of the ladder. The climb appears to be about 60 or 80 feet up. Each 20 feet of climb takes the character up on a different ladder.

The third ladder is special. When a character gets to the middle of it, the ladder swings down from the wall such that the top of it hits the chimney wall opposite the ladder. Two steel cables, thin but high-tension wire, protrude from the top of the ladder into the wall where the ladder is normally attached.

The tense part of the trap comes now. All of the rungs, with the exception of the one the character is hanging onto, are built to pull free when pressure is put on them from an angle other than normal when climbing. In other words, while they work normally for climbing, using them like horizontal bars pulls them free and causes a long fall if the delver does not have a strong grip on the good rung.

The way out of the trap, of course, is to hang onto the outside edges of the ladder and work

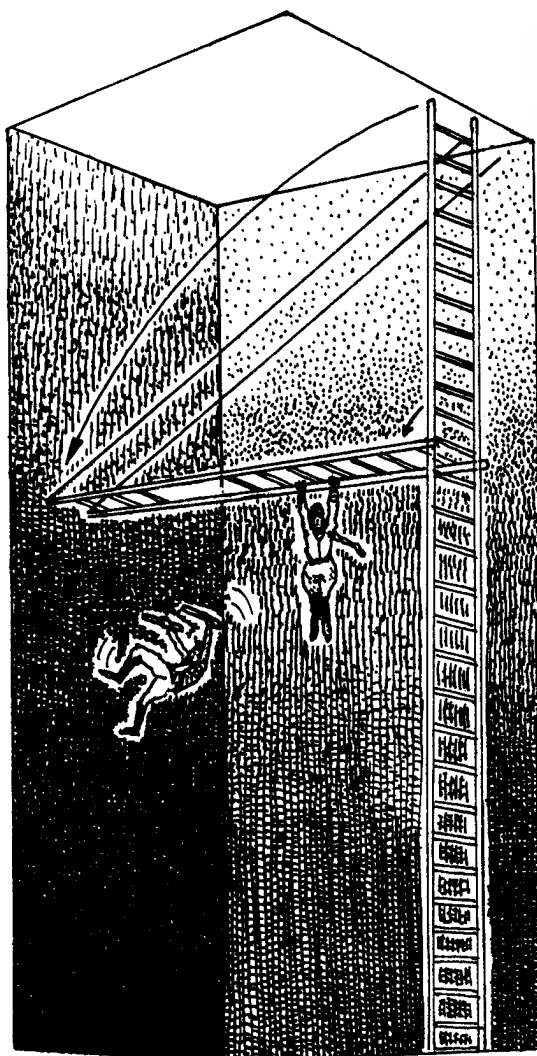

along that while ignoring the rungs altogether. If the adventurer gets to the cabled end, he triggers a switch that draws the ladder upright again. If he goes to the other end, the ladder retracts slowly as the balance is changed.



Step This Way, Please



CR:	8
Type:	Mechanical
Search:	Trap (DC 25), Trigger (DC 20).
Disable Device:	Trap (DC 25, 2d4 rounds); Trigger (DC 20, 2d4 rounds)
Primary Trigger:	Location (pressure plate on floor)
Primary Trap Effect:	Flames (3d6 fire damage) erupt from secret door.
Primary Save:	Reflex (DC 20)
Secondary Trigger:	Location (pressure plate on floor [same plate as the primary trigger])
Secondary Effect:	Weighted post slams down on victim standing on pressure plate (10d6 points of crushing damage).
Secondary Save:	Reflex (DC 25)
Reset:	Repair
Cost:	12,000 gp

This offering from Michael Stackpole is a time-activated trap. It uses the typical human trust that what was once safe is always safe.

The trap is activated by a pressure plate being stepped upon. This will work best in a paved corridor where the plate is actually brick or stone. Once it is stepped on, it will open a secret door about thirty feet up the corridor. Obviously, the party has found a catch for the secret door. Once the character steps off the plate, the door slides shut.

All of the characters will gather around the door while one of their fellows steps on the stone. Whoosh! The door slides open and a blast of flame envelopes the corridor up to fifteen feet away. The person stepping on the stone will be fine, but his buddies will be singed. He naturally steps off the stone to cut the flame off. This action should be rewarded; the damage should be less for the characters getting burned. Once they prepare themselves for fire, the stone will be stepped upon a third time. The third's the charm, as a weighted post slams down out of the ceiling to catch the stepper. Flame is optional this time, and yes, the post will keep the door open.



1st step: opens door

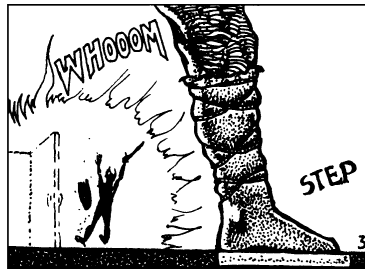

2nd step: releases flame

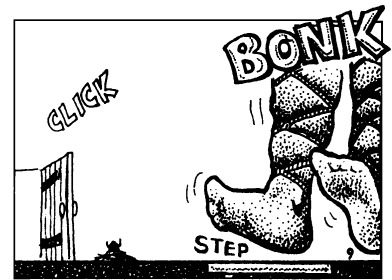

3rd step: stupifies stepper

Fore!



CR:	4 (or 10 depending on reset)
Type:	Mechanical (and perhaps Magical; see text)
Search:	Trap (DC 25), Trigger (DC 25).
Disable Device:	Trap (DC 20, 2d4 rounds); Trigger (DC 20, 2d4 rounds)
Primary Trigger:	Location (pressure plate on floor)
Primary Trap Effect:	Giant flying granite golf ball (5d6 points of damage; multiple targets in 5-foot by 20-foot area)
Primary Save:	Reflex (DC 22) avoids
Secondary Trigger:	Event (granite golf ball breaks floor supports)
Secondary Effect:	Placing more than 50 pounds of weight on the floor causes the floor to collapse; victims fall 10 feet (1d6 points of damage).
Reset:	Manual or Magical (see text)
Cost:	10,000 gp

From Michael Stackpole, this is a corridor trap only by dint of the fact that most of the action takes place in a corridor.

The set-up for the trap beings in a high-ceilinged corridor. There is a thick center beam running the length of the corridor. In the center of the stone-floored corridor there is a perfectly round boulder of granite resting upon a thin, granite pedestal that looks much like a golf tee. To the north, the corridor narrows, and the ceiling drops to the height of fifteen feet. Once the corridor gets smaller, the floor becomes made of wooden planks.

When the delvers hit a pressure plate in the wooden floor, the center beam of the main corridor swings down on a hidden hinge. A large, heavy section of the roof comes down with it, forming it into a mallet of sorts. This hits the boulder that goes flying down toward the party in the smaller corridor. The boulder

should land and bounce through the delvers before it hits a weak spot in the wooden flooring and crashes through. Once it has crashed through, it will run beneath the corridor and smash most, if not all, of the wooden floor supports. This should cause the wooden floor to collapse when delvers place weight on it.

To add insult to injury, and to reset the trap, Mike has suggested the addition of a pipe for the ball that will magically accelerate its rate of speed and curve around to launch the boulder back down the corridor toward the mallet that propelled it. If all goes well, the

ball will hit the mallet and smash it back into the ceiling while coming to rest back on its tee. If, however, adventurers get in the way....

Note: As detailed in the text above, the trap could possibly reset itself using a chute that allows the ball to pick up speed, hit the mallet, and reset itself back on the tee. If you opt for this magical reset, remember this. Any creature in the path of the speeding granite ball takes 12d6 points of crushing damage as it flies through them into the mallet. If you use this method, bump the CR of the trap to 10.

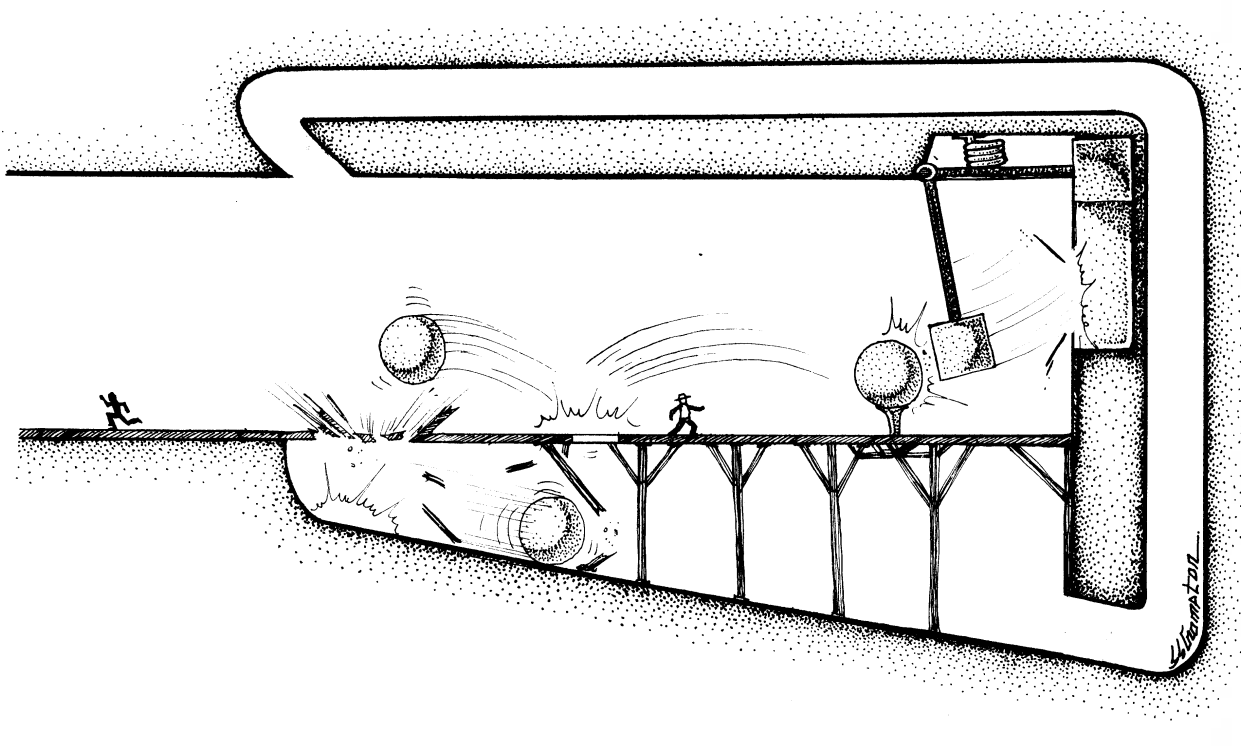

Hit 'Im Where He Ain't



CR:	2
Type:	Mechanical
Search:	Trap (DC 20), Trigger (DC 20).
Disable Device:	Trap (DC 20, 2d4 rounds); Trigger (DC 20, 2d4 rounds)
Primary Trigger:	Location (pressure plate)
Primary Trap Effect:	+10 melee (1d3 spears, 1d6 damage each spear)
Primary Save:	Reflex (DC 12) avoids, but make sure to ask if the PC dodges forward or backwards to evade the trap. If backwards, see Secondary Trap Effect.
Secondary Trap Effect:	+10 melee (1d4 spikes, 1d4 damage each spike)
Reset:	Automatic
Cost:	2,000 gp

Matt Nadelhaft designed this trap, which gets the adventurer coming or going. This trap can be located in any corridor that looks innocent and harmless (don't they all?). The delver will step on a pressure plate that causes two things to happen. Above the pressure plate, a section of the ceiling swings down and away from the delvers. From that section of the ceiling, a set of spears drops. The lucky character will actually dive forward. To step backwards is a problem.

At the same time as the spears are falling, the section of the floor the delver has just passed over will slide to the side. A rack of spikes will be snapped up into place behind the delver, blocking the corridor. If the delver jumps back, bang, impaled by his own weight.

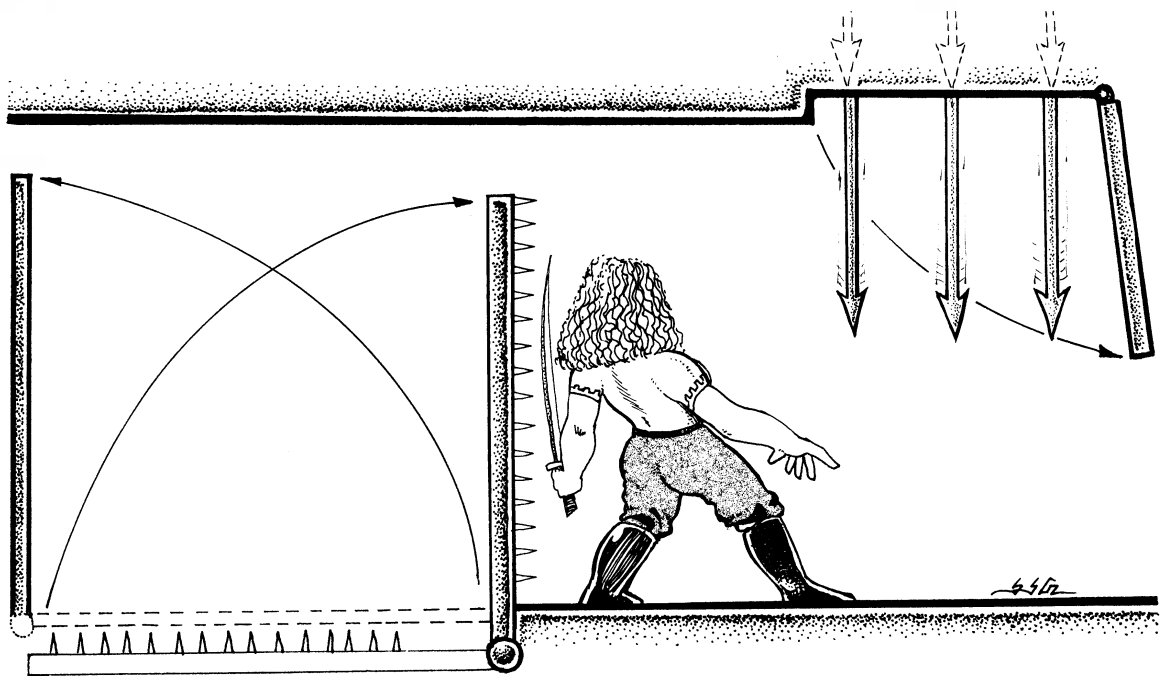

Bee-Hive Trap



CR:	1
Type:	Mechanical
Search:	Trap (DC 14), Trigger (DC 15).
Disable Device:	Trap (DC 20, 2d4 rounds); Trigger (DC 20, 2d4 rounds)
Primary Trigger:	Location (pressure plate)
Primary Trap Effect:	Volley of darts (+10 ranged, 1d4 darts at each target, 1d4+1 each dart; multiple targets in a 10-foot by 10-foot area)
Reset:	Manual
Cost:	500 gp

Fred Meyer is responsible for this trap. I recommend that you install it only in tunnels where the walls are already darkened or stained, as the trap has a tendency to dispatch delvers in a rather messy way. After all, you don't want to give away any clues as to what's ahead.

You can place it either in a dead-end corridor or on the ceiling of any hallway. The characters are likely to be a bit apprehensive when they spot the operating factor of this trap — a steel beehive with many perforations — but the gamble here is that such an odd object will make the delvers curious enough to abandon their normal caution.

The trap itself is activated when a pressure plate a few feet before the hive is stepped upon. This causes the hive to fire over one hundred half-inch steel darts down the corridor at

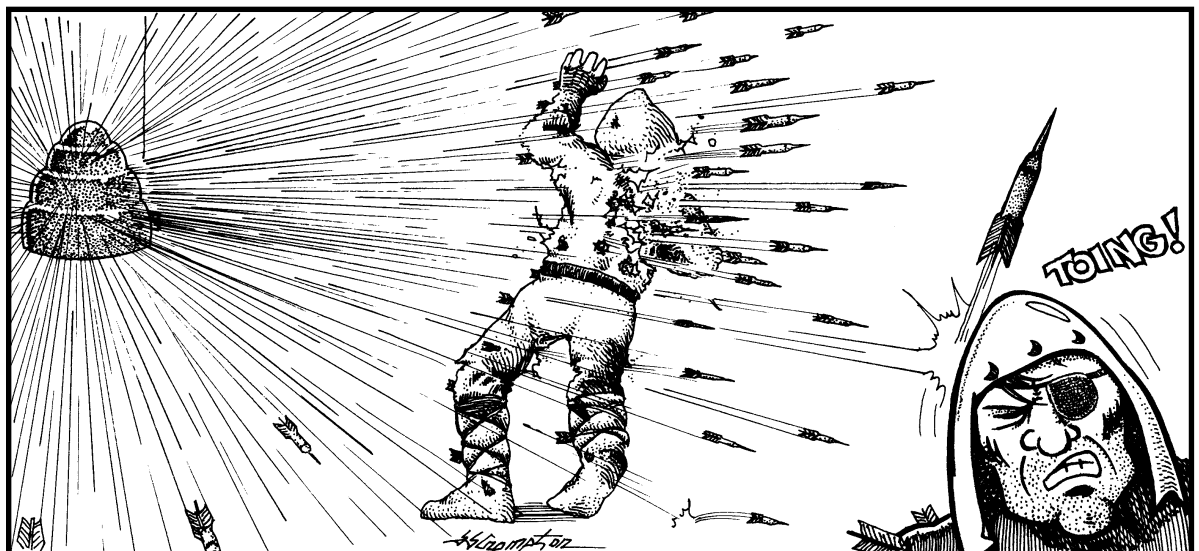

a dismaying speed. The darts will bounce off stone but will rip through flesh and most armor, resulting in total chaos in the section of corridor about five feet away from the hive.

For depravity above and beyond the call of duty, you can make the darts rusty or coat them with poison — or do both! — to ensure that even the merest nick will be painfully fatal...

The Double Scythe



CR: 2 or 8 if Variant: Massive Damage is used
Type: Mechanical
Search: Trap (DC 21), Trigger (DC 21).
Disable Device: Trap (DC 20, 2d4 rounds); Trigger (DC 20, 2d4 rounds)
Primary Trigger: Location (pressure plate)
Primary Trap Effect: Dual scythes (+10 melee each scythe; 1d8+3 each scythe, crit x4). Despite this trap generally not causing 50 or more points of damage, you could choose to require a Fortitude Save for Massive Damage, as per the Variant: Massive Damage from Chapter 2 of the *DMG* for anyone suffering damage from this trap due to the nature of the injury inflicted.
Bypass: Perhaps a hidden switch (Search DC 20) or pressure plate keeps the trap from activating.

Reset: Automatic

Cost: 4,000 gp

This heinous trap from Fred Meyer would make the Grim Reaper (a distant relative of mine) proud. If you want your killer traps to leave their victims in handy bite-sized chunks, then this is the trap for you.

Stepping upon a hidden pressure plate releases two scythe blades — one from the ceiling and one from the floor. The blades skim through the corridor at a sickening speed, in opposite directions. Even if a character is wearing armor thick enough to turn or stop the blades, he still faces the very real danger of a broken back from sheer impact damage alone.

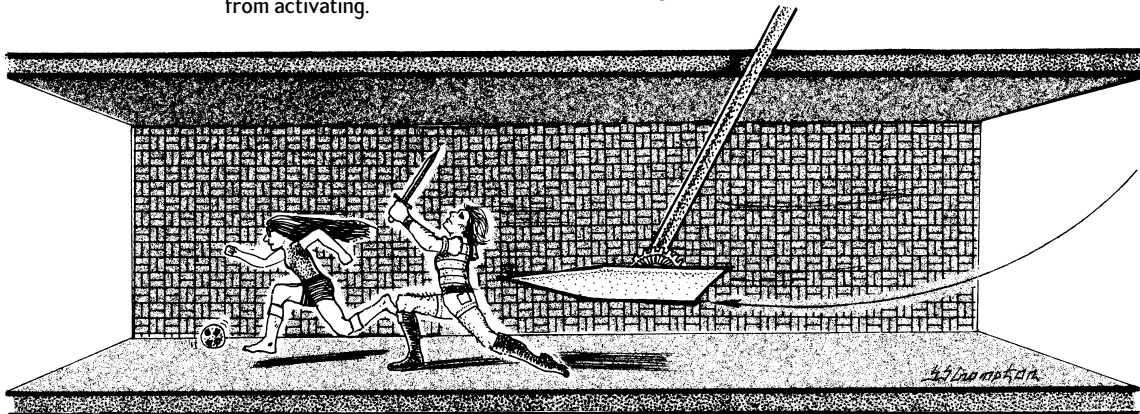

I'll Take a Stab at That



CR: 2
Type: Magical
Search: Trap (DC 20), Trigger (DC 20).
Disable Device: Trap (DC 20, 2d4 rounds); Trigger (DC 20, 2d4 rounds)
Primary Trigger: Location (sticking a weapon through one of the holes)
Primary Trap Effect: The weapon reappears behind the victim that stuck the weapon into the hole and stabs him (damage is normal for the weapon plus all magical adjustments and Strength adjustments, just as if the character had attacked an opponent)
Reset: No reset
Cost: 1,200 gp

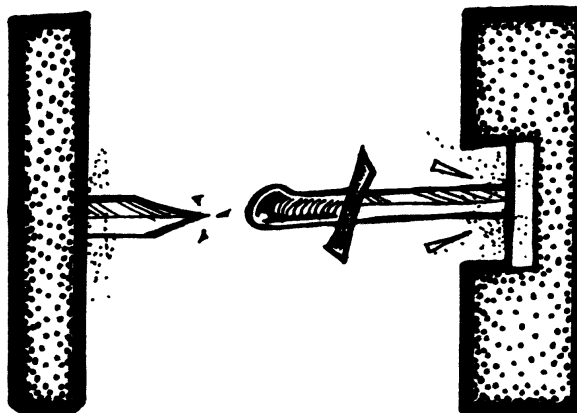

This corridor offering from Matt Nadelhaft is another do-it-yourself doom. This trap is located in a very narrow corridor where the characters may well have to move sideways to pass. As they move through the hallway, they notice archer's ports on one side of the corridor. Peering into the port will reveal a set of glowing eyes very close to the port itself. A bit of magic will be sensed by those able

to do so. The port is backed with a teleportation field that will make anything thrust into it appear directly across the corridor. If, then, a sword is thrust at the eyes in a northerly direction, it will reappear from the south wall traveling north. That should carry it right into the back of the character wielding it. And if the fields work reciprocally, woe be to the character who turns and thrusts at the wall behind him....

There and Back Again



CR:	2
Type:	Mechanical
Search:	Trap (DC 20), Trigger (DC 20).
Disable Device:	Trap (DC 20, 2d4 rounds); Trigger (DC 20, 2d4 rounds)
Primary Trigger:	Location (pressure plate)
Primary Trap Effect:	Fall into pit and bounce on trampoline back up into spikes 30 feet in the air (3d6 "falling" damage; +10 melee for spikes; 1d4 spikes, 1d4+2 damage each spike)
Reset:	Automatic
Cost:	4,000 gp

Larry DiTillio has designed this somewhat ridiculous (yet deadly) trap. It appears to the delvers

as a veritable cornfield of 5-foot high wooden stakes poking up out of the floor. This section of floor, in combination with an equal expanse of corridor floor in front of the stakes, forms an immense swinging trapdoor that covers a deep pit.

When a delver comes to within a few feet of the stakes, he will upset the balance of the trapdoor and drop into the pit below. As this happens, the trapdoor will continue to swing around and recover the pit — with the spikes facing down! Meanwhile, the delver will have hit the trampoline at the bottom of the pit. He bounces back up and onto the spikes, causing the trapdoor to flop back into its original position with the delver messily impaled upon the spikes....

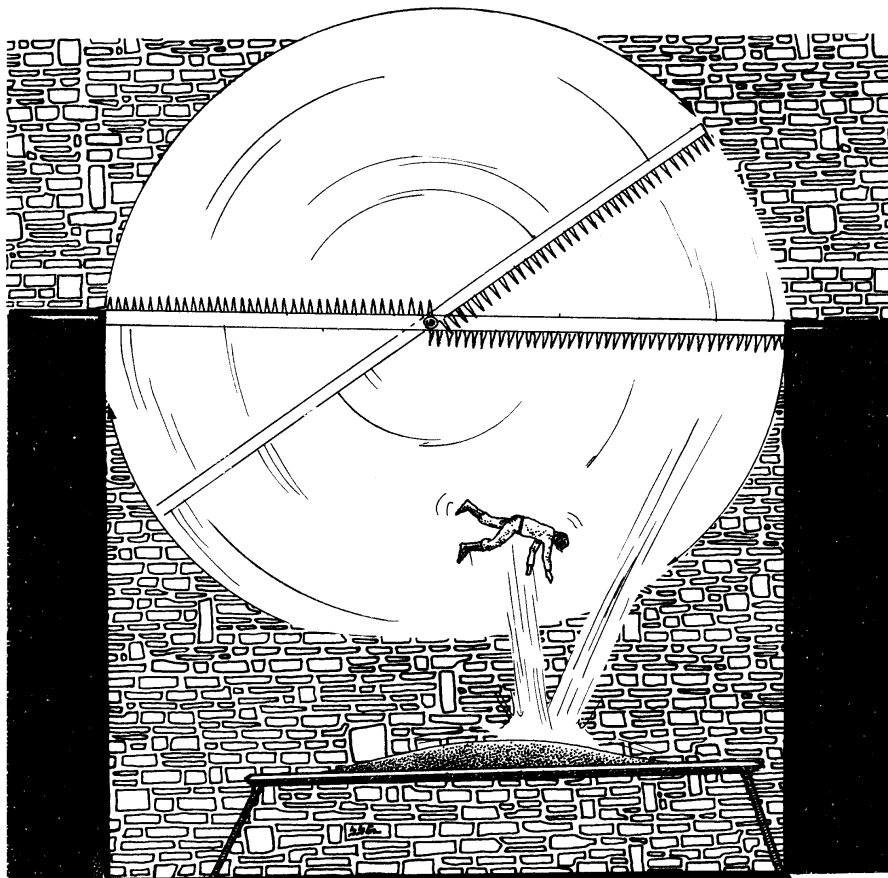

The Mangler



CR:	3
Type:	Mechanical
Search:	Trap (DC 25), Trigger (DC 20).
Disable Device:	Trap (DC 22, 2d4 rounds); Trigger (DC 22, 2d4 rounds)
Primary Trigger:	Location (pressure plate)
Primary Trap Effect:	Three spears (+20 melee; 1d8+3 points of damage each spear). Consider using Variant: Damage to Specific Areas found in Chapter 2 of the <i>DMG</i> if the victim is a medium sized humanoid.
Bypass:	Perhaps a hidden switch (Search DC 20) or lever keeps the trap from activating.
Reset:	Automatic
Cost:	12,000 gp

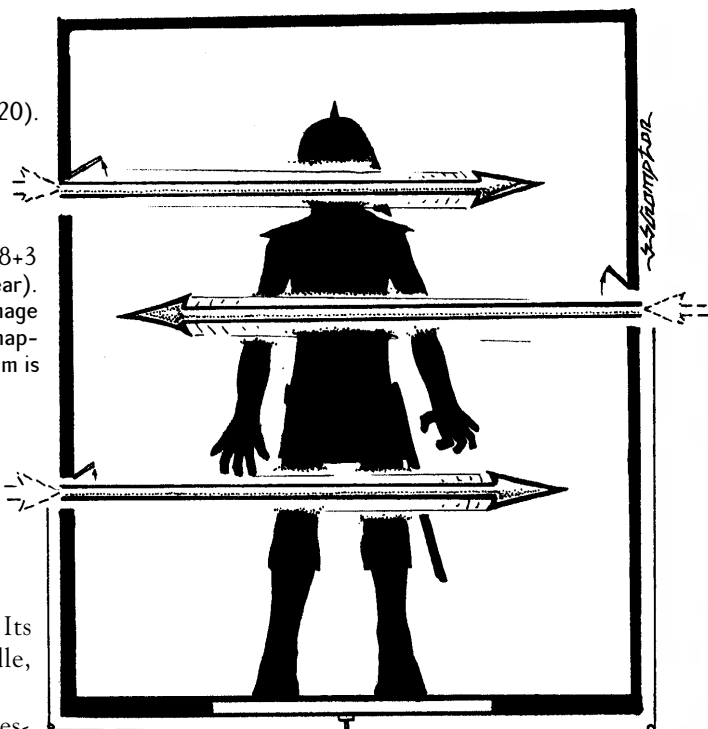

This trap by Larry DiTillio is his most savage. Its title tells it all, it was designed to bend, spindle, and mutilate most any delver.

The trap is activated by stepping upon a pressure plate. This causes three tempered steel rods to whip out from the nearest wall at three different heights. The two end bars move in one direction; the middle rod moves in the opposite direction. They should catch an average-sized human in the knees,

the small of the back, and the head — simultaneously. If such treatment doesn't kill the character outright, it should certainly cause some severe changes to his or her "alignment"....

Only Time Will Tile



CR:	2 (or higher)
Type:	Mechanical
Search:	Trap (DC 18), Trigger (DC 18).
Disable Device:	Trap (DC 20, 2d4 rounds); Trigger (DC 20, 2d4 rounds)
Primary Trigger:	Location (plaster floor)
Primary Trap Effect:	Floor breaks away and sends delvers plummeting into pit (we suggest at least 40 feet deep [4d6 falling damage])
Bypass:	Stay on the tiles!
Reset:	Repair (must replace plaster floor)
Cost:	2,000 gp or higher

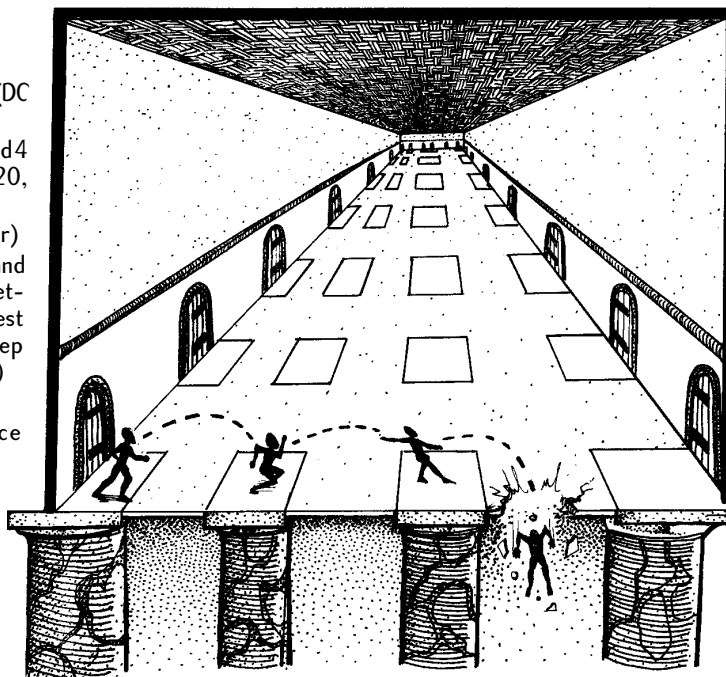

This corridor trap comes from David Steven Moskowitz. The setting is a long corridor with an object of great value displayed enticingly at the far end. The floor has been decorated with marble tiles that are separated by wide patches of grout or

plaster; the tiles are placed just far enough apart so that a character must leap from one to another to remain on the tiles.

Whenever a delver steps on a tile, a stream of poisoned darts shoots from a nearby wall, passing within inches of him. The delver will doubtless think his alertness and agility have saved him from certain death — but the darts are *supposed* to miss. However,

they should encourage characters to step off the tiles and onto the plaster.

The marble tiles are actually the tops of pillars in the room beneath this corridor — and the area between the tiles is only a thin layer of plaster. The result: when a delver puts his full weight onto the plaster, he'll fall through the floor to whatever doom awaits him below...

Meet the Pit



CR:	2
Type:	Combination (Mechanical and Magical)
Search:	Trap (DC 18), Trigger (DC 20).
Disable Device:	Trap (DC 20, 2d4 rounds); Trigger (DC 20, 2d4 rounds)
Primary Trigger:	Location (landing on illusory floor on opposite side of pit)
Primary Trap Effect:	Razorblades (+10 melee, 1d4 blades, 1d3 damage each razorblade)
Secondary Trap Effect:	Fall 15 feet into pit (1d6 falling damage plus worse if the pit is lined with spikes, acid, burning oil, etc)
Reset:	No reset needed
Cost:	1,200 gp

P.D.J. Wright offers us the British eye view of a nasty pit trap. As there are many ways to skin a cat, most of them painful, this trap shows us that there is more than one way to pit a delver.

The pit is a mere 6 feet across and as wide as the corridor itself. The delvers may walk to the edge of the pit and look in to see the bottom 25 feet below. The pit may be filled with anything — the sharper, the better — making the pit obviously something to be avoided. And what delver is going to be daunted by a leap of six feet?

The trap comes in when the delver lands on the other side and finds that the other side was an illusion. Even nastier is the idea of building the opposite lip of the pit up of the balsa wood and plaster, a construct solid enough for coins to land but weak enough to collapse under the weight of a jumping adventurer. Below the false lip is a 45-degree slope leading back into the pit. After sliding down the slope — perhaps it is studded with razor blades or hooks — the delver should have a fall of 12 feet into the bottom of the pit he just avoided.

We have met the pit, and we are his....

If you decide to replace the illusory floor with one of balsa wood or some other thin wood, change the trap type to Mechanical only.

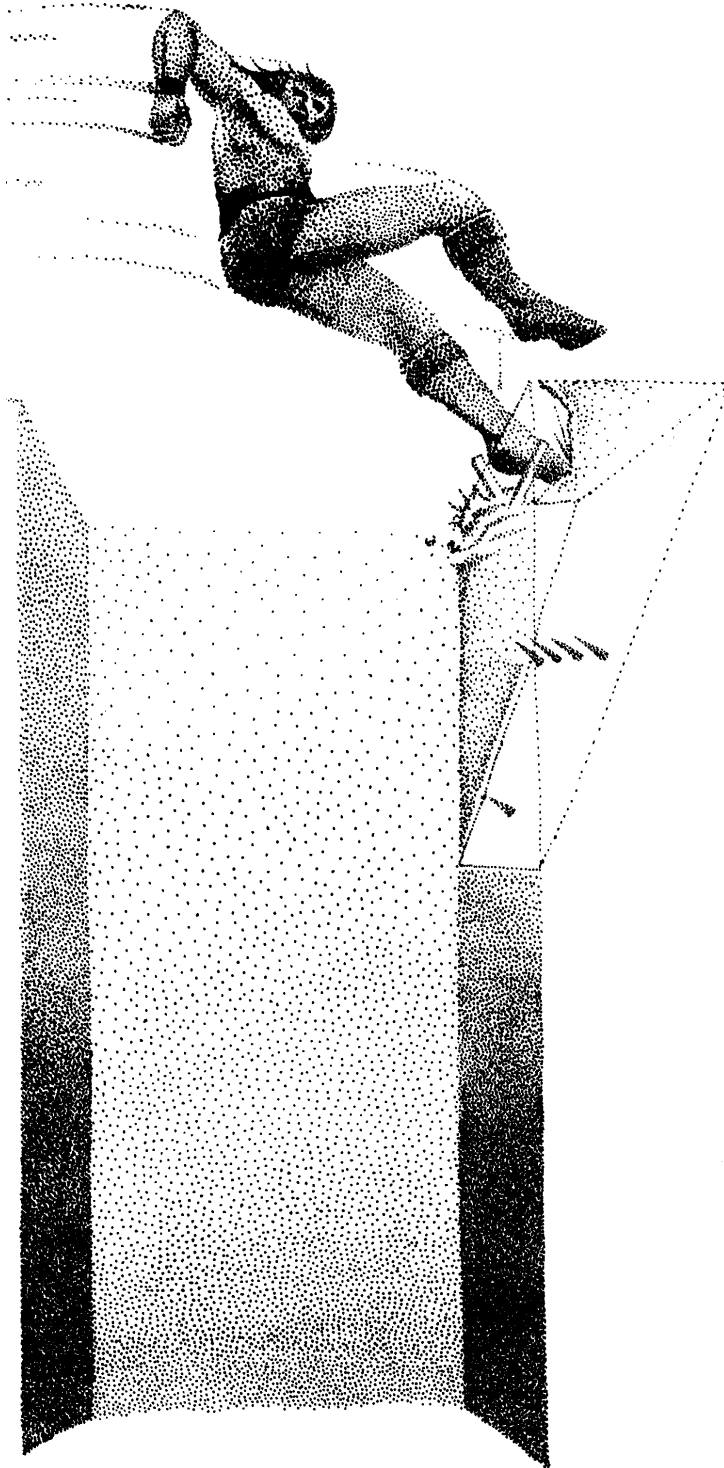

Amazing Ginsu Chute



CR:	4
Type:	Mechanical
Search:	Trap (DC 25), Trigger (DC 20).
Disable Device:	Trap (DC 20, 2d4 rounds); Trigger (DC 20, 2d4 rounds)
Primary Trigger:	Varies (left up to the DM as to how he uses it in his dungeon)
Primary Trap Effect:	Scythe blade (+20 melee; 2d4+10 damage and automatic critical hit; characters in heavy armor are unaffected by the blade but suffer 2d6 points of subdual damage and are stunned for 1 round)
Reset:	No reset needed
Cost:	17,000 gp

This is a very slippery chute barely large enough for a good-sized human to fit into. Just before the chute ends, it splits into two chutes half as large as the original. The dividing line for the chutes is a razor-sharp blade. The sliding delver's own momentum should provide enough force to neatly bisect him when he reaches the parting of the way... If the character is wearing heavy armor, the razor won't harm him; however, the impact will probably knock him silly enough to try to climb back up the slippery slope, whereupon he'll simply slide back down again (doubtless becoming more and more simple-minded in the process)....

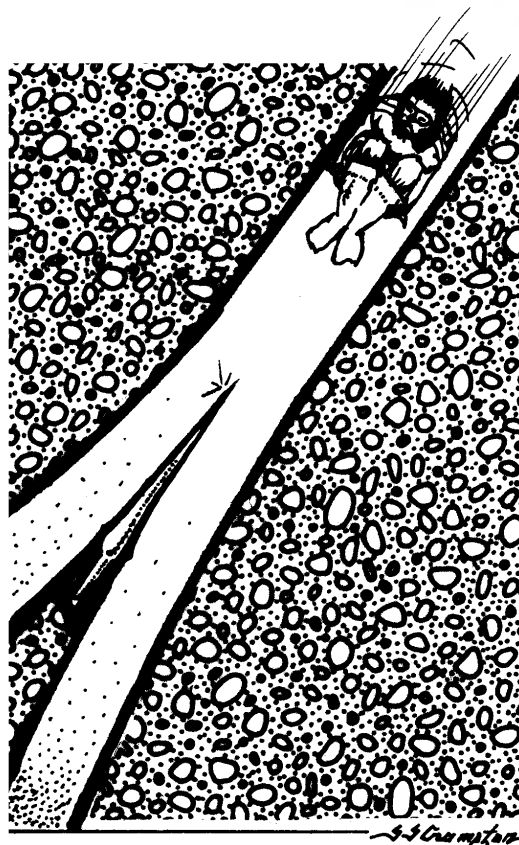

The chute itself is slippery and requires a DC 25 Climb check to ascend.

Dead End



CR:	2
Type:	Mechanical
Search:	Trap (DC 20), Trigger (DC 20).
Disable Device:	Trap (DC 20, 2d4 rounds); Trigger (DC 20, 2d4 rounds)
Primary Trigger:	Location (end of chute)
Primary Trap Effect:	Spikes (+10 melee, 1d4 spikes, 1d4+2 each spike)
Reset:	No reset needed
Cost:	1,600 gp

This trap adds a nice twist to your typical chute trap. The chute is large enough for one or two characters to enter at a time — and, as might be expected, terminates in a wall of spikes ready to impale whatever slides down to meet them.

However, this trap has an added feature. Halfway down is a spring-loaded guillotine blade that is triggered by the weight of a passing delver. After a character flashes by, the blade will shoot out and cut any rope that may be trailing back to the entrance of the chute....

Emergency Exit



CR:	10
Type:	Mechanical
Search:	Trap (DC 20), Trigger (DC 20).
Disable Device:	Trap (DC 25, 2d4 rounds); Trigger (DC 20, 2d4 rounds)
Primary Trigger:	Varies
Primary Trap Effect:	500-foot fall (no attack roll necessary; 18d6 damage, and Fortitude save to avoid death from massive damage possibly needed upon impact)
Reset:	No reset needed

Cost: 25,000 gp

Near the entrance to this chute, post a sign saying something like “Emergency Exit — this chute is guaranteed to get you out of the dungeon alive.” The chute itself should be very long — thousands of feet, at the very least — so that the delver must spend several minutes sliding through it in total darkness. When at last the chute ends, the victim zips out of a hole on the face of a cliff that’s at least 500 feet high. The character has indeed exited the dungeon alive, and he is in fine shape — assuming he can fly. Otherwise, the exit has indeed caused a real emergency....

Chuting Gallery



CR:	1 (or higher)
Type:	Mechanical
Search:	Trap (DC 20), Trigger (DC 20).
Disable Device:	Trap (DC 20, 2d4 rounds); Trigger (DC 20, 2d4 rounds)
Primary Trigger:	Varies
Primary Trap Effect:	Exiting chute and slamming into ceiling or floor deals 1d6 points of damage
Reset:	No reset needed
Cost:	1,000 gp

A Chuting Gallery is a nice item to install in your orc barracks, especially if you want to provide your poor monsters with some interesting entertainment.

The chute looks normal — but instead of ending at the bottom, it turns abruptly upward to propel its contents into the air. The delver will rocket out of the darkness of the chute and into your brightly lit barracks, where a squadron of orcs will be waiting with crossbows to blow him out of the air like a clay pigeon. Even if all the orcs miss their shots, the delver must still contend with slamming into the ceiling. And don't forget the orcs themselves, who will be understandably upset at their failure to feather their target...

The number of orcs and their current attitude when the delvers appear is left up to the DM.

Orcs: CR 1/2; hp 4.

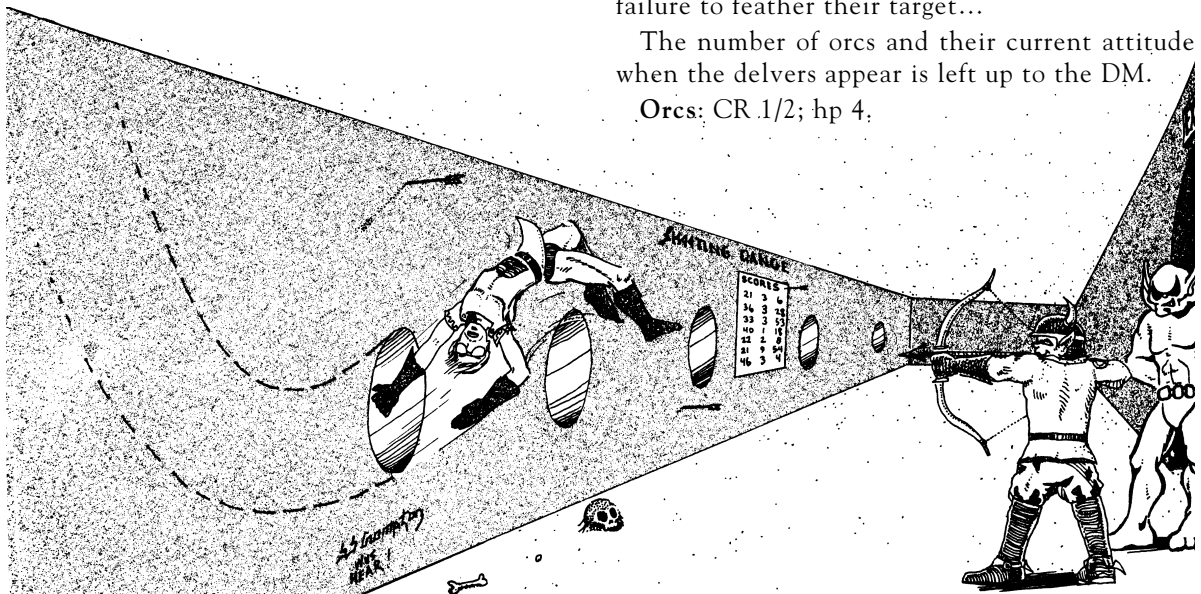

Impaling Pit



CR:	3
Type:	Mechanical
Search:	Trap (DC 20); Primary Trigger (DC 20)
Disable Device:	Trap (DC 20, 2d4 rounds)
Primary Trigger:	Event (stepping on pressure plate)
Primary Trap Effect:	Character falls into 30-foot pit. Five rounds in the pit, and the delver sees spikes begin "growing" from the floor (+15 melee, 1d4 spikes hit delver for 1d4 damage each). Each round the delver remains in the pit he is possibly hit by 1d2 more spikes (+15 melee, 1d4 damage each spike)
Primary Save:	Reflex (DC 20) avoids
Reset:	Automatic
Cost:	12,000 gp

plished by brute force. That judgment may be a bit harsh. As Rick Bourgeois proves with this trap, tools can accomplish the task with finesse.

The hapless (and soon to be deceased) character begins his own downfall by stepping on a pressure plate seconds before he plunges into a hidden pit. Pressure on the plate severs a wire, yet prevents the weight on the other end of the wire from falling. As the delver steps forward and falls into the pit, the weight is released. As it falls, the weight draws a section of flooring across the pit, making it seem as though the delver has been swallowed up by the floor itself.

The fallen delver finds the floor of the pit a curiosity in that there are one-inch diameter holes all over it. Steel spikes slowly grow out of these holes, rising toward the roof of the pit. When the first weight fell, it also severed a line that released two other weights, gently counterbalanced, that would raise these impaling stakes through the pit — and through anything in the pit.

I was told once that what separates you humans from beasts is that you use tools to do something easily accom-

The Pivoting Pit



CR:	5
Type:	Mechanical
Search:	Trap (DC 25), Primary Trigger (DC 20), Secondary Trigger (DC 20)
Disable Device:	Trap (DC 25, 2d4 rounds), Primary Trigger (DC 25, 2d4 rounds)
Primary Trigger:	Location (more than one-half the part crosses the pivot point in the floor)
Primary Trap Effect:	Floor tilts and dumps characters 15 feet (or more) into spiked pit (+10 melee, 1d4 spikes each character for 1d4 points of damage)
Secondary Trigger:	Touch (opening trap door in "ceiling")
Secondary Trap Effect:	Flood of rubbing alcohol rushes forth. Creatures hanging onto ropes, ladders, etc. must make a Reflex save to avoid losing their grip and falling. Those failing fall 30 feet into pit and take 3d6 falling damage and spike damage (as above).
Secondary Save:	Reflex (DC 20) avoids)
Bypass:	A hidden switch locks the floor in place so it doesn't pivot (Search DC 25)
Reset:	Automatic (floor resets after 5 minutes) and Repair (alcohol chamber must be refilled)
Cost:	20,000 gp

Movable corridor sections are a tried and true friend to all DMs, and Rich designed the Pivoting Pit with this firmly in mind. Chances are fair the nosy delvers will be punctured twice on the same set of spikes; double duty! Be sure to put this trap on a level well below ground level.

A corridor at least 30 feet long terminates in an ordinary door. The corridor is otherwise featureless. However, when the majority of the party passes the pivot point in the middle of the corridor, all 30 feet of corridor pivots down, throwing the entire group head over heels toward the door.

Unfortunately for the adventurers, the door is only a replica cunningly painted on thin cloth shim. The delvers will rip through the cloth and have an intimate encounter with the bed of spikes waiting behind.

Okay. But Rick isn't content to let it go at that... a sure sign of a properly devious mind in a trap-designer.

The corridor, now locked in a vertical position, provides access to a room on the level above (best left accessible in no other way). Those who survived the short 15-foot fall (and some will, most likely) can devise what means they will to climb 30 feet up into the room above.

Opening the trap door will be a disaster. The room above is full of rubbing alcohol. When the door is opened the liquid will rush out under such pressure that anyone climbing up will be knocked back down onto the spikes. And even if someone manages to hang onto a rope and not fall back on the spikes, all that alcohol is bound to sting worse than a manticores in the spike wounds earned earlier!

Any creature that was injured by a spike suffers 1d4 points of damage for 1d3 rounds when contacted by the rubbing alcohol.

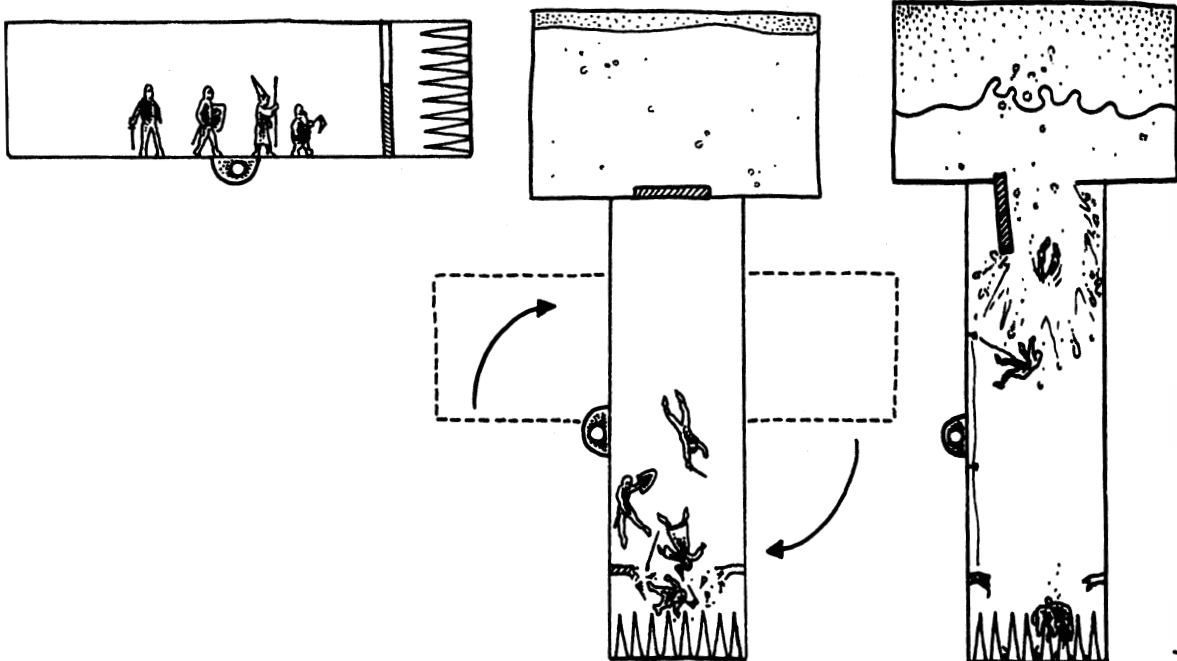

The Sucker Sucker



CR:	3
Type:	Mechanical
Search:	Trap (DC 20), Primary Trigger (DC 20)
Disable Device:	Trap (DC 20, 2d4 rounds), Primary Trigger (DC 20, 2d4 rounds)
Primary Trigger:	Location (pressure plate on floor)
Primary Trap Effect:	Victim falls 10 feet into pit (1d6 points of falling damage)
Secondary Trigger:	Location (pit floor)
Secondary Trap Effect:	Floor moves away (leaving needles) and sets up a vacuum that drains the victim's blood).
Bypass:	Hidden switch on wall perhaps slides metal plate over pit so person doesn't fall into pit.
Reset:	Automatic
Cost:	3,000 gp

I've always had a fondness for mad doctors, and Dr. Paul Ronkas is apparently one of the original models. He's created some of the most grisly traps in this tome. The Sucker Sucker is possibly the most gruesome of all, and a novel use for the ordinary spiked pit trap.

The trap appears only when it's encountered: a fairly typical ten foot square pit, hidden by illusion or paper-thin covering, with a self-closing steel plate for a lid when sudden weight hits the bottom of the pit. Instead of massing bone breaking, skin shredding spikes that the bottom, however, the floor of the pit is carpeted with tiny inch-long hollow needles, something like hypodermics. When a delver (or delvers) clumsily blunder into the pit, the same switch that closes the lid also releases a heavy block underneath the pit floor. The block

pulls away (the floor, with its needles remaining), creating a slight vacuum that increases in suction as the block falls. The effect of the vacuum will be to start drawing the victims' blood and other vital bodily fluids through the needles and into the cavity below. The sheer number of needles will also make it difficult for a desperate delver to move; the suction will hold him in place unless aided by someone else in the pit lucky enough not to be stuck.

The block eventually uncovers a small hole in one wall, allowing the blood to drain into a large catch basin in the opulent lair of an ingenious (and very lazy) vampire. This draining will release the suction on the victim(s), but by then they will probably be feeling too "drained" to care.

Of course, any substantial armor will defeat the tiny spikes, and allow the encrusted hooligan to help his buddies (if any). But there's still the problem of the covered pit, and for neatness' sake, there's probably something on the way to clean up what's left... something big. And hungry. And unlikely to take argument from its food very politely.

Creatures wearing armor that grants an armor bonus of +4 or higher (not including magical bonuses) or creatures with natural armor of +4 or greater are immune to the blood draining effects of this trap. Note that such creatures are still pinned to the floor by the suction effect.

The blood draining effect of the needles deals 1d2 points of temporary Con damage to the victim each round he remains trapped. The suction holding the creature to the floor requires a DC 25 Strength check to overcome. The suction effect lasts 1 minute (10 rounds) before ceasing.



Pits and Pancakes



CR: 6

Type:

Mechanical

Search:

Trap (DC 20), Primary Trigger (DC 30), Secondary Trigger (DC 20)

Disable Device:

Trap (DC 30, 2d4 rounds), Primary Trigger (DC 25, 2d4 rounds), Secondary Trigger (DC 20, 2d4 rounds)

Primary Trigger:

Location (pressure plate on far side of visible pit)

Primary Trap Effect:

Steel plates swing down from ceiling; no attack roll necessary, 6d6 points of crushing damage to characters in a 5-foot by 10-foot area.

Primary Area of Effect: Creatures standing in a 5-foot by 10-foot area near open pit.

Secondary Trigger:

vent (steel plate depresses button located on wall to trigger secondary and tertiary trap effects)

Secondary Trap Effect:

Pressure plate on far side of pit (that triggered the primary effect) is spring-loaded and catapults creature standing on it into visible pit (where he takes 1d6 points of damage per 10 feet fallen).

Tertiary Trigger:

Same as Secondary trigger (tertiary and secondary effects occur simultaneously).

Tertiary Effect:

Floor drops characters into 10-foot deep pit (1d6 points of falling damage). Reflex save (DC 20)

Tertiary Save:

Automatic

Reset:

28,000 gp

Many are the pits of peril a delver will face during his short life. Most are mortifyingly simple in construction and offer nothing in the way of suspense before they deliver the coup de grace to the delver unfortunate enough to have stumbled into them. Chris Crotty's Pits and Pancakes, on the other paw, anticipates the delver and hits him when he feels he's well out of danger with a trap complex and expensive enough to have been built by a defense contractor.

Coming upon this trap the characters walk over a covered pit disguised to look exactly like normal floor. The pit cover is solid under their weight, and unnoticeable. Besides, the characters will have

focused their attention on the immediate problem before them: a deep, visible pit, which you may fill with more than spikes if you wish to make the party absolutely paranoid.

After appropriate precautions have been taken (to ensure safety), one character will cross to the other side of the pit. Once his or her full weight (at least 50 pounds or more) trips the pressure plate on the other side, the bloodbath begins.

First two steel plates swing down from the ceiling, hinged right above the visible pit's nearest

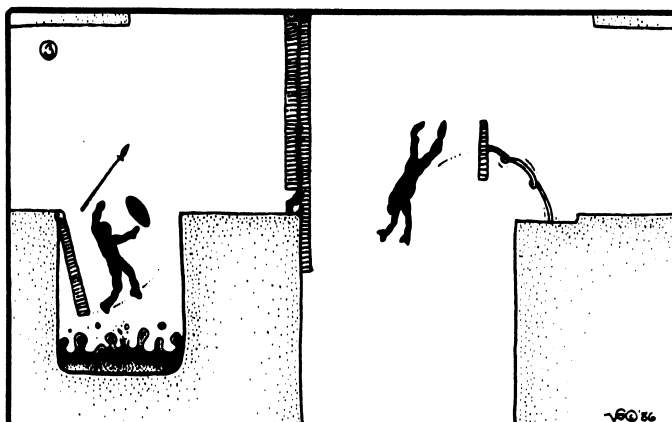
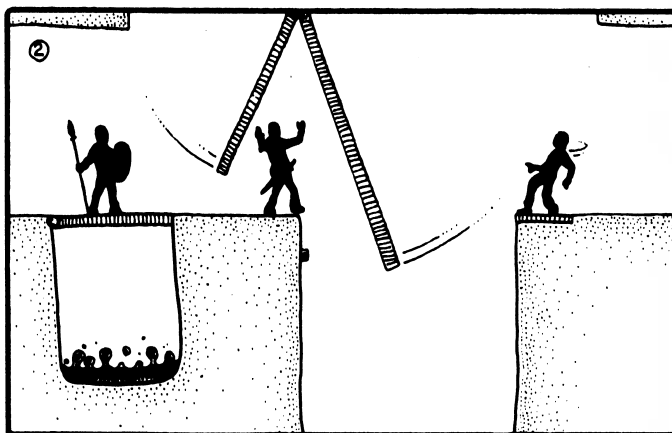
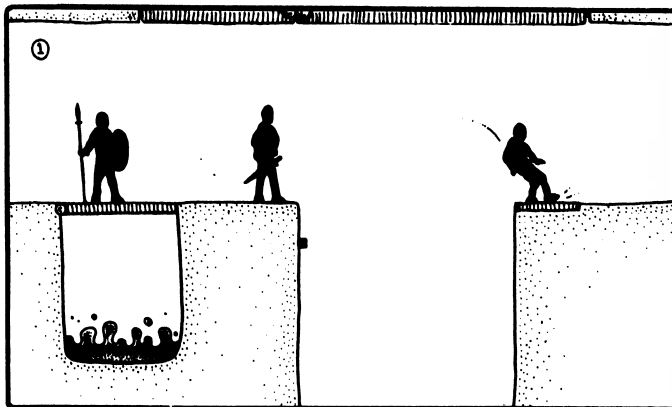

edge, to meet snugly and pulp characters standing there. The plate swinging down through the pit area is longer than its companion and it hits a button set inside the rear pit wall that releases two mechanisms. One is a spring beneath the pressure plate (below the character who crossed the pit to start all this). The spring catapults that character back into the open pit.

The second mechanism opens the "floor" over the enclosed pit, where the rear guard of the party has been standing. Even as they thank their lucky

stars they were not involved in the carnage before them, the floor opens and dumps them into the previously hidden pit. Instead of filling the pit they fall into you might drop a horror upon them from the area opened up when one of the ceiling plates swung down. Ever in you elect to let them fall unharmed, the adventurers will have a difficult time crawling out of the pit and then getting beyond the steel panels blocking the corridor before them. It'll keep 'em off the streets for a little while...

Anything He Can Do



CR:	2
Type:	Mechanical
Search:	Trap (DC 20), Trigger (DC 20)
Disable Device:	Trap (DC 20, 2d4 rounds), Trigger (DC 20, 2d4 rounds)
Primary Trigger:	Location (pressure plate at top of sloping corridor)
Primary Trap Effect:	Rollers release and drop characters standing in corridor into pit of boiling oil (1d6 points of heat damage each round)
Bypass:	Perhaps pressing the pressure plate again or a hidden switch (Search DC 20 to find) locks the rollers in place.
Reset:	Automatic
Cost:	2,000 gp

plate that removes the blocking mechanism. Now the adventurers on the rollers will find them rolling freely, sliding anyone back into the boiling oil. The careless followers will pay dearly for their presumption of safety.

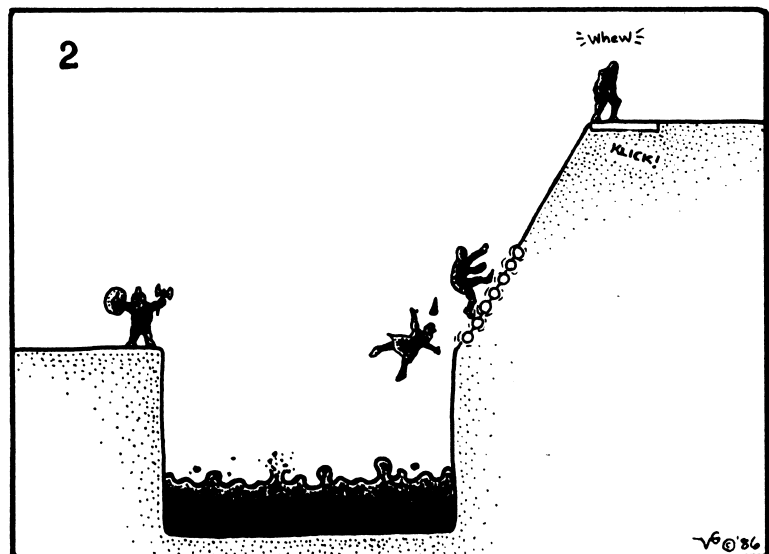
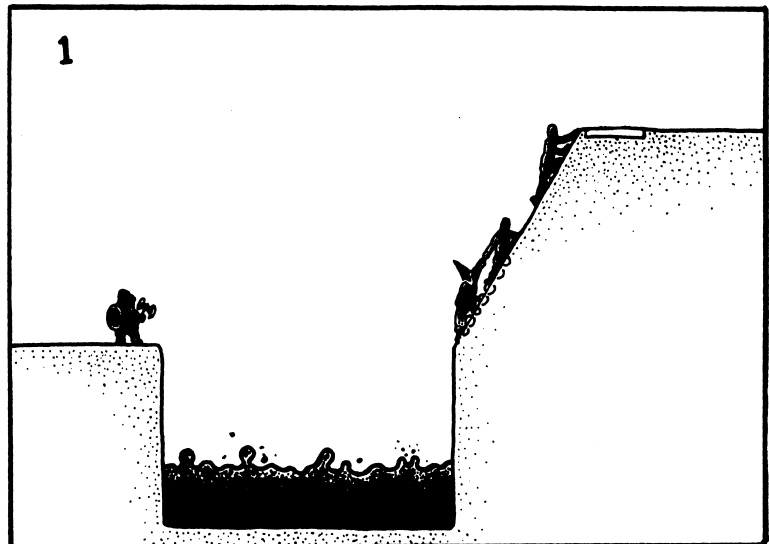

This has to be one of the more technically exacting traps in this tome. What adventurer imagines that there could be trouble if he does exactly what he just saw his buddy safely do? Precautions seem unnecessary, but doom comes as swiftly as ever.

The characters come up to a section of corridor bisected by a pit containing boiling oil. Beyond the trap the corridor slants up at a 60-degree angle, with the first 15 feet of corridor paved with rollers like rolling pins. The corridor continues its upward slant another 20 feet, and then levels out again.

The delvers swiftly discover that the rollers will not turn. In fact, the rollers are blocked. The first character scrambles up the slope; at the top, he hits a pressure

Slayground Ride



CR:	4
Type:	Mechanical
Search:	Trap (DC 20), Primary Trigger (DC 20)
Disable Device:	Trap (DC 25, 2d4 rounds), Trigger (DC 25, 2d4 rounds)
Primary Trigger:	Touch (turning doorknob)
Primary Trap Effect:	Character falls down chute (no attack roll necessary; no damage unless victim grabs handholds)
Secondary Trigger:	Touch (grabbing a handhold)
Secondary Trap Effect:	Razorblades pop from the lower half of the tube/chute and dice victim into little pieces; 8d6 points of damage total dealt by the end of the ride.
Reset:	Automatic
Cost:	4,000 gp

Let the delver curse his own childish stupidity. That's the philosophy behind this trap. As a detour, it's a straight shot to the lower levels. As a trap, it's a do-it-yourself delver dicer.

A delver thinks he's entering a room through an ordinary door. When the handle is turned, how-

ever, a large section of the floor slides away, and zip, the delver slides down the chute.

Halfway down are handholds. An intelligent delver (could one be found) wouldn't take a favor from a DM. Since intelligent delvers are a rarity, the delver will grab a handhold as he or she goes by. Alas, the handle breaks away instantly, releasing the catch holding back a veritable forest of razors that pop up along the lower half of the chute.

At the bottom of the chute, be sure to supply a thick pad of cotton batting to soak up the blood. It can also cushion the fall for those bright folks who leave the handles alone, and don't take favors from strangers. (And most DMs are unequivocally strange, thank you.)

There are countless ways to slay adventurers, from the complex to crazy and back again. However, subtle stresses can be more satisfying than bludgeoning characters with obvious fates. The next several traps are bewilders and confusion-makers, and the effects on a party can be more fun than a barrel of halflings.

The Click Plate



This trap, from Brent Jones, is not at all deadly in and of itself. It will, however, make many other traps more difficult to avoid.

This type of pressure plate is located randomly through the corridors and byways of a dungeon. When trodden on, the plate produces an audible *click*, perhaps no different from any other pressure plate that isn't kept properly oiled. Enough of these click plates will have the party flinching and wincing in confusion and paranoia, like sheep around a shepherd periodically crying, "Wolf!"

When they least expect it, the adventurers find a pressure plate that clicks. And activates a real trap, for a change....

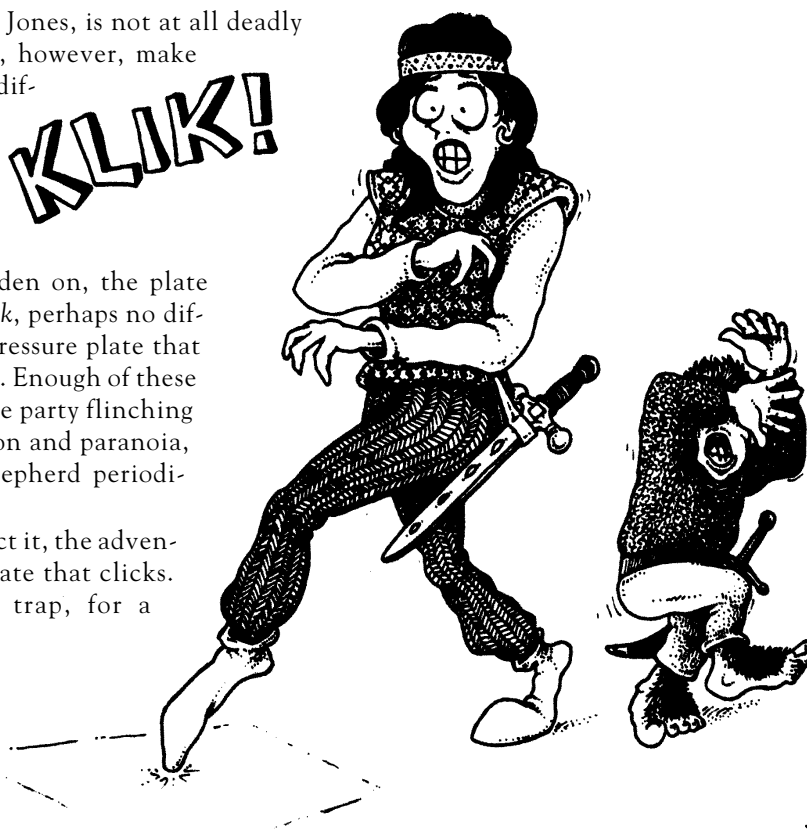

-60'86

Revolver



Adventurers who map dungeons and strongholds are an abomination. They always know which way is out and are never easy to trap far from safety. This trap, by Joe Formichella, provides a simple way to confuse and disorient such characters.

The trap is activated by a pressure plate set in a very long hallway. The first time the plate is stepped on it causes an imperceptible counter-clockwise rotation of the entire hall. At the end of the corridor, the delvers will locate a secret door designed to look much like the other dungeon walls. This door should lead into a room with something to entertain the characters, but not kill them all. After all, your entertainment is just about to start.

Leaving the secret room behind (the only entrance or exit is into the revolving corridor), the characters now discover the other end of the corridor appears to have been sealed off. As they head back toward the

sealed-off corridor, they will hit the plate again, and set it, moving the corridor counter-clockwise again. Once more the party's eagle eyes can find a secret door, but it doesn't lead out of the corridor via the route they entered. It leads to another room, with more "entertainment" for the adventurers. Once cleared away, the characters will have few options but to troop back to the other end of the corridor. The corridor rotates again, there's a third room behind yet another secret door.

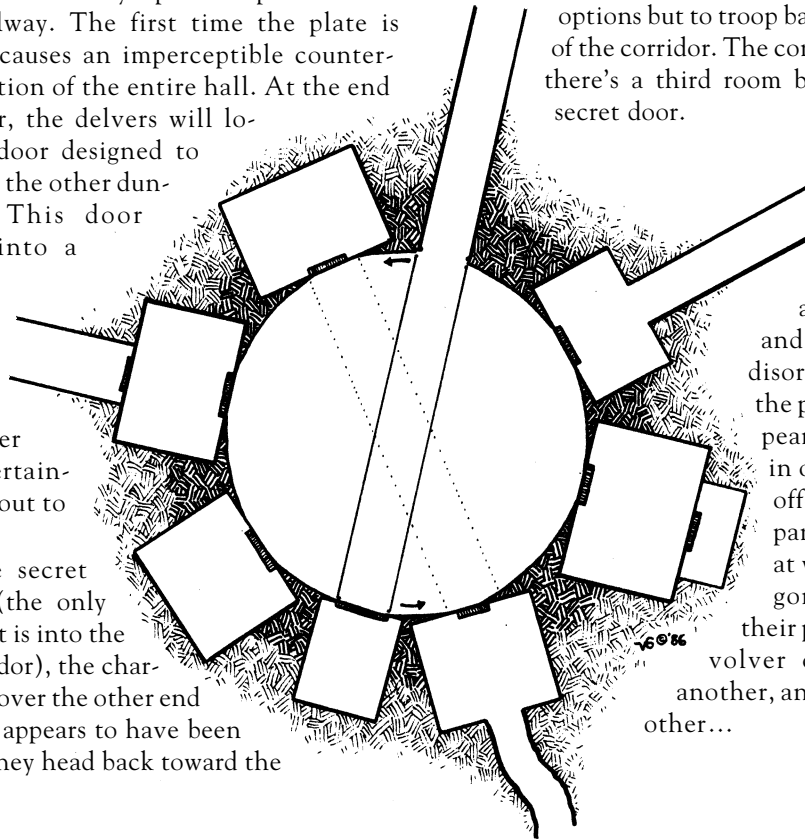

This sequence of bouncing back and forth between hidden rooms will stop after a fourth, fifth, and sixth room, totally disorienting them with the paradox of what appears to be three rooms in one. If these rooms offer other exits, the party may never know at what angle they've gone. And imagine their problems if one Revolver corridor leads to another, and another, and another...

That Sinking Feeling



CR:	1
Type:	Mechanical
Search:	Trap (DC 20), Trigger (DC 20)
Disable Device:	Trap (DC 20, 2d4 rounds), Trigger (DC 20, 2d4 rounds)
Primary Trigger:	Event (stepping on colored tile)
Primary Trap Effect:	Victim's ankle is mashed between plates; use the Variant: Damage to Specific Areas, found in Chapter 2 of the <i>DMG</i> .
Reset:	Automatic
Cost:	1,000 gp

Laurel Goulding offers another trap of the "step and die" variety, which is also dependent on decorative flooring. This trap is enough to make the strongest heart falter. The wrong step will have the mightiest hero on crutches for good.

The characters come to a section of corridor (or even a complete room) floored with neatly set, decorative tiles, each about 12 inches square. Many of the tiles are perfectly safe to step on. Quite a few, however, are not. Stepping on one of these randomly placed tiles will be a disabling experience. The trapped tile sinks about 5 inches and two of the surrounding tiles snap shut around the character's ankle. The enclosing tiles could be razor-edged, of course, although making them stone or blunt metal would be enough to make Major Macho Hero limp around on a smashed ankle for two or three weeks at best. And placing this trap right before a room where one has to jump from pillar to post, as with our opening room trap, can make for lots of fun with a broken ankle.

Spinning Spiral Stair



CR:	1
Type:	Mechanical
Search:	Trap (DC 25), Trigger (DC 20)
Disable Device:	Trap (DC 20, 2d4 rounds)
Primary Trigger:	Touch (stepping on and walking on stairs)
Reset:	No reset needed
Cost:	1,500 gp

One way to “expand” an old complex with space concerns is to provide an illusion of size. This trap is just the thing for desperate DMs on a budget.

Locate this stair anywhere you want to hint another dungeon level exists, without actually wanting to build the level. For all intents and purposes this seems a normal spiral staircase, but when the party travels halfway along the stair, the whole structure begins to turn. The turning motion is subtle and imperceptible — when the party stops moving, so too will the stair stop turning. The stair always turns in the same direction the party is moving, so this trap works whether the party is moving up or down.

This amounts to a treadmill stair that endlessly turns under the party’s feet. If you carefully synchronize the rotation of the stair with the motion of the party, the characters will think they’ve stumbled upon an incredibly long staircase that leads to heaven knows where. Eventually the party will give up in its quest to reach one end or the other of the stair and retrace their steps, in which case you should reverse the motion of the stair to simulate an equally long return journey. The result is the characters’ perception that a separate level of your dungeon exists where there is nothing at all. If you get lucky, some genius may even try to blindly teleport to where he is “sure” a dungeon level exists... and instead wind up in solid rock.

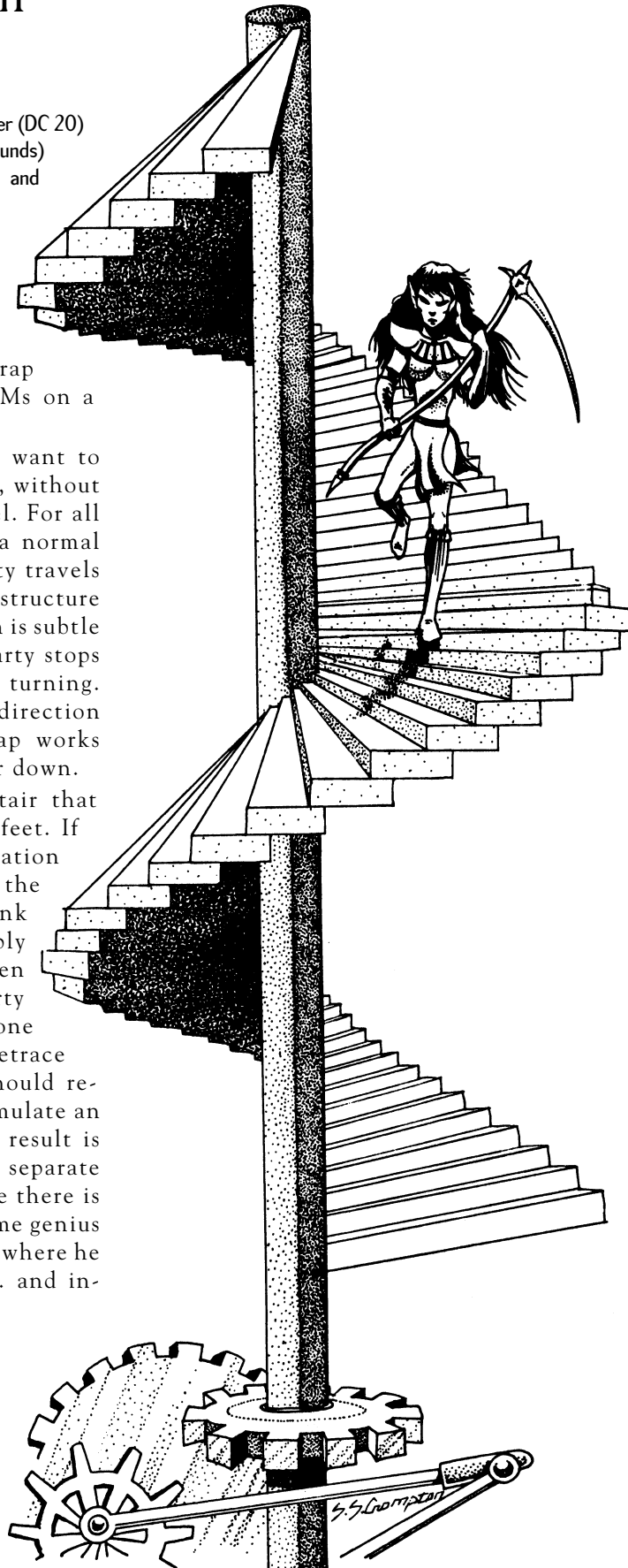

Beauty is in the Eye of the Beheader



CR:	5
Type:	Mechanical
Search:	Trap (DC 22); Trigger (DC 22)
Disable Device:	Trap (DC 25, 2d4 rounds); Trigger (DC 25, 2d4 rounds)
Primary Trigger:	Touch (stepping through guillotine blade)
Primary Trap Effect:	+20 melee (6d6, guillotine blade, crit 18–20/x2)
Bypass:	Creatures with a Charisma less than 10 can bypass the trap without the imp setting it off.
Reset:	Manual (the imp resets the trap from his position)
Cost:	25,000 gp (includes food for the imp)

Molly Ringworm is a fine trap designer, but she is a very ugly woman. As a friend of mine might say, “she could scare dogs off the back of a meat truck.” That’s a shame, because Molly is a fine person....

Imagine a normal dungeon corridor suddenly intersected by a huge guillotine. Arranged on shelves lining the walls are the severed heads of incredibly beautiful creatures of all races and genders. It should be obvious the heads were severed from the bodies of beings who tried to pass through the guillotine.

While the party is trying to decide what to do, a deep voice speaks from the darkness. “Only ugliness will I destroy — if you are fair, you need not fear my blade. Step across the threshold and be judged.” The wise thing to do is to run the other way, but if something suitably important is on the other side of

the guillotine (such as the exit from the dungeon), you should be able to harvest a few heads.

Characters inspecting the guillotine will notice there is a mirror hung nearby, and that the mirror is distorted like something you’d find in a funhouse. The mirror is angled such that it faces around a bend in the corridor on the far side of the guillotine. No light or image can be seen in the mirror. Some indication might also be provided that the guillotine is triggered by someone sitting around the corner... right about where the mirror faces.

Characters tempting the blade will learn that turnabout is fair play. A vicious little gremlin sits on the far side of the corridor, his finger just itching to pull the trigger on the guillotine. His standards of beauty are conventional, but he is positioned such that he can view the characters only through the distorted glass of the funhouse mirror. As a result, beautiful characters will appear ugly, while ugly characters will appear beautiful. The gremlin will act appropriately when someone tempts his blade, pulling the trigger on a beautiful character, but allowing an ugly one to pass by... because beauty is in the eye of the beheader.

Since the imp is viewing creatures through a “funhouse” mirror and a subject’s image appears distorted (and since an imp’s tastes in beauty differs from the average person’s), those creatures with a Charisma of 10 or higher are viewed as ugly and are subjected to the guillotine blade. Those with a Charisma less than 10 can safely pass through this trap unmolested.



Achilles' Willies



CR:	4
Type:	Mechanical
Search:	Trap (DC 22), Trigger (DC 15)
Disable Device:	Trap (DC 25, 2d4 rounds); Trigger (DC 20, 2d4 rounds)
Primary Trigger:	Location (stepping on pressure plate springs trap)
Primary Trap Effect:	+20 melee (2d4+6, scythe blade, crit x4), also use Variant: Damage to Specific Areas found in Chapter 2 of the <i>DMG</i> .
Reset:	Automatic
Cost:	17,800 gp

How could a traps book go to press without at least one trap that does something horrible to the feet? My first volume of traps devoted a whole subchapter to “step & die” traps. This volume has but one, but it is such a ferocious design it should be more than enough to satisfy all you foot freaks out there.

Andrew Bander's design requires a large trigger pad to operate, so it is best located in the midst of a mosaic, or some other floor type that easily hides lines and shifting surfaces. This trap also requires that its victim step directly onto it to function, so you can improve your batting average by locating several of these in close proximity to each other.

The illustration pretty much tells the tale with this trap. The downward motion of the footpad brings the victim's foot into line with the horizontal blade. A character stepping full into this trap will have his foot severed. If the victim only partially strikes the pad, he may still lose some toes before he can fully remove his foot. Don't forget it will be almost impossible to walk after suffering any sort of sever foot injury, so springing this trap on someone deep in a dungeon could ensure the victim never limps out to tell the tale.

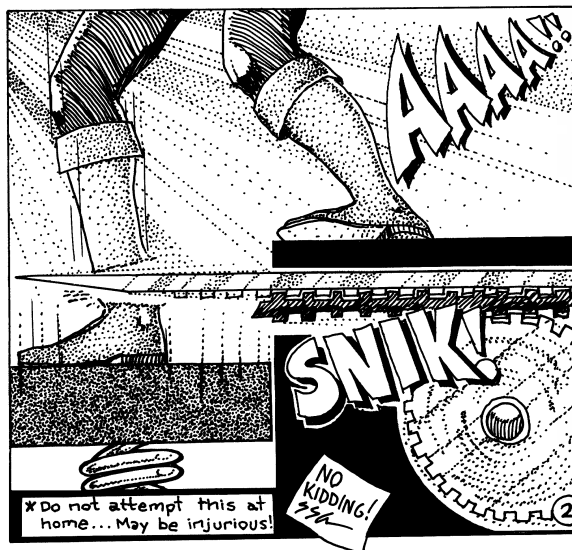
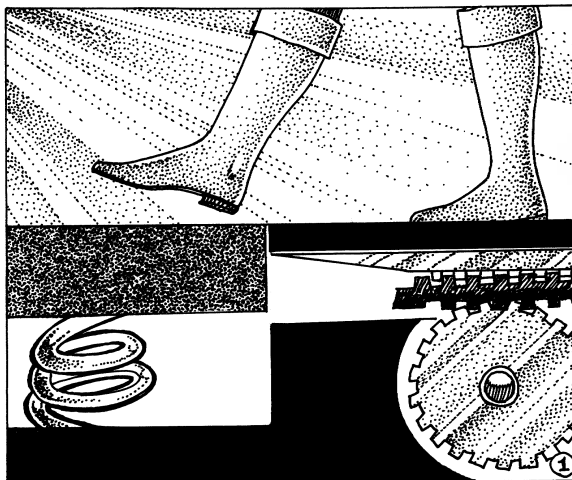

Palm Red



CR:	1
Type:	Mechanical
Search:	Trap (DC 15), Trigger (DC 15)
Disable Device:	Trap (DC 15, 1d4 rounds); Trigger (DC 15, 1d4 rounds)
Primary Trigger:	Event (sticking hand/arm in hole in the wall)
Primary Trap Effect:	Hand is painted red
Reset:	Repair
Cost:	300 gp (includes the cost of paint)

It's a shameless terrible old groaner of a pun, and we've all heard it a million times before, but the sheer audacity forces me to publish this next trap. I apologize in advance for what's about to happen.

A party traveling down any normal dungeon corridor discovers an unusual sight. Before them rises a fantastic wall

inscribed with gold moons and stars. Characters with scientific knowledge will notice the wall diagrams depict with astonishing accuracy the movement of local celestial bodies. The wall is a work of art, and the region positively glows with magical energy. At the center of this cosmic masterpiece is a hole about the size of a closed fist. When the characters draw near, a ghostly voice seems to speak from beyond the heavens. “The mysteries of the universe lay open before me. Within my heart there are no questions, only answers. If you would know your fate, step forward and have your Palm Red.”

It's one of the oldest jokes in the book but I bet you someone will fall for it. A character inserting his hand in the hole will feel his palm grow cold and wet for a moment — when the hand is withdrawn, the victim finds that it is stained with a rich red paint. Peals of hysterical laughter issues from behind the wall, and I have no doubt a similar chorus will shortly spring up from the victim's fellows. Palm red! What a jerk!

One Orc's Sauna is Another Man's Body Fluid

CR: 4

Type: Mechanical

Search: Trap (DC 22), Trigger (DC 20)

Disable Device: Trap (DC 27, 2d4 rounds); Trigger (DC 20, 2d4 rounds)

Primary Trigger: Location (trapdoor pressure plate)

Primary Trap Effect: Creature stepping on plate falls down slide and into "oven." For each round spend in the room, the creature takes 1d6 points of damage.

Reset: Manual

Cost: 8,000 gp (includes cost of coal or other fuels to heat the "oven")

I'm sure everyone is familiar with the old saying, one orc's sauna is another man's body fluid. I've taken this aphorism to heart with this trap designed to combine work and play for your dungeon's orcs. The adventure starts with a simple trap door and frictionless slide combination — you should have one lying around someplace. Delvers dropping through the door wind up on a hot steel sheet, from which it is exceptionally difficult to escape (they were delivered here by a frictionless slide, remember?). Slow death results, as it only gets hotter, and sooner or later the delver sizzles away to a burning little mass of thick liquid and steam. This byproduct drips through a funnel and into the secret room beyond, where weary orcs can enjoy a relaxing sauna before resetting the trap.

A trapped creature can scramble up the sides of the slide with a successful DC 80 Climb check (remember the walls of the slide are frictionless).

Tale of Two Pitys



CR:	7
Type:	Mechanical and Magical (<i>invisible wall, watching eye</i>)
Search:	Trap (DC 5), Trigger (DC 27), Secondary Trigger (DC 20), Tertiary Trigger (DC 27)
Disable Device:	Trap (DC 27, 2d4 rounds); Trigger (DC 27, 2d4 rounds)
Primary Trigger:	Event (leaping, flying over, moving over the first pit)
Secondary Trigger:	Location (frictionless floor)
Tertiary Trigger:	Touch (opening door)
Primary Trap Effect:	+10melee(1d6 force plus 1d4+2[1d4], spikes)
Primary Save:	Reflex (DC 25) avoids
Secondary Trap Effect:	Frictionless floor dumps creature on its backside and sends it into acid pit (submersion damage, 10d6 acid damage per round); those that attempt to fly and hit the invisible wall take 1d4 points of damage and fall into either pit 1 or pit 2 (50% chance of each).
Secondary Save:	Reflex save (DC 80) keeps creature from sliding into acid pit

Tertiary Trap Effect:	Spring-loaded door (1d4, door) sends creature into acid pit (see Secondary Trap Effect above).
Reset:	Automatic
Cost:	35,000 gp

Brian Lawton makes no excuses for his outrageous puns, but he does offer us a Tale of Two Pitys — a dastardly corridor pit trap. The party should know something is up when they see a spiked pit blocking the corridor before them. Directly above the pit, looking down into its dark depths, is a genuine living eye... the glassy orb alternatively rolls and stares, keeping the party in view.

A living eye in the ceiling is going to unnerve everyone, but the safest thing to do is destroy the eye by blade or fire. Otherwise, the eye is going to watch as the characters try to cross the it.... And will trigger the spring-loaded ram beneath the spikes at the bottom of the pit. This will cause the spikes to slam up to the ceiling — but note the gap

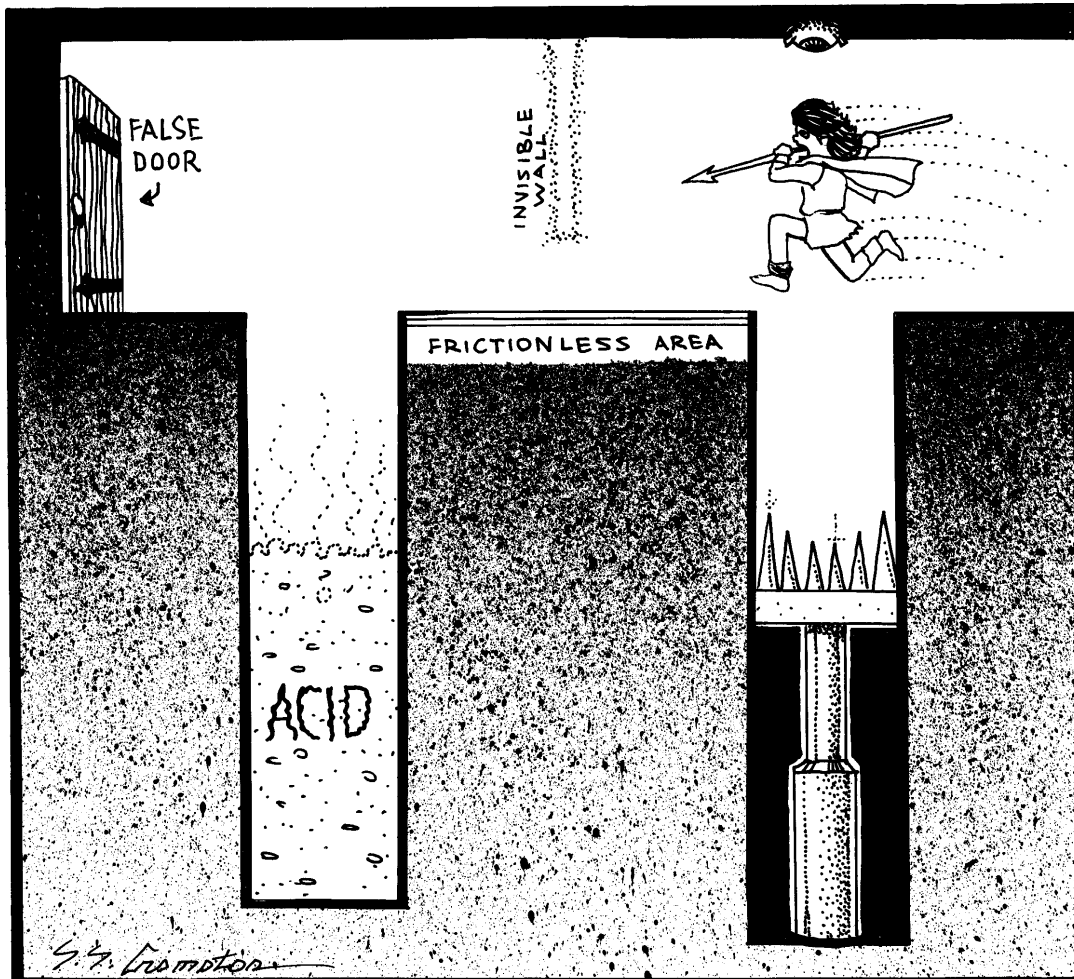

in the spikes, designed to protect the eye should it still be alive when the spikes are activated.

After a casualty or two, the delvers should feel confident they can get over the pit... but the ground on the far side is a frictionless slide, and anyone landing upon it will lose their footing and slip into a waiting pit of corrosive acid. If someone rakes a really long jump, they will collide with the invisible barrier hanging from the ceiling, and

then probably slide into one of the pits despite his best intentions. Flying characters are also likely to run into the invisible barrier.

Should the party avoid both pits, the frictionless slide, and the invisible barrier, they will find a door at the end of the corridor. Opening the door triggers a trap door beneath the character's feet, dumping him or her into the acid pit. Behind the door is... a brick wall. Pity.

Tipping Corridor



CR:	1 (or higher depending on what fills the reservoir)
Type:	Mechanical
Search:	Trap (DC 20), Trigger (DC 20)
Disable Device:	Trap (DC 22, 2d4 rounds); Trigger (DC 25, 2d4 rounds)
Primary Trigger:	Location (crossing mid-point of corridor activates the trap)
Primary Trap Effect:	Floor tilts slamming creatures into wall; 1d6 points of damage
Bypass:	Perhaps a hidden lever on the wall keeps the floor from tilting for those who know it is there (Search DC 25 to find).
Reset:	Automatic (floor resets itself after 1 minute); manual reset if reservoir is filled with something.
Cost:	1,000 gp (does not include the cost of filling the reservoir)

While many traps rely upon incredible complexity to operate, the visual simplicity of Brian Lawton's trap wins this next design a place in this volume. This trap can turn any dead end corridor into a truly dead end corridor, and you won't even need to rip out a bunch of walls to make it work.

Lure your victims into the dead end with any suitable bait — a treasure chest at the far end of the corridor should do the trick. When the party walks sufficiently past the fulcrum hidden beneath the corridor floor, the whole corridor tilts down, revealing a secret reservoir of whatever you like within the ceiling. Bowling balls should do nicely. Even if the characters survive the initial action of the trap, they may still find themselves entombed behind the simple sliding surfaces of this design.

The reservoir can be filled with solids (bowling balls, boulders, barrels, etc.), liquids (acid, for example), or even monsters (green slime or ochre jelly works nicely). This raises the CR of the trap by +1 to +4 (and multiplies the cost above by the new CR). The DM makes the call as to exactly how much higher the CR should be.

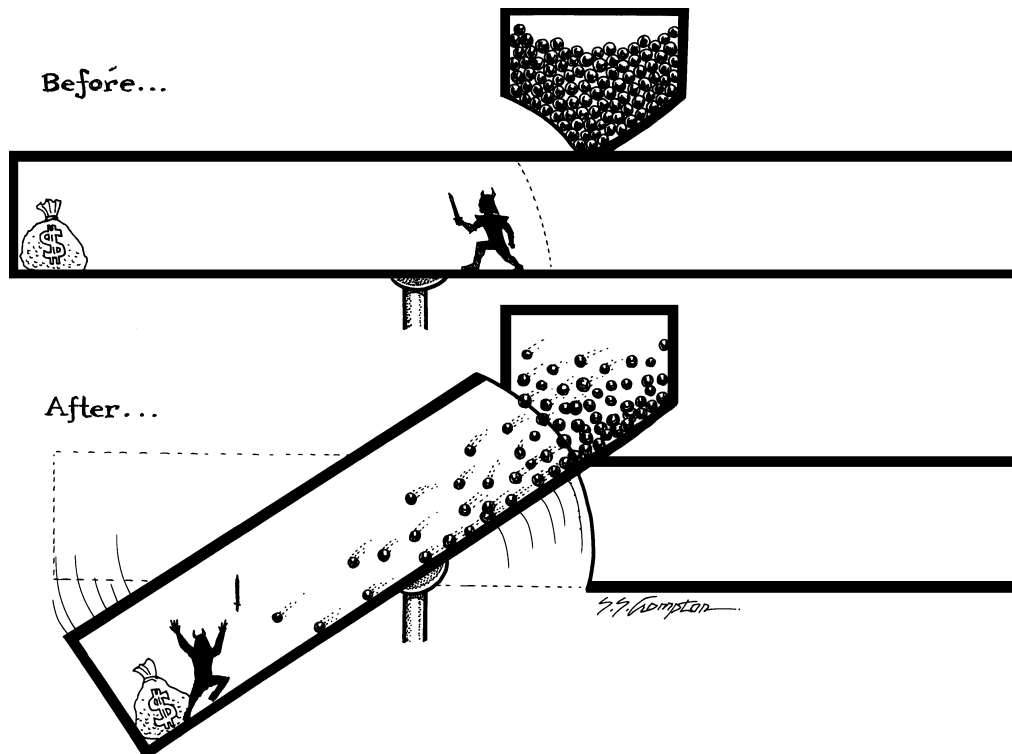

Triple Trap Tunnel



CR:	4
Type:	Mechanical
Search:	Trap (DC 22), Trigger (DC 20), Secondary Trigger (DC 22), Tertiary Trigger (DC 22)
Disable Device:	Trap (DC 25, 2d4 rounds); Trigger (DC 20, 2d4 rounds)
Primary Trigger:	Location (pressure plate)
Secondary Trigger:	Timed (1 round after primary trap springs)
Tertiary Trigger:	Timed (1 round after blade retracts into wall)
Primary Trap Effect:	+20 melee (1d8+6, piercing blade, crit 19–20/x2)
Area of Effect:	Creature standing on pressure plate; tertiary trap affects all in a 10-foot by 10-foot area centered on pressure plate.
Secondary Trap Effect:	Whirling ceiling fan blades rapidly descend to hit creature on pressure plate; damage 6d6, crit 19–20/x2.
Secondary Save:	Reflex (DC 20) allows creature to duck beneath blades.
Tertiary Trap Effect:	20-foot deep spiked pit trap; damage 2d6 (from fall); multiple spikes hit multiple targets (Atk +8 melee, 1d4 spikes per target, 1d6+2 damage).
Bypass:	A hidden lever of some sort can be installed to bypass or deactivate the pressure plate.
Reset:	Automatic
Cost:	10,000 gp

Remember when slowly revolving Casablanca ceiling fans were all the rage? Well, Sidney Greenstreet wouldn't dare sit under the fan in this next trap unless he wanted the top of his head removed. Dan

Logans is responsible for this terribly lethal corridor trap in the grand old fashion.

The trap is triggered by a pressure plate. Things happen almost too fast to follow. First, a long blade springs horizontally across the corridor. Dave says the blade should travel at 184 miles per hour, but my own tests have shown considerably greater velocity is possible if a properly large spring is used.

No sooner does the blade strike home than the ceiling is rolling away, revealing the furiously rotating fan. Engineer Dave claims a top speed of 9,835 rpm for the fan, but once again I think there is room for improvement. The ceiling fan descends to head height. The fan should rapidly dispose of the upper half of anyone impaled by the blade.

To complete the carnage, the horizontal blade retracts just in time for the pit to open beneath the party's feet, dumping any struggling bits of flesh that otherwise might survive onto the spikes below. The spikes, of course, are superfluous, but Dan's alternate name for this trap is "Overkill," so he can be forgiven his excess.

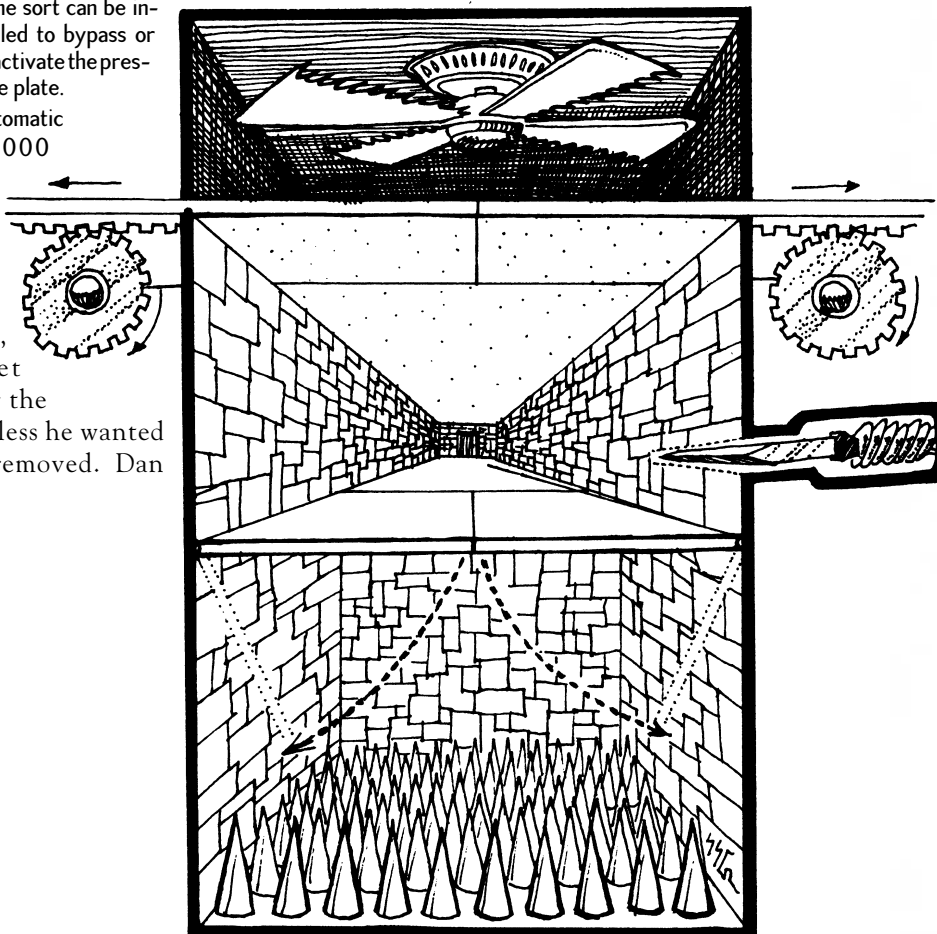

Heart of Glass



CR:	1
Type:	Mechanical
Search:	Trap (DC 18)
Disable Device:	Trap (DC 23, 2d4 rounds)
Primary Trigger:	Location (end of corridor)
Primary Trap Effect:	Multiple glass spikes; +10 melee (1d4+1, [x1d4], spikes)
Reset:	No reset
Cost:	1,200 gp

We've all seen delvers impaled on sharp spikes before, but Dan Logan pumps some new blood into the idea with this trap. I found out at a young age how sharp glass can be — my daddy hurled me through a plate glass window, once.

This trap takes the form of several very long and flat glass spikes affixed to a wall at one end of a corridor. When viewed point-on from a distance, the spikes are very difficult to see... at best, a character might see something shiny in the darkness (DC 25 Spot check). Have something big and mean chase a delver toward the spikes and his doom is assured. Even when right on top of the spikes a potential victim will be hard-pressed to notice the danger — until he is impaled on the spikes, and he finds he has a heart of glass.

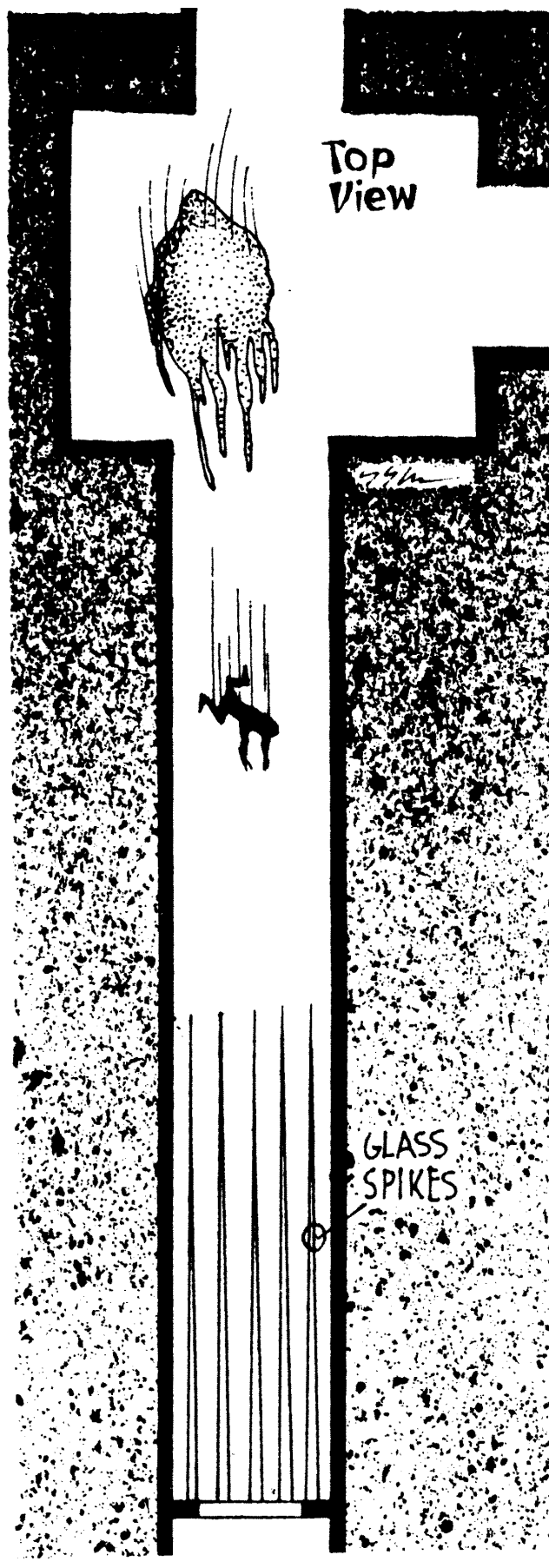

Wheel of Misfortune



CR:	5
Type:	Mechanical
Search:	Trap (DC 27), Trigger (DC 25)
Disable Device:	Trap (DC 27, 2d4 rounds)
Primary Trigger:	Timed (1 round after entering corridor)
Secondary Trigger:	Timed (1 round after metal-armored creature becomes stuck to wheel)
Primary Trap Effect:	No attack roll necessary; large magnetic wheel (speed 40 feet) pulls all metal weapons and armor to it; creatures wearing metal armor or wielding metal weapons must succeed at an opposed Strength check (Str 45) to avoid being stuck to the wheel (metal-armored creatures) or having their weapons yanked from their hands and stuck to the wheel (those wielding metal weapons).
Secondary Trap Effect:	Metal-armored creatures take 6d6 points of crushing damage from the turning wheel as they are smashed into the floor as it rolls down the corridor.
Reset:	Manual (large magnetic wheel must be rolled back into place)
Cost:	20,000 gp



not quite so wide as the corridor, and that a deft delver might avoid doom by pressing flat against a wall and letting the wheel roll pass. Armored characters are likely to take this option, as well all know how hard it is to flee when clad head to toe in gleaming plate mail.

As soon as the armored characters bail for the wall, their doom is sealed. The wheel will indeed roll past without striking the party, but the interior of the wheel is itself a powerful magnet. Armored characters will get stuck to the side of the wheel straight away, while unarmored characters should lose their weapons at the very least.

Thus stuck to the wheel, trapped characters will find themselves rotating around and around as the device speeds down the corridor to whatever doom you devise. Abruptly reducing the width of the corridor neatly solves the task of having to remove delvers from the wheel by hand.

We've all seen giant wheel traps before, but the Wheel of Misfortune puts a new twist on an old theme. Spring this horror on a party traveling along any sloping corridor section in your dungeon. The party's worst fears are realized when a huge wheel appears at the top of the slope, bearing down directly on the characters.

You can always let the delvers run away, but that's boring. Far better to point out the wheel is

Lose the Spock Ears, Clyde



CR:	1
Type:	Mechanical
Search:	Trap (DC 22), Trigger (DC 22)
Disable Device:	Trap (DC 20, 2d4 rounds); Trigger (DC 20, 2d4 rounds)
Primary Trigger:	Location (pressure plate)
Primary Trap Effect:	Clamps from ceiling flash down and catch Medium-size creatures by the ears; +10 melee (1d2 damage from clamps); creature caught is yanked into ceiling, 2d6 damage; creature is held for 1 minute before clamps release; 1d2 damage each round from pinching clamps

Primary Save:	Reflex save (DC 22) avoids
Reset:	Automatic
Cost:	1,000 gp

Odd Norm Strange strikes hard with this trap, designed to rid dungeon parties of elves, fair geeks, and Trekkies. This trap takes the form of two stiff metal rods, at the end of which are vicious metal clamps. The trap is activated by a pressure plate, causing the two stiff rods to flash down from the ceiling and whiz past the average delver's head. The metal clamps engage when the rods reach where the trap estimates the target's head should be located. The margin for error with this trap is very

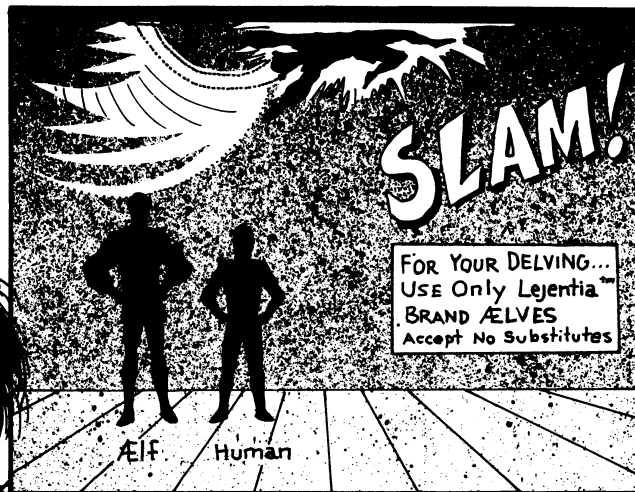
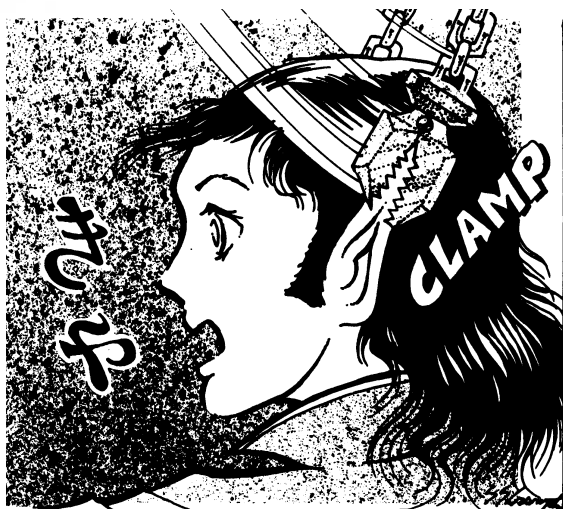

slight, and it might not work when you try it, but it's the thought that counts. Your average dungeon delver probably won't get hit by this thing, but will instead suffer an uncomfortably close call as the dangerous clamps whiz over his or her head. Elves, however, are a different story. Where I come from, dlves are taller than the average Joe,

and they have those freaky long pointed ears... just long enough to give the clamps a target. With a bit of luck, the clamps will catch an elf by the ears and yank the little bugger right off his or her feet, slamming the filthy cuss into the ceiling. Slapped into the roof by the ears — how if that for a special race bonus?!

See Ya Ladder



CR:	4
Type:	Mechanical
Search:	Trap (DC 22), Trigger (DC 20)
Disable Device:	Trap (DC 22, 2d4 rounds); Trigger (DC 20, 2d4 rounds)
Primary Trigger:	Touch (middle rung of ladder)
Primary Trap Effect:	No attack roll necessary (creatures on ladder take 6d8 points of damage when they smash the wall)
Area of Effect:	All creatures on ladder
Reset:	Automatic
Cost:	8,000 gp

Corridors go up and down as well as back and forth, and all too few DMs exploit the trap possibilities inherent with vertical shafts. To correct this oversight, George Andricopulos offers a vertical corridor trap with a painful punch line.

A vertical shaft contains a ladder set flush into one wall. Iron rungs protrude from the wall, providing steps and handholds for delvers wishing to transit the shaft. The rungs are sturdy and will resist even the most diligent attempts to remove them. The middle rung in the ladder, however, is trapped. No sooner does the trapped rung bear the full weight of an average delver than will the entire wall and ladder assembly smash against the opposite side of the shaft, impelled by a hidden battery of springs. Whoever is on the ladder at the time is going to get munched, and might even suffocate to death before his fellow can free him

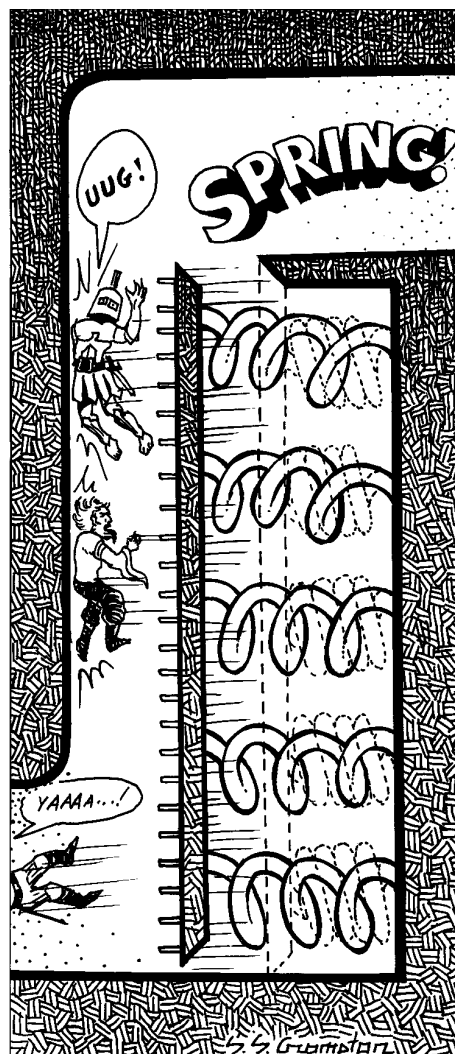

from the crushing pressure of the springs. The rest of the party will find their way up or down the shaft blocked by the now useless ladder and the coils of steel spring behind it. Yowza!

Characters that remain pinned behind the ladder/wall mechanism (when it is munched up against the wall) can hold their breath (as per the normal rules). After that they begin taking suffocation damage until freed.

Give Me A Lever Large Enough and I'll Move The World



CR:	10
Type:	Mechanical
Search:	Trap (DC 25), Trigger (DC 20), Secondary Trigger (can't be detected by conventional means)
Disable Device:	Trap (DC 25, 2d4 rounds); Trigger (Lever, DC 25, 2d4 rounds), Secondary trigger (can't be disabled unless character crawls under slab, then it is too late)
Primary Trigger:	Touch (moving the "lever" triggers the trap)
Primary Trap Effect:	No attack roll necessary (10-ft pit, 1d6 falling)
Area of Effect:	Creatures standing on covered pit
Secondary Trigger:	Burning rope releases stone block
Secondary Trap Effect:	No attack roll necessary (stone block, 18d6 crushing damage)
Secondary Area of Effect:	Creatures standing in pit
Tertiary Trigger:	Releasing lever
Tertiary Trap Effect:	No attack roll necessary (stone slab, 9d8 crushing damage)

Tertiary Area of Effect:	Creature under stone slab
Reset:	Repair
Cost:	35,500 gp

George Andricopulos reveals his Greek heritage with this next trap. I think it was Archimedes of Pythagoras or one of those ancient geeks who remarked, "Give me a lever large enough, and I'll move the world." Delves moving the lever in George's clever trap will move themselves into the next world.

The party will encounter a stone slab blocking the corridor with a wooden beam wedged beneath it. The beam in turn rests on a granite fulcrum, encouraging the party to pull down on the beam "lever" and raise the stone slab, thus clearing the way down the corridor. The fulcrum greatly assists this process, and with moderate effort the party will be able to raise the slab high enough to create a two-foot crawl space under the slab. If the delvers want to push even

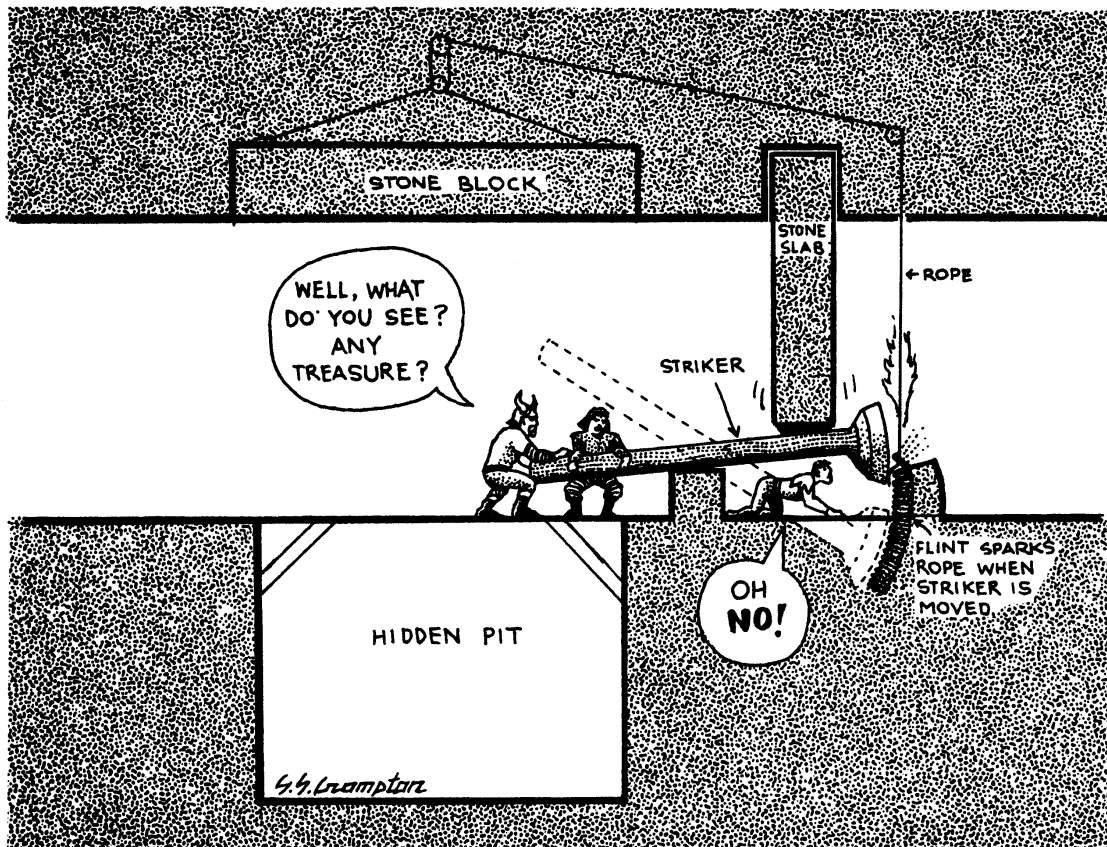

harder on the lever, however, they're in for smashing good time.

Hidden from view, on the far side of the stone slab, the end of the wooden beam is coated with iron. A vigorous push on the beam will cause the iron tip to strike against a block of flint, producing a spark that will quickly consume ropes hidden on the other side of the rock slab. The ropes are all that secures the now

free-falling block of stone positioned directly over the party's heads. Should the characters smell burning rope and quickly release the lever before the stone block can fall, the sudden transfer of weight will cause the party to break through into the pit hidden beneath their feet. Then you can laugh it up while the panicked party tries to scramble out of the pit before the slow-burning ropes loose the stone block to entomb them in the pit forever.

Grab For The Brass Ring



CR:	10
Type:	Mechanical
Search:	Trap (DC 22), Trigger (DC 30)
Disable Device:	Trap (DC 25, 2d4 rounds); Trigger (DC 25, 2d4 rounds)
Primary Trigger:	Location (grabbing middle ring causes floor to open and reveal molten lava)
Primary Trap Effect:	No attack roll necessary (molten lava, 20d6 per round of submersion; 10d6 for 1d3 rounds after exiting lava)
Bypass:	Perhaps a hidden lever on the wall keeps the ring from loosening for those who know it is there (Search DC 25 to find).
Reset:	Automatic
Cost:	30,000 gp (does not include the cost of filling the stream)

David Stevens penned this nasty trap. A normal dungeon corridor is blocked by a wide stream of fatal liquid. Acid, lava, or even molten diamond supplying the hot tub in the last chapter of this book — take your pick. From the ceiling descends a series of rings on chains leading out over the liquid, offering a way across the deadly stream to where the corridor continues on the other side. Brave characters may attempt to cross via the

rings, especially if pursued by sufficiently frightening monsters. Scientologists, maybe.

I'll leave aside the obvious potential of greased rings for David's more insidious suggestion. When the center one in the ring sequence is pulled upon, sections of the corridor floor slide away to reveal the stream of deadly liquid is wider than originally surmised. Whereas before the party could reasonably expect to cross the barrier via the rings, or at least make it back where they started, they're now stranded above the stuff, hanging by rapidly weakening hands, breathing in the hot and toxic steam of whatever bubbles below... well, like I said, I'll leave you to draw your own conclusions about what should happen next. Just to prove this trap is survivable, however, I'll suggest inventive victims might begin by roping themselves to whatever ring they hang from, then consider swinging back and forth until they arc over a safe section of corridor. I must be getting soft in my old age.

Characters can securely hold the rings for a number of rounds equal to their Strength score. After that, a character must succeed at a Strength check (DC 10, +1 for each additional round) to maintain his hold. If failed, the character's grip gives way and he falls into the lava stream.

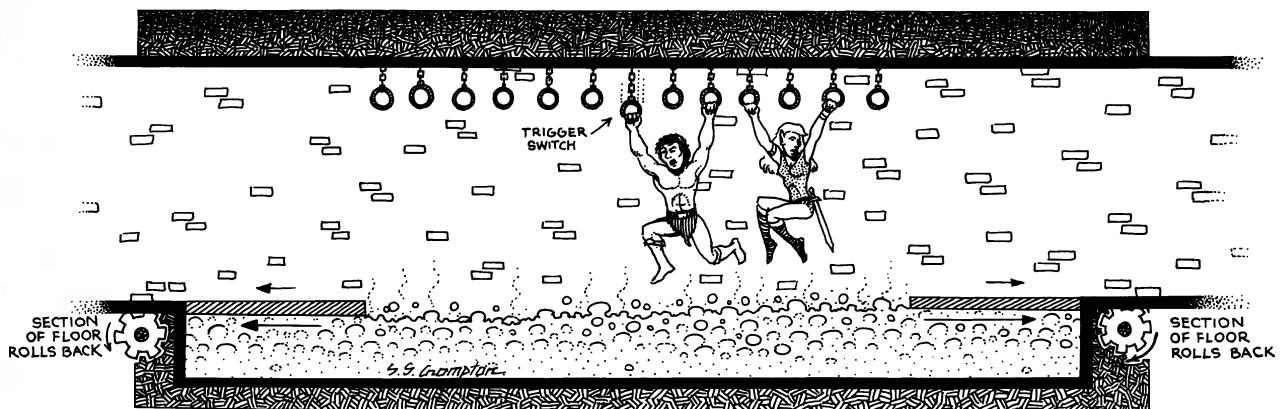

Life Is The Pits



CR:	4
Type:	Mechanical
Search:	Trap (DC 20), Trigger (DC 20), Secondary Trigger (DC 20)
Disable Device:	Trap (DC 20, 2d4 rounds); Trigger (DC 15, 1d4 rounds); Secondary Trigger (DC 15, 1d4 rounds)
Primary Trigger:	Location (stepping on paper floor)
Primary Trap Effect:	No attack roll necessary (1d6, fall 10 feet into pit)
Primary Save:	Reflex (DC 20) avoids
Secondary Trigger:	Location (stepping on paper floor)
Secondary Trap Effect:	No attack roll necessary (8d6, fall 80 feet into second pit)
Secondary Save:	Reflex (DC 20) avoids
Reset:	Repair
Cost:	3,800 gp

Life is the pits — like that's supposed to be some kind of bulletin. If you've any boundless optimists in the next party that delves your dungeon, be sure to introduce them to this bit of wickedness, to ensure they keep their eyes on the corruption of the earth

beneath them, rather than the boundless domain of the heavens above. Unless they want to quickly visit heaven, that is.

This is a simple pit trap with a difference. A paper mock-up of an ordinary section of floor covers a pit in the corridor. Anyone stepping on the paper will tumble into the pit below, suffering moderate damage. After picking himself up and dusting himself off, the victim will cast about for a means out of the pit. How considerate — there's a ladder up one side of the pit wall leading back to corridor level. Optimism rewarded! This is the best of all possible worlds!

Beanhead!

Directly before the ladder is a second pit, again covered with paper, and if you get the same guy a second time, he deserves whatever awaits him at the bottom of your second pit. Maybe the second pit shouldn't even have a bottom, so your optimistic, cheerful victim can tumble through space forever, certain he'll land in a soft space right up until the time he starves to death.

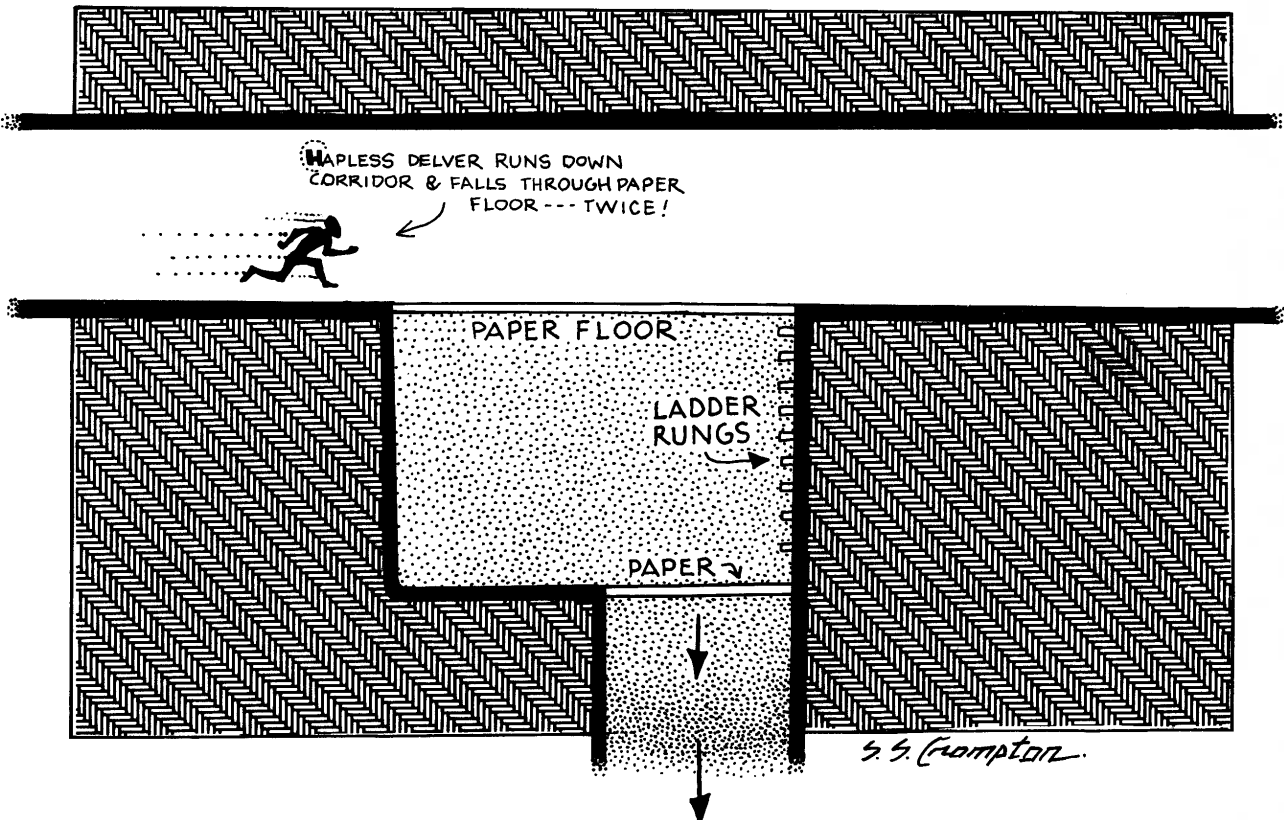

Boulder Trap



CR:	10 (actually ungodly and off the scale)
Type:	Mechanical
Search:	Trap (DC 25), Primary Trigger (DC 20), Secondary Trigger (DC 25), Tertiary Trigger (DC 30), Quinary Trigger (DC 25)
Disable Device:	Trap (DC 25, 2d4 rounds each section of trap); Primary Trigger (DC 20, 2d4 rounds), Secondary Trigger (DC 25, 2d4 rounds), Tertiary Trigger (DC 30, 2d4 rounds), Quinary Trigger (DC 25, 2d4 rounds)
Primary Trigger:	Location (weighted plate on floor triggers chute)
Primary Trap Effect:	Floor (width and length can vary) opens and dumps all creatures down 30-foot chute.
Area of Effect:	Creatures standing on affected area of floor
Primary Save:	Reflex (DC 20) avoids
Secondary Trigger:	Touch (touching the boulder)
Secondary Trap Effect:	Spring-loaded mechanism flings 20-foot long ladder and anyone near the top into the air (2d6 falling damage)
Secondary Area of Effect:	Creatures standing from mid-point to top of ladder
Tertiary Trigger:	Timed (falling ladder snaps net release cords)
Tertiary Trap Effect:	Three (or more) nets drop from ceiling to entangle those in the room (see <i>Weapons, Net</i> , in the <i>Player's Handbook</i>).
Tertiary Area of Effect:	One net covers a 10-foot by 10-foot area.
Tertiary Save:	Reflex (DC 20) avoids nets
Quaternary Trigger:	Touch (touching the boulder)
Quaternary Trap Effect:	No attack roll necessary (8d10 crush, boulder)
Quaternary Area of Effect:	Creatures standing in a 10-foot by 10-foot area in path of boulder are crushed as it drops to the floor and rolls over them and up the chute
Quaternary Save:	Reflex (DC 20) avoids
Quinary Trigger:	Boulder trips hidden switch
Quinary Trap Effect:	Volley of 20 spears fire from ceiling (+20 melee, 1d8+2, each spear); multiple spears (1d6) hit each target in a 10-foot by 10-foot area of room
Quinary Area of Effect:	The room
Senary Trigger:	Timed (boulder rolls up chute and then back down)
Senary Trap Effect:	No attack roll necessary (8d10 crush, boulder)
Senary Area of Effect:	Creatures standing in a 10-foot by 10-foot area in path of boulder and are crushed as it rolls back down chute and through the room
Senary Save:	Reflex (DC 20) avoids
Septenary Trigger:	Location (boulder breaks through wall under door)

Septenary Trap Effect: No attack roll necessary (1 Con perm drain/3d6 Con temp, burnt other vapors; Fort DC 18 resists)

Septenary Area of Effect: Gas fills room completely in 2 rounds
Septenary Save: Fortitude (DC 18) resists gas. A new save must be made each round a character remains in the gas.

Octonary Trigger: Boulder crashing through wall under door
Octonary Trap Effect: No attack roll necessary (18d6 crush, ceiling falls)

Octonary Area of Effect: Ceiling collapses and crushes anyone left in room

Reset: Manual
Cost: 120,000 gp, or 1,343,666 gp if you use Grimtooth's contractors

I like traps that can't work, at least not in any sane universe. My best designs rely on the laws of cartoon physics to operate. This trap, by David Stevens, certainly fits this description. No need to write a disclaimer in the front of the book warning kids not to try this one at home. This is a sheer flight of deadly fantasy.

David suggests you spring this trap on your victims just after they've rescued a hundred or so prisoners from the depths of your pit. I must admit this is the only reason I can imagine for releasing your hard-won prisoners. When the escaping party transits down a corridor, slapping themselves on the back and singing old dwarven war songs, dump the lot of them down a chute and into this vast, underground room.

When the party dusts itself off, they'll find the solitary features of the room are a slightly curved floor, a ladder that runs up to a door, and a large boulder that blocks the door. When someone climbs up the ladder and tampers with the boulder, this room becomes the devil's own playground.

First, steel rods burst from beneath the boulder, flinging it into the air. Simultaneously, another rod pushes the ladder away from the wall, causing it to describe a graceful arc as it plunges back into the room, hopefully with a couple delvers clinging to it like the Three Stooges hanging on the hook and ladder truck.

When the boulder strikes the ground, it will gather momentum on the curved floor and rush through the midst of any character standing about in shocked confusion. Meanwhile, the falling ladder will have snapped a length of wire stretched taut near the ceiling, releasing a score of cargo nets from a hidden recess in the roof. The falling nets should entangle anyone standing about in the room, and if you're springing this on a group of escaping prisoners as suggested, there should be quite a few victims to nab.



Grimtooth's Overkill + !! The Boulder Room

FIRST THE ADVENTURERS FALL DOWN A LONG CHUTE... *

* CHUTE SHOULD BE LONGER & STEEPER THAN SHOWN.

AAAHH!

AND INTO THIS ROOM...

DOOR

← BOULDER

LADDER

I THINK WE CAN GET OUT UP THERE.

CLIMBING THE LADDER TRIGGERS THE BOULDER & LADDER FALL...

WOO WOO WOO!

OH NO!

LADDER FALLING RELEASES NETS...

CRASH!

NETS FALLING, TRIGGERS CROSSBOWS, AS THE BOULDER ROLLS UP THE CHUTE...

UHH... I CAN'T BELIEVE I'M STILL ALIVE.

AND BACK DOWN, SMASHING DOWN THE OTHER WALL & RELEASING POISON GAS !!

AAAHH!!

BOOM

SMASHING THIS WALL ALSO KNOCKS OUT THE PLATFORM SUPPORT, WHICH COLLAPSES.

CRUMBLE!

PLOR

IT WILL CLEAN OUT THE ADVENTURERS & YOUR TREASURY IN REPAIRS, BUT WHAT A GREAT TRAP!

BILL
Repairs on Boulder Trap...
TOTAL: 1,343,666⁰⁰ gold pieces



© 92

G. G. Grompton

When the ladder falls all the way flat to the earth, the sides of the thing work like rails to help conduct the boulder along its way. The great hunk of stone will smash the struggling characters. Caught beneath the nets and shoot up the chute that conducted the party into this room in the first place. This is the cue for a volley of spears to rain down on the party, which should be good for some laughs.

It's momentum spent in the upward chute, the boulder now retraces it's path, crushing anew anyone who might manage to disentangle themselves from the net, the fallen ladder, and the painful passage of the boulder the first time around. The boulder then crashes through the wall at the base of the door, releasing a cloud of poison gas into the room from the chamber beyond.

Finally, the floors of the room tilt down at a steep angle, spilling the fleshy carnage that was once the party into the middle of the chamber, where they will be crushed to death by the ceiling that now collapses on cue. The wall beneath the door, as well, will collapse, dangerously weakened by the boulder. When the dust settles, I suggest you close off this wing of your dungeon, because there will be no survivors, and cost of resetting this trap will be prohibitive. But what the heck, it was fun while it lasted.

Characters can hold their breath when the burnt other gas is released (use the normal rules for holding one's breath), but I would imagine they will have too much on their minds to even think about it.

Oops, Aaaahhh!, Crash, Clang, Splat, Zap, Sizzle Trap



CR:	5
Type:	Mechanical
Search:	Trap (DC 22), Primary Trigger (DC 22)
Disable Device:	Trap (DC 25, 2d4 rounds), Primary Trigger (DC 25, 2d4 rounds)
Primary Trigger:	Pressure plate on stairs
Primary Trap Effect:	Stairs turn into slide and dump creatures into pit where they break through two glass panes (1d4 points of damage from each) and continue fall into 40-foot spiked pit (4d6 falling and 1d4+2 from 1d6 spikes [+20 melee each])
Primary Area of Effect:	Creatures on stairs
Primary Save:	Reflex (DC 20) avoids
Secondary Trigger:	Location (standing in pit)
Secondary Trap Effect:	Giant magnets rip metal armor, weapons, and shields from creatures in pit. A Strength check (DC 40) resists, but must be made for 5 rounds before he magnets shut off.
Secondary Area of Effect:	Anyone in the pit
Tertiary Trigger:	Location (standing in pit)
Tertiary Trap Effect:	No attack roll necessary (1d6 heat damage per round, boiling oil).
Quaternary Trigger:	Event (touching cable on wall)
Quaternary Trap Effect:	No attack roll necessary (1d6 electrical damage each round cable is touched; once grasped a creature must succeed at a Strength check DC 20 to break his grip on the cable)
Reset:	Repair
Cost:	15,800 gp

The title for this design from Brian Moroz certainly lives up to its name. If this beastly engine doesn't deserve six skulls, then nothing does. The trap is triggered when the party steps on a pressure plate hidden in a stairway. The stairs then flatten out, becoming a slide ("Oops"). The party will slide down the now-slick stairway and crash through a trap door at the base of the stair, tumbling into a pit ("Aaaahhh!"). The victims' fall down the pit is partially broken when they crash through several panes of glass, each of which is coated with alcohol and rock salt ("Crash"). After clearing the glass, a pair of magnets forcefully rip away whatever metal armor the party may be wearing ("Clang"). The fall down the pit terminates on a bed of spikes ("Splat").

But wait, there's more. If anyone is still alive, they'll find the bottom of the pit is being pumped full of boiling oil. The only chance of escape is to grasp a metal cable that dangles just within reach... but the cable is electrified, which should come as quite a shock ("Zap"). By the time the treacherous cable has been found out, the surviving party members should be submerged in boiling oil ("Sizzle"). Once the party has conceded defeat, be sure to explain the name of this trap to them, painfully recounting every last detail if need be.

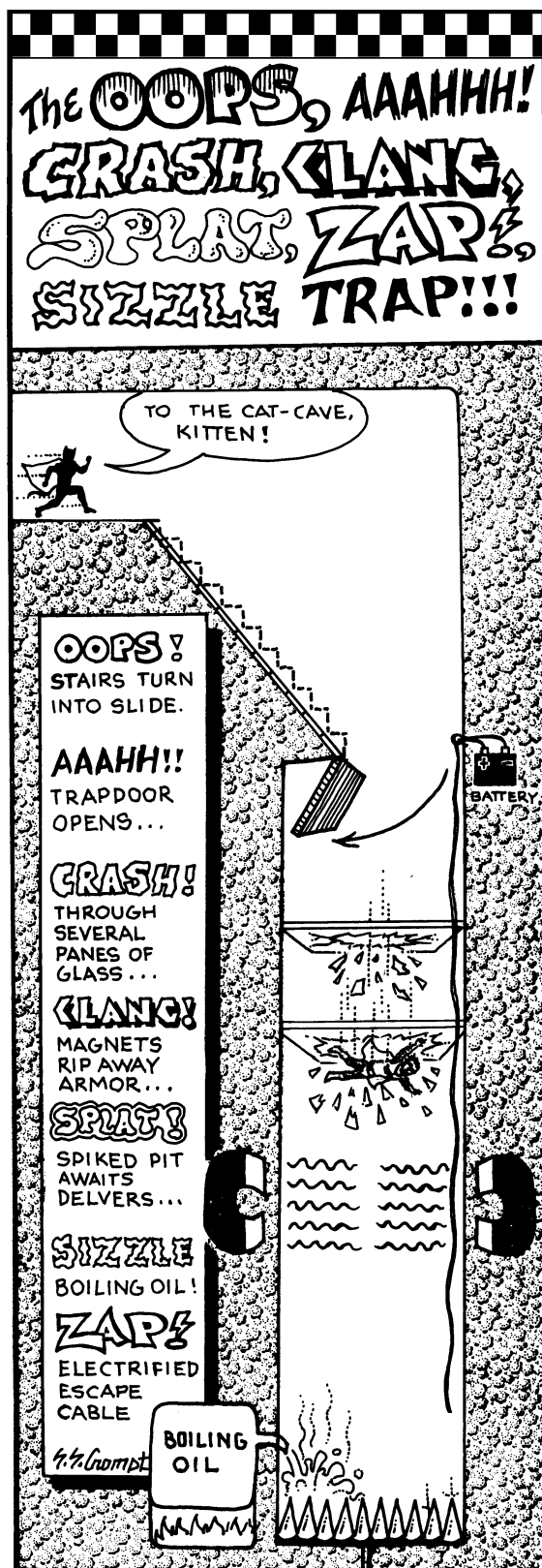

SECTION THREE:

DOOR TRAPS



Doors are probably the most overlooked items in a dungeon, and with good reason. By and large, doors are usually transition devices between areas where the real action takes place: a warm up act for the main attraction.

Door traps require a subtlety of design usually not required of corridor or room designs. Delvers naturally think of doors as gateways to danger. When confronted with a door your average dungeon delving party conducts a Chinese fire drill, spreading out in all directions, arranging themselves along this wall and that, someone watching the rear, someone watching the front, someone watching the Amazon's rear, someone standing in front of the door, someone standing beside the door... it really can be a bore after the second or fifth or tenth time you've seen it. But more often than not the characters succeed in protecting themselves from harm with their actions. Frequently delvers adopt a standard operating procedure when they reach a door, and go through their preparations wordlessly and without much enthusiasm. That's when their attention begins to wander. Just when they think they're safe — such as after traversing a hall with one hundred untrapped doors — *THAT'S* when to spring one of these beauties on them

Operating as they do — when a delver's guard is down — traps such as these are likely to create a high number of casualties. They will also lead to widespread, unreasoning paranoia.

Knock knock.

~ *Grimt*



DUNGEON of DOOM
TRAPS BAZAAR
TRAPS LIFE
TRAPS ATE
TRAPS FORE
TRAPS TOO
TRAPS

WURST of TRAPS

Giant's Razor



CR:	4
Type:	Mechanical
Search:	Trap (DC 21), Trigger (DC 21)
Disable Device:	Trap (DC 18, 2d4 rounds); Trigger (DC 18, 2d4 rounds)
Primary Trigger:	Touch (touching the door)
Primary Trap Effect:	Keen-edge razorblade (+20 melee; 2d4+8, crit 19-20/x4), also consider using Variant: Damage to Specific Areas found in Chapter 2 of the <i>DMG</i> .
Reset:	Automatic
Cost:	7,500 gp

John R. Greer provided this dismal doorway doom device. His Giant's Razor is designed to wreak havoc upon "standard door-opening techniques": standing to the side of a door as it is opened.

The door trap is held closed only by a common latch. When the latch is lifted, the weight of a 20-pound razor poised beyond — coupled with a powerful spring — will force the door to fly open. Unless the character is trying to hold the door closed, the portal will swing open and the blade will swoop through.

The razor's effect depends upon where the character stands. If he stands to the latch side of the door, he is in great danger of having his arm amputated. If he stands in a line with the middle of the door, the razor would probably hit him in the upper torso. A character who

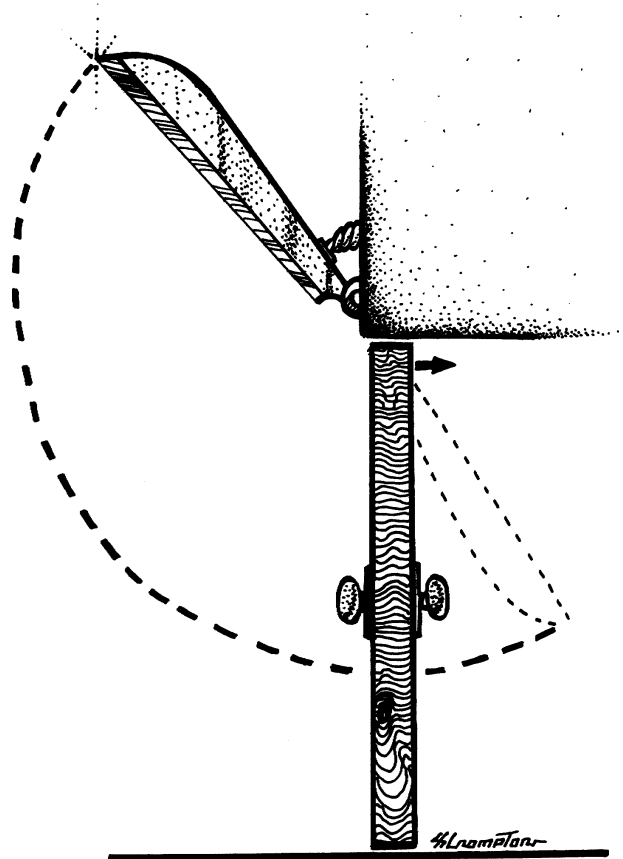

stood on the far side of the door from the latch would probably escape unharmed.

Guillotine Door Trap



CR:	4
Type:	Mechanical
Search:	Trap (DC 22), Trigger (DC 22)
Disable Device:	Trap (DC 20, 2d4 rounds); Trigger (DC 20, 2d4 rounds)
Primary Trigger:	Event (touching the door)
Primary Trap Effect:	Keen-edge guillotine blade (+20 melee; 2d4+6, crit 19-20/x2)
Reset:	Automatic
Cost:	17,800 gp

This trap, by James Brazier and Oliver Fittock, makes further use of blades and doorways to evil intent. Simple in construction, this trap simply drops a guillotine blade through the doorjamb shortly after the door is opened. Severed limbs or bodies will result, depending upon the circumstances.

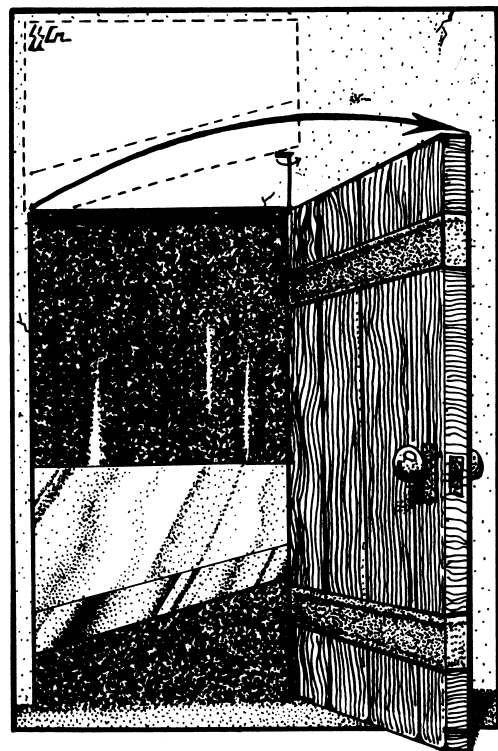

Poison Door



CR:	7
Type:	Mechanical
Search:	Trap (DC 21), Trigger (DC 21)
Disable Device:	Trap (DC 21, 2d4 rounds); Trigger (DC 21, 2d4 rounds)
Primary Trigger:	Touch (the door)
Primary Trap Effect:	Releases cloud of burnt othur fumes in 10-ft spread (1 Con [perm drain]/3d6 Con)
Primary Save:	Fortitude (DC 18)
Reset:	Repair (must replenish poison in door)
Cost:	17,500 gp

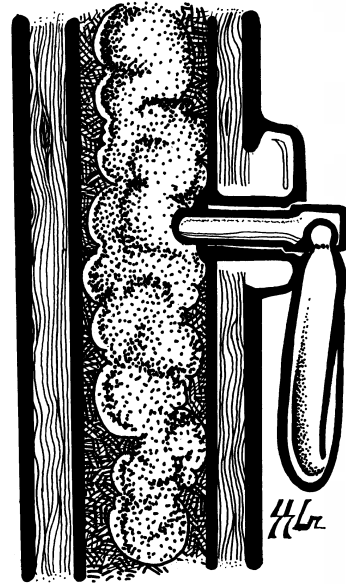
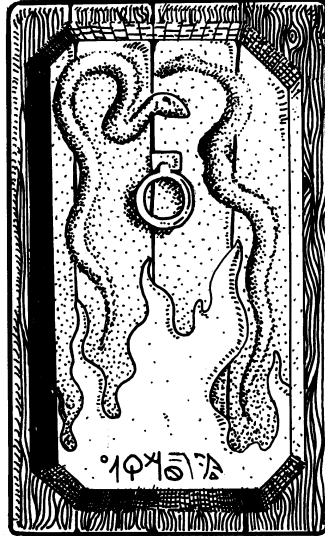

Rick Loomis designed this rather subtle device. Just because a door has a handle doesn't mean you have to use it — and if the delvers just push this door open, they'll live. Otherwise...

The trap is a hollow door filled with poison gas. The door is equipped with a plug "handle" which, when pulled out, releases the gas.

A somewhat more deadly (if that is possible) variation of this trap would be to fill the door with methane instead of poison gas. Odorless and colorless, methane ignites explosively in the presence of open flames (such as lamps and torches). Thus, if the delvers stand before the door, gaping at the "handle" and the hole in the door, doing nothing while methane floods the corridor about them, they probably wouldn't recognize the danger until the corridor exploded in a flash of fire.

Cure a Kicker Trap



CR:	4
Type:	Mechanical
Search:	Trap (DC 25), Trigger (DC 20)
Disable Device:	Trap (DC 25, 2d4 rounds); Trigger (DC 20, 2d4 rounds)
Primary Trigger:	Touch (forcing the door open [kicking, breaking it down, etc.])
Primary Trap Effect:	Extra-large spear (+20 melee; 2d8+4)
Reset:	Repair
Cost:	20,000 gp

By S.S.Crompton, this trap is not too subtle, being designed to take care of "lead-boot" dungeon delvers who enjoy kicking in expensive dungeon doors. After all, turnabout is fair play....

The trap is triggered around a weighted wire located within the door. As long as the door is opened normally, no appreciable dislocation of the wire will occur, and the delvers can proceed safely. If, however, the door is broken (as by a kick), then the wire will be freed, loosing the gear structure above to propel a large, spear-like beam toward the character.

The trap presents a wonderful display of overkill, but unless it is placed within a locked or hard-to-open door it will probably see little action. However, if you combine this trap with one of the other door devices listed in this chapter, and you have a two-edged doom-dealer sure to shred any delver.

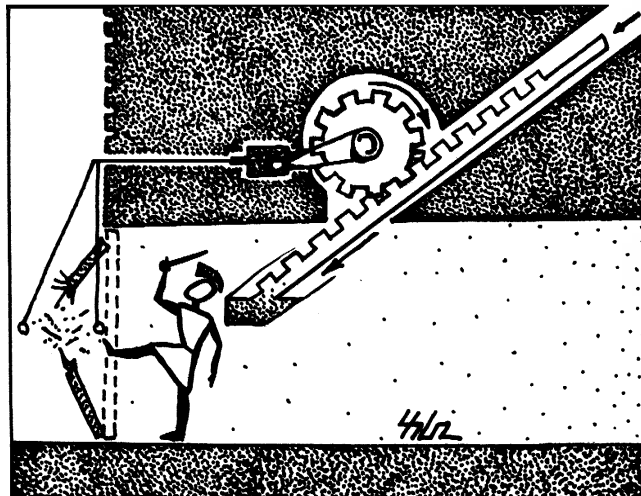

Dragging Doorway



CR:	1 or higher
Type:	Mechanical
Search:	Trap (DC 20), Trigger (DC 20)
Disable Device:	Trap (DC 20, 2d4 rounds); Trigger (DC 20, 2d4 rounds)
Primary Trigger:	Touch (forcing the door open [kicking, breaking it down, etc.])
Primary Trap Effect:	Limb is snared and dragged through door. What awaits it is entirely up to the DM.
Reset:	Repair
Cost:	1,000 gp or higher

This trap offers a novel method of dealing with door-kickers. Simply anchor a snare on the upper panel of the door; anchor another snare on the lower panel — and the snare captures the offending limb and drags it through the door into the room (and presumably off to meet some horrible fate).

Some suggestions for this trap:

Scything Blades: CR 1, +8 melee, 1d8+2 points of damage, crit x3, +700 gp to the cost.

Acid Bath: CR 1, +12 melee, 2d6 points of acid damage, +300 gp to the cost.

Monster: Anything you feel like putting on the other side of the door. Boost the CR of the trap so it is equal to the CR of the monster. Cost is whatever it costs to feed

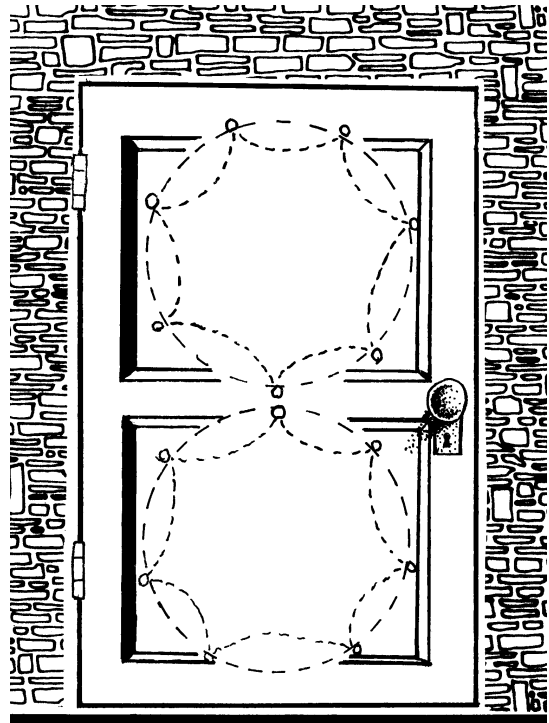

the monster itself (which isn't going to be much as it can dine on intrepid adventurers).

Double Door Doom



CR:	4
Type:	Mechanical
Search:	Trap (DC 21), Trigger (DC 21)
Disable Device:	Trap (DC 18, 2d4 rounds); Trigger (DC 20, 2d4 rounds)
Primary Trigger:	Touch (leaning through door or kicking, punching, breaking down door, etc.)
Primary Trap Effect:	Scything blade (+20 melee; 2d4+8/x4)
Reset:	Manual (blades must be reset)
Cost:	17,200 gp

Another product of Mike Stackpole's warped imagination, this design provides yet another variation on the blades-and-doors type of trap. This trap's double door construction also leads to several other possibilities for otherwise mundane dungeon doors — your doors needn't always be standard rectangular items from the warehouse...

The trap sports a spring-loaded blade in its lower half to slide through anyone who opens the upper door and leans through. The multi-purpose location of the lower door, along with a second blade in the upper half, also assures that anyone who

punches through this door won't keep his limb for long. When will delvers learn to simply open doors and walk through?

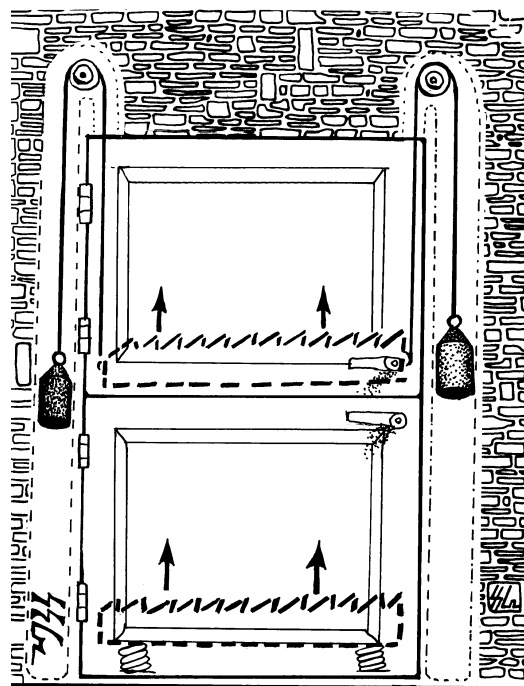

Delvermatic Dicer and Malingerer Trap



CR:	10
Type:	Mechanical
Search:	Trap (DC 28), Trigger (DC 22)
Disable Device:	Trap (DC 30, 2d4 rounds); Trigger (DC 24, 2d4 rounds)
Primary Trigger:	Touch (opening the secret door)
Primary Trap Effect:	Collapsing ceiling section (no attack roll needed; 8d6, crush; single target in a 5-ft square about 5 feet from door)
Primary Save:	Reflex (DC 30)
Secondary Trigger:	No trigger (automatic)
Secondary Trap Effect:	Keen-edge hook (+20 melee; 1d8+2, crit 19-20/x2; single target 10 feet from door [5 feet from victim hit by primary trap effect]).
Tertiary Trigger:	Touch (ceiling slams into pressure plate in floor and catapults those standing in area into spikes)
Tertiary Trap Effect:	Ceiling/Wall spikes (+20 melee; 1d4 spikes, 1d4+4 each spike; multiple targets in a line up to 20 feet away from door)
Quaternary Trigger:	Touch (bay doors swing down and push delver that opened the secret door through the monofilament)
Quaternary Trap Effect:	Monofilament (no attack roll necessary; 10d6, 19-20/x2)
Reset:	Manual
Cost:	65,500 gp

Liz Danforth and Mike Stackpole created this trap to take care of characters who open secret doors with gay abandon, but refuse to walk through them.

The secret door in question is set flush into the wall, and is designed to open by sliding into the ceiling (Search DC 20). When the door is thus opened, delvers will see a net-like web of monofilament line on the other side.

When the door slides up, it causes a section of the ceiling to swing down into the corridor. The arc of the section is such that it should slam into any character standing roughly six feet from the door. A devilish free-swinging hook trails the ceiling section, spelling doom for any delver standing about four feet from the fellow flattened by the ceiling section.

The ceiling section completes its arc by slamming into the floor — which is in reality a carefully balanced platform. This creates a catapult effect, and should send anyone standing as far away as twenty feet from the door flying into the spiked side of the ceiling section.

The poor idiot who opened the door in the first place is in for the worst fate of all. Bay doors kick out from the falling ceiling section when it finally hits the floor, propelling the hapless door-opener through the fine monofilament mesh — with the appropriate “cheese-grater” effect.

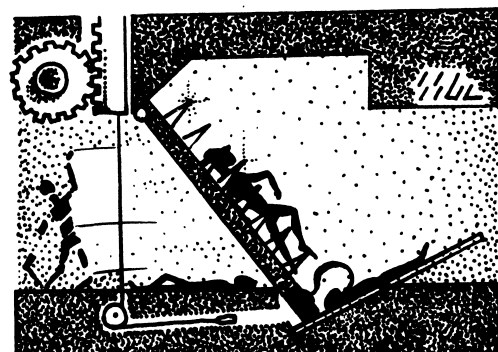
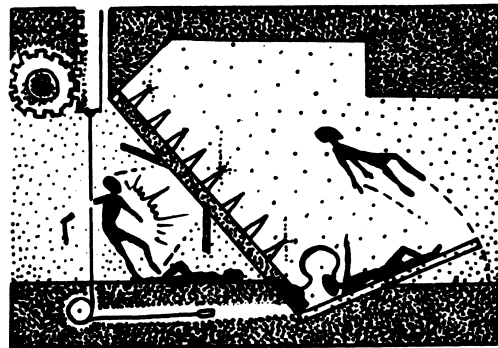
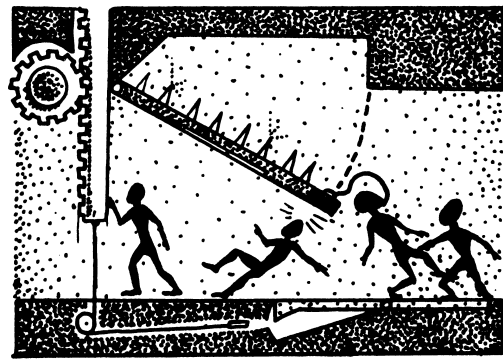
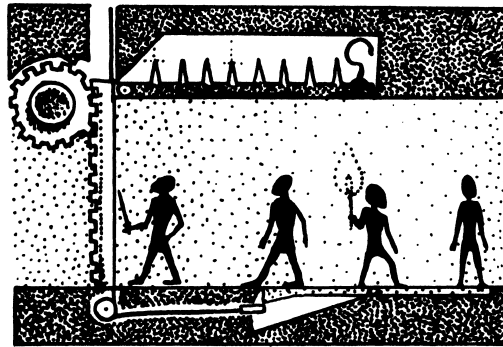

Double Trap



CR:	2
Type:	Mechanical
Search:	Trap (DC 22), Trigger (DC 18).
Disable Device:	Trap (DC 20, 2d4 rounds); Trigger (DC 20, 2d4 rounds)
Primary Trigger:	Touch (the door)
Primary Trap Effect:	Door slams victim(s) into wall spikes (+15 melee, 1d4 spikes, 1d4+8 damage each)
Reset:	Automatic (door resets in 1 round)
Cost:	6,000 gp

This is one of those devices that just screams, "Trap!!!" to anyone who sees it — but Mark put this effect to amazingly good use.

On one side of a corridor is an ornately carved door; on the opposite wall is a heavy panel, also ornately carved, with lots of iron spikes attached. Apparently any attempt to incorrectly open the door will tenderize a delver — and

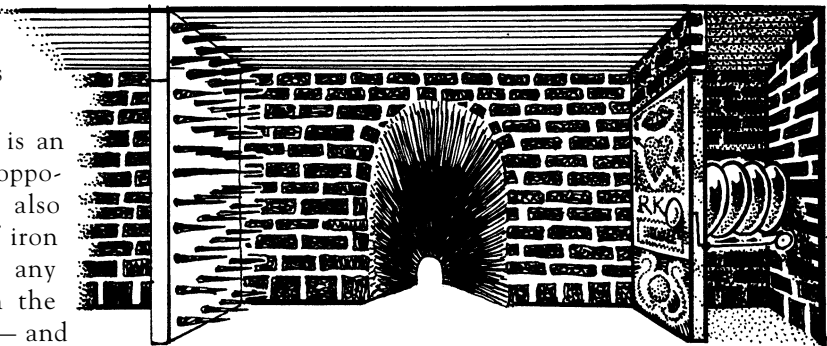

numerous bloodstains in the area only serve to reinforce this suspicion.

However, the spikes don't move — the door does. In fact, the door is just a false front for an enormous spring, which is set to slam the door across the corridor and into the wall of spikes. The spring is cocked at hair-trigger readiness, and the delver who monkeys with the door will be pulped before he can draw his last breath.

There is a door here, but it's a secret one. Where is it hidden? Why, behind the spikes, of course... (Search DC 25)

2 x 4 Headache



CR:	2
Type:	Mechanical
Search:	Trap (DC 18), Trigger (DC 18).
Disable Device:	Trap (DC 22, 2d4 rounds); Trigger (DC 20, 2d4 rounds)
Primary Trigger:	Touch (the door)
Primary Trap Effect:	Spikes (+20 melee; 1d6 spikes, 1d4+6 each spike)
Reset:	Automatic (spiked board resets in 1 round)
Cost:	6,000 gp

An even less subtle yet horrendous doom-bringer is this trap from Greg Day — sure to be a slap in the face for any careless delver...

Simple in its construction, this trap merely consists of a spike-studded board, which flops over into the doorway whenever the door is opened. If the delver is of normal (that usually means human) height, he receives a face full of spikes. If they are taller or shorter... well, you can use your own vivid imaginations to envision the possibilities!

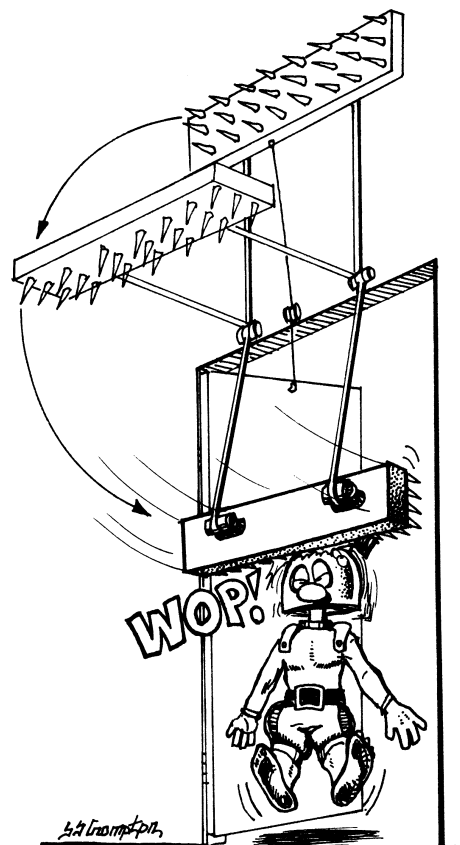

What You Don't Know WILL Hurt You



CR:	1 (or higher)
Type:	Mechanical
Search:	Trap (DC 25), Trigger (DC 25).
Disable Device:	Trap (DC 25, 2d4 rounds); Trigger (DC 25, 2d4 rounds)
Primary Trigger:	Touch (revolving door)
Primary Trap Effect:	Deep pit (1d6 damage per 10 feet fallen)
Primary Save:	Reflex (DC 20) avoids pit
Reset:	No reset needed
Cost:	2,000 gp or higher

This revolving door trap is from Brandon Corey (who is recovering quite nicely, thank you). This door trap is notable as much as it sinks to new depths — or at least the delvers caught in it do.

The revolving door will only move in a clockwise direction; near the end of the door's rotation, the floor drops away into a pit. If a delver is running through the door with careless abandon, his own momentum will sweep him into the pit. And even if the delver should notice the pit in time to stop the door, he'll still be trapped — the door revolves only in one direction. He'll escape only if he can somehow make it across the pit...

Backstabber



CR:	4
Type:	Mechanical
Search:	Trap (DC 25), Trigger (DC 22).
Disable Device:	Trap (DC 25, 2d4 rounds); Trigger (DC 22, 2d4 rounds)
Primary Trigger:	Touch (the door)
Primary Trap Effect:	Giant spear (+20 melee; 2d10+10 damage; multiple targets in a 5-ft by 50-foot line in front of the door)
Reset:	Repair
Cost:	16,000 gp

Tired of adventurers finding your well-placed poison needle in the lock trap? We designed the Backstabber, a splendid demonstration of overkill at its finest.

The delvers are presented with an innocuous-looking door. When the handle to the door is worked, the enormous, poisoned, sharpened telephone pole hidden in the wall opposite the door is fired toward the delver's back at tremendous speed. This ought to plaster the delver opening the door, and may take out a number of his buddies if they're standing close behind him. This pole is going fast enough to knock down the door, so don't use it to guard your teacup collection...

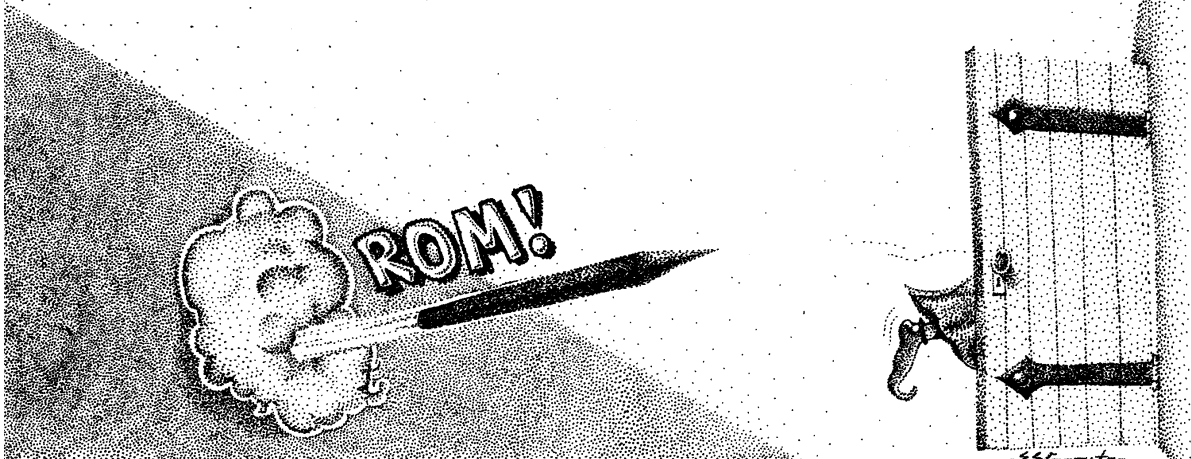

Beware of Doppelgangers



CR:	7
Type:	Magical (<i>greater teleport</i>)
Search:	Trap (DC 32), Trigger (DC 25).
Disable Device:	Trap (DC 32, 2d4 rounds); Trigger (DC 25, 2d4 rounds)
Primary Trigger:	Location (entering the room)
Primary Trap Effect:	Character entering room is teleported behind party in hallway. Due to the abrupt change from total darkness to light, the character is blinded (as per the <i>blindness</i> spell) for 1 round.
Reset:	No reset
Cost:	,550 gp

This trap is ingenious in its implication and sincerely horrid in application. Brent Halverson has designed the door to face the delvers with a puzzle and a threat they'll be dying to defeat. And really all they're fighting is themselves....

The delvers find a door. It can be anywhere, although it doesn't actually lead much of anywhere. Somewhere rather low on the door is scrawled, "Beware of Doppelgangers!" in what looks to be dried blood. A dying delver's last message to those who might come after? Doubtless. If the delvers are actually warned off, well, better luck next time.

However, if they open the door, they face a pitch-black void that no light penetrates. There would definitely be a sense of magic, for a few feet inside the doorway is a teleport plate. A delver enters will all due caution, and poof! He reappears in the vicinity of the door among his erstwhile friends.

Three things are relevant: 1) the void and blackness are intense enough that the abrupt return to a lit corridor will somewhat blind the character, 2) it is the nature of the void to briefly scramble the character's auditory mechanism, meaning his friend's voices sound like orcish grunts and dire threats; and 3) a thin voice, as from a considerable distance, cried out from inside the void, "No! That's not me! Don't let 'im fool you arruuuggghhh!" Handing the player of the unfortunate character a note that reads, "The figure in the corridor is you, now you convince them you are you, without showing them this note." is all the proof the other players will need that he is indeed a doppelganger!

With a formula like that, you should get a pretty good fight. And just for yucks, the second or third time the teleport plate is activated, you really could capture the real character and send out a doppelganger. If they keep shoving in characters, they deserve it.

Upsidaisy-Downsidaisy



CR:	7
Type:	Combination (Magical and Mechanical)
Search:	Trap (DC 32), Trigger (DC 25)
Disable Device:	Trap (DC 32, 2d4 rounds), Trigger (DC 25, 2d4 rounds)
Primary Trigger:	Touch (the doorknob)
Primary Trap Effect:	A <i>reverse gravity</i> spell carries the victim that touched the door (and those within 5 feet of him perhaps) through the ceiling and into a spiked ceiling (+10 melee, 1d4 spikes deal 1d4 points of damage each).

The second bank of spikes slides over the area where the victim "fell" upwards and shuts off the *reverse gravity*. The victim now falls 10 feet into another bed of spikes (+10 melee, 1d4 spikes for 1d4 points of damage each).

Reset:	Automatic (ceiling plate) and Repair (need to replace false ceiling that shields spikes from view)
Cost:	6,000 gp

Diana Harlan claims elven blood in her background, but she's a troll-hearted lass deep down inside. This trap of hers will have delvers pushing up daisies. Definitely.

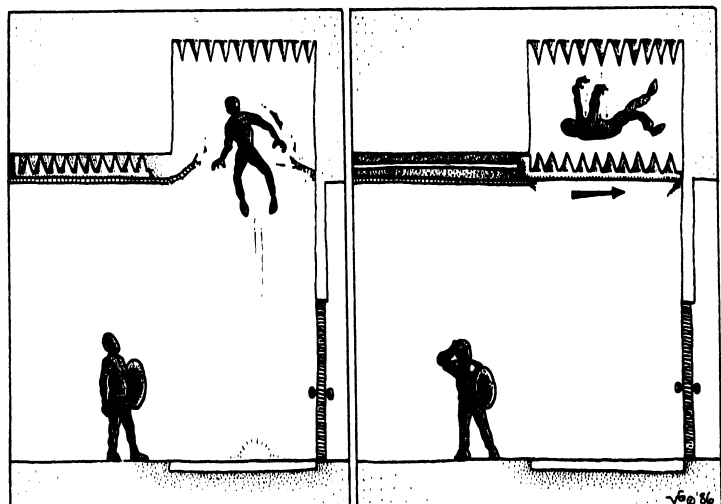

Prepare the delvers for this ahead of time by giving them object lessons against opening doors violently. When they've got their manners back, spring this on them — it's activated by someone touching the door handle in a normal fashion.

When the handle is touched, a pair of magical plates “turns on.” One plate is at the delver's feet and the other is overhead. The area in a 10-foot square in front of the door is transformed by a heavy reverse gravity field. Anyone standing in the area will fly up to the ceiling, and break on through the thin balsa shim that just looks like ceiling. His flight ends against the spikes in the real ceiling.

When the false ceiling breaks away, a catch releases and a second bank of spikes slides forward to block the opening. The reverse gravity field shuts off, and the flying delver has a “punctuated” landing on the lower spike bed.

For especially nasty DMs — are there any other sort? — add a hungry monster or three, and dose the spikes with a mild paralyzing poison....

The *reverse gravity* effect can be negated or dispelled. It functions at caster level 13th.

Heads Up!



CR:	2
Type:	Mechanical
Search:	Trap (DC 20), Trigger (DC 20)
Disable Device:	Trap (DC 20, 2d4 rounds), Trigger (DC 20, 2d4 rounds)
Primary Trigger:	Touch (pushing the “Open” button)
Primary Trap Effect:	Door drops and mashes character standing in 5-foot space in front of door (no attack roll needed, 3d6 points of crushing damage).
Primary Save:	Reflex (DC 20) avoids
Reset:	Manual (must place door back in position)
Cost:	2,000 gp

The next trap also requires a relatively normal approach to the door, so its placement is of crucial importance if you don't want the paranoid to circumvent it. Place this door at the head of a dead-end corridor, with the corridor not significantly wider than the door itself.

The door has no handles or other fixtures by which to open it. On the right hand wall, however, the delvers see a small button with the label “Open” on it.

Pushing the button will open the door. It drops out into the corridor like a drawbridge, crushing the simpleton who pushed the button.

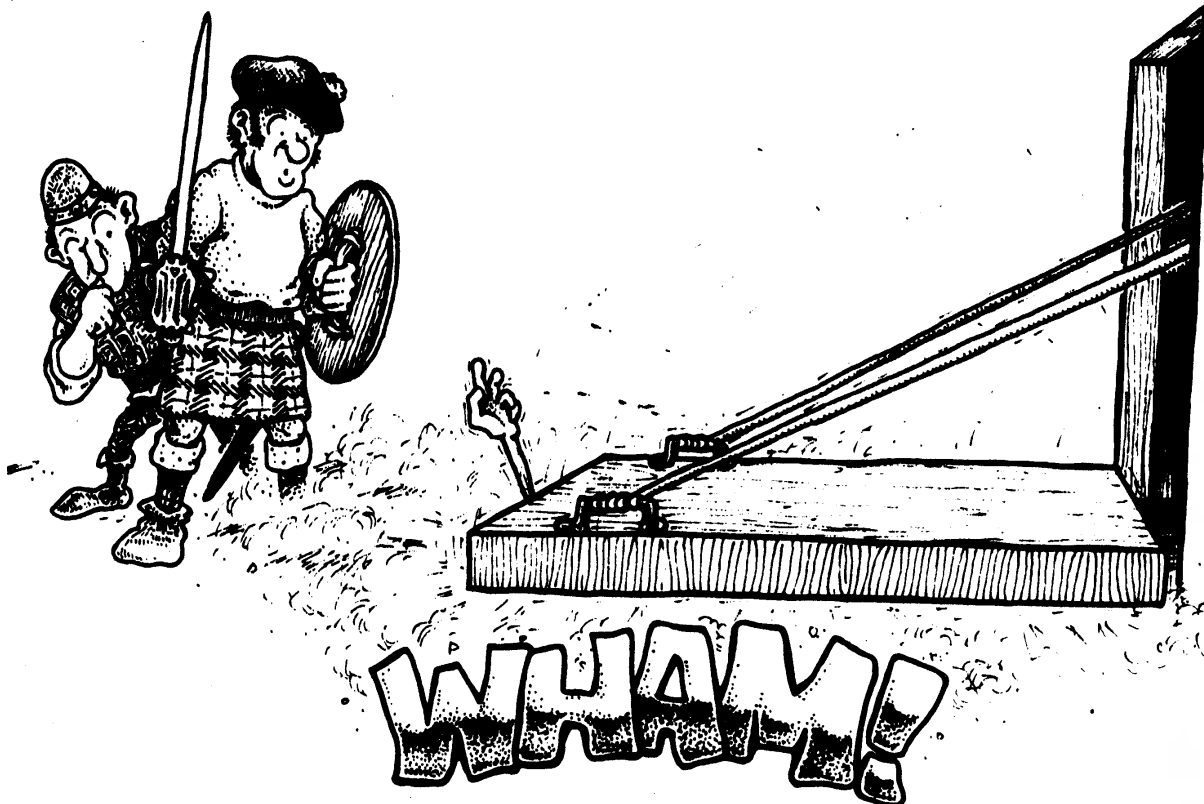

The Downer Door



CR:	10
Type:	Mechanical
Search:	Trap (DC 25), Trigger (DC 25)
Disable Device:	Trap (DC 25, 2d4 rounds), Trigger (DC 25, 2d4 rounds)
Primary Trigger:	Touch (pulling on door)
Primary Trap Effect:	The massive door drops on all within 250 feet of the door (no attack roll necessary; 18d6, crush)
Primary Trap Save:	Characters that are 250 feet minus 4x their full movement speed from the door can run from the falling door and make a Reflex save (DC 20) to avoid the door. Characters closer than that and to a distance of 30 feet from the door must succeed at a Reflex save (DC 25) or be mashed into a pulp. Those within 30 feet of the door must succeed at a Reflex save (DC 30) or be mashed. Use massive damage checks.
Reset:	Manual (must place door back into position)
Cost:	30,000 gp

How simple can 250 feet of door be? Such massive portals often decorate the very entrance of a tunnel complex, or indicate something Very Large Indeed lives behind it. Characters who only anticipate trouble after they pass through the door are fair prey for Caroline J. Maher's trap.

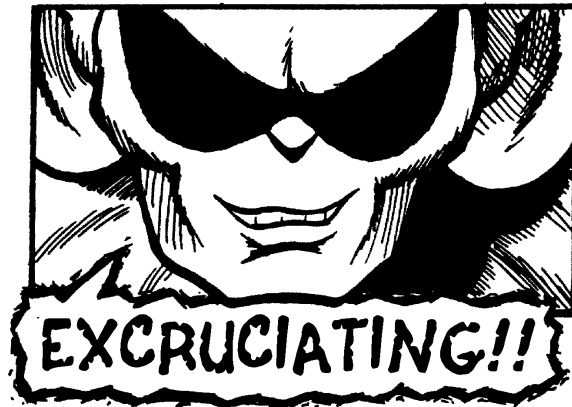

Joe and Jane Averagedelver (of the Soggybog Averagedelvers) whip out their trusty ropes to help them open the massive door with its latches/knobs/knockers placed too high to work in any ordinary fashion. After all, the portal has been examined for smaller entrances (and there are none), and the hinges indicate the door swings outward.

The hinges are false. When the delvers pull, they'll find the door is only propped up. Numerous spring-loaded bolts, triggered when the door moves an inch or two, slam into the top of the door and substantially increase the rate of its fall. It will be a very speedy delver, or one who teleports, who escapes getting flattened — the latches will smash into the door itself on impact, so there is no breathing space under the door after it falls.

The Bucket Over the Door



CR:	1 or higher
Type:	Mechanical
Search:	Trap (DC 20), Trigger (DC 20)
Disable Device:	Trap (DC 20, 2d4 rounds), Trigger (DC 20, 2d4 rounds)
Primary Trigger:	Touch (pulling on door)
Primary Trap Effect:	A bucket balanced atop the door spills its contents on the creature opening the door (see below for ideas).
Primary Save:	A Reflex save (DC 20) avoids the falling bucket and its contents, unless noted otherwise.
Reset:	Repair
Cost:	1,000 gp

Lovers of practical jokes will appreciate this trap, so simple as to be beyond the expectations of the average delver. It has all the potential of a joy buzzer or a squirting plastic flower... and when is a door not a door?

In simplest form, a door left slightly ajar provides the balance for a bucket full of, well, take your pick. The variations are endless. Ice water in a damp, cold dungeon may be unhealthy without being devastating. Fine glassy sand would get into the joints of armor, and under and into everything else. The itching and grating would be maddening, if non-fatal, but nothing to brag about back at the tavern.

Brine is another annoyance. Cold, and wet now, and outrageously itchy and uncomfortable when it dries in one's clothing. A nest of red ants or a bees' nest inside the bucket could have unpleasant consequences — more people die each year from bee stings than from snake-bites! Bright yellow dye would be laughable and might damage spell books; Eau de Comestible Monsterum could be dangerous, and plain old skunk oil would be enough to disband the party.

Naturally, more vicious options are available, from acid (in a glass bucket) to a bucket full of mercury. What's so nasty about mercury? Well,

it'll be tough on the digestive system of anyone who swallows some, but more importantly, it'll thoroughly coat anything they have that's made of gold, like gold coins for starters. There's no decent way to unbind mercury from gold, so the characters will have a sack full of coins that look suspiciously like fake goods. Then there is the old stand-by: a bucket full of lead-heavy rocks could cause a concussion or three.

Of course, even a mildly suspicious delver might think to look up when encountering a door that is not a door. (Because it's ajar!) The door can be left closed. The same assortment of exasperating annoyances can be kept in a reservoir above the door to spray out when the door is opened more than an inch or two!

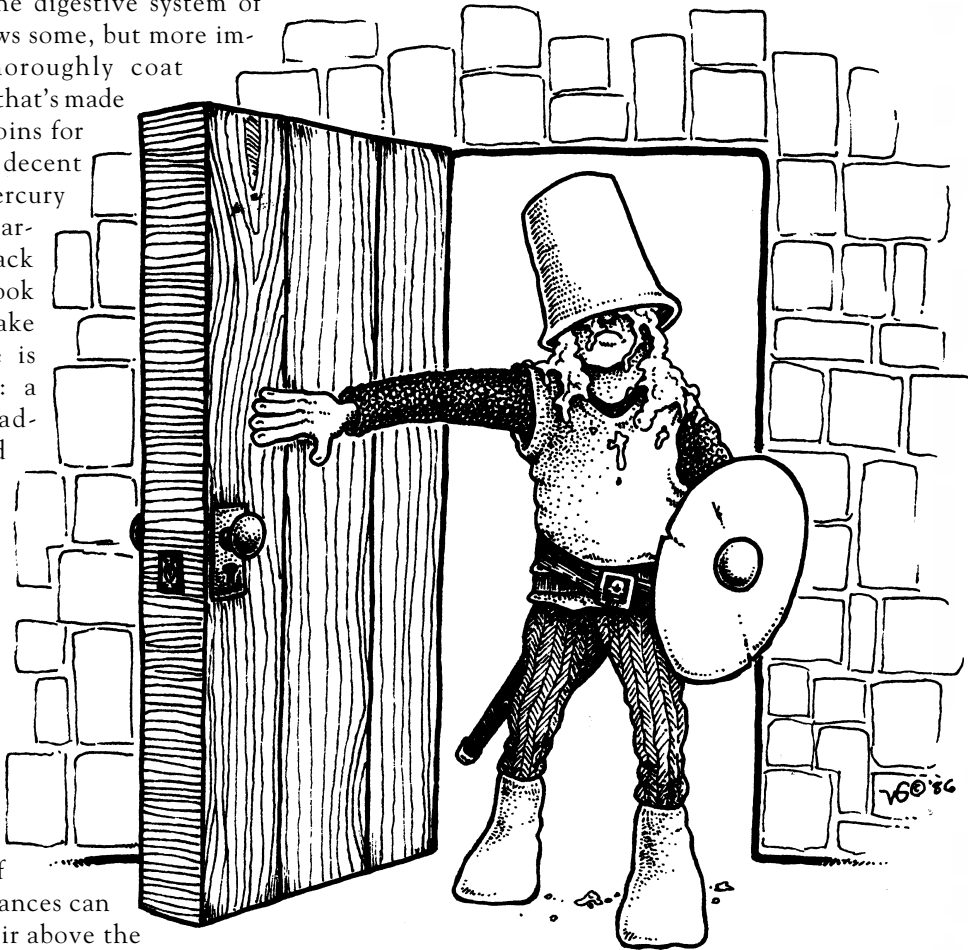

The Bookcase Cliché



CR:	2
Type:	Mechanical
Search:	Trap (DC 20), Trigger (DC 20)
Disable Device:	Trap (DC 20, 2d4 rounds), Trigger (DC 20, 2d4 rounds)
Primary Trigger:	Touch (moving the wall sconce a second time)
Primary Trap Effect:	Spikes impale character (+15 melee, 1d6 spikes, 1d4 points of damage each spike)
Bypass:	Hidden safety switch (Search DC 25 to locate)
Reset:	Automatic
Cost:	6,000 gp

Laurel Gouling provides yet another dreadful destiny for delvers in this unusual portal. She may have seen too many movies, but this trap is treachery incarnate. Not designed for the depths of a dank and dreary dungeon, this bookcase could be

the main secret entrance to a tunnel — just to start the party off on the right foot.

The Bookcase Cliché looks to be just that: a swiveling floor-to-ceiling bookcase of the sort one generally sees in old movies. Torches are conveniently placed on either side of the bookcase, and twisting either one of the sconces will cause the bookcase to make a very fast 180-degree turn on its platform. Perhaps the delvers will catch a glimpse of a passageway behind. An identical bookcase — previously the “back” of the other one — now rests where the original was.

The obvious solution is to get onto the platform and then have the torch sconce pulled for you. Easier said than done, but undoubtedly the cunning characters will find a way.

Unfortunately, the second time the bookcase is activated, without a safety switch known to the book's owner being thrown first, one half of the “bookcase” sprouts spikes just before it pivots in the middle directly onto the other half.

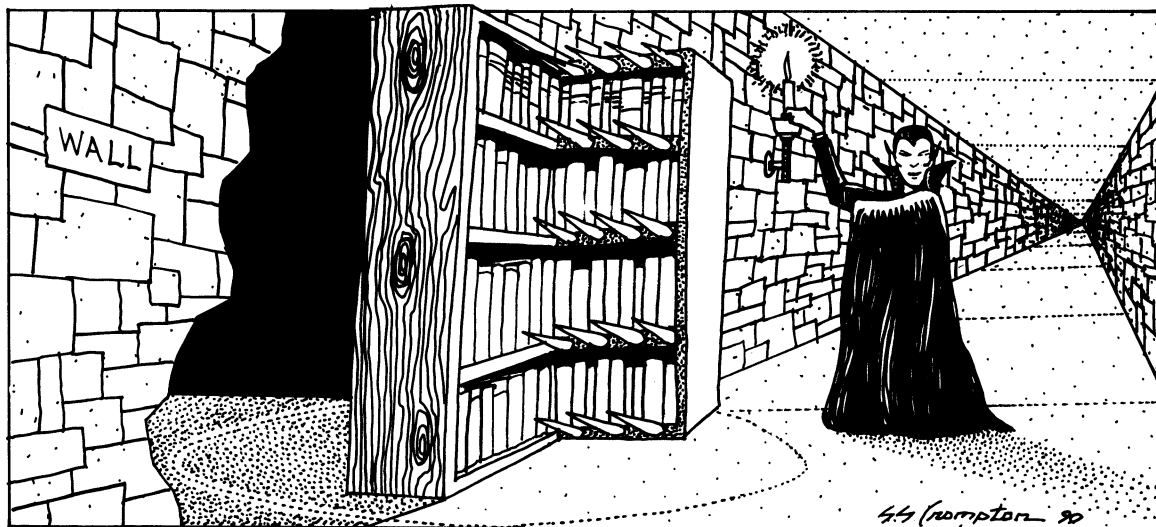

Buster's Facade



CR:	10
Type:	Mechanical
Search:	Trap (DC 22), Trigger (DC 22)
Disable Device:	Trap (DC 22, 2d4 rounds), Trigger (DC 20, 2d4 rounds)
Primary Trigger:	Touch (turning the doorknob)
Primary Trap Effect:	Crushing walls (no attack roll needed; 16d6, crush; all within a 10-foot by 10-foot area immediately behind the one that opened the door)
Primary Save:	Reflex (DC 22) avoids
Reset:	Repair
Cost:	23,000 gp

Although my previous collections of traps have nothing to do with the rampant paranoia of modern dungeon delvers, few characters are comfortable opening doors from the front. They cluster to either side of the door, cringing as one foolhardy soul gingerly twists the door's handle.

This in mind, I dedicate this trap to the memory of that famous old comedian. When the handle is turned the entire wall around the door falls out onto the party. Only the person with the handle in his hand — and the stupid look on his face — will escape unscathed. He'll also be a real "hit" with any surviving party members!

Springs 'N Spikes



CR:	2
Type:	Mechanical
Search:	Trap (DC 25), Trigger (DC 20), Secondary Trigger (DC 20)
Disable Device:	Trap (DC 20, 2d4 rounds); Trigger (DC 20, 2d4 rounds)
Primary Trigger:	Touch (breaking down door)
Secondary Trigger:	Timed (1 round after door is broken down)
Primary Trap Effect:	No damage
Area of Effect:	Creature standing on door
Secondary Trap Effect:	Creature is hurled 10 feet across the room into a wall full of spikes; multiple spikes affect target; +10 melee (1d4 spikes each, 1d4+2 damage each spike)
Reset:	Automatic
Cost:	4,000 gp

This trap is Drew Dietz's contribution to the door traps chapter. I liked this trap so much I've made it an event for this year's Orc Olympics, replacing the very silly but less lethal triple jump event.

This door seems wedged shut, and the characters should realize nothing short of ramming it down with a shoulder or forehead will get it open. When struck with sufficient force, the door — which is hinged on the bottom — will fall away, and the delver should land atop it. The original hinge disengages, and a new hinge snaps into place at the top of the door, turning the door into a primitive catapult when the spring on the far side of the door engages. The final result? One her hurled onto spikes!

Guillotine Portcullis



CR:	2
Type:	Mechanical
Search:	Trap (DC 20), Trigger (DC 20)
Disable Device:	Trap (DC 20, 2d4 rounds), Trigger (DC 20, 2d4 rounds)
Primary Trigger:	Touch (touching the portcullis)
Primary Trap Effect:	+15 melee (2d4+6, guillotine blade, crit x4)
Reset:	Automatic
Cost:	4,000 gp

Mike Patton offers this deadly little barrier that smart characters will just leave alone. This is a simple heavy portcullis, remarkable only in that it seems constructed of two separate halves, with a brief gap between the two. The separation, of course, permits a guillotine blade to flash down if someone tries to lift the portcullis, severing limbs or at least fingers. Mike suggests placing a false winch (presumably controlling the portcullis) in whatever room this traps guards, to encourage characters to wiggle under the barrier.

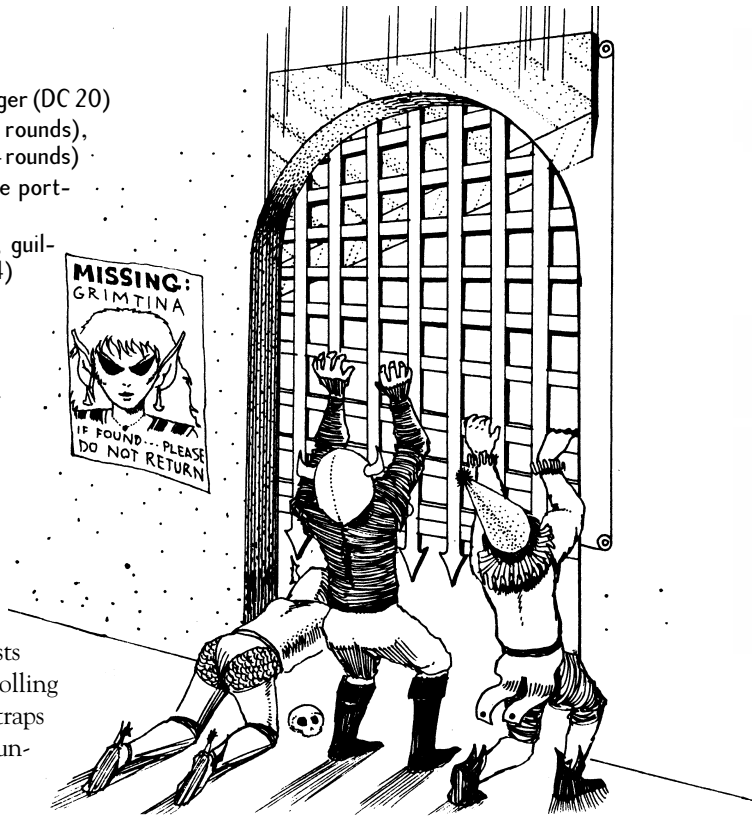

Mock Padlock



CR:	1
Type:	Mechanical
Search:	Trap (DC 18), Trigger (DC 18)
Disable Device:	Trap (DC 18, 1d4 rounds)
Primary Trigger:	Touch (tampering with lock triggers the trap)
Primary Trap Effect:	Trap deals 2d6 points of acid damage to tools or key inserted into lock. The special acid membrane bypasses the object's hardness.
Reset:	Repair (lock must be refilled every few months to insure the acid membrane remains potent)
Cost:	1,000 gp

This device, by Mike Patton, can be used on any door or even on treasure chests. This is simply a lock containing a wax-covered gelatinous acid membrane. Anything inserted into the lock — such as a thief's tools, or a pesky magic key — will rupture the membrane and be ruined. The lock itself is false, so while releasing the acid will destroy it, the party will be no closer to opening the door or chest, but they will have ruined their tools.

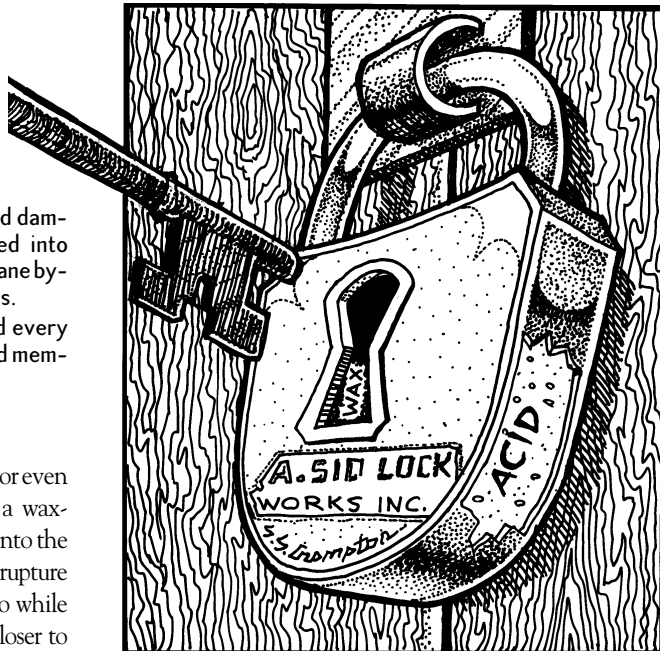

Knock Knock Door



CR:	3 (or higher if door sprays acid or poison)
Type:	Magical
Search:	Trap (DC 25), Trigger (DC 25)
Disable Device:	Trap (DC 25, 2d4 rounds)
Primary Trigger:	Event (touching the door handle)
Primary Trap Effect:	Demon comes to life (as detailed above); if the demon doesn't like the creature's joke it sprays it with acid (1d6), poison (DM's choice), or skunk oil (treat as troglodytestench), or some other substance.
Area of Effect:	Creature directly in front of door
Circumstance Bonuses:	Placing a shield (or such item) over the doorknob gives total cover against the attack.
Cost:	3,000 gp

Not nearly so stylish as other door traps, but twice as childish, is Norm Strange's contribution. This is an iron dungeon door possessing a living mouth and eyes, with a big brass knocker where a nose should be. Right about where a person would wear a flower in a lapel is the door handle... a handle that bears an incredible resemblance to a daisy.

The door is in fact an immensely powerful and indestructible magic demon. The only way to get past the thing is to endure a silly and tiresome ritual, which should really irk those boors who think there's no place for low comedy in high fantasy. The first step is to use the knocker — only two knocks, in quick succession, which initiates the sequence. In effect, the delvers must say, "knock knock."

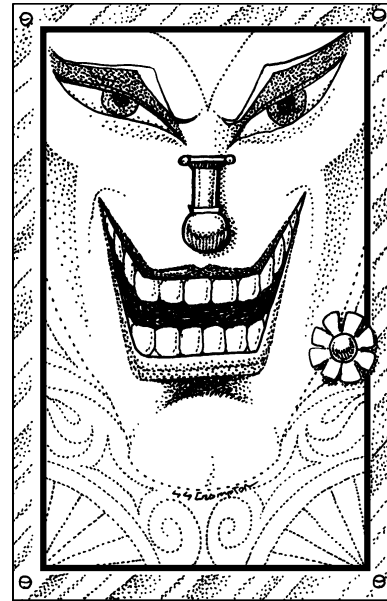

Need I say more? That's your cue. When the delvers say, "knock knock," the door mouths, "who's there?" and it's up to the delvers to come up with a suitably witty response. If the knock-knock joke thus offered is up to your liking, the door opens and the delvers may pass. If you don't care for the joke, give the party a little quirt from the center of the daisy — skunk oil if you feel forgiving, acid or poison if you don't. And don't forget everything else you can do with that mouth... laugh, belch, spit, curse, even vomit! Wow! Fun for all ages!

Last Of The Mimes



CR:	1
Type:	Magical
Search:	Trap (DC 20)
Disable Device:	Can only be disabled by breaking mirror; <i>dispel magic</i> , <i>antimagic shell</i> and the like have no effect on the mirror.
Primary Trigger:	Event (looking in the mirror triggers the mime)
Primary Trap Effect:	The character gazing into the mirror "summons" a mime duplicate of itself.
Bypass:	Don't look in the mirror!
Reset:	Automatic (immediately resets after mime is dispelled)
Cost:	1,000 gp

Jersey Turnpike has scared himself more than once with what he's seen in the mirror, so he must know whereof he speaks with this trap. Place this door in any dungeon corridor. Bolt the door, nail it shut, remove the doorknob, and wedge the thing in place, because behind it lurks the consummate

horror. Post signs warning delvers away from this portal. Lace the corridor with explosive pressure pads and post guards beside the door. Do what you must, but make sure the delvers know this door is not to be opened under any circumstances! They'll be sorry!

So, of course, the schmucks will move heaven and earth to open the door.

The door conceals a mirror. That's all, just a mirror. As a victim stares into the mirror, he'll watch as his own features take on a ghostly, white pallor. Dark lines will arch above his eyebrows. The image in the mirror will bring two white-gloved hands to either side of its suddenly expressive face, and show a round-mouthed display of amazement. That's right. The character's mirror image has been turned into a mime.

Worst of all, it's ghostly mime. The mime will step from the mirror and dog its victim, mimicking his double's every move with exaggerated and derogatory grace. When the mime isn't busy making his victim look like a buffoon, he'll walk against

the wind, press against an imaginary pane of glass, and peel and eat invisible bananas. What a pain in the neck! And because the mime is a ghost, he cannot be physically done away with.

Breaking the mirror will dispel the mime... at least until the character next observes his own reflection, when the mime will appear again. And again. And again. And again...

Note: The mime is a “phantom” and is impervious to all attacks (magical or otherwise). It cannot be turned, rebuked, or anything else. If the mirror is shattered, the mime immediately disappears. If more than one character peers into the mirror a mime duplicate of that character steps from the mirror. Also note that a character cannot be affected by the mirror so long as his mime duplicate is hanging around.

Open The Door



CR: Varies by demon summoned

One of Dr. E. L. Frederick’s favorite door tricks can be used anywhere one might want. No doubt you are familiar with the mythology of “demons” — in that, if you say a demon’s name out loud, there is a chance he will hear you and appear. Suppose you had a demon named “Opin Thedoor”? Every time your delvers say, “We open the door,” you make a die roll to see if he shows up. If he does appear, make him a suitably obnoxious but non-fatal sort of creep. He hangs around the party making bad puns and wisecracks until someone pays him to go away. He prefers magical items.

We all know that demons are mythical creatures that only schizophrenics and religious fanatics believe in, which is why religious fanatics try to ban all books that mention demons. So if you know anyone who believes in demons, don’t tell him about his page of the book, or we might get picketed. We’d be in all

the newspapers, on TV, and all that publicity would be... hmmm. Do I get a royalty on every copy of this book we sell?

Sample “Demon”

Opin Thedoor: CR 3; SZ M Outsider [Chaotic]; HD 3d8+3; hp 16; Init +1 (Dex); Spd 30 ft.; AC 14 (+1 Dex, +3 natural), touch 11, flat-footed 13; BAB/Grp +3/+4; Atk +4 melee (1d3 subdual, slap); Full Atk +4 melee (1d3 subdual [x2], slaps); SA spell-like abilities; SQ darkvision (60 ft), demon traits; AL CN; SV Fort +4, Ref +4, Will +4; Str 13, Dex 13, Con 13, Int 13, Wis 13, Cha 13.

Skills: Balance +5, Bluff +5, Hide +5, Intimidate +5, Listen +9, Move Silently +5, Search +4, Sleight of Hand +5, Spot +10.

Feats: Alertness, Combat Casting.

SA—Spell-Like Abilities: *change self, dancing lights, daze, flare, ghost sound, grease, mage hand, obscuring mist, prestidigitation.* Caster level 3rd; save DC 11.

Doggy Door



CR:

5

Type:

Magical

Search:

Trap (DC 25), Trigger (DC 25)

Disable Device:

Trap (DC 25, 2d4 rounds); Trigger (DC 25, 2d4 rounds); *dispel magic, antimagic field, and the like will dispel or suppress this trap.*

Primary Trigger:

Touch (crawling through doggy door)

Primary Trap Effect:

Creature crawling through door is immediately polymorphed into a dog (as per the *polymorph other* or *polymorph self* spell)

Reset:

No reset (door automatically works each time someone crawls through it)

Cost:

8,000 gp (does not include the cost of feeding the dire mama cat in the room)

Jersey Turnpike designed this powerful magic portal to cut any delver down to size. Place this locked door at the end of any hall. Try as the party might, they won’t be able to breach this door. Kick and bash though they may, all the delvers will manage to do is set up a wailing from what sounds like a house cat on the other side of the door. The only way to pass is through the free-swinging flap at the bottom of the door, very much like a large doggy door. Of course, anyone passing through the doggy door is turned into a dog.

Not fair, you say? Take a pill, pal! To reverse the enchantment, all the doggy delver need do is pass back through the door. Provided he thinks of it. Or has the time. Remember that wailing house cat? Well, the fat little cat exists only to bolt away in a furry frenzy at the first sign of a delver turned into a dog, and no self-respecting dog can resist chasing a cat. Off the delver will go, in pursuit of that cunning cat... of course, the small cat runs back to its mother, an over-fed giant, killer cat

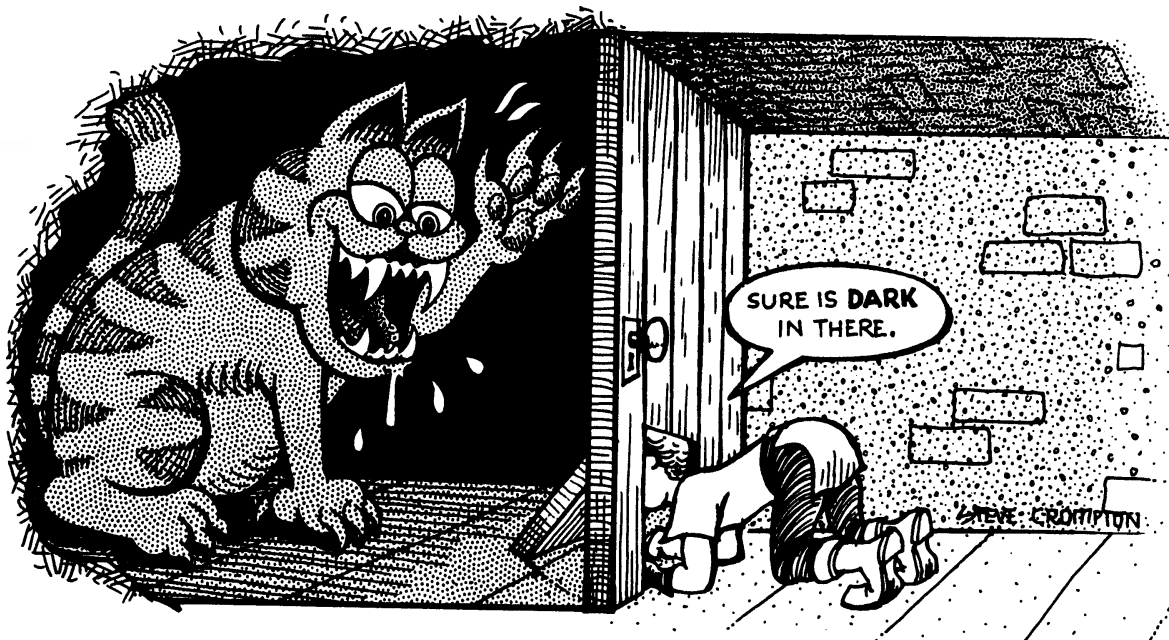

that just hates dogs. If the dog is lucky it will turn tail and run back. Or the party can crawl through the door looking for their companion, and go four footing, themselves. It's a dog's life, they say, and maybe someday I'll try it.

Note: To avoid chasing the tiny cat, the delver (now a dog) must succeed at a DC 15 Will save. If successful he suppresses his doggy temptations but must make a new save each round he remains in the room and hears the cat howling. See the MM for stats for the cat. Use the stats for the dire lion in the MM for the mama cat.

Eye-Catching Trap



CR: 4
Type: Mechanical
Search: Trap (DC 22), Trigger (DC 20)
Disable Device: Trap (DC 25, 2d4 rounds); Trigger (DC 20, 2d4 rounds)

Primary Trigger: Location (pressure plate on wall)
Primary Trap Effect: Darts swing down and hit victim in eyes (no attack roll necessary; 1d4+2; victim is blinded [as the spell] until magically healed)
Reset: Manual
Cost: 8,000 gp

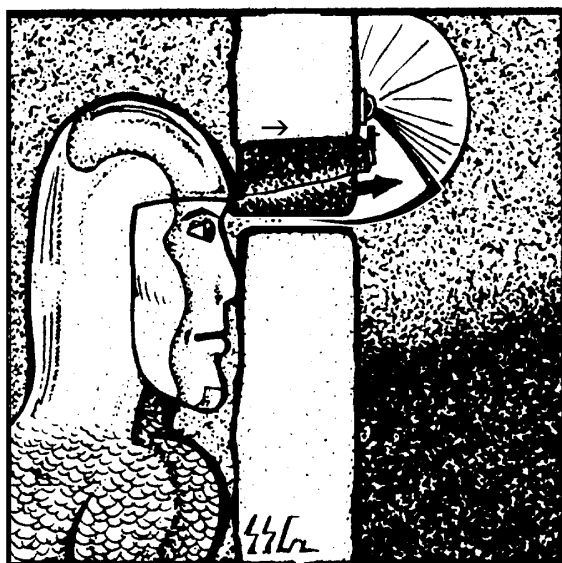
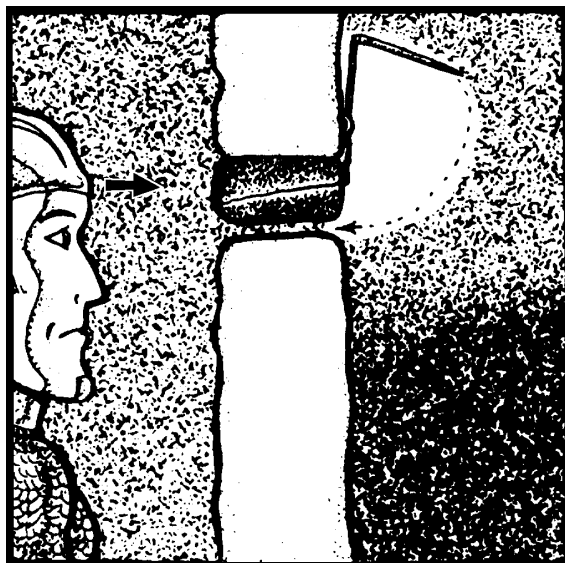

Mike Stackpole has developed a way to deal with peeping toms. Set in a door are two eyeholes. If a delver peers through them, he will see what lies in the room beyond. Fill the room with something that will interest the adventurer — anything from enemies to treasure to dancing girls should do the trick.

Inform the character that he can see a little of the room, but if he moved closer to the holes he could probably get a better view. After all, trying to peer through a small set of holes from a distance

is something like looking through a telescope held some distance from the eye.

If the character moves in closer to get a better look, the pressure of his forehead against the stone wall will cause a section of the wall to move slightly, dislodging the spike on the other side of the hole to swing freely. The whole assembly will swing down into the eyes of the delver, with predictable results. For added cruelty, the pokers can be made of barbed wood that will easily break loose when the character jerks his head away from the hole in pain.

SECTION FOUR:

TRAPS BAZAAR



The worst thing I ever did was teach Spike the Grimdog to fetch.

At first it was fun. I'd toss a bone down a hall or a hob— uh, I mean halfling down a pit. Spike ate it up. But when I tired of the game, he went looking for his own toys. And thanks to all the luckless visitors to my dungeon, Spike found plenty. The dog began raiding bodies, and loyally returning the booty to his beloved master. Me.

Not a night went by that the stupid dog didn't bring me another load of touching personal effects. Sometimes they were good for a laugh. Gimmicks, gizmos, I've seen 'em all. But it was time to clear 'em out and make space for the real business of being the most evil troll in print.

So I put some of these Buffalo people that are always hanging around trying to get my autograph or peek at Grimtina's tattoos to work taking inventory. They told me that I'll be surprised at the amount of goods that Spike has stockpiled over the past few months. They said I could open a store with all this stuff. Hm... not a bad idea. There's nothing I like better than parting delvers from their gold... except for killing 'em, but I've done enough of that in my previous books! So, with very LITTLE help from the minions of Flying Buffalo, I created the Traps Bazaar.

But back to business. I've collected and refined these item traps for your shopping pleasure. This is your opportunity to choose from the best inventory of magical and mechanical contraptions. If you see something you like, make me an offer. Send your sealed bid and any expendable first born to The Grimtooth Collection, c/o Dungeon of Doom: Souvenir Department. The Grimtooth Collection accepts no responsibility for offers that are lost, ridiculed, or altered to your disadvantage, and reserves the right to use any information contained within for purposes of extortion. Our motto is, "buyer beware."

You can start shopping in aisle one. Please finish by midnight, when I lock the doors and let the security wolves loose. That gives you... oh, how annoying. The clock seems to have stopped. I suppose I'll just have to let the wolves loose now...

~ Grimt



GAAH!

DUNGEON of DOOM
TRAPS BAZAAR
TRAPS LIFE

TRAPS ATE TRAPS FORE
TRAPS TOO TRAPS

WURST of TRAPS

DEATH PILLS

BUICKER

LAGER BEER

The Bazaar

Traps Bazaar is a most unusual marketplace. Within its borders you can shop for the most devious and evil item traps ever devised. Grimtooth the Troll, famed throughout the land for his many books on delver extermination, has opened this bazaar to supply other dungeon designers with the best security devices blood and money can buy. For your shopping convenience, Grimtooth's loyal staff has composed this guide to point out the highlights of his unusual emporium.

1. Entrance

Just around the corner from the Dungeon of Doom is the front gate of the bazaar. You can leave your horse in the convenient stables located on the northwest side of the building. Hanging on either side are the official Traps Bazaar greeters, recruited from the more attractive prisoners of Grimtooth's dungeon. If they forget to bid you a cheery welcome, please feel free to punch or prod them; that's why they're there!

2. Commercial Order Desk

If you're shopping for your local dark army or wizard's guild, please fill out the simple credit application available at this desk. It will simplify your check out of mass orders of Boomeraxes and Love Botas.

3. Check Out Counter

Grimtina will be happy to ring up your purchases if she happens to be in today, and if she feels like it. Should the counter be unattended, you'd better just wait until she shows up. The last fool who tried to drag her from the employee break room did not live long enough to regret it.

4. Manager's Office

Grimtooth's business office. The contents are none of your business. If you're really curious, I suppose you could try to break it. But there are easier and more pleasant ways to commit suicide. Two secret doors lead to the hidden hallway that runs around most of the Bazaar. Only Grimtooth knows about this hidden corridor, and he uses it to keep an eye on the employees and customers. Within the corridor are a couple of staircases that lead down to the basement area.

5. Research and Development Lab.

You may hear some alarming noises from behind these closed doors. Groomni Grimgri the Mad Dwarf and Grimmaldi the goblin tend to conduct some noisy experiments when they develop new and fiendish traps for the bazaar. Normally, they don't

like to be disturbed at their work. But should the doors be open, step right in. They're always looking for a few good volunteers to test their traps. You'll even get a gift certificate for your spending pleasure if you live.

6. Grimtooth's Best Sellers.

In this department you'll find magical items, along with booby-trapped weapons and other dungeon miscellany. I'm sure your desire for these goodies will exceed the limits of your purse. If you're tempted to steal an item or two, go ahead! Try it! It keeps our guards on their toes. Your inevitable capture and punishment will provide a moment of entertainment for the other shoppers.

This room contains 2d4+3 random minor magic items (CR 5 treasures) as well as various traps (left up to the DM).

7. Grimtina's Fashions to Die For.

Provide tempting outfits for your dungeon breakers from these racks of fashion trappings personally selected by Grimtooth's little sister, Grimtina. Don't miss the Friday afternoon fashion shows, where prisoners from the Dungeon of Doom are forced to model these deadly designer clothes. It gets messy, but it's quite a spectacle.

8. Changing Rooms.

Fitting rooms are provided for those who feel compelled to try on attire from the clothing department (and some of the enchanted duds can be very compelling!). There are separate booths for males, females, and those of indeterminate sex. Shapeshifters are welcome to use them if they feel the need to change into another species altogether. You can admire yourself in the full-length mirror provided in each booth. Some of our customers have complained that they've seen eyes peering at them from deep within the mirrors. Naahhhh. It must be their imagination...

9. Custom Corner.

This section of the bazaar contains all of the one-of-a-kind trap items collected from throughout Grimtooth's realm. Those with thin purses won't find any bargains here. These items are rare and expensive.

10. Infernal Machines.

These are the state-of-the-art traps from the Traps Bazaar research and development lab. Please take your purchases home before you start pushing buttons or pulling levers. Handy directions are provided in archaic runic on the inside of each package.

TRAPS Bazaar

MAP



GROUND LEVEL

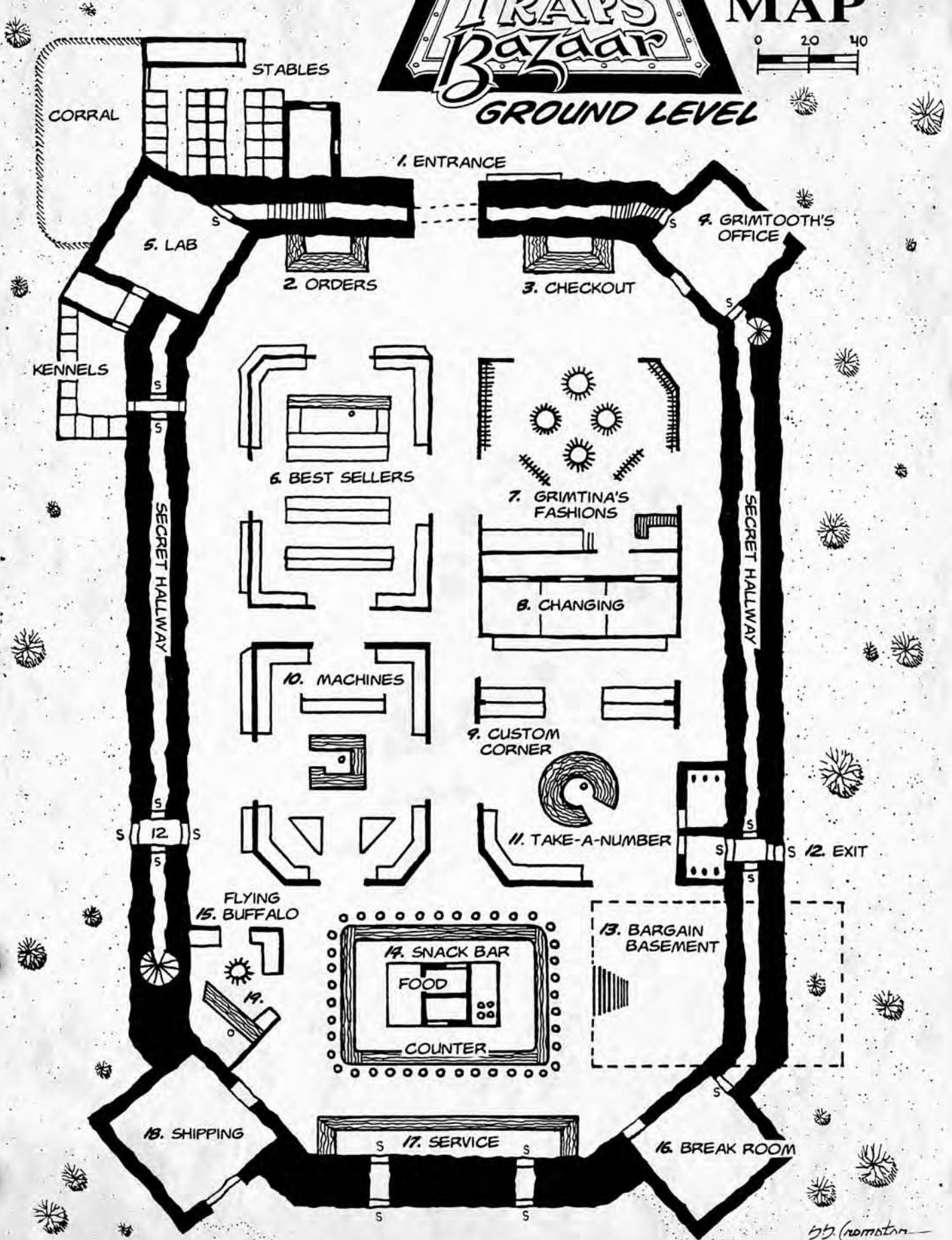

by (romator)

11. 101st Trap: TAKE A NUMBER.

Listen up, Grimtooth here. I installed this trap in the bazaar so as many of my customers as possible could enjoy it. It's one of those "please take a number for service" machines that are so popular nowadays in delicatessens and bakeries. This one is just slightly different, as you may have noticed if you took a number. Instead of counting upwards from one, it counts downwards from 100. And as you probably discovered, your number is no help whatsoever in getting served. Gotta problem with that? Take it to the Complaint Department! Anyway, the magic ticket generator continues spitting out numbers as it counts its way down to zero. 4, 3, 2, 1. And we all know what follows that: BOOM! All of you obedient shoppers who took your number have been in the possession of tickets programmed to explode in unison. What did you do with yours? Stick it in your satchel? In your pants pocket? Did you toss it heedlessly to the ground where some innocent child or hungry goat may have found it? No matter. You'll find out when it's time for the big bang.

12. Secret Emergency Exits.

Grimtooth's contract with the local volunteer fire department requires that additional exits be available for emergency use. However, the agreement did not state that he had to mark them! A skilled delver should be able to find the hidden pressure-plates that open these passages. (Note: The local fire company is a balor bucket brigade. Most of the fires they fight for hire are ones they've set themselves!)

13. Bargain Oubliette.

Don't overlook what's under this trapdoor. Down a short flight of slimy stone steps is a dank cellar showcasing items for the parsimonious shopper. These are the oddball traps and sale items that Grimtooth is clearing out at a discount. Be careful of the phosphorescent fungus on the wall. It's extremely corrosive to unprotected skin (1d6 points of acid damage per round of contact).

14. Snack Bar.

Who can resist a tasty corn-rat-on-a-stick? The Traps Bazaar snack bar can fill that void in your stomach (or force you to void your stomach) with its exotic culinary offerings. Spike the GrimDog is frequently seen here begging scraps. It's in your best interest to feed him, trust us...

15. Flying Buffalo Booth/Restrooms.

When Grimtooth's partners in publishing asked for "booth space" in Traps Bazaar, this wasn't exactly what they had in mind. But, wise folks that they are, they gladly accepted what the troll offered. So while you take care of any physical necessities, feel free to browse through the other fine Flying Buffalo merchandise. A few books from those Necromancer Games folks can be found here as well.

16. Employee Break Room.

This chamber in the back is reserved for Grimtooth's trusted employees. It contains the usual amenities including a fire pit for cooking and a selection of illuminated manuscripts for those who can read (or those who just like the pretty pictures). There are some crates to sit on and one hammock slung in a corner.

17. Customer Service Desk.

So you don't like that trap you bought, huh? Then take it up with the helpful fiends staffing this counter. They will cheerfully listen to your complaints. In fact, they usually get quite a giggle out of your hard luck stories. Some unhappy complainers just don't have a sense of humor; that's why the Traps Bazaar staff positioned this desk in front of the back doors (i.e., employees escape routes).

18. Shipping and Receiving.

You'll find packing crates, straw, nails, and a cheery selection of gift wrap in this back room — everything needed to mail your purchases to points near and far. Depending on the size of your bribe, your merchandise will be promptly shipped or left to languish in a corner.

19. Plug.

If you liked this description of Grimtooth's Traps Bazaar, look for reprints of the original Grimtooth series of books coming in the future from Flying Buffalo.

The Basement

Here is the map and description for the bargain basement and the secret area beyond the basement. Most adventurers never realize that this area even exists, but for the few brave souls who are nosy enough to snoop around, they may find some of my lesser-known treasures. Feel free to connect this basement domain to my nearby Dungeon of Doom, or even to your own underground caverns.

1. The Bargain Oubliette.

Down a short flight of slimy stone steps is a dank cellar showcasing oddball traps and sale items that are being cleared out at a discount. On the north wall is a secret door that leads to a dock and restrooms. The secret door can be located with an appropriate spell or by anyone who spends their free time looking for secret doors (Search DC 20 to find secret door).

Terrible Toilet Seat Trap



CR:	2
Type:	Mechanical
Search:	Trap (DC 20), Trigger (DC 20)
Disable Device:	Trap (DC 20, 2d4 rounds)
Primary Trigger:	Proximity (anything that enters or falls through opening)
Primary Trap Effect:	Seat snaps shut (+12 melee, 3d6 damage; crit 18–20/x2); on a successful critical, the “appendage” is severed.
Area of Effect:	Appendage or item passing through opening
Secondary Trap Effect:	If an appendage (a certain appendage, that is) is severed, the victim must succeed at a Will save or begin singing like the BeeGees.
Secondary Save:	Will (DC 20) avoids
Reset:	Automatic
Cost:	4,000 gp

Like most public toilets, this one has a seat in the shape of a “U” with the opening at the front. If anything (such as a certain delicate part of the male anatomy, for instance) should happen to fall or descend into or through the opening, it snaps shut (Ouch!). Hey, it’s only about 1% of your body. How big a loss could that be, right guys?

2. The Dock.

This old wooden dock has well-used gondolas tied up to it on one side, with a stone wall and two doors on the other side. One door is marked “humans” and the other is marked “Others.” Each door leads to restrooms that are set up for large monsters or humanoids. The humans’ restroom has an OSHA Terrible Toilet Seat Trap (see sidebar).

3. The Canals

This entire section of the basement is flooded to a level of about six feet. Grimtooth added gondolas and docks to make it easy to get around. On the east wall, is a cavern entrance formed by the dark water that runs through it. The cavern is high enough for a fully loaded gondola to enter the largely unexplored caverns that eventually reach the dock area in the Dungeon of Doom. (See #18 in Grimtooth’s Dungeon of Doom).

4. Grimtooth’s Root Cellar

A secret staircase leads here from the hidden hallway on the level above. This is where Grimtooth keeps a wall to floor collection of herbs, elixirs, medicines, and poisons which are stored in hundreds of bottles, all of which are labeled in code. If anyone takes anything from this room, a ghost who stays here will go and warn Grimtooth of an intruder.

5. Wine Cellar

There are several hundred bottles of wine and liquors that are stored here for Grimtooth’s use. About 10% of the bottles are poisoned with an undetectable elixir that will cause bizarre changes (like giant ears, glow in the dark skin, or very fast growing hair) to anyone who drinks from these bottles. A DC 2 Fortitude save negates the effects. Only Grimtooth knows which ones are safe.

6. The Ships

These two ships, one a Galleon, the other a strange Chinese Junk were placed here at Grimtina’s request. She likes boats, and thought it would be really cool if there were boats in a flooded basement. The staterooms in the ships are used as overnight rooms for visitors and a few select employees. Some small gems and gold pieces can be found in a few of the rooms (no more than 500 gp total). Left there by previous guests. Grimtina often hosts Tea and birthday parties on the upper deck.

It should be noted, that there are all manner of fresh water creatures living in the still waters, many of which are always looking for a good meal, so try not to fall in. Electro-squids, small death sharks, mega-leeches are some of the most common to be found here.

Electro-Squid: CR 3; SZ M Animal [Aquatic, Electricity]; HD 3d8; hp 13; Init +3; Spd swim 60 ft.; AC 16 (+3 Dex, +3 natural), touch 13, flat-footed 13; BAB/Grp +2/+4; Atk +5 melee (0 plus 1d6 electricity, tentacle); Full Atk +5 melee (0 plus 1d6 electricity [x10], tentacles), +0 melee (1d6+1 plus 1d6 electricity, bite); SA improved grab (+4 grapple bonus), electricity (melee attacks deal electrical damage); SQ ink cloud (20 ft by 20 ft by 40 ft, once per minute), jet (once per round; double move; 320 ft); AL N; SV Fort +3, Ref +6, Will +2; Str 14, Dex 17, Con 11, Int 1, Wis 12, Cha 2.

Skills: Listen +6, Spot +6. *Feats:* Alertness, Weapon Finesse.

Large Death Shark: CR 2; SZ L Animal (10 ft. long) [Aquatic]; HD 7d8+7; hp 38; Init +2; Spd Swim 60 ft.; AC 15 (-1 size, +2 Dex, +4 natural), touch 11, flat-footed 13; BAB/Grp +5/+12; Atk +8 melee (1d8+4, bite); SQ keen scent; AL N; SV Fort +6, Ref +7, Will +3; Str 17, Dex 15, Con 13, Int 1, Wis 12, Cha 2.

Skills: Listen +7, Spot +7. *Feats:* Alertness, Power Attack, Weapon Focus (bite).

Mega-Leech: CR 2; SZ M Vermin [Aquatic]; HD 2d8+2; hp 11; Init +1; Spd 20 ft.; AC 11 (+1 natural), touch 10, flat-footed 11; BAB/Grp +1/+1; Atk +2 melee (1d6, bite); SA attach, blood drain (1d4 temp Con); SQ vermin, scent, salt vulnerability; AL N; SV Fort +4, Ref +1, Will +0; Str 11, Dex 12, Con 12, Int —, Wis 10, Cha 2.

Skills: Hide +4, Spot +2. *Feats:* Weapon Finesse.

7. The Courtyard "Lagoon"

Can be found just past the arch and under the large Bargain Basement sign in the dock area and series of buildings' rooms. The wood docks are rather water-rotted, so watch your step! Five doors lead into different rooms.

8. Damaged Goods Storage

All sorts of broken and damaged items are haphazardly stored here, with the idea that they might be one day repaired and used or sold. Amongst the piles of items one might find are broken magic swords, damaged armor, cracked magic crystals, and non-working technological devices (there are lots of these!). On the west wall is a secret staircase (Search DC 20 to locate) that leads up the hidden hallway above.

9. Empty Workshop

Once used as a repair shop for the damaged goods in Room 8. Contains tools, some repair manuals and other equipment necessary for repairing various broken items. The room is in disarray, so finding anything useful will take a little time. The goblin who worked here was banished to limbo when he spoke to Grimtooth in a surly manner. Grimtooth is currently looking for a new repairman with a more respectful demeanor. Applicants should apply at Grimtooth's Office upstairs.

10. Hallway of Infinite Corridors

This hallway of ebony columns is a trap left by Grimtooth as a way to keep the curious away from the small vault he uses to store valuables and cash. See the Infinite Corridors Trap listing.

11. The Vault

Grimtooth keeps some of the very useful and powerful items that Spike has found in the dungeons. The vault is locked with chains, a combination lock and is magically hidden. Inside, on the many shelves, can be found powerful magical weapons (1d4+2 weapons of +2 to +4 value), potions of cure light wounds (1d6+2 potions), a plasma rifle (range increment 200 ft, 3d10 damage, weight 7 lb), a chainsaw (2d8 damage) and many different colored magical gems (1d4+2 *ioun stones*, 1d2 *gems of seeing*, and 1d2 *gems of brightness*), and smaller technological items of an undetermined nature. These items are kept here because Grimtooth feels they are too useful for the average adventurer.

Chains (hardness 10; hp 20; break DC 26; Open Lock DC 25).

Combination Lock (hardness 10; hp 20; break DC 25; Open Lock 30).

The vault is hidden behind a permanent *invisibility* spell. This magic can be dispelled by a caster of 15th level or higher, though the magical nature of the area causes the spell to reset itself after 1 hour.



Infinite Corridors Trap



CR:	3
Type:	Magical
Search:	Trap (DC 25), Trigger (DC 20)
Disable Device:	Trap (DC 35, 2d4 rounds)
Primary Trigger:	Event (walking down corridor)
Primary Trap Effect:	The hallway itself is a magical loop that tricks the visitor into believing that they are walking for miles and passing hundreds of columns, when in fact they are walking past the same 30 corridors over and over. The magic works in any direction, unless you are trying to exit the hallway the way you came in.
Area of Effect:	Creatures in the hallway
Reset:	There is no reset for this trap
Cost:	4,500 gp

This trap is not an illusion and cannot be disbelieved. It cannot be dispelled though a powerful *wish* or *miracle* might temporarily disable it.

The hallway itself is a magical loop that tricks the visitor into believing that they are walking for miles and passing hundreds of columns, when in fact they are walking past the same 30 corridors over and over. The magic works in any direction, unless you are trying to exit the hallway the way you came in.

TRAPS Bazaar

THE BASEMENT

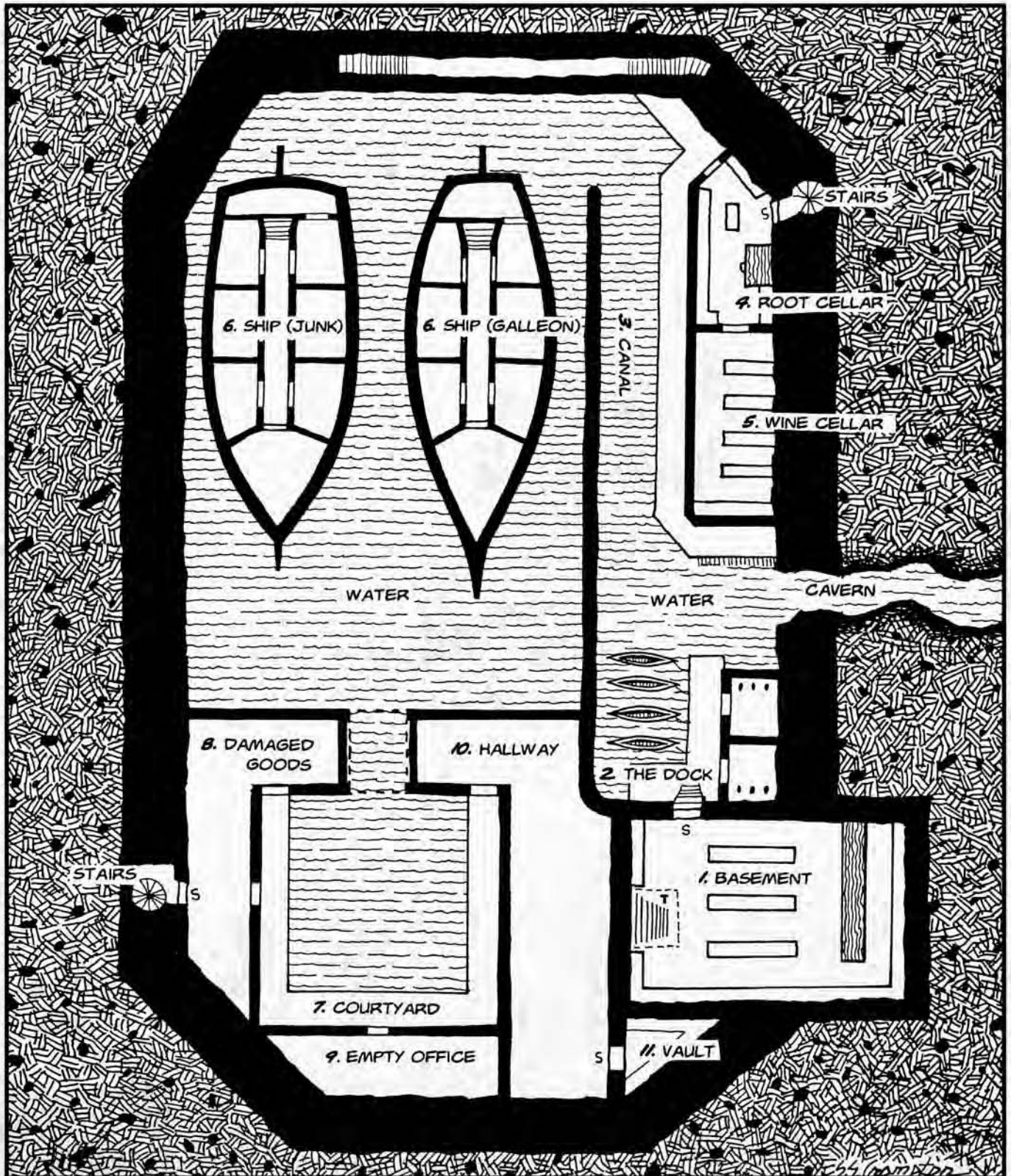
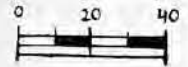

Dungeon Equipment Accessory Department ("DEAD")

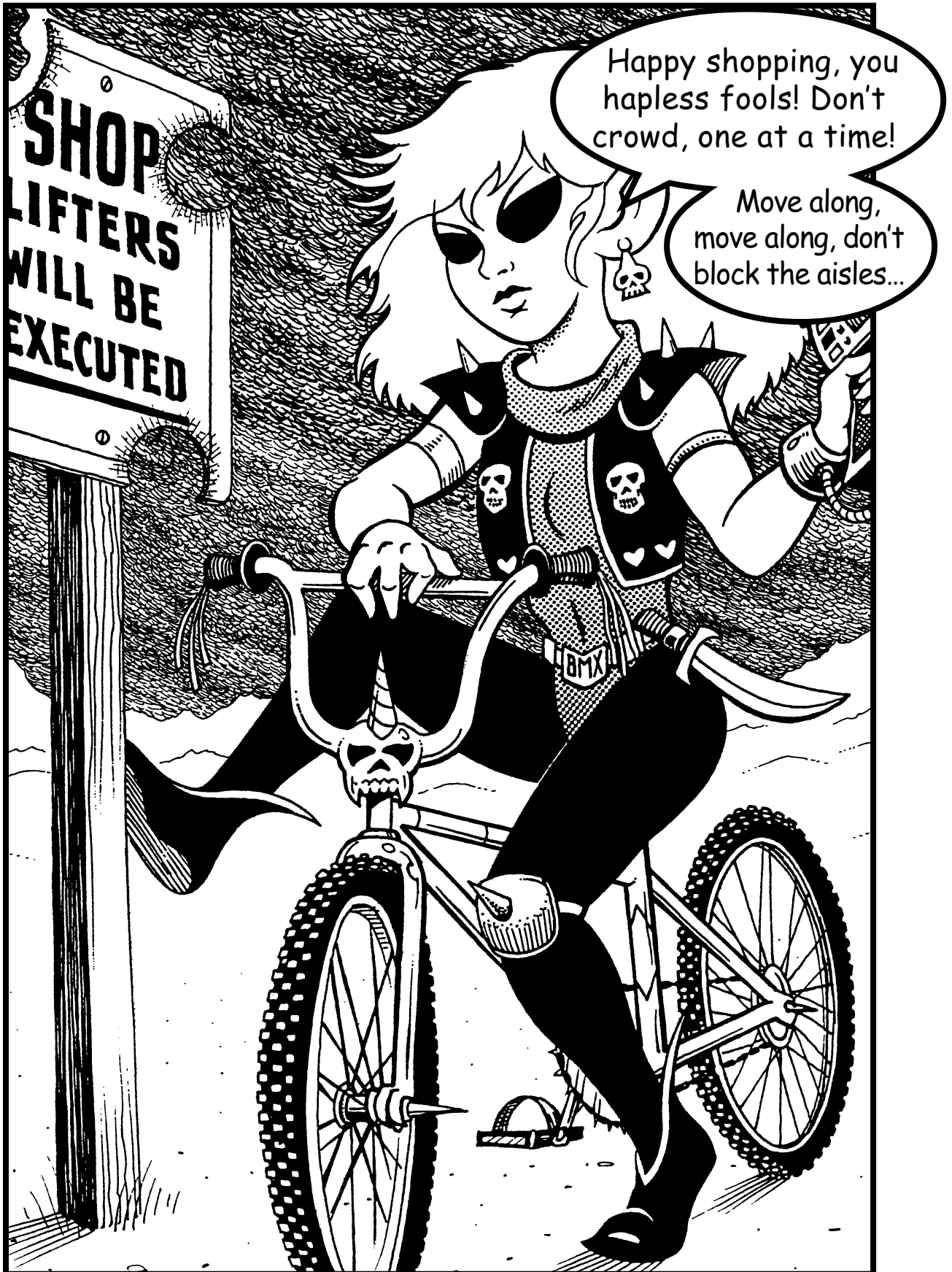

What? Are you “just looking?” This ain’t no art gallery, bub. Let me help you. (Hmmm... there seems to be something terribly wrong with that concept!) Nevertheless, in the interest of consumer fairness, follow me. I’ll point out some of my favorite items.

Our first stop is my favorite section of Grimtooth’s Best Sellers, known as the Dun-

geon Equipment Accessory Department (DEAD), where you’ll find lethal traps for the eradication of sword-swinging and sorcery-slinging delvers. Step carefully over and pay close attention to the bodies on the floor; those floor models will show you the practical effects of many of these traps.

Bellows of Ghosts and Flames



When some insignificant peasant in your service has slaved half his life away to save enough groats to buy his own paltry hovel, may I suggest a *bellows* as a housewarming gift? A cursed item, these *bellows* are home to an assortment of poltergeists. When the *bellows* is pumped, ghosts are freed one at a time, to the woe of the homeowner. There seems to be an inexhaustible supply of spirits trapped inside. True to the name of this item, the phantoms also make a deafening racket! Within minutes an angry delegation from the neighborhood should appear to demand the noise be quelled. The homeowner’s response to this problem may well be to toss the *bellows* into the nearby fireplace. (You’d be disappointed if I didn’t tell you this is the worst course of action to take, wouldn’t you?) If the *bellows* is set aflame, the poltergeists turn into flame demons, which burn the happy home to the ground.

Bellows of Ghosts and Flames: This normal looking bellows frees one poltergeist from it each time it is pumped. A poltergeist stays in the area until destroyed or dispelled and there is no limit to the number contained in the bellows.

Should the *bellows* be subjected to fire, the freed poltergeists change into fire elementals.

Moderate conjuration; CL 7th; Craft Wondrous Item, summon monster IV; Price 56,000 gp; Weight 5 lb.

Poltergeist: CR 2; SZ M Undead [Incorporeal]; HD 2d12; hp 13; Init +1; Spd 10 ft., fly 20 ft. (g00d); AC 12 (+1 Dex, +1 deflection), touch 12, flat-footed 11; BAB/Grp +1/+2;

Atk telekinesis; SA fear (touch, DC 12; flee 2d6 rounds), telekinesis; SQ darkvision (60 ft.), natural invisibility, incorporeal traits, unnatural aura, undead traits; AL LE; SV Fort +0, Ref +1, Will +4; Str —, Dex 13, Con —, Int 5, Wis 12, Cha 12.

Skills: Listen +6, Spot +5. *Feats:* Alertness.

SA—*Telekinesis (Su):* A poltergeist can create a telekinetic effect to hurl one object or creature within 10 feet to a distance of 60 feet (no range increment). This ability functions as the combat maneuver version of the *telekinesis* spell (caster level 6th) with the following exceptions: the poltergeist does not have to concentrate to use or maintain this ability; the poltergeist can hurl only one object or creature per round; the poltergeist uses its Charisma modifier (usually +1) to modify its base attack bonus. A creature targeted by this ability can make a DC 12 Will save to avoid being hurled by the poltergeist. The save DC is Charisma-based.

SQ—*Natural Invisibility (Su):* This ability is constant, allowing the poltergeist to remain invisible even when attacking. This ability is inherent and cannot be dispelled or negated (such as through the *invisibility purge* spell).

SQ—*Unnatural Aura (Su):* Both wild and domesticated animals can sense the unnatural presence of a poltergeist at a distance of 30 feet. They will not willingly approach nearer than that and panic if forced to do so; they remain panicked as long as they are within that range.

Fire Elemental: CR 3; hp 26.

The Wizard Alazo’s Stick



I have a soft spot for weapons that erratically backfire on the overconfident muscle that wields them. The *wizard Alazo’s stick* is a personal favorite. Alazo created a magical stick that would inflict a grievous wound on any living thing it struck. This wound would often be mortal. To discourage theft of his stick, Alazo also placed a curse on it. (Of course it was stolen by some big dummy who didn’t believe in curses). The curse is that the wound will sometimes appear on the wielder instead of the target. This risk can be avoided by thinking a secret word of power while striking

your target. The only way to determine the secret word of power involved payments to expensive sages who can perform powerful spells of divination. Or you can help me find the directions, which have been lost in my Dungeon of Doom for thousands of days.

The Wizard Alazo’s Stick: This magical device appears to be a wand. When used to touch a living creature, the wand deals

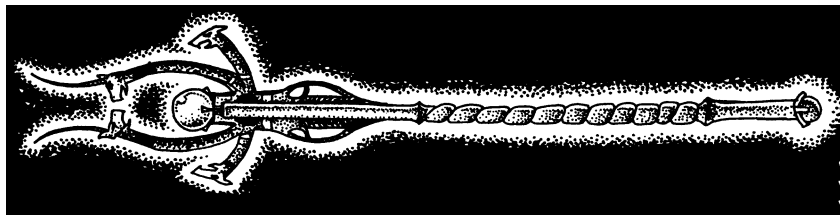

1d4 points of damage and acts as a *wounding* weapon (see Magic Weapon Special Abilities, *Wounding*, in the DMG), so long as the user thinks of the command word while using it. If the command word is unknown or is not correctly thought of, the weapon backfires, and deals the damage (including the *wound-*

ing effect) to the user. In the heat of battle, a DC 10 Concentration check is required to concentrate and focus on the word of power used to invoke this weapon's special abilities.

Moderate evocation; CL 10th; Craft Wand, *Morden's sword*; Price 2,600 gp; Weight.

The Books Of Hjalfyar

In the last decade of the existence of the southern isles, the wizard Hjalfyar gathered the best of the books and scrolls from the Library of Knowledge at Southport. His purpose was to protect the volumes from destruction at the hands of the religious fanatics who were growing in power and violence as the old king grew weak.

Knowing that he had little time, Hjalfyar had the books loaded aboard a ship and ordered the captain to take him and his cargo to the far away kingdom of Nordhiem. The captain agreed when offered a great fee to be paid in gold and magic. Unfortunately, the wizard did not know that the captain had already converted to the new faith. Three days after sailing, he broke into Hjalfyar's cabin and dragged him onto the deck of the ship.

The unfortunate bibliophile was forced to watch as his books and scrolls were tossed into the ocean. Then he was cast into the ink-stained water. His last breath was a curse on the captain and each of the members of his crew. Such was the power of the curse that not all of the books were destroyed. Many of them were transformed into even more powerful magic tomes. Several hundred still exist. These books fall into three categories.

The Books Of Hjalfyar (Snappers): *Snappers* rest quietly on the shelves of any library. At midnight, they snap open disgorging weird little worms. These are demonic bookworms that devour the ink from the pages of magical tomes, erasing the text and slowly rendering the book worthless. At dawn, they return to their own book, which snaps shut. In some cases, they regurgitate the ink onto its pages.

Each *snapper* contains 10–40 bookworms.

Bookworm (CR 1/10): The bookworm is a tiny, 1-inch long gray seemingly normal worm. It is the bane of scholars, wizards, and sages, for its primary source of food is the paper, wood, and leather that make up books.

Bookworms cannot harm living creatures, but burrow through wood, leather, rope, and paper very quickly. They can ignore the hardness of such materials and a burrowing bookworm deals 3 points of damage per round to dead wood, rope, paper, or leather. Bookworms are quick and agile (moving at 20 feet per round) and seek to avoid being seen. To this end, they can alter their body color to match that of their surroundings (it takes a successful Spot check at DC 20 to see a bookworm that has camouflaged itself).

Spells on scrolls are destroyed and unusable if a bookworm burrows through the scroll. Spellbooks lose one

spell level per round that a bookworm spends burrowing into it.

A typical lair (or brood) contains 10–40 bookworms. They are easily killed by attacks that deal damage over an area (such as fire or cold). Consider one worm killed for each point of damage dealt.

The Books Of Hjalfyar (Crumblers): These books are cursed to grow heavier and heavier, slowly becoming far too heavy to lift. This is but one facet of their curse. The other involves where the extra weight comes from. The book will slowly leach the fat from any living beings near it. This fat is magically processed into ink, which is stored on the books' pages. Each page is enchanted to hold as much as 16 ounces of ink on each side, with each page weighing in at 2 pounds. There will be upwards of 200 pages in each book. If the *crumbler* is jiggled or moved, the ink will spill out. Where's the trap, you ask? Have you ever seen what happens to an anorexic?

Each hour that a *crumbler* book is carried, the victim loses 2 pounds from his current weight and suffers 1 point of temporary Strength damage. The book gains the weight absorbed from the victim. Once in his possession, a victim of the *crumbler's* curse is oblivious to what is happening to him and refuses to part with the book. If force is used to get the book away from the victim, he fights to get it back. A *remove curse* dispels the effects of this book.

The Books Of Hjalfyar (Muncher): The last type of book is a *muncher*. Left anywhere near other books, it will absorb one book per day. The eaten book will be transported to interdimensional space where it must remain until Hjalfyar is reborn to release it. At first the clueless owner of the *muncher* will assume that someone is borrowing or stealing his books. It should be quite some time before he begins to suspect the *muncher*. At that point, nothing will return the lost books. However, the *muncher* can be discarded, preventing further losses.

This magical cursed tome absorbs one book per day, sending it to a pocket dimension on the Astral Plane. No known magic detection, scrying, viewing, etc. reveals the location of the missing books.

Snapper: Faint conjuration; CL 5th; Craft Wondrous Item, *summon monster I*; Price 1,000 gp.

Crumbler: Faint transmutation; CL 5th; Craft Wondrous Item, *bull's strength*; Price 5,000 gp.

Muncher: Strong necromancy; CL 17th; Craft Wondrous Item, *astral projection*; Price 200,000 gp.

The Athenian Amphora



This large pottery jug is about 30 inches high, 24 inches in diameter at its widest point, and is very heavy for its size. Painted around the circumference of the amphora are 10 Greek warriors in full battle armor. A large snake decorates the neck of the jug, its fangs forming one handle, its tail forming the other.

Nobody really knows where the *amphora* was made or who made it. All that is known is its history. It was first found about 100 years ago by a merchant in the Far East. He sold it to a man who collected artifacts and relics in a port city in the south. It came into my hands some years later. The rest of the story is far more interesting.

The merchant had elected to keep the amphora, and had installed it as a decoration in a guest bedroom in his home. Under compulsion, he told me of a caliph who was murdered under mysterious circumstances in that room. It was only with the greatest of difficulty that he was able to escape prosecution for the poor man's murder. The dealer quickly sold the jug to another merchant.

The new buyer kept the jug in his showroom for only two days. Late in the night, a great deal of noise was heard coming from the showroom. When guards burst into the room, they were greeted by a scene of butchery. The night watchmen and their dogs were all slaughtered, hacked

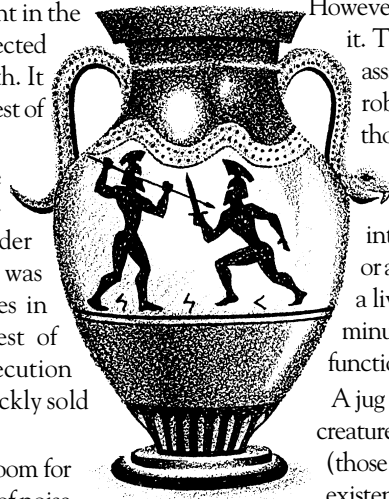

and stabbed to death by swords and spears. Knowing my interest in things arcane and murderous, the dealer quickly brought this incident to my attention. I was quickly able to determine that the jug was in fact a complex bit of performance art. On certain nights, when the moon is full and large in the sky, the jug shows its true nature. It is formed of a strange clay that can take on the form of any creature that is drawn on it, or molded from it. The clay has no life or mind of its own.

However, it does react to the fears of those near it. Thus, a caliph who feared assassins was assassinated, and watchmen who feared robbers, slain. Try to think pleasant thoughts, if you can.

The Athenian Amphora: This clay jug has the ability to transform into any creature inscribed on its surface or any creature that enters the thoughts of a living creature that spends more than 1 minute within 5 feet of the jug. This jug only functions on eves when the moon is full.

A jug creature is formed entirely of clay. The creature remains until it has slain those near it (those fearing it that actually brought it into existence), those within 30 feet of the jug, or until the moon sets. At this time, the creature disappears and the jug retakes its original shape.

Moderate transmutation; CL 11th; Craft Wondrous Item, *animate objects*; Price 120,000 gp.

Jug Creature Template

“Jug Creature” is a template that can be added to any corporeal creature except oozes or elementals—hereafter referred to as the “base creature.” The creature is formed entirely of clay and its type changes to construct.

A jug creature uses all of the base creature's abilities except as noted below.

Size and Hit Dice: Change to d10. The base creature gains bonus hit points (like other constructs) based on its size.

Speed: Jug creatures have 75% of the speed of the base creature. If the base creature could fly it has 50% of the flying speed of the base creature and its maneuverability falls to poor.

Armor Class: The base creature's natural armor increases by +4.

Attacks: The jug creature retains all the attacks of the base creature.

Special Attacks: The jug creature retains all of the special attacks of the base creature and gains those listed here.

Haste (Ex): After it has engaged in at least 1 round of combat, a jug creature can haste itself once per day as a

free action. The effect lasts 3 rounds and is otherwise the same as the spell.

Special Qualities: The jug creature retains all of the special qualities of the base creature and gains those listed here. It gains the special qualities of the construct type.

Immune to Slashing and Piercing (Ex): Because of its clay body, the jug creature takes no damage from slashing or piercing weapons, including magical weapons of this type.

Abilities: Modify from the base creature's scores as follows: Str +4, Dex -4, Con —, Int —, Wis -2, Cha -10 (minimum score of 1).

Skills: Constructs have no skills; the jug creature loses any skills the base creature possessed in life.

Feats: Constructs have no feats; the jug creature loses any feats the base creature possessed in life.

Environment: Any land and underground

Organization: Solitary

Challenge Rating: Up to 11 HD: as base creature +2; 12 + HD: as base creature +1

Treasure: None

Alignment: Always neutral

Mirrors of the Soul



There was once a young lady from Kzan who was rather taken by her own reflection in mirrors. She could spend hours sitting in her room, grooming her hair, fixing her makeup, and plucking her lashes. One day she tired of her mirror and decided to obtain a new one.

On the way to the market she chanced to cross paths with a gentleman of strange demeanor. His complexion was pasty, and he had long pointy fangs in need of a good brushing. She never did get to the market that day, and when she returned home she discovered that her reflection was absent from all the mirrors in the house. Enraged, she went to the local witch and demanded a cure.

The witch had no idea how to cure the girl's condition, but being a good businesswoman she never let on. Instead, she set out to correct the visual symptom of the girl's vampiric curse. She enchanted several mirrors to show the soul of the person gazing upon them, rather than their physical reflection. Unaware of the girl's obsessive vanity, the witch failed to consider that a conceited soul might not be as beautiful as its wrapping.

When the girl gazed into the mirror, she saw the ugliness of her narcissism and flew into a rage. She killed the witch by bludgeoning her with the mirror. Nothing was ever seen of the girl again. Some say the sight of her vanity-ridden soul caused her to commit suicide. Others say she was captured by the witch's master and enslaved in a bottle. The enchanted mirrors, however, still exist. Leave one in your dungeon to test the purity of those white knights; they may



not cope well with what they see. Though personally, I think I look rather handsome in my mirror.

Mirror of the Soul: This *mirror* resembles an ordinary looking glass 5 feet tall and 2 feet wide. The possessor that gazes into the mirror sees a reflection of his soul rather than his natural reflection. Soul reflections simply show the character his alignment as a combination of the following colors: lawful = white, neutral = gray, chaotic = black; good = blue, evil = red. So, a lawful good creature peering into the mirror sees his soul as an aura of shimmering white and blue.

Carpet Bag



This rug looks like any other floor covering. However, anything that can fit under its edges is concealed. The illusion spell that enchants it smoothes out all those unsightly bulges associated with hidden loot. So far, a rather mundane and uninteresting adventure into simple illusionary interior design. With a few modifications added by my own favorite decorator, Groomni Grimgri the mad dwarf, this *carpet* becomes a must for any really chic dungeon.

You can indeed put anything that will fit under it into hiding. But try finding it! Grimgri added a few little traps into the weave to ensnare any reaching or clutching hands. Those folks feeling around for goodies will inevitably grasp one of Grimgri's traps which will send a shot

of electricity coursing through their paw sufficient to knock a good sized troll for a loop! The *carpet* recharges itself by absorbing and storing the static electricity generated from people walking over it. Let the delvers see you hide your gold here, then sneak around the corner and watch the fun.

Carpet Bag: A *carpet bag* is a 5 foot by 3 foot rug. This item functions similar to a *bag of holding* in that anything placed under it (rather than in it) disappears and is stored in an extra-dimensional space. A creature that reaches under the rug to retrieve a stashed item is shocked for 6d6 points of electricity damage (Fortitude save DC 15 for half).

Moderate conjuration and evocation; CL 9th; Craft Wondrous Item, *Leomand's secret chest*, *lightning bolt*; Price 10,000 gp.

Satan's Bow



The thought of encountering *Satan's bow* makes me wince. This metal bow is skillfully crafted and glows with a magical radiance. The light is really just a sucker's hook, designed to attract characters grabby for magical items. The bow is enchanted with a self-contained *light* spell to maintain this deception.

The trap portion of the bow lies in the bowstring. The string is made of a very fine, diamond-dust studded wire. The bow itself, being made of metal, will not have the flex one would expect. The result — anyone trying to draw back the string of this bow will lose three fingers for the effort (automatic; no save). The creature suffers a -2 penalty

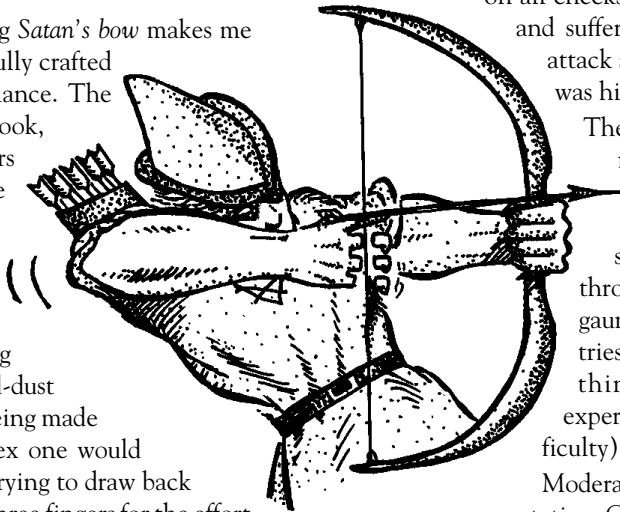

on all checks when using his hands and suffers the same penalty to attack and damage rolls if this was his primary sword hand.

The only way to avoid this fate is to use a thumb ring when drawing the string, which is sharp enough to cut through even light leather gauntlets (and anyone who tries to use a bow with anything heavier will experience a great deal of difficulty).

Moderate evocation and transmutation; CL 7th; Craft Wondrous Item, *light*, *keen edge*; Price 50,000 gp.

The Acid Test Scabbard



The *acid test scabbard* is an innocent-looking, well-tooled sword scabbard designed to fit a broadsword. At the very bottom of the scabbard is a thin bladder of acid, which will be punctured when a sword is thrust within. When the sword is re-drawn, the blade's condition will leave a lot to be desired. Non-magical weapons automatically take 1d6 points of acid dam-

age each round they are in the scabbard. A magical weapon receives a save DC 18 Fort save each time it is inserted into the scabbard. On a failed save, the magical weapon takes 1d6 points of acid damage each round it remains in the scabbard.

Moderate conjuration and transmutation; CL 10th; Craft Wondrous Item, *acid splash*, *disintegrate*; Price 100,000 gp.

Speak Down



Disgusted by the way excessively vocal delvers often take undeserved control of a party, Steve Crompton developed this item trap. Given the proper circumstances, and some smooth talking by the DM, this item could very well put a game back on even footing.

The trap takes the form of a bottle of blue liquid labeled "Blue Rose: *Bottled by the Voiceless Ones.*" No magic can be detected from either the bottle or its contents — in fact, the liquid smells like a fine wine.

The liquid contains a mixture of rare and powerful chemicals known only as *Kromptonite*. This mixture,

when imbibed, causes an instant paralysis of the vocal cords for a duration of not more than twelve hours. Any character drinking from the bottle will be struck dumb (no save; treat as a *feeblemind* spell). The person playing the character is restricted to making gestures and writing notes — he may not speak again!

With a bit of luck and some crafty maneuvering, there's a good chance you could trick the party leader into drinking from the bottle. This will force the usually quiet characters to speak up, and might even lead to the doom of the "Big Mouth."

Idiot's Vase



One of Ken St. Andre's treasures is the *idiot's vase*, which will point out how *stupid* some delvers can be. The item is a magical crystal vase; 80 gold pieces are visible inside. The vase itself radiates negative magi-

cal vibes. Whoever carries the vase suffers 2 points of permanent Strength drain each round the vase is held. Whoever breaks the vase suffers 6 points of permanent Intelligence drain. Whoever reaches into the vase will turn blue, unless he is already blue — in

which case he turns green. All attribute losses and changes are permanent.

The way to defeat this trap is painfully simple: merely turn the vase upside down and pour the gold

out. Delvers whose mentalities are geared to destruction will seldom think of this.

Moderate necromancy; CL 10th; Craft Wondrous Item, *bestow curse*; Price 28,000 gp.

Trap Detection Amulet



Dan Logan's *trap detection amulet* does perform as advertised, but perhaps not exactly in the fashion a delver would like. Dan suggests you place this item at the center of a maze guarded by a number of painfully obvious traps. Several of the traps should be sprung, and the remains of dead delvers should be at every hand.

At the center of the trapped labyrinth, the characters will find the *amulet* resting on a pedestal. An inscription on the *amulet* indicates it will detect traps, and aid in disarming the same. The item does in fact detect traps, but it also interferes with the party's senses. The result is that even simple traps prove difficult to defeat, as the party is deluded by the *amulet's* magic into thinking a trap has been disarmed, when in fact it is still poised to kill. In effect, a characters' chance of getting

killed by a trap is increased ten-fold when this *amulet* is on hand.

Trap Detection Amulet: This magical *amulet* grants the wearer a +10 circumstance bonus to Search checks when looking for traps. Additionally, it also imposes a -10 penalty to Disable Device checks. Even if the Disable Device check fails, the wearer believes the trap is disabled unless he makes a successful DC 25 Will save.

Faint (no school); CL 3rd; Craft Wondrous Item, 5 or more ranks in Search; Price 2,000 gp.



Ring Of Doom



I do not like it when the doorbell rings. I clatter across the cave and put my head down flat on the front hall tiles and bark myself silly when the bell rings. This, however, is a different sort of *ring of doom* — designed by Rick Loomis — so I will get right to it.

The party finds a gold ring of exquisite manufacture as party of a treasure trove. The ring is engraved with images of dogs running away with their tails between their legs. I agree this is hitting too close to home but I did not design this trap so do not blame me my doggy friends. The inside of the ring bears an engraving that reads

RING OF DOOM.

Wear on index finger. Point at biggest, nastiest enemy. Shout the worst insult you can think of. The worse the insult, the better the ring will work.

Of course this ring is really just useless junk jewelry. The dog motif is in especially poor taste. The ring has no magical effects but if some poor idiot follows the instructions he should find the rings does indeed ensure his doom. Arrroooooooooo!

Have a Ball



CR: 3
Type: Mechanical
Search: Trap (DC 20), Trigger (DC 15)
Disable Device: Trap (DC 20, 2d4 rounds)
Primary Trigger: Location (placing fingers in hole)
Primary Trap Effect: Tiny needles poke creature's fingers dealing 1d2 points of damage plus they deliver a dose of scorpion venom (initial and secondary damage 1d6 temporary Strength damage).

Primary Save: Fortitude DC 18 to resist poison
Secondary Save: One minute after primary save, another Fortitude save (DC 18) must be made to avoid the secondary effects of the poison.

Reset: There is no reset for this trap

Cost: 3,000 gp (does not include the price of building a bowling alley)

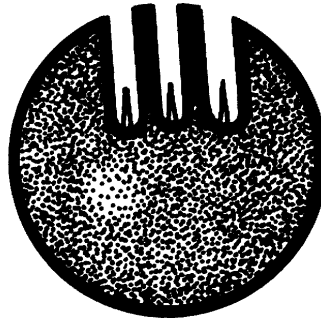

Uriah Ward has contributed an interesting item trap, guaranteed to ensure that your characters... have a ball.

To use this trap, you must install a bowling alley somewhere in your dungeon. Make it fully automated, and award gold pieces or some such for each pin knocked down. After a while, balls are returned to the characters that have poisoned spikes carefully located in the finger holes. *Strike!*

Grimtina's Fashions To-Die-For

I love shopping! And it's even more fun when I get an employee discount! I promised big brother I wouldn't take too many goodies for myself, but some of them are

hard to resist. My bedroom closets are just filled with new toys that I can try out on my boyfriends. They never seem to last very long, though. The boyfriends, that is. Traps



Bazaar products come with an iron clad guarantee. If any of my big brother's traps should break or malfunction, you can be sure that its entirely your fault and not the

result of any defects. What kinda joint do ya think we're running here? Geez, why don't you just look at these great clothes and quit complaining!

Ehpos Cloak



This satyr's cloak will make the wearer invisible. While wearing the garment, he will not be detectable by non-magical methods. But since satyrs are, shall we say, naturalists, the only suit that can be worn under this cloak is a birthday suit. Any other clothing or item will render the charm ineffectual. Another rather problematic side effect has to do with the nature of satyrs. The

wearer will become extremely excited in the presence of women. His self-control will be sorely tested (DC 20 Concentration check to maintain self-control) for the cloak cannot be removed until the satyr spirit that powers it has been satisfied. Completely. (By the way, the cloak will not work on women at all.)

Faint illusion; CL 3rd; Craft Wondrous Item, *invisibility*, a few hairs from a satyr; Price 10,000 gp.

Kaynar's Clothes



Aside from passing down some minor tricks of a troll's trade in my books, I have never agreed to take on an apprentice. Who needs some eager, young idiot tugging at your elbow with a millions stupid questions? Well, maybe editors do, but the mage whose apprentice created this trap certainly could have done without his protégé. Kaynar the apprentice sneaked a look at his master's grimoire. He came across a spell to enchant ordinary clothing to be impervious to any attack. In his haste to steal the spell, Kaynar omitted some important steps, which changed the effects of the magic. Although *Kaynar's clothes* are impervious to damage from heavy weapons (morning stars, broadswords, maces, etc.), an

assault by a small weapon will succeed for 6 times the weapon's normal damage. Poor Kaynar met his doom one evening when he came home late for dinner and his wife set upon him with a wooden spoon.

Kaynar's Clothes: These appear as an ordinary set of clothes (noble, artisan, or any other type). When donned, they grant the wearer complete immunity to attacks from any melee or ranged weapon (normal or magical) of Medium size or larger. Weapons of Small or smaller size deal x6 normal damage on a successful hit. Once donned, the clothes can only be removed by *remove curse* or greater magic.

Faint abjuration; CL 3rd; Craft Wondrous Item, *shield*; Price 6,000 gp.

Get a Grip Gauntlets



These metal gauntlets, inlaid with silver runes, reek of magic. The enchantment is obvious even to the most incompetent magic user (and we are sure your players fall into this category): invulnerability! Runic scholars will be able to make out the inscriptions on the gauntlets' wrist pieces. The word "Gryp" is on the right hand and the word "Ghrasp" is on the left.

These gauntlets are one-size-fits-all garments. The gleaming gloves slide on and off with ease. If tested, they are truly invulnerable. Fire, explosions, even acid will not mar their surface. And the person wearing the gauntlets will be likewise unaffected in the area covered by the gauntlets.

However, once either of these gloves closes around something, it cannot be released. If, for example, the wearer grabs a sword, the gauntlet and sword handle will be as one! This will be a miserable encumbrance at parties or while eating dinner. After this catastrophe, the delver will try to remove the gauntlets. But the grip on the hand is just as sure. The gauntlets



will drop off only when the hand inside them no longer lives or a *wish* or *miracle* is used to remove them.

Moderate transmutation; CL 12th; Craft Wondrous Item, *make whole*; Price 12,000 gp.

Seven Leak Boots



This is a wonderful trap, but a word to the wise — unless you employ plenty of custodial slaves, play this trick in someone else's dungeon. The *seven leak boots* are made of fine leather, with sturdy, hardwearing soles, and they are always a perfect fit for the finder. A golden buckle bearing the image of a waterfall adorns the boots, and on the heel, a seven is stamped. In all appearance, these are excellent traveling boots, and would provide the owner with protection from the hazards of the road (i.e. rocks, thorns, snakes, scorpions, etc.). In fact, they deliver all this, plus a slight bit more due to a mild magical spell of protection cast on the wearer. Unfortunately, these boots were made for more than just walking.

They are cursed. Once an adventurer puts on the boots, they cannot be taken off, although they may be removed by cutting them apart (hardness 10, hp 20, Break DC 30). They cause no immediate discomfort or constriction. The curse reveals itself to the wearer only when he tries to walk. Every seven steps, the unlucky delver is stricken with an overwhelming desire to urinate, and *must* relieve himself. It will be all he can do to keep from wetting his armor! Incidentally, the urine is magical in nature, and is generated by the boots, not the adventurer's body. He runs no risk of dehydration. The curse may be bypassed if the wearer has a horse to ride, can fly or teleport, or has friends willing to carry his around, thus avoiding taking any steps.

Faint conjuration; CL 3rd; Craft Wondrous Item, *create water*; Price 2,000 gp.

Cape of Dorian Grey



An even subtler item trap is the *cape of Dorian Grey*. The cape is old and tattered, yet looks like it might be worth picking up as a souvenir. The longer a character wears the cape, the better the cloak will look — and the character will seem just a little older....

The cape, of course, leaches age from those who wear it. The change should be very vague at first even when the aging is detected, the cause shouldn't be immediately

recognizable. After about a week, the character will be an old man... unless he rids himself of the cape. The cape ages the wearer to the base age in the next age category listed in the *Player's Handbook* every three days the cape is worn. (For example, an adult human wearing this cape would become middle-aged and 35 years old in three days. In three more days, the same character would be 53 years old and of the "Old" category.)

Strong necromancy; CL 15th; Craft Wondrous Item, *bestow curse*, *finger of death*; Price 150,000 gp.

Gauntlets of Doom

I love items traps that turn usually trusty weapons into very nasty devices indeed. One such item is the *gauntlets of doom*. These gauntlets appear normal in every fashion, and will comfortably fit any normal-sized human. To make them more attractive to prospective delvers, you might wish to forge the gauntlets from silver.

The problems with these gauntlets will become apparent the first time someone tries to punch something with them. The gauntlets are equipped with a thin bladder located between the lining of the glove and the external metal surface. If something is struck with sufficient force the bladder will break, spilling its contents onto the hands of the wearer.

Naturally, the bladder holds a fatal contact poison. The wearer must succeed at a DC 18 Fortitude save or take 3d6 points of Con damage. One minute later another save must be made (same DC) to avoid taking another 3d6 points of Con damage.

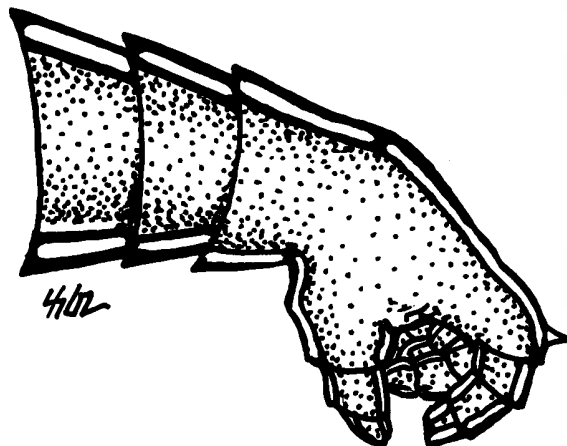

CUT AWAY
OPEN - UH
THIS DOOR!

SECTION FIVE:
**GRIMTOOTH'S
DUNGEON OF
DOOM**



Salutations, fellow character crunching, creation compacting, creature crippling, cognoscenti of chaos. It is time once again to enter that entertaining world of mind boggling mayhem that makes the operation and maintenance of dungeons such an attractive career. Come with me once more into the world of traps!

Over the last fifth of a century I've been scouring the known (and to a degree unknown) world to supply you with individual traps. Each has been attractive in its own charmingly gruesome way. They have, however, been like a double handful of unset gemstones. They flash with brilliance, but they are alone; isolated from the striking settings that will enhance their natural diabolical luster.

In previous chapters you have come to enjoy the thrill of knowing in advance just what cleverness the hapless boobs that blunder into your arrays of my devices of doom will need just to survive. But in the end you have had to fall back on the usual run of the mill cast of monsters, orcs, golems, and such like less clever, and more fallible minions. This will change.

After years of globetrotting for your edification and delight I have finally unearthed (literally) a true gem. Yes, after all this time of serving you tidbits piecemeal I now can offer you a feast. Built from the ground up, a dungeon consisting entirely of traps!

Once characters enter here they will be thrown back on that one resource that you and I know they possess in shortest supply: their wits. Rest assured you can use each trap and mechanism separately to punch up the sagging "kill ratio" of your local family maze or warren, but for the first time ever you will now have access to a true Traps Dungeon, that in and of itself is complete and fully functional.

As I am eager to begin, let me just step aside and bid you enter into the wonderful world of the Ancient Mage Evinrood, and his intricate Tomb.

~ Grimt



DUNGEON of DOOM
TRAPS BAZAAR
TRAPS LITE
TRAPS ATE
TRAPS FORE
TRAPS TOO
TRAPS

WURST of TRAPS

Some Background...

The search for the perfect traps dungeon is rooted in antiquity. It involves a duel between two of the greatest mages of their time. A time so long ago that all records have been lost. Until now. (If we kept records on something other than vellum scrolls and other such primitive materials we would probably find out that the "a time lost in antiquity" is in reality something like two or three hundred years ago.)

=On a cliff overlooking the sea, I discovered (with very little help) a great Capstone. Upon closer inspection it was found to be covered with an inscription. The letters that made up the message were so faded that it was only with great care that the legend was deciphered.

It read as follows:

"This was the Final resting place of Evinrood the Water Mage. He did battle with Selgolub the Master of Daemons in the year of the Bitter Wyvern. He failed to over throw Selgolub and was Accursed. Herein lies the master Mage; Savior of Karthaki, friend of the dwarves, and kobolds, Master of the Elements. Here too lies his greatest treasure. Disturb this slumber at your peril."

After prolonged research more was found about the legendary Evinrood by consulting an archivist sorcerer whose specialty is restoring ancient records. (This is a mage who spends his time restoring old scrolls hoping one will contain a map to some old castle site, dungeon, or tomb. These he sells to hapless fools through a "broker." This is considerably safer than exploring them by himself.)

It seems Evinrood's chief claim to fame was a feat of conjuration he performed at the behest of Shillary Lockwood, Chateline Of Karthaki. (As with all mages it was more than likely a large "gold" behest.) During the third year of the Reign of Terror, brought on by the Death Empress of Khazan, attacks into the reign around Karthaki were rife. Evinrood destroyed one such expeditionary force out of Kharkadan. He used his control of the earth elementals, and the aid of the dwarves and kobolds to drive the horde to the banks of the river Dajja. There on the banks of the river he summoned a myriad of water elementals. The attacking horde was dragged into the river and consumed by the elemental force. Thus ended the Battle of Three Plains. (The archivist/mage will gladly sell you a map to the site for a "small fee, so good luck, you'll need it.")

The Entrance...

...or, Evinrood has the treasure, and the Delvers get the shaft.

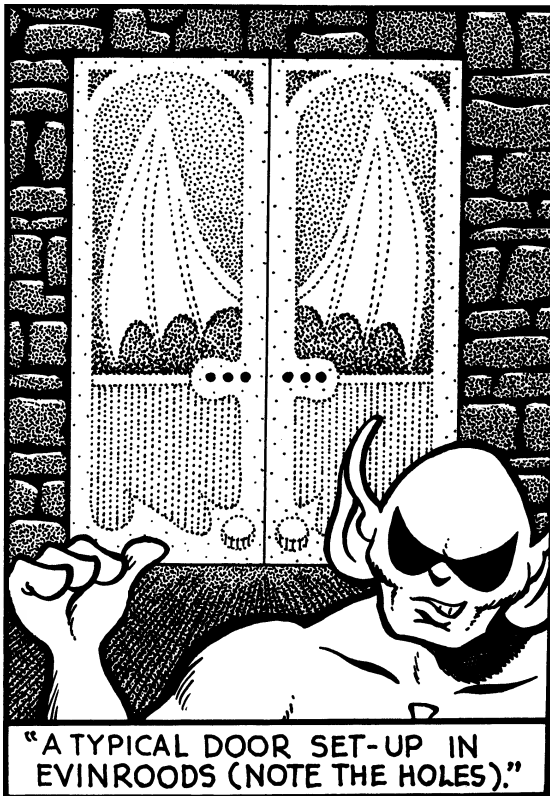

"A TYPICAL DOOR SET-UP IN EVINROODS (NOTE THE HOLES)."

The entrance to the Tomb of Evinrood is located on a grim, dark moor overlooking the sea. Soaring sea birds seem to cry his lament, as well as a forlorn warning to the advancing party of delvers.

The actual location is marked by a large graven capstone set almost flush to the ground, in a collar ring of stone work. One the surface of the capstone is a message, carved so long ago that the letters have faded almost to illegibility. With care the carving becomes clear:

This is the last resting place of EVINROOD the Water Mage

He did battle with Selgolub the Master of Daemons

In the year of the Bitter Wyvern, Sixth year of the Reign of the Death Empress

He failed to overthrow the daemon lord and was Accursed EVINROOD, Savior of Karthaki, friend of the dwarves, and kobolds

MASTER OF THE ELEMENTS THEMSELVES

Rests herein with his great treasure disturb them at your peril!

If the promise of treasure and what is clearly an undisturbed Tomb complex doesn't inspire your prospective victims they are in the wrong line of work. So it is without further ado I submit for you approval the first trap. (Being as it is, before the party actually enters the Tomb, this will serve to separate the sheep from the goats in any party of delvers).

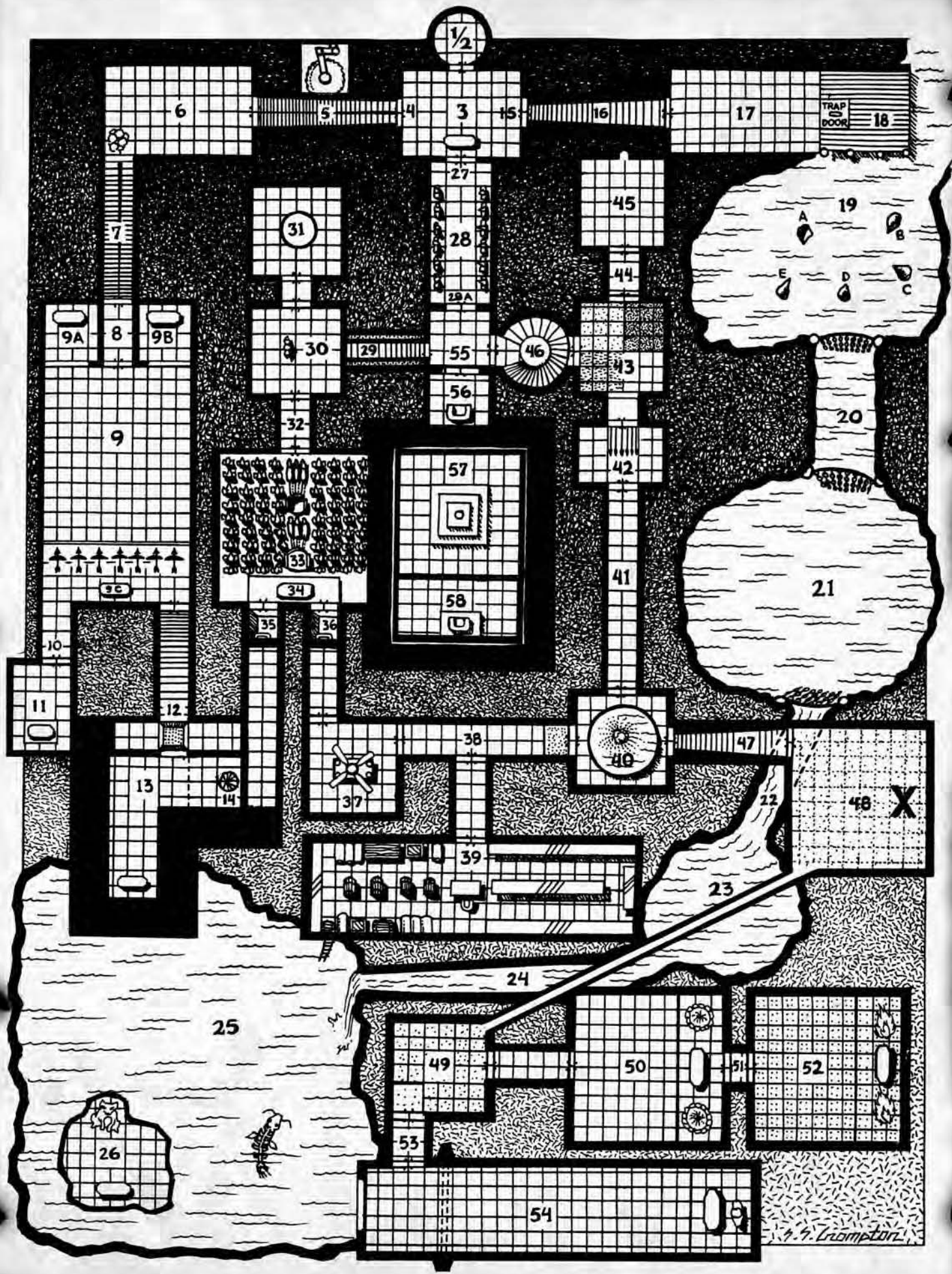

1/2



TRAP DOOR

A B C D E

X

S. G. Crumpton

Trap #1: When I Do This I Get This Tingling Sensation!



CR:	2
Type:	Mechanical
Search:	Trap (DC 22), Trigger (DC 22)
Disable Device:	Trap (DC 26, 2d4 rounds); Trigger (DC 26, 2d4 rounds)
Primary Trigger:	Touch (lifting the capstone)
Primary Trap Effect:	Jolt of electricity (no attack roll necessary; 2d6 points of electrical damage)
Primary Save:	Fortitude (DC 20) half
Reset:	Automatic
Cost:	8,200 gp

The capstone is 10 feet in diameters. It is set tightly enough into the stone collar that it is just possible to insert a crowbar, or such like implement of destruction into the gap around the edge. (Note: If the party is foolish enough to use sword points, the weapon must succeed at a Fortitude save at DC 18 or break). With suitable grunts and groans they will be able to pry the stone up high enough out of the stone collar to grasp the edge. A Strength check (DC 35) allows the stone to be moved.

If they try to peek in around the stone before they attempt to move it the darkness will not permit them to see any great detail. That is unless they lift the stone high enough, which will, of course, set off the trap.

As the party lifts the capstone clear they will be treated to one of the cleverest nonmagical “Zap” traps available.

The underside of the capstone is covered with a thin layer of copper plate. This plating goes all the way to the edge. If the stone is lifted by hand it will be impossible to do so without touching this copper plate.

In the center of the underside of the capstone is an axle on which is mounted a 5 foot copper-coated lodestone disk in such a way that it will spin freely (don't ask me where he got a lodestone — at least it is nonmagic). Out from the axle is fixed a long thin copper brush making a radius of the copper disk and just touching it. Wound around the axle is 200 feet of a fine elven rope that is resistant to the ravages of time. This rope passes over a pulley also mounted on the bottom of the capstone, and thence on to a 20-pound stone weight set in an alcove cared 4 feet below the lip of the stone collar. Also fastened to the same peg as the pulley is a thin piece of thread which runs with very little slack to a ring bolt set in a tiny wedge that prevents the 20 pound weight from falling

into the long dark shaft below (see illustration). There is one last little item, fastened to the bottom of the capstone. On the opposite side from the pulley there is, fastened by a copper pin, a thin copper thread. This tread trails into the depths about 7 feet where it is fastened to the wall with a copper peg; this is the “ground” wire!

When the hapless party lifts the stone, the wedge is pulled free allowing the 20-pound stone to plummet into the abyss. This turns the copper disk at a fairly good clip against the brush on the capstone's copper plated bottom. A static electric spark of fair proportions will be generated and short out through the fingers of the delvers! The charge should be fatal to any character with a below average constitution, or any one with a heart condition. (Right! A delver with a heart condition, be still my beating heart!) It should knock those with average constitutions on their kiesters. Those who are stout of heart, and great of wind and limb might just hang on despite the jolt of electricity, but remember there is a 20 pound stone dropping 200 feet involved here, the jerk as it hits should cause even the greatest “hero” to loose his grip and drop the capstone.

The beauty of this is that the stone is now harmless, but the party need not know this. They can be presented with this as a sign that the power of Evinrood reaches beyond the grave.

I'd rate this babe at two skulls, but the potential comic value is great.

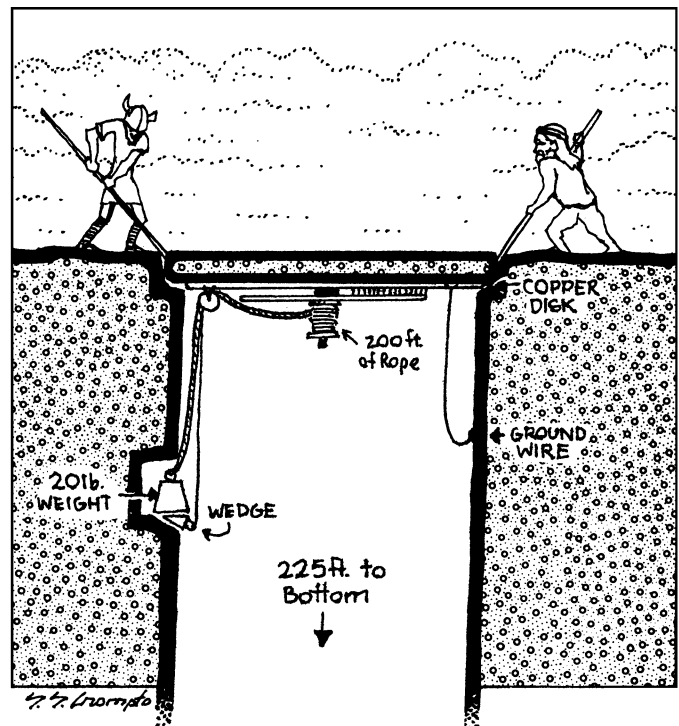

The second trap is located at the bottom of the shaft. The party will be taken somewhat aback by the capstone trap, after they have plucked up enough courage to finally displace the capstone they will be confronted by a deep, dark, seemingly bottomless shaft opening in the ground. If they have any wits at all they will find at their disposal a 200-foot length of elfish rope (very strong, light, and obviously not subject to the ravages of time). Keep in mind there is a 20-pound weight fastened to the end. The first thing the party is likely to do is drop the stone sans the rope into the abyss. If they do or drop such other items as they choose they will, after a brief pause, hear a splash. A descent will be necessary.

At this point it is important to remind you, my cohort in chaos, that this Tomb is not lighted in any fashion. It behooves you to make sure the delvers are aware of this fact. Even with the light of lamps or torches it will be dim in most circumstances. Even at the bottom of a shaft open to the sun there is precious little light 225 feet down! Don't let the party take it for granted there is "enough light" from "other sources" to see by. Some member of the party will have to be carrying a torch, lamp, or providing some kind of magical "witch light." Remind them frequently, the reasons for this will be clear at a number of points.

Trap #2: Some Bottomless Pits Are Deeper Than Others



CR:	7
Type:	Mechanical
Search:	Trap (DC 27), Trigger (DC 25),
Disable Device:	Trap (DC 26, 2d4 rounds); Trigger (DC 26, 2d4 rounds)
Primary Trigger:	Touch (unlocking door)
Primary Trap Effect:	75-foot (or further) fall (no attack roll necessary; 7d6 points of damage [at least])
Reset:	Automatic
Cost:	25,000 gp

If the party can come up with 225 feet of rope they can move on to the next part of this torturous endeavor (keep in mind if they use the elven rope they will be 25 feet short and will have to climb back up the rope to get more, and then back down again.)

The "bottom" of the shaft is filled to a depth of 4 feet with water; this despite the fact that the capstone was very tight, and the shaft coming down showed no obvious leaks. As the intrepid delver on the end of the rope reaches the bottom he will be confronted with a set of two 5-foot wide 10-foot tall, graven stone doors, half submerged under the water. They are inset into the wall. If he is able to sense magic he will note a low level spell on them, if not he will note they are locked somehow so that his strength is unequal to the task of opening them (Hardness 15, 50 hp, Break DC 40). A magic mage with a skill sufficient to open a locked door will have to come down and help out. With any luck the mage will come down the same way as everyone else... headfirst!

The trap is operated by the unlocking of the doors (Open Lock DC 22), which are in fact just two stone slabs carved by dwarven craftsmen into the wall of the shaft. The lock in reality holds the floor of the shaft in place. When the unlocking spell is performed, a latch is released which permits the thin stone covered metal plate that is the floor to plummet into the depths a further 75 feet down!

A high level mage might be able to *fly*, or *levitate* himself out of danger. Furthermore a delver with foresight enough to tie himself with the rope will only drop a short way and bump his nose on the wall of the shaft. There is insufficient carving on the doors to grasp. There is a 30% chance a delver might save himself by grabbing the dangling rope (L3).

The final descent of 300 feet overall, or an additional 75 feet from Trap 2, will bring the party to a rubble filled bottom with the same 4 feet of water in it (not to mention the corpses of those who fell victim to the previous trap). They will again be confronting a 5-foot wide 10-foot high set of dwarven-crafted doors, which radiate a low level of magic.

There should be a fair amount of consternation among the delvers when they find themselves in the same position as at the doors above. This will result in a number of precautions being taken, which when the magic is employed to "unlock" the doors again will prove needless.

The doors will open into a room 40 feet wide and 30 feet deep. The water from the shaft will spill out over the floor. The walls are covered with stucco and painted with a variety of the scenes of Evinrood's greatest successes. Not more than 6 feet from the wall opposite the entrance is a raised stone pedestal, upon which rests, undisturbed an ornately carved coffin of pale stone. The designs on its surface are geometrical only, not scenes.

At this point it is only fair to tell any magic users they sense an uncomfortable "background magic" in this room. This will continue throughout the dungeon. It is not enough to impair their ability to sense magic or operate in any way, but it is there. It is analogous to turning on a light in a room that is brightly lit by sunlight, it doesn't add measurably to the ambient light in the room, but it is there. This is the maintenance spell, set by Evinrood to keep the daemons that the curse sent to claim him at bay.

Above the coffin is a roundel also painted on the stucco. In it the first character who enters see what is

clearly the images of him or herself dying in a number of hideous fashions! The images will change as a new character enters the Tomb. They each will see the images of themselves dying in a variety of different ways. This is a great opportunity to apply psychological pressure on the delvers. The images can show a character transfixed with arrows, ground into hamburger, sliced into convenient bits, drowning, burning, or in the grasp of dimly defined creatures that are ripping him apart. Limit yourself to trap results actually available in the Tomb. Furthermore if one or more characters have

already died in the first two traps who their images too after everyone else has entered, but their image will be as the party saw them at the point of their demise. This will serve to further reinforce the point. If you link the traps available and the delvers you may eventually actually match up a victim to a trap. At that point you can recall the image to the minds of the party. Or better still when the party enters the environs of a given trap you can indicate that this looks like an area remembered from the images this will serve to make party members hesitant to rush headlong into a "foredoomed" situation.

Trap #3: ...And You Thought This Was Going To Be Easy



CR:	6
Type:	Mechanical
Search:	Trap (DC 22), Trigger (DC 22)
Disable Device:	Trap (DC 22, 2d4 rounds); Trigger (DC 22, 2d4 rounds)
Primary Trigger:	Touch (opening coffin lid)
Primary Trap Effect:	Scything blade (+20 melee; 2d4+8, crit x4)
Secondary Trigger:	Timed (the blade automatically swings twice)
Secondary Trap Effect:	Scything blade (+20 melee; 2d4+8, crit x4)
Reset:	Automatic
Cost:	34,400 gp

The coffin itself is carved so deep that a cursory examination will not reveal the trap that it contains. The coffin is 9 feet long, 4 feet wide, and 4 feet high. It is topped by a heavy stone lid that must be lifted to gain entrance to the coffin (Strength check DC 25). It is also enchanted with a high level spell that negates certain types of magic. Prolonged experimentation will show the negated spell to be a spell of detection, and that it has a radius of 5 feet in all directions from the coffin.

Within the coffin there is a concealed blade, 2 feet up from the base of the pedestal. The blade is concealed by the intricate carving on the sides. The blade is 3 and 1/2 feet long and pinned in the center of the coffin on an axle. It is spring loaded so that when the lid is lifted it will swing free through an arc if unimpeded by a very stout object (hint: a leg, neck, arm, or fleshy what-have-you will not even slow it down). Armor, if it is of less than excellent quality may be insufficient (an indestructible mage's staff, or very stout sword blade would be fine brakes for our little slicer).

What the party hears as the blade swings through its arc back into the opposite side of its groove is a "click." This is what makes this trap so appealing: inside the coffin is another spring set to go off again if the lid is lifted.

The chief failing of this trap is that it only attacks the front of the coffin. A human should receive severe cuts to his legs while a dwarf might be beheaded! Assess hits and damage accordingly, keeping in mind you will want to know where every one is standing, and how tall they are.

I'd rate this trap at two skulls; one for the second swing of the blade unless the party is cripplingly stupid!

Inside the sarcophagus are the springs for launching the blade, and a suitable collection of dust.

(To some this dungeon will seem to lack treasure but a canny delving party with brains bigger than walnuts will recognize various articles as having significant value. The entrance trap yielded the elfish rope and several pounds of copper, while the coffin will yield the party a very serviceable sword blade, and two stout springs, items that are both difficult and expensive to manufacture in any quasimedieval world. If they can't broker these to a smith or mage on their journeys they aren't half trying. Keep an eye out for other "intrinsic" treasures, and keep in mind if the party doesn't pick up on them it is their loss!)

One last note: on the surface of the coffin facing the wall opposite the entrance is a small irregularity in the patterns. This irregularity when pressed will open the double doors concealed behind the stucco on this wall. The deviation in pattern will require a dedicated search to detect (Search DC 22). Keep in mind that these doors cannot be revealed magically due to the magic on the coffin, which inhibits spells of detection.

At this point the party will be left with a room that seemingly has no exits. Spells of detection on the walls to the right or left will reveal the presence of doors behind the stucco and frescos. Obviously acts of random violence will also reveal the presence of stonework behind the plaster so they can be detected manually by shipping off the stucco.

Trap #4: Ye Olde Digit Dicer

	2
CR:	2
Type:	Mechanical
Search:	Trap (DC 20), Trigger (DC 20)
Disable Device:	Trap (DC 20, 2d4 rounds); Trigger (DC 20, 2d4 rounds)
Primary Trigger:	Touch (inserting fingers or object into left or right holes)
Primary Trap Effect:	Blades automatically slice off the finger unless the creature is wearing armor that grants an armor bonus of +5 or higher (or natural armor of +5 or higher). Magical bonuses do not count for determination of armor bonus in regards to this. (2d6 damage; -2 circumstance penalty to all checks using hand and -2 circumstance penalty to attack rolls if this was the victim's primary weapon hand). A <i>restoration</i> type spell can restore a creature's missing digits.
Bypass:	Magically unlocking the doors
Reset:	Automatic
Cost:	3,000 gp

Once the doors have been discovered, and the plaster removed to reveal their size, (10 feet tall and 5 feet wide doubled as with the entrance), one other thing will be apparent: there are three finger-sized holes about waist high on the right hand door. This will seem clearly an unlocking or drawing open mechanism.

Keeping in mind the doors can be unlocked magically with no harm to anyone, a non-magic user may choose to insert a finger, or three fingers into these holes. In this case the center one will depress a mechanism that unlocks the door. The other two will depress mechanisms that release small steel blades that will slice off fingers that are not armored (leather will not help; they must have bronze, or steel gauntlets). This trap is a toss in just to keep the party on its toes. The series will be repeated on every door unless otherwise indicated, but eh "correct" finger hole will vary (I think Evinrood must have gotten a quantity discount on



these). I rate it at One Skull dropping to zero unless the party is very, very dim. Any finger-sized object may be used to unlock the door, metal being preferred if you wish to keep the device use intact.

The doors in either case swing inward, revealing a pair of staircases. The one on the right leads down while the one on the left leads up. The stairs are 50 feet in length, rising or descending 50 feet to similar sets of double doors. There is no landing; the stairs stop flush to the doors.

If the party elects to explore the one to the right, continue on to the next section, "Right Face!" If the party presses on to the left, page ahead to the section entitled "Leftward Ho!" And if by some chance the party has found the entrance behind the coffin then page on to the section entitled "The Path Less Traveled!"

Trap #5: Just When You Thought It Was Safe...

	6
CR:	6
Type:	Mechanical
Search:	Trap (DC 22), Trigger (DC 22), Secondary Trigger (DC 25)
Disable Device:	Trap (DC 25, 3d4 rounds); Trigger (DC 25, 2d4 rounds), Secondary Trigger (DC 25, 2d4 rounds)
Primary Trigger:	Location (pressure plate)
Primary Trap Effect:	Stairs turn into slide (no attack roll necessary; 1d2 damage)
Secondary Trigger:	Location (pressure plate)

Secondary Trap Effect:	Giant spinning blade-wheel (no attack roll necessary; 6d6, crit 19-20/x2)
Secondary Save:	Reflex (DC 25) avoids
Reset:	Manual
Cost:	22,000 gp

The stairs are a trap: any delver who can't figure this out deserves the old "step on the stairs and have them turn into a slide" bit. This is exactly what happens when the first weight of any substantial amount is placed on the upper surface of any of the

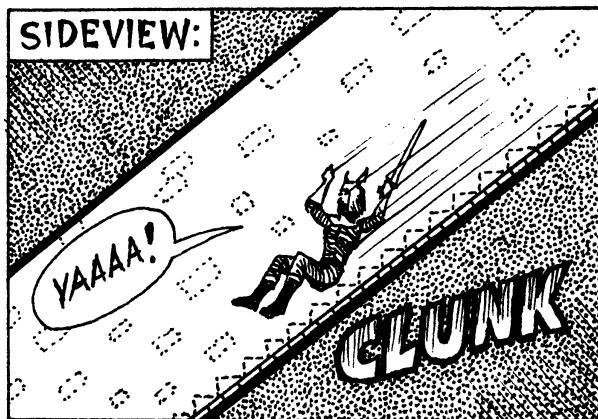

STAIR TURNS INTO SLIDE...

steps (yes, I know this is so old the dinosaurs stopped laughing at it, but just wait).

After the first "victim" (or whatever "weight" that was used to trip the "trap") reaches the doors at the bottom, the "real" trap will be set. The weight of the first slider will depress the end portion of the slide. This activates a second pressure plate in the center of the slide. When the next member of the party attempts to descend the slide, either by sliding (which is to be wished) or rappelling down on a rope, he will depress this plate, releasing a spinning disk of metal on a moving arm from the right hand wall 2 and + feet above the surface of the slide.

Inside the wall is an hydraulically driven piston (see sketch) that presses against a shaft that has the metal disk mounted to it by an axle pin through its center point. Around the axle is wound a short stout rope fastened to the stone wall at the back of the gallery. As the shaft advances the rope unwinds



SPINNING BLADE BUSTS WALL!

imparting a spin to the metal wheel. The wheel, 20 feet in diameter, is pushed through the stucco into the corridor. Spinning merrily it should cut through anyone in its path. There is a 30% chance a character might be able to lay prone out of its way (L3).

This trap is rated at 3 Skulls for surprise and lethality (a case could be made for having the blade dig into the opposite wall and stop short of hitting all the space 20 feet up and down the stair/slide way so it is not 100% efficient. Unfortunately!)

Once this trap has been tripped the corridor is safe enough if the party avoids the blade. It will be very difficult to loot this trap as the blade is very large and of an inferior grade of metal, sharp but brittle.

At the bottom we come to the doors, with their three holes again. This time the hole on the right is safe, just in case the party has gotten careless or cocky.

Trap #6: The Sand Gets In Your Eyes



CR:	5
Type:	Mechanical
Search:	Trap (DC 22), Trigger (DC 22), Secondary Trigger (DC 25)
Disable Device:	Trap (DC 22, 2d4 rounds); Trigger (DC 22, 2d4 rounds), Secondary Trigger (DC 25, 2d4 rounds)
Primary Trigger:	Location (pressure plate)
Primary Trap Effect:	Locks the door
Secondary Trigger:	Location (pressure plate under the bags)
Secondary Trap Effect:	Releases an air elemental into the room (see below for stats)
Reset:	Manual
Cost:	10,000 gp

Once you have bested the door you enter a room 20 feet wide by 50 feet long by 10 feet tall. Like the entry room the walls are covered with frescos. In this room there is a slight difference, the coffin is missing and in the far left corner is a small stack of dust-covered sacks. The

cloth is old and timeworn, so that some of the contents can be seen from the entrance. There is the fatal yellow glint of gold!

By now it should be clear to even the densest of your hapless victims that Evinrood "...wants to be alone...", but the lure of gold is a powerful magnet for the average delver. Given time they will enter the room.

If the party enters the room in a mass without taking precautions, by the time they reach a point 40 feet from the door they will activate a rocker panel in the floor that will cause the door to close (the rocker panel is a slab 5 feet wide that stretches across the tomb from one wall to the other. It is balance don a simple 1/8th of an inch "ridge" in the floor running the width of the room. When stepped on this switch will descend with an audible "click" to the side the delver has stepped on and thus activate whatever device is described, in this case a door closer, and a locking device).

There will be a moment of tension as the party braces for the worst. You can even expect some frantic efforts to

reopen the door. Let them try; the finger holes on this side will be in a different order than on the opposite side of the door, and if they rush they could do themselves a great disservice. What they will find in the end is that the door will reopen easily, but every time someone steps on the rocker panel the door will close and lock again. They may give up in frustration, or they may leave something or someone blocking the door. In any event there is little else that will happen dealing with the door. This is all a ruse to lull the party into falling into the actual trap!

Upon close inspection the bags will be exactly what they seem. Old, time decayed canvas bags, leaking fine piles of gold dust from a number of burst seams. There are no obvious strings attached, the bags will be sitting there free for the taking. There is no magic on the bags.

With even the most cautious bunch, someone will eventually attempt to move the bags. It is at this point that the fun begins. First the tripping mechanism is operated by the lifting of even one of the bags. They are resting on a pressure plate, the weight of even one of them being removed will cause the panel in the center of the room to open.

From the center of the ceiling will drop an air elemental. Along with the elemental this panel will release a room full of sand, which is also stored in the chamber above. This chamber is 20 feet wide, by 20 feet deep, and 35 feet in height. The elemental has been entombed here for centuries, and is measurably upset. It will attack the party in the only fashion open to it. By swirling the sand that is falling, and coincidentally the gold dust from the relatively fragile bags, into their faces, and against exposed skin surfaces. This attack will have little but nuisance value and is no real threat to the delvers, but you don't have to tell them that. They will attempt to

counter attack but unless they have enchanted weapons or attack with magic spells they will have little effect (Magically the elemental is fairly formidable and should not be dismissed by a simple spell or low level dispersal. The object being to divert even a powerful mage for a few moments.).

Large Air Elemental: CR 5; hp 60; see the *MM* for details.

The chief purpose of the elemental is to disburse the gold dust all about the room, and primarily to blind the party with a mini-sandstorm, while the room fills with sand!

I rate this room at only two skulls, because it is not primarily lethal (unless some delving ditz happens to be standing under the panel when it opens and gets several tons of sand on his head). The party can ignore the elemental and make a break for the exit across the room, but the entrance door should be blocked with piled sand in a very short time (movement reduced to one-half). The delvers may be able to thrash their way through the sand heap but only with considerable hard labor, a word that is seldom used to describe the goals of the average delver.

They also could rightly conclude that there is an exit in this corner and actively seek it. There is a door behind the stucco in this corner (see map), with the ever-present finger trap. This door can be found by revelation magic, or actively chipping at the stucco. (If you are one of these weak-kneed dungeon masters, who is averse to weeding out the weak and feeble among the delving parties, you could have some of the stucco flaked off over time, "revealing" the exit to even the densest of delvers.)

In any event the party will almost certainly have lost the gold dust. If they go back into the entrance chamber, return to the options there. If they press on then they will find themselves in the clutches of the next trap.

Trap #7: You Bring These Things On Yourself



CR:	9
Type:	Mechanical
Search:	Trap (DC 26), Trigger (DC 26)
Disable Device:	Trap (DC 26, 2d4 rounds); Trigger (DC 26, 2d4 rounds), Secondary Trap (DC 28, 2d4 rounds)
Primary Trigger:	Location (pressure plate near top of stairs)
Primary Trap Effect:	Rotary cheese slicer stairs (no attack roll necessary; 6d6, crit 18–20/x2; multiple targets at bottom of stairs)
Secondary Trap Effect:	Crushing ceiling (no attack roll necessary; 12d6; multiple targets on stairs and at base of stairs)
Reset:	Manual
Cost:	40,000 gp

As the party exits trap #6 they will find themselves at the head of a stair, 50 feet long, 10 feet wide, and 15 feet tall, leading down.

The stair is plated with metal, and the edges of each step are very sharp angles. The stairs are not dangerous if the party steps carefully. This trap is released by any of the step in the last 10 feet of the stairway. Once pressure is put on any of these surfaces the entire stair is released, and begins at once to act like a giant treadmill. The weight of the delvers will force it down, and their natural instinct will be to back up. This is reinforced by the fact that there is a blank wall at the bottom of the stair and the sharpened stair edges are slipping under it at an ever-increasing pace. The moving stair will act like a giant rotary cheese slicer if anyone stops at the bottom and can't climb the wall. Even if they can, what is the alternative to the entire party stacking up at the bottom? The most likely result will be the party attempting to run back up the stair at a pretty good clip. This will buy some time, but not as much as they think.

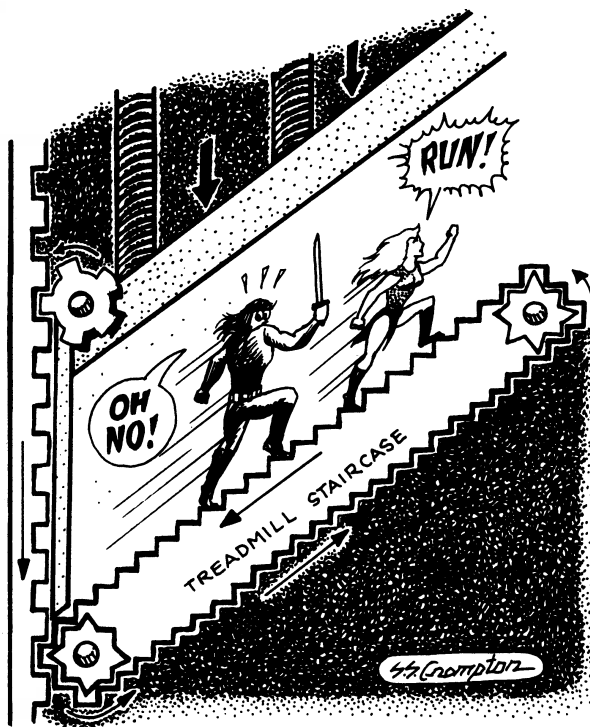

As the pace increases the party will begin to notice that the ceiling seems to be getting closer. The stairway/treadmill is attached to a mechanism in the wall that drives a huge gear, which in turn lowers the ceiling.

I rate this puppy at three skulls. There are only good results that can be anticipated here for the aspirant trap master. Either the entire party is thinly sliced for convenient serving, or they are mashed to a pulp by the ceiling. If they by some magical method reach the top they are trapped by the sand, and finally if they somehow jamb the stair the entire mechanism comes to a screeching stop and everyone is dumped in a heap at the bottom of the stairs.

(Bruises and bumps at least, broken bones for the unlucky, say a 10% chance (L1)). Keep in mind that the stairs are very sharp and that even average gauge armor plate will be slivered away in thin layers by a large enough blade, (the stair is solid and 10 feet across) driven by multiple delver power, and gravity! The blocking device will have to be formidable in definition. (There are a variety of “indestructible” magical items that will serve well, or a one foot thick block of solid stone or metal... right — let’s just check the old backpack!)

The ultimate reward will be to escape by opening the next door, behind the stucco on the wall at the bottom of the stair, probably revealed by the various bashings on the surface caused by the stair trap. It will be the usual three finger hole lock release door. (There is a slight difference, there is only on 10-foot tall 5-foot wide panel of the usual double doors, this is so the ceiling lowering mechanism can be fit into the end of the stairway.)

Trap #8: Going Down?



CR:	2 (or higher)
Type:	Mechanical
Search:	Trap (DC 25), Trigger (DC 25)
Disable Device:	Trap (DC 25, 2d4 rounds); Trigger (DC 25, 2d4 rounds)
Primary Trigger:	Touch (pulling the chain)
Primary Trap Effect:	Accelerated elevator floor that crashes into the ground. It is up to the DM as to how far the victims fall (1d6 falling damage per 10 feet fallen).
Reset:	Manual
Cost:	5,000 gp

and a runic inscription in an ancient version of the common tongue which reads, “Pulle Thye Chain!”

This area is just a little length of corridor, a kind of small room with a door at the far end. The “room” is 20 feet long by 10 feet wide, by 10 feet high. The door at the far end has no visible locking, or opening mechanism, it is a blank stone panel, beside which hangs a gold chain with a leather wrapped grip on the end.

The party will try everything to open the door except pulling the chain. Eventually they will have managed to pull, bash or dig away the stone door (Hardness 10, 50 hp, Break DC 25), to reveal a metal plate beyond,

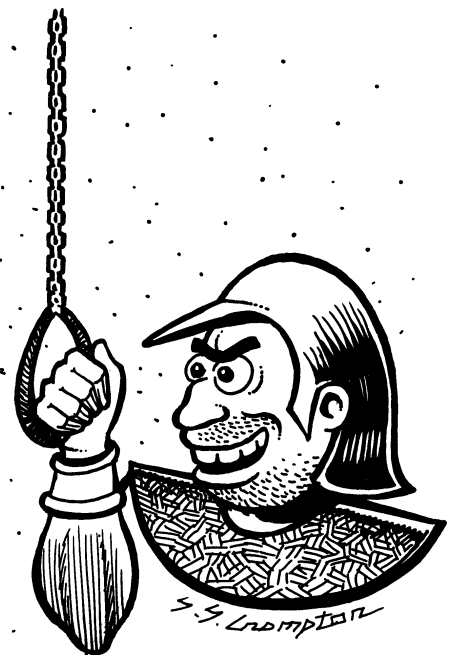

If the party decides to do so, the floor of the room begins to descend, slowly at first, but accelerating. If you lower it at just the right speed, the party will stay with it for a fairly long time. At 15 feet down the floor will trip a release that drops the steel plate door into a slot in the ground and the entrance to the next room will be open. However, the floor will keep going down and accelerating, like the out-of-control elevator that it is. (Although Evinrood has chosen to let the victims of this trap drop what seems like forever, you can keep this up for hundreds of feet waiting until one of the party members says something really dim like, "Gee, when are we going to reach the bottom?" and then have the floor crash to the "bottom" with results appropriate to a fall of the corresponding duration.)

A wise party will leave most of its members on the stair, and possibly tie a rope to the hapless boob picked to pull

the chain. In any event the door to the next room is opened by the action, as the floor will drop even if the delvers don't. Rescue from the falling floor is always possible with increasing degrees of difficulty, if the entire party doesn't go down with the floor. Evinrood had this shaft made virtually "bottomless." Nothing ties up a group of goody-goody delvers like a forlorn voice echoing up from this shaft begging for rescue, as the possibilities become more and more unlikely, and difficult!

This trap has a variable rating depending on just how foolish the party allows itself to be. Two or three skulls. Incidentally, the gold chain is worth about 1,500 gp if the party has not forgotten about it entirely by now.

In any event, once all the nattering and fooling around is over, the party will in all likelihood press on to the next room and...

Trap #9: If At First You Don't Succeed Try, Try, And Keep On Trying!



CR:	10
Type:	Combination (Magical and Mechanical)
Search:	Primary Trap (DC 28), Primary Trigger (DC 26), Quaternary Trigger (DC 25), Quinary Trigger (DC 25), Senary Trigger (DC 25)
Disable Device:	Primary Trap (DC 26, 2d4 rounds); Primary Trigger (DC 26, 2d4 rounds); Tertiary Trap (DC 26, 2d4 rounds); Quinary Trap (DC 26, 2d4 rounds); Senary Trigger (DC 26, 2d4 rounds)
Primary Trigger:	Proximity (30 feet from far wall)
Primary Trap Effect:	8 giant crossbows (+10 melee; 2d6+2 each crossbow; multiple targets in a 20-foot by 10-foot area)
Secondary Trigger:	Timed (crossbows firing)
Secondary Trap Effect:	Iron door seals off chamber, secret door opens, and water floods room to a depth of 4 feet. Victims must succeed at a Reflex save to remain standing, otherwise they are buffeted against the walls for 1d6 points of damage
Secondary Save:	Reflex (DC 20) avoids
Tertiary Trigger:	Timed (water releases next wave of crossbows 1 minute after flooding room)
Tertiary Trap Effect:	8 giant crossbows (+10 melee; 1d8+2 each crossbow; multiple targets in a 20-foot by 10-foot area).
Quaternary Trigger:	Touch (opening coffin lid)
Quaternary Trap Effect:	School of piranha (see text below)
Quinary Trigger:	Touch (opening second coffin lid)
Quinary Trap Effect:	8 giant crossbows (+10 melee; 1d8+2 each; multiple targets in a 20-foot by 10-foot area)
Senary Trigger:	Location (false bottom in sarcophagus)
Senary Trap Effect:	Fire elemental and torrent of water explode in blast of steam and shrapnel (from

the sarcophagus); explosion (no attack roll necessary; 1d6 damage to those within 10 feet and 8d6 to those within 11–20 feet from the sarcophagus)

Reset:	Manual
Cost:	130,000 gp

This room is a masterpiece of the trapsters art. It has all the elements of a continuing classic. There is slapstick, Rube Goldberg devices, low comedy, and a continuing punch line. Old Evinrood really had it in for whoever he expected to come along trying to dig him up, I'll give him that.

The room seems to be 50 feet wide, by 60 feet long, by 10 feet in height. The floor is made up of 5-foot by 5-foot colored tiles in alternating colors of blue and green. The tiles are glazed and shine faintly. They can be seen to be set in the floor separately. (This sort of thing drives delvers nuts, they are convinced that everyone will set off some trap or plummet into space. Every tomb should have tiled floors.)

There is magic on the far wall. It is faint, but can be detected from the entrance. The walls are covered by the usual stucco covered in frescos. Keep in mind that the far wall will be only dimly lit by a lamp or torches, so the images are indistinct at best.

The party will eventually enter the room. Regardless or the precautions taken, at a point 30 feet from the far wall, the magic will take effect. The magic is in the frescos painted on the far wall. This senses the approach of a party and at a distance of 30 feet trigger the first phase of the trap.

Behind the wall covered by a thin veneer stucco are ports through which can fire giant crossbows. There are eight poles mounted in the stone and on each at various heights are three large crossbows, aimed in various directions.

The lowest bank of these, located 2 and 1/2 feet off the ground release their bolts through the plaster and into the room. Every member of the party has a 20% chance

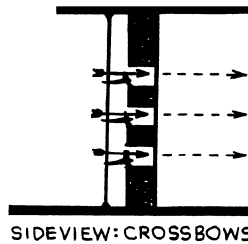
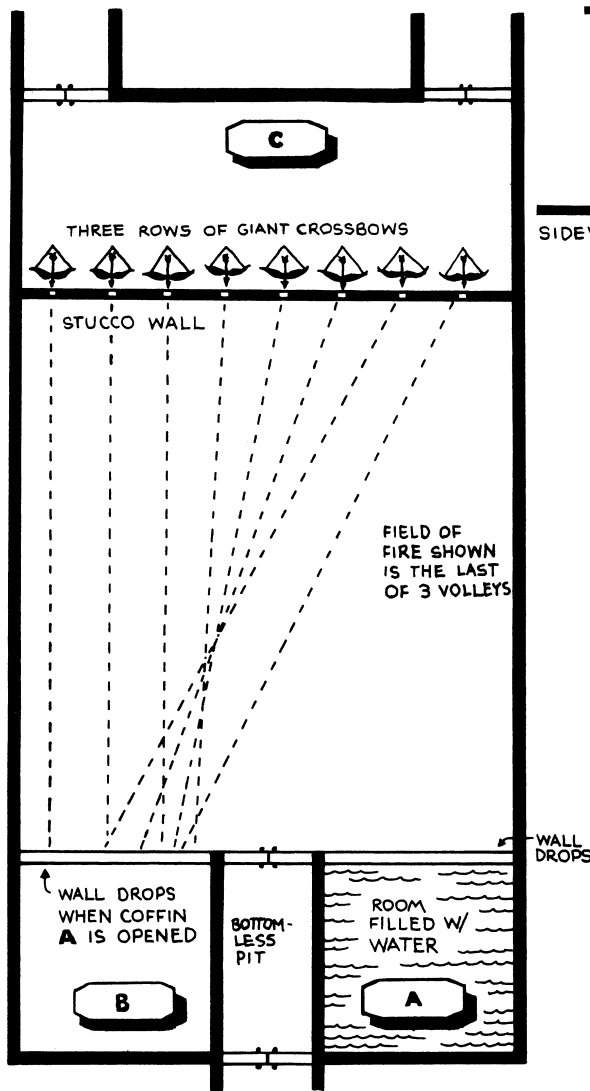

In the back of the newly created alcove is a coffin on a pedestal. It is in such a position that the lid is 5 feet above the floor and as such 1 foot above the surface of the water. When the lid is opened it releases the wall on the room on the opposite side of the entrance door. There is nothing

in the sarcophagus, but note that its lip is above water level: this will become important soon.

The leaks through the end wall caused by the holes from the first bolts will have lowered the water level slightly. This will be compensated for by the water and its inhabitants from the second newly created alcove. This room is only 20 feet by 20 feet by 10 in height, but it contains a school of piranha kept in stasis by a magical field until this very moment. Needless to say if any member of the party has open wounds, say from crossbow bolts for example, the hungry little fish will be more than happy to administer euthanasia. Attack value should be high for wounded delvers and those with exposed flesh in large amounts. (Ever notice how female warriors are usually shown wearing two old V.W. hubcaps and the bottom half or a wire mesh bikini? This is one of those situations where more is better.) Any delver who is quick of wit (yes, I realize this is a contradiction in terms) will be able to jump into the sarcophagus and thus buy time to plot out how not to feed the fish. (For my money Evinrood slipped up here. I would have added a bed of nails, or better still spear in a false bottom for just such an occasion, but I guess dying old archmages can't think of everything.)

Use the following stats for the piranha:

Piranha (50): CR 1/8 ; SZ D Animal [Aquatic]; HD 1/4d8; hp 1; Init +2; Spd swim 30 ft.; AC 16 (+4 size, +2 Dex), touch 16, flat-footed 14; BAB/Grp +0/-16; Atk +6 melee (1d3-3, bite); Full Atk +6 melee (1d3-3, bite); SA killing frenzy; SQ keen scent, low-light vision, swarm; AL N; SV Fort +0, Ref +4, Will +1; Str 4, Dex 15, Con 10, Int 1, Wis 12, Cha 2.

Skills: Hide +16, Listen +2, Spot +2, Swim +5.

Feats: Weapon Finesse.

SA—Killing Frenzy (Ex): A piranha that detects blood in the water enters a frenzied state the following round, along with all other piranha within a 100-foot radius. Frenzied piranha bite until they or their opponents are dead. A frenzied piranha gains a +2 attack bonus and -2 AC each round for 1 minute. The creature cannot end the killing frenzy voluntarily.

SA—Keen Scent (Ex): A piranha can notice creatures by scent in a 60-foot radius and detect blood in the water at ranges of up to 100 feet. Giant piranhas can detect blood in the water up to 300 feet away.

SA—Swarm (Ex): Due to their diminutive size and because of their attack methods, up to 25 piranhas can enter a single 5-foot space and attack a single opponent.

See *Tome of Horrors 2* (by Necromancer Games) for more information.

of being hit! (L2). (There are only eight possible hits, so if there are more than eight who fail, portion out the damage to the eight who miss by the largest margin.)

The release of the first crossbows triggers the next phase of the trap. The iron door that closed off this room from the falling floor trap begins to rise back into place. The stone wall of the secret room to the right of the door drops into the floor. This acts on a geared mechanism lifting the iron door back up, and releases the torrent of water stored in the chamber. This room is only 20 feet wide by 20 feet deep, but it is over 35 feet tall, this will yield enough water to fill both rooms to a depth of 4 feet.

The entire party will be buffeted about as the torrent of water is released, and the water hitting the far wall has the effect of causing the next bank of crossbow bolts to fire one minute after the wall gets wet. This bank of bows is set at 4 and 1/2 feet in height. Any normal human, or human-sized characters are in jeopardy, and any of the shorter types will be bobbing about like so many floating pumpkins conveniently exposed. Once again there is a 20% chance of a party member being hit (L2), up to eight as described above.

Once the fish have been overcome, the party will notice there is another coffin in the back of this adjacent alcove. Once again opening it triggers yet another flight of crossbow bolts. These are 6 and + feet above the ground and all aimed in the direction of the left hand coffin. Those in the left alcove will note that the next crossbow volley is aimed so as to concentrate on this alcove. Party members positioned in this alcove have a 30% chance of being hit (L3). Anyone in or near the right hand alcove will not be menaced at all. Unlike the right hand coffin this one is full of silver ingots making it impossible to hide in to escape the projectiles.

There are 15,000 sp weight of the metal in the coffin (1,500 gp value).

A note: after the second flight the party may have decided to "look into" this wall with extreme prejudice. If so the third trap may be thwarted, as the wall is easy enough to bring down. But if the party doesn't dismantle the crossbow traps, but rather goes on and opens the next coffin they will still launch at any attempt to open the left hand coffin.

The third volley of crossbow bolts will certainly provoke an assault on the far wall. It is easily broken down (Break DC 15) with applied force revealing yet another chamber 20 feet deep, as wide as the main room and as high. The sarcophagus in the back of this room is by far the most ornate yet discovered. It is of carved red marble, and rests on the floor. The water laps almost to its lip. It is hard to see what the carving consists of but a tactile inspection of the sides reveal the pattern to be perpendicular lines, all the way around from base to the edge that support the lid. A magic user who is able

to detect magic will be able to tell the party that there is a magical presence in the sarcophagus but it is passive.

If the lid is lifted there is a thump inside. When it is removed the coffin will appear empty. If any member of the party pokes the bottom, or jumps in, it will set off the last trap in this room.

The sarcophagus contained a fire elemental, resting on a false bottom, when the lid is lifted it dumped the elemental into the base of the sarcophagus waking it out of the enchantment that contained it. This will also set the false bottom to operate the next part of the trap. When pressure is applied to the false bottom it causes the panels in all the carved parallel lines on sides to open and water to rush in on the now awakened and angry fire elemental. The elemental is tough but this much water will destroy it. The resultant steam explosion should be a thing of beauty! The shrapnel caused by the explosion blowing out the segmented sides of the sarcophagus will be as dangerous as an attack by the elemental itself would have been. Carnage should ensue. Distance from the point of the explosion will mitigate the attack with those at over 20 feet distant being only nominally affected.

Given the multiple nature of this trap, and the manifold opportunities for death or disability I rate it a four skuller. After all... "it keeps going, and going, and going..."

The resultant explosion will in all likelihood chip enough plaster off the real back wall of this room to reveal the locations of two new doors.

If the hapless delvers have not had enough, press on to the next trap.

Trap #10: We Must Be Getting Close I Smell Smoke

	
CR:	3
Type:	Mechanical
Search:	Trap (DC 24), Trigger (DC 24)
Disable Device:	Trap (DC 28, 2d4 rounds); Trigger (DC 24, 2d4 rounds)
Primary Trigger:	Touch (turning wheel on door)
Primary Trap Effect:	Molten lead (1d6 fire damage each round; 10d6 each round if character is submerged)
Bypass:	Perhaps a locking or bypass mechanism is set into the wheel (Search DC 20)
Reset:	Manual
Cost:	9,000 gp

Opening the door to the right will lead the delvers into a short stairway leading up. It is 20 feet long, 10 feet wide, and an average of 10 feet in height. At the far end is a door. Instead of the usual three finger hole door this one is made of cast bronze.

Located in the center of the door is a large wheel. It will seem that to open the door you will need to turn the wheel. If some hapless delver does this, the trap will begin to operate.

In a cistern above the "door" is located a pool of lead kept molten by the "kid brother" to the fire elemental in the room below. His only task is to keep the "hot side hot..." The door itself is filled with hollow tubes, and while it is quite solid, and thick (5 inches) there are enough of these tubes to carry a substantial amount of this molten lead through the door. This is exactly what will occur when the wheel is turned. The wheel turning will also result in a panel at the base of the door opening to allow the tubes within the door to drain out onto the stairs!

The fun is really under way now. The party on the stairs is being treated to a

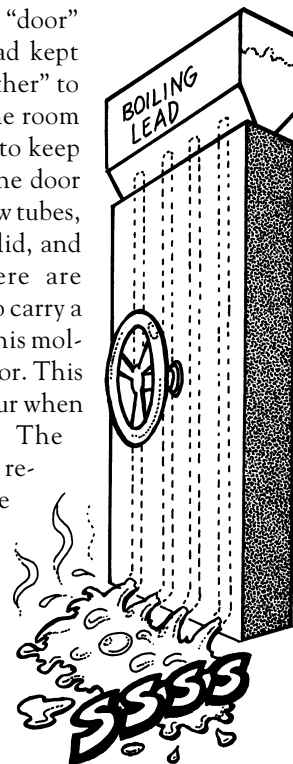

wonderful hot floor. The lead that reaches the water in the lower room will start to create a sauna effect in the stairwell. The first boob that tries to turn the wheel will find out that the entire door is red hot including the wheel, making it crippling to try to turn it off without insulation.

This is a one skull trap, no death but much dishonor. The beauty of this trap is that the wheel is like a combination lock, you have to turn it in a direction that will activate the trap, then turn the trap off (at the risk of it not life then at least limb) and then turn it in the "on" direction again to open the door. The second time you turn it "on" it will open.

Trap #11: Finally Our Just Reward!



CR:	3
Type:	Mechanical
Search:	Trap (DC 25), Trigger (DC 20)
Disable Device:	Trap (DC 25, 2d4 rounds); Trigger (DC 20, 2d4 rounds)
Primary Trigger:	Location (weight placed inside sarcophagus or lack of weight [i.e., removing the lead bars])
Primary Trap Effect:	Smashed into ceiling (no attack roll necessary; 3d6+6; multiple targets in or on stairs and sarcophagus)
Primary Save:	Reflex (DC 20) avoids
Reset:	Manual
Cost:	6,000 gp (does not include the cost of the lead bars)

The room is entered left of center. It is 20 feet wide, 30 feet long and 10 feet in height. All eyes will be drawn to an elaborate coffin at the end of the room. It is made of an ornately carved green stone, and seems to rest on a pedestal consisting of three steps leading up to the actual coffin. The steps are 3 feet high, and the sides of the sarcophagus are an additional 4 feet high bringing the top of the whole affair within 3 feet of the ceiling.

The figures on the sides of the elaborate coffin are not the usual geometric designs, but a series of images of a man growing up. There are scenes of his youth, adolescence, and young manhood on the side facing the center of the room. There are no signs of slits, openings, or any sign of trap doors or hidden compartments on the outside of the coffin. Even magic detects none of the above! This box is entirely safe (no, really, would good old Grimtooth lie to you?). By now the party would not be sure if they had a written guarantee, but they will eventually draw on hidden reserves of greed and open the sarcophagus.

Within they will find their wildest dreams come true. Peering into the container they will see a layer of what seems to be fine gold bricks. They are in fact lead bricks plated with gold. Only a dwarf with the dwarf's affinity for metal work would be able to tell (DC 20).

The party will be somewhat dismayed that the level of the gold seems to be below the level of the container itself, as if it were in the stepped pedestal instead. The pocket in which the gold is resting conforms to the interior dimensions of the sarcophagus. To reach the first layer of bricks a member of the party will have to lean over the side, and at that the gold will be 4 feet down. Even a long-armed human-sized character will have some difficulty touching, let alone lifting out a sample. The easiest way to remove the ingots is for one member of the party to get into the sarcophagus and hand out the gold. Again there should be some wrangling over just who the sacrificial lamb...er... lucky volunteer will be. This sort of thing is almost as much fun as watching the traps actually operate. Eventually they will either come up with a way of lifting out the gold, or one of their number will enter the coffin. This is when the real fun begins.

This trap is activated by weight, or rather the absence or presence of same. If a brave member of the party jumps in the weight on the plate below the gold is increased and one part of this trap is set off. The sides of the "pedestal" are really concentric boxes of stone that when released are forced into the ceiling by hydraulic pressure from below (see diagram). This will trap the character in the

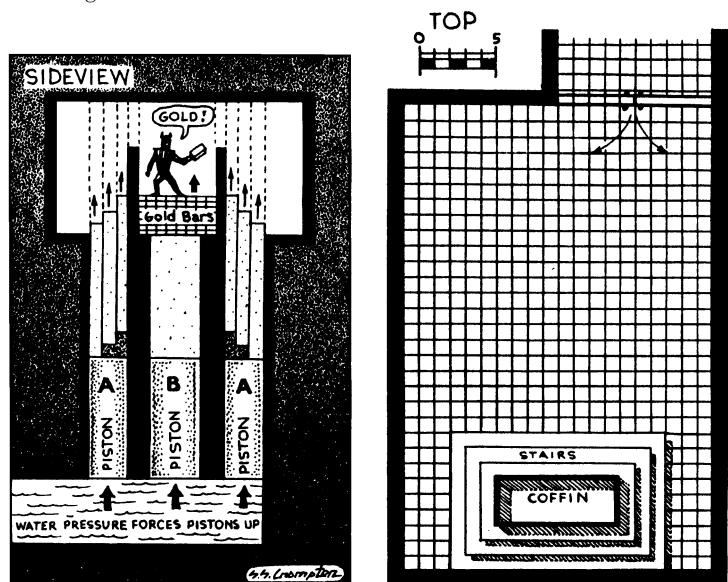

ADDING WEIGHT INSIDE COFFIN RELEASES PISTONS 'A' REDUCING WEIGHT RELEASES PISTON 'B'.

sarcophagus within three feet of stone, and subject anyone standing on the stairs to the threat of being crushed into the ceiling.

If the party has a method of lifting out an ingot, either by having a long armed fellow lift it out by bending *waaaaay* over, or by magic they will lighten the weight on the plate in the bottom. This has the effect of releasing the bottom of the sarcophagus, gold and all to smash into the ceiling! The effect on the guy reaching in when the ingot is lifted will be interesting. There is a chance he will be able to get clear; hopping up, out, and backwards, bend nearly double, leaning into a hold, and holding an ingot of heavy metal. Wow! It could be an Olympic event, the Up, Out, and Back-Bent Ingot Toss!

Once the gold is mashed into the ceiling, along with what ever other grisly object it picks up on the way, the party can work the bricks free. There will be a gross (144)

of the lead-filled ingots. The gold plate is nominal perhaps as much as 250 gp, but the lead too has a market value, at one copper piece per weight unit, or about 14,400 copper pieces (or another 144 gp).

I rate the outside pedestal stairs a two skuller, easy enough to get off if you are quick. Of course if the delvers don't have a way to tunnel through the 3 feet of stone, the poor boob trapped inside the sarcophagus is gone from lack of air eventually. Now the plate inside the coffin rates four skulls for the contortion value alone. Keep in mind that even if the outside pedestal trap has been tripped, the inner trap is still intact. If the party is resourceful enough to get back in to the trapped man, and he hands out enough ingots, the inside trap will activate. Or if he gets out and tries to take an ingot with him when his feet leave the bottom, snap! Or if he gets out then leans in to snag an ingot... well, you get the idea. Loads of fun for the party!

Trap #12: Climbing The Stairway To Heaven



CR:	4
Type:	Combination (Magical and Mechanical)
Search:	Trap (DC 25), Trigger (DC 28)
Disable Device:	Trap (DC 28, 2d4 rounds); Trigger (DC 25, 2d4 rounds)
Primary Trigger:	Location (pit)
Primary Trap Effect:	30-foot spiked pit (3d6 falling; +20 melee; 1d4 spikes, 1d4+5 damage each spike)
Primary Save:	Reflex (DC 25) avoids
Reset:	No reset required
Cost:	12,000 gp

Opening the door to the left has a profound effect. Once the party has operated the three finger mechanism the door will swing out, dumping a billow of fog into the room. The fog seems harmless, and after the initial surge it becomes a steady ankle high flow. What the tomb robbers will see is what looks like a waterfall of fog billowing from the top of what seems to be stairs. At the top is a white light of unusual brightness. The light is of coarse magic in nature, and seems to be set above a door at the top of the stairs. The only way the party can tell there are stairs is because of the peculiar rippling effect the fog takes as it nears the bottom.

Creatures within 10 feet of the door where the light is generated function as if blinded.

The stairs are 40 feet long and 10 feet wide, with a 15-foot high ceiling. Once the party overcomes its initial fear of the fog, they will head up the

stairs. (Cries of, "Run, it's a corrosive acid!" or "Yieeee! Poison gas!" are enough to make me wish it really was, but enough of that wishful thinking.) Keep in mind there is a blinding light all around them from the ceiling above the door. When they come within 10 feet of the door at the top, then the fun will begin.

The fog is being generated in a deep steel-lined pit (30 feet deep and 10 feet in width and breadth). At the bottom of the pit, gratings permit a warm, slow inflow of water from the subterranean river. The sides are cooled so that a fog is sure to boil up out of the pit a most at all times. Oh My! Did I forget to mention the spikes? How inhospitable of me.

There is nothing but the use of their native intelligence that can save the lead members of the party from falling into the pit (I'd be suspicious, but then I know Evinrood's rep). Unless the victim(s) is equipped with impenetrable armor there is little hope for survival.

The hi-jinks supplied by the party as it tries to rescue the fallen member and the tribulations of the delvers as they attempt to open the door at the top will provide additional amusement.

This is a three skull trap, good but don't be surprised if a particularly canny delver anticipates it.

The door at the top is the usual three finger hole type, but it will provide some problems. You see, it opens outward (now me, I'd provide it with a spring, but then I'm not a nice fellow!).

Trap #13: Water? What Water, I Don't See Any Water



CR:	6
Type:	Mechanical
Search:	Trap (DC 22), Trigger (DC 22)
Disable Device:	Trap (DC 22, 2d4 rounds); Trigger (DC 22, 2d4 rounds)
Primary Trigger:	Touch or Location (opening the coffin or a pressure plate located on floor near the "toe" of the "L")
Primary Trap Effect:	Steel plate drops in front of door. Anyone standing there is crushed (12d6 crushing damage) unless a Reflex save is successful
Primary Save:	Reflex (DC 18) avoids
Secondary Trap Effect:	Floor sinks down and room floods with water
Tertiary Trigger:	Timed (water triggers a pressure plate 4 feet below the lip of the alcove)
Tertiary Trap Effect:	Clear quartz panel (no attack roll necessary; 6d6, crit 19–20/x2)
Tertiary Save:	Reflex (DC 20) avoids
Reset:	Manual
Cost:	12,000 gp

This trap is a little on the complicated side, but deliciously devious in the end. The room is "L" shaped, 50 feet along the outside of the "L," and 20 feet wide, to two 30-foot walls on the inner side of the "L." The ceiling is 10 feet high.

The entrance is off to the left of the stem of the "L," on the base. Off to the right, down the stem of the "L" is... yes, another coffin! The walls are covered with the usual stucco, wonderful stuff, really, as you have seen it can hide a multitude of surprises. The magic users in the delvers' party can sense no magic.

The party will eventually approach the coffin. As with the previous coffins, this one is stone, ornately carved with geometric patterns and 8 feet, by 4 feet, by 4 feet high. If the sarcophagus is opened it will set in motion the trap mechanism for this room.

By now the party may have decided they don't want to open any sarcophagi they come upon because this brings them only problems. C'est la vie! The trap will also be activated by stepping on a pressure plate to the left of the entrance at a point, on the floor in the center of the wall at the "toe" of the "L." In either event, once tripped the nature of the room changes rapidly.

The first thing the party will notice is the sound of a terrific Crash as a 10 by 10 foot block of steel-plated stone drops down into the doorway. If the party left one of its number in the entrance as a guard, or to keep the door open, there is a 30% chance he will be crushed (L3); survival based on luck or speed. This will effectively seal off the room.

The next thing the party will notice is that the room is descending into the ground. All that is, except a 20 by 20 foot alcove at the "toe" of the "L." Any that take the time to look into the sarcophagus will notice that it is full of silver ingots. (These are 58,000 sp weight of them. About 5,800 gp value at the current rate of exchange.) A point to take note of at this time is that any reasonably agile character will have no trouble jumping into the alcove created by the dropping floor in the toe of the "L," but his will become increasingly difficult as the floor drops.

The floor will be dropping at a fair clip. In 6 seconds it will have dropped 40 feet, at which point it will lock into place, and a trap door 20 feet wide and 10 feet deep, in the ceiling above the coffin will open. By now the room is well below the surface of the underground lake

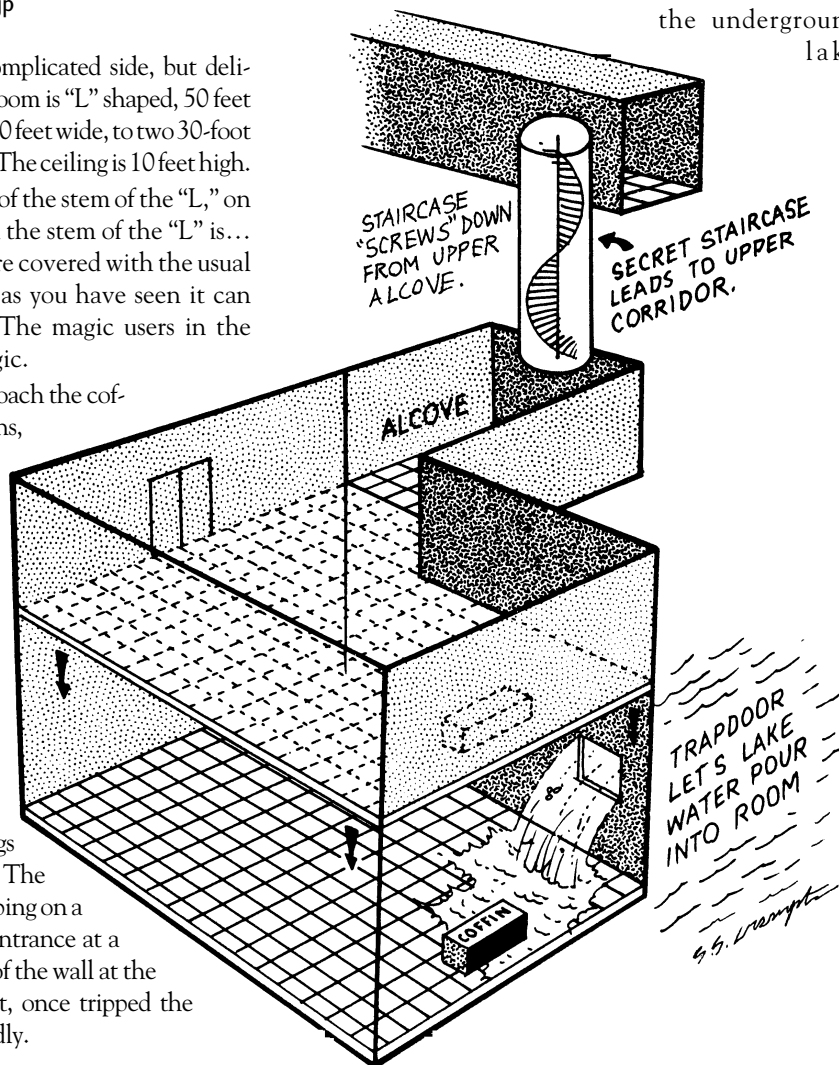

(see main map). Hundreds of tons of water, and the denizens therein will pour into the chamber.

Now to reach the alcove will require some pretty fancy footwork. Characters attempting to swim must make a successful Swim check (DC 20) or begin drowning. If the characters have some mechanism that allows them not to drown and thus they stay put and defy the water, there are denizens of the aforesaid lake that have to be dealt with as well (see Leftward Ho section for denizens of the water list).

For those who do make it to the alcove the show goes on. Those already safe will get to watch the struggles of those who have failed. The ones who think they are clever will be waiting for the water level to get to the point they can clamber into the alcove. This will mean fending off the attentions of one or two of the lake dwellers just for sport. For these swimmers all is not as it seems. When the water reaches a point 4 feet below the lip of the alcove it will set off another trap. A pin is released on a rocker panel in the floor of the alcove. As soon as the weight of a delver trying to climb out is put on the edge it will tip setting off the last part of the trap.

From the ceiling will descend, through the stucco, and from wall to wall, a clear quartz panel. The edge of this panel will be razor sharp. Its descent is not outrageously

fast (Quartz being relatively fragile to drop it would risk breakage). What to do here if the party hesitates the save DC to avoid increases by +1 per round, until the wall drops into contact with the floor. (Delves with severe judgment problems can elect to stay in the rising water with no *additional* peril besides the risks already encountered.)

Compassionate delvers may wish to try breaking the quartz wall, but it will soon become apparent why this is not a survival-oriented decision. The water level rises past the edge of the alcove and will eventually afford those in the alcove with a wonderful floor to ceiling fish tank. This will come complete with views of their struggling friends, those in armor, and those who either by luck or decision decided to chance the rising waters.

At this point there are two obvious weaknesses of this trap from MY point of view. First the quartz wall doesn't leak. Too bad Evinrood really falls down here; nothing puts the edge on a victim like a time limit. The other is less obvious but even more critical. Those still in the water filled portion of the room could just try to swim out once the pressure equalizes. (There are still the lake dwellers but if the delvers last this long they probably aren't that concerned by the fish.)

I rate this baby at two skulls, too many ways out, lots of entertainment value, but not lethal enough.

Trap #14: Things Get All Screwed Up



CR:	5
Type:	Mechanical
Search:	Trap (DC 25), Trigger (DC 25)
Disable Device:	Trap (DC 25, 2d4 rounds); Trigger (DC 20, 2d4 rounds)
Primary Trigger:	Timed (central pole in staircase pulls out as stairs are lowered)
Primary Trap Effect:	Invisible gas released into staircase. By midpoint of the stairs, the PCs must hold their breath or begin taking suffocation damage (see Suffocation in the <i>DMG</i>)
Reset:	Manual
Cost:	15,000 gp

The alcove will seem like a death trap — a dead end (I love that phrase). Under the stucco, the walls are steel-plated stone. Through the quartz wall is a lake bottom. Oh woe is the poor delvers. The answer to their prayers is just above their heads. It may not occur to them for some time but a magical spell will show the outline of a trap door in the ceiling. Chipping the stucco of the ceiling will do this as well but my guess is the average gang of would-be tomb robbers will have to be nudged into looking into the ceiling for an escape.

Once the trap door is found it is easy enough to open. All you have to do is figure which one of three

finger holes is the release and gravity will do the rest. What will be revealed is the bottom of what seems to be a 5-foot round tightly spiraled stairway. The eager delvers can with some small contrivance reach the bottom step. Upon doing this they will find that the stair will slowly “screw” itself into the room. The banister of the stair turns in grooves carved into the wall until it reaches the floor. This will allow easy access to the ladder and release the trap that waits above!

The center pole of the stair extends into the ceiling at the top of the shaft up which the stair leads. As the staircase is lowered into the room the center pole will be pulled out of a chamber containing a heavier than air gas. This gas will slowly descend down the shaft as the delvers begin their walk up it. The shaft is 50 feet high, and by the time the delvers are well along, they should encounter serious breathing difficulties. Death does that to you.

Now there are those lightweights who have some misplaced sense of mercy for the hapless dolts that would steal away the loot of defenseless old high-level mages. I am not one of these, but if at this point you wish to continue the show, or extend some sort of misplaced “mercy” you could make this a harmless sleeping gas, or let the “deadly” effects of Evinrood's gas only apply to those in the alcove at the bottom where the gas collects, rendering those on the stair

temporarily unconscious. For my money I say let 'em croak. The next bunch will bring gas masks.

The stairs will seem to dead end (there's that phrase again) at the top. But with the judicious use of a boot

the delvers will emerge through the thin sheet of stucco-covered rock into a corridor (see main map).

The stairs are four skulls if used correctly, but far less if the gas effects are limited.

Trap #15: These Things Sort of Spring Out At You!



CR:	7
Type:	Mechanical
Search:	Trap (DC 25), Trigger (DC 25)
Disable Device:	Trap (DC 25, 2d4 rounds); Trigger (DC 25, 2d4 rounds)
Primary Trigger:	Touch (unlocking or opening door)
Primary Trap Effect:	Spring-loaded doors (no attack roll necessary; 7d6 crushing damage; multiple targets standing directly in front of doors)
Primary Save:	Reflex (DC 20) avoids
Secondary Trap Effect:	6 flying springs (+10 melee; 1d6 springs; 1d6 damage each spring)
Reset:	Manual
Cost:	25,500 gp

On the left side of the entrance chamber is another door. This door is 10 feet tall, and consists of two panels, each 5 feet wide. There are three finger holes on the left hand door, and the doors seem to be locked. This three hole locking mechanism works exactly like all the other three hole locks, or as with the others it can be opened with the appropriate low level door opening spell.

It is only after the doors are unlocked that the real fun begins. These babies are hinged in the middle, so that the doors are released from the opposite ends. This brings them together in the middle, flush, with no knobs or opening rings to keep them apart. This makes the greatest crepe press

you've ever seen. In order to create this delvermatic patty-maker there are six large springs of various lengths mounted at different heights against the stairs behind the doors. When the locks are released the doors clap together, splat! The effect is deliciously gooey, and should be effective on the delver who opens the doors and has to use the finger holes. If the doors are opened by a magic user, the saving throw can be mitigated by the distance from the doors, up to a clean miss (drat!) at over 5 feet away. Don't let a miss disturb you because there are still the six springs. Once they have slammed the doors together the springs are released to fly wildly about the room with vicious (though not lethal, alas!) force causing contusions to all and sundry.

The springs are worth 100 gp each due to the difficulty of obtaining this type of dwarfish craftsmanship.

The door is a three skull trap, tough but evadable. The springs are only one skull but they do provide entertainment value.

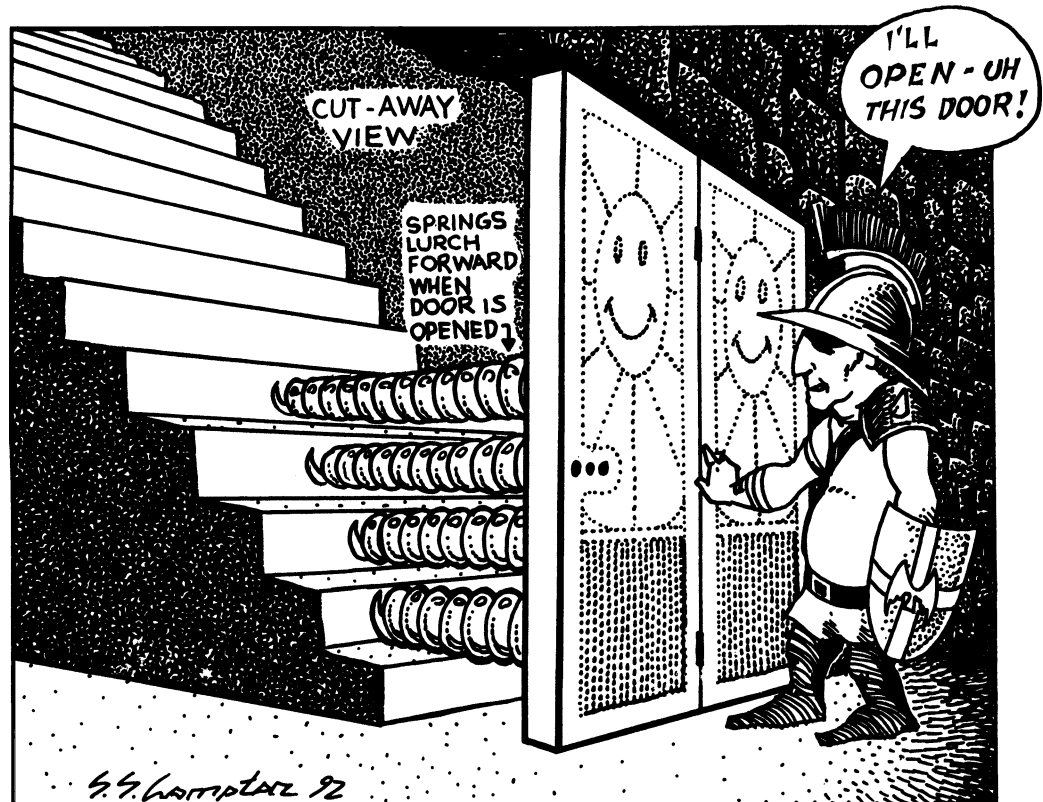

Trap #16: What Goes Up Must Come Down!



CR:	4
Type:	Mechanical
Search:	Trap (DC 24), Trigger (DC 24), Secondary Trap (DC 25)
Disable Device:	Trap (DC 20, 2d4 rounds); Trigger (DC 20, 2d4 rounds), Secondary Trap (DC 22, 2d4 rounds)
Primary Trigger:	Location (stairs)
Primary Trap Effect:	Stairs tilt and dump victim(s) 60 feet to floor (6d6 points of falling damage)
Primary Save:	Reflex (DC 20) avoids
Secondary Trigger:	Location/Touch (weight in excess of 100 pounds tugging on doors)
Secondary Trap:	Doors break free of hinges (by chance, if they hit someone each door is +10 melee and deals 1d6 points of damage)
Reset:	Manual
Cost:	12,000 gp
Note:	S pikes, acid, oil, lava, or some such can be added to the pit under the stairs. This boosts the CR by +1 for spikes or oil or +2 for acid or lava

Once the party has negotiated the door opening mechanism they are confronted by a 10-foot wide staircase going up 50 feet. The ceiling near the doors is 60 feet high tapering as the stair rises to a mere 10 feet. At the top of the stairs can be seen, faintly in the light of your torches or lanterns, a set of doors that are different from the usual stuccoed stone doors, found throughout the tomb. From there it is hard to tell but they may be wooden.

The delver attention will hopefully be focused on the doors at the far end and as such they will not be thinking of a trap on the stairs themselves. It is the stairs that form the trap.

The design for these stairs was so homey it took me back to my very roots. Oh, how I long for those early years, the innocent naiveté of the delvers, the lovely gasps of shock as they stumbled from trap to trap... sigh. In *Traps One* there was a stair trap, the fabulous Folly Flight, designed by the fabled trap master John R. Greer. This stair trap seems to be a variation on the Folly Flight theme.

The stairs are hinged at the base, and when a delver, or delvers reach a point 25 feet from the bottom the weight will pass the balance point and cause the pins at

the center point to release. Unlike John's trap, "Evinrood's Variation" causes the entire length of the stair to fall back against the near wall. This reveals the stairwell for the deep narrow room it really is. The chamber thus formed is 110 feet deep (50 feet to the ceiling, and an additional 60 feet to the floor) and 50 feet across to the doors near the roof on the far side. The room is still only 10 feet wide.

Filling the bottom of this trap with spears, spikes, or acid-excreting slugs would provide a wonderful counterpoint to the delvers plunge to his likely demise. Evinrood just left the floor plain old stone, trusting the fall alone to do in would-be tomb robbers. Perhaps he did not want to discourage the parties too much.

The delvers will not be put off for long by this trap. Luckily it is only part one. Almost immediately one of the delvers will think of trying to shoot a rope over to the doors on the far side. The plan may be to use this rope to rescue the remains of their fallen comrades, or more likely to gain access to the far end of the room. The doors on the far end of the room consist of heavy wooden beams bound by old rusted iron bands. They have no hinges and are only wedged in place, a fact that the delvers will not be able to tell across 50 feet of space by torchlight. A stout tug, such as one that the party might give to see if the arrow has seated will not be enough to pull the doors free. In fact, the weight of one average delver will not be enough to dislodge them, but once more than the weight of one delver is applied the doors will come free. Granted this is just an elaboration, but picture the

looks on the faces of your victims as they attempt to cross over, hand over hand, or better still climbing up from the floor below as the doors come free and plummet down upon them.

Eventually the party will find a way into the room behind those wooden doors, probably by climbing up the far wall using pitons and ropes like mountain climbers. Having invested this much time, and effort they will have to go on! Dungeon delvers are like that.

If this trap is operated as is, it is a three skuller, but if embellished with spears or acid pools, it can go all the way up to four!

HEH
HEH
HEH...
//

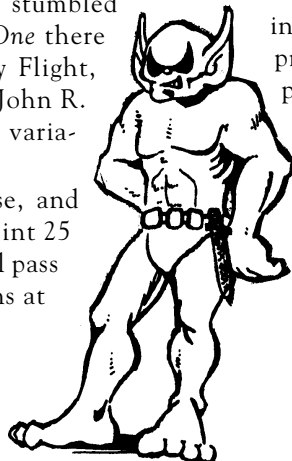

Trap #17: The "What's Up" Dock.



CR:	5
Type:	Mechanical
Search:	Trap (DC 24), Trigger (DC 24)
Disable Device:	Trap (DC 22, 2d4 rounds); Trigger (DC 22, 2d4 rounds)
Primary Trigger:	Location (stepping on pier or stepping on a pressure plate on each side of trap door) and Touch (opening the trap door)
Primary Trap Effect:	Tiles pivot on center axle. Those standing on the tiles fall into the water tank underneath the tiled floor. In this watery playground can be found the monsters detailed below.
Primary Save:	Reflex (DC 25) avoids a dip in the "pool"
Bypass:	Don't touch the trapdoor, pier, or pressure plates.
Reset:	Manual
Cost:	20,000 gp (doesn't include the cost of feeding the critters in the water, though careless delvers should provide more than an adequate food supply)

This room exhibits an immediate difference from those so far seen. It is 80 feet long and 30 feet wide, with a 15-foot tall ceiling. The most obvious difference is the fact that at the far end of the room there is a 30-foot by 30-foot wooden pier, opening into a cavern, the inky

depths of which are impenetrable by feeble torchlight. The pier itself is just out of clear view in the flickering light. The sounds of running water are very clearly audible; in fact the roar of moving water can be heard echoing from inside the room.

The party of delvers will sense no magic in this room. The floor is tiled with large green and blue 10-foot by 10-foot tiles, looking very much like a giant checkerboard.

Any mean spirited attempt to use magic to see if there are trapdoors in the floor will result in the entire floor glowing dully for a few moments, then fading. That should really stir the delvers up.

Any attempt to walk on the tile floor will show it to be quite substantial, and yielding no "nasty" surprises. The party can jump up and down on the tiles if they like and nothing will result. As the party gets nearer to the pier they will be able to see that it is made of large wooden beams, old and rotten with the passage of time. At points they will be able to see dark water 15 feet below the pier through sections that seem to have just given way to decay.

In the center of the leading edge of the pier, touching the tiles, is an old trap door 10 feet by 10 feet square. Set in the center of this wooden panel is a ring bolt over 1 foot around, and covered with corrosion. The party can, if it chooses, open this door from the tile side without risking the rotten old pier. If any member of the party steps onto the pier, on either side of the trap door, or tries to open the trap door, all the tiles in the other part of the

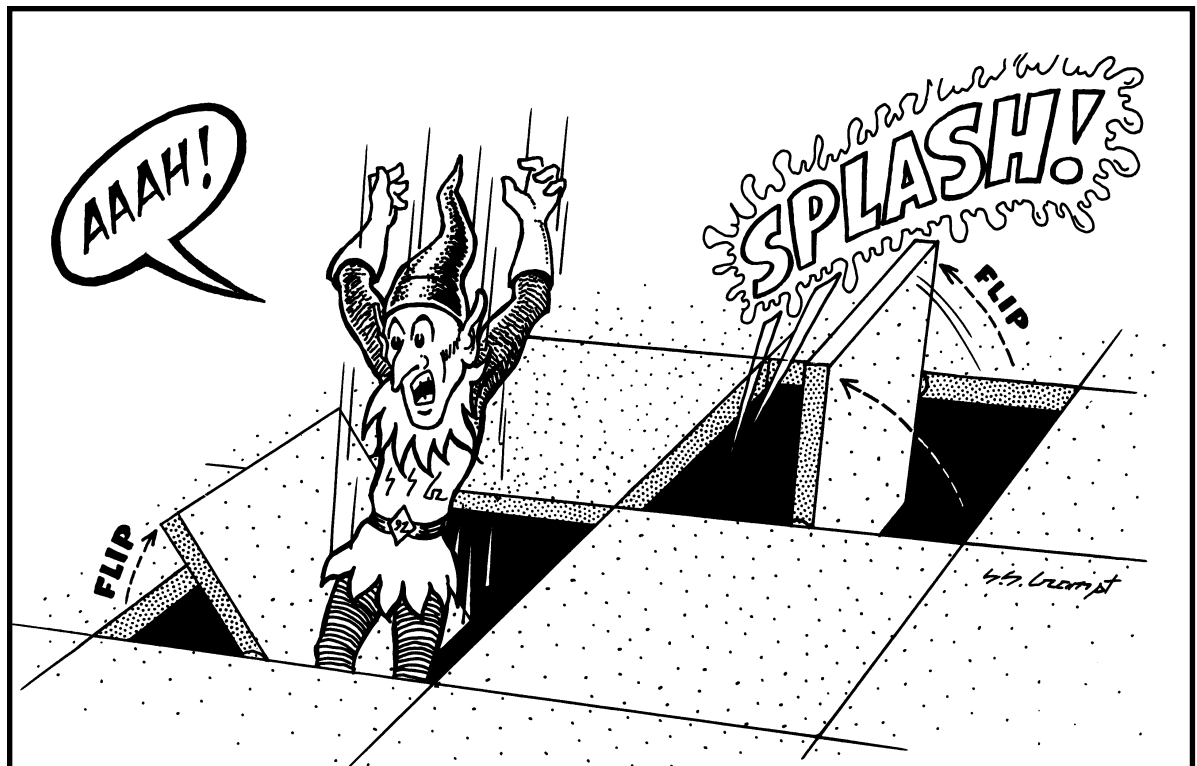

room flip over. The tiles are giant panels locked in place until the trap is tripped. Once released, they are free to pivot on iron shafts that penetrate them through the center. This whole trap operates like one of the child's beanbag tossing games (see diagram).

The net result will dump any member of the party without the ability to fly into an arm of the grotto at the far end of the room. There is almost no other way, except flight, to escape this trap. A lucky jump in all but one direction will either place the delver on another tile... flip-flop splash! Or back out the entrance and... zip-splat! A 110-foot drop. A victim may try to reach the "safety" of the pier, but there is only a slim chance of success. At any rate most of the party should end up in the drink.

At this point I should describe the reasons why delvers won't enjoy their refreshing dip. This underground river system is part of the vast network of uncharted rivers that run under the plains of Khosht. The reasons for its remaining uncharted are twofold. The first reason is the concentrations of gold, and loot-like substances are too widely scattered to make it attractive to large-scale delving operations. The second reason is the existence of hideous denizens that have bred herein thriving on the residual magic and corruption leaking down into the water table from the innumerable dungeons located above the river system.

In this pleasant little tributary can be found:

[insert illustration DOD_PG25.tif]

A. Pack Piranha: Hordes of ravenous little beasties that can strip an elf to his ear rings in seconds (these creatures travel in large groups and should be considered very tough).

Piranha: CR 1/8, hp 1; see Trap #9, above.

B. Albino Cave Sharks: Often over 8 feet long, a ghastly white in color, hunt by motion sensing, so if you fall into the water remain absolutely still and you will be just food... er... fine. (These creatures can be found in groups of 3 to 8 (1D6+2) and are individually tough. If the odds are 3 or 4 to one even superhuman delvers will find themselves in dire straits.)

Albino Cave Shark (1d6+2): CR 2; SZ L Animal (10 ft. long) [Aquatic]; HD 7d8+7; hp 38; Init +2; Spd Swim 60 ft.; AC 15 (-1 size, +2 Dex, +4 natural), touch 11, flat-footed 13; BAB/Grap +5/+12; Atk +8 melee (1d8+4, bite); Full Atk +8 melee (1d8+4, bite); SQ keen scent; AL N; SV Fort +6, Ref +7, Will +3; Str 17, Dex 15, Con 13, Int 1, Wis 12, Cha 2.

Skills: Listen +8, Spot +8, Swim +11.

Feats: Alertness, Power Attack, Weapon Focus (bite).

C. Electro-Squids: These cute little fellows pack a wallop that would do justice to a lightning bolt. Being small and relatively feeble they either grab hold of prey and zap it for food, or in the case of larger monsters which gulp them down whole, they zap them into unconsciousness, then nibble their way out! (These guys are not so tough but the "electro" can finish off the uninitiated by stunning them. If help is not forthcoming, drowning and lunch soon follow.)

Electro-Squid: CR 3; SZ M Animal [Aquatic, Electricity]; HD 3d8; hp 13; Init +3; Spd swim 60 ft.; AC 16 (+3 Dex, +3 natural), touch 13, flat-footed 13; BAB/Grap +2/+4; Atk +4 melee (0 plus 1d6 electricity, tentacle); Full Atk +4 melee (0 plus 1d6 electricity [x10] tentacles), -1 melee (1d6+1 plus 1d6 electricity, bite); SA improved grab (+4 grapple bonus), electricity (melee attacks deal electrical damage); SQ ink cloud (20 ft by 20 ft by 40 ft, once per minute), jet (once per round; double move; 320 ft); AL N; SV Fort +3, Ref +6, Will +4; Str 14, Dex 17, Con 11, Int 1, Wis 12, Cha 2.

Skills: Listen +6, Spot +6.



Feats: Alertness, Iron Will.

D. Blind Barracudas: These creatures travel in schools and are famed for the length of their teeth and their healthy appetites (again a style of monster that travels in groups. Not as small or as hard to hit as piranha or as big, mean and strong as the sharks these critters can be beaten in combat).

Blind Barracuda: CR 1/4; SZ T Animal [Aquatic]; HD 1d8; hp 4; Init +2; Spd swim 30 ft.; AC 16 (+4 size, +2 Dex), touch 12, flat-footed 14; BAB/Grp +0/-10; Atk +6 melee (1d2-1, bite); Full Atk +6 melee (1d2-1, bite); SQ keen scent, low-light vision; AL N; SV Fort +2, Ref +4, Will +1; Str 8, Dex 14, Con 10, Int 1, Wis 12, Cha 2.

Skills: Listen +3, Spot +3, Swim +7. *Feats:* Weapon Finesse.

SQ—*Keen Scent (Ex):* A barracuda can notice creatures by scent in a 90-foot radius and detect blood in the water at ranges of up to 500 feet.

E. Crystal Sea Snakes: They do not travel in large groups, and they are physically fragile. An average warrior can easily kill one in hand-to-hand combat. They are lightning fast and their venom is deadly, and works

almost instantaneously. (There is a substantial volume of thought that this is one of the few forms of poison more virulent than dragon venom! Capturing one of these creatures and milking it for venom would be an interesting commercial enterprise, if one were to survive the quick strike capabilities.)

Crystal Sea Snake: CR 1; SZ M Animal: CR 1; HD 2d8; hp 9; Init +3; Spd 20 ft., climb 20 ft., swim 20 ft.; AC 16 (+3 Dex, +3 natural), touch 13, flat-footed 13; BAB/Grp +1/+0; Atk +4 melee (1d4-1 plus poison, bite); Full Atk +4 melee (1d4-1 plus poison, bite); SA poison (Fort DC 11; 2d6 Con/2d6 Con); SQ Scent; AL N; SV Fort +3, Ref +6, Will +1; Str 8, Dex 17, Con 11, Int 1, Wis 12, Cha 2.

Skills: Balance +11, Climb +11, Hide +12, Listen +9, Spot +9, Swim +7. *Feats:* Weapon Finesse.

Keep in mind most of the above creatures travel in groups. Add them liberally to spice up any member of the tomb robbing party's bracing dip in the underground river.

The trap itself is worth two skulls; the denizens of the river can collect their own skulls. (As a matter of fact, it will be your skulls they will be collecting!)

Semitrap #18: Boating Has Its Ups and Downs.



We left our party foundering around in a pleasant little grotto under the “flip-flop tiles.” You may at this time call upon any of the denizens listed above to keep them entertained and sit back and watch the ensuing carnage. However, if you desire, out of some misplaced sense of “fair play” to permit this farce to continue you can allow the party to see that the wooden trap door in the plank decking overhead leads down to a water level area of wood planking 10 feet wide and 30 feet long. On this planking are pulled up two boats.

If the party survives its dip, and climbs up onto the lower pier, or if they had “braved” the upper level of the seemingly rotten pier, opened

the trap door, and climbed down the stairs they may inspect the boats.

They will find two flat-bottomed boats each 3 feet wide and 10 feet in length. The boats will seat three comfortably on thwarts in the bottom. Four will fit with some scrunching, and five in a pinch although the boat would then be quite crowded. They are old, and made of wood, but they seem quite substantial. There is also a set of oars with each boat.

The fun begins again when the party finally decides to put the boats into the water. With no

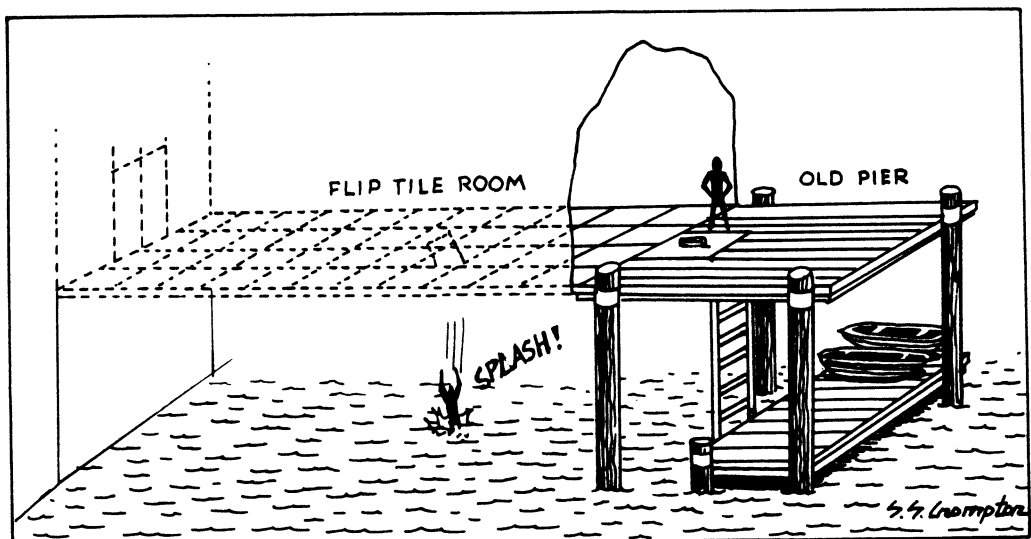

load in them the boats will float well, high and very dry. Once the tomb robbers actually enter the boats there will be a few moments when “surface tension” will keep the water from rushing in. Eventually the delvers will begin maneuvering the boats around heading out into the pool away from the pier.

This pool is dark, and clear, in the torchlight you can see flickering shapes that make its inky depths seem less than inviting. There are 5 huge, much-eroded stalagmites that thrust out of the water at various points. The stalagmites are various sizes around 2 to 3 feet in diameter at the water line, taking into account the erosion. A member of the group could climb out onto one if they so desired. The pool is approximately 80 feet wide by 60 feet in length. The ceiling at this point is out of easy sight overhead.

Once the group is under way the occupations of the “crews” should be, one with a torch, and very likely one, possibly two with the oars. It is at this point we will give the third, fourth and in fact any others in the boat something very important to do: bail!

Boats are generally kept in a wet condition (this happens when you spend a great deal of time in the water). When the wood is wet it swells and keep the spaces between the planks tightly sealed. These boats have lain here high and very very dry for thousands of years. The old dry wood of the boats has shrunk causing the seams between the planks to open. When the boats start moving around this exerts a variety of lateral forces on them thus breaking the surface tension that was only just

barely keeping them afloat. The water begins to literally pour in.

The boats will begin to fill quickly once the party has moved away from the pier (completely sinking in 1 minute). If the boat has only 3 people in it they can make it to one of the stalagmites. If they try for the pier the “captain” must succeed at a Profession (sailor) check at DC 5. If the boat has 4 people in it the “captain” must succeed at a Profession (sailor) check at DC 5 to make the stalagmites. A four-man crew must succeed at a Profession (sailor) check at DC 10 to make the pier. If there are five in the boat the crew must succeed at a Profession (sailor) check at DC 10 to make the stalagmites, and to make the pier requires a check at DC 12. Any more than five in a boat and the pier is out of the question; it is a wonder they didn't go down without the leaks. A crew with more than five must succeed at a Profession (sailor) check at DC 14 to even make one of the stalagmites.

If the party makes it back to the pier they can look around. If they go back up to the upper pier through the trap door they will find that it is more substantial than it seemed and if they check out the ceiling in the center of the left hand wall (see diagram) they will find a trap door. Opening it they will find a pair of elven canoes. These are similar in construction to the birch bark canoes of certain American Indians, and being crafted by the elves they will float as long as they remain in one piece. They will hold up to three human-sized people each. Each elven boat is Hardness 5, hp 20, and Break DC 30.

The boats are one skull wonders, the denizens are once again responsible for their own rating.

Trap #19: More Ups and Downs!



CR:	4
Type:	Mechanical
Search:	Trap (DC 25), Trigger (DC 25)
Disable Device:	Trap (DC 25, 2d4 rounds); Trigger (DC 25, 2d4 rounds)
Primary Trigger:	Touch (the stalagmites)
Primary Trap Effect:	Stalagmites A, B, and D begin sinking into the water completely disappearing in 3 rounds.
Secondary Trigger:	Touch (the stalagmites)
Secondary Trap Effect:	Stalagmites C and E rise and penetrate the ceiling in 3 rounds. In 2 more rounds, the stalagmites are covered with fish oil (Climb check DC 40 to maintain hold)
Reset:	Manual
Cost:	12,000 gp
Note:	Fish oil immediately attracts any of the water denizens to the area within 1 round

The delvers who don't make it to the pier will have much more fun. As the boat empties of its occupants and settles down into the glassy depths, the would-be robbers will find themselves clinging like rats to one or more of the stalagmites, unless they choose to “go down with their ship.” (Delvers'll do the darnedest things under pressure.) If this is the case, sic some of the water dwellers on them.

Those who are clinging to the stalagmites will feel more than hear the “click” as the traps here are released. Stalagmites A, B, and D begin to slowly sink into the water. This provides an entertaining spectacle as the delvers frantically climb up the ever-thinning stone. More and more delvers, less and less room at the top, reminds me of my old corporate structure. Add at this point a few ghostly white dorsal fins circling and you have true art!

Stalagmites C and E begin to rise. At first this will seem like a blessing. Some of the delvers trapped on A, B, or D may even try to swim over and join them. It is after all only 10 or 12 feet... chomp, chomp! Eventually the sharp point of the stalagmites will reach the ceiling. At this point the ceiling is 45 feet above the water level. The stalagmite's point will drive itself into the ceiling breaking into the small chambers cleverly placed overhead.

Stalagmites C and E penetrate rooms fill with particularly slippery, and smelly fish oil. The relatively smooth

surface of the stalagmites will soon be covered with the extremely slippery substance. (Please note the ceiling here consists of crumbling limestone formations. Attempts to drive pitons into it will result in collapsing parts of the fragile structure down around the delvers ears, and probably knocking out the bottom of the room overhead.)

The fish oil will attract predators from miles around in the underground river network. Just what the delvers will need at this point, more company.

Once again Evinrood seems to be just toying with the hapless tomb robbers, amusing but only worth one skull.

Trap #20: Row, Row, Row Your Boat, Life Is But A Scream!



The current will carry anyone who has found the elfish boats toward a point in the center of the far wall of the grotto. At this point there is a curtain of old chains hanging down from a fixture in the ceiling. The chains are set closely enough together that the delvers cannot see what lies beyond. The chains also come within inches of the water's surface so they cannot be looked under. They are heavy enough that they hang straight down, but loose enough that the prow of a canoe, or boat will force them apart. Unless otherwise noted, chain curtains like this separate every part of this river system in the Tomb from every other part.

Once the delvers have parted the curtain they will find themselves on a swifter, much narrower and shallower portion of the river. At this point there will be no real necessity for the party to paddle unless they are really into speed. They can use paddles to steer if they like, but there doesn't appear to be any part of the waterway different than any other part.

The trap here lies just below the surface, and is a wonder of dwarven technology in its simplest form. Set in the river bottom pointing back into the current are three lines of razor-sharp spears. They are set inches below the surface and are thin enough that they do not ruffle the water's surface. They are elevated in response to any lateral pressure on the curtain at the entrance. Push aside the curtain and you will release a counterweight that lifts the spears off the bottom and upward at just the right attitude to spoil the delvers day! The spears are made of a corrosion-proof alloy perfected by the dwarves. They are as sharp today as they were the day they were set in place. This is one of those intrinsic treasures that the party is likely to overlook in the ensuing carnage. Metal of this type that holds its edge against any test, and

resist corrosion under water for centuries would be worth over 1000 gp per blade to any weaponsmith. They would also serve any delver who survives well as a weapon. Just the thing to build overconfidence.

The object of the spears is not, as some would think, to impale tomb robbers through the bottom of their flimsy boats. Oh no! Evinrood has been far more subtle than that. The spears are in place to slice open any watercraft that finds its way down this merry waterway. (Oh I suppose if the party chose to swim down the river, battling the underwater denizens every turn of the way, that these spears would hit them about chest high. But no one would be fool enough to try to swim the length of the river... well, we are talking dungeon delvers after all.) The spears automatically hit any creature or boat that crosses them and deal damage as if they had scored a successful critical hit (normal damage is 2d6, crit x3).

Keep in mind the current is very swift here. Ruination is almost a certainty. After the first boat has been impaled there will be little that its crew can do to avoid being carried along in their rapidly sinking craft. Any boat behind it may take a lesson from what happens to the first, but being delvers the occupants of the first boat will more than likely be inarticulate in their confused babble. If some kind of halt can be accomplished the spears can be pulled out of the sockets they are set in with little effort. The spears are dwarfish steel Pila. Any party that cannot stop but manages to avoid the spears will be swept on into another curtain at the end of the short tunnel, and into the next trap.

The risk factor against life for those in the boats is low; clearly this is to rob the delvers of their transportation. Against boat people a one skull rating. For the swimmers the rating goes up to three, a nasty surprise for the combat-weary.

Trap #21: Poke, Grapple, Wrestle, and Chomp: Personal Injuries a Specialty!



CR:	9
Type:	Mechanical
Search:	Trap (DC 30), Trigger (DC 25)
Disable Device:	Trap (DC 28, 2d4 rounds); Trigger (DC 28, 2d4 rounds)
Primary Trigger:	Touch (pulling the chains)
Primary Trap Effect:	Bed of spikes (+20 melee; 1d4 spikes, 1d4+5 damage each spike)
Reset:	Manual
Cost:	30,000 gp

The action at this point speeds up greatly. If by some miracle the party is still in the boat it will meet the same fate, but lets deal with the “floaters” first. When the would-be tomb robber reaches the curtain they will become aware that just beyond the chain the water plunges off a cliff. This is one of the sources of the roaring water noise that was heard in the grotto room. Swept into the chains, as swimmer’s instinct alone will impel him or her to grab onto then.

“Floaters” or boaters, if they do not grab onto the chains, will fall 100 feet to their great discomfort in the pool that awaits below (10d6 falling damage). Those plunging over the falls must succeed at a Swim check (DC 20) to remain afloat. If no one grabs the chains in the crew of a boat, or none of the “floaters” have grabbed the chains, then the boat will survive the fall intact: everyone will be dumped out but the boat will be fine.

Enough of this gloomy speculation, they are bound to grab the chains in desperation. Now the real fun begins. Instead of finding a semisafe place to pause and reflect on their current predicament, the delvers will find that the chains are anything but secure. There will be an initial pause, then the chain will begin to play out down the face of the falls. The lip of the falls is undercut so that even if the delvers can manage to swing through the torrent they will encounter nothing but more water on the back swing. The chains will play

out about 20 feet, just enough to allow the torrent to pound the would-be tomb robber senseless (1d3 nonlethal damage each round), but still 80 feet above the pool below, where the chain will stop unreeling.

At this point the options seem to be to hang here and be pounded by the water (1d3 nonlethal damage each round), attempt to climb back up in the face of the torrent on a slippery chain (Climb check at DC 30), or trust to luck and drop into the pool (8d6 points of falling damage). If the boat went over first, or other swimmers have made the plunge first the last alternative might not look impossible. Keep in mind that the only light in this cavern is from a few (very few) patches of bioluminescent lichens. This will serve to outline objects but not to illuminate things. Torches will be needed to make enlightened decisions.

Alas, what fools these delvers be. When the chain played out it also served to raise a bed of spikes up under the falls. Not too far up, only to within a foot of the surface of the pool. Zip-splat! Delver kabobs with fresh seafood — my favorite.

An interesting variation would be to have the chain break off once the spears are locked in place.

At this point I must inject a brief editorial statement. You might think that tomb operation in this enlightened time would be relatively free of the craven interference by lobby groups, special labor representatives and such like vermin. Not so! This tomb being a masterpiece of the trap masters art needs very few “live” monsters. As a result of this my offices were beset by picketers from the Brotherhood of Very Large Vermin Local 666. (You haven’t lived until you have seen a cadre of dragons, land sharks, tyrannosaurs, and giant gastropods holding Unfair to Labor sings. It was enough to put *me* off my lunch.) So without further ado, the Lurker Past the

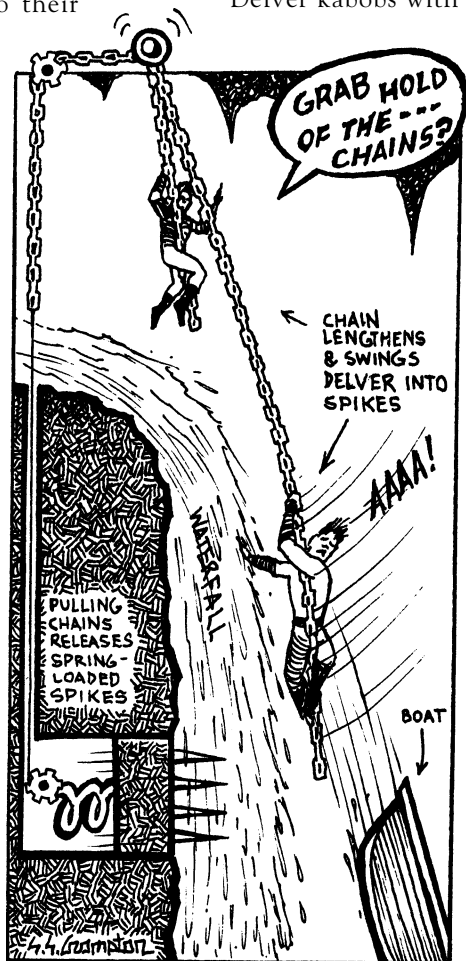

Threshold part of this trap. (What the hey, the room was big enough and just going to waste.)

The pool is 70 feet across and 100 feet wide, and deep enough that even with a determined effort the bottom cannot be found. In the inky depths can be found a life form that will find the thrashing and struggling of the delvers very interesting in a gustatory way. A giant albino cave squid (see below) lurks at the bottom of the pool. As it thrives on the occasional passing shark, or barracuda, a few foundering delvers will prove just the thing to draw an exploratory tentacle up from the icy depths.

If the party can get back in their boat fast and paddle, or if the boat has been impaled, and they elect to swim (DC 18) for the exit they will only have to deal with a few probing tentacles. If they lollygag about noticing for the moment the dearth of predatory cave critters, they will be confronted by the spelunkers answer to leviathan! (The tentacles alone would be marginally tough, but the entire 8 tentacles and 2 elongated grappling arms will be in my humble estimation a lethal combination without the application of very unusual means.

In this case quick recovery from the fall and quicker departure is the most likely key to having the tomb robbers prolong our fun.

The whole room rates four skulls, with the <ensored> monster. The spears at the bottom of the fall pulled up by the frantic delvers is really a nice touch.

Use the following stats for the giant albino squid.

Giant Albino Squid: CR 9; SZ H Animal [Aquatic]; HD 12d8+18; hp 72; Init +3; Spd Swim 80 ft.; AC 17 (-2 size, +3 Dex, +6 natural), touch 11, flat-footed 14; BAB/Grp +9/+29; Atk +15 melee (1d6+8, tentacle); Full Atk +15 melee (1d6+8 [x10], tentacles), +10 melee (2d8+4, bite); Face/Reach 15 ft./15 ft. (30 ft. with tentacle); SA improved grab, constrict (1d6+8); SQ ink cloud, jet, low-light vision; AL N; SV Fort +9, Ref +11, Will +5; Str 26, Dex 17, Con 13, Int 1, Wis 12, Cha 2.

Skills: Listen +10, Spot +11, Swim +16.

Feats: Alertness, Diehard, Endurance, Toughness (x2).

Trap #22: "Rock and Roll River" by Evinrood and the Delvers!



CR:	7
Type:	Mechanical
Search:	Trap (DC 28), Trigger (DC 28)
Disable Device:	Trap (DC 28, 2d4 rounds); Trigger (DC 28, 2d4 rounds)
Primary Trigger:	Location (the last shiny rock)
Primary Trap Effect:	4 scything blades (+22 melee each; 2d4+8 each, crit x4; multiple targets in boat or water)
Reset:	Manual
Cost:	35,000 gp

In the wall opposite the waterfall is another entrance covered by tightly space chains that barely touch the water. If the party has even a shred of sense they will make for this exit at great speed (I've had great fun betting on which delver will make the exit first, kinda like cockroach races).

Once through the chains the tomb robbers may want to turn back. Before them is a narrow tunnel 7 to 10 feet wide, and about twice that in height (half of this filled with very rapidly moving water). Adding to the trepidation is the fact that the tunnel bends out of sight to the right. (Lights, torches would be nice here!) The speed of the current will preclude any deep thought on the party of the delvers. There are stalactites depending from the ceiling which have a mere 10% chance of beaming someone upright in the boat. Their presence will nicely obscure the real traps in this section.

Evinrood being in this for the long haul, needed a way to keep the narrower parts of his waterway clear of debris, most of which would be biological, so as with the shred-

ding spears earlier he devised a clever slicer here. The Rolling Rocks of Doom are perhaps the most diabolical traps so far rendered. As the party is swept along, both boaters and "floaters," they will encounter water-smoothed rocks that lurk just below the surface. Aside from some bumps and bruises they will not seriously disturb the "floaters," and the boaters will just scrape over them with little ill effect due to the speed of the current. No problem, think the delvers. "Ha!" says you. The next smooth rock they come to is anything but.

The upstream side is a smooth rock surface counter-weighted so that the smooth side faces upriver. Rushing water will not upset this balance. The impact of a heavy object, like a large dead fish, or a boatload of foolish tomb robbers will cause the balance to tip. Mounted on dwarfish steel axles, the rock portion drops down, out from under the delvers, presenting a broad flat surface to the current of the stream. This will force the other end of the device to swing around, up and over, presenting the party with a rack of parallel scythe-like blades. These blades will flash around and neatly flense your victims into convenient longitudinal slices. The force of the river's motion on the now, ahem, clogged blades will bring the smooth rock face back around and help the flenser.

I suppose if a high enough level character with incredible armor on could see the trap coming, he could roll into a ball, and the scythe blades might just hook him around and under, freeing him on the other side. But this would stretch the bounds of credulity.

Three skulls are about the best I can go on this one good effort for a janitorial tool.

Trap #23: It Is Always Darkest Before Things Go Right Down The Drain!



CR:	10
Type:	Mechanical
Search:	Trap (DC 28), Trigger (DC 28)
Disable Device:	Trap (DC 28, 2d4 rounds); Trigger (DC 28, 2d4 rounds)
Primary Trigger:	Touch (rubies)
Primary Trap Effect:	Drains contents of chamber into chamber underneath it. Delvers holding the chain or falling from the chain into the water are sucked through the drain (4d6 points of force damage) and deposited on the cavern floor 100 feet below (10d6 points of falling damage).
Secondary Trap Effect:	Falling ceiling rocks (+20 meleee; 3d6 damage)
Tertiary Trap Effect:	Torrent of water (20d6 nonlethal damage)
Tertiary Area of Effect:	Delvers below drain hole
Tertiary Save:	Reflex (DC 25) avoids
Quaternary Trap Effect:	Flooded chamber (victims are now beneath at least 50 feet of water)
Quinary Trap Effect:	Denizens in the water are sucked through hole.
Reset:	Manual
Cost:	80,000 gp

The best thing about the last trap is that in the space of 50 to 100 feet you can have 2 to 5 of them. By the time what's left of the party has drifted out of the tunnel they will need a rest. And the always-generous Evinrood is glad to oblige. The room the party has drifted into is 50 feet in all directions, up, down and side to side. Furthermore it has an inhibitory spell on it that works as follows. Any of the lower life forms that drift into the chamber, like barracudas, albino sharks, wandering lawyers and such will not be able to sense the presence of food. If the party can manage to obtain light they will be able to see that the water is quite deep, and crystal clear. The frightful denizens are clearly seen all about the delving party, moving on into the next part of the river (Descriptions in detail of what they have been struggling against would be an excellent use of terror at this point! Gives the party something to look forward to.)

Also to be seen is a great chain that is in the center of the room. It is anchored to the ceiling, and descends into the depths of the pool, where it is also anchored to a round dwarf carved and positioned stone slab. Near the chain at the top can e seen a glittering that is near and dead to the heart of any dungeon delver and tomb trespasser; crystalline formations. These are so clearly

gem quality it can be seen from the river surface 50 feet away. It is as if the grotto had been eaten away from below by the river until it came to this layer of uncut gems.

Up to this point the only things of value salvageable by the party have been fine dwarven stainless cutlery (1,000–1,750 gp value each. Hey didn't I tell you Evinrood had a government-sized budget on this place.) The delvers have been battered, beaten, sliced, spiked and nibbled; if they don't go for this bait check them for signs of brain damage.

The chain is easy to climb for there is no slack to it (DC 5). The delvers should all be able to fit on the chain, as it is 50 feet in length from the water to the ceiling. When the first delver reaches the top of the chain he will see a ruby the size of his head nestled amongst similar stones that are packed together in a bed of shale. Or so it will seem. When the party starts to loosen the stones around the ruby, or tries to take the ruby itself they will seal their own fate.

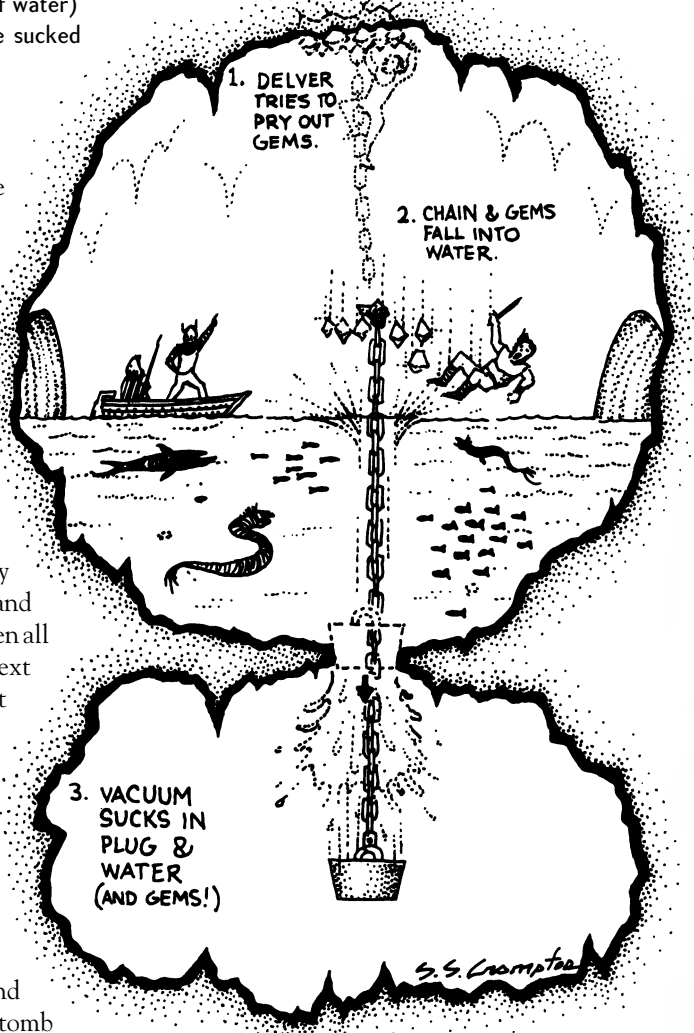

The Ruby is attached to the mechanism that holds the chain in place in the ceiling. The chain in turn holds the plug in the bottom of the room in place. Things start happening fast at this point. Number one, the chain shoots straight into the water below like an arrow. The partial vacuum imparted in times long past to the large chamber under this one will suck the block to which the chain is fastened into the chamber below like an egg into a bottle. (You know, milk bottle, lighted match, egg on the opening — thoop — into the bottle? Arg! What's happened to young trapsters these days? Don't any of you watch Mr. Science?")

Any delvers who do not let go should really not survive being sucked through a hole under water at high speed. If any members of the party survive, there is a chance they will be stunned by the 100-foot fall to the chamber bottom. This will cause them to drown unless rescued from the following events. The party will then be hit by the torrent of water from above with the power of a high-speed fire hose!

Tomb robbers lucky enough to have been in the water still, or to have let go in time are now treated to a merry-go-round ride the likes of which they have never experienced. Like a giant tub emptied by an extra large drain, the circular chamber has become a vortex! The suction, combined with the speed of the current has started a whirlpool effect that will begin to fill the vast chamber under the pool. The delvers will be powerless to resist.

Those that can fly out of the water will be knocked out of the air by falling rocks from the ceiling above. The mecha-

nism holding the top of the chain in place also serves to start a "cave in" of the gem bearing slate layer. This was designed to peel off just the 1-foot thick layer that was "plastered" onto the roof, especially with flying mages in mind.

If a member of the group survives being pulled into the lower chamber keep in mind that it will fill up in fairly short order having as its source of supply the entire river system, and that this will leave the party under 50 feet of water once the incoming pressure equalizes. To add insult to injury the gems themselves, having been washed out of the falling rock will be sucked down into the bottom of the lower chamber. Oh yes, there is more: the "no lunch" spell is only good in the upper chamber. All the denizens that are swept into the lower chamber to keep the delvers company will be in full fighting trim. Salvaging the jewels should pose a daunting prospect. 100 feet from the surface of the pool, through a fairly narrow opening, past the hungry river dwellers, without any light, should keep them out, but the prospect of 10,000 gp (uncut, as is) will prove a powerful temptation.

Oh, one last thing, being pulled through the "drain hole" will be none too good for the structure of the party's boat, or boats! Let's face it, those old wooden boats will be irrecoverable. So don't let any wise-guy members of the party tell you otherwise.

All right! If someone in the group has the right magical ability the *might* be able to put the boats back together again with the right spell. Sheesh!

This trap rates four skulls: with so many ways to go this one is almost a sure thing.

Trap #24: Chutes and Graters



CR:	8
Type:	Mechanical
Search:	Trap (DC 22), Trigger (trigger cannot be disabled)
Disable Device:	Trap (DC 30, 2d4 rounds)
Primary Trigger:	Location (traveling down chute)
Primary Trap Effect:	Razor-sharp grater blades (no attack roll necessary; 10d6 points of damage)
Reset:	No reset needed (cleaning perhaps, but no reset)
Cost:	4,000 gp

As hard as it may be to believe, there are those who will find a way past the Drain Trap, but that's OK, because good old Evinrood believes in overkill. (That's one of the things I like about the old fossil.)

Across from the passage that led the party into the last trap there is a low-roofed tunnel that exits the drain room. Once the large room under the upper chamber has filled the current will carry the delvers on into this tunnel.

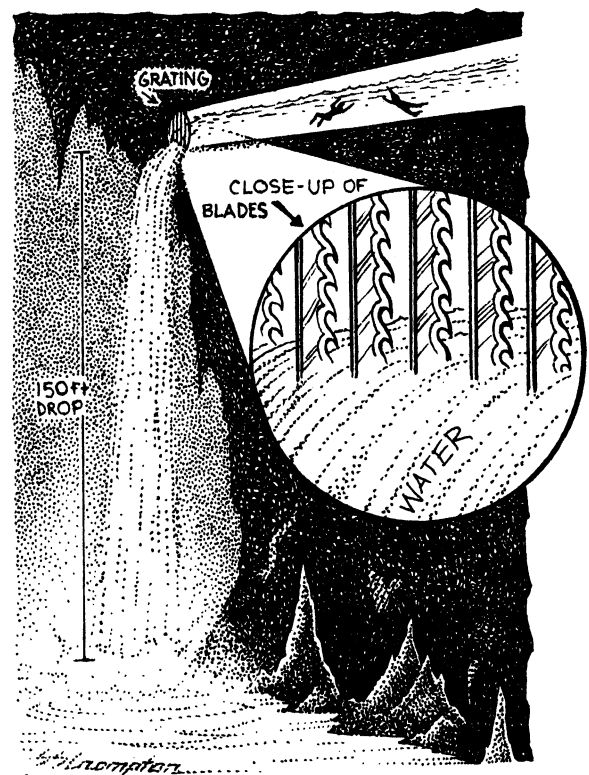

The delvers will quickly discover that the walls are worn very smooth, and that the tunnel is fairly shallow. One of the ways a delver may discover the smoothness is by trying to stand up. Given the smooth rock and the swift current, standing up is out of the question. (No, Gargantua the Mighty, 15th level warrior, strength has nothing to do with it.) The walls and ceiling are worn smooth as well (Balance check DC 50 to stand).

The tunnel starts out as a 12-foot round tube. As it goes on the hapless crew will notice that it is sloped downward in an ever-increasing angle. The pace picks up as the volume of water is accelerated by gravity. Further along the tube begins to narrow, first to 10 feet round, 8 feet, finally to 6 feet. The water level rises almost to the top of the tube, and is accelerated still more. (Nope, Gargantua, sorry, strength fails again. Now even though the walls are close enough to press against they are still slick, and the water will back up against you increasing the weight with every passing second!)

This is all well and good you say but what's the punch line? The chute, like all fun things must come to an end. By now the party's torches should be out, or at best casting a flickering light only inches from the roof of the tunnel. The party will be carried along at a pace that will

be hard to determine, but everyone involved will know it is fast. All this set the stage for the end of the tunnel.

Remember the dwarven metal spears, and scythe blades? Remember Evinrood's fastidious preoccupation with keeping organic matter from backing up in the system? Remember that the end of most tunnels had a screen on them as a recurring design feature? At the end of the tunnel, with the party flying along at very good speed and little chance to stop, they will find a grating. Floor to ceiling spaced less than 8 inches apart are as nice a set of corrosion resistant dwarven metal blades as you could imagine. As razor sharp as you could hope for! This should give any party encountering it cause to review their itinerary.

(Now you may think the party will end right here. Hasn't the fact that they have gotten this far proven anything to you? Delvers are the most devious and conniving scum on the planet, and there are a few ways to escape even this trap. (If Gargantua has a magic sword that will destroy all other blades it encounters, for example.) So make it hard for the party to see this one coming, and force some high level luck usage.)

This babe is three skulls if the party is unarmored dropping to two skulls if the party is armored. Either way, it's a really sharp little trap.

Trap #25: How Long Can You Tread Water?



What is left of the tomb robbing party will be ejected out over a vast underground lake. They will be carried by the pressure of the entire river far out from the wall, where they will plummet to the surface of the lake below... 150 feet below! Luck will play a major part in surviving a fall from this height. Drowning from the depth of the plunge is what will likely turn up on the coroner's report (the last primarily applies to heavily armored characters).

At the point below the area in which most of the debris from the falls hits the lake there will be a collection of bones, most sliced into convenient 8 inch bits. It would

be here that an appearance of the legendary glass catfish would be very convenient. The party winded, bereft of boat, thrashing about in the water, perfect!

The legendary glass catfish will be found lurking at the bottoms of this grotto. This baby is a giant breed of catfish whose flesh is transparent. The Glass Cat just lays waiting for lunch to come to it. Lying on the bottom he looks like an old skeleton picked clean and left by time, unless he has just eaten. Digestion can be a gross process especially if it is someone you know! He can grow up to 40 feet in length depending upon his food supply. (Almost always found one at a time this creature is like fighting a subterranean killer whale: *Very tough.*)

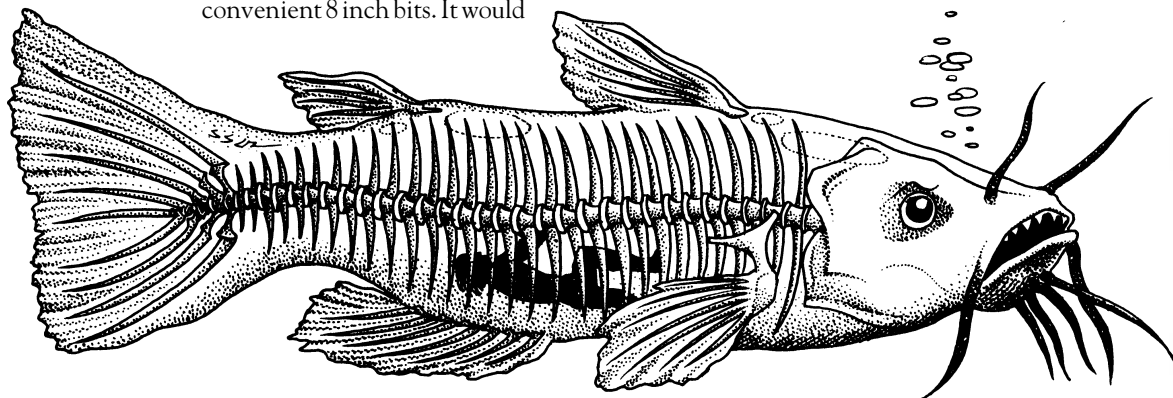

If you find the fish and the party are reluctant to mix it up there is always a way to bait the delvers into diving down and stirring up the fish. Liberally sprinkle the bottom with about 15,000 gp worth of gold and gems mixed in with the jumbled bones and I don't think you will have any problems.

Keeping in mind that the "fish" should be tough (remember Gargantua) the trap only rates two skulls. With just the fish and the fall this trap is more scenic than deadly.

Use the following stats for the glass catfish:

Dire Shark: CR 9, hp 147; see the MM for details.

Trap #26: What's the Matter? Cat Got Your Tongue?



CR:	5
Type:	Combination (Magical and Mechanical)
Search:	Trap (DC 25), Trigger (DC 25)
Disable Device:	Trap (DC 25); Trigger (DC 25)
Primary Trigger:	Touch (opening coffin)
Primary Trap Effect:	Releases deadly algae (treat as green slime)
Secondary Trigger:	Location (pressure plate in bottom of coffin)
Secondary Trap Effect:	Crumbling statue releases lava (2d6 points of damage each round of contact; 20d6 for submersion)
Bypass:	Don't open the coffin!
Reset:	Manual
Cost:	10,000 gp

By now the party will have noticed that they can see their way around this vast chamber fairly well. This is because of the lambent light cast by a huge statue of a cat sitting on an island in the lake.

This is clearly no ordinary cat and no ordinary statue. It is over 15 feet tall, and made of a transparent emerald-like substance. The light is odd in that it is not really bright, but very difficult to look at for long periods of time. The figure is obviously a cat but like no cat the delvers have ever seen. It is long bodied and obviously female, but it stands erect on its hind legs. It is also holding in one "hand" a staff.

The statue's eyes are the only things not carved from the same transparent green stone. They are difficult to see clearly, but they seem to be a rich topaz color, embedded in the statue.

The statue is facing a low pedestal upon which sets a stone coffin, covered with

carvings. They depict a pair of figures, one a short male human and one a tall catlike creature. They appear to be locked in some kind of struggle.

If the party makes it to the island they will find it to be an oval roughly 50 feet long, and 40 feet wide. It rises barely a foot above the lake's surface.

If any of the party's magic users have survived this far they will detect no magic from the coffin or the statue, but there is a great deal of nonactive magic on the staff, in the statue's hand. This staff is made of the same substance as the statue, with the exception that the staff is veined throughout with a very fine lattice-work of gold wire.

The coffin will yield the same scenes of combat seen from the water, but in more detail. Clearly they depict a mage's duel between the catlike creature and Evinrood. It is likely that this island is much associated with that conflict.

The coffin opens from the top. The lid can be removed with ease by any member of the party. The contents will



at first seem to be a slab of the same translucent substance that makes up the cat statue. Lying under the emerald slab can be seen, vaguely, items of exotic jewelry, all cast in gold. This "slab" of emerald completely fills the bottom of the coffin, glittering. If any member of the party touches it, even with a sword of intermediary device, like a stick or staff, an immediate reaction will occur.

The "awful green stuff" is the horribly diabolical way Evinrood used to defeat the cat-daemon. It is an algae, which is projected from a compartment in his staff. This enabled him to both defend himself from its attack and counterattack with devastating effect at the same time. The abilities of these algae are threefold: first it will consume a carbon containing substance, second it grows extremely rapidly (so fast that it can seem to leap toward its victims) and third it is very difficult to kill. The algae will lie dormant in the absence of "food" but once "food" presents itself the growth is explosive! This is where the delvers come it.

The "blob" will explode out of the coffin, and engulf the first character who comes in contact with it (if a trapmaster is a real namby-pamby he could permit the character to drop the object up which the growth has occurred. Keep in mind this stuff is fast. A Dexterity check at DC 20 indicates success at dropping the object.) After the character has been "consumed" the growth will be explosive. The island will be covered with a thin layer of algae in a matter of seconds. The delvers will be left with two options; dive back into the lake and all that that entails — chomp, chomp, or climb the cat statue and hope it is not edible, or attractive to the "blob."

The algae will stop at the water's edge. This is not a hospitable environment for this type of algae, as it is fresh water. The algae need salt for its growth. If the party is in a position to watch they will see little fish come up and nibble the fringes of the algae as it comes into contact with the water. They in turn are instantly dragged onto the island and turned into little blobs of algal mass. It cannot grow in the water but, it loses none of its potency, right up to the edge!

The party that has climbed upon the cat statue (Climb check DC 18) will notice that the eyes mentioned earlier are in fact giant gemstones. They will also note that the statue is laced throughout with microfine lines. The light comes from a hole beneath the base of the statue that opens into a volcanic pit. The glowing lava is somehow magnified by the construction features of this incredibly valuable statue. If the party attempts to removed the "eyes" they will cause the statue to shatter into millions of shards (If they are hanging onto it they will be dumped to the ground suffering 1d6 points of falling damage, or the next closest thing if they work over the statue after opening the coffin.) The "eyes" will remain intact and have a value of 10,000 gp each!

If the party has attacked the statue before the coffin nothing else will happen. If the "blob" is loosed first, after

the statue crumbles and the party has fallen into the "blob" and been consumed, the lava which has been held in check beneath the statue is released. This is as a result of the releasing of a pressure plate in the bottom of the coffin. Once the "blob" has gone out hunting, the pressure will be released, and the quartz panel will be withdrawn, if the statue is destroyed. The lava will clean off the island of the last vestiges of the "blob." The party will only see this if they are in the water.

The only loose end in this whole setup is the staff the statue was holding. It is the staff of the catlike daemon that battled Evinrood. It will not be consumed by the "blob," and it will not be melted or burned by the lava. It still radiates powerful magic. If any member of the party touches this staff his or her brain will short out. He or she will become if effect a first level mage with one heck of a magic staff. (The staff will act as a magical amplifier making it possible for the character who possesses it to cast spells at any level once it learns them. This will be without the usual costs.) The character will also be transformed into a 15-foot tall catlike creature, with attributes and personality corresponding there too (Str +4, Dex +4, Con +2). The character will not remember anything of its own past life and the brain patterns of the cat-mage will not be able to impress themselves on the ordinary delver brain (Brains? Imagine that; delvers have brains! Who'd have thought such a thing?)

IMPORTANT SURVIVAL TIP: Don't play with the toys of high-level mages.

There is a way out of this lake other than trying to crawl all the way back up the river. If the party, or what if left of it, looks around the wall to the right of the waterfall, they will find the ranks of dripping stalactites interrupted by a column of green algae. This slimy pillar stretches up into the dim light until it reaches the roof of the cavern. If the gang of cavern crawlers inspects this more closely, they will find it to be the only practical exit from this chamber. Under the layers of algal growth, the tomb trashing party will find a rust-coated ladder, almost corroded through in places. Ascending this slimy tower will call for a fair amount of dexterity and daring, coated as it is with muck (Climb check DC 20).

At the top will be found a stone hatch (Strength DC 12 to open). There is a 20% chance that a rung of the ladder will break as he tried to lift the hatch. (The reason it is so heavy is that there is a chest of treasure sitting on top of it.) If they make it through, the party will find themselves coming up into Trap #39 from below.

The blob is a four skull horror; speed and animal reflexes are essential. Not opening the coffin is the best defense. The gold in the coffin is all that remains of the cat creature. The cat mage infected by the blob was trapped in the coffin by Evinrood. The lava will clear off the island and melt the coffin.

The Road Less Traveled

For the party of tomb trespassers to have even found this path indicates that they think deviously. This is good, it means they may last a few traps longer and prolong the fun. This path through the devious treachery of Evinrood's traps has as its theme misdirection. In most cases what you see is *not* what you get, or what you get is very definitely not what you expected, which leads us to....

Trap #27: I'm Sure You'll Get The Point!



CR:	3
Type:	Mechanical
Search:	Trap (DC 22), Trigger (DC 22)
Disable Device:	Trap (DC 22, 3d4 rounds); Trigger (DC 22, 2d4 rounds)
Primary Trigger:	Touch (sticking anything in the three holes)
Primary Trap Effect:	3 darts (+15 melee; 1d4+2)
Secondary Trigger:	Touch (door)
Secondary Trap Effect:	Volley of darts (+15 melee; 1d6 darts, 1d4+2 each dart; multiple targets in 10-ft by 10-ft area in front of door)
Reset:	Manual
Cost:	6,000 gp

The doors behind the stucco are, once cleared, revealed to be the same as the doors on the right, the “Ye Olde Digit Dicer” lock type. They consist of two large 10-foot by 10-foot panels, 10 feet tall. The locking mechanism will seem familiar, however these have a twist. The party will discover to its chagrin that the door cannot be opened by a simple magic spell. In fact they cannot be opened by a complex magic spell either. They are two layers deep. The first was the decorative fresco coat that had to be chopped off before the party could even get at them. The second coat is a false stone veneer, which is set in place over the real doors themselves. This stone veneer can be discovered by magic, and the real doors will be revealed. But we should deal with those who don't have high-level mages hanging on their coattails.

If the delvers treat this door as if it were just the ordinary “stick something in the right pattern” three-hole lock they are in for a surprise. By now they will have learned, if they have encountered this type of lock before, that using your own digits to trip the lock is detrimental to one's continued well-being. Some form of device is likely to be employed in the holes in lieu of a digit. This will be fine as the trap works in a new and startling way.

Once the appropriate digit-sized device is inserted in the door, the trap is triggered. Out of all three finger holes will shoot 2 and 1/2 foot long steel darts. These darts are propelled by powerful springs, and as a result they will splinter any wooden or fleshy objects used. If the digit used is armored the point on the dart is such that it will penetrate any but the finest or magically protected armor.

As you can see this variation will cause some surprise to delvers who expect one thing and are served up yet another.

Once the delvers figure that the stone façade is not the real door, either the party's mage will blast away the rock or the beefier warrior types will manually removed the stone. Revealed will be the faces of two massive bronze doors of exactly the same dimensions. They are works of the bronze casters art.

They depict the climactic scene of Evinrood's battle with the daemon lord. There are vile-faced terrors swarming all about a central figure on the right who is marshaling them to the attack. On the left is the stumpy figure of Evinrood surrounded by ranks of earth, air, fire, and especially water elementals. Their vaguely humanoid faces are intent on the fight. All the monstrous faces are turned to face the observer, not the respective foe, only the mage's faces are turned toward each other. On the left hand door there are three empty holes just like there were on the stone fascia. (There may be a few of the delvers who do not realize that these are the holes out of which the darts fired. Don't clue them in, let them timidly probe them for awhile. It will serve to heighten their apprehension.)

The bronze is hardened to a surprising degree so the doors are not subject to any but the most powerful physical attack (Hardness 15, hp 90, Break DC 45 [includes +10 for *arcane lock* spell]). The doors radiate the presence of a magical spell. As there is no other observable way to open the doors it is clear that they are magically locked and will require a mage to open them.

The spell required to unlock the doors is not a difficult one. Almost any intermediate level spell of opening will suffice to set off the trap and open the doors.

The baleful malice-filled eyes, sunk like dark hole sin the monstrous daemon and elemental faces were just that, holes. From the eyes of every monster face shoot the 2 and 1/2 foot darts the party will have encountered from the three-hole lock attempt in the stone façade. There are dozens of the darts and they cover the entire face of both doors. Anyone in front of the doors will be hit by 1d6 darts.

Incidentally, if there are any of the tomb traipsers left at this point, the doors open by themselves and swing inward. They are three feet thick (so that the darts can be loaded into the works) and counterweighted to swing freely. (Lest the party thinks of purloining the doors [don't laugh, it's happened before] they are hollow, and their actual value (2,000 gp) is in the art work and in the trap mechanism within.)

The party will be free to continue on down the corridor thus revealed.

The door is a two skull trap; clever but the darts are a little wimpy to be rated three.

Trap #28: The Danger Here Will Be Crystal Clear

	
CR:	3
Type:	Mechanical
Search:	Trap (DC 25), Trigger (DC 22)
Disable Device:	Trap (DC 22, 2d4 rounds); Trigger (DC 25, 2d4 rounds)
Primary Trigger:	Location (pressure plate)
Primary Trap Effect:	Statues fall forward, smashing into a rain of glass and crystal (no attack roll necessary; 3d6)
Bypass:	Smash the statues when the room is entered
Reset:	Manual
Cost:	7,000 gp (doesn't include the cost of the crystal statues)

The would-be tomb robbers will look down a broad corridor that is 20 feet wide, and 50 feet long. The ceiling is 15 feet high. They will see that after an interval wide enough to permit the bronze entry doors to swing wide the hall is occupied. In a rank along the walls on either side, for 30 feet, are 12-foot tall statues of warriors. These warriors are truly unique. They are tall, oddly think warriors with unnaturally elongated limbs and long, hollow cheeked faces. They are sculpted entirely out of crystal. These warriors are a symphony of sharp points and acute angles. Armed with pole weapons edged up their entire length, these object would be dangerous to a character's continued health if they were even brushed against, let alone if they were to attack.

The crystal warriors are stationary and transparent. The light from the party's torches will be refracted into a million rainbow glints and highlights, by the thousands of crystalline edges. They are not as great a threat to armored warriors as they would be to lightly armored mages and rogues who must travel light.

An alert leader will take one look at this arrangement of "glass-ware" and do his level best to smash the warriors where they stand. The statues are easily broken up (Hardness 1, hp 6, Break DC 10). A sharp blow will do the job with ease. The statues will collapse into heap of dagger-like shards, each shard glass-sharp on all its edges. Beyond reducing these statues to shards there is little else that can be done as

further attacking the piles of shards will only results in smaller, sharper shards. Once they are destroyed there can be seen a mechanism like a stone piston that was fastened to the back of each warrior.

If the party is not astute enough to smash the statues, and instead goes on through the room, they will be entertained and diverted by a fairly simple mechanism. As the room radiates no magic they will be on their guard for mechanical traps. The entire floor surface is the activator mechanism. It is a long tilt plate rocker switch constructed to balance on a slight bump in the middle so that when the party enters the room it tilts down to set, and when they pass the halfway point the party's weight brings it down on the activator.

The net result is that the crystal warriors are thrust forward on hydraulically driven pistons to smash into each other, and coincidentally any hapless delvers who are in between. This will have a two-fold potential for injury. First from the force of the pistons, which is considerable, and secondarily from the multitude of sharp and penetrating surfaces on the statues themselves. As a result of the overall rough treatment the statues will shatter into shards as described above. (This may seem obvious, but if the statues are smashed in advance the location of the pistons will be obvious.)



Once the statues have been overcome the party may feel free to proceed to the large double doors at the hall's end. Wrong.

This trap may seem like rather ornate but clumsy effort, rating a mere two skulls, but as with many of Evinrood's best traps this is just the set up.

Trap #28a: Just What Every Delver Needs. A Little Polish



CR:	10
Type:	Mechanical
Search:	Trap (DC 25), Trigger (DC 25), Secondary Trigger (DC 30), Secondary Trap (DC 35).
Disable Device:	Trap (DC 25, 2d4 rounds); Trigger (DC 25, 2d4 rounds), Secondary Trigger (DC 25, 2d4 rounds), Secondary Trap (DC 30, 2d4 rounds)
Primary Trigger:	Touch (tampering with the door locks)
Primary Trap Effect:	30-foot fall (3d6 falling damage)
Secondary Trigger:	Location (pressure plate on floor of tumbler chamber)
Secondary Trap Effect:	Room begins to spin, mixing delvers and broken crystal together (no attack roll necessary; 16d6 slashing damage)
Reset:	Manual
Cost:	25,000 gp

The doors at the end of the hall are the standard double doors, featureless, except for the three-hole lock mechanism. They are 10 feet tall and 10 feet wide. With the crushed crystal warriors at their back the party will likely feel that the doors are their only problem.

The doors are unlocked by the usual method, either a low level magic spell, or by "probing" the holes for the right one. When the locking mechanism is tripped is when the fun begins again.

The first noticeable reaction to the unlocking of the doors is that the floor of the room the party is in splits down the middle, dumping the party and the crushed crystal warriors into a chamber 30 feet below the main hall. This chamber has a rounded bottom and is 50 feet long by 20 feet in diameter. Once the tomb traipsers land in the chamber the weight of their fall causes door over their heads to close and lock in place. This will effectively create a 50-foot long cylindrical can inside which are the party, and several hundred pounds of crushed crystal.

A quick-thinking mage may fly himself out of this trap by not allowing himself to fall but most other delvers should be trapped by this.

Now comes the part that makes this really special. Once the lid has trapped the delvers a door is opened near the end of the giant can. This door is

at the end of a tunnel that leads back to the underground river. The purpose of this water is to turn a large water wheel at the greatest possible velocity. The water wheel is joined to the end of the trap can by a series of geared wheels (Evinrood's design, dwarven manufacture). The trapped delves are in no position to appreciate this marvel of manufactured genius, but they are uniquely placed to enjoy its effects.

As the water brings the wheel up to speed, the gears will turn the entire cylinder mechanism at an increasing rate. The cylinder's far end is anchored by a large axle that allows this turning to proceed smoothly. The party inside the can will be subjected to the exact same treatment that is used to polish gemstone smooth. The crushed crystal, and the buffeting turning as the speed picks up will be sufficient to take the edge off even the most uncouth, loutish warrior. (If you want comic relief you can have the speed increase slowly enough that for a short period of time delvers who are sufficiently agile can run in the direction of the spin. Of course the river is tireless, the same can seldom be said for the average dungeon delver.)

Once the tomb robbing party has gotten out of the Tumbler Trap (and believe me a party eventually will, in some devious and destructive manner), they will find that the 20-foot wide doors have been released. (One or the other of the opening trap components also release the doors, I forget which, perhaps the one that turns on the water?) The party will be confronted by a "T" intersection. To the right and left are 10-foot wide doors. (There is also a secret panel but for reasons that will become obvious we are saving this for last. The party is being offered two perfectly obvious alternatives, why would they look for a third?)

The polisher is a four skull trap for artistic value as well as torturous intent. The one-two phase set up wasn't bad either.

If the party elects to go to the right, proceed to the next trap. If the party elects to go to the left then go to trap #44 and run things backward to this point!

If by some tragic mischance the party detects the secret door, then go to "Done Too Soon." (With any luck they'll get there none too soon.)

Trap #29: Heated Harassment Harries Hapless Hunters



CR:	2
Type:	Mechanical
Search:	Trap (DC 20), Trigger (DC 20)
Disable Device:	Trap (DC 22, 2d4 rounds); Trigger (DC 22, 2d4 rounds)
Primary Trigger:	Touch (breaking the tripwire)
Primary Trap Effect:	Geothermal steam heats the stairs (1d6 points of heat damage each round)
Primary Area of Effect:	Stairs
Reset:	Automatic
Cost:	3,000 gp

The stair to the right leads upward 30 feet and is 10 feet wide. The stairs themselves are metal and inclined at a steep angle. At the far end of the stairs is a nonstandard door, the details of which are hard to make out at this distance. As the party climbs the stair they will, within 10 feet of the bottom, encounter some cobwebs. They are slightly sticky and break easily to the passage of the torch or the brush of a hand. They cover the entire opening of the stairway, but so thinly that they are only just visible in the torch (or whatever) light. Concealed amongst the cobwebs is an ultra fine trip wire (Search or Spot DC 25 to locate).

In a complex of chambers above the stairs there is a network of steam vents. Their source is a geyser-like geothermal energy. When the wire is broken, the

steam flows down conduits in the walls and into a network of metal pipes under the stairs. The bottom of this pipeline is perforated so that the steam will flow out fast enough so to permit a steady flow of more fresh, hot steam. All this drains down into a vast chamber under the stairs. The stairs will in short order take on the heat of the live steam, and reach a temperature of several hundred degrees. Barefooted characters will be deeply distressed; those with armored footgear will also be negatively affected as their “protection” heats up.

The best part of the trap is that the door, when reached, has no handle, and seemingly no opening mechanism at all. The plaster that covers it is laid over iron so attempts to dig through or chop down the door will be fruitless, and time consuming, as the temperature of the stairwell increases. If a character spends more than three turns engages in strenuous activity at the top of the stairs there is a very real chance of heat stroke (30% chance)!

The punch line of the joke is that the door will open by itself in 1 hour, when the supply of steam runs out and the residual condenses. At this time the door simply drops into a slot in the floor, assuming the party has not so deformed it that it will no longer fit.

I like a hot foot as much as the next guy and this one is pretty well done, but with the exception of the heat stroke potential, and some potential foot burns, this trap only rated one skull. This trap gives the party a chance to take a “breather” for a change.

Trap #30: Put That Down, You Don't Know Where It's Been



When the door is opened it will reveal a room 30 feet by 30 feet with a 15-foot high ceiling. The door is centered in one wall, and all the other walls are featureless, save for frescoes on the stucco depicting a short stumpy mage doing battle with a warrior wearing a bright crimson suit of armor. The mage seems to be getting the worst of the battle. At various points the scenes depict a variety of magical attacks being defeated by the armored figure, who is pursuing the mage determinedly.

The delvers will get a chance to inspect this wonderful armor first hand. There before the party, in the center of the room, arrayed on a frame manikin is the same suit. Needless to say it reeks of magic at a level so high, and spells so overlain that it is hard to discern just exactly what they are intended to do.

If the party is wise they will give this armor a wide berth, but if they were wise they would not be traipsing about this deep delver-shredding machine.

The armor seems to consist of crimson baked ceramic panels. Close inspection will show these panels to be

made up of tightly packed fibers in a resinous matrix, baked into the various necessary forms for plate armor. The most unique aspect of this suit is that the helm is featureless. There are no eye openings at all. In all other respects this armor seems made to fit a normal human.

Don't fear; eventually someone will crack. Then either they will try it on, or some member of the party will be “volunteered” to try it on. Better still, not trusting each other, various members of the party will try on various parts at the same time. What they will find is that the armor will conform to whoever dons it, from the most petite female rogue to the most burly brute of a warrior. The second thing they will note is that the armor will not allow itself to be worn over other protection. If a delver attempts to put the armor on over another piece of armor, regardless of its nature, the crimson armor will absorb the other pieces and the original armor will no longer exist!

The party can test the armor to their hearts content. Magical spells cast at the armor are either deflected off, in the case of the more elemental powers, flame, wind, or

energy blasts, or they are absorbed into the fabric of the armor in the case of more cerebral spells, like mind control, illusions, or death spells that attack the substance of ones being. It is proof against enchantment up to any level the party, in fact any party can generate. All in all it is a most remarkable suit!

In all the joy of finding a room where nothing is trying to kill them, and a treasure that is genuinely a treasure, the party may not notice that the frame manikin from which they extracted the suit is still radiating very powerful magic. This will require a direct detection of magic spell upon the frame manikin. The only spell remaining hereupon is one of restraint, at an unprecedented level. (Note the subtle hint!) The party will also note if a mage tries to cast magic with the armor, or a piece of the armor on he finds that the armor works just as well from the inside as from the outside. In fact if the mage is wearing the gauntlets and casts a flame spell he will be subject to the blast reflected back into the gauntlets and toasting his hands!

If all this seems too good to be true — *it is*. The effect of the armor will begin once the wearer is outside the 30-foot range of the frame manikin. This armor is in fact proof against all magical attack. It was created to house the daemoniac assassin sent by Selgolub in one of the earliest attempts to destroy Evinrood. This daemoniac agent still exists, trapped by Evinrood within the fabric of the armor itself. The armor cannot act as an agent of destruction, not having the substance to move itself unaided. The imprisoned daemon trapped therein can and will take over the wearer and thus once again become the killing machine it once was.

If one member of the party is wearing the armor he will be destroyed by the daemon, and the armor-encased monster will attack the party with a vengeance. The magic defense capabilities are already known, as for the daemons martial skills, he will have whatever weapons the character previously had and 5 times the physical attributes. The armor will take up to 20 points of physical damage per turn without material damage. Magical weapons are ineffective against it except as they represent the weapon type. (For example: A *longsword of burning*, usually a 100D6 weapon, has the affect of an ordinary longsword.)

The best form of chaos is if two or more members of the group are wearing parts of the armor. Then the daemon takes them all over. The thus-subjected members of the party then will attack all the unaffected party members. (The parts of the “daemonized” characters protected by the armor are defended as above, but there is no enhancement of attributes.) If the attackers are successful

they will turn on each other until there is only one left who will don all the armor and stalk out of the dungeon seeking the shade of Evinrood! If the remaining unaffected members of the party can render the affected members unconscious they can remove the armor and toss it back into the room, where the restraint spell holds the daemon contained, and the unconscious delvers will return to normal. (this trick only works with partial armor wearers, if the affected delver is wearing the whole suit, even if the armor is defeated he is dead.

While not a genuine trap in the mechanical sense this armored suit is better than flypaper where tomb robbers are concerned. Still it only rates three skulls. The whole setup is absolutely safe is the delvers just say, “No.”

Demon-Infused Armor of Spell Absorption and Spell Turning: This armor grants damage reduction 10/magic and automatically absorbs any non-elemental spells cast at it or the wearer and reflects elemental (fire, earth, cold, air, electricity, acid) spells back upon the caster with full effect.

In addition, the armor is infused with the demonic spirit of Selgolub who possesses the wearer (similar to a *magic jar* spell) and causes him to attack his fellow party members. Selgolub uses all of the character's available weapons (including spells) to attack the rest of the party. The former party member's soul is stored in the nearby manikin. If the armor is split into different pieces, Selgolub can control any party member that dons a piece of the armor. If Selgolub is slain, the party member is slain as well.

If the demon can be subdued, rendered unconscious or contained somehow and the armor removed, the party member returns to normal (though he doesn't remember anything that just happened).

Selgolub: CR 13; SZ M Outsider (Chaotic, Evil, Extraplanar); HD 13d8+65; hp 113; Init +5; Spd 40 ft., fly 60 ft. (average); AC 25 (+1 Dex, +14 natural), touch 11, flat-footed 24; BAB +13/+20; Atk +20 melee (1d6+7, claw); Full Atk +20 melee (1d6+7 [x2], claws), +15 melee (2d6+3, bite); SA fear aura (20-ft radius; Will DC 19 or flee 1d6 rounds), improved grab, constrict (2d4+10), sneak attack (+4d6); SQ damage reduction (10/cold iron), SR 28, demon qualities, telepathy; AL CE; SV Fort +13, Ref +9, Will +13; Str 25, Dex 13, Con 21, Int 20, Wis 20, Cha 16.

Skills: Bluff +19, Climb +23, Concentration +21, Disguise +19, Hide +17, Jump +23, Knowledge (arcana) +21, Knowledge (the planes) +21, Listen +23, Move Silently +17, Search +21, Spellcraft +21, Spot +23.

Feats: Alertness, Cleave, Great Cleave, Improved Initiative, Power Attack.

Trap #31: Proof Positive That All High Level Mages Are Screwy!



CR:	10
Type:	Mechanical
Search:	Trap (DC 25), Trigger (DC 25)
Disable Device:	Trap (DC 28, 2d4 rounds); Trigger (DC 28, 2d4 rounds)
Primary Trigger:	Location and Touch (center disk in floor is actually a large screw)
Primary Trap Effect:	Pressurized cylinder slams into ceiling (no attack roll necessary; 16d6 crushing; multiple targets [those standing on disk])
Primary Save:	Reflex (DC 30) avoids or Reflex (DC 25) for half
Reset:	Automatic (disk resets in 1 minute)
Cost:	22,000 gp

To leave the armor room requires that the party find one of two doors concealed under the stucco, or they can return the way they came. If they detect the hidden doors they will find that there is one on the right as they entered the room, and one on the left. The doors are centered in the middle of each respective wall, and are the usual three hole lock type, 10 feet wide. Starting with the right hand side the party will find the door opens into the armor room, and that it leads into a small 10-foot by 10-foot hallway. Directly opposite the door through which they entered is another door. This one is also the standard dungeon door, and it opens inward.

The room revealed by this door is decorated in the most amazing style. The entire room is covered in stucco, with the exception of the floor, which appears to be inlaid stone. The predominating patten is one of large circles. The room is 30 by 30 feet with a 30-foot tall ceiling. Centered on each

wall, the ceiling and the floor are a recurring design. A large, 12-foot circle, centered by a much smaller one, about 1 foot in diameter. The large circle is painted a rusty iron reddish brown, with the center, smaller circle being gold.

Close inspection of the gold circle in each wall will reveal that each disk is inlaid in the plaster, and bisected with a groove. If the party senses for magic they will find that there is none to be found anywhere in the room. The groove in the golden disks is just right to accommodate a broken sword, or flattened shovel blade. (I for one have seldom seen a delving party is possession of a 1-foot wide screwdriver, but with dungeon delvers... you never know.)

If the party starts with the disks on the wall they will find that by twisting the disks they will work free of the walls. They are about 1 inch thick and seem to be solid gold (value about 1,500 gp). The one in the ceiling is exactly the same. (Lest the delvers try to pull a fast one on you, remember the door makes it so there are only three disks from the walls, and the ones in the floor and ceiling.) The disk in the floor will prove a little bit of a problem, it seems to be attached to a somewhat larger, or perhaps thicker disk. If the party continues turning the disk in the floor will begin to show itself to be in fact much deeper than the ones on the walls.

The floor disk is in fact a large golden screw, turned into the floor. As the party turns it out they will see there is much more gold in this object than in the other four put together. Once the screw has withdrawn 1 and + feet out of the floor, the trap will be activated.

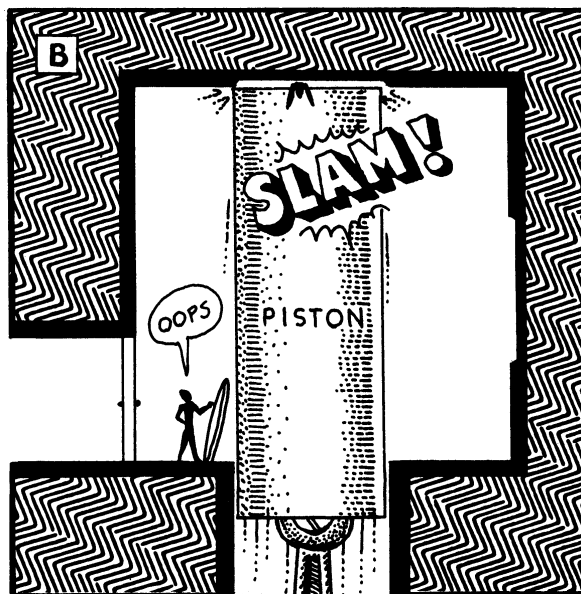
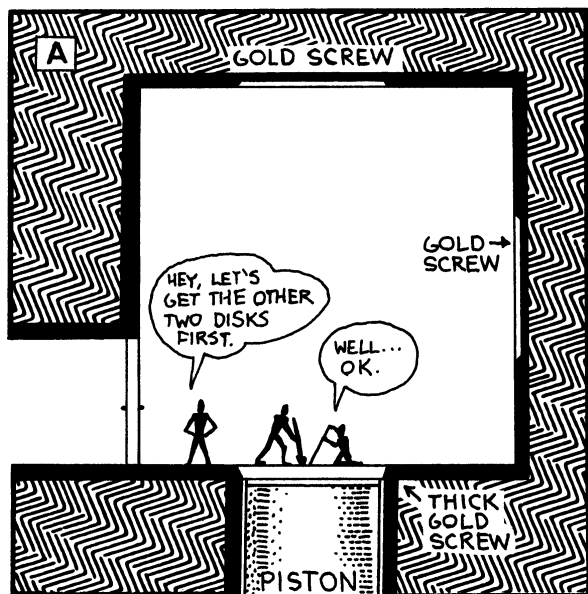

This screw is in fact an anchor for a large iron piston in the floor. Once the screw is withdrawn the entire 12-foot iron disk is propelled to the ceiling by pneumatic pressure. Clearly this will have a deleterious effect on any delvers turning the screw, as well as anyone loitering around nearby. There is a chance that a lucky or agile delver could leap free before the deadly impact. (For real amusement value allow partial success to count and have the delvers pinned by various crushed appendages depending on the amount by which they miss their rolls.)

All is not lost: with much grunting and groaning the party, using brute force and leverage (Strength check DC 30), can still pry the screw free from its resting place mashed into the ceiling. The value of the gold screw is easily 10 to 15,000 gp.

There is no other exit from this room save the door that the party entered from.

As artistic as this trap is, once again it requires a large blind spot on the part of the delvers. Three skulls for lethality, one if the party has the collective brains of a handful of walnuts. (Well, they might actually figure this one out!)

Trap #32: To Sleep, Perchance To Dream...



CR:	2
Type:	Mechanical
Search:	Trap (DC 20), Trigger (DC 20)
Disable Device:	Trap (DC 22, 2d4 rounds); Trigger (DC 22, 2d4 rounds)
Primary Trigger:	Touch (doorknob)
Primary Trap Effect:	Doorknob explodes (3d6 damage)
Secondary Trap Effect:	Doorknob is coated with poison that induces sleep (no save) for 1 hour (see details above)
Reset:	Manual
Cost:	4,200 gp

The party will be forced to backtrack through the armor room. From here they can either flee the dungeon, hopefully screaming in terror, or they can go over to the door that was on the left, as they originally entered the armor room.

Once the typical three hole lock has been overcome, they will find themselves in a corridor 10-feet wide and 20 feet long and 15 feet in height. The door at the end of the corridor is truly different from most of the rest encountered so far.

It is set in the middle of a wall covered in green tiles. It is only 5 feet wide and 8 feet tall. It is made of red stone with the details of a great battle graven on its surface. There is an army of hundreds of warriors arrayed against one man standing upon a small hill. The single man resembles the depictions of Evinrood that the gang of tomb robbers has seen before. The army is led by a huge figure on a horse-drawn chariot. There is no magic on the door, and it has a common knoblike handle.

If any member of the party turns the knob there will be a loud bang, and the knob will explode in the hand of the person who turned it. If the character is not using a gauntlet the damage to the

hand is considerable! (Barring magical intervention he will lose effective use of the hand.) If the delver in question is armored, and the armor is not magically impenetrable, he will find that while the explosion has not affected him, there are a number of small metal fragments that have penetrated his gauntlet. If the armor is magically impervious then the trap is wasted! (Curses, foiled again!)

If the character is wearing the non-magical gauntlet, he will likely start pulling the flechettes out of his paw. When he removes the last one he will begin to feel the effects of the herbal potion that was applied to the knob. (If the guy had no gauntlet at all, exsanguinations will serve to flush the potion's affects right out of the system. Lucky him.)

The potion's effect is to cause the delver to fall into a deep narcotic sleep. This will last for 1 hour, despite all efforts to mitigate the result. During this time the delver will be subjected to wildly hallucinogenic dreams. These dreams will forecast the termination of members of the party in a variety of horrible fashions. The visions never show the traps themselves, only the end results: bodies covered with bugs, characters entombed in sand, or writing on the floor of a room clutching at their throat. I'm sure you get the picture.

(Note: Take the player aside and tell him all this. It will sow the seeds of dissent, even if the player rushes back in and tells the whole truth. No one will be entirely sure he isn't holding out.)

After the knob explodes there will be revealed a panel under the remains of the lock trap. This panel will have the familiar three hole lock mechanism. The door opens outward into the corridor. This trap set-up rates as two skulls.

Trap #33: A Thousand And One Ways To Use Killer Bees!

	
CR:	4
Type:	Combination (Magical and Mechanical)
Search:	Trap (DC 31), Trigger (DC 31)
Disable Device:	Trap (DC 31, 2d4 rounds); Trigger (DC 31, 2d4 rounds)
Primary Trigger:	Touch/Location (entering the room or tossing any object into the room plus the chain reaction destruction of the statues)
Primary Trap Effect:	Swarm of killer bees is released (see stats below)
Reset:	Manual
Cost:	5,000 gp

This trap is a genuine work of art. I won't even let Grimtina come into this room for obvious reasons. It is grim and foreboding in its potential, and beautiful in its execution. The open door brings the party face to face with a horse-drawn chariot at full charge.

The wild-eyed stallions are literally about to lunge through the open portal upon the unsuspecting party. The delvers' torch light will flash brightly in the glaring eyes and caress the contours of the flaring nostrils. This apparition should cause even the most hardened delver to jump back.

After a momentary pause the party will find that they are confronted not by a warrior's ghost reaching across the span of time since the tomb was closed but a remarkably life-like reproduction of a battle chariot. As the party looks into the room they will find it is filled with a veritable army of statues. In paraded ranks on either side of the chariot can be seen, glinting in the light of the torch, ranks of daemonic-looking soldiers. They are clad in blue enameled armor, and holding 6-foot long spears. At their belts are short swords, and on their heads are bizarre flared helmets that partially obscure the hideous faces.

Behind the first chariot there is another. Further back in the room on a raised dais at the rear can be found a coffin. It is covered with a blue enamel looking almost as if it were a solid block of blue seawater captured while in churning motion.

The warriors are all slightly over six feet in height. They also can be felt to radiate magic. The spell is of a very low nature, almost a simple maintenance spell. Upon the party's intrusion into the chamber in any fashion the spell will dissipate. (At this time please note the operative word "intrusion." This means any form of entrance into the room. If, for example, the party loses a

crossbow into the room intrusion will have taken place.) When the magic dissipates there is no noticeable affect. (Most delvers hate the line, "No noticeable effect." They are sure there is some *Unnoticed* affect that they have missed.)

There is very little room in the chamber to move about. The statue-soldiers are packed in with only inches separating them. A close tactile investigation of the arrayed force will reveal them to be fired terra cotta. They are a brightly painted porcelain army, each one, his weapons and armor, of a single piece.

Now I, for one, see the party reacting in much the same way that it did when confronted with the crystal warriors earlier; that being to start smashing the statuary. This is the natural tendency of a gang of delvers when confronted with any extremely valuable, but vaguely threatening object. If they do follow this course they will find the statues easy to upset. In fact they are balanced in such a manner that it is almost impossible not to tip one into the next, like giant dominoes. The resulting serial crashing should momentarily warm the cockles of the delvers' tiny vandalistic hearts. Then will come the time to pay the piper, or in this case the beekeeper.

If the tomb robbers are still possessed of one or two thinking individuals, or are operating on a greed-based system of looting, the value of these statues will be immediately obvious. Each one is an artistic masterpiece from an era gone these thousands of years. If they could be transported intact to a major city they would have a market value as high as 3,000 gp each. This would diminish if they were dumped on the market all at once but even massed as a haul they would bring 875 gp each. The chariots would be worth three times that.

A party thinking like this will take great care not to break the statues. It is for their benefit that the area is so closely packed, and the warriors so carefully balanced. Even with due care, for a fully armed and equipped party to be able to cross this room to the dais will require the utmost dexterity and agility. Notwithstanding their best efforts there is still a 20% chance (L2) of accidentally setting off a smashing chain reaction.

The magic spell that dissipated at the party's intrusion into the chamber was one that held in a form of magical stasis the occupants of the statues. Contained within each statue is a small swarm of so-called Killer Bees. (Don't you just love that name, so evocative!) When the chain reaction toppling begins, the bees will swarm, irritated by the crashing falls that release them. To be sure a few will be done in by

GEE...
AT LEAST I GET
A CAMEO IN
THIS PART!

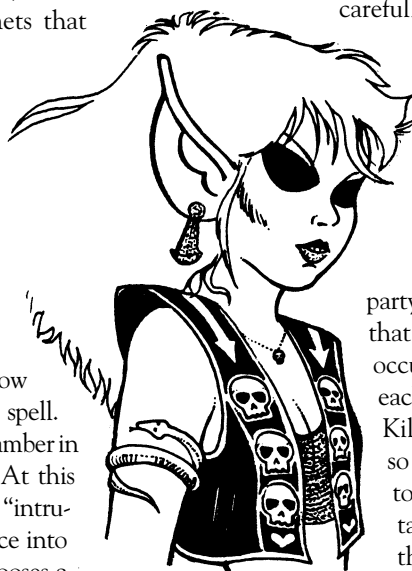

the crashing of the statue containers, but rest assured there are more than enough survivors to go around.

The swarming bees are not dangerous as single individuals. (Although there is always the pleasant possibility some delver is allergic, about 1% chance!) It is in a swarm, or in this case, groups of swarms, that they are lethal. Even armored tomb crashers are affected. Any

exposed patch of skin that can be reached by a creature smaller than + an inch in size will be attacked.

Oh yea, there are ways to take care of these critters: poison gas, high-grade commercial bug bombs, a really large, fast anteater... but they are tough. Most parties won't survive to reach the coffin. (Now you see why this room is off limits to Grimtina, with her dexterity it is not

STATUES OF LIMITATION ...



OR: NONE OF YOUR BEES WAX !

G. S. Dromptor

a matter of if, but when. I'm not that worried about her well being. It's the thought of sitting up nights with a pot of super-glue trying to reset this baby...)

This trap is beautiful to look at, but rates only two skulls. The bees will chase the delvers off. Chances of death are slim.

Use the following stats for the killer bees:

Killer Bee Swarm: CR 4; SZ D Vermin [Swarm]; HD 9d8-9; hp 31; Init +4; Spd 5 ft., fly 40 ft.; AC 18 (+4 size, +4 Dex), touch 18, flat-footed 14;

BAB/Grp +6/—; Atk swarm (2d6 plus poison); Full Atk swarm (2d6 plus poison); SA distraction, poison (Fort DC 13, 1d4/1d4 Con); SQ darkvision 60 ft., immune to weapon damage, swarm traits, vermin traits; AL N; SV Fort +5, Ref +7, Will +3; Str 1, Dex 19, Con 8, Int —, Wis 10, Cha 2.

Skills: Spot +4. Killer bee swarms gain a +4 racial bonus to Spot checks.

Feats: Weapon Finesse^B.

See the MM for details on swarms.

Trap #34: Did Someone Mention Poison Gas?

	2
CR:	2
Type:	Mechanical
Search:	Trap (DC 20), Trigger (DC 20)
Disable Device:	Trap (DC 20, 2d4 rounds); Trigger (DC 20, 2d4 rounds)
Primary Trigger:	Event (opening coffin)
Primary Trap Effect:	Grimmy's backlash fumes (1d2 Con/1d2 Con each round in the room)
Primary Save:	Fortitude (DC 15)
Reset:	Manual
Cost:	2,000 gp

After the beauty of the last trap, the childish simplicity of this next one is almost embarrassing. Upon reaching the coffin, the party will find that it has a lid that is almost indistinguishable from the base. The stone from which the coffin is carved is unlike any you have ever seen. Even a dwarf will be hard pressed to remember any like it. The stone is rare and of great inherent value, perhaps as much as 15,000 gp delivered in usable condition. A dwarf, if present, can make a Knowledge (stonework) or Craft (stonework) check (DC 18) to identify it as having been quarried on the

long-lost continent of Hy-atlan, sunk beneath the sea millennia ago during the myth-shrouded Age of Upheaval. This stone's like is found nowhere else in the world today.

This is all very nice and will serve to cloud the issue. Once the party summons up the courage to open the lid they will release the trap mechanism.

Simply put, once the lid is moved, a piston that fills the base of the coffin begins to push upward forcing out of the long deep shaft within a heavier than air toxic cloud. Even attempting to put the lid back in place will not stop the outflow for long. The piston will simply continue until the pressure buildup is sufficient to displace the lid. The gas will begin to build up and spill out over the floor. If the party left the entrance open it will not reach higher than the delvers' ankles. If the door was left closed then the room will eventually fill. This will kill any remaining bees, and any air-breathing members of the party.

If by some miracle there are non-air breathing members of the tomb robbing team, or they get the door open they will find no treasure inside the coffin.

The gas trap is a one skuller, unless the party is made up of real boneheads.

Trap #35: C'mon Guys Get A Grip!

	5
CR:	5
Type:	Mechanical
Search:	Trap (DC 28), Trigger (DC 28)
Disable Device:	Trap (DC 26, 2d4 rounds); Trigger (DC 26, 2d4 rounds)
Primary Trigger:	Touch (the ladder)
Primary Trap Effect:	Oil coats side rails and crossties of ladder (Climb check DC 25 to continue climbing or moving on ladder)
Secondary Trigger:	Location (stepping on crosstie 55 feet down ladder)
Secondary Trap Effect:	All crossties on ladder release and those on ladder fall (1d6 points of falling damage for each 10 feet fallen)
Reset:	Manual
Cost:	12,000 gp

Once the party has exhausted all the options of this room without finding the elusive treasure, they will begin to search the walls for doors. On the wall opposite the entrance beneath the stucco, as usual, there can be found two doors. The doors are located just beyond the ends of the coffin at either end of the platform.

Both doors are of the three finger hold type, and once opened present the delver with the same vista. The doors open into the room of the terra cotta soldiers, and reveal a 10-foot by 10-foot shaft leading down. There is a ladder in each shaft, but it is on the wall opposite the door in each case.

Let us begin with the door on the right. Clearly to go on will call for a leap of faith. Sure there are ways to laboriously inch a party's way around the walls over to the ladder. Pitons and climbing ropes, and

such craven devices come to mind. A more likely delver I.Q. level solution will be to tie a rope to a party member and have him jump over, and grab hold of the ladder (Jump check DC 10). To the party's surprise this will work. It will also set off the trap.

In a reservoir at the top of the ladder is a tank of thin, and extremely slippery oil. When the first party member's weight is put upon the ladder it will slip down a fraction of an inch, allowing the oil to run down the sides of the ladder. Very little of the oil will get on the crossties, but close observation will reveal the crossties are set in parallel grooves on the sides of the ladder. The oil will coat the sides very quickly. Other than glistening in the torchlight, the oil will seem to have no affect.

At some point the party will have to continue on down. If they give up on the ladder altogether they will need 90 feet of rope to reach the bottom of the shaft. If they trust the ladder, they will find, if their initial tester is willing to climb up and down a little, that the ladder is perfectly safe and solid for at least the first 25 feet down, and back up. Hopefully at this point, oily sides notwithstanding, the delvers are likely to give the ladder a try.

At a point 55 feet down there is a series of 10 rungs, any one of which will cause the trap to activate. Once weight

is brought to bear on one of these rungs a release in the upright sides of the ladder is tripped, and all the crossties are released. As they have been thoroughly lubricated, they will slide down the grooves until they reach the bottom of the shaft, 45 to 90 feet below. Efforts to grab hold of the sides of the ladder are largely futile, first because of the lubricant oil, and second because of the falling crossties. Any grip will necessarily require all or part of the delver's hand to cover the groove. Thump, the first crosstie hits, thump, the second, the third, and so forth, the Chinese water torture has nothing on this. Eventually the repeated impacts, or the weight of the mounting crossties (not to mention other members of the party foolish enough to be on the ladder above) will knock even the toughest delver off.

Eventually the tomb robbers will end up in a heap along with 80 metal crossties at the bottom of the shaft. The shaft and the ladder end 10 feet before the actual floor as the tunnel continues off in that direction.

This is a three skull trap, fairly lethal. It escapes four skulls by the fact that most delvers will tie themselves off to the top somehow, and thus escape the death plummet.

If the party elects to continue on down the tunnel thus discovered return to the portion of the tomb labeled "RIGHT FACE!" and run the traps in reverse order! This corridor will dead end next to the door out of which Trap #14 "Things Get All Screwed Up" emerges.

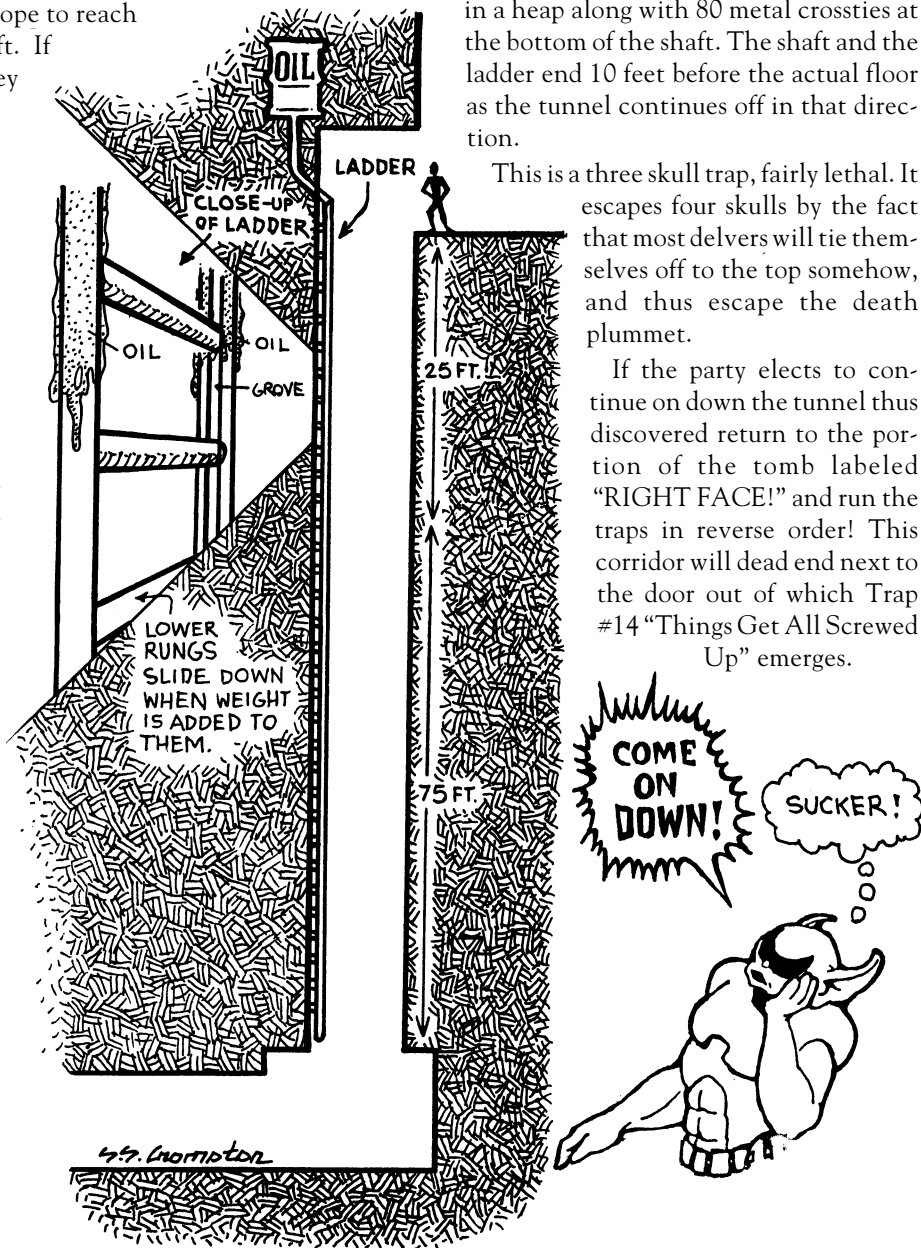

W.S. GORMITON

Trap #36: So You Want To Get To The Bottom Of This, Eh?



CR:	10
Type:	Mechanical
Search:	Trap (DC 30), Trigger (DC 28)
Disable Device:	Trap (DC 35, 2d4 rounds); Trigger (DC 28, 2d4 rounds)
Primary Trigger:	Location (pressure plate on floor of shaft)
Primary Trap Effect:	Concussive blast (16d6 points of force damage to those within 10 feet of floor, 12d6 to those within 11-20 feet, 10d6 to those 21-40 feet away, and 8d6 to those up to 100 feet away)
Primary Save:	Reflex (DC 25) for half (only those 20 feet or more away receive a save)
Reset:	Manual
Cost:	30,000 gp

To avoid a long description, the door on the left leads to a shaft and ladder arrangement exactly the same in appearance to the one behind the door on the right. There are two differences. The first is that the shaft behind this door is 200 feet deep, and the second is that there is no vat of oil at the top of this ladder. As with Trap #35, the party will in all likelihood be reluctant to just jump over and grab a rung. With patience and careful coaxing they will eventually work up the requisite nerve to perch themselves on the ladder. They will be sure of

some doom befalling them on the ladder, so this time there is a surprise in store for them. The trap is at the bottom. After an agonizing descent the party will find itself within 10 feet of the bottom of the shaft when they run out of ladder. The party must drop to the floor below. The first weight that hits the 10 by 10 foot space at the bottom of the shaft set the trap for the next. (Ideally the party will have dropped something down the shaft as a test and really cooked their own geese.)

When the second weight hits the bottom of the shaft the 10 by 10 foot panel will explode upward with great force! When the first weight hit the panel, it locked in place. Into a room below the panel, was vented water from the supply that honeycombs the tomb area. This water comes into contact with another of Evinrood's dormant fire elementals contained herein. The water is converted to live steam, as the elemental is annihilated. Then the second weight trips the release that causes the panel to be blown back up the shaft by the force of the steam explosion. When the panel hits the ladder, parts of both will become shrapnel flying back up the shaft.

The ladder will be ruined by all this, and certain members of the party as well!

Four big skulls for this one, death is not only likely, but probable for at least one of the tomb robbers! It's a great way to give the delvers the shaft....

Trap #37: Evinrood Tries To Dust Off The Party



CR:	3
Type:	Mechanical
Search:	Trap (DC 20), Trigger (DC 20), Secondary Trigger (DC 25)
Disable Device:	Trap (DC 20, 2d4 rounds); Trigger (DC 20, 2d4 rounds), Secondary Trigger (DC 25, 2d4 rounds)
Primary Trigger:	Trap #36
Primary Trap Effect:	Shaft fills to 10 feet with water
Secondary Trigger:	Touch (loosening one or more of the gold balls on the sarcophagus)
Secondary Trap Effect:	Blood Dream Poppy powder is blown in a 20-foot radius (see the effects in the text below)
Reset:	Manual
Cost:	5,800 gp

Any party members who survive the explosion will find themselves in a rapidly filling pool of water at the bottom of the ladder shaft. This is not intended as a trap in and of itself, it being the last remnant of the water supply used to set the trap originally. The space at the bottom of the shaft will fill up to the level of the old floor then stop. This does create a pool 10 feet deep, in the 10 by 10 foot shaft. Heavily armored delvers will be well advised to exit as fast as they can through a door in the

wall directly under the place where the ladder ended. (Any delvers that are really slow on the uptake can be forced to make a roll to survive being immersed. However, at this point it is unlikely that any of them will be dumb enough to stand about and wait for the water to lap over their heads.)

The delvers will find themselves in a corridor 30 feet long and 10 feet wide. At the corridors end there is an obvious door. The door's surface is covered with bronze plate into which a design has been impressed. The design shows the stubby figure you recognize as Evinrood. He seems to be fighting a battery of half-seen images, the rest of the inlaid figures are very indistinct. They seem to be horrific creatures but the work appears to be incomplete and the images only half formed.

The door has a golden lever as its latch release. (The gold value is about 150-175 gp — the question *will* be asked.) This will give the party a few moments of concern, especially when they pluck up the courage to turn it. (A gang of delving thugs don't like anything out of the ordinary, and will often bicker about the "signs and portents" of a "different" event endlessly!)

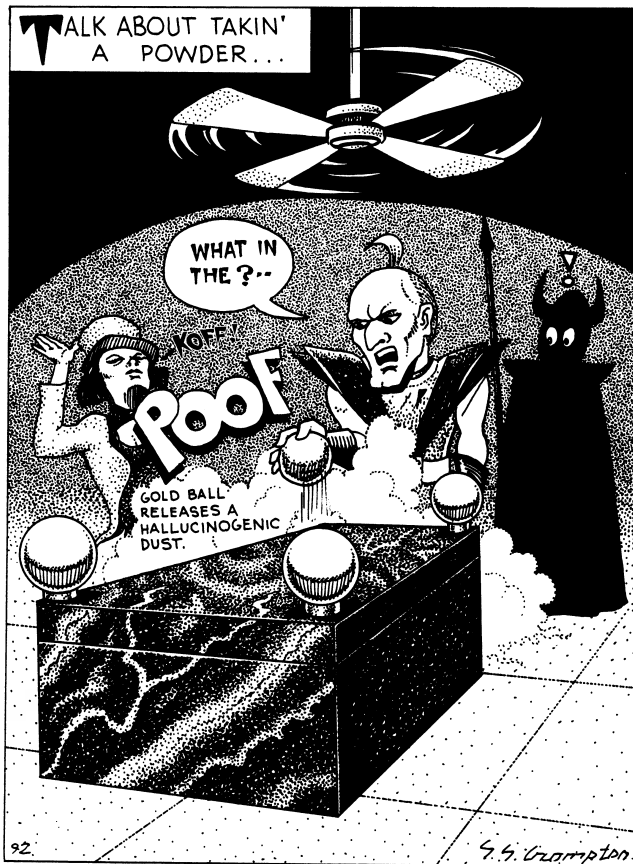

When the latch is depressed there is an audible “click.” (If you thought the party was concerned before this should really put them on edge.) The door opens into the hallway and reveals a room 30 feet by 30 feet with a 20-foot ceiling. In the center of the room is a raised dais on which sits yet another sarcophagus. Above the sarcophagus there is a vast, rapidly turning ceiling fan, the arms of which are over 20 feet in length. It is made of woven rattan and as such it is not likely to be lethal. (Ah, those whirling blades of doom, I have used them well, alas.) The fan does cause a fairly still breeze within the confines of the room.

The sarcophagus is made of black stone, and is very plain, save that the lid is held in place by four golden balls. These balls are very large, 14 inches in diameter, and appear to be attached somehow to the top of the sarcophagus.

The walls of the room are covered with a fresco of Evinrood working in what seems to be a laboratory, when a large birdlike creature arrives with a parcel. Out of the parcel emerges an army of misshapen daemons. Evinrood struggles in vain against them and is overwhelmed. The last panel shows Evinrood rising from the floor in his laboratory, and the daemons are gone. Every last lone of them, vanished!

The frescos will serve more to confuse the party than aid it, but then what can they expect from clues provided by an eccentric, high-level mage?

The tomb robbers will try a variety of methods to open the sarcophagus before trying the gold balls. Which they are sure will release some bizarre doom. But, gold being gold, the balls will keep drawing them back. The balls are screwed onto metal posts at the corners of the sarcophagus. They will turn easily and after a point they will come free. The balls are fairly thick but hollow, their value in gold is 1,250 gp each. But their chief value will not be the gold but what they contain.

Just as the party frees the first ball (it would really be wild if the delver would release all the balls at once) a very fine whitish-pink powder will spill out of the ball. This will be very hard to stop as the posts are 5 inches in diameter, and the party is unlikely to expect the golden ball to be a container. The party will also be lifting the ball off the post so a large spill is even more likely. The powder is so fine that the wind from the fan will swirl it instantly about the room. If the delvers trashed the fan earlier on, in act of delver-like vandalism the effect will be diminished but by no means eliminated.

The powder is the “dust” of the “blood dream poppy.”

For those with average or less Constitution scores (10 or less), it is a violent, and nearly instantaneous hallucinogen. Those exposed must succeed at a Fortitude save (DC 15) or be affected. These individuals will collapse to the floor writhing and twitching in fear from dreams too horrible to imagine. Among these individuals there is a 40% chance of complete madness (affected by a permanent insanity spell). (If all four balls were removed at once the dose will be massive, and the chance of madness for below average delvers will be 80%!)

For delvers with average to slightly above average Constitutions (10-14) the “dust”

ALL THEY ARE IS DUST IN THE WIND...

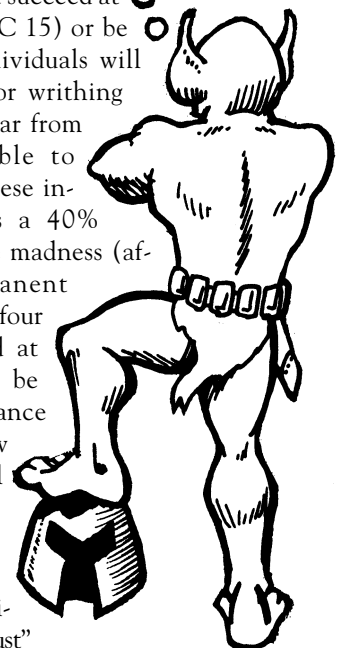

will create vivid images of horrific monsters, or terrible traps closing upon them if they fail a Fortitude save (DC 15). They will strike out at anything that comes to hand, not recognizing friends, or even inanimate objects. There is a 25% chance that any character of average Constitution will from this point on experience flash backs to this drug effect for the rest of the delver's career. (For the purposes of future play there is a 1% chance in a critical situation that the delver will "flash-back" and attack friends instead of foes. Fellows like this are often tagged with the nickname Whosits the Mad!)

Delvers possessed of extraordinary Constitutions (14+) that fail their Fortitude save (DC 15) are affected as described from the Average constitution delvers above. If they don't come under the effects they will find their movements sluggish and less well directed than usual (movement at one-half speed and -4 to attack rolls, damage rolls, checks, and saves). They will have lost their "edge." Thus if the average characters are thrashing around trying to kill the "daemons" they see, the "tougher" delvers will have to defend themselves at less than their normal effectiveness.

All the effects will pass in 10 minutes, with the exception of the madness and flashbacks. The Poppy "dust" has a significant commercial value if it can be contained (1,500 gp at least). (Where there is a will there is a way, and the delvers will be carrying this stuff around corked in the gold balls.)

Note: If the fan is broken (hardness 5, hp 20, Break DC 18) reduce all the percentages by 10%, the dust will disseminate from the gesture required to remove the ball and the cloud will have its effect. Even a very small amount of this stuff goes a long, long way!

The sarcophagus is just a solid stone slab with an inlaid line at the top to give the illusion that there is a lid to be removed.

In the left hand corner of the room nearest the entrance is a standard three finger hole door, possibly revealed by stucco removed during the party's drug induced struggles.

This is a two skull trap. Death will result if sufficient "average" delvers are affected, otherwise the effects are entertaining but less than lethal.

Trap #38: ...It Makes Me Feel Tingly All Over!



CR:	1
Type:	Mechanical
Search:	Trap (DC 18), Trigger (DC 20), Bypass (DC 20).
Disable Device:	Trap (DC 22, 2d4 rounds); Trigger (DC 22 2d4 rounds)
Primary Trigger:	Touch (turning the wheel)
Primary Trap Effect:	Electric jolt (2d6 electricity damage)
Primary Save:	Reflex save (DC 20) to let go of door before jolt
Reset:	Automatic
Cost:	1,600 gp

Once the Party has left the room with the narcotic dust, they will find themselves in a hall 50 feet tall and 10 feet wide. The end of the hall is invisible in the darkness, and upon inspection will be found to end in a blank stone wall. No amount of digging or scraping will reveal anything but stone. However, 30 feet down on the right hand side is a bronze door.

When the party reaches the door they will find it to be yet another of those doors that depict an event in the life of the mage Evinrood. On the face of the door, a masterpiece of the bronze casters art, is depicted a young Evinrood. He is familiar by his short stumpy stature. He is in a vast library, seated at a desk. There is a look of profound surprise on his face.

In the center of the door there is a large wheel. This is clearly the mechanism by which the door can be opened. A careful inspection will reveal no other alternatives,

and the door is formidable in construction, ruling out direct assault (Hardness 10, hp 110, Break DC 35).

As usual the delvers will be certain it is a trap, which of course it is, and will attempt to put off the inevitable by discussing it. This fear of the unknown will eventually be overcome by basic greed and finally the wheel will be turned, with no visible effect.

The wheel turns with gradually increasing effort, and once turned the direction cannot be reversed. After 25 to 30 full rotations there will be heard a loud "Thung!" sound from within the structure of the door itself. At the same time there will be a sudden release of tension on the wheel.

Inside the door is a spring mechanism that the hapless tomb robber has been obligingly winding for us. At a certain point the spring will reach optimum tension and break free of the winding mechanism. This creates the "Thung" sound. The spring will then begin to unwind at great speed turning a copper covered lodestone disk against a brush-like arrangement within the door. The copper disk is 5 feet in diameter and spins freely, driven by the spring. This will create a very lively spark, which just happens to be grounded out through the wheel that is used to wind the spring. (This is a contained, and smaller version of the trap at the entrance. Neat, portable, and usable everywhere. If they weren't so difficult to make I think the old Mage would have used them throughout the dungeon.)

The lucky tomb crasher can make a Reflex save to let go otherwise he will be subjected to the static jolt! If the character is of less than average physical health the

shock will likely cause cardiac arrest. If the delver is of average or greater constitution, there will just be a nasty jolt, and some burns on the hands.

As usual in this cozy tomb, once the trap has been sprung, the door opens.

I'd rate this trap at only one skull. By this time the party is probably using insulated gloves, and anticipating traps on

everything. If they are not, the trap is still fairly lightweight, because Evinrood really doesn't want to discourage entry to the upcoming room. If a Trap master wanted to use this trap to its best advantage, a combination of gears will amplify the speed of the copper wheel, and copper plating placed on the floor of the corridor will enhance the effect. (then you end up with at least a two skuller.)

Trap #39: Make Mine Very Dry...



The door opens onto a 30-foot corridor ending in another bronze door. This is identical to the one the party just passed through, down to the wheel in the center. After the party has insulated themselves they will more than likely start turning. Nothing obvious will happen. What this wheel does is release the large block of stone at the end of the corridor the party has just come from.

If the party was put off by the first bronze door they will have proceeded to the end of the first corridor and encountered the blank stone wall. When this door wheel is turned it will activate a mechanism that causes the corridor to open by lowering the stone into the floor or the corridor. The reason for this will become apparent. This is the initial set up for one of the best "one-two punch" traps I have ever seen. (And believe me, I've seen 'em all!)

Eventually the door, or in the case of those entering from Trap #25, the trap door, will open to reveal a very large room 30 feet deep, and opening 50 feet off to the right and 50 feet off to the left. The ceiling is over 12 feet high. To the left as the tomb robbers enter are shelves of scrolls and bound notes. Off to the right are numerous chests, and containers, as well as bolts of what looks like cloth. Directly in front of the party is a vast oaken desk behind which is a throne-like wooden chair. Members of the party with any mercantile skills at all will be able to tell the others that the desk and chair would have great value (2,500 gp) even if the other stuff is junk (Craft or Profession [merchant] check at DC 12).

Magic-using members of the party will at this point want to extend a cautionary note. The room is permeated by a magical spell. Upon investigation the magely members of the group will know it is a spell of preservation, which will make sense because of the paper, and cloth contents of the room. The spell will not trigger any overt offensive actions. It serves only to protect the contents of the room from the ravages of being stored for a long, long time, in a potentially damp environment.

The party will want to enter the room to inspect the contents, but in light of past events they will be very cautious. Eventually on or all of them will go in.

Now the fun begins! They members of the party will find that there are chests containing very valuable silks, and linens. They will also find, in the chests farthest from the door, cloth-of-gold. This is a type of fabric woven of fine metal filaments, so that it feels like fabric but is in fact pure gold. There is also copper and silver fabric as well, each so unique that its like is not found in the world today, save in the courts of kings and emperors. There is one chest each of each metal fabric, and the value is over 10,000 gp each. The nine other chests of other fabrics are worth 1,000 gp each! The party should be overjoyed. Of course this inventory should take some time, oh trap master, and you should keep track of this passage of time. It is under one of these chests of exotic fabric that the Trap Door up from Trap #25 is located.

The scroll side of the room is a veritable treasure trove as well. Each parchment is an historical document, and could be sold to antiquarians and mages for princely sums. The piece-de-resistance is the short shelf on the wall farthest from the entrance. On this shelf is a collection of spell scrolls, many of which have gone out of the world! This information is priceless, or would be if any member of the party knew the languages they were written in. Delvers should not be daunted. They will discern, if there is still a living magic user among them, what the scrolls are. Someone can be found who will be able to translate them. The value of the entire collection is over 50,000 gp! As with the silks, an inventory will take time.

The reason for keeping track of the time spent in this room is that the spell laid on the room is a Spell of Desiccation (variant of a lesser *horrid wilting*). It excludes moisture in *all* forms. If the party spends only one round in the room, they will be thirsty, but not be extraordinarily so. Two rounds, brings a noticeable thirst with some urgency. Three rounds, brings an obsessive desire for a drink. Four rounds or longer and the party members who have entered the room will kill for a drink of any substance that even gives the impression of moisture!

A full canteen will slake the thirst of one person, the catch being that any canteen that has been in the room will be "bone-dry." The thirst effect will only begin to be felt after it reaches the third round level,

then only as an urgent thirst. The party will likely flee unless the brightest members have already become trap tofu. If they leave the room before the fourth round effect sets in, keep in mind the effect is cumulative. If they go back in they will just get dryer, and dryer. Looting this room is thirsty work, *very thirsty work!*

The room is only a one skuller, but don't let that dismay you, the best is yet to come!

If they party entered this trap from the Trap Door in the floor under the chests of cloth, reverse the operation of the entrance door, Trap #38. We wouldn't want the party to miss out on any of the fun, would we? And keep in mind the level of thirst keeps increasing. This could force trips up and down the ladder for water while the party waits for the door to open. Remember the canteens will be dry before they can cross the room from the Trap Door to the regular entrance.

Trap #40: ...Cool, Clear, Water!



CR:	8
Type:	Mechanical
Search:	Trap (DC 25)
Disable Device:	Trap (DC 20, 2d4 rounds)
Primary Trigger:	Trap #39
Primary Trap Effect:	Sulfuric acid pool (no attack roll necessary; 1d6 acid damage per round of contact). Should a delver actually drink the acid, he must succeed at a Fortitude save (DC 30) or die immediately.
Primary Save:	Fortitude (DC 30) avoids death from the acid
Reset:	No reset needed
Cost:	18,000 gp

When the party emerges from the thirty-foot corridor leading to the storeroom they will find that the stone block at the end of the original corridor is gone! They will also trigger a tilt plate that was not set until they opened the door to Trap #38.

This tilt plate starts a lyrical sound that right now is better than music to the delvers' ears: the sweet tinkle of a fountain. The party can see it glinting in their torch light 40 feet away. The sparkle of falling droplets will be an almost irresistible magnet to any party member who was in the storeroom for three rounds. (A Will save at DC 18 prevents the creature from rushing the water obsessively.) Those who have not entered the room, or were in the room for only one or

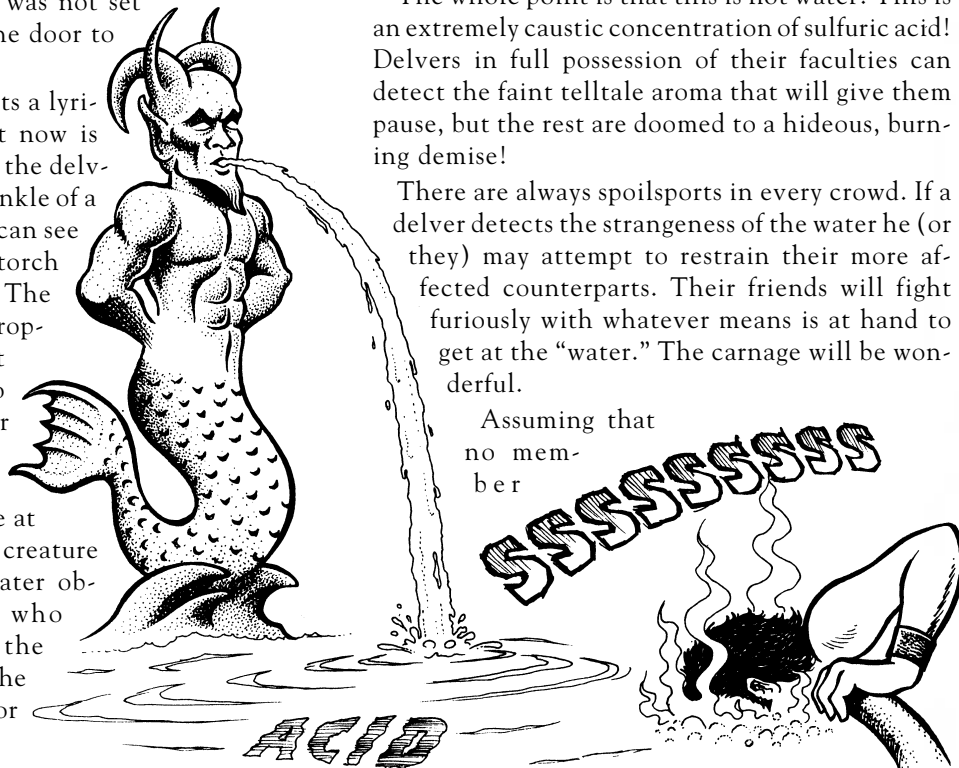

two rounds will be able to resist the lure.

Those party members who were in the room *four* rounds or more, will go mad with thirst and bolt for the water with a berserk single-mindedness (no save)! The beauty of this trap begins to unfold. (Now comes the *really* great part!)

Upon entering the room the party will find large shallow fountain. In the center of the fountain is the statue of a fish-bodied daemon from whose mouth issues the scintillating stream of "water." The pool surrounding the fountain is over twenty feet round and almost fills the 30-foot by 30-foot room. The pool is only 2 feet deep, and in the bottom can be seen the glint of gold pieces. There are over 10,000 gp scattered about the bottom of the pool. The gold will make literally no difference to the berserk Three round delvers and all Four or more round delvers. What they see is the water!

The whole point is that this is not water! This is an extremely caustic concentration of sulfuric acid! Delvers in full possession of their faculties can detect the faint telltale aroma that will give them pause, but the rest are doomed to a hideous, burning demise!

There are always spoilsports in every crowd. If a delver detects the strangeness of the water he (or they) may attempt to restrain their more affected counterparts. Their friends will fight furiously with whatever means is at hand to get at the "water." The carnage will be wonderful.

Assuming that
no mem-
ber

of the party was in the storeroom too long, but they all fail to react to the acid smell, there is always the presence of the gold to get a delver to reach into the pool.

This acid will affect metal even more than leather armor, and is more likely to “leak” into it. Flesh will be extremely adversely affected by the acid. (I’d call turning bright red, blistering, and peeling away in shreds adversely affecting, but I’m a big fan of adverse affects.)

Any metal tools used to fish out the gold will be functionally useless from the effects of the acid. (It is very unlikely the party will have anything to dilute the acid, or a sufficient supply of caustic base substance to neutralize it on the tools or exposed skin.)

This trap is so diabolically set up that in combination with The Desiccation Room it rates the brightest four skulls. Even without the “dying of thirst” aspect, the room rates three skulls on the premise that the delvers will play with it until they get burned.

Trap #41: These Things Tend To Get Away From You!



CR:	10
Type:	Combination (Magical and Mechanical)
Search:	Trap (DC 28), Trigger (DC 28)
Disable Device:	Trap (DC 30, 2d4 rounds); Trigger (DC 30, 2d4 rounds)
Primary Trigger:	Location (steps)
Primary Trap Effect:	Affects creature stepping on stairs by increasing his rate of descent if he fails a Will save. The first step is at normal movement, the second step is at a trot, the third at a run, and so on until the delver is descending the steps at an inhuman speed.
Primary Save:	Will (DC 25) avoids
Secondary Trap Effect:	Delver running down the stairs slams into stone door (no attack roll necessary; 10d6 crushing damage)
Tertiary Trigger:	Touch (if delver manages to open the door before slamming into it)
Tertiary Effect:	Character is propelled into the acid pool in trap #40 (1d6 points of acid damage each round of contact; 6d6 submersion).
Reset:	Manual
Cost:	38,000 gp

There is an open doorway leading out of this room on the wall to the left of the entry. There is a hidden door directly opposite the storeroom entrance, but the party will have to find it (Search at DC 20). Detection magic or stucco flaking again is required. If the party does detect it and goes that way, advance in the text to “Loading the Gun” and continue on. If the party looks to the open doorway this is what they find.

First they will find a small plaque on the wall about eye level to a human. It is inscribed, “West Construction, Wayne West Chief Engineer.” They also find themselves looking down a long flight of stairs into the darkness.

These stairs are over 70 feet long. Magic users will detect a slight magical aura. Each step is possessed of a low level magical charm. It appears

to be akin to some of the less effective spells of combat enhancement that lower level mages might cast. It has been laid on in such a way that it cannot be dispelled, but on the whole is not too threatening.

If any member of the party elects to try the stairs the spell’s effect will become obvious. Each step doubles the rate of speed at which it was entered. Step down at walking pace, the next step is taken at a trot, then a run, by round four the character is sprinting! There are 70 steps. The speeds attainable can be amazing. The character can achieve greater than his normal running speed due to the magic laid on the steps.

The character will not be able to control his momentum by conventional means. Though you may fid that clever delvers will attempt various devices, I leave it to you to judge their success. (Once again a mage could fly off then regain control, but others who must remain in the grip of gravity will have to resort to more innovative solutions.)

At the bottom of the stairs is a locked stone door. At the speed the delver should be going there is certain to be a wonderful, *splat!* Or at the very least the satisfying *crunch!* of breaking bones. In the event that the delver or delvers can open the door on the fly (Dexterity check at DC 40), with a spell or magic charm, an even greater surprise awaits them.

This trap will work in reverse, accelerating upwards until at blinding speed the stair climber is propelled into the Acid pool room and into the 2-foot high edge of the pool itself. (I really love it when these things work so well in both directions.)

Up or down this babe is a four skuller. In acid or onto spears at several times the speed a man can run with virtually no safeguards... Even if the character runs into the door at the bottom without opening it the result will be heralded by the satisfying crunch of breaking bones. These are a few of my favorite sounds...

Trap #42: And You Thought You Got Away



CR:	7
Type:	Mechanical
Search:	Trap (DC 20), Secondary Trigger (DC 20)
Disable Device:	Trap (DC 22); Secondary Trigger (DC 22)
Primary Trigger:	Location (delver is affected by Trap #41)
Primary Trap Effect:	Wall of spears (+20 melee, 1d6 spears, 1d8+12 damage each spear, crit x3) or collision with walls in room (8d6 points of crushing damage)
Secondary Trigger:	Location (pressure plate on floor)
Secondary Trap Effect:	20-ft deep pit (2d6 falling damage)
Secondary Save:	Reflex (DC 20) avoids
Tertiary Trigger:	Location (floor tilts and smashes into wall when someone falls into pit)
Tertiary Trap Effect:	Volley of spears (+20 melee, 1d6 spears, 1d8 damage each spear)
Tertiary Area of Effect:	Multiple targets in the pit
Reset:	Manual
Cost:	22,000 gp

Picture this, the tomb traipsers are blazing down the stairs, at the last second he magics the lock in the door, and it flies open to reveal 10 feet away a wall of spears! The look on their faces is priceless! (Disappointingly there is a slim chance of survival, from acrobatic contortions out of the way. But if they miss the spears there is still the impact with some other part of the room. This will generate disabling damage in some cases.

The spears are 10 feet long and crafted of dwarvish steel. They are set lightly in sockets in the wall and can be easily removed. Due to the craftsmanship involved in their construction they are worth 10 times what spears of this type would be worth (that's about 400 gp each, and there are 30 of them).

As competent trap masters you will recognize that as difficult as it is there are those who will survive these stairs. Fear not, this room will not let them go that lightly. For those who reach the bottom of the stairs unscathed (or by virtue of unbelievable constitutions only slightly scathed) they will have to open the door and enter in a more conventional manner. If they do this they will be treated to the second best part of this trap.

The party will be naturally surprised when the spears in the far wall do not leap out at them. After a time they will begin to think perhaps these are time released and want to enter the room. A 10-foot by 10-foot square section of the floor just inside the entrance is a trap door. When the first party member enters, the floor falls away forward and down, depositing the hapless creature in a 10 by 10 foot by 20-foot deep pit under the floor. The unique thing about this trap, since I know you expect

something better than an ordinary hole in the floor from your host, is that the floor section that falls away under the victim's weight is joined by an axle to the section of floor under the wall of spears. As a result when the floor falls the other floor section will pivot upward taking the wall of spears with it. The wall of spears will crash into the wall above the door and the spears will drop into the pit impaling the poor fellow who first entered.

The best part of this trap is that in order to proceed, the party must trip the trap, because the wall of spears is the exit to the room!

If by some mischance the room is entered from the opposite direction this trap will be activated resulting in the spears falling harmlessly into the pit. If old Evinrood were perfect, being a high level mage, he'd probably still be with us. (An elaboration that suggests itself would be to put a weight limit on the initial floor section in order to "trap" more delvers. This could backfire however if the party enters one at a time.)

Once the trap has been tripped the way is open to proceed.

In concert with the stairs the trap is a three skuller, and entered from the Acid Fountain side without benefit of speed it is still a two skull trap, but alas if entered from the wrong direction the whole thing is a bust.

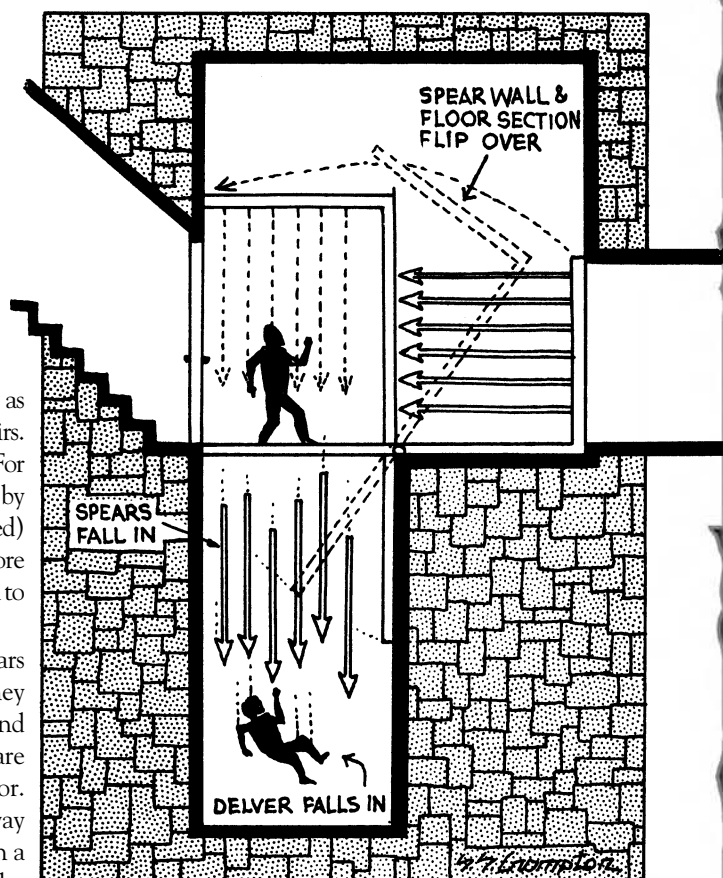

TRY WIGGLIES SPEARMENT GUM...

Trap #43: I Always Figured Tomb Robbers Deserve A Good Trashing



CR:	8
Type:	Mechanical
Search:	Trap (DC 25), Trigger (DC 25), Bypass (DC 25).
Disable Device:	Trap (DC 25, 2d4 rounds); Trigger (DC 25, 2d4 rounds)
Primary Trigger:	Location (pressure plate on floor activates when 500 pounds or more weight enters room)
Primary Trap Effect:	20-foot fall onto blades (2d6 points of falling damage)
Primary Save:	Reflex (DC 26) avoids
Secondary Trap Effect:	Giant-bladed thrashing machine (no attack roll necessary; 8d6 slashing damage each round)
Bypass:	A hidden switch perhaps locks the floor in place (Search DC 20 to locate)
Reset:	No reset needed (unless blades are jammed)
Cost:	27,000 gp

Upon exiting the “wall of spears” room the party will find themselves in a small corridor 10 feet wide and 20 feet long, with a ceiling 10 feet high. At the end is a blank wall. Beneath the stucco is a typical three finger hold door. Once the party has opened the door they will find a 30 by 30 foot room with the usual doorless walls. They are covered with stucco. The floor is divided into four square sections, of four different colors. The colors are irrelevant but in order to add to the party’s confusion by feeding idle speculation, they are red, gold, green and blue. Once the party begins to enter the room keep track of the total weight of the characters. You don’t want to be caught unawares when the 500-pound limit is reached and the trap activates.

Once 500 pounds of tomb robber on the hoof enters the room the floor splits down the middle and dumps the

entrants into the jaws of a giant bladed thrashing machine. The floor then slams back into place.

The thrasher is a truly inspired device. No dungeon should be without one. This beauty consists of two giant counter rotating axles studded with crude, rusty, iron blades. The whole mechanism is built 20 feet below the floor level. The blades are set to rotating by surprisingly noiseless water wheels fed from the underground river. The water is released into the trap by the opening of the doors. (If the party lies on the ground before entering they will hear the sound of rushing water, and perhaps the rumble of the turning wheel, but seriously, when was the last time you saw a party of delvers do that?)

There is a 30% chance that heavy plate armor will jam the works, which will save all the others who fell in from death. If the party has any “indestructible” item (a Deluxe Staff, The Sword of Incredible Hardness, or such like) this will serve to jam the device as well.

Anything used to jam the thrasher will be lost. The blades cannot be pried apart with the pressure of the river pressing upon it. If the person inside the plate armor can demonstrate the ability to get out of the armor by wriggling about (Dexterity check at DC 18) he can get free. If that agile, he will be subject to the same damage as one of the lightly armored fellows when the thrasher jerks snug, crushing or twisting some now empty piece of armor.

Below the thrasher there is a wide assortment of chipped bones, crushed armor, and battered odds and ends. There is also about 3,000 gp worth of loose change.

Once the mechanism that operates the floor sections has been understood, or jammed, the party can check out the walls for doors.

With armor this is only a one skull trap, but if there is no heavy armor present, it moves up to a three skuller.

Trap #44: This Trap Is A Gas!



CR:	6
Type:	Mechanical
Search:	Trap (DC 24), Trigger (DC 22)
Disable Device:	Trap (DC 24, 2d4 rounds); Trigger (DC 24, 2d4 rounds)
Primary Trigger:	Event (turning the door wheel)
Primary Trap Effect:	Releases a highly flammable and volatile gas into the area that quickly fills the hallway
Secondary Trigger:	Proximity (any incendiary device or open flame type object within 5 feet of door)
Secondary Trap Effect:	Explosion that deals 6d6 points of damage to all within 20 feet of door. Those within 5 feet of the door automatically catch fire (see Catching on Fire in the <i>DMG</i>).
Tertiary Trigger:	Timed (the explosion)

Tertiary Trap Effect: Jet of flame 5 feet long from door (1d6 points of fire damage and catch on fire). The jet of flame burns for 2 minutes.

Quaternary Trigger: Timed (the fire and heat)

Quaternary Trap Effect: The door is searing hot and remains so for 5 minutes after the flames die out. Touching the door deals 1d6 points of heat damage.

Quinary Trigger: Location/Timed (party exits area and allows gas to build in hallway without triggering the first explosion or flames)

Quinary Trap Effect: Gas builds in hallway to deadly levels

Senary Trigger: Location (party enters hallway with incendiary device or open flame)

Senary Trap Effect: Massive explosion (12d6 fire damage to all within a 20-foot radius and catch on fire)

Reset: Manual

Cost: 45,000 gp

Directly across the room from the "wall of spears" door can be found a typical three finger hole door under the stucco. Once it is opened the treasure hunters will find a corridor 10 feet wide, 10 feet high, and 20 feet long. This hall ends in a bronze door.

The bronze door depicts upon its beautifully crafted surface a human figure wreathed in flames. The figure is beset by daemonic figures that are doing their best to destroy the flaming humanoid.

In the center of the door is a wheel. Turning this device seems to be the only way to open the door.

Once the party begins to turn the wheel, a cap in the center of the wheel pops off giving vent to a thin high-pitched hissing sound. A Listen check (DC 12) detects the sound. And in any event the unusual noise will doubtless have the party scrambling back to the edge of the Thresher room.

If the individual turning the wheel is made of sterner stuff, or is too stupid to care, check to see if he is holding a torch, or if there is someone within 5 feet of him holding a torch, lamp or like incendiary device. If there is, then an unpleasant explosion occurs. The door is hollow and solid metal. It was chilled as much as possible then pumped full of and explosive gas, and the wheel driven in. Once the wheel is turned the venting system in its center releases the gas. If the delver stays with the door despite the hissing and an explosion results, there will be relatively little gas present. The delver at the door will find all his cloth garments on fire, as well as his hair,

but if he thinks quickly he can save himself, or be saved by having the flames smothered in short order.

If the delvers stayed with the door and the small explosion resulted, there will be a small jet of flame out the center of the wheel, until the gas has burned off then the door will be safe to open (1d2 minutes). (Note the party will almost certainly use the wheel to pull the door open, it will be very hot after all this time spouting flame (2d6 points of heat damage). It will contribute to the comic fun if one or two members of the gang of thieves scorch their paws before they figure this out.)

The best result on this trap is if the party is in fact timorous. They will back up as far as they can, or better still retreat to the Thrasher room. If this is the case the as will vent entirely into the hallway where it will collect, invisible but deadly. The party hearing the hissing die down will think that it is safe and reenter the hall. Whereupon the first torch, lantern, or such like incendiary device, will set off a massive explosion!

The entire membership of the party in the hall at the time will be set on fire. Prompt action by any members not alight will be needed to aid these new members of human torchdom.

After all the fireworks the door will open easily.

The trap is a two skuller due to the fact that most of the potential damage is the result of the fires ignited by the gas, and these are easily dealt with if the party acts quickly.

Trap #45: This Will Really Light Your Fire!

????

CR: 10

Type: Combination (Magical and Mechanical)

Search: Trap (DC 28), Trigger (DC 31)

Disable Device: Trap (DC 28, 2d4 rounds); Trigger (DC 28, 2d4 rounds)

Primary Trigger: Touch (moving the necklace)

Primary Trap Effect: Ceiling collapses (no attack roll necessary; 16d6 crushing damage)

Primary Area of Effect: All creatures within the room

Primary Save: Reflex (DC 25) avoids. Each 5 feet a character is in the room increases his save DC to avoid by +2

Reset: Manual

Cost: 25,000 gp

The room entered through the bronze door is 30 by 30 feet with a vaulted ceiling consisting of four triangular panels which meet at a square peak 30 feet overhead.

On the walls to the right and left are frescoes of a magical being striding through massed hordes of daemons. The creature seems to be a mass of flame with human features.

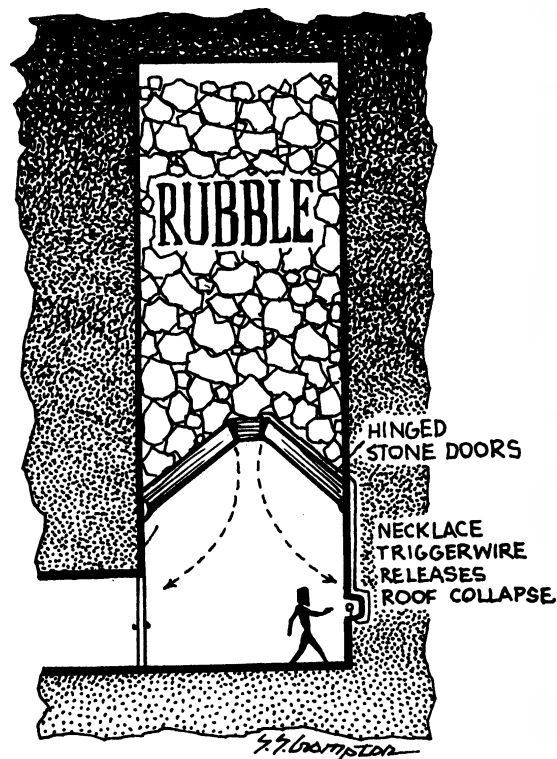

In the wall opposite the door is an alcove, in the center of which is a gold chain, draped over a wooden rest. On the chain is a golden amulet in the center of which is a green stone. It is clearly an emerald. Any jewelers or dwarves in the group begin to drool immediately. Its value is easily over 25,000 gp! It is also, for those parties that can check this out, fairly reeking of magic.

After the usual chattering about who will have the dubious honor of stealing the necklace some member of the party will eventually attempt to do so. This of course is when the fun begins.

I, for one, think Evinrood is being far too generous with great loot at this point, but what the hey, maybe a few baubles keeps the party motivated to march to their doom.

The tomb robber who plucks free the necklace will notice there is a slight resistance to this. A small wire is fastened to the amulet itself, and leads into the base of the alcove. If the would-be thief inspects the base, even carefully, the chances are very, very slim of his noticing the single wire. This is due to the fact that the gold necklace is made up of hundred of loose wires unbraided or bundled, so there are dozens of them that mingle with the one key wire.

The wire releases a trap, which will be set in motion slowly enough that if the necklace thief wishes to put the necklace on he may.

If the necklace is not put on this is the net result. There is a momentary pause then the center portion of the vaulted ceiling plummets earthward. This event is followed almost immediately by the triangular sections, which are hinged at their bases, swinging downward, releasing the contents of the ceiling upon the party below. The room is 50 feet taller than the ceiling and filled with loose rocks, gravel, and dust. This will crash down on the delvers, suffocating those it does not crush outright!

When the dust settles the door to the room will be entirely filled with sifting rubble from top to bottom, packed solid with the exception of slightly settling dust grains.

Now if the necklace thief wishes to don the purloined item the following events occur. First, the delver immediately bursts into an eerie green flame, which suffuses his entire being. He will not feel a thing, and will sense no difference, at the onset. The rest of the party will be momentarily distracted. Then the ceiling will fall in!

The delver translated into a human elemental will have a slightly higher chance of escaping (+2

bonus on Reflex save), as he is not distracted, and is already pointed in the right direction.

If the character altered by the necklace is not trapped, and subsequently smothered by the avalanche. He will find himself uniquely altered. He will find the amulet is now part of his chest. If it is removed the delver's body will be consumed by the elemental flame (automatic death, no save), but the enchanted stone will remain. This stone was a failed experiment by Evinrood to create an army of intelligent elementals, the standard kind being very wild and hard to control due to their limited intelligence and, well, elemental nature. The experiment was a failure because the "human elemental" created by the amulet while powerful was independently intelligent and thus innately uncontrollable. (Just like real people. Oh gee, what a surprise!)

Player's note: The elemental is burning: this will work well as a torch, but don't slap him on the back after a victory! He cannot use any weapon, save perhaps those magic ones that happen to be indestructible, assuming the party possesses one. The human elemental can fire a bolt of fire once per round that deals 1d6 points of damage per HD/level possessed (maximum 10d6). This cannot be projected further than 10 feet, but may be manifested as a "sword of fire" that just from the player's fist. This may seem to make the player very tough, but there are some notorious disadvantages. The elemental takes triple the damage from a water, ice or steam-based attack. He can be attacked by conventional weapons, and takes double damage from any magic weapons used against him. If the character is buried entirely in the ground he will die immediately (no save). If he is trapped in a closed room he will use up the available air 10 times as fast as a normal man. Finally if he is immersed in water, even for an instant the result will be a steam explosion that deals 20d6 points of damage to the character.

The Avalanche is a four skull trap, but I still think the amulet is too much loot. If the circumstances permit, you can swap some other nice shiny bauble and the delvers will never be the wiser.

The only exit to this room is back into the Thrasher, and from there to either the Wall of Spears room, or the door to the right of the Amulet room. Whichever door the party did not enter through will still be covered in stucco.

Trap #46: Hit 'Em And Hit 'Em, This Trap Will Leave 'Em No Place To Go



CR:	10
Type:	Mechanical
Search:	Trap (DC 26), Trigger (DC 26)
Disable Device:	Trap (DC 26, 2d4 rounds); Trigger (DC 26, 2d4 rounds)
Primary Trigger:	Location (pressure plate)
Primary Trap Effect:	Giant stone ball (no attack roll necessary; 16d6 crushing)
Primary Area of Effect:	Multiple targets on the stairs
Secondary Trigger:	Timed (1 round after the first ball rolls down the stairs, the second one follows)
Secondary Trap Effect:	Smaller giant stone ball (no attack roll necessary; 12d6 crushing)
Secondary Area of Effect:	Multiple targets on the stairs
Reset:	Manual
Cost:	36,000 gp

Once this door is entered the party will find itself at the bottom of a circular staircase. This stair has an unusually broad banister on both the inside central pole, and the outside against the stone wall. The stair leads up into the darkness.

Once the party begins to ascend they will find the steps are a comfortable distance apart and the climb is smooth and gradual. There is no obvious problem, until the party reaches a point 50 feet up the cylindrical shaft of the stairs. At this point they will find a fine wire stretching from one banister to the other.

This is so clearly a trap that the party will go to great lengths to avoid it. In so doing they will not notice that 10 steps beyond this they will come to a series of 10 steps,

any one of which when depressed will set off the trap at the top of the spiral stairs. (Keep in mind that if descending this stair the trap will activate just as well.)

At the top a panel concealed beneath the stucco of the ceiling will open and out will roll a gigantic stone ball over 10 feet in diameter. This will fall onto the banisters and race down the stairs with escalating speed until it hits the party. The telltale crash and resultant roaring rumble will hint to the party that something is on its way down to meet them.

The only way to avoid the doom that is descending upon the party is to get down as low as possible on the stairs. (Note mages have been able to fly out of many of these traps. Let's hope they think like that now!)

Anyone who has not ducked under the ball will be hit by it about chest high. The ball deals damage and proceeds unimpeded.

While the party has been dodging the onrushing roar of this ball a second ball has been released at the top only 6 seconds behind the first. This one is only slightly smaller than 10 feet and fits neatly under the banisters. This ball comes rumbling down the stairs.

Any delvers who feel neglected by the first ball will very likely meet the second. The way to survive is to duck under the first ball, then jump up on the banister in the face of the second, equally lethal ball. The balls will smash into gravel upon impact at the bottom, for neatness sake.

Once again Evinrood delivers his customary one-two punch, this one is a four skull wonder. At the top of the stairs the party reemerges at the end of the hall of crystal warriors.

Trap #47: Oh No, Not The Old Chutes And Razors Gag!



CR:	4
Type:	Mechanical
Search:	Trap (DC 26), Trigger (DC 22)
Disable Device:	Trap (DC 28, 2d4 rounds); Trigger (DC 22, 2d4 rounds)
Primary Trigger:	Location (pressure plate)
Primary Trap Effect:	Multiple razorblades (no attack roll necessary)
Primary Save:	Reflex (DC 20) avoids stair chute
Bypass:	Perhaps a hidden switch (Search DC 20) locks the plate in place
Reset:	Manual
Cost:	12,000 gp

Lest you think old Grimtooth has lost his marbles, I am aware that we missed something back at Trap #39. There is another way out of the room housing the acid fountain. It lies to the left of the "racing

stairs" and directly across from the hall entrance leading from the desiccation storeroom. As usual it lies beneath the stucco. It is the usual three finger hole lock type entry.

Once the door has been opened the tomb robbers will see a long flight of stairs leading down. In the distance in the limit of the torchlight is the glint of bronze.

What follows is a trap so old and hackneyed I for one am almost embarrassed to see it used, but perhaps this tomb was constructed so long ago that it was somewhat fresher then. (Right, either that or Evinrood had dinosaur consultants on this one.)

As the party pushes on down the stairs to a point about 25 feet down they will encounter three steps in succession that set off the trap. And as if we did not all expect this, the stair turns into a chute, in the ages old tradition of slapstick horror. Down the party will

slide to some unspeakable peril. You guessed it. At a point on the chute 35 to 45 feet down from the top, 6-inch long sharpened blades, shark's tooth in shape, project 6 inches into the party's path from wall to wall, one to a foot in a staggered pattern.

There is a fair chance that the delvers will fall for this if distracted, but even the most naïve young

delver should recognize the potential in a descending stair. If, however, the delvers are foolish enough to trip the trap, they will sustain damage of some major sort to whatever portion of their body is pointed at the bottom of the chute.

I'll only dignify this one with two skulls, old saws like this one give trapmasters a bad name, but they work so well...

Trap #48: Arr! Here There Be Barried Treasure!



CR:	5
Type:	Mechanical
Search:	Trap (DC 25), Trigger (DC 25)
Disable Device:	Trap (DC 25, 2d4 rounds); Trigger (DC 25, 2d4 rounds)
Primary Trigger:	Touch (turning the wheel on the door)
Primary Trap Effect:	Sand turns to quicksand (Swim check DC 20 to remain afloat). Those that sink can hold their breath (as per the normal rules) and unless rescued begin suffocating when their air runs out.
Reset:	Manual
Cost:	13,400 gp (includes the cost of the buried treasure)

The bronze door the tomb traipsers saw from the top is revealed to be another of those masterpieces of bronze casting that have been appearing throughout the tomb complex. It depicts the stumpy figure of Evinrood standing in the prow of a sailing ship. Around him in the air and the water are depicted the usual distorted humanlike figures of the elementals he commands. In the distance is a ship that appears to be fleeing him.

There is a wheel in the center of the door, which must be turned before it will open.

I am fond of pointing out that there is usually some trepidation on the part of the party when forced to do things they know from past experience can be fatal. This reaction should be cute in this case, as there has been no previous time when turning one of these wheels has not at least resulted in extreme discomfort. Rest assured they will eventually turn it, curiosity, can and delvers all having a fatal relationship.

When the wheel is turned it will do so slowly, regardless of the strength of the individual who is turning it. It will give out with a painful sounding squeal, as if some part of the mechanism is badly corroded. And then...

The door will open, with no apparent ill effects! Surprised? Don't be, the trap has already been set in motion!

What the party sees is a room full of pristine white sand. It is loose, almost powdery, but firm enough to walk on with little effort. In the center of the wall opposite the door on the surface of the sand is a large "X." This curious mark is laid out in a meticulous fashion with a fine black sand. The implications are obvious, perhaps too obvious!

The desired reaction is that the delvers dig at this point. If they do so they will find, at a point six feet down, a chest. In the chest is a substantial amount of gold coinage, and a map! (The inscriptions on the map are indistinct, more will be revealed about the map later!). The gold will total up to 5,000 gp.

If the party wishes prudently to ignore the obvious invitation of the black "X," they will be able to indulge themselves in searching the room for other exits. In the upper most corner on the same wall as the entrance door can be found, covered with stucco as usual, a circular opening 3 feet in diameter! There is no other exit.

In the event that the party digs, or searches, the time taken will be roughly the same. (If this seems unlikely, in the words of a famous leader of another era, "Make it so!" On this trap, timing is everything.)

When the door was opened to enter the room, it also opened, deep beneath the sand, a series of gratings, which allowed water from the underground river to begin to seep into the bottom of the room. This water is under some pressure, taken as it is from up stream, and is trying to reach its own level. Due to this pressure, perhaps seep is the wrong word, at any rate the fine sand is rapidly becoming saturated from the bottom up. Lest the diggers be disturbed immediately the room extends 30 feet down, below the sand's surface.

While this may seem like a digression, a brief discussion of the dynamics of sand in riverbeds is very relevant at this point. In what is a normally dry sandy river bottom a very strange reaction can sometimes occur, when water is added to flooding upstream. While the river may not begin to actually flow, the water will return to the riverbed, underground. This will saturate the sand and at a certain point the sand will suddenly go from being a supportive solid to a nonsupportive semi-liquid! Quicksand.

Back to the room. The water has been percolating into the sand for some time now. If the party is searching the walls for alternate solutions to what seem to be their stymied travels they will find one. The sand at their feet. Bloop! It will happen very fast. The reason for the suddenness of this event is that when the sand reaches total saturation, it in effect "turns over" under the heavier surface features, having lost in that instant its load-bearing capacity.

Now I'll grant you that only in the cases of those delvers grossly overloaded with, say, gold for instance, is

this trap going to be fatal. Don't let this get you down after all there are those who will dig at the "X"!

In the case of the treasure hunters, a good thing to do will be to let them find the chest and open it. They will start stuffing various pockets with the gold, increasing their weight. Then point out the water that seems to be rising in the bottom of the hole! Frantic efforts to get out can be played out, but keep in mind the ages old axiom,

"Some quick sand is quicker than others!" Bloop! Adjust the chances of failure upwards and you will have an excellent opportunity to teach a bunch of tomb robbers the delicate art of mud breathing!

If the party is in the hole when the water saturates the sand, this is a three skull trap. If they are just rummaging around there are too many ways to outfox quicksand to rate it much higher than a two skuller.

Trap #49: You'll Get A Bang Out Of This One



CR:	10
Type:	Mechanical
Search:	Trap (DC 25), Trigger (DC 22)
Disable Device:	Trap (DC 30)
Primary Trigger:	Location or Proximity (any incendiary device or open flame brought within the room has a cumulative 10% chance per round of igniting the dust particles)
Primary Trap Effect:	Massive concussive explosion (20d6 force damage to those in the room [and see Secondary Trigger and Trap Effect below], 10d6 to those in the tube within 5 feet of the room, 5d6 to those in the tube and within 6–10 feet of the room, 2d6 to those in the tube and within 11–20 feet of the room. Those in the tube must succeed at a Reflex save (DC 15) or be blown back into the previous room with the quicksand. Characters that fail their save and slam into someone behind them that made their save are not thrown into the quicksand, but suffer 1d6 points of damage instead.
Secondary Trigger:	Timed (explosion)
Secondary Trap Effect:	Oxygen supply is completely "sucked up" when the explosion goes off. PCs in the room (if there are any left alive) cannot hold their breath and immediately begin taking suffocation damage (see Suffocation in the <i>DMG</i>).
Reset:	Manual
Cost:	30,000 gp

The mere fact that the sand room is now filled with quicksand should only serve to whet the delvers' appetite for what is beyond it. There are many ways to get to the hole in the wall that leads on from here. If the delvers are too simple-minded or faint-hearted to go on, don't fear — others will return who are not.

Just sit back and watch as they try to get to the 3-foot wide tunnel in the upper corner of the room.

The tunnel is dark, over 110 feet long, and totally unlighted. The fact that most delvers will have to crawl will serve to block torchlight from penetrating to the delvers behind the torchbearers. Every few feet the crawling delvers will scuff their knees on an odd

curved ridge that seems to circle around the tunnel. This ridge is not too high, and seems to occur at regular intervals. The tomb robber in the lead will be able to see the curving spiral of these lines leading him off into the distance.

Eventually the leader will find himself at the end of the tube that emerges from a point high on the side wall of a 30-foot by 30-foot room, with a ceiling 12 feet from what seems to be the floor.

From his vantage point on the wall near the ceiling the lead member of tomb trashers anonymous can see what looks like a featureless room. The walls are white stucco (so what else is new), while the floor and ceiling also seem to be covered with white stucco as well.

Obviously it is a trap. (Oh my. What a surprise!) The delvers, cramped and confused will now go bats trying to figure out just what sort of trap it is.

The "floor" is in fact the top of 18 feet of finely milled flour. If the first delver just crawls up and jumps out, he will begin to stir up a fine cloud of flour dust. Once even one delver is in the chamber stirring about there is a chance of the trap being "activated."

Professor Grimtooth of the University of Extremely Hard Knocks will now deliver a lecture on explosive clouds of particulate matter. If a sufficient amount of small but even remotely flammable particles go into suspension in common "room" air and a spark (or the flame of a torch) is applied the subsequent ignition will result in an explosion of incredible violence and force! (If you find this hard to believe, check out the past history of grain silo, and similar grain storage explosions. This is also the foundation theory behind fuel/air aerosol explosives.)

The more members in the room thrashing about looking for doors and such will drive up the chance of explosion dramatically.

The ignition will eventually occur unless the party is possessed with a familiarity with the concept of grain explosions and comes up with another method of "seeing."

The force of the explosion will be deadly for whoever is in the room. If the blast doesn't kill the character outright, the lack of oxygen will. For those

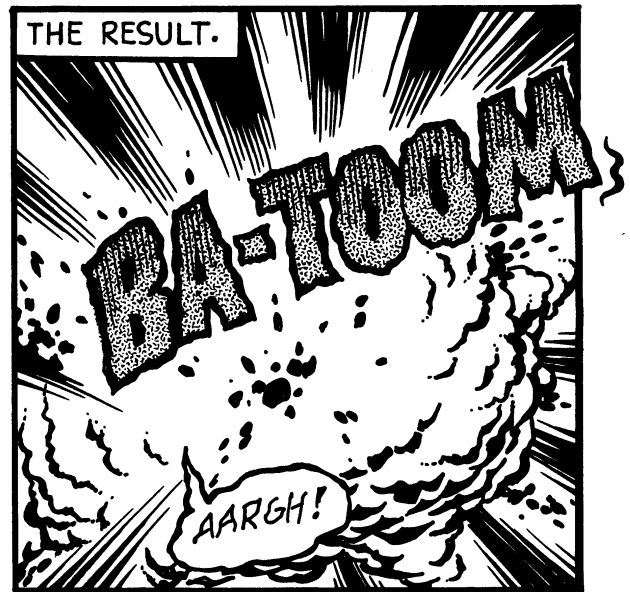
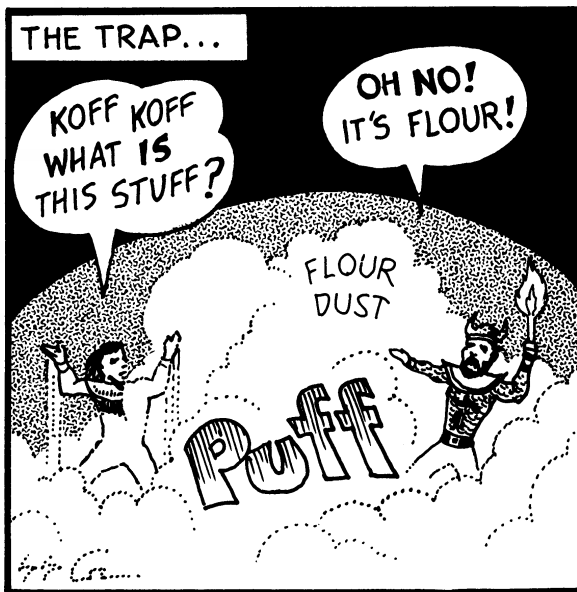

still in the tube damage is proportional to the distance away from the explosion when it happens. Any additional delvers are safe, the force having been expended on each “obstruction” down the line. In addition, the force of the blast will throw the occupants back down the tube, literally firing them like soft bullets out of the end of the tunnel. If there are few of them, say 2 or 3, the unabated force will throw them out the end of the tunnel and into the nice soothing quicksand. If they are capable of absorbing the force of the blast (!) this should give them something to think about!

To make matters worse, to get through this room the party will have to burrow into the flour! There is a bronze door on the same wall as the tube’s entry

hole, the top of which is about 8 feet down. There is a trap door at the bottom of the far wall, but this is a lot harder to find, although it can be detected by magic. In either event there will have to be much digging and thrashing around, further enhancing the chance of an explosion, or even repeated explosions. (Trap masters don’t despair there are magical ways of seeing that recommend themselves. Your victims will come back.)

This is a four skull trap, almost unavoidable even if the delvers are aware of the way it works, having the exits beneath the level of the flour is the piece-de-resistance. The delvers are truly doomed! But alas, they are also persistent, devious, and infinitely crafty, as a result we must continue on!

Trap #50: Some How This All Seems Too Easy!



The bronze door near the entry tunnel is fairly typical of those found so far. Very fine truly artistic work, its estimated value is 1,200 gp in art and construction. On its surface are depicted the images of a man and a woman. The man is clearly Evinrood (the fact that he comes up to the woman’s chin reveals the stumpy stature that has come to be associated with past images found in the tomb). The woman is tall and lithe, even the image betrays a fluid grace that transcends the time since the door’s crafting in the background are some of the most bizarre creatures seen yet. They look like the daemon dogs found as statuary in certain eastern temples. They are leaping playfully about the couple’s feet. The couple depicted is clearly not engaged in combat.

The wheel in the door’s center must be turned for the door to be opened. Once the party resolves to do so the delver who does the turning will hear a rushing sound, as

if a source of water has been released. The door will take many turns to open and when it does it will reveal a vault-like thickness, which serves to explain why it was not blown open by the blast. The door opens into the flour room, which could be a problem, but by now the party should have that troublesome explosion problem under control! Even so the door is unlikely to be opened all the way. It is, after all, at the bottom of 18 feet of flour.

The party will be able to squeeze into a hall 10 feet wide and 15 tall, that slants slightly downward. The hall is 40 feet long, and has one additional unique feature. Just inside the doorway is a grating in the floor out of which is pouring a steady stream of water. It covers the floor from wall to wall, and runs smoothly down into the room below. The water stream is only about 2 or 3 inches deep. From the room below is coming a pale blue light.

Thrashing through this rivulet to the entrance of the chamber below the party will be confronted with a scene of unearthly beauty. The room is 50 feet by 50 feet square,

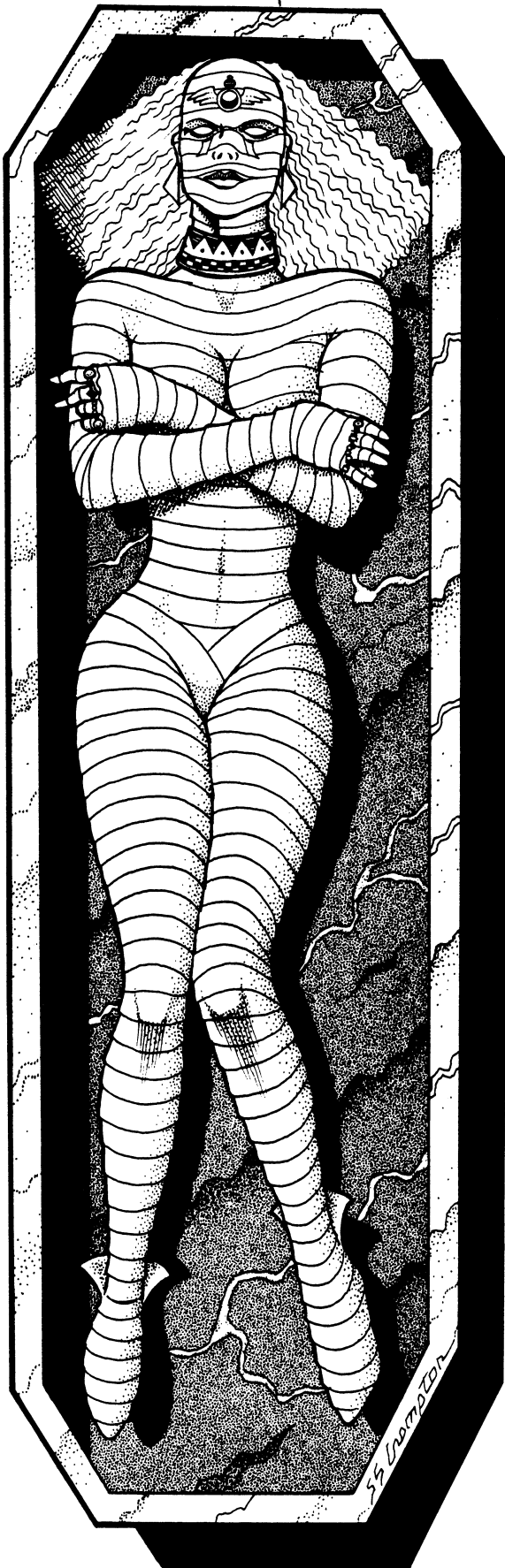

with a 25-foot high ceiling. It, like the hall leading into it, is slightly slanted downward away from the entrance. All along the wall nearest the party is a grating out of which pours more water. This covers the entire floor with a softly gurgling sheen of water just like the hall. The water appears to be drained off at the far wall, but in the dim blue glow the party can't see the drain gratings.

The walls are tiled in a scintillating blue which seems to give off the pale blue glow. Opposite the door the party is standing in there is a raised dais. On this dais is a sarcophagus of the same rare hy-Atlantaen stone seen in the room of the Terra-cotta soldiers. The seemingly frozen sea wave grain in the stone seems even more magnetic in the light of the florescent tiles. This is clearly the resting place of a figure of some importance.

At either end of the dais a fountain raises out of the running water, this coincides with the entrance of the party into the chamber. This should serve to unnerve the party a bit. The activator panel was under the water and thus rendered indistinct. The pleasant sound of falling water sounds almost musical in the silence of the tomb!

The sarcophagus can be opened with relative ease, and within will be found the wrapped body of a woman. The mummy has been resting undisturbed in this tomb for millennia as is evidence by the fact that none of the artifacts in the sarcophagus have been disturbed. The linen wrappings are as fresh as if they body was just placed herein. Magic users will be expressing great agitation at this point. The mummy is under a very powerful spell of preservation. It is the likes of which they will not have seen.

On the mummy's hands are 8 rings, each identical, made of the fabulous blue stone of hy-Atlan. These rings are carved in the shapes of elongated versions of the same daemon dogs found on the entrance door. The eyes of the dogs on the rings are flawless star sapphires, which wink with hidden knowledge.

The magic-using members of the party will be able to relate that the spell on the mummy doesn't extend to the rings which they feel may be removed without affecting the wrapped figure.

I've kept out of this melodramatic little piece of overblown sentimentality up to this point out of respect for the great Trapmeister that Evinrood was, but at this point given the vandalistic streak that most delvers possess, I must intrude. The spell on the recumbent lady will *absolutely* thwart the party's any and every effort to do damage to her physical form. Although she can be moved and searched, she will not come unwrapped and absolutely no physical harm can come to her. That is until Evinrood's spirit has truly left this plane of existence (*hint!*).

The party will almost certainly take the rings. From a physical value standpoint the rings are easily worth

2,000 gp each (less due to the sudden quantity of hy-Atlantaen stone that will be hitting the market soon).

There are magical enhancements on all the rings but the spells are unique and their purposes are hidden from any magical investigation, save experimentation. It is at this point that the trap aspect of this room begins to emerge. Eight choices, much to gain, and everything to lose.

The party will find that while the rings fit well on the mummy they seem to be able to fit the fingers of any member of the party who is looking them over. This is true for the most dainty female elf or the most hippopotamic oaf of a human warrior. There is one problem, however, these rings will not fit over armor, or gloves.

The eight rings react as follows:

Two of these rings when donned summon elemental manifestations known as "water dogs." These creatures will form out of the fountains on either side of the sarcophagus. They look like animated water in the shape of the oriental temple dogs. The party member will have absolute control of them. They are the size of Great Danes. They attack by biting and clawing. (Their teeth and claws turn to ice for an instant at the point of inflicting damage.)

Water Dog: CR 3; SZ M Elemental [Extraplanar, Water]; HD 4d8; hp 18; Init +3; Spd 30 ft.; AC 16 (+3 Dex, +3 natural), touch 13, flat-footed 13; BAB/Grp +3/+4; Atk +4 melee (1d6+1, bite); Full Atk +4 melee (1d6+1, bite), -1 melee (1d4 [x2], claws); SQ elemental traits, damage reduction (5/magic), scent, vulnerable to fire (+50% damage on a failed save); ALLG; SV Fort +4, Ref +4, Will +2; Str 12, Dex 17, Con 10, Int 10, Wis 13, Cha 11.

Skills: Hide +6, Listen +7, Sense Motive +4, Spot +7.

Feats: Alertness, Power Attack.

One of the rings when donned will turn the bearer into one of the fabled *Tsunami Warriors*. The bearer can turn his body into water, this includes his armor, and the ring. (Just to shock the stuffing out of the party have it happen spontaneously the first time, then have the character "pull himself back together." It'll serve to make them less cocky.)

This delver will take damage just as the water dog described above does. (A further note, being reduced to steam is bad, death through dissipation usually results, and the ring will be lost. Being turned to ice will paralyze the delver as if by *hold person*. Of course if broken be sure you gather up *all* the pieces, then wait for the thaw.)

The other five rings, when removed, activate traps.

The first and perhaps simplest is the *ring of water*. When this ring is put on the magic turns the wearer into water if he fails a Fortitude save (DC 22), leaving the ring behind. Oops. Care to try again?

The second is the *ring of desiccation*. This ring draws all the water out of a delver (dealing 20d6 points of damage; Fortitude save DC 22 for half) just as if he had been hit by *horrid wilting* cast by a 20th-level caster. The mind boggles at the possible effect of these two rings at once! The delver becomes a leather-covered skeleton in an instant if he dies.

A mechanism within the third ring, when withdrawn from the finger of the rightful bearer, causes a tiny sliver of metal to spring free. This sliver is coated with a powerful paralytic poison that paralyzes the wearer instantly for 1d4+10 minutes if the wearer fails a Fortitude save (DC 20).

The delver can only be saved by quick administration of an antidote (administered in the same round the poison was activated). ("Hello, Poison Control? I've got a fellow here who has a nasty jab of poison from a thousand of years old mummy's ring. Hold? What do you mean can I hold?") There is also the possibility of healing magic. ("Arrrrrgh!")

The fourth ring has the same sliver mechanism, but what it administers is a hallucinogenic drug that slowly induces a heightened paranoid state. Every 10 minutes there the wearer must

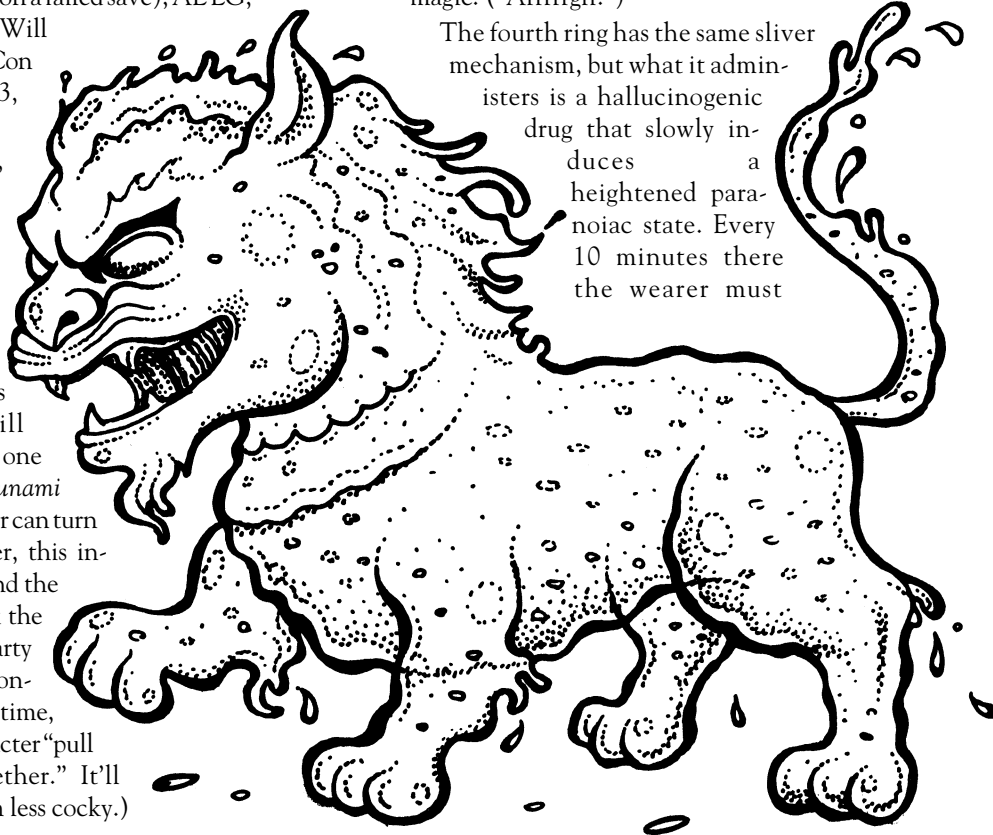

succeed at a Will save (DC 15 + 1 per 10 minutes thereafter) or believe that the other members of the party are “out to get him” and attack one or all of them. The combat will resolve itself. In this case a magical anti-toxin spell (such as *neutralize poison*) is most likely to have the most beneficial effect. Until the delver attacks the other party members there are no overt signs of the oncoming paranoia. He doesn't want them to know that he knows!

The fifth ring is totally innocuous. At least to the wearer! The trap here will be activated if he extends his

hand to another. If he takes a grip of any other person's unarmored hand, or has to grip someone's hand to lift them up, a pin will be thrust out on the palm side injecting a dose of the paralyzing poison described above (the person stuck must succeed at a Fortitude save DC 20 or be paralyzed for 1d4+10 minutes).

These rings are of variable ratings, from four skulls for the *water* or *desiccation* rings to two skulls for the paranoia ring.

Once the rings have been parceled out the party can go on.

Trap #51: The Things You Must Go Through For Loot!



CR:	10
Type:	Mechanical
Search:	Trap (DC 28), Trigger (DC 28)
Disable Device:	Trap (DC 28, 2d4 rounds); Trigger (DC 28, 2d4 rounds)
Primary Trigger:	Touch (turning the door wheel)
Primary Trap Effect:	Crushing ceiling (no attack roll necessary; 16d6 crushing)
Primary Area of Effect:	Multiple targets in 10-ft by 10-ft area.
Reset:	Automatic
Cost:	28,000 gp

Behind the bier on the wall opposite the entrance there is another three finger hole door behind the tiles. Pry out the tiles and the door can be opened. The door opens into the “Blue” room, and reveals a small chamber 10 by 10 by 10 feet in size. On the opposite side is a bronze door. (Remember, most of the rooms are in dead blackness.)

This door again depicts Evinrood and a beautiful woman. This woman seems to be possessed of a flashy quickness that seems to leap out of the image. In the background can be seen a number of indistinct catlike figures lying about or rubbing against the figures legs.

In the center of the door is a wheel which must be turned to open the portal. The wheel will not turn until the door to the “Blue” room is closed. Once this has been

done the wheel will turn freely. The wheel will take several turns, then there will sound a sudden click. At this point the ceiling will begin to descend into the room.

This will cause almost certain panic. Indestructible items can be used to block the descending stone. The party can also attack the three finger hole door with some hope of success. Keep in mind it is fairly thick (6 inches of stone; Hardness 8, hp 90, Break DC 35) and this could take some time.

Once the ceiling reaches a point about 5 feet down from the top the wheel will be snapped off the bronze door. Steel panels will fall out of the base of the wall. These panels reveal gratings about 6 inches high along both sides of the room. At this point the water dogs and the tsunami warrior can quit worrying; there is their refuge. The others have a very short time to look for an escape.

This room was designed to “wring” the water out of anything entering the room. This works very well for other liquids as well, and most delvers will be liquids by the time the stone reaches the floor one way or another.

In any event the ceiling will withdraw once it has been effectively stopped. Once the ceiling is back in place the thick steel bolts will be withdrawn and the vault-like door will open. Not that this will matter to the tomb robbers at this point.

This room is hydraulically driven once the wheel is turned, and also hydraulically raised once it stops. The room is a four skuller if there are none of those cursed indestructible items amongst the party.

Trap #52: You Light Up My Life!



The room that opens before you is brightly lighted. It is 50 feet by 50 feet by 25, just like the “Blue” room before it. The walls are covered with reddish-orange tiles that have a lambent glow. The floor is perforated with small holes out of which are leaping a waving sea of small (1/8th inch high) blue flames, which flicker and reignite when disturbed, rippling over the floor. At the end of the room there on a bier is a carrelian sarcophagus. At either end of the bier there are columns of dancing flame 9 feet high. The small flames are cool enough to be endurable

by anyone wearing thick boots. There is a definite danger if dangling fabrics are present (see *Catching on Fire* in the *DMG*).

This would be an excellent place to comment that perhaps the water dog and tsunami warrior members of the party may wish to retreat. They will take 1D6 of damage for every turn in this room. They may not heal from this damage while in the room. The net result is that this damage will be cumulative. This effect is the same for those members of the party who are barefoot, or shod in metal, which will conduct the heat.

A close inspection of the sarcophagus shows that has not obvious tricks. It will open with ease to reveal another mummy of a woman, very well preserved and protected exactly like the one in the "Blue" room. (Another vandalism update: even laying the mummy in the flames will have no effect, but give the delvers an "A" for effort.)

On this mummy's fingers are eight rings in the form of long-bodied cat creatures. These rings are formed of carnelian with rubies for eyes. Their cash value is over 2,500 gp. As with the rings in the other room these have a variety of magical spells upon them, and like before some are good and some bad. Keep n mind all will fit, but not over armor.

First the good. Two of the rings will give control of elemental creatures known as "fire cats." They are made up of flickering licks of flame. They have faces like giant lynxs and bodies the size of cougars.

Fire Cat: CR 3; SZ M Elemental [Fire]; HD 3d8+6; hp 19; Init +4; Spd 40 ft., climb 20 ft.; AC 15 (+4 Dex, +1 natural), touch 14, flat-footed 11; BAB/Grap +2/+5; Atk +6 melee (1d6+3 plus 1d6 fire, bite); Full Atk +6 melee (1d6+3 plus 1d6 fire, bite), +1 melee (1d3+1 plus 1d6 fire [x2], claws); SA pounce, improved grab, rake (1d3+1 plus 1d6 fire); SQ elemental traits, damage reduction (5/magic), fire immunity, scent; AL N; SV Fort +3, Ref +7, Will +2; Str 16, Dex 19, Con 15, Int 2, Wis 12, Cha 6.

Skills: Balance +5, Climb +11, Hide +6, Listen +4, Move Silently +5, Spot +4.

Feats: Alertness, Weapon Finesse.

The third ring is the fabled *ring of fire*. This ring enables the delver who bears it to burst into flame. This is hard on cloth garments, and will spoil the temper of a good sword after a time, but will enable the delver to act as a torch without tying up his hands, allows the wearer to deal 1d6 points of fire damage with a touch attack or melee attack [the heat and fire carry over to the wearer's weapons], and grants the delver completely immunity to all fire-based attacks.

The fourth ring is the *ring of the fire-maker*. This ring renders the wearer immune to fire, flame, or intense heat.

The last four rings are somewhat less salubrious. The fifth ring causes the bearer to be consumed by the flame (dealing 20d6 points of fire damage to the wearer; Fortitude save DC 22 for half damage) and leaving the ring behind if the wearer is incinerated.

The sixth ring has the backsticking pin coated with a nerve poison that makes the tomb robber afflicted by it to feel as if his body were on fire. Needless to say this is quite painful and will stop most delvers from being able to do anything but writhe in pain (the delver must succeed at a Will save DC 20 each time he attempts to take any action). Again, only a magical cure will help (maybe).

The seventh ring injects a hallucinogen that induces a carelessness that nears the state of drunken recklessness. There is a chance of the delver who has been jabbed in this fashion behaving in a grossly irresponsible way if he fails a Will save (DC 15). An example being if the party goes back to the flour room to search for the trap door. They will leave all flaming devices outside and perhaps be foundering around on the ground. The affected member of the party will say, "we need a light," and thereupon strike a spark to light a torch. For this poor sod logic will be a constant exercise in will power.

The eighth ring will burst into flame itself, burning off the flesh of the finger on which it is placed (1d6 points of fire damage each round until removed). The ring cannot be pulled off, and will continue to burn forever, unless the finger is removed. The good news is that the rest of the delver's hand is immune to the fiery effects.

This ring is a blessing in disguise, for in tomb work it can act as a torch without tying up a hand. A cautionary note though: don't hand this fellow any scrolls to read. (For that matter, think of the effect he will have on any bed he tries to sleep in. Talk about the hazards of smoking in bed!)

Again the rings are skull rated from four to two.

Once last note: while Evinrood was known to consort with both these ladies during his checkered career, it was never at the same time for what will become obvious reasons.

The lady in the Blue Room was the Sorceress of the Inland Sea. She had control of a variety of water-based creatures, most notable of which were her water dogs, which she would set upon her enemies. It is known that this cool, levelheaded lady was the love of Evinrood's youth. Her fate has passed into the mysteries of the past, but clearly Evinrood has taken steps to look after her remains.

The other lady was the so-called Goddess of the Fire Ridge. She may have had elemental antecedents. She arrived at the same time as a fiery volcano in the lands that Evinrood knew, bringing with her her wildly unpredictable fire cats. This fiery, mercurial woman was the love of Evinrood's majority. Her end too is lost in the mists of time, but he likewise took steps to protect her.

There is a problem that the servants of these two women will pose for the party. Fire cats and water dogs are basically elementals of two mutually antagonistic types. Under the command of an elemental master they ca be made to work together. Under the inept guidance of the delvers the two will rush together in a steam explosion the first time they meet. (A cat and dog explosion deals 10d6 points of force damage to all within 10 feet, and keep in mind there are two of them. Evinrood giveth and Grimtooth taketh away!)

Trap #53: Lest You Become Too Complacent Evinrood Pitches A Curve!



CR:	10
Type:	Mechanical
Search:	Trap (DC 28), Trigger (DC 28), Secondary Trigger (DC 25), Secondary Trap (DC 28), Tertiary Trigger (DC 28), Tertiary Trap (DC 28)
Disable Device:	Trap (DC 28, 2d4 rounds); Trigger (DC 28, 2d4 rounds), Secondary Trigger (DC 25, 2d4 rounds), Secondary Trap (DC 28, 2d4 rounds), Tertiary Trigger (DC 28, 2d4 rounds), Tertiary Trap (DC 28, 2d4 rounds)
Primary Trigger:	Touch (pushing button)
Primary Trap Effect:	Julienne cheese grater ceiling (no attack roll necessary; 15d6 slashing damage; multiple targets in hallway)
Primary Area of Effect:	Multiple targets in 10-ft by 10-ft area
Primary Save:	Reflex (DC 28) avoids
Secondary Trigger:	Touch (pushing button)
Secondary Trap Effect:	Floor falls away and dumps delvers into bottomless pit (no attack roll necessary). Unless rescued magically, the delver is gone forever.
Secondary Area of Effect:	10-ft by 10-ft area in front of door
Secondary Save:	Reflex (DC 28) avoids
Tertiary Trigger:	Touch (pushing button)
Tertiary Trap Effect:	Flyswatter door (no attack roll necessary; 8d6 crushing damage)
Tertiary Area of Effect:	10-ft by 10-ft area in front of door (where the hole for the Secondary trap is located)
Tertiary Save:	Reflex (DC 28) avoids
Reset:	Manual
Cost:	100,000 gp

To progress further the party will have to return to the Flour/Explosion room. The tomb robbers will have to be more thorough in their search. Keep in mind the same kind of spell that have been revealing the doors hidden behind the stucco can also serve to point the way to a trap door hidden beneath the flour (Search DC 20). This will mean more digging, and if the party has not learned its lesson more chances to be blown up (see the explosion trap above)!

Once the tomb robbers have levered the trap door open they will find it a short 10-foot hop to the floor of a hall leading 20 feet to a blank stucco wall. This hall is 20 feet long, 10 feet wide and 10 feet tall. Along the walls are patterns, twisted geometric forms, worked in gold leaf. These patterns reveal no images, just random-seeming forms, one after another culminating in a final whirlpool of gold on the far wall.

The value of the gold leaf is nominal. All together there would not be much over 50 gp. It is hammered micro-thin and cemented in place on the stucco. (The party will ask. Given a glint of gold their rapacious little hearts will want to scrape it off the very walls!)

The door can be found under the stucco at the end of the hall. As usual this is a three finger hole door. What is unusual is what happens when the holes are probed. By now the delvers will have sunk into a routine when confronted by these types of doors. It will be "we open the door in the usual manner." Sticks will be poked, armored fingers inserted, or an appropriate low level spell cast. If they do this now the fun will really begin.

If the tomb robbers push one button at a time, the results will be as follows. Out of the ceiling in the first 10 by 10 foot section will emerge a large hydraulically driven steel framework. This will be driven down to the floor with considerable force. It is in effect like a giant egg slicer, razor sharp, driven by the force of tons of water pressure! The mesh and the driving mechanism, four giant pistons concealed in the corners of the ceiling, will remain extended. The grid is only about a foot thick. Any delvers caught in it should slump over rather easily, or rather long slender parts of them!

The second button will cause the 10 foot by 10 foot floor section right before the door to fall out from under the feet of the delvers operating the door opening mechanism. If the delvers fail to leap out of the way, they will plummet into what is to all intents and purposes a bottomless pit. Screams should echo up out of it, magnified by the walls for some time, fading slowly as the distance increases!

The last finger hole pushed will cause another hydraulically driven piston to slam the door downward from its top on the place where the floor was. This will neatly cover the hole, and also serve to whack flyswatter like any flying character who happens to be pressing the last button. If the floor has fallen away, the flying delver might be able to escape. Of course if the floor has not fallen away then, squoosh!

The most dramatic effect can be achieved if a mage magics the door open or if the party pushes all three at once! All the traps activate simultaneously, and chances of survival in this case are very, very dim!

This door and hall trap is a masterpiece, using the delvers' complacency about a deadly device against them, and having the traps come in eaves, if they are not maximally careless. Four skulls, for sure. Watch the delvers scramble.

Trap #54: If You Think You've Got It Made You're All Wet!



CR:	10
Type:	Mechanical
Search:	Trap (DC 26), Trigger (DC 26)
Disable Device:	Trap (DC 26, 2d4 rounds); Trigger (DC 26, 2d4 rounds)
Primary Trigger:	Touch (opening sarcophagus or moving the statue)
Primary Trap Effect:	Floor tilts and falls vertically, slamming delvers, contents and everything else against walls (no attack roll necessary; 10d6 points of damage)
Secondary Trigger:	Timed (room pivots)
Secondary Trap Effect:	Ceiling collapses under weight of water (no attack roll necessary; 8d6 points of crushing damage from falling debris)
Tertiary Trigger:	Timed (ceiling collapses)
Tertiary Trap Effect:	Room floods with water (no attack roll necessary; 10d6 points of crushing damage from weight of the water and party is now under 130 feet of water)
Reset:	Manual
Cost:	60,000 gp

At this point the party may now enter the room. It is huge: 130 feet long, and 30 feet wide. The ceiling is 20 feet overhead and covered with more gold leaf, from end to end. The gold leaf on the ceiling is worked into fantastic patterns of soaring elemental forms flying and leaping about, cavorting with an inhuman joy. Covering the floor at the party's feet are 10 foot by 10 foot tiles of rust-colored porcelain, worked throughout with gold wire. These tiles depict a different type of elementals surging and thrusting in a dance of brutish abandon.

The walls are covered with a bright crimson damask worked with golden threads. The elementals here are picked out in a rushing, flashing, flickering dance of glee, and destruction. A truly wondrous sight.

(Sorry to interrupt this epic scene, but loot is loot. The tiles, if pried up, are worth 1,000 gp each. If the delvers try to break it up and get at the gold wire they are idiot and the tiles will be worthless. The damask on the walls will come free if pulled carefully. It is remarkably well preserved, and worth 50 gp a square yard. Again if they try to pluck out the gold thread they are boobs of the first water and all will

be worthless. Lastly the gold leaf on the ceiling is worth about 3,500 gp but will take a great deal of time to remove. Delvers will ask if they live up to the true vandalistic nature that makes them so much fun to provoke into acts of self destruction.)

At the far end of the room is a raised dais, upon which is an ebon sarcophagus. Behind it there is a golden statue, which illuminates the room with a magical glow. It is a statue of a short stumpy man robed as a great mage. It is cloaked in the signed robe, with the conical peaked hat. In one hand is a staff of a unique and twisted design. In the statue's other hand is a golden orb from which comes the light that illuminates the room. The visage is familiar to the entire party. This is a golden statue of Evinrood the Water Mage, Master of the Elementals. (Fanfare! Bells, whistles, let fly the confetti.) The party is in the presence of more wealth in one place than at any other point in the dungeon. This golden statue is worth well over 150,000 gp. Have fun carrying it out!

Tomb robbers being tomb robbers, greed will more than likely compel them to open the sarcophagus. If, however, they have a sudden burst of good sense and try to take the statue (which weighs about 5 tons) the same events will transpire.

If the lid of the sarcophagus is opened, or the statue moved, or broken (which will cause it to move) the trap will be sprung.

The only element not represented by the art in this room is water. Ever the completist, Evinrood's devices hasten to oblige. The entire room is a gigantic iron box, which when released swings down at the end with the statue, the sarcophagus, and presumably the entire party in it. The pivot point is a giant shaft under the floor just

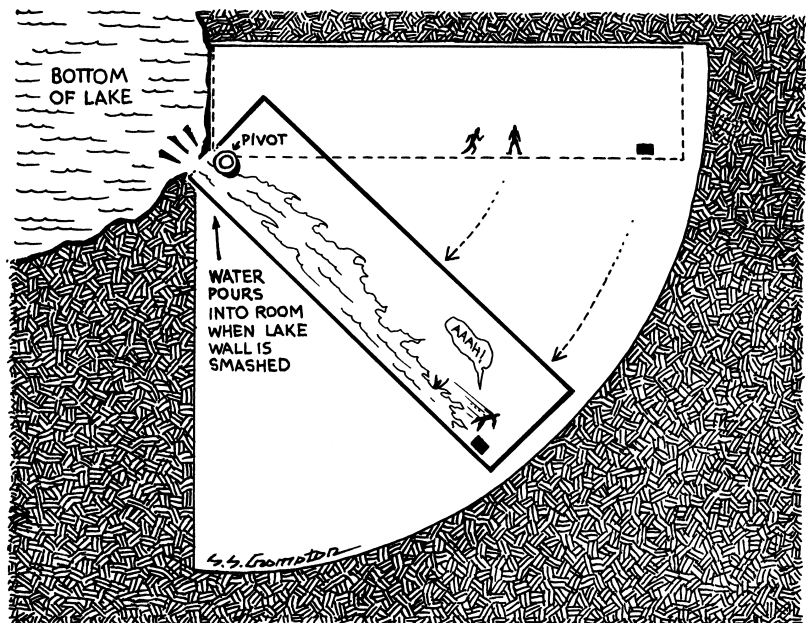

beyond the door. The room will rush through an arc and crash with lethal suddenness into the wall below. In this position the last 25 feet of the room will swing through the bottom of the lake. At this time the far wall, which is now the ceiling will collapse under the weight of the lake and the room will fill with water, the final element.

The impact of the room hitting the wall at the end of its swing, the multi-ton statue flying around, not to mention the stone dais, and the sarcophagus, the ceiling falling 130 feet in a rain of stony debris, and finally being at the bottom of a 130-foot waterfall, should result in a satisfying climax. I for one have seldom seen more ways to be done in at one time in one trap. This is a four skull trap if there ever was one. It even provides a hint for the faint-hearted trap master to use to say "I warned you!" (If by some happenstance a demigod has wandered in with the party add a final insult and dump the glass catfish in on top of him. If all this fails maybe he will climb out on the island and the green blob will get him.)

At this point it will seem the best is over. The delvers have ransacked, or been ransacked by, the tomb and there seems to be nothing else to assault. Well have no fear, Evinrood has not been found as the delvers peered into the black sarcophagus they saw it was empty. The

stumpy little rat is in here somewhere. There must be someplace that was missed.

Clues to his whereabouts can be found on the "treasure map" from the "X" room. The map at the time showed undifferentiated information but a flash of insight will cause the tomb robbers to look at it again. If they have exhausted all the other possibilities in the dungeon, then the map will reveal itself as a layout of the dungeon. If there are other places the party has not checked the map will seem blank.

If the map is revealed the party will notice an area in the very center of the dungeon where there are rooms they have not explored.

A clue can also be supplied to the party even if they lost the map to the quicksand. A member of the group could, upon racking his brain, (yes, contrary to popular belief delver do have brains) recognize that at the point after the crystal warrior/delver-polishing room there was an architectural anomaly. The corridor leading to the blank wall that forces the delvers to turn to the doors that lead to the entrance of "The Road Less Traveled" is 20 feet wide but the doors themselves are only 10 feet wide. Clearly there should be a 20-foot wide corridor leading from this point as well!

Done Too Soon

Trap #55: Check Your Daemons At the Door!



CR:	5
Type:	Combination (Mechanical and Magical)
Search:	Trap (DC 20), Trigger (DC 20), Secondary Trigger (DC 27), Secondary Trap (DC 27)
Disable Device:	Trap (DC 20, 2d4 rounds); Trigger (DC 20, 2d4 rounds), Secondary Trigger (DC 30, 2d4 rounds), Secondary Trap (DC 30, 2d4 rounds)
Primary Trigger:	Location (left hand buttons)
Primary Trap Effect:	Blades automatically slice off the finger unless the creature is wearing armor that grants an armor bonus of +5 or higher (or natural armor of +5 or higher). Magical bonuses do not count for determination of armor bonus in regards to this. (2d6 damage; -2 circumstance penalty to all checks using hand and -2 circumstance penalty to attack rolls if this was the victim's primary weapon hand).
Secondary Trigger:	Location (right hand buttons)
Secondary Trap Effect:	Magical beasts and elementals are sucked into the finger holes. All others (except elves) feel a cold chill (1d4 cold damage). Elves receive a minor electrical shock (1d4 electricity damage).
Reset:	No reset needed
Cost:	15,000 gp

It doesn't matter how the party finds its way to this point. It will either be by the noble, torturous route, the party having gone through every other alternative, and then finally having the significance of the "pirate map" made clear to them. Or it will possibly be after the crystal warrior/delver polisher that some architectural genius will come up with an idea. "Why does a 20-foot corridor lead to two 10-foot doors set at right angles, and leave me facing a blank wall?"

In either event the party will find that they have to scrape off a substantial amount of stucco to reveal these doors (takes about 1 minute of digging). When they have, they find themselves facing two 10-foot high 10-foot wide bronze doors. On these doors is depicted the final battle of Evinrood's career. The confrontation with the lord of the daemons!

On the right hand door can be found the image of a tall, imposing, dead-eyed man. This is Selgolub Lord of the Daemons. About his are the twisted visages of half human nightmare things, vile characters of things that might have been created in an evil dream. They are directed at the figures on the left hand door in magical onslaught.

On the left hand door is the depiction of a stumpy, harried figure, arms upraised, marshaling his forces. This can be recognized from other doors like this throughout the tomb as the image of Evinrood, Lord of the Elementals. All about him are the humanoid shapes of pure energy that represent the elementals. This strange force when compared to the things on the right hand door seems pure, and somehow pathetic!

But enough of this maudlin drivel. The art tour will be through after the tomb robbers have taken all the good stuff. These doors both have three finger holes in them. (That makes 6 altogether for those warriors in the party.) Those in the right hand door have an aura of magic about them. This will prompt the party to try the ones on the left. Too bad, as in that case all three will work as digit dicers, and the door still will not open. (No these doors will not respond to the low level magic opening spell of all the other.) To open the left hand door the party must first try the right hand holes!

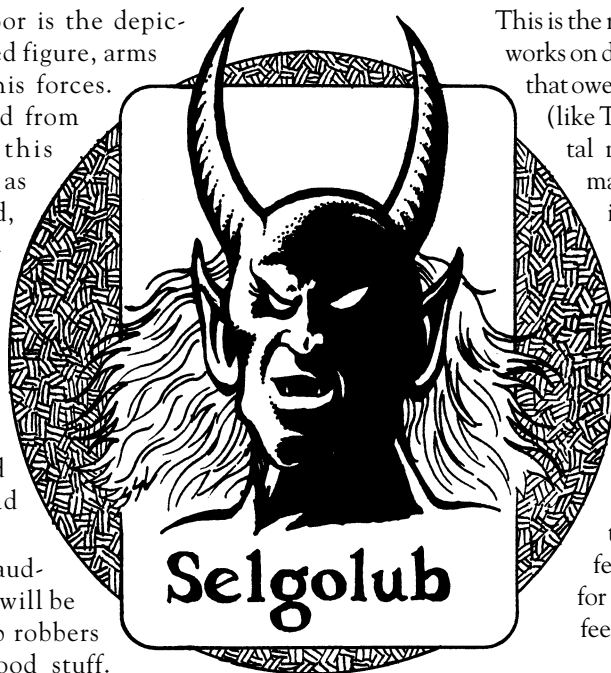

S. S. Gumpston

for laughs, to zap a few of the high browed, pointy-eared wood rats.)

After the party has tried the right hand door the left hand door will work in the usual manner. The huge doors will open, revealing a chamber.

The door is a four skull trap for those types of beings affected; all others will only be affected by the left not working until the right does, one skull at best.

This is the real trap and regrettably it only works on daemons, elementals, creatures that owe their existence to magic alone, (like Tsunami warriors, and Elemental men) or beings consisting of magical force. If any of this limited fraternity insert anything into these holes they will be slowly, and messily, sucked into the finger holes. Keep track of the beings thus affected's physical Strength, and Intelligence, it will be potentially relevant later on. If normal mortals, or nonmagically sustained creatures stick digits in, they will feel a cold chill. This is except for any elfish delvers: they will feel an electric shock, mild unfortunately, but startling. (It's a little trick of my own added

Trap #56: The Fabled "Earthly Reason" At Work

	
CR:	10
Type:	Combination (Magical and Mechanical)
Search:	Trap (DC 25), Trigger (DC 25)
Disable Device:	Trap (DC 25, 2d4 rounds); Trigger (DC 25, 2d4 rounds)
Primary Trigger:	Location (placing weight in excess of 20 pounds on throne)
Primary Trap Effect:	Throne flips over and deposits delver into 20-foot pit (no attack roll necessary; 2d6 falling damage)
Primary Save:	Reflex (DC 25) avoids
Secondary Trigger:	Timed (automatically triggers when first effect goes off)
Secondary Trap Effect:	Summons an earth elemental (see stats below) to do battle with the party
Reset:	Manual
Cost:	26,000 gp

The room beyond the doors is a 20-foot cube, one wall of which consists of the doors the party has just opened. On a raised platform near the



back wall is a throne three times human size. Behind the throne is an inscription inlaid in gold, on the wall.

"No souls escape the place beyond the seat of Earthly Wisdom!"

There are no detectable exits from this room. There are no magical auras to be found in the room either. In short it is just the party and the chair (comments about the relative intelligence of either are welcome).

Clearly some one must sit in the chair, although any suitable weight will do. (Oh, some parties will think of the "throw a backpack on the chair" trick but most won't.)

Once the throne has received weight in any volume above 20 pounds the trap will activate. The throne, and the stairs are mounted on a pivot. The whole ensemble will flip over through 180 degrees. This will have two effects, first anyone on the stairs or the throne will be dumped into an identical room below this one. The damage potential of a fall of 20 feet for a delver who has reached this point is negligible, but there is always the possibility that someone could break his fool neck.

The second effect is to bring up an identical throne upon which is seated a humanoid figure of superhuman proportions. This figure is magical in nature, and looks like a slab of rocky mud. On the creature's lap is a sword with a rust-colored blade. In its pommel is a dull amber stone. When the

floor locks back in place the Earth Elemental will raise, taking up the sword and attacks the party.

(A note to all mages: The stone in the pommel not only renders the elemental immune to magical attack, but casts a counter spell trapping the mage who cast the spell as if by *trap the soul*. This trap will consist of a pentagram etched in magic fire on the floor of the room, and will last only 30 minutes.)

Use the following stats for the earth elemental:

Elder Earth Elemental: CR 11, hp 228; see the MM for details.

If the party flees the room the earth elemental will return to the throne and sit down to await their return.

If the party defeats the elemental a section of the wall behind the throne 20 feet wide will sink slowly into the ground.

The elemental's blade will remain but in the hands of a normal delver it will be only a Huge +1 *greatsword*. The gem in the pommel will still be magical in nature, but it will only ward off direct magical attack (SR 20), not trap the spell caster.

The trap is not lethal unless those who are on the stairs or throne cannot think of a way out of the room under the throne. I suppose they could starve to death. But this is only a one skull trap, of course the golem is quite another thing, but he is a trap only for mages, and in that he does them no harm.

Trap #57: Never Touch A High Level Mage's Stuff'



CR:	8
Type:	Mechanical
Search:	Trap (DC 26), Trigger (DC 22)
Disable Device:	Trap (DC 26, 2d4 rounds); Trigger (DC 24, 2d4 rounds)
Primary Trigger:	Touch (the staff)
Primary Trap Effect:	Electrical jolt (no attack roll necessary; 8d6 points of electrical damage)
Primary Save:	Fortitude (DC 25) for half
Secondary Trigger:	Touch (trying to remove the staff at the same time a touch occurs)
Secondary Trap Effect:	Seals room. Walls are armor-plated (Hardness 20, hp 300, Break DC 45) and a spell akin to <i>dimensional anchor</i> prevents any sort of magical exit from the room.
Reset:	Manual
Cost:	26,600 gp

Before the party presses on the mages in the group will go amok, issuing a stern warning. Here there be *high level magic!* It is in the rock of the

entrance that sank into the ground, and in the walls, floor and ceiling. All these areas for a depth of 10 feet are interpenetrated with a magic spell. The level of this spell and its nature are impossible to discern. (Although the gold lettering behind the throne might provide a clue, hint, hint.) The party will also notice that the rock is clad with dwarven steel on the side that faces into the chamber.

Easily in the party's sight with light reflected off the polished steel walls is a chamber. It is a 40-foot cube of shining steel, in the center of which is a pyramid of three steps, the total over 5 feet high. The base of the pyramid is 20 feet on a side and set in the exact center of the room.

At the apex of the monument is a cube of the blue hy-Atlantaen stone. Thrust into this stone is a gnarled old wooden seeming staff. Three guesses whom this handy item once belonged to.

Eventually someone is going to want this handy little tool badly enough to try to pull it out of the stone. Any one of the tomb robbers who try will meet

with a truly colorful fate. Anyone touching the staff, either with their hands, or by some mechanical means, will end up on the receiving end of a jolt that will give the outward appearance of being magical. (You don't think the delvers will try to rope it, or slice it off with a sword? What have I been trying to teach you, about the deviousness of all prospective trap fodder? When you least expect it — zamm — up they come with some new harebrained plan. Expect the unexpected.)

Beneath this room is a gigantic version of the shock-generating wheel found at the entrance and in one of the bronze doors. It is driven by yet another branch of the underground stream. The power generated is enough to act as a joy buzzer for the entire City of Khazan, all 50,000 at once. Channeled through one or two delvers, it creates a beautiful blue spark, as it arcs to the ground. Of course what's left of the delvers after the experience could be conveniently stored in a shoebox.

A scenic note is that if the party tries to remove the staff, at the same time as a touch occurs, a

hydraulic force will drive the stone blocks that sank into the ground when the golem was defeated back into place, effectively trapping the party in a steel box. A little experimentation on the part of the magic users will show that nothing will get out of this room. The armor on the walls is proof against digging. The magic in the walls prevents teleportation. In short, nothing leaves the room, not man, magic, or immortal soul!

Now the arc to the ground is perfectly natural, but at the same time from the bodies of any delvers foolish to touch the staff a golden bolt of lightning will shoot into the wall opposite the entrance, flash once and be gone.

This is a three skull trap, too easy to just walk away from, but no delver will, and once they try the trap becomes a four skuller. With only one exit.

After enough of the party has tried in desperation to pull the staff out or somehow free it from the stone, and thereby created a fair number of little soot piles they will reach the level required to lead us to the final step on this journey.

Trap #58: As You Sow So Shall You Reap! or “Ladies and Gentlemen, Evinrood Has Left The Tomb”



The entire steel wall opposite the entry slowly sinks into the ground. This will reveal a room 20 feet deep and 40 feet wide. This is in reality an extension of the staff room, steel walls and all.

At the back of the room there is a large, comfortable, thronelike chair. The chair is resting on a low pedestal. In the air above the chair is a glowing crystal globe. The globe pulses with a brilliant red light. It is this light that illuminates this portion of the room.

On the throne is a stumpy figure. It is clad in the almost comically familiar mage's robe, complete with sun, moon, and star symbols. The figure seems to be sleeping.

The gang of tomb robbers has it in their power at this time to attack the dozing figure, or the glowing sphere above it.

If the delvers attack they will seal their own fate. The globe will loose the energy stored from the daemons, and those who have tried to touch the staff. It will blast *all* the remaining delvers with annihilatory force (note not flame, but the primal force of disintegration) and then go back to waiting for the next party. Those who fail a Fortitude save (DC 28) are disintegrated (as the spell).

Can't you see it now? The delvers have bashed, thrashed, and trashed their way into this magely

presence, and then blow the whole deal by acting just like delvers always do. “Look there he is George, it's Evinrood. Let's blow him up and see what happens.” This is what is most likely to happen. Good old humanoid tomb trashers, they seldom let me down.

Yet it is possible that they will exert some forbearance. If so, they will have a chance to witness the return from a form of magical hibernation one crafty mage.

Evinrood's soul and the magical power it possessed would have been seized at the time of his death by the minions of Selgolub. Keep in mind Evinrood had tried and failed to defeat the daemon lord and his operatives before. So Evinrood knew he needed a plan or he was going to become a karmic power plant for the plans of conquest the Daemon Lord was fostering.

Evinrood constructed this entire network with the aid of the dwarves, who owed him quite a few favors, and his own elementals. The purpose of the tomb's trap network was to thwart the assassins, both human and daemonic, that would be sent to see just why his soul could not be taken. Then in the center of the complex he built a place he could go and not-exactly-die. The steel room with his staff in place was set up to store power to bring his body back to life. The magic in the walls would keep his soul from escaping into the clutches of Selgolub. The globe stored the energy of Strength

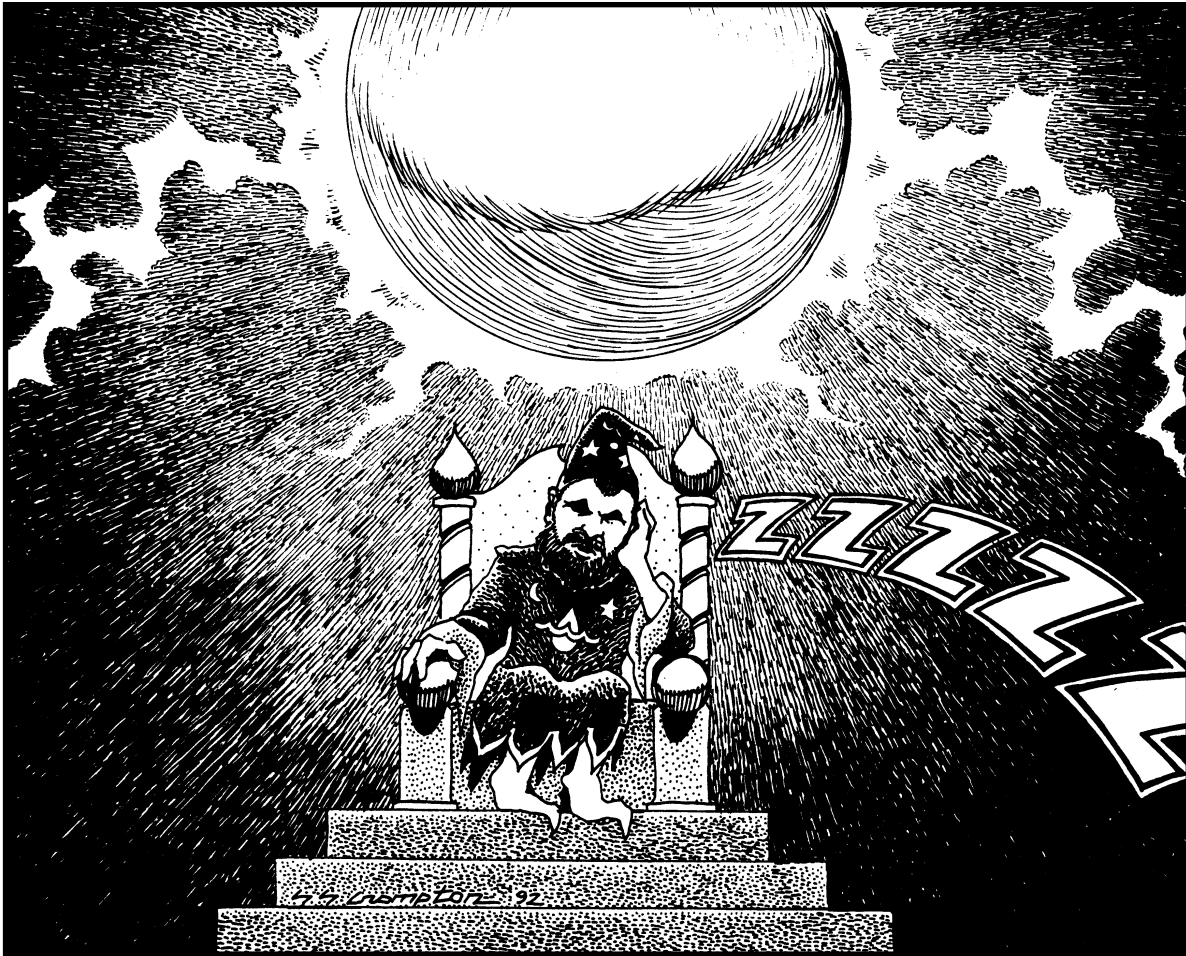

and Intelligence until enough was available to enable Evinrood to return to normal.

What the party witnesses is a blinding flash of light from the globe. When after image of the light have cleared Evinrood will be standing up.

At this point he will go into some maudlin diatribe about how nice everybody was to come in and help him out. This is after he checks to see if the two ladies in traps #50 and #52 are okay. (If they aren't then the globe fires another disintegration ray at any remaining delvers! See there is always hope. No foolish deed goes unpunished!)

The old mage has obviously gone soft in his old age, as at this point he will bestow on the remaining members of the party the globe. (Which has changed to ordinary iron and is about the size and weight of an eight-pound shot.) He tells the party that this device can act as a storehouse for any human attribute (protects against the first 5 points of ability damage to any single attribute suffered in one day) but only one at a time. If it is not used for this it can be used to store up to five spells for a

mage which can be cast simultaneously, or one at a time as well as the mage's own. The total spell levels must be 40 or less.

He will then turn to leave. Walking through the staff room, he stops to pull the staff out of the stone, and notices the little piles of ash. "Oh my, I knew I was forgetting something." And with a gesture all the delvers blasted will be restored! With another gesture, they are all teleported to the nearest village outside the trap complex (after all this, just walking out would be anti-climactic).

Now I know that most of you would just as soon see the delvers get their just desserts, but it seems that only nice old high-level mages have the time to devote to trap science, at least in the old days. As a result this namby-pamby ending will have to do. But for those who have a real feeling for irony, just let yourself stop at the point where the doddering old psychotic blasts everyone and exits laughing. It is a sight to warm the cockles of a trap master's heart.

That's it for now....

OH... YOU'RE
READY TO LEAVE?
WELL, IT'LL COST
YOU...

TO EXIT

Grimtooth's

DUNGEON OF DOOM

a game-master's aid for
all role-playing systems

YOU MUST
PURCHASE AN
EXIT TICKET!

COST: ONE MAJOR
BODY PART.



W. W. Wrayton

AND NOW A WORD FROM GRIMTINA!



HERE'S A MAP I MADE* THAT SHOWS HOW TO FIND MY BIG BROTHER'S

DUNGEON DOOM

FIND THE RUINS ON THE PLAIN OF TOMB-MEE
GO SW FOR ONE MILE. FIND THE RING OF STONES,

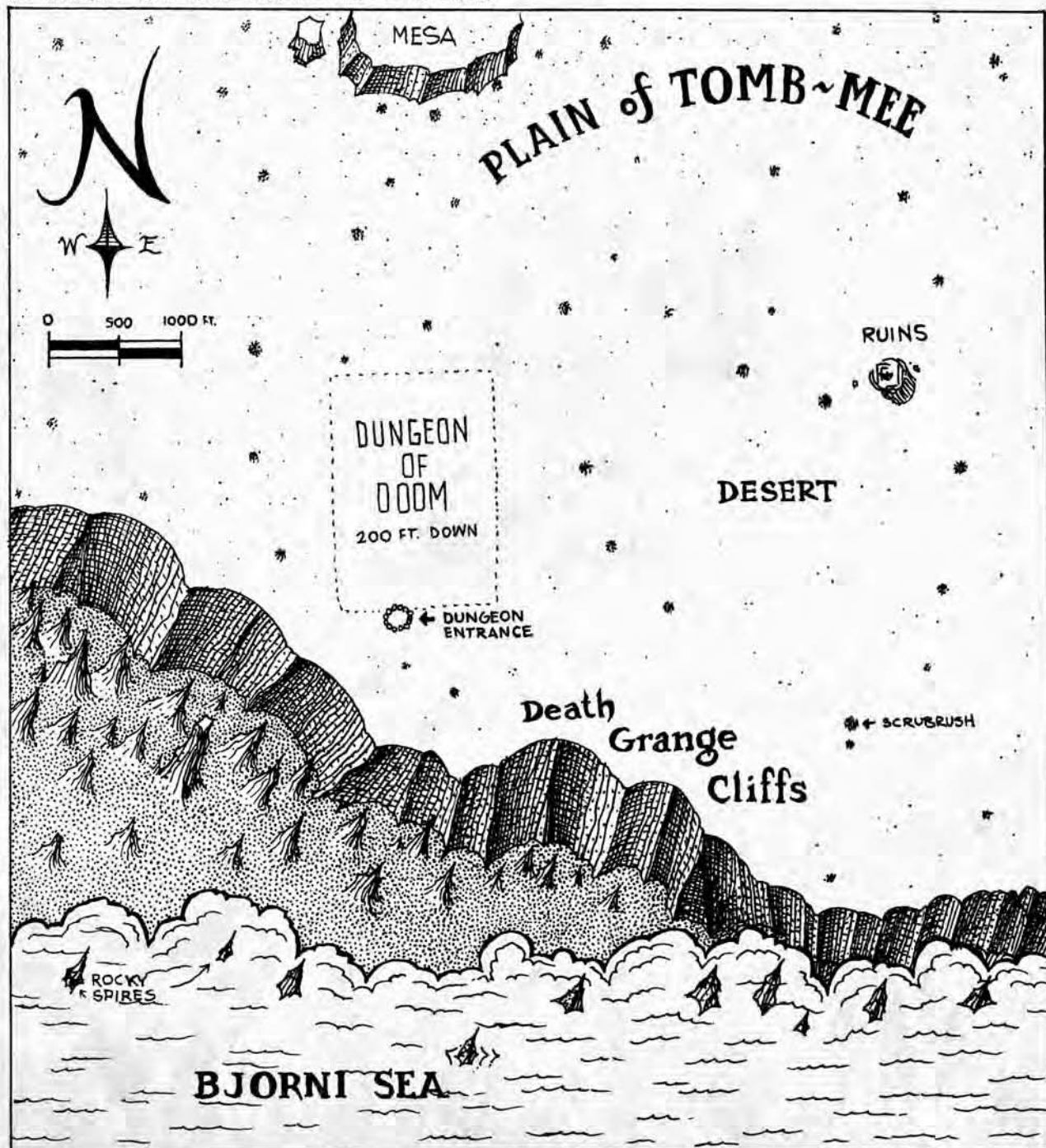

* with a little help from S. S. Grompton

Boy, that Dungeon of Doom sure was evil. I'd hate to fall victim to one of those nasty traps.

Well, I guess Grimtooth should be around here in a minute to say goodbye to us. Who knew that troll would be so nice to see us off? Maybe people have been wrong about him all these years.

WHAT WAS THAT?

Hey Bill, can you light that lantern?

Bill...?



Well, that should take care of those two Necromancer nuisances. Now this is my book.

And just for you, dear reader, I have prepared something special. A final trap.

The publication of this tome of traps is itself a rare thing, and is thus deserving of such a final performance.

The preparation of this final trap was a long and trying one. I had to search the world over to find the precise ingredients required. Everything had to be just so. The ink of the rare purple devilfish. A tuft of hair from a blind gibbon with no lungs. The wishbone of a duck. The intangible innocence of a newborn babe. These and other items I then mixed in a great vat, shuttered away from prying eyes in the deep recesses of my pits. Accompanied by the tolling of an iron bell, I uttered the words of the softly spoken magic spells. A moment of cosmic tension then, finally, the deed was done.

The resultant potion was a clear odorless one that proved undetectable when spread upon most any surface. It dried to a thin, almost filmy consistency within a few moments. This film would remain undetected on the surface to which it had been applied until such time as human hands touched it. The oils secreted by human skin, you see, interact violently with the potion when the two come into contact. This results in the film regaining viscosity in the form of a fast acting neurotoxin contact poison. The poison enters the victim's body in a matter of seconds. Painful death usually follows within a few minutes.

As a demonstration, I've taken the liberty of applying a measure of this potion to this page in certain copies of this book.

If you picked up one of them, the poison should be well within your system at this time. By my calculations, you should have just enough time to replace this book on the shelf where you found it before you pitch over in frothing fits. Of course, there's always the chance you got lucky.

Next time around, remember your station and keep your nose out of books that are none of your business.

Pleasant dreams.

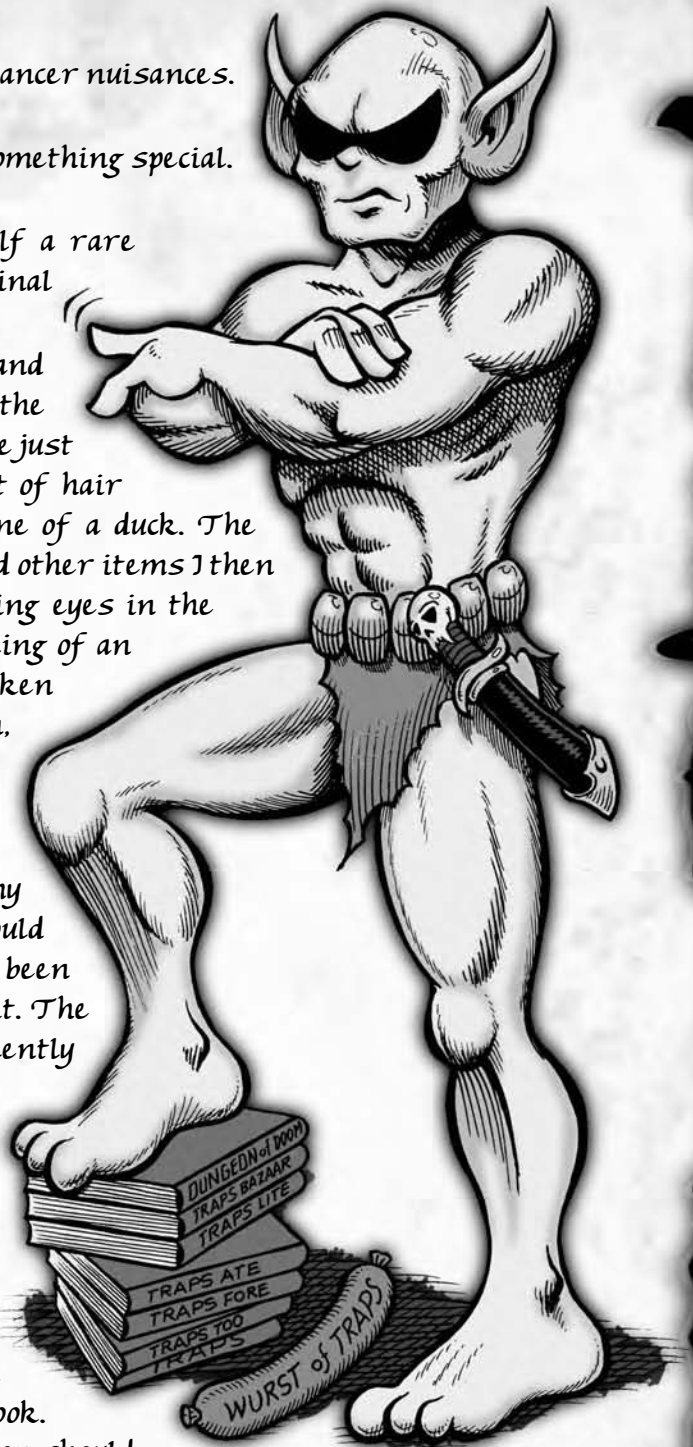

~ Grint

Index By Alphabetical Order

2 x 4 Headache	114		
A		D	
A Thousand And One Ways To Use Killer Bees!	183	Danger Here Will Be Crystal Clear, The	177
Achilles' Willies	93	Danger Room, The	39
Acid Rain	73	Dastardly Lava Room, The	19
Acid Test Scabbard, The	139	Dead End	83
After the Flood	47	Death of 1000 Slices	31
Amazing Ginsu Chute	83	Deluxe Centerpost, The	19
And You Thought This Was Going To Be Easy	150	Delvermatic Dicer and Malingerer Trap	113
And You Thought You Got Away	193	Did Someone Mention Poison Gas?	185
Anything He Can Do	88	Doggy Door	123
Archer's Tunnel	57	Door-Lover's Room	27
Arr! Here There Be Barried Treasure!	198	Double Door Doom	112
As You Sow So Shall You Reap! or "Ladies and Gentlemen, Evinrood Has Left The Tomb"	210	Double Scythe, The	79
Athenian Amphora, The	137	Double Trap	114
Atlas Affair, The	22	Downer Door, The	118
B		Dragging Doorway	112
Backstabber	115	E	
Ball Bearing Corridor	63	Ehpos Cloak	142
Beauty is in the Eye of the Beheader	92	Emergency Exit	83
Bee-Hive Trap	78	Evinrood Tries To Dust Off The Party	187
Bellows of Ghosts and Flames	135	Eye-Catching Trap	124
Better Mousetrap, The	33	F	
Between a Rock and a Hard Place	61	Fabled 'Earthly Reason' At Work, The	208
Beware of Doppelgangers	116	Finally Our Just Reward!	158
Bigger They Are..., The	20	Fire and Ice	25
Bookcase Cliché, The	119	First Step Trap	69
Books Of Hjalpyar, The	136	Flesh Pot, The	72
Boulder Trap	104	Folly Flight	66
Bridge at Rue Vincent, The	22	Fore!	76
Bridge Too Far, A	49	Free Fall Room	44
Bucket Over the Door, The	118	G	
Buster's Façade	120	Gauntlets of Doom	143
C		Get a Grip Gauntlets	142
C'mon Guys Get A Grip!	185	Giant's Razor	110
Cape of Dorian Grey	143	Give Me A Lever Large Enough And I'll Move The World	101
Carpet Bag	138	Going Down?	154
Ceiling Trap, The	32	Grab For The Brass Ring	102
Check Your Daemons At the Door!	207	Greystoke Memorial, The	62
Chute and Hammer Trap	64	Guillotine Door Trap	110
Chutes and Graters	172	Guillotine Portcullis	121
Chuting Gallery	84	H	
Click Plate, The	89	Have a Ball	141
Climbing The Stairway To Heaven	159	Heads Up!	117
Cool, Clear, Water!	191	Heart of Glass	98
Cretin in the Circular Citadel	30	Heated Harassment Harries Hapless Hunters	179
Crossbow Thirteen	70		
Cure a Kicker Trap	111		
Cyclone the Deadly May-Pole	45		

- | | | | |
|---|-----|---|-----|
| Hero Sandwich | 71 | Mirrors of The Soul | 138 |
| Hit 'Im Where He Ain't | 77 | Mock Padlock | 121 |
| Hit 'em And Hit 'em, This Trap Will | | More Ups and Downs! | 167 |
| Leave 'em No Place To Go | 197 | Music To My Ears | 36 |
| Hole and the Wall Bang | 51 | | |
| Hoovermatic Trap, The | 19 | N | |
| Hop, Skip and a Jump | 56 | Never Touch A High Level Mage's Stuff! | 209 |
| How Long Can You Tread Water? | 173 | Now You See It, Now You're Dead! | 74 |
| | | | |
| I | | O | |
| I Always Figured Tomb Robbers Deserve A Good Trashing | 194 | Oh No, Not The Old Chutes And Razors Gag! | 197 |
| I'll Take a Stab at That | 79 | Oh What A Tangled Web We Weave | 52 |
| Idiot's Vase | 139 | One Orc's Sauna is Another Man's Body Liquid | 94 |
| If At First You Don't Succeed Try, Try, And Keep On Trying! | 155 | One That Got Away, The | 21 |
| If You Think You've Got It Made You're All Wet! | 206 | One Way Or Another | 24 |
| Illusions | 16 | Only Time Will Tile | 81 |
| I'm Sure You'll Get The Point! | 176 | Oops, Aaaaahh!, Crash, Clang, Splat, Zap, Sizzle Trap | 107 |
| Impaling Pit | 84 | Open The Door | 123 |
| Infamous Wheel Trap, The | 14 | Orfile's Slide of Delver Dumping | 65 |
| Infinite Corridors Trap | 132 | | |
| It Is Always Darkest Before Things Go Right Down The Drain! | 171 | | |
| It Makes Me Feel Tingly All Over! | 189 | | |
| | | P | |
| J | | Palm Red | 93 |
| Just What Every Delver Needs. A Little Polish | 178 | Peerless Pillar Room, The | 35 |
| Just When You Thought It Was Safe... | 151 | Permanent Rope Burn | 42 |
| | | Piano Floor | 72 |
| K | | Pilum Pacifier | 66 |
| Kareem Abdul-Jabbar Memorial Sky Hook Trap, The | 46 | Pits and Pancakes | 87 |
| Kaynar's Clothes | 142 | Pivoting Pit, The | 85 |
| Kiss of Death | 33 | Poison Door | 111 |
| Knock Knock Door | 122 | Poke, Grapple, Wrestle, and Chomp: | |
| | | Personal Injuries a Specialty! | 169 |
| L | | Proof Positive That All High Level Mages Are Screwy! | 181 |
| Last Laugh Trap | 60 | Put That Down, You Don't Know Where It's Been | 179 |
| Last Of The Mimes | 122 | | |
| Lest You Become Too Complacent Evinrood Pitches A Curve! | 205 | R | |
| Let Me At 'Em | 32 | Revolver | 90 |
| Life Is The Pits | 103 | Ring Of Doom | 140 |
| Lighthouse Gem, The | 48 | "Rock and Roll River" by Evinrood and the Delvers! | 170 |
| Lobster Trap, The | 17 | Rolling Stone, The | 68 |
| Look Before You Leap | 59 | Roman Amphitheatre Trap | 15 |
| Lose the Spock Ears, Clyde | 99 | Row, Row, Row Your Boat, Life Is But A Scream! | 168 |
| | | | |
| M | | S | |
| Magnificent Marble Misadventure | 59 | Safe-Cracker's Nemesis, The | 29 |
| Make Mine Very Dry... | 190 | Sand Gets In Your Eyes, The | 152 |
| Mangler, The | 81 | Sands of Time, The | 43 |
| Mapper Maddener | 65 | Satan's Bow | 139 |
| Meet the Pit | 82 | Sauna | 38 |
| Mirror, Mirror, and the Fall | 58 | Sectioning Corridor | 57 |
| | | See Ya Ladder | 100 |
| | | See-Saw Corridor | 67 |

THE WURST OF GRIMTOOTH'S TRAPS

See-Saw Room	27	Toe Tickler	25
Seven Leak Boots, The	143	Trap Detection Amulet	140
Shock Treatment	34	Trip Wire That Isn't	60
Shower of Gold	72	Triple Trap Tunnel	97
Slayground Ride	89	Troll's Bridge-Work	30
Slider Spiker Trap	16		
Smashing Floor Trap, The	68		
So You Want To Get To The Bottom Of This, Eh?	187	U	
Some Bottomless Pits Are Deeper Than Others	149	Upsidaisy-Downsidaisy	116
Some How This All Seems Too Easy!	200		
Speak Down	139		
Spinning Spiral Stair	91	W	
Springs 'N Spikes	120	Water? What Water, I Don't See Any Water	160
Stair Snare	70	We Must Be Getting Close I Smell Smoke	157
Step This Way, Please	76	Wet Pit	74
Sucker Sucker, The	86	What Goes Up Must Come Down!	163
Supercharger Crawlway	67	What You Don't Know WILL Hurt You	115
Suspension Ladder	75	What's the Matter? Cat Got Your Tongue?	174
		"What's Up" Dock, The	164
T		Wheel of Misfortune	99
Tale of Two Pity's	95	When I Do This I Get This Tingling Sensation!	148
Teeter-Totter Room, The	23	Which Way to the Front?	64
Terrible Toilet Seat Trap	131	Whipped-Cream Pit	74
That Sinking Feeling	90	Whirling Blade Boot Bloodier	69
There and Back Again	80	Wimp's Revenge	37
These Things Sort of Spring Out At You!	162	Wizard Alazo's Stick, The	135
These Things Tend To Get Away From You!	192		
Thief Squasher	40	Y	
Things Get All Screwed Up	161	Ye Olde Digit Dicer	151
Things You Must Go Through For Loot!, The	203	You Bring These Things On Yourself	153
This Trap Is A Gas!	194	You Light Up My Life!	203
This Will Really Light Your Fire!	195	You Rang?	28
Tipping Corridor	96	You'll Get A Bang Out Of This One	199
To Sleep, Perchance To Dream...	182		

Index by Trap CR

The traps in this table are organized by the “base” CR, which may be higher or lower depending on variations used by the DM.

No listed CR

Traps in this category can be cursed items or situations that present problems but not necessarily danger.

Acid Test Scabbard, The	139
Archer's Tunnel	57
As You Sow So Shall You Reap! or “Ladies and Gentlemen, Evinrood Has Left The Tomb”	210
Athenian Amphora, The	137
Bellows of Ghosts and Flames	135
Books Of HjalFYar, The	136
Cape of Dorian Grey	143
Carpet Bag	138
Click Plate, The	89
Ehpos Cloak	142
Flesh Pot, The	72
Gauntlets of Doom	143
Get a Grip Gauntlets	142
How Long Can You Tread Water?	173
Idiot's Vase	139
Kaynar's Clothes	142
Look Before You Leap	59
Make Mine Very Dry...	190
Mapper Maddener	65
Mirrors of The Soul	138
Peerless Pillar Room, The	35
Put That Down, You Don't Know Where It's Been	179
Revolver	90
Ring Of Doom	140
Row, Row, Row Your Boat, Life Is But A Scream!	168
Satan's Bow	139
Seven Leak Boots, The	143
Some How This All Seems Too Easy!	200
Speak Down	139
Trap Detection Amulet	140
Wet Pit	74
Which Way to the Front?	64
Wizard Alazo's Stick, The	135
You Light Up My Life!	203

CR 1 or less

Acid Rain	73
Bee-Hive Trap	78
Bucket Over the Door, The	118
Chuting Gallery	84
Dragging Doorway	112
Folly Flight	66
Free Fall Room	44
Heart of Glass	98
It Makes Me Feel Tingly All Over!	189
Last Of The Mimes	122
Lose the Spock Ears, Clyde	99
Magnificent Marble Misadventure	59
Mock Padlock	121

Open The Door	123
Orfile's Slide of Delver Dumping	65
Palm Red	93
Safe-Cracker's Nemesis, The	29
Sectioning Corridor	57
Spinning Spiral Stair	91
That Sinking Feeling	90
Tipping Corridor	96
Trip Wire That Isn't	60
Troll's Bridge-Work	30
What You Don't Know WILL Hurt You	115
Whipped-Cream Pit	74

CR 2

2 x 4 Headache	114
Anything He Can Do	88
Ball Bearing Corridor	63
Bookcase Cliché, The	119
Chute and Hammer Trap	64
Dead End	83
Did Someone Mention Poison Gas?	185
Double Scythe, The	79
Double Trap	114
Going Down?	154
Guillotine Portcullis	121
Heads Up!	117
Heated Harassment Harries Hapless Hunters	179
Hero Sandwich	71
Hit 'Im Where He Ain't	77
I'll Take a Stab at That	79
Illusions	16
Meet the Pit	82
Music To My Ears	36
Now You See It, Now You're Dead!	74
Only Time Will Tile	81
Permanent Rope Burn	42
Piano Floor	72
Rolling Stone, The	68
Springs 'N Spikes	120
Stair Snare	70
Terrible Toilet Seat Trap	131
The Teeter-Totter Room	23
There and Back Again	80
To Sleep, Perchance To Dream...	182
When I Do This I Get This Tingling Sensation!	148
Whirling Blade Boot Bloodier	69
Wimp's Revenge	37
Ye Olde Digit Dicer	151
You Rang?	28

CR 3

Bridge Too Far, A	49
Cyclone the Deadly May-Pole	45

Danger Here Will Be Crystal Clear, The	177
Death of 1000 Slices	31
Evinrood Tries To Dust Off The Party	187
Finally Our Just Reward!	158
Have a Ball	141
Hole and the Wall Bang	51
I'm Sure You'll Get The Point!	176
Impaling Pit	84
Infinite Corridors Trap	132
Kareem Abdul-Jabbar Memorial Sky Hook Trap, The	46
Knock Knock Door	122
Lighthouse Gem, The	48
Mangler, The	81
Oh What A Tangled Web We Weave	52
Pilum Pacifier	66
Sucker Sucker, The	86
Suspension Ladder	75
We Must Be Getting Close I Smell Smoke	157

CR 4

A Thousand And One Ways To Use Killer Bees!	183
Achilles' Willies	93
Amazing Ginsu Chute	83
Backstabber	115
Climbing The Stairway To Heaven	159
Cure a Kicker Trap	111
Double Door Doom	112
Eye-Catching Trap	124
Fore!	76
Giant's Razor	110
Guillotine Door Trap	110
Hoovermatic Trap, The	19
Kiss of Death	33
Life Is The Pits	103
More Ups and Downs!	167
Oh No, Not The Old Chutes And Razors Gag!	197
One Orc's Sauna is Another Man's Body Liquid	94
See Ya Ladder	100
Shock Treatment	34
Slayground Ride	89
Supercharger Crawlway	67
Toe Tickler	25
Triple Trap Tunnel	97
What Goes Up Must Come Down!	163

CR 5

Arr! Here There Be Barrired Treasure!	198
Beauty is in the Eye of the Beheader	92
C'mon Guys Get A Grip!	185
Check Your Daemons At the Door!	207
Doggy Door	123
Door-Lover's Room	27
Fire and Ice	25
First Step Trap	69
Oops, Aaaahhh!, Crash, Clang, Splat, Zap, Sizzle Trap	107
Pivoting Pit, The	85
Sand Gets In Your Eyes, The	152
Sands of Time, The	43

Sauna	38
Slider Spiker Trap	16
Things Get All Screwed Up	161
What's the Matter? Cat Got Your Tongue?	174
"What's Up" Dock, The	164
Wheel of Misfortune	99

CR 6

And You Thought This Was Going To Be Easy	150
Bridge at Rue Vincent, The	22
Cretin in the Circular Citadel	30
Crossbow Thirteen	70
Just When You Thought It Was Safe...	151
Lobster Trap, The	17
One That Got Away, The	21
Pits and Pancakes	87
See-Saw Corridor	67
See-Saw Room	27
This Trap Is A Gas!	194
Water? What Water, I Don't See Any Water	160

CR 7

And You Thought You Got Away	193
Better Mousetrap, The	33
Beware of Doppelgangers	116
Poison Door	111
"Rock and Roll River" by Evinrood and the Delves!	170
Some Bottomless Pits Are Deeper Than Others	149
Tale of Two Pity's	95
These Things Sort of Spring Out At You!	162
Upsidaisy-Downsidaisy	116

CR 8

Chutes and Graters	172
Cool, Clear, Water!	191
I Always Figgured Tomb Robbers Deserve A Good Trashing	194
Mirror, Mirror, and the Fall	58
Never Touch A High Level Mage's Stuff!	209
Step This Way, Please	76
Thief Squasher	40

CR 9

Between a Rock and a Hard Place	61
Bigger They Are..., The	20
Poke, Grapple, Wrestle, and Chomp: Personal I njuries a Specialty!	169
Smashing Floor Trap, The	68
You Bring These Things On Yourself	153

CR 10

After the Flood	47
Atlas Affair, The	22
Boulder Trap (actually CR is ungodly and off the scale)	104
Buster's Façade	120
Ceiling Trap, The	32
Danger Room, The	39

Dastardly Lava Room, The	19	Right Down The Drain!	171
Deluxe Centerpost, The	19	Just What Every Delver Needs. A Little Polish	178
Delvermatic Dicer and Malingerer Trap	113	Last Laugh Trap	60
Downer Door, The	118	Lest You Become Too Complacent	
Emergency Exit	83	Evinrood Pitches A Curve!	205
Fabled 'Earthly Reason' At Work, The	208	Let Me At 'Em	32
Give Me A Lever Large Enough And I'll Move The World	101	One Way Or Another	24
Grab For The Brass Ring	102	Proof Positive That All High Level Mages Are Screwy!	181
Greystoke Memorial, The	62	Roman Ampitheatre Trap	15
Hit 'em And Hit 'em, This Trap Will Leave 'em No Place To Go	197	Shower of Gold	72
Hop, Skip and a Jump	56	So You Want To Get To The Bottom Of This, Eh?	187
If At First You Don't Succeed Try, Try, And Keep On Trying!	155	These Things Tend To Get Away From You!	192
If You Think You've Got It Made You're All Wet!	206	Things You Must Go Through For Loot!, The	203
Infamous Wheel Trap, The	14	This Will Really Light Your Fire!	195
It Is Always Darkest Before Things Go		You'll Get A Bang Out Of This One	199



Legal Appendix

This printing of *The Wurst of Grimtooth's Traps* is done under version 1.0a of the of the Open Game License, below, and version 6.0 of the d20 System Trademark License and version 5.0 of the d20 System Trademark Logo Guide.

Notice of Open Game Content: This product contains Open Game Content, as defined in the Open Game License, below. Open Game Content may only be Used under and in terms of the Open Game License.

Designation of Open Game Content: All text containing game-related content within this product—excluding any text on the inside or outside of the front or back cover or on the Credits page—is hereby designated as Open Game Content, subject to the Product Identity designation below. Any questions regarding the Open Game Content within this module should be directed to Clark Peterson at clark@necromancergames.com.

Use of Content from Flying Buffalo: This product contains content from previously published products by Flying Buffalo that is used by permission and pursuant to license, including but not limited to any names or content that appear in this product that has previously appeared in a Flying Buffalo product. Any such content is not Open Game Content. Any failure in this designation does not cause such content to become Open Game Content.

Designation of Product Identity: The following items are hereby designated as Product Identity as provided in section 1(e) of the Open Game License:

1. The name “Necromancer Games” as well as all logos and identifying marks of Necromancer Games, Inc., including but not limited to the Orcus logo and the phrase “Third Edition Rules, First Edition Feel” as well as the trade dress of Necromancer Games products;

2. The Necromancer Games product name “The Wurst of Grimtooth's Traps,” as well as any and all Necromancer Games product names referenced in the work;

3. The names Grimtooth, Grimmy, Grimtina, Spike the Grimdog, the Dungeon of Doom, the names of any previously published Grimtooth products published by Flying Buffalo, as well as any and all content from any previously published Grimtooth product published by Flying Buffalo that appears herein;

4. All artwork, illustration, graphic design, maps, and cartography, including any text contained within such artwork, illustration, maps or cartography;

5. The proper names, personality, descriptions and/or motivations of all artifacts, characters, races, countries, creatures, geographic locations, gods, deities, historic events, magic items, spells, feats, organizations and/or groups unique to this book, but not their stat blocks or other game mechanic descriptions (if any);

6. The story, storylines, histories, plots, thematic elements and dialogue in this book;

7. Any other content previously designated as Product Identity is hereby designated as Product Identity and is used with permission and/or pursuant to license.

OPEN GAME LICENSE Version 1.0a

The following text is the property of Wizards of the Coast, Inc. and is Copyright 2000 Wizards of the Coast, Inc. (“Wizards”). All Rights Reserved.

1. **Definitions:** (a) “Contributors” means the copyright and/or trademark owners who have contributed Open Game Content; (b) “Derivative Material” means copyrighted material including derivative works and translations (including into other computer languages), potation, modification, correction, addition, extension, upgrade, improvement, compilation, abridgment or other form in which an existing work may be recast, transformed or adapted; (c) “Distribute” means to reproduce, license, rent, lease, sell, broadcast, publicly display, transmit or otherwise distribute; (d) “Open Game Content” means the game mechanic and includes the methods, procedures, processes and routines to the extent such content does not embody the Product Identity and is an enhancement over the prior art and any additional content clearly identified as Open Game Content by the Contributor, and means any work covered by this License, including translations and derivative works under copyright law, but specifically excludes Product Identity; (e) “Product Identity” means product and product line names, logos and identifying marks including trade dress; artifacts; creatures characters; stories, storylines, plots, thematic elements, dialogue, incidents, language, artwork, symbols, designs, depictions, likenesses, formats, poses, concepts, themes and graphic, photographic and other visual or audio representations; names and descriptions of characters, spells, enchantments, personalities, teams, personas, likenesses and special abilities; places, locations, environments, creatures, equipment, magical or supernatural abilities or effects, logos, symbols, or graphic designs; and any other trademark or registered trademark clearly identified as Product identity by the owner of the Product Identity, and which specifically excludes the Open Game Content; (f) “Trademark” means the logos, names, mark, sign, motto, designs that are used by a Contributor to identify itself or its products or the associated products contributed to the Open Game License by the Contributor; (g) “Use”, “Used” or “Using” means to use, Distribute, copy, edit, format, modify, translate and otherwise create Derivative Material of Open Game Content; (h) “You” or “Your” means the licensee in terms of this agreement.

2. **The License:** This License applies to any Open Game Content that contains a notice indicating that the Open Game Content may only be Used under and in terms of this License. You must affix such a notice to any Open Game Content that you Use. No terms may be added to or subtracted from this License except as described by the License itself. No other terms or conditions may be applied to any Open Game Content distributed using this License.

3. **Offer and Acceptance:** By Using the Open Game Content You indicate Your acceptance of the terms of this License.

4. **Grant and Consideration:** In consideration for agreeing to use this License, the Contributors grant You a perpetual, worldwide, royalty-free, non-exclusive license with the exact terms of this License to Use, the Open Game Content.

5. **Representation of Authority to Contribute:** If You are contributing original material as Open Game Content, You represent that Your Contributions are Your original creation and/or You have sufficient rights to grant the rights conveyed by this License.

6. **Notice of License Copyright:** You must update the COPYRIGHT NOTICE portion of this License to include the exact text of the COPYRIGHT NOTICE of any

Open Game Content You are copying, modifying or distributing, and You must add the title, the copyright date, and the copyright holder's name to the COPYRIGHT NOTICE of any original Open Game Content you Distribute.

7. **Use of Product Identity:** You agree not to Use any Product Identity, including as an indication as to compatibility, except as expressly licensed in another, independent Agreement with the owner of each element of that Product Identity. You agree not to indicate compatibility or co-adaptability with any Trademark or Registered Trademark in conjunction with a work containing Open Game Content except as expressly licensed in another, independent Agreement with the owner of such Trademark or Registered Trademark. The use of any Product Identity in Open Game Content does not constitute a challenge to the ownership of that Product Identity. The owner of any Product Identity used in Open Game Content shall retain all rights, title and interest in and to that Product Identity.

8. **Identification:** If you distribute Open Game Content You must clearly indicate which portions of the work that you are distributing are Open Game Content.

9. **Updating the License:** Wizards or its designated Agents may publish updated versions of this License. You may use any authorized version of this License to copy, modify and distribute any Open Game Content originally distributed under any version of this License.

10. **Copy of this License:** You MUST include a copy of this License with every copy of the Open Game Content You Distribute.

11. **Use of Contributor Credits:** You may not market or advertise the Open Game Content using the name of any Contributor unless You have written permission from the Contributor to do so.

12. **Inability to Comply:** If it is impossible for You to comply with any of the terms of this License with respect to some or all of the Open Game Content due to statute, judicial order, or governmental regulation then You may not Use any Open Game Material so affected.

13. **Termination:** This License will terminate automatically if You fail to comply with all terms herein and fail to cure such breach within 30 days of becoming aware of the breach. All sublicenses shall survive the termination of this License.

14. **Reformation:** If any provision of this License is held to be unenforceable, such provision shall be reformed only to the extent necessary to make it enforceable.

15. COPYRIGHT NOTICE

Open Game License v 1.0a Copyright 2000, Wizards of the Coast, Inc.

System Reference Document Copyright 2000-2003, Wizards of the Coast, Inc.; Authors Jonathan Tweet, Monte Cook, Skip Williams, Rich Baker, Andy Collins, David Noonan, Rich Redman, Bruce R. Cordell, based on original material by E. Gary Gygax and Dave Arneson.

Original Spell Name Compendium Copyright 2002 Clark Peterson; based on NPC-named spells from the *Player's Handbook* that were renamed in the System Reference Document. The *Compendium* can be found on the legal page of www.necromancergames.com

The Wurst of Grimtooth's Traps Copyright 2005 Flying Buffalo, Inc., produced and distributed by Necromancer Games, Inc., under license; Authors Scott Greene and Clark Peterson, based on original material by Rick Loomis, Steve Crompton, Liz Danforth and the staff of Flying Buffalo.

FLYING

BUFFALO

WE'RE
BACK!!



i n c o r p o r a

If you liked the traps found in this book, look for reprints of the Classic Grimtooth's Traps books coming soon from Flying Buffalo.

WWW.FLYINGBUFFALO.COM



Dead Man's Chest

A Treasury of Nautical Lore

No place offers more adventure than the ocean. No dungeon is as deep, no jungle as full of exotic and dangerous life. Most folk spend their entire lives on dry ground, unaware that entire civilizations thrive beneath the waves, sometimes far more ancient and steeped in mystery than any on the world's upper surface. Though player characters (PCs) have long grown familiar with the air-breathing world above, seldom do they venture into the depths, and when they do, they discover wonders they never dreamed existed. The ocean offers a venue for adventure that is at once alien and appealing. Strange things exist down there, as perilous as they are compelling.

Maritime Adventure

Dead Man's Chest lays bare the ocean and the creatures that inhabit it. Within these pages are detailed rules for ship movement, as well as guidelines for underwater exploration, and three complete maritime adventures. At last there is a comprehensive source for sailing and the sea—packed with over 100 new magic items, monsters, feats, prestige classes, and spells.

COMING SOON FROM NECROMANCER GAMES

THE WORST OF GRIMTOOTH'S TRAPS

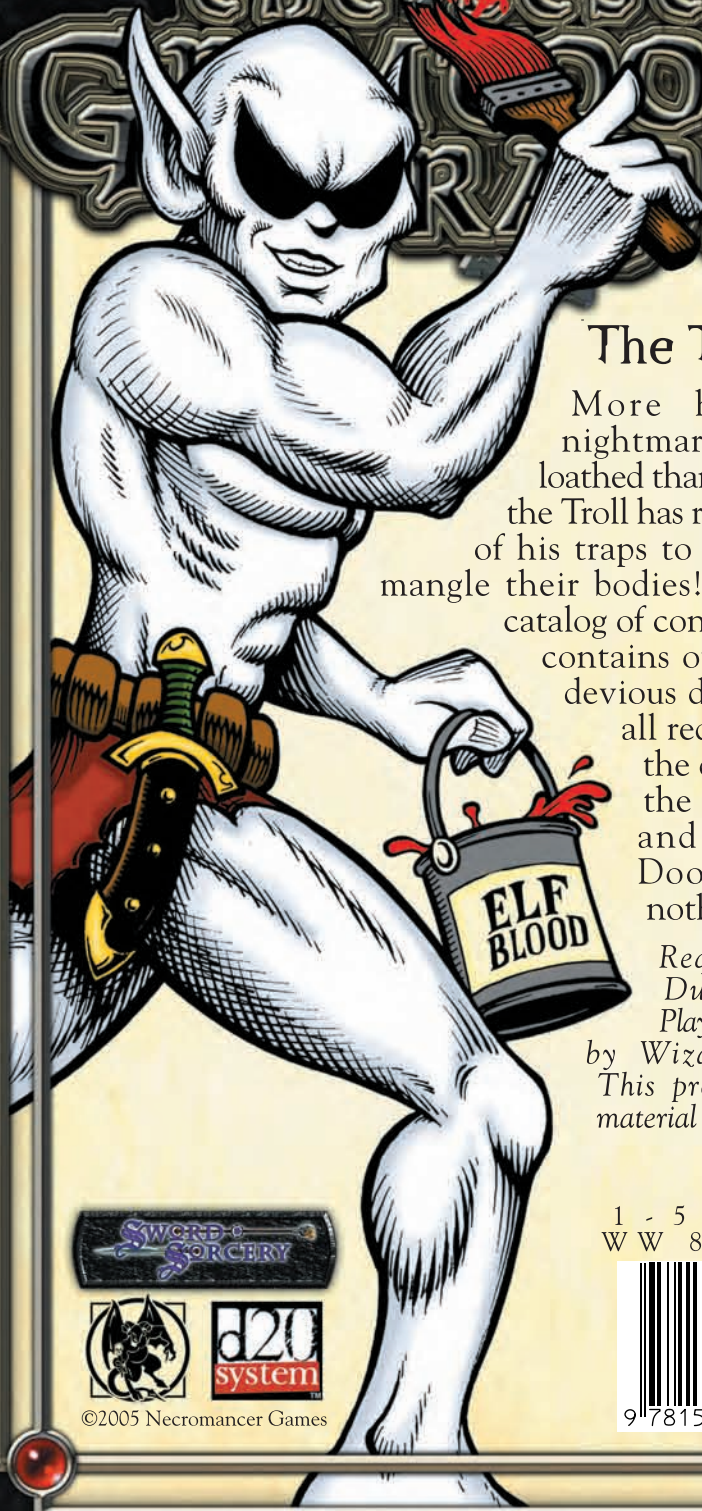

The Troll Is Back!

More horrible than a nightmare, more feared and loathed than the IRS, Grimtooth the Troll has returned with the best of his traps to try men's souls and mangle their bodies! This connoisseur's catalog of condemnable calamities contains over 200 of the most devious devices ever devised, all redesigned for use with the d20 System. Includes the famous Traps Bazaar and the Dungeon of Doom, a dungeon of nothing but traps!

Requires the use of the Dungeons & Dragons® Player's Handbook, published by Wizards of the Coast®. This product utilizes updated material from the v.3.5 revision.



©2005 Necromancer Games

1 - 5 8 8 4 6 - 1 3 9 - 4
W W 8 3 8 6 \$ 3 4 . 9 9 U . S .

