



MUTANT CHRONICLES™

THE BROTHERHOOD

THE CLEANSING FLAME
OF THE CARDINAL

Paul Bonner

THE BROTHERHOOD™



AUTHOR: MATT FORBECK

CONCEPT: NILS GULLIKSSON, MICHAEL STENMARK,

HENRIK STRANDBERG, MAGNUS SETER, JERKER

SOJDELIUS, STEFAN THULIN, FREDRIK MALMBERG

ART DIRECTION: STEFAN THULIN, JERKER

SOJDELIUS, NILS GULLIKSSON

ORIGINALS: STEFAN THULIN

COVER ARTWORK: PAUL BONNER

INTERIOR ARTWORK: PETER BERGTING,

LARS NORDBECK, PAUL BONNER, MAGNUS OLSSON,

NILS GULLIKSSON, TONY BAGGE, PAOLO PARENTE

For More Information
Contact:

Heartbreaker
P.O. Box 105
Folsom PA
19033 U.S.A.

or

Gamecraft
A16 Gardners Row
Liverpool, L36JT
England

COPYRIGHT © 1993 TARGET GAMES AB, ALL RIGHTS RESERVED. MUTANT CHRONICLES, MUTANT CHRONICLES THE TECHNO-FANTASY ROLEPLAYING GAME, THE BROTHERHOOD AND ALL CHARACTER NAMES AND LIKENESS(ES) THEREOF ARE TRADEMARKS OF TARGET GAMES AB. PRINTED IN THE U. S. A.



CARDINAL DOMINIC

Cardinal Dominic is the Cardinal of the Cathedral on Luna and therefore the Brotherhood's second in command. He is a member of the Curia, and hopes to one day become the Cardinal himself. He has no idea that he doesn't have a chance, so he holds out some hope.

Known as the Sheriff of Luna, Dominic is an old man made infamous by his penchant for torture. There is nothing he likes better than to while away the hours not occupied by the duties of his office by interrogating some truly stubborn young heretic. Dominic will stop at nothing to obtain the answers he desires. No form of maiming or mutilation is too grotesque for this man—in fact, the more pain he can cause, the better.

Dominic managed to rise to his current position through nothing more than ruthless efficiency. No matter what the task, he always gets the job done, no matter what the cost. His tactics have met with disapproval by many, but as he always growls to any who question his judgment, there's a war on. In his opinion, the Brotherhood can't afford to be nice—there simply isn't enough time. Besides, you don't think the Legions of Darkness ever gave a human a second chance, do you?

He was appointed to the Cardinalship of Luna by Nathaniel in his last term in office. Alexander deeply regrets his brother's choice, but Nathaniel always was much more of a bottom line kind of guy than he. Results are what counts, he would say, while Alexander is of the opinion that how the results are achieved is at least as important as getting them. The first time Dominic slips up, Alexander is going to have him removed. So far, though, he's been flawless, at least as far as Alexander can see.

Dominic's demeanor is that of a bitter old man, for that's what he is. He is cold and heartless, and the only time a gleam of life leaps into his eye is when he's presented with the opportunity to inflict cruelties upon others. He has a short temper which often snaps quickly and loudly. He expects nothing but total subservience from those around him, and he always gets it or an unpleasant example is made.





In the beginning, there was chaos. The world was encompassed by darkness and despair. Out of this disorder came a man called Nathaniel Durand. It was he who became our savior, the first Cardinal, he who showed humanity the way out of the long, starless night and into the light.

Not long after, humanity in its hubris reached for the stars. Instead, they found Nero, the tenth and final planet. There they discovered things long hidden, things that had fallen asleep before our ancestors had become brave enough to come down out of the trees. Their arrival awoke these creatures, these beasts of evil, and their wrath arose with them to be focused on these upstart beings in this barren universe that dared to call themselves humans.

It was these forces of darkness that delved deep into the things that made us so excessively proud: our so-called knowledge and our far-too-relied-upon technology. Soon our devices turned against us, and artificial creations were never to be trusted again for fear that they had been tainted with some horrible aspect of Dark Symmetry.

Cardinal Durand saw this and knew instantly what must be done. Calling his brethren together, the Cardinal laid down the three basic credos by which each member of the Brotherhood swears to live by until the end of their days and beyond.



The first of these is this: Thou shalt obey the Cardinal (and, by transposition, anyone else above thou in the Brotherhood) in all things, for his wisdom is unquestionable. By this way, the loyalty and discipline needed to transform the sorry bulk of humanity into a force of good can be found.

The second is this: Thou shalt recruit others into the Brotherhood for the good of the Brotherhood and themselves. Only through the work of the Missionaries can the word of the Cardinal be spread to the ignorant. Elsewise, those who live in the darkness of our worlds cannot ever see the light.

The third is this: Thou shalt constantly beware the horrible influence of Dark Symmetry in others and in thyself. Only by constant vigilance against such incursions into their souls can good men and women hope to stand against the seductive powers of the Darkness.



Brothers who follow these three tenets will serve the Cardinal's and the Brotherhood's needs. By this, they strive to aid the greater good of humanity as well. These blessed members will be remembered by the Cardinal and the remainder of his loyal brethren for all time.

Once Cardinal Durand had founded the Brotherhood, he wisely saw that he would need to divide his beloved brethren into more easily manageable divisions, each of which would have its own distinct jurisdiction and purpose. And so he invited the most faithful of our members to become the first Curates of the Curia, the council of elders who assist the Cardinal in his governing of the Brotherhood and from amongst which each successive Cardinal is selected. Guided by the wisdom of these learned people, Cardinal Durand formed the four Directorates which are known to this day.



The First Directorate formed was that of the Mystics. Amongst these were the Distorters, who can manipulate the very fabric of reality, the Changellors, who have mastered the powers of the mind, and the Seers, who can see both into the farthest future and the most distant past. It is up to the Mystics to harness the powers of Light against Darkness—the powers of the Art.

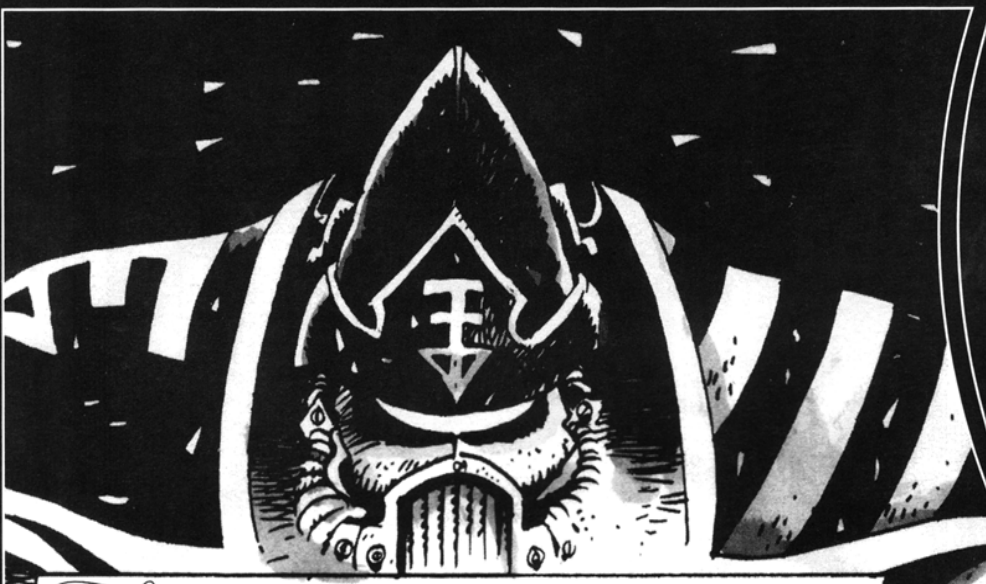

The Second Directorate is that of the Inquisition. This all-seeing organization has one of the most important vocations of all: to locate and root out the influences of Dark Symmetry wherever it may be found. This calling can take them from the surface of Nero to the heart of sacred Luna itself, and it often does. Inquisitors can be found almost anywhere humans gather in large numbers, and Sacred Warriors are constantly found in the thick of the harshest and deadliest battles against the demonic powers in the eternal night of deepest space. Only the Light can triumph against the Darkness against which the whole of humanity is otherwise helpless.



Once he had arranged the Brotherhood in this quadratic pattern, the Cardinal looked down upon it and saw that it was good. Then he was finally free to go about the work that had been his original calling: to stamp out any instances of Dark Symmetry wherever they may flourish. Mighty and devout Cardinal Durand's objective didn't end with the defense of humanity. Not satisfied with merely stemming the tide of Darkness that was forever threatening to overwhelm humankind in its ignorance and weakness, Cardinal Durand brought the battle directly to the Dark Legion itself. Smug in its previous victories against the unenlightened armies of the Corporations, the Dark Legion had become bold. The Dark Apostles built citadel after citadel on the Corporation's planets, those closest to the edge of our solar system and farthest away from our home

The Third Directorate is the Mission. These brothers and sisters make up the masses necessary to provide support to the Brotherhood's needs. Cardinal Durand knew that if the Mystics were the Brotherhood's soul and the Inquisition its mighty arm, the Mission was its holy body without which the other branches were naught. These men and women spread the Cardinal's word to the ignorant. They also seek out and preserve or destroy the mystic artifacts of both Darkness and Light. The most humble brothers are found in this part of the Brotherhood, transcribing the accumulated knowledge of the Brotherhood by hand so as to keep it from any hint of influence from Dark Symmetry.

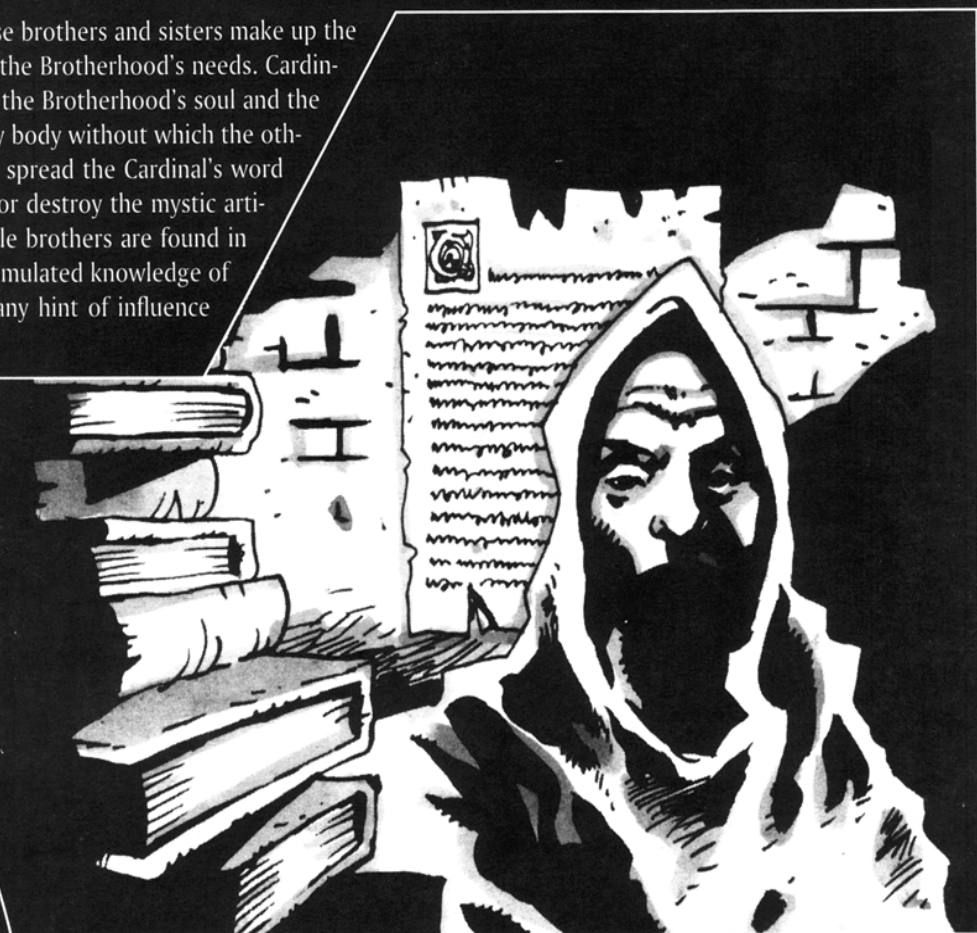

The Fourth and final Directorate can be thought of as the Brotherhood's nervous system. It is by means of the Administration that humanity's largest and most powerful organization can get anything done at all. Conquests and donations are simply not enough to sustain such a massive fraternity. The Administration's businessmen ensure that the Cardinal's sacred calling has enough resources to be answered at any time. The Administration also routes personnel and supplies for the entire Brotherhood and acts as the Brotherhood's liaison with other personal and corporate entities.

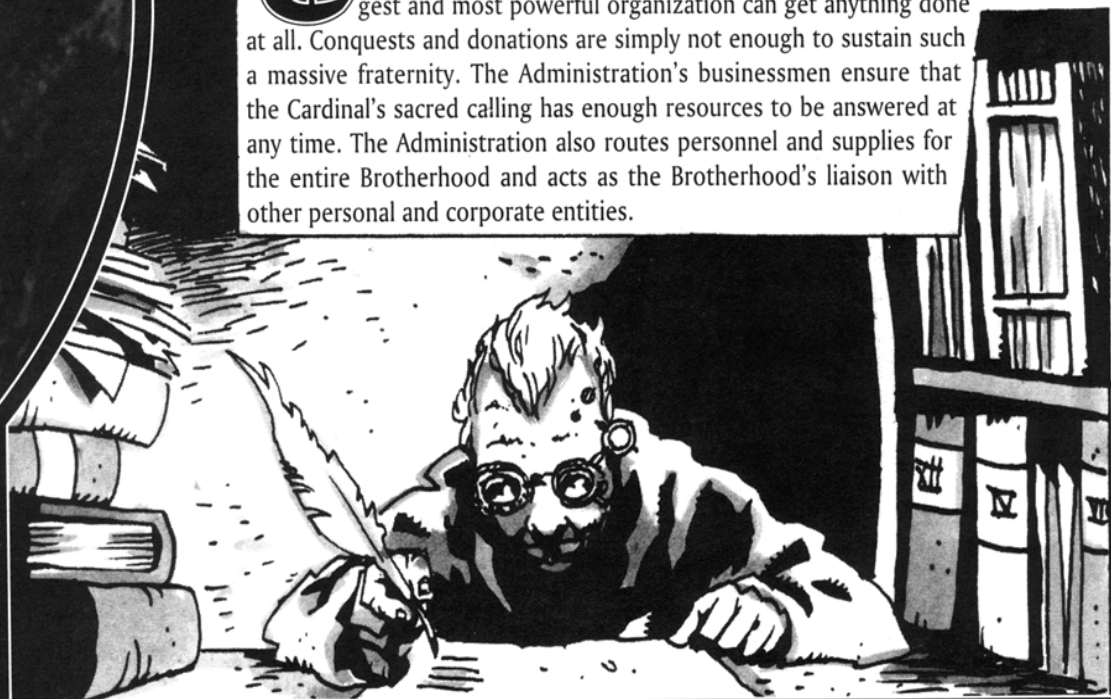

planet of Earth and its sacred daughter Luna. Determined not to let these Dark Siblings have their way with innocent souls, Cardinal Durand himself threw off his holy robes, baring his blessed battle armor, and led the Sacred Warriors into righteous war against the mutant sons and daughters of the personification of evil in our worlds—the Dark Soul.

Cardinal Durand knew that walking through the Venusian valleys of Darkness would cause a battle like none ever seen in this war or any other. In the many years since the Dark Soul had been unleashed upon the worlds of humanity, many such assaults had been attempted. None had succeeded. Most had concluded that such a battle could not be won. The Cardinal ignored them saying, "In the battle of good versus evil, we must not be content simply to stave off the encroaching Darkness. We must instead be willing to lay down our lives so that the Light may shine into every corner of every world once again. Darkness succeeds only where the Light fails. For the good of humanity, we must not—we cannot—fail."

Thereafter, with only as much delay as was required to muster his troops, Cardinal Durand led a direct assault upon a citadel of Algoth's deep in the heart of the Venusian jungles. The first and mightiest Cardinal sprang from the breast of the powerful Bauhaus corporation, and it was their pleas that first he heard and to their aid that first he came. Thus it was that he turned his attention to the purpose of ridding Bahausian Venus of the greatest known citadel of the Dark Apostle Algoth.

Once on Venus, the battle was soon met. The Cardinal led his personal guard—the now legendary Fury—into battle himself, and they were followed by units from each of the four corporations: the Venusian Rangers, the Sealions, the Hatamoto and the Blood Berets. A special Cartel attachment of elite forces known as the Doomtroopers was assigned to accompany the Cardinal in battle. This was the Doomtroopers' first and most glorious mission, and their reputation has grown by leaps and bounds ever since.

The assault was a long and laborious one. For every three feet the Cardinal's forces fought forward, they were pushed two back by Algoth's Nepharites, Necromutants and Undead Legionnaires. Soon after, these creatures of darkness were joined by Ezoghoul, Razides and Pretorian Stalkers. Later yet, the Cardinal's troopers—in the form of the valiant sisterhood of the Valkyries—encountered the most horrifying and pernicious servants of the Dark Soul, barring only its Apostles: captured humans turned against their former comrades in arms by the horrible influence of dark technology, the Great Darkness' newest and most terrible servants, the Centurions of Algoth.

Many martyrs were made that day, while still others won glory that would hardly be surpassed by any within their lifetimes or beyond, and in the end, Algoth's citadel fell. The Cardinal himself, surrounded by the Doomtroopers and what remained of the Fury, caught up with the Apostle in the very heart of his citadel. The Cardinal hurled himself headlong into final battle with his nemesis, and the Demon Lord of Dark Technology met him and stood against him toe to toe.

Any other human would have instantly shriveled before the awesome power of the Mage of Twisted Biotechnology, but the Cardinal, protected mostly by the power of the light within his soul, drew forth his mystical sword, the Bringer of Light, which banished all remaining shadows from the citadel's great hall. While the battle raged about them, these two combatants danced a whirlwind of Darkness and Light that could only end in victory for one and, for the other, death. The Cardinal beat his way through Algoth's defenses once, twice, then thrice. On the third time, with a single mighty blow, Cardinal Nathaniel Durand I cleaved the demon Algoth in twain. Even whilst his parts fell in separate directions, the demon cackled one last time and then disappeared in a flash of Darkness.

With the loss of their leader, the rest of Algoth's forces either fell or were routed quickly. When all was over, the Brotherhood had triumphed, but only at an unspeakable price. More than six out of every ten of the human troopers that had entered the battle were now dead. Several of the Doomtroopers and most of the Fury had fallen as well. Worst yet, Cardinal Durand had been mortally wounded in his deadly dance with Algoth.

The Cardinal managed to make it back to Luna before he died. He lay in state for seven days, and millions upon millions of mourners from every corner of the solar system came to bid him farewell before he was cremated and his ashes were interred in the heart of Luna, in the place to be known thereafter as the Cardinal's Tomb.

Thus was ended the life of Cardinal Nathaniel Durand I, a man whose legacy will live on until the last humans breath their last breaths. May his legend live forever to inspire us all!

— Excerpts from the First Chronicle carved on the walls of the First Cathedral on Luna.



HOW TO CREATE A BROTHERHOOD CHARACTER

The original *Mutant Chronicles* book gives detailed information on how to create an Inquisitor or a Mystic. Below, you'll find out how to create all sorts of other Brotherhood characters, too. It's suggested that these new rules also be used to generate any new Inquisitors or Mystics, but it's up to the GM. Brotherhood characters created with the rules in the *Mutant Chronicles* are completely compatible with *The Brotherhood*.

Creating a Brotherhood character is just like coming up with any other sort of character, with a few notable exceptions. Basic capabilities are generated normally, but from there on, most other things are a bit different. The Brotherhood apprenticeships have been altered slightly, and Brotherhood characters use their own special method of generating their backgrounds. Plus, they now have a much wider selection of professions to choose from.

JOINING THE BROTHERHOOD

There are three ways a character can join the Brotherhood, and none of them are easy.

While just about anyone can join the Mission after having reached adulthood, only the most promising young men and women have even the slightest chance of being taken straight into the Brotherhood at all, much less into the First or Second Directorates. The three ways to join are:

1 At creation. If you have an MST or PER of 15 or more, you will be approached by the Brotherhood during your early adolescence and asked to join. If you do, you then undergo an apprenticeship as described below. From there, you go straight into background development.

2 During your background repetitions. At any time during your background repetitions that you have an MST or PER of 15 or more, you can join the Brotherhood by choosing the straight Missionary profession. After one development round as a Missionary, you can then choose any other profession you like and develop yourself just like any other Brotherhood character. You do not go through an apprenticeship, though. (You should have already rolled on the standard Adolescence Events Table by that time.)

3 During regular play. Any time after the character has been finished and you have decided to start adventuring, you can approach the Brotherhood and ask to be allowed to join. There are no prerequisites to join, but you must begin your career with the Brotherhood as a straight Missionary. Exceptions might be made for higher level characters who have a lot to offer the Brotherhood. For example, a Bauhaus officer might be made an Administrator instead. No one gets directly inducted into the Mystics or the Inquisition, though, except maybe as a Trooper. The only way a person who was not inducted into the Brotherhood during development can gain use of the Art is by rolling it on the Brotherhood Special Events Table. People who enter the Brotherhood in that way are inducted through a special initiation rite in which their loyalty to the Brotherhood is tested until it is beyond doubt. Those who fail the trial often die.

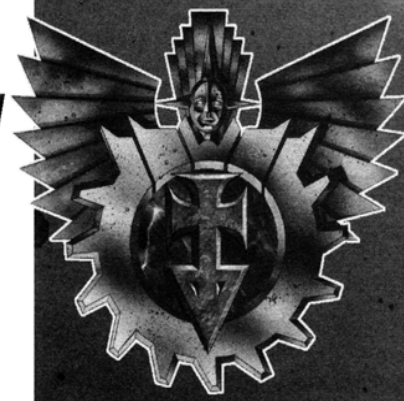

LIARS

Lars Gufman screamed for mercy as the long, thin, steel needle bit into the soft part of his elbow and buried itself within his arm, setting his nerves afire. In his entire life, he had never known such horrible, excruciating pain. Unlike the sharp flick of a knife, which was over in an instant, this seemed to go on forever and ever.

Lars screamed again and fought helplessly against the leather straps which held him rough and naked to the sharply inclined aluminum table. Every one of his muscles strained uselessly to move and to remove the thing that had invaded his nerves. Tears streamed uncontrollably down the mask of pain that was his face. Then he stopped short as he began coughing up blood. He wanted to vomit, but didn't think he had the strength remaining.

The needle was slowly withdrawn, and every inch that it traveled through his flesh was a mile of agony. He strained against it again, more by pointless instinct than through any hope of freedom. When the instrument finally left him, Lars' muscles finally gave and turned to putty. He was as weak as a newborn kitten. He mewed hoarsely, as if to himself. He tried to curl up into a ball, but the straps restrained him.

"What was that?" asked the Inquisitor.

Lars opened his eyes slowly. The operating light overhead shone directly into his



THE APPRENTICESHIP

The period of time from when you are inducted into the Brotherhood (usually at around 8-12 years of age) until you're ready to start your training as a full-fledged member of the Brotherhood (at 16) is called an apprenticeship. During this time, Brotherhood characters get to make five skill picks in Communications, two picks in Movement, and four free picks to be used in the Combat, Firearms and Special fields, excluding any spells.

Just as stated in *Mutant Chronicles*, a Brotherhood character does not roll on the standard Adolescence

Events Table in the *Mutant Chronicles* book. Instead, you must roll three times on the new Brotherhood Adolescence Events Table on page 10-11. Basic skill values are figured normally.

Note that as soon as you enter the Brotherhood, your social standing becomes 5. It only changes if your Level of Perfection in any Art is over 5, in which case, your social standing is equal to your Level of Perfection. It can also be changed by certain rolls on the Brotherhood Adolescence Events Table and the Brotherhood Special Events Table.

constricting pupils and prevented him from seeing anything but the head and shoulders of the black-robed Inquisitor leaning over him. Blood from his wracking coughs had splattered redly across his torturer's masked face and his tall, peaked, black helmet. He hadn't bothered to wipe it away.

The Inquisitor repeated his demand again. His voice, muffled by the mask, sounded like that of a demon. And this was an unforgiving foe. Lars simply whimpered softly to himself. His throat scratched raw from screaming, he found it almost too painful to talk.

The Inquisitor raised his gloved hand in front of Lars' face. The needle, still covered with Lars' crimson fluids, jutted out of its index finger inches from his nose. Tears ran down Lars' face again, mercifully blurring his vision.

"What—what do you want?" Lars cried.

"Anything—I'll tell you anything."

"You know what I want." The voice was raspy, almost soft with emotion. "Give it to me, my son, and the pain will end. By the Cardinal's mercy, I'll set you free."

The Inquisitor's eyes glared out from behind his helmet and bored into Lars' mind. They were the only part of his face uncovered, and they were the worst things Lars has ever seen. The Inquisitor's costume had



BROTHERHOOD BACKGROUNDS

Just as before, each period of background development covers a two-year period in the character's life. After every two years, characters have the option of continuing on developing their backgrounds or starting out as adventurers in the ranks of the Cardinal's believers.

PROCEDURE

1 Choose an Art in which you want to undergo trial. For new Arts see pages 32-38.

2 Roll a d20. If the result is higher than or equal to your INT, PER and MST, you may continue. Otherwise, you have been deemed unworthy of continuing on in your chosen career and must spend two years as a Missionary before trying another career again. Missionaries skip directly to step 5. If you started this development round as a Missionary, continue on to step 3.

3 Roll a d10. If this is higher than or equal to your current Level of Perfection, you pass the test. If you fail the roll, skip to step 5. Exception: Troopers and straight Missionaries do not make this roll unless they have already achieved the First Level of Protection in an Art as rolled on the new

Brotherhood Special Events Table. Otherwise, they skip to step 5.

4 Raise your Level of Perfection in the Art you chose earlier by one.

5 Make your skill picks according to your profession. If you blew your roll in step 2, remember to make your skill picks as a Missionary of the appropriate type, no matter which profession you were when you started this development round. Note that Brotherhood characters can use any Combat & Firearms picks for skills in any field, except spells. Only Free picks can be used for spells.

6 Adjust your social standing if you've reached a new Level of Perfection above your current social standing. Also adjust your PER and MST and your age.

Repeat these steps until you feel your character is ready to be a part of the game. Since lucky Brotherhood characters can become powerful fairly quickly, it's up to the GM to set a limit as to how mighty a character can be before he or she has to come out of development. This limit should be based upon how tough a game the GM wants to run. The players should be informed of this limit before they start work on their characters.

BACKGROUND DESCRIPTIONS

Brotherhood characters can choose from any of the following professions. Often, characters will start off in one profession, say as an Inquisitor, but end up in another, less glamorous position, like that of a Missionary. Players should not be disheartened by these sorts of happenings. They should simply be regarded as temporary setbacks in the characters' path toward inevitable glory for themselves and the Cardinal.

REQUIREMENTS: Means the minimum requirements you have to meet for that occupation. The requirements only have to be filled on the day you start in that career. Normally, a social standing of 1 is a requirement for any background, but this requirement can be ignored by members of the Brotherhood, each of which has a social standing of at least 5.

FIELDS OF EXPERTISE: The number after each field of expertise tells how many skill picks you may make from that field after each period of service. The Free skill picks may be made from any field of expertise, including the Special skills. The Special skills include spells, so the Free picks are especially important to a member of the Brotherhood, as they are the only way to pick up spells.

Unlike other professions, Brotherhood professions have had the fields of Combat and Firearms combined into a single field for purposes of assigning skill picks. Picks from this field can be used for any of the other skills as well, not including spells.

SOCIAL STANDING: This is ignored while developing Brotherhood characters. All of the brethren start with a social standing of 5. This can only be changed by rolls on the Brotherhood Adolescent or Special Event Tables or by attaining a Level of Perfection higher than 5. If the Level of Perfection is higher than your social standing, raise your social standing to the same value as your Level of Perfection.

PER-MODIFICATION: Doing well at your job boosts your ego and makes your personality stronger. This modifier is applied to your PER value every time you make your picks.

MST-MODIFICATION: The extraordinary mental training that members of the Brotherhood receive is reflected by the fact that they get a modification to their MST value every time a background is repeated. This is treated just like the PER modification.



been designed to intimidate those on trial, Lars knew, but no part of it was nearly as oppressive as the cold, shark-like eyes of the man within the suit. What life there was in those eyes waxed and waned only with the flowing and ebbing of Lars' own pain.

He couldn't bear the eyes anymore.

Lars' began rattling off names one after the other.

As each one left his mouth, he felt as if he'd spat out a

rotten tooth—something once useful to him, but now, cracked and broken, only a source of throbbing pain. Were any of them heretics? He didn't know, nor at this point did he care. All that mattered was turning off those eyes.

When Lars had finished, the Inquisitor looked questioningly over his shoulder at the timid, little Missionary who had been transcribing Lars' confession. The frail, white-faced young man nodded a little too sharply to indicate that he had recorded it all.

Lars looked up at the Inquisitor hopefully. He'd done as he had been



2D20 ADOLESCENCE EVENT

2 MORTAL SIN COMMITTED•. You have been accused of a horrible sin against the Cardinal and the Brotherhood. Guilty or not, you are now stuck in the Mission (at least until you begin adventuring). You must spend the next 1d6+3 years as a Missionary. Also, you suffer a disablement due to the wrath of the Inquisition. See result 3 below.

3 DISABLED•. A horrible accident almost cripples you. Read your movement allowance from the line above the normal on the Combat Statistics Table. You may not be a member of the Inquisition.

4 FAINT-HEARTED•. When confronted with danger, you often feel faint. Your actions per round should always be read from the line above the normal on the Combat Statistics Table. You may not be a member of the Inquisition or the Mystics.

5 VENIAL SIN COMMITTED•. You have been accused of a minor transgression against the Brotherhood. Although your conscience may be clear, your record has been blemished. You must spend the next 1d3 years as a Missionary. You may not be a Mystic, and the only way you can be a part of the Inquisition is as a Trooper (at least until you start adventuring).

6 WEAK BONE STRUCTURE•. You just don't take damage very well. Subtract 5 from your total Body Points.

7 DIMWITTED•. Quite frankly, you're not too swift. Your Defensive and Perception Bonuses should always be read from one line above the normal on the Combat Statistics Table.

8 BACKED THE WRONG HORSE. In one of the Brotherhood's ongoing political games, you chose the side that lost. You must spend your first development round as a Missionary.

9 SLOW•. You're a sharp enough person, but for some reason, the world always seems to be passing you by. Take a -1 penalty to your defensive and offensive bonuses.

10 INQUISITION TRAINING•. An Inquisitor sees a lot of him- or herself in you. Take a round of skill picks as if you spent two years as a Missionary from the Inquisition.

11 MYSTIC TRAINING•. A powerful Mystic senses your potential and takes you under his or her wing. Take a round of skill picks as if you spent two years as a Missionary from the Mystics.

12 ADMINISTRATION TRAINING•. A member of the Fourth Directorate seems to think you'd make a good addition to his or her team—someday. Take a round of skill picks as if you spent two years as a Missionary from the Administration.

13 MISSIONARY TRAINING•. For some reason, a high level Missionary takes a liking to you. You may not have aspirations in the Third Directorate, but you're happy to take advantage of this person's kindness. Take a round of skill picks as if you spent two years as a straight Missionary.

14 INFLUENTIAL BENEFACTOR•. For some reason, you have gained the attention of an influential member of the Brotherhood. Choose one of the results 10-13.

15 TOP OF YOUR CLASS•. You were so proficient in your studies, that the Brotherhood sees no reason to test you straight out of your apprenticeship. You don't have to make an INT/PER/MST roll for your first trial. You pass it automatically. Congratulations.

16 SLICK SPEAKER. Some say you speak with a forked tongue. You just say you know how to express yourself eloquently. You get +1 in all Communications SVs.

17 NATURAL TECHNICIAN. When it comes to tech, you're a real whiz-kid. You get +1 in all Technician SVs.

18 WEAPONS FANATIC. You think that guns, knives and other tools of destruction are the coolest things you've ever seen. You get +1 in all Firearm SVs and Weapons Systems.

19 BROTHERHOOD MARTIAL ARTS TRAINING. You see combat as a true art form—one that you wish to practice. You get +1 in Brotherhood Martial Arts. See page 28 for more about Brotherhood Martial Arts.

20 ANATOMICAL SIXTH SENSE•. You instinctively know where to hit people where it hurts them most. Add +1 to your Offensive Bonus.

21 SUPERB SENSES. Your senses are extraordinarily sharp. You get +1 to your Perception and Avoid SVs.

22 STRONG WILL. Once you set your mind to something, nothing can stand in your way. Add +1 to your MST and +3 to your Interrogation SV.

23 CHARISMATIC VOICE. When you talk, people listen. Raise your PER and all your Communication SVs by +2.

24 GOOD BODY CONTROL. You know just where every part of your body is at all times, and you know how to make them move just right. Add +1 to your COR and +2 to your Movement SVs.

25 CONTACT WITHIN A MEGACORPORATION. You have a contact within one of the megacorporations. Roll 1d6. 1=Mishima, 2=Capitol, 3 or 4=Imperial, 5=Bauhaus, 6=Cybertronic. The GM decides how the contact works, but it should be a considerable advantage whenever the character wants information about the corporation's doings or wants an entrance pass to a corporate building, etc.

26 CONTACT WITHIN A DIRECTORATE. You have a contact within one of the Directorates. Roll 1d6. 1=Inquisition, 2 or 3=Administration, 4 or 5=Mission, 6=Mystics. The GM decides how the contact works, but it should be a considerable advantage whenever the character wants information about that particular Directorate's doings or wants an entrance pass to a Directorate building or needs help when running afoul of that Directorate, etc.

27 RESISTANT TO PAIN. You're tough. No matter what anybody throws at you, you can take it. Add +1 to your BPs in each body part.

28 A TALENT FOR AN ART. Suddenly it's all so clear to you. You automatically gain the first Level of Perfection in the Art of your choice.

29 GIFTED STUDENT•. For some reason, that adolescent training just clicked. Take your adolescent skill picks again.



asked. Would the pain stop now? his eyes feebly asked. Behind his mask, the Inquisitor smiled.

Then with one quick motion, he grabbed a scalpel from the operating tray beside the aluminum table and slit Lars' throat.

While Lars' life's blood gurgled out of him, the Inquisitor muttered a blessing over his departing soul and turned to leave, beckoning the young Missionary to follow after him. The novitiate, transfixed by the sight of Lars' death, stuttered, "But, Inquisitor, you promised to set him free."

Knowing that the young man couldn't see it, the Inquisitor smiled again, the hellacious glow of life returning for a moment to his eyes. "And so I did, my son. But if you feel that I misled him, then call me a liar." The Inquisitor paused for a deadpan moment to savor the boy's look of sheer terror. "For a liar I am."

The Inquisitor turned back to gaze upon Lars' now still corpse before turning once again to leave the cold, dark chamber and the swiftly decomposing body behind. "But then again, so was he."



A GOOD DEATH

Lieutenant Walter Bozniak surveyed the field of destruction before him. Shots were ringing all around the place, and artillery shells exploded off in the distance. He stood amongst it all, entirely unaffected, as if he knew it was not yet his time to die.

He and his Sacred Warriors had put up a good fight, but Algeroth's Nepharites had simply known the surrounding jungle too well—much better than Brotherhood intelligence had revealed to Boz. Those blasted Necromutants, supported by wave after wave of those half-living, half-dead Undead Legionnaires. It looked like the Dark Soul had taken this one. It was time for the Warriors to cut their losses.

Just as Bozniak was about to give the order to pull out, a message came in over the radio. The private with the communications rig handed the headpiece to Boz, and he slipped it on over his burning ears, the microphone sliding into place before his lips. "Yes?" he said with dread in his voice. He had seen the battle plans. He knew what was coming next.

He listened intently to the man on the other end of the line and nodded slowly to himself as he mutely absorbed what the man had to say. It was Colonel Walsh. Once

30 FOIL A PLOT. You manage to foil a plot against the Brotherhood. Raise your social standing by +1.

31 SEE THE LIGHT. You have an epiphany. You now have a strong understanding of the Brotherhood's role as the savior of the universe. Raise your MST by +1.

32 SPURN THE DARKNESS. You have an inadvertent encounter with a person under the influence of Dark Symmetry. You not only survive the incident, but the experience has made you stronger. Raise your MST by +2.

33 BLESSED BY THE CARDINAL. You have been blessed by the Cardinal himself. Raise your MST, your PER and your social standing by +1 each.

34 CONTACT WITHIN THE CARTEL. You know someone in the Cartel. To a limited extent, this contact can be used to find out information about any of the megacorporations, as well, or even about a Directorate of the Brotherhood.

35 TRUE ENLIGHTENMENT. You have gained what few have acquired, but many covet: full comprehension of the Art. You need never roll 1d10 to raise your Level of Perfection again. Anytime the opportunity to make the roll arises, you automatically succeed.

36 VOCATION. Someone in the upper levels of your chosen career realizes that you have a calling to that profession. You need never make an INT/PER/MST roll again.

37 CONTACT WITHIN THE CURIA. You know one of the people within the Brotherhood's inner circle. The GM decides how the contact works, but it should be a considerable advantage whenever the character wants information about the upper

levels of the Brotherhood's doings or wants an entrance pass to a restricted area of a Brotherhood building or needs help when running afoul of the Brotherhood, etc. This is a powerful contact and should be handled by the GM carefully.

38 ELITE TROOPER TRAINING. You've been hand-picked to become one of the Cardinal's finest fighters. In four years of training (add this to your starting age of 16), you get a +2 to all your basic capabilities (except PER), two picks from each field of expertise, four free skill picks and +5 to your PER. If you still don't make the requirements for an Elite Trooper, they'll let you slide. You still have to make the INT/PER/MST roll, of course.

39 INTENSE INQUISITOR TRAINING. Someone in the Second Directorate thinks you've got what it takes. Roll 1d6. 1=Inquisitor or Valkyrie, 2 or 3=Revisor, 4 or 5=Archangel, 6=Mortificator. In four years of training (add this to your starting age of 16), you get a +2 to all your basic abilities and four free skill picks. If you still don't make the requirements for your profession, they'll let you slide. You still have to make the INT/PER/MST roll, of course. You automatically gain the first Level of Perfection in an Art of your choice.

40 INTENSE MYSTIC TRAINING. You have a talent for the Art, and the Mystics want to tap it. In six years of training, you get a +2 to all your basic abilities and four free skills picks. If you still don't make the requirements for a Mystic, they'll let you slide. You still have to make the INT/PER/MST roll, of course. You also automatically gain the first Level of Perfection in an Art of your choice.

BROTHERHOOD SPECIAL EVENTS TABLE

2D20 SPECIAL EVENT

2 MORTAL SIN COMMITTED• You have been accused of a horrible sin against the Cardinal and the Brotherhood. Guilty or not, you are now stuck in the Mission (at least until you begin adventuring). You must spend the next 1d6+3 years as a Missionary. Also, you suffer a disablement due to the wrath of the Inquisition. See result 3 below.

3 DISABLED• A horrible accident almost cripples you. Read your movement allowance from the line above the normal on the Combat Statistics Table. You may not be a member of the Inquisition. See result 8, as well.

4 INVOLVED IN A MYSTICAL EXPERIMENT• And, unfortunately for you, it failed. Back to the drawing board for the First Directorate and -5 to your MST for you.

5 VENIAL SIN COMMITTED• You have been accused of a minor transgression against the Brotherhood. Although your conscience may be clear, your record has been blemished. You must spend the next 1d3 years as a Missionary. You may not be a Mystic, and the only way you can be a part of the Inquisition is as a Trooper (at least until you start adventuring).

6 BONE DISEASE• You just don't take damage very well. Subtract 5 from your total Body Points. An operation to fix it would cost about 50 grand, or you could just wait 1d2 years to get it cured by an Exorcist. See result 8 as well.

7 SEVERE CONCUSSION• That last blow to the head must have knocked a screw loose. Your Defensive and Perception Bonuses should always be read one line above the normal in the Combat Statistics Table. Also, see result 8.

8 BUSTED. Either through intrigue, sheer stupidity or some random misfortune (it hardly matters, does it?), you've fallen from grace with your superiors. You must spend your next 1d3 development rounds as a Missionary unless you start your adventuring career right away.

9 POWERFUL FOE• Somehow, you managed to anger someone who does not have direct power over you, someone who may or may not be in the Brotherhood. This person has vowed to personally see to your doom, and he or she has the power to back up that threat. It's up to the GM to decide exactly how this works in the game, but it should become a major hassle that crops up at least once every other playing session if not more often.

10 HOBBY GYMNAST. You love spending your free time tumbling around in a gym. Add +1 to your COR.

11 HOBBY ATHLETE. You love to compete in anything physical: wrestling, running, you name it. Add +2 to your STR and PHY.

12 GOOD NEGOTIATOR. You could sell flashlights to the Dark Legion. You get +2 on your social standing rolls.

13 GLAMOROUS ASSIGNMENT. You pulled one honey of a job this time around. Raise your PER by +1.



14 INFLUENTIAL BENEFACTOR• For some reason, you have gained the attention of an influential member of the Brotherhood. Choose one of the results 15-19.

15 INTENSE EDUCATION. You got involved in an intensive, holistic crash course education program. Subtract two years from your age or spend a two year development round for free.

16 INTENSE PILOTING COURSE. They'll make a pilot out of you yet. Get a +1 in Flying Vehicles.

17 TECHNICAL CRASH COURSE. If there's anything about technology you don't know by now, your brain's too crammed with it to take any more (at least until your next development round). Take two free Technical skill picks in addition to your standard picks.

18 WEAPONS CRASH COURSE. You learn more about guns in six months than most people learn in two years. Take two free skill picks in Firearms.

Boz's mentor, he was now his direct superior. At that moment, he was signing a death warrant for Boz and his crew.

The battle had gone badly all along the lines. Apparently, almost all of the Brotherhood units were preparing to rout. The Inquisition needed someone to stay behind and keep the Dark Legion occupied while the rest of the soldiers made good their escape.

Located at the vanguard of the Inquisition's wedge, Boz and his men had been elected to perform the job.

"Farewell, son," the colonel rasped, his voice rough with regret. Boz knew it was one of the hardest things the man had ever had to do. A shell detonated off in the distance, destroying a communications relay tower. Before Boz could reply, the line went dead.

He tore off the headset and threw it to the ground. He wouldn't be needing it from here on out, anyhow. Then he cleared his throat and shouted for the Sacred Warriors to gather around.

The Dark Legion's forces had temporarily fallen back to regroup, but they'd return in scant moments. In the meantime, Lieutenant Bozniak had to tell his people that they had been selected to die.

"All right, soldiers. Word's come down from above that this operation has hit the fan. The rest of our forces are pulling out. It's our job to stay behind and buy them the time they need."

19 **BROTHERHOOD MARTIAL ARTS TRAINING.** You see combat as a true art form—one that you wish to practice. You get +1 in Brotherhood Martial Arts. See page 28 for more about Brotherhood Martial Arts.

20-21 **A TALENT FOR AN ART.** Suddenly it's all so clear to you. All those lessons that your Brothers have been beating into your head finally make sense. You automatically gain the first Level of Perfection in the Art of your choice.

22 **INTENSE DRIVING COURSE.** Spend some time as a driver for a high-ranking Brother. Get +1 to Ground Vehicles.

23 **HOBBY STUDENT.** In your spare time, you like nothing better than sharpening your mind. Get +1 to your INT.

24 **HOBBY ACTOR.** On your off days, you work in one of the Brotherhood's many theater troupes. Add +1 to your PER.

25 **CONTACT WITHIN A MEGACORPORATION.** You have a contact within one of the megacorporations. Roll 1d6. 1=Mishima, 2=Capitol, 3 or 4=Imperial, 5 or 6=Bauhaus. The GM decides how the contact works, but it should be a considerable advantage whenever the character wants information about the corporation's doings or wants an entrance pass to a corporate building, etc.

26 **CONTACT WITHIN A DIRECTORATE.** You have a contact within one of the Directorates. Roll 1d6. 1=Inquisition, 2 or 3=Administration, 4 or 5=Mission, 6=Mystics. The GM decides how the contact works, but it should be a considerable advantage whenever the character wants information about that particular Directorate's doings or wants an entrance pass to a Directorate building or needs help when running afoul of that Directorate, etc.

27 **PAIN CONDITIONING.** You used to be a wimp, but after months of conditioning, you can take more than most people can dish out. Add +1 to your BPs in each body part.

28 **CHANCE OF A LIFETIME.** Someone powerful has taken a liking to you and wants you by his or her side. Choose any profession you like to develop this round, ignoring any requirements. You still have to make the INT/PER/MST roll, of course.

29 **INVOLVED IN A MYSTICAL EXPERIMENT.** And what do you know? It worked! Add +5 to your MST.

30 **FOIL A PLOT.** You manage to foil a plot against the Brotherhood. Raise your social standing by +1.

31 **SEE THE LIGHT.** You have an epiphany. You now have a strong understanding of the Brotherhood's role as the savior of the universe. Raise your MST by +1.

32 **SPURN THE DARKNESS.** You have an inadvertent encounter with a person under the influence of Dark Symmetry. You not only survive the incident, but the experience has made you stronger. Raise your MST by +2.

33 **BLESSED BY THE CARDINAL.** You have been blessed by the Cardinal himself. Raise your MST, your PER and your social standing by +1 each.

34 **CONTACT WITHIN THE CARTEL.** You know someone in the Cartel. To a limited extent, this contact can be used to find out information about any of the megacorporations, as well, or even about a Directorate of the Brotherhood.

35 **TRUE ENLIGHTENMENT.** You have gained what few have acquired, but many covet: full comprehension of the Art. You need never roll 1d10 to raise your Level of Perfection again. Anytime the opportunity to make the roll arises, you automatically succeed.

36 **VOCATION.** Someone in the upper levels of your chosen career realizes that you have a calling to that profession. You need never make an INT/PER/MST roll again.

37 **CONTACT WITHIN THE CURIA.** You know one of the people within the Brotherhood's inner circle. The GM decides how the contact works, but it should be a considerable advantage whenever the character wants information about the upper levels of the Brotherhood's doings or wants an entrance pass to a restricted area of a Brotherhood building or needs help when running afoul of the Brotherhood, etc.

This is a powerful contact and should be handled by the GM carefully.

38 **ELITE TROOPER TRAINING.** You've been hand-picked to become one of the Cardinal's finest fighters. In four years of training, you get a +2 to all your basic capabilities (except PER), two picks from each field of expertise, four free skill picks and +5 to your PER. If you still don't make the requirements for an Elite Trooper, they'll let you slide. You still have to make the INT/PER/MST roll, of course.

39 **INTENSE INQUISITOR TRAINING.** Someone in the Second Directorate thinks you've got what it takes. Roll 1d6. 1=Inquisitor or Valkyrie, 2 or 3=Revisor, 4 or 5=Archangel, 6=Mortificator. In four years of training, you get a +2 to all your basic abilities and four free skill picks. If you still don't make the requirements for your profession, they'll let you slide. You still have to make the INT/PER/MST roll, of course.

You automatically gain the first Level of Perfection in an Art of your choice.

40 **INTENSE MYSTIC TRAINING.** You have a talent for the Art, and the Mystics want to tap it. In six years of training, you get a +2 to all your basic abilities and four free skills picks. If you still don't make the requirements for a Mystic, they'll let you slide. You still have to make the INT/PER/MST roll, of course. You also automatically gain the first Level of Perfection in an Art of your choice.

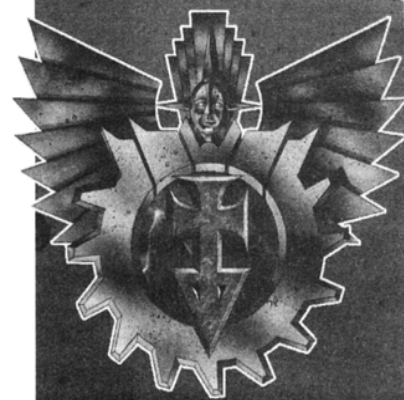

He looked out at the long-haired, helmetless men and women around him. Each of them hung on his every word. Some wore an expression of disbelief. Most other faces showed only sheer determination.

"I won't lie to you. Most of us—probably all of us—won't be walking away from this one. But because we choose to stay, our brethren will be able to get away and come back to fight these abominations another day. We all knew it might come to this some day. I can't say I'm not sorry it has.

"There's only one thing left for us to do, soldiers, and that's to sell our lives as dearly as we can." He raised his Avenger sword high above his head and issued a battle cry: "For the Cardinal! For the Brotherhood! For humanity itself!"

A resounding response leapt up from those around him, and then they turned and assumed their final positions, each of them choosing the plot of ground on which they would die as the fading sunlight glinted off their holy armor and their flashing blades. Bozniak watched them taking up their stations without a moment's hesitation, each of them knowing that all that awaited them at the end of the day was death, and his heart swelled with pride.

This would be a good death.

ADVISOR/DIPLOMAT/ADMINISTRATOR/OBSERVER

The members of the Fourth Directorate—the Administration—are the most visible presence of the Inquisition in most peoples' everyday lives. *Advisors* are businessmen, merchants in the Brotherhood's employ. *Diplomats* acts as liaisons between the Brotherhood and the rest of humanity's organizations, i.e. the Corporations and the major freelance houses. *Administrators* act as an elite organization of bodyguards to the hundreds of top Brotherhood officials that need protection on a daily basis. *Observers* act as information gatherers and are placed both openly and covertly in every major organization in human space.

The two things that tie these four occupations together are 1) they all have a similar advancement structure, and 2) since they're the top people on the front lines of the Brotherhood's interaction with the rest of humanity, they're usually the first contact the Inquisition has with an incident of Darkness.

Members of the Administration can choose any Art to train in at the beginning of any round of development. They are still restricted by any choices made in previous careers, however.



REQUIREMENTS:

INT 10, PER 10

	ADVIS- ORS	DIPLO- MATS	ADMINIST- RATORS	OBSER- VERS
COMBAT AND FIREARMS:	1	2	3	1
COMMUNICATION:	2	3	1	2
MOVEMENT:	1	1	2	2
TECHNICAL:	2	1	—	1
FREE:	3	3	3	3
PER-MODIFICATION:	+1	+2	+0	±0
MST-MODIFICATION:	±0	±0	+1	+1

MISSIONARY

The members of the Third Directorate are the common people of the Brotherhood, and they make up the vast bulk of its numbers. Missionaries can be called on to do almost anything at any time, depending on the wisdom of their superiors. They do get some training in the Art, so it's generally not too hard to find willing recruits. Many characters will end up here after flunking out of their dream careers. There's always the possibility of moving up, though, and since Missionaries are on the bottom of the Brotherhood's hierarchy, there's nowhere else to go.

Missionaries learn spells just like other Brotherhood characters, but they don't achieve the First Level of Perfection until they roll it on the new Brotherhood Special Events Table. Missionaries that obtain use of the Art have found their ticket to the big time. They're usually in demand by every Directorate.

Missionaries can choose any Art to train in at the beginning of any round of development. They are still restricted by any choices made in previous careers, however. Many Missionaries are people who have failed to stand up for a trial for elevation in one of the other directorates. These people choose skills differently based upon whichever directorate they were last in before joining the Mission.

Note that Missionaries from the Mystics and the Inquisition are the same as those sorts of Disciples which were described in the *Mutant Chronicles* book on page 167.



REQUIREMENTS:

	NONE			
	MYSTICS	INQUI- TION	MISSION	ADMINIS- TRATION
COMBAT AND FIREARMS:—		3	—	1
COMMUNICATION:	1	2	2	2
MOVEMENT:	1	1	1	1
TECHNICAL:	1	—	1	1
FREE:	5	3	3	3
PER-MODIFICATION:	±0	±0	±0	±0
MST-MODIFICATION:	+2	+1	±0	±0

REVISOR

The Revisors are the undercover people of the Inquisition. Most often drop outs from the Inquisitor profession (sometimes by choice, usually not), these guys do most of the preliminary investigations and handle most of the legwork in rooting out the influence of Dark Symmetry within human settlements. Then they call in the heavies (i.e. the Inquisitors) to "make the collar." At lower levels, Revisors work like private eyes, but at higher levels, they're akin to galactic intelligence operatives. Their work is secret and dangerous, and if they screw it up, they often find themselves hung out to dry.

Like Inquisitors, Revisors must specialize in a single Art. Once a character begins development as a Revisor, that character can never switch over to another Art, even if the character later changes careers.

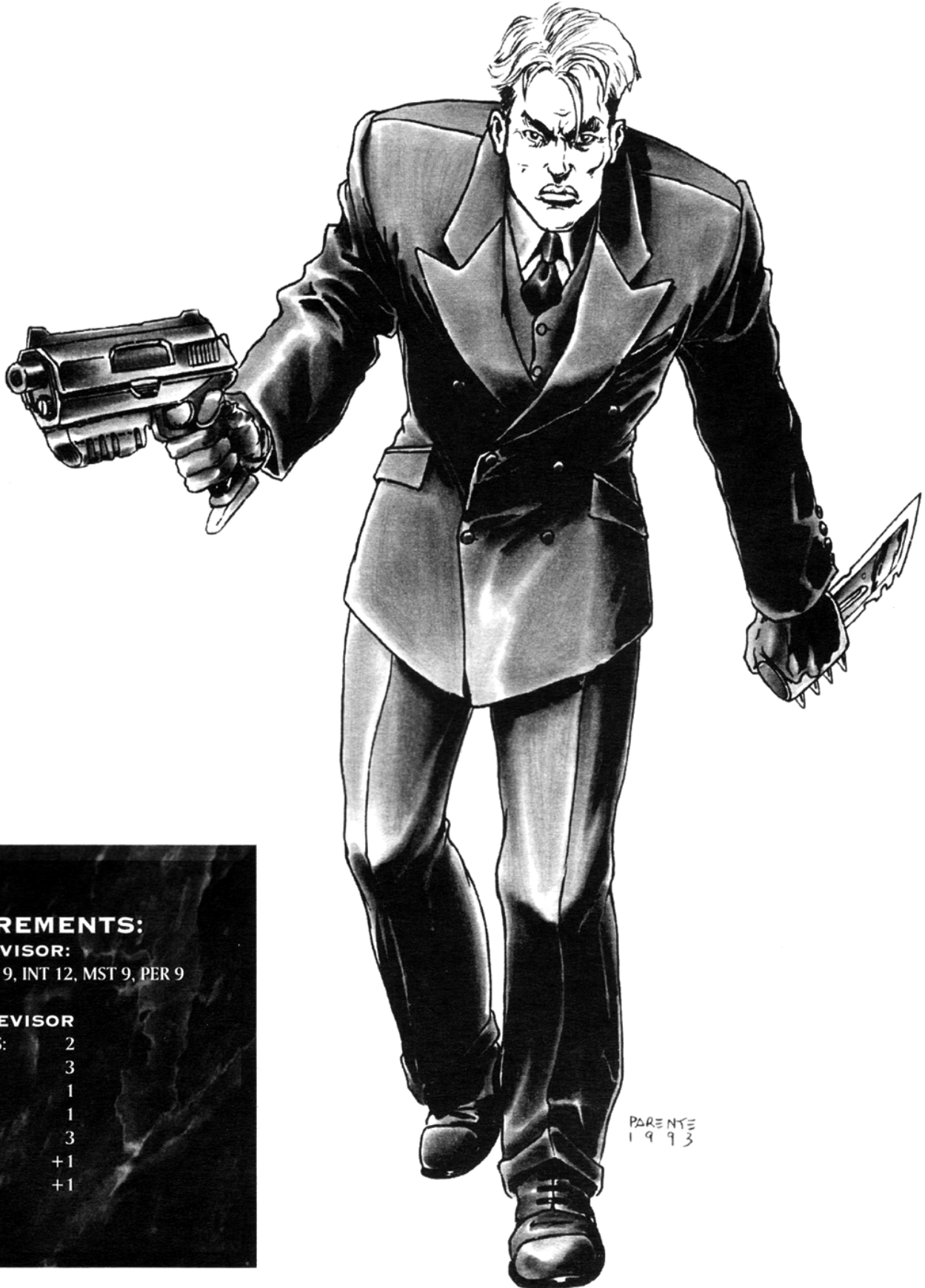

REQUIREMENTS:

REVISOR:

STR 9, PHY 9, COR 9, INT 12, MST 9, PER 9

REVISOR

COMBAT AND FIREARMS:	2
COMMUNICATION:	3
MOVEMENT:	1
TECHNICAL:	1
FREE:	3
PER-MODIFICATION:	+1
MST-MODIFICATION:	+1



MYSTIC/KEEPER OF THE ART

The other top dogs of the Brotherhood, these people are the best spell casters in the universe. Making the advancement roll between levels is difficult, but the payoffs for success are nearly unimaginable. Most Mystic characters will eventually fall from grace, but those few that succeed will become Keepers of the Art, some of the most powerful people in the entire universe. Accordingly, they get a large number of Free skill picks.

Mystics can choose any Art to train in at the beginning of any round of development. They are not restricted by choices made in any previous rounds. They are still restricted by any choices made in previous careers, however.



REQUIREMENTS:

MYSTIC:

STR 9, COR 9, PHY 12, INT 13, MST 13, PER 9;

KEEPER OF THE ART:

STR 9, COR 9, PHY 12, INT 13, MST 50, PER 24.

	MYSTIC	KEEPER OF THE ART
COMBAT AND FIREARMS:	-	-
COMMUNICATION:	2	2
MOVEMENT:	1	1
TECHNICAL:	1	1
FREE:	6	9
PER-MODIFICATION:	+1	+2
MST-MODIFICATION:	+3	+4



MORTIFICATOR

These are the Brotherhood's ninjas. These covert specialists are generally called in only for lightning raids or assassinations. To many people, the Mortificators are only the stuff of legends, as few people have actually seen one and lived to tell about it.

Like the other members of the Second Directorate, Mortificators must specialize in a single Art. Once a character begins development as a Mortificator, that character can never switch over to another Art, even if the character later changes careers.

REQUIREMENTS:

MORTIFICATOR

STR 9, PHY 9, COR 16, INT 14, MST 11, PER 9

MORTIFICATOR

COMBAT AND FIREARMS:	3
COMMUNICATION:	-
MOVEMENT:	4
TECHNICAL:	-
FREE:	4
PER-MODIFICATION:	+2
MST-MODIFICATION:	+1



**SACRED WARRIOR/FURY
ELITE GUARD**

The Sacred Warriors are finest of the Cardinal's battlefield troops. They are used exclusively against the Dark Legion, as to pit them against any lesser foes would be a waste of their formidable talents. The Fury Elite Guard are the Cardinal's own personal bodyguards, and they enter battle only at his side. They are also used as the elite troops at every Cathedral where they act as the bodyguard for any members of the Curia located there.

Sacred Warriors and Furies must specialize in a single Art. Once a character begins development as one of these types of soldiers, that character can never switch over to another Art, even if the character later changes careers.

REQUIREMENTS:

SACRED WARRIOR:

STR 15, PHY 14, COR 16, INT 12, MST 17, PER 13;

FURY ELITE GUARD:

STR: 15, PHY 14, COR 16, INT 12, MST 17, PER 13.

	SACRED WARRIOR	FURY ELITE GUARD
COMBAT AND FIREARMS:	3	3
COMMUNICATION:	3	3
MOVEMENT:	2	1
TECHNICAL:	-	-
FREE:	4	5
PER-MODIFICATION:	+2	+2
MST-MODIFICATION:	+2	+2



VALKYRIE

Basically specialist Inquisitors, these women are part of the all-female division of the Second Directorate: the Valkyrie Sisterhood. These battle-hardened women take their role in the Inquisition extremely seriously. They often work as liaisons between the Brotherhood's armed forces and those of the Corporations, and they are regularly used as commander units. No one ever questions these ladies' loyalties, though. They always do the Cardinal's work, and they always lead from the front!

Just like their brother Inquisitors, Valkyries must specialize in a single Art. Once a character begins development as a Valkyrie, that character can never switch over to another Art, even if the character later changes careers.



REQUIREMENTS:

VALKYRIE

STR 13, PHY 13, COR 16, INT 12, MST 9, PER 9

VALKYRIE

COMBAT AND FIREARMS:	3
COMMUNICATION:	3
MOVEMENT:	1
TECHNICAL:	-
FREE:	4
PER-MODIFICATION:	+2
MST-MODIFICATION:	+1

ARCHANGEL

The Archangels form the Inquisition's air support branch. Most members of this elite corps are proficient in the Art of Mentalism which allows them to focus themselves into perfect pilots. On the ground, Archangels are distinguishable in the Second Directorate by their spotless white flight suits and their long, flowing hair (the Valkyries and the Sacred Warriors are the only other division to wear their hair long). The sight of a flight of Archangels soaring over a battlefield in their Icarus jet fighters has been the harbinger of disaster for many a member of the Dark Legion.

Archangels must specialize in a single Art. Once a character begins development as a Archangel, that character can never switch over to another Art, even if the character later changes careers.

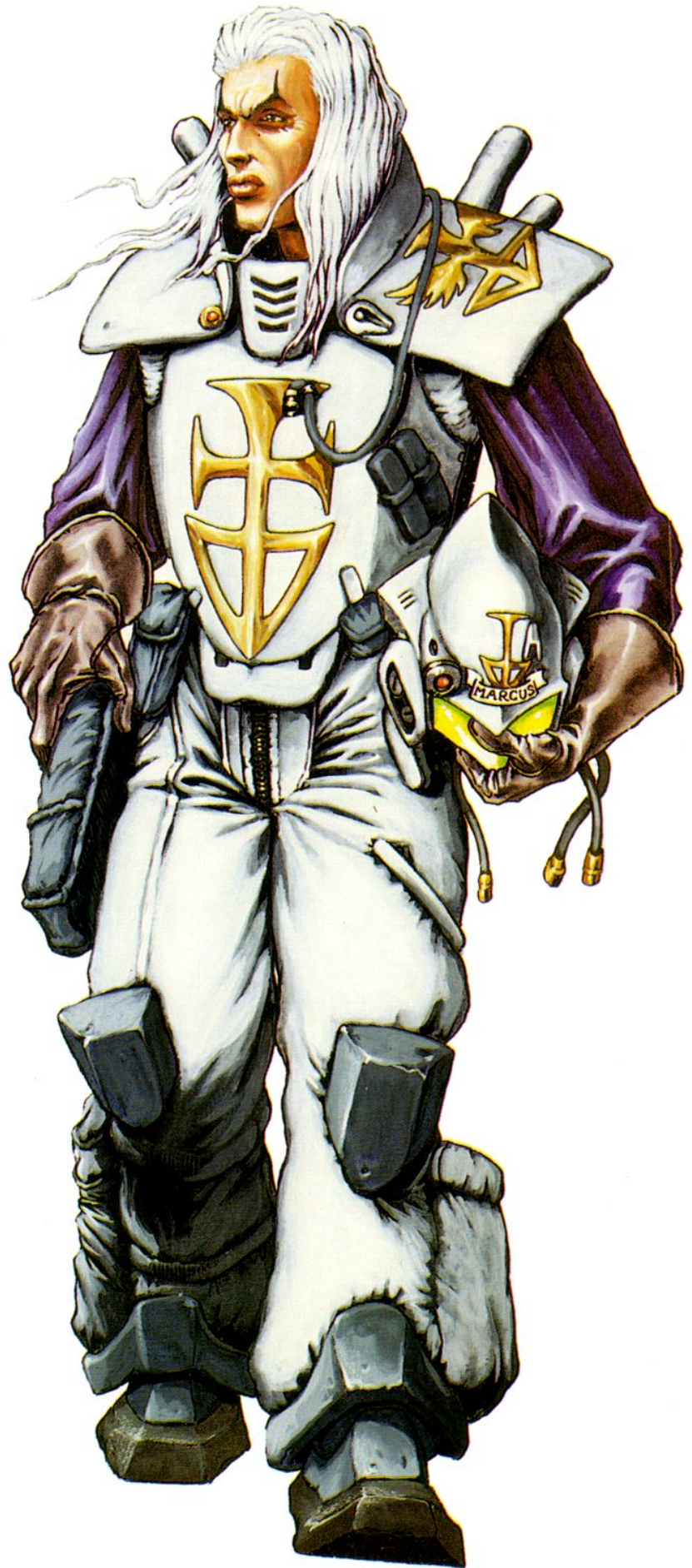

REQUIREMENTS:

ARCHANGEL

STR 14, PHY 10, COR 16, INT 12, MST 10, PER 9

ARCHANGEL

COMBAT AND FIREARMS:	3
COMMUNICATION:	-
MOVEMENT:	4
TECHNICAL:	-
FREE:	4
PER-MODIFICATION:	+2
MST-MODIFICATION:	+1



INQUISITOR/ INQUISITOR MAJORIS

Inquisitors are the top-of-the-line warriors that the Brotherhood has to offer, and everyone in the Brotherhood wants to be one (except maybe the Mystics). They do the Cardinal's messy work, and they get all the glory. The mere mention of an Inquisitor strikes fear into the hearts of all but the most faithful, for there are few whose thoughts are entirely pure and the Inquisition has powerful ways of exposing these sorts of secrets. Inquisitor Majores (sing. Majoris) are the elite of the Inquisitors. Few things can stand against them in battle or in the interrogation room.

Inquisitors must specialize in a single Art. Once a character begins development as an Inquisitor, that character can never switch over to another Art, even if the character later changes careers.

REQUIREMENTS:

INQUISITOR:

STR 15, COR 16, PHY 14, INT 12, MST 9, PER 9;

INQUISITOR MAJORIS:

STR 15, COR 16, PHY 14, INT 12, MST 20, PER 25.

	INQUISITOR	INQUISITOR MAJORIS
COMBAT AND FIREARMS:	3	3
COMMUNICATION:	3	3
MOVEMENT:	1	1
TECHNICAL:	—	—
FREE:	4	6
PER-MODIFICATION:	+2	+2
MST-MODIFICATION:	+1	+2



TROOPER/ELITE TROOPER

These are the grunts of the Brotherhood armies. Even so, due to their thorough and rigorous training, these soldiers are among the best. Plus, they get trained in the Art at higher levels, making them even more formidable than ever.

Troopers learn spells just like other Brotherhood characters, but they don't achieve the First Level of Perfection until they roll it on the new Brotherhood Special Events Table. Soldiers that obtain use of the Art are often transferred into the ranks of the Inquisition.

Although they may never gain the actual ability to cast spells, Troopers must specialize in a single Art. Once a character begins development as a Trooper, that character can never switch over to another Art, even if the character later changes careers.



REQUIREMENTS:

TROOPER:

STR 10, PHY 10, COR 10;

ELITE TROOPER:

STR: 13, PHY 13, COR 13.

TROOPER

ELITE TROOPER

COMBAT AND FIREARMS:	2	2
COMMUNICATION:	—	1
MOVEMENT:	2	2
TECHNICAL:	—	1
FREE:	1	2
PER-MODIFICATION:	+2	+1
MST-MODIFICATION:	± 0	+1

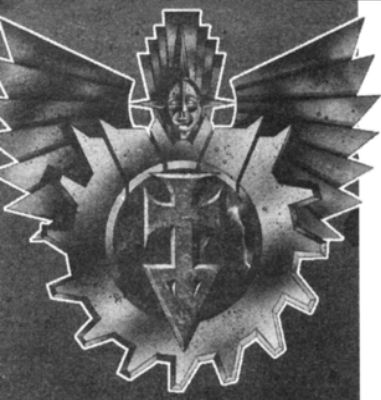

A HARD LESSON

The long, wooden rod smashed into the side of Wallace's head and sent him spinning to the ground. He rolled over onto his hands and knees for a moment and groaned. His head hurt awful, and his vision was blurred. Maybe he had a concussion.

Before he could get up, a second blow poked him in the ribs. He thought he felt one of them give way. He rolled away from his attacker as quickly as he could until he nudged into the wall. With a burst of effort that made his head spin, he leapt to his feet and assumed a defensive position.

Trudeau was watching him from across the room, the wooden pole resting comfortably in her hands. Wallace shook his head to clear his vision. It seemed to work, although it felt like his brain was rattling around loose in his skull. These Brotherhood Martial Arts training sessions were brutal.

Wallace touched his ribs and winced. Trudeau laughed once before her

ARCHETYPES

The following character sketches have a two-fold purpose. First, they give the GM some quick and easy handles on some of the most typical sorts of people within the Brotherhood. This will make it easy for the GM to quickly use these kinds of characters in many different game encounters.

Second, they allow the players to see how certain types of characters are perceived. Players can form their characters to mimic the archetypes and live up to the expectations of those around them, or they can

have their characters be something special that cuts against the typical grain. This makes for an even more exciting and spectacular roleplaying experience.

INQUISITOR

The standard haughty Inquisitor comes from just about any part of the Fourth Directorate, except for the Troopers who have a slightly different attitude. Inquisitors believe that Darkness is around them always, and it is only by constant watchfulness that it can be fended off or even defeated.

Vigilance is the watchword of the Inquisitors. But often mere vigilance is not enough. Sometimes it is necessary to actively investigate the possibility of infestations of Dark Symmetry in those around us. Since Dark Symmetry can find its roots in cold technology or even in the warmest, most right-thinking of hearts, no one can be trusted. All must prove their faith, their belief in the Cardinal and the light he shines upon humanity.

Sometimes innocents are caught up in the Inquisition's wide-reaching attempts to root out the influences of evil wherever it may be found. This is, of course, unfortunate, but when the fate of the entire human race is at stake, the lives of a few virtuous people means nothing balanced against it.

Any Inquisitor—and this includes them all—would gladly give up his or her life for the greater good of humanity, and they expect no less from those around them. Sometimes Inquisitors find that it is up to them to make these hard choices, to risk the lives of a few unknowns to ensure the safety of all human souls, but they always find themselves equal to the task.

Due to the nature of their job, Inquisitors rarely form close friendships with any person whose faith in the Cardinal and the Light is not unquestionable. They look upon all others with distrust. Those that have had their faith affirmed are deserving of infinite respect, while those who have not are treated with just as much suspicion and disdain.



While it may be that some Inquisitors actually enjoy interrogating suspects, this not true of them all. Still, if such an image can prove helpful in acquiring the information they desire, few Inquisitors will bother to dissuade their subjects from these sorts of terrifying beliefs.

And despite what most people may fear, all of an Inquisitor's time is not spent tracking down heretics. Often they are called into the heart of a full-out battle with the Dark Legion, the tangible forces of the Dark Soul itself. It is at these times that Inquisitors feel most at home. On the battlefield, there are no gray shadows that resist the prying of the light. There is only good and evil, black and white, darkness and light. When fighting against the Dark Legions, the foes are clear and directly at hand. This is the time that most Inquisitors live for.

QUOTE: "I know when you are lying, my son. And I will have the truth from you, or you will suffer beyond your worst mares. Have your pick!"

MISSIONARY

Most Missionaries have two faces, one that they show to the rest of the world and one that only the Brotherhood ever sees. To the world outside the Cathedrals, Missionaries seem to be the most devout, confident and well-adjusted group of men and women most people will ever meet. They are universally pleasant and well-mannered, except when roused into a fervor about the evils that are affecting humanity from beyond the ninth planet.

It's at these times that a faint glow enters the Missionaries' eyes. They begin spouting out chapter and verse of the Book of Law and arguing almost feverishly about how the fate of humanity is at stake and nothing but the Cardinal and his Brotherhood stand between the human race and complete and total annihilation.

When inside a Cathedral, however, a change comes over the Missionaries that is not difficult to explain. Therein, there are no unbelievers to be converted, no heretics to be spotted. There are only the faithful. If there are any worms eating away at the heart of the Brotherhood, it is the Inquisition's job to root them out. Frankly, most Missionaries wouldn't feel qualified to even try.

Typically, with only the exception of higher ranking Brothers, Missionaries see their brethren from the First and Second Directorates as more important than they. And from the Cardinal's point of view, they're correct. After all, Missionaries are plentiful—the bulk of the Brotherhood is made up of them—but members of the Mystics and the Inquisition are fewer in number and play more specialized roles. Who could argue that an Inquisitor is more vital to the Cardinal's mission to defend humanity than a lowly Missionary preaching on the street?

Missionaries can be reprimanded by any member of the two directorates superior to them, and they are reminded of this constantly. For most, a reprimand means that they will fail their biannual trial, which means that their hopes for advancement within the ranks of the Mission, or perhaps even to another Directorate, will be—at least temporarily—dashed.

Because of this, most Missionaries are extremely

deferential when in the company of a Mystic or Inquisitor or even a higher-ranking Missionary. This has given them the reputation amongst their brethren for being timid. Even the Missionary who only hours before had been giving fiery sermons on the evils that threaten human society is quiet and respectful when in the presence of an Inquisitor or a Mystic.

Missionaries tend to be less gifted than their brethren from the other directorates. After all, there are no requirements for becoming a Missionary. They'll let anybody in. Because of this, as well as the Missionaries' well-known fear of those in more powerful positions, most people from other directorates look down upon the members of the Mission. When looking at the big picture, their calling may be an important one, perhaps one which left unfulfilled would spell the end of the Brotherhood, but it is rarely as distinctly vital as that of their brethren. And it shows in everything they do.

QUOTE: "May I be of service to you, Brother?"

WARRIOR

Warriors are the Cardinal's strong right arm, and they know it. Often they draw the most grueling, and occasionally the most boring, duties of all the Cardinal's brethren. Besides making up the bulk of the Cardinal's forces in battles with the Dark Legion and, occasionally, with the megacorporations, warriors can be found filling a variety of military posts ranging from cooking for the rest of the troops to standing guard at a branch of the Cardinal's Bank.

In their off hours, warriors like to blow off some steam. Unlike the rest of the Brotherhood, they often do this in the same ways that soldiers have done so for centuries, i.e. drinking, carousing, pulling pranks, etc. Warriors are rough and ready sorts, always itching for some kind of action, as most of their time is spent waiting for something to happen. When long periods of idleness go by, warriors often turn to making up their own fun to stave off their boredom.

Although the warriors' apparent relative lack of piety is often disturbing to the upper ranks of the Brotherhood, most minor transgressions are left unnoticed. Warriors are careful to show the proper amount of respect to their superiors, however. Most of them have aspirations of moving up the Brotherhood's ladder, and they know that a word from a higher official might leave them stuck in the Troopers for the rest of their lives.

Still, there are worse places to be.

And no one ever questions the warriors' dedication. In battle, they have few equals in bravery and have stood toe to toe with the forces of the Dark Legion. Often they survive; sometimes they even win.

All warriors hope to one day do better for themselves. Most hope to move quickly up the ranks of the Inquisition. Others figure they'll join up with the Fourth Directorate when their youth or their luck runs out. Most warriors have fun toying with Missionaries whenever they can, but what they're really doing is trying to cover up a fear that they



expression turned serious.

"You've a lot to learn yet, young man," she said. When you're hit, you move. If you stay still to nurse your wounds, you just provide your opponent with a better target. That's the kind of mistake you only get to make once."

Wallace tried to take a deep breath and pain stabbed through his side where the blow had landed. He called for time just before he collapsed to a sitting position on the floor.

Trudeau was with him in an instant. She placed one hand on his side and the other on the goose egg that was already forming over his left temple. As she closed her eyes and concentrated, a warm glow appeared on her arms. It ran down through her hands and onto the places where Wallace had been bruised. The glow felt good, and Wallace suddenly realized that his pain had gone away.

He started to thank her, but she stood up and waved him off, walking off to the other side of the room. "You are my student," she said. "It is my responsibility to teach you. You can only learn from lessons you can recover from, and the quicker, the better."

"I believe I have learned mine," offered Wallace.

She snapped around to face him, her eyes full of discerning fire. "Have you?" she asked. "I wonder.

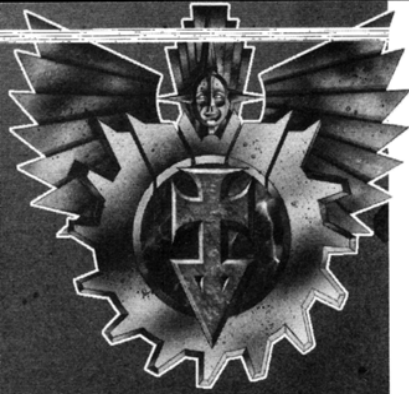

might someday end up wearing a Missionary's robes.
QUOTE: "What do you think you're looking at, wise guy? Oh, sorry, sir. I didn't realize it was you."

ETERNAL STUDENT

Many of those within the Brotherhood fit the eternal student archetype, no matter which directorate they hail from. This sort of Brother has dedicated himself to the study of the world, particularly the effect of Dark Symmetry upon it. All eternal students are well aware of the pitfalls of their calling. Those who investigate the darkness run the risk of falling victim to its seductive lure. They are on guard against the possibilities of such tragedies at all times.

Because of this, eternal students are the members of the Brotherhood looked upon with the most suspicion by the Inquisition. While the Inquisition realizes and acknowledges the need for their sort, most Inquisitors wouldn't trust an eternal student as far as they could throw them. Considering the relative

size of an Inquisitor to a student, though, this is farther than one would think.

Despite all this, the Inquisition and the rest of the Brotherhood often find themselves dependent upon eternal students for information that they could not hope to retrieve or uncover themselves. This irks the rest of the Brotherhood somewhat, but it's the sole source of the eternal student's pride. In many cases, interacting with brethren like the Inquisition is the only way that an eternal student's life's work will ever have any impact on anyone in their lifetime, and they always look upon such encounters with anticipation bordering on lunacy.

When talking with other members of the Brotherhood, eternal students feel a great amount of pressure to justify their work. They often get nervous and start speaking loudly and quickly, almost stumbling over their words in an effort to convince the listeners that their work has real meaning before the people begin to nod off.

Whenever eternal students hear the mention of something relating to their work, they inevitably become terribly curious to know exactly what the speaker knows about the field. If it becomes apparent that the speaker knows less than the student, the student will either grow haughty and imperious or confront the speaker with a lesson about what the truth of the matter really is. All of this depends entirely on the speaker's manner and demeanor.

If, however, the speaker seems to know as much as or even more than the student, the eternal student will immediately attempt to engage the speaker in a conversation. During the course of their talk, the student will attempt to learn everything he or she can from the speaker and will even go so far as to suggest that they get together sometime in the near future to compare notes on the matter.

Occasionally, eternal students will get pushy or irritable without even realizing it. Their manner will continuously worsen until someone points out to them exactly how rudely they're behaving. Then they will apologize profusely and become as pleasant as can be again—at least for a little while.

QUOTE: "Oh, I know all about that! Let me tell you...."

TUTOR

The tutor is a wise, older person who has had his or her day in the spotlight and is now looking to pass on his or her accumulated knowledge to some worthy young

Sometimes I wonder why I waste my time."

Wallace staggered to his feet. He was still a bit woozy from the aftereffects. "Come on," he pleaded, "I'll get better. I'm just starting out. Weren't you ever young once? Didn't you ever make a mistake?"

A strange look crossed over Trudeau's face, one Wallace had never seen before. She gazed at him slowly, then bent over and rolled up the left leg of her loose training robes. A long, vicious scar ran the length of her shapely leg from her shin, up past her knee, until it disappeared in her hiked-up robes.

Wallace released a low whistle of amazement. "I got this when I was your age," she said, "in a fight on the streets."

"How come you never had the scar removed?" he asked. Modern medicine could have easily made the leg look like new.

"Because it reminds me of a hard won lesson. The same sort of lesson I am trying to teach you. And it's a lesson I don't ever intend to forget. I have many scars—I have learned many





student. It just could be that one of the characters has been chosen to be the recipient of this wonderful gift.

Tutors have the perspective that only age and experience can give, and they are usually eager to share it. Sometimes, though, they worry that the people they've chosen don't truly appreciate all that is being done for them and that they aren't worthy of the tutor's time. When this happens, the tutors will often withdraw and become sullen until confronted by their pupils.

If the pupils are apologetic and beg for another chance, the tutors will usually give in and begin the lessons again. If the pupils show anger or frustration, however, the tutors will respond that there is nothing that they can do with so unwilling and unreceptive people for students. They will send them away until they are ready to be taught again.

Tutors are generally soft-spoken and world-weary. They've (often literally) seen it all, and these young whippersnappers that call themselves their pupils hold no surprises for them—only disappointment or joy. Despite this, tutors are incredibly understanding. At one point, they were in the students' shoes themselves. They know exactly how they feel.

While tutors are undeniably founts of wisdom, they are people, too, and each of them has their secrets and their

weaknesses. After all, if they're so smart, why aren't they in the upper echelons of the Brotherhood? Why are they wasting time with rookies like the players' characters?

All tutors have a past that's as rich and full as any future the characters could ever hope to have. But each of these pasts holds a tragedy of some kind, one that forced the tutor to hang up the rifle and sword, to turn in the power stabilizer or to toss out the battle armor. These secrets may come back to haunt the tutors, and they may very well affect the tutors' pupils as well.

Many tutors have ulterior motives for training the pupils. Possibly the tutors hope that when the time comes and their pasts catch up with them, their pupils will stand by their side or, if it's too late for that, come to their rescue or avenge their deaths.

QUOTE: "Patience, my child, patience. All things come in time."

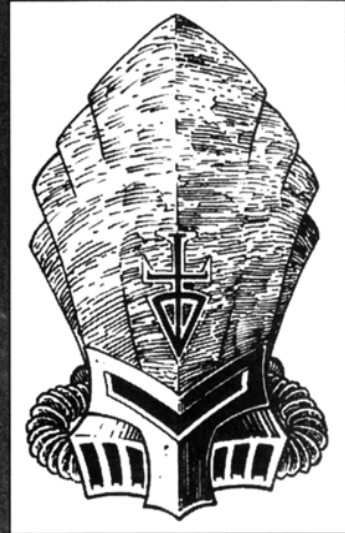

lessons the hard way. And I would like to pass them on to others. It's up to you how hard the lessons will be."

Right then, Wallace decided to try for the easy way first.





BROTHERHOOD SKILLS

TRUE CONFESSION

Mahatma Moideen had much on his mind that he felt the need to unburden himself of. Just yesterday, an old friend of his had revealed to him that he was a member of a secret society dedicated to the undermining of the Brotherhood. How such a person could have risen so high in the ranks of Mishima, Moideen could not understand, but there it was, and so it was his duty to report it.

He knelt in the Cathedral and waited for an opening in one of the Confessionals. He knew that his heart was pure, but would the Brotherhood? Would the Cardinal's brethren be able to see with his vision, to see into his soul to know that he was not guilty simply by association? He sincerely hoped that this would be so. Otherwise, he held no hope for this world.

Suddenly there was a hand on his shoulder. He looked up and saw a Missionary motioning toward a confessional. His time had finally arrived. He stood up, determined to take whatever medicine his confessor might prescribe.

He entered into the tiny wooden cubicle and sat down on a low,

Members of the Brotherhood can use any of the skills described in *Mutant Chronicles*, plus a few others that are unique to their organization. Descriptions of these

new skills follow. After that, there's a list of which skills are most appropriate to each profession.

This should help players who are a little unsure as to how to go about choosing their characters' skills.

COMBAT

BROTHERHOOD MARTIAL ARTS

BASIC CAPABILITY: (STR+COR)/2

The members of the Brotherhood are the last true practitioners of this particular martial arts discipline. No one outside of the Brotherhood may learn this skill, as only members of the Brotherhood know it and they will not teach it to one who is not of their brethren. This skill is similar to brawling, but allows you to do 2d3+OB damage with your fists and 2d4+OB damage with your feet. Additionally, you get to parry melee attacks just as with the skill Parrying. This skill costs twice the normal number of skill picks.

MORTIFICATION

BASIC CAPABILITY: MST

This is the ability to kill people with a single, perfectly placed blow. It also involves knowledge of other means of killing individuals, i.e. using poisons, faking suicides, etc.

In combat, if you have the Mortification skill and have managed to come upon an opponent unawares, you have the ability to do triple the weapon's normal damage with a single attack.

Only Mortificators can pick this skill. It is an ancient art related to Brotherhood Martial Arts. No one outside of the Mortificators fully understands it, and the Mortificators will not teach it to anyone else.



COMMUNICATION

KNOWLEDGE OF THE BROTHERHOOD

BASIC CAPABILITY: INT

The ability to know things about the Brotherhood, like who is currently on the Curia, what's written on the walls of each of the Cathedrals, the names of all the Cardinals, etc. This allows you to appear to be extremely devout and to avoid any unpleasant social blunders like misusing an Inquisitor Majoris's proper title. You can pick this skill for the Brotherhood in general or any of the four directorates. Knowledge about each of the directorates is a sub-skill of this general skill.

KNOWLEDGE OF THE DARK LEGION

BASIC CAPABILITY: INT

The ability to either learn or recall from memory things concerning the Brotherhood's most hated foes: the Dark Legion. Truly necessary when dealing with the minions of the Dark Soul.

You can pick this skill for the Dark Legion in general or choose it separately for any of the five Dark Apostles. Knowledge about each of the Dark Apostles is a sub-skill of this general skill.

TECHNICAL

SECURITY SYSTEMS

BASIC CAPABILITY: INT

You know how to set up and defeat any and all types of security systems, whether they be electronic, animal or human based or any combination of these. This ability is almost essential for Mortificators, who need to be able to get in and out of protected buildings and areas without alerting anyone to their presence.

SURVEILLANCE

BASIC CAPABILITY: INT

The ability to set up and maintain a constant watch over a person, a building or some other thing.

This may involve cameras, bugs, tailing a person, watching a building in shifts, etc. Revisors find this skill to be indispensable.

SKILLS FOR YOUR PROFESSION

Certain skills go particularly well with certain professions, but with the variety of skills available to you, it's easy to overlook some of them while developing your character. The following lists describe which skills are most appropriate for each profession. Players can use these lists to help in developing their characters, while GMs will find them useful for figuring out just what a Brotherhood non-player character is likely capable of.

ADMINISTRATOR Administrators should focus on communications skills, particularly the obvious one: Administration. Oratory is a good one to have, too. Administrators might also benefit from Computer skills and possibly from a good deal of Perception.

ADVISOR As businessmen, Advisors should concentrate on communications skills, too. Dealing is essential, and if your character wants to make some less than straightforward transactions, you should

pick up Conning as well. The Social skill helps as well. It can never hurt a businessperson to have as many contacts as possible.

ARCHANGEL Archangels should put as many skill picks as they can into Flying Vehicles. This is, after all, what they do. After that, they should toss all of their free picks into getting spells, especially those from the Art of Mentalism. The Weapons Systems and Heavy Automatics skills can come in handy, too, as do Avoid and Perception.

DIPLOMAT The Diplomat must have a good deal of the Social skill. After that, any of the Communications skills will be useful, specifically Oratory and Administration. The Perception skill is often indispensable.

INQUISITOR/INQUISITOR MAJORIS Inquisitors need to spread their skill picks amongst both weapons skills and spells, plus get a healthy amount



wooden bench. Soundproofing covered the ceiling and walls, all except for the screen that separated him from the confessor. He could see the outline of the confessor's head through the screen, but could not make out her features. He hoped that the same was true for her vision of him.

Quickly and efficiently, Moideen described yesterday's encounter in its entirety, leaving out no details. The confessor grew serious and asked him many questions, each of which he tried to answer as best he could.

When it was over, Moideen felt immeasurably better. He had handled the situation as well as he thought could be done, and he felt deservedly proud of himself. When he got up to leave, though, he found that he was locked in. Suddenly, fear made a home in his heart.

"Don't be frightened, my son," said the confessor in a soothing voice. "The Inquisition would simply like to ask you some questions before you leave."

The Inquisition! Moideen had come here specifically to avoid having anything to do with their kind. Like most citizens, faithful to the Cardinal or not, Moideen had a healthy horror of Inquisitors. The rumors of their methods and their unforgiving methods struck terror into most people's hearts, and Moideen believed them with all his heart.

He turned and tried the



“Don’t be frightened, my son,” said the confessor in a soothing voice. “The Inquisition would simply like to ask you some questions before you leave.”

of Avoid and Perception. Spells from the Arts of Kinetics and Mentalism are appropriate. If the Inquisitor plans on using the standard Punisher pistol and short sword combo, you’d better pick up Handguns and Melee Weapons as well. And no Inquisitor would be complete without some ability in Interrogation. If you’ve got any picks left over, toss a few into Parrying. You never know when some extra defensive ability will come in handy.

MORTIFICATOR The primary skill here is, of course, Mortification, although Brotherhood Martial Arts is a close second. In order to be able to use these properly, you’ll need Stealth, Avoid and Perception. Agility and Climbing come in handy for getting into and out of the kind of places where Mortificators do their best work. You’ll also need to invest in Security Systems so that you’ll be able to get at your targets when they believe they’re best protected. It’s at those times that people are at their most relaxed—and their most vulnerable.

MISSIONARY Missionaries should base their skill choices on the kind of profession they want to get into. Since Missionaries don’t have to choose just one Art to specialize in, characters starting out as Missionaries have the advantage of picking up spells in many different Arts before choosing a career that will limit them to a single Art. Straight Missionaries should concentrate on communications skills, particularly Oratory and Administration. Social wouldn’t hurt at all, either.

MYSTIC/KEEPER OF THE ART Mystics should play up their strength—buy as many spells as you possibly can. The types of spells you buy will really depend on what role you want your Mystic to play. Warrior types should focus on the Arts of Kinetics and Mentalism or perhaps Elements. More subtle characters will enjoy Manipulation and Changeling. In large battle situations, it’s often helpful to have a Mystic strong in the Art of Exorcism around to assist in healing the more gung ho members of the adventuring group.

Warrior mystics will want to pick up some combat skills and Avoid and Perception, although these take away from their free picks, so be cautious here. Other Mystics with gentler ways will want to choose Oratory or even Stealth.

OBSERVER Observers need to pick up a good deal of Perception and, after that, as many communications skills as possible. The best for them are Administration, Interrogation, Social and Conning. They may also find Stealth and Slight of Hand to be useful in their line of work. Having the Computer skill won’t hurt either, especially if you need to hack your way into a protected computer system.

REVISOR The Brotherhood’s undercover people need the broadest variety of skills, as they never know what they’ll be called on to do next. The need for some skills seems to come up more often than others, though. Among these are Stealth, Conning, Interrogation, Handguns and Brotherhood Martial Arts. Avoid and Perception often come in really handy, too.

SACRED WARRIOR/FURY ELITE GUARD These battlefield troops need to pick weapons skills, like any of the Firearms skills. Melee weapons and Brotherhood Martial Arts are often extremely useful, as well. The strongest advantage Sacred Warriors and Furies have over standard troops, though, is their ability to cast spells, and this should be exploited at every opportunity. The best Arts are probably Kinetics and Mentalism, although most of them can be useful in one way or another.

TROOPER/ELITE TROOPER Troopers need to stick to what they do best: fight. To this end, they should concentrate on Combat and Firearms skills. Troops often specialize in a certain type of weapon and become extremely proficient in its use. This way, a team of specialists can be much more effective than a group of identical Troopers with the exact same broadly based set of skills. All Troopers should have Handguns, but after that, it’s up to the players to figure out how to individualize and specialize.

VALKYRIE Valkyries are extremely proficient in Brotherhood Martial Arts. Their abilities in this skill are second to none. They also rely heavily on the Melee Weapons skill so that they can properly use their Castigator spears. Beyond that, Valkyries should stock up on spells, particularly those from the Arts of Kinetics and Mentalism. Some Valkyries should get spells from the Art of Exorcism. With the amount of in-close fighting these sisters do, once the smoke has cleared they’re going to need someone to pick up the pieces and patch them together.



SELECTING SKILLS AS A GROUP

One of the reasons adventurers travel in groups is because it's nearly impossible for one person to be able to do it all. The best warrior in a group is rarely the best spell caster, and even amongst spell casters, there tends to be a great deal of specialization. Beginning characters simply don't have enough skill picks for each of them to be able to cover every last detail that might crop up.

When forming a group of characters, all of the players should get together to talk about what kinds of characters they each want to play and how they see these characters fitting into the group. With the GM's help, you should be able to spot any potential weaknesses in the group's makeup. Then, while selecting the characters' skills, you should be able to plan to fill each of these holes carefully.

There are certain types of characters you ought to be trying to generate. You'll need a smooth talker or two to help investigate things, and there should be a sneaky person to help out with gathering information in quasi- or illegal manners. And once everything hits the fan, you'll need some bruisers to help you put your money where your mouth is.

Also, combat skills are vital in the futuristic world of *Mutant Chronicles*. Guns are the great equalizers, and even a top level Brotherhood Martial Artist could,

at worst, be taken down by a rookie with an M606 light machine-gun.

Of course, this won't always apply. Guns simply aren't allowed in some places, especially for unauthorized personnel, which the characters will often be. In these cases, Brotherhood Martial Arts can be a deciding factor in any sort of brawl.

If at all possible, you should have at least one member of the group act as a healer. A mystic specializing in the Art of Exorcism fits this bill nicely, particularly if he or she has also got the Medicine skill. This type of character is essential on missions when the characters are in the field for a long time, far away from ambulances, hospitals or any other kind of aid. If possible, make sure you have a backup healer, just in case your primary one becomes incapacitated.

Particular adventures may call for certain types of specialists as well. For this reason, it's smart to have each of the group's characters concentrate on a sub-specialty. This may be anything from Flying or Driving Vehicles to Social or Dealing to Mechanics or Electronics. The need for these skills may not arise every adventure, but when they do, if even just one person in your group has them, you'll be prepared.



knob again, but it was no use. He started to pound on the door, on the walls, but he knew the soundproofing would keep anyone outside from hearing. Just as he was about to turn his attention to the screen, it slid aside to admit a pair of Inquisitors into his half of the confessional. He screamed and screamed, but outside in the Cathedral's Great Chamber, no one heard a thing.





THE ART

A HOT STORY

Hosni al-Qarim's fingers flew across his manual typewriter, his thick fingers pounding the keys, shaping the words that would make the greatest story the *Daily Chronicle* had ever told. Al-Qarim had spent the last several months of his life working undercover at the Cybertronic megacorp, and he had finally gathered enough facts to blow the lid right off of one of Cybertronic's major secrets. For years, the world had wondered how come the megacorp's employees never worried about any sorts of incursions by the Dark Legion, and in tomorrow's paper, they were going to find out.

He had talked it over with his editor, and this thing was going to get front page coverage with the biggest headline the *Chronicle* had run since the last Cardinal had assumed the throne. He knew that this was his ticket to instant notoriety, the one he'd been working for all his life. He just hoped the Inquisition wouldn't dump on it just this once.

He was so intently working on the story that he didn't even hear the pair from

Mutant Chronicles describes the three most common aspects of the Art on pages 168-171 of that book. The spells included there are powerful and broad reaching, but they by no means cover the entire spectrum of the Art available to students of the Brotherhood. Here are four more aspects of the Art for player characters.

AREA OF EFFECT: How large an area the spell affects. P=Personal; it only affects the caster.

RANGE: The maximum range of the spell, from user

to target. P=Personal; it only affects the caster. T=Touch; the caster must touch the target.

DURATION: How long the effect lasts. I=Instantaneous. C=Concentration; it lasts as long as the caster's concentration is not broken (either voluntarily or by being struck, etc.).

DAMAGE: Any damage caused by the spell.

NOTE: All stats are given for a spell of the first magnitude. Effects of increasing the magnitude are given in the spell description.

THE ART OF EXORCISM

The Art of Exorcism is based entirely upon healing. Exorcists are able to use the power of their minds to realign unhealthy or disrupted patterns in the human body into healthy or fully aligned ones. They can cure

disease, infection, wounds, poisons and insanity and even remove the influence of Dark Symmetry. By means of Exorcism, those who are hurt or tainted can become whole again, and lambs that have strayed from the flock can be brought back into the fold.

Some of the most important and dedicated Brothers are those who have been affected by Dark Symmetry and then had those influences removed. They know from personal experience what it means to be seduced by the Dark Soul, and this gives them the strength and the knowledge to fight it all the more vehemently.

EXORCISE DISEASE

AREA OF EFFECT: 1 target

RANGE: T

DURATION: I

As with all of the Exorcism spells, this causes the caster's hands to glow with a soft, red light. When the caster touches the target, the light extends itself onto the target. The light quickly finds the areas in need of exorcism (i.e. healing) and concentrates upon those bits as it departs from the caster's hands. The glow intensifies briefly and then fades away. When the glow is gone, the problem has been exorcised and the target is cured.

This spell removes a disease from any target. The disease can range from a hangover to brain cancer. Only the disease is removed. Any physical effects caused by the disease remain, but these are curable naturally or with Exorcise Wound. This spell can only be used against one disease at a time.

Each extra magnitude will cause one of the following effects:

- Increase the range by 10 squares (15 m).
- Add one target to the area of effect.
- Allow the spell to be used against one more disease within the same target.



EXORCISE WOUND

AREA OF EFFECT: 1 target

RANGE: T

DURATION: 1

This spell instantly heals up to 1d6 Body Points of damage. Any application of this spell immediately halts any bleeding, as well as any loss of Body points deriving from the loss of blood. In any case, you cannot be "healed" to more Body Points than you naturally have.

Each extra magnitude will cause one of the following effects:

- Increase the range by 10 squares (15 m).
- Add one target to the area of effect.
- Add 1d6 to the spell's effect.

For two extra magnitudes, the spell will restore a critically wounded limb so that it can be used again. This application does not restore any Body Points.

For four extra magnitudes, the spell can heal a critically wounded chest or stomach if applied within five combat rounds. This application does not restore any Body Points.

Nothing can heal a critical wound to the head.

EXORCISE INFECTION

AREA OF EFFECT: 1 target

RANGE: T

DURATION: 1

Infection occurs when you're wounded by a septic blade or in a septic area and you do not receive proper medical care in a timely fashion. Once an infection sets in (it's up to the GM as to when this occurs), the character loses 1d3 Body Points per day until he or she receives proper medical care.

This spell removes any infection raging through the target's body. Only the infection itself is removed. Any physical effects caused by the infection remain, but

these are curable naturally or with Exorcise Wound. Each extra magnitude will cause one of the following effects:

- Increase the range by 10 squares (15 m).
- Add one target to the area of effect.

EXORCISE POISON

AREA OF EFFECT: 1 target

RANGE: T

DURATION: 1

(If the target is unwilling or unaware, deduct the victim's MST from the CS and add the spell's MGs plus the caster's perfection level to the CS).

This spell removes a poison from the target's body. It can also be used to neutralize a single dose of poison, whether on a weapon, in a container or held in a living creature's poison sacs. If cast on a rattlesnake, for instance, the rattler's next bite will not be poisonous, although later bites will. When the poison is removed, any damage caused by the poison still remains. This can be healed naturally or via Exorcise Wound.

Each extra magnitude will cause one of the following effects:

- Increase the range by 10 squares (15 m).
- Add one target to the area of effect.
- Allow the spell to be used against one more dose of poison within the same target (not necessarily of the same type).

EXORCISE EVIL THOUGHTS

AREA OF EFFECT: 1 target

RANGE: T

DURATION: varies (see below)

(If the target is unwilling or unaware, deduct the victim's MST from the CS and add the spell's MGs plus the caster's perfection level to the CS).



the Cell of Intelligence come up behind him. When the woman spoke, he almost leaped out of his pants.

He spun about and there they were—a man and a woman dressed in the pseudo-uniforms "official" Revisors had worn since the Brotherhood's founding: dark blue business suits and instantly polarizing glasses. To most people, they would have looked like any corporate security types, but al-Qarim knew better. They had their identification cards out, and he scanned them. They looked real.

"Will you come with us, sir? We'd like to ask you some questions about your story," said the woman. The man remained stony-faced and mute, but a gentle smile played across the woman's lips. "It's okay. It's just that you've managed to get some fairly important people interested in your research, and they'd like to get the whole story straight from the man who uncovered it."

She smiled at him again, and al-Qarim smiled back. "Sure, sure," he said, standing up quickly, grabbing his coat and gathering his notes. He wanted to make sure he got all his facts straight. He'd been brought in for questioning before, and he knew these people appreciated you getting it right the first time.

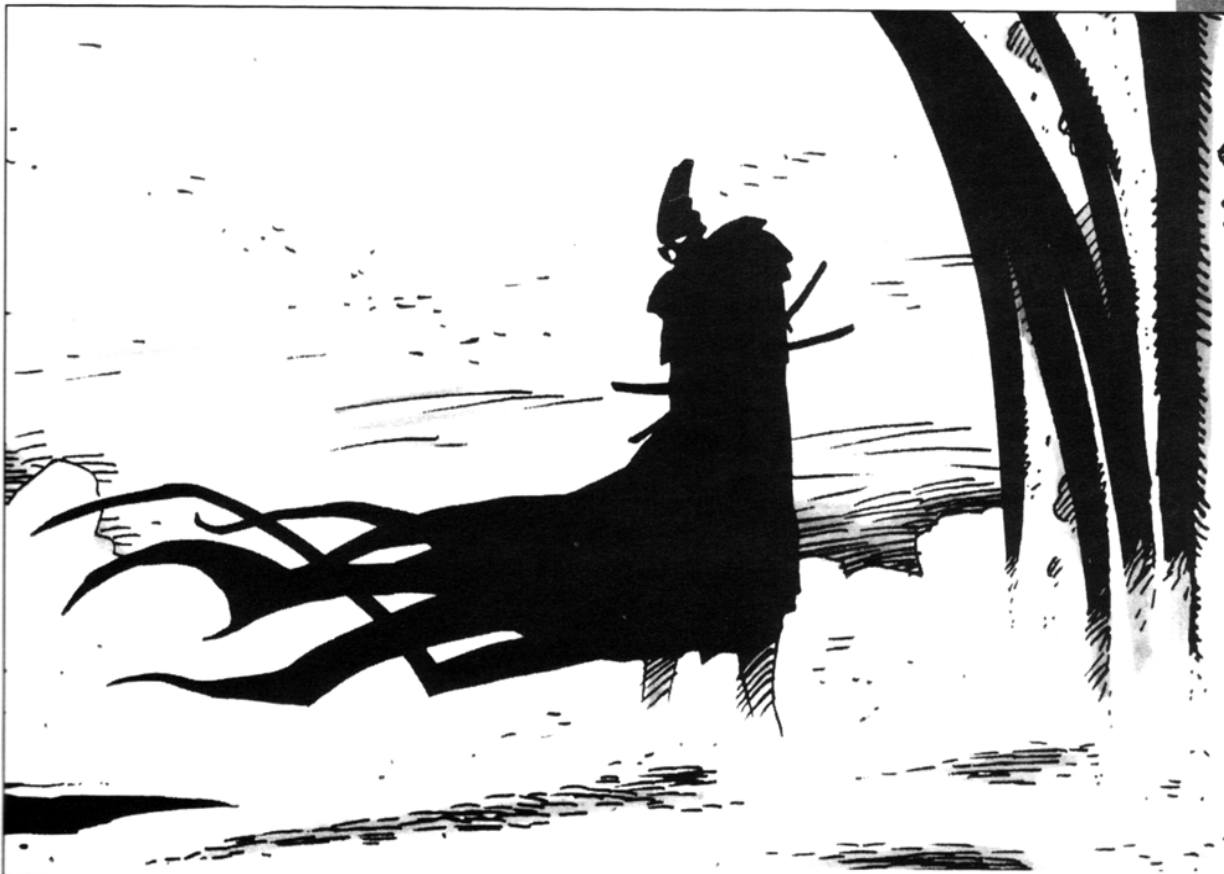



Evil thoughts come in two varieties. In the first, they are possessed by a person or creature who wishes to do someone or something else harm. In the second, they are actually a mental imbalance, a form of insanity. This spell can “cure” the first sort, causing the target to suddenly feel good about everything, even the spell caster.

This effect lasts for 1d6 combat rounds, during which the target is incapable of taking actions that might bring harm to others. The target will always defend him- or herself, however.

Each extra magnitude will cause one of the following effects:

- Increase the range by 10 squares (15 m).
- Add one target to the area of effect.
- Add 1d6 CRs to the spell's duration.

An extra four magnitudes will allow the caster to cure the second type of evil thoughts: insanity. More magnitudes may be required for especially entrenched forms of craziness.

EXORCISE DARK INFLUENCES

AREA OF EFFECT: 1 target

RANGE: T

DURATION: varies (see below)

(If the target is unwilling or unaware, deduct the victim's MST from the CS and add the spell's MGs plus the caster's perfection level to the CS).

This is essentially identical to the Exorcism spell from the Art of Changeling.

This spell is used to convert heretics back to “normal.” The magnitude of the spell must be higher than the heretic's Rank. A success converts the heretic completely. The target will no longer show any signs of Dark Influence. A failure merely lowers the heretic's Rank by 1. Another Exorcism attempt can be made after 24 hours have passed.

Exorcise Dark Influences does just that. It does not affect any side effects the Dark Influence may have caused (i.e. diseases, infections and the like). These can be cured separately however.

Each extra magnitude will cause one of the following effects:

- Increase the range by 10 squares (15 m).
- Add one target to the area of effect.

THE ART OF ELEMENTS

This Art brings its users in close contact with the world around them. Elementalists generally view the universe as a garden and the Brotherhood as its caretakers. Their work with the world allows Elementalists great insight into its fundamental workings, and this is how they manage to focus their mind in the proper way to rearrange the world as fits their needs.

The Art of Elements is unusual as it has only four spells in it, but each of these spells can be based upon any of the four traditional elements (air, water, earth and fire). This makes this aspect one of the broadest available. Players with good imaginations will be able to exploit its powers quite a bit (e.g. by turning a wall of earth into a bridge).

ELEMENTAL WALL

AREA OF EFFECT: 1 x 1 meter

RANGE: 10 squares

DURATION: 1 minute

DAMAGE: varies

Produces a wall of wind that can be used as a shield, to block passage of an enemy or to simply cause a foe damage. The form that the wind takes depends on the number of magnitudes pumped into the spell.



As they strode out of the elevator and toward the Chronicle's entrance, al-Qarim with a Revisor on each arm, he joked, “So, you guys do this sort of thing often? You're kind of pushy for a first date.” Neither Revisor laughed.

“Tough crowd,” al-Qarim said mostly to himself. They would be the last words he would ever say.

The trio burst out onto the street and turned toward the Cathedral, only three blocks away. As they waited for the light to change, a large bald-headed man stepped out of the crowd and drew a flame-thrower from beneath his long raincoat. The two Revisors went for their guns, but by the time they had drawn them, it was too late. Before he had a chance to scream, al-Qarim was engulfed in fire.

The assassin only got two steps before the Revisors opened fire. One of their bullets caught his fuel tank, and he went up in an even larger column of flame than the one that was destroying al-Qarim and all his notes.

The woman Revisor looked at her partner, a grimace on her face, and said, “We're going to have a hell of a time explaining this one.”

For each extra magnitude, the caster can cause one of the following effects:

- Increase the area of effect to MG x MG (a wall of wind of the third magnitude would be 3 x 3 meters).
- Add a third dimension (an MG 2 wall of wind would be 1 x 1 x 1 meter), which can be increased by an additional meter for each magnitude.
- Change the element the wall is composed of, from wind to water, water to earth and earth to fire (a 1x1 MG 4 wall would be made of fire).
- Extend the wall's duration by 5 minutes for each additional magnitude.
- Increase the range by 10 squares (15 m).

For each meter thick, a wall of wind has an armor value of 1 and can sustain 10 points of damage before being destroyed. A wall of wind dissipates when its time expires. Anyone caught inside a wall of wind must make a COR roll or be knocked to the ground.

A wall of water has an armor value of 2 and can sustain 20 points of damage before being destroyed for each meter thick. It causes a -1 to an attacker's chance to hit (per meter thick) due to the warping effect of looking through water. A wall of water flows to the ground when its time is up. The water does not disappear, though; it simply loses coherence as a wall. The floor is now wet. Anyone inside a wall of water must make a COR roll each round or be knocked to the ground. Characters knocked to the ground begin to drown, taking 1d6 points of suffocation damage per CR.

A wall of earth has an armor value of 3 and can sustain 30 points of damage for each meter thick. The duration of the wall is permanent until someone tears it down. A wall of earth blocks line of sight. A person cannot be caught inside a wall of earth, but it can be made to fall on a victim. The target takes 1d6 points of damage for each meter the wall is thick.

A wall of fire blocks line of sight. It has no armor value, but it cannot be destroyed (although it could be extinguished by an equivalent amount of water). Once its time has expired, the wall fades away into nothingness. Anyone caught in a wall of flame takes 1d6 damage for every CR spent inside it.

ELEMENTAL BALL

AREA OF EFFECT: 1 square

RANGE: 10 squares

DURATION: 1

DAMAGE: varies (#TA 3; SR:0)

This spell creates an explosive ball of wind that affects anyone standing in the square where it goes off.

For each extra magnitude, the caster can cause one of the following effects:

- Increase the shrapnel range (SR) by one square.
- Increase the number of target areas (#TA) by one.
- Change the element the ball is composed of, from wind to water, water to earth and earth to fire (a MG 3 ball would be made of earth).
- Increase the range by 10 squares (15 m).

A ball of air forces all targets to make a COR roll or be knocked down.

A ball of water forces all targets to make a COR roll or be knocked down. Additionally, it does 1d3 points of damage to each target area.

A ball of earth forces all targets to make a COR roll or be knocked down. It also does 1d4 points of damage to each target area.

A ball of fire forces all targets to make a COR roll or be knocked down. It also does 1d6 points of damage to each target area.

ELEMENTAL BOLT

AREA OF EFFECT: 1 target

RANGE: 10 squares

DURATION: 1

DAMAGE: varies

This spell creates a bolt of wind that affects a single target within the caster's line of sight.

For each extra magnitude, the caster can cause one of the following effects:

- Increase the number of targets by one.
- Change the element the bolt is composed of, from wind to water, water to earth and earth to fire (a MG 2 bolt would be made of water).
- Increase the range by 20 squares (30 m).
- Increase the amount of damage done by +2.

For two extra magnitudes, the caster can ignore line of sight restrictions. The target need only be within range to be affected.

A bolt of air forces the target to make a COR roll or be knocked down.

A bolt of water forces the target to make a COR roll or be knocked down. Additionally, it does 1d6 points of damage.

A bolt of earth forces the target to make a COR roll or be knocked down. It also does 1d6+2 points of damage.

A bolt of fire forces the target to make a COR roll or be knocked down. It also does 1d6+4 points of damage.

RESIST ELEMENTS

AREA OF EFFECT: 1 target

RANGE: T

DURATION: 1 minute

This spell makes the target immune to the effects of some or all of the four elements. This includes the effects of any elemental spells. The basic spell protects against wind only.

For each extra magnitude, the caster can cause one of the following effects:

- Increase the number of targets by one.
- Alter the element being resisted, from wind to water, water to earth and earth to fire (a MG 2 resistance would be effective against water).
- Increase the range by 10 squares (15 m).
- Increase the duration of the spell by 5 minutes.

Wind resistance protects against the cold and from being knocked down by the wind. Water resistance allows the target to breathe freely underwater and prevents the target from being knocked down or being subjected to currents. Earth resistance allows the target to breathe underground (quite useful if you've been buried alive) and move freely through earth at the target's normal walking rate. Fire resistance makes the target immune to fire and its effects.



ROGUE

INQUISITOR

Revisor Ralston stumbled into the Gibson Cathedral and collapsed on the floor of the great chamber. "The Cardinal," he cried, "is the Cardinal here?" A pair of young Missionaries spotted him and hauled him into a private room behind the great chamber. One of them went for the Cardinal while the other stayed behind to tend the Revisor's wounds.

Suddenly Ralston revived, the fever of the infection that was running through him breaking on his brow. He sat up and cried out for the Cardinal again, then fell back onto the couch on which he was sitting. Then he spotted the frightened young Missionary bending over him with a damp cloth to press against his forehead.

Ralston reached up and grabbed the boy's arms and clenched them in a vise-like grip it took most of his strength to maintain. "You," he said through teeth gritted with superhuman effort. "You must listen to me. I don't have long to live."

"Frank went to summon him," the boy sputtered. He had never seen someone die before, but from the look of the man who was holding him—hurting him—he was sure he was only moments away from his first time. He tried to wrench his arms



THE ART OF MANIPULATION

Since Inquisitors are only allowed to practice a single art, the Inquisition channeled a lot of its energies into creating an Art that would be tailor-made for their specific needs. And so they composed an aspect based entirely upon affecting the minds of others. Not all Inquisitors dedicate themselves to Manipulation, but those that do often find interrogating suspected heretics a little less frustrating.

This Art crosses over into the aspects of both Premonition and Changeling, but also has a few entirely new spells. Most Inquisitors use this Art, as they find it to be most helpful in pursuing their cause.

SUGGESTION

AREA OF EFFECT: 1 target

RANGE: T

DURATION: 1

(If the target is unwilling or unaware, deduct the victim's MST from the CS and add the spell's MGs plus the caster's perfection level to the CS).

This spell allows the caster to make a short suggestion to the target. The target will believe whatever the caster is telling him, even if it is an outright lie. An Inquisitor could make a heretic believe they are friends, for example. The CS can be modified upward or downward if what the caster is suggesting is easily believable or simply hard to swallow. The spell's effects are permanent until someone else offers the victim compelling evidence to the contrary. If the spell fails, the target will probably look at you funny for suggesting something so obviously wrong—and then hurt you.

For example, you might be able to suggest to a Cybertronic officer that you are innocent of trespassing although he's caught you red-handed rifling through the files of a member of the Cybertronic board. He'll walk away like nothing's wrong. If someone else spots you, however, and sounds the alarm, that guard will quickly lose his erroneous beliefs.

For each additional magnitude, the caster can cause one of the following effects:

- Increase the number of targets by one.
- Increase the range by 10 squares (15 m).

DISCERN TRUTH

AREA OF EFFECT: 1 target

RANGE: T

DURATION: 1 minute

(If the target is unwilling or unaware, deduct the victim's MST from the CS and add the spell's MGs plus the caster's perfection level to the CS).

The caster can tell whether the target is lying or telling the truth. This spell is extremely useful for Inquisitors during interrogation. Whether the spell fails or not, the target has no way of knowing that the spell has been cast.

For each additional magnitude, the caster can cause one of the following effects:

- Increase the number of targets by one.
- Increase the range by 10 squares (15 m).
- Increase the duration of the spell by 5 minutes.

TELEPATHIC MESSAGE

AREA OF EFFECT: 1 target

RANGE: 100 squares (150 m)

DURATION: 1

(If the target is unwilling or unaware, deduct the victim's MST from the CS and add the spell's MGs plus the caster's perfection level to the CS).

The caster can send a twenty-five word message to someone else via telepathy. No one but the sender and the recipient will know that the message has been sent. This spell can be used to disrupt another spell caster's concentration. For each additional MG, the caster can cause one of the following effects:

- Increase the number of recipients by one.
- Increase the range by 100 squares (150 m).
- Increase the length of the message by twenty-five words.

TELEPATHY

AREA OF EFFECT: 1 target

RANGE: 10 squares (15 m)

DURATION: 1

(If the target is unwilling or unaware, deduct the victim's MST from the CS and add the spell's MGs plus the caster's perfection level to the CS).

This spell is equivalent to the Telepathy spell from the Art of Premonition.

The caster can scan the target's mind and get a yes/no answer to any question the target may know something about. A failed question can only be retried after 24 hours. In any case, the target never knows that he or she is being scanned.

Since the answer comes from the target's own mind, this spell cannot differentiate between Domination implanted or erased memories and real ones. All questions must be phrased in the past or present tense. Future tense questions cannot be answered, unless the target has some way of predicting the future. This spell is often used when a target doesn't respond well to Hypnotism or the caster has a need for subtlety.

Example: "Did you participate in the assassination of Inquisitor Marcus?" A success produces a yes or a no feeling in the caster's mind. Failure brings nothing.

HYPNOSIS

AREA OF EFFECT: 1 target

RANGE: 3 squares (4.5 m)

DURATION: Until canceled; maximum 24 hours

(If the target is unwilling or unaware, deduct the victim's MST from the CS and add the spell's MGs plus the caster's perfection level to the CS).

This spell is akin to the Hypnosis spell from the Art of Changeling.

The caster causes the target to fall into a deep hypnosis. The target can then be ordered to perform tasks that lie within his or her normal abilities and that don't expose him or her to obvious hazards.

The target will remember what happened during the hypnosis, provided the memories aren't removed via Domination, but he or she will not automatically be aware of having been hypnotized.

away, but the Revisor refused to let go.

"No," he said, "you can't leave me. You must listen." The boy slowly nodded and ceased his struggles. The Revisor tentatively relaxed his grip. Then he let go entirely as his body was wracked by a horrible coughing fit. When he stopped, his lips were red, and a trickle of blood ran down his chin from one corner of his mouth.

The Revisor wiped his chin and began to speak. "It's Primus," he rasped. It sounded as if his lungs were filling with fluid. "He's still alive. You understand, boy? He's still alive.

"He's out there, in the jungle, over 300 miles up the Rio Muerte. It's unbelievable. He's gone rogue. He's become the greatest blasphemy I've ever seen." His eye were wide open now, so much so that the boy feared they might fall out of his head.

"He's managed to take control of a group of Heretic Legionnaires. And he's forced them to do his bidding, to build—to build that thing. That awful, horrible thing."

The Revisor's voice was becoming thicker by the moment. The boy was sure he didn't have too much longer to live. Ralston bent over and vomited black blood onto the chamber floor. Still bent over, he continued on.

"Primus is building himself

If the attempt fails, nothing happens. The target will be unaware of the hypnosis attempt. Inquisitors often use this spell while interrogating a subject, forcing the truth to be told. This can also be used to program a person to perform a task at a later time or upon a pre-arranged signal.

DOMINATION

AREA OF EFFECT: 1 target

RANGE: 3 squares (4.5 m)

DURATION: 1 or 6 hours

(If the target is unwilling or unaware, deduct the victim's MST from the CS and add the spell's MGs plus the caster's perfection level to the CS).

This spell is similar to the Domination spell from the Art of Changeling.

The caster can erase a target's memories or implant new ones in place of the old. For short, simple memories (e.g. "Forget this conversation"), only 3 MGs are required. The process is instant and only requires a successful skill roll.

Longer or more complicated memories (e.g. replacing three months of torture with a holiday trip to Venus) require maybe a hundred MGs, and the target must be hypnotized or drugged during the process, as it may take several days to spend so many MGs.

This spell is often used to eradicate memories of interrogations, secret missions or sessions of hypnosis.

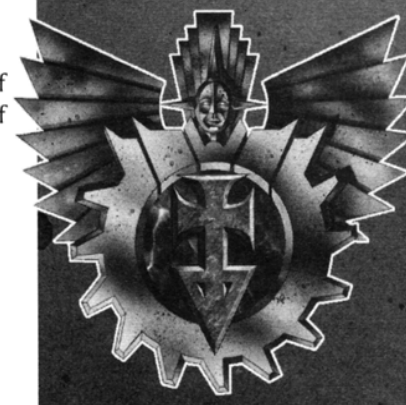

a Cathedral, a Dark Cathedral." With what little strength he had left to him, Ralston turned over and sat back up. He steadied himself by holding onto the boy's arms. With one last final effort, he spat out what he had come all this way to say.

"Don't you understand? He's set himself up as a mockery of all we hold dear. He's become a Dark Cardinal, and if he's not stopped, he'll bring his army down and destroy us—destroy us all!"

Ralston's eyes rolled back into his head, and he pitched forward onto the floor. The pain from smacking his head on the stone floor momentarily brought him back. "He must be stopped," he whispered through his death rattle. "He must be stopped."

THE ART OF MENTALISM

The Art allows members of the Brotherhood to do fantastic things that other human beings would find nearly impossible to comprehend, much less accomplish, but most aspects concentrate on affecting others. This is fine if the practitioner is in a group, particularly a group of Brothers, but for Brothers that do most of their work on their own, this is often not their biggest worry.

The Art of Mentalism allows Brothers to focus their mental powers inwards upon themselves. By the power of their minds, Mentalists can transform themselves into virtual superhumans. This aspect is heavily favored by Brothers who often find that they have no one to rely on but themselves, as do Archangels and Revisors.

PROFICIENCY

AREA OF EFFECT: P

RANGE: P

DURATION: C

You can boost your skill levels in any skill, whether you already possess the skill or not. If you already have the skill, the spell gives you a +1 to that skill. Each extra magnitude causes one of the following effects:

- Add another +1 to the skill.
- Cause the duration to last for 1 minute without the caster having to concentrate on it. The time limit starts immediately upon casting the spell.
- Make the spell last an additional 5 minutes.

For two extra magnitudes, you can use a skill you don't already have as if you had made one skill pick in it. This skill can be improved upon by

adding more magnitudes to it, just as if you really had the skill.

Archangels use this skill for targeting enemy aircraft by boosting their Heavy Automatic Weapons skill.

Inquisitors sometimes use this to boost their Interrogation skill.

This spell cannot be used to boost other spells.

SPEED

AREA OF EFFECT: P

RANGE: P

DURATION: 1 minute

This spell adds +1 to the caster's movement allowance and gives the caster an additional action every round. Each additional magnitude causes one of the following effects:

- Another +1 to the caster's movement allowance.
- The spell lasts another 5 minutes.

INVULNERABILITY

AREA OF EFFECT: P

RANGE: P

DURATION: 1 minute

You get an Armor Value of 1 on every part of your body. This is cumulative with any armor the character is already wearing.

Example: Inquisitor Paolo is wearing a bullet-proof vest which gives him an Armor Value of 3 on his stomach and chest. He casts Invulnerability. He now has an Armor Value of 1 on his entire body, except for his stomach and chest, which have an Armor Value of 4.

Each additional magnitude causes one of the following effects:



- An additional +1 to the character's **Armor Value**.
- The spell lasts for another 5 minutes.

EXORCISE SELF

AREA OF EFFECT: P

RANGE: P

DURATION: 1

This spell is similar to the Exorcise Wound spell from the Art of Exorcism, but it can only be used to heal the caster. It instantly heals up to 1d6 Body Points of damage. Any application of this spell immediately halts any bleeding, as well as any loss of Body points deriving from the loss of blood. In any case, you cannot be "healed" to more Body Points than you naturally have. Each extra magnitude adds 1d6 to the spell's effect.

For two extra magnitudes, the spell will restore a critically wounded limb so that it can be used again. This application does not restore any Body Points.

For four extra magnitudes, the spell can heal a critically wounded chest or stomach if applied within five combat rounds. This application does not restore any Body Points.

Nothing can heal a critical wound to the head.

IMPROVE SELF

AREA OF EFFECT: P

RANGE: P

DURATION: 1 minute

This is like the Proficiency spell, but instead of boosting skills, you boost your abilities. This adds

+1 to any one ability. This can alter some of your combat statistics, so be sure to keep track of them when boosting an ability. Alternatively, you can directly boost a combat statistic on its own.

Each extra magnitude confers one of the following effects:

- An additional +1 to any of the character's skills or stats.
- The spell lasts for another 5 minutes.

FLY

AREA OF EFFECT: P

RANGE: P

DURATION: C

This spell is similar to the Levitation spell from the Art of Kinetics, but bears some distinct differences. It causes the caster to rise into the air at a rate of 15 meters per action. Additionally, the caster can move forward at a speed of 10 squares per action. Each added magnitude causes one of the following effects:

- Cause the duration to last for 1 minute without the caster having to concentrate on it. The time limit starts immediately upon casting the spell.
- Make the spell last an additional 5 minutes.
- Increase the horizontal speed by 10 squares per action. If necessary, count one action as two seconds.
- Allows the character to carry as much weight as he or she normally could standing on the ground. This is the limit of how much the character may carry.

SIDE EFFECTS

In some ways, using the Art is a natural thing to do, and in a few other ways, it's not. The ability to use it has lain dormant in human brains for the last several centuries, and put simply, our hardware just isn't used to this kind of software anymore.

Like most things, using the Art is best in small doses. When a Brother overuses it, it can have some side effects. A few of these effects are actually beneficial, while others can be disastrous and even lethal.

As most Brothers will tell you, a good rule of thumb is to not cast more spells a day than three times your Level of Perfection. While you may be forced to break this rule from time to time, you'd better be prepared to suffer the effects. Sometimes they can be pretty horrible. The other side of the coin, of course, is that when you're pushed into a corner, you can always try to cast a few little spells, break the limit on the number of spells you've cast that day and hope for a stupendous side effect.

3D6 ROLL SIDE EFFECT

3 Oh! A blood vessel bursts in your brain, and you have a mild stroke. You immediately fall to the ground unconscious. You're in pretty bad shape. In fact, you're in a coma and need a hospital to recover in. You should be up and around and on your feet in a few weeks—maybe more. Roll 1d4+2 to find out how many weeks you'll be out. Your MST drops to zero. A stroke can be healed by a fifth Magnitude Exorcise Wound spell.

4 Good night. You find yourself unable to maintain consciousness, and faint on the spot. Your MST drops to zero.

5 Whoa! You feel woozy for a moment, but you manage to recover. You still feel a bit out of it, though. Lose your next action and half of your remaining MST.

6 Ouch! You've suddenly got a horrible headache. Lose a quarter of your remaining MST.

7-15 A euphoric feeling overcomes you. You feel content knowing that you have used your abilities to further the goals of the Cardinal and the Brotherhood for the good of all humanity. Carry on.

16 Whew! That's better. That headache you felt coming on seems to have disappeared. You regain 1d3 MST points.

17 That was easy! In fact, it took absolutely no effort on your part at all. Regain all the MST points you spent on the spell you just cast.

18 Bingo! For a single, achingly clear moment, everything clicks into extra-sharp focus and the world is a wonderful place indeed. Suddenly you feel extremely refreshed. All lost MST points are returned.

CEREMONIAL RITE

Sometimes you're going to want to pump more magnitudes into a spell than you have the MST points to back up. The fact is that you don't have to go it alone. You can call on your brethren for help and combine their power with your own. In this way, you can perform incredible feats like levitating entire crowds of people or healing a platoon of wounded soldiers.

There's a catch though. The only way such amazing uses of the Art can be performed is via a ceremonial rite. Any Brother with the ability to cast spells can lead a rite, and only other spell casters can join in.

When two or more spell-casters join hands, forming a human chain, they begin chanting the ancient words that fuse their minds into one. This collects all of their MST values into an MST pool. The value of the pool is equal to the sum of the Brothers' points less one point that each Brother holds back in order to maintain his or her individual consciousness.

This pool of points can then be used to cast any spell that at least one of the Brothers knows. The only limit to the number of magnitudes that can be generated is the number of Brothers joined in the

rite multiplied by the Level of Perfection of the Brother most proficient with that spell.

Example: Three Brothers unite in a ceremonial rite to cast a Levitation spell. Only one Brother knows the spell, but he is at the fourth Level of Perfection in that Art. Thus, up to 12 magnitudes (3 Brothers x 4 Levels of Perfection) can be spent on the spell.

A ceremonial rite is a delicate thing. It takes a full combat round for each magnitude the Brothers are pumping into the spell for the spell to actually take effect. Thus, completing the spell in the above example would require 12 combat rounds. If the chain is broken, the spell fails and each Brother loses a number of MST points equal to the number of magnitudes used in the spell divided by the number of Brothers involved. In the example above, if the Brothers had only used nine 9 magnitudes and the spell was broken, each Brother would lose 3 MST points.

If you lose more MST points than you have, your soul withers and dies. Brothers with low MST should not involve themselves in a ritual unless the situation is entirely desperate. It can easily prove fatal.

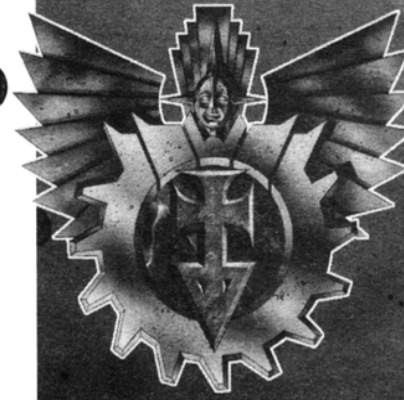



NOWHERE TO RUN

Arnold Malcolm was running for his life. A former street preacher for the Mission, Malcolm had been seduced by the lure of the Dark Apostle Ilian. He had gone over to the other side and been working as a sort of double agent for his dark mistress. And somehow—he had no idea how; it had all seemed so perfect—the Inquisition had found out. And now they were going to make him pay, possibly with his life.

Malcolm dashed down the crowded street, knocking

EQUIPMENT

Unlike people in many other professions, members of the Brotherhood don't have to bother purchasing armor, weapons, clothing or other equipment. It's all issued to them directly by the Brotherhood. The Fourth Directorate does an excellent job of making sure that every member of the Brotherhood gets the proper equipment to do his or her job. The Brotherhood is

wealthy, and while it does not have an infinite amount of resources, the Cardinal believes in buying his people the best.

Many of the articles listed below cannot be found outside the Brotherhood and cannot be had for sale to outside parties at any price. Anyone found in possession of Brotherhood property who is not a member of the Brotherhood is dealt with accordingly.

INQUISITORS

BATTLE DRESS

Inquisitor battle dress is among the finest in the system. Beneath their robes rests heavy ballistic composite armor that gives them an Armor Value of 8 from neck to toe. Their distinctive, peaked helmet has been layered and reinforced even more for an Armor Value of 10 on an Inquisitor's head.

An Inquisitor Majoris's protective gear varies from a standard Inquisitor's only in shape and color, not

function. An Inquisitor's battle dress is usually white with red trim, although more flamboyant Inquisitor's have worn nearly every color imaginable, except for black which is reserved exclusively for the Inquisitor Majores. Additionally, Inquisitor Majores have a double layer of shoulder pads, while Inquisitors only have one.

Most Inquisitors are armed with the Punisher combo (see *Mutant Chronicles* page 84, 179, 181 and 192), which consists of a Punisher handgun and a Punisher short sword.

Additionally, Inquisitors each carry a copy of the Book of Law hanging from their belts. Sometime this is secreted away under their robes, but often it is worn proudly as a symbol of their office.

THE POWER STABILIZER

You can tell how powerful an Inquisitor—or any user of the Art—is by the number of tubes jutting out of the power stabilizer on his or her back. Each tube is color-coded to one of the seven basic colors of the rainbow. This represents the breaking up of the Light using the human mind as a prism.

Each color represents one of the seven aspects of the Art. This means you can tell which aspects a practitioner is proficient in by the color of the tubes on his or her back. The minimum number of tubes on a stabilizer is four, but if the user knows less than four different aspects, one or more tubes will be colored the same in proportions in line with the Brother's talents.

The maximum number of tubes a person can have is seven. Only the Cardinal and several members of the Curia have this many tubes. The peacock-tail-like appendages are like badges of power within the Brotherhood, and those that have many of them are treated—deservedly so—with tremendous respect.



MYSTICS

BATTLE DRESS

Mystics do not enter battle as often as their brethren in the Second Directorate, but the only time most people ever see them outside of a cathedral is when they're dressed—quite literally—to kill. In many ways, their dress and armor is similar to that of an Inquisitor. Their robes tend to be more elaborate, and their shoulder pads are more rounded. Accordingly, the Mystics' armor is tougher (Armor Value 9), although their helmet is nearly identical to that of an Inquisitor (Armor Value 10).

Keepers of the Art have even more elaborate armor. It's heavier (Armor Value 11 for entire body) and includes extensive life support systems designed to keep the occupant alive, even after suffering severe trauma. Any time a Keeper of the Art takes a critical wound in any limb, the suit will immediately patch it and stop the bleeding. This is the equivalent of getting proper medical care, so the limb will not be rendered useless.

A Keeper's suit also has the equivalent of a combat medic unit enmeshed in its systems. The Keeper can activate it at any time to regain up to 10 Body Points. If the Keeper is hurt and knocked unconscious, the suit's medical features kick in automatically. This can save the life of a Keeper with a critical wound in the stomach or chest, although it will then only restore the Keeper's Body Points in the wounded area(s) to zero. The Keeper will remain unconscious.

All Mystics carry a copy of the Book of Law. This is usually kept hidden under their voluminous robes. They each, of course, wear a power stabilizer, color coded to their own unique abilities.

REVISORS

The Revisor is the only profession within the Brotherhood that does not have a uniform of some type. As undercover agents, Revisors wear whatever they feel is appropriate to the situation at hand. Since they mostly work on the streets of the city or infiltrate the offices and boardrooms high above the earth, they rarely, if ever, wear combat armor.

Revisors aren't that trusting of the rest of humanity, however. If they feel that they can get away with it, they'll be sure to wear a bullet-proof vest (Armor Value 3, stomach and chest). Since they often pose as bodyguards or investigators for megacorporations or freelance firms, even if they're discovered wearing the vest, it won't blow their cover, as it's in character with who they're posing as.

The typical Revisor often hits the street in the clothes of an average Jane or Joe. Some people joke that you can spot a Revisor a mile away by their

Most Mystics bring a Punisher combo into battle, just like their Inquisitorial brethren. Keepers of the Art often substitute a Violator sword (*Mutant Chronicles* page 192) in place of the Punisher short sword for that extra added punch.



bulky, high-collared, standard issue trenchcoat, but entertainment programs have made these coats so popular with the general populace that this is simply no longer true.

The trenchcoats are wonderful for hiding weapons under. Revisors tend to favor carrying Punishers in shoulder holsters, but when they know they're cruising for big game, they'll slip the street version of the HG-14 (*Mutant Chronicles* page 194) into the long pocket on the inside right front of their coat. They also like to use Piranhas as holdout weapons.

Revisors are the only members of the Inquisition that don't carry the Book of Law, as its presence would give them away. Most Revisors claim that they've got the thing memorized anyway, and besides, there's no such thing as law in the places where they do their work.

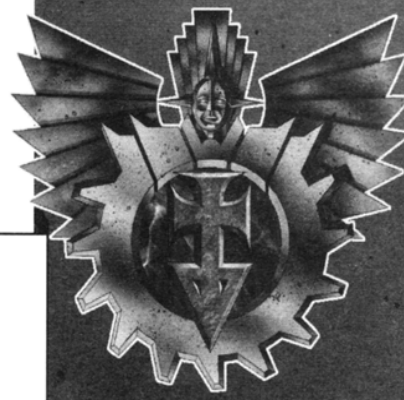

over trash cans and vendor's carts, shouldering and elbowing pedestrians aside. Far behind him, he could hear the shots being fired over the crowd's heads, warning shots telling the people to move out of the way, to get down. They were followed by several screams and the screeching tires of dozens of cars braking to a halt.

A bullet whizzed past Malcolm's shoulder. He glanced back and saw the Inquisitors coming on full steam, the formerly protective crowd having parted before them, revealing the sprinting Malcolm who suddenly felt extremely naked. He spotted an open doorway up ahead and turned into it.

Instantly, he knew he had made a mistake. But what else could he have done? If he'd stayed out on the street, they'd have had him. Better to take his chances in the building. No matter how slim they might be, they were better than the alternative.

What was it the Book prescribed? Malcolm took the nearest stairs three at a time, making for the roof several stories above. Suddenly, he heard the sound of the building's main entranceway being blown to bits. It was followed soon after by another set of explosions that shook the place to its foundation. Oh, yeah. "Create new methods



MORTIFICATORS

Mortificators wear nothing but flat black, and when they're working, any exposed flesh is painted black as well. Mortificators do their best work in the dark, and they dress to fit the part. They wear a billowing black cloak that makes them appear to their foes to be larger than they actually are. Beneath the cloak, they wear a stylized, tight-fitting knee length tunic of ballistic nylon (Armor Value 2) with large slits along both legs up to the hips, and they wear leggings of the same material beneath that. Their helmet (Armor Value 4) covers all of their head except their eyes.

Over the tunic, they wear a combat harness engraved with symbols of their position and rank. A grappling hook hangs from their sides, and a number

of different types of grenades dangle from their belts. They also carry a Nemesis handgun and a double-edged Mortis sword.

MP-210 «NEMESIS» HANDGUN

The Nemesis is Bauhaus' deluxe version of their MP-105 redone especially at the Cardinal's request. The magazine has been worked into the hand grip which has been extended to accommodate the ammunition. The ammunition is still caseless, which is a big plus in the Mortificators' line of work. It not only makes the weapon a lot lighter, but means that there's no shells to go scurrying after once the job is done. The automatic firing mechanism is sacrificed at the cost of the reverse-angle magazine, but the price is more than made up in ease of handling.

to pass between floors." Malcolm cursed, something he never would have done in his faithful Brotherhood days. How far had he fallen?

He realized he should have taken refuge in one of the megacorp's office buildings. Then they would have had to wait and call for permission to enter. But he simply hadn't had the time. They had eliminated that option. If he had just been able to make it to the Cybertronic headquarters, they might never have caught him.

Still, there was no use for such thoughts now. It was too late. The Inquisition never failed. At least, never that they told anyone about.

Malcolm kept pounding up the stairs, floor after floor. Forty

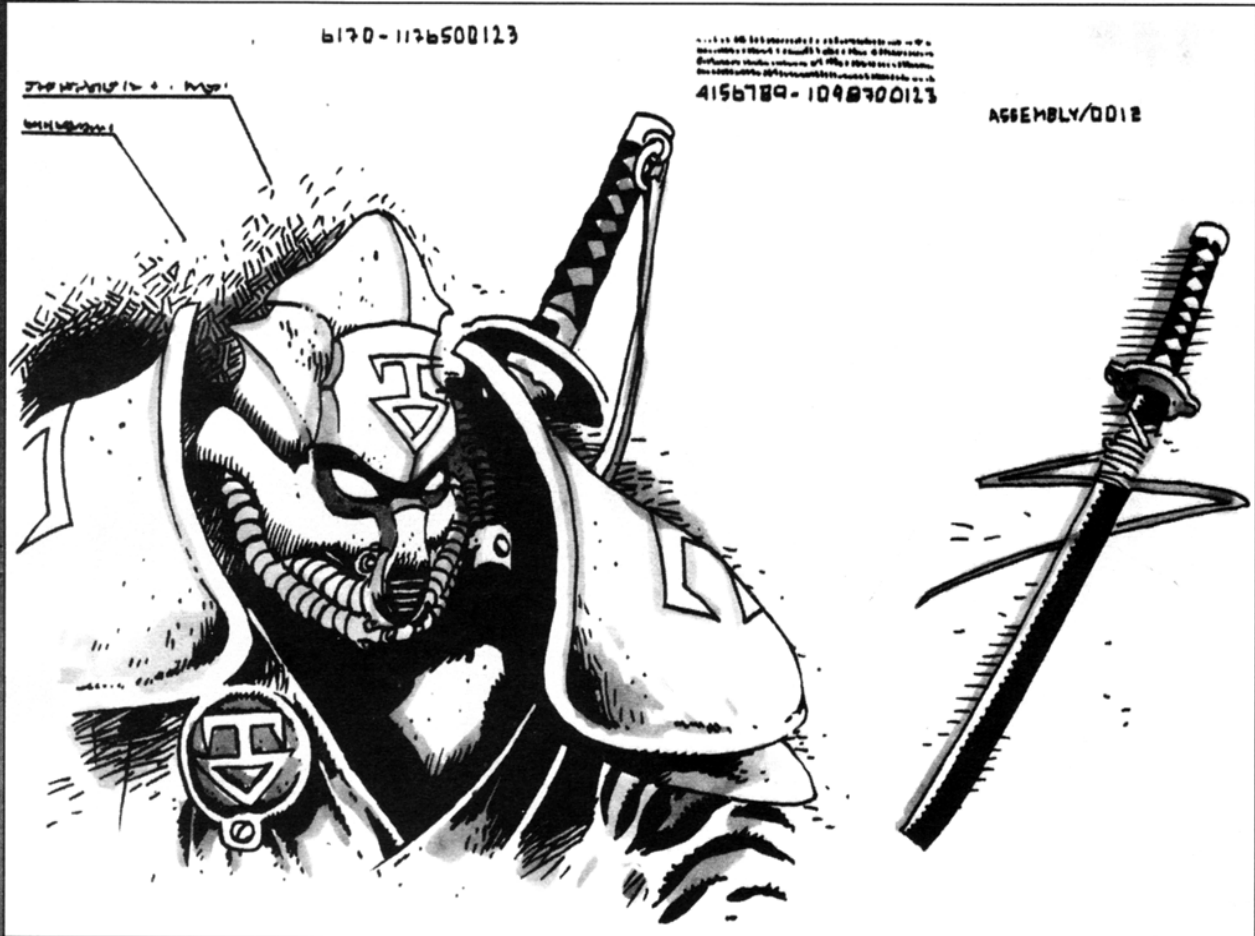

MP-210 «NEMESIS» HANDGUN

W	L	MC	TSS	GL	CB	TS
2.3	43	40	opt	N	N	opt
FUNC	RANGE	STR	RT	JF	DAM	COST
S	20/30	13	1	8	1d6	17,500

MORTIS

Like the Mortificators that use it, the Mortis sword is appropriately named for the death it usually inflicts on anyone unfortunate enough to encounter the business end of one. These light, quick, double-edged weapons are the exclusive property of the Mortificators who find the matte black color of the carbon steel blade and leather-covered grip particularly well suited to their line of work. Almost more than the Mortificator's uniform, this weapon is a sign of the user's profession that serves to scare potential enemies off to search for lesser prey.

The weapon is almost exclusively used by Mortificators, as people seen with one on the streets are usually beaten mercilessly unless they can demonstrate that they know how to use it. If you have Brotherhood Martial Arts, you can use the Mortis to attack up to two targets in adjacent squares with a single action.

MORTIS

W	L	STR	DAM (1H)	DAM (2H)	COST
3.2	100	9	1d6	1d6+2	9,450

SACRED WARRIOR

Sacred Warriors laugh at death, and it shows in their gear, or lack of it. As the only soldiers dedicated solely to fighting the forces of the Dark Soul, their humor in the face of such odds is often refreshing. Sacred Warriors wear intricately carved metallic armor layered over plastics and ceramics (Armor Value 10) into battle, but they rarely, if ever, wear helmets. Most of them wear their hair long and free to accentuate the fact that they think so little of their foes' abilities as to go helmetless.

They carry one of the most truly awesome combinations of weaponry employed by human forces. In one hand, they tote a Retributor carbine, while in the other they carry a legendary Avenger sword each one hand-made for its owner and embellished with symbols of his or her rank. A Book of Law rests in a leather case on a Sacred Warrior's chest.

R75 «RETRIBUTOR» CARBINE

This weapon is a larger, more effective version of the Brotherhood's Punisher pistol. The Retributor has the same famed power and reliability of its little sibling, plus a much better range. Unlike some carbines, this model features no grenade launcher. The designers instead decided to go with heavier caliber ammunition and leaving the weapon light enough to be fired one-handed, although only by extremely strong soldiers like the Sacred Warriors.

AVENGER

The Avenger sword is a badge of honor for the bearer, as it identifies him or her as a member of the Sacred Warriors. Each of these swords are hand-made and tailored to the individual owner's strengths and weaknesses, and each is balanced for its owner's fighting style. No better swords are made. Additionally, Avengers are electro-charged and edged with a monomolecular filament, making for an even more devastating attack. Few opponents can hope to stand up to an Avenger in the hands of a Sacred Warrior, and even less will want to try. These swords are not available to the public at any price. The penalty for private possession of an Avenger by anyone outside of the Brotherhood is execution.

Using an Avenger, you can attack more than one opponent at once. In fact, you can attack targets in all adjacent squares with a single action.



flights later, he started to run out of breath. There was no way he could keep this pace up for very long. The life of a Missionary just wasn't that physically demanding. He could hear the explosions continuing below, regular as clockwork, as the Inquisitors made their way from floor to floor.

He decided that he'd had enough of the stairs. He opened the doorway and staggered into an office area. Off to his left, he saw windows looking out onto the street from which he had come. Ropes writhed along the surface of the plate glass, and for a moment, Malcolm stood there and tried to figure out what they were for.

While he was standing there dumbfounded, a portion of the ceiling between him and the windows suddenly disappeared in a fiery bang

R75 «RETRIBUTOR» CARBINE

W	L	MC	TSS	GL	CB	TS
5.0	30	30	det	N	N	x4-x12
FUNC	RANGE	STR	RT	JF	DAM	COST
A	200/300	17	1	7	1d6+4	16,400

AVENGER

W	L	STR	DAM (1H)	DAM (2H)	COST
5.0	120	14	1d6+1	2d6	—



and a cloud of dust. His ears were ringing so loudly he couldn't hear the Inquisitor dropping through the hole to the floor in front of him, but he saw her as she stepped out of the billowing cloud of white.

The dust seemed to slide gently off of the Inquisitor's white robes, almost as if she



FURY ELITE GUARD

Furies often opt for long red cloaks instead of robes so as to be able to show off their beautiful antique armor, many suits of which have been handed down from Guard to Guard over the centuries. The armor is composed of gorgeously carved and highly polished metal plates over layers of plastic and ceramic and special ablative laminates (Armor Value 11). A Book of Law rests in a metallic compartment imbedded over each Guard's heart.

Furies enter battle with a Deliverer battlesword and a Protector powershield. They also haul along a Punisher handgun for ranged attacks.

DELIVERER

The Deliverer is basically a souped up version of the Violator (*Mutant Chronicles* page 192), an electro-charged blade with the capacity for taking down several foes with one blow. Like the Violator and the Avenger, all adjacent squares can be attacked with a single action. The thing that makes the Deliverer special is the fact that only members of the Fury Elite Guard are allowed to wield them. A limited number of Deliverers were made when the Brotherhood was founded, and only a very few have been forged since. These swords are handed down from generation to generation, and after the sword has emerged from each battle, runes are engraved on its blade to tell the tale of its glory. Some honored swords are almost entirely covered with runes, forcing the engravers to become more creative in their placement of new tales. In any case, there is a story behind every sword—often several.

PROTECTOR

The Protector powershield is fairly unique in the armaments of humanity. Few other warriors besides the Furies have ever carried one into combat. Its use clarifies the Furies' position as the top close combat troops in the Cardinal's forces.

A Fury armed with a Protector gets an additional +2 to any attempts to parry a melee weapon blow. It also gives the Fury a +1 against any missile attacks from the front or left sides (or the right side if the Fury is left-handed). Plus, it gives the user an extra Armor Value of 6 to whichever body parts it's being used to cover.



TROOPER

Troopers usually don't bother with cloaks or robes. Either they haven't yet earned the right to wear them, or they've realized that such clothing would probably only hamper their effectiveness in combat. Troopers don't need to stand out as examples of Brotherhood prowess to each other. They just need to get the job done.

Because of their sheer numbers and the prohibitive cost of outfitting them all, Troopers rarely get to wear a full suit of armor. Usually, they have to struggle along with only with only a helmet, shoulder pads, vest and gloves (Armor Value 3 for each) over their plain gray and white coveralls.

Elite Troopers are awarded with a full suit of armor (Armor Value 5) upon entering the ranks of this renowned group. They don't bother with cloaks or robes, either, instead opting for a simple tunic worn over their armor.

Both sorts of Troopers can be outfitted with a variety of weapons, but the rank and file are generally given a basic weapons combination. For Troopers, this combo consists of a Panzerknacker (*Mutant Chronicles* page 187) and a Bolter (*Mutant Chronicles* page 180). Elite troopers most often use a Bolter and a L&A Plasma Carbine (*Mutant Chronicles* page 186).

PROTECTOR

W	L	STR	COST
3.2	125	11	—

DELIVERER

W	L	STR	DAM (1H)	DAM (2H)	COST
5.1	125	14	1d6+2	1d10+2	—

VALKYRIE

The members of the only all-female branch of the Brotherhood wear long, blue capes over their highly polished, metallic armor, etched with symbols of the Brotherhood and their own Valkyrie Sisterhood (Armor Value 9). Always ready for battle, Valkyries are rarely seen out of their armor, and when they are, their full battle dress is never far from hand.

When entering a conflict, Valkyries carry a Punisher (*Mutant Chronicles* page 181) at their side for medium range attacks. In close combat, these women holster their pistols and reach for their electro-charged Castigators—known not-so-jokingly to some outside the Sisterhood as their Castrators.

One end of a Castigator terminates in a spearhead shaped like the symbol of the Brotherhood. The other features a viciously spiked morning star at the end of a cross—a brutally stylized version of the traditional symbol for women. Valkyries are the only people ever trained in the use of this weapon, and they can employ it with devastating effect.

ARCHANGEL

Unlike most of the members of the Second Directorate, Archangels rarely, if ever, wear armor. As the pilots of the Brotherhood's jet fighters, their weapons and armor are all entirely contained in their planes. They rarely need any additional armament, but they often carry a Piranha (*Mutant Chronicles* page 181) as a backup weapon. When on the ground and heading for a confrontation out of their element (i.e. not in the sky), many Archangels reach for a Punisher (*Mutant Chronicles* page 181) to lend strength to their holy wrath.

As stated before, Archangels do not wear armor. They're most often seen lounging around in their brilliantly white flight suits instead. At important events, they switch into their dress uniforms, but these sorts of occasions are rare.

THE ICARUS JET FIGHTER

The Icarus is the current cutting edge of jet fighters, and given the way that the threat of Dark Symmetry has curtailed the use of technology—especially the development of new tech—it will probably hold that spot for quite some time. The controls and technology of the Icarus are fairly primitive compared to what was once available. This places more of the burden for flying the plane and firing its weapons upon the pilot, but that's the way the Archangels like it.

Only the best pilots in the solar system would have a prayer of handling a plane like this, but the Archangels do it with style. Some of them compare it to sitting on top of a rocket and guiding it with your thighs, but no one has ever heard them actually complain. Each Archangel has his or her own Icarus and is personally responsible for its

CASTIGATOR

A Castigator is a two-handed electro-charged battlespear. Each head is similar in internal design to the Deliverer or the Avenger but has its own unique shape. Only Valkyries may use this weapon. No one else has ever been trained in its use.

This unique weapon can be used to attack all adjacent squares with a single action. Alternatively, it can reach out up to two squares away to attack a single opponent.

CASTIGATOR					
W	L	STR	DAM (1H)	DAM (2H)	COST
5.1	125	14	—	1d8+1	—

maintenance and general upkeep. Keeping his or her ship in tip-top shape is a matter of great pride for an Archangel. You'll never see a bit of dirt staining an Icarus's star-white body or any stains upon its wings. These are clean, lean flying machines.

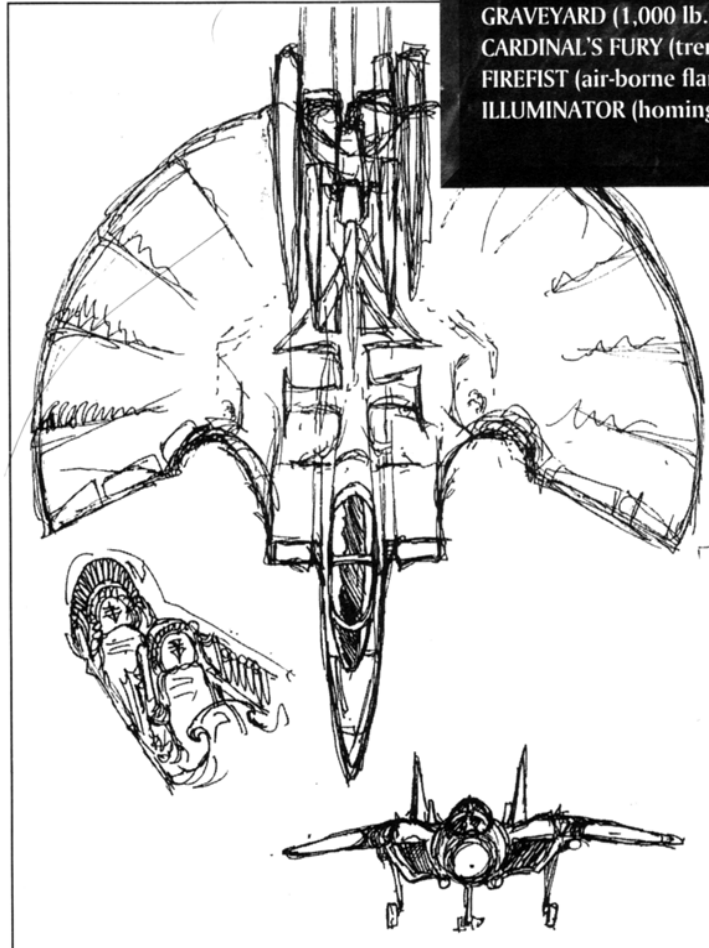

THE ICARUS JET FIGHTER

LENGTH: 18.6 m

CREW: 2 (Archangel + navigator)

MAXIMUM SPEED: 1,300 mph

ACTION RADIUS: 2,000 miles

COMBAT RADIUS: 500 miles

MAX. CARGO CAPACITY: 24,000 lbs.

ARMAMENT: 8 hard-points each able to carry one of the following:

Gun-pod (8-barrel 25 mm Gatling with 1,800 rnds)

HEARTSEEKER aircraft-destroying air-torpedo

GRAVEYARD (1,000 lb. steel- and powder bomb)

CARDINAL'S FURY (trench-torpedo)

FIREFIST (air-borne flame-thrower (range 1,200 m))

ILLUMINATOR (homing vehicle-demolisher)

was immune to such mundane things as filth. The tubes from her power stabilizer were glowing with the residue of her Art. But Malcolm didn't notice most of these things. He only saw the barrel of her Punisher directed at his head.

"Arnold Malcolm." The Inquisitor's voice was muffled behind her helmet. Malcolm knew that her use of his name was not a question.

"Y-yes?" he stuttered.

The Inquisitor stepped forward and pistol whipped him with her heavy gun. Malcolm collapsed like a





house of cards. She looked down at him lying unconscious on the floor. "You're under arrest."

A NEW CALLING

The hallway was dark and cold, and that probably should have alerted Francis that something was wrong. Instead, he simply ignored any warning signs he might have seen and kept his eyes focused on the back of the beautiful young woman leading him into the building.

He had met Kara on the street last week, and she had stood there and listened to him preach the Cardinal's word for two whole hours. Francis had been impressed. It wasn't too often that people stopped and listened to him speak for longer than fifteen minutes, much less a hundred and twenty of them. When he decided to take a break, she had still been there, and she had sat with him and asked him all sorts of questions about the Brotherhood.

Apparently, she was thinking about becoming a

ADMINISTRATION

Members of the Fourth Directorate—Observers, Advisors, Diplomats and, of course, Administrators—almost never wear armor. It is not their duty to become involved in conflicts. They are the oil on the gears that keeps the Brotherhood machine moving along.

Instead of armor, these people wear stylish, layered garments consisting of mantles, albs, tunics and the like that come together to fashion a variation on the modern business suit. These clothes are embroidered with symbols relating to the wearer's place within the Brotherhood and are much valued because of it.

The best and easiest way to discern a person's calling is by the color combination that makes up his or her suit. Diplomats wear red and black, Advisors wear gray and white, Administrators wear gray and blue, and Observers wear green and black. An individual can, of course, wear something different if he or she wants. At these times, you can be sure that the person will be wearing something—a broach, a handkerchief, a tie—featuring the colors favored by his or her branch of the Administration.

MISSIONARY

Members of the Third Directorate wear simple above-the-knee tunics colored in earth tones. Beneath these, they wear leggings or pants. More flamboyant Missionaries wear brightly colored

leggings, as this is the only form of personal expression they are allowed in their clothing, but most just wear brown, black, gray or blue.

Missionaries rarely wear armor. Their calling is a peaceful one, and they generally have no need for it. In times of great need, every member of the Brotherhood may be called upon to defend it, of course, but it's been a long time since a Missionary was asked to pick up a gun in open war.

You can tell which cell a Missionary is in by the color of the rope he or she uses as a belt. Members of the Cell of the Mission—by far the largest sector of the Brotherhood—wear red to symbolize their assignment to bring all of humanity in contact with the Cardinal. The red stands for the blood that unites us all.

Those of the Cell of Artifacts wear blue ropes. These stand for the blue aura that surrounds many different types of artifacts when their magic is activated. The blue also reflects the color of the sky, which filters the harshness of straight light into something that humans can handle and be exposed to without terrible damage, just as artifacts filter the Light of the Art and harness it for normal people to use.

Brothers from the Cell of Scribes wear white ropes to symbolize the sum total of human knowledge that they work with. To them, knowledge is the pure light which with they can banish the darkness that threatens to envelop us all.

ARTIFACTS

Artifacts are devices of power which have magical properties. These devices can be used to cast spells or generate other, more unique forms of magical expression. Artifacts are rare—most are unique—and their use by the uninitiated can be disastrous. One entire cell of the Third Directorate is dedicated to researching, locating and recovering artifacts of any kind.

Some artifacts are aligned toward the Light—others, to the Darkness. Those that utilize the Light are often released into the care of the First Directorate which uses them to further the Cardinal's ends. Those of Darkness are usually destroyed, if a method can be found to do so. Those which are too durable are secreted away in impregnable vaults

located deep beneath the Brotherhood's Cathedrals.

Some of the more common types of artifacts are described below, along with a few of a more unique nature. Whether or not these show up in a *Mutant Chronicles* game is up to the GM. Take care when introducing these into your game, for they can quickly make the player characters a lot more powerful than they were before. Any artifacts recovered by Brotherhood characters must immediately be submitted to the Cell of the Artifacts for evaluation. The players will likely never see them again.

This is by no means an exhaustive list. It's only cursory at best. New artifacts will continually appear in future *Mutant Chronicles* supplements and game aids.

BRINGER OF LIGHT

This legendary, monstrous, electro-charged battle-sword is the Cardinal's own personal melee weapon,

its scabbard, the sword sheds a brilliant, white light over a 100 meter radius, turning even the darkest night into a sort of ephemeral day. Creatures looking directly at it will be temporarily blinded by its glare. This gives any foes trying to fire a weapon at the Cardinal a -2 to their chance to hit.

Besides its offensive and defensive capabilities, the sword also acts as a Staff of Casting (see below) allowing the Cardinal to store up his magnitudes for later use. Most foes, when confronted with such a weapon will turn tail and run. The blood of those who haven't done so has been regularly drunk by this awesome blade until its thirst for righteous vengeance has been temporarily slaked.

BRINGER OF LIGHT

W	L	STR	DAM (1H)	DAM (2H)	COST
7.0 °	140	17	1d8+2	2d8+4	—

and it rarely if ever leaves his side. When drawn from

The Bringer of Light was personally forged by Cardinal Durand I, and it has been passed down from Cardinal to Cardinal ever since. Each Cardinal tried to add a feature of his own to the sword, and so it

seems that there are doubtlessly many properties of this spectacular weapon which have yet to be publicly revealed.



Missionary herself. She claimed to have been a follower of the Cardinal all her life, and she was just now beginning to think that she might be hearing his call. She wasn't sure which vocation would be right for her, but as she had few marketable skills, she had thought that maybe she would join the Mission and see how things went from there.

Francis had found her conversation—and her beauty—extremely stimulating. He had been disappointed when she finally said that she had to be getting back to take care of her mother who had been confined to their apartment

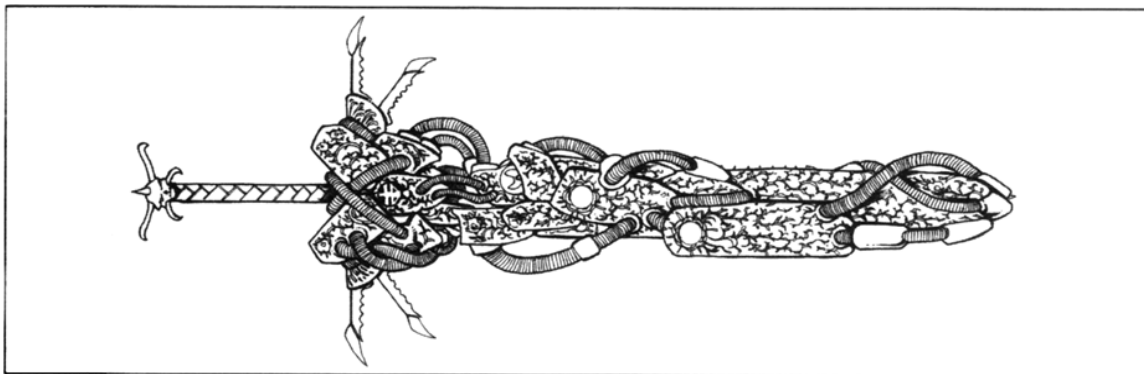
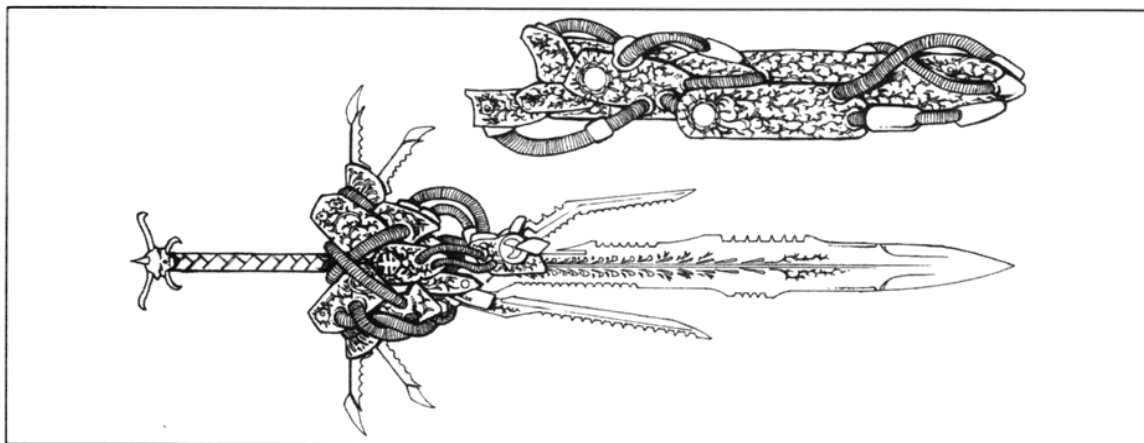

STAFF OF CASTING

This staff allows a character to store up to a full day's worth of magnitudes for later use. It can only be charged by a single spell caster, and only that spell caster can call upon the magnitudes charged therein. The charges remain in place until used or displaced by someone else's charging of the staff. Once the charges are depleted, the staff can be recharged again.

Any time a person recharges a staff, any charges left therein by someone else are instantly and permanently lost. The best way to use the staff is to take a full day to charge it before you go out on an adventure. Then the caster can draw extra magnitudes off it as needed. Once the charges start running low, if the caster has any magnitudes left at the end of a day, they should be deposited in the staff.

A staff of casting looks like a six foot long shaft of a good, strong wood measuring two inches in diameter. Iron bands etched with mystical symbols wrap around the staff at one-foot intervals. It is these bands which hold the power. The wooden shaft may be destroyed, but it can be replaced later with an identical piece of wood bound by the bands.

This artifact can only be used by someone with the power to cast spells—either from the Art or through Dark Symmetry. Spells cast using these points do not contribute to the caster's chance to incur side effects for use of magic, although using magnitudes to charge the staff counts as one spell.

EXORCIST GLOVES

These gloves give their wearer the power to cast spells from the Art of Exorcism each day. Lesser pairs only feature three magnitudes per day. Greater pairs allow the user to expend seven magnitudes per day.

These white gloves appear to be made out of some kind of latex but, when touched or worn, feel only like the finest silk. Anyone can use these gloves, as long as they are free of the taint of Dark Symmetry. Use of the gloves cannot cause any kind of side effects.

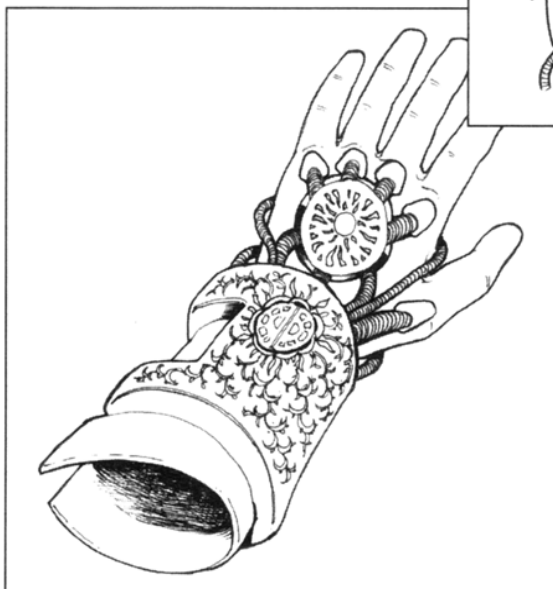
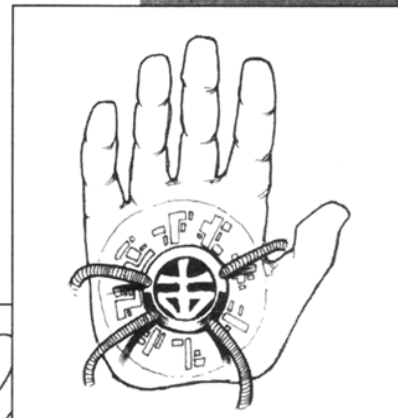

for health reasons. But if his heart fell when she left, it jumped twice as high when she returned the next day.

This went on for most of the week until Kara finally and publicly announced her decision to become a Missionary. Afterward, she begged Francis to come home with her to bring the joyous news to her mother.



GATE

A Gate is a teleportation device permanently imbedded in an object or place. Anyone can use it to teleport themselves to a location with another Gate within 10 kilometers. Spell casters can use their abilities to shunt magnitudes of their own into the Gate. Each additional magnitude causes one of the following effects:

- Allows the caster to bring along an additional person.
- Increases the range by 10 kilometers.

Gates can take a number of different forms. They have been cataloged by the Cell of the Artifacts as a mirror, a one-way doorway, a pool of water, a window and a brick wall at the end of a street, just to name a few. Unless you know that the gate's there, you won't even see it or be able to use it. A Gate can be eliminated by destroying the item in which it's imbedded.

For example, a team of Inquisitors may believe that they have a heretic cornered in a nightclub. Realizing that the Inquisition is hot on his tail, the heretic makes his way into the men's room. The Inquisitors see him and make a beeline for the bathroom. He walks into the back stall and closes the door behind him. The back of the door is a Gate which he activates and walks through. By the time the Inquisitors get there, he's gone. Search as they might, they have little chance of finding him, as the Gate could be anywhere in the entire room. Time to call in the Missionaries from the Cell of Artifacts to see what they can find.

SPELL FINDER

This is a small, wrist-worn device that acts like a compass for magic and magical devices. Instead of pointing north, it points to the nearest instance of magic in the area (100 meter radius). The Brothers from the Cell of Artifacts find this device to be nearly invaluable in their work.

Although a Spell Finder can't be boosted to allow the scanning of large areas—after about 100 meters,

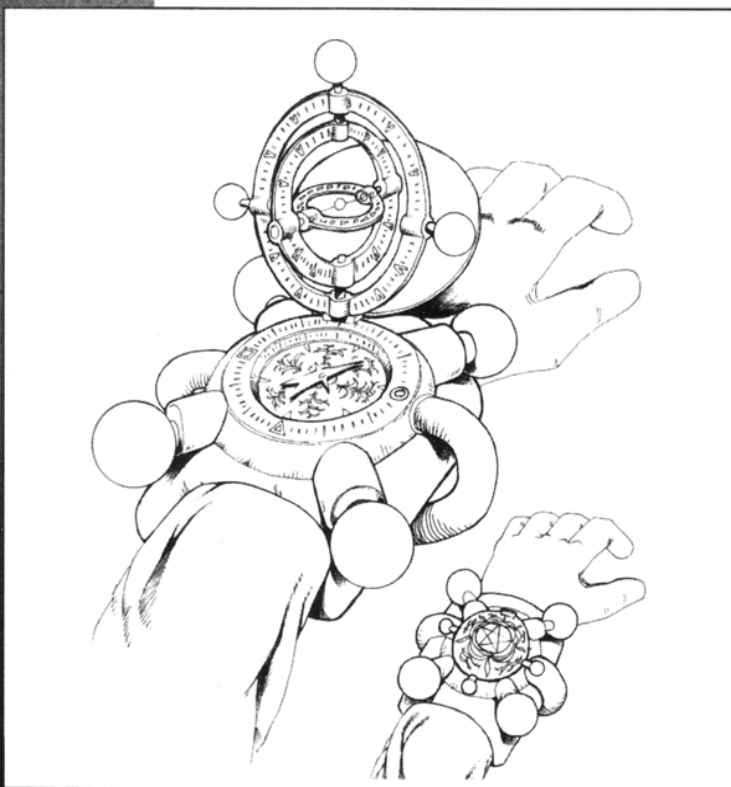

the background nature of the universe makes sensing other magic nearly impossible—it is a wonderful tool for close work. Spell Finders are often used to locate Gates and other hard to spot artifacts.

The only drawback of a Spell Finder is that it picks up all magic and directs its users to the closest instance. This means that the users cannot be utilizing magic of their own, whether it be in the form of spells or other artifacts of their own.

SYMBOL OF LIGHT

This artifact is fairly common as artifacts go. It's used by the Brotherhood to help ward off the effects of Dark Symmetry. Any that are found or manufactured are immediately placed in use. Symbols of Light vary in strength, but each one gives its owner a bonus to his or her MST when resisting a Dark Symmetry spell.

The Cardinal employs the most powerful one known: a Symbol of Light +7, which gives him +7 to his MST against Dark Symmetry. This, along with his already dominant Mental Strength, makes him virtually impervious to any magical attacks by the Dark Legion.

Most Symbols of Light are +1. They can be built by a Brother who has attained the seventh Level of Perfection in an Art. The creation of a Symbol of Light is an important part of the Rite of Passage toward becoming an Inquisitor Majoris or a Keeper of the Art. A Symbol of Light gets +1 for each Art that the caster has mastered up to the seventh Level of Perfection.

The power for the Symbol comes from within the character, and so a character can never have more than one at a time. If a Symbol is lost or stolen, it can be used by another until the former owner builds a new one. When the new Symbol is completed, the old one's power is drained and forever lost.

Symbols not attached to any living Brother come from those who are now dead. Though their life may have ended, their power lives on through their Symbols which can now be used by their lesser brethren. The use of several Symbols is not cumulative, so it makes little sense for a Brother to carry more than one. A Brother able to make his own Symbol will rarely carry the Symbol of another, as most Brothers are eager to make their own mark upon the world and not simply stand on the shoulders of those who came before them.

SYMBOL OF DARKNESS

A Symbol of Darkness is similar to a Symbol of Light, except that it's used by followers of the Dark Soul to protect themselves from the powers of the Brotherhood. Most Symbols of Darkness are +1, but ones as powerful as +6 have been encountered. These Symbols are only found in the hands of powerful followers of the Darkness, as they would otherwise have been stolen by those even more powerful than they.

A Symbol of Darkness can be extremely frustrating to Brotherhood spell casters. More than one Inquisitor has fallen victim to his or her own overconfidence when encountering a powerful heretic or renegade armed with a Symbol of Darkness. Such Symbols often make up the narrow difference between life and death.

He had respectfully agreed. And so here he was, making his way further and further up the dimly lit stairs until they reached the thirteenth floor. Kara turned back and smiled at him as they made the landing and walked down the hallway toward apartment 66. There was a gleam of something in her eyes as she unlocked the door and held it open for her companion. Francis thought it might be excitement.

He stepped into the apartment and saw that it was entirely dark. Then he heard the door close behind him and a lock slip into place. He turned to ask Kara what was happening, but before he could open his mouth, he suddenly felt her lips against his. For a moment, he responded, but then he remembered himself and pushed her away.

Then he could see her eyes glowing redly in the darkness. "Come to me, Francis," she said. "I will show you the way out of the Light. It's better in the Dark, you know." She cackled loudly, and Francis felt a part of himself attracted to her, but he pushed it

SIGN OF TERROR

There are two types of Signs of Terror: a Sign of Fear and the true Sign of Terror.

All those who happen to see a Sign of Fear must make an easy MST roll or use their following 1d10 actions to flee from the Sign as quickly as possible. Those who make the roll have the chance of success of their next attack against the holder of the sign modified by -4.

Those seeing a true Sign of Terror must make a normal MST roll or have a heart attack, i.e. take 1d10 points of damage in the chest. There's also a 1 in 6 chance that a victim's hair will turn white as well. Even if their rolls succeed, all viewers make their next 1d6 actions at -4 to any chances of success.

FORCE BLASTER

This artifact is a one foot long, hollow wooden tube about one inch in diameter. It's painted black and features intricate arcane designs carved along its length. It can fire a Strike spell, just like the description on *Mutant Chronicles* page 169.

The Force Blaster has 10 magnitudes in it to start with. It can be recharged by any spell caster willing to pump magnitudes into it (never more than 10). Only spell casters can make it use more than a single magnitude at once. Strikes cast using these points do not contribute to the caster's chance to incur side effects for use of magic, although magnitudes used to charge the Force Blaster count as one spell.

FORCE BOMBER

This offensive artifact looks like a can with both ends

removed. Like the Force Blaster, it's made of wood, painted black and covered with runes. It's about six inches long and three inches in diameter. It can fire an Explosion spell out of whichever end the user wants, as per the spell description on *Mutant Chronicles* page 169.

The Force Bomber starts with 10 magnitudes. It can be recharged normally, although it can never hold more charges than 10. Only spell casters can make it use more than a single magnitude at once. Explosions cast using these points do not contribute to the caster's chance to incur side effects for use of magic, although magnitudes used to charge the Force Bomber count as one spell.

FORCE SHIELD

This object is shaped and carried like a traditional shield but is made entirely from a shimmering blue force field, much like the Shield spell from the Art of Kinetics (*Mutant Chronicles* page 169). A Force Shield has an Armor Value of 4 and protects against attacks from the front and left sides (or right side if the user is left-handed). Spell users can add to the Shield's Armor Value by +1 for each magnitude spent on it. This effect lasts for only one minute.

For example, Inquisitor Benjus has a Force Shield and is involved in an ambush by a well-armed group of heretics. He pumps three magnitudes into his Shield, giving it an Armor Value of 7 for one minute.

Force Shields can be pierced, but they immediately restructure themselves. They cannot be destroyed by normal means.



down into the recesses of his soul.

Then he remembered the Book resting in the holster on his hip. What did the Book say about handling Darkness? He didn't have to look it up. He knew instinctively that his was beyond his ability to handle this situation. He had to get out of there now.

He started for the door, but tripped over something and tumbled to the ground. Kara was on top of him immediately, her fetid breath making him want to vomit. He cursed her and the Darkness, refuting them both and staying true to his faith.

He didn't know it then, but he would have been grateful that he was blinded by the darkness. It didn't allow him to see the creature Kara had transformed into. But instead of giving thanks for the lack of light, he started to scream, and he never stopped screaming for the rest of his life.

WEAPONS

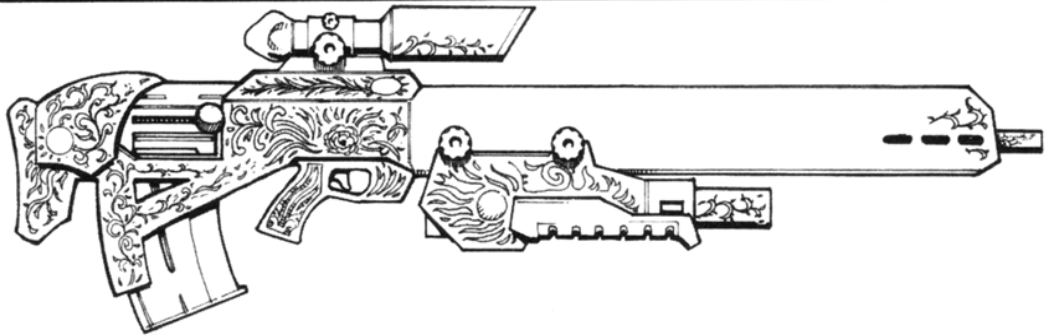

AC-19 «VOLCANO» ASSAULT CARBINE

W	L	MC	TSS	GL	CB	TS	FUNC	RANGE	STR	RT	JF	DAM	COST
6.2	116	20	N	opt	opt	x2-x4	A	400/600	17	1	7	1d6+3	22,000
GRENADE LAUNCHER													
SW	MC	FUNC	RANGE	STR	RT	JF	#TA	SR	DAM	COST			
1.0	3	M	50/75	+6°	1/rnd	7	1d6	2	1d6+1	3,900			

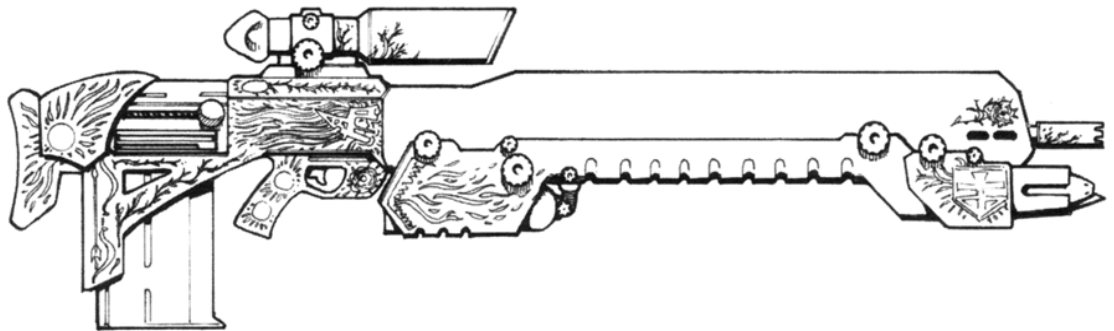

HAC-20 «ERUPTOR» HEAVY ASSAULT CARBINE

W	L	MC	TSS	GL	CB	TS	FUNC	RANGE	STR	RT	JF	DAM	COST
8.0	128	12	N	opt	opt	x2-x4	A	600/900	21	1	7	1d6+4	27,750
FLAME THROWER													
SW	MC	FUNC	RANGE	STR	RT	JF	DAM	COST					
2.7	8	M	12/18	+10°	2	8	1d10	6,800					

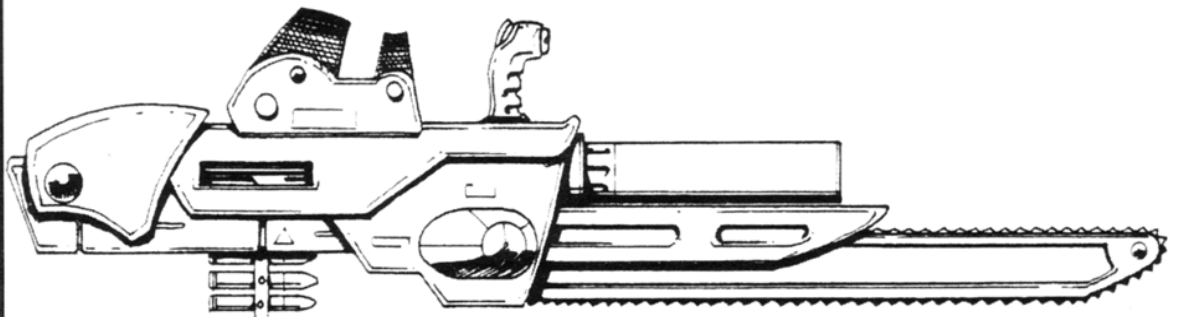

AC-40 «JUSTIFIER» HOLY DISEMBOWELER MACHINEGUN

W	L	MBL	BIP	GL	CB	TS	FUNC	RANGE	STR	RT	JF	DAM	COST
6.2	101	400	N	N	int	N	A	100/150	14	3	8	1d6+1	24,000
DISEMBOWELER													
SW	L	DAM											
—	85	1d6+1											

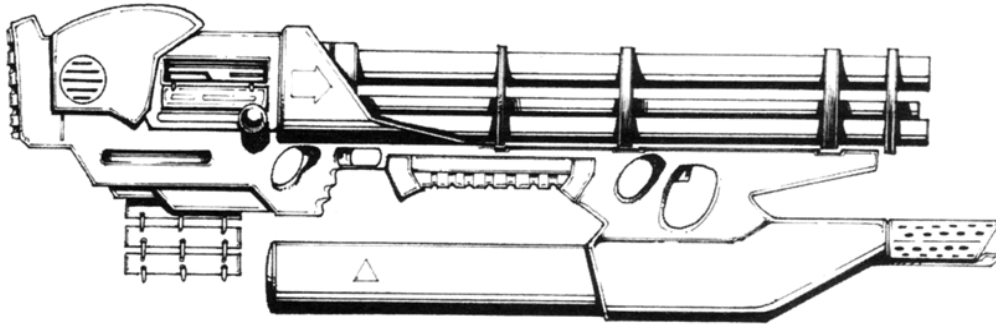

AC-41 «PURIFIER» EXTRA HEAVY MACHINEGUN

W	L	MBL	BIP	GL	CB	TS	FUNC	RANGE	STR	RT	JF	DAM	COST
14.7	98	750	N	N	N	N	A	600	25°	3	7	1d6+4	26,500

PURIFIER INCINERATOR

SW	MC	FUNC	RANGE	STR	RT	JF	DAM	COST
6.0	14	M	20/30	25°	2	8	1d10+2	8,600

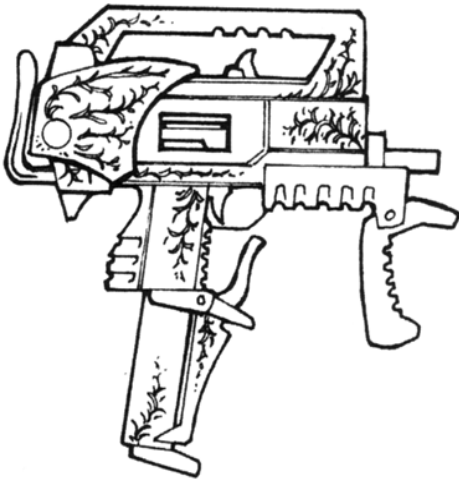

**MP-21 «NEMESIS»
HANDGUN**

W	2.2
L	38
MC	40
TSS	det
GL	opt
CB	N
TS	opt
FUNC	A
RANGE	100/150
STR	11
RT	1
JF	8
DAM	1d6+1
COST	13,500

Not caseless.

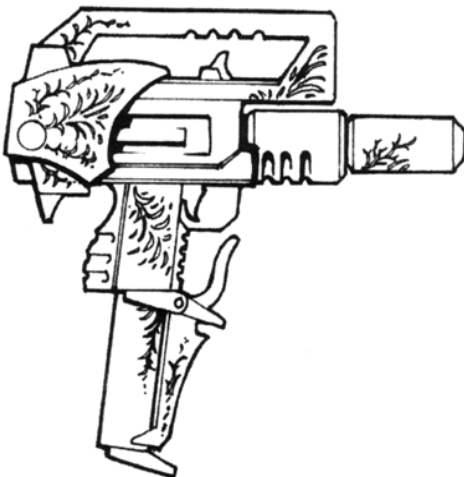

**MP-210 (NEMESIS
STEALTH VERSION)**

W	2.3
L	43
MC	40
TSS	opt
GL	N
CB	N
TS	opt
FUNC	S
RANGE	20/30
STR	13
RT	1
JF	8
DAM	1d6
COST	17,500

Caseless
ammunition.
Integrated
silencer.
Standard weapon
for Mortificators.

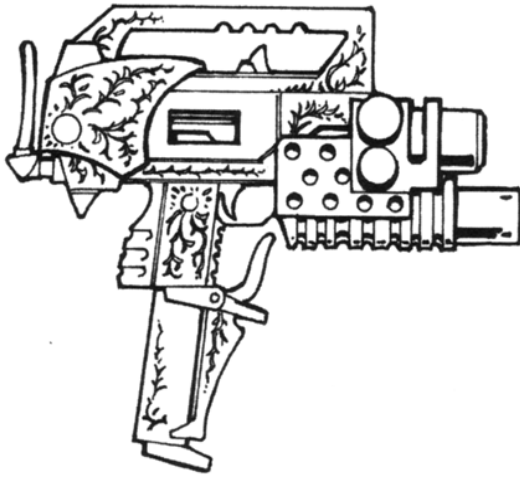

**GL-221
(GRENADE LAUNCHER)**

SW	0.8
MC	1
FUNC	M
RANGE	30/45
STR	+2*
RT	1
JF	7
#TA	1d4
SR	0
DAM	1d6
COST	3,200

Fits with the MP-21.

Picture shows a standard MP-21 with the GL-221 mounted.

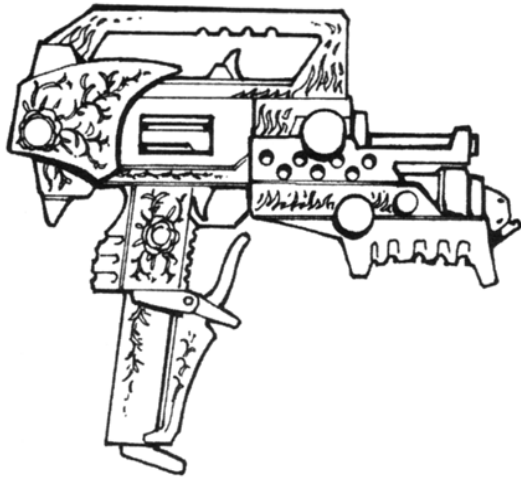

F-214 (FLAMER)

SW	1.0
MC	3
FUNC	M
RANGE	8/12
STR	+2*
RT	2
JF	5
DAM	1d6+1
COST	2,100

Fits with the MP-21.

Picture shows an MP-21 with the telescopic shoulder support removed, but with the F-214 mounted.

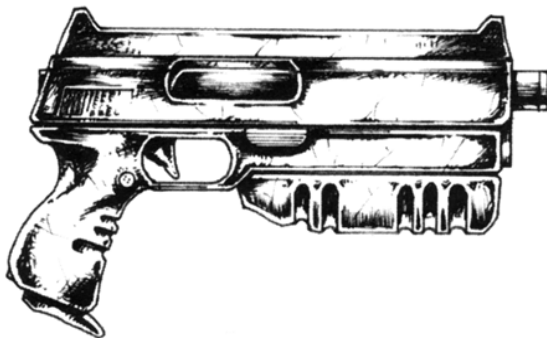

P60 PUNISHER

W	2.5
L	32
MC	13
TSS	N
GL	N
CB	N
TS	N
FUNC	A
RANGE	70/105
STR	14
RT	1
JF	7
DAM	1d6+2
COST	8,400

THE BOOK OF LAW

The Book of Law is the ultimate storehouse of sacred knowledge for any member of the Brotherhood. It forms the basis of the entire organization, and every Brother, from the most humble to the most exalted, carries a copy at all times, with the obvious exception of anyone working undercover. More than just about anything else, the easiest way to identify a member of the Brotherhood is whether or not a copy of the Book of Law is in that person's hands or hanging from that person's side.

Each book is hand-crafted by the Mission's Cell of Scribes. The paper is made of paper specially prepared by the Brotherhood's Mystics, and each word is meticulously hand-copied onto each page by a Scribe.

It's the Scribe's life-work to make copies of the Book of Law for the rest of the brethren. Dark Symmetry has infested too many devices of technology for any but the most primitive methods to be used in creating the

books. Other members of the Scribes hand-sew each book's binding, and for important Brothers, they emboss the Brother's name on the cover and inlay the letters with gold.

The Book of Law is everything to the Brotherhood. If a Brother has a question at any time, the book has an answer for it. This ranges from matters entirely having to do with the influence of Darkness upon human souls to the most tried and true method of tracking down and exterminating a heretic inside a major city.

Chapters of the Book are entitled "The Light," "The Darkness," "Purging," "Military Procedure," "The Art," "Identification," "The Dark Legions," and "The Cardinal," amongst others. Much of the information about the Dark Legions and the Brotherhood found in *Mutant Chronicles* and this book is culled directly from the pages of the Book of Law.



THE EXORCIST

Exorcist Rico strode into the tiny interrogation room and, as per his training, immediately assessed the situation. A young man lay strapped by large buckled, leather restraints to an aluminum vivisectionist's table, a white-hot light glaring down into his bulging, bloodshot eyes. Behind the victim stood an Inquisitor—lyotake he believed her name was—with a number of surgical instruments in her hands. A young Missionary over in the corner looked as if he was ready to lose his first meal of the day.

Already the suspect's left arm had been laid open. He looked drawn and pale, but whether from pain, fear or simply loss of blood it was impossible to tell. Tear tracks covered the man's cheeks, implying that maybe it was a combination of all three.

When the man finally spotted Rico, his pained look suddenly turned to a sneer. lyotake had been right to call him in on this case. His talents would be required here if she was to get anywhere with this subject.

Rico greeted lyotake, ignoring the young Missionary cowering in the corner. He looked down at the subject again and noticed how the flesh had been flayed from his arm.



PURGING



The "Purging" chapter of the Book of Law is really a how-to manual for ferreting out and capturing or eradicating heretics and other minions of the Dark Soul that have managed to infiltrate human space—the sort of thing that most roleplaying game sessions consist of. It's mostly directed toward the Inquisition, but it also takes into account the fact that most first contact between the Brotherhood and those influenced by Darkness is rarely made by Inquisitors.

In fact, more often than not, an Inquisitor isn't even involved. Darkness is everywhere, and its influence is extremely pervasive. Members of the other directorates regularly find themselves entangled in encounters with those tainted by Darkness, and at times like these, those Brothers can turn immediately to the Book of Law to figure out exactly what they should do.

Some samples of the "Purging" chapter are featured below.

PURGING OBJECTIVE: TRACK SINGLE HERETIC

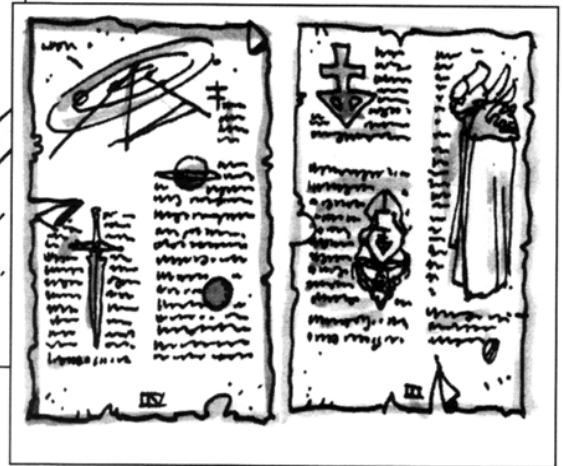

Minimum Cell Size: Inquisitor

Suggested Combat Techniques: Location, Elimination

Support Units: The Mission

Support: Locating shall be carried out with all possible aid of the Third Directorate. If estimated hide-out is strongly fortified, request assistance from the Quarter Master or the local Cell of the Inquisition. All civilian resources may be used with few restrictions. Uniformed corporate personnel must not be taken into custody, although may be recipients of Arts and questions at any time. If heretic is prominent or extraordinary problems occur, pleas for assistance may be posted toward the Curia. Answers should be forthcoming within three or fewer hours.

Location: In all tracking missions, possible hide-outs must first be estimated. All effort shall be spent on eliminating unlikely ones. If hide-out is a corporate possession, Section One of the local Fourth Directorate must be advised for permission to proceed.

Execution: Secure each room. Create new methods to pass between floors. Existing stairwells or other openings shall be avoided. Purging of hide-out commences with Purifier machine gun bursts, followed by grenades. If the target can be secured alive, so much the better, but lives should not be put at risk unless specified by the squadron commander.

In an urban street environment, limited care should be taken regarding innocent civilian bystanders. In rural outdoor environments, risks to civilians may be disregarded. Utmost care must at all times be taken regarding uniformed corporate personnel and

Brotherhood officials. Avengers and Punishers are preferred weapons. The Art must not be used other than in self-defense or when at least the squadron commander has so ordered.

PURGING OBJECTIVE: TRACK RENEGADE MYSTIC

Minimum Cell Size: Inquisitor—Mystic recommended

Suggested Combat Techniques: Location, Elimination

Support Units: The Mission, Revisors

Support: Locating shall be carried out with all possible aid of the Third Directorate. If suspected location is strongly fortified, request assistance from the Quarter Master or the local Cell of the Mystics. All civilian resources may be used without restrictions. Uniformed corporate personnel may only be taken into custody if it is determined that they have been tainted by the renegade's Darkness, although they may receive Arts and questions at any time. If renegade is prominent or extraordinary problems occur, call the local Revisors headquarters for on-site assistance. Only if this fails, contact the Curia.

Location: The primary concern is estimating all potential hide-outs and eliminating them one by one. If a potential hide-out is a corporate possession, inform Section One of the local Fourth Directorate for permission.

Execution: Secure each room. Create new methods to pass between floors. Do not use existing stairwells or

"Why wasn't I called in sooner?" he asked. "Isn't it apparent that this man has been touched by Darkness."

"Your forgiveness, please, Exorcist," answered the Inquisitor. "The subject was a difficult one. At first, I thought he was only being stubborn. Now I see that I was mistaken."

Rico looked down at the man and shrugged. "No matter. One way or another, this will soon be resolved."

The man had a gag in his mouth. Rico removed it.

"Any last words, demon?" he asked the spirit that inhabited the man's body.

The man responded with a string of curses that could have tarnished a Book of Law's golden hinges. Rico responded by slapping him across the face.

"Kiss your host good-bye, spirit of Darkness." Rico closed his eyes and began to concentrate upon the spell that would rip the parasitic entity out of the man's soul.

While he was midway through his work, the man suddenly spit something hot onto Rico's face. Rico opened his eyes and looked down. Between his feet, he spotted the man's tongue.

Rico cursed inwardly at having been so sloppy. He reached a hand out to the Missionary who was already bringing him the rubberized device that would prevent

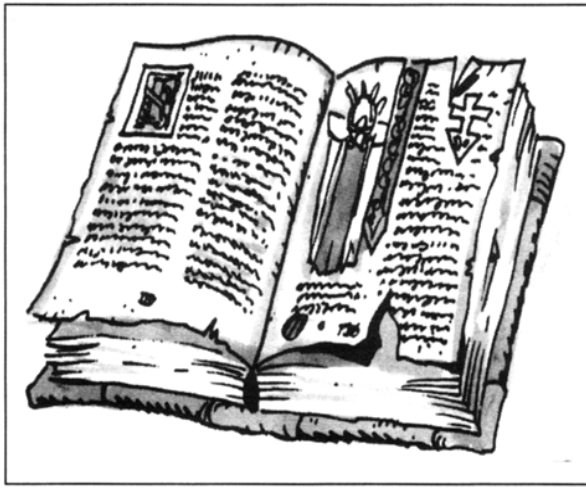

other openings. Purging of hide-out commences with Purifier machine gun bursts, followed by grenades. Use of heavier ordnance is authorized. Alternatively, snipers may be used.

In an urban street environment, limited care should be taken regarding civilian bystanders. In rural outdoor environments, risks to civilians and other indigent life may be ignored. At all times, take care regarding corporate personnel and Brotherhood officials. Avengers and Punishers are preferred weapons. Use of the Art is fully authorized, especially in self defense.

PURGING OBJECTIVE: FIRST CONTACT WITH DARKNESS

Minimum Cell Size: Inquisitor

Suggested Combat Techniques: Elimination or Retreat

Support Units: All members of the Brotherhood

Support: At such time that first contact is made with a force of Darkness, it is up to the individual Brother to evaluate the situation and deal with it accordingly. How the situation is handled depends mostly upon whether or not the Brother(s) involved in the first contact feel capable of handling the target on their own. If so, the Brother should proceed as outlined below. Otherwise, the Brother should immediately retreat to a position from which he or she can contact the Brotherhood and alert them to the situation.

Location: If time is of the essence and you fear that the minion of Darkness will escape if not immediately dealt with, corner it and eliminate it. If a potential hide-out is a corporate possession, inform Section One of the local Fourth Directorate for permission. Again, if time is short, you may ignore this restriction. The job at hand takes precedence over such ephemeral things as property.

Execution: Any weapons at hand may be employed. Use of heavy ordnance is authorized, although discouraged depending on the size of the group contacted. Ordnance is not to be wasted.

Alternatively, snipers may be used, although chances are that they will take too long to arrive. If the encounter develops into an up close and personal match, any and all combat techniques are authorized, including the use of Brotherhood Martial Arts. If the Brother is confident of his or her ability to track down the minion, this should be done with little or no delay. In no case—even after a retreat—should contact be completely and totally lost. Only under threat of grievous harm can a character entirely abandon the duty to track the Dark creatures down and have them eliminated.

In an urban street environment, care should be taken regarding civilian bystanders and possessions. In rural outdoor environments, risks to civilians and other indigent life may be ignored. At all times, take care

regarding corporate personnel and Brotherhood officials. Avengers and Punishers are preferred weapons, although Piranhas may be useful in a pinch. Use of the Art is fully authorized, especially in self defense.

PURGING OBJECTIVE: ERADICATE DARK INFLUENCE IN BODY

Minimum Cell Size: Inquisitor or Mystic

Suggested Techniques: Exorcism

Support Units: The Mission

Support: Cleansing an individual of the influence of Dark Symmetry is generally a straightforward job. The only requirements are an Inquisitor or Mystic with skill in the Exorcism spell from the Art of Changeling or the Exorcise Dark Influences spell from the Art of Exorcism. Additional Brothers may be required to hold down or subdue the target while the caster prepares the spell. If your cell has no person with the ability to exorcise the influences of Darkness, contact the head master of the local chapter of the First Directorate for assistance and a capable Mystic will be dispatched.

Location: Exorcisms can be carried out anywhere, but preferred locales include the holding cells beneath the local Cathedral or any other place secure from the taint of Dark Symmetry. Exorcisms carried out in unsecured places run the risk of being interrupted by associates of the person to be exorcised. This can prove disastrous. Only perform such exorcisms in the direst of straights.

Execution: Cathedrals are ideal. Security is already in place, and there is no need to worry about sudden interruptions. Once the exorcism has been performed, remove the cleansed person to the nearest hospital for treatment of any secondary ailments that may have been incurred while influenced by the Darkness, particularly those incurred during tracking and capture.

Weapons are not usually required during Exorcisms, but it's always good to have them around in case of an unforeseen incident. Punisher combos are preferred. Full use of the Art is authorized and expected.

PURGING OBJECTIVE: LOCATE ARTIFACT

Minimum Cell Size: Mission—Revisor recommended

Suggested Combat Techniques: Location, Recovery

Support Units: The Mission

Support: Locating shall be carried out with all possible aid of the Third Directorate. If at all possible, the track squadron will be equipped with a Spell Finder to aid them in their search. Otherwise, squadron will engage in a systematic room-to-room search of the entire area in which the artifact is suspected to be located.

Location: Potential location of artifact will be less than one square mile. If a potential location is a corporate possession, inform Section One of the local Fourth Directorate for permission to enter and search premises. If cell is using a Spell Finder and determines that artifact is on the move, track object immediately. If tracking takes the cell out of the established territory, contact the main office at the nearest opportunity. Otherwise, proceed with the most extreme caution.

Execution: Secure each room. Use existing measures to move from one room to the next. Move cautiously and be on the look out for ambushes at all times. If artifact is in the possession of someone under the influence of Dark Symmetry, use all means necessary to recover artifact and initiate procedure for first contact with Darkness. If the owner is not tainted by the Dark Soul, attempt to negotiate for possession of artifact. If



“Any last words, demon?” he asked the spirit that inhabited the man’s body. The man responded with a string of curses that could have tarnished a Book of Law’s golden hinges. Rico responded by slapping him across the face.



owner is recalcitrant, contact main office with details for further instructions.

At all times, take care regarding corporate personnel and Brotherhood officials. Punisher combos are the preferred weapon sets. Use of the Art is only authorized in self defense.

PURGING OBJECTIVE: PERFORM INTERROGATION

Minimum Cell Size: Inquisitor

Suggested Techniques: Intimidation, Domination, Hypnosis, Manipulation

Support Units: The Mission

Support: Interrogating a suspected or confirmed heretic is simple. The only requirements are an Inquisitor. Skill in the Arts of Premonition, Changeling or Manipulation may help a great deal. Additional Brothers, preferably from the Mission, may be required to hold down or subdue the target while the Inquisitor prepares the spells. If the cell has no person with ability in the appropriate aspects of the Art, contact the head master of the local chapter of the Second Directorate for assistance and a capable Inquisitor will be dispatched. If time is of the essence, Inquisitors will have to rely on other methods to extract the required information from the subject. Suspects should be allowed to live for rehabilitation if at all possible.

Location: Interrogations can be carried out anywhere, but preferred locales include the holding cells beneath the local cathedral and any place secure from the taint of Dark Symmetry. Impromptu interrogations carried out in unsecured places run the risk of being interrupted by associates of the suspect. This can prove disastrous. Such interrogations should only be performed when absolutely necessary, such as when in hot pursuit of a

minion of the Dark Soul. All possible precautions should still be taken.

Execution: Cathedrals are ideal. Security is already in place, and there is no need to worry about sudden interruptions. Once the interrogation has been performed, remove the suspect to the nearest hospital for treatment of any secondary ailments that may have been incurred during the interrogation. If time is of the essence, the suspect may be left in that locale for later pickup, although it's suggested that the Inquisitors ensure that the suspect won't be capable of warning his or her associates of the Inquisitor's intentions. In such cases, call for ambulatory care at the next possible convenience.

Weapons aren't usually necessary for interrogations, but most Inquisitors have the Punisher combo on them at all times. Full use of the Art is authorized for interrogations.

PURGING OBJECTIVE: INFILTRATE ORGANIZATION

Minimum Cell Size: Revisor

Suggested Techniques: Infiltration, Espionage

Support Units: The Mission, the Inquisition

Support: Due to the nature of infiltration, support for a Revisor in deep cover is accordingly limited. The Revisor is essentially on his or her own. Most judgment calls will have to be made in the field. The Brotherhood will back up any Revisor's actions as long as they appear to be to the benefit of the Brotherhood.

Location: Revisors may be asked to infiltrate just about any organization in human space. The higher up the position the Revisor is to have in the compromised

organization, the more dangerous the assignment generally will be. All but the deepest cover Revisors will be given a personal contact with whom messages and information can be exchanged. All others will be allotted some method by which communication with the Inquisition can be established. This may vary from placing coded ads in local papers to leaving notes at an agreed-upon drop site to miniaturized broadcast and receive systems.

Execution: Every infiltration is unique. Most often, the Revisor is obliged to spend a certain amount of time gaining the trust of those in the infiltrated organization in order to be able to extract any sort of information. This may involve the passage of certain rites of loyalty. It is understood that any rite undertaken while on assignment are not to be held against the Revisor at all. This is simply part of the job.

Once the Revisor has gained the trust of members of the organization, it's time to start snooping around. Any and all opportunities to gather information directly related to the Revisor's mission must be taken. Risks should be minimized according to the prospective gains. Once any information has been obtained, the Revisors must make contact with the Inquisition to inform them of any progress that has been made. Further instructions will be issued then.

At some point, the Revisor may be extracted from his or her current assignment. This may be in several days, months or even years. Once this happens, the Revisor is to make his or her way to the nearest Cathedral or other agreed-upon location for a full debriefing.

In case of emergency, the Revisor should contact an immediate supervisor. If this is not possible, the Curia should be notified immediately, as drastic measures may be in order. Preferably, the Revisor will not be armed, but even most deep cover Revisors at least have a Piranha. Full use of the Art is authorized.

PURGING OBJECTIVE: MORTIFICATION

Minimum Cell Size: Mortificator

Suggested Techniques: Mortification

Support Units: The Mission

Support: Mortifications are done almost entirely without support. The fewer people that know about a mortification, before and after the attempt, the better. Mortificators that fail in their task are often hung out to dry. As such, Mortificators should make every effort to avoid being identified as members of the Brotherhood. If they are identified as such, they should terminate any and all witnesses unless under specific orders to perform otherwise.

Location: Mortifications can be held anywhere. Ideally, they take place in an area far from the public eye so that the Mortificator can avoid being spotted. For this same reason, most mortifications should take place at night. For various reasons, this may prove impossible, in which case extraordinary measures should be taken to conceal the Mortificator's identity.

Execution: The first obstacle to any mortification is to identify and overcome any and all security surrounding the target. This is best accomplished through established surveillance procedures, such as staking out or bugging the target's place of work and business or following the target around. At all times, the Mortificator must be at work assessing the situation at hand and the best way to surmount any difficulties it may present.

Sniping is a good, clean method of Mortification, but if the target is constantly surrounded by innocents, this may not be possible or particularly effective. In such cases, poisoning may work, as may actually breaking

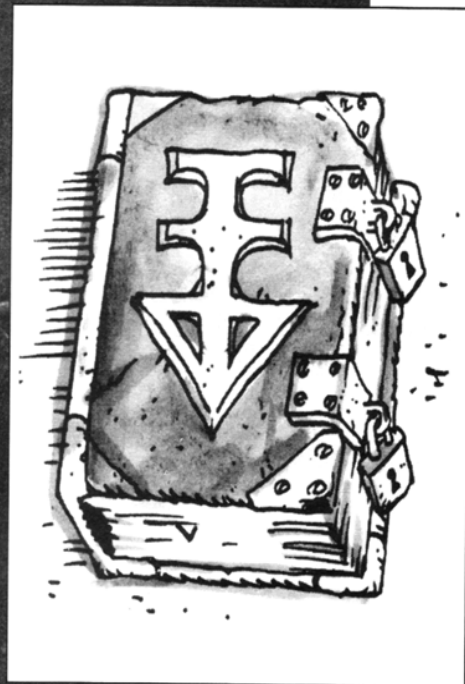

the man from chewing the rest of his mouth to shreds.

When the man saw it he clenched his jaw tight and refused to let it in. Rico's fist smashed into the side of the man's head so hard that he was momentarily stunned. Rico grabbed the man's jaws, pried them apart with his bare hands and shoved the device in. Then he drew the rubber restraining strap around the man's head so that he couldn't spit the device out. He smiled savagely as he wiped the blood from his hands and began again.

This time the spell proceeded uninterrupted. Soon Rico felt the spirit shrivel up in the man's soul and wither away into something less than ashes. Rico sighed deeply. His work here was not yet done.

into the target's living quarters at night and paying a personal visit. As a last resort, the Mortificator may wear a disguise and attempt to gun the target down in broad daylight, even in the middle of a crowd. Careful planning is of the essence here. A distraction placed on the scene can be helpful, and the Mortificator must always be hunting for a way to escape the scene.

It is possible that unqualified Brothers will be called upon to perform a Mortification. In such cases, these Brothers must adhere to the established guidelines as closely as possible. In almost all such cases, the Inquisition will provide the stand-ins with as much intelligence as possible and suggest methods of completing the mission. The Brothers need only follow their orders closely, and the situation should be resolved positively.

Mortis swords and Nemesis handguns are the preferred weapons for Mortificators. The Mephisto (*Mutant Chronicles* page 190) is the preferred sniper weapon. Other Brothers should choose their weapons as they see fit. Full use of the Art is authorized.

PURGING OBJECTIVE: INVESTIGATE LOCATION

Minimum Cell Size: Trooper

Suggested Techniques: Investigation, Recovery, Elimination

Support Units: The Mission, the Inquisition

Support: Usually support will be on call at all times in the form of either combat support from the Inquisition or more mundane support from the Mission. Sometimes, this is not possible, however. In such cases, utmost care should be taken by the squadron to work as a team and complete mission objectives.

Location: Investigation of unknown locales can occur in almost any area except one controlled directly by the Brotherhood. If location to be investigated is a corporate possession, Section One of the local Fourth Directorate must be advised for permission to proceed.

Execution: Investigating an unknown site is one of the assignments most fraught with the possibility of disaster. Brothers are literally entering an area about which little is known, their objective to discover as much about the locale as possible and report back to their superiors. Brothers in this situation must constantly be on guard against traps and ambushes.

All reasonable precautions must be taken. If possible, a Brother skilled in the Art of Premonition should scan the area for the presence of the Dark Legion. Such casters are also useful in seeing through walls and debris and locating the best path to take in any given situation. If no such user of the Art is along on the assignment, the squadron commander should request one, although the request will by no means be certainly granted. If the request is denied, the Brothers will have to make do with more conventional methods.

If any person or object of import is discovered, it should immediately be recovered. If this is not possible, it should be marked for subsequent retrieval. If a person tainted by the Dark Soul is encountered, the Brothers should immediately refer to the guidelines on first

contact with Darkness. Punisher combos are the preferred weapons, but weaker Brothers may substitute Aggressors for Punishers. Use of the Art is only permitted in self-defense unless otherwise ordered by the squadron commander.

PURGING OBJECTIVE: RESCUE HOSTAGES

Minimum Cell Size: Trooper—Inquisitor recommended

Suggested Techniques: Investigation, Rescue, Elimination

Support Units: The Mission, the Inquisition

Support: All civilian resources may be used with few restrictions. Uniformed corporate personnel must not be taken into custody, although may be recipients of Arts and questions at any time. If terrorists are prominent or extraordinary problems occur, pleas for assistance may be posted toward the Curia. Answers should be forthcoming within three or fewer hours.

Location: In a hostage situation, one advantage the Brothers have is the ability to do research about the location in advance. Chances are excellent that the targets will not stray too far from the site from which the terrorists' demands were issued. Brothers skilled in the Art of Premonition should be utilized to gather as much instant information about the situation as possible.

Execution: Once all possible intelligence has been collected, it's up to the team on the scene to form a plan of attack. Create a new opening in the side of any construct protecting the terrorists from harm. Follow up with smoke grenades and immediately enter the structure. Create new methods to pass between floors. Existing stairwells or other openings shall be avoided. Infra-red goggles should be used to help distinguish friends from foes. Care should be taken not to shoot innocents, but when in doubt, fire away. It's better to have a few dead civilians than to lose the entire bunch because a Brother hesitated to fire when an unidentified target presented itself. Don't bother with capturing terrorists alive. With the civilians in the area, there's too much at stake.

After all hostiles have been eliminated, gather and remove all hostages as quickly as possible. Terrorists have been known to booby trap locales in case of their demise. These traps can often be avoided by a speedy departure from the premises. Carry the wounded and herd the unharmed ahead of you. Use of non-lethal force to persuade hysterical or stubborn hostages to comply is approved.

In an urban environment, innocent bystanders should be cleared from the area before any action is initiated. In rural outdoor environments, risks to civilians may be ignored. Utmost care must at all times be taken regarding uniformed corporate personnel and Brotherhood officials.

Punisher combos are the preferred weapons, but weaker Brothers may substitute Aggressors for Punishers. Use of the Art is only permitted in self-defense unless otherwise ordered by the squadron commander.



He picked up the man's tongue and held it before his eyes. It was a wonder the man could see anything at all with the torrent of tears that were rushing out of him from his grief and shame, but when he saw the amputated flesh, he began to moan loudly in soul-searing pain.

Rico removed the device from the man's mouth and ordered him to be quiet. Then he place the tip of the tongue back in its owner's mouth and began to concentrate once again. Within moments, the man's tongue was repaired so that it was almost like new. He immediately began to use it to give the Exorcist thanks for saving his poor, rotten soul.

Rico nodded and muttered a blessing over the man. His job here was finished. As he turned to leave, he shot back over his shoulder at Iyotake, "And get someone to look at that man's arm, would you?"



THE CATHEDRALS

A LONG DAY

Mark Samuels had been following a heretic for several minutes. He was an elderly man, the kind you didn't see around too often anymore, the type that people in the old flicks would've called "Gramps." He had a kindly air about him, and to just about anyone else, he would've seemed like a harmless old man. But to Samuels, a Revisor trained in the Art of Mentalism, he was a part of the Great Darkness.

Samuels wasn't sure what had tipped him off at first. Maybe it was the way the old man had looked askance at the Cathedral. Or how he hadn't bothered to cross the street when that Mystic had come strolling along. Anyhow, it had been enough to set off Samuels' finely honed Revisor's instincts. He had grabbed the Mystic and had him scan for the presence of Darkness. They'd come up with a royal flush.

And so Samuels had thanked the Mystic and begun tailing the man. After several blocks, the man had ducked into an Underground station. Samuels almost lost him getting onto the train, but he managed to squeeze on at the last second.

The old man got off deep in the Perimeters. He walked three blocks up, turned left and then entered an old apartment building. Samuels stopped out front.

He needed to assess the

There are fully eight Cathedrals in the system, and each of them bears a sacred Chronicle engraved upon its marble walls. No matter what city they're in, the Cathedrals are the tallest, most majestic buildings there or anywhere else on the planet. Each of them is unique, but they do share some common elements.

Each Cathedral is modeled upon the first and

greatest of them all: the Cathedral on Luna. They each have a Great Chamber in which mass is said, confessionals in which to hear the sins of the brethren, interrogation cells in which to question suspected heretics and libraries in which to gather the storehouse of knowledge the Brotherhood has accumulated over the centuries. They differ mostly in location, size and attendance.



THE FIRST CATHEDRAL

The First Cathedral is far and away the most glorious of the eight. Composed of layers of intricately carved black stone draped over a framework of steel, the facade of the Cathedral is covered with gargoyles and statues of the various Brothers and Cardinals that served the Brotherhood well. Chimneys poke out of the surface everywhere, giving the neo-Romantic architecture a faintly Gothic feel. The steam used to heat this massive structure constantly pours out of these pipes, shrouding the upper levels of the building in an unearthly haze. The building towers over the surrounding overbuilt landscape, standing head and shoulders above even the home offices of each and every megacorporation that does business in the realm of humanity.

The Cathedral is over 200 stories tall, shaped roughly like the Brotherhood's symbol, and squats over dozens of levels scratched deep into the dermis of the moon. Colossal spotlights illuminate its sides at all times, making it a beacon of hope for humanity, even in the darkest night. The Cardinal himself makes his home at the top of the spire that juts out of the triangle-shaped base of the symbol far enough into space to make the gravity at the top even lighter than that at the bottom.

Situated in the middle of the city, directly in the midst of the Ancient Quarters, the First Cathedral (often simply referred to as the Cathedral) is the social, spiritual and political center of the entire solar system. All things rotate around the Cathedral, and everyone in the system is fully aware of it.

Most of the Cathedral consists of office chambers and living and training quarters for each of the four directorates. The sheer number of people involved in the Brotherhood is staggering. The Cathedral is like a mini-city unto itself. It has a hospital, schools, gymnasiums, Underground stations and offices for every sort of professional occupation you could think of. Manufacturing facilities and the Brotherhood's own spaceport are located out toward the fringe of Luna, as are some of the Brotherhood's farming communities, but almost all else is contained within the Cathedral's walls.

THE GREAT CHAMBER

The Great Chamber is fully thirty stories tall and has room for over 100,000 people to attend mass at once. It is rarely full throughout the week, but on Sundays, the place is jammed to the rafters. After all, 75% of Luna's citizens visit the Cathedral at least once a week.

Mass is held once a day, beginning at seven p.m. and lasting until at least ten that evening. It's broadcast live on television and radio so that even those followers who cannot, for reasons of their own, make it to the mass, can join in the celebration, at least vicariously.

The vast altar stands at once end of the chamber, and the Cardinal's throne rests behind it. The Cardinal only says mass once a week, usually on Sundays. On each of the other days, a member of the Curia holds mass in his stead. Behind the altar is a great, free-standing, white-washed wall that runs twenty stories into the air. The television broadcast is projected onto this wall, so that even those in the most distant seats can watch and participate in the ceremonies.

The great wall stands twenty meters from the back of the Great Chamber. The back of the wall is covered with a lattice work of ladders and platforms and floodlights illuminating its surface. The letters and words of the First Chronicle are inscribed upon the bare stone surface.

THE CONFESSIONALS

The Brotherhood's confessionals are arrayed on the ground in the space between the great wall and the back wall of the chamber. These are open every day, around the clock, so that people may come seeking absolution. Many of those who seek it actually find forgiveness.

A confessional is an enclosed and soundproofed booth separated on the inside by a privacy screen which forms two small cubicles. A door enters into each cubicle. The Missionary to hear the confession sits in one room and waits for penitents to enter into the other.

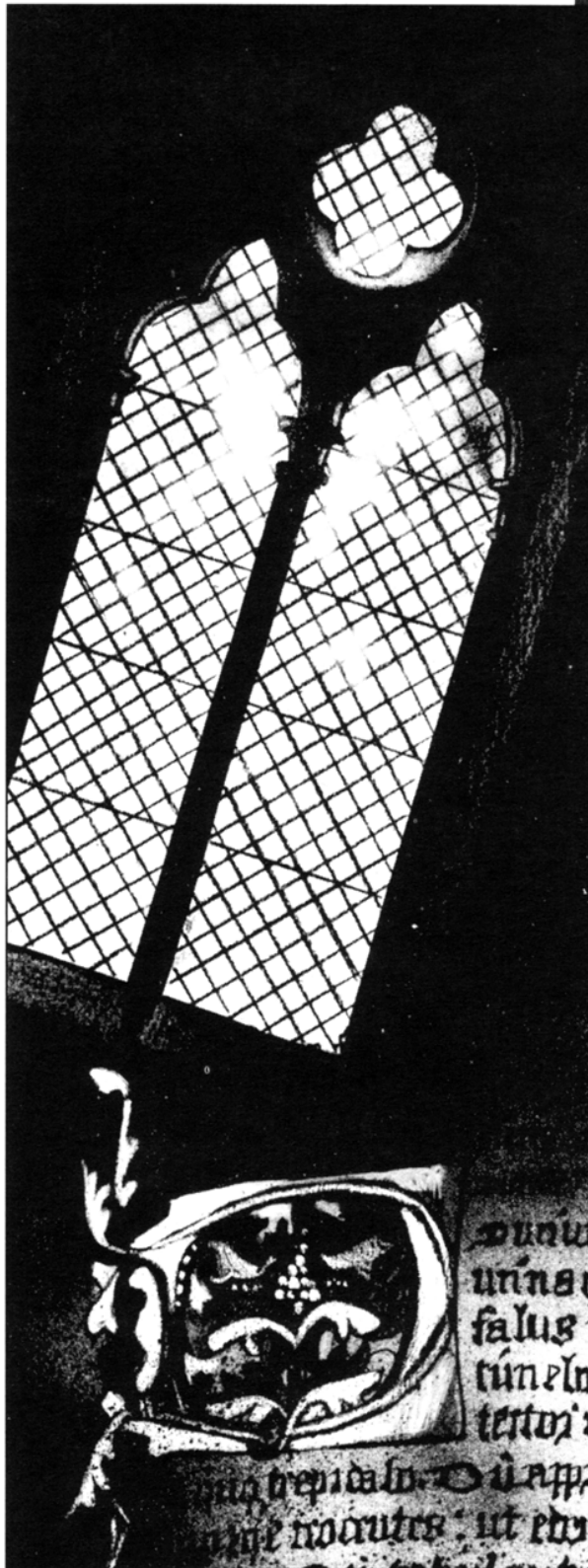

situation. It was a small building made decrepit by age, possibly an old warehouse converted into living quarters, each floor making up a single large apartment. Who knew what secrets the place held? He could call for backup, but by the time it arrived, the old man could be gone. Besides, he was probably just some old fogey dabbling with Dark books, mostly harmless. If he called in assistance on that kind of case, he'd get ribbed about it for the next month. He decided to go it alone.

He entered the building and stopped and listened. He heard a set of footsteps moving up the stairwell. He padded up the steps after them as quietly as he could. They stopped at the third floor.

Samuels heard the sound of a key in a lock and then a door opening and closing. He tiptoed up to the third floor landing, then stopped and put his ear up next to the old metal door. He couldn't hear a thing inside, but that might be from soundproofing in the door. He wavered for a second and then made a decision.

He drew his Punisher from its shoulder holster, aimed it at the lock and fired. Then he shoved in the door with his shoulder, his gun at the ready.

The old man was standing across the large room, a shocked look on his face.



Five other people were sitting in a group of couches he was standing in front of. The place reeked of spilt blood and rotting flesh.

One of the men on the couches drew a gun, but before he could use it Samuels started firing. The man went down in a shower of blood without having squeezed off a shot. The others went for their weapons and Samuels kept firing.

Most of the people either went down or dove for cover. One man in the center of the couches stood up and simply snarled. The man drew a weapon from beneath the couch, a sword-like thing Samuels recognized as a Vassht.

Samuels stopped firing for a moment to get a good look at the man who was ignoring his bullets. Suddenly the world seemed to shift sideways for a moment, and something was standing in the man's place.

It was like a small, skinny man, much smaller than the man it had replaced. Its skin was black and leathery, and he could swear its eyes were softly glowing red. The creature snarled at Samuels again and threw its Vassht at him.

Samuels hit the floor, and the weapon sailed over his head and buried itself in the stairwell wall. He glanced back and saw the thing dislodge itself from the plaster and zoom back

When you enter, you fall on your knees and beg the Missionary for forgiveness. You then rattle off your sins, one after the other. The Missionary may stop you at any time to ask you to clarify a point, but most confessions are completed uninterrupted.

If your sins are negligible—for instance, having had dark thoughts about some of the people around you—the Missionary will assign a fine and absolve you of your sins. You are then free to go on your way. Once you've paid the fine, the sins will be forgiven, and your conscience will be cleared. Fines are assigned according to the magnitude of the sin and the penitent's ability to pay. The greater either of these things, the greater the fine will be. Rarely is a fine assessed that cannot be paid, although particularly troubled followers may often find their bank accounts empty at the end of the month.

If your sins are too serious to be ignored, the Missionary will secretly buzz a contingent of Inquisitors. These Brothers will study the guilty party's face and follow that person back to his or her home. Once they established where the person lives, the Inquisition will research the person's background and formulate a plan of attack. In most cases, the person is awakened in the middle of the night after having made a confession earlier that day. The person is subdued and hauled into the interrogation cells in the bowels of the Cathedral. Alternatively, the Inquisitors may opt to apprehend the sinner while still in the confessional. Many sinners have entered the Cathedral to confess their sins and ended up in the interrogation cells mere minutes later.



THE INTERROGATION CELLS

The interrogation cells are cold, dimly lit and oppressive cubicles carved out of the dead rock of Luna's crust. Everyone's seen them in Brotherhood sponsored television dramas a million times, but there's nothing quite like experiencing one first hand. Each cell has the smell of blood and defecation about it, and its walls are stained with splatters of deep, dark red.

In the center of the cell is an aluminum surgeon's table, complete with troughs and collecting pots for any leaking bodily fluids. Leather straps hang from the sides, showing signs of long use. A tall, adjustable lamp stands on the far side of the bench, needing only a casual twist to send blinding illumination into a subject's eyes. A surgeon's tray sits at the near side of the bench, its top covered with various polished, gleaming, sterilized instruments of torture.

The official word is that a Inquisitor rarely has to turn

to such primitive methods to obtain the information he or she wants. Word on the street is, though, that some Inquisitors ignore using the Art to scan a subject's mind in favor of older, less effective methods which they simply enjoy administering more. Few people who have actually experienced an interrogation by the Inquisition have ever come forth to talk about it. Even if they did, the Brotherhood controlled media would never allow any stories of inhumanities performed during interrogations to be let out.

Most people who leave the chamber head immediately to a nearby holding cell. While there, their minds are worked on until they can't remember a thing about any of the questioning at all. Once their wounds (if they have any) are healed, they're allowed on their way to resume wholesome versions of their previous lives.

Of course, some people are found to be tainted by the Great Darkness. These souls undergo an exorcism by a qualified Mystic before they are allowed to re-enter society. After leaving the Cathedral, many of these people are followed by Revisors in the hopes that they may inadvertently or unknowingly lead the Inquisition to the people or creatures that brought the taint into their hearts.

THE SANATORIUM

The Sanatorium is the Brotherhood's version of not just a hospital, but a total care facility. Patients come or are brought here for cures for just about any kind of ailment known to humanity. If the Mission's white-robed doctors cannot heal whatever ails a person, you can be sure that the Exorcists from the First Directorate have the power to make up for what their more mundane counterparts cannot.

This is not to say that these services come cheaply, however. The Sanatorium is only for members of the Brotherhood. Those who do not follow the Cardinal's word are not welcome within its walls, no matter whatever else may be offered. There is only one price for treatment: you must believe.

The first portion of the Sanatorium most people see is the triage. Here, patients are placed in line to see the on-duty physicians and healers in the order that the severity of their disorder demands. Severely wounded people go right to the front of the line, while those with relatively minor cases spend some time in the waiting room.

The Brotherhood's policy is to try healing by normal, natural means first. Only if that fails is someone to be treated with the Art. Usage of the Art is conserved as much as possible at all times. You never know when a Mystic is going to need Mental Strength points to heal a really messed up patient later in the day.

Special restorative Exorcisms can be arranged for by appointment, but these usually have to be run through each Exorcist's private office. There is still no charge for these services, but the patient may have to wait for up to months or even years at a time in order to receive the services he or she needs.

Exceptions are made for members of the Brotherhood involved in dangerous or vital active duty. These men and women are healed up and placed back on the job as quickly as possible. Health of his armed forces is always of primary concern to the Cardinal. The forces of the Dark Soul don't take a break while a squadron of Sacred Warriors recuperates from their wounds, and so they are needed back at their posts immediately, if not sooner.

THE ARMORY

The Armory is another place frequently visited by player characters. It's here that you can get equipped with everything you need to complete your next assignment. Of course, once you're done, the borrowed objects must be returned, but that's no reason to worry. They'll be there again when you need them later.

The Armory contains a vast assortment of personal and squad level weaponry and in quantities enough to arm the entire Brotherhood against the legions of Darkness—from the lowest Missionary to the Cardinal himself—if need be. Of course, the material that you can get from the Armory is limited entirely by your profession and your rank. See the Equipment section for specifics on what articles are allotted to each type of occupation.

Only members of the Brotherhood are allowed within the Armory's hall. All others are detained outside by members of the Fury Elite Guard, soldiers hand-picked for their position by the Cardinal himself. Each of these guards is proficient in the use of the art of Changeling, particularly in the Empathy spell. Any suspicious-looking characters will be scanned by a Fury before being allowed to enter the Armory. Those who do not pass the test are executed on the spot.

The most of the Armory that the vast majority of characters will regularly see consists of the front desk and a fitting room or two. If you're not sure what you need, and you have the pull to actually be able to have a choice in the matter, you'll be led to a showroom in which each item stored in the Armory is on display with a card featuring pertinent information about that object.

The vast main storeroom is not open to the public, not even to most members of the Brotherhood. Upon occasion, the Cardinal opens it up for limited public viewing. The tremendous amount of firepower at the Brotherhood's control (and this doesn't even include the material already in the field) is enough to convince most people that the Cardinal's brethren are humanity's best hope in the war against Darkness.

THE STONE ARCHIVES

From the outside, the Stone Archives building doesn't look like much. It's only forty stories high—not much when you consider it stands in the shadow of the Cathedral proper, a building more than five times as tall—and there's nary a window to be seen. But once inside, you find that its subterranean levels sink as equally far into the ground as the rest of the building juts into the sky.

This is the repository of all the Brotherhood's recorded knowledge—its library. Its walls enclose just about every bit of anything published or broadcast by humanity since even before the foundation of the Brotherhood itself. The collection goes almost back to the beginning of the written word.

Looking for children's books, videotapes, copies of speeches, constitutions of long-dead governments, restaurant place mats, first editions of the Daily Chronicle or just about anything else? It's all here. To access it, all you have to do is be able to understand the complex system of indexing and cross-referencing the Brothers of the Cell of Archives have developed to ease access to the wealth of material that surrounds them.

The system relies heavily on use of antique metal punch cards and a computer system run almost entirely by steam. The rooms that contain the computer fill several floors in the lowest part of the basement. The only way to find your way around this system is to ask one of the clerical Brothers for help. It's almost impossible to find anything without some sort of aid. Asking for certain things loudly will almost certainly draw attention, but most Archivists can be trusted to maintain complete confidentiality. Under no circumstances are any materials allowed to be removed from the archives. It can be arranged for a Scribe to make a copy for a Brother, but this will take time, from hours to weeks depending upon the amount of material, the urgency of its need and the pull of the person doing the asking.

THE SCRIPTORIUM

The Scriptorium is in the levels of the Cathedral just below the surface. At some key points, the Scriptorium actually links up through underground passages with its sister organization in the Stone Archives next door. Many of the things created by the Scribes go directly to the Archives, and when a copy of something in the Archives needs to be made, it goes directly to the Scriptorium.

The Scriptorium is nothing more than a series of large halls in which thousands of Brothers transcribe manuscripts by candlelight for their Brothers who need them. Fully half of the Scriptorium's efforts go toward creating new copies of the Book of Law for new members of the Brotherhood and to replace others lost or damaged. The rest of the Scribes' time is spent copying things from the Archives and making copies of other sacred or critical documents that the Cardinal or one of his higher-ranking brothers don't feel comfortable duplicating by other more technological means due to the constant threat of the invasion of Dark Symmetry.

The halls are long and wide and carved out of Luna's stone. Scribes scratch away at their work, each seated at his or her own workbench made of rough-hewn wood. Candles are the only illumination allowed, and young apprentices constantly walk the aisles, replacing spent candles as they go. Usually only one shift works each day, but in times of great need, second and third shifts have been added until there are scribes working around the clock.

THE CHRONICLES BUILDING

This modest, black stone, thirty-story high building houses the Cell of the Chronicles which includes the Missionaries that control a large percentage of Luna's media. From these offices, the Daily Chronicles—the most popular newspaper of all time—is published, and the broadcasts of the Cardinal's masses are produced for both radio and television. Additionally, the Brothers that monitor and approve all broadcasted or printed material before it is sent out maintain their offices here.

The Cardinal-sponsored hourly news updates broadcast on all major television channels and radio



across the room to return to the thing's hand.

Then Samuels remembered the creature from his apprenticeship training. He had heard many rumors of these things but never actually seen one. Most people unfortunate enough to have the experience didn't survive it. A Callistonian intruder—damn.

It was going to be a long day.





WHO WATCHES THE WATCHERS?

Michelle Winston had always enjoyed her job. A secret Observer assigned to infiltrate Cybertronic's HQ in Heimburg—how cushy could you get? Cybertronic employees were cleaner than her brethren, if that was possible. And even if they were up to something sneaky, as scuttlebutt had it, they certainly wouldn't be silly enough to be working on it in their headquarters, especially not in front of someone with as low a security clearance as hers.

At least that's what she had always thought. Now, she wasn't so sure.

She had learned something. As an Observer, that was the definition of her job, but this was something Cybertronic had definitely not wanted her to see. She had been working in the Cybertronic building late one night, as her job as a janitor dictated, when she had wandered by the office of Keith Wilshire, the office's top executive.

She had heard a voice inside and recognized it as Wilshire's. He was engaged in a heated conversation with someone he referred to as "Mr. Executive" and "Mr. Mannerheim" alternatively. Apparently, Wilshire had discovered someone in the local Bauhaus HQ, a junior

frequencies are made from here. The building is home to hundreds of reporters whose beats span the entire system. Not all of the information these people collect makes its way into the public's hands—it all gets absorbed and filtered by the Cardinal's people before it's released for public consumption. The rest of it goes directly to the Inquisition, which makes vital use of any sensitive intelligence.

Reporters here are often glad to discuss anything they might know about with members of the Mystics or the Inquisition. They're happy to know that their work could be of some direct help to the Cardinal's work. Some of the more experienced ones have become jaded, of course, and won't be too willing to waste their time on someone of lesser rank. In the end, all these sorts of reporters need is a little talking to. Threats work, but flattery is more efficient, particularly if you want to use that reporter as a resource in the future.

THE CARDINAL'S BANK

The Cathedral on Luna is also home to the largest, most powerful bank in the entire realm of humanity. The saying "I'd swear on a Cardinal" didn't just pop out of mid-air. It came about because the Cardinal's Crown is the most stable and universally accepted currency around. This is due almost entirely to the efforts of the Brothers that run the Cardinal's Bank.

The Bank itself occupies several dozen floors in one wing of the Cathedral. It's a large, impersonal place, designed more to handle funds for megacorporations than to deal with the average citizen, although it does that, too. As with most banks, personal service is lousy unless you've got a Social Standing of at least 7. Even then, things keep getting better and better as your Social Standing goes up.

With a Social Standing of 6 or less, chances are you'll have to stand in line for up to two or three hours, and



then you might simply be put into another line. Exceptions are made for Inquisitors and Mystics, as well as anyone else on urgent Cardinal's business, but even then the lines can be long.

As the most powerful bank in the system, the Cardinal's Bank can actually affect the rise and fall of the megacorporations. This is yet another lever that the Cardinal can use to bring stray lambs into his flock, as the Bank is less likely to loan money to someone who doesn't follow the Cardinal than someone who does. Accordingly, Cybertronic hasn't gotten a dime directly out of the Cardinal's Bank, although several of their holding companies—whose ownership is maintained secretly through several dummy corporations—have.

When the Cardinal's Bank calls in a bad debt, it has the power to send forces from the Second Directorate out to collect. Many battles have been fought over an interest point here or a monthly payment there. The Bank is run like most other businesses, though. Military actions are not to be taken unless the potential profit of doing so outweighs the costs. Even then, the Cardinal would like to have a moral leg to stand on. The Bank doesn't go around acquiring assets it has no rights to. It simply enforces its agreements with its borrowers.

THE CATHEDRALS AND THE CHRONICLES

Here's a quick look at each of the Cathedrals and the Chronicles engraved within their walls. The Cathedral on Luna is described in full above. Most of the other Cathedrals will follow it in content, if not exactly in form, although each of them will, of course, do so on a relatively smaller scale. They are listed in order of their founding, from the oldest to the most recent.

THE CATHEDRAL ON LUNA

This Cathedral was the first to be built, and it is the largest of them all. In fact, it is the largest building in the entire solar system. It was founded long ago by Cardinal Nathaniel Durand.

On its walls are inscribed the First Chronicle: *The Arrival of the Darkness and the Call of the Cardinal* by Alexander Horatio. This Chronicle tells of the founding of the Brotherhood by the first Cardinal and of the rise of the first four megacorporations. It also relates the tale of the discovery of Nero, the tenth planet, and the awakening of the Dark Soul that rose to threaten humanity. It tells of the Cardinal's call to all humanity to join the Brotherhood and his plans to rescue us all.

THE HEIMBURG CATHEDRAL

The fourth largest Cathedral, this vast complex was built mostly through donation of the faithful at Bauhaus, as well as through generous contributions from the megacorporation itself. As the first four Cardinals came from Bauhaus, it seemed only fitting that they build for the Brotherhood one of its finest houses. The Heimburg Cathedral is universally acknowledged to be one of the most luxurious, yet awe-inspiring edifices ever to be built. Whereas the San Dorado Cathedral focuses solely upon efficiency and functionality, the one in Heimburg exudes an atmosphere of only the highest, no-expense-spared quality. Only the Cathedral on Luna stands above it.

The Second Chronicle: *Ilian and the Dark Symmetry* by Plinius Varro appears on its walls. It tells all about the coming of the first of the Dark Soul's Apostles: Ilian, the Mistress of the Void. Ilian is the most powerful of the Great Darkness's children, and it was she who introduced the powers of Dark Symmetry into our lives. The tale also describes her Nephartes and her Templars, as well as those known as the Children of Ilian.

CARDINAL DURAND'S TOMB

The Cardinal's Tomb is at the entrance to the Cathedral at the top of the Brotherhood logo. It is one of the most popular tourist attractions on the planet, and on weekends, lines to get in to see it are often three or more hours long.

A gargantuan statue of the late first Cardinal stands in the middle of the long, wide steps up to the entranceway. Inside is a museum of the Brotherhood and the many Cardinals who served it. Wrapped in the origins of the Brotherhood itself, Cardinal Durand I has an entire wing of the museum all to himself.

At the front of this wing lies a gigantic tomb with a figure, carved in white marble atop its lid, of the Cardinal lying in state. Like all of his brethren, the Cardinal's body was supposedly cremated upon his death, and ashes—not his body—rest within the tomb.

The museum is truly inspirational. Many Brothers visit it regularly, and it's a good place to spot important people on weekend afternoons. Sometimes the place is even graced with a visit from members of the Curia and—more rarely—from Cardinal Durand XVII himself.

THE LONGSHORE CATHEDRAL

This monumental complex is situated in the center of the crater which contains all of Longshore. One of the few buildings taller than the crater is deep, it towers several stories over the next highest building. Shaped out of steel covered with brilliant white adobe, the fifth largest Cathedral's brilliant white spires jut out over ground level so that from a distance they look like needles standing in the clay bowl of Longshore.

The Third Chronicle: *The Corporate Wars* by Valerius Catullus is engraved on the Heimburg Cathedral's walls. It tells of the fall of the human race and how the forces of Darkness, led by the Dark Apostle Ilian, forever corrupted not only the minds of humankind, but also the very soil and oceans of the planet from whence humanity sprung. It is a common teaching that the Corporate wars were the first results of the Dark Legion's influence, hence the name of the Chronicle.

This Cathedral was financed, soon after the awakening of the evil, through the good nature of the Mishima megacorporation. Relations between Mishima and the Brotherhood have cooled off dramatically in the past few years, due mostly to the Brotherhood's support of Imperial in its usurpation of Mishima's city of the future: Fukido.

THE SAN DORADO CATHEDRAL

The third largest Cathedral, this was the fourth to be built. It stabs out of the San Doradan skyline like a broken bone sticking out of a dinosaur's back. It was built through the generosity of the Capitol corporation and the numerous followers the Brotherhood counts within that megacorporation's ranks.

Its few solid stone walls are adorned with the Fourth Chronicle: *The Arrival of Semai and Muawijhe* by Lapidus Asolvos. It tells about the coming of the next two Dark Apostles: Semai, the Lord of Spite, and Muawijhe, the Demon of Screaming Insanity. It also describes the unique horrors that entered our reality with these Dark ones: the Zenithian Soulslayers, the Screaming Legionnaires, the Callistonian Intruders and the Heretic Legionnaires.



associate, who had some sort of link to Cardinal Durand—Durand the First!

She couldn't believe her ears, so she stopped and listened more closely. It seemed that Mr. Wilshire was convinced that this man had to be captured and made to talk about his hidden past. The 19th Executive did not seem to concur, but he apparently agreed to allow Wilshire to go ahead with his plan, as Wilshire's tone of voice turned gradually from desperate to convivial.

Just as Winston felt the conversation was ending, she heard a noise behind her. She turned and saw that it was a Cybertronic security guard clearing his throat. She tried to use the Art of Manipulation on him.

"You don't need to bother me," she told him, a strange timbre to her voice. "I'm just cleaning up here. That's my job."

A glazed look came over the guard's eyes. "That's your job," he repeated.

"You can run along now," she continued motioning off behind him.

"I'll just run along now," he said. Then he turned and left.

Winston blew out a deep breath. She almost couldn't believe it had worked. She couldn't depend on her little trick lasting for long, though. Cybertronic had safeguards against such things, like the miniature



THE BURROUGHS CATHEDRAL

A smaller Cathedral, the one in Burroughs marked the first time that two Cathedrals occupied the same planet, Mars. At the time of the Cathedral's founding, Burroughs was a relatively small city, but since then it has grown by leaps and bounds. The site was originally chosen as a launching-off site for attacks against Citadels located in that hemisphere of the planet. In recent years, Burroughs has become a city with an identity all its own.

The Fifth Chronicle: *Algeroth and Demogognis* by Horka Mikhalos lines the walls of this red brick Cathedral. It relates all concerning the arrival of the final two demon lords: Algeroth, the Demon Lord of Dark Technology, and Demogognis, the Befouler. It describes the Necromutants, the Centurions, the Razides, the Curators and the Ezoghous amongst others. Initially written in the time of Cardinal Augustus, it also tells all about the founding of the Second Directorate and the beginning of the Inquisition.

THE VOLKSBURG CATHEDRAL

Like the one in Burroughs, the Volksburg Cathedral was originally meant as an outpost from which to launch attacks against the Dark Apostles' citadels on the other side of Venus from Heimbürg, the main settlement. The Cathedral is the only truly large building in all of Volksburg, and the view from the top is a spectacular one. Nothing but jungle surrounds Volksburg for miles around, although the jungles are filled with all sorts of traps, sentries and alarms to alert the populace of any impending Dark Legion attack.

Volksburg is a city on the edge of chaos, and this is reflected in the construction of the Cathedral which looks more like a fortress than any of the others. Appearances, in this case, are not deceiving. The Cathedral is built to withstand direct attacks from the Dark Legions, and in times of trouble, the entire populace can find shelter within its walls.

Written on these walls is the Sixth Chronicle: *The Crusades and the Inquisition* by Galileo Achrostidies. This relates the history of the Brotherhood in its attempts to eradicate the heretics that had infiltrated humanity, a time known as the Great Purge. It was during this period that large amounts of time and effort were spent in researching the Art and defining the original three aspects (Kinetics, Changeling and Premonition).

THE GIBSON CATHEDRAL

The smallest of the Cathedrals, this is the only one that could possibly be seen as a failure. Like the ones in Burroughs and Volksburg, this Cathedral was built mainly as a battle station. And like all Cathedrals, it depended on the local populace for support. Unfortunately, soon after the founding of this Cathedral, the Cybertronic corporation came on the scene.

Cybertronic slowly but surely took over most of Gibson, with many of the Bauhaus people who had been such staunch supporters of the Brotherhood defecting over to the new kids on the block. These same people now did not care a bit about the Brotherhood, and so the Cathedral's halls grew empty. A staff composed mostly of soldiers and their

support crews still occupies the Cathedral. A skeleton crew handles the rest. If not for the fact that the Cathedral is there, the Brotherhood would probably have abandoned the city altogether. As it is, they hang on for honor's sake.

The Seventh Chronicle: *The Venusian Fury* by Pius the Elder adorns this building's walls. It concerns the Dark Legion's assault on Venus and Imperial's and the Brotherhood's counterstrikes. A smaller section also describes the further work that was done on the Art and the four additional aspects (Exorcism, Elements, Manipulation and Mentalism) that were developed. It also details the triumphant invention of the power stabilizer, a great force for good.

THE FUKIDO CATHEDRAL

The newest of the Cathedrals, this is also one of the most magnificent. Second in size only to the Cathedral on Luna, this wondrous melange of Imperial and Mishiman influences was built almost entirely through contributions of Imperial in exchange for the Brotherhood's support for their acquisition of most of Fukido. The Cardinal didn't see how he could lose. While Imperial's lease is only for a hundred years, the Cathedral will be there long after that.

It seems that Imperial learned from the mistakes Mishima had made in helping construct the Cathedral in Longshore. This Cathedral is tasteful, yet spacious. Less attention was paid to efficiency, as there was room in Fukido to spare. As a result, the Cathedral has a much more comfortable feel to it. It is said that the Cardinal was immeasurably pleased by the way it developed. He is seen here more often than at any other Cathedral, with the exception, of course, of the Cathedral at Luna.

The Eighth Chronicle: *The Megacorporations and the Cartel* by Lucretii Marcellianus is carved on this Cathedral's walls. It tells the story of the individual rise of each of the corporations, including the Cybertronic unbelievers. Additionally, it tells of the formation of the Cartel and the role that the Brotherhood plays in its operation.

THE CARTEL OFFICES

The Brotherhood has offices all over the solar system, mostly for recruitment of new followers and emergency aid for existing ones. The only major offices, other than those attached to the Cathedrals, that the Brotherhood has are located in the Cartel building.

Although the Brotherhood had no official voice in the Cartel, its influence is recognized by the fact that it has a non-voting seat on the Cartel's board. Another mark of its power is the fact that the Brotherhood's offices are on the floors closest to the top of the building, right under those of the Cartel itself.

Due to the sensitive nature of the political workings within the Cartel, all Brotherhood Observers who work therein are required to wear cowls at all times to keep their features hidden. The Cardinal feels that this help to contribute to the notion that the members of the Cartel are not dealing with individuals and their own hopes and aspirations, but directly with the will of the Cardinal himself. So far, it seems to have worked.

security camera imbedded in his badge. She couldn't fool the people monitoring the cameras. She had to get out of there now!

She ran to the elevators and pushed the button. It came, but it took so long, she was afraid the guard would catch her before she could get on. She jumped inside of it and ordered it to take her to the ground floor.

As soon as the elevator started moving, she reached up and shattered the security camera. Then she climbed up on the railing around the middle of the walls and opened the hatch in the car's ceiling. Just as she cleared the top of the car, it stopped.

She was far above the



THE FOUR DIRECTORATES

The Brotherhood is divided into four main categories known as directorates. Each member of the brethren—with the exception of the Cardinal and the Curia who are above it all—falls under the purview of one of these four directorates as dictated by his or her profession. Although the areas of responsibility for each directorate are well-defined, members of different directorates often work in concert toward a common goal. They are, after all is said and done, all members of the same organization: the Brotherhood.

Political infighting is the exception rather than the rule

in the Brotherhood, and so the directorates usually manage to cooperate with each other quite easily. Only at the higher levels do politics mean anything, and even then, the Brothers would never do anything that could ever hurt the Brotherhood as a whole.

Each Directorate is divided up into cells, and these are further divided up into sub-cells. This structure provides the Brotherhood with a strict chain of command. Above each of the directorates lies the Curia and, beyond them, only the Cardinal, to whom each member of the Brotherhood is ultimately responsible.

THE MYSTICS

The First Directorate is easily the most powerful. It consists entirely of the Mystics, men and women that have dedicated their lives to the study and use of the Art in order to further the Cardinal's ends. Because of the fact that they alone are able to command all aspects of the magical powers of the Art, Mystics are easily the most personally powerful people in all of humanity.

This directorate is divided up into four cells, each of which is divided into two sub-cells. This gives the Mystics an easy-to-follow chain of command and helps to make sure everyone knows who's in charge of who. Individuals are often placed on loan from their own sub-cells to other sub-cells or even other directorates. Sometimes Mystics may even find themselves working for one of the megacorporations. There is no doubt about where these people's loyalties lie, though. For them, the Cardinal calls all the shots.

Mystics come in one of four flavors: Distorters, Changellors, Seers and Keepers of the Art.

Distorters use the Art to manipulate reality and people's perceptions of it. They usually concentrate on the Arts of Kinetics, Exorcism, Elements and Mentalism. This allows them to heal people, create illusions, attack others and warp the elements to their wills.

There are two types of Distorters, too. The Healer's forte is that of Exorcism. Warriors make full use of all of the other Distorter Arts. These types of Mystics are the ones most often seen on the battlefield or working alongside their brethren in the Second Directorate. Additionally, many Healers do stints in the Sanatoriums of their Cathedrals to hone their skills in preparation for the days of war ahead when such



ground floor. The monitors must have sounded the alarm. The car started to move upward at an alarming speed. Looking around for a way to escape, Winston saw her only way out. She gauged the distance from her car to the cables of the next, took a deep breath and leaped.

She managed to grab onto the cable, but it was slippery, and she began sliding downward fast—too fast.

She desperately clung to it with her hands and arms and wrapped her legs around it. Eventually, she began to slow.

The grease on the cable prevented the friction from becoming too much, but she knew she was going to have some beautiful blisters when this was all over. She let herself down as slowly as she could, and within minutes she reached the ground floor.

She stood on top of the elevator car to which her cable was attached and drew the Piranha from its hiding place within her now-filthy powder blue jumpsuit. Cautiously, she raised the hatch back and peered inside.

No one was in the car and the doors were open. She cocked

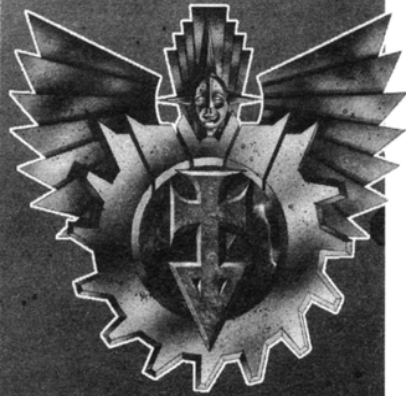

her pistol and leapt down inside.

Like most places Cybertronic had been engineered to keep people out, not in. There were only two guards in the lobby. One of them had his gun drawn, and the other was managing the communications station by the front doors, probably calling for assistance.

When Winston saw the man with the gun, she immediately fired. She'd never killed a person before, but for a first-timer, she did a damn good job. The bullet crashed into the man's chest and sent him sprawling across the lobby floor.

The gun's report drew the attention of the other guard who drew his weapon as well. Before he could bring it over the countertop he was behind, Winston dropped him with a second shot that caught him in the eye.

Thinking the coast was clear, Winston dashed for the unprotected doors. Just as she reached them, a shot rang out from behind and a bullet pierced her right shoulder, knocking her straight through a now-shattered, plate glass door. An alarm started sounding somewhere as she turned to face her attacker.

It was the man she had shot first, a dented steel plate showing where her bullet had torn through his uniform. He was one of those blasted chasseurs!

From her position in the

abilities may mean the difference between the life and death of the Brotherhood itself.

Changellors are devoted to taking advantage of the secrets of the mind. They dedicate themselves to the

the Cell of Diplomats. It's their job to assist these ambassadors and secretaries with their unique skills. Some Liaisons dabble in the Art of Premonition as well, as they find that on-the-spot evaluations of outsiders via



Mentalism, Exorcism and Changeling Arts. They specialize in delving into the minds of both themselves and others.

The two types of Changellors have duties as different as night and day. The Interrogators work deep in the bowels of the Cathedrals questioning particularly stubborn suspects for the Inquisition. Sometimes Inquisitors need to know something right away and have either exhausted their comparatively meager abilities or they simply don't have any time to waste. That's where the Interrogators come in. Few subjects can resist their skillful probing.

Liaison Changellors use their skills to work with the members of the Fourth Directorate that operate under

that Art can prove invaluable in their line of work. Seers work with the previously immutable thing called time. They generally dedicate themselves entirely to the Art of Premonition, which allows them to both look into the future and to research the past.

Seer Prophets gaze into the far and near future in an effort to determine what fate is in store for the Brotherhood and humanity as a whole. Chroniclers perform the same tasks, but work exclusively on the past. In both cases, the farther away from the present day the questing moves, the harder it is to get any sort of results that can be interpreted meaningfully. Apprentices for both fields act as scribes, making transcripts of all

that their teachers see. They also busy themselves with creating complete records of current events to give future Chroniclers something to refer to and check their results against. For this reason, the Prophet apprentices often find themselves working closely with the Cell of Chroniclers from the Third Directorate.

The most powerful users of the Art are made a part of the Cell of Keepers. This cell is entirely composed of Keepers of the Art. The Sub-cell of Researchers features Keepers that have dedicated themselves to further developing new and existing aspects of the Art. It was

this cell that invented the power stabilizer and discovered how the Art is actually broken down into aspects.

The Sub-cell of Engineers includes the Keepers that everyone always hears about. These ultra-powerful men and women work in the field, finding new ways to apply the fruits of their sister cell's findings. Without the Engineers, all of the Researchers' work would be stillborn in the laboratory. As it is, their triumph in the lab is added to the Cardinal's glory in the world.

THE INQUISITION

While the First Directorate may be the most powerful of the four, the Second is definitely the most widely feared. Most people will probably go their entire lives without actually having to personally see a Mystic, much less a Keeper of the Art, but the presence of the Inquisition is all-pervasive. Inquisitors are everywhere, and not just on television dramas. And their reputation precedes them. Even honest citizens cross the street to avoid any thought of complications when they see an Inquisitor walking down the street.

The Inquisition is divided into four cells: Inquisitors, Intelligence, Sacred Warriors and Military. Some of these have their own divisions within their ranks.

The Cell of Inquisitors (the term Inquisitor can be applied strictly to those who work within this cell or loosely to anyone working within the Second Directorate) is the most visible of these four cells, particularly on a daily basis. Most of the people working with the cell are either Inquisitors, Inquisitor Majores or Revisors. Since Revisors work undercover, the Inquisitors are obviously the most visible part of this force, but the Revisors' work is at least as important to the cell's efforts, if not more so. Without the secretive part of their cell, the Inquisitors would never know who to suspect or where to find them. It's the Revisors' job to dig up that kind of dirt and report it to their flashier brethren.

This cell is further divided into Sub-cells of Internal and External Investigations. Internal Investigations checks out threats of the presence of the Dark Soul's influence within the Brotherhood. External Investigations checks out everyone else. Most people have had some sort of experience with External Investigations, but run-ins with the Internal side of the coin are few and far between. The vast majority of Brothers are squeaky clean, dedicated to the Cardinal above all else, but when a Brother goes bad, the damage that can be done is almost immeasurable. For this reason, Internal Investigations is even more active and less forgiving than External, if that's possible. Those who have felt the wrath of Internal Investigations will tell you that—to their great misfortune—it is so.

The Cell of Intelligence is one of the most effective

intelligence agencies in the entire solar systems. These Revisors have one advantage that the others don't—the Art—and they use it to their fullest benefit. Only Revisors work in this cell, with few exceptions. To most Revisors, this is the ultimate assignment for their profession. Anyway, it sure beats working for Internal Investigations. Nobody likes those guys. They make everybody nervous.

When Internal Investigations needs investigating, Intelligence is called in. No one else has the skills, the expertise or the simple organizational machinery in place to even try. These sorts of investigations are of the utmost secrecy and can involve incredible amounts of danger. When a Brother inside of Internal Investigations goes bad, the potential for disaster is staggering, and the Cardinal knows it. Accordingly Internal Investigations and Intelligence are constantly checking each other out, making sure that everyone inside each organization is entirely loyal. Usually, there are no problems, but when there are, you'll see sparks fly.

The Sacred Warriors are so special, they have a cell all to their own. They come under the jurisdiction only of the head of the Inquisition, the Curia and the Cardinal himself. As such, they completely bypass the traditional Military chain of command, which suits them just fine. As the only troops in the system specially trained to stand up to the Dark Legion, these people don't need to waste their time with lesser duties.

The last cell is that of the Military. These are the members of the Brotherhood that charge fearlessly into battle against evil any time it raises its head. Inquisitors from any of the other cells can be called into active service in the Military at almost any time, as can most Mystics, with the notable exception of the Sacred Warriors, who have already formed an army of their own, and any Revisors in deep cover.

The Military is broken into two Sub-cells: the Ground and the Air. The Sub-cell of the Air includes the Archangels, the Brotherhood's only qualified combat pilots. The Sub-cell of the Ground covers everyone else: Inquisitors, Inquisitor Majores, Mystics, Keepers of the Art, Valkyries, Troopers and Elite Troopers.

THE MISSION

The Third Directorate is easily the largest of the four. Entry requirements are low (there are none), and most people can find some sort of work within the directorate that they find challenging and rewarding without being overwhelming. The Mission is split up into three main cells: Artifacts, Mission and Scribes.

There are dozens of sub-cells, but only those most pertinent to game characters are mentioned here.

The Sub-cell of Artifacts is divided into two Sub-cells: Locators and Caretakers. The Cell of Locators concerns itself with research about artifacts aimed at discovering their existence and pinpointing their locations. The



broken glass, Winston fired at the guard three more times, each shot knocking him further back until he finally stumbled and fell. Then Winston got up and started running as fast as her cable-burned legs would carry her. She was outside now—she was free.

Now all she had to do was make it to the Cathedral before she passed out.



actual acquisition of these articles is often turned over to the Cell of Inquisitors or the Cell of Intelligence in the Second Directorate, but occasionally, the Locators opt to handle the recovery of an artifact themselves. This happens with more regularity when the Inquisition is occupied with more pressing matters, like military actions against the Dark Legion.

The Sub-cell of Caretakers deals with the task of identifying and cataloging any artifacts acquired by the Brotherhood. They also determine the relative safety of any item and decide whether or not a particular item will be released into a Brother's individual care so that the artifact may be put to proper use. The Caretakers also hold and contain evil artifacts that are being researched or that are simply too powerful to destroy. Most Cathedral Armories have a special vault especially set aside for artifacts, as it seems that these are the only places with enough security to be able to handle the storage of such devices.

The Cell of Scribes is also split into two Sub-cells. The Sub-cell of Scribes occupies each Cathedral's Scriptorium. Far beneath the public levels of the Cathedral's hallowed halls, men and women work away at transcribing by hand all the documents the Brotherhood requires. Around half of their work is dedicated to making copies of the Book of Law, as no Brother is permitted to go without one (except, of course, Revisors doing undercover work). The Scribes work closely with their brethren in the Archives, as their duties occasionally overlap.

The Sub-cell of Archivists also work in chambers deep beneath Cathedrals or nearby buildings. Their job involves collecting and cataloging every bit of written or published material that the Brotherhood can get their hands on. When copies of something need to be made, the Archivists send the jobs off to the Scribes, confident that the work will be well done and untouched by Dark Symmetry.

The Cell of the Mission is divided into numerous sub-cells. The attitude seems to be that if no one else does it, you can be sure that the Cell of the Mission does. The most visible Sub-cells are those of Chroniclers, Servers, Preachers, Recruiters, Doctors, Armorers and Bankers.

The Sub-cell of the Chroniclers is broken up into two additional units: the Investigators and the Producers. Investigators are the members of the Brotherhood's media that go out and actually find and report on the news. The Producers are the staff that make sure that the Investigators' information makes it to the eyes and ears of the knowledge-hungry public.

The Brotherhood has one of the best media machines around. Their television and radio stations,

combined with the Daily Chronicles, make them the most highly respected news organization humanity has ever seen. Sure, some of their stuff might be a bit whitewashed for the good of humanity, but that's the price you pay for saving the entire race.

The Sub-cell of the Servers covers everyone who works in the service industry. This includes food services, gophers, production assistance, janitors and anyone else who performs the kind of general labor needed to keep a monolithic institution running along.

One of the most visible presences of the Brotherhood is the men and women delivering the Cardinal's word to the people on the street. These devout followers belong to the Cell of Preachers, and it's their job to stand on street corners, in market districts and underground stations and anywhere else people congregate or move through in massive volume. A copy of the Book of Law in hand, these people shout out the Cardinal's message to those who would listen and show the Brotherhood's pervasive power to those who won't.

Another highly visible group of people work in the Brotherhood's recruiting offices. While the Preachers may convince people to join the Brotherhood, it's the Recruiters that help them sign up. Some Recruiters spend most of their time in their offices handling the constant stream of people that always seem to be pouring in. Others actually go out into the field and locate people with the kinds of strengths and abilities the Brotherhood needs. Some people are recruited as young as eight years old, and it's the Recruiters that spot them and bring them into the fold.

The Sub-cell of Doctors has its home in the Sanatoriums located inside of each Cathedral. While they rarely have advanced use of the Art, these men and women use their knowledge of the human body to supplement the work of the Mystics that labor by their side. Some Doctors have offices in clinics where they deal with illnesses or disorders of a less immediate nature.

Each Cathedral's Armory is staffed by members of the Sub-cell of Armorers. These people stock, care for, distribute and, if necessary, customize all sorts of armaments for the rest of the Brotherhood. Without them, the great Brotherhood military would quickly find themselves out of ordnance.

The Sub-cell of Bankers occupies and operates the Cardinal's Bank located in each Cathedral. The main branch of the bank is on Luna, but each Cathedral has a smaller version of their own. These people control the flow of money throughout much of the system. They have great economic power, and they wield it carefully, all for the Cardinal's greater glory and the salvation of humanity.

THE ADMINISTRATION

The Fourth Directorate is the least public part of the Brotherhood, but it is by no means any less important. A massive organization like the Brotherhood requires a great deal of oil to lubricate its gigantic cogs. It's the Administration's job to keep things running smoothly.

There are four Cells in the Administration: Administrators, Observers, Diplomats, Advisors. Each of these has their own distinct place in the Directorate, but through their combined efforts, the wheels of salvation run along that much more smoothly.

The Cell of the Administrators' largest duty is to

handle the security for the numerous important personages within the Brotherhood. They are also responsible for any of the Brotherhood's official guests. The men and women who work in this cell would literally take a bullet for one of their charges. The rest of the cell's duties include investigating potential threats to any of their charges. Because of this, they often work closely with many different members of the Second Directorate, especially Intelligence.

The work of the Cell of the Observers is fairly straightforward. They're simply sent into other

organizations—e.g. the megacorporations, the Cartel, any of the major freelance houses—to watch and make sure that the presence of the Great Darkness is never felt. Observers often wear cowls in addition to their normal clothing when on sensitive assignments. These help those around them to treat them as neutral observers, like human cameras, instead of snooping interlopers. Observers are stationed, overtly and covertly, in almost every area of human endeavor in the system.

The business of the Brotherhood is the salvation of humanity. But you still gotta eat. The Cell of Advisors was founded upon this principle. Advisors handle the Cardinal's goods and money and provide services to other people and organizations. They also act as buyers of goods and services that the Brotherhood is in need of. This is not the most glorious post within the Brotherhood, but somebody's got to make sure that

everyone gets housed and fed. This cell comprises two sub-cells: the Cell of Sellers and the Cell of Buyers.

In contrast, the most glamorous Brotherhood jobs are often within the Cell of Diplomats. These people get sent off to every major organization in the system to act as liaisons between them and the Brotherhood. It's the Diplomats' responsibility to keep relations between their hosts and the Brotherhood as pleasant as possible. While this is not always an easy task, the results can be rewarding. Many people in the Diplomats show some ability with the Art, and many Mystics and Inquisitors are assigned to work with the Diplomats, as their abilities can prove invaluable to a stymied Diplomat.

This cell has two sub-cells: Receivers and Emissaries. Receivers handle the ambassadors sent to the Brotherhood by other organizations, and Emissaries are handed posts stationed within other organizations.

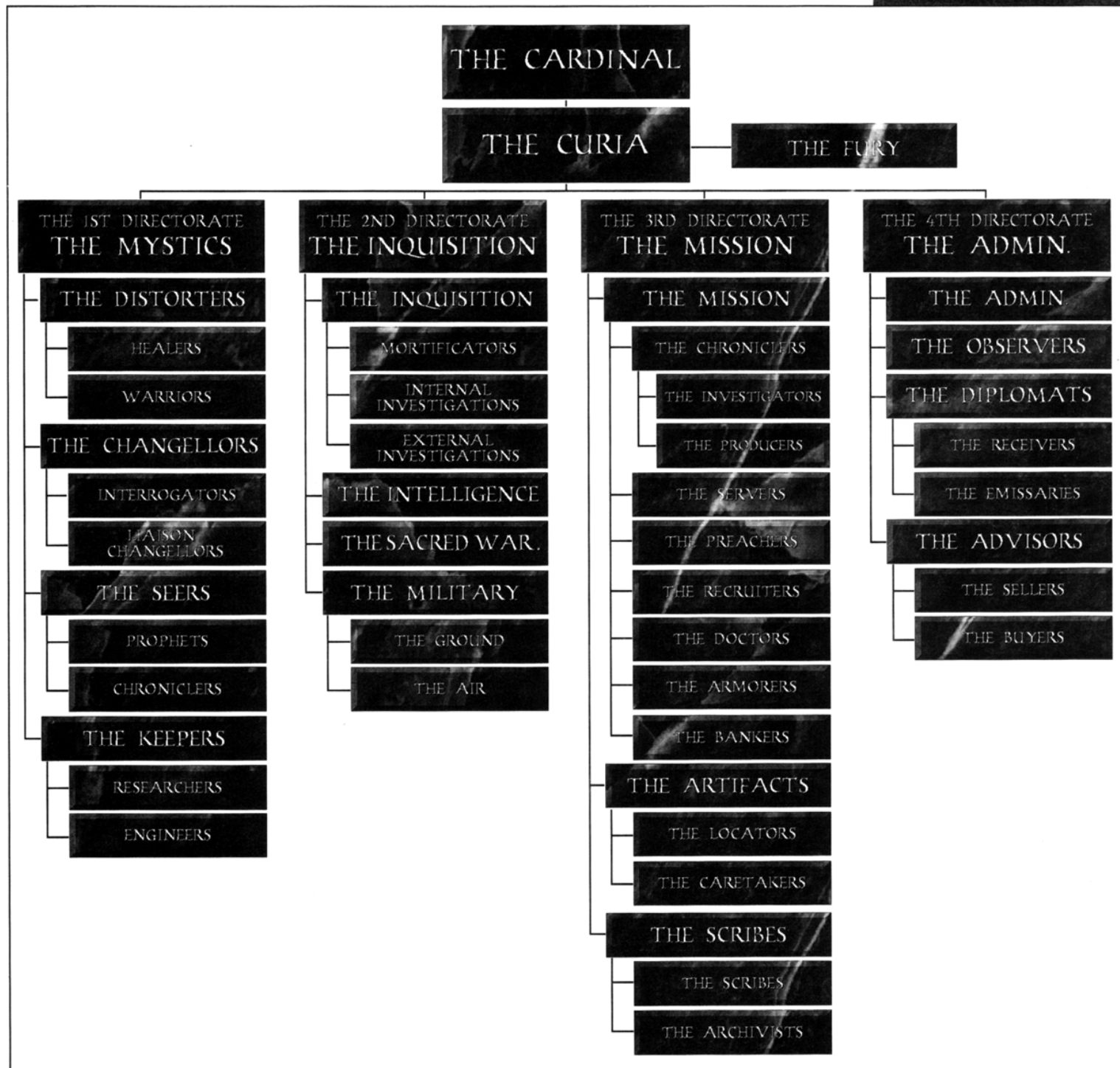



BROTHERHOOD PERSONALITIES

TAKE A SHOT

Cardinal Dominic was not normally a happy man, but today he was in a particularly foul mood. Things on Luna were not getting any better. On the contrary, they seemed to be continually degenerating. And capture and torture as many people as he could, there seemed to be little he could actually do about it.

The Great Darkness was rearing its disgusting head nearly everywhere, and not just in the jungles of Venus or on the rocky surface of Mars. It was all over Luna, out in the Perimeters, in the industries and the ports, even deep the mine shafts and Underground tunnels that riddled Luna's rocky crust. And now, it seemed, its clammy touch was even being felt here within his beloved Brotherhood.

It saddened him to think of these things, but he had no time for sorrow, no moments in which to pause for regrets. He had to keep pushing on, keep trying to make the system a better place for all of humanity, especially the Cardinal's brethren. And right now, he had a mass to celebrate, so he'd better start concentrating on that instead.

The Brotherhood is crammed full of important people, some of which the characters may actually run into. Many will simply influence the factors that affect the characters' lives without them actually ever understanding how

or why. Here are presented a couple of the most important men in the Brotherhood, plus a few other high-powered characters that the characters might encounter in some way in the course of a campaign.

CARDINAL DURAND XVII



Probably the most powerful individual in the known universe, barring only the Dark Soul itself, Cardinal Durand is the leader of the Brotherhood. He is a good man, quiet and thoughtful at times, but always ready for any sort of action. He has gained much wisdom over the years, and his advanced age gives him the kind of perspective that few people could ever hope to match.

Although he is the seventeenth in the line of Cardinals, each of which have taken the last name Durand in honor of the first, Durand the XVII is actually only one of three men who have ever held the position of Cardinal. The first of these men, the original Nathaniel Durand, discovered a seventh spell in the Art of Mentalism, one that youthened the recipient to the age of a young man. Nathaniel realized at once that, as the spell required a complicated and costly ritual as well as over 500 magnitudes to cast, he would need some trusted friends to share this power with.

He brought on his two brothers, Alexander and Peter, and explained his plan to them. Nathaniel had realized that while people might be willing to accept a long-lived Cardinal, if the fact that he had acquired the secret to eternal youth were to ever be revealed, each of the megacorporations would wage a war against the Brotherhood in order to wrest control of the organization of Light and take the power of the spell for their own. The resulting strife would drastically weaken humanity at a point in its history during which it could ill afford it.

The threat of the Dark Soul was too close. Nathaniel decided he couldn't risk the outbreak of open and desperate hostilities within the human race. Humanity needed to focus its energies outward, toward the Darkness that threatened to engulf them all. And so he formulated a plan.

Alexander was already a member of the Curia, and the much younger Peter was an up and coming Mystic in his own right. At a politically advantageous point the future, Nathaniel would fake his own death. There was little doubt that Alexander would be able to succeed to the throne.

During Alexander's tenure, Peter would be appointed to the Curia and groomed to take his place. Meanwhile, the youthened Nathaniel would start his life over again in a brand new identity at Bauhaus and later work his way up the Brotherhood's ranks. When Alexander was ready to retire, his death would be faked, and Peter would step into his boots. Soon thereafter, the young Nathaniel would be appointed to the Curia. They decided to try it, and lo and behold, it worked. No one suspected a thing, or if they did, they were quickly disposed of. The three brothers were ecstatic. Together, they would share the power of the Cardinal's throne throughout eternity.

The three of them had the best interests of humanity in mind, they argued. The Darkness had an immortal leader, and this gave it a terrible amount of continuity to its single-mindedness that no single human leader could have provided—until now. The worlds now had the immortal leader they needed for their own, and no one was the wiser.

Alexander is the Cardinal currently on the throne, and it's his sixth time through. Peter is a Keeper of the Art in the Sub-cell of Engineers, and he's scheduled to be named to the Curia within the year. Nathaniel is a young man at work for Bauhaus again, and he's planning to (re)join the Brotherhood soon after Peter makes the Curia. Each of them has had plastic surgery performed shortly after each youthening to ensure that there's no way someone could recognize them from an old portrait of

themselves in one of their former lives.

Alexander is a larger man than either of his brothers, but he is also the gentlest of the three. Unless in the midst of combat, Alexander is the soul of patient reason. He is an excellent speaker, although he lacks Nathaniel's keen sense of drama and Peter's equally sharp sense of humor. People in his presence often feel like they have been privileged to encounter one of the holiest and most good-natured men alive.

The only thing that gets Alexander's dander up is the mention of the Dark Legion. He truly cares about the future of humanity, and his greatest concern is the army of the Great Darkness. Battling it has been the work of several lifetimes for him, and it's the only thing that really keeps him going on. Otherwise, he probably would have let one of his lives run its natural course long ago.

Nathaniel has a stronger sense of purpose, and Peter has a greater zest for life, but Alexander's wisdom is paralleled by none. His greatest contribution to the Cardinalship in particular and the Brotherhood in general is his even-handedness and his calm, confident leadership.

Before Nathaniel discovered the youthening spell, Alexander and his brothers were sure that the complete and total corruption of humanity was only a matter of time. Now that they have time in their grasp, it seems there is a light at the end of the tunnel. It's still just so far away.

CARDINAL DOMINIC

Cardinal Dominic is the Cardinal of the Cathedral on Luna and therefore the Brotherhood's second in command. He is a member of the Curia, and hopes to one day become the Cardinal himself. He has no idea that he doesn't have a chance, so he holds out some hope.

Known as the Sheriff of Luna, Dominic is an old man made infamous by his penchant for torture. There is nothing he likes better than to while away the hours not occupied by the duties of his office by interrogating some truly stubborn young heretic. Dominic will stop at nothing to obtain the answers he desires. No form of maiming or mutilation is too grotesque for this man—in fact, the more pain he can cause, the better.

Dominic managed to rise to his current position through nothing more than ruthless efficiency. No matter what the task, he always gets the job done, no matter what the cost. His tactics have met with disapproval by many, but as he always growls to any who question his judgment, there's a war on. In his opinion, the Brotherhood can't afford to be nice—

there simply isn't enough time. Besides, you don't think the Legions of Darkness ever gave a human a second chance, do you?

He was appointed to the Cardinalship of Luna by Nathaniel in his last term in office. Alexander deeply regrets his brother's choice, but Nathaniel always was much more of a bottom line kind of guy than he. Results are what counts, he would say, while Alexander is of the opinion that how the results are achieved is at least as important as getting them. The first time Dominic slips up, Alexander is going to have him removed. So far, though, he's been flawless, at least as far as Alexander can see.

Dominic's demeanor is that of a bitter old man, for that's what he is. He is cold and heartless, and the only time a gleam of life leaps into his eye is when he's presented with the opportunity to inflict cruelties upon others. He has a short temper which often snaps quickly and loudly. He expects nothing but total subservience from those around him, and he always gets it or an unpleasant example is made.



The mass went well for the most part. It was the same standard fare that Dominic had heard and performed day after day, but it never failed to inspire him, to uplift his sagging spirits. They had come to his favorite part now. He stepped up to the pulpit and cleared his throat in preparation giving his sermon.

"Brothers and sisters," he began as he always did, "we are gathered here today to celebrate our unity of purpose under the guidance of the greatest leader of our time: Cardinal Nathaniel Durand the Seventeenth." From there, Dominic segued into his standard spiel about how the forces of Darkness were everywhere and all of humanity must be on guard against them at all times.

Suddenly, just as he was getting to the best part, he heard someone coming up from behind him. He turned and saw one of his Administrators racing towards him, screaming something he couldn't understand. He turned back to face the collected brethren, and up in a far corner of the great chamber, he saw a flash of light glint off of something shiny. Just as he was trying to figure out what it was, the Administrator tackled him from behind, cleanly bringing him to the ground.

Just before his head hit the marble floor, Dominic heard a shot go off somewhere in the direction from which he had seen the glint. Then his



MARIA "NIRVANA" GARCIA

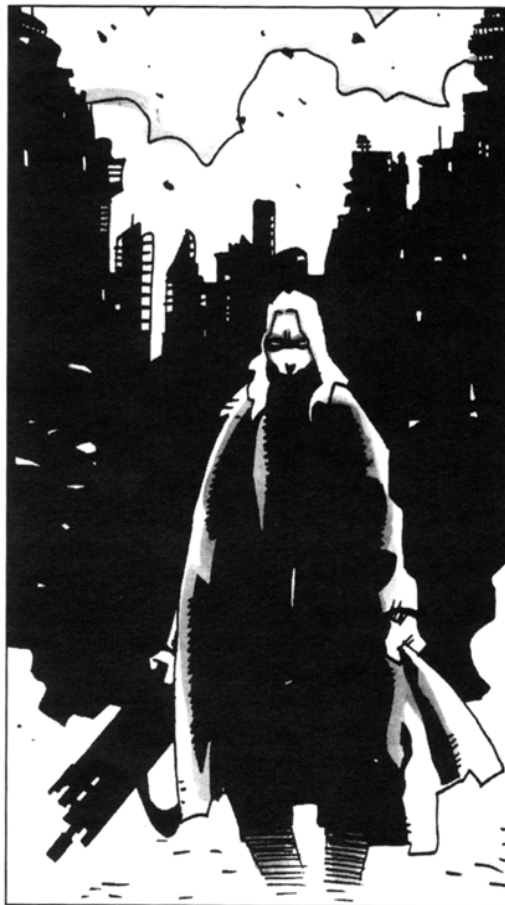

Although the Sacred Warriors eschew titles, Nirvana Garcia is acknowledged by all to be their "leader." Nirvana started out in the Brotherhood as a young child, orphaned when both her parents were killed in a battle with the Legions of Muawijhe. Nirvana has sworn to exact personal vengeance upon the Dark Apostle, and she has worked all her life to put herself into a position from which she can take it.

As a beautiful young lady, Nirvana found it hard to be accepted amongst the Sacred Warriors when she began her apprenticeship. She suffered teasing and was the butt of many pranks in the beginning. Within her first year, she maimed an older apprentice that had been molesting her. The jokes stopped immediately thereafter.

Nirvana is a harsh taskmaster and a brilliant strategist. She trains the people under her mercilessly, believing that the only way to prevent disaster is to prepare for it. On the battlefield, she is matchless in her use of innovative tactics. Many Dark foes have cackled with glee at having cornered her and her forces only to find the tables quickly turned upon them with the hunters becoming the hunted.

Nirvana is a woman of few words. When she talks, she expects to be listened to. She does not enjoy punishing those who disobey her or show her disrespect, but she will not hesitate to do so. She is a woman with little mercy. No one remembers ever having seen her smile.

She has been offered membership in the Curia dozens of times but has refused the honor in favor of remaining in the position where she feels she can do the most good—on the battlefield. A few of the Sacred Warriors below her have

accepted similar offers, and so despite the fact she had refused to assume the mantle of a Curate herself, Nirvana does have some influence in the Curia.

She has, upon occasions of great import, participated in the Curia's meetings in order to offer them her incisive assessments of how the war against the Darkness is faring. The Cardinal himself has taken notice of her and values her advice above most others, a fact of which she is aware and truly proud.

CHANG DANG-VU

A member of the Curia, Dang-Vu is one of the most powerful Keepers of the Art ever known. He is a short, thin, elderly Asian gentleman whom, if it were not for the stately robes of his office, few would take notice of, much less suspect he is a being of such tremendous power. He is the father of several and the grandfather of dozens. A loving patriarch, he dedicates his work for the Cardinal to his family, the members of which have supported him strongly throughout the years.

Dang-Vu has a gentle way about himself. He is entirely in tune with the world around him. He views the Great Darkness as a blight, a cancerous growth within the beautiful order that is our universe. He sees it as his greatest duty to root out this cancer and heal the great emptiness it has created in our reality. He does this for all of humanity, but especially for his progeny.

This masterful Keeper has mastered each of the Arts with the exception of Kinetics. He is especially fond of the aspect of the Elements, and much of his abilities are concentrated on the mastery of its spells. It's all part of his oneness with the world about him.

Dang-Vu is patient and forgiving to those

underneath him—which is just about everybody. He is an extremely wise and serene man who feels strongly his duty to pass on his learning and philosophy to those who will come after him. He often spins parables when trying to make a point, and he is liberal with his use of metaphors and similes in his regular speech. Most people who meet him come away from the encounter feeling refreshed and inspired, their faith in the Brotherhood renewed and made mightier than ever.

Dang-Vu is a great opponent of Cardinal Dominic, who he views as a man ever in danger of tumbling headlong into the Darkness. Such a man should not be allowed so much power, he feels, and he worries of the things that this man's potency permits him to do. Dominic is aware of the Curate's disapproval, but to him Dang-Vu is just one of the many in the Brotherhood who simply don't have the stomach to fight the Dark Soul with the ferocity and tenacity it demands.

Someday, Dang-Vu will inevitably be offered a Cardinalship, but he will probably turn it down. Research into the Art is his life, and although he is aware of the political games that Cardinals have to

skull connected with the stone, and for a moment, he lost consciousness.

When he awoke a moment later, his head hurt badly and he realized he was covered in blood. It wasn't until he shrugged the Administrator's body off his back that he realized that very little of the fluid was his own. The young man had taken the shot meant for him, a shot that would have no doubt ended his charmed existence.

Then he was surrounded by more Administrators. One of them, Johnson, their commander, said, "Please stay still, sir. There's an Exorcist on the way."

Dominic ignored him and struggled to his feet. "Don't be absurd," he grumbled. "I'm fine, thanks to this valorous young man." He shot a look at the commander. "And little thanks to you."

He looked at the crowd of men now encircling him. "Have they got the assassin?" he asked.

"Yes," said Johnson. "He's already in our custody."

"He's alive?" Dominic asked, surprised. Johnson nodded. "Good." The Cardinal of Luna cracked a mirthless smile. "I'll be wanting to question that one personally."

"I'll make the arrangements, sir," Johnson assured him.

"See that you do," Dominic nodded. "Now, kindly have your people step aside. It's important that the congregation see that I am all right."

play, and even from time to time becomes involved in them himself, he has little or no desire to become entirely enmeshed in them. He knows where his talents lie, and they would be better utilized elsewhere.

Still, he cares about the Curia and the Cardinal's

progress, and so he works the political games as an outsider, one who has no personal interest in the players of the game. He cares only about ensuring that the Brotherhood is on the winning side in the war that overshadows all.

SEBASTIAN CRENSHAW

The name Crenshaw is legendary amongst assassins everywhere. No other Mortificator in the history of the Brotherhood has racked up more confirmed kills against so many important targets. The legends say that Crenshaw has never failed—at least when working on his own. The legends are right.

Now in his late fifties, Crenshaw is the picture of a noble gentleman. Originally, he hailed from the Imperial clan of Crenshaw, but he has long since been disowned by his family, which regards him as their black sheep. His early breeding still shows, though. He speaks with a crisp, stilted accent harking back to the times of knights and castles, and his mannerisms are as sharp and refined as his philosophy and his mind.

He is a great hit at official parties and celebrations. Always the charmer, he can discuss just about any topic with anyone and more often than not come out on top. He never loses an argument, as he refuses to be drawn into any situation from which he cannot at least force a stalemate.

His mustache and full head of hair are a brilliant white, as are his bushy eyebrows which stand out over his sparkling, pale blue eyes. The beginnings of a smile almost constantly play around the corners of his lips, and he always has something ready and witty to say.

In the field, of course, he is a different man. When Crenshaw dons his Mortificator uniform, he suddenly becomes all business. There is little honor in assassinating a person, he knows, but it's a job that must be done, and as he has the stomach and, apparently, a fair amount of talent for it, he does it.

He rarely if ever discusses his work, and when he does, he uses only simple, straightforward words to describe what he has accomplished. He considers himself to be a valuable servant of the Cardinal, which is what he is. He often reports directly to the Cardinal himself, and never to anyone of lower rank than the Curia.

Due to his position, Crenshaw is occasionally asked to work with younger Mortificators to kind of show them the ropes. Nothing frustrates him more than thoughtlessness and incompetence. He is mercilessly frank in his evaluations of those who work under him and never hesitates to express his opinions. He knows that younger Mortificators will learn quickly, and they had better, for a Mortificator who learns slowly is often a dead Mortificator.

He is perfectly willing to let his students make their own mistakes, up until the point that they're jeopardizing his life, their own or the mission. Then

he slams on the brakes and wrests control, griping all the while about being forced to work with such rank amateurs.

Once someone makes a mistake, he is not likely to let them forget it. He is not a complete ogre, however. He respects and admires competency and knows the importance of a person struggling to give his or her best. He will go to bat for his people, refusing to let them be made scapegoats in a scandal. He has offered himself up to shoulder



the blame in the place of many younger Mortificators when a job has been bungled. So far, no one has ever dared to take him up on it.

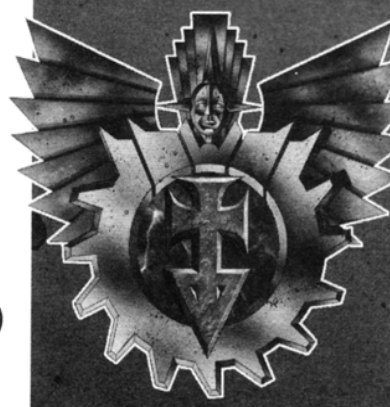

Before they complied, Johnson removed his ceremonial robe and handed it to Dominic. "Better clean yourself up with this first, sir. You're quite a sight."

Dominic smiled. "All the better, don't you think,

Commander?

When the public sees me standing here covered with blood, yet healthy as can be, it will only contribute to the rumors of my immortality. Now have your people move out of my way."

Johnson motioned for his people to comply, and they did without hesitation. As Dominic raised his arms to the congregation, a great cry went up, and they began to pray loudly to the Cardinal in celebration of his great servant's salvation.



THE TRINITY

The Cardinal's private quarters were supposed to be secure, but you could never be sure about such things. Instead, Cardinal Durand XVII, originally known as Alexander Durand, met with his two brothers, Nathaniel and Peter, in the same anonymous subterranean vault they always employed on such occasions. Its secret had held up since the Brotherhood's beginnings, and it would serve as well now as it always had.

It was time for their semi-annual meeting anyway, but Peter had something to tell the others that he felt sure he could have called an emergency meeting for. Luckily, the timing had been right, and he hadn't been forced to.

After the greetings and small talk were over and they were gathered around the rough-hewn table in the center of the small cell, Peter leapt right to the business at hand. "We have a problem. I have been made to understand that it is possible that certain members of Cybertronic are possibly onto our deception. Particularly, it seems that the man known as the 19th Executive is interested in investigating the claims that have been made to the truth, although he remains far from convinced that they are, in fact, accurate. After all," he chuckled, leaning back on his chair, "we've been at this a while, and I think we've gotten pretty good at it."

Alexander remained silent, but Nathaniel, ever the sharpest of the three, immediately leapt to the response. "What you say concerns me deeply, but I think we've all seen this coming for a long while. All we can do now is delay the inevitable. This will buy us some time in which to come up with some options in the eventuality that the secret of our immortality is uncovered once and for all." He looked Peter in the eyes.

Alexander remained silent, but Nathaniel, ever the sharpest of the three, immediately leapt to the response. "What you say concerns me deeply, but I think we've all seen this coming for a long while. All we can do now is delay the inevitable. This will buy us some time in which to come up with some options in the eventuality that the secret of our immortality is uncovered once and for all." He looked Peter in the eyes.

HEART OF SYMMETRY

Heat of Symmetry is a short *Mutant Chronicles* adventure designed for experienced players. At least one of the player characters must be an Inquisitor, preferably one of some power. The others can be of any profession, although they are encouraged to be members of the Brotherhood. Cybertronic characters are discouraged but can be fit in with some reservations on the part of the Brotherhood characters.

This section of the book is for the Game Master's eyes only. Players should not even glimpse through this section. Knowledge of what the game involves prior to playing it can ruin the players' enjoyment of the scenario.

Game Masters should read through this entire chapter carefully. You will need to know it backwards and forwards in order to be able to run the game confidently.

Some of the work involved in tailoring the adventure to your playing group's unique strengths and weaknesses has been left for you. For instance, an encounter description might tell you that the characters will be attacked by a group of Heretic Legionnaires. It's up to you to decide just how many of these creatures there are, based upon the number and strength of the people in the PC's group. The stronger the group, the more Legionnaires you should toss at them. The weaker the group, the easier you should go on them.

Tailoring an adventure is an essential part of being a Game Master. It can be difficult to determine the proper

amount of danger to place the PCs in. You want to give them a challenge, to let them know that their lives are in danger, but you don't want to force them to face certain death. It might look like certain death, but it certainly shouldn't be. If all the characters get killed off in the first encounter, where's the fun in that?

Characters will—and in some cases probably should—die. This is a part of the game. The characters are living dangerous lives and are occupied in high-risk professions. Sooner or later, their luck will run out. That's simply the way it is.

As the GM, though, you should do your best to ensure that their deaths are meaningful. Dramatically, there's a big difference between getting shot during a mugging and standing off a rampaging horde of Legionnaires led by the largest Nephrite you've ever seen just so your buddies can continue on and complete the mission.

Work at making sure that the players don't die senselessly. If they constantly seem determined to throw caution to the wind, along with their lives in the bargain, let them suffer the consequences. They'll learn from their mistakes, and next time they'll do better. But don't let them get taken out simply because of a run of bad luck on their dice rolls. This is too discouraging, and when you ask who wants to make up their next character, you may not find too many takers.

Work with the players to create a dramatically satisfying tale for everyone involved, and you'll all have fun. That's something you can all feel good about.

THE SET-UP

If the players are not all of the Brotherhood, getting them together will require some work on the GM's part. This might involve the Inquisition hiring on freelancers or making an arrangement with some of the characters' employers for them to act as liaisons to the Brotherhood on this single assignment. In any case, once it's been arranged, all of the characters meet in the nearest Cathedral for a mission briefing.

The man giving the briefing is a member of the Curia. This Curate's name is Dale Bartson, and he is a Mystic of no little power. He is an elderly man with only wisps of white hair straying over his mottled scalp, and his health is failing. He is constantly coughing into a handkerchief, and his blood red lips stand out frighteningly against skin so pale it may never have seen the sun. His dark, watery eyes are constantly blinking away tears of frustration and pain, but he something to say to the PCs, and they are going to listen to him say it!

He tells them of an Inquisitor named Marcon Primus. Inquisitor Primus was stationed at the Gibson Cathedral,

his mission to root out any heretics he might find. In a city severely tainted with the presence of Cybertronic, Primus had a difficult time finding any souls in need of his services. He soon grew bored and turned his attentions outside of the city, into the jungle.

There he found a horde of Heretic Legionnaires camped 300 miles upriver from Gibson. The Dark Apostle Semai had gathered and left them there after their last unsuccessful siege of the city. There they scuttled around, performing unknown deeds in preparation for their lord's return and his subsequent call to the never-ending battle against the light.

One day, Primus decided to take a group of Inquisitors out to investigate the encampment. They never came back.

They were all presumed dead. The Cell of Intelligence has gathered reports that this is not so. At least Primus is alive, and perhaps some of the others, although this is unclear.

Apparently Primus has gone over to the other side.

As everyone in the Brotherhood knows, there's little worse than an Inquisitor gone bad. Primus has set himself up as the leader of his "tribe" of Heretic Legionnaires, and he's directing them in the building of a Dark Cathedral, his own mockery of the one in Gibson. He's been heard to boast that his travesty might not be as majestic as the original, but at least it will be better attended.

Simply put, it's the characters' job to make their way up the river to Primus's Dark Cathedral and take him out. Have him removed. Kill him. Make him dead.

GETTING THERE

Once the briefing is over, the characters are ordered to take the next Brotherhood transport to Heimburg. From there, they'll make their way to Gibson. There, they'll receive their equipment and final orders. From that point, they're on their own.

If the PCs are not on Venus when they get their initial briefing, they're transported there by the Brotherhood, free of charge. Travel times between different planets are listed on page 15 of *Mutant Chronicles*.

Once they arrive in Heimburg, they're greeted by a local member of the Curia who will arrange for their trip by jet to Gibson. This only takes 12 hours.

In Gibson, they're greeted by Brother Nigel Shueston, another member of the Curia and the personal assistant of Cardinal Reilly, the Cardinal of the Gibson Cathedral. Shueston is in his mid-twenties, and the fire of his zeal for the Brotherhood burns strongly in his deep, brown eyes. His brown hair is swept back nobly from his high, well-tanned brow. His knowing smiles bare teeth in a mouth that has never tasted battle.

Shueston was a member of the Administration before his meteoric rise landed him a seat on the Curia. Word has it that his mother, a member of the Curia on Luna, was influential in his rapid ascent to power, but the fact is that Shueston almost deserves it. He is a brilliant Advisor, and he has performed so excellently up to now that Cardinal Reilly has made him the manager of the Cathedral's day to day business. He also trusts young Shueston enough to place him in charge of such sensitive matters as the one he is dealing with now: the business of Inquisitor Primus.

When the PCs reach the Cathedral, they are hustled up to Shueston's office to receive their final orders. Once they have them, they're allowed the run of the

Cathedral for the evening. They're to depart upriver the following morning. If any of the PCs bother to ask Shueston anything about Primus, he will gladly share with them the following information.

INQUISITOR PRIMUS

Inquisitor Primus was a promising young apprentice when he began his life with the Brotherhood. He developed into an even more promising Inquisitor. He made his home in the Cell of Warriors, and he rapidly advanced up the ladder. There was talk at one point of nominating him to the Curia. He begged to remain in the field instead. There was no way a man like him could do any good sitting in an office somewhere, he said. He needed to be where the action was to be able to do any good.

To cement his denial of any chance of becoming a Curate, he put in for a transfer to the place in the solar system where he figured the most action would be: Venus. When he got there, he was not disappointed. He was placed within the Gibson Cathedral at the high point of Semai's siege of the city. He led one of the most talked about counter-offensives against the Legion of Darkness that anyone had ever seen. Through his efforts, the Brotherhood was able to beat the Dark Apostle's forces back.

They never returned.

Primus turned his attention to the Inquisition of the citizens of Gibson, but this time he was sorely disappointed. Most of the citizens were employees of Cybertronic, and none of them showed the slightest trace of any kind of corruption. Try as he could, torture who he would, Primus could not find any foe worth his mettle. He knew that Cybertronic was up to something, but couldn't prove it. No one was that clean. No one.

His frustration slowly drove him mad.

Eventually, he decided that if the Symmetry was no longer in the heart of the city, he would go to the heart of Symmetry. He assembled a core of the finest warriors the Gibson Cathedral had to offer and then disappeared upriver. What he found there is unknown, but it was enough to convince him to stay, to stay and build a monolithic mockery of everything he had ever held dear. He set himself up as a Dark Cardinal in his own Dark Cathedral, and he was going to have to be brought down.

SETTING OUT

The next morning, the PCs join Shueston for breakfast before heading out. This is their last chance to ask him any questions. Once breakfast is over, they grab a limousine down to the docks.

There, they're shown aboard a patrol boat and introduced to Missionary Martin Dikembe, the ship's pilot. Dikembe is a short, thin man with dark skin and curly black hair shaved close to his head. His pale eyes stand out sharply against his dusky features. He has a ready smile that belies the nervousness around his eyes. They are the only clue as to any doubts he may have, though.

Although the *Lightbearer* belongs to the Brotherhood, Dikembe has been piloting it up and down the Rio Muerte since his apprenticeship, and he considers it to be his own. He has little tolerance for those who do not

know their way around a boat, and he will not take the time to teach them until their incompetence has aggravated him enough. Even then, he tells them, he's not doing this for their safety, but for his own. There's no way he's going to let some fool from off-planet get him killed.

Dikembe's knowledge of the river is great, and he knows of his value to the PCs. Once they get on the river, they're almost totally dependent on him. Without his guidance, they'd never be able to make their way safely up the river. He knows this and will let the players know it any time there's a disagreement and they try to pull rank on him. They can handle the things that they know about; just let him take care of the boat. He'll get them to where they need to be, as long as they shut up long enough that they don't all get killed.



"You know the situation. What do you suggest we do?"

Peter grinned. He already had a plan. "We can eliminate the investigation, or at least slow it down for a short while, by the selective removal of key personnel within the Cybertronic organization. I have a list of names."

Alexander looked at his younger brother thoughtfully. "Crenshaw?" he asked meaningfully. Peter winked at him, bearing a savage grin.

"Do we need to put this to a vote?" asked Nathaniel. It was a rhetorical question, and they all knew it.

"All right, Alexander," he continued. "Peter will provide you with his list, and you'll get Crenshaw on it straight away. Any questions?" He looked at each of his younger brothers in turn. "No? Well then, in the meantime, I suggest we step up our propaganda campaigns and investigations of Cybertronic. In this case, the best defense might very well be a great offense. If we can shut them down before they get too close, we'll have killed several birds with one stone."

The younger brothers both nodded their approval. "Now, on to other business."

MISSION

ACCOMPLISHED

It was cold up here atop the Bauhaus headquarters, but Sebastian Crenshaw knew it was the best vantage point from which to perform his latest assignment. There was a man in Cybertronic by the name of Miles Jabbar, a man who the Cardinal had decided was to die.

Crenshaw had no idea why this man had incurred a death sentence, and he really didn't care. It was none of his business. He trusted the Cardinal's judgment, and he never



really had any say in his targets anyway.

Besides which, after having Mr. Jabbar under surveillance for the last few days, Crenshaw didn't think he was going to have any trouble killing him at all. Jabbar was a slimy little man with disgusting tastes in both his activities and his sexual partners. From what little Crenshaw had been able to determine about him, he deserved to die.

Of course, then again, so did a large portion of humanity. But Jabbar had been singled out by the Cardinal, Crenshaw's only superior, beside the Curia, of course. That didn't mean Crenshaw had to enjoy Jabbar's demise, but he would.

He had been waiting for Jabbar to enter his apartment on the sixth from the top level of the Cybertronic building just as he usually did at this time of day. He was late, but Crenshaw wasn't worried. He could bear the cold all night. Eventually his chicken would come home to roost.

And sure enough, there he was. And he had a child with him—a boy who couldn't have been more than twelve.

Crenshaw cursed. This was going to make things more difficult, especially since Jabbar had a corner apartment. If he disappeared into his bedroom, Crenshaw wouldn't be able to reach him from his present perch. He'd have to move, and at this altitude, that would be a real pain.

Of course, things went as badly as possible. Jabbar only spent a few minutes in his living room—every other night, he'd relaxed there for an hour watching the news: a sitting duck—and the child was between him and the window almost the entire time. Then they moved into the bedroom, and he couldn't see them at all.

Crenshaw cursed again, more

Shueston bids them each good luck and farewell as they board the boat. Then he gets into his limousine and waves while the chauffeur drives off.

The *Lightbearer* is a small ship, just large enough for each of the PCs to lie down next to each other on the deck, as long as they don't mind lying too close. The only room below deck is for the engine, the gas tanks and a small amount of storage. The PCs can keep their weapons or extra gear here if they like, though they might note that Dikembe is armed at all times.

An AC-41 Purifier is mounted on the bow of the ship. It features armor plates to each side of the mount that will give the gunner an additional Armor Value of 6 to the chest, stomach and arms for any attacks from the front. Dikembe will suggest that one PC be kept at the Purifier at all times (he cannot, as he has to pilot the boat). The PCs can take turns if they like.

Once everyone is ready, Dikembe starts up the motor, and they move out onto the Rio Muerte.

ROUGH PASSAGE

The first part of the trip passes uneventfully. The PCs can go ashore if they like, but there's nothing there of any interest unless they're particularly interested in jungle flora. The ship moves along at a steady clip, and at the rate they're going, they should reach the Dark Cathedral on the morning of the third day.

Unfortunately, the peacefulness of this part of the journey doesn't last long. Sometime in the mid-afternoon, they turn a bend in the river and run smack dab into a war zone. Dikembe explains that this part of the river is where Brotherhood control ends, and there's almost always a skirmish going on between the Inquisition and the Dark Legion here. Right now, the Brotherhood has launched another offensive designed to clear the Legionnaires away from the river long enough for the *Lightbearer* to get past.

Once they get past this section of the river, they'll be behind the Dark Legion's defenses, and with any luck, they'll be able to proceed upriver unmolested. Before they do that, though, they're to report in to the commander of the Brotherhood's forces here, a Sacred Warrior named "Ace" Kowalski.

Finding Ace will probably prove tougher than the PCs hope. She's currently in the thick of the battle, but should return fairly soon. There's nothing for them to do but wait. Dikembe suggests that they hang out in the company headquarters. Soon after they enter, they're guided to a sparsely furnished room and left to cool their heels.

Before Ace arrives, a pair of Ezoghoul's that have managed to sneak behind the Brotherhood's lines under the cover of the river's surface come rampaging out of the river and head right for the company HQ. They smash directly into the room the PCs are in and tear a hole through one of the walls. It's likely the PCs will be surprised by this unless one of them manages to make a PER roll. Either way, the Ezoghoul's—armed with Kratachs (*Mutant Chronicles* page 122)—are coming in, ready or not.

The rest of the Brotherhood's warriors are busy elsewhere. They will arrive in 1d5+5 Combat Rounds. By then, the battle should be over one way or the other. The PCs might try to run away until they can get more

backup, but the Ezoghoul's will pursue them. If they split up, each Ezoghoul will take off after a randomly determined character and pursue him or her until either it or the character is dead.

Once the smoke has cleared, the PCs should emerge victorious. Soon afterward, Ace will enter the building to survey the damage.

Ace is a beautiful woman with long hair made bright blond by the Venusian sun. Her face is well-tanned, but her icy blue eyes are cold and determined enough to freeze the heart of a Razide on the spot. She grins grimly at the PCs' handiwork before offering her hand in greeting.

She introduces herself and notes that they're a little early, which is no matter, since her forces have already completed their part of the job. The river is clear, and they're going to be able to keep it that way for the next four hours. She sighs deeply and begins to remove her armor. She's wearing some sort of body suit beneath it that leaves her arms and legs bare. They're just as darkly tanned as her face.

If anyone bothers to ask what she's doing, she'll tell them. She's going swimming. It's not often that the river is clear, and she plans on taking full advantage of it. They're invited to join in if they like. Several other Sacred Warriors are already on their way.

If anyone seems tempted to take her up on her offer, Dikembe will remind them that they ought to be going. No matter what Ace says, the Sacred Warrior line could be broken at any time, and they should move upriver while they still can. Ace will shrug her shoulders, take a towel from one of her subordinates, shoulder a Purifier and walk them out to their boat.

Once the PCs embark upriver, Ace takes a closer look at the river, activates her Purifier's flame-thrower and brushes the fire along the river's edge. A trio of Necromutants in the deep foliage on the river's bank stand up suddenly, screaming and burning. Ace dispatches them with three short machine gun bursts, then tosses her gun aside and dives into the water. As she surfaces, she grins and waves at them, yelling, "Just like bath water!"

SHORE LEAVE

Once the PCs get above the battlefield, leaving the boat can be dangerous. The lands around the river are loaded with creatures of the Dark Legion roaming randomly about or scurrying from one encampment to another on missions only the Dark Apostles would fully understand. Every time someone, for any reason at all, decides to disembark from the ship and wander around on the shore (perhaps they're looking for fresh fruit, or maybe they thought they heard a cry for help, etc., the GM can be as creative as he or she likes here), there's a 10% chance for every ten minutes spent ashore that they'll encounter a lone Razide on a solo mission of some sort.

Play on the PCs' tension as they wander around the jungle. Toss them a few red herrings—a bat fluttering about here, a wild pig rampaging through the forest there—and then spring the Razide on them. They'll probably be expecting something to happen, but done properly, it'll still give them a shock.

THE FIRST NIGHT

As darkness falls, one of the characters might suggest that they find a place to moor the boat for the night. It's too dangerous to be on the river in the middle of the night—there are too many ways to be caught upon rocks—and the noise of the engine might incur the curiosity of a Dark Legion patrol.

Dikembe ignores the idea. He has a pair of low light goggles with him, and he claims to know the river well enough to be able to navigate it blindfolded. Better to push on.

Someone may notice later that Dikembe is starting to yawn a lot. Unless somebody stays up with him to keep him awake, he will fall asleep at the wheel. They have the option of pushing on with a companion for Dikembe or mooring the boat for the night.

Dikembe will protest at any attempt to pull to shore, but if he is overruled, he will shrug his shoulders and comply with whatever these oh-so-wise people who think they know so much about the river want him to do. They cannot anchor themselves in the river, for the bed is too soft to hold them. If they want to stop, they must tie the boat to a tree on the shore.

Any boat moored near the shore will be discovered if the characters use any sort of light source at all (e.g. lanterns or a fire). A small troop of Necromutants (one for every two PCs) will investigate the boat in the middle of the night. If the players are keeping watch in shifts, randomly determine which shift the Necromutants appear on.

The Necromutants will stumble loudly though the brush until suddenly appearing out of the undergrowth (subtlety is not one of their strong points). The players should just be waking up by the time they arrive, unless of course, the PC on watch has opted not to wake them,

as she or he has been hearing noises in the brush all night long.

It's up to the GM to play this up. Perhaps the PCs have been awakened on false alarms twice already before the Necromutants arrive. This might make the PC on watch hesitant to wake up the others for fear of irritating them for another false alarm.

Anyway, once the Necromutants have been defeated or avoided, Dikembe will insist that they must press on immediately. The noise of their battle could bring more of the Dark Legion, and he doesn't want to be around when they arrive. Besides which, he's wide awake now and doesn't think he could sleep if he tried.

AMBUSH

At some point during the next day, a group of 10 Undead Legionnaires along one bank of the river hear the approach of the boat. They lie in wait amongst the tall foliage on the river's edge until the boat is within range. Then they open fire.

The PCs' best bet here is to run past the threat as quickly as possible, and Dikembe knows it, even if no one else does. No matter what orders he is given, he will press forward, full speed ahead. The Necromutants will only have three Combat Rounds to fire at the boat before it moves around a bend in the river and out of range.

Any PCs that lie flat in the boat will be protected from any bullets by the sides of the ship. Anyone staffing the Purifier will be exposed, although armored as described above. Dikembe's head will be exposed the entire time, but the rest of him has an Armor Value of 6 due to the steel plating surrounding the pilot's seat.

THE SECOND NIGHT

Their previous experiences should have convinced the PCs not to bother trying to camp alongside the river at night, and so they push on. Sometime toward midnight, a brightly lit Bauhaus encampment appears on the left bank. If none of the others think of it, Dikembe suggests that they might stop there for the night.

The encampment is in total chaos. Men and women are running about everywhere. Artillery is constantly firing off into the distance. Shots ring out nearly everywhere, but strangely enough, the center of the compound appears to be safe.

As the PCs dock their ship, a well-muscled Venusian Ranger named Private Albrecht comes out to meet them. He's armed with a MG-80 (*Mutant Chronicles* page 200), and it's leveled directly at them. In the glare of the flares constantly being fired overhead, he recognizes that they're human, but he doesn't lower his gun.

He demands to know what they're doing there. If they're cooperative, he agrees to take them to his superiors. If they're not, he noses the machine gun at them menacingly and orders them to move along.

Hopefully, the players will react reasonably. If not, they can continue on down the river unmolested. If they treat the Ranger with respect, he will lead them to a building in the center of the compound. The windows are covered over so that no light leaks out, so the place

appears dead from the outside, but when they enter the building, the bright lights hurt the PCs eyes and someone shouts at them to close the door.

Once inside, they're greeted by a Sergeant Klemmer. Tall, with short blond hair and blazing blue eyes, he could be Albrecht's brother. He greets the PCs and demands to know what they're doing there.

He is as pleasant as can be expected under such circumstances, which is not very. If they request it, he'll offer to put the PCs up in a small room in the rear of the building. There are enough cots for them all. He won't ask them about their mission. Frankly, he's got enough problems on his hands, and he doesn't want to know.

At some point, someone should realize that it's a bit strange that a Sergeant would be in charge of the entire camp. If they ask what happened to the superior officers, Klemmer will explain that they've all been killed. Chances are good that the camp will be overrun in the next forty-eight hours. Klemmer has been waiting for some more officers to come in and lead the evacuation. He was hoping that the PCs were these people.

Now, he figures that the rescue effort isn't coming. It looks like he and his people are on their own. At this point, he asks which way the PCs are headed. Upriver is the wrong way. He's going to have to figure out how to



heartily this time, and slung his Mephisto over his back. Then he reached into his back pack and withdrew a small crossbow with a coil of cable attached to the bolt.

He drove a piton into the roof, then attached the loose end of the cable to it and made sure it was secure. Then he took careful aim at the roof of the building kitty-corner from the Bauhaus HQ. It was shorter than the Bauhaus building, but not by too much. In fact, the new angle would give Crenshaw a perfect shot into Jabbar's bedroom window.

He fired the bolt, and it flew straight and true, burying itself deep within the rooftop's stone surface. Then he brought out the hand cart and slung it over the line. With a quick prayer, Crenshaw lowered himself over the edge of the building and grabbed onto the handcart with both hands. Then he released the brake.

He slid down to the other rooftop at dizzying speed, but he jammed the brake on at the last second and came to an acceptable stop on the new building's roof. He carefully bent over and cut the cable and tossed the bolt into a nearby steam chimney. No one would ever find it.

The steam covered Crenshaw's position beautifully, so he unslung his rifle and got to work. Soon he had Jabbar within his sights. He had just finished undressing and was standing in front of his bedroom window, enjoying the view. Crenshaw grinned to himself and squeezed the rifle's trigger.

The bullet pierced Jabbar's window, then smashed through his eye and into his brain. The impact knocked out the back of his skull, and he fell over backward, quite dead.

Planning was always the key, Crenshaw thought to himself as he packed up and prepared to leave. Mission accomplished.



A PROBLEM UP THE RIO MUERTE

The meeting had been going on for some time when the issue of Inquisitor Primus finally came up. It was the great Keeper of the Art Reinhold Walters who brought it to the Curia's attention. It seemed that one of the Brotherhood's most promising Inquisitors had gone rogue.

Located some 300 miles up the Rio Muerte from the Gibson Cathedral, Primus had somehow managed to take control of a sizable number of Heretic Legionnaires, usually under the control of Semai, the Lord of Spite. Not only that, but he had set himself up as their Dark Cardinal and was using the Legionnaires to build a Dark Cathedral of his own.

Cardinal Dominic was the first to respond. "This man is an abomination," he croaked. He still bore a bandage on his head from a blow he had sustained during a recent assassination attempt. "I say we send in the Archangels and bomb this blasphemer and his evil works out of existence. There is no other solution for this kind."

There were many murmurs around the long, donut-shaped table. Most of them seemed to agree with the dreaded Sheriff of Luna. Some did not.

Chang Dang-Vu spoke up for the dissenters. "I beg the Cardinal's pardon," he began, "but I disagree, and I do not think I am alone in my position." He looked around and received fewer nods than he would have liked, but they were from the right people.

"It is my belief that there is a great opportunity to learn something from this unique situation. For instance, just how did this man gain control of these Legionnaires? Did the Mage of Twisted Biotechnology give them to him in exchange for his service, or did he somehow manage to wrest power over them on his own? And just why did this man become seduced by the Darkness? From what I understand of him, he was a model Inquisitor. Up

get these soldiers out of here himself. With a bitter grimace, he bids them goodnight and heads out to begin the abandonment of the camp.

Albrecht wakes up the PCs early the next morning and tells them that they have to get going now. The Rangers are heading out in under twenty minutes, and if the PCs don't leave now, he can't ensure their safety.

As the PCs climb aboard the boat, Klemmer dashes by to bid them good luck. While the *Lightbearer* swings

out into the river, the PCs can see Klemmer hustling Albrecht off to see to the final preparations.

Fifteen minutes later, when the PCs are already a good way up the river, a mighty explosion comes from down river and a small mushroom cloud can be seen in the direction where the camp used to be. Apparently, if the Rangers can't have the camp, they made sure that the Dark Legion couldn't either.

THE DARK CATHEDRAL

Just after noon, Dikembe warns the PCs that the Dark Cathedral should be coming up around the next big bend in the river. As they swing around the bend, they can see it rising in the distance.

It's in the middle of being built, but even so, when it's finished, it'll be a lot smaller than any of the real Cathedrals, even the one in Gibson. Scaffolding runs several stories into the sky, high over the six stories that have already been completed. The facade has barely begun being built, and the Great Chamber—obviously designed with some sort of Dark mass in mind—is still open to the air. As the *Lightbearer* moves up closer, the PCs can actually see into the middle of it.

The building is constructed entirely of bamboo and wood. It's shaped much like the Cathedral on Luna, but without the metal framework or any glass in the windows. In some places, the Dark Cathedral seems to simply rise out of the jungle, as if it and the surrounding landscape are cut from the same cloth. Snakes, lizards and other creatures of the jungle, both big and small, are constantly slithering, creeping and crawling in and out all of the openings, and even through cracks in the poorly built walls. Heretic Legionnaires are everywhere, running all about the place, clambering up and down the scaffolding. As the PCs come closer, everyone on the shore suddenly stops what they are doing and turns to stare at the intruders.

The silence is nearly unbelievable. Hundreds of Legionnaires stand perfectly still, watching them without making a single sound. Even the wild creatures of the jungle seem to have frozen in anticipation of what will happen next.

The moment is broken by the appearance of a woman in soiled and tattered Inquisitor's robes coming out of the darkness in the center of the building and jogging down toward the shore. She waves at the PCs and tells them that it's all right. They can come on in and park their boat at the rough looking dock jutting out from a cleared section of the bank. She waits there for them until they make their decision to come ashore.

If the players ask at any time, the woman tells them all about herself. Her name is Amanda Barley, and she was one of the Inquisitors that came upriver with Primus on his expedition. Besides Primus, she's the only one who survived. The others were either killed in their initial encounter with the Legionnaires or later succumbed to various sorts of illness.

Once they come ashore, Barley offers to bring the PCs to meet Primus if they like. He has been expecting them. Oh sure, he could have sensed their coming, but he didn't have to. He just knew that the Brotherhood wouldn't let a project like his go unmolested for long.

Barley is completely overwhelmed by Primus, almost to the point of worshipping him as the Legionnaires

around them do. It seems that once they got to this spot, when most of the expedition had been killed off and their boat had been sunk, a revelation came upon Primus, and he sort of evolved to a higher level of being, at least mentally. He was able to wrest control of the Heretic Legionnaires that surrounded them and force them to his will.

Barley is in awe of the man and won't hesitate to tell the PCs that this is so. She believes that he has taken the next step in human evolution toward godhead—that he has become a kind of being on par with the Cardinal himself. That's why building a Cathedral of his own made so much sense.

She leads them in through the open front of the Dark Cathedral and into a room behind the Great Chamber. Primus is in it, surrounded by armed Dark Legionnaires. They are not pointing their weapons at anyone, but there is no doubt that if the PCs open fire, it will be the last thing they ever do.

THE DARK CARDINAL

Primus has the PCs disarmed, and then sends his minions away. The guns are taken to the PCs' boat, so they'll be there when they return. They are now alone with Primus, and he is unarmed as well. The PCs should realize, however, that dozens of Dark Legionnaires are waiting just outside the entranceway to the room should they decide to attack.

Primus wants to talk to the PCs. He wants to explain himself—his revelations and his new life—to his former brethren. When he speaks, he looks exclusively at any members of the Brotherhood. He doesn't expect anyone else to understand.

He's not too sure the Brotherhood PCs will understand either, but they're his only chance. He sees that this charade, this travesty he's made of all that was ever important in his life, must soon come to an end. If the PCs are unwilling or incapable of killing him, he's determined that he will soon end his life himself, although he won't directly inform them of this.

He tells them that when he was a part of the Brotherhood, he was blind. He had been blinded by the Cardinal's Light, just as the Cardinal had told him he would be lost in the Darkness. But once he got away from the Cardinal, first at the desolate Cathedral at Gibson and later deep in the Venusian jungles, then he entered the areas in which Light and Darkness intermixed in shades of gray. For the first time in his life, he could finally see.

It was lies, all lies. The Cardinal was a lie. Even the Darkness was a lie.

They were extremes that blinded you to the horror of the reality around you, neither allowing you to see things as they really were. Once Primus came here, to

this spot, and met with the abandoned Legionnaires, it was as if a veil had been lifted from his eyes. Suddenly, he could see all too clearly.

And so he decided to call a spade a spade. He began to build his Dark Cathedral and set himself up as a Dark Cardinal so as to be able to highlight how hollow the Brotherhood had become. He transformed the Heretic Legionnaires into a Dark Brotherhood, and they become his tools by which he could show others how the Light and the Darkness weren't all that far apart—really just two sides of the same coin. Primus had realized that most of human existence wasn't spent simply on one side or the other. Most people lived on the edge.

But the Light and the Dark were becoming closer and closer to each other, and the edge was becoming narrower, sharper. Soon, it would be impossible to live on the edge any longer. One would have to choose to side with one face or the other or confront the possibility of being split in half on the razor's edge.

THE WIND-UP

The PCs must figure out some way to break out of the cages and kill Primus. Once they do, the Heretic Legionnaires will immediately stop fighting. They have no wills of their own, and once the will controlling them (i.e. Primus) is snuffed out, they will wander about aimlessly until taken up again by one familiar with the secrets of their control.

This is the players' chance to show how creative they are. Most players will have many different ideas to try for breaking out of the cages. If one or more of the PCs has the Art, this could obviously be used to their advantage. Brute strength probably won't be any good, and even if it was, they'll still have the Legionnaires to contend with.

A diversion might work. Maybe they can draw the dimwitted Legionnaires into the cages by having one of them fake a wound. The Legionnaires know their Dark Cardinal wants the PCs alive, so it's possible they'd open the door and walk in to check things out. Then they could clobber them.

Once the PCs get out of the cages, they might head back to the boat to grab their weapons or they could simply head straight for Primus's quarters. Either way, when they get to the man's bedroom, they find him awake and waiting for them. He will call for his Legionnaires and fight the PCs with all his might.

If the PCs are smart, they might try drawing some of the Legionnaires away from Primus's quarters by setting the Dark Cathedral on fire. This would allow them to get closer to Primus before having to start blowing things away.

Play the battle out as best you can. If the PCs

This terrifying realization had driven Primus mad. He knew he was mad. He had only moments of horrifying lucidity interspersed with hours—sometimes days—of living in a haze. And so he called in someone to end his existence in the only way he knew how, by creating something so true to reality that it could not be ignored by those whose job it was to consecrate the lie.

And so they had come. Now it's up to them to do their job. But he's not going to make it too easy for them. No, he values his life far too much to simply surrender it without a struggle. They would have to take it from him—to kill him before he could go too far.

At this point, Primus calls in his Legionnaires and has them take the PCs out and place them in bamboo cages near the river's edge. They are guarded by Legionnaires with Vasshts (*Mutant Chronicles* page 114). The PCs are to be sacrificed the next morning.

die, let them know that within forty-eight hours after their failure, an air strike was called in and the Dark Cathedral was bombed out of existence. The planes were able to target upon a tracer hidden in the bottom of their boat. Primus's body was never recovered, although he is suspected to be dead.

If the PCs succeed, remind them that there are other forces out in the jungle, some of which were probably being kept at bay by Primus's Legionnaires. Now that they're disabled, the others will come streaming in like water through a broken dam. Middle of the night or not, they need to head out now.

Either way, Inquisitor Barley is missing. She was nowhere to be seen during the PCs' assault on the Dark Cathedral, and afterward, no matter how much the PCs search, she cannot be found. Maybe they'll run into her again someday.

Anyhow, the trip back is uneventful. The PCs can go home and heal their wounds and soak up the acclaim of their superiors. And maybe they can even somehow manage to forget the jungle madman who set himself up as a Dark Cardinal and how, even as he said the most blasphemous things, the light of sanity shone brightly in his eyes.

INQUISITOR PRIMUS

STR	17	ACT/CR:	6
INT	18	AVOID/PARRY:	5
COR	16	BPS ^o ARMOR (AV)	
PHY	15	HEAD	4 10
MST	35	ARM	8 8
PER	43	STOMACH	8 8
MOVEMENT:	3/225	LEG	9 8
OB:	+1	CHEST	9 8

ATTACKS: Art, Punisher, Punisher short sword

FIELDS OF EXPERTISE: Combat 19, Firearms 14, Communication 18, Movement 3, Technology 0.

SPECIAL ABILITIES: Knowledge of the Dark Legion 17, Knowledge of Algeroth 20.

ART: Mentalism (Proficiency, Speed, Invulnerable, Exorcise Self, Improve Self, Fly)

LEVEL OF PERFECTION: 10



until this time, we might have been happy to have more just like him." He grinned and a wave of soft laughter traveled around the room.

"Obviously, this is not what we want. And so we need to learn how it happened so that in the future we might hope to prevent it." Dang-Vu folded his hands in front of himself and waited for a response. It was not long in coming.

Dominic's face had already turned red by the time he managed to speak. "I cannot believe what I am hearing," he sputtered. "Should we waste time examining this crime, or should we simply call it what it is—a crime against all humanity—and punish it swiftly and with all available force. I say we make an example of this man. Such a thing shall work as more of a deterrent than your pointless 'research.'"

Then the Cardinal himself spoke, and the sneer quickly vanished from Dominic's face.

Durand XVII spoke softly, but clearly, and there was no doubt that everyone in the room could hear him, for they each hung on his every word. "It is my carefully considered opinion that we should give Dang-Vu's idea a chance before we entirely discard it. He is correct. Such a thing has never before occurred, and we should seize the opportunity to learn from it." A serene smile appeared on Dang-Vu's face.

"Of course," the Cardinal continued, "we cannot afford to have such a situation continue for long. If word of it were to get out, it could be quite demoralizing for our brethren." A nasty grin popped back on Dominic's lips.

"We will give Dang-Vu's idea a single chance. Send out a team to investigate. If they fail, the place shall be bombed as Dominic has suggested." He paused for a moment to collect himself. "And if they succeed, the place will be bombed as soon as they can leave."

Cardinal Durand XVII sat back in his chair and placed his hands flat on the table in front of him. "That is all that shall be said. I have spoken."

IN THE BEGINNING, ALL WAS ENVELOPED IN CHAOS.
HOPE HAD FLED FROM THE HEARTS OF HUMANITY
AND DARKNESS HAD ENTERED OUR SOULS.

THEN CAME THE CARDINAL, AND HE SHED LIGHT
INTO THE DARKNESS.
HE CALLED UPON OUR SALVATION FROM WITHIN
OUR VERY SELVES.
HE ILLUMINATED THE WAY.

THE DARK LEGION RESPONDED WITH
MURDEROUS FORCE,
BUT THE CARDINAL STOOD STRONG,
AND STRENGTHENED BY HIS STRENGTH,
WE, HIS BROTHERHOOD, STOOD WITH HIM.

SO NOW WE FIGHT, NOT ONLY AGAINST THE THREAT
FROM BEYOND THE REACH OF OUR FADING SUN,
BUT THE DECAY ATTACKING US FROM WITHIN.
AND JUST AS THE CARDINAL LAYS WASTE TO THE
ALIEN BATTLESCAPES, HE SHOWS US OUR INNER
FOES SO THAT WE MAY SMITE THEM
WITH ALL OUR RIGHTEOUS FURY.

NOW IS THE TIME TO STAND AGAINST THE
DARKNESS,
TO STAND WITH THE CARDINAL AND HIS
BROTHERHOOD.

NOW IS THE TIME FOR HEROES.

in «The Brotherhood», you will find everything you need to know about the most proud and powerful association in the fantastic world of Mutant Chronicles—the glorious Brotherhood. you'll find descriptions of Inquisitors, Mystics, Mortificators, the Cardinal, the Archangels, the Sacred Warriors, the Fury Elite Guard, Retributor Carbines and Castigator spears, the Icarus jet-fighter, Artifacts, The First Cathedral, four new aspects of the Art with more than twenty new spells, seventeen new backgrounds, unique Brotherhood skills and special events, Heart of Symmetry: a complete adventure, plus much more...

NOTE: In order to be able to use «The Brotherhood», you must have access to «Mutant Chronicles the Techno~Fantasy Roleplaying game».



Front cover: Cardinal Dominic—the Sheriff of Luna—sermonizes in the Luna Cathedral, surrounded by his personal Inquisitor guard.



4002

Heartbreaker