

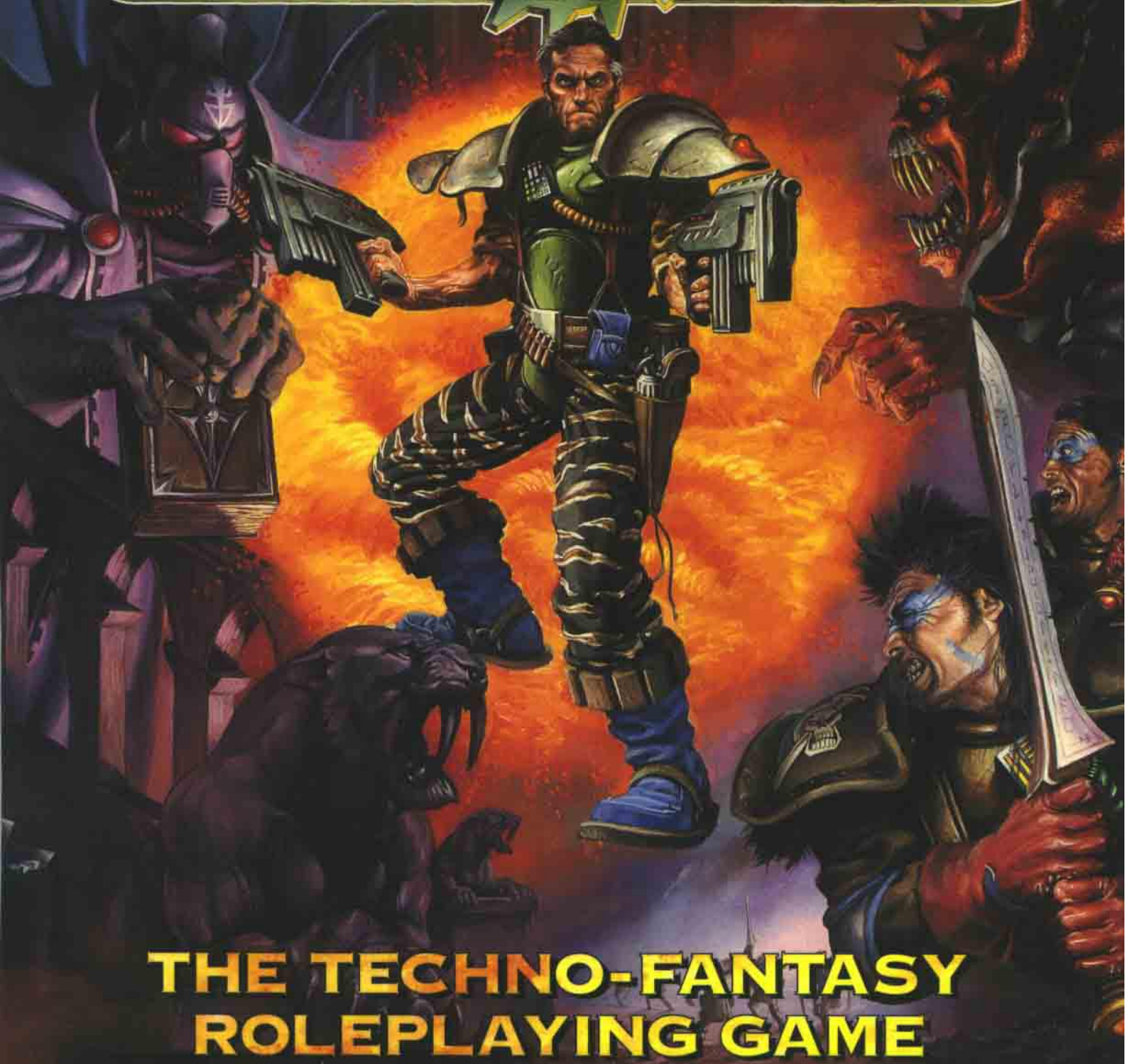

# MUTANT CHRONICLES™



**THE TECHNO-FANTASY  
ROLEPLAYING GAME**



# MUTANT CHRONICLES™

THE TECHNO-FANTASY  
ROLEPLAYING GAME



# CONTENTS

<b>INTRO</b>	<b>5</b>	THE DOOMTROOPERS	84	BACKGROUNDS	135
<b>THE ADVENTURER</b>	<b>11</b>	CREATING A DOOMTROOPER	85	BACKGROUND DESCRIPTIONS	135
FREELANCERS	11	<b>THE BROTHERHOOD</b>	<b>87</b>	ADOLESCENCE EVENTS	140
EMPLOYERS	12	THE NEW LIGHT	87	SPECIAL EVENTS	140
<b>LUNA</b>	<b>13</b>	THE CALLING OF THE CARDINAL	88	COMBAT STATISTICS	143
LUNA CITY	13	THE ART	89	SOCIAL STANDING AND EQUIPMENT	144
OUTLOOK	13	STRUCTURE	89	THE PERSONALITY FORM	146
ARCHITECTURE	15	THE DIRECTORATES	90	<b>FIELDS OF EXPERTISE</b>	<b>147</b>
SHOPPING	15	THE CATHEDRALS	91	THE SKILL VALUE	147
FOOD	16	MILITARY	92	COMBAT	147
ENTERTAINMENT	16	CREATING A BROTHERHOOD PLAYER	92	FIREARMS	148
THE BROTHERHOOD	16	CHARACTER	92	COMMUNICATION	148
MEDIA	17	BROTHERHOOD SWORDS	92	MOVEMENT	149
TRANSPORTATION	17	<b>THE DARK LEGION</b>	<b>95</b>	TECHNICAL	149
LAW ENFORCEMENT	17	THE ARRIVAL OF THE APOSTLES	95	SPECIAL SKILLS	150
LIVING OUTSIDE THE SYSTEM	20	THE SOUL OF DARKNESS	96	THE SKILL ROLL	151
DRESSED TO KILL	21	THE APOSTLES	99	USING THE BASIC CAPABILITY VALUES	152
<b>THE CORPORATIONS</b>	<b>23</b>	SIBLING RIVALRY	99	IMPROVING SKILLS	152
THE MERCHANT CORPORATIONS	23	THE LEGIONS	100	CREATING NEW SKILLS AND	
<b>CAPITOL</b>	<b>25</b>	THE DARK PATTERNS	101	SUB-SKILLS	154
STRUCTURE	26	THE CITADELS	102	<b>COMBAT</b>	<b>155</b>
THE CAPITOLIANS	27	<b>ILIAN</b>	<b>103</b>	ORDER OF BATTLE	155
CAPITOL ARMED FORCES	28	THE MISTRESS OF THE VOID	103	MOVEMENT	156
MARS AND SAN DORADO	30	THE LEGIONS OF ILIAN	104	ATTACKING	156
THE PARTNERS	32	<b>MUAWIJHE</b>	<b>107</b>	CALCULATING THE ATTACK RESULT	159
<b>BAUHAUS</b>	<b>37</b>	THE LORD OF VISIONS	107	SPECIAL WEAPONS DAMAGE	159
THE DUKE ELECTORS	38	SCREAMING LEGIONS	108	EFFECTS OF DAMAGE	160
THE BAUHAUSER	39	TECHNOLOGY	110	SPECIAL SITUATIONS	161
THE MILITARY	40	<b>SEMAI</b>	<b>111</b>	COMBAT MODIFIERS	163
HEIMBURG & VENUS	43	THE LORD OF SPITE	111	COMBAT EXAMPLE	163
THE COMPETITORS	44	THE LEGIONS OF SEMAI	112	<b>THE ART</b>	<b>165</b>
<b>MISHIMA</b>	<b>47</b>	TECHNOLOGY	114	THE DIRECTORATE OF THE MYSTICS	165
THE LORD HEIRS	48	<b>ALGEROTH</b>	<b>117</b>	BECOMING A MYSTIC	166
THE MISHIMAN	51	THE LORD OF TECHNOLOGY	117	BACKGROUNDS	166
THE MILITARY	51	THE DARK TECHNOLOGY	118	BACKGROUND DESCRIPTIONS	167
LONGSHORE & MERCURY	55	ALGEROTH'S HORDES	120	LEARNING SPELLS	168
THE GUNSHIP DIPLOMACY	55	TECHNOLOGY	122	DESCRIPTION OF THE ARTS	168
<b>IMPERIAL</b>	<b>59</b>	<b>DEMNOGONIS</b>	<b>123</b>	THE ART OF KINETICS	169
THE BIRTH OF AN EMPIRE	60	THE BEFOULER	123	THE ART OF PREMONITION	170
THE CLANS	61	THE LEGIONS OF DEMNOGONIS	124	THE ART OF CHANGELING	171
THE IMPERIALS	63	TECHNOLOGY	126	<b>THE DARK SYMMETRY</b>	<b>172</b>
THE MILITARY	64	<b>HERETICS</b>	<b>127</b>	THE DARK GIFTS	172
THE SETTLEMENTS	65	THE TAINTED	127	LEARNING THE DARK SYMMETRY	172
IMPERIAL DIPLOMACY	67	BECOMING A HERETIC	127	DARK SYMMETRY GIFTS	175
THE ISC	68	THE DARK GIFT	128	THE DARK PATTERN GIFTS	175
<b>CYBERTRONIC</b>	<b>73</b>	THE LIGHT OF THE INQUISITION	128	ILIAN	175
FACTS ON THE FOUNDING	74	<b>WHAT IS A RPG?</b>	<b>129</b>	MUAWIJHE	176
THE THEORIES	75	WHAT IS A ROLEPLAYING GAME?	130	SEMAI	177
THE CARDINAL'S WORD	75	GAMING EXAMPLE	131	ALGEROTH	177
THE CARTEL	76	DESIGNING ADVENTURES	131	DEMNOGONIS	178
THE OFFENHAUER THEORY	76	WHAT REALLY HAPPENED...	132	<b>WEAPONS</b>	<b>179</b>
THE SULLIVAN SYNDROME	78	...AND WHAT HAPPENED NEXT...	132	HANDGUNS	180
IMPERIAL	78	<b>THE CHARACTER</b>	<b>133</b>	SUB-MACHINE GUNS	182
THE MISHIMA DOCTRINE	78	BASIC CAPABILITIES	133	ASSAULT RIFLES	184
<b>THE CARTEL</b>	<b>81</b>	SOCIAL STANDING	134	SNIPER RIFLES	187
BACKGROUND	81	SKILLS	134	SHOTGUNS	190
STRUCTURE	82	ADOLESCENCE SKILLS	134	LIGHT MACHINE-GUNS	195
OPERATIONS	83	AGING EFFECTS	134	HEAVY MACHINE-GUNS	198
CARTEL SECURITY	83			ROCKET LAUNCHERS	201
				<b>EQUIPMENT</b>	<b>203</b>



«I write these my last words to humankind in pure despair.»



«No one harkeneth my words any longer, and the Inquisitors will soon collect me for the last trial. I fear this is the end. The evil patterns of the Dark symmetry have stretched even into the Brotherhood — my brilliant, beloved Brotherhood.

But here, I am but a mere scribe, a dying star on the endless night-sky. Who will notice mine eternal absence? I pray in the name of the Cardinal Nathaniel — the Untainted — that this my last work will not have been in vain.»

## MUTANT CHRONICLES™

«The beginning was in the Darkness of the Void.

We had long striven to free ourselves from the bonds of gravity, to escape the Hell-pit we had created for ourselves on the planet of dead opportunities, Earth.»

«The Capitolians were the first and the most successful. Wherever they staked their claims — on Luna, on Mars, or outside the Asteroids — they brought with them their way, the Capitolian way. Their messages were simple and without confusion, and to Cardinal Nathaniel's honor they raised the First Cathedral in the city of Luna, and in the raw stone of its walls the First Chronicle was engraved.»



«Our most devoted disciples, Bauhaus, followed shortly after and even before they were established on Luna, their proud Homebuilders, hand-picked from the ancient families of admirals and counts, began to clear the mighty jungles of Venus and raised the foundations of Heimburg, the Home of Hope. With the matchless craftsmanship of Bauhaus, they erected the Second Cathedral to be the home of Cardinal Toth, and in its mighty garnet walls the Second Chronicle was carved.»



«Third was Mishima, who gathered all their power and selected the Chosen Few that would carry the proud name of the Mishima clan out to the New World. In the appealing hollow underworlds of Mercury they founded the cities of Longshore and Fukido, to eternally remind humankind of the success and brilliance of the now sadly divided clan. Piercing the crimson clouds that cover the ground is the Third Cathedral, home of Cardinal Randolph and the Third Chronicle.»

«The fearless Pioneers of the Capitol corporation founded the first settlements on the Moon and the red planet of Mars, and more settlers followed from the other prominent corporations — the Homebuilders of Bauhaus on Venus, Mishima's Chosen Few on Mercury, the Conquistadors of Imperial among the asteroids and even further out. New empires were built in the new world, empires of hope, empires for a better future.

Among the hopeful generations that followed, the light and ambition prospered as never before. The cities grew, and the new rulers, the managers and directors of the four megacorporations, were just and fair. In the face of the Infinity of space, new teachings arose and the glorious Brotherhood, may its name never be soiled, was founded and united humankind towards a promise of paradise.»



«Last followed the glorious and haughty Imperial, whose noblemen struck from below at their larger competitors. With brute force they challenged and conquered, and their bold cadres of Conquistadors reached further out than anyone had ever dared to go before. Guided by the light of our Brotherhood they sought out the mysteries and secrets of outer space, attracting what should never have been attracted, awoke what should never have been awakened, challenged what should never have been challenged...»

«On Luna, the pioneer spirit of the megacorporations took physical form with the first of the megacities.»



«Here the administrations of the Quartet gathered, and like a magnet attracted the freelancing enterprises, the basis of creativity and innovation. Within the span of a few generations, the site where the Capitol pioneers placed their founding flag grew into the largest metropolis of all time.

In those days the city was low and spacious, to allow entrance to the play of the dim light. The blind faith in the technology that destroyed Earth was dead and buried, and the mayors and citizens of Luna proudly expanded their city, improved it, allowed the free enterprises to settle and prosper. Those were the days of the city that never slept, when Luna throbbed with activity and cheerful smiles.

Alas, at the peak of success the city transformed and the society took new shape. Man began to shiver and question his strengths, feeling comfort only in the hands of our Brotherhood and in the monumentality of the Cathedrals. Instead of advancing, he began to erect memorials of old times and buildings more and more imposing, yea, Brethren, even competing with the Cathedrals. The bright avenues were shadowed by the ever higher buildings, the open squares became crowded and bustling, the underground was explored to create space for commuters and sewers. I say unto you, THIS was the arrival of the Darkness, and it is for this I now must pay.

For the first time since our leap into space, there arose conflicts over small strips of land in the infinity of space. Hard wars were fought over petty mines and strategic outposts, and in the board rooms on Luna, the competition among the megacorporations and the freelancers was drawn to its extremes. Man was no longer happy, greed and ruthlessness took the place of joy and bliss.»



«As the Conquistadors of Imperial took their first steps on the Tenth planet, discovered through the visions of Cardinal Nero, a gust of cold wind swept over the world. Thus it was that the Darkness stirred, and with unequalled ferocity it fell upon the young worlds of Man like a firestorm, destroying and corrupting all that lay in its way. Only with the strongest determination, endless sacrifices and the power of the sacred Arts of the Brotherhood, was the wave of Evil brought to a halt. Mankind sighed with relief and the megacorporations plumed themselves on their efforts and continued their internal feuds.

But the damage was done and Darkness had come to stay.»



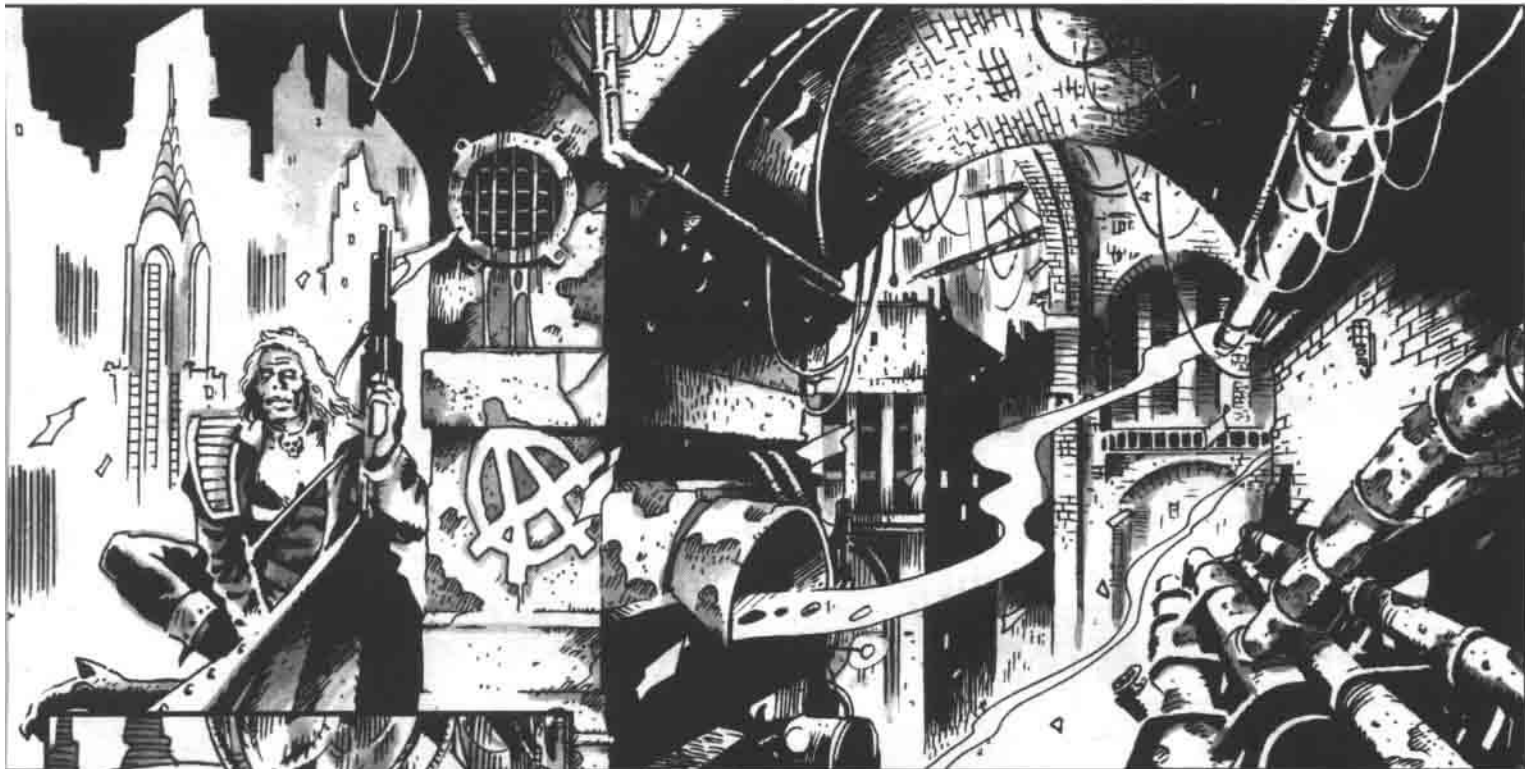

«At almost the same time as the Arrival of the Darkness, a new actor entered the stage of high finance and technology. A small and insignificant free enterprise, Cybertronic, managed overnight to gain a position that their four competitors had struggled and warred for centuries to achieve — the status of being a megacorporation. Despite decades of research, both by our Inquisitors and by the other megacorporations' agents, no one hath yet been able to uncover the secret behind Cybertronic's rise to power.»

«Finally our Observers managed to force the megacorporations to stand united against the threat from the Dark Legion, and The Cartel was founded. But our hopes were all in vain — the Cartel was soon infested with their own thoughts of Evil, not much good was done and instead the Cartel became an institution for protecting the interests of the megacorporations against the freelancing enterprises.

Finally, they managed to agree on one point, which developed into the brightest new hope since the Inquisition was founded — the Doomtrooper force, solely devoted to do battle against the Dark Legions, made up from the best of the megacorporations' soldiers.»



«If ye forgive an old man a small note about these brave knights, the Doomtroopers. I am but a layman, but I cannot help admiring these young men, that so often have saved the innocent without a thought about their own lives. Verily, they are the best warriors ever to have spoken a tongue of Mankind, they deserve all my respect and honor. Even the best of our Mortificators cannot match them in open combat — I should know. I tried.»

«As the First Chronicler later carved into the gray marble of the Luna Cathedral — and may I one day be forgiven for duplicating these words—'And so did the Dark Legion descend upon us, howling with lust for destruction and corruption. Snarling and barking, the degenerate wolves bared their teeth, smelling the blood and carnage that lay ahead.'»

«Algeroth—the Lord of Technology—is the Apostle of war and destruction. From the birchchambers deep within his citadels, endless processions of twisted beasts march towards humanity.»

«The followers of Semai — the Lord of Spite — infiltrate the human societies to corrupt humanity from within. His Corruptors steal in shadows, promising wealth, glory and power to the weak of mind.»

«Ilian — the Mistress of the Void — was the first of the five Apostles to emerge from the shadows of infinity. She is the most potent in interpreting the mysterious ways of the Dark Symmetry.»

«Muawijhe—the Lord of Visions— invades and desecrates the dreams of man and nurtures the insanity latent in our minds. Spinning his webs of confusion he rules the insane and the feeble minded.»

«Demnogonis—the Befouler—brings plague and pestilence to the human worlds, thereby weakening our defenses and paving way for the forces of the Darkness.»

«The face of the Legion is truly a terrible one, but even more horrible is the brain behind it all, the dark and cunning scheme that corrupteth mankind and turneth good into evil. For centuries we have watched this — spite, malice, envy and greed — grow in human society, even in my brilliant Brotherhood. Aye, I dare claim this without hesitating. But my days are done. I hear the rattling of keys in the door...»





## MARTIAN SUNSET

Copyright © 1993 Target Games AB. All Rights Reserved. MUTANT CHRONICLES and all character names and distinctive likeness (es) thereof are Trademarks of Target Games AB





IMPERIAL™

## FREELANCER

### MICHAEL MCBRIDE

Someone said I represent the «Average Guy» among the freelancers, which doesn't feel very comforting.

Right now, I'm working on the Frazetti case. One day, Axelthorpe of the ISC dropped a note in the mail-slot, briefing me about what's going on in my old neighborhood. He also gave me Martin and Bentoni, two «dishonorables», and told us to nose around.

And what the heck, you gotta pay bills. We would get enough dough to make it through the next few months, and maybe even a bonus.

For this mission, I used the Bauhaus shoulder pads—light and flexible—Capitol fatigue pants and a pair of M13 Bolters.



### SGT. MICHAEL MCBRIDE

My name? I'm Michael McBride—friends call me Mike—«former» staff sergeant of the Imperial Special Forces. I'm 29, live in a decent two-room condo in central Luna, have no family, at least that I know of, and right now, I'm making my living out of odd jobs in the, well «security business», mainly for the ISC. A while ago, I made the headlines and appeared a couple of times on the news, but nowadays I'm hardly recognized on the streets anymore—which is just as well. You get the picture—that's me at the peak of my career. Pretty cool guy, eh?

On this picture, I wear a heavy assault combat armor Mk. III with venusian cammo, a Mk. 43 Intruder assault rifle plus an Aggressor, and, of course, the Blood Beret. You see the stripes on my right shoulder—they're my sergeants stripes.



# THE ADVENTURER

So, is there a job for you in the dark and dirty world of *Mutant Chronicles*? As a **FREELANCER** your only guarantees are action and adventure. Success depends on your skill, bravery and, of course, a whole lot of luck.

When you first set foot on the world, you'll have a questionable past and no job. The last thing you want is the suit and tie existence of the corporate world, even if it means a steady paycheck. No, you've decided on adventure, intrigue, and an occasional cash deposit in your account. Hours are lousy and danger is high. But, somehow it all appeals to you. That's why you are a freelancer.

Speaking of money, the old crowns are starting to get scarce. Time to hit the streets, drum up some business. Maybe you ought to head down to the Dugout, toss a few back and check the rumor net. Don't forget your vest and piece.

## FREELANCERS...

For the imaginative, there are no restrictions. Making money is easy, earning glory and power is harder. You will gain experience and a reputation, good or bad. Take your pick!

But you won't make it on your own. You need backup. You gather some street pals and start a Firm: **WE'LL DO IT ANYTIME!** Welcome to the world of Free Enterprise.

Whoever employs you will hire a crew of determined, hardened men. The only thing they know about you is your rep and your price. Trust just goes with the turf.

There are many unwritten laws among the corporations. One of them is that you don't unnecessarily hazard the lives of your own; why do so when there are Freelancers? Typical tasks for the Free Enterprises—you—are:

**INFILTRATION.** One method of gathering information—and not an uncommon one—is to give Freelancers fake identities, drop them off in an industrial plant or some office, and wait and see what happens. As infiltrators, you'll have to rely on your acting skills, earn confidences, and walk out with as much information as you can. Not technically illegal, but definitely questionable.

**ANTI-LEGION OPERATIVES.** Few things are as feared as the Dark Legion, since the corporations know very little about it. Agents and soldiers returning from battles and missions have carried with them parasites and infections which are totally devastating when *activated* in the cities and base-camps. People have been so twisted by the Dark symmetry that they never will be able to function normally again. And those are the ones who return.

**CONCLUSION:** Better ten freelancers in a Citadel than one corporate agent.

**DELIVERIES.** There's lots of stuff that's simply too hot to handle. Stolen goods, equipment under restrictions, kidnapped persons, physically hazardous wares, corporate secrets, and much more. Inevitably, this at some time has to travel from point A to point B, and in case of failure, the corporation mustn't be connected with whatever it is. Good luck!

**INVESTIGATION.** Also when it comes to invest-

igating things—murders, disappearances, mysterious events, abnormal financial increases, acts of heresy, mutinies and rebellions—the corporations don't necessarily want to use their own, after all, some of them might be involved, or at least suspect.

Your tasks will be gathering information and investigating clues with little or no support from your employers.

**SURVEILLANCE.** The megacorporations' agents know each other at a glance. If a person needs to be shadowed or a building observed, they use freelancers.

**EXPLORATION.** The exact flows of the Dark Patterns are as mysterious as they are many. Dispatching top agents to explore a Citadel, the Legion's trenches, a Heretic's nest, infested sewers throbbing with the Dark symmetry, etc., is a waste of valuable resources. Instead, they call for the freelancers...



**HAPPENINGS.** Somehow, the freelancers always seem to get in trouble, whether they attract it or create it. They witness murders that are supposed to have no witnesses, they are constantly caught in the middle of car-chases, they are mistaken for inter-corporational gangsters in the Inquisition's Black Book, their friends are kidnapped and their relatives disappear. That's life, especially in this world.



## SURVIVING

Your daily life will look quite normal. You have a place somewhere, probably a car, and a decent bank account. You can choose between doing your own cooking or eating out. You go to the bank once in a while to pay your bills, get your morning newspaper, watch TV, pop a top and relax.

Boring. This is hopefully not why you bought this RPG. To make a long story short, don't bother too much about remembering to eat, going to the bathroom and filling up your car. Let's move!



## EMPLOYEES...

If you get steady employment, your situation is slightly different than as a contract freelancer. You'll be supported by your bosses, handed information, money, weapons, equipment, backup and maybe even military support. But the demands on you will also be higher. And if you LET them down, they will KNOCK you down...

Your tasks don't differ much from those of the freelancers, but you trade a steady paycheck for the

natural thing to do, advance in the organization, and even while it does happen from time to time that freelancers are hand-picked and put right into the top slots, this won't happen as long as you're there, will it?

### COMPETITION

This leads us into one of the most vital things about being employed—competition. You'll soon notice the corruption, jealousy, greed, ruthlessness and dishonor among your colleagues.

You'll soon notice that there are certain files in the office that mustn't be opened, people who are never seen, accounts never touched, people never promoted, deals never fulfilled.

You'll soon notice the whispers in the corridors, the faint audible clicks on your phone-line, the hidden mikes in your office.

Suddenly your budget has been decreased by 50% («We have to make some cuts in our expenses...»). Authorizations for your ID are suddenly canceled. Relocating your office and equipment, and expressive «no-can-do's» from your bosses when you've finally reached the goal in your work, occur more and more.

It's not easy being employed when the primary objective is to satisfy the bosses. But at least you'll have a steady income.

### AREAS OF WORK

Anyway, your area of work could be just about anything. News-agencies; morning-papers, military forces, security bureaus, police forces, fire-fighters, research plants, PI bureaus, just about any place where there's some action.



### PAY DAY

One of the unwritten laws among freelancers is CASH ONLY, preferably in Cardinal's Crowns. That's it, and that's that. Either you get paid when the job is done, or, for longer jobs, you have monthly pay. It is common practice to get a small payment in advance, usually around 20% of the total bill. Some well reputed freelancers, known for being reliable and efficient, can cut deals like having any court costs, balls, health care expenses and insurance paid, etc. You'll be lucky to live that long.

option of saying no. As an employee, you do as you are told. With the higher ranks of society involved, the game is much bigger.

And above all, you have before you THE CAREER. It's the



# LUNA

Circling the wasted Earth is the greatest city ever constructed, spanning large parts of the surface of Luna and even burrowing deep into the heart of the moon. Luna, once just a spectral orb in the night sky, had become the new home for man.

This is the city of Luna. From the Ancient Quarters, downtown Luna, the worlds of man are ruled by the enlightened Brotherhood and the often corrupt and scheming megacorporations. Outside the Ancient Quarters, into the Perimeters, the city has grown to cover ten times the area of any city man has ever known, and it is still spreading like a cancer.

Luna is an open city, regarding architecture, mind and restrictions. You can travel freely almost anywhere, you can talk to anyone and get a straight answer, and most of the time, you'll see the sky. However, you'll notice sharp contrasts between the different districts, mainly due to the living standards. As always, the rich have gathered together in their own areas, the factories have been clustered away from where people live, and shopping districts have been established to more easily attract larger numbers of people.

## LUNA CITY

Luna is the home of millions and millions of people, and despite the fact that there is little *status* in living at the center of the world, people from every branch and level of society can be found. All the megacorporations and most of the more prominent free enterprises have their head offices here, and the corps of officials, agents, managers and businessmen is HUGE. And since they all

need people around to take care of them—the service sector, is even larger.

Just surviving the day is no big deal—most parts of society is pretty smooth and simple. The difficulties begin when you start messing things up. It's not a good idea to make enemies among the megacorps.



## THE «ONCE HIGH-TECH SOCIETY»

With the onslaught of the Dark Legion and the invisible influence of the Dark symmetry, society changed drastically, many electronic machines could no longer be trusted; at best, they simply broke down. At worst, they ran riot and became the bane of many who put their fate in the hands of the deceptive and incomprehensible technology.

But still, the know-how exists. The industrial robots are still there, disconnected and stripped of all their chips. The gigantic spaceships that carried man to the edges of space still exist as hollow skeletons of the past, the computers that ruled the society of humankind are stored in museums and protected from the Darkness. Blueprints of IC-cards remain in the archives, designs of laser-weapons and assault satellites are meticulously filed, out of reach of the competitors, until the scientists and inquisitors can find functional ways of screening the Dark symmetry.

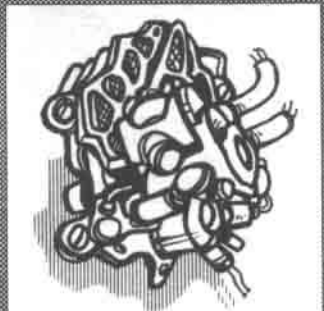

## OUTLOOK

Luna as it is today was built on the foundations of the early colonies. It was logical that the construction of the new city followed the basic structure of the settlements and Luna was initially constructed mainly under ground. Stronger structures were devised against natural hazards and allowed the city to surface and develop in a more conventional way.

Seen in profile, Luna could be compared to a gigantic, lone volcano, slowly rising higher and higher to finally, in the center, rise sharply in a feeble attempt to slice the sky. Here and there the spires of Cathedrals pierce the slopes like darning-needles; the tops of huge monuments can be seen scattered along the hillsides like decapitated heads; parks and rambling areas can occasionally be seen as moss-growths; and where the volcano rises from ground level, strings of smoke rise from innumerable chimneys, and the constant rumble from the city creates the impression that the volcano might erupt at any time.

## THE ANCIENT QUARTERS

As in most cities, the richer parts of Luna are concentrated in the older areas. The further under the surface you go, the more wretched the surroundings become.

The central parts of Luna were designed by a new cadre of architects, the new romantics. They returned to





## CRIME AND PUNISHMENT

Luna is a liberal city, which reflects in the laws and regulations, but they vary a lot depending on the victim. Carrying arms is not prohibited, but without a special waiver, you may only use them for self-defense. Certain areas are restricted for unauthorized citizens, but the enforcement of this also varies. Of course, all kinds of unnecessary violence and seizing of others' possession (i. e. burglaries, muggings, thefts) are strictly forbidden.

The punishment regulations are also a web of paragraphs and exceptions. The most common punishment is on-the-spot execution, as most law enforcers fire first and ask questions later. Too many policemen have been killed to take any chances. Otherwise, common sentences are hard labor (for years) or deportation. Fines are rare.

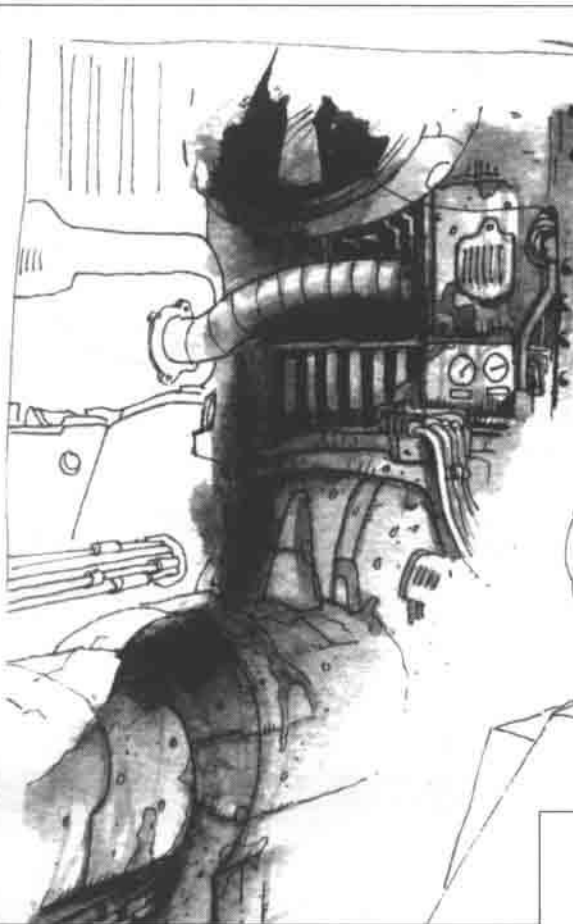

older values and created a monument to lost times. The architecture is massive and the buildings that make up this older part of Luna are huge behemoths of black marble, stone, steel and glass. Their heights vary. The highest sky-scrapers compete with the Cathedrals, stretching hundreds of meters into the skies.

Centered around the Tower—the enormous First Cathedral of the Brotherhood and the home of the Cardinal—the city spreads out like a disease. The Tower is the highest building, reaching towards the sky like an enormous spire, several hundred meters high.

Around the Cathedral the megacorporations have made their homes. Offices and research facilities abound, as do high-class shopping centers and luxury entertainment palaces. The areas here are totally under corporate control and the security and surveillance is heavy.

## THE PERIMETERS

The area between the older parts and the industrial zones along the city's edge contain the largest portion of inhabitants. People live here and work for minor freelancing firms and at the industrial areas and the ports, trying to get by without trouble. Out here, the buildings and apartments are mostly small and uncomfortable and many people sleep on the streets. The dismal pattern is occasionally broken by magnificent parks and artificial lakes, or by fashionable villa areas for those few who can afford to escape the gloom of the streets.

But here can also be found the shady parts of human civilization. The nightclubs and bars are frequented by criminals and people who want to operate without

attracting too much attention. Entertainment of all kinds can be found, both on the streets and inside the worn walls.

It is also a lawless area. Unwritten rules govern much of what happens here and the Cartel leaves the area to govern itself. Only in cases of major riots or insurrections do the megacorporations or the Brotherhood bring in their own military forces to quell the disturbances.

Life in the Perimeters is harsh and unforgiving. Here, the city is darker and colder, shrouded in steam from leaking pipes and coughing machines. The blue light of the street gaslights throws distorted shadows across the walls and people flutter like ghosts between the archways and narrow alleyways. Wheezing vehicles make their way through the confusion, their heavy engines grinding and hacking.

## THE INDUSTRIES

Southeast of the city and close to the ports lie vast industrial complexes. This concentration of heavy industry has no equal in the world. Stretching on for kilometer after kilometer, this area is larger than most other cities. It is rivaled only by the industrial might of Mars.

All different types of industries are represented, and in spite of the advanced technology available today, most work is still carried out by a human labor force. The jobs



are hard and dirty and pay is poor but the need for money keeps the work pool filled.

The demands for profit by the megacorporations ensure the running of these industries around the clock. In the tunnels under the surface, diesel and steam-engines connect the industrial zones to the ports. There the gigantic transports are constantly shipping newly manufactured goods to the corners of our system. The heavy pollution and the constant din of the machines makes this area hell to work in.

And even so people are living amidst the smoke and despair. Some workers never leave their posts and only rest between shifts. Few enjoy their work and most people dream of another world, another life, maybe in the financial world, maybe in the military, maybe on the other side of the law, or even in the embrace of the Dark symmetry. Only dream of something better and faith in the Brotherhood keep the citizens of the industrial areas from falling into total despair.

## THE PORTS

The major ports of Luna can be found in the more remote parts of the city. A few older and derelict ports exist within the city itself, but these are seldom used except by smugglers or people who can't afford the charges at the larger ports.

Dirty and under constant construction and repair, the port areas are huge complexes dedicated to the arrival and departure of the ships that traffic between the planets. All ports have the facilities to maintain and repair ships and guard them fiercely.

Most ports belong to the different megacorporations. A few of the ports are independent and run by freelancing firms and companies. These ports are not as tightly secured but still have a sizable force of guards and mercenaries to prevent any trouble. They are often used by smugglers and illegal immigrants to gain entry to Luna without having to pass through the normal channels as

well as providing escape routes for those who have made enemies within the Brotherhood or the megacorporations.

The majority of the ports are also self-sufficient, to prevent tshutdown in case of problems in other areas of Luna or anywhere else in our solar-system.

## THE MINES

Most of the early colonists' original constructions were mining settlements situated under ground, to provide protection against the meteorites that once pounded the surface. The major part of this ENORMOUS system of mines and settlements is still there; some of it has been used for the Underground lines, some shafts have been used as dumps, others as sewers or ventilation tunnels, and thousands and thousands of entrances have been plugged.

But most of the old mines are still there, empty or providing shelter for the homeless.



## SPACE TRAVEL

The only purpose of this passage is to enable the GM to get the characters from point A to B. Space travel is not a vital part in *Mutant Chronicles*, and therefore we don't detail it—especially since it is almost perfectly similar to today's charter travel. You go to an air(space)port, check in your luggage, board the air(space)craft, take off, and a while later you'll find yourself in a new place. Travel times (check-in, boarding, etc., not included) and costs in crowns are:

Distance	Travel time	Cost
Mercury-Venus	5 days	5,990
Venus-Luna	4 days	5,490
Luna-Earth	1 day	3,990
Luna-Mars	8 days	6,690
Mars-Asteroids	19 days	19,990
Asteroids-Jupiter	18 days	*
Jupiter-Saturn	32 days	*
Saturn-Uranus	72 days	*
Uranus-Neptune	80 days	*
Neptune-Pluto	70 days	*
Pluto-Nero	6 days	*

\*: per agreement.

## ARCHITECTURE

The architecture of Luna is massive and the buildings are huge behemoths of black stone and steel. Covering the façades are statues and gargoyles and enormous tubes and outlets for the steam used to heat many buildings. The buildings are connected at many levels by stone bridges or rusting iron steps. The further out you get into the Perimeter, the lower the city profile is, and therefore many prefer to live here, in the light and open areas. Then again, the further away you get from the Ancient Quarters, the more hazardous the environment gets.

Downtown at night, the streets are shrouded in the cold wet fog that spews out from the ventilation systems when the temperature falls. The streets are lit by gaslights, giving the buildings a blue tone and throwing diffused shadows on the walls.

Another philosophy behind Luna's architecture is MONUMENTALITY. To strike the populace with the power, might and glory of the Brotherhood and the corporations, the buildings are made as imposing as possible, façades are covered with expensive ornaments, memorials are raised, archways are adorned with names of conquests and deeds—all to impress the man on the street and convince him that the Establishment is all powerful.

## SHOPPING

Going shopping in Luna is a real treat, especially if you go to the shopping districts downtown. You can find absolutely anything you want, and there's such a mix anyone can find exactly what he's looking for, even if it'll take a while.

But of course, if you're looking for something really SPECIAL, you'll have to go outside the center, to the Perimeters, and you'll need connections. This is especially true for weapons and drugs; you won't find them inside the megacorporations' security lines.

All currency is valid in Luna. The standards of the stores vary with their profitability—from crude counters in front of a hole in the wall, to magnificent shopping palaces.





## THE CARDINAL'S CROWN

The only currency in universal use in the world of *Mutant Chronicles* is the Brotherhood's CARDINAL'S CROWN. It is used everywhere by everyone, and it is always the most favored currency in stores and when striking business deals. All the stock markets use the CC, all trade between the megacorporations is executed in CCs, and it's the only currency that you can be sure is legal tender everywhere, even if the Imperial Sterling and the Capitol Dollar are also current in almost all parts of the system.

The «heads» side of the coins all carry a stylized picture of the current Cardinal, with his name and number at the bottom. On the «tails» side is the denomination and the device of the Brotherhood, «The Light and Wisdom of the Cardinals». All coins—they come in 10,000, 1,000, 500, 100, 20, 10, 5, 1 and 1/2 CC values—are made in 12 carat gold and the only difference is size and thickness.



## FOOD

The prevailing philosophy in the Luna cuisine is that food is a means of filling your stomach. Of course, there are restaurants that serve the finest cuisine on Luna, but the prices are out of range. You could spend two months' salary on one dinner.

So most of the time, people go to lunch restaurants or a street shack, do their own cooking for dinner, or maybe go to their local diner, where they are served a homely fare without any exotic ingredients. The menu looks like

it always has—though what is real and what is synthetic is always questionable. This goes for what you drink as well—but stay away from Martian ale, sometimes the yeast mutates and, well, the results aren't pretty.

The local diners are always open and serve as a meeting place for friends and family. They're often furnished with a jukebox playing the latest hits and a few arcade-machines.

## ENTERTAINMENT

So, what's up after work? You could always go to a bar or dance-hall, to a cinema, theater, museum, opera, a live-music restaurant, or whatever. People enjoy what has always been enjoyed, music, action, art and that stuff. The entertainment business is a breeding-ground for corruption—undeclared money makes up most of their profits.

But also, surprisingly, many people visit the Cathedrals regularly, to find solace in the words of the Brotherhood, to get away from the bustling streets and the stress of work, for confessions. Many also do it just out of habit.

## THE BROTHERHOOD

More than three quarters of Luna's population go to the Cathedral at least once a week, just in case the Dark Symmetry should fall upon them. Besides the Cathedrals, the Brotherhood is constantly visible, in the form of street missionaries, recruiting offices, and, most spectacularly, the characteristic Inquisitors and Mystics on the streets.

The Brotherhood has POWER. Inquisitors are more

respected than any law enforcers, people cross the street to avoid meeting a Mystic on the sidewalk, and if anyone wants to say something disrespectful about the Brotherhood, it's done in whispers.

The Brotherhood's propaganda flyers constantly warn of heretics and foul creatures of the dark, a reminder of how badly in need of the Brotherhood the common, helpless citizens are.

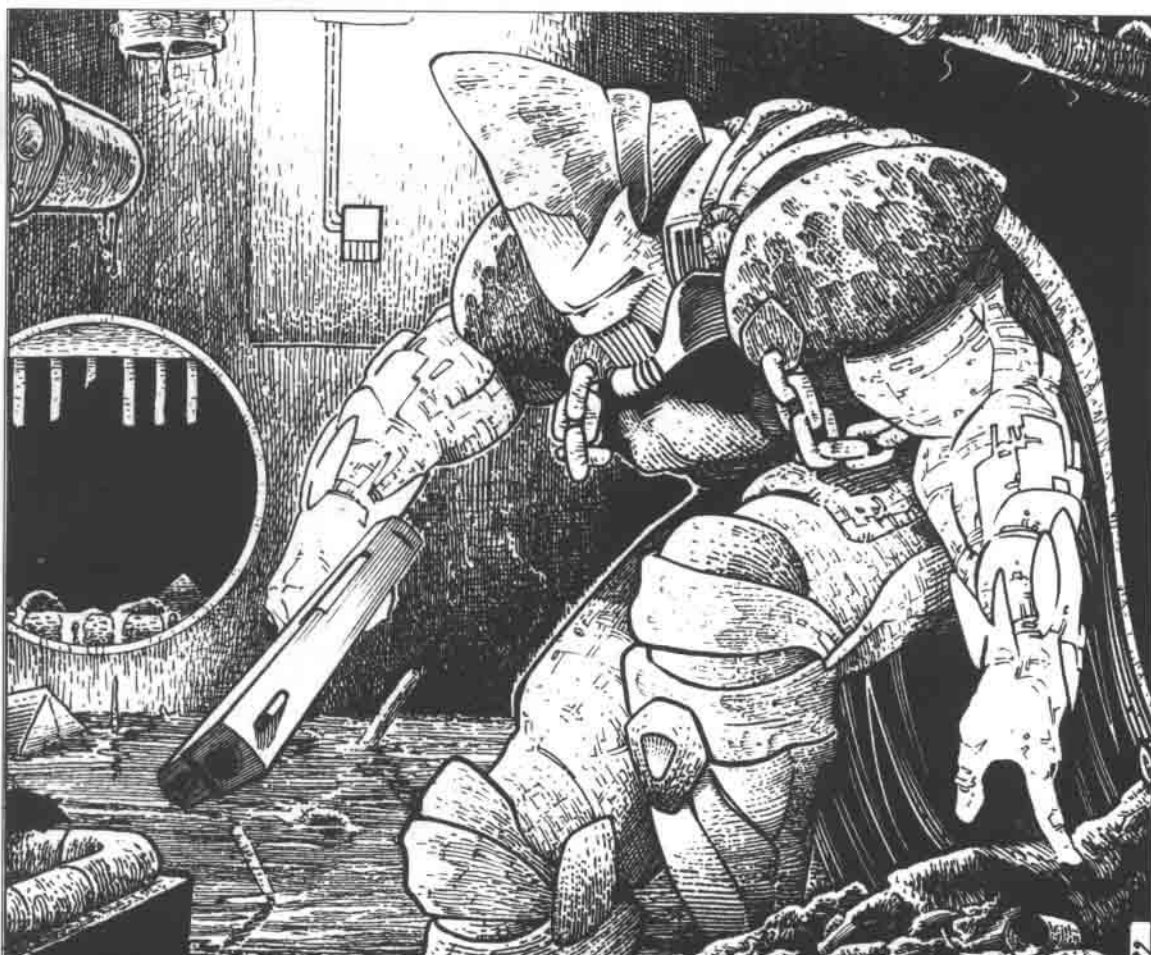

## MEDIA

The major media sources are the morning papers and TV. In the morning people switch on the radio. Every hour the Brotherhood broadcasts a special news bulletin, reporting the developments within the city and the system. Between these broadcasts the megacorporations have their own programs, informing all about their wonderful products through expensive Infomercials and providing light, corporate-produced entertainment.

Three hours every night the Brotherhood broadcasts their evening mass over the television network. At other times the corporations send light entertainment and commercials, closely monitored by the Brotherhood.

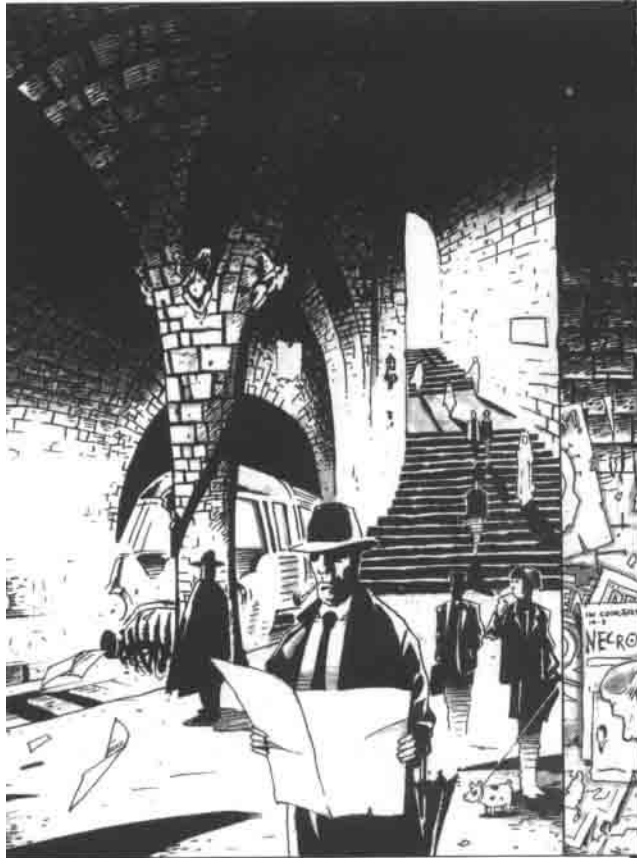

But the Cardinal's Crowns represent much more than just money. To most people, it's a symbol for constancy and consistency. For example, some people use them as charms, it is common practice to «swear by a Cardinal», and just about every soldier carries a 10,000, or at least a 1,000 CC coin around the neck, both to bring luck and to pay for medical treatment or a funeral should they be wounded or killed in action.

### THE CAB COMPANIES

There are a multitude of larger and smaller freelance cab companies fighting for the millions of people wanting transport every day.

Taking a taxi is still the safest way of using public transportation, and if you're lucky you might even get to your meeting on time. Most people make sure they are armed before entering a taxi and often use the local company where they are familiar with the drivers.

The cost for taking a taxi varies from 10 Crowns per kilometer up to 40 Crowns, so you'd better watch out and get a set price before getting into the car.

## TRANSPORTATION

Moving about in Luna is sometimes an adventure in itself. The chaos on the streets, where cars and taxis battle for supremacy, can drive anyone insane and is a clear hazard for pedestrians. Still, for shorter distances, walking is the quickest way of moving around, at least in the «safe» areas. In other areas, whatever you do, don't leave the car...

As for longer distances, remember that the city is ENORMOUS. Getting from one place to another, even within the same district, might involve several hours of waiting for the right transport to show up. The best bet is to take your own car if you don't have connections within the megacorporations, or, as a last option, take the commuter trains. Otherwise, there are always the cab companies, but they might be VERY expensive for long distance drives.

The megacorporations have fleet taxis usable by

everyone within the embrace of the company. They are often armored (heavy) and sometimes use sheer force to push through crowds or traffic jams.

### THE TRAINS

The major means of transportation in Luna are the trains, both the Underground and the commuter trains. The different lines are run by different corporations, each with their own limited responsibility for the maintenance and expansion of the line. The underground corporations all have a standing force of troopers who patrol the lines in search of terrorists and the evil creatures of the Dark Legion. They face an almost impossible task, as the rails have been expanding for hundreds of years and many of the old lines have been forgotten, providing sanctuary for the mutant scum and filth that fill the lower levels of Luna.





### THE BLACK-HOUSE UNDERGROUND STATION

Imperial-controlled Great Circle Lines' most important junction is the Black-house Underground station. This complex ties the North, Green and Great Circle lines together, and thousands of passengers enter, exit and change here every hour. The proximity to the Reading Palace and the many official buildings makes this a natural destination for many Imperials, and the Bauhaus Twin Towers are also within walking distance.

### THE TUBE DISPATCH SYSTEM

The gigantic official buildings in Luna, with tens of thousands of employees inside, have forced the architects to solve the communications problems in a more rational manner than with errand-boys and delivery firms.

Therefore, virtually all buildings have tube dispatch systems within the walls, connecting the most important departments together. In some cases, the tubes even go between buildings.

Most people use the Underground to get to and from work. The dark network of huge tunnels stretches across the city and connects the inner parts, the outer areas, the industrial areas and the ports. It is the best way of reaching different locations in the city, but like all transport systems of this kind, it has its drawbacks. The tunnels are favorite targets for terrorists and criminals who blow up the track and then plunder the trains. The

stations are crowded with pickpockets and robbers and the risk of getting into trouble is high. It is cheap, fairly reliable without too many delays, but you always run the risk of getting mugged and murdered in some dark tunnel. And they're slow—calculate that a two-day trip will involve ten to fifteen changes to get from the center to one of the remote ports. If nothing unexpected happens, that is.

## LAW ENFORCEMENT



The pressure of urban life is nerve-wracking. There is no personal space, no quiet retreat for the common man. Criminals and subversive elements place bombs on the supermarket shelves, blowing innocents to pieces. People who can't take the pressure run berserk in the underground stations, taking scores of people with them to their own private hells. Food and supply poisonings, riots, and snipers, are all part of everyday life in Luna.

Downtown, the corporations keep the order. Mostly, their patrolmen walk the streets in pairs, in constant contact with the station, which is never far away. Patrol and squad cars are occasionally seen on emergency missions, with sirens and lights flashing, using the sidewalks to get around the traffic. Alarm posts for



emergency use are randomly scattered and mostly out of order.

In the perimeters, the extent of the megacorporations' patrols is limited to the fashionable areas. Instead, freelance security companies and guards enforce the law. They often have contracts with the landlords or store keepers, including everything from constant patrol to occasional checks of locks and window hatches. They are not very heavily armed, their morale and reliability differs drastically, as do their fares. But generally, you get what you pay for.

Also, apart from normal law enforcement, squads of Inquisitors and Brotherhood troopers patrol the entire city, searching for terrorists and other criminals, as well as maintaining the peace. These imposing figures move through the neighborhoods, scaring the children, forever searching for the evil within ourselves. They act on information given by informants. Sometimes they find the real terrorists, sometimes only innocents, which is almost just as bad. The «Inkies» aren't known for asking politely before firing. They rarely interfere in disturbances, muggings, stick-ups or burglaries unless they suspect Dark influence, but as ANYONE is suspect, most people avoid the Brotherhood on the street, altogether.



## DISEASES AND MUTATIONS

Plagues and diseases hold large parts of the unregistered population of Luna in a firm grip. They vary in danger from harmless but annoying to lethal. The Brotherhood claims it's the Heretic cults that spread these diseases.

The MUTATIONS strike in a more irrational manner. All levels of society can be affected by these horrible distortions that make legs grow backwards, arms twist, spines bend inwards, skulls rot, hair fall out, etc. No one has any rational explanation to this horrendous phenomena that turns even top-executives into outcast sewer-rats.





## THE STONE ARCHIVES

Right next to the First Cathedral lies the Stone Archives, the Brotherhood's magnificent library and collection of the written word.

The building contains absolutely everything that is worth saving, from advertising brochures and children's book to dictionaries, hand-written chronicles and constitutional acts.

The enormous library is organized with a complicated system of metal punched cards, but you have to consult one of the librarians, apprentices of the fourth Directorate, otherwise you can be stuck for hours. It is forbidden to take any scriptures out of the mighty stone walls of the Archive.

## FASHION

Luna is a motley society. Styles, fashion and designs are mixed together in a melting-pot of cultures and schools. Generally, though, fashion design strives towards simplicity.

Those who can afford it wear clothes from the large haute-couture houses, hand-sewn in the finest of materials. All officials are obliged to own at least one of these suits or dresses. The standard outfit is black or brown leather shoes or boots, a striped dark double-buttoned suit, a trenchcoat and a brimmed hat. Officials and business men prefer ties.

## LIVING OUTSIDE THE SYSTEM

For those who live outside the system, on and by the street, life is a blur of violence, frustration and fear. The backstreets are filled with the dregs of humanity and death is only a heartbeat away for the unwary. They support themselves by begging and stealing, and by digging through the wastes of the rich.

Many of the inhabitants of Luna are homeless. How many is not officially known, as they are not registered by the Brotherhood and live outside the social system. The homeless can be found wandering the backstreets

at night, trying to avoid the Brotherhood troopers and the dreaded Purges. They seek shelter in the sewers and garbage dumps, falling prey to the perverted mutant bands or psychopathic vigilantes.

Many of the homeless live underground, in the vast labyrinths opened when laying out the underground railway. They live close to the filth dumped from the city and by the megacorporations, and disease and mutations are common. Bands of homeless roam the underground kingdom, preying on the weak and defenseless.

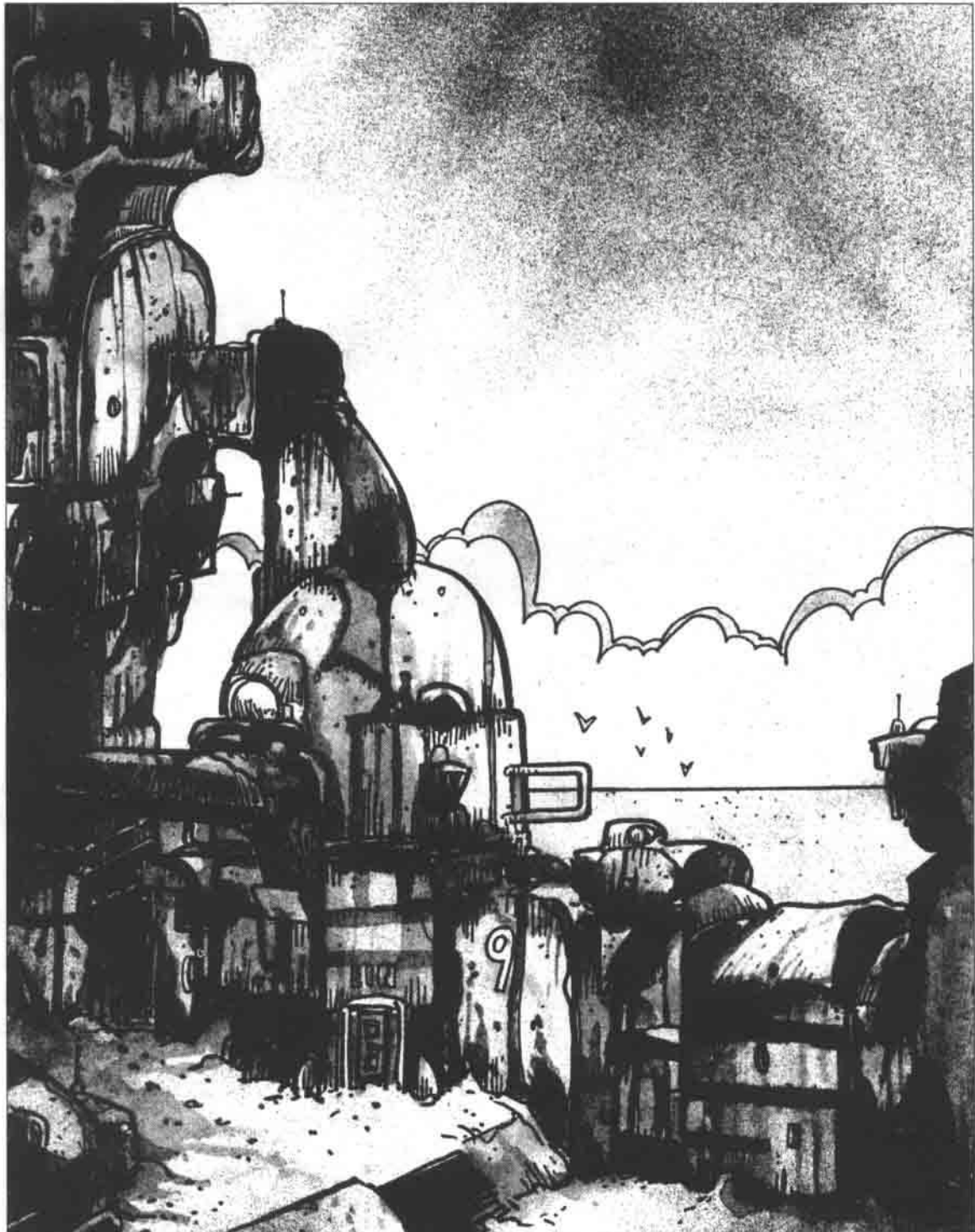

## DRESSED TO KILL

Knowing how to dress properly in the world of high-society and finance is just as important to the freelancer as it is to the corporate climbing executive.

Following is a short guide presented by Cartel Consultant Jonathan Cordinger.

*(Cordinger is presently the main player to investigations by the Johnston Commission, where he is being cross-examined about a series of union worker murders on Venus while he was a military advisor there.)*

### BAUHAUS

The Bauhaus suit is definitely the most daring outfit you can have in the corporate world. Fabrics, colors and designs all send the message of self-confidence, wealth, and social standing. The high price tag makes these suits common among media and movie stars, and are therefore considered very chic among corporate officials and eager young executives.

**SUITS.** Bauhaus suits have narrow lapels and a rounded cut to the sleeve, and the jackets are longer than those of the other corporations. Suits come with more color variety than any other brand. Dark tones of green and blues are the most common. Vests of contrasting color and bold patterns complete the apparel.



**SHIRTS AND TIES.** Bauhaus shirts come with the rounded collars and are always made from delicate fabrics. The ties come in a wide selection with striking patterns. The use of Bauhaus ties with Capitol suits is common for those who can only afford the tie and want to make an attempt at a statement.

### CYBERTRONIC

Because of the diverse fields of the employees of Cybertronic, there is no standard suit type, though both Capitol and Imperial are common. However, the board of directors and media spokespeople all seem to favor what is known as the «chic chips». These suits have also found a market among the art and media crowd.

**SUITS.** The «Chic Chip» is a fusion between a uniform, work outfit and ordinary suit. The lapels are only a straight strip of contrasting fabric with buttons to one side, giving it a very stern, militaristic look. Colors are limited to dark gray and black.



**SHIRTS AND TIES.** The Cybertronic shirt is white with a thin line for a collar. It is not recommended to wear a tie with it.

### CAPITOL

The most common suit on Luna, the Capitol suit comes in a number of styles and grades. This is the classic suit for the common man and is accessible in all price ranges. As it is so common, it is also the standard outfit for many security firms as well as the Cartel.

**SUITS.** Suits are straight and always worn with a vest of the same fabric. Colors vary but usually blues and grays are common, some with pinstripes. Many people cut the tag out of a Capitol suit and try to pass it off as a more expensive brand—no upstart executive would be caught dead in a cheap Capitol suit.



**SHIRTS AND TIES.** Button down collars on white or light colors, some with stripes. Ties are usually abstract patterns that go subtly with the suit.

### IMPERIAL

Imperial suits are considered very classy and, like Bauhaus, very expensive. However, the Imperial corporation ensures that most of their officials wear an Imperial suit by offering discounts to workers through

the corporate stores. This is another reason you see many senior citizens in Imperial suits.

**SUITS.** These suits are double breasted, three buttoned, and range in color from dark green to black. The fabric is treated to ensure a flatter look than its competitors.

**SHIRTS AND TIES.** The Imperial shirt is plain, straight and white. The ties are often a solid color with small decorative patterns. The patterns are important, as they are usually the symbol of a regiment, university, academy, or organization and Imperial citizens place a lot of importance on this sort of thing.



### MISHIMA

This corporation is similar to Cybertronic, since they often use other company suits in the field. The most common is the black Capitol suit. The Mishima suit is unique and very formal and is worn only by the high executives, but has also been adopted by diplomats of the other corporations and the Cartel when important negotiations with Mishima are involved.



**SUITS.** The jacket has the lapels of a dinner jacket, always in dark gray shades, with a buttonless (concealed) vest in either black or gray.

**SHIRTS AND TIES.** The shirt is similar to a white tuxedo shirt. The tie is wider than your average tie and comes either solid or striped in red or black.



### COST OF LIVING

The rent for a two-room apartment is about 3,000 Crowns per month. The closer to the safer areas—the Ancient Quarters and the Cathedrals—the more expensive it gets. Those are the chosen areas the rich inhabitants of Luna, both because of the safety and the cleaner air.

In the more desolate areas of Luna, rent is considerably lower. If you have to pay at all. There are drawbacks with living there, most notably the violence and the constant purging by the Brotherhood.

If you would like to buy your own apartment you would have to pay from one hundred thousand Crowns up to several million for a flat in the richer areas.

### NEWSPAPERS

There are several large newspapers in circulation. The Daily Chronicles is the most widely read, closely followed by the Independent Citizen financed by Capitol and Imperial. The Chronicles, issued by the Brotherhood, is a serious, intellectual newspaper covering the political scene and the development of the invasion of the Dark Legions. The Citizen is more spectacular and covers the rich and famous. That paper also has an extensive sports coverage. One can say that the Chronicles is read by the corporate world and the Citizen by the working classes.



## LIFE AFTER DEATH

The MEMORITAPHS serve as tombstones of all those citizens who have passed on. Early in history, the Purgers of the Brotherhood recognized the Dark symmetry's influence on the remains of mankind's dead and decided that cremation—purging—was the only possible way of permanently avoiding the corpses being corrupted. All the ancient graveyards were dug up and the corpses cremated.

Instead of graveyards and tombstones, the people of Luna raise memoritaphs of their dead; gargoyles, memorial brass plates, carvings in the stone walls, small statues, etc., all to commemorate their dead.

## BANKING

It's not a coincidence that people prefer cash before credit vouchers. The financial system in Luna is, to say the least, complicated and circumstantial. For the man on the street, that is. The banks are not designed to take care of private customers, the lines are gigantic, service slow, interests low and fees high. That's why most salaries come in cash.

## JUST ANOTHER MORNING

This day started much like any other. Sirens had kept me awake all night but around five I managed to drift off to sleep.

I got up at seven and shut off the alarm-clock. It was ringing like crazy, the little hammer beating on the bell again and again. I hate the sound. Susie was already up and about in the kitchen and I could hear her turn on the gas to fry some bacon and eggs. The floor was cold and as I slipped my feet into the slippers I looked out the window. Between the bars I could see a red rain coming down, staining the plate glass, making it hard to see outside. I knew the view anyway, the blankly staring gargoyles of the neighboring block of flats. If I opened up the window and leaned out I could see the great monument of the sacred warriors and the Blood Berets, and the great clock towering over the statues.

My head was beating after only two hours of sleep. I was at the pub too long, but I hadn't seen Phil for two years and we had a lot to catch up on.

I got into the bathroom and turned on the filters. Another ten minutes and I would have enough clean water to have a quick cold shower. To heat it up we have to use gas so I take the showers cold. Susie doesn't, but that's one of the few luxuries I'm able to give her.

I took the razor-blade and shaved in the stale water left over from yesterday. Using the rest of the water I quickly brushed my teeth. From the kitchen I could hear Susie saying that the breakfast was ready.

On the way out I stopped at the radio. It was giving us trouble again, fading in and out. I opened the panel at the back, but all the glass tubes and wiring only confused me. So I gave it good kick, and it seemed to help. The news was on and they reported from the Brotherhood mass, where the Cardinal had spoken out against the evil within our society. Then they played a few hymns. A good man, the Cardinal. Where would we be without him?

I fluttered out the Chronicle and sat down in the darkness of the kitchen, trying to at least make out the headline in the gloom. Susie had served breakfast and was getting ready to leave for work. I watched her dress and put on her hat. She was on her way out when I reminded her of her protective vest. And the rain coat. After that she had to run to catch the underground steam-train—



jees, I still can't believe they put steam-trains on our line after the latest cuts in the transportation budget. Anyway, I don't like to have her running after the train, not in the state she's in. Just another three months now. How will I be able to support them both?

I popped two slices of bread in the toaster and turned on the gas. The blue light fluttered weakly and I had some difficulties getting it alight. I could hear the rattle of the elevator as it stopped at our level. Someone pushed the metal doors to the side and got out. Then they disappeared along the corridor. I've complained about the elevator several times but they don't seem to be getting around to fixing it. I heard that Mrs. Stevens got stuck for three hours last week. If it had been a cold night she might have died. Well, if they don't do anything about it I'll make sure that the Boarding Commission hears of it.

I ate the last of the bacon and got up from the table. I had two hours to get to the job so I had to get going soon. After the shower I got out my suit and holster and started to get dressed. I finished off with the protective trenchcoat and the dark hat Susie gave me. I checked that I had all my papers in the briefcase, and brought out a large pile of grammar tests that I should have corrected last night. Then I checked the gun, made sure it was loaded and in working order. The things teachers have to go through...

# THE CORPORATIONS

And so it was that the merchants gathered together. They looked out across Earth and divided it among themselves. They built large temples for themselves and gathered their disciples. They shut themselves out from the rest of the world, and their warriors patrolled the borders of the chosen lands. Few were those who saw the splendor within the walls, and even fewer were those who emerged to tell about it. So the merchants grew in power and soon they controlled both the lands beyond the walls and those who dwelled there.

But as is the way of man without the Light of Guidance, the merchants soon started to bicker among themselves. They fought over land and gold and control of them all.

And all this they brought with them out into the young worlds, and it was this that attracted the Darkness that would soon multiply the sufferings.

— *The Eighth Chronicle, The Megacorporations and the Cartel* \ Lucretii Marcellianus



## THE MERCHANT CORPORATIONS

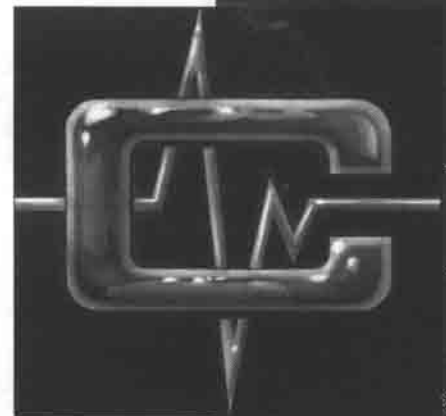
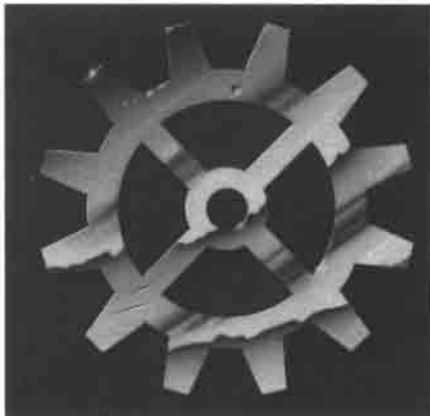

The world of *Mutant Chronicles* is largely controlled by the boards of the corporations, instead of, as in times past, the government of a nation. In fact, a man employed by the Capitol corporation, for example, might actually be called a citizen of Capitol.

Not much differs, though, except that there are no longer any nations. Society is now multi-cultural, and on all levels of society, in every branch of employment, all that matters is that you're part of a team, the corporation.

This attitude was already set before the Brotherhood entered the scene. Large companies took control of smaller enterprises and incorporated these into their own growing businesses. Large areas of land were bought

and reserved for the employees. The corporations could offer a lifestyle without starvation and insecurity. People lived their lives within their corporation. Education, housing, medicine, security, everything was provided by the employer. The MEGACORPORATIONS were born.

Four megacorporations managed to survive after the wasting wars in our solar system. These were corporations that personified certain ancient ideas and values allowing them to present a strong front towards other competitors. These four were Capitol, Bauhaus, Mishima and Imperial. Soon they were joined by a surprise new force in the corporate world, Cybertronic.

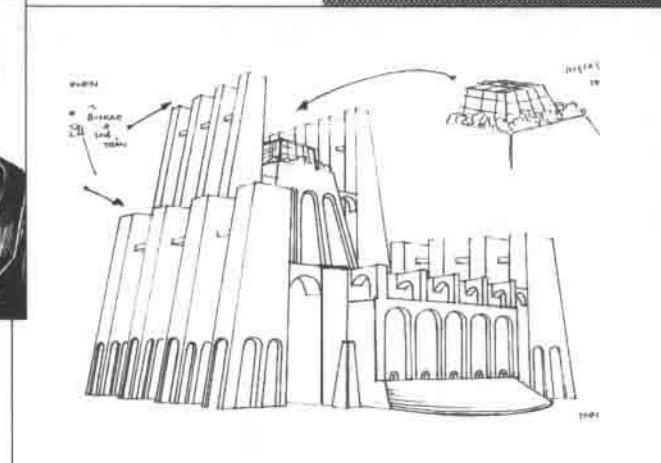



## THE FREELANCERS

Today, the five megacorporations make up the bulk of the corporate world. Their combined assets are enormous and they indirectly control other independent businesses, the **FREELANCERS**, who depend on the larger corporations for survival.

But this state of dependence is really mutual. Without freelancing enterprises to conglomerate, there wouldn't be any megacorporations. In fact, more than 85% percent of the solar-system's amassed production lies in the hands of the Freelancers; even if most of these are at least 51% controlled by one of the megacorporations.

From the upper management of their parent corporations, the Freelancers get financing and general guidelines. If they do well, they get better backing and are able to expand; if they don't perform, their credits are withdrawn and their interest rates soar.

## WAYS OF LIFE

The megacorporations are much more than just financiers and employers. They are cultures, ways of life. And since most people actually do have a **WAY OF LIFE**, they

in one way or another *belong* to a megacorporation, even if they aren't directly employed.

All aspects of life involve the megacorporations in one way or another. They provide security in the cities, supply food and other goods people need to survive, and

so on. For those employed by the corporations life is often secure and uneventful. For those outside the safety of the corporations life is more of a hazard. But at least they can entertain the illusion of freedom.

## THE CONFLICTS

There is constant war between the corporations as they all try to grow and become the single largest power in our solar-system. So far no one has gained the upper hand, and the future will see if they can stand against the onslaught of the Legions of Darkness, or if they will be engulfed by the powers of destruction.

To avoid disaster, the megacorporations have formed an organization through which they can solve their problems on a diplomatic level. This organization has been named the **CARTEL** and consists of delegations from all the five megacorporations as well as Observers from the Brotherhood. It is the purpose of this organization to coordinate the battle against the Legions of Darkness as well as to promote a greater understanding between the different megacorporations. It is hard to see which of the two tasks is more difficult.

And while the megacorporations bicker among themselves, the Darkness has infiltrated humanity and spreads like a rotting disease...

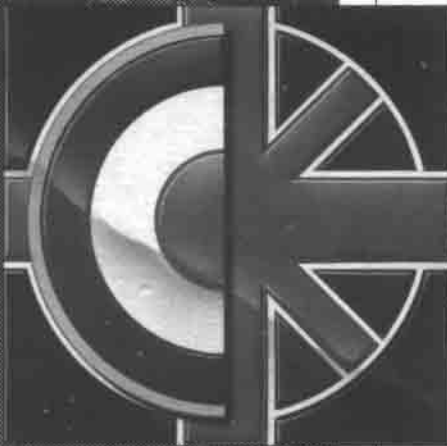

# CAPITOL

And so it was in the Sea of Tranquillity that the Pioneers raised high the banners of Capitol, conquering Luna and then Mars. And the corporation grew to dominate mankind, since their message was clear and just and without confusion; and the culture they spread was generous and inviting. Wherever they went, they established a human presence, and it was far and wide. Our Brothers followed in their trail, but were rejected and scorned and mocked by the presumptuous Capitolians.

And in this way the first signs of the Darkness were discovered, and the pioneers shivered and sought shelter in their shiny buildings protruding from the Lunar desert. Then our glorious Brothers exposed the vulnerability within Capitol and its teachings, and the giant began to stumble. Soon engaged in wars all over the solar system, Capitol was slowly bleeding to death.

But they clutched for any straws they could find and managed to continue their struggle in spite of what our Prophets and Seers predicted. The pioneers possessed a strength we hadn't reckoned with and their bravery was unequaled among the other megacorporations. This propelled Capitol towards its position as a leading power, and that same strength kept it going long after it had been written off by its competitors.

And so it was when Capitol took the last steps into the cataclysm that was the age of Nathaniel.

— *The Eighth Chronicle, The Megacorporations and the Cartel \ Lucretii Marcellianus*

## BUSINESS PHILOSOPHY

Like the other megacorporations, Capitol actively tries to control as much of the total market as possible. They strive to control all the links in the chain, from raw material processing to assembling and selling the product. Unlike the other megacorporations, they are reluctant to strike deals with independent freelancers and will instead buy anyone they need. They very rarely use armed forces when taking over other companies.

The prevailing philosophy within Capitol is to provide the perfect product for the customer, whoever he is and whatever he wants. «You name it, we make it». Hence, much of their energy is spent on market surveys, keeping design studios and advertising agencies busy. And since most Capitolians like reliable but cheap products, preferably Capitol-made, this is the corporation's specialty. Being sure a product will sell millions, much effort can be spent on development.

In the export market, the only philosophy is to kill the competitors with lower prices and greater accessibility.

«Better sold than good» is a common expression, though not publicly. And, it works. For the non-Capitol market, quality demands aren't as high, but still reasonable.

Within the field of manufacturing Capitol is engaged in most branches and the total production of Capitol goods is enormous, about 20% larger than Mishima's. The products from Capitol are often of a modern design integrating the newest technologies.

Apart from the manufacturing industries, the major source of income for Capitol is mass market consumables. Being the major force within the food industry, Capitol controls a large part of the food-production industries in the system. Backed by an aggressive marketing division, the philosophy of Capitol is to export to every corner of the system. This side of the business is also closely linked to the entertainment industry, in which Capitol wages an open war against Imperial and Bauhaus.



## THE PINNACLE

A brilliant example of Capitol's power is the Pinnacle, their Luna embassy. It rises more than 170 floors above ground, and the black steel and glass façade is constantly illuminated by large spotlights.

The Pinnacle's most important function is as the main office for the Luna administration, and is almost as large as the one on Mars. It is very well guarded and the three bottom floors are one gigantic CSS station, blending well into the surroundings.







**THE AH/UH-19  
«GRAPESHOT/  
GUARDIAN»**

This very powerful flying gunship was developed for the Capitol Air Force by Secord United, Inc., as an easily convertible assault and utility chopper. The assault version, the «Grapeshot», is used for Close Air Support (CAS), hovering in firing position hidden behind a ridge or wood curtain up to 1.000 meters from the target. The utility version, the «Guardian», is used for transport of ammo or wounded, or, with the jet-turbines, as dispatch/observation/recon/command platform.

(Values are unloaded, max fuel. Values in brackets are fully loaded)

**Length:** 49.5 m

**Crew:** 2 («Grapeshot» 3)

**Max speed:**

Standard engines: 94 (63) mph

Ext. jet-turbines: 157 (125) mph

**Action radius:** ≈ 900 km

**Combat radius:** ≈ 200 km

**Max cargo capacity:**

Standard engines: 8.4 (2.2) tons

Ext. jet-turbines: 7.4 (0.2) tons

**Storage space:**

12 fully equipped troopers (2 tons) or 1 APC (5.2 tons)

**Armament:**

4 x 30 mm twin autocannon in automatic turrets

1 x eight-barrel 25 mm Gatling in manned cheek turret («Grapeshot»)

8 x pylons for bombs, rockets, missiles or autocannon pods (450 kg each)

2 x pylons for external jet-turbines or multi-missile racks (1.800 kg each)

**Armor:** Single-layer Chodram (AV 6)



**STRUCTURE**

Literally speaking, Capitol is the only real CORPORATION of the five megacorporations. In the other corporations, power has been brutally pulled out of the hands of the original founders and placed among the aristocracy.

The Capitol management consists of a BOARD OF DIRECTORS where every single stockholder in the corporation holds a place and a number of votes in relation to his number of shares.

Every director has two areas of responsibility, one geographical and one by business branch, for example, one director could be the representative of all citizens in the Zeeland district in San Dorado, as well as being the spokesman for all Capitol-employed mine-construction workers. Even if this form of democracy isn't very direct, it is far more so than in any other corporation. And furthermore, there are no restrictions whatsoever in becoming a stockholder, except for the money required, of course.

The BOARD OF EXECUTIVES is subordinate to the board of directors and takes care of the day-to-day business, while the directors make all the important decisions.

**THE PRESIDENT**

The chairman of the board of executives is called the President, at least that is how he is commonly referred to. Although his tasks include supervising and organizing the work of the executives, his powers are far more extensive, having the final word in most matters of corporate security and finance.

The President is elected by the executives, who are in turn elected from the Board of Directors. The President personally appoints Capitol's representative in the Cartel High Council and the Security Council.

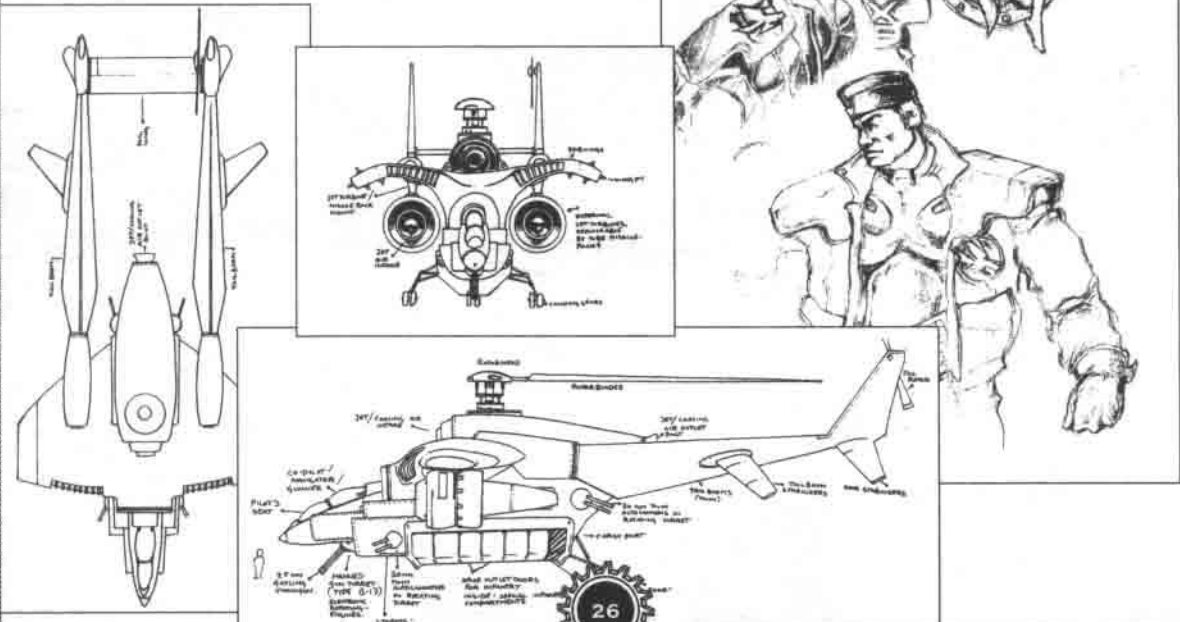



## THE CAPITOLIANS

It is very difficult to give a description of a typical «Capitolian», since the corporation is such a huge melting-pot of professions and origins. Being the largest corporation, it also has the greatest mix of employees, which in turn is Capitol's strength. Adaptability, flexibility, sensitivity and tolerance are expressions that are hammered into the employees' minds from the first day of their education.

In accordance, they ADAPT to the current circumstances to make life more tolerable for themselves, their surroundings and their fellow employees.

They try to be FLEXIBLE in order to avoid conflicts with their colleagues. They have a SENSITIVE ear to the wishes of their customers and finally, they are TOLERANT of opposing opinions and lifestyles.

At least, this is «the Capitol way» which is eagerly spread to the other corporations primarily through the media and the entertainment business, as well as through diplomatic and business channels. The prevailing philosophy is that if you treat your neighbor like you want to be treated yourself, the world will be a better place.

One important thought which hasn't really stuck as much in the other corporations, is the ability to regard oneself as a part of the whole. The other corporations desperately try to convince their people to make sacrifices, or else the corporation will suffer. Within Capitol, this mentality is only really seen within the Armed Forces.



## THE STOCKHOLDERS

A listing of the largest and most prominent stockholders of the Capitol board of Directors:

Abrams	5.2%
Gibbs	5.2%
Colding	5.2%
Hendryx	5.2%
Ewing	5.1%
Lavache	5.0%
Berenger	4.7%
Darrelmeyer	3.6%
Irving-Jorgensen	3.6%
Kell	3.6%
Wood	3.6%
The rest (679 in total)	50.0%

## THE CAPITOL DOLLAR

On one face is the Capitol logo, the swooping eagle, and on the other the value and a small note of origin, where it was minted. It comes in the following denominations: \$100, \$20, \$5, \$1, 50¢ and 10¢ and are all minted in silver. They are frequently used in the Asteroid belt, since the settlers there trade with Mars, but are very rarely seen inside Luna. 1 Capitol dollar (CS 1) = 100 cents (c100) = 7 Cardinal's Crowns.



## CAPITOL SECURITY SERVICE

CSS is the largest law enforcement company and the one most frequently requested within Capitol's areas. Their policemen and -women (around 40%) are known for being relatively just and polite, not at all acting with the same brute force and ruthlessness as, for example, Cybercurity's officers.

They are normally equipped with a light handgun and a police truncheon, but when expecting violence this is supplemented with the full range of military weapons, bullet-proof jackets and greaves, shoulderpads, riot shields and assault helmets.

Being a police officer within CSS is high-status, they have good training and are well respected by both Capitolians and visitors.

Their jurisdiction only spans outside corporate management; they are not allowed to act against the megacorporation itself, this is the work for the Internal Investigations.

## THE PRESIDENT

Charles William Colding, 46, former managing director of Colding Arms, Inc., is the single most powerful person in Capitol, and maybe even in the solar system next to the Cardinal. He is short, pale, and thin, but has extraordinary charisma and power of persuasion. Under his guidance, Capitol has increased their net total production by 2.5 percent, almost a record.



## CAPITOL ARMED FORCES

In a hostile world, ARMED FORCES are necessary. So also with Capitol, which is constantly beset by its competitors.

There are two major philosophies guiding the development of the AFC, the Armed Forces of Capitol—DETERRENT and RETALIATION. First, see to it that no one dares to attack you. Second, if they are foolish enough to try, nail them so quickly they don't even know what hit them. An effective

philosophy, but extremely expensive. However, most Capitolians think its worth it, since it is always a comfort to know you are protected by the world's largest military force.

If this belief is true, no one knows. The clashes BETWEEN the AFC and other corporate units are rare and ambiguous. When battling the only «neutral» opponent, the Dark Legion, the results aren't any better than anyone else's.

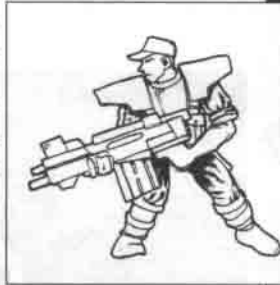

High priority goes to anti-tank and mass-destruction weapons. In both cases these are primarily air-launched. The ground forces are used to follow up air-strikes and dig in.

**THE AIR FORCE.** A day dream among most young Capitolians, the fighter pilots of the CAF are among the most reputed and glorified military personnel. They fly the best aircraft available, with the most efficient weapons, not to mention the most expensive. These aces are considered system wide to be the best pilots.

**THE GROUND FORCES.** In the shadow of the air force, the CGF lead an unglamorous and hard life. The highest motivation lies in the fact that they are absolutely necessary for the survival of the corporation, but they actually do have problems recruiting enough people. In times of extreme threats, primarily from the Legion, the

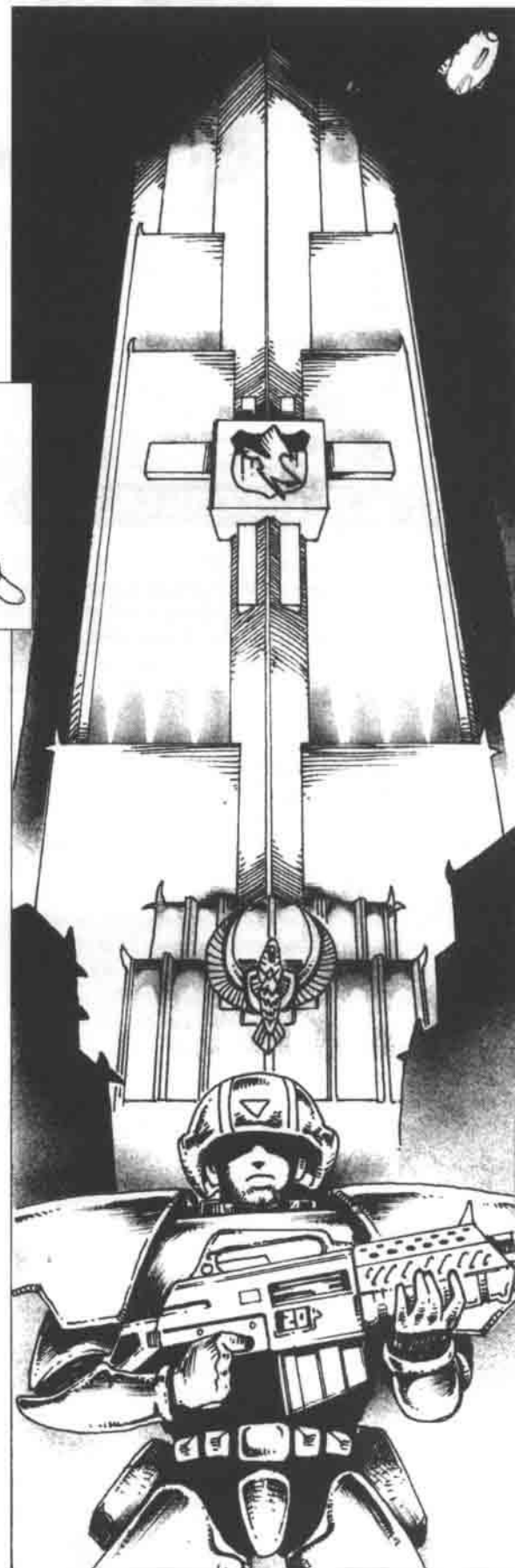
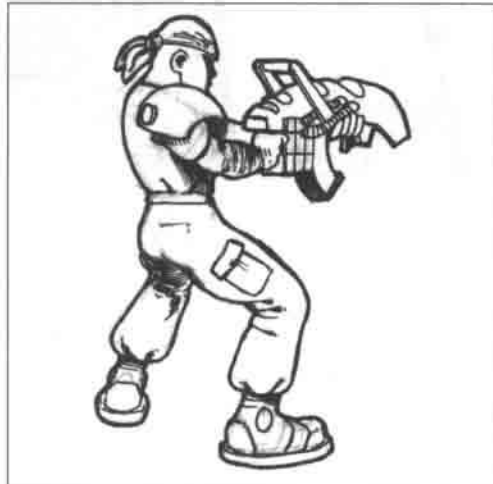

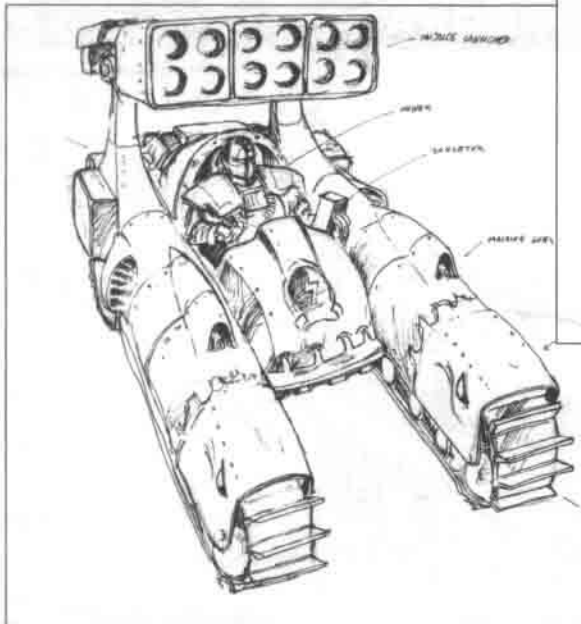

deployed in the war against Mishima on southern Mars.

## EQUIPMENT

Where equipment and technology level is concerned, the AFC is very divided. On the one hand, they have the best available

equipment, but on the other hand they don't have very much of it. And what they have is primarily concentrated to elite units and the air force, while the regular forces have to do with standard equipment, not inferior to that of their opponents, but far from the leading edge.

## UNIFORMS AND DECORATIONS



There is a great honor in being a defender of Capitol, but when it comes to awarding services for the corporation, a word of appreciation and a pat on the shoulder easily

disappears in the media flow of the largest corporation in the universe.

Therefore, the AFC extensively practices the use of medals and honor awards for devoted or extra-ordinary service. Uniforms are to be worn at all times except for leaves lasting longer than 15 days and on under-cover missions.

Accordingly, all uniformed personnel have special rights and follow military laws and regulations rather than the more stricter laws of normal civilians. Also, in most stores and service establishments, they receive considerable discounts.

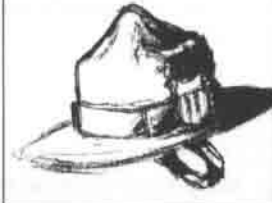

### THE SPECIAL FORCES.

For extremely important missions, the Capitol special forces are used, but this is actually an area where Capitol stands at a disadvantage against their competitors. Resources are funneled more to the elite units in the regular infantry. The most reputed of all Capitol special forces are the FREE MARINES, deployed all over the system, the SEALIONS, operating in the Graveton archipelago on Venus, the SUNSET STRIKERS on Mercury and last, but definitely not least, the MARTIAN BANSHEES,



## COLONEL JOHN FITZMARTIN

One of the greatest heroes of the Capitol Armed Forces, Colonel John Fitz-



Martin, 31, was given the Chairman's Legion of Honor some six months ago. Here we see him in full pilot harness, with the characteristic leather flying suit and the white fighter pilot helmet. On his left shoulder pad can be seen two «hundred kills-badges». The yellow scarf is unique for the pilots of FitzMartin's fleet of aircraft, the F/A-99 FELINE deep penetration/ deep interdiction jet-fighter.

## CAPITOL SWORD OF HONOR

This sword is purely a token of position. It is given to officers who are awarded the Chairman's Legion of Honor for their battle valor and usefulness to the corporation. Unlike the Legion of Honor medal, the sword CAN'T be awarded to civilians.

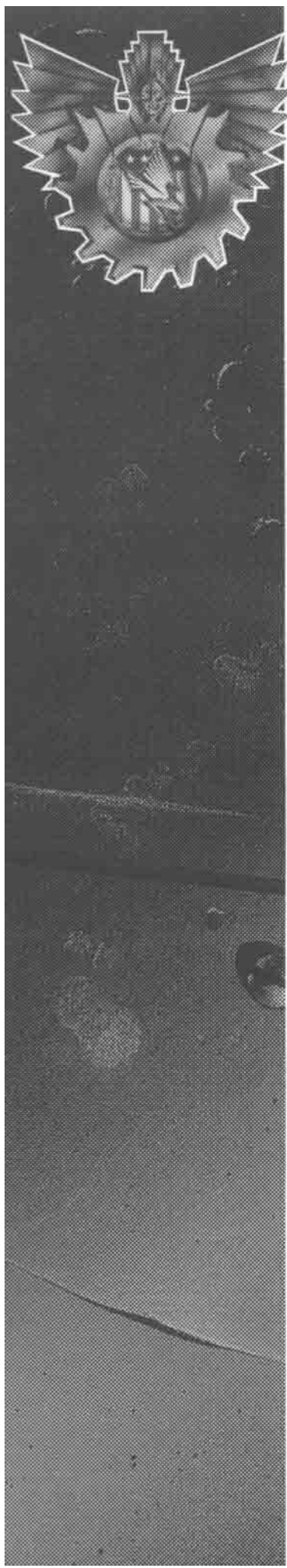

## MARS & SAN DORADO

Mars, the red planet, the home of the pioneers, is—at least from Capitol's point of view—«Capitol turf». They control almost three quarters of the planet's surface, with the last quarter made up by a few Imperial naval bases and settlements, a dozen Mishima and Bauhaus cities and a handful of Citadels. Despite decades of sieges, assaults and battering, not even Capitol has managed to eradicate the Dark Legion's forces from Mars.

Mars is less than a third of Earth's size and mostly covered by barren, rocky wastelands and deep, black, almost lifeless oceans. Development has come to a halt because of the corporate wars.

### SAN DORADO

Cradled between the mighty Kirkwood mountains, the slopes of the gigantic Mariner crater and the shores of the Sea of Tranquillity, lies San Dorado, Capitol's «capital». After Luna, it is the largest city in the solar system, containing most of Capitol's assets and large legacies from the other megacorporations.

It is impossible to set a certain profile to San Dorado, except maybe by calling it an well-rounded city. It contains all kinds of industries, factories, service establishments, official buildings and offices. The northern outskirts and the areas some hundred miles north of San Dorado are characterized by thousands and thousands of oil wells, their pump-towers stretching hundreds of meters towards the clear-blue sky. Bordering these oil-fields, life-important for Capitol, lie the Effenberger mines, containing A LOT of Capitol's raw materials.

The patch-work of avenues and streets downtown lie in the shadow of skyscrapers containing both offices and apartments for the five corporations, primarily Capitol. The tallest are more than a hundred stories, providing places of work for tens of thousands of people.

San Dorado is said to be the most well-organized megacity in the system, but when you are standing in the street it is impossible to see how. Looking up, the sky is barely visible due to the elevated highways, intersections, passages and rails running between the buildings. The street beside you is completely jammed, if you can see the street at all. Normal conversation is impossible. Everywhere car horns, whistles, shouts and screeching tires are heard. It is the HEART of the largest corporation in the world, and you can feel it.

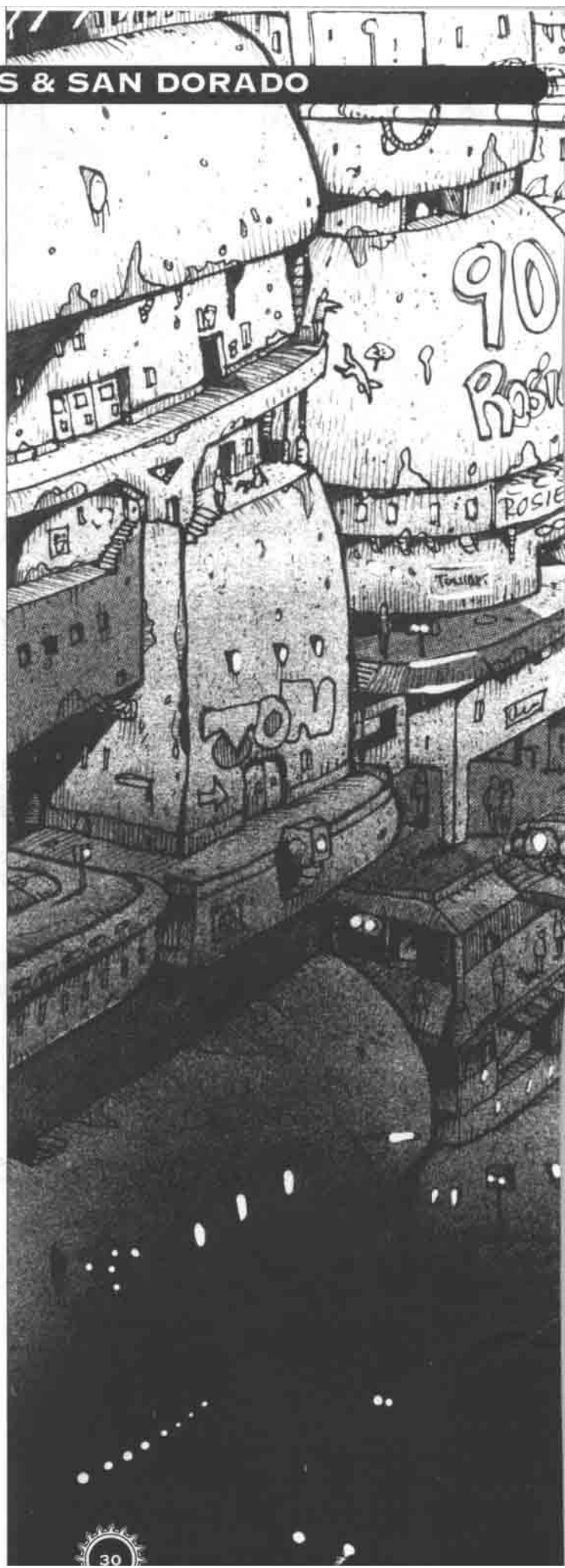

## THE «DOUGHPITS»

There hasn't been peace on Mars since the first Imperial soldier set foot on its surface. Since then, Mishima and Bauhaus have followed in Imperial's steps, establishing both military outposts and production settlements, often combined.

And when Darkness appeared in the human worlds, it didn't take long until it showed its ugly face on Mars. When the foundations of the first citadel were laid out in the mountainous areas on the exact antipode of San Dorado, Capitol forces rushed to crush them before the Legion was able to spread.

But internal struggles, deceit and foul play stopped the intervening forces before they even reached their

target. Imperial anti-aircraft downed four fifths of the strike-force, for unknown reasons, creating disastrous consequences.

The citadel of the nepharite overlord Saladin was finished and fortified beyond what human technology could defeat, and there were more citadels to follow. In these remote warzones, a grievous and never-ending battle rages, occasionally quiet and almost forgotten, occasionally shaking the entire planet and rocking the skyscrapers of San Dorado.

The citadels on Mars are all completely surrounded by trenches, moats, walls, fortifications, guard-towers and electrical barbed wire fences. It is a resource-devouring job, but it has to be done.

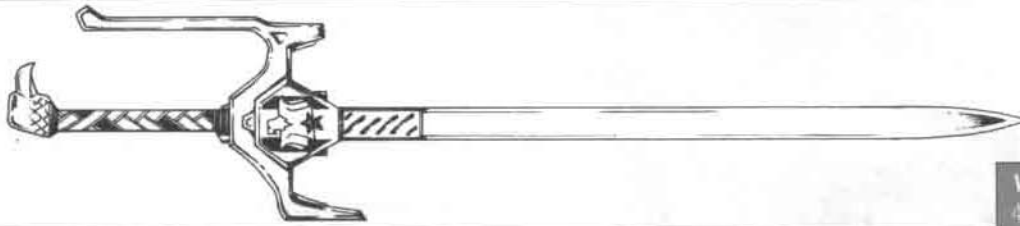

W	L	STR	Dam (1H)	Dam (2H)	Cost
4.0	115	9	1d4	1dB	NA

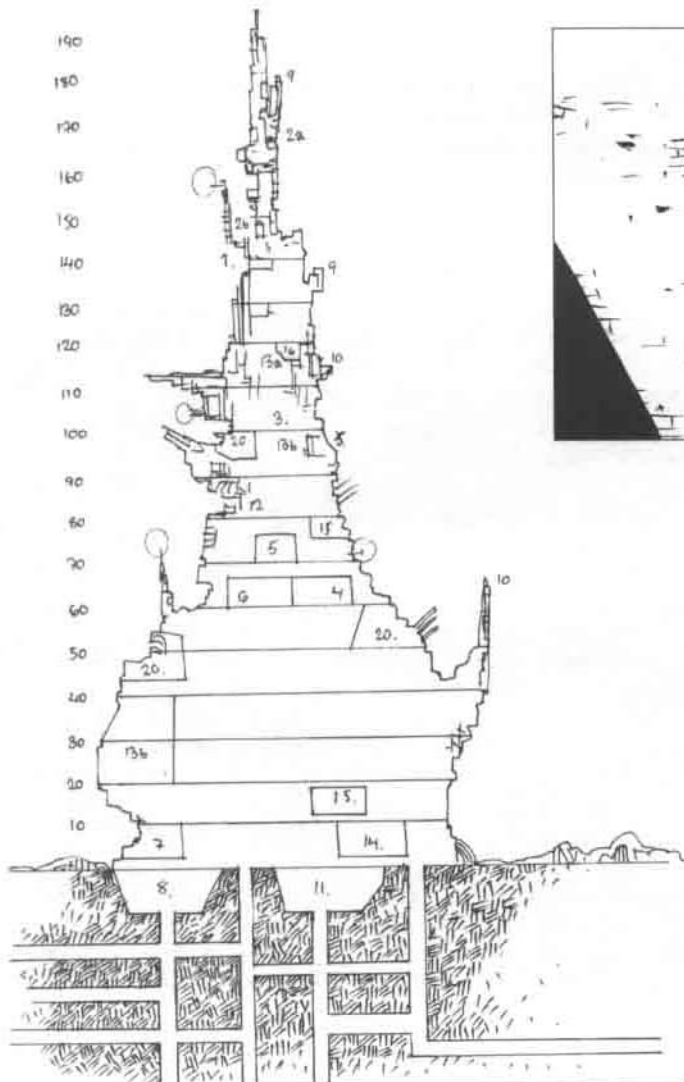



## THE PARTNERS



The Capitol way is clearly reflected in their foreign affairs and diplomatic relations with their competitors. Knowing economical success rests in open-mindedness and diplomacy, even Imperial must be forgiven to some extent.

**MISHIMA.** Mercury and Lord Heir Moya's business empire is Capitol's largest export market and the corporations are rarely involved in open hostilities. Even though completely self-sufficient, Capitol imports a lot of Mishima's cheap, high-quality electronics to fill the shelves in the low-cost super-markets.

**BAUHAUS.** The expensive and extremely high-quality products of Bauhaus will always find their buyers, also within the Capitol business empire, even if they are restricted to the upper corporates. In turn, Bauhaus receives a lot of their raw materials from the Capitol mines of Mars.

**IMPERIAL.** Even though they have limited contacts, the Capitol businessmen have never really managed to cope with the Imperials. Had it not been for the unquestionable economical gains of being partners, they would hardly speak to each other.

**CYBERTRONIC.** Not the best of friends but certainly not enemies, Capitol and Cybertronic have extensive business dealings. This is maybe where «the Capitol way» shows most clearly—no other corporation have such open-minded relations with Cybertronic.

**THE BROTHERHOOD.** Capitol is unique in the sense that they don't have an official opinion about the Brotherhood. The Brotherhood respects this, maybe because of the fact that ninety-nine Capitolians out of a hundred are devoted to the word of the Brotherhood anyway.

### A SIMPLE REQUEST

Under the overcast sky, the wind ripped into the clothes of the four men assembled behind the Loughton Monument in Pioneer Park. Two were dressed in the black and blue uniform of the Capitol security forces and stood close together, engaged in conversation. One of the men pointed at the others present, two men dressed in the bulky jackets of the Cartel. Their backs were emblazoned with the letters BEI. The letters flashed yellow in the reflected light from the headlights of the large van parked nearby.

«Sir, these are officers Clayton and Johnson of the Bureau of External Investigation. They have requested that they should speak to you in private.»

The older man, carrying the insignias of a general, carefully examined the two civilians. Then he seemed to reach a decision and turned to the sergeant.

«Leave me until further orders are given.»

Sergeant Lewis acknowledged the order from his superior with a salute. Mystified by the circumstances the soldier retreated to the van that had brought him and the general there.

The general motioned the two Cartel officials away from the ascending car, waiting until the low, rumbling din of the large V12 engine disappeared into the distance before speaking.

«What is it I can do for you, gentlemen?»

Clayton turned towards him, a scornful smile on his lips.

«You know what the matter is, General Wayne. We are in need of troops in the Freedom Lands, to cleanse the area of the infestations.»

Wayne noted the smile and carefully made a mental note to make Clayton regret his insult sometime in the future. Right now the demand from the Cartel man disturbed him more.

«I am under orders to provide you with the necessary help. But we need to know what we are up against this time. I don't want another Lorn Valley, I don't want to lose my men.»

«General, I truly am sorry. We can't give you any information about the area apart from what is commonly known. Believe me, it wouldn't make any difference if you knew.»

Angrily Wayne turned from the Externals. He threw his arms in the air.

«When are you going to realize that we're dealing with human lives. You want me to send Capitol men and women to their deaths so that you can... do whatever it is you're doing.»

His voice was strained and his gestures agitated. The reply from Clayton the opposite.

«It has to be done. The Cartel knows what it's doing. In order to save the many we have to sacrifice a few. I hope you are not going to oppose this operation, General Wayne?»

The last question was delivered with an edge of threat in the voice. Wayne's shoulders slumped, and he turned again to Clayton and Johnson.

«I'll lead them myself.»

### SACRIFICE AND PREVAIL

Charles W. Colding looked out over the assembly. The people gathered there were his children, his followers and his brothers and sisters. They had placed him where he was today, at the pinnacle of power. In a position to change the future, to command the forces of freedom in the final battle against the Darkness.

He rose to thunderous applause and approached the microphones of the assembled press. This was a moment shared with billions across the system, caught in a historic climax, about to see the curtain fall and unveil a brighter future. Colding adjusted his tie and fixed his gaze on the large cameras relaying his image to television sets on distant worlds. He smiled and searched his memory for the opening phrase.

«Ladies and gentlemen, representatives of the press, and viewers at home.» His broad gestures encompassed all present, who observed the man in focus with such interest that the air seemed charged with electricity.

«We stand here today at a crossroads in time. The task to chose the way was given to you, the people of our great corporation. You had the choice of trudging on in the same dreary path, without light or comfort, or take a new, uncertain route that could lead you to the light at the end of the tunnel.»

Colding raised his voice and regarded the assembly with such devotion that it brought tears to the eyes of many of those gathered.

«And I am proud to see that you chose to fight, to throw out the old, I dare even say decrepit, representatives who have spent the last years bending like a weak sapling as the wind changed. They have sold out our glorious standards and they have let the Darkness creep upon us.»

At these words Colding formed his right hand to a fist and banged it on the table in front of him. The left hand was raised in the air, also clenched.

«But you have told them your wishes. You have said that it is enough. We do not wish to see our great corporation, built by our ancestors and ourselves, sold out, destroyed. You have chosen







to fight and under my guidance we shall fight. We shall continue our quest and make sure that we remain the largest free power in the worlds of man. We shall provide the light of freedom to others and set a shining example for all to follow.»

Colding made a dramatic pause as he brought his hands together in front of him.

«But it will be difficult. Many will have to make great sacrifices for the good of even more. These sacrifices will be made in the name of freedom and all that is good in man and will be remembered forever. I am now making such a sacrifice. I know the task will not be easy and I will work day and night, until I fall fighting the Darkness or until I succeed. We all will have to sacrifice to prevail. With these words I wish to remind all my brothers and sisters of the difficult times ahead, but also of the hope you now have and the secure knowledge that whatever might come, our corporation is founded in such strong values that it will always prevail.»

Lowering his head he humbly announced:

«I hereby accept the position as the Chairman of the Capitol Corporation Board of Executives.»

### LIBERATION

A shudder ran through the length of the landing craft. Sergeant Miller checked his chronometer and shouted out the orders to the grunts.

«Okay, marines, look sharp. I don't want any bull when we hit. Clean and quick, by the book. No screw-ups like last time. Check your weapons. Moore, you go point, Gibbons and Jones cover him. The rest drop according to Delta-formation.»

Then the craft shook as it hit the ground. Instantly the hatch popped open and the marines started moving.

With the skill and experience of a veteran, Moore took the lead, cradling his heavy M89 support gun. He surveyed the area and constantly conveyed a flow of information to his combat coordinator.

«It's a small clearing, 25 meters diameter. Surrounded by trees, single rocks strewn across the area, two... no, three bodies, all Free Marines. Weapons removed.»

Gibbons and Jones moved up after Moore, scanning the area with their surveillance equipment, weapons ready. The distant voice of the combat coordinator sparked in their headsets.

«Watch out for enemy troops, possibly armed with Capitol weapons, probably an (Eighty-niner or an (M606). Suggest extreme caution and that you leave the area as quickly as possible.»

Miller followed the last two marines out of the craft. He didn't like the set-up. He only had ten men with him, and only three of them had any previous experience. The last squad that had been sent on recon had disappeared, but the generals had decided to go ahead with the operation anyway. This made Miller feel uneasy. It indicated that the officers knew something about the situation that they were reluctant to tell the soldiers. Only the Cardinal could know what fate had in store for them.

The squad quickly followed the heavily armed Moore and were accompanied by an intense whining sound as the engines of the landing craft started up. The hatch closed and the craft lifted from the ground.

Miller saw it disappear into the air and felt an intense wish to again be under the protecting guns of the armored landing craft. Then he heard Moore cry out over the intercom.

«Enemy close and closing.»

The calm and concentrated voice of the combat coordinator sounded in the headsets of the marines.

«Two squads at twelve and ten o'clock. Closing fast, probably lightly armed. Estimate 15 soldiers. Difficult to get a fix.»

Miller quickly moved to the front. This was what he was trained for, lived for. The adrenaline kicked in and he exchanged glances with Moore and Gibbons.

«Alright troops, shape up. Take cover at those stones. Short, controlled bursts... and remember, it's them or us.»

As the squad moved into position they threw furtive glances at the surrounding forests. The liberation of Freedom Lands had begun, but none of the marines knew who they were liberating, or from whom.

## THE FREE MARINES

Free Marines is the nick-name for specially trained rangers, elite soldiers with at least two years of active duty, three battles behind them, recommendation for promotion, and in addition, they must all have received the Chairman's Legion of Honor. With all this in their file, they have earned a second chance—all soldiers in these units have faced court-martial for disciplinary problems—insubordination or the like—and been sentenced. They don't have very much else to fight for than the restoration of their personal honor. Accordingly, the nature of their missions requires a motivation above the normal.

The Free Marines are used for operations FAR behind enemy lines; ambush, rescue, sabotage or infiltration. Their standard method of deployment is either to be air-dropped behind the front, or to dig in and let the enemy roll over them, then pop up and harass the enemy from behind. In these missions, they have no one commanding them from an outpost, hence their nick-name. Not that anyone could control them, but experience has showed that they are most effective when acting totally independent.



CAPITOL™



## THE INFANTRY

Shown here is a typical infantry trooper of the Capitol Armed Forces. He is dressed up in Body Double Protection, Inc.'s «Tortoise HFPS-M94 Heavy Full Protection Suit», the standard armor of the Capitol Armed Forces' heavier units. It has some unique features :

- First, several shock-sensitive autoinjectors containing life-supporting and anti-toxins have been integrated, to enable the trooper to fight on and survive even when critically damaged.
- Second, it is treated to resist even the engulfing flames of weapons like the Hindenburger incinerator used by the Pretorian stalkers, the Tzoteth and other mass area weapons. It is heat-isolated and all exposed surfaces are treated with flame-proof substances.
- Third, the flat areas on the thighs, shoulder pads and chest have a self-sealing inner coating, which drastically improves the durability.
- Fourth, it is only about 70% the weight of the normal Tortoise armor, while up to 50% stronger on high-priority spots.

This trooper carries a Calix Carbine, an experimental design which didn't become very popular because of the rather heavy recoil. He also carries an Ironfist handgun in a holster on the left hip, a combat coordinator on the chest and the standard gear pouches around the ankles.

On the left shoulder pad is the Capitol Armed Forces logo, with the color pattern indicating the rank of captain. On the right shoulder is the Doomtrooper badge, the ultimate proof that «the trooper»—captain Mitch Hunter—is one of Universe' best fighters.

## VENUSIAN RANGERS

The most famed of all Bauhaus special forces are the Venusian Rangers, who single-handedly fought off thirty-five Pretorian stalker-reinforced cohorts in the Grafenstahl sector on Venus' North pole. Shortly after, they sacked and ruined Nepharite Overlord Argonath's Citadel in the 23rd Lowlands, and despite them being an experimental force from the beginning, the Venusian Rangers are now among the most famous and trusted military units there are.

The rangers are organized in divisions holding around ten thousand elite troopers each. They are provided with state of the art Bauhaus armor, currently the M-4 Heavy Personal Protection Suit (AF 11), and weaponry (Deathlockdrums and Panzerknackers). Each squadron chooses their own camouflage pattern for their armor; while some prefer the conventional light green-brown-gray jungle-cammo, others stand out and keep the manufacturer's bone-white basic color, reasoning that the best of the best don't have to hide from anyone. Also, their protection masks are designed as to intimidate and strike fear into their opponents.

The basic requirements for a Venusian Ranger are extraordinary endurance and physical strength, combined with determination and will-power far beyond what normal men will ever be able to abide. The Rangers are hand-picked from regular elite forces, placed in a two-year Ranger training camp («the Forge»), and then are sent directly to the Venusian trenches.



BAUHAUS™



## THE ETOILES MORTANTS

As a part of Bauhaus' program against Dark Legion infiltration on Venus, the «Etoiles Mortants», the Dying Stars, were formed as a kamikaze-unit for reconnaissance and sabotage against the Dark Legion strongholds. What was previously regarded as impossible became everyday events for Etoiles, and their small units of well-equipped and trained soldiers are the ones who have revealed the most of humanity's knowledge of the Dark Legion. Rumors have it that the Brotherhood is secretly supporting the units with seers and other powerful mystics to reinforce the task forces sent out on missions, but no one has been able to reveal the truth. Some even say that the members of the Etoiles are trained in the use of the Arts.

The Etoiles are most often lightly armored and equipped, holding speed and stealth before firepower. They have often sent their best soldiers to the Doomtrooper squads, due to their great knowledge about the Dark Legion's tactics. Their badge displays a white supernova on top of a black cross.



# BAUHAUS

And it soon became apparent that the four Duke Electors of the Bauhaus corporate empire wished to be more than onlookers on the new scene of struggle. With the determination and steadfastness that only generations of military discipline could produce, the Bauhaus management staked their claims on the planet in Cardinal Toth's visions—the sacred planet of Venus.

What Capitol's Pioneers had once done on Mars, the Bauhaus Homebuilders did on Venus by clearing the mighty jungles, where they established the stronghold of Heimbürg, as proof of Bauhaus' ambition to carry the epithet of Megacorporation.

In the light of their new position, the Bauhaus smithies began to produce quality none had seen in long ages. Everywhere the products carrying the symbol of the twelve-cogged wheel, the symbol of the four Duke Electors and their advisors, became the icon for a new thinking, a bold philosophy. The Bauhaus mark of quality became unquestioned wherever it appeared and the strategy of providing the worlds of man with the best goods available became inherent.

But even into the honorable and undefiled nobility of Bauhaus the Darkness managed to intrude. The power of our Inquisitors was more and more requested, and in the sacred jungles of Venus our combined forces clashed mightily against the dark intruders from Nero, and so do they still in this never-ending war of grief and suffering.

— *The Eighth Chronicle, The Megacorporations and the Cartel* \ Lucretii Marcellianus

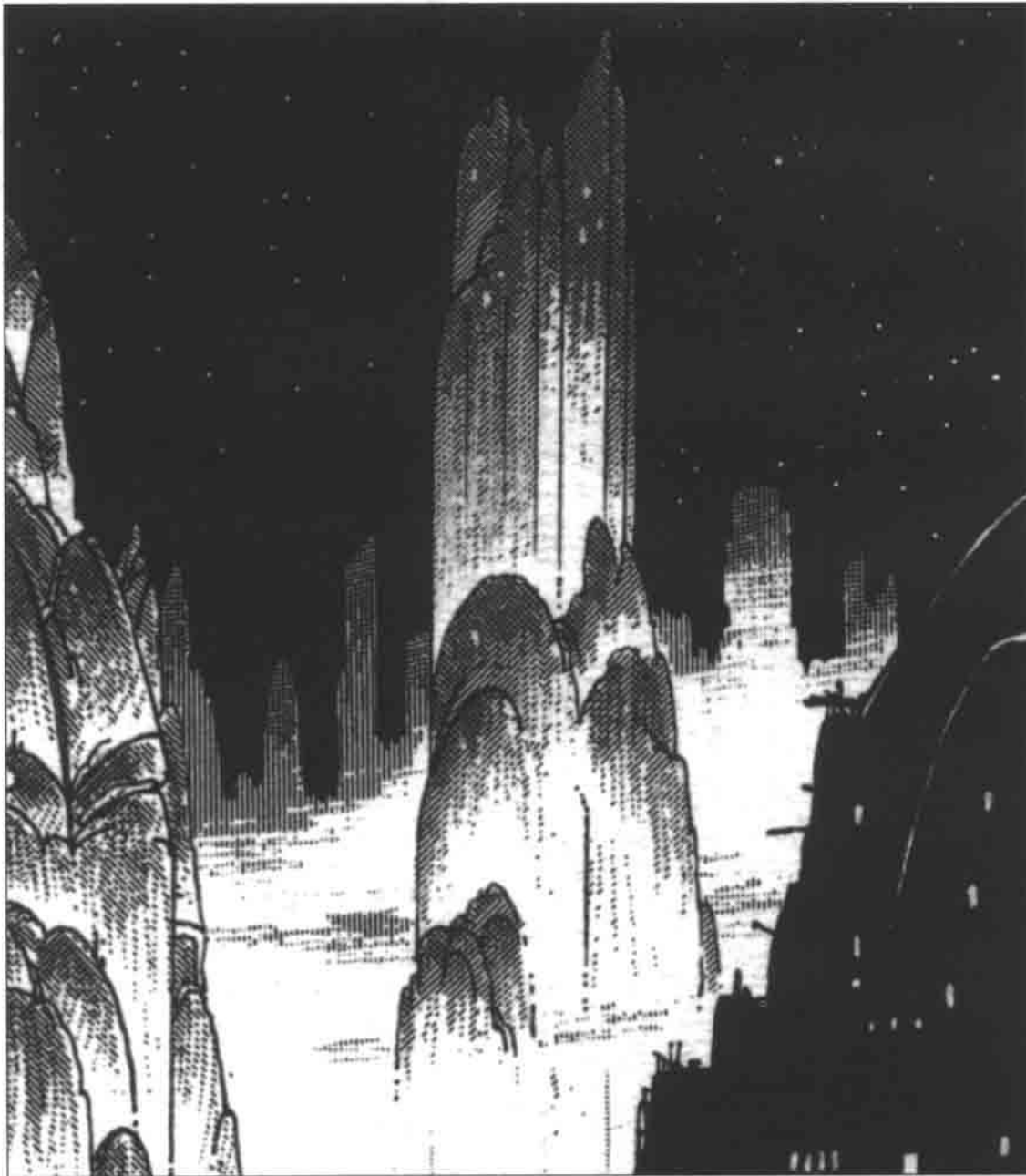

## THE BAUHAUS COG-WHEEL

The four families of Duke Electors draw their heritage from the times long before the conquest of space and gradually emerged from the Corridors of Advisors to the Halls of Directors. They and their «areas of responsibility», are:

**ROMANOV.** «THE COMMANDORE OF THE ARMY» General of Staff Constance Romanov is the supreme commander of the combined armed forces of Bauhaus.

**RICHTHAUSEN.** «THE DIRECTOR OF INDUSTRY» The Richthausen family is the oldest of the four, and its head, Grand Admiral Stanislaw Richthausen, is in charge of industry and what might be called the «economy».

**BERNHEIM.** «THE SERVANT OF THE POPULACE» Field Marshal Enzo Bernheim is responsible for the well-being of the Bauhaus employees and the «social services» area.

**SAGLIELLI.** «THE KEEPER OF THE FAITH» A tough and important duty, Supreme Air-Marshal Vittorio Saglielli is in charge of internal security, counter-Lagion measures and the Justice within Bauhaus.

Together they form the four spokes of the Bauhaus cog-wheel, with their advisors to their right and their crown-heir to the left. And as always in the Bauhaus organization, the Brotherhood holds a central position as advisors and auditors, here with a Princeps Inquisitor as chairman in the center of the wheel.



# THE DUKE ELECTORS

• EXPERIENCE IS HERITAGE •

The Bauhaus hierarchy is built around the four ancient families of DUKE ELECTORS, once only prominent military advisors to the corporation management, they are now in complete control of all Bauhaus' business and each with total responsibility for one division within the corporation.

Due to the unbroken lineage of the military within the four Duke Elector families, the military still holds a very strong position within the corporation, and only officers

## MILITARY RANKS

Ground forces	Air forces
Private	Airman
Banner Sgt	Wing Sergeant
Sergeant	Flight Sergeant
Lieutenant	2nd Lieutenant
Capitaine	1st Lieutenant
Major	Capitaine
Colonel	Commodore
General	Admiral
Marshal	Air Marshal



may hold high positions. However, an official with civilian background is quickly promoted to staff colonel or equivalent should he prove valuable enough to the corporation. Gold-braced uniforms and ceremonial swords are therefore common features in the corridors and gathering halls of the Bauhaus business empire.

## BUSINESS STRATEGY

• CRAFT IS ALL, COST IS NOTHING •

BAUHAUS has always been a trademark of quality. This is a deliberate policy with two purposes—ONE, to provide their own with the best, and TWO, to be able to compete with the others regardless of type of product and market.

The demands on designers and employees are high and only approved products may leave the factories. The result is always competitive with the best of what the other corporations produce.

However, the drawback is the price; Bauhaus-products are regarded as unreachable luxuries. To provide affordable alternatives, they supply the stores with low-cost alternatives carrying other trademarks.

As with the other megacorporations, Bauhaus' market strategy relies on producing everything, thereby spreading the risks. Therefore, the corporate empire includes just about every type of business, from crude oil refineries, gas fields and copper mines to HAUTE COUTURE design studios, hospitals, bakeries, finance corporations and fast-food chains.

If one industrial branch should be held before any other, it would be the heavy mechanical industry, manufacturing heavy-duty construction vehicles, mining machinery, steel girders for skyscraper construction, and so on.

## THE SYSTEM OF ORDERS

• IN FELLOWSHIP RESTS SUCCESS •

If you want to be SOMEONE in Bauhaus society, there are two requirements: military title and membership of an order. If you lack either, you will be provided with it when required. There aren't so many skilled persons by birth.

There are hundreds of illustrious orders with more or less well-defined purposes. However, they all serve the purpose to preserve the Bauhaus corps-spirit, to create a community and as «business lobbies». They are strictly ranked and your stack of membership cards says much about your status in the corporation, maybe even more than the gold on your collar.

# THE BAUHAUSERS

## • PRIDE AND PROTECTION •

In Bauhaus more than in any other corporation it is possible to describe such a thing as the «average guy», a «Bauhauser». The level of education, wealth and influence is fairly equal in all levels of society, which reflects in a fairly similar way of thinking.

The average Bauhaus employee works in the industry as an engineer, operator or fitter. He enjoys his work simply because he feels that what he's doing is important for the corporation, and in a greater sense, also the Brotherhood. Also, he has a pretty good salary which is more than enough to support a spouse and two children in their own apartment.

He has had around 8 years in school, he doesn't know much about the other megacorporations or, in fact, his own. He occasionally hears on the news that Bauhaus has had a great military success somewhere, but it doesn't concern him. He is well satisfied with the city life as long as he doesn't have to deal with the life on the street.

Above all, «Bauhaus» for the average Bauhauser is security and protection against whatever might happen; accidents, diseases, alien invasions. He is proud to be a part of the best of societies.

## • A SMALL COG IN THE • • BAUHAUS WHEEL •



## THE BAUHAUS GREAT INFURIOR

The largest existing piece of ordnance is the Bauhaus Great Infurior self-propelled automatic howitzer, with a total weight of 230 tons, total length of 51 meters and a caliber of 56 cm.s. The Great Infurior is a modified and improved version of the Excelsior, which had shorter range and severe problems with the hydraulic reloading mechanism (loaders got arms chopped off).

The Infurior has remarkably good terrain-performance due to the double track bogies, and the 1.2 meter wide tracks effectively distribute the enormous weight. Together with each Infurior goes one ammunition truck and two heavy support tanks for close protection and anti-aircraft protection.

- Barrel length:** 42 m
- Caliber:** 560 mm
- Total length:** 51 m
- Total weight:** 230 tons
- Weight/round:** 1,350 lbs
- Function:** A
- Max range:** 32,000 m
- Rate of fire:** 12/min
- Reaiming lapse:** 40 secs (180°)
- Max speed:** 16 mph
- Crew:** 11
- Detonator:** Proximity fuse, Tempered or Impact
- Ammunition:** Shrapnel, High-explosive, Gas or Fire

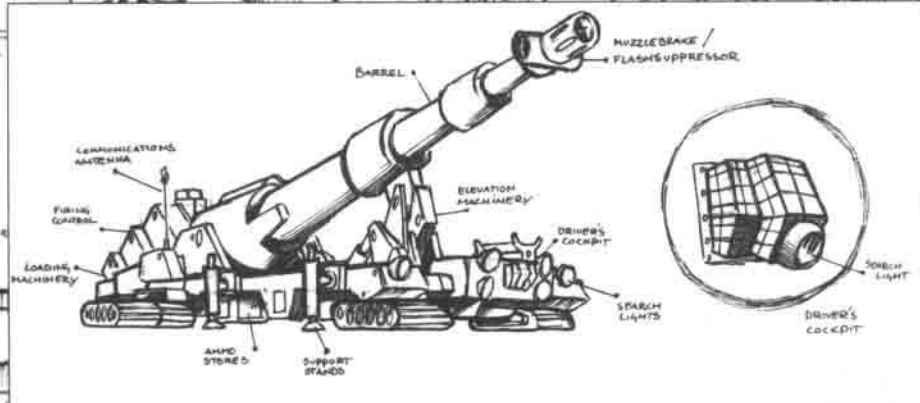



# THE MILITARY

## • TRADITION AND DISCIPLINE •

Bauhaus military forces have a deserved reputation of being well armed and trained, and they compensate what they lack in fire-power and numbers with high versatility and degree of armor.

The armored forces, the DRAGOON REGIMENTS, are the most respected of all the Bauhaus forces, and becoming a dragoon officer is regarded as one of the greatest honors.

Equipment is, of course, of very high quality, though not the most powerful. Instead, weapons and armor are optimized to combine the greatest mobility with the greatest possible effectiveness. Again, the price-tag and

the production capacity are limiting. With the high status of a military career tempting hordes of young men to enlist, the amount of material is never enough to put them all in operative status.

## ORGANIZATION

The armed forces, falling under the jurisdiction of Duke Elector Romanov, are divided into four service branches:

- ARMORED FORCES (dragoons)
- INFANTRY (hussars)
- AIR CAVALRY
- SPECIAL FORCES

Especially talented soldiers might attend military academy to become an NCO, but most of the time are picked from the «nobility». All commissioned officers somehow have this in their blood, but only after several years in one of the unit-designated academies are they subjected to real combat.

Code of honor is very important, especially among officers, and there are extremely few disciplinary problems. For example, prisoners (from other corporations, that is) are treated well, cease-fires are usually respected and wounded and dead from both sides are well taken care of after the battle.

## THE T-32 «WOLF-CLAW» JBT

The Wolfclaw Jungle Battle Tank, designed and manufactured by Fieldhausen Motors, has one of the highest productions runs ever when it comes to armored vehicles.

The idea behind the Wolfclaw was to come up with a small and reliable vehicle suited for jungle terrain battles. It has a conventional steering system, instead of the usual hydraulic track differential system, which failed every so often.

The short barrels make it possible to rotate the turret even in narrow jungle environments, where the combat distances are fairly short and accuracy subordinated. In front, there is a heavy chain saw device used when the sheer weight of the vehicle is not enough to force its way through the jungle.

- Length/Height/Width: 7.8/3.2/4.2 m
- Crew: 3 (gunner, driver, commander)
- Armament: 3 x 65 mm rifle-bore autocannons, caliber 50 MG in commander's hatch
- Road Speed: 45 mph (72 km/h)
- Ammo capacity: Gun: 60; MG: 750
- Functions: Gun: A; MG: A
- Ranges: Gun: 400/600; MG: 800/1200
- Damage: Gun: 1d10+0; MG: 1d6+4
- Armor: Multi-layer Chobham (AV 15)

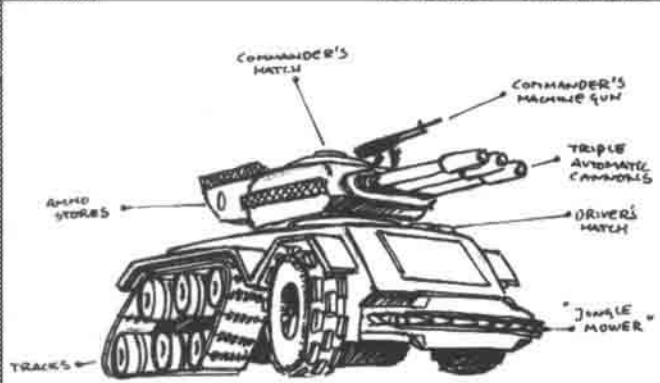

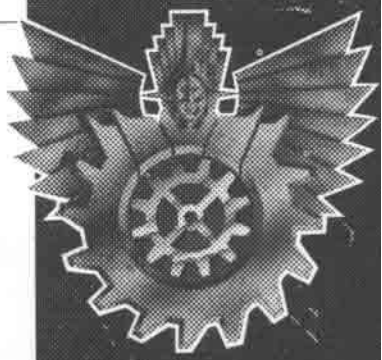

### ORDERS

The most respected order of Bauhaus society is the HIGH ORDER OF MERIT OF VENUS' KNIGHT TEMPLARS, or simply the High Order. Membership requirements are either general's or admiral's rank, monthly income of 250,000 Crowns and that you've been suggested for membership by at least two members of the order's Board.

Another renowned order for deeds worthy of recognition is the ORDER OF THE PAULDRON, the members carry a chromed steel shoulder pad on the left shoulder. Although the bulk of the membership consists of officers, prominent scientists and diplomats have been incorporated as well.

The ORDER OF OXIA PALUS is a secretive society for «preventive actions» against the Dark Legion. Many Inquisitors and Mystics are rumored to be members, and the order has a somewhat bad reputation for its bloody methods.

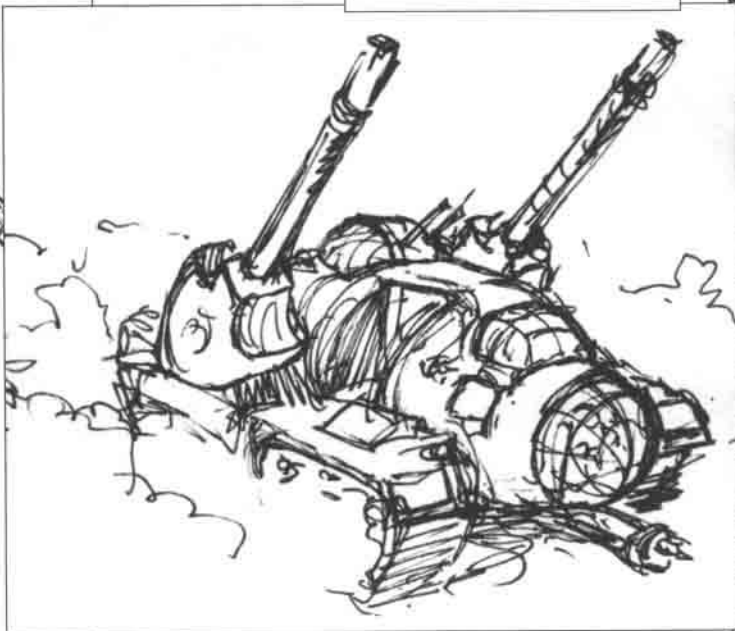

**ARMORED FORCES.** The Bauhaus «Dragoons» make up the core of the armed forces. Originally organized for battle in open terrain, they have adapted to the current main battle theater, the Venusian jungles, mainly by redesigning the battle-wagons, but also by implementing new tactics and organization.

**INFANTRY.** The «Hussars» is the nickname for the more conventional ground military forces. They have lighter equipment and less training, but are a good match for any regular unit of any corporation.

**AIR CAVALRY.** The air cavalry provides needed support during operations as well as transportation for airlifts. This small and costly organization is mainly

equipped with large, heavily armed and armored helicopters.

**SPECIAL FORCES.** Along with Imperial, Bauhaus can boast having the best special forces in the system, lacking nothing of equipment, training or support. They are composed of the best soldiers from the regular elite units. Renowned are the «Bauhaus Blitzers», a legendary anti-armor unit used for «impossible missions» against other armored forces; the «Etoiles Mortants», the Dying Stars, with special training and equipment for fighting the Dark Legion's forces; and, of course, the «Venusian Rangers», whose name speaks for itself.

• RENOWN IS OUR REWARD •



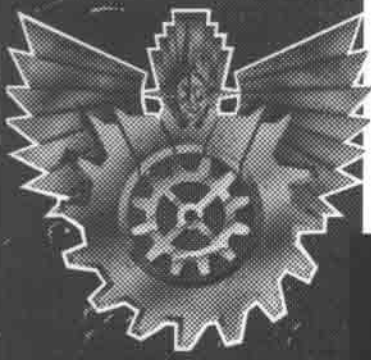

## THE TWIN TOWERS

The Bauhaus Twin Towers on Luna hold all the central functions of the Bauhaus corporate management, as well as the departments and the ministries of the four Duke Electors. The top floors of the west tower (the building faces south) contains almost the entire ministry of defense, and in the lower regions are what commonly are called «the Corridors of Advisors», the many different departments and coordination boards for freelance corporations within Bauhaus.

The east tower holds, from the top, the boardrooms of the Duke Electors, the boards for economy, industry and social services.

The Duke Electors and other high officials have their own elevators leading directly to sub-ground level, where private culverts lead directly to their respective palaces downtown. The security in the Twin Towers is strict but it doesn't go to excesses like in the Cybertronic HQ or Imperial's Reading Palace.

## SURVIVAL OF THE FITTEST

Sergeant Fernandez quickly checked the surrounding jungle, desperately trying to detect any trace of the enemy. From a distance he could still hear the sounds of Capitol machine-guns as they picked off the last of the Bauhaus hussars. The shots were interrupted only by the screams of the wounded and the shouts of the Capitol marines. The ambush had been well planned. Neither Fernandez or Capitaine

Kluger had suspected enemy activity at this stage of the operation. If everything had gone according to the plan, the hussars would have ambushed the filthy marines, instead of the other way around. They had disembarked from a hovercraft two days ago and had been making good time towards the reported site of the Capitol incursion.

Then suddenly all Hell had broken loose. When passing a rushing stream, machine-gun fire had erupted from the jungle, killing many men immediately, wounding others. Fernandez had tried to bring some order to the confusion but the men had panicked, running away aimlessly, becoming easy prey for the ambushers.

Then a bullet struck the protective vest of Fernandez and he was thrown into the rushing water and quickly swept away. That was the last he had seen of his men but the sounds he was hearing left no doubt as to the outcome of the attack.

He carefully drew his army issue pistol and scrambled to the side of the stream, into the protecting jungle. Rattled, his senses were playing tricks and he desperately wished he had his combat coordinator on-line to give him a close-up on the surrounding area.

Then he stepped behind a tree and looked straight into the eyes of a surprised Capitol marine. Acting instinctively Fernandez grabbed the muzzle of his enemy's weapon causing it to fire harmlessly into the air. The Capitol soldier reacted by throwing all his weight on the sergeant, causing him to stumble, balancing on the edge of a small slope.

Knowing that letting go of his opponent would result in his own death, Fernandez grabbed the man's arm and they both tumbled down the slope, onto the muddy riverbank. The hussar lost grip of his pistol and it landed a few meters away from him, buried in the mud. The marine was no luckier.

As the two men struggled to get up, Fernandez slipped and his opponent made a frantic bid to reach his weapon first. As Fernandez scrambled to his own gun he knew he was too late. He heard the chuckle of the marine and turned towards him. The soldier was standing ten meters away from him, his retrieved rifle raised, muzzle fixed on the heart of Fernandez. With a twisted smile the soldier pulled the trigger.

His smile twisted to frozen agony as the mud caused the gun to jam. The sound of the misfired round brought life to Fernandez who quickly brought up his own pistol, firing two shots. The bullets brought the desperate marine down, still struggling to clear his jammed weapon.

With a note of satisfaction Fernandez saluted his fallen enemy and heard this silly voice inside his head: «When nothing can go wrong—choose Bauhaus...»

With the advertisement jingle still ringing in his head, he once again slipped into the jungle.



## HEIMBURG & VENUS

### • HOME OF HOPE •

Venus is Bauhaus' most important stronghold in the inner parts of the solar system, Bauhaus' «capital», Heimburg, is located there, on the northern hemisphere.

More than two thirds of the planet is covered by a dense, hostile jungle, the southern hemisphere is partially covered by an ocean of shallow mud. Towards the poles and the Equator it all lightens up and gradually changes into flat steppes. The jungle is crossed everywhere by slow, shallow rivers, their dirty water carrying just about every disease you can name.

### HEIMBURG

As a sharp contrast Heimburg rises above the highest tiers of the jungle, its highest skyscrapers stretching hundreds of meters towards the bright bluish sky.

Heimburg is a clean city, at least in the corporate districts. Towards the outskirts and suburbs, it is just like any other megacity. The architecture is solid and imposing, creating large, black shadows in the narrow alleys and rounded silhouettes in the magnificent boulevards leading up to memorials of those who must never be forgotten.

Heimburg is characterized by the Bauhaus corporate

districts, but out of the total number of habitants, only around 10% are of Bauhaus descent. The rest are freelancers and all their employees, fortune-seekers, spies, and employees from the other megacorporations, of which Imperial is the largest in Heimburg. It is a bustling city, throbbing with life and energy, famed for an everlasting optimism.

### THE BATTLE ZONES

All over the surface of Venus there are skirmishes going on, occasionally escalating into ravaging battles, partly between the corporations but primarily against the Dark Legion. The struggle against Imperial is the hardest and saddest; a continuous struggle over land and resources. Like jackals the Blood Berets and other Imperial SWAT-teams hound the Bauhaus forces, battle-worn and fatigued from the struggle against the Legion.

The Legion has erected numerous citadels all over the planet surface, surrounded by trenches and guard-posts. The activity around the citadels varies strongly, from open war to anxious surveillance.

- IN TIMES OF PEACE •
- PREPARE FOR WAR •



### BAUHAUS LAW ENFORCEMENT UNITS

The BLEU, or «the Blue» as they are commonly referred to, are Bauhaus' one and only police force, renowned for extreme efficiency and swiftness. The Blue focuses strongly on crime-prevention rather than law enforcement, and it is almost impossible to move around in a Bauhaus-controlled area without running into pairs of foot-patrol Blues every five minutes.

BLEU police officers are tall, minimum height is 6'3", which excludes many women for service in the field. When patrolling on foot, they are normally equipped with hand-guns and one tear-gas grenade, wearing light protection vests (AV 2) under the blue-black uniform.

In demeanor they are stern and tough, giving the impression that you'd better not mess with them. And when abused or assaulted, they don't exactly treat their adversaries with kid gloves.

Small police stations housing 4-12 officers are located in every other block. Each such office has one riot vehicle and equipment for real combat, and in addition, there is one main station holding around 200 officers and 20 vehicles per square kilometer.

## THE COMPETITORS

### • SHAKE THE HANDS OF • • THOSE YOU TRUST •

Bauhaus is regarded a tough but just business partner, always reliable when a deal has been closed, but hard to close deals with.

Accordingly, the financial and diplomatic relations between Bauhaus and other corporations are good, but they are known for being slow to commit, due to accuracy and an acute attention to all details.

This demand for accuracy is often mistaken for snobbishness, giving Bauhaus negotiators a bad reputation.

### • PROFESSIONALISM AND • • PERFECTION •

### THE CARTEL

Bauhaus' relations with the other megacorporations is not reflected within the Cartel, which in Bauhaus' eyes is a shot clearly off the target. Therefore officials are sent to the gigantic Cartel organization as trainees to see and learn the Art of Diplomacy, not really with authority to do anything.

Another, more tangible, problem is that the invisible struggle between the four Duke Electors cripples them substantially when appointing negotiators to the Cartel High Council. Instead, Bauhaus often appeals to the Brotherhood to solve conflicts that would normally be on the Cartel's agenda.

Even though persuasion has always been necessary, the Doomtroopers have always been supplied with the finest of Bauhaus soldiers.

### THE BROTHERHOOD

#### • STRENGTH IN SPIRIT • • HEALTH OF MIND •

Indeed, the first four Cardinals proceeded from the ranks of Bauhaus and the corporation and the Duke Electors have always been their strongest supporters. However hard they have struggled to erase this link between Bauhaus and the Brotherhood, they didn't quite succeed until much later, when the first major conflicts arose, eventually escalating to open war on Venus.

And hence, the relations are ambivalent; the Romanovs and most of the body of officers regard the Brotherhood as a potential threat not yet erupted, while the other families embrace the Brotherhood.

Still, the Brotherhood has a very strong influence on the average Bauhaus man as well as on anything that the corporation does.

### THE DARK LEGION

#### • WHEN DARKNESS FALLS • • IGNITE YOUR INCINERATOR •

Bauhaus is the corporation that has suffered most from the armed onslaught of the Dark Legion and it is also the corporation that has put the most resources into the armed struggle, simply out of self-preservation. Venus is the largest and most obvious battle-zone in the system, and thousands upon thousands of young men have been sacrificed in this struggle.

The Dark Legion and its minions are fiercely attacked at all levels, with all means, at any cost. From Bauhaus point of view, anything short of honor and civilians can be sacrificed in the war against the Legion. The corporation's close relations to the Brotherhood has been of help in the cities and among common man, but it has helped little on the battle-fields.



### VINCIANO- TRAFFAUX

If you want to move about with class and style you choose a Vinciano-Traffaux car. These cars are powerful and give the driver and passengers good protection.

Shown here is the official vehicle for Bauhaus representatives and officials. It is a heavy convertible run by the multi-power Bauhaus-Traffaux engine. It is capable of speeds up to 150 kph under manual control.

For the protection of the driver and the passengers the car has been equipped with heavy armor-plates and the frame it is built on is reinforced with durable and heavy metal alloys.

### THE HEIMBURG DUCATES

Within Bauhaus the DUCATE is often used instead of the Cardinal's Crowns. They're pure gold and silver coins minted in Heimbürg and are rarely seen outside Bauhaus-controlled areas. They occur as gold-coins in 1,000 and 500 ducate coins and as silver coins in 100, 20, 5 and 1 ducate denominations. 1 ducate is officially equal to 1 Cardinal's Crown, but in reality they're worthless on Mars and Mercury.



## FOR SERVICES RENDERED

«You are a disgrace... to both your regiment and your father.»

Lecomte turned away from the soldier and gazed out the window.

«None of this must be known to the crew upstairs,» he continued, «and if it does you're going to burn for it. Nobody fails me and lives to tell about it, so make sure this is handled with the greatest discretion. Someone is going to pay for this fiasco, mark my words.»

Steiner stood in the center of the room, dirty and disheveled. He still wore his heavy armor, marked with the signs of desperate combat and his face was a mask of exhaustion.

«We returned from Venus with only two men of the three hundred sent,» Steiner answered the dark figure by the stained glass window. His voice mirrored his appearance. «Only one survived, sir.»

Lecomte raised his hands looking out over the surface of the city. He spoke and his voice was strained by anger.

«I lost a lot of prestige in this operation, and I hope you realize this, Steiner. Someone will have to pay for this failure, this loss of face.»

Steiner hadn't realized Lecomte's game until now, too late. He had been used by this ruthless executive, Lecomte had used Steiner and his men as a child would use his toys. The wheeling and dealing brat had sacrificed the lives of three hundred good men on a whim, for his personal profit. Lecomte's dirty plans had caused Steiner the loss of all his brothers in arms and made himself an active part of this treachery. Steiner reached his decision, cocked his submachine gun and turned around to face Lecomte.

«Yes sir, someone WILL pay...» Steiner mumbled, squeezed the trigger, and in a cascade of broken glass he sent Lecomte's screaming body through the window down to the street far, far below.

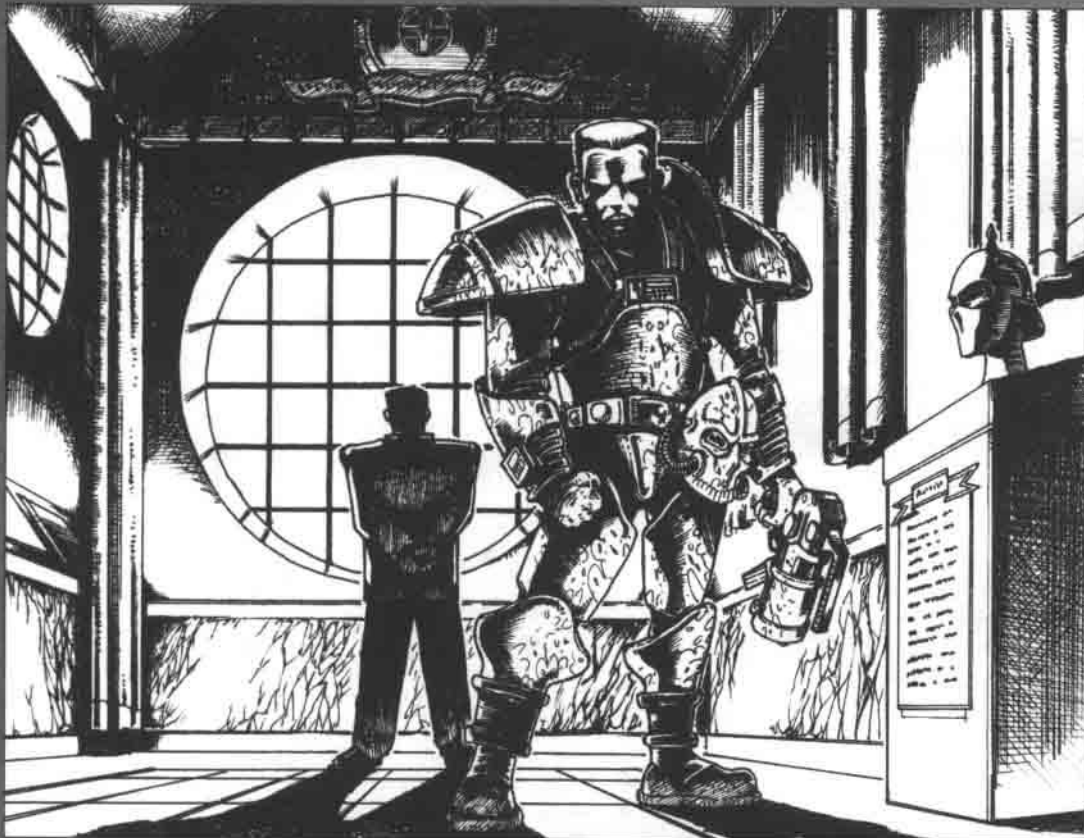

## VINCIANO BMP-35

The BMP-35 is a durable and heavy armored vehicle extensively used by the security forces of Bauhaus. Its main task is to assist troops involved in riot control. The passengers and the weapon-systems are encased in a fire-proof and bullet-proof shell of armor-plates. The turrets can be equipped with either a standard water-cannon or with a 30mm auto-cannon firing slugs or grenades.

## HOMEBUILDERS' LOGGING SWORD

The symbol of office for the Duke Electors and their closest men are these ancient bastard swords, each one carrying its own history. Legend has it that they were brought by the first homebuilders to Venus as logging tools, and as a reminder of these brave men they are now regarded as the ultimate symbols of honor.



### A COMMONER'S MISTAKE

«You know he has to die...» Grand Master Yvain didn't express even the slightest pity when producing the death sentence.

«But Master, brother Anderson is just a...»

«Just a commoner, that's right! And that just makes it worse. We should never have elected him into the Order from the beginning. Honor Colonel or not, he's just a petty careerist among all the others. He's not one of us, and never will be. Remember Jura.»

The reference to the disastrous conference in Jura still gave General von Luck the creeps. The «commoner», Colonel Anderson, had been commissioned to close an already set deal with the Imperial military attachés, but seriously screwed up.

When the Imperials' wouldn't agree on the pace of the retreat from the worthless Jura complex, Anderson had gone berserk, finally expressively ordering his banner guard to put them under arrest. In the following fight, all the Imperial ambassadors had been killed. The retaliation from the Imperial Blood Berets was horrifying—29 dead Bauhaus civilians and one entire dragoon squadron captured or killed. Their commander—Colonel Anderson.

All this might have been excused, had it not been for the fact that Anderson made a new, totally unauthorized deal with his captors, trading himself against four Imperial officers in the Order's captivity. Though reluctant, Master Richthausen was bound by an officer's code of honor to fulfill the stupid promise from his orderly vassal.

«I see your point. This must not happen again.» Grand Master Yvain Richthausen took the gold-plated pen and signed the document with a sharp rasping sound.

«Now general, you have carte blanche with MISTER Anderson. Just one bit of advice, use an Imperial freelancer, Johnstone or Major Thomas.»

von Luck smiled at the irony. «So be it, Master Richthausen.»

W	L	STR	Dam (1H)	Dam (2H)	Cost
5.0	114	13	1d4	1d6	N

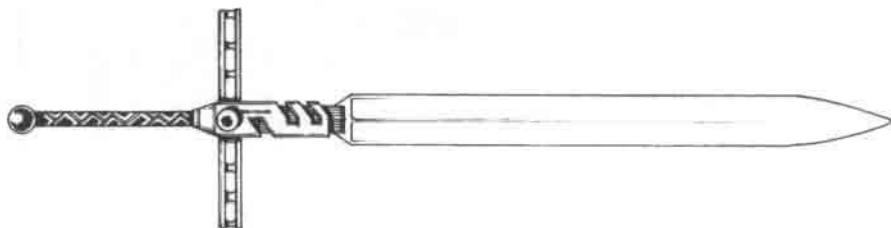

# MISHIMA

As the populace grew along with the Mishima dynasty, the rulers' control over the vassals decreased at the same pace as the disappointment among the people increased. Demands for the abdication of the Overlord were loud, mayhem and revolt ruled and held Mishima at bay.

And so it happened at Cardinal Randolph's elevation that the Overlord proclaimed that the Mishima dynasty and all its work and all its land and all its assets would for eternal time no longer be administrated by the Overlord, but by his three Lord Heirs and the Lord Heirs of the future Overlords.

Great rejoicing followed and the corporation was prosperous and happy under the new rule of the Lord Heirs. But soon our glorious Inquisitors in their infinite wisdom saw the Darkness fall over the Mishima corporation. Feuds among the Lord Heirs could no longer be solved in the gathering halls, but resulted in hostilities leading to grief among the stock holders and the mothers of many young men.

The Overlord warned against the Evil in order to end the conflict, but the Lord Heirs no longer respected their Master and put him in exile on Luna, while they themselves continued their petty wars and hostilities on the sacred planet in Cardinal Randolph's visions—the blessed planet of Mercury.

And this blood-feud became the most obvious sign that the Darkness from within was a greater threat than the threat from its Legions—when the son raised hand against his father and rejected him.

— *The First Chronicle, The Arrival of the Darkness and the Call of the Cardinal* \ Alexander Horatio

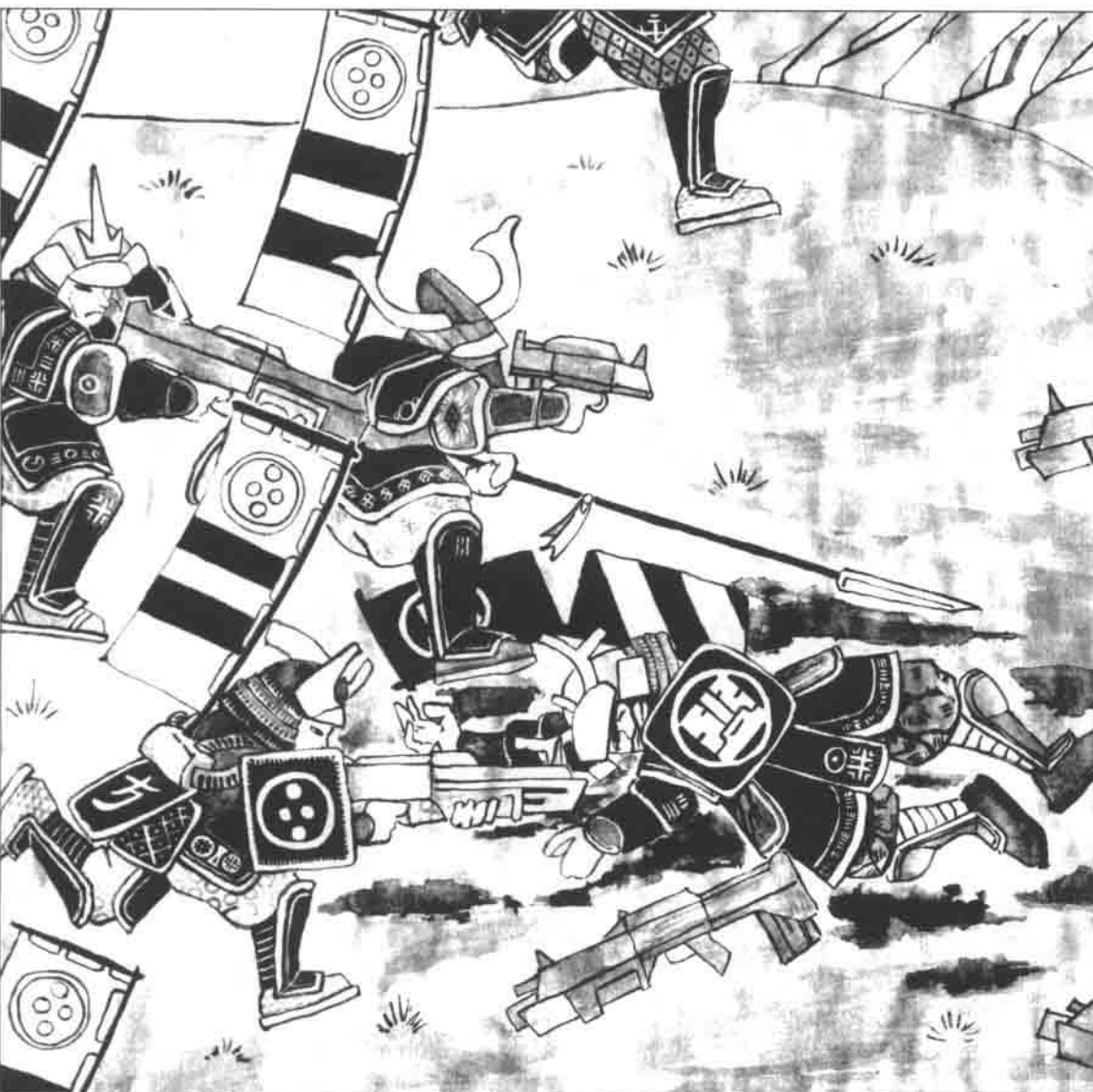

Prince of Fire, Governor of Luna, Ambassador of Mishima, Emperor of Thousand Suns, The Father above All, are titles inherited by the Overlord.

Even though he has little formal power, he has quite a strong influence on the populace. A very intelligent old man, full of wisdom and insight, the Cardinal often turns to the Overlord Mishima for advice.

## THE LORD HEIRS LORD HEIR MOYA.

Prince of Soil, Governor of Mercury, Moya resides in Longshore and controls most of the Mishima business empire with a firm hand. He is famed for being totally ruthless, but is also rumored to be schizophrenic.



**LORD HEIR MARU.**  
Prince of Water, Governor of Venus, Lord heir Maru is «second in command» in the Mishima empire. He skillfully balances between openly opposing Moya and obeying him blindly.



#### LORD HEIRESS

**MARIKO.** Princess of the Skies, Governess of Mars, this beautiful woman is independent from her older brothers. She is known to be very cruel, both in business and combat.



## THE LORD HEIRS

The Mishima corporation has since their founding been a family company, administrated and ruled by the Mishima dynasty. At the top as chairman and president had been the Overlord, usually the family head.

But eventually the corporation expanded far beyond what one person could effectively control, which forced the Overlord to split the empire into three separate divisions, each headed by one prominent family member, the Lord Heirs.

Today the Lord Heirs, the two sons and daughter of the Overlord, govern all Mishima business on Mercury, Venus and Mars respectively. Lord Moya, Prince of Soil and Governor of Mercury, is held highest of the three and unofficially functions as the family head.

There is open rivalry going on between the three Lord Heirs, manifesting itself in hostile take-overs, assassinations, broken promises; everything short of open war. Since their respective divisions are nearly self-sufficient and geographically separated, the conflict isn't very obvious to the outside world.

And of course the worst debate is over who will be the next Overlord. The sibling chosen will hold the true sword of power over his family and be in total control of Mishima.

#### THE OVERLORD

The Overlord Mishima himself is but a crippled shadow of his ancestors, put in exile in the Luna palace, without any real power but still in position as the corporation's figurehead. Formally, he is the ONE AND ONLY Mishima ambassador, it is he who negotiates in the Cartel and it is he who dictates the corporate guidelines, but it is the Lord Heirs and their vassals who make all the decisions.

Even though he is treated with due respect by ambassadors of other corporations, the dealings with him are only ceremonial, and simultaneous with the *real* dealings with the Lord Heirs.

And so it is that Overlord Mishima, Emperor of Thousand Suns, the Prince of Fire, the Father Above All has become a bitter relic, unwanted by his heirs, unknown by the populace, secretly mocked by his peers, and vainly struggling to mediate in the conflict between the Lord

Heirs. His only vassals are a court of ten thousand and a bodyguard of one thousand, the «HATAMOTO». These servants hold the highest honored positions within the entire corporation and they are always hand-picked by the Overlord himself.

#### BUSINESS STRATEGY

Some say the moral decline of the once proud Mishima organization has showed in its business policies. Others call the Mishima management economical geniuses, smart and ruthless, well adapted to the current circumstances.

In any case, the rise of the Mishima business empire has been astonishing. In a short time, they had managed to become the second largest corporation after Capitol,



producing absolutely EVERYTHING, and often at lower cost and with a more appealing design.

The recipe—ruthless business methods, low development costs(plagiarism), the largest industrial espionage budget of all the corporations, and of course, the inherent CRAFTSMANSHIP, and the WILL that is absolutely essential when you have an ambition to be the best.

This strategy results in the fact that their own product developers can concentrate on finishing up and improving existing models and products, and thereby gain an advantage over their competitors.

Also, by literally stuffing the store-shelves with their own goods—maybe even with the same product packaged in many different ways—they make sure that they secure the most exposure.

Mishima are renowned for always sticking to a deal, but they are even more renowned for their shrewdness in deal-making. Their business lawyers are only matched

by Cybertronic's in this area—and it is difficult to make really good deals with Mishima partners (unless they want you to, for strategic reasons).

## CRAFTSMANSHIP AND COMPETITION

The weapon that has made Mishima a force to be reckoned with is the ability to produce large quantities of high tech equipment at low costs. This gives the buyer cheaper alternatives to Capitol's or Bauhaus' equipment, but they have one drawback. The design and technology involved have resulted in Mishima producing equipment that is more expensive to repair than to manufacture. This has a wide appeal to the massmarkets but has given Mishima a somewhat bad reputation within the military industry, especially with freelancing mercenaries who need to be able to fix equipment themselves in battle.



## WARHEADS

There are three general types of warheads, combat, recon and suicide. The first is usually equipped with bombs and autocannons, the second with cameras and microphones, the third with one HEAVY explosive charges.

It is not known whether they are manned or not, but estimations are that they contain SOME form of intelligence.

Their appearance vary a lot, but the early prototypes spotted so far have looked like variations of flying cigars.





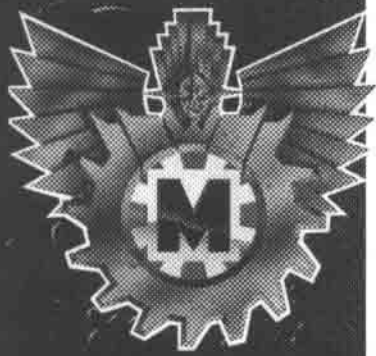

### THE CUIRASS

A typical cuirass consists of a harness and half-greaves protecting the front of the cuirassier. The arms end in variations of heavy weapons, like chainguns, flamers or grenade launchers. In order to be able to move around properly, the joints are enhanced with hydraulics. The large container on the back contains highly flammable hydraulic fluid, a great source of grief among the cuirassiers.

### LONGSHORE

The megacity surrounds a huge basin which also serves as a harbor for the ocean- and river-going vessels that provide the bulk of Mercury's communications. The basin is split in two by a 100 meter wide runway that stretches some two kilometers out in the still, crystal-clear water.

The end of this «pier» consists of two gigantic statues of Lord Heir Moya and his spouse.

### FUKIDO

The «FREE SETTLEMENT OF FUKIDO» was originally an attempt from Mishima to attract freelance corporations to settle on Mercury, but overnight the entire territory was taken over by Imperial and despite furious attempts from Mishima's lawyers to cancel the purchase contracts, Imperial stood its ground—much thanks to the Brotherhood's support—and within weeks it was a heavily



## THE MISHIMAN

A Mishima employee will in every situation do his utmost for his employer, not necessarily Mishima, but his Lord Heir and his vassals. Most would even sacrifice their lives if necessary. There are many explanations:

**FAMILY.** To a great extent, the FAMILY is what keeps the Mishima society together. You must never, EVER, give your family a bad name, and you are supposed to follow in your family's footsteps and preferably also improve your name's reputation.

**TRADITION.** «It has always been like this, and it always will be. It has always worked, and those in opposition have quickly come to regret it.»

**LOYALTY.** Mishima employees are born into the organization, and from their first day they are taken care of. For free.

And from the first day of his life, the Mishima subordinate is taught that he has the organization to thank for everything. Everything is only borrowed. And the organization has the right to collect on the loan—at any time.

**GLORY.** The Corporation remembers sacrifices. For example, soldier's salaries are low, but survivor's pensions are generous. Every day, memorials are held for those who died in service of the corporation, and they are honored above all others.

## THE MILITARY

As in all megacorporations, the Mishima military corps is an elite group very much living under their own laws and ethics. It doesn't hold the same prominent position as in Bauhaus or Imperial. «Friendly methods», non-violent means, are preferred when having to defeat someone. Warfare is too costly and unpredictable.

The military commanders and the corporation managers are formally synonymous, even if the military advisors, the ADMINISTRATORS, hold the real military power.

### ORGANIZATION

The military organization of Mishima is composed of three divisions, and the separate armies have altogether different purposes and organization. It is only on Mercury that the military has a prominent and highly preferred position; on Venus and Mars they are used for defense purposes. This is a great relief on Lord Maru's and Lady Mariko's finances—warfare is extremely expensive—and this makes them economically competitive with Lord Heir Moya considering their limited budgets.

The military forces of Mercury mostly consist of lightly armed and armored infantry units. The light equipment is a consequence of the rough Mercurian underground terrain, where the soldiers might be forced to crawl through narrow cracks or flooded tunnels.

### TACTICS

Mishima's motto «DESTROY OR DEFEND» describes the core in the strategy very well—if they can't destroy an enemy right away, they hold fast on the spot until reinforced, alternatively until they die. No glory is greater than dying in service of the Corporation. Another internal motto is «NEVER GIVE AN INCH»—no one wants to be remembered as the one who surrendered to the enemy.

This makes Mishima units dreaded enemies—you can never attack them without being certain of success, and since they can rely on quick and large reinforcements, you'd better wipe them out quickly, which is easier said than done when they always fight to the last man.

«ASSISTANCE IS NEVER FAR».



fortified, rapidly growing base for Imperial and any freelancing corporation that wanted in. The system's second largest cathedral was erected, courtesy of Imperial, as a sign of gratitude, and this has helped to keep the Darkness away from the planet.

However, the contracts only run on a hundred-year basis, and you can bet Mishima won't make the same mistake twice.

### THE GOLD DUBLOONS

Mishima officially has its own currency in the form of the GOLD DUBLOONS, but these are very seldom used even within the Mishima corporation. Salaries are never accepted in dubloons, and no other corporations will touch them at all. They can only be exchanged for other currencies at special Mishima exchange offices. The official exchange rate against the Cardinal's Crown is one to one, but you'll be lucky to get one for three.





## MISHIMA'S POLICE SYSTEM

Mishima practices the system of free enterprise in its law enforcement system, meaning that this is governed by uncountable small companies and enterprises with each up to maybe a thousand officers, which has both its pros and cons.

This system is almost a necessity because of the split corporate management; it would be impossible to have one single uniformed police force within the separate domains of the three different Lord heirs. Additionally, Mishima has always feared a strong police system as opponents against the management.

The major problems are coordination, cooperation and corruption. Even while command structures and routines are homogenous, there are great differences in equipment and mentality. Corruption is very extensive, and it is not at all unusual





MISHIMA™

## HATAMOTO COMBAT ARMOR

Shown here is the heavy combat armor worn in all-out combat situations, in which the Hatamoto is rarely involved, though. The only thing that differs this suit of armor from the standard samurai suit is the color—the dark blue is restricted for the Overlord and the Hatamoto. So apart from the color and the Overlord's mon on the left shoulder pad, this could be any samurai.

Note the two swords—the Hatamoto saber (the short one) and the Hatamoto katana (the long one) with the ambers indicating the rank of Samurai—stuck into the sash. The firearm is a rather unusual weapon, a traditional samurai weapon tracing its origins further back than any living man can remember. It is a high-velocity light machinegun with unstable ballistic performance, inflicting severe damage when penetrating the armor.



## THE HATAMOTO

The Hatamoto is one of the last surviving signs of the Overlord's power and status, a traditional guard of honor that has survived through the centuries, despite conflicts and moral decay. They are the best of the best of Mishima's elite warriors, handpicked by the Overlord himself and granted privileges beyond even those of the Lord Heirs.

The ceremonial armor worn by the palace guards is a combination of dark blue—the Overlord's color—and bright red, and the most significant details are the headband carrying the Mishima mon—the «rising M»—the design of arm- and leg greaves and the «kilt».

The shoulder pads of the ceremonial armor are of the typical, characteristic Mishima design, as are the two large circular breastplates. On the left shoulder pad is the Mishima logo, which reveals the belonging to the Hatamoto (regular soldiers of the Mishima armed forces always carry the badge of their own unit/company/regiment instead—the plain «M» would rather indicate «undetached»). On the right shoulder is carried a badge showing the specialty of the guard, for example commander, technician, ceremonial master, etc.

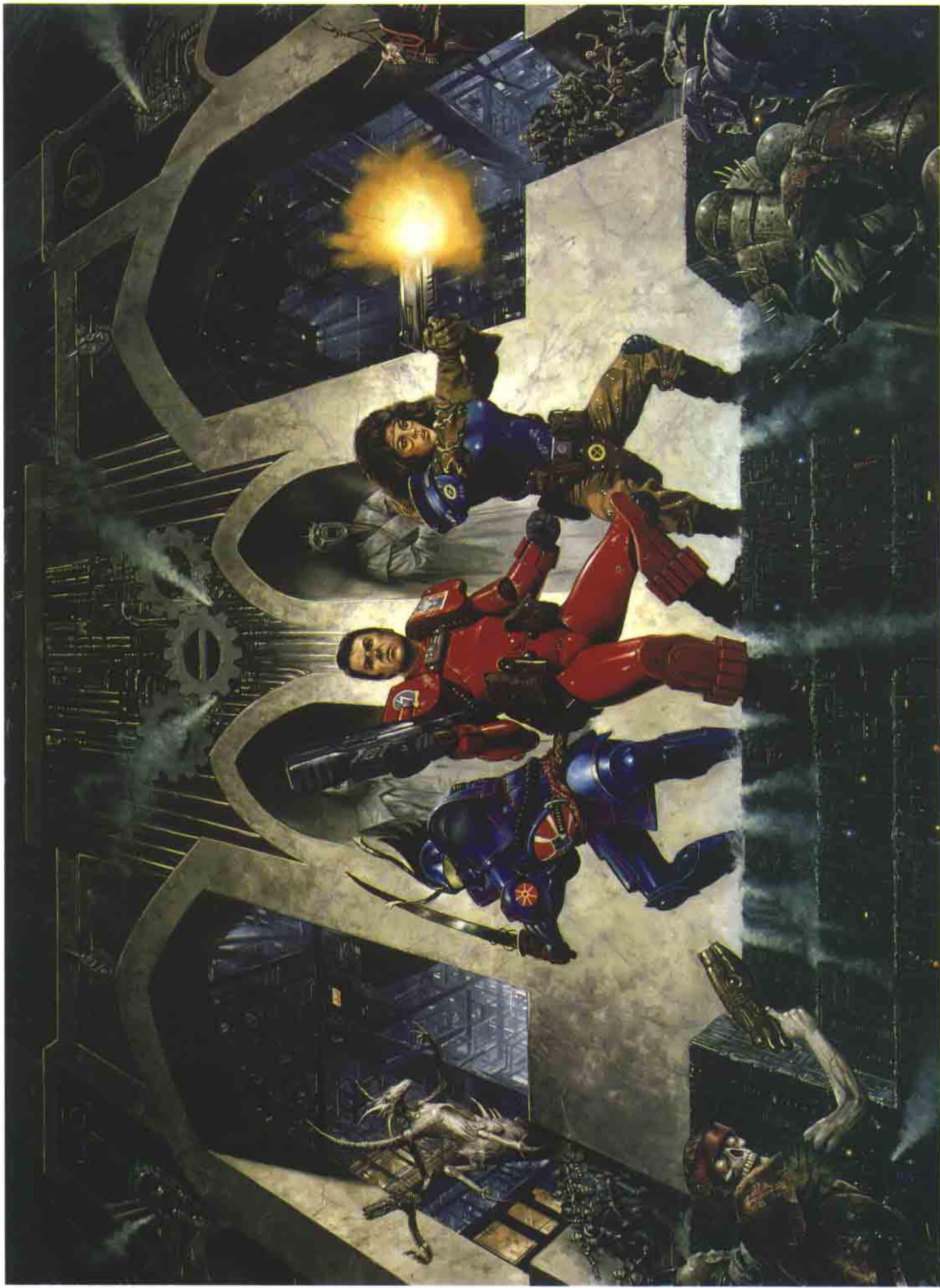

# EZOGHOUL ATTACK

Copyright © 1993 Target Games AB. All Rights Reserved. MUTANT CHRONICLES and all character names and distinctive likeness (es) thereof are Trademarks of Target Games AB

## THE SAMURAI

The finest warriors in the Mishima organization are promoted to personal SAMURAI of the Lord Heirs and their vassals. In other corporations, they are called elite guards, with the task to do the work of the special forces.

In reality, a military commander's only special forces are his personal body of samurai, maybe reinforced with a couple of cuirassiers. Usually, a Lord Heir has five or six hundred samurai, a loyal general might have some two or three hundred at his call. Each samurai is worth ten standard soldiers.

## EQUIPMENT

The Mishima foot-soldier somewhat suffers from the business philosophy of Mishima craftsmanship, but spare parts are in good supply and the technicians are many. So this is not a major problem.

## LONGSHORE & MERCURY

Closest to the sun, a small and extremely hot red-orange planet, Mercury is still somewhat of a gold-mine to the megacorporations. It is also the most exciting and challenging of the new worlds.

The planet has been a Mishima claim ever since the conquest of space began, and even while the planet itself is extremely hostile to mankind the Mishima engineers have managed to create fairly acceptable conditions, especially in the extensive system of underground caverns and gigantic craters.

The surface of the planet is hot, humid and sterile. Only a handful of mining complexes, guardposts and automated observation decks are situated there. It is the bright and inviting UNDERWORLD, the huge network of tunnels, crevices and gigantic halls and caverns that make Mercury a prosperous and profitable affair.

## LONGSHORE

Longshore, «The Mishima capital» and residence of Lord Heir Moya and his administration and most of the central bureaucracy, is situated in such a crater, its highest towers and buildings barely reaching up above «ground level».

The city is a bustling splash of cultures and buildings. «The never-sleeping city» serves as a port for almost all trade and contains all important official buildings of the Mishima empire, trading centers, military academies, stock markets, universities, etc. Imperial also has much of its important administration in Longshore and its

## THE GUNSHIP DIPLOMACY

The third Overlord Mishima, Taro, had a saying, «WHAT CAN'T BE ACHIEVED WITH VIOLENCE IS NOT WORTH FIGHTING FOR», and this reflects Mishima's relations to its competitors rather well. When a Mishima businessman has decided to achieve something, no means are sacred.

## THE CARTEL

Mishima's representative in the Cartel High Council is no

Mishima have developed two unique weapons systems especially well suited to the Mercurian underworld—the WARHEADS and the COMBAT CUIRASSES.

**WARHEADS.** Semi-intelligent, self-sufficient and self-operated weapons platforms, the WARHEADS are used for missions that are considered suicidal. They are very advanced robots with sophisticated mechanisms. Extremely tough and with LOTS of weapons, but also very rare and expensive.

**COMBAT CUIRASSES.** These imposing mechanical suits of armor provide the CUIRASSIERS with a fair amount of body protection and heavy weapons, while improving their mobility. In short they are hydraulic-enhanced suits of armor with built-in heavy weapons. They are used by elite units and assault regiments.

nearby twin city, Fukido, which is entirely in Imperial's control.

## THE WARZONES

Mercury is to a great extent virgin ground to both the Dark Legion and the other corporations, the latter most obviously reflected in the frequent clashes of arms between Imperial settlers and Mishima troops. Lord Heir Moya clearly regards the planet as his territory and does his utmost to destroy all intruders, with the brilliant exception of the city of Fukido, where a fragile peace is upheld thanks to the Brotherhood.

There are no definite front-lines on Mercury, but Lord Moya's forces are spread out all over the underworld, in outposts holding between one and five squadrons of thirty warriors each. They are never more than fifty kilometers apart, to ensure that the «destroy or defend» strategy works. Also, strategic reserves of two to five regiments (five squadrons) are kept at regular intervals.

Most armed conflicts consist of skirmishes between these Mishima defense troops and settlers from the other corporations. These rarely last more than a couple of months, almost always resulting in either a face saving solution (the settlers may stay but pay tribute to Lord heir Moya), or total extinction of the colony.

There are currently some fifty such conflicts going on, with only a few involving more than two hundred soldiers.

one less than the Overlord himself, which should, on paper, guarantee a strong position.

However, not even the representatives of the other corporations respect the Overlord. The Overlord is a marionette without real power, and if a corporation wants to bargain with Mishima or put in a formal protest, they present it to Lord Moya.



that high police officials wink at drug-pushers and protection rackets within their districts. This has led to a situation where the Lord Heirs and larger companies within Mishima ALSO have their own police forces, increasing their numbers even further.

## THE MISHIMA RESIDENCE

One of the oldest buildings in Luna, Overlord Mishima's Residence is placed in the center of the city, not far from the Cathedral of Cardinal Nathaniel. It is fairly small compared to the other corporations' headquarters, but then again, this isn't Mishima's REAL HQ.

The residence contains the Overlord's quarters and his entire court, lodgings and camps for the Hatamoto and some offices for his envoys. The building is completely sealed for anyone not belonging to the Mishima inner circle.

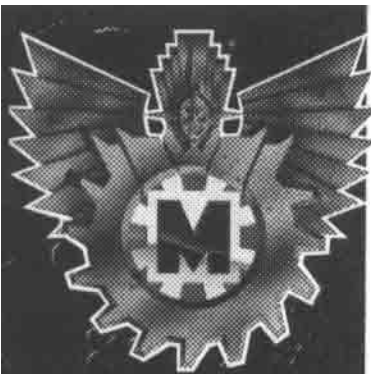

### SCALPER

These single-edged sabers are copies of surgeons' scalpels, and are most often used one handed along with a handgun. They are popular both ori among the street gangs and law enforcement units, primarily because of their terrifying design.

### THE BROTHERHOOD

Mishima's relationship to the Brotherhood can be described as tense, to say the least. Mishima has allowed the Brotherhood full access to their organization and Observers from the Brotherhood can be found at all levels of management.

This is not to say they have insight into Mishima. The proud officials at Mishima can at any time throw Observers out, keep them imprisoned or even execute them. Due apologies will be offered to the Brotherhood, but Mishima's secrets will be safe. This is extremely frustrating for the Cardinal and the Brotherhood, who have no idea how to approach this problem. For now an uneasy peace rests between the Brotherhood and Mishima.

Normally, the Mishima man feels a stronger allegiance to the corporation and his *liege*, his closest boss, than to the Brotherhood. But winds are changing and the Inquisitors are gaining more and more influence over the common man, mainly due to the growing threat from the Darkness.

All this is not seen with much approval by the aristocracy, but as long as the other corporations are strong supporters of the Brotherhood, Mishima will keep the proper face forward. But Longshore is still one of the few places where an Inquisitor can fear to be defied, and the higher lords of Mishima are the only ones who can openly defy them without fear of retaliation.

### THE DARK LEGION

Mishima has so far been spared the massive armed onslaughts of the Dark Legion, for better and for worse. The greatest threat has come from within, from Heretics and Messengers, and the workings of the Dark symmetry has time and again sowed spite and malice among the populace.

On the few occasions that Mishima forces have crossed swords with legionnaires, necromutants or even nepharites, they have been badly beaten and sometimes even forced to request assistance from Capitol.

W	L	STR	Dam (1H)	Dam (2H)	Cost
3,4	119	12	1d4	1d6	9,700



## UNEXPECTED PROBLEMS

Bakin looked anxiously at the large chair in front of him. The back was turned towards him and the only indication that it was occupied were the puffs of smoke that rose from it.

«So, let's hear your report, Administrator.»

The voice was soft but Bakin had been present when the same voice had sentenced scores of people to extinction. He swallowed hard and looked down at his notes, trying to find the courage to go on.

«Well... we discussed the issue with the delegation from Imperial but our differences were too big to be resolved through the normal channels. They blankly refused to shut down the operation and withdraw their settlements.»

Again the soft voice drifted towards him on puffs of smoke from behind the chair.

«Not even the presence of our troops moved them?»

Bakin lifted a hand to his brow and wiped the sweat from his forehead.

«Ahh... well, I offered the opportunity of a merger or a transfer of stock. I thought that if we could solve it on an economical...»

The chair swung round to reveal an older man dressed in the suit of a high-ranking Mishima official. His face was cold and dark, lit up only by the glow of his cigar.

«You're too soft Bakin. I told you to get rid of those Imperial swines, not to make deals! This is high corporate finance, you don't give an inch. Bring in the troops and get rid of those settlers.»

Immediately Bakin snapped to attention. All he wanted was to get out of here.

«Lord, the troops have already entered the perimeter. So far we can count fifty-three civilian casualties but hope that this figure will rise as we penetrate deeper into the settlements. Most of the heavy machinery on site has been destroyed and we calculate a substantial economic loss for Imperial. Credential Mining's shares are falling and will be rock-bottom before nightfall.»

This far the operation had seemed a standard one. But after the initial engagement other news, disturbing news, had started to come in. And it was his task to deliver them.

«Unfortunately our own losses are heavy. Fifteen troopers and two cuirassiers have been killed during the initial exchange of fire and several squads have disappeared while securing the mining areas. Also, an official protest from Imperial is expected to be delivered to the Cartel within the hour. The Brotherhood is also taking an interest in the operation.»

The chair swung around again and Bakin was left staring at the back of it.

«I don't want the Brotherhood to interfere. If they do we might lose the franchise and we don't want that to happen, do we Bakin? I want you to wrap this operation up, as soon as possible. I will not tolerate any failures this time. Dismissed.»

## STAND AND DELIVER

The great sword screamed as Misko swung the arm of the cuirass. It shuddered as it struck the wretched creature in front of the warrior and the beast let out a wail of pain as its chest was ripped open. Misko lifted up his fallen enemy and let out a cry of triumph before he flung the limp body unto the pile of corpses at his feet. The Dark Legions had paid dearly for their attack on the bridge and now the ground was littered with their twisted remains.

But they were not the only casualties in this desperate battle. As Misko shifted the heavy feet of his heavy battle-machine he let his eyes fall on his fallen brother and sister. The Mishima force had been overwhelmed by the ferocity of the dark creatures and only the courage of the cuirass unit had given the rest of the troops time to retreat. Side by side they had stood, Misko, Georgine and Hakito. Like rocks against the tide, stopping the assault in its tracks.

Their swords had cut a bloody swath through the beasts and the fists of the cuirass had crushed many of the enemies. Like a cleansing storm their bullets had hailed over the heads of the abominations of the Dark symmetry.

But in the end not even the armor, weapons or the determination of the three warriors could stop the charge. Georgine had her arm torn off, and without the protection of the machine-gun, she was soon overwhelmed, and lost under a quivering horde of bodies. The last thought Misko had heard from his combat sister was a desperate curse followed by the thuds from Georgine's personal pistol. Hakito had reacted immediately, lifting the hydraulic feet and taking two thundering steps backwards, closer to Georgine. The bridge had shuddered under the strain but remained intact. He had firmly planted the feet of the cuirass and swept his incinerator round, letting the fire fall over the legionnaires, who twisted and died. But it was too late, Georgine was lost.

As Hakito turned, something had screamed past Misko. He smelled the foul stench and heard a faint gibbering but the object had passed too quickly for him to see what it was.

But the effect had been obvious.







A black hole suddenly appeared in the armor covering Hakito's chest and black smoke poured out of the wound. Hakito's face twisted in agony but he didn't let one cry of pain escape. He raised his left arm and fixed the muzzle of the heavy machine-gun at the charging legionnaires. With his last dying strength, he released the automatic fire and as the weapon rattled he closed his eyes forever, a smile on his lips.

And now Misko was standing alone on the bridge. On the other side of the chasm, the soldiers of the Dark Legion were regrouping, making themselves ready for the final assault. A great wave of peace swept through Misko as he reached his decision. With mighty steps he strode forwards until he was standing in the middle of the bridge. There he stopped and fixed his gaze on the legionnaires, challenging them to dare approach, weapons raised defiantly.

And they took up his challenge, charging, screaming and foaming, onto the bridge.

### SAFE AS HOUSES

Trishio looked up as the bell on the door rang. Two men, dressed in immaculate blue suits entered his tiny shop. Casually they strolled up the aisles, looking over his herbal medicines and teas, expressing pleasure when they found something that appealed to them.

Trishio wiped the sweat from his brow and prepared himself for the discussion that would follow.

One of the men went up to the counter while the other continued browsing. The man looked Trishio in the eyes, a faint smile on his lips. He handed the store-keeper a colorful leaflet, the name «Personal Protection for the People Inc.» printed on the cover.

«Well, my dear friend, have you given sufficient thought to our proposition.»

He opened the leaflet and pointed at the last page.

«As you can see we have a special neighborhood protection offer this week. A few extras thrown in if you decide to make a deal.»

Trishio swallowed hard, trying to keep his voice level.

«No deal, I can't afford it.»

The suit leaned slightly towards Trishio and put his hands on the counter.

«Yeah, you mean you're saying no to free personal patrol, instant alarm button and a personal complaints officer?»

The old man felt the anger rise inside him. His voice came out strained and agitated.

«Yes, I'm saying no to that. I've already signed a contract with the local law enforcers and with Three Suns Protection. On top of that, I'm paying the Family to keep them off my grounds. I can't afford any more expenses.»

The men seemed surprised at this outburst and regarded each other innocently. The second man stepped up to Trishio, flapping open his suit, revealing a dark and ominous-looking pistol.

«I really hope this was not meant to threaten us, my dear old friend. As you most certainly know after having studied our leaflet, which I do hope you have, we at Personal Protection for the People have a running agreement and extensive cooperation with Three Suns. And we all have friends at the local police station. That's a way of making sure all our customers get the service they are entitled to. If we can't do anything about it, perhaps our friends can.»

Trishio stepped back, his arms folded in front of him. His face was twisted in an insane grimace.

«I say this now, I will not sign another protection contract. Take that to your hoodlum chiefs.»

The two men stepped back with anger in their faces.

«You stupid old man. You've had your chances. But don't worry, you have nothing to fear from Personal Protection for the People. We care for our customers.»

A faint glimmer of hope emerged in Trishio's mind, only to be brutally extinguished the next moment.

«But what the employees do in their spare time is another business altogether.»

With these words the men drew their pistols.

# IMPERIAL

And so it was that Imperial grew. The families amassed wealth and knowledge and, led by Her Imperial Serenity, raised the foundations of their new Empire. They haughtily shook their fists and rattled their swords at the larger competitors. Imperial stood up to fight for its traditions and developed into a Megacorporation, a position of power and influence that guaranteed the survival of Imperial values and politics.

Their position had been gained through the devotion of the families and clans that created the corporation and it was this zeal that enabled them to challenge their mightier brethren.

But this was not seen with kind eyes by all. Bloody wars were instigated to quench the spirit of the challenger and Imperial was threatened and without allies in the cold world of corporate finance. But they stood their ground and built a strong defense, based on the strengths of the clans and the families that ruled them.

And it was Imperial that first realized the threat of the Dark Legions. They saw the seeds of Darkness and the mysterious patterns of the Dark symmetry that spread among our cities.

The cults of the Heretics and the renegades grew and the dark shadow of evil threatened to engulf us all. It was then, o Brothers, that the leaders of Imperial called for the mighty Blood Berets. The valiant warriors did fight the Dark Legion side by side with our blessed crusaders. In the deepest jungles on Venus the battle raged and many men did forever scribe their names in the eternal ledger of heroes.

— *The Eighth Chronicle, The Megacorporations and the Cartel \ Lucretii Marcellianus*



## THE IMPERIAL SERENITY

The chairman of the board is the Imperial Serenity, with the right to veto any decision made by the Parliament, but may not officially give them any propositions on new laws or have influence on corporate strategies.

The current Serenity, Victoria Paladine, is a strong woman, a skilled diplomat and Imperial has much to thank her for its current strong position. She often sends propositions to the Parliament under false names (which are known to all MPs); so her proposals are always approved by both chambers. She is a very good friend with the Serjeant Primus (a Keeper of the Art, at the least), so in a way, she has the casting vote. She is generous to the Brotherhood, as are the chambers.

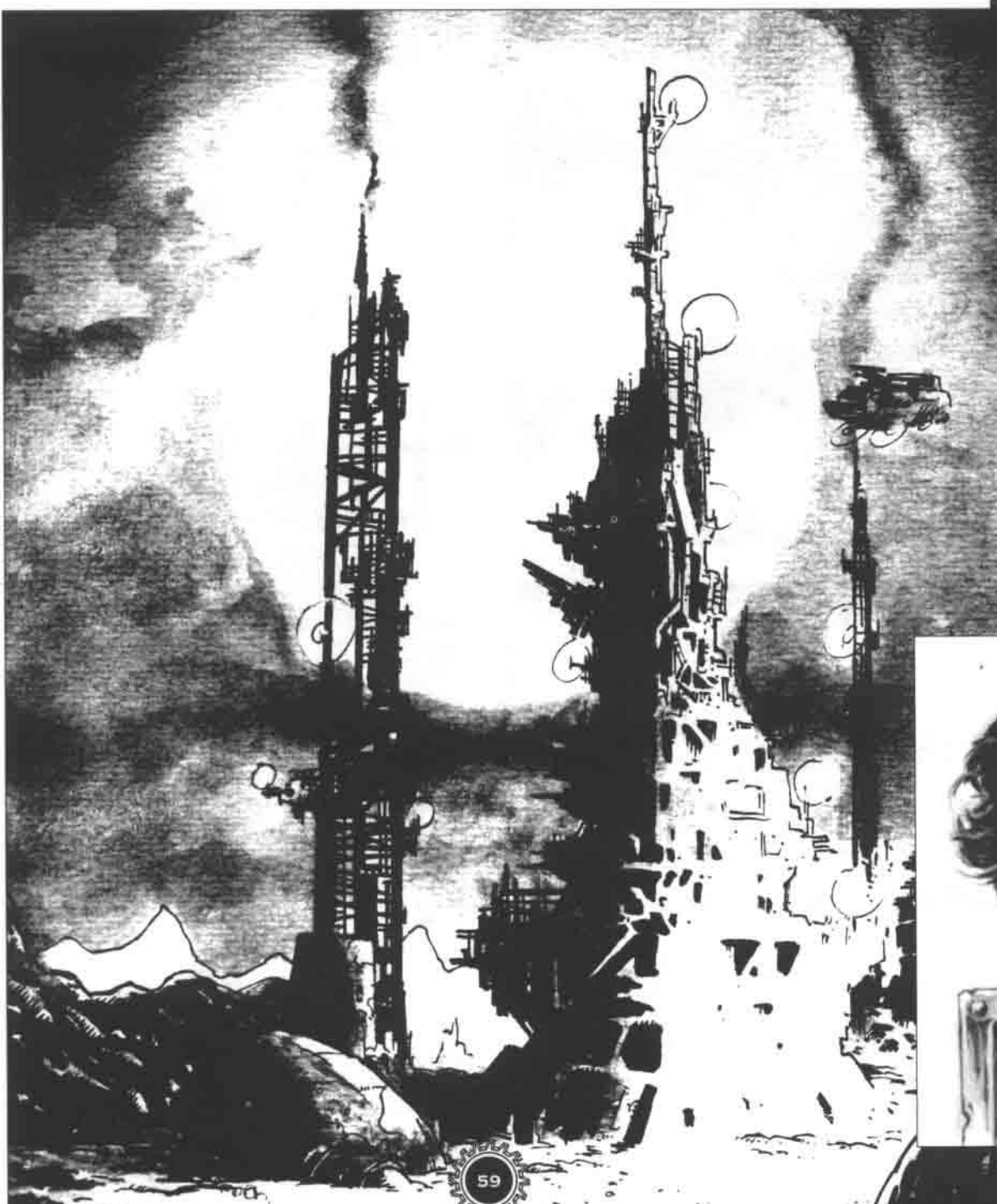

## THE BIRTH OF AN EMPIRE

### THE IMPERIAL BUREAUCRACY

The BF (Bureaucracy Factor; number of bureaucrats per 1000 citizens) is 155. Second in this league is Mishima with 49. This is the best description of the Imperial bureaucracy—a colossus on clay feet. It is huge, slow and inefficient, and it is always impossible to grasp their work. Regardless of what you want to do, it will always require an application form written in at least four copies sent to six different administrations. The usual way to get around it is to have connections or use bribes.



Over the years, the determination and steadfastness of the Imperial investors, officials and ambassadors has maneuvered the corporation to a position in the limelight. By acquiring freelance corporations and making claims in the new worlds the empire has gradually grown. «Acquiring» has always been a key-word—while Bauhaus and Capitol have built their corporations from scratch with their own resources, Imperial's strategy has always been to purchase promising freelance companies and re-develop and reorganize them to fit into the Imperial way of thinking.

Imperial has always been an «aristocratic» corporation, headed by the IMPERIAL SERENITY, owned and ruled by a body of families, the NOBLE CLANS, and governed by the PARLIAMENT. Much of this has been adopted from the ancient monarchies of mankind, and tradition is considered law within Imperial.

The head of this gigantic organization is the Imperial Serenity, an honorary title instituted to make the corporation more folksy, to give employees a figurehead and to emphasize the person as an example, a model of piety and goodness. The Serenity has limited power though, the real decision-making lies in the hands of the parliament.



The Parliament is a dazzling body of colorful uniforms, ceremonial swords, gold and silver rank insignias, expensive business suits and briefcases. This is power

personified—a collection of the CHAMBER OF LORDS, the sixty-two most blue-blooded and noble men and women, and the CHAMBER OF COMMONS, the sixty-two most successful and prominent of businessmen, managers, scientists, lawyers and diplomats. And in the middle, the three untouchable SERJEANTS; the Brotherhood representatives, maybe the most influential persons in the empire along with the present Her Serenity.

The process of decision making is complicated, as is everything within the gigantic Imperial government bureaucracy. The demands for democracy and justice are so important that nothing may go wrong, and therefore every decision has to be checked, double-checked, referred to fifty places for consideration, re-developed, checked with the High Court, checked and double-checked again before finally being passed.

## THE CLANS



During the ages since the founding of the corporation, hundreds of families have achieved the honorary title of «noble» as a reward for their services. Nowadays, although legally possible, no more titles are awarded, even though it happens that extremely prominent

persons are adopted or married into the clan and inherit the title. Currently, there are sixty-two such noble clans in the Imperial corporation empire.

Lots of traditions and ceremonies surround the nobility and their doings. They hold a unique position which



## THE IMPERIAL DOOMLORD

The Imperial Doomlord is the «Old Reliable» of the armed forces. Despite the model having several years behind it, this gunship still has a forward position in armored divisions. The flexibility of the Doomlord makes it the perfect war-machine, still in use for transports, assault- and support-missions.

The Doomlord's great range and maneuverability provides the capacity to use it in inaccessible areas, like the endless jungles on Venus and the mountains on Mars. A common use is transporting two M-311 Imperial Vermin APC's.

(Values are for unloaded, max fuel. Values in brackets are for fully loaded)

**Length:** 55 m

**Crew:** 8 (5x gunners, pilot, co-pilot, commander)

**Max speed:** 85, (65) mph

**Action radius:** ~500 km

**Combat radius:** ~150 km

**Max cargo capacity:** 9 (0.2) tons

**Storage space:** 25 fully equipped troopers (4.1 tons) or 2 APC's (4 tons each)

**Armament:** 6 x caliber .50 twin autocannons in manned turrets

3 x five barrel 14 mm Gatling chainguns in automated cheek turret  
2 x AA-missile racks (7 guided air-to-air missiles each)

**Armor:** Single-layer Chobham (AF 6)

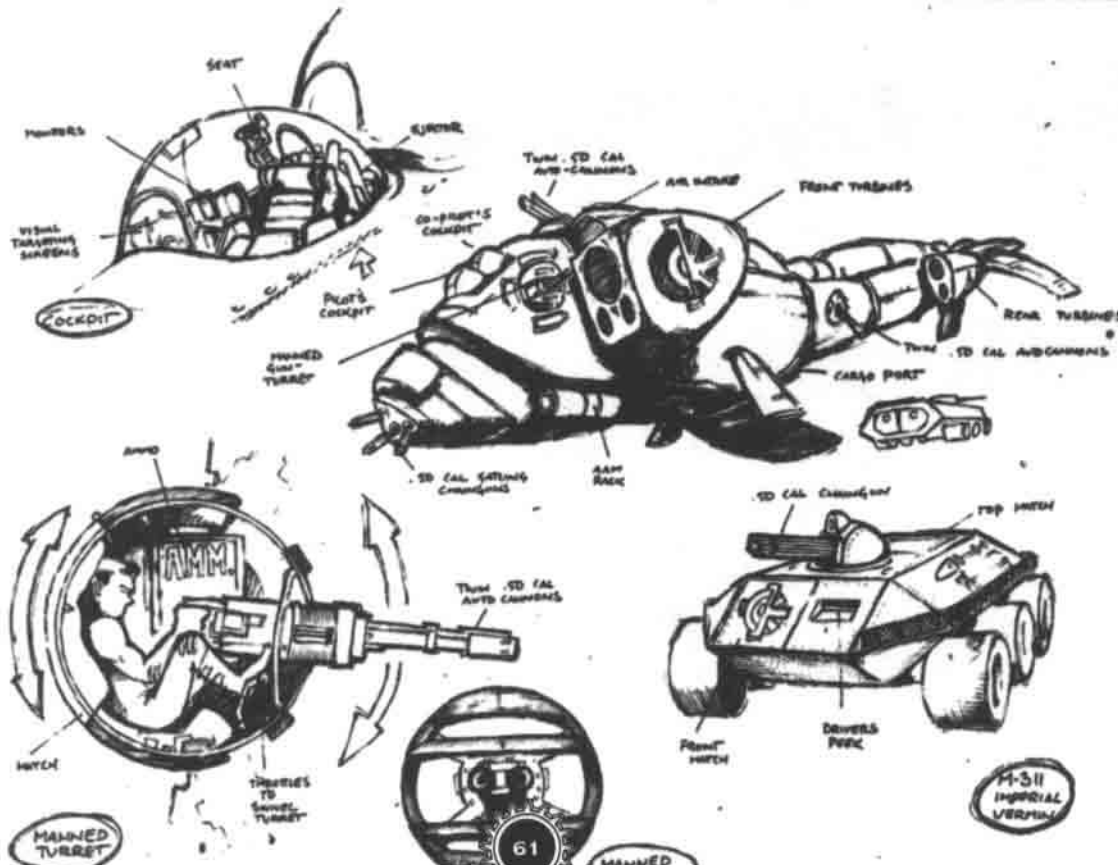



## THE IMPERIAL STERLING

The Imperial STERLING is the strongest minted currency next to the Cardinal's Crown, and is legal tender all over the system. Like the Crown, it's solid 12 carat gold and available in S50 (sovereign), S10, S1, s10 and s1 denominations. 1 Imperial Sterling (S1) = 10 shillings (s10) = 10 Cardinal's Crowns.

## THE BARTHOLOMEWS

The Bartholomew family is the force that rules Imperial. It traces its origins back to the uneasy times before the fall of the powers on Earth and have since then fought desperately and successfully to gain the current position of power.

They are the masters of intrigue and their history is filled with rumors of assassinations of both family members and other competitors. It is a bloody spectacle made famous by contemporary legends.



guarantees wealth, power and influence as long as they abide to the strict unspoken laws of the Nobility, the code of honor commonly referred to as chivalry.

The members of the noble clans hold without exception high offices within the corporation. They attend their own academies, and functions, leading totally different lives compared to common man. This seclusion from the real world gives most of them an elitist attitude and a somewhat inaccurate view of the world. They adhere to the Code, else they are quickly blacklisted and have their names and titles removed so not to soil the reputation of the clan.

There is an unofficial ranking among the clans. The three most prominent are Bartholomew, Murdoch and MacGuire, ages ago the FOUNDERS of the Imperial business empire. Today, they are enormous, holding almost half of the top positions in the Parliament's two chambers. Publicly, they work together for the benefit of Imperial and the nobility, but their differences in policies show through in the internal politics and feuds.



## THE GREAT RESENTMENT

Ever since the SAD STRUGGLE there has been hostility among the three founding clans and their supporters. Though several generations have been buried since Bartholomew won the prominent position, the anger has been sustained by the other two families, MacGuire and Murdoch. A way of life had begun among the families—assassinations, kidnappings, black-mailings and other dubious dealings became a matter of course—but everything was kept behind the curtains. The average man just saw the blood-stains on the sidewalk the next morning. The Kingsfield clan, who is rumored to have been the instigator of the feud, was almost wiped out and have never recovered their strength.

Today, the GREAT RESENTMENT is even



more clandestine through methods not quite as hostile. The Bartholomews have an open politic of opposition within the corporation, skillfully maneuvering their opponents and advancing their own positions step by step. The MacGuires are their strongest opponents, while the Murdochs try to stay outside but doubtlessly support the MacGuires. The two control most of the profitable colonies and the heavy industry, while the Bartholomews control much of the military forces and the Imperial Security Corps, the ISC.

Despite the great resentment the clans always stick together against outer threats and when dealing with external matters, such as the conquest of new colonies.

### BUSINESS STRATEGY

Imperial does not have a specific business profile, mainly because it's still too small to have a strong influence. Instead, it concentrates on growth. Nevertheless, products that carry the Imperial mark and companies that apply to be called «serene purveyors» are subjected to very comprehensive and stringent requirements from at least 42 testing institutes.

A unique «business strategy» for Imperial is the openly expressed philosophy that armed conquest is a legitimate means for acquisition. This is primarily and frequently practiced in remote settlements on Mercury, Venus and Mars. While other corporations buy out such competitors, Imperial might very well send in a special force armed to the teeth to conquer an established settlement. The excuse most often used is that the settlement was «Cybertronic-controlled» or that the



expedition was searching for a Cybertronic sympathizer.

The same violent strategy is practiced when it concerns business. It is a bold philosophy which includes acute planning before a «mission», where the stakes are high, but so is the profit.

In its ambition to become self-providing, the Imperial business empire has grown to include just about all branches of production. The only products that might be called «typically Imperial» are their arms and armor, which always, almost without any exceptions, are the heaviest and most efficient on the market (and often the most expensive).

## THE IMPERIALS



Considering the size of Imperial one might be led to believe that they are an easy target for their larger and more powerful opponents. This is not the case.

Imperial will defend its values and colors to the last trooper, never backing down from a conflict, always driving a hard bargain. Any agreement is enforced to the letter and Imperial will fiercely defend any contracts entered into. They are quick to anger, and the troops of Imperial will often best their enemies through sheer will and devotion to the families that rule them.

### THE IMPERIAL SPIRIT

The spirit within Imperial society is very strong and positive. Knowing they are still the underdog and need to struggle for survival, «every man and officer will do his duty». This spirit is actually stronger at the lower levels of society than among the nobility, which often doesn't have the same motivation.

The loyalty towards Imperial is extremely strong among the military, where no sacrifice is too great. The reason is mostly pride and honor; in a society where everyone is almost equal (apart from the unreachable nobility), only honor and glory separate the weak from the strong. And no glory is greater than doing your utmost in the service of Imperial.

In civilian areas of work, thirst for conquest and profit rules and the move-ahead spirit and ambition are important key-words. «You must never be satisfied».



### THE MACGUIRES

The main adversaries of the Bartholomew family are the MacGuires. They have a long standing feud with the rulers of Imperial and are the second most powerful family.

The MacGuire family has been appointed the industries in the asteroid-belt and are developing these into competitive enterprises. The money they make is used to build up a strong army which in the future can be used to best the Bartholomews.

They contribute to the Imperial special forces with the fiercest warriors known, the dreaded Wolfbane commando, which is composed of renegade clansmen who have, for their own reasons, split from their bloodlines and joined «the Wolves».

### THE MURDOCHS

This family represents the large clans found on Mars. These clans are traditionally opposed to the aristocratic families ruling Imperial and are actively trying to get rid of the Bartholomew family through secret schemes.

The clansfolk, as they are known throughout the system, are some of the fiercest human warriors to be found. They contribute to the Imperial special forces with the Highlander Clan Warriors.



## FIGHTING THE DARKNESS

The ISC agents have vast experience fighting the Legions of Darkness. Ever since the first indications of infiltration and sabotage, the ISC has had a special department for anti-Legion counter-measures. Through continuous surveillance, tapping and other kinds of espionage, they seek out and track down infiltrators at work within the corporation. The struggle has resulted in many casualties.

«When is the delivery expected to arrive?»

«Sssh, not so loud, you idiot!»

«No, you shut up, Greenham! Brother Malacocht is very annoyed about your rôle in this operation. Don't you never, ever, let him down!»

«I'm just worried the ISC might be at our heels...»

«Shut up, Greenham, or do you want to find out more about the Dark Symmetry...?»

«No...»

«Right, when is the delivery due to arrive, we need those fuses now!»



## THE MILITARY

A small business empire, Imperial also has limited military power. The military forces are strictly divided into two separate branches, the DEFENSE FORCES and the SPECIAL FORCES. While the special forces have much better training and equipment, the two hold the same status, since neither could survive without the other.

### THE OFFICERS

Becoming an officer in the armed forces is one of the greatest honors among the Imperials. The non-commissioned officers, at squad and platoon level, are all

elite soldiers, experienced, skilled and good leaders. Most of them would easily qualify for the special forces in any corporation, but once they get their stripes they are forever true to Imperial. The requirements for becoming a higher officer, at company or battalion level, are very strict. Promotion is in accordance to your achievements, where loyalty, skill and boldness are valued.

Usually, there are no disciplinary problems within the Imperial military, since all recruits are volunteers and most officers are just and skilled in leadership.

## THE DEFENSE FORCES

The DEFENSE FORCES are the regular army. They are responsible for defending all Imperial assets and holdings, for transportation and escorts, for surveillance, patrol and body-guard missions. They are competitive with regular forces of other corporations, but they are limited in numbers. Therefore their tactics rely on high mobility, great fire-power, and heavy armor, so that they always can be where needed and are strong regardless of which type of enemy is encountered.

Like all military units, the Imperial defense forces have their own elite units, in this case separated from the «regular» special forces.

## THE SPECIAL FORCES

Imperial Armed forces rely STRONGLY on their many different specially designed units. What they lack in numbers, they make up for with extreme training and special equipment. Their one drawback is a limited field of use—all soldiers are hand-picked for a very specific kind of combat type and their training for other situations is limited. For example, a jungle assault soldier would not be best utilized defending a fortress in the polar regions of Mars.



## THE READING PALACE

Imperial's most important building, the Reading Palace, by the Imperial Plaza in Luna, contains all vital offices of the mega-corporation's management functions. Apart from the Parliament with the Houses of Lords and Commons, the Serjeant's office and the High Courts, the top 29 floors of the Reading Palace is the home of the entire Serene family.

The palace is erected in stone and the monumental architecture makes it one of the more imposing buildings in Luna.

Large banners and flags surround the palace and the square in front of it, and numerous monuments, memorials and statues meet the visitor both on the square and inside the huge entrance-hall. The interior is also very monumental, with very high arch-ways and pillared halls, marble walls and floors, statues and epochal works of art.

The security routines are rigorous both inside and outside the palace, and the higher you get in the building, the more strict are the permit checkpoints. The most important board-rooms can only be accessed through special elevators not leading anywhere else.

## THE SETTLEMENTS



Imperial is the most successful corporation when it comes to founding new settlements under hostile conditions, be they hostile due to the environment itself or because of unfriendly forces.

A typical expedition is initiated with an ARMED CLAIMING EXPEDITION being landed or dropped into the zone—a mine, a production complex, an oil well, a refinery, or the like. Next, when the perimeter has been secured, a small clearing is opened to allow units of engineers to safely drop their equipment and vehicles. If resistance is found at the site, it is either eliminated or the claiming force is picked up on a pre-determined spot.

Otherwise, a landing strip and defense structures are built, mine-fields are laid and electric fences erected, all within 24 hours, to make sure the settlement is protected.

After about a week the settlement is ready for civilian personnel; miners, engineers, geologists, construction workers, administrators, craftsmen, and their families, only a small unit of regular soldiers stay for surveillance and defense purposes.

In this way Imperial has founded thousands of small settlements all over





### MARK 54 «THE BAUHAUS BULLY»

This warmachine was Imperial's answer to Bauhaus' armored forces on Venus and served almost as a mockery of all the streamlined vehicles of Bauhaus.

The «Bully» is very heavy and has extraordinary terrain capacity, but it is fairly slow. However, its armor is far too powerful for most conventional tank guns.

**Dimensions (L/H/W):**

8.5/4.2/ 5.0 m

**Crew:** (2 x gunner, driver, commander)

**Armament:** 1 x 145 mm rifle-bore gun, 2 x .80 caliber MG in side-pod

**Road Speed:** 32 mph (51 km/h)

**Ammo capacity:** Gun: 24; MG's: 1,400

**Modes:** Gun: M; MG: A

**Ranges:** Gun: 300/450; MG: 1000/1500

**Damage:** Gun: 1d10+3; MG: 1d6+6

**Armor:** Front: AF 18; sides, top, rear AF 8

Mercury, Venus and Mars. Usually, they accommodate 1,000 pioneers, but the largest have expanded far beyond 50,000 and become small cities. These bold settlers struggling for the growth of the corporation are regarded as the greatest of heroes and are held in much higher esteem than any bureaucrat in Luna.

### FUKIDO

The free settlement of Fukido is, apart from Luna, Imperial's largest base of operation. Originally a Mishima colony, Imperial investors managed to lease the whole thing overnight. Today, it is the second largest megacity on Mercury and still growing to compete with its twin counterpart, Longshore, where Imperial also has much interest.

The most dazzling thing about Fukido that immediately catches your eye is the gigantic Hieronymus-cathedral, eclipsed only by the Cardinal's site on Luna. Hence, all Fukido and very much of the rest of Mercury alike is very strongly influenced by the Brotherhood and its doings. Everywhere Inquisitors, mystics and advisors stroll the streets and alleys, seeking for any sign of the

Legion's influence in the shape of heretics, or artifacts.

Imperial's one problem with Fukido is that the «leasing contracts» only run for one-hundred-years, so eventually Mishima will reclaim the grounds and the buildings.

### THE BATTLE ZONES

Hardened by decades of armed struggles, the soldiers of Imperial have learned one thing—discipline. And when an order from above comes, the Imperial soldier does his utmost to carry out the order.

Battle zones where Imperial is involved are characterized by trenches, defense towers, mine-fields, traps and ambush sites. Where the other corporations practice the tactics of mobile combat, rapid assaults or vertical wrappings, the Imperial soldier stands his ground and demonstrates his unmatched proficiency in defensive fighting.

The special forces practice a drastically different tactic: charge, assault, attack and conquer. Surprise and swiftness are the key words to an assault soldier, he knows that attack is the only defense.



## IMPERIAL DIPLOMACY

Because of the aggressive policy of the United Imperial Corporation, its relations towards the other corporations could definitely be better. This is compensated by an open-minded and generous economical policy; if Imperial captures a Capitol refinery, it'll most probably sell the refined products for a lower price than Capitol did when it ran the refinery. Not popular whit Capitol, but it helps save face with the other corporations.

### THE CARTEL

Imperial is represented in the Cartel High Council by a prominent member of the Serene family, usually the contender for the position of Serenity. The one problem is that the representative can only act with authority from the Parliament, in which he is not a part. Also, the Serene family's interests don't always correspond with the Parliament. Bauhaus and Imperial are the two fractions whose opinions are the most similar with the Cartel. The only area where they differ drastically is concerning Cybertronic; Bauhaus' main business partner and Imperial's main adversary.

### THE BROTHERHOOD

Like Bauhaus, Imperial has a very strong connection with the Brotherhood and these two corporations supply the four directorates with by far the most disciples. Wherever you look in the Imperial bureaucracy, you'll find an advisor ready to make comments or corrections to corporate decisions.



### CYBERTRONIC

Like the Brotherhood, the nobles of Imperial openly claim that Cybertronic are messengers and disciples of the Dark Legion, under influence of an invisible pattern of the Dark symmetry. The conviction varies from blind fanaticism to mild dislike. In remote areas on all planets, there's an open, constant war going on. Cybertronic holdings are even given higher priority than those of the Legion, since the latter give no profit. Also, «Cybertronic» provides the perfect excuse to attack and conquer settlements of other corporations as well.

### THE DARK LEGION

Imperial is the corporation that takes the threat from the Legions of Darkness most seriously. This is partly



because of the damage the Darkness has caused to Imperial's infrastructure. Again and again the Legions have washed over settlements and industrial sites belonging to Imperial. This has resulted in Imperial

backing the Brotherhood to a greater extent and the founding of several military units devoted to the destruction of the Legions of Darkness, such as the Blood Berets and the Highlander Clan Warriors.

## THE ISC

The ISC, the Imperial Security Command, is the system's most highly prioritized and busy security force. Their tasks range from counter-espionage, advising and educating against terrorist groups as well as counter-terrorist precautions, to the handling of internal crime affairs and ordinary street law enforcement.

### ISC GENDARMARY

The larger, visible part of the Imperial Security Command consists of the Gendarmery, the street name for the Citizen Service patrols. Like Bauhaus, these are under

direct command of the corporate management and feel strong loyalty and companionship towards the man on the street. They are the management's major public face.

Normally, the gendarme is armed only with a light semi-automatic handgun and carries no body-protection. They patrol in pairs and use vehicles only in emergencies. Even while respected, most people regard the gendarmes more as «patrolmen» rather than crime-fighters. This is the task for the rest of the ISC, the agents, who are almost as common but always undercover and never assigned to a special district.

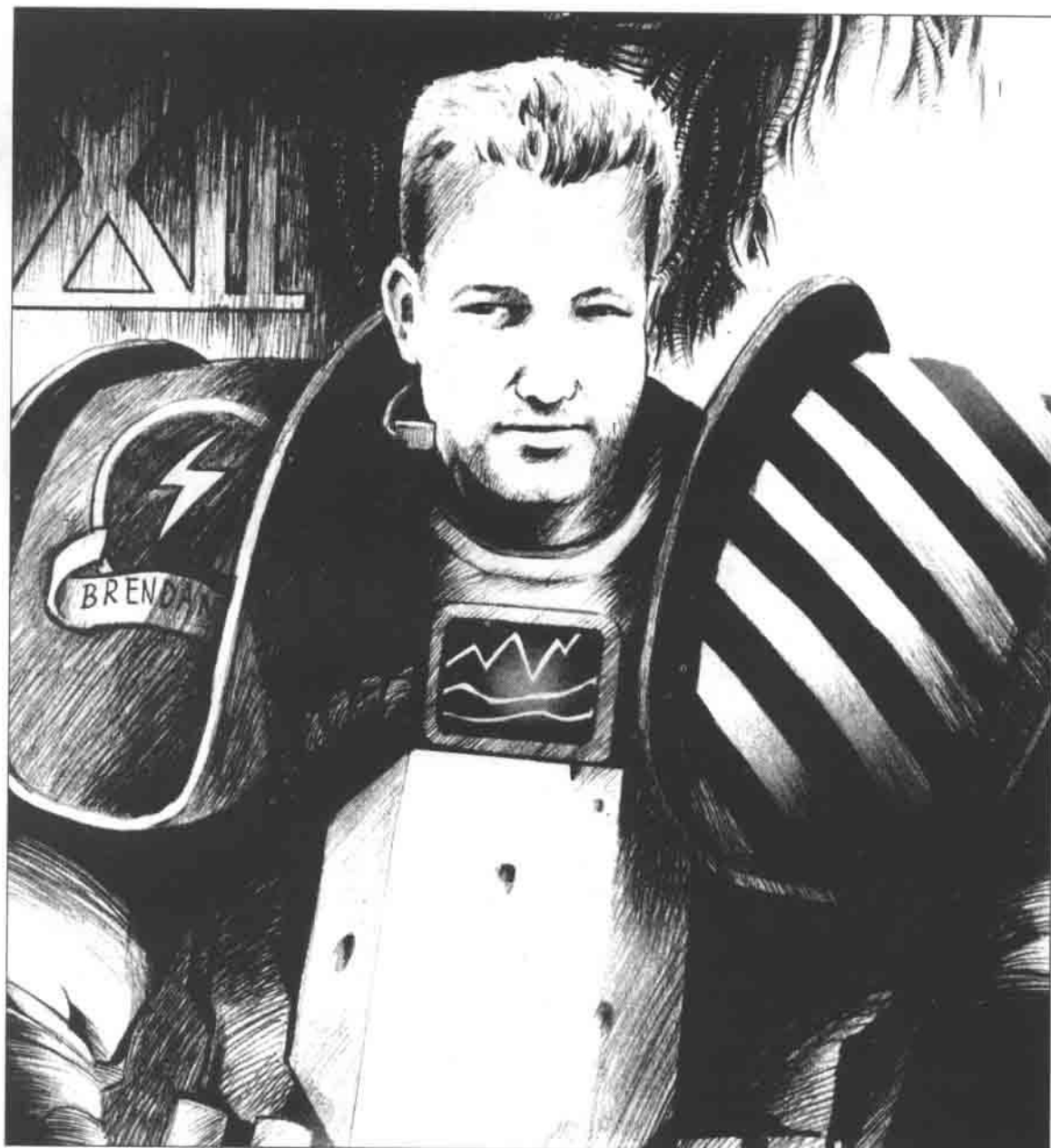



### THE AGENTS

However, ISC's primary task is to track down and eliminate infiltrators and sympathizers of the Dark Legion and Cybertronic, which are synonymous to most

members of the command. With regular intervals, they manage to reveal Cybertronic agents at top positions within the Imperial bureaucracy, on some occasions even inside the Parliament. This has really shaken the Imperial management, and the ISC nowadays have almost unrestricted authority and resources.

ISC agents always act under-cover and are exclusively hand-picked elite soldiers given new identities to be able to avoid suspicion.



### CLANSMAN CLAYMORE

These fearsome two-handed swords have an almost «religious» significance among the clansmen, who often carry them in battle instead of fire-arms, without any obvious logical reasons, but they are said to protect against the influence from the Dark Symmetry. Manufactured by Consolidated Arms.

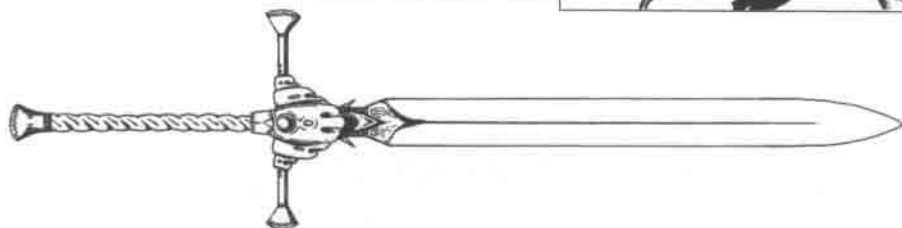

W	L	STR	Dam (1H)	Dam (2H)	Cost
4,8	114	11	1d4	1d6	5,40

### A CASE FOR THE WOLVES

Malcolm MacGuire was literally thrown behind the car by his huge body-guard as bullets whistled past his ears. He could hear the short, distinct bursts of automatic fire, the ricochets, broken glass, the screams from bystanders hit by stray bullets...

Lying face-down in the filthy street, the MacGuire clan's chief negotiator felt afraid and naked. It was as if all the years of soft living had caught up with him in a single evening.

«Stay down, Malc, I'll take care of this!» Clifford snapped. From under his coat he produced a single grenade. Yanking the pin out, he let it fly toward the gunfire. The assailant with the automatic disappeared in a cloud of smoke and flames. It was over before it could even begin. Clifford dusted himself off and surveyed the damage.

«We've lost Gillian, and Turner is badly wounded.»

Malcolm MacGuire rose on weak legs. He was aware that tonight's objective was KILL him. He realized his job put him in danger, but he hadn't thought that the attempt could be so obvious, so vulgar and unsophisticated. An open assassination on the street hadn't occurred in a long time within Imperial. Political maneuvers and all sorts of conspiracy could be expected, but this... to actually KILL him! Slowly, his disbelief turned to cold rage.

«It is time to call the Wolves. This is something James Bartholomew will deeply regret...»



## THE LAST CHARGE

«How many of the clansmen can do battle?»

Lady Moira Murdoch looked out across the valley, letting her eyes fall on the ranks upon ranks of dark figures that blocked their way to freedom. She was tall, even taller than her father, the legendary Fergan Murdoch, the hero of the battle of the Epping Fords. Moira's hands rested on her battle-sword, the sword that had been her father's, and her grandfather's before that, through many battles and skirmishes. Her long hair fluttered in the wind and the rain stung her eyes.

«Hard to tell, ma'm. Eric and Thomas have both taken heavy wounds. I don't think they will live to sunset. And the others are tired from the march and the fighting. We lost many men last night.»

The man who spoke was Moira's second brother. They were standing on top of the hill, the cold wind whipping at their garbs. The clansmen wrapped themselves tighter in the bearskins and shifted their feet on the ground, unsure what to do. Moira turned around to face her brother.

«I asked if they can fight!»

Her brother turned towards a group of ten clansmen. Two clan warriors were seated on the ground. Their faces were pale and their hair and beards caked with blood. A glance and a nod said it all.

«Aye, ma'm. They will fight.»

Moira looked out over the rolling hills before she turned towards her clan brothers.

«This is our time in history. We will roll over the enemy like a wave of anger and sweep them off their feet, drive them back to the unholy dimensions from whence they came. Our fathers and brothers will be proud of us and we will forever be remembered when they speak of the ancient heroes in the Hall of Meeting.»

She turned and pointed her heavy sword at the dark legions assembled beneath the clansmen.

«Stand proud, look them in the eye and drive your swords through their perverted bodies. Think of our forefathers and your aim will be true. Give no pardon, clear your minds and follow me!»

Moira lifted her sword towards the sky. She felt elation fill her and she could almost hear the ancient warsongs as they had been sung at the Epping Fords. The battered and wounded clan warriors rose from the ground and gathered around her. As one they lifted their weapons and let their warcry echo over the valley.

## THE JET CHUTES

«OK guys, fifteen seconds to drop-zone... ten... eight... six... five...» the pilot's count was slow but steady as the huge Doomlord helicopter slowed down to dropping speed, just below 10 meters a second. Through the slide-doors I could only see a rectangle of glowing flares placed by the recon squad. They had only been given five minutes to make a clearing. «two... one... and... GO!»

Kicking hard with the left foot, I flung myself out into the pitch-black night, crouching with the knees and the head to the chest to make a smaller target. I had always liked the good old standard silk chutes better, but gliding time proved too long and mid-air casualties too heavy. Finally, they had developed this monster, the jet chute, lovingly called the «pile-driver». Just as gentle to your rib-cage and just as easy to carry about. But, with the pile-drivers, they could drop us to 90 feet, even though the manufacturer only gave guarantees for 150.

The «Bitchin' Betty»-signal notified me to turn on the jet if I wanted to avoid being smashed to the ground. I didn't even have time to turn the damn thing off before the automatic ignition mechanism released, almost splitting my eardrum and most certainly breaking every single bone in my body. It stabilized vertically at 30 feet, the reflecting flames almost burning my eyebrows off before I remembered to put the goggles on. As I slowly sank to the ground, despite the blood in my mouth, the pain in the chest, the burns on my shins and the ringing in my ears, I couldn't avoid loving the little marvel. The bloody thing actually worked. Again.

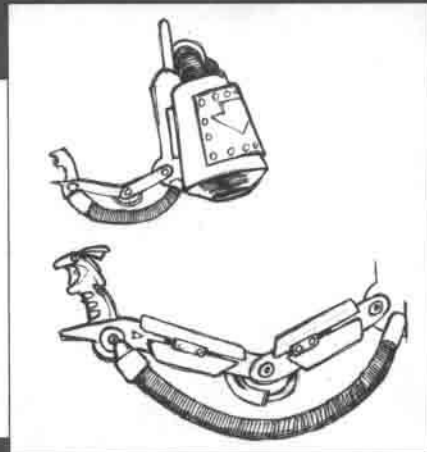
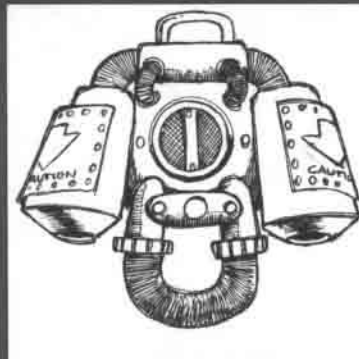



IMPERIAL™



## GOLDEN LIONS

Seen here is lieutenant colonel Edward S. Murdoch, squad commander of the Imperial Golden Lions.

The armor is a quite conventional Imperial heavy assault combat armor Mk. III (treat as heavy combat composite, AF 8), here seen with the red and gray-striped painting unique for the Lions. However, note that shoulder-pads are of the lighter Mk. I design (compare with the more rounded, double pads of the Mk. III suit of sgt. McBride). The TR-145 head-set is standard Imperial design, used by both the SC and most special forces, as are the IR-goggles and the «VIRTUTI» combat coordination unit seen on the left shoulder.

On the right shoulder is the standard Imperial Armed Forces badge, carried by all Imperial men-at-arms, and below it the rank (here lieutenant colonel's stripes in red and yellow). As with all regimental officers, the rank is also indicated on the wrist. The left shoulder carries the insignia of the Special forces, which is often replaced by the unit's unique badge, but here, instead the flash of the «Steel Leeks» (3rd Regiment, 12th Battery) is worn on the knee.

Murdoch is armed with an Intruder assault rifle Mk. 43, an early version of the Mk. IVP Plasma Intruder SMG.

## THE WOLFBANES

The fiercest warriors known, the dreaded Wolfbane commandos of the MacGuire clan is composed of renegade clansmen who have, for their own reasons, split from their bloodlines and joined «the Wolves».

The most characteristic features of these blue-blooded warriors are the long hair, worn in a pony-tail, the fur coat and the hardened leather overall and tunic. Furthermore, the war-paint is rarely used except by the Wolves and the Highland Clan warriors of the Murdoch clan. This picture shows the war-painting of Commander Chieftain Sean Gallagher.

On Sean's left shoulder is the insignia of the Imperial armed forces, the Union Jack cross and the skull, but as a sign of defiance, the yellow-blue-white-red half circle has been removed. Instead, it is found on his right shoulder, along with the SKULL of the Wolfbanes and the SWORD representing the close-combat units of the commando. The support fire units have a flash insignia instead.

The Wolves always use either traditional, inherited, Clansmen swords or heavy weapons like the Charger HMG.



## CUIRASSIERS AND CHASSEURS

Technological marvels not found anywhere else than in the ranks of Cybertronic, the chasseurs provide with the utmost troopers when it comes to firepower and armor. The explanation is simple, but the methods obscure—the Cybers have found methods to integrate mechanical machinery with the human body, creating a symbiosis between man and machine.

The Attila units are state of the art in this branch of technology, the «cuirassier» combat robots. Impossibly strong, loyal to the end and pre-programmed for more mission-scenarios than any human can grasp, they can be deployed virtually anywhere, on short notice and with a minimum of briefing and preparation. With their weight of nearly one thousand pounds, they can carry the heaviest firearms available, alternatively swing mêlée weapons twice the size of a normal man. Clean hits with explosive ammunition are a must to stop these ultimate foes, that perform their tasks with a surgeon's accuracy regardless of defense.

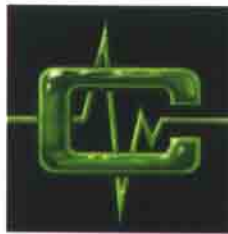

**CYBER-  
TRONIC™**



But robots are not the limit of Cybertronic's achievements—maybe even more remarkable are the «chasseurs». Half men, half machines, they do not have the strength of the cuirassiers, but certainly possess much more of the creative imagination that cold steel and logical microchips will always lack. It is disputed which description fits best—a machine with human emotions or a human with a machine's emotions—but they certainly carry out their tasks with cold efficiency without letting anything stop them. Their «humanity» primarily shows in their ability to cooperate with humans and understand them.

As with the cuirassiers, the chasseurs carry exceptionally heavy weapons and their armor plates will stop even clean hits with very heavy weapons (AF 10+).

# CYBERTRONIC

Just as the Cardinal Roland was about to speak, a messenger of the Cartel High Council entered the hall and called for silence. He bore with him grievous news for the people gathered at the devotion, and while he spoke the hall was emptied, leaving only Cardinal Roland and his kin of the Brotherhood. And the Cardinal had a premonition of dark times for the corporations and mankind, because a new power had entered the scene. And the Cardinal's followers cried out in grief and fear, because the already meager resources of mankind were now further divided. And it was this that was to become known as the Founding of Cybertronic.

And just as the Cardinal Roland had foreseen, the rise of the new business empire seemed to have no ceiling. Day by day new losses were discovered among the directors of Mishima and Capitol; smithies, pits, docks, banks, universities and garrisons were secretly purchased by the Cybertronic crew, who were all former employees of the other megacorporations.

But however hard we tried, o Brothers, none of us could find the slightest trace of influence from the Dark Legion. Not even the Changellors grasping far into their minds found anything but cleanliness and health.

And so it was that the fifth, and so far last, of the megacorporations saw the light of day.

— *The Eighth Chronicle, The Megacorporations and the Cartel \ Lucretii Marcellianus*



## CYBERTRONIC HQ

«The HQ» is the common name of the huge circular skyscraper containing Cybertronic's management. It stands isolated from all other buildings, surrounded on all sides by a wide canal making it very difficult to enter the building any other way than through the very well guarded main entrance, accessible only by a long bridge.

The HQ is circular but open on the front, creating a «C» profile if seen from above. It is mainly built of steel and dark glass and gives a more futuristic impression than the other corporations' main buildings.

The building is restricted area for all but Cybertronic officials, and it is under continuous surveillance both from the Brotherhood and Imperial, watching for any signs of Heresy.







## FACTS ON THE FOUNDING

### CYBERCURITY

A small portion of Cybercurity's military forces are constantly used as law enforcers, as part of their training and active duty. Their policemen ARE military and are equipped accordingly, but with slightly less armament and body protection. They have their regulations to stick to, and its never a good idea to argue with a Cybercurity MP.

Combined with the general «robotic» behavior of many Cyber's—especially true within Cybercurity—this makes them extremely disliked and feared among visitors. Their hits and raids are always carried out in a military manner, with military equipment and precision, and casualties are, like in war, «stuff that happens».

A normal Cybercurity patrolling officer or security guard is armed with a CAW2000 SMG, bulletproof vest and greaves under a black overall. They have personal short-range radio-gear and night-goggles after nightfall.

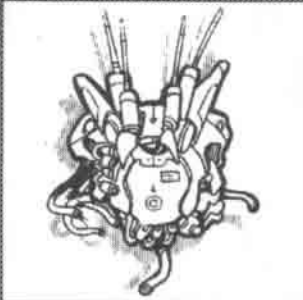

The Founding of Cybertronic was a sudden, massive take-over of corporate assets by a small, insignificant holding company, Cybertronic Investment, Inc. In the course of only hours, hundreds of billions of crowns changed hands and suddenly a new megacorporation had taken shape, the fifth in size, sniffing at Imperial's heels in terms of total value of assets. Investigations showed that false notes had been presented for the majority of the purchases; it would have been almost impossible to recognize and stop the deals even if someone had known what was going on.

### THE TRAITORS

But this was only the beginning of the Cybertronic saga. When the new corporation had formed its boards of directors, management groups, and marketing agencies, a rush of knowledge to the new organization began. From everywhere, from all corporations, expert scientists, professors, high-ranking officers, directors, diplomats and administrators broke with their traditions, quit their jobs and joined Cybertronic along with their families. In only two years, the populace of Cybertronic had increased to match its competitors. Suspicion increased among the megacorporations and the Brotherhood, but, however hard they tried, no one could find an answer to the «Cybertronic phenomenon».



### THE INFILTRATORS

It is assumed that high officials in the competing corporations are persuaded to become agents for Cybertronic, in the same manner as Heretics of the Dark Legion. There has never been any proof of these activities and of course, Cybertronic has never admitted nor denied this. (The competing corporations spend huge sums on the forces that track down the infiltrators.) Ninety percent of the persons that are accused of the crime of being a Cybertronic infiltrator confess, but 90% of the time, it takes torture to make them confess...

### BUSINESS FACTS

Cybertronic manufactures most of its own equipment. The products are extremely advanced and incorporate the newest breakthroughs in miniaturization technology and bioelectronics. The designs use ceramics and plastic and special super alloys as base materials, giving them superior performance compared to other products within the same field.

The relatively small size of the megacorporation makes these designs rare on the open market. Because of the technology and materials used, Cybertronic products have been impossible to duplicate. This also means that Cybertronic equipment is very expensive for everyone not involved directly in the megacorporation.

### THE CHASSEURS

The most striking thing about Cybertronic and what has made it famous to the man on the street is the CHASSEURS—a fusion of robots and normal men. So far, none of the other corporations possesses the technology required to copy this now legendary fighter.

Shortly after the Founding, the first chasseurs appeared on the battle-fields as mechanically enhanced humans. Their functions weren't unique, but their combat enhancement equipment was integrated with their bodies and linked to the neural system in such a way that they actually became normal parts of their bodies.

Normal «chass-gear» are laser range finders, IR-goggles, motion scanners and other pieces of equipment unique for the Cybertronic technology level.

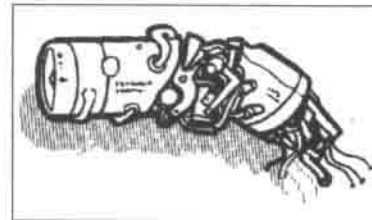

## THE THEORIES

Ever since the Founding, the scientists and managers of the other megacorporations have struggled to understand the underlying power behind the Cybertronic business group. There are multiple theories, some official, some unofficial, some very provable and trustworthy, others pure fabrications. But no matter which one you accept the fact remains—the Cybertronic scientists possess knowledge that their colleagues don't, and this has a strong influence on all the employees.

Industrial spies and infiltrators have been of no use; sometimes they returned with little or nothing of value to report, but most of the time they just didn't return. Not even the Mishima agents, specialists at the task, have managed to uncover anything.

All these things that make Cybertronic so unique—their sudden appearance in the world of high finance, their ability to recruit the intellectual elite of the other corporations, their astonishing technological breakthroughs—puzzle the rest of the megacorporations. There are only a lot of theories to explain what is called the «CYBERTRONIC PHENOMENON».

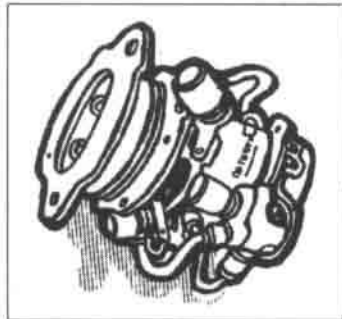

### THE CYBERTRONIC PIASTRE

The most unusual corporate currency is the CYBERTRONIC PIASTRE, which is only a paper-product. It comes in three denominations, the rectangular platinum piastre, the square gold piastre and the round silver piastre, worth 100, 20 and 5 piastres, respectively. They are used as credit vouchers, checks, but are only exchangeable in Cybertronic banks. 1 Piastre equals 1 Cardinal's Crown.

### CHEMIMAN

The «ChemiMan» is a remote controlled or homing carrier for biological or chemical weapons, large as a coffin and capable of killing scores of enemies in very short time.

The ChemiMan can be supplied with several different gas exhausts, depending on the circumstances. Since Cybertronic's armed forces to such small extent consists of conventional forces, self sufficient weapons like this are very important.

The ChemiMan has not been used against corporate forces.

## THE CARDINAL'S WORD

«Brother Luciano, the scroll you required on Cybertronic is on your desk. Eyes only.»

«Good work, brother. But nothing of this may be known to the Directorate. It's strictly unofficial.»

Cybertronic's donations to the Brotherhood are purely symbolical and not at all in relation to its true wealth. Cathedrals erected in Cybertronic's districts stand empty and desolate. Bans and threats of excommunication from the Curia are ignored, preachers and even inquisitors talk to deaf ears when painting the scenes of the death and destruction at the hands of the Dark Legions.

Changellors and Seers talk of mysterious, inexplicable visions when using the Art to explore the minds of the Cybertronics—they are so undefiled it is too good to be true. No one has ever found even a trace of the Dark symmetry or other evils in Cybertronic employees. Why would they support the Brotherhood when no fear of the Dark symmetry haunts them?

The Brotherhood is a STRONG ally of the other corporations, and this is the reason Cybertronic maintains any contact at all. The Cardinal does have limited influence on the Cybertronic management.

The Brotherhood's official explanation to the Cybertronic phenomenon is that nothing special has actually occurred. At the time of the Founding, the other megacorporations made lots of serious mistakes—which they

won't admit—that opened door for a fifth competitor. Attracted by the possibility to work with the very best experts, managers and scientists from all over the solar-system joined the ranks of Cybertronic.

There's no proof whatsoever of any difference among the Cybertronics, neither physically or mentally than anyone else, which rules out Dark symmetry influence. This is the official version.

### THE UNOFFICIAL DOCTRINE

The unofficial thought eagerly supported by a majority of the Brotherhood and Imperial, is that this is the first sign of a new pattern in the Dark symmetry, so far invisible to mankind, but slowly expanding and growing like a cancer into human society. Once Cybertronic's objective to dominate the entire solar system has been reached, the pattern will transform and show its real, horrible face.

Needless to say, diplomatic relations between Cybertronic and the Brotherhood are strained.

The Brotherhood and Cybertronic have only had a few clashes of arms, most of the time resulting in draws or victories for the Brotherhood. The fanaticism of the second Directorate has held the Cybertronics at bay; even though superior in equipment and training, their numbers have been too small. Whenever Cybertronic has acted against the Brotherhood, tenfold warriors have rushed in to stop the intrusion of Cybertronic.



### CSA404

The 400-series of Cybertronic-produced close combat side-arm is one of the more popular among military forces, even though they have never really had any impact on the streets. The 404 model is supplied with a heating device inside the hand-guard, heating the blade to 800°C, adding to the damage.

W	L	STR	Dam (1H)	Dam (2H)	Cost
3.8	113	6	1d6+1	—	12.200

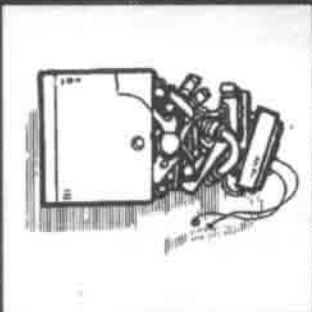

## THE CARTEL

«Hey, Hedges, did you find anything in the «Robustum» files?»

«Well, it's difficult to make something out of it. They're 36% controlled by Consolidator Trusts, 22% by Regalis Holding and 21% by each Jensen & Jessep and Mercurioil. There's a stain on your tie.»

«Thanks. You know, Rexington Bank are the main stockholders of all four companies.»

«Surprise. And let me take a wild guess: Robustum controls Rexington.»

«Bulls-eye. I think it's coffee.»

The Cartel hasn't been able to do very much about Cybertronic, nor have they tried. As long as they pay their share of the Cartel's expenses, it can't dictate any restrictions although Imperial, the Brotherhood and Mishima have all filed complaints.

However, a large section of External personnel is busy tracking down and untangling the impenetrable web that is supposed to be Cybertronic's corporation structure.

In some cases, up to five-hundred links of ownership have been investigated before finally being able to trace the ownership to Cybertronic. And since the holding companies might change owners and names by the week, one can understand the difficulty of mapping the Cybertronic corporate empire.

«Corporal, it's true the Cybers are sending us a «stiff?»»

«Yep, but he's rumored to be one of the best. Just stick close to him and he'll save your butt. It's sort of in their programming...»

The soldiers of Cybertronic have had an ambivalent position in the Doomtrooper squads; always superb warriors, unmatched in strength and skill, but for obvious reasons they have had difficulties blending in with the others. On the other hand, all Doomtroopers are experienced enough to realize there can't be any conflicts within a squad. Everybody's life depends on it.

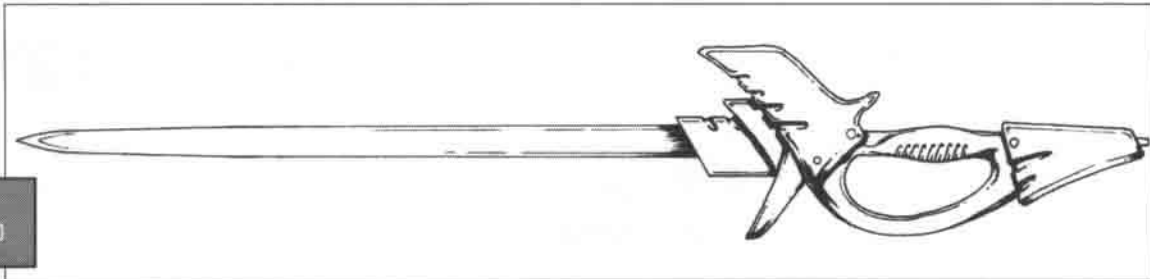

## THE OFFENHAUER THEORY

«Major, will we get any indirect fire support during the assault?»

«Negative, but do you remember brigadier Viancino? Nowadays, he's in Cybercurity service and just happens to be deployed with fifteen chasseur squads 1300 meters north of objective Charlie. Call him on frequency Blue-Five. And send my best regards.»

«Will do, Sir!»

Within BAUHAUS, the interdisciplinary theory created by the group of scientists led by General Jean-Louis Offenbauer has come to be the prevailing one. In short, it believes that Cybertronic has developed biochemical methods for altering the body's physical functions, and even the functions of the mind, the nervous system and the brain functions are manipulated by a secret substance, bacterium or genetic pattern.

By *infecting* a person with the substance, his brain begins to work in line with the Cybertronic mentality, with little or no emotional influence in decision-making. The theory's main support is based on the fact that the Cybertronic crew is infamous for being predictable, almost machine-like in doing what seems most logical at the time, taking absolutely ALL possible factors into account.

General Offenbauer, 96, is currently chairman of Cyberchemicals, Inc.

### BAUHAUS' INFLUENCE

Bauhaus is the corporation that has suffered most from Cybertronic's recruitment. A large amount of officers have deserted the corporation, and become devoted Cybertronic employees, showing even more loyalty to their new masters than they formerly had to Bauhaus. One would think that Bauhaus would react negatively, but instead they only show respect and admiration for those who have managed to lure their elite away from their origins. Within the minds of many Bauhaus officials rests the dream of being recruited to Cybertronic, the elite, the ultimate proof of success.

Most of the «traitors» from Bauhaus are men who have received high positions within the military structure, Cybercurity, where they currently make up a large part of the body of generals, marshals and strategists. This is apparent in Cybertronic's military tactics. It is very similar to Bauhaus', but modified to work in the small special units of Imperial style.

Other fields of influence from Bauhaus is engineering craft and heavy industry. Top-engineers have been recruited to design the most advanced equipment available, not always the best, but the most optimized and cost-efficient goods. Bauhaus has adopted much of the available Cybertronic technology, gaining at least something from their lost intellectual elite.

## BUSINESS RELATIONS

The Founding of Cybertronic was a hard strike for Bauhaus and in early days they did everything in their power to reclaim their lost possessions. Cybertronic's hold was too firm, and even when Bauhaus managed to reclaim some mines and refineries, they found everything changed and the repossession in vain. The former workers no longer believed in the Bauhaus way, and they revolted against their former employers.

Today, Bauhaus' subcontractors are Cybertronic's largest market, and Bauhaus is Cybertronic's largest supplier of crude material, provisions and services. The co-operation and mutual understanding is based on a number of things:

First, both have a similar mentality concerning management, design, quality and lifestyles—only the best is good enough.

Second, Bauhaus needs co-operation to be able to compete with Capitol and Mishima, because only Cybertronic can provide the technology necessary to manufacture the best of the best in quality measures.

Third, by investing in Cybertronic while they are still small, the Bauhaus stock brokers hope to make a really good deal in the end. Almost a third of Cybertronic's sub-divisions and retailers are to at least 49% Bauhaus-controlled.

Fourth, the Bauhaus scientists want to make sure they are the first to crack the secret behind the «Cybertronic phenomenon». So far, they are not even close.

## CONFLICTS

On both Mars and Mercury, Bauhaus troops have been seen fighting side-by-side with Cybercurity forces, and only on a handful of occasions have they fought each other, primarily on Venus. Every single time, the Bauhaus generals have easily beaten their former brothers-in-arms by anticipating their moves. And therefore, Cybertronic has learned their lesson and nowadays avoids conflicts with Bauhaus. The general odds AGAINST attacking an equal Bauhaus force has proven to be as much as 1:5,2. And reversed, in the eyes of a Bauhaus officer, it is almost unthinkable to even discuss an unprovoked attack on a former colleague and orderly brother.

So, the contacts and co-operation between Bauhaus and Cybertronic are rather extensive.



## TICKER

Monosodiumortoben-saliumamononitrile-3, or «Ticker», as it is commonly called, is one of modern science's greatest achievements. It was invented and first produced by second lieutenant Miriam Duval of BauChemicals.

Ticker is a hyper-conductive biochemical substance which injected into the cerebral cortex optimizes the transmission of nervous impulses, thereby improving the brain's capacity and boosting its activity. With slight alterations, Ticker can also direct-transmit these impulses from the nervous system to conventional electronics, which in theory opens up unlimited possibilities for mechanical enhancement of the human body.

Ticker is still on a stadium of testing and still has some severe side-effects—eye ticks (which has given it its name), suppression of the emotional center in the brain, muscle cramps, convulsions and severe frothing also have occurred.

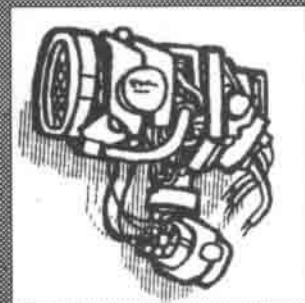
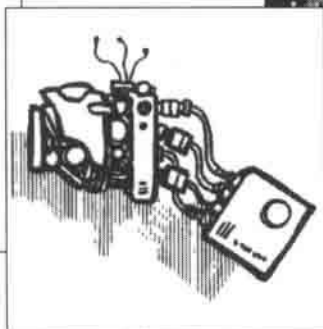
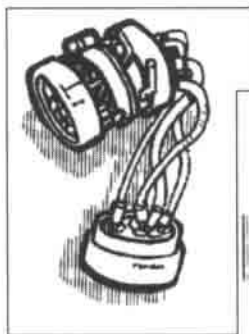



## BLUEBERRIES

During Bauhaus' research, these blue pills have been used to suppress the physical side-effects of Ticker. The goal of the research-program is, of course, to develop Ticker into something which gives similar effects to what Cybertronic seemingly have achieved.

The effect of blueberries is that they numb parts of the somatic nervous system, which controls all muscles, thereby preventing it from running riot (this has repeatedly resulted in cardiac infarctions and cerebral hemorrhages). However, it has no effect on the suppression of the emotional center that Ticker causes.

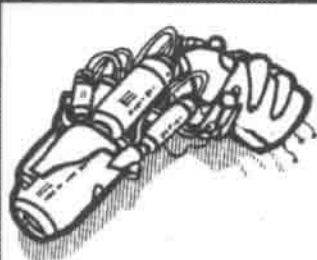

## THE SULLIVAN SYNDROME

Former CAPITOL Psychologist Dr. Simon Sullivan, expert on psychological combat reactions, theorized that the «Cybertronic Phenomenon» is the effect of a mental abnormality among the traitors. Faced with the perpetual threat from the Dark Legion, the terror-propaganda from the Brotherhood, and the high demands from society, these persons have been struck by a mental disease which reminds us of schizophrenia, causing them to give up their past and start a new career in a new environment. The syndrome, he continues, also changes the brain's chemical makeup, which improves the capability of logical thinking and calculation while suppressing emotions and imagination.

The theory has gained much reputation, and even if no one takes it seriously, the Sullivan Syndrome still causes lots of trouble to the Cybertronic propaganda machine.

Dr. Sullivan died from heart failure at the age of 28.

## RELATIONS

The average Capitolian has no special prejudice or preferences concerning Cybertronic. They are like any other business partner. The business relations between Capitol and Cybertronic are healthy and prosperous. They have not suffered notably from either infiltrators or traitors, and as long as Cybertronic doesn't mess with Capitol, Capitol doesn't mess with them. Cybertronic controls large business, production and entertainment districts in San Dorado, Capitol's «capital» on Mars.

If anything negative can be pointed out in the relations between Capitol and Cybertronic, it is the drastic difference between the corporations' view on the individual. Most Capitolians have difficulty coping with the elitist attitude of the Cybertronics, but business is good...

## IMPERIAL

*«So, Allen, where do we strike next?»*

*«Cybercadium. Milton on ISC5 was very specific—civilian casualties are a must. They must remember the Fire Birds.»*

IMPERIAL sticks openly to the Brotherhood's unofficial doctrine, that all Cybertronics and all their work are linked to the Dark Legion. This doesn't mean open war, but it means they have no diplomatic communication whatsoever, no business and no joint-venture settlements. On the contrary, Cybertronic-controlled settlements, or remote complexes in general, are «allowed targets» to all military forces, especially Imperial's. This excuse is VERY frequently used, no matter if its true or not, it's a good excuse when conquering Capitol settlements as well...

In urban CIVILIZED areas, the war is limited to terrorist actions carried out by freelancers; Imperial wouldn't risk

their own personnel in these actions. Instead, they engage street-gangs and criminals to place bombs, assassinate, and sabotage. The reply from Cybertronic is exactly the same, which has led to extreme security precautions in the corporations' official buildings. These attacks are, if not organized, at least supported by the ISC and the Bartholomew clan in particular.

But as in all other areas where money is involved, greed and profit often stands before personal conviction. And even in Fukido, Imperial's «capital» on Mercury, Cybertronic has companies and offices. These «bunkers» are among the most heavily fortified buildings ever built, with 50 foot concrete walls and 20 foot armored glass for windows, surrounded by mine-fields and barbed wire electric fences, they are as close to impenetrable as possible.

## THE MISHIMA DOCTRINE

*«Mr. Kurito, have we received the shipments from Cybertox yet?»*

*«I'm very sorry, Mr. George, but there seems to have been some sort of trouble at the customs. We suspect that Bakin and Lord Heir Moya's men got there before us...»*

*«Damn it, Kurito! I specifically ordered you to personally supervise this! Reorder those medications on the double, the expenses will be deducted from your salary.»*

*«But Mr. George, it's more than fifteen millio...»*

*«That's all, Kurito!»*

The relations between Mishima and Cybertronic are very similar to those between Capitol and Cybertronic, secular

and open-minded, but Mishima's trading connections aren't at all as extensive. In trade for the unique Cybertronic technology, necessary in many of Mishima's electronic products, Mishima provides them with provisions, raw material and services. In general, the Mishima management sticks to the Brotherhood's official explanation of the «Cybertronic phenomenon».

All this is true for the Venus and Mars branches of Mishima, while the Mercury branch, with Lord Heir Moya on top, refuses to have ANYTHING to do with Cybertronic. No business, no neighboring settlements, no military co-operation. It doesn't go to the same dimensions as Imperial, they simply ignore Cybertronic. Cybertronic technology is purchased through Lord Heiress Mariko's and Lord Heir Maru's channels.

## WHO GOES THERE?

Jansen slammed the door of the cab as he got out. It had been a difficult morning, and it showed on him. Not enough time to take a shower or shave, he had to rush into his clothes and down to a cab. Just because the alarm didn't go off. Halfway to work he realized he had forgotten his briefcase as well, containing all the papers necessary for the Nelson-deal. He couldn't turn back and get them or he would be in even more trouble if he was late.

He quickened his pace as he approached the security zone, fishing in his pockets for identification and security papers.

«Halt! Who goes there?»

The familiar challenge of the Cybertronic security guards didn't stop him and he approached the two men posted outside the gate. He recognized one of them.

«Morning, Joe. Nice to see you. Just hang on a second, I'll get my papers out...»

He was interrupted by the guard, who raised the muzzle of his automatic weapon.

«Identify yourself or leave this area!»

Jansen paused in his frantic attempts to find the papers and threw a surprised glance at the man.

«Hey, Joe, you remember me, Jansen. You worked under me at Research. Two months ago.»

«Present your identification or leave the area. This is the last warning.»

The coldness of the guard irritated Jansen. He started searching his pockets again when it suddenly hit him.

«I left it at home. It's on my kitchen table. But let me just call Dr. Thompson, he'll...»

The heavy rattle of the automatic weapon interrupted Jansen and threw him several yards backwards, his chest riddled with bullets. His face was frozen in agony and surprise.

As he slumped against a lamp-post, one of the guards approached the body, weapon ready to fire.

«Unidentified intruder neutralized at entrance B45. Failed to produce identification. Requesting clean-up. Returning to duty. Over and out.»

## KNOW YOUR ENEMY

This operation was a mess. From the start Waters had felt that something was wrong, something he couldn't put his finger on.

It had all started a few weeks ago when Takasha Electronics had approached him with a proposition. It sounded simple enough, find out who was trying to stop Takasha business on Luna.

Then the trouble started. When Waters had tried to tap the computers for background information on Takasha, a couple of goons started shadowing him. After that it had gotten worse. When he finally got through the red tape, the maze of connections nearly defeated his attempts to find out who really owned the company, and what kind of enemies he could expect.

After going through fifty-three façades he finally pulled the name of the big one. Cybertronic. He should have known.

No one protects their assets like Cybertronic. It's all cloak and dagger, you can't tell black from white.

And when he confronted Takasha about it the director said they didn't know, but now that they did know, did it really change anything?

Anyway, now Waters knew what kind of people he was up against. And where to look for them.

He'd asked at the water-holes, and soon found out he was on the right track. Other Freelancers had been approached about hitting Takasha, hitting it hard. Joker and Travis had accepted and the word was that they were working together with a corporation. If the money's right, some guys will do anything.

He had found out that the two freelancers were planning an attack on the plant that night, backed up by forces that had been flown in from Mars. When he had told Takasha, the man had reacted with uncommon swiftness. A contract had been offered to Waters, where he had been offered command over five squads of Cybertronic security men to stop the assault.

And now, there he was. On a roof-top opposite the Takasha plant, with a lot of Cybertronic security forces, armed to the teeth.

Suddenly the sound of marching feet interrupted his train of thought. He looked about him, finally fixing his gaze on the alley where the shadows of soldiers played on the walls. But something was wrong. Waters strained his eyes and then suddenly realization dawned upon him.

He quickly looked at the soldiers lying beside him, the blue and black uniforms, the characteristic helmets.

Then he looked back at the advancing soldiers, the enemy led by Travis and Joker. The troops mirrored the appearance of his own soldiers. Cybertronic security forces were attacking thier own. Waters let out an audible groan. This operation really was a mess.



## C-BASE

«CYBERTOX, the most important and prominent of the Cybertronic empire's chemical companies, has its laboratory, refinery and mining facilities and the largest part of their production complexes in this base. The C-Base, as it is commonly referred to, is really an architectonic marvel, designed as a gigantic shaft straight through this small piece of rock—Callban—in the third Kirkwood-band of the Asteroid-belt. The administration and management reside on Luna, though.

The most astonishing rumors about the C-Base have it that it was finished in only 246 days, which says a lot of Cybertronic's efficiency and resources. Even Capitol Constructions would not match that.

According to Mishima spies, later captured and used as guinea-pigs, all mining takes place on the middle sections, that's in the middle of the planetoid, while the laboratories, offices, security sectors and the docks are in either end of the shaft.

The employees are said to have tremendous salaries and accommodations, but must in turn live with the rigorous security restrictions and accept the fact that the deployment to C-Base lasts for life. This must be considered a low price for the benefit of being among the pioneers of science.»

«Thank you very much, dr. Johnston. Well, gentlemen, any questions? Right, Alpha battalion will assault from sector 15. Bravo from 14, while Charlie and Foxtrot will wait and defend their positions here and he...»



## THE 19TH EXECUTIVE

«Our agents have found that this insignificant building in the outskirts of Luna is in fact a secret underground mausoleum for Cybertronic's nineteenth member of the Board, Raoul Mannerheim.»

As you know, Mannerheim was one of the geniuses that turned Cybertronic into a megacorporation, much thanks to his brilliant leadership within Cyberchemicals, and his uncompromising concentration on research which was so advanced it was considered radical by contemporary authorities.

We have proof that Sergei Mannerheim, nephew and one of the Executives of Cybertronic, has access to the building and that he visits it regularly. According to usually reliable sources, Sergei isn't exactly a genius himself, but somehow he manages to keep his position in his uncle's foot-steps anyway.

We have strong reasons to suspect that Raoul's mausoleum, erected by his family after instructions found in the will, apart from the body also contains a necrotechnological incubator which preserves the body intact and makes it possible to keep some cerebral functions alive.

Special agent Williams of the ISC rolled the large map to a tube, folded it double and put it down into the briefcase.

«Seems enough to me, Williams. We'll see what the Brotherhood thinks...»

## UNITED WE STAND

Inquisitor Mathias confidently stepped up to the podium. Around him was gathered representatives from the Second Directorate and the Curia, and at the back high officials from Imperial sat uneasy, not sure what would happen. Inquisitor Mathias took out the Book and his personal notes and placed them on the table in front of him. He turned his imposing figure towards the senior brothers and sisters but didn't even glance at the corporate jackals.

«Brothers and sisters. We all know that we stand here against the darkness that is threatening to engulf us all. The darkness is seeking to extinguish the light that is humanity and all that is good. We are all aware of that.»

But the threat does not only come from the stars, but from within our own castles, from those we should call our friends. They have proved to be our enemies and we have gathered here today to decide what is to be done. Let us listen to a true brother, and let him speak his mind on the matter, Mister Henry Bartholomew.»

At these words one of the Imperial officials stood up and approached the podium. He stopped in front of the assembled brothers and sisters. He was a powerful man and his voice was confident as he spoke.

«The Inquisitor Mathias speaks truly and with great wisdom. We have ourselves been attacked by this aspect of the Dark Legion. They have infiltrated not only our corporation but also the very heart of humanity, posing as a friend and savior. They have attacked our industries, using the cursed legionnaires and they have assassinated many of our heroes in the battle against the Dark symmetry.»

Now the old man was clearly agitated.

«The threat was at first taken to be only competition, a run at becoming one of the great powers through... accepted methods.»

Bartholomew made an embarrassed pause, well aware of the methods his own company used to maintain their power. He masked the interruption with a cough and cleared his throat.

«But they have stepped outside the boundaries, and it is clear that this is a work of evil, another manifestation of the darkness from outside the sphere of light.»

With this the leader of Imperial withdrew, leaving the podium for the Inquisitor Mathias. The armor-clad man folded his heavy arms in front of him as he again turned to his superiors.

«This has been noted by our brothers in Imperial and they have brought much that is new into our investigations. You have now heard their pledge to our cause and it is with great satisfaction that I finally can present evidence of the corrupting symmetry in our midst. We must now decide what must be done to stop influence of the evil power known as Cybertronic.»



# THE CARTEL

At long last did the megacorporations realize that solving differences by military might would soon lead to their own destruction.

To avoid this, they created the Cartel. A body of officials from all of the corporations, it undertook the enormous task of coordinating the different corporations and their conflicting policies.

As time passed and the presence of the Darkness descended upon us the Cartel also did battle against the Dark Legions. To combat the evil forces the Doomtroopers were created.

The most formidable of warriors, these men and women could best even our own Inquisitors in combat. A formidable ally but also a frightening enemy. This made it necessary for us to gain even more control over the council that controlled these warriors.

The Cartel did promote greater cooperation between the megacorporations but it was also a breeding place for its own petty squabbles and human greed. It was a cesspool of degeneration and cruelty. Some officials stopped at nothing to achieve their own goals and the Cartel was made into a secret society, existing only for the sake of its own.

— *The Eighth Chronicle: The Megacorporations and the Cartel* \ Lucretii Marcellianus

## BACKGROUND

In order to have a forum where the megacorporations could discuss their differences on a purely diplomatic level without having to resort to hostile activities, the CARTEL was created.

Made up of five delegations from each of the major megacorporations, the Cartel has become one of the major powers in the system. Each delegation consists of thousands of diplomats, administrators and corporate officials.

Originally created to facilitate cooperation between the megacorporations, the Cartel has, with the appearance of the Legions of Darkness, been given a more aggressive role and extended authority to battle the new evil. This was the one place the megacorporations could bring their resources together to stand against the Darkness.

The Cartel has created a military elite force, the DOOMTROOPERS, made up of crack soldiers and military strategists. The primary function of this force is to do battle with the Legion wherever they can be found. This is all coordinated and managed by the Cartel.

The Cartel carries out a considerable amount of internal investigations to stop infiltrators from the Legions of Darkness. Operations that are so secret not even the corporate managers have any idea of what's going on within the Cartel.

In this complex web of secret operations there have evolved groups within the Cartel operating totally without direction or interference from higher officials and towards their own obscure ends. They use their powers and connections to promote illegal operations such as drugs and weapons smuggling, assassinations and supplying secret information. Some of these have gone so far as to make contact with the Legions of Darkness and the heretic cults, for reasons no one knows.



## THE CARTEL BUILDING

Right in the center of Luna, the Cartel building rises like a gigantic tombstone over the hopes once placed in this organization. Once, the light gray stone building contained the entire Cartel organization, now it has swollen to occupy the neighboring blocks as well. There seems to be no limit to how large the Cartel and its subdivisions can actually become.

The Cartel building itself contains none of the really powerful sections of the Cartel, except for the High Council which occupies the top fifteen floors. From the Council Assembly hall on the top floor, you have the best view in entire Luna. The rest of the building contains offices for the delegations; from the bottom the FLIC, Cybertronic, Imperial, Mishima, Bauhaus, Capitol and finally the Brotherhood. The entire Cartel building is guarded by the Cartel's «independent» security forces.

The Security Council, the BEI, the BII, and the Doomtroopers' HQ are all fairly new installations, so they reside in the neighboring blocks.







### CARTEL EMPLOYEES AND OFFICIALS EXPERT ADVISORS.

This is a title given to the agents working for the Cartel. These agents carry out different kinds of operations, from investigations to assassinations.

The classical Cartel garb is a strict, black suit with a matching tie. On top of this is worn a gray trenchcoat. Obligatory are the black shades.

Many agents carry a concealed large caliber hand-gun in a holster fastened on the back.

### ADMINISTRATORS.

The administrators of the Cartel are supplied by the megacorporations. They are picked from the best available businessmen and given the task to further the cause of their own corporation. Soon enough they're absorbed by the web of the Cartel and only work to further their own goals, or those of the powers behind the veil. The administrators can be distinguished by the special tie and the badge pinned to their suit.

## STRUCTURE

The Cartel is organized into five delegations, one from each of the megacorporations. Every delegation is in itself an enormous organization. Thousands of politicians, diplomats, experts, advisors and administrators are supplied by the megacorporations to run the delegation and promote different issues within the Cartel. The leading officials gather in what is known as the HIGH COUNCIL which has the highest authority in all matters except security. That is handled in the SECURITY COUNCIL by a select number of delegates and diplomats from each delegation. The security council has direct authority over the Doomtrooper force.

There are two additional branches of the High Council. These are the INVESTIGATION COMMITTEE (CIC) and the COOPERATION COMMITTEE (CCC). The purpose of these are to look at issues requiring full cooperative efforts, such as investigation of the powers of the Darkness and the coordination of joint operations.

The Brotherhood is represented by a separate delegation in the Cartel. This delegation is made up of administrators and observers and are given insight into most of the committees within the organization. The Brotherhood is aware of the existence of secret organizations within the Cartel and is actively trying to infiltrate these to gain more control over the Cartel, and thereby over the megacorporations.

### THE FLIC

The «Freelancing Independent Corporations' Committee» is a small, yet important part of the Cartel, handling legal matters. If not for the FLIC, the Cartel wouldn't have any jurisdiction over the freelancers.

Physically, the FLIC consists of a couple of hundred negotiators officially appointed by various freelancing corporations, but in reality they are more or less marionettes of the megacorporations. The FLIC is advised before any major system-wide restrictions are imposed, but they rarely turn anything down or come up with suggestions. The fact that they exist and have a right to speak prescribed by law means that the Cartel's decisions are valid for all citizens of the solar system and that Cartel officials have authority EVERYWHERE.

### THE COOPERATION

**CAPITOL.** The original instigators of the Cartel, Capitol is still its primary benefactor and supporter, the one that is most interested in its existence. It tries to

abide by the regulations of the High Council, and actively enforces the regulations even within the other corporations' areas of jurisdiction.

**IMPERIAL.** Imperial also spends time and effort keeping the Cartel a functioning institute. Its representative in the High Council is a prominent member of the Serene family, but he's more of a messenger and spokesman than a negotiator. It is difficult to make deals with Imperial through the Cartel channels, since all the prominent clans of Imperial want to have their say before any decisions are made.

Along with Bauhaus, Imperial provides a sort of counterweight against Capitol.

**BAUHAUS.** The Bauhaus management is not particularly impressed with the work of the Cartel, and they don't try to do very much about it. Instead, they use the Cartel administration as a «bureaucrat-kennel», where advisors, diplomats and executives are trained in diplomacy. They have the same problem as Imperial when it comes to decision-making.

**MISHIMA.** Mishima's work in the Cartel is a sad chapter. Headed by the Overlord Mishima and consisting of representatives of his son and competitor, Lord Heir Moya, the Mishima delegation is totally disrupted. They have a strong position in the security council, since the Overlord has no influence there, but in the High Council their hands are tied. Notes and suggestions given to the Overlord are pointless and only a play for the gallery.

**CYBERTRONIC.** Either feared, hated or at the best merely avoided, the Cybertronic delegation has a hard time in the Cartel. They don't have very much influence except for the decisive decisions in the High Council, but that is enough. When Cybertronic really wants to drive something through the Cartel, they often use the Bauhaus channels instead.

**BROTHERHOOD.** The Brotherhood have representatives—observers—everywhere within the Cartel organization, just supervising, noting, and reporting. These men are often feared and respected administrators, and even though they don't have any legislated power, most people do what they say.

## OPERATIONS

The Cartel was created to find a neutral ground where the megacorporations could cooperate and resolve their differences by negotiating and informing each other of future operational moves and strategies. To attain this effect the DELEGATIONS were created. Originally small groups of highly educated corporate officials, the delegations soon grew into the monstrous behemoths of today.

As the delegations grew, the number of operations sanctioned by the Cartel also grew. The communications within the departments and between the delegations were poor, at best, and this soon resulted in the turbulence that exists today. In reality the never-ending wars and conflicts between the megacorporations have resulted in the breakdown of the cooperation and talks and negotiations have time after time resulted in bloody battles and endless accusations.

Instead of promoting cooperation between the megacorporations the delegations are once again looking after their own interests.

One of the few projects that has shown results is the Doomtrooper force, partly due to the fact that the security council is made up of extremely competent officers and is the only part of the organization that is working according to the original plans.

Several smaller groups have also been given the task of investigating and controlling the freelancers, the smaller enterprises not connected to the megacorporations. Secret operations are carried out in the name of the Cartel to limit competing businesses or to gain control over these smaller companies. But there are also groups within the separate delegations who use their power to strike against the other megacorporations.

### THE POWERS BEHIND THE VEIL

The exact work of the delegations is often secret, in reality independent from their actual employers, the megacorporations. They have access to huge amounts of



money, without really having to specify what it is used for.

It is only natural that parts of the organization have fallen into criminality and corruption. Corporate politicians and advisors use their positions of power to promote illegal operations, thereby gaining even more influence and wealth. This rot has spread within the Cartel and many of the higher ranking advisors and military diplomats are involved in shady deals of different kinds.

## CARTEL SECURITY

The power of the Cartel has been severely limited by the lack of a true police force. This was an important issue for the leading politicians within the organization and finally they managed to force the corporations to allow the Cartel to keep a security force. This force would be financed by the Cartel, trained by the Cartel and equipped by the Cartel. It was only to be used as a security force.

These security officers are really a para-military force. The Cartel refers to many problems as a security matter, which gives it authority to use its own forces.

The security forces of the Cartel are used for a range of different operations. They are in charge of protecting Cartel installations but can also have been encountered as death-squads or even conventional troops. The recruits for the Cartel security forces are mainly picked from the freelance corporations, and are independent enough to be deployed even AGAINST the megacorporations.



### CARTEL SECURITY.

The security forces of the Cartel are known for their total lack of discretion. They all conform to the standard image of a Cartel security officer. Rank is shown on the shoulder patches.

The standard outfit of the Cartel security officer is camouflage coveralls and an armor protection jacket. He also wears a full protection helmet equipped with several electronic targeting and communication devices.

They are normally armed with both an automatic carbine and large caliber hand-gun.

### BROTHERHOOD

**OBSERVERS.** The observers from the Brotherhood are present at almost all levels of administration within the Cartel. They are dressed in the simple robes of the Brotherhood and always wear a cowl over their heads, so as not to reveal their faces. They are never armed though there are rumors that some of them possess mystic powers.

### THE BUREAUS

Any matters of investigation are handled by one of the two Cartel bureaus. The most well-known is the BEI, the Bureau for External Investigations, often called THE EXTERNAL for short, which investigates all matters not directly involving Cartel officials. This may include tracking down agents of the Dark Legion or trying to break up rings of pirates and smugglers. Most murders are investigated by the Externals.

The second bureau is the BII, the Bureau for Internal Investigations, called THE INTERNAL by the operatives and Cartel officials. This bureau investigates all matters involving Cartel officials or where internal policies are involved. The Internal is often used to track down infiltrators or heretics within the structure of the Cartel.



### PUNISHER SHORTSWORD

This single-edged one-handed weapon is designed for combat as well as law enforcement. Among others, the famous Doomtroopers carry them into combat against the Dark Legions. Their main advantage is that they are almost impossible to break.

W	L	STR	Dam (1H)	Dam (2H)	Cost
3	4	81	10	1d6	1d6 14,600

## THE DOOMTROOPERS

The official military force of the Cartel is the Doomtroopers, the most famous and respected soldiers in the solar system. Elite commando warriors specially trained to battle the forces of the Dark Legions, to match the ferocity of the Nepharites and to strike at the very core of the evil.

The Doomtroopers are under the control of the Security Council. The soldiers are provided by the megacorporations, who also have the responsibility to maintain the status of the force and supply soldiers to keep the force at its five hundred field operatives. The technical support and other secondary functions within the force are organized by the Cartel but is also made up mostly of recruits.

### THE COMBAT UNIT

A Doomtrooper unit is usually made up of two soldiers. They are both trained in all aspects of combat but to varying degrees; one is a close combat expert and his partner specializes in giving support fire.

These units can be changed and have different compositions depending on the nature of the Doomtroopers' mission.

### EQUIPMENT

The equipment and the weapons used by the Doomtroopers are developed by the megacorporations in close cooperation with the Doomtrooper technicians. The technology used is always state of the art and superior to standard designs available. Many of the weapons only exist as prototypes.

The armor carried by the soldiers are made by light plastics and ceramics, given a cushioned interior constructed from new energy-absorbing materials provided by Cybertronic.

### MISSIONS

The Doomtroopers are assigned varying missions but are never used to resolve differences between corporations or private officials, and never against the Brotherhood. They are intended solely for use against the Dark Legion.

The Doomtrooper units provide the ultimate war machine for small scale combat. Doomtroopers are used for commando strikes against enemy strongholds and these missions seldom involve more than ten or twenty men.

The most dangerous missions are raids against Heretic nests or the citadels of the Dark Legions.



## CREATING A DOOMTROOPER

A Doomtrooper character is created in much the same way as any other, and the Doomtrooper background can be chosen just like any other. The main difference is that the Doomtroopers' training is more specialized than other backgrounds and the resulting warriors are superior to any other troopers in the corporate forces. The extreme demands of the service is represented by harder conditions when you check to see if you keep the job: instead of making an «INT/PER»-roll, you must make an «inverted INT/PER/PHY»-roll, i. e. the roll may not be higher than EITHER INT, PER or PHY.

**SPECIALIZING.** The player creating a Doomtrooper must choose what field of expertise he wants to specialize in; either close combat or support fire. This means that he must chose EITHER the Combat field of expertise OR the Firearm field of expertise as his SPECIALIZATION (4 skill picks per background repetition). The field he doesn't chose is called his

SECONDARY, with only one skill pick per background repetition. He must stick to this specialization for the rest of his background development (i. e. from one increase occasion to the next he can't swap from Combat specialization to Firearms).

### DOOMTROOPER

**REQUIREMENTS:** STR 13, PHY 13, COR 13, INT 9, MST 9, SV 13 in at least three skills from the Combat and Firearms fields of expertise

Specialization.....	4
Secondary .....	1
Communication .....	—
Movement.....	1
Technical .....	1
Free.....	3
Social standing .....	2d10
PER-modification .....	+2





## THE END JUSTIFIES THE MEANS

The woman grasped the headset, putting the microphone to her mouth.

«Yes, sir. This is officer Brooks, sir. Yes, I read you loud and clear.»

Brooks was surrounded by other officers, most of them heavily armed and armored. All were dressed in the black and blue uniform of the Cartel, and the three letters BEI showed that the Externals were once more on the move. They were surrounded by pine forest and a cold wind had them huddled together for warmth.

«Yes, sir,» Brooks continued, «the mission is well under way. We have had some difficulties in making contact with the third party, but our infiltrators are doing their best. It will not put the operation in any jeopardy at all. As soon as you give the signal, we will move.»

She listened once more to the sparking headset, concentrating to hear the faint voice over the screaming wind.

«Yes, sir, the briefing will begin immediately. Over and out.»

Brooks handed over the headset to her aide and stepped over to the officers gathered around the electrical radiator. As she stepped into the circle they all snapped to attention. Brooks removed her gloves and picked up stick which she used to indicate a map spread on the ground in front of her.

«As you all know we are here to stop illegal Bauhaus occupation of Imperial ground. As the local Bauhaus representatives do not seem to pay any attention to the orders given from their home-office, we have a possibility of there being Dark Legion infiltrators present. Satellite surveillance have given further information to strengthen this theory.»

Brooks pointed at the map.

«The Bauhaus troops are positioned here, here and here. They are armed with state of the art weaponry and have probably received reinforcements from legionnaires wandering the area. We are talking about 20 hussars and 30 legionnaires.»

This information was received with utmost concern by the Cartel officials, who themselves numbered only 12. But Brooks continued.

«It is impossible for us at this moment to stop this occupation by ourselves. I have therefore made a deal with two local warbands, guerrillas fighting Bauhaus exploitation. They will help us if we provide the weapons for them. The weapons are contained in these crates here.»

With these words she indicated the crates loaded on the all-terrain vehicles parked close by. But one of the men expressed a doubt and posed his question pointedly.

«You mean that we are giving weapons to bands of criminal?»

Brooks faced the man and looked him straight in the eye.

«As for now, officer Wiley, we need allies. Unless you wish to conduct the raid yourself. As I was saying, she continued, giving Wiley an icy stare, «the weapons will be distributed to the bands who will then assist us in the assault. We will act as tactical advisers, and those of you with experience as combat co-ordinators will be assigned as such.»

Again she turned to Wiley.

«And you don't have to worry about the weapons. They are timed to self-destruct in 24 hours. Do you think I'm stupid enough to provide weapons to our enemies?»

# THE BROTHERHOOD

And so Nathaniel gazed over the worlds and all he saw was evil. The worlds were filth and waste, decay and destruction. Civil wars were waged on endless battlefields and brother fought brother in the chaos we had inherited. We had turned the cradle of humanity into a burial pit. Traitors and renegades hid in the dark. Outside the borders of the cities mutants, and beasts from the pits of Darkness roamed.

Then the veil was lifted and Nathaniel saw the light. He saw the winding road to salvation and he felt the warmth of the cleansing fires that would burn the filth away and once again light up the world. A great power surged through Nathaniel and he found that he could shape the powers of the night at will. He once again gazed over the world, and spoke:

«Let this be the end of Darkness and the beginning of the triumphant light that will shine over the worlds of man forever.»

And around him he gathered those of faith, and they called him their leader. So it was that the Brotherhood was formed to do battle against the Darkness. Nathaniel was the first of the sacred Cardinals.

He raised the banners of the just and right and lit the fires of redemption. And their light did shine over the worlds, filling the skies. And the fallen did end their warring and looked to the light, and wondered what it would bring.

— *The First Chronicle, The Arrival of the Darkness and the Calling of the Cardinal* \ Alexander Horatio

## THE NEW LIGHT

With the world faced with the threat of destruction at the hands of the Dark Legion, the Brotherhood has grown into a powerful organization. It is represented all across our solar system, from Mercury to Pluto. And wherever the light of the Brotherhood falls, the battle against the Darkness continues.

The Brotherhood represents an all governing unearthly power that is personified by the CARDINAL, the spiritual leader of our solar system. He is the single most powerful man alive and commands mysterious energies of immense power. Deep within the vast libraries of the cathedrals the mystics of the Brotherhood, guided by their Cardinal, are searching into both the past and the ever-changing future to find the answers that will lead the way into the light.

To do battle against the Dark Legions the Cardinal has created the INQUISITION. This institution is seeking to cleanse our solar system of the festering evil that can be found both in space and within ourselves. The Inquisitors of the Brotherhood, in their magnificent suits of armor,



are scouring the worlds of humanity purging every sign of evil from our society. They can be found in the cold wastes of Pluto and Jupiter as well as the scorching deserts of Mars and Mercury relentlessly seeking out infestations of evil. They are forever vigilant and ready to strike against the Dark Legion and the scores of heretics whatever shape they may take.

Observers from the Brotherhood are present at every level of organization within the megacorporations and the Cartel. Observing, studying, never resting, searching for any sign of the rot of Darkness. To work against the Brotherhood is seen as going against humanity itself.

This philosophy and the power of the Inquisition have made the megacorporations accept the presence of the Brotherhood at their board meetings and administrative functions. As much as possible is hidden from the prying eyes of the Inquisitors. It has developed into a deadly game of hide and seek, played by the Brotherhood and the megacorporations.

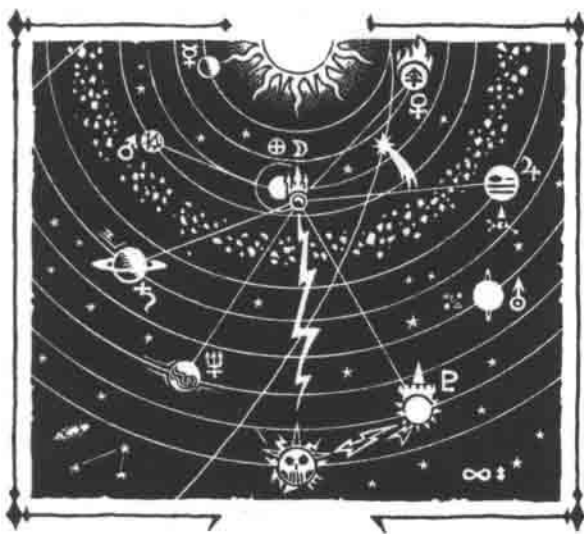

## THE VOW OF THE CARDINAL

Upon entering the Brotherhood and before being elevated to the First level of Perfection, every apprentice has to swear the Vow of the Cardinal, pledging allegiance and silence and to obey every word of a superior, to reveal everything of Darkness and never to go against the Brotherhood.

## LEAVING THE TRAIL

Defecting from the Brotherhood is regarded as an act of heresy and punished accordingly—with purging. This is not out of malice; in the wrong hands (i. e. the hands of a follower of Darkness), a scholar of the Art might become extremely dangerous. Also, the secrets of the Brotherhood are too many and too dangerous to be spread. Therefore, drop-outs are hunted even more fanatically than Heretics.



### CARDINAL DURAND.

Cardinal Durand has governed the Brotherhood longer than any living man can remember. Before he was called upon to lead the Brotherhood he was the greatest Mystic and sacred warrior ever known. His insights as Inquisitor were remarkable and he could as no other man before wield the ancient powers.

He is an imposing man and wears clothes and armor outshining even those of the sacred warriors or the Inquisitors. He is involved in all matters concerning the Brotherhood. Cardinal Durand is always ready to lead his elite guard to battle against the dark apostles and the wind that is trying to blow out the frail candle that is humanity.

The Cardinal is the most impressive man in the solar system. He stands over two meters tall and his broad features are enhanced by the armor and the flowing capes he wears. He is normally dressed in this combat armor, brandishing the Bringer of Light in one hand and a holy automatic gun in the other. Over his shoulder, secured by a golden chain, hangs the Book of Law, forever by his side.

The sacred Bringer of Light was once the weapon of Nathaniel, the first of the Cardinals. It has since his death been passed down from Cardinal to Cardinal. It has been blessed by the powers of the light and bestows holy powers upon the rightful wielder.

## THE CALLING OF THE CARDINAL



The Brotherhood has been endowed with a mission to eradicate the Darkness around and within us. This is the CALLING OF THE CARDINAL. This mission is the all governing policy of the Brotherhood and anything interfering with it is dealt with swiftly and with extreme measures.

The mission is based on the Word, as it is interpreted by the Cardinal, and the Third Directorate. The Calling of the Cardinal is central to the mission and the Brotherhood relies heavily on strong leaders personifying the Calling.

The phrase can be found all over the system, shouted on the battlefields, sprayed as graffiti on walls and as the backbone of the preaching of the Inquisitors.



### THE BOOK OF LAW

The Word has been collected into one gigantic tome, the Book of Law. This book forms the basis of the mission and the Inquisition, and all the faithful carry a copy of the book with them wherever they go.

The book is written on sacred paper manufactured by the Mystics of the Brotherhood. It is hand-written by the disciples of the Third Directorate in halls protected by the powerful Mystics and their apprentices.

The Book of Law is used by the preachers of the mission when addressing the masses. It is used by the sacred brethren when offering advice and solace to the faithful. It is used as the lawbook by the Inquisitors.

Wherever the Brotherhood can be found there will also be the Book of Law.

### THE CHRONICLES

In early days the Cardinal Nathaniel recognized the influence of the Dark symmetry in the written word. When studying the ancient tomes, registers and scrolls recapitulating the history of humankind, all he saw was perverted and evil and infested by the Darkness.

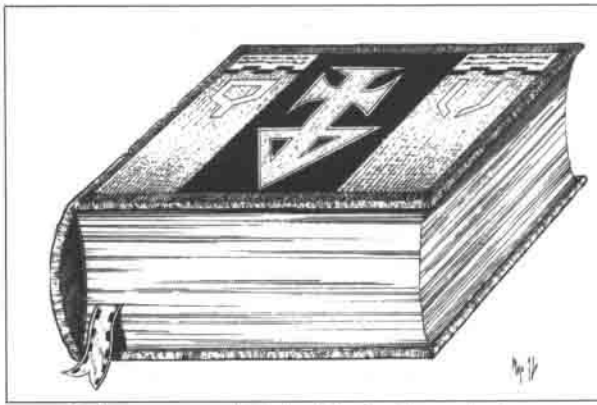

So he summoned his Lord Scribe Alexander to appear before the Curia and assigned him with the task of compiling the knowledge of the Brotherhood into a Chronicle. And as the first Cathedral was erected, Alexander personally carved into its sacred marble walls the First Chronicle, out of reach of the Darkness.

And as to further deny the Dark symmetry any chances to distort the flow of history, there was an order from the Cardinal himself on the handling of the Chronicles, saying that no man or woman for times eternal was allowed to duplicate the Chronicles.

And as more Cathedrals were erected, further Chronicles came to adorn their indestructible walls, untouchable to the Dark symmetry and ensured to last as long as the world and the Brotherhood itself.

Today, the number of Chronicles have reached eight, each one engraved into the walls of a Cathedral. They are forbidden words to speak or write, and not even the Keepers of the Art themselves dare at anytime divulge even one word of the sacred scriptures en clair. It is forbidden on penalty of death.

The pillared halls of the Cathedrals are always filled with apprentices of the Brotherhood who learn the words by heart. Commoners and visitors are allowed entrance under very strict surveillance only; photographers are executed on the spot.

## THE ART

Under the guiding light of the Cardinals the Brotherhood learned how to tap into ancient powers long lost to common man. A source of power was opened up and the Mystics devoted their lives to understand and ultimately control this new force.

Though several lifetimes have been spent studying this force of life, precious little has been learned. It is known that it can be controlled by beings pure of thought and soul, and shaped into different forms, both for offensive and protective purposes. And it is not only for destruction that the power can be used. Mystics who have devoted their life to the ART OF PREMONITION have

achieved powers of perception far beyond the normal senses. They are spying into the future trying to predict the flow of time. They search the minds of millions upon millions searching for even the most meager trace of Darkness and evil. They spy into the darkest chambers of the Dark Legions trying to find the way to their undoing.

But the future is not their only domain. The Mystics also search the past, scribing the events that shaped our present age.

The powers of the Mystics and the different ways of controlling THE ART is described in the section «The Art».

## STRUCTURE

The order of the Brotherhood is strictly hierarchical. The leader is the Cardinal and directly under him is the Curia. This council of highly ranked brothers govern the four Directorates which in turn takes care of the different cells under their authority.

### THE CARDINAL

The Brotherhood is led by a worldly and spiritual leader, the CARDINAL. His power and enlightenment are unquestionable and he has been given the authority to rule the Brotherhood until he is called into the light. His Calling, and final goal, is to purge our solar system of all infestations of evil, be they the Dark Legion, mutants or cesspits of plague and degeneration. This eternal Calling is carried on from Cardinal to Cardinal and will be their eternal mission until they have succeeded.

The powers invested in the Cardinal gives him an insight into the spiritual world unequalled by any living being within the sphere of light.

The Cardinal is the absolute supreme leader. He is at the same time supreme commander of the military forces of the Brotherhood, the High Inquisitor, the wisest and most powerful of Mystics and the foremost preacher of the Word.

### THE CURIA

Directly under the Cardinal is the Curia. This council is made up of highly esteemed brothers appointed to govern parts of the Brotherhood's sphere of influence.

The Curia directly governs the four Directorates and is vested with the power to perform internal inquisitions, investigations and purging at will. The Curia only answers to the Cardinal and the High Inquisition.



### FURY ELITE

**GUARD.** A Fury Elite Guard is easily recognized by his armor, which has been designed with traditional values in mind. The armor covers the whole body and is made up of metal chains and lightweight plates, giving the warrior an ancient appearance. Weapons used by the guard are the Deliverer battlesword and the Protector powershield, along with a holy Punisher large caliber automatic gun in a holster. Also fastened in the belt is a small bag carrying the Book of Law.

**INQUISITOR.** The Inquisitors are the most imposing soldiers of the Brotherhood. Dressed in enormous battle armor these formidable warriors can cut down almost any enemy with their might. Their large helmets are designed according to an ancient tradition and contains advanced electronic equipment and vision enhancers. They often wear cloaks of different colors adorned with the runes of the Brotherhood.

The Inquisitors are armed with a large caliber single function hand-gun and always carry the Book of Law.





### **INQUISITOR**

**MAJORIS.** These are senior Inquisitors and are distinguished by their black cloaks. Another distinguishing feature is the helmet, which indicates the rank of the Inquisitor Majoris.

**MORTIFICATOR.** The assassins of the Brotherhood, dressed in traditional black garments with a black cloak used to confuse enemies in combat. The helmet is the traditional Mortificator helmet with several advanced targeting and sensor systems. The combat harness is also noticeable, where he keeps a grappling hook and several types of grenades.

The Mortificators are armed with the twin edged Mortis sword and a Nemesis heavy caliber hand-gun.

**ELITE TROOPER.** The Elite Troopers are given more advanced armor than the mere troopers. This armor often covers the whole of the body and provides the trooper with good protection against enemy attacks. The design of this armor is based on the armor of the Inquisitors but Elite Troopers wear a simple tunic over their armor instead of the cloaks favored by the Inquisitors.

He is armed with a rapid fire automatic shotgun.

## **THE DIRECTORATES**

Under the Curia work the four Directorates. These are departments within the Brotherhood devoted to one aspect each of the mission. They all have one area of responsibility and have almost unlimited authority within this area. Each Directorate is divided into cells and each cell has its own network of cells under it.

### **THE MYSTICS**

The First Directorate is that of the MYSTICS. They are divided into three major cells; the DISTORTERS, the SEERS and the CHANGELLORS.

The DISTORTERS use the Art to manipulate reality, to create physical phenomena for offensive, defensive and divertive purposes. They are the masters of illusion and distortion of the elements.

Those Mystics devoted to the secrets of the mind are titled CHANGELLORS. They use their powers to search and manipulate the minds of sentient beings. They have the power to look behind the normal mental barriers of man and to understand the thoughts, memories, feelings, emotions and sub-conscious activities. They are possibly even more feared than the Distorters.

The CELL OF THE SEERS, divided into the CELL OF THE PROPHETS and the CELL OF THE CHRONICLERS, researches the past, drawing upon mysterious powers to look back and gaze upon the history of man. Their apprentices perform the eternal task of writing down the current events of the world and depicting the flow of the Dark symmetry for future Chroniclers to interpret. Also, they channel the energy of the dynamic future and try to predict the flow of history.

The KEEPERS OF THE ART are the most mysterious of the Brotherhood's Mystics. They have in their chosen field attained such insight as to rival that of the Cardinal. They are extremely powerful and form the inner circle around the Cardinal, acting as his advisors in mystic matters.

### **THE INQUISITION**

The Second Directorate is the INQUISITION. This organization is divided into several minor cells where the most important are those of the INQUISITORS, the INTELLIGENCE, the SACRED WARRIORS, other military units and the INTERNAL and EXTERNAL INVESTIGATIONS.

The Inquisition is the Cardinal's most important means of completing his enormous task. This organization controls all the military forces in direct confrontation with the Dark Legion and all campaigns are led by High Inquisitors.

The Inquisition searches for Heretics that have fallen under the sway of Darkness and the agents of the Dark Legion all over our solar system. The Inquisitors stage trials and investigations condemning those who have weak souls; forever searching for those who have collaborated with the Darkness. Spreading the cleansing fire, the Inquisition has the authority to act on any judgment they make. The Inquisitors themselves are always ready to carry out their sacred mission.

The Inquisitors are elite members of the Brotherhood,

possessing powers beyond normal men. Highly trained in the Art of Warfare they are among the most formidable warriors mankind has ever produced. They are rivaled only by the best of the Sacred Warriors and the Doomtroopers. They are vested with an enormous authority and will never hesitate to use whatever force necessary to eradicate evil from the worlds of humanity.

The special task forces of the Inquisition, assigned for pure assassination missions, are referred to as the MORTIFICATORS, Inquisitors specialized in stealth and covert missions.

### **THE MISSION**

The Third Directorate is often referred to as the Mission. It is the task of this department to bring forth the message of the Brotherhood, to keep it and nourish it so that it will not be lost in the darkness of our times.

This is the largest of the Directorates and is divided into the greatest number of cells. The most important of these are the cells of the Mission, the Artifacts and the Scribes.

The CELL OF THE MISSION spreads the Word in all manners of ways. Using both their own and the corporations' media channels, the Brotherhood hammers the viewers with messages on how to be a good citizen, and how to recognize the spread of the Darkness. Preachers walk the streets, missionary groups visit companies and factories, speaking the Word and giving the people someone and something to believe in. Through this and the media the Mission spreads the Word to billions of people. This is also used by the Second Directorate as a source of information.

It is the task of the CELL OF THE ARTIFACTS to keep and preserve all those holy—and unholy—artifacts that have seen the light of day since the age of Cardinal Nathaniel. These learned men and women, often scientists and Mystics, have the responsibility of tracking, researching and storing these items of power and also destroying those which are too dangerous for mankind to keep.

The CELL OF THE SCRIBES have a tedious but very important task, that of updating and learning the Chronicles and the Book of Law, and to preserve the true readings of all parts of the Word. Under the watchful eye of the interpreters—the Archivists—and the Inquisitors, the scribes fill the scriptoriums in this endless but essential task. No faith is put in mechanical devices as a means of copying the Word; too many machines have been infested with the Dark symmetry for them to be reliable.

### **THE ADMINISTRATION**

The most worldly of the Directorates is the Fourth—the ADMINISTRATION. It is involved in the everyday running of the Brotherhood as well as the supervision of the activities of the megacorporations. Most of the people working within this Directorate are diplomats or businessmen.

One of the main focuses of this Directorate is to ensure that the Brotherhood has enough resources to

carry out its Mission. These resources are partly generated by conquests and through donations from the faithful but a large part stems from the Brotherhood's financial involvement in the megacorporations. Through shares in associated enterprises, the Brotherhood can control parts of the operations of the corporations. This power is sometimes used to make demands or to have

the corporations back down on important issues. The diplomatic operations of the Fourth Directorate are extensive and are carried out within the Cartel as well as directly within the megacorporations. The diplomats of the Brotherhood are extremely skilled and ruthless and will not stop at threats of violence, excommunication or inquisitorial investigations to obtain their goals.

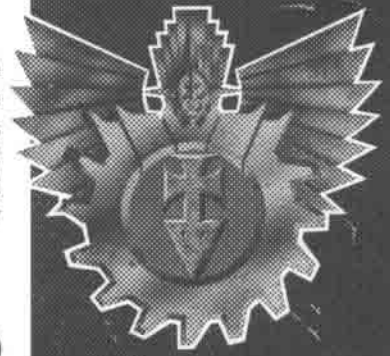

## THE CATHEDRALS

On places where the Brotherhood has established a strong presence and is supported by a large number of followers it is customary to erect a cathedral.

The cathedral is made up of towers of immense proportions, decorated with spires, painted lead windows and stone gargoyles. Arches and huge domes create an atmosphere of serenity and piety. Statues of holy martyrs and sacred warriors stand in the open courts, and in the endless hallways the Cardinals gaze down upon their followers. All to create the impression of force, power and invincibility. The cathedral acts as a symbol of the movement and as a gathering place for the followers. All

cathedrals are sacred places and dedicated both to the faithful and as a base for the activities of the Brotherhood. The enormous cathedrals house military bases, the secret departments and the dungeons of the Inquisition as well as vast halls devoted to meditation. In larger cathedrals there are deep catacombs given to the Scribes for storing the immense libraries of the Brotherhood.

The largest cathedral is of course the Sacred Dome on Luna, also containing the sacred tomb of Nathaniel, the first Cardinal. The second largest cathedral—the Hieronymus Dôme—stands in Fukido on Mercury and the third in size is in San Dorado, Mars.

**TROOPER.** The standard trooper of the Brotherhood does not differ much from his counterparts in the megacorporations. His coveralls are the standard gray and white and his equipment similar to many other troopers. He is armed with a heavy assault rifle and carries a handgun in his belt.

**SACRED WARRIOR.** The Sacred Warriors are drawn from every level of our society. Their armor has broad shoulder pads and intricate decorations on the armor plates. They carry an Avenger sword and a small leather container where they can keep the Book of Law. The sword is at the same time an indication of his rank as well as a deadly weapon along with a large caliber automatic carbine. They rarely use helmets.

**KEEPER OF THE ART.** The Keepers of the Art are strange Mystics with an unmatched insight into the ancient Art. They are often dressed in heavy armor which includes extensive life-support systems. They always wear their helmets. Few have seen a keeper without his stately robes.



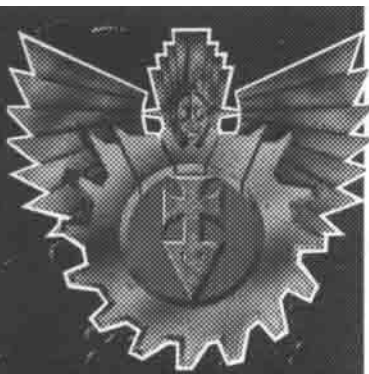

**DIPLOMATS.** The skillful Diplomats of the Brotherhood are easily distinguished by their dress. Made up of several garments they trace their origin to the early Brotherhood. Colors favored are black and red to tell them apart from the Advisors. The runes on his garb is a representation of the Calling of the Cardinal.

**ADVISORS.** Advisors are often Diplomats who have been given a new position as Advisors due to their intimate knowledge of the Word. They are present at almost all levels in the megacorporations as observers and advisors. They report directly to the Inquisition and in extreme cases to the Cardinal himself.

Their dress is similar to that of the Diplomats but the colors chosen are gray and white. Like the Diplomats the rank of Advisor is distinguished by the runes adorning the garb.



## MILITARY

The military forces of the Brotherhood are many and diversified. The most famous are the elite guard of the Cardinal, the Fury, and the devoted soldiers of the Inquisition, the Sacred Warriors.

### THE FURY

THE FURY consists of veteran soldiers with years of service within the Brotherhood and a proven devotion to the cause. This body of soldiers acts only on orders from the Cardinal or the Curia and is separated from the rest of the Brotherhood. It is trained by the Cardinal and the Keepers of the Art and only hand-picked Inquisitors are allowed to command them in battle.

### THE TROOPERS

The remainder of the military might of the Brotherhood is governed by the Inquisition. This covers everything from common troops to the elite special commandos that have gathered under the banners of the Brotherhood to do battle against evil. This common goal and the work of the Third Directorate has resulted in a very high morale within the armies of the Brotherhood. Deserters are few and far between, and the fear of the Inquisition is as tangible as the fear of the evil Darkness.

The soldiers of the Brotherhood are picked from the organizations of the Brotherhood, the megacorporations

and the free enterprises. A large number are volunteers and these make up the bulk of the Brotherhood's troopers.

All soldiers who join the forces of the Brotherhood receive training in the Art of Warfare but are also given lectures from the Book of Law.

### THE SACRED WARRIORS

THE SACRED WARRIORS, the fanatical soldiers who take part in the battle against evil come from every part of society. Brotherhood troopers sign up alongside megacorporate Doomtroopers. They have one factor in common; complete devotion to the cause of the Brotherhood. They have been given the task to eradicate evil from our solar-system, and nothing will stop them. The demands on a Sacred Warrior are heavy and very few of the applicants are given the honor. Those who make it are highly thought of and gain certain privileges no other citizen enjoy. They are often sent directly to the worst combat areas of the system. Torn by war and infested with evil, these battlefields provide the ultimate test of faith for the Sacred Warriors. They often operate behind enemy lines and form strategic spearheads when major offensives are launched.

The Sacred Warriors are never used against troops not associated with the Dark Legion, but as the rot spreads within our system it is difficult to tell when evil is at large. So the Sacred Warriors battle on.

## CREATING A BROTHERHOOD PLAYER CHARACTER

It is possible for players to create characters with a background as Inquisitors or Mystics. In this case, it is a calling for life. After being trained as an Inquisitor or Mystic you cannot leave the Brotherhood to start adventuring on your own. The dedication and loyalty to the Cardinal and the mission is too great to be overcome by petty quests for excitement and wealth. Leaving the Brotherhood is considered heresy and punishable by purging (death).

All Inquisitors and Mystics are trained from an early age when they have been called by the mystic powers. They undergo rigorous physical and mental training, transforming their bodies and minds to that of superbeings, superior to normal man. These characters are the only ones who will ever learn to master the mystical powers of the Art.

Being an Inquisitor or Mystic is no easy task. The

demands are high and the trials many. «Burn-outs», Inquisitors that fail, end up as archivists or scribes.

**A NOTE TO THE GAMEMASTER:** If one of your players insists on playing an Inquisitor or a Mystic, inform him of the Vow and the punishment for dropping out. He can participate as any other character in an adventure, but he will never be able to conceal his allegiances, and he must never oppose the Brotherhood.

Independent Inquisitors and Mystics acting undercover in the field together with freelancers are rare, but quite possible. It isn't even certain that the other players know of the Mystic's true identity, but as a Mystic, he must report all signs of the Darkness to his superiors, or combat them himself.

Refer to the chapter on «The Art» for further details on how to create an Inquisitor or Mystic character.

## BROTHERHOOD SWORDS

### AVENGER SWORD

They large Avenger swords are used by most Inquisition troopers, both to indicate their status and as close combat weapons. They come in many different versions, the most advanced having multiple integrated sensor- and alert-systems.

W	L	STR	Dam (1H)	Dam (2H)	Cost
5,7	114	16	1d6+1	1d6+3	24.600

### MORTIS SWORD

The Mortis swords are forged using the ancient smithing methods of Mishima's most skilled swordsmiths. Today, they are only used by the mortificators and a few special units within the Mishima security service. They are extremely sharp, easy to handle and easily concealable. The scabbard can sometimes be used as a blow-gun.

W	L	STR	Dam (1H)	Dam (2H)	Cost
1,7	65	8	1d6	1d6+1	37.500



## TRUST IN THE LIGHT

The dark shape of Inquisitor Thorsen slid down from the opening in the sewer-outlet. He was dressed in his heavy combat-armor and carried his «Hammer», the trusted Punisher automatic pistol. It had taken him several hours to reach this far down into the catacombs and mazes under the city, but he knew that he was on the right track. The only diversions had been mutants and he let the «Hammer» fall mightily on them.

Silently he dropped to the floor of the room. It was dark and the only sound was that of dripping water. Inquisitor Thorsen concentrated and let his feelings reach out to the far corners of the empty hall, searching for a sign of life, or death.

Then the wall at the far end suddenly lit up and Thorsen was bathed in a sickly green light, his ears ringing with an insane laughter. His mind reeled back and he instinctively erected a protective shield. All without moving an inch, never showing surprise or alarm.

He felt the shield shudder as something struck it, but it held fast and Thorsen was unharmed.

He let his eyes fall on the creature standing ten or twenty meters away from him.

It was tall, as tall as Thorsen, but it was not as heavily armored. It had broad shoulders with long thin arms, hooked claws for hands. The armor was covered with writhing patterns, forever changing shape and color, like worms or maggots. From his head sprouted fat worms, moving to a rhythm Thorsen couldn't hear, reaching out towards him, beckoning him closer. It was a nepharite, one of Muawijhe's lieutenants.

Thorsen felt a surge of satisfaction. He had been right, there was something here.

The nepharite regarded Thorsen with an insane calm, a coldness that froze the air between them. Its features were twisted in a demented grin, and as Thorsen watched the nepharite took two steps forward, bringing out a large, hooked sword from behind. The sword seemed to quiver as it was turned towards the Inquisitor and Thorsen could faintly hear the screaming wind from far dimensions.

Even though Inquisitor Thorsen knew it would be pointless he brought up his «Hammer» and let it deliver three mighty thunderclaps. The explosions filled the room with noise and the smell of powder but was also followed by the laughter of the beast. The bullets had struck it in the chest, but it was unharmed.

With care Thorsen holstered his pistol, never letting his eyes from the hideous apparition and brought his hands to the sword sheathed on his back. The steel sang as it was removed from the scabbard and the runes on the blade glowed. It shone with a clear, white light. Then Thorsen reached up and removed the clasps on his great helmet, revealing his dark and weathered features. As the helmet fell to the floor the nepharite took a step backwards, regarding Thorsen with a puzzled face.

The Inquisitor was smiling.

This would be a battle long remembered.

## INSTANT JUSTICE

At the long table seven men were seated, three at each long side and one at the head, back turned against the large stained window. They were dressed in the suits common to the high officials of the Capitol corporation. A young man stood up and addressed his senior.

«Why has the Brotherhood demanded to see us here, today? I have better things to do than to sit here and wait for them. We've been sitting here for two hours now, without a sign of them showing up.»

The man at the end of the table made an impatient gesture to the young man. His voice floated across the room, resigned and colorless.

«Sit down, Jenkins. They will come, when they so choose. Remember that. As to why they want to see us, I can only guess.»

Six heads turned towards him, the question evident in their faces. Jenkins sat down, a frown creasing his forehead. The older man continued speaking, as an answer to their silent question.

«Capitol is the most powerful free corporation on the worlds of humanity. We strive to give our employees the best, a freedom of mind and will. But this is not enough for everyone. There are those who crave for more power than they are given and who are





willing to use any means to reach that goal. There are even those who would turn to the Dark Legion for aid.»

Jenkins regarded the chairman intensely, then let his gaze wander over the features of those gathered with him. Some looked anxiously back while a few turned their gaze to the table.

«Pardon me, Mr. Krajicek. Are you telling me that the Brotherhood is coming here today to discuss infiltration from the Dark Legion? At what levels?»

The question was never answered. Suddenly the doors of the room burst open and the frame of the archway was filled with the imposing figures of two Inquisitors, dressed in ceremonial armor and garb. They were carrying the Book and each was armed with a grotesque-looking pistol, the thick black barrel and muzzle pointed at the floor. The voice of the senior Inquisitor was filtered through the helmet, but you could still hear the threatening tone.

«Okogawa, Simmons, Banks.»

The three men stood up, caught in the spell of authority radiating from the Inquisitors.

«Mr. Krajicek...»

Causally the two warriors lifted their guns, firing two shots each. The bodies of the men tumbled down, knocked the chairs back and finally rested in twisted shapes on the floor. Jenkins felt grateful that he was already sitting down, choking on the smell of blood and gunpowder.

Without another word the Inquisitors turned and strode out of the room.

### THE PRICE

General Hawkins stopped at the door, uncertain if he should proceed or not. Reluctantly he raised his hand to knock but was startled as the door opened. A soft voice drifted out from the dark room inside.

«Enter, general. We have been expecting you.»

Hawkins stepped into the circular chamber. It was thirty meters in diameter, and twice as high. It was dark, no windows, and the only light to see by came from seven flickering candles placed around a large oak table in the center of the room. Around the table three robed and cowed figures sat, suspended two feet in the air. As he took another step into the room the door slowly closed. Turning, Hawkins strained to see who had opened the door, but all he could see was darkness and fleeting shadows.

Uneasily he walked up to the mysterious figures in the middle of the room, stopping a couple of meters from them. A voice drifted in from behind him, soothing and electrifying at the same moment.

«So, the soldier has finally turned to the powers of the light. You seek guidance, so that you can help your men.»

Hawkins closed his eyes and made an effort to steady his voice.

«Yes, I need to know what the dark creatures have planned for tomorrow. I must know.»

Another voice chimed in, mixing with the first, confusing Hawkins who had to strain his senses to hear what the voices told him.

«It is true that we can show you the future. And by doing that you could be able to save your men. But remember, the future has a price...»

Hawkins didn't hesitate a second. He knew that if they didn't concentrate their forces at the right place tomorrow the Dark Legions would sweep through his defenses like a tidal wave, killing all and leaving the city open for plunder and pillaging.

«Show it to me. I will pay your price.»

The three Seers linked their hands together and slowly the air in the circle they formed started to swirl and change color. Soon Hawkins saw the battlements of the fortress, the two towers at the south end. And there, the force of screaming legionnaires assaulting the battlements, raising ladders, firing cannons and rocket-launchers, quickly breaching the wall. Then his own soldiers appeared, well-prepared. Now he knew what he would have to do.

But suddenly his gaze fell on a familiar figure. He could see a man wearing his own armor, carrying his own weapons, leading the men against the onslaught. It suddenly dawned on him that it was himself he was seeing.

Then suddenly the vision focused on the general, as his armor exploded and he fell to the ground, soon overwhelmed by the Dark Legions.

In shock, Hawkins cried out and the vision disappeared. The voice of the Seers drifted in his mind.

«This is the price you must pay. None can glance at the future without paying the price.»



# THE DARK LEGION

As the merchants laid claim to the tenth planet they woke the sleeping beast, may its name be forever cursed and despised. Greed and pride led their steps onto the path of eternal damnation as they turned their backs on our glorious and all-seeing prophets, ignoring their holy warnings. The merchants set foot on the planet and defiantly broke the chains that held the Darkness at bay. In their pride and folly they also opened up the gates to our universe, admitting entry to the evil once again.

And so did the Dark Legion descend upon us, howling with lust for destruction and corruption. Snarling and barking, the degenerate wolves bared their teeth, smelling the blood and carnage that lay ahead. Hordes of Heretics were whipped into an evil frenzy by the Dark Apostles and they marched under cursed banners towards the light of our Brotherhood.

It was the followers of the Cardinal who stood against the Dark Apostles and their legions. Scores of good men and women answered the holy calling for a crusade against the beasts of Darkness and so the battle was begun.

On the side of evil stood creatures from unholy dimensions, forever doomed to burn in the cleansing fires of damnation.

Against this the Brotherhood raised the shield of righteousness and wielded the sword of truth.

— *The First Chronicle, The Arrival of the Darkness and the Calling of the Cardinal* \ Alexander Horatio

## THE ARRIVAL OF THE APOSTLES

The Dark Legion is evil and Darkness incarnate. For untold ages the Dark Apostles waited to gain entry to our solar-system and begin the Dark crusade against humanity.

It was the first human colonists on the tenth planet, Nero, who awoke the sleeping horror. They found unworldly formations and seals and under the insidious influence of the Dark symmetry released the Darkness from its bounds.

Doing this they opened the gate for the Dark soul's allies and led them into our world. Soon the weak-minded and those of Dark thoughts were lured by the temptations of the Apostles. The Darkness sought its nourishment from the twisted minds and corrupted thoughts of humanity. The power of the human mind gave the Dark soul the energy it craved and it gave birth

to the First Apostle, LIAN, the Dark Mistress. Under her guidance the Dark symmetry silently assaulted the worlds of man and laid the foundation for the Darkness that was to ascend upon us.

As the despair and confusion grew, more and more of the citizens of our solar system cried out in anguish. Nurtured on despair and anxiety, MUAWIJE, the Lord of Insanity, emerged and entered the realms of the sleeping and dreaming. No more could mankind find peace in the lands of sleep.

Humanity tried to do battle against the Apostles but could not lay aside their own petty squabbles. The Megacorporations waged their wars against each other, and trust was wearing thin. From this the Darkness drew SEMAI, the Lord of Spite, the Nurturer of Revenge. To him was given the mission to turn brother against brother, to



### THE STEEL TABLET

The first men who landed on Pluto were the Imperial Conquistadors, scientists, astronomers, explorers and astronauts dedicated to expanding the knowledge of the solar system and the Universe.

Here, they found the First Steel Tablet. Buried kilometers into the solid surface, it immediately responded to the sensitive instruments, puzzling, teasing and tempting. It was only a matter of time before the Darkness would manifest physically in the worlds of humankind.

There are no pictures of the Steel Tablet, nor any survivors of this first encounter. A distant, scraping, transmitted voice told us about a

radiant and shimmering plaque placed in the centre of a gigantic altar, resting on a vault with engravings similar to those of Earth's ancient Neolithic cultures.

Then all was silent.

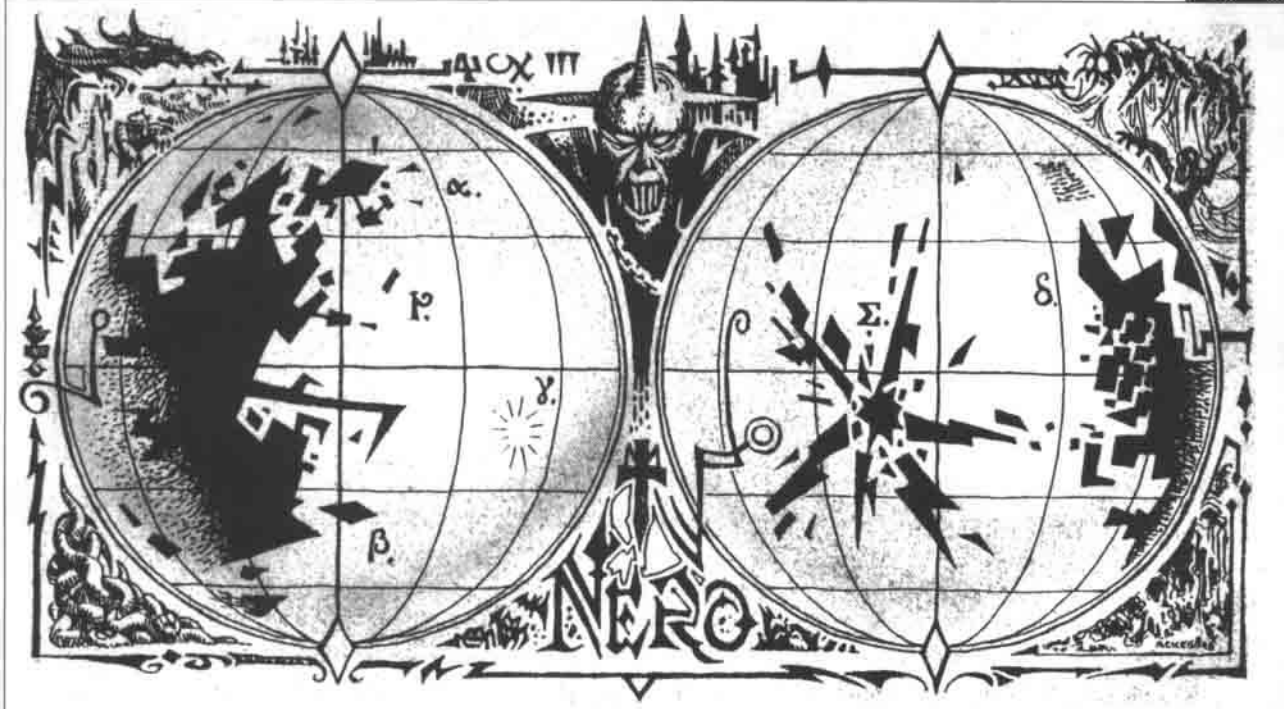



## CREATURES

The creatures of the Dark Legion are described in the following format. Refer to the «Character generation» section of the Rules for further details.

**MOVEMENT:** Movement ability in squares per action and meters per minute.

**OB:** The creature's Offensive Bonus.

**ACT/CR:** The number of actions allowed every CR.

**AVOID/PARRY:** The creature's SV in Avoid and Parry.

**BP'S AND ARMOR (AV):** In this table is given the creature's body points, armor and armor value in each part of the body.

**ATTACKS:** The creature's natural weapons (use «Combat SV») and their damage. The order indicates the creature's preference of attack: it will primarily use the first attack type, etc.

**FIELDS OF EXPERTISE:** The creature's APPROXIMATE SV's in the different fields of expertise. «Combat 15» would normally mean the creature has between 12 and 17 in all relevant Combat skills.

**SPECIAL ABILITIES:** Any special abilities that the creature may hold.

**DARK GIFTS:** What Dark Gifts the creature possesses.

corrupt the leaders of humanity and to sow the seeds of Darkness in the minds of man.

The scene was set for the greatest conflict humanity had ever faced. On one side stood the Brotherhood and the forces of the Megacorporations, as they were, and on the other the forces of Darkness. From the turmoil of the initial skirmishes and battles on the borderline of Darkness grew ALGEROTH. The Demon Lord of the Dark Technology and the Lord of Destruction. He took the forces of the Dark, transformed them into the Dark Legions and gave evil a might with which to devastate worlds.

Led by the mighty conqueror the hordes of Darkness marched to battle. Relentlessly they threw themselves against the defenses of our forces and mighty battles raged across the solar system. On every world the fires of war burned and bodies littered the fields and plains. Soon DEMNOGONIS, the Fifth Apostle, gazed out across the void. Filth and plague, famine and mutations followed his trail as he slithered from world to world, from battlefield to battlefield. He infested our cities with the Heretic mutants and spread the rot of Darkness among our troops.

## THE AGE OF THE DARK SYMMETRY

This was only the beginning of the Dark time.

It is now our future. Our era. And ours is the most desperate time.

Plagues and mutations spread throughout the solar-system, sometimes whole worlds fall victim to the destructive powers of the Darkness. The Dark prophets and the corruptors of the Dark symmetry agitate and infiltrate, aiming to bring the downfall of humanity from within. In this they are aided by the Heretics, humans that have been lured by the promises of the Dark symmetry. The Heretics destroy the very foundations of society and seduce the weak to serve the powers of Darkness.

On the battlefields the Dark Apostles, the generals of the Dark Legion drive their twisted legionnaires and necromutants to attack the desperate forces of humanity again and again.

Driven by the terrible Nepharites and the razides, the lost souls of the Dark Legions battle on with mad frenzy and energy. This is the age of the Dark symmetry.

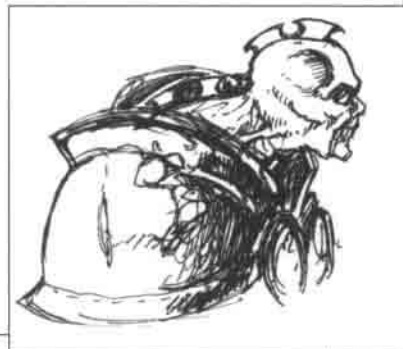

## THE SOUL OF DARKNESS

The Dark Legion has a supreme power, an entity so powerful that other beings are mere reflections of its might. This entity has no name and no known physical manifestation. It has been called the Great Darkness and the Dark Soul.

None but the Apostles and a few privileged Neph-

arites have ever experienced its presence.

In secret, outside our material spheres, this being exists and works its unfathomable plans. With the patience only attainable by a higher entity the Darkness struggles towards its final goal. It is well aware that its greatest ally is time.



**NEPHARITE OVERLORD**

Copyright © 1993 Target Games AB. All Rights Reserved. MUTANT CHRONICLES and all character names and distinctive likeness (es) thereof are Trademarks of Target Games AB.





## NECROMUTANT

Necromutants are alien warriors transformed by the twisted science of the tekrons into beings perfectly adapted to combat. They are massively built, with broad shoulders and muscular arms able of carrying almost any type of weapon. Their skin is the color of soot and their eyes expressionless wells of darkness. Their veins pulsate with an unholy glow.

Even though sometimes simple-minded and stupid, necromutants act as sub-lieutenants in Algoth's cohorts. Followed by hordes of legionnaires, these cohorts of up to 50 warriors will fearlessly assault even the strongest fortifications. The necromutants also serve as special commandos, sometimes commanded by centurions, and honor guards of the nepharites.



## DARK LEGION™

## UNDEAD LEGIONNAIRE

The undead legionnaires make up the bulk of Algoth's assault forces. They are the reanimated human dead of the battlefield, brought back to life by necro-technology. This procedure remains a mystery to human scientists—it is assumed, however, that it includes a long stay in an incubator where the twisting flows of the Dark symmetry can run freely. It is the tekrons and the mentors, both creatures of Algoth, who carry out the task of erasing the corpses' soul and mind while restructuring the organs and flesh to match the ugly face of the Lord of the Black Technology.

The ghoulish twisted grins and glowing eyes of the undead legionnaires are enough to strike fear into any soldier's heart. Their equipment and armor are the plunder of combat or the scarred and battle-worn remains of their original equipment, often enhanced by necro-technology.

The undead legionnaires are mindless zombies that act without any will of their own. They are slaves to the will of a commanding nepharite or Dark Legion superior, such as heretics or centurions.



## THE APOSTLES

From the Dark symmetry the five Apostles were born. Feeding on the confusion and fear that grips the human worlds, these Dark generals march before the hordes of evil engulfing our solar-system.

The Dark Apostles are the five most powerful servants of the Dark Soul and they command its worldly and mysterious armies. They have been given the power to seduce and entrap the souls of the weak, to create and lead the terrible legions and to distort and corrupt

reality, time and space. They are deities to the untold souls that make up the Dark Legions and for the forever cursed Heretics that have betrayed the light.

The five Apostles are each unique. They all have their own Dark missions and control their own legions. These missions are all part of the complex web of power that the Dark Soul is weaving, where the final victory is the extinction of mankind.

## SIBLING RIVALRY

All the Apostles have emerged from the same raw power, the Dark symmetry. Their ultimate master is the Dark Soul but otherwise they answer to no one.

As the First Apostle, Ilian is the leader of the five. Her control of the Dark symmetry is unrivaled and is her means of controlling her brothers. Algoth is the Apostle that openly opposes Ilian and actively plots against her. He is supported by Semai while Demnogonis and Muawijhe work their own Dark and mysterious plans. They do not openly support either one of their mightier brethren, hoping the two will clash in a mighty duel, and leave the scene open for the other Apostles.

Ilian is well aware of the rivalry among her lesser kin and the plots against her but stays her hand as she still has to answer to the Dark Soul, as do her brothers.

Since the final goal of all the Apostles is

the same, the quenching of the last light in our solar-system, they have a certain degree of cooperation. Some powers not available to one Apostle may be given by another, but at a cost. This bargaining has gone on for untold ages and from it the legions of the Apostles have emerged.



### NEPHARITE OF ILIAN

STR	34
INT	21
COR	20
PHY	18
MST	35
PER	28

MOVEMENT: 4/275

OB: +4

ACT/CR: 6

AVOID/PARRY: 10

#### BP'S ARMOR (AV)

Head	5	none 3
Arm	9	plate 8
Stomach	9	plate 10
Leg	10	plate 8
Chest	10	plate 10

ATTACKS: Grasp (see below), Gifts, 2-H melee weapon

FIELDS OF EXPERTISE: Combat 21, Firearms 15, Communication 18, Movement 19, Technical 14

#### SPECIAL ABILITIES:

By taking hold of a victim and defeating his MST with his own MST on the resistance table the Nepharite may send the soul of the victim into the void. The victim is lost forever. The Nepharite also possesses nightvision and does not feel pain.

DARK GIFTS: TERROR, DARK FIRE, INVOKE PAIN, BLINDNESS, DIMENSIONAL HOLE, DISRUPT POWER, HAND OF DEATH, TIME-DEATH, TRUE GATE



## THE LEGIONS

The armies of the Dark Legion are made up of scores of lost souls imprisoned by the technology of the Dark symmetry, infused with the spirit of the Dark Soul.

Beings from other dimensions make up the hierarchy under the apostles. Each Apostle has the eternal service of the Nepharites, corrupted by the nature of their master. The Nepharites act as lieutenants in the legions and command the hordes into battle.

Under the Nepharites can be found other beings—some human. Razides, desparytes, ezoghous, curators and defilers, all can be found in the ranks of Darkness. They have been created by the Apostles or recruited on distant worlds to join the crusade against humanity. Each Apostle has unique beings following it.

By the millions the legionnaires gather around the banners of the Apostles. The bulk of the Dark Legion is made up of these doomed souls, prisoners once dead, taken from the battlefields and given a wretched new life under the thrall of the Dark symmetry. These hordes of zombie warriors mindlessly charge across the battlefields, overrunning the defenses of humanity.

### THE NEPHARITES

Serving under the Apostles are the Nepharites, the eternal enemies of mankind. The Nepharites are the most powerful creatures in the ranks of the Dark Legion and act as the officers in the army of Darkness. The evil lieutenants are ranked in a strict hierarchy with the Nepharite Overlords as the supreme rulers. They only answer to their Apostle.

Every Nepharite has powers and abilities that make it unique. Their nature varies and is ultimately controlled by their Apostle. Some Nepharites have a great understanding of the Dark symmetry and wields its powers in the battle against mankind.

The Nepharites are the most competitive of the warriors in the Dark Legions. They are experienced and have the ability to make decisions on their own and their loyalty is without doubt.

They exercise total control over their subordinates and the slightest mistakes are rewarded with a fate worse than death.

The physical appearance of the Nepharites varies greatly depending on which Apostle they follow. They all strike a Dark and powerful pose, radiating evil. Sharp spikes or other metallic implements cover their bodies. Their strength is reflected in their faces which are a grotesque mockery of man.

The blank, staring eyes lack pupils and the deformed shapes of the faces are macabre nightmare masks.

Nepharite Overlords do not conform to these standards. As they grow in power they become more twisted and corrupted and are often reborn in other shapes, more true to their natures. The appearance of these Nepharites varies from individual to individual.



### TEMPLAR

STR	19
INT	10
COR	15
PHY	21
MST	12
PER	24

MOVEMENT: 4/275

OB: +2

ACT/CR: 3

AVOID/PARRY: 8

BP: SARMOR (AV)

Head	3	plate 10
Arm	6	plate 6
Stomach	6	plate 7
Leg	7	plate 6
Chest	7	plate 7

ATTACKS: 2-H melee  
weapon or firearm

FIELDS OF EXPERT-

ISE: Combat 15, Fire-  
arms 15, Commun-  
ication 11, Movement  
16, Technical 8

SPECIAL ABILITIES:

The Templars may  
sense pain and fear at a  
range of 50 sqs/75 m.

Their senses are sharp  
enough to allow them to  
separate individual  
beings. They can also  
sense the intention of  
causing pain at a range  
of 50 sqs/75 m. The  
Templars also possess  
nightvision.

DARK GIFTS: RESIST  
PAIN



## THE DARK PATTERNS

The Dark Legion is surrounded by an aura, Dark and powerful. This aura is known as the Dark symmetry and is the legion's source of power, the gate to the Soul of Darkness. From this complex field of power the Apostles, the Nepharites and the Mystics of the Dark soul channel their evil powers. Heretics are initiated in the use of the Dark symmetry by the higher beings and cultists within the hierarchy of the legions.

Each Apostle represents a unique pattern in the Dark symmetry, intimately linked to their mission. This pattern



gives the followers of the Apostles different powers depending on which master they serve.

**ILIAN.** As the guardian of the Dark symmetry, Ilian is the most powerful of the Apostles. There is nothing she cannot accomplish with the aid of the Dark Soul.

The servants of Ilian conjure up beings from other dimensions and open portals to other realms, forever searching to destroy the forces of humanity. They walk the Darkness of the void and control the gates between the planes. Their destructive powers are immense and they fill the minds of countless millions with Dark dreams and terrible visions.

**MUAWIHJE.** Muawijhe uses the Dark symmetry to further spread insanity across our worlds. His mages are skilled in distorting minds and senses and inducing terrible visions. They also possess the secret of walking across the dimensions, switching between realities at will.

**SEMAI.** Semai uses the Dark symmetry to spy upon the worlds of humanity and to twist the realities around us. His mystics corrupt innocent victims, endlessly trying to find new ways of spreading the heresy of their Lord. They observe the flow of light and Darkness, predicting the movements of the Brotherhood and directing the forces of the Dark Soul.

**ALGEROTH.** In the Dark symmetry Algeroth walks the path of fire and destruction. The mages of Algeroth open gates and portals to other, Darker planes of existence and dimensions. Through these gates they lure deadly beings of unknown creators which they let loose on their enemies.

**DEMNOGONIS.** Most of all Demnogonis' minions use decay and rot to fulfill his mission. His mystics corrupt and inflict decay upon our solar-system, forever searching for new diseases and rotting beings to spread the disease.



### CHILD OF ILIAN

STR	6
INT	9
COR	12
PHY	7
MST	13
PER	3

MOVEMENT: 3/175

OB: —

ACT/CR: 3

AVOID/PARRY: 4

#### BP:S ARMOR (AV)

Head	3	none 0
Arm	5	none 0
Stomach	5	none 0
Leg	6	none 0
Chest	6	none 0

**ATTACKS:** 1-H melee weapon or firearm (kratach)

**FIELDS OF EXPERTISE:** Combat 6, Firearms 8, Communication 5, Movement 13, Technical 16

**SPECIAL ABILITIES:** none

**DARK GIFTS:** none



## THE CITADELS

Important to the strategy of the Dark Legions are the citadels. Mirroring the dark citadel on Nero they strike a deep fear in the hearts of man.

Dark, twisted and wreathed in shadows and Dark clouds, these magnificent structures serve to further the cause of evil. Swarms of Algoth's tekrons and their slave labor invade the newly conquered land, and in only one night the foundations are laid. After a few days and nights the corrupted cathedral stands finished, covered

knowledge.

These citadels are erected in places where the Darkness has a permanent influence, where the prying eyes of the Brotherhood cannot reach. Nero and Pluto are her major strongholds but her presence is strong on Venus as well.

**MUAWIJHE.** Muawijhe secretly erects his citadels where his followers have strong cults or where insanity abounds. The number of citadels are relatively few and therefore secrecy is stressed when establishing a stronghold. It is often only by observing the behavior of people that one has clues to the presence of the Lord of Visions, as insanity always follows in his trail.

**SEMAI.** Semai's citadels are few and secret, situated on planets where the influence of the Dark Legions is strong and unchallenged. Here, the servants of the Lord of Spite tap into the powers of the Dark symmetry, trying to find those with weak minds.

The majority of the citadels of Semai are built within the structures of humanity, in the jungles of Venus, on the plains of Mars and deep in our Metropolises. They vary greatly in design but have one feature in common, the mirrors through which the Heretics and the corruptors maintain contact with Semai and spy on the weak minded.

The smaller citadels function as places of worship for cults as well as hiding places for the agents of the Liar. Only the larger and stronger citadels are governed by a Nepharite, since his presence would surely attract the attention of the Brotherhood.

**ALGEROTH.** Algoth has a great need for bases from which he can launch and replenish his forces. He therefore tries to build his citadels in well-protected areas hidden from the prying eyes of the Brotherhood.

The citadels are also important manufacturing industries. Algoth's need for new weapons, more legionnaires and creatures for his Dark Legions is endless. Therefore large parts of Algoth's citadels consist of mechanical and biotechnological plants where the tekrons and their slaves constantly toil with new designs.

**DEMNOGONIS.** The twisted towers of Demnogonis can be seen wherever major battles have ravaged the soil and left deep scars in the surroundings.

To these citadels, Demnogonis brings victims captured on the battlefields to use as raw material for developing new and wasting plagues. Huge halls are devoted to the research and the stench of death and rot rises from each corner in the buildings. Deep pits contain those not yet blessed with the corruption or those too diseased to be of any use, even for the great Befouler.

with the Dark and secret symbols of the Symmetry.

The citadels have several functions. They act as outposts at the borderline of evil, clearly marking their domains. They also provide fortifications against the enemy and act as bases and training camps, prisons and torture chambers, libraries and mystic temples.

The lord of the citadel is a Nepharite overlord. He commands the military force of the citadel, which is made up of warriors that can defend the citadel against attacks as well as carry out offensive operations of their own. An important role of this cohort is to bring new victims to the lord of the citadel so that the ranks of the legions may swell.

If the lord of the citadel controls the Dark symmetry to a high degree or has the aid of the Mistress of the Void, he can open gates to bring new beings into the battle. These portals are also used for communication between the generals of the apostles and their masters.

All citadels are placed according to a complicated Symmetry associated with each Apostle. The significance of this Symmetry is only known to the Apostles.

**ILIAN.** The citadels of Ilian are huge monasteries, with arches and endless stone-floored corridors. Here the disciples of Ilian are trained in the mysteries of the Dark symmetry. Like hooded monks they shuffle from lecture to lecture, ever growing in power and

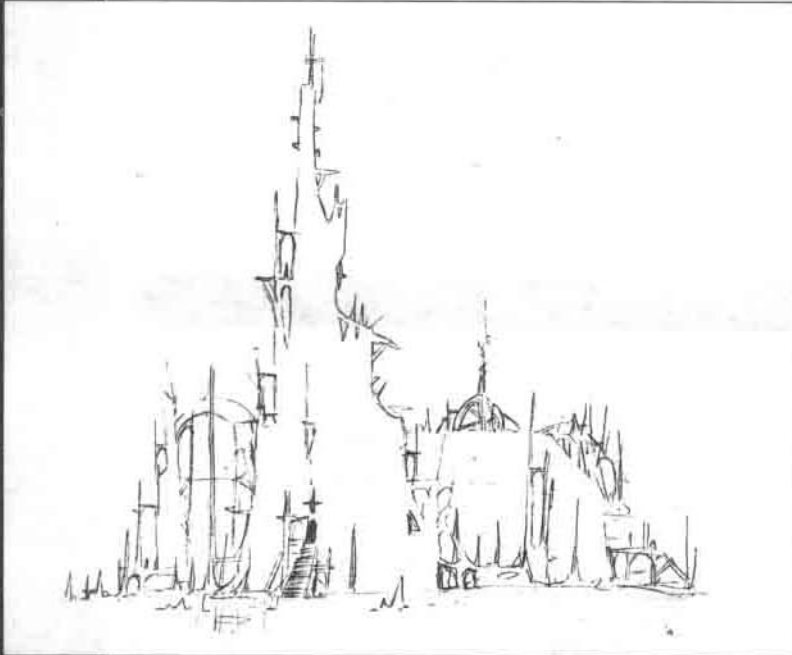

# ILIAN

From the nothingness of the void she emerged. The Cardinal stirred in his sleep, knowing in his bones that the world was changed and that new powers were rising. Strange tidings were brought before the Cardinal, omens of ill portent. The seventh star in the seventh constellation was eclipsed and no light did reach our worlds from that shining beacon, the Guardian of the Gate.

On Earth, tidal waves surged over the land leaving many dead and even more homeless. In the city of Methusalem the sky was dark with clouds of blood for thirty days and thirty nights. And in the dreams of man the dark beast howled at the moon.

The prophets first told of the Mistress of the Void as she spoke to them in their dreams. She wandered the shrouded paths of the art, stealing into the corners of our minds. Feeling, observing and learning, Ilian made no mistake as she entered our world.

Portals to other dimensions were opened and through them the Mistress of the Void called the keepers of the Dark symmetry. They did emerge and brought with them the secrets of shaping the Darkness. So the Mistress of the Void became the guardian of the profane secrets.

— *The Second Chronicle, Ilian and the Dark symmetry \ Plinius Varro*

## THE MISTRESS OF THE VOID

Ilian was the first of the Apostles, the Harbinger of Darkness and the Mistress of the Void. She was the first born of the Dark Soul, the first to enter the minds of mankind. She is the guardian of the gate, the keeper of the Dark symmetry and she wields magnificent powers. Ilian is the most powerful of the Apostles and keeps close watch over her lesser brethren. As they gain in power her control over them diminishes and a rebellion against her draws ever closer as the grip on the human

worlds grows tighter and victory seems at hand.

But Ilian grows in power as the Darkness claims more and more lives. She drinks in the essence of destruction and revels in the despair and desolation that follows in the wake of war and destruction. As the Dark Legions march over the shattered forces of humanity Ilian casts an ever growing shadow over our worlds.

Her power lies in her intimate control of the Dark symmetry. With this she conjures up beings from other dimensions and opens portals to other realms. Dark beings of immense power fill the ranks of Ilian's legions and creatures of Darkness crawl before their marching feet.

Her appearance radiates a precise and cold beauty, enhancing her true evil. Lithe and seductive, her long black hair hangs down to her waist, contrasting her pale skin. She is clothed in the Darkness of space and mystical runes adorn her robes.



### NEPHARITE OF MUAWIJHE

STR	32
INT	21
COR	26
PHY	15
MST	27
PER	28

MOVEMENT: 5/325

OB: +3

ACT/CR: 6

AVOID/PARRY: 9

#### BP: S ARMOR (AV)

Head	4	none 2
Arm	8	none 3
Stomach	8	plate 8
Leg	9	none 3
Chest	9	plate 8

ATTACKS: Kiss (see below), Gifts, Tzoteth or Shrieketh

FIELDS OF EXPERTISE: Combat 19, Firearms 15, Communication 18, Movement 17, Technical 16

#### SPECIAL ABILITIES:

The Kiss of Muawijhe has a base chance of 10.

It will drain 2d6 points of MST from the victim. If the MST is reduced to 0 the victim will rise as a Screaming Legionnaire. The Nepharite also possesses nightvision and does not feel pain.

DARK GIFTS: TERROR, INVOKE PAIN, CONFUSE, INSANE DANCE, SEND DREAMS, SLEEP, WIND OF INSANITY, INVOKE FRENZY (Algeroth)



## THE LEGIONS OF ILIAN

Ilian was the first of the Apostles and has gathered around her creatures summoned from other distant planes, twisted abominations skilled in the crafts of the Dark. Weaving the fragile threads of the symmetric loom, they shape the energies to assault humankind's forces.

The combat troops of Ilian are few and concentrated to her citadels. Many of her lieutenants act as observers and take active parts in the battles fought by the other Apostles. They lend their powers to aid the Darkness as

well as furthering the cause of Ilian.

### THE NEPHARITES

The Eternal enemies that make up the higher echelons of Ilian's court are magicians and powerful warriors. They can open portals to other planes where they gather their legions to fill the dark ranks. They act as Ilian's observers and Advisers to the other Apostles.

The Nepharites of Ilian are dressed in simple tunics,

### ZENITHIAN SOULSLAYER

STR	27
INT	12
COR	10
PHY	24
MST	27
PER	26

MOVEMENT: 3/225

OB: +4

ACT/CR: 4

AVOID/PARRY: 9

#### BP:S ARMOR (AV)

Head	5	none	4
Arm	9	none	4
Stomach	9	none	5
Leg	10	none	5
Chest	10	none	5

ATTACKS: Claws (2d6),  
Gifts, Blades (2d6+1),  
Tail (1d6)

#### FIELDS OF EXPERTISE:

Combat 17, Fire-  
arms 0, Communication  
0, Movement 14,  
Technical 0

#### SPECIAL ABILITIES:

Nightvision

#### DARK GIFTS: TERROR,

CONFUSE, INSANE DANCE,  
WIND OF INSANITY, INVOKE  
FRENZY (Algeroth)



covered with the symbols of the Harbinger of Darkness. Over these tunics they carry heavy plate armor, forever covered in ice and frost from the cold void.

Ilian's Nepharites are covered in living chains ending in wicked hooks. The chains weave back and forth according to the will of their master and are used to trap and tear victims apart. In addition to these the Nepharite carries a heavy close combat weapon, often endowed with dark powers.

The Nepharites of Ilian all have a special ability. Upon grasping a victim they may envelop him in the Darkness of space, sending the unfortunate soul into the endless void. There his soul is hunted forever by the wild hunt of Ilian.

## THE TEMPLARS

Guarding the citadels of Ilian are the **TEMPLARS**, or Temple Guards, a secret race of half-mechanical warriors. Ilian have taken them from their native plane of existence and fulfilled their wishes for endless destruction and conflict.

They are shaped like humans but with massive bodies. Their powerful physique enables them to carry heavy armor and weaponry and still maintain mobility.

Their true appearance is unknown as they always wear heavy armor and clothing decorated with the forever swirling stars of their Mistress. A spiked helmet covers the head and is connected to protective systems

under the armor. These systems and the heavy armor give the Templars a unique advantage on any battlefield. A Templar will never take cover and will march relentlessly towards its enemies, spreading death and destruction on its way.

The Templars possess minds perfectly attuned to combat. They can sense waves of pain and fear from far away and thereby sense the direction of any battle close to them. They can also sense the intent of those causing pain and are therefore used as guards at Ilian's citadels and temples.







## THE CHILDREN OF ILIAN

Among the followers of Ilian are a race of servants simply referred to as the CHILDREN OF ILIAN. These are diminutive beings with twisted and deformed bodies. Their skin is pale, almost transparent. The children have long arms and short legs and their large head is connected to pulsating tubes linking the brain to the central nervous system. Their faces glow with demented mirth and they speak in high squeaking voices, endlessly

gibbering meaningless phrases.

In their tool-belts they carry small devices of necrotechnology. These are used for repairing damaged equipment or constructing new and twisted designs.

The children are used as servants by the more powerful in the ranks of Ilian. They do not normally participate in combat but might, if they are present in large numbers, attack larger enemies in a blood-curdling frenzy.



# MUAWIJHE

It was the great prophet Aglialos who spoke of the Lord of Visions.

In dreams the Dark Lord had first emerged, bringing with him fools and jesters to make merry in the minds of man. Howling hordes were released to haunt our dreams, leaving us no rest or peace.

In his dreams Aglialos wandered far and wide, searching the flows of the future. He walked across the Fields of Desolation and found that his steps had taken him to the great necropolis. But the gates were closed and try as he might, Aglialos did not have the power to open them.

In his anger the great prophet shouted a mighty challenge to the powers that held the gates shut.

With a flare of trumpets and piping flutes the gates did then open. From the gaping maw of the portal there emerged hideous creatures, wildly dancing and laughing. Strange colors filled the skies and Aglialos felt the flow of reality shy back and pure insanity fill its wake.

And then did the Lord of Visions appear. He filled the portal in his might and the snakes that sprouted from his head danced as if enthralled by the music.

Muawijhe then held up his hand to the great prophet, who could take no more. Turning, he ran for the safety of his cell, to the light of the Brotherhood.

— *The Fourth Chronicle, The Arrival of Semai and Muawijhe \ Lapidus Asolvos*

## THE LORD OF VISIONS

Lord of Visions, the Demon of Screaming Insanity, both are names given to MUAWIJHE. He invades the dreams of man and nurtures the insanity latent in our minds. Spinning his webs of confusion and terror he rules the insane and weak minded. Walking between the dimensions of reality and insanity he is an intangible shadow shutting out the light of the Brotherhood.

In his hordes march the mad and demented fools snatched from the comforting warmth of humanity and

thrown into the insane legions of Muawijhe. His followers are widespread and his secret citadels open up the realm of dream for him and his nightmare beasts all over the solar system.

Twice as tall as a man with broad shoulders and long thin arms ending in clawed hands, the Lord radiates total and pure insanity but remains a perfect calm in the eye of the storm. He is dressed in armor made out of dreamstuff distilled from the insanity of his legions. His

clothing is covered with writhing patterns constantly changing both shape and color, forever pulsating with light. His wide cloak shows the images of captured dreamers streaming over the fabric like clouds over the sky, twisted in insane screams forever trying to find the way out. From his belt hangs long chains and hooks which he uses to capture his prey.

From his head sprouts huge, fat worms, constantly moving to the symphonies of insanity. They seem to forever crawl out of the Lord's head and reach out for victims for they can with the slightest touch drive a man over the cliffs of insanity. They tear down any walls the victim may have and drowns him in pure insanity. There is no return and anyone exposed is transformed to a screaming, drooling idiot forever bound to the service of the Lord of Visions.



### SCREAMING LEGIONNAIRE

STR	14
INT	2
COR	5
PHY	15
MST	1
PER	6

MOVEMENT: 3/175

OB: +1

ACT/CR: 2

AVOID/PARRY: 3

#### BP: S ARMOR (AV)

Head	3	none 0
Arm	5	none 0
Stomach	5	none 0
Leg	6	none 0
Chest	6	none 0

ATTACKS: WIND OF INSANITY (see below), Firearm (kratach) or melee weapon

FIELDS OF EXPERTISE: Combat 7, Firearms 12, Communication 4, Movement 6, Technical 2

SPECIAL ABILITIES: A Screaming Legionnaire has the ability to automatically invoke a WIND OF INSANITY once a day without any MST-cost and without having to make any die-roll. However, it doesn't do any physical damage. The level is 1 per Legionnaire, i. e. 10 screaming Legionnaires joined in this invocation will create this effect for 10 CR:s.

DARK GIFTS: See above





### NEPHARITE OF SEMAI

STR 21  
INT 29  
COR 19  
PHY 22  
MST 27  
PER 25

MOVEMENT: 5/325

OB: +3

ACT/CR: 5

AVOID/PARRY: 8

#### BP'S ARMOR (AV)

Head	4	none 4
Arm	8	none 4
Stomach	8	none 4
Leg	9	none 4
Chest	9	none 4

**ATTACKS:** Gift, 2-H  
melee weapon, firearm

**FIELDS OF EXPERTISE:** Combat 16, Fire-  
arms 13, Commun-  
ication 21, Movement  
14, Technical 23

#### SPECIAL ABILITIES:

By taking hold of a  
victim with the GIFT OF  
POSSESSION, the  
Nepharite may twist and  
corrupt target's shape,  
thus creating a Heretic  
Legionnaire. The  
Nepharite also  
possesses nightvision  
and does not feel pain.

**DARK GIFTS:** TERROR,  
BLINDNESS, ILLUSION, MIND-  
MELT, POSSESS



## SCREAMING LEGIONS

The legions of Muawijhe are made up of the creatures that haunt our worst nightmares and the insane legionnaires, twisted beings driven over the edge by the powers of the Lord of Screaming. He has gathered his hosts around him over the years and his ranks constantly swell with new victims driven insane by the Darkness of our times.

### THE NEPHARITES

The Nepharites of Muawijhe resemble their master. They mirror his appearance but not the calm control over insanity their master possess. They act as generals in the Screaming legions and their sole purpose is to spread the madness and the terror and collect those who have been smitten by the Dark Lord's presence. The Nepharites of Muawijhe are able to travel between the realms of reality and nightmare without hindrance, all to please their master's thirst for new souls.

From this mouth, the Nepharite can throw forth a black wormlike tentacle that if it touches a victim unites the poor soul's mind with Muawijhe's. The effect of the Kiss of Muawijhe results in the creation a new Screaming Legionnaire.

### ZENITHIAN SOULSLAYERS

Following the Screaming Legionnaires, whipping them to a frenzy and steering their destructive powers at their enemies are the ZENITHIAN SOULSLAYERS. Huge monsters, three meters or more, they tower behind the ranks of the doomed, often surrounded by a squad of demented drummers and pipers.

The Zenithian Soulslayers are vaguely humanoid in shape with a torso and a head, two arms and two legs. There the similarity ends. The head is long and the lower part taken up by two enormous jaws, devoid of lips and twisted into a hideous grin. The two eyes burn with the fires of hate.

The arms are long and end in terrible claws, razor-sharp and dripping in slime. The legs are powerful and permit movement at high speed. Protruding from the back of the Zenithian Soulslayers are two twisted blades made out of hard bone. These blades are connected to powerful muscles and may be used as pincers, cutting a victim in half. The tail may also be used as a thrusting weapon.

The Zenithian Soulslayers act as officers of the Screaming Legions, taking command over the Screaming

Legionnaires, pushing them into combat and keeping them in line.

## THE SCREAMING LEGIONNAIRES

In the minds of man, in the corner of our dreams and on the endless battlefields the Screaming Legionnaires dance and taunt. Dressed in ragtag uniforms and forever screaming they roam both the material planes and the insane worlds of their master.

The Screaming Legionnaires are humans who have been drawn into the insanity of Muawijhe. Their bodies are twisted into spasms and uncontrollable fits and their minds have withered. Only the screams of their master fill their life.

The legionnaires are dressed in whatever clothing they can salvage on the battlefields, giving them a colorful and bizarre appearance. They are mostly armed with close combat weapons and light missile weapons. In addition to this the Screaming

Legionnaires carries a wide spectrum of instruments, from howling pipes to beating drums and singing harps.

Their power lies in their ability to channel the dark insanity that surrounds us. By performing a wild dance, a screaming legionnaire is able to channel this force and create a whirlwind of power, which travels across the battlefield engulfing unknowing victims. The whirlwind assaults the mind of its victim, burning it out and leaving nothing but an empty shell. The legionnaires may combine their powers creating larger, more powerful whirlwinds.

Some legionnaires make up special troops armed only with instruments twisted by the dark technology. The music from these instruments has the ability to shape and distort the nature of things and are also able to channel the powers of the Dark symmetry.





## TECHNOLOGY

The special weapons used by Muawijhe's legions are all created from the insanity of the Lord of Vision and reflect his nature.

### SHRIEKETH

The Screaming Legions are armed with weapons forged from the insanity their master wields. The SHRIEKETH vaguely resembles a conventional gun but have been constructed from organic material. It is covered with tubes and cables and the writhing patterns that are the marks of Muawijhe. The weapon is capable of firing twisted, hooked spikes and has the ability to tear through even the thickest armor.

W	L	MC	FUNC	RANGE	STR	RT	JF	DAM
4	40	12	M	20/30	12	1	9	1d6

### TZOTETH

The TZOTETH is a heavier support weapon based on a principle similar to that of the common flamer. It fires gusts of insanity which envelop the victims in a black sea of fire, crawling like a demented beast over its target's body. The effect is devastating and any person hit is immediately struck by an attack of pure madness. The brain and blood of the weak-minded begins to boil from

Anyone that is hit by a spike and survives is within a few hours caught in the web of insanity and is doomed to serve the screaming legions forever.

**FOR THE GAMEMASTER:** If the victim takes at least one point of damage in any body part he must make a Hard MST-roll. If it fails, he will begin to transform into a Screaming Legionnaire within 1d6 hours. The process can only be canceled with a successful ART OF EXORCISM of the second magnitude being performed on the victim, else he is forever lost to humankind.

the heat and blisters form on the skin. After a few seconds the victim is totally engulfed in black flames and is incinerated.

**FOR THE GAMEMASTER:** Treat as an incinerator attack. Any person that is subject to a successful attack roll must make a Normal MST-roll. If it fails, he's dead.

W	L	MC	FUNC	RANGE	STR	RT	JF	DAM
7	100	6	M	30/45	25	6	10	3d10



# SEMAI

As the glorious crusaders lifted their arms and marched towards the Darkness on the battlefield, the Inquisitors took up the challenge of an even greater peril.

For Semai, the Lord of Spite, spread his poison over the worlds of humanity, snaring those who lusted for power and perverted pleasures. The Darkness grew from within, corrupting our society like a cancerous growth.

The Inquisitors left no stone unturned as they sought out the evil ways and the signs of corruption. But even the light from a thousand cleansing fires could not banish the Darkness within ourselves.

The whispers of Semai did turn brother against brother, mother against daughter, yes, even the Brotherhood was smitten by the rotting lies of the Great Perverter.

The fires burned higher and brighter. And as the fires roared ever higher the shadow cast by the Dark Legion grew ever longer.

So it was that the Megacorporations fell into the vile clutches of the Dark Soul. Within the highest ranks Heretics would rule and could avoid the all-seeing eyes of the sacred Inquisitors. Semai whispered dark and untold secrets in their ears, crowning them kings and princes and promising the glory of the past. And such was the powers of those visions that many embraced them blindly only to wake up as one of the eternally damned.

— *The Fourth Chronicle, The Arrival of Semai and Muawijhe\ Lapidus Asolvos*



## CALLISTONIAN INTRUDER

STR	16
INT	12
COR	18
PHY	25
MST	12
PER	12

MOVEMENT: 5/325

OB: +3

ACT/CR: 3

AVOID/PARRY: 12

### BP:s ARMOR (AV)

Head	4	none 3
Arm	7	Light 6
Stomach	7	Light 7
Leg	8	Light 6
Chest	8	Light 7

ATTACKS: Grenade, Jahkb, Vassht, firearm

### FIELDS OF EXPERTISE:

Combat 16, Firearms 12, Communication 9, Movement 26, Technical 12

### SPECIAL ABILITIES:

The intruders regenerate 1 Body point per minute of rest. Nightvision.

### DARK GIFTS: ILLUSION,

SHROUD

## THE LORD OF SPITE

As the Darkness spread across our solar-system the foundations of humanity started to crumble. The third Apostle followed in the footsteps of the Lord of Visions and spread his poison and spun his web around all of humanity. SEMAI had emerged.

Semai is the Lord of Spite, the Eternal Liar and the Great Perverter. His mission is to snare the human souls, to corrupt and tempt us and have us join the Darkness, marching towards our own destruction. His corruptors hide in the shadows, promising wealth and glory to the weak of mind. The Heretics are infiltrating the leading powers of humanity and the cults following the Apostles are growing in power. Semai is the most subtle of the apostles.

As the Dark symmetry wins followers the power of Semai grows. His ranks are made up of the HERETIC LEGIONNAIRES who have given their soul to the Darkness and in return been given the ultimate suffering.

Although Semai is not among the

most powerful of the Apostles his control over the worlds of humanity is unequalled. His poison has spread to the very core of our system and many are those who have given their soul to Semai.

The Lord of Spite stands over two meters tall and almost as wide. His skin is greasy with fat and his hairless head a bulging mass of chins and cheeks. He wears flowing blue cloaks and a heavy battlesuit. His hands are covered with heavy iron gauntlets. From a pouch in his belt hangs his crystal orb of promises and in his right hand he carries the scroll upon which the first lies are inscribed.

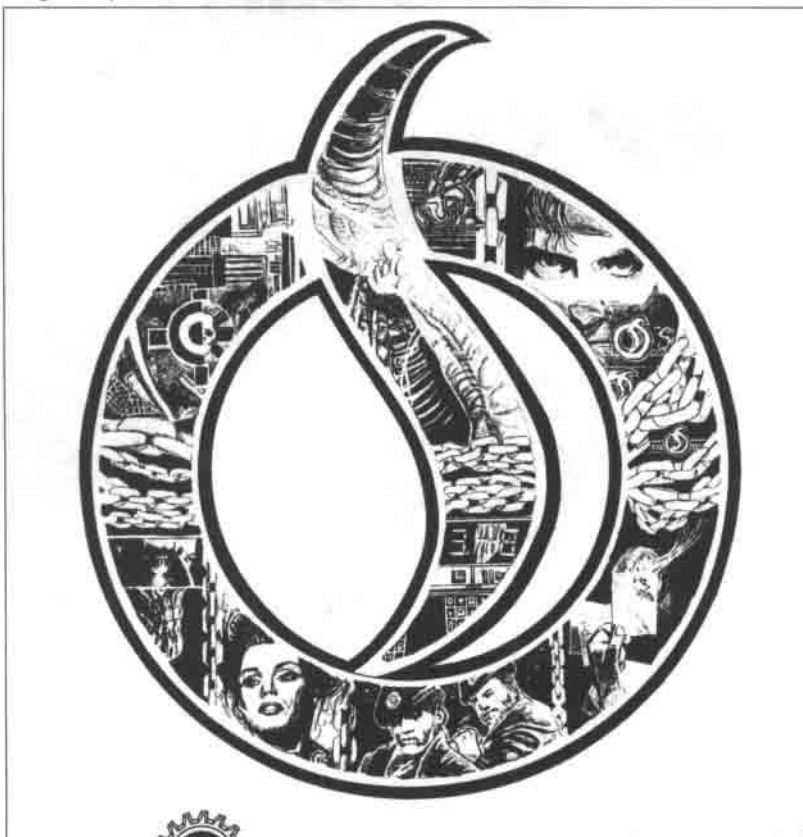



## HERETIC LEGIONNAIRE

STR	15
INT	3
COR	11
PHY	13
MST	7
PER	4

**MOVEMENT:** 3/225

**OB:** +1

**ACT/CR:** 3

**AVOID/PARRY:** 5

**BP:ARMOR (AV)**

Head	3	none 1
Arm	5	none 1
Stomach	5	none 1
Leg	6	none 1
Chest	6	none 1

**ATTACKS:** melee  
weapon or firearm  
(kratach)

**FIELDS OF EXPERTISE:** Combat 11, Fire-  
arms 12, Commun-  
ication 3, Movement 11,  
Technical 4

**SPECIAL ABILITIES:**  
Nightvision. During  
their time since they  
joined the ranks of the  
Legion, they have  
forgotten what pain is  
and therefore ignore all  
wounds until killed.

**DARK GIFTS:** none



## THE LEGIONS OF SEMAI

Semai surrounds himself with creatures that dwell in the shadows. His legions are not as numerous as those of his sister or brothers but they cause just as much damage to humanity. They infiltrate and corrupt, spy and steal. The secrets we keep are Semais' to revel in. The Lord of Spite exploits our weaknesses and turns brother against brother in the battle for mankind.

His forces are scattered over the solar-system and conduct guerrilla warfare from hidden bases. They fight in closely knit units, led by a **CORRUPTOR** or a Nepharite. These units are highly trained and proficient at taking command over their own situation when they have no one else to turn to.

On the battlefield his Nepharites and **DESPARYTES** lead scores of Heretic Legionnaires into the combat.

### THE NEPHARITES

The lieutenants of Semai walk along the borders of humanity, lending help to cults and Heretics as they see fit. They agitate the dark masses to rise against the Brotherhood and the rule of the Megacorporations. They read the minds of people and control the corruptors who spread their poison in the human society.

The Nepharites of Semai are the ones who most resemble humans. They are tall and foreboding but lack

the spikes on the head and body. Instead their skin is covered with smoldering runes, branded onto their bodies untold eons ago. These runes represent the first lies in the creation and hold considerable power.

The Nepharites conceal these runes by dressing in heavy armor and flowing cloaks. They always wear impressive helmets and may sometimes pose as Inquisitors when persuading the ignorant masses.

The Nepharites of Semai have a unique gift to reshape mind and matter. Upon grasping an object or a being they may corrupt its shape or soul by sheer force of mind. Like clay they twist and bend the creature to serve their own dark purposes.

### CALLISTONIAN INTRUDERS

To sabotage important facilities and assassinate powerful enemies Semai uses the **CALLISTONIAN INTRUDERS**. These are a race of hunters and assassins devoted to the art of secrecy and war. They carry out operations behind enemy lines and make up the strike-forces of Semai.

The intruders are humanoid with a slender build. In spite of their small body mass these warriors possess considerable strength and constitution. Their ability to quickly heal non-fatal wounds gives them a considerable advantage when carrying out covert operations.



The black skin is leathery and provides good natural protection as well as good camouflage at night. The eyes glow softly in the dark and give the intruders perfect night-sight as well as good vision in day-light. To cover the glow of the eyes the intruders often wear a helmet with a grotesque death-mask attached, thus making the intruders virtually impossible to detect in darkness.

The Callistonian Intruders wear light armor over their whole body. The armor is often covered with blades and spikes making capture difficult.

They are often armed with their two favorite necrotech weapons, the JAKHT and the VASSHT, as well as a silenced heavy automatic gun. They often employ gas-grenades and blast-grenades in their operations.

## THE HERETIC LEGIONNAIRES

In mighty hordes the Heretics march across the solar-system. Rank upon rank are filled with the misled, the corrupted and the twisted. The Heretic Legionnaires fill Semai's legions and make up the fighting force of the Lord of Spite. They guard his citadels and under his banner charge against the enemies of the Darkness.

The Heretic Legionnaires were once humans. Now they are pale and hollow-eyed, their faces twisted in eternal agony. All have been snared by the corruptors, who have promised eternal glory in the ranks of the Apostle. In the end they have no choice but to submit to the ruling of the Lord of Spite and join his army.

The Heretics have all given their soul to the Dark Apostle by their own free will. This binds them forever to the Darkness and not even death may part the two. The

Heretic Legionnaires have experienced death and pain thousand upon thousands of times and are now no more than puppets dancing at the pull of a string. Their minds have been burned away by the fire of endless pain and they follow the Nepharites and the desparytes that lead them into battle.

The Heretic Legionnaires use arms captured from their enemies or supplied to them by higher ranking Heretics or corruptors.







## TECHNOLOGY

### JAHKT

The JAHKT is a small disc with razor-sharp teeth lining the circumference. The disc is a thrown weapon that rotates with an enormous speed. Inside the disc is a heat-seeking device guiding the jahkt to its victims, thereby increasing the chance of success with +6. For the jahkt to function properly it needs 2 body points of blood every day, normally taken from their user.

W	RANGE	STR	DAM
0,6	STR squares	5	1d6+1

### VASSHT

The VASSHT is a close combat weapon resembling a sword, but it can be thrown with great penetration and accuracy. It is built out of necrotechnology and has the ability of always returning to the hand of the user, from which it sucks 1 BP of blood every day. No one else than the attuned user can use the vassht.

W	RANGE	STR	DAM (close combat)	DAM (thrown)
1STRx2	squares10	1T6+1	1T6	1T6





**DARK  
LEGION™**



## **RAZIDE**

A razide is a hybrid collection of flesh, iron, and stone. Unearthly organs connected by endless tubes pump dark liquids through the razide's muscular body and send ripples across its skin. They tower over an average person and can crush stone with their bare hands.

The razide is a beast from another time and existence, impossibly strong and given a constitution beyond any man's. Under the command of a nepharite or centurion, they are the Dark Legion's support troops and fire power.

## CENTURION

Centurions are the special forces of the Dark Legion. They physically resemble the necromutants, but they are much taller and their skin is more greenish than sooted. There are different races of centurions, some created in the same foulish way as the legionnaires, others are distorted beings from other existances, resculptured to humanoid shape and human appearance. The centurions are the most «human» of all creatures of the Dark Legions, their complexion and features purposely manipulated with surgery and Symmetry as to resemble mockeries of human beings. In some levels of society, they even pass as humans...

Centurions are superior to the necromutants, a little more intelligent and imaginative—almost human... Their combat abilities and equipment are also better, and they are often used for special missions as well as commanding troops. Along with heretics, the centurions serve under a nepharite as educators, captains, commanders and commandos.



**DARK  
LEGION™**



## NEPHARITE OF ALGEROTH

Dressed in shining dark armor covered with spikes, the nepharite is twice the size of a man. Commanding their forces with mighty battleries that echo through the battlefield long after the carnage is done, they are coldly efficient creatures of doom.

Utterly evil and possessing considerable skills in the Dark patterns, the nepharites are the eternal enemies of mankind. They seek solace in the chaos of war and stalk the battlefields in their search for new victims. They are the Legion's finest commanders, serving immediately under the apostles to carry out their fiendish plots.

# ALGEROTH

Aware of the magnificent rule of Cardinal Augustus, may he be forever blessed and protected by the powers of light; the spawn of the bottomless Darkness and the instigator of devastation gazed over the outer worlds. Algeroth brought with him his faithful lieutenant, the bestial Nepharite Alakhai. With the aid of the silent tekrons they together created the first legion out of the bodies left on the countless battlefields in our system.

They did then march against humanity. World after world shuddered under the feet of Algeroth's legions and his forces grew stronger and stronger after every battle. As one man fell on the side of the Brotherhood another would join the ranks of the cursed.

New monstrosities and perverted beings were hatched in the biotechnological factories in the black heart of the dark citadels. The Ezoghoul soon proudly galloped over the battlefields, sniffing the death that was its to cherish.

The divided forces of humanity fell back when assaulted by the massive attacks from the Apostle. Heretics and traitors joined in his name and the cults that did his bidding grew in power. The sick and twisted technology spread over the worlds of man and soon scores and scores of people were under their thrall.

Soon the twisted and corrupted spires of the citadels could be seen on all our worlds.

The Cardinal saw all this.

All that had been told to him by the holy prophets had turned true. It was now clear that if humanity were to be saved from the soul of Darkness he had to unite the warring factions under one flag, the light of the Brotherhood. So the Cardinal called upon the second directorate to commence, and the inquisition was born to seek out the Heretics and traitors within our ranks and destroy the Dark Legion wherever it might be found.

— *The Fifth Chronicle, Algeroth and Demnogonis \ Horka Mikhalos*



## NEPHARITE OF ALGEROTH

STR	45
INT	16
COR	19
PHY	23
MST	21
PER	29

MOVEMENT: 5/325

OB: +5

ACT/CR: 4

AVOID/PARRY: 10

### BP'S ARMOR (AV)

Head	4	none 4
Arm	8	none 4
Stomach	8	plate 8
Leg	9	plate 8
Chest	9	plate 8

**ATTACKS:** melee weapon and/or firearm (most probably enhanced with necro- and/or bio-technology), Gifts

**FIELDS OF EXPERTISE:** Combat 19, Firearms 18, Communication 16, Movement 21, Technical 18

**SPECIAL ABILITIES:** The Nepharite possesses nightvision and does not feel pain.

**DARK GIFTS:** TERROR, DARK FIRE, INVOKE PAIN, BLINDNESS, INDIGESTION, DIMENSIONAL WARP, FLOW OF ACID, INVOKE FRENZY

## THE LORD OF THE TECHNOLOGY

ALGEROTH is the Apostle of War, the Demon Lord of the Dark Technology and the Mage of the Twisted Biotechnology. He has been given the dark mission of spreading the corrupted sciences of the Darkness across the worlds he tramples under his feet. He is the most powerful Apostle after Ilian and has a close tie to Semai, the Apostle of Spite. Together they carry out complex plans to throw the worlds into war.

His legions are the most numerous and fanatic LEGIONNAIRES and NECROMUTANTS who charge in endless hordes across the bloodstained battlefields. The standard of Algeroth flies over many of the dark Citadels.

His physical manifestation is a huge muscular man. He is massive and covered with tubes and electrical cables. Living biotechnology is attached to his body and some of them have merged with the flesh of the Apostle forming a symbiotic relationship with the Dark Lord. He

carries heavy weapons of different designs and an imposing battle armor, weighted down with combat computers and additional weaponry.





## THE DARK TECHNOLOGY

Algeroth is the unchallenged master of the Dark Technology. In his service can be found the silent TEKTRONS who carry out the dark designs of their master. They manufacture all the technology the Dark Legions of Algeroth possess.

Algeroth's tektrons are the most cunning and skilled among the technicians of the Dark Legions. Their twisted creativity has conjured up innumerable creatures of unworldly shapes and forms. New weapons of immense destructive powers have been created from the visions of the Dark Lord. Enormous breeding farms can always be found wherever Algeroth's dark minions do battle. It is the efficiency of the tektrons that allow Algeroth to create huge monsters and he jealously guards his secrets. The only way the other Apostles can access the technology of Algeroth is by paying for it, in Heretic souls or patterns from the Dark symmetry otherwise forbidden for the Demon of Dark Technology. Through his position Algeroth has provided many soldiers and weapons to the forces of the other Apostles and has gained a position of power and influence only checked by the powers of Ilian.

None of the weapons, vehicles or other equipment used by the Dark Legion or created by Algeroth's minions conform to the traditional designs used by the forces of humanity. They bear a slight similarity to conventional equipment but are melted and twisted. In spite of the appearance the Dark Technology creates equipment with high standards capable of performing better than human-built counterparts. The weapons are deadly and have edges that can be used to devastating effect in a melee. They can easily slice a man's arm off or pierce battle armor.

The technology of the Dark Legions is divided into

three main groups; BLACK TECHNOLOGY, NECROTECHNOLOGY and BIOTECHNOLOGY.

### THE BLACK TECHNOLOGY

The BLACK TECHNOLOGY is the process of twisting and corrupting existing human technology. Weapons and other equipment captured from the Megacorporations and the Brotherhood are transformed by the weaponsmiths of the Dark Legion, the tektrons. The resulting equipment looks like melted machinery and the mechanisms have been warped into new and strange shapes. This process gives the equipment new, sharp edges, letting the user cause even more damage and pain. It is impossible for humans to use these twisted creations.

The Black Technology is used to provide the hordes of Legionnaire and Necromutants with weapons and other equipment. It is used on weapons as well as vehicles and the result is a piece of equipment with better performance than the original. The major drawback is that the black technology tends to be a bit unreliable.

### NECROTECHNOLOGY

The NECROTECHNOLOGY uses dead, organic material which is animated or bestowed with a controlling spirit from the netherworlds.

The weapons designed with this technology often carry dark souls captured inside. These souls have demonic natures and will slowly corrupt and pervert their owners. They have their own minds and draw the energy they need from their surroundings. The stored energy can be released in enormous bursts of energy which cause great damage.

### CENTURION

STR	18
INT	14
COR	16
PHY	18
MST	9
PER	20

MOVEMENT: 3/225

OB: +2

ACT/CR: 3

AVOID/PARRY: 6

#### BP'S ARMOR (AV)

Head	3	none	3
Arm	6	light	4
Stomach	6	light	4
Leg	7	light	4
Chest	7	light	4

ATTACKS: melee  
weapon or firearm  
(kratach or handgun)

#### FIELDS OF EXPERTISE:

Combat 10, Firearms 14, Communication 12, Movement 9, Technical 9

#### SPECIAL

ABILITIES:  
Nightvision

#### DARK GIFTS:

RESIST PAIN,  
INVOKE FRENZY

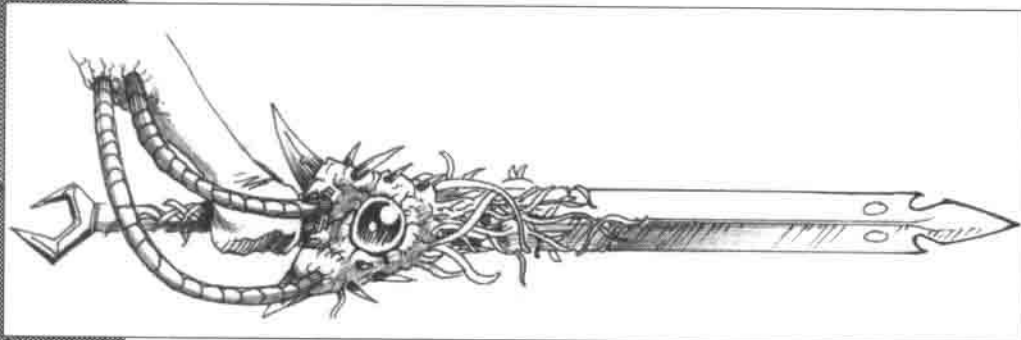
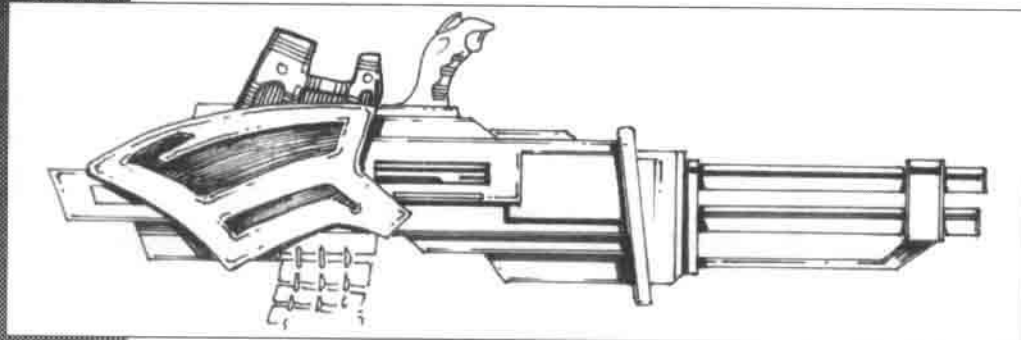

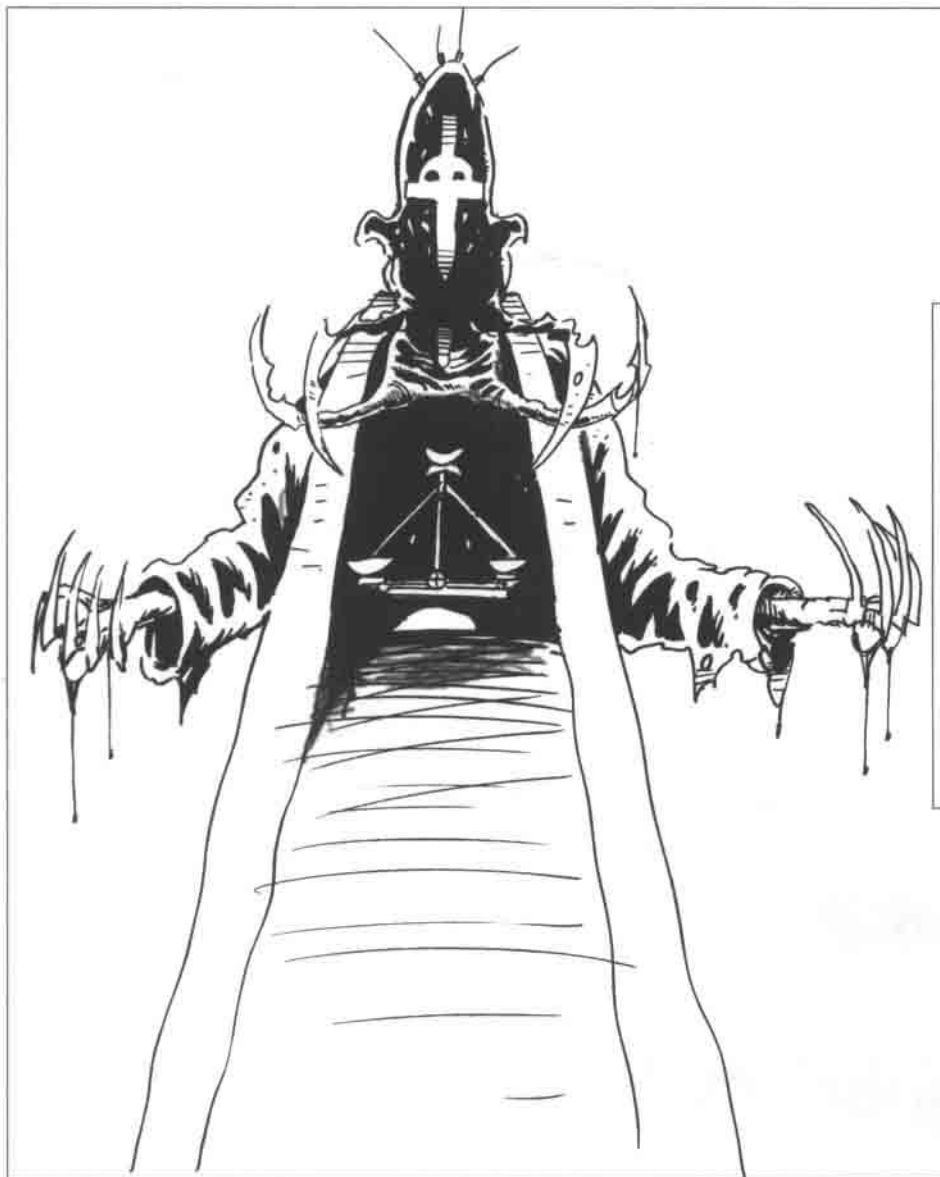

## BIOTECHNOLOGY

The basis of the BIOTECHNOLOGY is the living organism. Using embryos and living creatures, new shapes and forms are bred. From simple genetic material the biotechnology can create hideous and extremely complicated beings.

The tekron biotechnicians work with embryos that have been removed from their natural environment and placed in an artificial womb. This is a part of a larger organism, often a gigantic biotechnological design. This organism is only a tool for the tekrons, a mindless machine whose sole purpose is to create new life and to twist the shapes into new grotesque forms. Endless numbers of chambers all varying in size can be part of the gigantic bioorganism.

Inside the separate chambers the embryo is attached to the host being through a complex system of organic tubes and neural connections. The DNA-code of the embryo is erased and manipulated creating a new being ready to shape. The tekrons then reprogram the code according to the wishes of their masters. Nutriment and

proteins are added and the new life rapidly goes through several stages of development. In the end the new being is born, often fully grown and developed and ready to do battle against the enemies of Algeroth. The creature's lack of true experience is to a certain extent compensated through artificial processes added to the living brain or neural system by the tekrons. The range of the biotechnology allows the Dark Legions to create anything from small personal equipment to the Biogiants, huge living battle machines.

Biotech designs often have a tendency to meld with their owners and create a symbiotic relationship. This is one explanation to the bizarre outgrowths found on the Razides and Ezoghoul's which form part of their impressive weaponry.

The biotech designs often share bodily fluids and nervous systems with their host although they are a separate entity.

Human technology have so far found it impossible to separate a biotech design from its host without destroying both.

## NECROMUTANT

STR	10
INT	9
COR	14
PHY	15
MST	10
PER	21

MOVEMENT: 3/225

OB: +2

ACT/CR: 3

AVOID/PARRY: 6

### BP'S ARMOR (AV)

Head	3	none	1
Arm	6	light	4
Stomach	6	plate	5
Leg	7	light	4
Chest	7	plate	5

ATTACKS: melee weapon or firearm (kratach or heavier)

FIELDS OF EXPERTISE: Combat 13, Firearms 12, Communication 9, Movement 8, Technical 7

SPECIAL ABILITIES: Nightvision

DARK GIFTS: RESIST PAIN



## ALGEROTH'S HORDES

Algeroth's devotion to the art of war means that he is in constant need of new and more destructive forces. All the creatures that are found in his legions are created for combat. Algeroth himself and his faithful tekrons have created an army filled with strange and powerful beasts, many of which have been born for his service only. All are filled with an obsessive loyalty to the legions.

tekrons and utterly reshaped into beings of pure evil.

The Centurions are often placed in direct command over small groups of Legionnaire and Necromutants. They are fearsome humanoids standing over two meters tall, with swelling muscles and strong build. Their skin is grayish-green and very durable. They are often unarmored.

The Centurions are the most human-like of the Dark Legion's minions. They have thick, black hair, and human features.

### THE NEPHARITES

The Nepharites who follow Algeroth are devoted to the art of war and act as his dark generals, leading the forces in combat. They gladly participate in the wanton destruction being carried out and stalk the battlefields in their search for new victims.

The Nepharites are huge, often twice as tall as any man and clad in shining dark armor covered with sharp spikes. They carry heavy weapons, both for melee and for fire-fights. Many of their weapons systems are connected to biotechnological combat coordinators.

They always radiate calm and lead their armies with cold efficiency and command their forces with mighty battle cries.

### THE NECROMUTANTS

From the chambers of Black Technology the NECROMUTANTS march in ever growing numbers. Living captives are brought into the mechanized distortion-chambers. Through the process the structure of the victim's muscles is changed and the basic genetic code reprogrammed. The result is being with the perfect combat physique. The skin is the color of soot and their hair silvery white or black. In places the skin is treated to add protection giving it the texture of leather. The limbs are often reshaped by the Dark Technology and are adapted to accept weapons, tools and so on.

The result is a soldier with near to perfect combat abilities. The Necromutant still retains some activity in the brain and is capable of taking initiative on its own. It also retains a part of its original personality.

The small remains of human creativity in the Necromutants make them perfect commanders of small groups of Legionnaires.

### THE UNDEAD LEGIONNAIRE

In silent hordes the UNDEAD LEGIONNAIRES of Algeroth march against the light of humanity. These soldiers are zombies, humans killed in battle and reanimated with the help of the dark technology.

The Legionnaire forces are the backbone of Algeroth's Dark Legions. The bodies are stolen from the uncountable mass graves that litter the battlefields of our solar system and from ancient burial grounds on the colonized worlds. This fact gives the Legionnaire a frightening appearance. Their equipment is a mix of modern and ancient technology and their state of decay varies.

The Legionnaires have lost their souls and minds a long time ago. They are mindless slaves under the control of the Nepharites or other higher officers within the Dark Legions and have no powers to act on their own. A Legionnaire that has lost his commander will stand motionless without performing any actions until another commander regains control. It is unknown how many Legionnaires a Nepharite may control at the same time and it is unclear as to how this control works. It appears though that the commander of the Legionnaires does so with sweeping commands instead of detailed strategies.

The undead Legionnaire are grotesque parodies of the humans they once were. Their eyes are empty and dead and their faces blank. They carry equipment that has been twisted by the Dark Technology and given new bizarre functions. They are armed with edged weapons which they use to mutilate their opponents.

Undead Legionnaires that lose body parts through combat or decay have parts of their bodies replaced with

### UNDEAD LEGIONNAIRE

STR	16
INT	3
COR	11
PHY	12
MST	4
PER	4

MOVEMENT: 3/225

OB: +1

ACT/CR: 3

AVOID/PARRY: 4

BP'S ARMOR (AV)

Head 3

helmet 6

Arm 5

none 1

Stomach 5

light 3

Leg 6

light 3

Chest 7

light 3

ATTACKS: melee

weapon or

firearm (kratach)

FIELDS OF

EXPERTISE:

Combat 9, Fire-

arms 10,

Communication

3, Movement 5,

Technical 2

SPECIAL

ABILITIES:

Nightvision

DARK GIFTS:

none



### THE CENTURIONS

The most frightening example of what can be achieved through the use of the dark technology is the CENTURIONS, the captains of Algeroth's cohorts of malicious creatures. They are captives and deserters picked from the ranks of humankind, brought to the distortion-chambers of the

grotesque field cybernetics. This gives them an even more bizarre appearance.

## EZOHOUL

The gigantic EZOHOUL is a being with one sole purpose, to do battle. Its soul is devoted to the destruction of other beings and to the glory of the battlefield.

The body is carried into combat on four powerful legs and the two strong arms can easily handle heavy weaponry. Its body is merged with an external metal skeleton and half of the Ezoghoul is made of artificial materials.

It can reach a height of four meters and a length of three. It does not seem to be able to communicate verbally but transmits telepathic images. The Ezoghoul can breathe normal atmosphere only through an ILLITACHK, a biotech design covering the face of the beast.

The Ezoghoul can be found wherever a battle is fought. They seem to be attracted to combat zones and are always ready to wreak havoc. They most often cooperate with the hordes of Legionnaires but also act by themselves in smaller groups.

## RAZIDES

The RAZIDES are gigantic creatures, over three meters tall. Conceived by the dark technicians of Algoth the bodies of these monsters are made out of metal and black iron, glass and tissue, blood and muscles. Their eyes glow with a sick yellow light. Between the eyes two holes give the monster the ability to breathe. The cheeks are made completely out of unearthly alloys and furnished with sharp fangs.

The bodily fluids of the Razides flow through tubes and metal pipes and the creature is held together by a partial outer metal skeleton, covered with tissue and muscles.

The Razides are devoted to the mission of Algoth and act as enforcers of the Nephartes, leading the Legionnaires and the Necromutants to battle.

They often carry heavy support weapons, either captured from their enemies or Dark Tech supplied by the tekrons. They don't normally wear armor but will protect themselves if faced with a truly potent adversary.

## PRETORIAN STALKERS

This hideous creation was named by Imperial's Blood Berets and is considered one of their sworn enemies. The STALKER is a formidable war machine without equal in the forces of the Dark symmetry. It was created by Algoth's tekrons and shaped after the Dark Lord's visions of the ultimate front line soldier.

The body is a technological marvel propelled by motorized limbs and upheld by servo-controlled artificial organs. The stalker is a machine, the only organic part is the brain which is encapsulated in the mechanical head of the warrior. The fragile organs and the neural connections are well protected by several layers of armor. The purpose of the machine-like body is to enable the Pretorian Stalker to carry heavy support weapons such as flamers and grenade launchers or any weapon with a capacity for large scale destruction.

Even though the central part of the stalker is a biological brain they are completely devoid of feelings and basic instincts.



### EZOHOUL

STR	34
INT	15
COR	22
PHY	29
MST	16
PER	24

MOVEMENT: 6/400

OB: +5

ACT/CR: 4

AVOID/PARRY: 8

#### BP: S ARMOR (AV)

Head	4	none 4
Arm	8	none 4
Stomach	8	none 5
Leg (x4)	9	none 4
Chest	9	none 5

ATTACKS: melee  
weapon or heavy  
firearm, kick (1d6)

FIELDS OF EXPERTISE: Combat 17, Firearms 16, Communication 17, Movement 20, Technical 14

SPECIAL ABILITIES:  
Nightvision, immune to  
gases

DARK GIFTS:  
TERROR, DARK FIRE

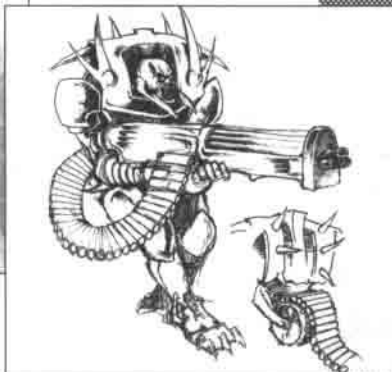





## TECHNOLOGY

The weapons used by the forces of the Dark Legion are twisted abominations created by the hideous Dark Technology or the profane necrotechnology. It is Algeroth who provides the other Apostles with many of their tools of destruction.

### KRATACH

The Kratach is what might be called the «standard weapon» of the Dark Legion, and they are seen among the legionnaire cohorts of all the apostles. They don't have any special abilities deriving from the Dark technology, but have the capability of firing many different kinds of ammunition without any modifications.

### RAZIDE

STR	45
INT	12
COR	11
PHY	31
MST	14
PER	26

MOVEMENT: 5/325

OB: +5

ACT/CR: 3

AVOID/PARRY: 5

#### BP:S ARMOR (AV)

Head	4	none 5
Arm	8	none 5
Stomach	8	none 7
Leg	9	none 5
Chest	9	none 7

ATTACKS: melee weapon or very heavy firearm

#### FIELDS OF

##### EXPERTISE:

Combat 14, Firearms 16, Communication 10, Movement 7, Technical 15

#### SPECIAL

ABILITIES: none

#### DARK GIFTS:

RESIST PAIN

W	L	MC	FUNC	RANGE	STR	RT	JF	DAM
5	70	40	A	300/450	17	1	2	1d6+1



# DEMNOGONIS

So did the Darkness turn over yet another stone and from under it slithered Demnagonis, the Befouler. Born from pain and suffering, filth and famine, plagues and diseases the Corrupted Lord shook his fists against the pure skies of the Cardinal. He cursed the air and the water and the blinding light of the Brotherhood. His was the universe of decay, filth and plague and he envisioned a time when our worlds would be twisted and corrupted from the black diseases brought forward by the Dark symmetry. And in the wake of his brethren he found a feast of corruption. As soldiers died on the battlefields the corpses lay rotting, breeding places for parasites and diseases. Foul creatures were created from the rotting flesh and tainted souls of the dead and wounded. The dark breeding pits of Demnagonis were filled with the doomed and cursed.

This was a haven for the legions of Demnagonis and so the rot was spread from battlefield to battlefield, from world to world.

And so it was that the cleansing fires began. From those days the funeral fires have burned on every battlefield, in every city where men and women draw their last breaths.

— *The Fifth Chronicle, Algeroth and Demnagonis* \ Horka Mikhailos

## THE BEFOULER

As the solar system was plunged into war, countless battles were fought on the plains and in the jungles, in the mountains and in the streets. Thousands upon thousands of lives were lost every day and the dead could only be counted in millions.

On the battlefields the vultures fed on the bloated corpses. The rotting carcasses were spread over the system and soon plague and pestilence ran rampant among our human forces. From this cesspool of death and decay DEMNOGONIS THE BEFOULER emerged.

Demnagonis is the fifth of the Apostles to have emerged from the Darkness. He has followed in his brother Algeroth's footsteps and is spreading the Black Death in his wake. His mission is to spread plague and

pestilence to the human worlds, thereby weakening the defenses and paving the way for the forces of Darkness.

The legions of Demnagonis march under tattered banners carrying with them the stench of decay and corruption.

Demnagonis himself appears as a thin, bony man whose tall body shows signs of various diseases and sicknesses. All his hair has fallen out and his eyes are misty white. The Befouler is dressed in tattered robes made of dark cloth and pieces of leather. Under the rotting clothing his body is held together by stitches and necrotechnology. Tubes are connected to each limb and pulsating organs glow from under the transparent skin.



### PRETORIAN STALKER

STR	50
INT	9
COR	14
PHY	35
MST	10
PER	27

MOVEMENT: 5/325

OB: +6

ACT/CR: 3

AVOID/PARRY: 6

#### BP'S ARMOR (AV)

Head	4	none 9
Arm	8	none 7
Stomach	8	none 7
Leg	9	none 7
Chest	9	none 7

ATTACKS: Scythe of Semai, Carcass Launcher, Hindenburger incinerator

FIELDS OF EXPERTISE: Combat 18, Firearms 18, Communication 12, Movement 19, Technical 14

SPECIAL ABILITIES: Ignores all wounds until dead. Immune to fire and gases.

DARK GIFTS: none

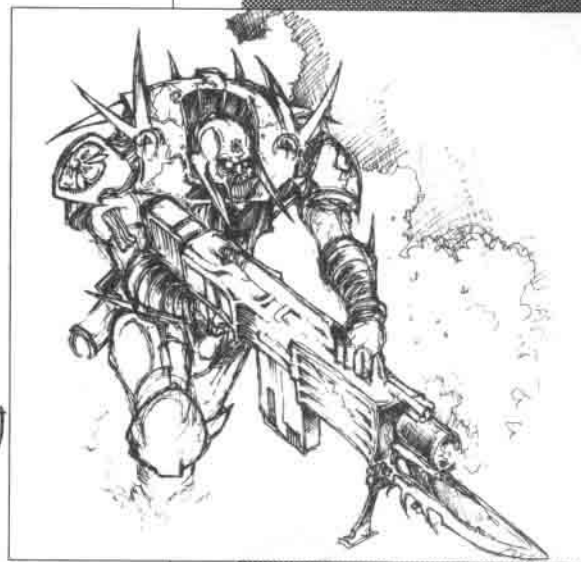
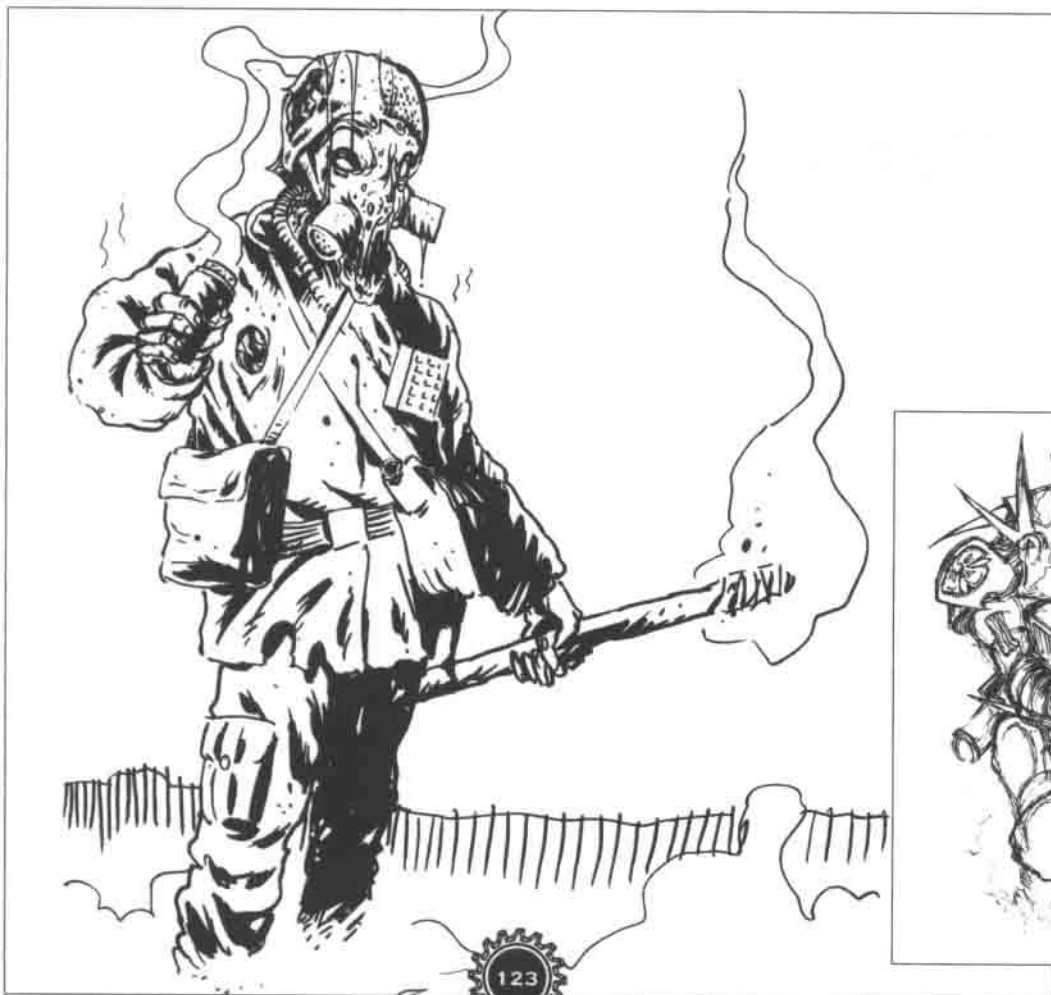

## THE LEGIONS OF DEMNOGONIS

The hordes of Demnogonis are devoted to spreading the curse of the Black Death over the solar system. Shuffling and pushing the Blessed Legionnaires swarm over the defenses of the Brotherhood, stopped only by total annihilation. These are followed by creatures from other worlds who plant the seeds of disease in our bodies, using us as vessels for death.

The forces of Demnogonis prefer helpless targets and often attack just after the legions of Algeroth have devastated the battlefield. They prevail in numbers and if they cannot win by force they will often lay siege to a city, knowing that time is working against the defenders.

### THE NEPHARITES

Leading the forces of Demnogonis are the Nepharites, the Eternal Enemies. They possess tremendous knowledge of sickness and plague and the art of administering these to other beings. They lead the Blessed to combat and soil the areas around our human society.

All Nepharites in the service of Demnogonis are

tainted by their master. Their pale, yellow skin is stitched together and limbs have been replaced by necrotechnology. Open sores ooze with pus and tubes connecting organs pulsate under the skin. The bodies show signs of sickness and rot and a terrible stench of death follows the Nepharites. Large spikes have grown from within the body, piercing the skin. From their veins worms and maggots crawl, clinging to the spikes and spilling to the ground.

The Nepharites are often dressed in white flowing capes adorned with the red runes of their master. Under this the Nepharites wear heavy armor and medical equipment designed with the aid of necrotechnology. They also carry heavy weapons, but prefer using close combat weapons endowed with dark and mysterious powers.

### CAIRATH

The CAIRATH was created in the most terrible of the birthchambers of the Dark Legions. Devised by the

### NEPHARITE OF DEMNOGONIS

STR	16
INT	21
COR	14
PHY	9
MST	31
PER	22

MOVEMENT: 3/225

OB: +1

ACT/CR: 5

AVOID/PARRY: 7

#### BP:5 ARMOR (AV)

Head	4	none	4
Arm	7	plate	8
Stomach	7	plate	10
Leg	8		
		plate	8
Chest	8		
		plate	10

ATTACKS: Gifts, melee weapons, missile weapons

#### FIELDS OF

##### EXPERTISE:

Combat 16, Firearms 12, Communication 19, Movement 8, Technical 14

#### SPECIAL

ABILITIES: The Nepharite possesses nightvision and does not feel pain.

#### DARK GIFTS:

TERROR, DARK FIRE, INVOKE PAIN, BLINDNESS, ANIMATE DEAD, DEFORM, INFECTION



Nepharites of Demnogonis it is used as a token of the Befouler's might and is given to cults all over our solar-system.

A Cairath is released into a sewer or a swamp close to human civilization when still only an embryo. The Cairath feeds on the living material around it and grows rapidly as it absorbs organic material.

This blind creature is constructed on a frame of living metal and rotting flesh. To this frame the Cairath then adds other material, both inorganic and organic. It lacks a mouth and its only sense is touch, which it uses for navigating and finding prey.

A Cairath does not devour its victim but incapacitates it and absorbs it into its own hideous body. It then draws energy from the victim which may survive several days in this symbiotic state. The process is extremely painful and the victims soon lose their senses, being reduced to screaming flesh. After the life of the victim has expired the Cairath must find new life to merge to its own body.

Cults are often given a Cairath as a reward for their services. They are then pledged to giving the ever-growing monster victims that will keep it alive. Some cultists sacrifice themselves to the Cairath to be one with their Apostle.

## CURATOR

These insane medics stalk the battlefields giving the last aid to the wounded. Dressed like a doctors' nightmare, they are equipped with all kinds of medical devices, both corrupted by necrotechnology and not.

The CURATORS are beings picked from plague worlds in another existence. They are devoted to the secrets of pain and disease and are used by the great Befouler to collect and cure the wounded from the battles in their own special way.

The beings are shaped like humans but are taller than the average man. The body is muscular and the limbs are strong and massive, often replaced by bizarre cybernetics. The skin is stitched together, sometimes replaced by leather or plastic sheets. The head is bare, without skin, showing a grinning skull often linked to various devices by pulsating tubes and electrical cables. The eyes glow with a sickly yellow light. The creatures giggle softly as they carry out their operations.

The Curators are dressed in tattered white clothes, adorned with the red runes of Demnogonis. The clothing covers the spiked armor protecting vital organs.

They carry various devices of a medical nature, often corrupted by necrotechnology. This equipment is always crude and infected with bacteria. The Curators are also hosts to several parasites carrying plague and disease which they administer to wounded patients.

These macabre doctors are mostly armed with sharp swords, infected with disease and large caliber hand-guns which they use to administer the last aid.

In spite of their nature the Curators are

skilled in the art of reviving beings and making them able to fight again. They often use necrotechnology and replace limbs and organs to once again make use of a fallen soldier.

## THE BLESSED LEGIONNAIRES

The hordes of Demnogonis are made up of the BLESSED LEGIONNAIRES, riddled with disease and plague. Like enormous swarms of flies these wretched creatures march to the mad commands of their Apostle. They never stop and can only be defeated by total destruction. By sheer numbers they wash over their enemies like a tidal wave of rotting corpses bringing filth and plague in their wake.

The Blessed are humans that have been collected from the countless battlefields in the solar system. The wounded have been brought to the pits in the citadels of Demnogonis and there been given the gift of the Dark Apostle. With twisted minds and screaming souls the blessed emerge to find their eternal peace on the battlefield.

It is the promise of eternal sleep and freedom of the crawling diseases ravaging their bodies that fills the Blessed with their frenzy and lust for combat. For in death, there is peace. Hopefully.

The Blessed are not normally armed at the beginning of a battle for the fear of rebellion. As the battle rages the blessed march over the battlefields in tattered clothes and pick up the weapons of their fallen enemies or brethren.

The greatest danger of the blessed are the diseases they carry. Even with the host dead, the plague lives and the infection can spread.



### CAIRATH

STR	32
INT	4
COR	9
PHY	24
MST	10
PER	24

MOVEMENT: 3/225

OB: +4

ACT/CR: 3

AVOID/PARRY: 3

### BP:S ARMOR (AV)

Head	10	none 4
Arm (x4)	7	none 4
Stomach	10	none 4
Leg (x4)	7	none 4
Chest	10	none 4

ATTACKS: Grapple (special), bite (2d6), bash (1d6+2)

FIELDS OF EXPERTISE: Combat 14, Firearms 0, Communication 0, Movement 4, Technical 0

### SPECIAL

#### ABILITIES:

Victims grappled by the Cairath will automatically be hit by any bite-attacks. If a victim takes more than all his remaining hits in one single bite attack, he is swallowed. He will slowly be digested inside the Cairath, and after 5 days becomes a part of it.

DARK GIFTS: none





## TECHNOLOGY

The hordes of Demnogonis use weapons designed to spread disease and to maim and to cause wounds rather than to kill, so that infections and fever can cause even more suffering and pain.

### PLAGUE GUN

The **PLAGUE GUN** is a missile weapon carried by the Sacred Defilers. It has been designed to spread disease and other infections among the enemy forces.

The plague gun is designed after normal ballistic principles with some added black technology details. The magazine is inserted into the handle of the gun and is loaded with semi-organic bullets made of a slug-like creature capable of absorbing liquids. As the magazine is inserted into the gun the bullets are drenched in a liquid infectant which is stored in a transparent glass tube in front of the trigger guard. The slugs absorb the infectant

and will upon impact transmit the disease to the target through the wound or by entering through the skin.

The plague gun is also equipped with a large hypodermic syringe which is used in close combat. Upon striking a target it injects a dose of infectant into the bloodstream of the victim, gradually incapacitating it.

The plague gun is capable of firing rapid bursts and is an extremely capable weapon.

**FOR THE GAMEMASTER:** A person taking at least one point of damage from a plague gun wound must make a Normal PHY-roll. If it fails, he will gradually turn into a Blessed Legionnaire over the course of a week. The only way of stopping this process is to cleanse him with the **ART OF EXORCISM** of the fourth magnitude.

W	L	MC	FUNC	RANGE	STR	RT	JF	DAM
3	30	30	S	20/30	12	1	3	1d6+2

### CURATOR

STR	14
INT	13
COR	17
PHY	14
MST	13
PER	12

MOVEMENT: 3/225

OB: +1

ACT/CR: 3

AVOID/PARRY: 6

BP:S ARMO

(AV)

Head	3
none	2
Arm	6
none	2
Stomach	6
none	2
Leg	7
none	2
Chest	7
none	2

**ATTACKS:** curator sword and plague gun, Gift

**FIELDS OF EXPERTISE:** Combat 8, Firearms 14, Communication 12, Movement 9, Technical 23

**SPECIAL ABILITIES:** Nightvision

**DARK GIFTS:** INVOKE PAIN, BLINDNESS, TIME ROT, DECAY, INFECTION



### CURATOR SWORD

This is the sword carried by both the Curators and the Sacred Defilers. It has earned respect among the forces of man as a weapon to be feared and the mere sight of the Curators charging with raised weapons is sometimes enough to rout human forces.

The Curator Sword has a long handle, made of metal

with a rough surface to make it easier to grip. The blade is thin but relatively broad, with one extremely sharp edge. The blade is covered in fine grooves shaped in the runes and symbols of the Dark symmetry. These grooves are filled with infectious liquids which are transferred to the victim when a hit is scored. The terrible wound caused by the Curator Sword is infected and will never heal properly, if the victim survives the fever and the pain.

**FOR THE GAMEMASTER:** A person taking at least one point of damage from a Curator Sword wound must make a Hard PHY-roll. If it fails, the wound will never heal unless being treated with an **ART OF EXORCISM** of at least the seventh magnitude.

W	L	STR	DAM (1H)	DAM (2H)
6	135	21	1d6+2	1d6+3

### BACTERIA GRENADES

These weapons are extensively used by the Sacred Defilers. A **BACTERIA GRENADE** is constructed out of a long glass tube carrying an extremely infectious bacteria culture. The tube is inserted into a metal frame and this is connected to bioorganic explosives. When detonated, the infected fragments from the glass tube and the shrapnel from the metal cause hideous wounds on the target and ensure that the bacteria enters the bloodstream of the victim. Even if no victims are present the shards retain their infection and may enter the system of creatures passing by, through the air or if touched, by entering through the skin.

**FOR THE GAMEMASTER:** Any person taking at least one point of damage from a bacteria grenade must make a Hard PHY-roll. If it fails, the victim must permanently lose 1d4 points from all basic capabilities. Further, he will lie in a coma for 1d4 weeks.

W	STR	DAM	RANGE	#TA	SR
1	13	1d6	STR squares	1d4	2

# HERETICS

The Dark Legions were a threat who knew no equal. They scoured the worlds of man and destroyed all that lay in their way. In their trail followed corruption and disease.

But not all of the Legions worked this kind of evil. Within our own Metropolises, on our own worlds, walked the Dark Prophets, the Corrupters, who spoke to the weak of mind and soul. They promised them power and glory, everything that a man wished, if only they walked the path of Darkness.

And so the ranks of Darkness swelled as the poison spread from within. The Heretics spread their corruption from world to world and the damage they caused equalled that of the Dark Legions themselves. For the Heretics dealt their blows where it was least expected and rocked the very foundations the Brotherhood had laid down.

It was these Heretics the Inquisition was dedicated to tracking down and eradicating from our worlds. But they were strong in their evil ways and long evaded the righteous light of the Cardinal.

— *The Sixth Chronicle, The Crusades and the Inquisition \ Galileo Achrostidies*

## THE TAINTED

The dark world of *Mutant Chronicles* is not only the scene of great heroics and just crusades against the evils of the Dark Legions. Intrigue and espionage are a vital part of corporate life. Untold millions have been tempted by the promises of the Dark symmetry and have been converted to its corrupt ways. They have become agents for the Dark Legions and are trying to cause the downfall of the powers of the Brotherhood and the megacorporations. It is their task to prepare the way for the final assault of the Dark Legions.

Many of the enemies that your Adventurer will

confront in his adventures have been corrupted by the Darkness and are acting for the Legions from within the shelter of humanity.

It is also possible for you play a character who has been swayed by the Dark symmetry. This variant will provide your adventures with an extra dimension as you take on the full might of the Brotherhood and the Inquisition. It is also possible for the Gamemaster to include a Heretic in an otherwise normal group to provide an extra challenge for all players.

## BECOMING A HERETIC

The power of the Dark symmetry is forever searching for strong and potent souls and minds to convert to its glorious cause. It projects visions of power and might to untold millions in the hope of planting a seed of doubt in their minds. Out of these seeds a few find nourishment and will lead the recipient onto the path of Darkness.

### THE CORRUPTORS

The envoys of the Dark Legions travel the worlds of humanity helping secret cults and Heretics. These envoys—called the Corruptors—are constantly on the lookout for possible converts to the dark cause. These converts are led to dark deeds and thoughts, and the envoy will soon confront the Heretic-to-be with the truth about his intentions.

They will through visions and dreams flesh out the mysterious and powerful forces the Heretic will gain if he devotes his soul to the cause of the Darkness. The Heretic will be confronted with the immense power of the Dark symmetry, he will see the inevitable ending of the world, and he will soon see that the only way to survive is to join the ranks of the invincible Darkness.

If the mis-guided soul tries to refuse the offer, the Corruptors will subtly try to persuade him to perform actions in line with the Dark symmetry. Sooner or later the Corruptors will claim him.

### THE INITIATION

When this happens the Heretic will undergo an initiation rite where the Well of the Dark symmetry will be opened up for him. In return for his devotion to the Dark symmetry, he will be given dark powers that will help him in his fight against the «deceiving» light of the Brotherhood. He will be given his first Dark Gift.



### BLESSED LEGIONNAIRE

STR	11
INT	3
COR	12
PHY	5
MST	10
PER	5

MOVEMENT: 3/175

OB: none

ACT/CR: 3

AVOID/PARRY: 4

#### BP: S ARMOR (AV)

Head	3	none 0
Arm	5	none 0
Stomach	5	none 0
Leg	6	none 0
Chest	6	none 0

ATTACKS: melee  
weapon or firearm,  
claws (1d6+2)

FIELDS OF EXPERTISE: Combat 8, Firearms 9, Communication 4, Movement 6, Technical 2

#### SPECIAL

ABILITIES: Any combatant who takes at least one hit from an attack from a Blessed Legionnaire must make a Normal PHY-roll. If it fails, he will catch an



## CREATING A HERETIC CHARACTER

If you want to play a Heretic character from the beginning you must have the permission of your Gamemaster. Only he can decide if a Heretic fits in his adventures.

A beginning Heretic has already been contacted by the Corruptors and undergone the initiation rite. He can choose any one Gift from the Dark symmetry (not the dark patterns) as his Dark Gift. He will also have a Tutor, created by the Gamemaster, as his contact with the Dark Legions.

As the Heretic performs dark actions and evil deeds, he will gain in power and become elevated in the ranks of the Heretics, as described below in «The Dark Gift». He will gain one additional Dark Gift per background repetition.

## BECOMING A HERETIC

A character can become a Heretic during the game as well. If you insist on playing your character in a way that is considered as evil or corrupt, and if your character insists on furthering the goals of the Dark Legions, you will sooner or later be contacted by the Corruptors. These have been attracted by your character's dark thoughts and actions and will offer him the Dark Gift.

For every action that your character performs that would give a Heretic advancement points, the Gamemaster can choose to make a note of the action. When the character has performed enough of these actions he will be approached by the Corruptors and offered the Dark Gift and initiated, as described above.

## THE DARK GIFT

In the initiation rite the new Heretic is endowed with the basic powers of the Dark symmetry and given one Gift and the title of Acolyte, the First Rank.

At the same time as the Heretic Acolyte is bestowed with his first Gift, he is given a QUEST consisting of one or more tasks. When these have been carried out, he will be presented with the second Gift (and another quest), and so it will continue.

## INCREASING IN POWER

For every quest the Heretic tackles successfully, he will gain one Rank and be given more powers and responsibility. However, he will also fall more and more under the influence of his Tutor, be more and more wanted and easily detected by the Inquisition, and it will be more difficult for him to do things out of line with the Dark symmetry.

An Acolyte (Rank 1 Heretic) that falls off the trail might get away with it, if helped from the outside, while a Rank 4 Heretic will quickly be spotted by his masters, having his soul ripped out of his body and placed in the Chambers of eternal torture.

## THE QUESTS

The quests given should become more difficult, more questionable and more hazardous. Every time the character has succeeded with one, he must in some way return to his tutor. There he will be given another Gift, another Rank and another quest. Also, his MST will

increase by +1d6.

As long as this goes on, the Heretic will slowly grow in power. He should also be awarded hero points just as any other character.

## CHOOSING GIFTS

Every time the Heretic chooses a Gift, he may freely choose one of the ten available to him (the five from the Dark symmetry and the five of his Dark Pattern).

When a Heretic reaches the rank of 10 he is again approached by the Corruptors and offered to join their ranks. This is a proof of his services to the Dark symmetry.

At Rank 10, he will also be given two new powers: first, the power of handing Gifts to other people; and second, he is able to receive Gifts from the other patterns:

The Ranks and their titles are:

- |    |                        |
|----|------------------------|
| 1  | Acolyte                |
| 2  | Adept                  |
| 3  | Apprentice             |
| 4  | Novice                 |
| 5  | Postulant              |
| 6  | Symmetrician           |
| 7  | Weaver                 |
| 8  | Master Heretic         |
| 9  | Lord Heretic           |
| 10 | Corruptor and/or Tutor |

## THE LIGHT OF THE INQUISITION

The Dark Powers of the Heretics do not go without notice from the Inquisition. Each time a Heretic is elevated in rank or uses his Dark Powers, the Gamemaster rolls a d20. If the result is LOWER THAN the Heretic's Rank, the Inquisitors will have had a prophetic vision of the Heretic and his deeds. One or more Inquisitors will from now on devote their time to tracking down the Heretic and cleanse him from the evil of the Dark symmetry. The result of the roll should be kept secret to the player playing the Heretic, as well as to any other players.

The Inquisitors also have the ability to sense the presence of the Dark symmetry when they are close to it. If an Inquisitor is within 50 meters of a Heretic, the Gamemaster should roll a d20. If the result is LOWER THAN the rank of the Heretic, the Inquisitor will sense the presence of the Dark symmetry.

He is unable to pinpoint where the Dark symmetry comes from but will certainly use his authority to seal the area off and perform a trial to find out.



# WHAT IS A RPG?

Slowly, we slipped further down the alley. The only illumination came from the garbage-can fires at the far end of the street, giving the entire scene a surreal air of filth and poverty, occasionally coming real in the flickering fires. A few street bums had gathered round the warming flames, shoeless and clad in rags, they were no threat to us and certainly not connected to the Frazetti brothers. It was dead silent.

There were three of us, Martin, the arms-dealer and former commando; Bentoni, unemployed, disillusioned ex-combat pilot, and me, sergeant Michael McBride. Just out after a four year prison sentence, I was as eager as ever to nail those Frazetti clowns who put me behind bars and ruined my military career. This was my mission, my revenge, my way to pay back and put an end to the Frazetti regime of terror and extortion in the Palo District, my old neighborhood.

An almost-invisible nod from Martin signaled that we weren't alone<sup>1</sup>. «Guys, wait...» I stopped, lit a cigarette and took the opportunity to glance around, noticing four guys back at the entrance of the alley. I couldn't see their faces because of those wide-brimmed hats, but they wore long trenches, ideal for concealing SMG's or even assault rifles. They had stopped and were now nervously looking our way, two of them obviously conferring<sup>2</sup>. We were completely trapped if they attacked us now, unless...

«Ambush!!!» Martin's large hand landed on my shoulder and almost scared the hell out of me. I was literally thrown into a doorway just tenths of a second before a slug from a 10 gauge shotgun, tore at my footsteps<sup>3</sup>. «I'm sorry Mike, I knew all about it all the time, I should have warned you earlier, but I...» Martin was actually whimpering.

«Shut up, let's get outta here!» I snapped, crouching and carefully peering out of the doorway. I would have throttled him then and there, but I figured he had a real good story. No sign of the four guys, they must have taken cover as well. I signed towards Bentoni, kneeling behind a pile of scrap wood and sheet metal, to cover me. I counted down three and threw myself out and sprinted towards the alley entrance, careful to stay close to the wall out and of Bentoni's line of fire.

His heavy CAR-24 sub-machinegun rattled behind me a few moments as I threw myself into another doorway, closer to our opponents<sup>4</sup>. The sound of a heavy shotgun blasted through the sharper sound of the sub-machinegun, and I spun around in the same moment as I pulled out my Bolter handgun<sup>5</sup>. A shadow leaned out from a window above Martin's doorway, a clearly visible silhouette against the darkening sky. It was obviously the guy who had tried to kill me just seconds ago. I placed my red-point laser-sight on him and fired<sup>6</sup>. The silhouette tumbled out of the window and fell to the concrete. If the shot didn't kill him, the fall definitely had<sup>7</sup>.

«Mike, get down!» Martin shouted as he leaned out of the doorway with the pin of a grenade clenched between his teeth. In one motion, he pulled the catch and let the grenade fly in a high arch above my head, landing some five meters short of the alley entrance, rolling and bouncing another few meters to explode in an inferno of shrapnel and burning phosphorus<sup>8</sup>. Instinctively, I put my arm up to block the blinding explosion<sup>9</sup>. A growl from behind told me Bentoni hadn't been as lucky, I couldn't count on him for a minute or two, but I wouldn't have to fear the men in the alley. With a steady grip around my handgun, I stood and walked slowly towards the alley entrance, prepared to fire at anything that moved.

A couple of meters from the entrance I stopped, slowly peeking out into the main street. Two massacred bodies to the right were half a pound heavier with titanium shrapnel. To the left, sounds of heavy footsteps and dark-red pools on the ground indicated that the remaining couple had fled, probably to a waiting car or a hide-out nearby. A flapping sound and a circle of intense light came closer from down the street. «This is Capitol Citizen Security Division. Lay down your arms and put your hands behind your head, or we will shoot to kill...» I turned and ran, ran as fast as I could away from the chopper. Hopefully, they would spot and follow the two snipers, otherwise my chances would be slim<sup>10</sup>. As for Martin, they could have him. Obviously, he was an informer for Frazetti, and as for Bentoni, I didn't worry. He had gotten out of far worse situations before. I threw off my leather jacket, left it in the street, and ran on towards safety.

I spat out the cigarette on the sidewalk and heard it hiss in a puddle of old rain. They wouldn't bust me again, never...



## FOOTNOTES

**1.** The GM makes a hidden Perception skill roll to see if any of the characters notice the four men behind them. It succeeds, so the GM tells Martin what showed up and his player decides to inform the others with a nod.

**2.** Again, the GM makes a hidden Perception skill roll to see how well McBride perceives the situation. He rolls a «2», which is very good, so the GM decides to give McBride's player a clear hint that the men are hostile.

**3.** Martin's player suddenly decides to help McBride and tells the GM that he immediately throws himself and McBride into the doorway, taking cover. The GM rolls the dice symbolically and decides that they are successful. In this way, he encourages Martin's gesture; if he hadn't acted, McBride would probably be dead by now.

**4.** McBride's player makes a Coordination roll to see if the charge is successful. Bentoni's player makes an attack roll for an area spray-attack with his automatic weapon, but it fails and no one is hit.

**5.** The GM decides that this is such a routine action that it doesn't require a skill roll, but McBride loses one action. The man with the shotgun, firing with a penalty due to the insufficient light in the alley, misses Bentoni with a hair's breadth.







6. McBride's player makes a single shot attack-roll, but now without the insufficient light penalty, due to the light background. He hits, and since the man in the window has already made his actions for the round he has no chance to avoid the shot. The bullet hits the man's shoulder and makes him lose his balance.

7. Another roll, and the GM decides that the man falls out of the window, a fall of four meters. And indeed, the fall does at least render him unconscious; the GM rolls  $1d6+1$  twice, and both times the damage is taken in the chest, in all 12 points of damage.

8. Martin spends only one action taking out the grenade, arming and throwing it, which gives him  $-5$  on the attack roll. The roll fails, and GM rolls  $1d10$  ( $=7$ ) to randomly determine where the grenade lands; one square short and left of the intended target. Another roll; the grenade bounces forward 1 square ( $=5$  feet) and explodes right on target anyway!

9. McBride makes a Perception roll to see if he gets

## WHAT IS A ROLEPLAYING GAME?

The world of *Mutant Chronicles* is a world of adventures, a world of possibilities, a world of struggle and a world of heroism. In this game, you control the actions of a fictional character through a series of events. For example, you and your two friends could have been McBride, Bentoni and Martin in the scene described above.

Imagine you're an actor about to play in an action-movie taking place somewhere in the solar system in a distant future. The world—well, the world is described quite closely in this book. However, there's no script to the movie, there's no beginning, story or end, and you don't know what your movie character looks like, what he's called or what he's like. Yet.

This section will explain the role of the GAME MASTER (director, producer and writer), how he creates an adventure (script) and how he gets things going.

The following section explains how you create your CHARACTER, your adventurer, and the last sections cover how to resolve the different situations that come up in the game. Will you make the shot, will you manage to convince the police officer, will you crack the secret computer access code, will you be able to repair the broken chopper, will you withstand the poison of the sewer-rats? The combat rules are the most detailed, since these situations are the most dangerous and exciting.

### THE GAME MASTER

One of you must be the GAME MASTER (henceforth called GM), the referee, story-teller, opponent and designer, all in one person. In short, the GM decides (aided by the rules and the dice) what happens in the adventures. If one of the adventurers says «I take the right corridor!», the GM says «OK, this is what happens:», and then he tells the player what happens, either he makes it up himself, or he describes what is written in a pre-constructed adventure.

And so it continues. Whenever there's a conflict, the GM checks the rules, the players make die-rolls to see how well they manage to do something, the GM describes what their opponents (non-player characters) do and makes all their dice-rolls. The whole idea is to have an exciting and heroic game where everyone has fun, the idea is not to try to kill or defeat the others. The goal is to work together as a team.

### THE NPCs

The NON-PLAYER CHARACTERS, NPCs, are the minor actors and extras in the adventure. They are controlled by the GM, who must decide exactly who they are, and what they do. The GM makes all their die rolls. He must decide how well he should define and flesh out the NPCs, the more important ones should be fairly well described, while it could be enough just to supply combat statistics for more simple adversaries, like street gangs and police officers.

### THE PLAYER CHARACTERS

Your CHARACTER will be your alter ego in the game. What he's like is pretty much up to you, so try to get a clear idea of how you would like him and what role you would like to play, before you start the dice-rolling. Do you want to be the tough former commando, the disillusioned ex-pilot, the stinking rich ex-stockbroker, or maybe the brilliant scientist who deserted and became an illegal arms-manufacturer? The character is ultimately under your control but has limitations which are given in the rules.

The characters in the game are defined by a set of numbers. These numbers describe the basic attributes of the character, such as strength, intelligence and physique, and what skills he has, for example how adept he is at using a sub-machine-gun, driving a car or programming a computer.

### NECESSARY EQUIPMENT

Apart from this rules-book, there are a few things you'll need to get the most out of your game. Most important are the dice, available in most hobby stores. This game uses four-sided, six-sided, ten-sided and twenty-sided dice.

The character sheets are also very helpful to record all information you need about your character, from his skills to his equipment and notes on people he has met. Use a pencil when writing on the character sheets, since much of the information is changed frequently throughout the game. You may photo-copy them for personal use.

In combat, it is necessary to have some floorplans (squared, using 20 x 20 mm squares) and some sort of playing pieces, most gamers use metal miniatures (available through most hobby stores).

Also, you will need an adventure, either one that your GM has designed himself, or a pre-constructed official *Mutant Chronicles* adventure. These can be found where you bought this book.

### DICE

In the rules you will often be asked to roll one or more dice. This is indicated by a number and letter combination.

The first number indicates the number of dice to be rolled and the second which type. Separating these numbers is the letter «d» which stands for «die». When rolling several dice add the results together to come up with the total. Any modifications to the roll are given after the combination and are added or subtracted from the sum total.

*Example: 3d6 means that you roll the six-sided die three times and add the results. 2d10+2 means that you roll the ten-sided die twice, add the results, and then add two to the sum.*

1d2 would stand for a «two-sided» die, but since there is no such die, roll a d6 instead. If the result is 1, 2 or 3, read it as «1»—if the result is 4, 5 or 6, read it as «2».

Similarly, the six-sided dice is used when a d3 is required. A result of 1 or 2 is read as «1», a result of 3 or 4 is read as «2», and if you roll 5 or 6 this means «3».



## GAMING EXAMPLE

«Well, my friends, it's all settled then, eh? Just a last second of your time... As you can see, this whole operation is quite a delicate matter, I take it you'll handle it with the utmost discretion...» The fat man leaned back in the leather armchair, crossed his fat arms above the fat chest and wrinkled his fat forehead. «And if you mess it up, I have never seen you... and the other way around, I hope, eh» A fat man's childish giggle popped out of his throat, the loose skin wobbling below his chin when his fat face split in a massive smile.

It was Martin's idea to be here. His version was, afterwards, of course, that he'd had no idea of what it was all about: «C'mon, guys, it's just some sort of routine business, you know, making a delivery downtown. I promised him we could take care of it... We really do owe him this one...» Reluctantly we had agreed to meet this «Fat Freddie», the boss of the Imperial-connected branch of the Frazetti empire. In one way, I just had to meet him to learn more about the Frazettis, but on the other hand, it might just as well be another set-up... But I decided to trust Martin this time. After all, Imperial was his turf, and I was as lost as a tracer-bullet in a lava-stream in these quarters.

Fat Freddie lived up to his name. He was huge, could barely move or even speak properly, since his cheeks weighed down on his lower jaw so much. He spoke extremely slowly, articulating every word meticulously, smacking and snorting all the while. It looked as if he had been poured down into his armchair. I instinctively hated him.

Anyway, the deal was simple and lucrative: go to the corner of Gorden and MacGuire, meet with a Frazetti courier, give him a parcel and get a briefcase, and return here. And for this, we'd get 5 big ones? Each? It was all so simple the whole thing just screamed «WARNING! SET-UP!», but, what the heck, if we were just careful enough... I almost hoped they would try to pull a trick on us; that would give me a fair reason to perforate the disgusting fat-blob in front of me.

«Certainly, sir, we have a deal and you won't be disappointed...», I managed to say, even though my thoughts mainly circled around if this meant I would have to shake hands with him. «Splendid, McBride, that's my man! Take the details with Johnstone and we'll meet here tomorrow...» He made no sign of rising, so I just nodded, relieved, made a perfect military about face, sweeping my long cloak around as strikingly as possible, and marched towards the door, my steel heels echoing against the marble floor. It was my experience from eight

years of service that nothing impressed fat majors and colonels as much as determination and efficiency. From that point of view, Fat Freddie could have been a field marshal.

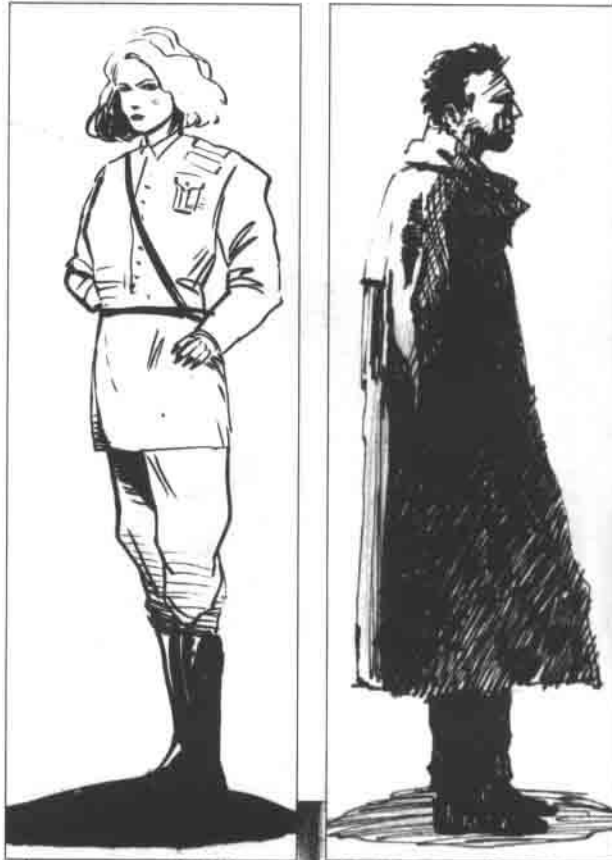

the message and acts quickly enough. Had Martin waited another action with the throw, this would have been unnecessary.

10. The GM decides that there is a fifty-fifty chance that the officers will spot the crooks before they spot McBride. He makes a roll, and tells McBride's player that the flapping sound seems more and more distant...

## DESIGNING ADVENTURES

The most difficult thing for an inexperienced GM is to design his first adventure. However, it is not that hard. Above is an example of how a typical adventure can begin: the characters get a mission or a task from someone, in this case Fat Freddie, and when they're

finished, they are to get some kind of reward, in this case 5,000 CCs. Let's assume that Mike plays McBride, Martin plays Martin and Stephen plays Bentoni in the scene above. It would probably have sounded something like this during the gaming session:



## WHAT REALLY HAPPENED...

*GM [speaking with a British accent, slowly and very carefully but with a slight lisp, imitating Fat Freddie]:* «Well, my friendh, it' th all thettled then, eh?»

*Mike [to Martin and Stephen]:* «What do you think, guys?»

*GM [pitched voice]:* «Jutht a latht thecond of your time... Ath you can thee, thith whole operation ith quite a delicate matter, I take it you will handle it with the utmotht dithcretion...»



*Martin [to Mike and Stephen]:* «I say we go for it.»

*Stephen:* «Sure.»

*Mike [to GM]:* «You say he was how fat...?»

*GM:* «Unimaginably. I mean, the guy would crush Jabba the Hut.»

*Mike [to Stephen and Martin]:* «C'mon, we know something is very fishy around here, what do you say, we rush into it anyway...?»

*Martin:* «Definitely. I'm trigger-happy. And remember, four thousand...»

*Stephen:* «I want five.»

*Mike [to GM/Fat Freddie, imitating McBride]:* «OK, sir, we'll do it for five grand. We have some expenses...»

*GM [as Fat Freddie and Johnstone, his aide]:* «What do you thay, Johnthtone, should we give them five?—Alright with me, sir.—Very well, then, let uth thay five thouthand, if that thuitth you better.»

*Mike [to GM/Fat Freddie]:* «Certainly, sir, we have a deal and you won't be disappointed. [to the GM] Euuh, do I have to shake his hand now...»

*GM:* «Thplendid, McBride, that' th my man! Take the detailth with Johnthtone and we'll meet here tomorrow... No, Mike, he doesn't seem too excited about touching you either, he just sits there... Not that he's physically able to move, but...»

*Mike:* «OK, I walk out of the room as quick as I can. No, wait, I command myself to attention, make an about turn, and march out of the room.»

*Martin:* «I do the same, walking at arm's length behind him.»

*Stephen:* «Are you guys for real? [to GM] I just follow them as pathetically as I can...»

*GM [making a reaction roll secretly]:* «Well, Johnstone also rises to strict attention, obviously by instinct, but Jabba doesn't look too impressed.»

*Stephen:* «Hey, maybe that's why he's familiar! Maybe we met at the flight academy!?»

*GM [muttering]:* «Well, maybe...»

*Stephen:* «C'mon, did I? I should remember that, right? It's just six years ago. I have INT sixteen.»

*GM:* «OK, make an INT-roll. Normal.»

*Stephen:* «OK, I have intelligence sixteen... [rolls a d20] Five! Made it...»

*GM:* «Right, you suddenly remember he was in the class above you, but he was flunked and demoted for leaking classified information to Bauhaus agents.»

*Mike:* «I wonder if Jabba knows that...?»

## ...AND WHAT HAPPENED NEXT...

In this way, the GM can use the characters' background to weave in information and hints. The players may soon realize that Johnstone is an under-cover agent for Bauhaus, currently employed by an Imperial-allied mafioso...

The plot thickens, especially when the players get to the rendezvous with the Frazetti agent. The GM's plan (the adventure plot) is to throw in a Bauhaus assault team to attack the players and try to steal the parcel. The assault team fails in getting the parcel, but kills the Frazetti agent and takes his briefcase, which is stuffed with money. They disappear in an armored car, but after just a few seconds it explodes. Obviously, the players' money was quite explosive...

If the players do some research and maybe interrogation they'll find that the parcel contains blueprints of a secret fantastic gadget that Bauhaus scientists have invented (however, it takes an expert to see what it is). They were stolen from the Bauhaus research lab by Fat Freddie's gorillas, and Johnstone, of course, told the Bauhaus management all about it.

The players are probably upset with Johnstone who set the trap, with the Bauhaus guys who almost killed them, with Fat Freddie since they can forget the five thousand, and with Frazetti, who tried to blow them into orbit. They still have the blueprints, though.

On the other hand, Bauhaus wants the players (and the blueprints), Fat Freddie wants them (he had promised Frazetti the blueprints), Frazetti wants them (so that he can sell the blueprints back to Bauhaus), Johnstone wants them (since he is a Bauhaus-guy) and Imperial wants them (and the blueprints, which Fat Freddie has told them about).

Good luck, there's your storyline... Only the characters' actions can decide what really happens in the future, the GM's work is to develop stats for the NPCs (Johnstone, the Bauhaus assault team, the Imperial agents, Frazetti, etc.), invent the fantastic gadget that everyone wants, draw maps of the combat scenes, and try to make up a logical and believable conclusion that makes everyone happy.

# THE CHARACTER

The character is your hero, your adventurer in the world of *Mutant Chronicles*. Physically, he is just a set of values on a sheet of paper, but in the game he is much more. Below is described how you calculate the figures that help you use your character in the game.

You will need a character sheet, pencil and eraser and the dice. Some scrap paper might also come in handy.

In short, the procedure for generating your character goes like this:

- Determine your Basic capabilities
- Determine your initial Social standing
- Develop your Adolescence skills
- Choose a Background and go through the «Background loop» as many times as you wish. Apply any aging effects as soon as they occur.
- Determine your Combat statistics
- Buy equipment, fill out the Personality form, and enter the adventure!

## BASIC CAPABILITIES

The Basic capabilities are the most important of your character's values. One of their most important functions is that they are used to calculate your Combat statistics. Because the basic capabilities will change a lot during the character generation process, it is best to wait on the Combat statistics until you begin the adventure.

The basic capabilities range from 1 to 20, where low is bad and high is good. They are:

**STRENGTH (STR).** Your physical strength and your ability to use it properly in different situations. It is essential in hand-to-hand combat and also restricts which firearms you may use.

with a low intelligence. With a low value here, you'd better have a high PER-value instead.

**MENTAL STRENGTH (MST).** Will-power, determination, resiliency to shock, pain and things mystical. This capability is mainly used for determining your damage capacity and how fast you can act in combat situations. It is also essential when you face the terrors of the Dark Legion—a low value will undoubtedly result in a panicky character.

**PERSONALITY (PER).** Charisma, charm, outward appearance. The higher the value, the cooler you are.

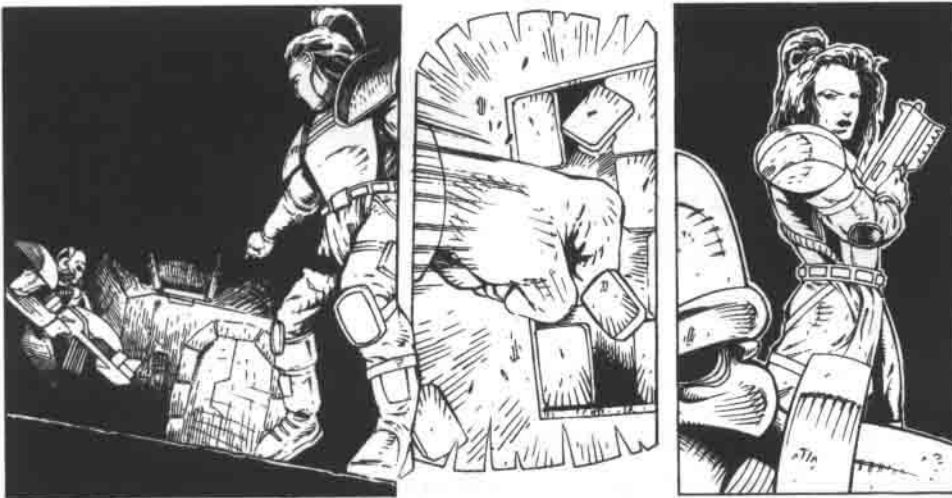

**PHYSIQUE (PHY).** Your physical status in terms of endurance, shock and pain resiliency and immune defense. It is mainly used to determine how much damage you can take.

**COORDINATION (COR).** Deftness, speed, agility, coordination, etc. COR determines your accuracy when using missile weapons, how fast you can act in combat, and your defensive capabilities. If you want to be a good fighter a high COR-value is essential.

**INTELLIGENCE (INT).** Reasoning, memory, perception, the ability to learn. An important capability for all characters, since you won't be able to acquire any skills

With a low value, you won't be able to impress anyone, meaning you can't get an occupation, meaning you won't learn anything. This is the capability that varies most during the game.

## DETERMINE THE BASIC CAPABILITIES

Roll 3d6 eight times, remove the two lowest values, and distribute the remaining six among the basic capabilities. You may transfer points from one basic capability to another on a two to one-basis, i. e. reducing one basic capability by two, or two by one, allows you to raise another basic capability by one.





## SOCIAL STANDING

Your social standing primarily decides how much money and what possessions you have when the game begins. A result of (1) would mean you've been raised on the street, while a result of (0) (=10) would mean your parents are top officials of a major corporation.

Roll 1d10 to determine your social standing. It will be modified several times during the character generation process, and it is only the final result that counts (i. e. even if you have a very high income during some of your background years, you can't save anything for later).

**RAISING YOUR SOCIAL STANDING.** However hard, it is possible to break with the past and try to raise your social standing. By spending one point EACH of PER and PHY, you may raise your social standing by one, up to a maximum of 8. If your initial social standing was 8 or more, you may not raise it. Raising social standing may only be done before you continue with the rest of the character generation.

## SKILLS

There are 32 skills described in this game, listed under «Fields of Expertise». How proficient you are in a skill is described by a SKILL VALUE (SV), which most of the time ranges from 1 (worthless) to 20 (a real master).

You improve your proficiency in the skills by making

**SKILL PICKS.** Every time you make a pick, the SV in that skill is raised, as indicated in the skill pick boxes on the character sheet. For the first pick, the SV is increased by +3, for the second, it is increased with an additional +2 (a total of +5), etc.

## ADOLESCENCE SKILLS

Your **ADOLESCENCE SKILLS** reflect what you have learned before you get yourself a job, everything you learn until the age of 16. It consists of a Base Skill Value, elementary education skill picks and three rolls on the Adolescence events table.

### BASE SKILL VALUE (B-SV)

Your **BASE SKILL VALUE** depends on the value of the basic capability connected with the skill, and you get one in all skills. This B-SV is never changed during the game, even if the Basic capability should change. For the Special skills, the B-SV is derived from the Combat statistics, which are calculated later on.

#### BASE SKILL VALUE TABLE

Basic Capability Value	Base Skill Value
1-5	2
6-9	3
10-14	4
15-16	5
17+	6

### ELEMENTARY EDUCATION

You may make a number of skill picks depending on your INT. Also, you **MUST** make 3 rolls on the «Adolescence events table». These events come in chronological order. Reroll if a result marked with (♦) comes up twice.

#### ELEMENTARY EDUCATION TABLE

INT	# of skill picks from start
1-5	4
6-9	5
10-14	6
15-16	7
17+	8

Right now, you are 16 years of age and ready to go adventuring in the world of *Mutant Chronicles*. However, you are young and inexperienced and unless you have very high basic capabilities you won't last very long out on the street. Therefore, you'd better get a job before you go adventuring.

## AGING EFFECTS

The effects of age are critical in the world of *Mutant Chronicles*, where the average life-span is about 40 years due to the hostile environment. When you reach the age on line 1 (27, 33, 39, etc.), apply the modifications in the column to your basic capabilities. For example, a 38-year old character becoming 39 would have to lower STR, PHY and COR by one and raise his MST and PER by one.

All effects of aging are applied immediately and the combat statistics are recalculated.

#### AGING EFFECTS TABLE

	27	33	39	45*	51*
STR	±0	-1	-1	-1	-1
PHY	-1	-1	-1	-2	-4
COR	±0	-1	-1	-1	-1
INT	+1	+1	±0	±0	-2
MST	±0	±0	+1	+1	+1
PER	±0	+1	+1	±0	-4

\*: Roll a d20 every year; if it is higher than your PHY value, you die from old age. If any of your basic capabilities reach «0», you die anyway.

## BACKGROUNDS

Your **BACKGROUND DEVELOPMENT** will provide your character with his initial skills. You will spend a number of two-year periods either working in one of eight occupation categories (referred to as «BACKGROUNDS» below), or as unemployed. From the Special events rolls you will also learn much about your character's background.

### PROCEDURE

- 1 Choose one of the backgrounds below. Most of them have requirements that will have to be met before being considered for employment (the requirements only have to be fulfilled at the day of employment).
- 2 Roll a d20. If it is lower than or equal to EITHER your INT OR your PER, you get the job and continue with step (3), otherwise, see «Unemployment» below.
- 3 Make your **SKILL PICKS**. Adjust PER and roll for Social standing modification. Make two rolls on the «Special events table»(reroll if a result marked with «•» comes up twice). Add +2 to Age and apply any Aging effects.
- 4 Roll a d20. If it is HIGHER than BOTH your PER AND your INT, you're sacked and must choose a new background (return to step (1); a roll of (20) always means the sack). If it is LOWER THAN OR EQUAL TO EITHER PER OR INT, you have THE OPTION to sign up for another two years (go to step (3)), but you can also opt to try to get a new background (return to step (1)).
- 5 Continue steps 3 and 4 until sacked or broke. After this, try to get a new background (go to step (1)) or go adventuring.

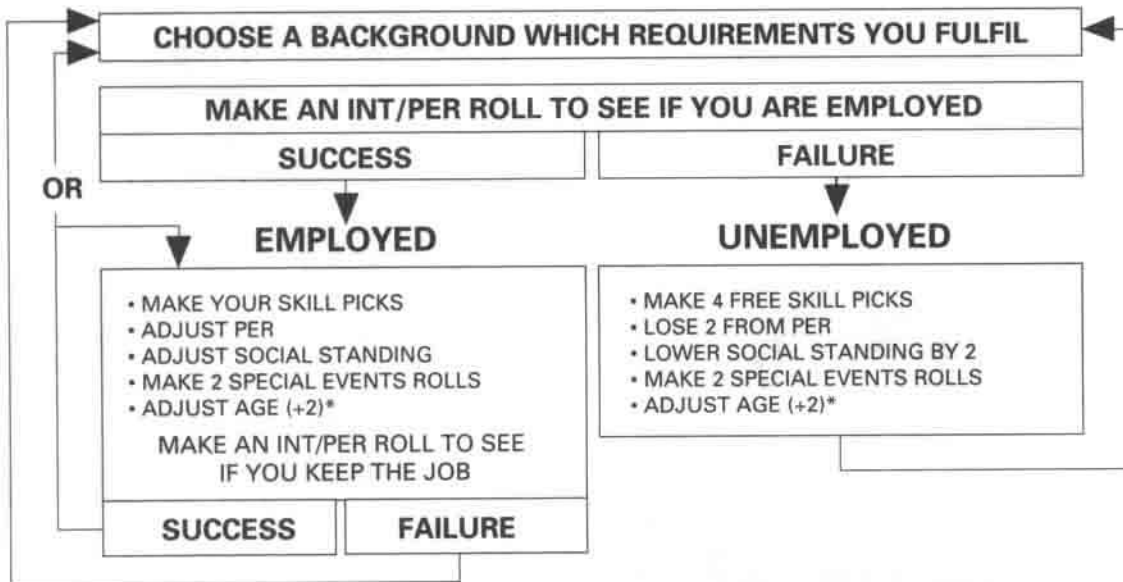

\* = AFTER YOU HAVE ADJUSTED YOUR AGE AND APPLIED AGING EFFECTS YOU HAVE THE OPTION TO QUIT AND GO ADVENTURING. IF YOUR SOCIAL STANDING IS «0» YOU MUST CHOOSE THIS OPTION.

### UNEMPLOYMENT

For each period of unemployment (always two years at a time), make four free skill picks. Lose 2 from PER and lower your Social standing by 2. Make two Special

events rolls. Adjust Age (+2) and apply any Aging effects. Now, two years have passed and you may return to step «1» or start your career as an adventurer.

## BACKGROUND DESCRIPTIONS

**REQUIREMENTS:** Means the requirements you have to meet for the occupation. The requirements only have to be fulfilled at the day of employment. Social standing «1» is a requirement for ALL backgrounds.

**FIELDS OF EXPERTISE:** The figure after each field of expertise tells how many skill picks you may make from the field of expertise after each period of service. The «Free» picks may be made from any field of

expertise, including the Special skills.

**SOCIAL STANDING:** Roll the die combination. If the result is HIGHER than your current social standing, it is raised by 1. If the result is LOWER than your current social standing, it is lowered by 1. If you roll EQUAL to your current social standing, it is not changed.

**PER-MODIFICATION:** This modifier is applied to your PER-value every time you make your picks.



### OTHER BACKGROUND OPTIONS

Apart from the eight backgrounds described here, there are three additional backgrounds to consider—the Inquisitor, the Mystic and the Doomtrooper.

The Brotherhood backgrounds—the Inquisitor and the Mystic—require life-long practice and the character generation procedure is different from the one described here. If you want to choose any of these backgrounds, which is only recommended for players who have played a couple of times, go DIRECTLY to the chapter «the Brotherhood» when you have rolled your Basic capabilities and developed your Base Skill Values (don't roll Social standing).

The Doomtrooper background doesn't differ from the ones described in this chapter, but have such high requirements that you have to spend some years in another background, preferably the «Military/Law enforcement» or the «Security/Investigation» background.



## MILITARY/LAW ENFORCEMENT

You work as a soldier, security guard, law enforcer or internal investigation agent, probably within the security detachment of a larger freelance corporation. It is doubtful that you will see any real action, but your basic training and tasks will involve firearms and combat.

**REQUIREMENTS:** *Grunt:* STR 9, COR 9, PHY 9; *Officer:* Max 25 years. Military academy

	Grunt	Officer
Combat:	1	1
Firearms:	2	2
Communication:	—	1
Movement:	1	1
Technical:	1	1
Free:	1	2
Social standing	2d4	2d6
PER-modification	+2	+1

### RANKS

If you choose the «Military/Law Enforcement» background, you will eventually get a rank. Everytime you are «re-employed» (i. e. succeed with the INT/PER-roll to keep the job), you will gain one rank in the table below. Before the slash are given examples of military titles, after the slash «civilian» (law enforcement) titles:

#### Roll Grunt Rank

- 1 Private/Patrolman
- 2 Private 1st class/Senior Patrolman
- 3 Corporal/Patrol Commander
- 4 Sergeant/Commanding Supervisor
- 5 Staff Sergeant/Sergeant
- 6 Sergeant Gunnery/Senior Sergeant
- 7 Sergeant 1st Class/Acting Supervisor
- 8 Sergeant Major/Acting Supervisor

#### Roll Officer Rank

- 1 Cadet/Trainee
- 2 Cadet Officer/Lieutenant Cadet
- 3 Second Lieutenant/Junior Lieutenant
- 4 First Lieutenant/Lieutenant
- 5 Captain/Captain
- 6 Commander/Chief
- 7 Major/Commissar
- 8 Commodore/Commissioner
- 9 Colonel/Chief Commissioner
- 10 General/Superior Commissioner

The exact title varies from one employer to the other, but these are



### MEDIA

The Media-background covers reporters, journalists, camera-men in the field, free-lancing muckrakers, paparazzi, etc. You are either employed on a FREE-LANCING basis or have a steady job as a REPORTER. The employer is a smaller freelance media company and your basic training and experiences are focused on collecting information and dealing with people on all levels of society.

**REQUIREMENTS:** *Freelancer:* Max 25 years. PER 13; *Reporter:* Max 25 years. Media College

	Freelancer	Reporter
Combat:	—	—
Firearms:	—	—
Communications:	2	4
Movement:	1	1
Technical:	—	1
Free:	3	2
Social standing	1d10	2d6
PER-modification	±0	±0

## SCIENCE/CONSTRUCTION

You are employed by a smaller freelance corporation as an engineer, mechanic or scientist. Your experiences and education are mainly within the technical field of expertise. However, the sterile and isolated environment in the labs makes you lose contact with reality somewhat.

**REQUIREMENTS:** *Mechanic:* Max 25 years. INT 13;  
*Scientist:* Max 25 years. Technical university

	Mech	Scientist
Combat:	—	—
Firearms:	—	—
Communications:	1	2
Movement:	—	—
Technical:	3	4
Free:	2	2
Social standing	2d4	2d10
PER-modification	-1	-2



## STAFF SERGEANT MICHAEL MCBRIDE

Below is described the complete generation of the player character belonging to Mike. In the beginning, he only knows he would prefer a military type of character, skilled primarily in fighting and moving maneuvers.

### BASIC CAPABILITIES

First, he rolls 3d6 eight times, resulting in the following results: 14, 10, 6, 15, 12, 9, 13 and 17. He removes the two lowest values, (6) and (9), and the other six now remain to be distributed among the six basic capabilities in the boxes in the top left of the character sheet. He knows

STR	PHY	COR	INT	MST	PER
12	14	17	15	13	10

## SECURITY/INVESTIGATION

Your area of work is security matters and private investigation. You are probably employed by a small freelance surveillance or investigation bureau, and have a very flexible and multi-faceted training. However, the requirements are also hard to meet.

**REQUIREMENTS:** Max 25 years. Any higher education. No criminal record

Combat:	1
Firearms:	1
Communications:	1
Movement:	1
Technical:	1
Free:	3
Social standing	1d10
PER-modification	+1



that a high COR-value is vital for him as a warrior, and allocates his highest value to that capability. He also wants to be pretty smart and determined, and puts high values in the INT and MST capabilities as well. He checks the «Combat Statistics Table» and makes a preliminary calculation, seeing that none of the Combat statistics are «on the edge» of being increased. Therefore, he chooses not to make any transfers of capability points.





### SOCIAL STANDING

Next, he rolls a d10 to determine his INITIAL social standing, «5», and records this in the «Social standing»-box in the top right. Knowing that this will be changed several times during the character generation, he chooses not to raise it any further at this point.

Social standing: 5

### ADOLESCENCE SKILLS

Now it's time to record the adolescence skills, and referring to the table, McBride gets a free skill value of «4» in all skills based on STR, PHY, MST and PER. He gets «5» in the INT-based skills; Shoulder launched weapons, Administration, Dealing and all the Technical skills. Suits him fine, since he doesn't plan to develop these any further in his military career. Last, he gets a free skill value of «6» in all COR-based skills. Perfect. He records all these values in the «B-SV»-column.

Since he doesn't have any Defensive Bonus or Perception Bonus yet, the Special skills are left for now.

Next, it's time for McBride to make his first skill picks, his INT of 15 allows him to make seven free skill picks, from any skills. He makes two picks in each of the Special skills (Avoid and

## ADMINISTRATION/ ECONOMICS/LAW

You are an office clerk, secretary, lawyer, salesman, accountant or some sort of manager or director, employed by a minor freelancing company. Your primary tasks are administration, economics, and law and you are well aware of how the megacorporations work, which is very useful in a career as an adventurer.

**REQUIREMENTS:** Max 25 years. Business school. No criminal record. Social standing 5

Combat:	—
Firearms:	—
Communications:	3
Movement:	1
Technical:	1
Free:	2
Social standing	1d20
PER-modification	-1



## CRIMINAL

As a criminal, you make your living on the street; as a drug-dealer, arms-dealer, owner of an illegal bar, or just as a common crook. A varied and flexible living, but also a hazardous one; should the «re-employment roll» at any time be unsuccessful, you must immediately make an extra roll on the Special events table with 1d4+4 instead of 2d20.

**REQUIREMENTS:** None

Combat:	2
Firearms:	1
Communications:	2
Movement:	1
Technical:	1
Free:	1
Social standing	1d20
PER-modification	+1

## STUDENT

You spend a couple of years as a student at some sort of school or academy, getting the higher education degree which is a requirement for many well-paid jobs (*military academy: officer; media college: reporter; business school: administration/economy/law; technical university: scientist*). An expensive and secluded life, but fairly free and flexible. The «re-employment-roll» shows if you got your degree or if you were flunked (if the roll fails, you get the picks anyway, but not the degree).

**REQUIREMENTS:** Max 25 years. INT 7. Social standing 4

	Military academy	Media college	Business school	Tech. univ.
Combat:	1	—	—	—
Firearms:	1	—	—	—
Communications:	—	2	2	—
Movement:	1	1	—	—
Technical:	—	—	1	3
Free:	2	2	2	2
Social standing	1d4	1d4	1d4	1d4
PER-modification	±0	-1	-1	-1



Perception) and one pick in each of Handguns, Rifles and Dealing skills.

He also makes his three «Adolescence Events rolls» from the table. The results (3 times 2d20) are «23», «34» and, finally, «17»! Not only is McBride a slick speaker (+1 to all Communication Svs), he is also truly a lucky stiff (Social standing +3)! The modifications are noted where appropriate, and he also sees that he will automatically be able to choose the «Officer» background if he wants to (due to the result of 17).

Finally, he



Social standing:  Age:

Events: (slick speaker, lucky stiff), MILITARY CONNECTIONS

### FIREARMS

	SV	B-SV mod	Notes	skill picks						
Handguns										
Rifles (COR)	6									
Light automatics (STR)	6									
Heavy automatics (STR)	4									
Shoulder launched weapons (INT)	4									
Grenade launchers (COR)	5									
COMMUNICATION	6									
Administration (INT)										
Oratory (PER)	5									
Dealing (INT)	4	+1 (slick speaker)								
Social (PER)	5	+1								
Interrogation (PER)	4	+1								
Conning (PER)	4	+1								
SPECIAL	4	+1								
Avoid (DB)										
Perception (PB)										

## FRANCHISER/Common Man

As the title suggests, you don't have a particularly exciting life, but just spend your time letting the time pass, with no exact requirements or responsibilities, minimum wage, minimum excitement and minimum bonds.

**REQUIREMENTS:** None

Combat:	—
Firearms:	—
Communications:	2
Movement:	1
Technical:	—
Free:	2
Social standing	1d6
PER-modification	±0

records that he is 16 years old. If McBride should choose to start adventuring right now, he would have some proficiency in handling light weapons (SV 9 in Handguns and Rifles), have fair defensive capabilities (SV 2 in Avoid, plus his Defensive bonus) and be just slightly more perceptive than normal (SV 2 plus his Perception bonus). Also, he is quite adept in Dealing (SV 9).

## ADOLESCENCE EVENTS

### 2D20 ADOLESCENCE EVENT

- 2 **DISABLED\***. You have a terrible accident which almost cripples you. Your Movement allowance values should always be read from the line above the normal in the Combat statistics table.
- 3 **WIMP\***. In pressing situations you tend to pass out. Your Actions/round value should always be read from the line above the normal in the Combat statistics table.
- 4 **WEAK BONE STRUCTURE\***. Subtract 5 from Total Body points.
- 5 **DIMWITTED\***. Your Defensive and Perception bonuses should always be read one line above the normal in the Combat statistics table.
- 6 **SERIOUS CRIME COMMITTED**. Guilty or not, you are sentenced for a serious crime which renders you 1d6+3 years in labor camp (add these to your normal starting age of 16). +3 to STR, PHY and PER, but -1 to COR, INT and MST. +4 to Brawling. Also, see result (8).
- 7 **MINOR CRIME COMMITTED**. You are found guilty of a minor crime which results in 1d3 years in prison (add these to your normal starting age of 16). +1 to STR and PER and +2 to Brawling. -1 to PHY. Also, see result (8).
- 8 **CRIMINAL RECORD**. You've taken part in some criminal act and have a large red circle around your name in the criminal records—probably for the rest of your life.
- 9 **BAD COMPANY**. Unfortunately, you've spent a lot of time in the wrong company. +2 to Brawling and Dealing, but -1 to Social standing (1 is minimum).
- 10 **TRAGIC ACCIDENT\***. Both your parents died in a terrible accident and you were sent to an orphanage. Social standing is lowered by 3 (1 is minimum).
- 11 **INFLUENTIAL GODFATHER\***. You have a godfather with connections everywhere. THE FIRST TIME you try to get a job, there are no requirements whatsoever, you only have to make the die roll...
- 12 **INFLUENTIAL BENEFACTOR\***. Your family has a very influential benefactor that allows you to choose any higher education (choose one of the results (13) through (16) below).
- 13 **MILITARY HERITAGE\***. You come from a family of high-ranking military men. You may spend two years (add these to your normal starting age) in Military academy and make the proper skill picks. Raise INT to 7 if it is lower.
- 14 **TECHNICAL TALENT\***. You receive a scholarship that enables you to spend two years in Technical university (add these to your normal starting age). Make the proper picks and raise INT to 12 if it is lower.
- 15 **BUSINESS FAMILY\***. You come from a family of ambitious businessmen and therefore have the option to be put in Business school for two years (add these to your normal starting age). You may make the proper skill picks and raise INT to 10 if it is lower.
- 16 **MEDIA FAMILY\***. A close relative manages to get you a place at Media college, where you may stay for two years (add these to your normal starting age). You may make the proper picks and raise INT to 9 if it is lower.
- 17 **MILITARY CONNECTIONS\***. You have the right connections within the military and ignore all requirements if you want to become an officer.
- 18 **APPRENTICE SCIENTIST\***. Due to your weeks as holiday apprentice in the science-lab, you have no requirements if you want to become a scientist.
- 19 **HOBBY FREELANCER\***. Your deep interest in the media is noticed among some studio workers. You ignore all requirements if you want to become a reporter.
- 20 **ECONOMICAL TALENT\***. Your interest and talent in the stock market is highly appreciated. You ignore all requirements if you want to choose a background in Administration/Economy/Law.
- 21 **SAFE JOB\***. You don't have to make any INT/PER-roll THE FIRST TIME you wish to be employed.
- 22 **HOLD ON EMPLOYER**. You may choose one background where you will never have to make any INT/ PER rolls, either to get a job or to keep it (you'll have to meet the normal requirements, though).
- 23 **SLICK SPEAKER**. You get +1 in all Communications Svs.
- 24 **NATURAL TECHNICIAN**. You get +1 in all Technical Svs.
- 25 **SLENDER BODY**. You get +1 in all Movement Svs.
- 26 **WEAPONS FANATIC**. You get +1 in all Firearm Svs and Weapons systems.
- 27 **MARTIAL ARTS TRAINING**. You get +1 in all Combat Svs and may make a free pick from the Combat field of expertise. Add +2 to PER.
- 28 **ANATOMICAL SIXTH SENSE\***. Somehow you always seem to hit people where it hurts the most. Add +1 to your offensive bonus.
- 29 **SUPERB SENSES**. You get +1 to your Perception and Avoid Svs.
- 30 **STRONG WILL**. Add +1 to MST and +3 to Interrogation SV.
- 31 **CHARISMATIC VOICE**. Raise your PER and all Communication Svs by 2.
- 32 **GOOD BODY CONTROL**. Raise COR by 1 and all Movement Svs by 2.
- 33 **CONTACT WITHIN A MEGACORP**. You have a contact within one of the megacorporations (Roll 1d6. 1=Bauhaus, 2=Mishima, 3=Capitol, 4=Cybertronic, 5=Imperial, 6=The Brotherhood). The GM decides exactly how the contact works, but it should be a considerable advantage whenever the character wants information about the corporation's doings, if



### DEVELOPING BACKGROUND

Without hesitating, Mike chooses to develop within the «Officer» background. Since he has MILITARY CONNECTIONS, the requirement that he must have attended Military academy is overruled.

He rolls a d20 to see if he is employed as an officer. The result is (14), higher than his PER but lower than his INT, so he succeeds and can continue down the diagram in the «EMPLOYED»-column.

He makes one skill pick in each of the Combat (he chooses Thrown weapons), Communication (Interrogation), Movement (Stealth) and Technical (Weapons systems) fields of expertise, and two skill picks in the Firearms field (Rifles and Heavy automatics). In addition, he may make two free skill picks, and chooses Rifles and Avoid.

**PER-MODIFICATION.** As an «officer», McBride gains +1 to his PER basic capability, increasing it to (11).

**SOCIAL STANDING.** McBride rolls 2d6 (5), which means his Social standing is lowered by one to (7).

**SPECIAL EVENTS.** McBride rolls twice with 2d20, resulting in (27) (GIFTED CHILDHOOD) and (19) (EVENING CLASSES); altogether three free skill

he wants to get an entrance pass to one of the corporation's official buildings, if he wants to be bailed out when arrested by the corporation's security agents, etc.

- 34 LUCKY STIFF. You win a fortune on lottery. Raise Social standing by 3 (10 is still maximum).
- 35 RELATIVE WITHIN DA DEPT\*. Should you ever get in trouble with the Law, roll a d20 once. If it is lower than your PER, the case is immediately dismissed. If you're already in the records, make the roll anyway. If you succeed, you're out now.
- 36 RESISTANT TO PAIN. Add +1 to your BP's in each body part.

- 37 SOLE HEIR TO WEALTHY AUNT. Raise your Social standing by 5 (10 is still maximum).
- 38 GIFTED STUDENT\*. You may repeat your Elementary education.
- 39 GIFTED BODY. Add +3 to any Basic capability.
- 40 COMMANDO TRAINING\*. You are picked by corporation elite forces talent scouts and spend four years becoming a commando (equivalent to Military academy; add these four years to your normal starting age of 16). Add +2 to all basic capabilities and make two picks from each field of expertise and four free picks. +5 to PER, +2 to Social standing (10 is still maximum).

## SPECIAL EVENTS

### 2D20 SPECIAL EVENT

- 2 DISABLED\*. You have a terrible accident which almost cripples you. Your Movement allowance values should always be read from the line above the normal in the Combat statistics table. An operation would cost you about 100,000 crowns. Also, see result (9).
- 3 BONE DISEASE\*. Subtract 5 from your Total Body points. An operation to fix it would cost about 50 grand. Also, see result (9).
- 4 SEVERE CONCUSSION\*. You will never be quite yourself again after that last bop. Your Defensive and Perception bonuses should always be read one line above the normal in the Combat statistics table. Also, see result (9).
- 5 INVOLVED IN SERIOUS CRIME. Guilty or not, you've been sentenced to 1d6+3 years of hard labor (adjust your age immediately). Add +3 to STR, PHY and PER, but subtract 2 from INT and MST. Also, see result (8).
- 6 INVOLVED IN MINOR CRIME. You get involved in some petty organized criminal business and sentenced to 1d3 years (adjust your age immediately) of prison. -2 to STR, PHY and MST. +2 to PER. Also, see result (8).
- 7 SPEEDING TICKET. You are fined a small amount for a petty crime. Nothing serious, but bad enough. See result (8).
- 8 CRIMINAL RECORD. Your name is mentioned in connection with a criminal act and has a large red circle around it in the criminal records—probably for the rest of your life. You are automatically sacked and MUST start your adventuring career right away. Your Social standing drops to 1.
- 9 SACKED! Intrigue and/or mistakes make you lose

your job and forces you to go unemployed for 1d3 periods of two years each, unless you start your adventuring career right away.

- 10 INTENSE EDUCATION. Subtract 2 years from your age (or spend a two year employment period «for free»).
- 11 PART OF UNEMPLOYMENT PROGRAM\*. Should you ever be unemployed, you may automatically choose the Student background instead, regardless of requirements (you still have to make the PER/INT-roll, though...).
- 12 GOOD NEGOTIATOR. You always have +2 on your Social standing rolls.
- 13 GLAMOROUS EMPLOYMENT\*. Your PER-modifier at your current occupation is raised by +1 (if you're unemployed, raise your PER by +1).
- 14 CONTACT WITHIN A MEGACORP. You have a contact within one of the megacorporations. (Roll 1d6. 1=Bauhaus, 2=Mishima, 3=Capitol, 4=Cybertronic, 5=Imperial, 6=The Brotherhood.) The GM decides exactly how the contact works, but it should be a considerable advantage whenever the character wants information about the corporation's doings, if he wants to get an entrance pass to one of the corporation's official buildings, if he wants to be bailed out when arrested by the



picks (Handguns, Agility and Ground vehicles). Looks good so far.

**ADJUST AGE.** All these adjustments have taken two years of training, which means McBride is currently 18 years of age. No aging effects take place so far. Right now, he has the option to quit the training and go adventuring, but McBride decides it is better to get some more flesh on his bones before facing the cold reality.

**MAKE INT/PER-ROLL.** He makes another roll with 1d20, and rolls «5» well below the required «15» (at this, he also records he now has the rank of Cadet). He now has the option either to get straight into the «Officer-development» again, or to choose another background, in which case he has to make a new INT/PER-roll to see if he is employed. Naturally, he opts for the Officer background again.

### REPEATING THE BACKGROUND

In this way, McBride continues to develop into an experienced character. As long as he makes his «re-employment» rolls and no critical results are rolled on the Special Events table, McBride just gets better and better, but older and older.

STR	PHY	COR	INT	MST	PER	Character name: <i>Michael McBride</i>	
12	14	17	15	13	11	Player name: <i>Mike</i>	
<p align="center"><b>Character Sketch</b></p> <p>Backgrounds (years spent): <i>Officer 11</i></p> <p>Events: <i>(slick speaker, lucky stiff), MILITARY CONNECTIONS, (gifted childhood, evening classes),</i></p>						Profession: <i>Military/Officer</i>	
						Social standing: <input type="text" value="7"/>	Age: <input type="text" value="18"/>
						Height: _____	
						Weight: _____	
						Hair: _____	
						Eyes: _____	
						ID-code/Nickname: _____	
						Place of birth: _____	



**REPETITION #2.** McBride has one pick in each Brawling, Light Automatics, Shoulder launched weapons, Administration, Sleight of hand and Weapon systems. The free picks are Light automatics and Avoid. The PER is increased by one, he rolls «9» for Social standing, an increase by one.

The special events rolls are: #34 POWERFUL ENEMY (GM decides that one of McBride's nosebleed teachers, Major Carrington, will sometime in the future get him flunked out of the military.); and: #13 GLAMOROUS EMPLOYMENT (GM decides McBride is detached to some sort of special unit, slightly more glamorous than normal military units. This is later, after a long discussion, determined to be the Imperial Blood Berets.)

Finally, age is set to «20» and he rolls a «9» for re-employment—comfortable success. McBride notes he is now a «Cadet Officer».

**REPETITION #3.** When repeating the Officer-background, McBride has one pick in each Melee weapons, Handguns, Rifles, Oratory, Stealth and Medicine. The Free picks are Perception and Rifles. The PER is now increased by 2, due to the GLAMOROUS EMPLOYMENT event, to «14», and the Social standing roll is an «11», another increase by one.

corporation's security agents, etc.

- 15 NATIONAL GUARDS' TRAINING. You may make one free skill pick from each of the Firearms and Combat fields of expertise.
- 16 TECHNICAL CRASH COURSE. You may make two free skill picks from the Technical field of expertise.
- 17 ADMINISTRATIONS COURSE. You may make two free skill picks from the Communications field of expertise.
- 18 GYMNASTICS CLASSES. You may make two free skill picks from the Movement field of expertise.
- 19 EVENING CLASSES. You may make one free skill pick.
- 20 INTERESTING CHARACTER. You always seem to fascinate people. Add +1 to your PER-value.
- 21 HARD LABOR. You have some really tough tasks at work. Add +1 to your STR-value.
- 22 STRONG WILL. Unending disputes and hardships has hardened you. Add +1 to your MST-value.
- 23 HEALTH CARE. The healthy lunches at work really strengthen you. Add +1 to your PHY-value.
- 24 HOBBY GYMNAST. Add +1 to your COR-value.
- 25 GOOD IMMUNE DEFENSE\*. Your body is extremely resistant to alien organic substances. +5 to PHY everytime you have to make a Resistance roll against such (i. e. diseases, parasites, etc.).
- 26 EXTRAORDINARY CHEMICAL RESILIENCY\*. Your body is extremely resistant to artificial substances. +5 to PHY everytime you have to make a Resistance roll against poisons or gases.
- 27 GIFTED CHILDHOOD. You get two free skill picks, but not in the Special field of expertise.
- 28 WEALTHY BOY-/GIRLFRIEND. Your boy- or girlfriend is very wealthy, and also quite generous. Add +1 to your Social standing (10 is still maximum).
- 29 HOLD ON EMPLOYER\*. You never have to roll to see if you are sacked from your current occupation—you may stay anyway (if you are unemployed, you automatically get a job next time). This event is always overruled by result «9» on this table.
- 30 HOBBY ATHLETE\*. Add +2 to STR and PHY. Should your Social standing drop below 4, you must remove these bonuses again (if it already is 3 or lower, it may not drop further).
- 31 CHANCE OF A LIFETIME. You get an offer to choose any other former occupation you want to, regardless of any normal requirements (you still have to make the roll, though).
- 32 CONTACTS WITHIN POLICE DEPT\*. You will never, ever, get your name on a criminal record. If you're there already, you're out now.
- 33 SOLE HEIR TO WEALTHY AUNT. Your extremely rich aunt remembered you in her will. Add +3 to your Social standing (10 is still maximum).
- 34 POWERFUL, FANATIC ENEMY\*. Somehow, you manage to get yourself a deadly enemy, who unfortunately also happens to be quite powerful. It might be a district attorney, an old girlfriend, a jealous classmate, or whatever.
- 35 LONG LEGS\*. Your Movement allowance values should always be read from the line below the normal in the Combat statistics table.
- 36 FAMOUS FACE\*. You happen to be an exact look-alike of a very famous person. +5 to PER.
- 37 MOVIE-STAR\*. You've had a couple of small parts in soap-operas and B-movies. Add +1 to Social standing, +2 to PER and make one free pick in each of Social and Conning.
- 38 PROMOTION. Add +3 to Social standing and PER.
- 39 SUBJECT TO EXPERIMENTS\*. You volunteer to take part in a secret medical experiment which happens to succeed. Add +5 to MST.
- 40 COMMANDO TRAINING\*. Instead of your next two background periods, you may spend four years in elite commando training (equivalent to Military academy). Add +2 to all your basic capabilities, make two picks in each field of expertise and four free picks. Add +5 to PER and +2 to Social standing (10 is still maximum).



# COMBAT STATISTICS

The Combat statistics are calculated directly from the basic capabilities and are used every time you stumble into a combat situation. Whenever a Basic capability changes, the Combat statistics are immediately recalculated, except for one case:

*Temporary loss of MST-points due to use of the Art or*

*the Dark symmetry does not affect the Combat statistics.*

Add the two basic capabilities connected to the Combat statistics. Find the result in the leftmost column and read the Combat statistic value in the equivalent column to the right.

**COMBAT STATISTICS TABLE**

	Movement allowance (sqr/act) (m/min)		Offensive Bonus (OB)	Actions per round (Actions/CR)	Defensive bonus (DB)	Perception bonus (PB)
Result	COR+PHY		STR+PHY	COR+MST	COR+INT	INT+MST
2-10	2	150	-1	2	+2	+2
11-20	3	175	none	3	+3	+3
21-34	3	225	+1	3	+4	+4
35-40	4	275	+2	4	+5	+5
41-50	5	325	+3	5	+6	+6
51-60	6	400	+4	6	+7	+7
61-80	7	500	+5	7	+8	+8
+20	+1	+100	+1	+1	+1	+1

## COMBAT STATISTICS DESCRIPTIONS

**MOVEMENT ALLOWANCE.** You have two values, one used in combat situations showing how many squares you can move on the game board for each action spent. The other value is METERS PER MINUTE, which is used in other situations when you don't use the game board. Both values may be doubled if you choose to sprint (only if you are unencumbered and the outer circumstances allow it).

**OFFENSIVE BONUS (OB).** The bonus is added to the damage you inflict in hand-to-hand combat.

**ACTIONS PER ROUND.** How many actions you may perform every combat round.

**DEFENSIVE BONUS (DB).** This bonus is the base for your ability to avoid incoming fire.

**PERCEPTION BONUS (PB).** The bonus is the base for your ability to detect hidden objects, sudden threats and phenomena not normally perceivable to the five senses.

**BODY POINTS (BP).** Just add your PHY and MST-values. The result is your Total BP's, which is used to calculate how much damage you can take in each part of the body.

## BODY POINTS

Your Total BP's (=damage capacity) are used to calculate your BP's in the separate parts of the body.

**BODY POINTS TABLE**

PHY+MST	Head	Arm	Stomach	Leg	Chest
2-10	2	4	4	5	5
11-20	3	5	5	6	6
21-34	3	6	6	7	7
35-40	4	7	7	8	8
41-50	4	8	8	9	9
51-60	5	9	9	10	10
+10	+0.5	+1	+1	+1	+1



He rolls for special events: First a «23», HEALTH CARE, which suits him fine. GM decides the training with the special unit is harder than usual and awards him a +1 bonus to PHY. The next roll is another «23», and since this event doesn't have a «♦»-mark, he gains another +1 to PHY. Very much harder training, obviously.

Finally, age is increased to «22» and the re-employment roll is «15»—you can't get closer to unemployment than that, but he gets his «2nd Lieutenant» stripes.

**REPETITION #4.** The skill picks are Parrying, Heavy automatics, Grenade launchers, Social, Stealth and Chemistry. Both Free picks are spent on Avoid. PER is increased another two steps to 16, the Social standing roll fails, a «4», reducing it to «8».

The special events rolls are «27», GIFTED CHILDHOOD, and «18», GYMNASTICS CLASSES, and without further reflecting on an explanation, McBride has two picks in each Agility and Sleight of hand.

Age is increased to «24» and the re-employment roll is «6»—McBride is promoted to 1st Lieutenant.

**REPETITION #5.** Skill picks: Melee weapons, Rifles, Light automatics, Conning, Stealth and Weapon systems, and the Free picks are Perception and Melee weapons. PER is increased to «18». The



Social standing roll fails again (a «6»), reducing social standing to «7». Maybe a bad omen...

The first special events roll is a «9», SACKED! The GM grins cheerfully when explaining that the powerful enemy, nowadays Brigadier Carrington, gave McBride some stupid order that he just couldn't obey. McBride faces immediate dishonourable discharge, he loses his officer's stripes and is demoted to Staff Sergeant (what he would have been had he flunked). Anyway, he makes his second roll, #16 TECHNICAL CRASH COURSE, but GM interferes immediately and decides this is part of an unemployment program with the purpose of promoting First Aid-skills, and forces McBride to make the two skill picks in Medicine.

McBride, now 26 years of age, realizes most jobs are closed to him due to the 25-year maximum requirement, thinks this is it and decides to start a new career rather than to go unemployed (thereby losing PER and money and becoming subject to aging effects, while gaining little in the form of skill-picks. McBride feels pretty satisfied so far).

### SUMMING UP

The values found in the «skill picks»-boxes to the right are transferred to the «Modifications»-column, and the «B-SV» and

## SOCIAL STANDING AND EQUIPMENT

The Social standing value determines your initial amount of fresh cash just waiting to be converted into weapons and items. It also decides the status of your accommodation and your starting equipment (alternatively, how much it is worth if sold second hand).

The «Available» heading gives you starting capital without having to sell anything. If you have something to sell that can boost your starting capital, this is mentioned in the text along with the value (a high Dealing SV might very well be able to raise this...).

### 0 • LOW-LIFE PUNK

**AVAILABLE:** 500

You are one of the thousands of non-registered citizens. Your only possessions are the rags on your body. You survive by begging, scavenging garbage-cans, and by stealing from the rich and giving to yourself. It can't get worse...

### 1 • HOME-LESS NOBODY

**AVAILABLE:** 2,000

Extremely poor, but you could be worse off. You don't have your own home but live at a friend's place, in a borrowed flat, or a self-made shelter made out of corrugated sheet metal and scrap wood or in an abandoned warehouse. Your only possessions are a couple of second hand changes of clothes, some hygiene articles and worthless family heirlooms. You live on social aid or minimum wage, barely enough to feed yourself.

### 2 • POOR SUCKER

**AVAILABLE:** 5,000

You are poor, but at least have a place of your own, a joke of a car (value 2,000), and the basic household necessities (1,000). You have a decent wardrobe with a Sunday suit (total value 1,000), but none of the basic luxuries of life such as a stereo, a TV-set or a washing machine.

			skill picks											
			SV	B-SV	mod	Notes	+3	+5	+7	+8	+9	+10	+11	+12
<b>COMBAT</b>	(COR)	6	6											
Missile weapons	(STR)	7	4	+3										
Brawling	(COR)	6	6											
Wrestling	(COR)	9	6	+3										
Thrown weapons	(STR)	11	4	+7										
Melee weapons	(COR)	9	6	+3										
Parrying														
<b>FIREARMS</b>	(COR)	13	6	+7										
Handguns	(COR)	16	6	+10										
Rifles	(STR)	11	4	+7										
Light automatics	(STR)	9	4	+5										
Heavy automatics	(STR)	8	5	+3										
Shoulder launched weapons	(INT)	9	6	+3										
Grenade launchers	(COR)													
<b>COMMUNICATION</b>	(INT)	9	5	+3	+1 (stick speaker)									
Administration	(PER)	8	4	+3	+1									
Oratory	(INT)	9	5	+3	+1									
Dealing	(PER)	8	4	+3	+1									
Social	(PER)	8	4	+3	+1									
Interrogation	(PER)	8	4	+3	+1									
Conning														
<b>MOVEMENT</b>	(COR)	13	6	+7										
Sleight of hand	(COR)	14	6	+8										
Stealth	(COR)	13	6	+7										
Agility	(STR)	4	4											
Climbing	(MST)	4	4											
Flying vehicles	(COR)	9	6	+3										
Ground vehicles														
<b>TECHNICAL</b>	(INT)	8	5	+3										
Chemistry	(INT)	12	5	+7										
Weapon systems	(INT)	5	5											
Computers	(INT)	5	5											
Electronics	(INT)	12	5	+7										
Medicine	(INT)	5	5											
Mechanics														
<b>SPECIAL</b>	(DB)	9	+4	+5										
Avoid	(PB)	8	+4	+4										
Perception														



### 3 • POOR BUT HAPPY

**AVAILABLE:** 10,000

You have managed to get most of the things needed to lead a decent life, such as a place of your own (small shabby rented flat), a working car (value 5,000), basic home electronics (5,000), but savings or excesses are out of the question.

### 4 • LOW STANDARD

**AVAILABLE:** 20,000

Even though your living leaves much to be desired, you get along pretty well. You live in a small rented apartment, but you have your own car (value 10,000) and a fair amount of furniture, appliances, home electronics and clothes (total value 15,000).

### 5 • AVERAGE GUY

**AVAILABLE:** 30,000

Well, you have managed to become an average Luna citizen, with average income, average living standard (decent rented flat), average car (value 15,000), average home electronics (10,000), average wardrobe (10,000), average furniture (10,000), average jewelry (10,000), average hobby equipment (10,000) and everything else just about average (total value 10,000).

### 6 • COMFORTABLE

**AVAILABLE:** 40,000

You have managed to climb on the ladder of society up to a point where you can feel economically independent. Since you left the «Average Guy»-level (5; see above), the values of all your belongings have doubled. In addition, you have purchased a place of your own (value 300,000).

### 7 • WELL-TO-DO

**AVAILABLE:** 50,000

You have reached the stage where you can lean back and feel pretty comfortable, above average but not wealthy. You have an apartment of your own (value 500,000), a fairly new car (50,000), the more expensive products from the home electronics' manufacturers (value 50,000), some real collectibles (50,000), a gold-plated watch (50,000), designer made furniture (50,000) and clothes (50,000) and most of the other stuff that make life worth living (total value 100,000).

### 8 • WEALTHY

**AVAILABLE:** 200,000

You are almost part of high-society, reaching sky-high above the average man but still far below the real crème-de-la-crème of Luna city. Since you left the «well-to-do»-level (7; see above), the values of all your belongings have doubled.

### 9 • VERY RICH

**AVAILABLE:** 1,000,000

You have succeeded pretty well in life and managed to get most of the things you ever dreamed of. You have a really nice place of your own (value 2,000,000), a couple of fancy cars (value 500,000 each) and your total belongings, valuables, collectibles and electronics would have an estimated value of 2,000,000 Cardinal's Crowns.

### 10 • STINKING RICH

**AVAILABLE:** 20,000,000

You are one of the successful people, a megayuppie with an unlimited checkbook. You live in a minor palace (value 5,000,000), own 1d4+1 of the most expensive cars on the market (2,000,000 each), and your possessions (stereos, computers, TVs, household appliances, collectibles, etc.) are insured to a value of 10,000,000 Cardinal's Crowns. You're on the top now, and can only go one way...



«Mod» columns are added together in the Skill Value-column. This is the total Skill Value used whenever attempting to perform something that falls into the skill. McBride waits to calculate the Svs in the Special skills until he has calculated the Combat statistics.

#### CALCULATING COMBAT STATISTICS.

McBride's total Body points, PHY+MST, is 29, meaning he has 3 BP's in the Head, 6 BP's in each Arm and the Stomach and 7 BP's in each Leg and the Chest.

Referring to the Combat statistics table, McBride sees his Movement allowance is set to 3 squares per action/225 meters per minute; he has +1 in Offensive Bonus; he has three actions per round, and he has +4 in both Defensive Bonus and Perception Bonus, which gives him Svs of +9 and +8 in Avoid and Perception, respectively.

Pretty standard all over.

#### BUYING EQUIPMENT.

McBride is still «Well-to-do» and decides to keep all those things that he has earned so far, which gives him 50,000

Cardinal's Crowns to spend on equipment.

Also, the GM tells him his running expenses (flat maintenance, gas,

electricity, fuel, etc) will be 5,000 Crowns per month.





### FLESHING OUT

With this, McBride's finished, in the sense that he can be thrown into the game. But maybe the most important thing is still to come, the fleshing out of the CHARACTER McBride. Right now, he is just a set of figures on a paper, not a hero.

So, in cooperation with the GM, Mike starts to create McBride by filling the blanks on the Personality form.

## THE PERSONALITY FORM

The Personality form should be completed when you feel that you are ready with the character development. It is an aid both to yourself, your fellow players and to the GM when you create the campaign and eventually go adventuring. There are no restrictions when you fill all those empty boxes on the sheet, let your imagination loose to create an interesting character (however, you

should consult your GM before deciding that your character is a mutant famous all over the galaxy for his extreme heroism during gladiator freak shows—it just MIGHT ruin his intended campaign). Of course, your social standard fluctuations, special events and events during your background development should reflect in the personality description.

<b>STR</b>	<b>PHY</b>	<b>COR</b>	<b>INT</b>	<b>MST</b>	<b>PER</b>
12	16	17	15	13	18

**Character name:** Michael McBride  
**Player name:** Mike  
**Profession:** ex. Military/Officer (Staff Sergeant)  
**Social standing:**  **Age:**   
**Height:** 6'3"  
**Weight:** 195 lbs.  
**Hair:** Long, brown, in pony-tail  
**Eyes:** Green  
**ID-code/Nickname:** \_\_\_\_\_  
**Place of birth:** Luna

**Character Sketch**

**Backgrounds (years spent):** Officer III IIII

**Events:** (slick speaker, lucky stiff), MILITARY CONNECTIONS, (gifted childhood, evening classes), POWERFUL ENEMY, GLAMOROUS EMPLOYMENT, (health care x 2, gifted childhood, gym classes), SACKED!, (technical crash course)

**COMBAT STATISTICS**

<input type="text" value="29"/>	<b>Total Body Points</b>	
<input type="text" value="3"/>	<b>Movement allowance</b> <small>Squares/action Meters/minute</small>	<input type="text" value="225"/>
<input type="text" value="+1"/>	<b>Offensive Bonus (OB)</b>	
<input type="text" value="3"/>	<b>Actions/round</b>	
<input type="text" value="+4"/>	<b>Defensive Bonus (DB)</b>	
<input type="text" value="+4"/>	<b>Perception Bonus (PB)</b>	

AREA	CLOSE COMBAT	MISSILE COMBAT	ARMOR TYPE	ARMOR VALUE	MAX BP-S	BODY POINT COUNTDOWN
Left leg	1-4	1-3			7	
Right leg	4-6	4-6			7	
Left arm	7-9	7-8			6	
Right arm	10-12	9-10			6	
Stomach	13-15	11-14			6	
Chest	16-18	15-19			6	
Head	19-20	20			7	
					3	

0 hits left: Arms: Out  
 1 hit left: Arms: -5 on attacks  
 Legs: -2 steps/actn  
 Legs: -1 step/actn  
 Chest, Stom, Head: Unconscious  
 Chest, Stom, Head: -1 actn/CR

# FIELDS OF EXPERTISE

The five different FIELDS OF EXPERTISE and their associated skills are described in the following section. They are Combat, Firearms, Communications, Movement and Technical. Under each Field of expertise you will find six skills. There is also a «Special» field of expertise with Avoid, Perception and the Art. These work exactly as normal, but the Skill Value is calculated differently.



## THE SKILL VALUE

The Skill Value (SV) comes into play whenever you want to use a skill. It is the sum of your Base skill value, modifications achieved from your skill picks and any other skill modifiers. In short, the SV is a measurement of how capable you are at the different proficiencies that go under the skill. For example, with a high SV in

Handguns, you are a crack pistol-shot; with a high SV in Oratory, you can talk people into doing just about anything; with a high SV in Agility, you could very well get a job as a circus acrobat. The SV usually ranges from 1 to 20, where 1 means you are totally unskilled and 20 means you're an expert.

## COMBAT

### MISSILE WEAPONS

**BASIC CAPABILITY:** COR

This skill covers bows and crossbows, blowguns and other primitive missile weapons.

### BRAWLING

**BASIC CAPABILITY:** STR

Your ability to fight without weapons, using your fists (normal damage: 1d3+OB) and feet (normal damage: 1d4+OB).

### WRESTLING

**BASIC CAPABILITY:** COR

Grappling and wrestling, immobilizing opponents. The skill is also used when throwing your opponents. These attacks don't normally inflict any damage, but if an attack succeeds, you roll on the Resistance table with the opponent's STR+SV in Wrestling as «DL», and your own STR+SV in Wrestling as «Basic capability». If also this roll succeeds, the opponent is down and immobilized.

### THROWN WEAPONS

**BASIC CAPABILITY:** COR

Your ability to use all kinds of thrown weapons, such as shuriken, hand grenades and throwing knives and spears.

### MELEE WEAPONS

**BASIC CAPABILITY:** STR

This skill is used for all kinds of hand-to-hand weapons, both onehanded and two handed; swords, knives, axes, clubs, etc.

### PARRYING

**BASIC CAPABILITY:** COR

This skill is used whenever you want to parry or deflect a melee attack.





## FIREARMS



### HANDGUNS

#### BASIC

#### CAPABILITY: COR

This skill is used whenever using firearms with one hand, normally pistols and submachine-guns. It is used in all attacks, but when making automatic attacks the appropriate Automatics skill is also required. Also used for repairing and maintenance.

### RIFLES

#### BASIC CAPABILITY: COR

This skill is used whenever using firearms with two hands, normally rifles, sub-machine guns, assault rifles, machine guns, etc. It is used in all attacks, but when making automatic attacks the appropriate Automatics skill is also required. Also used for repairing and maintenance.

### LIGHT AUTOMATICS

#### BASIC CAPABILITY: STR

The ability to fire controlled automatic fire with light firearms, such as automatic pistols and sub-machine

guns (STR requirement 16 or less). Also used for repairing and maintenance.

### HEAVY AUTOMATICS

#### BASIC CAPABILITY: STR

The ability to fire controlled automatic fire with heavier firearms, such as assault rifles, carbines and machine guns (STR requirement 17 or more). Also used for repairing and maintenance.

### SHOULDER-LAUNCHED WEAPONS

#### BASIC CAPABILITY: INT

Use this skill when you operate and maintain shoulder-launched weapons systems, such as anti-tank rifles and infantry anti-aircraft missiles. This skill is used in all attacks, but when making automatic attacks the appropriate Automatics skill is also required.

### GRENADE LAUNCHERS

#### BASIC CAPABILITY: COR

Used when firing grenade launchers and maintaining the equipment for firing. It is used in all attacks, but when making automatic attacks the appropriate Automatics skill is also required.

## COMMUNICATION

### ADMINISTRATION

#### BASIC CAPABILITY: INT

The knowledge of how the official administration works, how to fill out forms, what phone calls to make, who you should talk to and what to say to get things done, how to deal with officials, etc. Useful when trying to make appointments with high officials. Knowledge of the law also falls into this skill.

### ORATORY

#### BASIC CAPABILITY: PER

The ability to convince people that the speaker is right. A combination of saying the right words and making the right impression. A must for politicians, lawyers, careerists, clergymen, high-ranking officers, gang leaders, etc. Often used when addressing crowds or when appealing to people's feelings.

### DEALING

#### BASIC CAPABILITY: INT

This skill covers most of a character's involvement with money, economics and the financial system, from haggling with street peddlers to making bargains on the stock market. The character knows how to cut deals and where he can get the best offers. The cornerstones are evaluation, calculation and persuasion.

### SOCIAL

#### BASIC CAPABILITY: PER

This is the knowledge of how to behave properly and how to be socially correct. It's also working knowledge of who's who in the world of *Mutant Chronicles*. It is used when trying to impress people, be they beggars or chief executives and is a must at cocktail parties unless you want to make a fool out of yourself or have a very high PER-score.

### INTERROGATION

#### BASIC CAPABILITY: PER

This skill is used when extracting information from someone, either during an interview, an interrogation, a cross-examination or just an ordinary conversation. With the right technique, the «victim» will not know until afterwards that he has said far too much. The skill is absolutely essential for journalists, attorneys, inquisitors, agents, policemen, interrogators, etc., and runs the gamut from rhetoric to pure intimidation.

### CONNING

#### BASIC CAPABILITY: PER

This skill is used whenever the character tries to pull a trick on someone, when he passes himself off as someone else, etc. Especially useful for under-cover agents, muckrakers, corporate infiltrators, spies, inquisitors and common confidence tricksters.

## MOVEMENT

### SLEIGHT OF HAND

**BASIC CAPABILITY:** COR  
This skill is useful for picking pockets and similar small thefts which are performed in the presence of witnesses. It is also used when picking mechanical locks, performing small tricks like card tricks or disappearing objects, disarming or triggering traps, etc.

### STEALTH

**BASIC CAPABILITY:** COR  
This is your capability to blend with the surroundings so that no one notices you. It is also used when sneaking up on people or when shadowing someone.

### AGILITY

**BASIC CAPABILITY:** COR  
This skill covers jumping, running, acrobatics, swinging, pole-vaulting and other athletic actions.

### CLIMBING

**BASIC CAPABILITY:** STR  
This skill is used for most climbing and scaling maneuvers, such as climbing walls, ropes, ladders, hills, etc.

### FLYING

### VEHICLES

**BASIC CAPABILITY:** MST  
Rather than the purely technical act of flying, this skill reflects the ability to keep cool and do the right things in a critical situation. Used in dog-fights, stressed battle situations, chases, etc. Failure will result in a crash, a stall, engine breakdown, etc. The skill covers the handling of airplanes, helicopters, hovercraft, spacecraft, etc.



### GROUND VEHICLES

**BASIC CAPABILITY:** COR  
As Flying vehicles, except that this skill covers all types of ground vehicles (cars, tracked vehicles, motorcycles, and so on).

## TECHNICAL

### CHEMISTRY

**BASIC CAPABILITY:** INT  
Knowledge of chemical compounds and the ability to prepare such. Can be used to identify unknown substances, to create explosives, to prepare poisons and gases, and much more.

### WEAPONS SYSTEMS

**BASIC CAPABILITY:** INT  
This skill is used for using, repairing, maintaining and

designing all kinds of weapons systems. It also includes weapons accessories such as ammunition, sights, clips, etc. For example, the skill can be used to modify an existing weapon to use with another type of ammo, to increase its rate of fire, ammo capacity, etc. The skill is also used when priming or disarming explosive charges.

### COMPUTER

**BASIC CAPABILITY:** INT  
With this skill, you can program, modify, use and repair



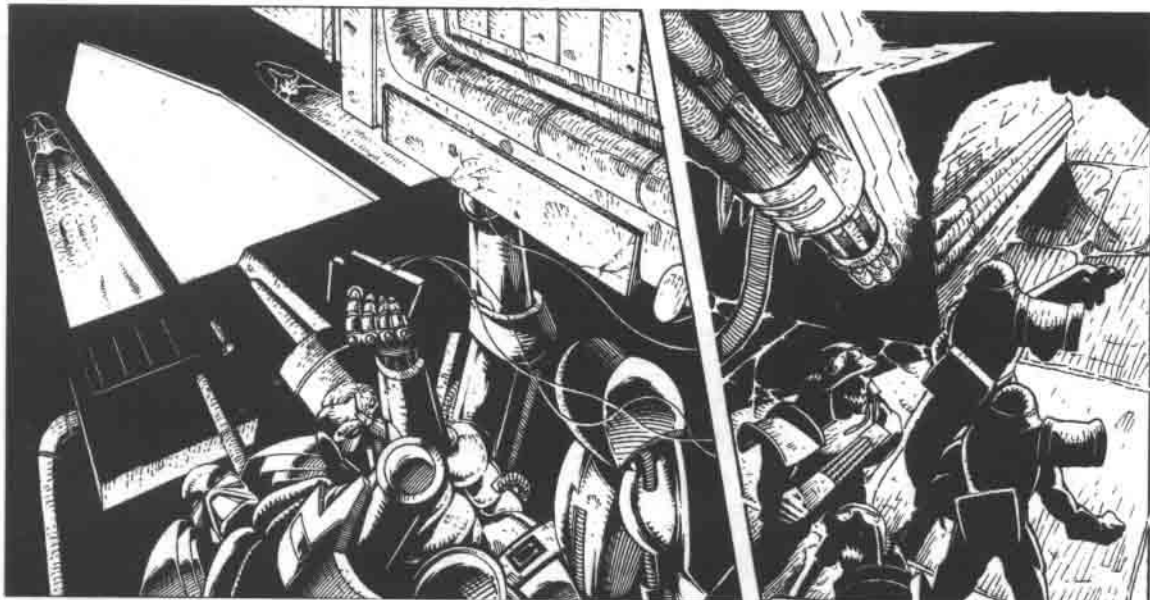

computers. Many computer programs can be used by anyone and do not require this skill; this skill makes you a computer expert.

### ELECTRONICS

**BASIC CAPABILITY:** INT

With this skill, you can build, modify and repair electronic gadgets such as robots, household appliances, alarm systems, detonators, weapons accessories, etc. It is also useful when dealing with computers.

### MEDICINE

**BASIC CAPABILITY:** INT

Your character can dress wounds, set and splint broken legs, treat concussions and shock, and so on.

Medicine also includes pharmaceutical knowledge, i. e. your character will have a fair knowledge of which medicines to use against a particular disease, and which antidotes will help against a poison.

### MECHANICS

**BASIC CAPABILITY:** INT

This skill is used when your character wants to build, modify or repair mechanical equipment, e. g. robots, engines, vehicles, machines, tools, etc.

## SPECIAL SKILLS

### AVOID

**BASIC CAPABILITY:** Special

This skill is used whenever you want to avoid incoming fire or other potential threats that come up extremely quickly. It is more of a sixth sense than a normal skill. Use your DB combat statistic, derived from COR and INT, as your Base skill value.

### PERCEPTION

**BASIC CAPABILITY:** Special

Whenever the GM needs to check if you perceive something hidden, either if you are actively searching for it or if you just happen to notice it, he should make a hidden skill roll in Perception. Use your PB combat statistic, derived from INT and MST, as your Base skill value.

### THE ART

**BASIC CAPABILITY:** Special

This «skill» is only mentioned here for consistency, to show that spells of the Art are purchased with the Free skill picks. Learning spells is resolved separately from the rest of the skills. Only Inquisitors and Mystics may learn spells. Refer to the chapters covering «the Brotherhood» and «the Art» for details.



## THE SKILL ROLL

Whenever you want to do something and there is a reasonable risk that you won't succeed, make a skill roll. The GM decides which skill is the most appropriate at the moment and which modifiers apply.

### MODIFICATIONS

It is more difficult to balance on a slack rope than on a tight one. It is more difficult to climb an icy glass-façade on a skyscraper than a common ladder. It is easier to hit with a rifle-shot if you're on a shooting range a calm and sunny Sunday afternoon than when you're severely wounded in the middle of a desperate fight against hordes of fierce and screaming Necromutants in the smoky, stinking, slippery, pitch-black catacombs underneath Nephariote Overlord Alakhai's Citadel on Venus.

Therefore, the characters' skill values are MODIFIED by the GM. Some typical modifiers:

- |                              |                           |
|------------------------------|---------------------------|
| <b>Negative modifiers</b>    | <b>Positive modifiers</b> |
| • Wounds                     | • Preparations            |
| • Insufficient light         | • Experience              |
| • Adverse weather conditions | • Perfect conditions      |
| • Extreme stress             | • Completely calm         |
| • Movement                   | • Stationary              |
| • Awkwardly equipped         | • Special equipment       |

For every negative modifier that applies, temporarily lower the SV with between -1 and -5. For every positive modifier that applies, increase the SV with between +1 and +5. The result—SV with all modifiers applied—is called CHANCE OF SUCCESS (CS), which is exactly what it is.

Below is a table to give you an idea of how extreme modifiers should be. Also refer to the Combat-section of

these rules for modifiers in combat situations.

It is impossible to put up exact guidelines for every situation that might come up in the game, so as the GM you must be prepared to be flexible and apply your own modifiers. Remember, it normally takes about 4 years of training to get +5 in a Skill Value.

### INTERPRETING THE SKILL ROLL

The skill roll is always made with 1d20 and compared to the CS. A skill roll can have four different results—perfect success, success, failure and fumble.

**PERFECT SUCCESS.** Any skill roll of <1> is always a PERFECT SUCCESS. The exact effects of a perfect success are decided by the GM, but it should always be the most positive outcome possible. For example, in combat it means you automatically inflict maximum damage without deducting for armor.

**SUCCESS.** If you roll lower than or equal to the Chance of Success, you have succeeded in your attempt.

**FAILURE.** If the skill roll is higher than the CS, you have failed in your attempt.

**FUMBLE.** Any skill roll of <20> is always a FUMBLE. The exact effects of a fumble are decided by the GM, but it should always be the most negative outcome possible. The outcome should be worse for a character with a low CS or SV than for a character with high values.



Circumstance	Wounds	Light	Weather	Stress	Movement	Equipment
-1	You have taken one or two hits in one body part	Dawn/dusk outdoors or single torch indoors	Wind or light rain	Someone fires at you	You're jogging	The powder in your cartridges is moist
-2	You have taken three or four hits in one body part	Full moon outdoors or single candle indoors	Heavy wind or heavy rain	People fire at you from several directions	You're running	You're in a car chase with a flat tire
-3	You are wounded in more than one body part	A single candle in a gym-hall	Gale, snowfall or hail	<i>«WARNING! Three seconds to auto-destruct»</i>	You're sprinting	Your rifle's sight is broken or uncalibrated
-4	One body part has zero body points left	Shrouded moonlight outdoors	Snow- or hailstorm	Your clothes are on fire	You're running for your life	You try to scramble a TV-net with a Walkman
-5	Two or more body parts have 0 body points left	Pitch black or blindfolded	Hurricane and blizzard	You're in mid-air, falling towards certain death	You're hanging from a helicopter	You try to bribe a prison guard with tooth-picks.



## USING THE BASIC CAPABILITY VALUES

In some situations, your earlier experiences aren't worth peanuts, and you must rely totally on your basic physical and mental resources, the basic capabilities. Some examples are when you try to budge a 400-pound steel pillar away from the chest of your combat companion, when resisting a mental attack from an utterly evil creature using the Dark symmetry to distort your mind, when resisting poisons and gases, when trying to decipher obscure arcane symbols written in blood and unknown to humanity, etc.

These are all situations when you use your BASIC CAPABILITY VALUES instead of a Skill Value. Most of the time, it will be stated in the text whether it is appropriate to use a skill or a basic capability value.

**DETERMINING DIFFICULTY.** First, the GM

appoints a difficulty to the problem (the fallen pillar, the poison, the evil spell, etc.), ranging from Very easy to Extremely hard. This is converted to a difficulty level between 1 and 25:

Difficulty	Difficulty level (DL)
Very easy	1
Easy	5
Normal	10
Hard	15
Very hard	20
Extremely hard	25

After this, consult the RESISTANCE TABLE to get a chance of success.

## IMPROVING SKILLS

As the adventures progress your character will gain experience in old skills and also learn new skills. This is reflected by awarding the characters with Hero points which can be converted into skill picks or raised basic capabilities. The hero points may be spent immediately or saved until later.

- For ONE HERO POINT you may make ONE FREE SKILL PICK, but not in a skill in which you already have eight skill picks (normal maximum). You may always make up to eight skill picks in all skills, and in certain skills even more.
- For TWO HERO POINTS you may make ONE SKILL PICK ON TOP OF THE EIGHTH skill pick, provided your SV is lower than the value of the basic capability that the skill is based on. You get +1 for skill picks above the eighth.

(You may never have more than eight skill picks in the Special skills, except for spells.)

- For ONE HERO POINT you may raise your PERSONALITY value by one. There is no limit to how high your PERSONALITY can be, but you may only raise it one at a time.
- For THREE HERO POINTS you may raise ANY OTHER BASIC CAPABILITY VALUE BY ONE. There is no limit to how high values you may have, but you may only raise it with one at a time.

All increases of the basic capability values immediately affect any connected Combat statistics. The increases also affect the maximum number of skill picks, as implemented above.

## THE RESISTANCE TABLE

DL	BASIC CAPABILITY VALUE																				
	1	2	3	4	5	6	7	8	9	10	11	12	13	14	15	16	17	18	19	20	21
1	10	11	12	13	14	15	16	17	18	19	—	—	—	—	—	—	—	—	—	—	—
2	9	10	11	12	13	14	15	16	17	18	19	—	—	—	—	—	—	—	—	—	—
3	8	9	10	11	12	13	14	15	16	17	18	19	—	—	—	—	—	—	—	—	—
4	7	8	9	10	11	12	13	14	15	16	17	18	19	—	—	—	—	—	—	—	—
5	6	7	8	9	10	11	12	13	14	15	16	17	18	19	—	—	—	—	—	—	—
6	5	6	7	8	9	10	11	12	13	14	15	16	17	18	19	—	—	—	—	—	—
7	4	5	6	7	8	9	10	11	12	13	14	15	16	17	18	19	—	—	—	—	—
8	3	4	5	6	7	8	9	10	11	12	13	14	15	16	17	18	19	—	—	—	—
9	2	3	4	5	6	7	8	9	10	11	12	13	14	15	16	17	18	19	—	—	—
10	1	2	3	4	5	6	7	8	9	10	11	12	13	14	15	16	17	18	19	—	—
11	†	†	†	†	†	†	†	†	†	†	†	†	†	†	†	†	†	†	†	†	†
12	†	†	†	†	†	†	†	†	†	†	†	†	†	†	†	†	†	†	†	†	†
13	†	†	†	†	†	†	†	†	†	†	†	†	†	†	†	†	†	†	†	†	†
14	†	†	†	†	†	†	†	†	†	†	†	†	†	†	†	†	†	†	†	†	†
15	†	†	†	†	†	†	†	†	†	†	†	†	†	†	†	†	†	†	†	†	†
16	†	†	†	†	†	†	†	†	†	†	†	†	†	†	†	†	†	†	†	†	†
17	†	†	†	†	†	†	†	†	†	†	†	†	†	†	†	†	†	†	†	†	†
18	†	†	†	†	†	†	†	†	†	†	†	†	†	†	†	†	†	†	†	†	†
19	†	†	†	†	†	†	†	†	†	†	†	†	†	†	†	†	†	†	†	†	†
20	†	†	†	†	†	†	†	†	†	†	†	†	†	†	†	†	†	†	†	†	†
21	†	†	†	†	†	†	†	†	†	†	†	†	†	†	†	†	†	†	†	†	†

etc.

Cross-index the Difficulty level and the basic capability value. You must roll lower than or equal to the given figure with 1d20 in order to succeed.

†: Automatic failure

—: Automatic success

*Example: McBride (PHY 14) is exposed to a nerve gas with DL 20. He must roll 4 or lower with 1d20 in order to resist the effects of the gas. Against a gas with DL 24 he is helpless.*

## AWARDING HERO POINTS

One of your most important tasks as GM is to award hero points—if you're too greedy with them the players will be bored to death, and if you're too generous with them the players will be spoiled and the challenge disappears.

Typical examples of when to award hero points:

- When a character, against all odds, succeeds spectacularly with a die roll that really, really saves the day. (1HP.)
- When a

character single-handedly performs an act of extreme heroism, for example slays a Nephrite Overlord or rescues an entire armored assault division. (5–10 HPs.)

- When a character/player substantially takes part in the completion of an adventure. (2–4 HPs.)
- When a player role-plays very well. (2–4 HPs.)
- Also, for every two months of intensive, goal-oriented training, the character receives one hero point. However, it will cost him 10,000 Cardinal's Crowns a month for the trainer's expenses.





## CREATING NEW SKILLS AND SUB-SKILLS

The skills presented here have been carefully chosen to provide you with a wide selection of basic skills for all kinds of characters in *Mutant Chronicles*. However, we can't describe every single skill there is, since the rules-book wouldn't cover them all. Therefore you should feel free to create your own skills and place them within the field of expertise that seems most fitting. If a skill is very similar to an already existing skill, make it into a «sub-skill», meaning that half the SV of the «old» skill is transferred to the new (for example, a character with SV 14 in Administration would get SV 7 «for free» when learning the new sub-skill Law).

Some suggestions on new skills and sub-skills:

**COMBAT:** All different kinds of martial arts (COR or STR), Commando fighting (COR), Pole-arms (COR), Team fighting (MST), Two weapons (COR).

**FIREARMS:** Incinerators (STR or COR), Mounted guns (COR), Cannons (STR, COR or INT), Hipshots (COR), Specific weapons systems (INT, COR or STR).

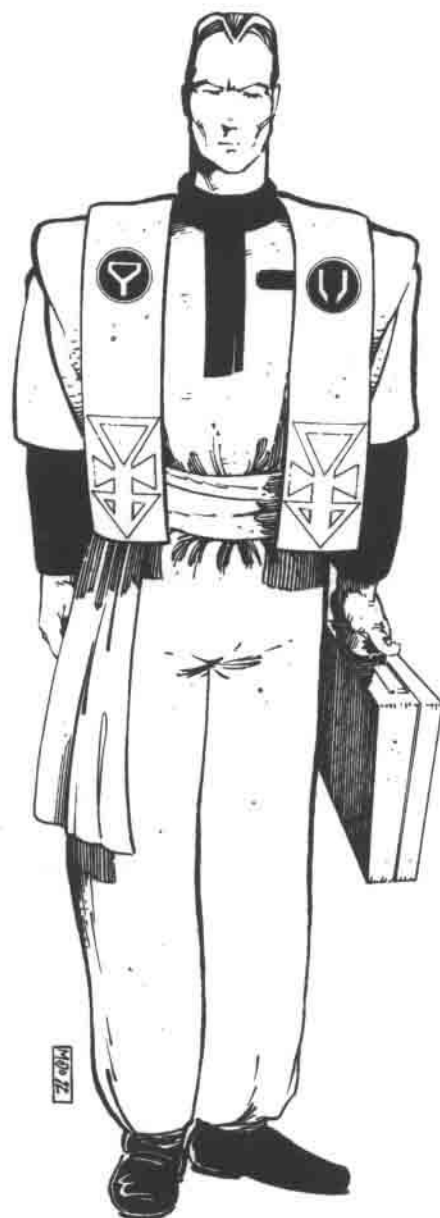

**COMMUNICATION:** Bribing (PER), Lying (PER), Evaluation (INT), Hagglng (PER), Interviewing (PER/INT), Law (INT), Economy (INT), All kinds of languages (INT), Knowledge about the Dark Legion (INT), Religion (INT), Psychology (INT), Philosophy (INT).

**MOVEMENT:** Fly jet-fighter (MST/INT), Fly helicopter (INT/ MST), Drive tracked vehicle (COR), Drive motorcycle (COR), All kinds of sports (COR or STR), Skiing (STR), Hiding (COR), Acrobatics (COR/STR), Sailing (COR), Tumbling (COR), Falling/diving (COR), Riding (COR).

**TECHNICAL:** Cybernetics (INT), Math (INT), Physics (INT), Nuclear science (INT), Surgery (INT), Knitting (COR), All kinds of crafts (INT or COR).

# COMBAT

In combat, you use floorplans and miniatures to visualize the situation. It is recommended that each combatant has his own playing piece, a painted Heartbreaker™ metal miniature is best. Try to set up the whole scene as accurately as possible, with tables, walls, chairs, stairs, doors and other features marked by a simple drawing or with some kind of object.

Combat is one of the most important and exciting elements of role-playing in the world of *Mutant Chronicles*. It is also one of the most obvious hazards to the characters, and because of all this, the rules for combat are fairly extensive. The order of combat goes like this:

- Determine the order of battle.
- The character with the highest initiative begins, doing all his actions. However, he may save one or more actions in case he is attacked by the characters that have not yet acted. For each saved action, he may make one Avoid roll later in the round.
- If the character does attempt any attacks, they are resolved immediately. He makes one or more skill roll to see if he hits; the target may make Avoid rolls, but if he is hit damage is rolled and applied immediately.
- When the first character is satisfied with his turn, it goes to the next character, until everyone has moved and the Combat round ends. Then you roll initiative again, and the battle continues until everyone has fled or been rendered helpless.

## ORDER OF BATTLE

To determine the order of battle, each character should roll 1d10 and add his COR-score. The GM rolls for all the NPCs. The result is called INITIATIVE SCORE. Should there be a conflict between two or more characters, reroll to determine the order between those specific characters. It's a good idea to make a list of all combatants and note their initiative scores.

The combatant with the highest initiative acts first in the round, then the combatant with the second highest initiative score, etc. When it is a combatant's turn, he performs all actions that he has left (i. e. not already spent on avoiding).

However, PLAYER CHARACTERS have the option to HAND OVER THE INITIATIVE and act last of all, instead of during their turn. In this way, they can await the actions of the bad guys and see what happens. On the other hand, it is always an advantage to fire first... Player characters may also SAVE actions so that they can make avoid-rolls later in the round, but they may not save actions for the next round. Actions saved for avoiding are lost if they aren't used.

Effects of damage and avoiding are applied immediately (i. e. a character losing actions due to a wound early in the round might not be able to do anything at all).

## TYPES OF ACTIONS

There are four different types of actions, representing things which take time in the game. It doesn't take time to speak, to think or to turn around, and therefore these aren't actions. Actions that don't fall into «real combat», such as priming explosives, starting a car, toppling a shelf, etc. usually take three actions (=one entire combat round for the average character). These aren't covered by the combat system itself, but are used in the normal way.

The four different combat actions are:

- Movement
- Attack
- Avoid
- Special actions

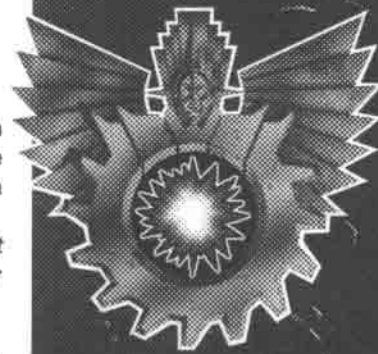

## HINTS FOR LARGE BATTLES

This combat system is primarily designed for skirmishes and street-fights. In combat situations where many combatants are involved, or where ranges are very long, miniatures and floorplans might not be used. Therefore, all weapon ranges and range modifiers are given in meters as well as in squares (1 square = 1.5 meters = 5 feet).

Making initiative rolls for every participant in a large combat situation could be tedious. Instead, take a piece of paper for every combatant, write his name on it, and shuffle them. In the beginning of each CR, randomly pick one of them to determine who begins. When he is done, pick another piece, and so on. Characters with high COR (like 15+)

get two pieces each, doubling their chance to move early (when his second one is picked it is disregarded).

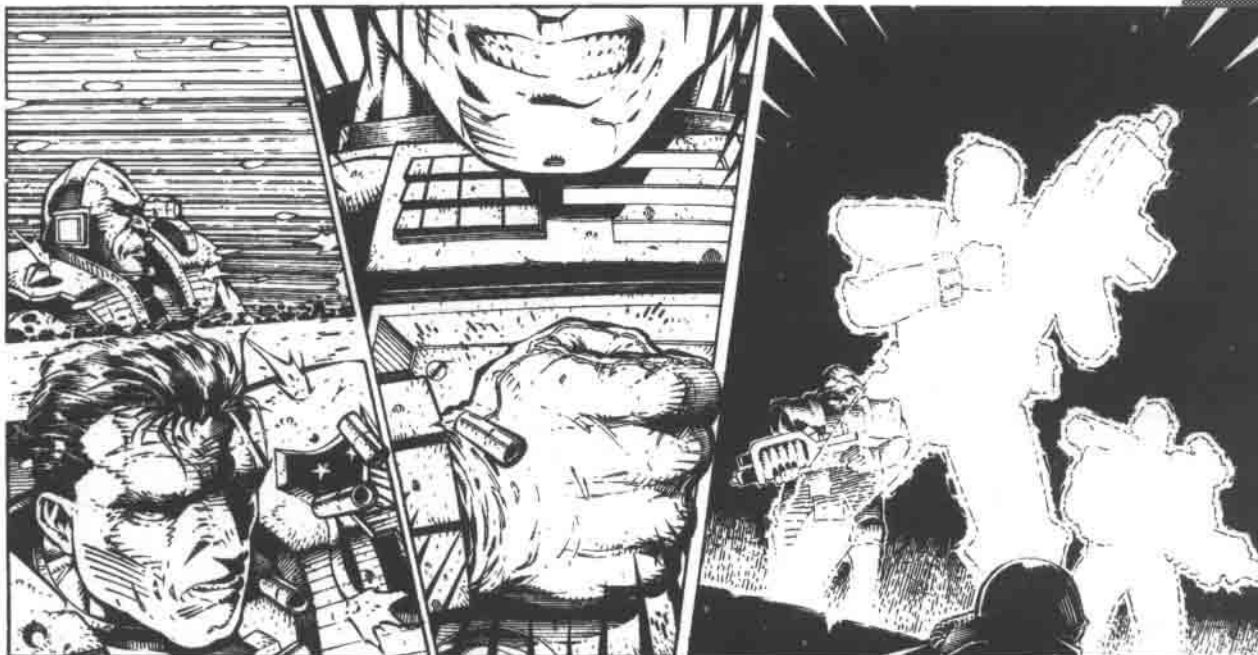

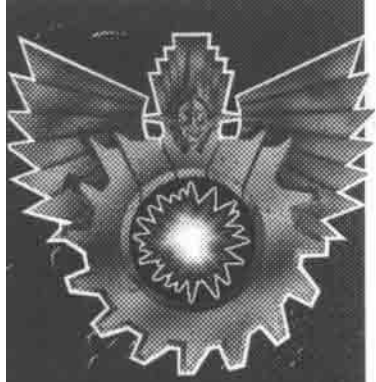

## A NOTE ON AVOIDING

The Avoid-skill reflects the combat experience and awareness that allows a heroic character to avoid incoming missiles. Of course, in reality, it is impossible to dodge a bullet traveling some 1000 m/s, but this is not reality, but a saga where the characters are the heroes—and it is not very heroic being killed by a sniper's bullet. Therefore, we have included the Avoid skill.

To achieve more realism, the unmodified Defensive Bonus might be used instead of the Avoid or Parrying SV in situations where the target is unaware that he is attacked.

### UNCONTROLLED ATTACKS (1 ACTION)

Range	CS modification
1 square	-3
2-5 squares	±0
6-8 squares	-1
9-11 squares	-2
12-14 squares	-3
15-17 squares	-4
18-20 squares	-5
+3 squares	-1

### AIMED ATTACKS (2 ACTIONS)

Range	CS modification
3-150 m (2-100 squares)	±0
150-300 m (100-200 squares)	-3
300-450 m (200-300 squares)	-6
450-750 m (300-500 squares)	-9
750-1050 m (500-700 squares)	-12
+300 m (+200 squares)	-3

## MOVEMENT

The rules for movement are simple: one square—one step. You may move forwards, backwards, sideways or diagonally. Changing the facing doesn't cost any steps. Opening a door costs one extra step.

A character may always move at least 1 square per

action as long as he is alive and has at least one hit left in one leg.

Some terrain may be more demanding than others and cost two steps per square, for example stairs, mud, tightropes, etc. This is up to the GM.

## ATTACKING

For each attack action spent, you may make one:

- **MISSILE ATTACK** (fire-arms, thrown weapons, missile weapons)

or one

- **MELEE ATTACK** (all hand-to-hand attacks)

### LINE OF SIGHT

In order to be able to FIRE at an opponent you must have a line of sight to him, i. e. there mustn't be any objects blocking the path of the projectile. Imagine a straight line between the center of the square you're in, to the center of the square that your target is in. If the line is stopped by a wall or cuts through a square occupied by another combatant, you don't have a line of sight. Corners don't count. Be generous. Refer to the illustration for easy reference.

### RANGE

Range between two combatants is counted in squares (one square = approx. 1.5 meters; 5 feet). Range is counted like steps; the range to an adjacent square is 1. The «Range»-value for the weapons gives the limit on maximum range. At longer ranges, the weapon is not effective enough to motivate a die-roll.

Normally, a missile attack, i. e. the act of pointing the weapon in the right direction and pulling the trigger, takes one action. If you want accuracy, you will have to spend two actions, one to aim and one to fire. The range modifier to your Chance of Success depends on how you fire, if you spend one or two actions.

Note the -3 penalty if firing at someone in an adjacent square. Also note that it is impossible to aim at someone within two squares (3 meters; 10 feet).

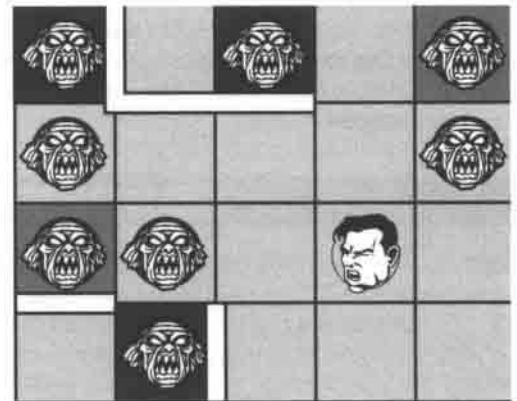

These figures are not in line of sight (blocked by other figures)



These figures are not in line of sight (blocked by walls)



## AVOIDING & PARRYING

Avoid-rolls may be made against any successful missile or melee attacks, whether it's your turn or not. It takes one action to make an Avoid-roll, so if you have no actions left, you may not Avoid.

To Avoid, roll 1d20 lower than or equal to your modified Avoid skill value. If the roll is successful, the attack misses.

**PARRYING.** Parrying works exactly like Avoid-rolls, but they can only be made against melee attacks. If you don't have a weapon or other object to parry with, the attack automatically hits one of your arms (choose which yourself).

When you parry, you use your Parrying skill value instead of your Avoid skill value.

## COMBINED ACTIONS

Combined actions may also be combined with each other, unless otherwise stated. They may only be executed by Heroes, i. e. player characters and prominent NPCs.

*Example: McBride combines an «accurately aimed» melee attack with a «charge». The first action he charges one square, which lowers his CS to 10 instead of normal 14. In the second action he «aims accurately» adding a bonus of +3, so the final CS is 13. In the third action the attack would have come, but since this is part of the charge, and he has already been penalized, it takes no action. The entire maneuver takes two actions, one for the Accurate aiming and one for the Charge. Had it been a missile attack, McBride would have used the «Uncontrolled attacks» modifiers.*

**CHARGING.** Charging takes one action and allows you to move one or two squares and then make an attack as usual. If it is a missile attack, you may move only one square, and you must halve your CS (rounded up). If making a melee attack, you may move one or two steps (if you are physically able) but get -4 on the CS per step (i. e. -4 or -8).

**ACCURATE AIMING.** Accurate aiming can be made in both melee and missile combat and takes one action. The attack must follow immediately after the

accurate aiming, in the subsequent action. When you aim, you can choose between getting +3 on your CS or modifying the hit location roll with up to  $\pm 5$  (i. e. if you roll 12, you may choose any hit location between 7 and 17). An aimed attack with Accurate aiming takes three actions.

**FOCUSING.** Focusing can only be made in melee combat and takes one action. The attack must follow immediately after the focusing, in the subsequent action. When you focus your powers, you should make a Normal MST-roll. If it succeeds, you inflict double damage (= roll hit location once, damage twice). If it fails, you only inflict half the damage (rounded up).

**TAKING COVER.** Taking cover means you throw yourself towards the nearest shelter (cupboard, desk, corner, bomb crater, etc., max 1 square away). It also means you may make Avoid rolls against ALL successful missile attacks made against you during the round. However, you may not do ANYTHING ELSE during the round (if you have already spent one or more actions during the round, or if you are wounded so severely that you are losing actions, you may not take cover). You may not take cover in order to avoid melee attacks.

In awkward situations, when there is absolutely nothing to cover up behind, the GM may modify the player's Avoid-rolls.

A character that has taken cover may stay there, COVERING UP. All subsequent rounds to the «Taking cover»-round, attackers have a -5 penalty to their CS (missile attacks only), but Avoid actions must be spent as normal (i. e. one per successful attack). A character covering up may not move or attack, but it is a fairly safe strategy if you have to reload or fix a weapon jam.

**AMBUSH.** Ambush is a very useful, but also quite hazardous maneuver. It takes two entire actions and allows the character to move one step, make an attack, and move back to the original square. The ambusher has no penalty to his CS (as opposed to when charging), but before he may make his attack roll, any character within line of sight that hasn't acted yet and has actions left, may attack the ambusher. The ambusher may not avoid these attacks.

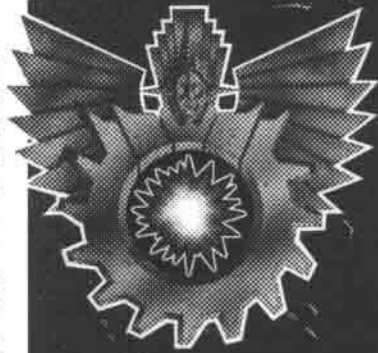

## SPECIAL SIGHTS MODIFIERS

**LASER SIGHT.** With a red-point laser sight, aimed attacks take one action only. «Accurately aimed» aimed attacks take two actions instead of three. Range 100 meters.

**TELESCOPIC SIGHT.** Divide range with magnification to get new range, when calculating range modifier. Weapon CAN NOT be used for AIMING if range is less than [magnification factor x 10 squares].

*Example: A weapon with a x6 telescopic sight may not be used for aimed attack if range is shorter than 60 squares.*

**NIGHT SIGHT.** Night sights can work in many different ways, but the effect is that negative light modifiers are cancelled. Some have limited range, other designs can't see through rain or snow, while some have no limits what so ever.

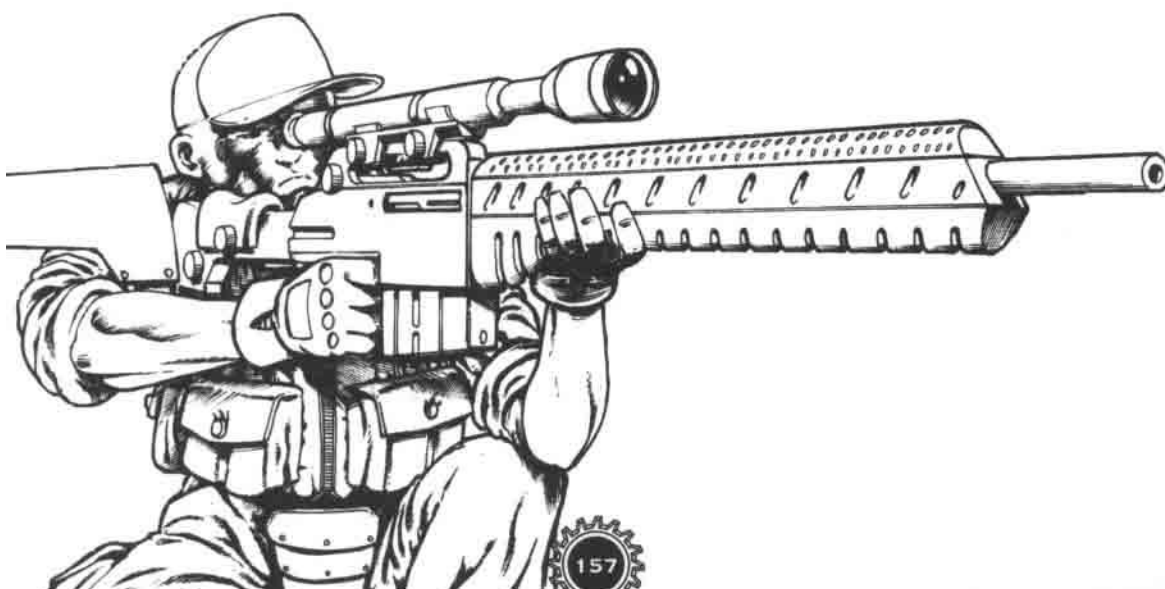

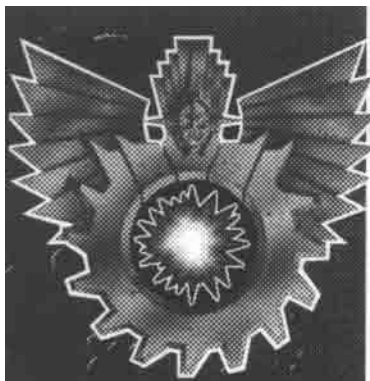

## STUNNING AND SHOCK RESISTANCE

### OPTIONAL RULE:

Every time you are hit, you are stunned and lose one action, unless you succeed in making a shock resistance roll, a Normal PHY-roll. If you succeed, nothing special happens. Non-heroic characters, such as innocent bystanders, pedestrians that happen to be in the way, etc., are automatically transformed into screaming bundles when hit, and remain in this state until attended to.



## DIFFERENT FIRING MODES

There are five different firing modes. Which firing modes that are possible for a weapon depends on its function, as indicated in the «Weapons»-chapter.

All the attacks normally take one action, unless aimed or combined.

**SINGLE-ROUND ATTACK.** With a SINGLE-ROUND ATTACK, make an attack roll with the appropriate skill (Handgun, Rifle, Shoulder-launched weapons, or Grenade launchers.); if it succeeds, roll normal damage. Lose one ammo. The attack can be avoided as normal.

**BURST.** With a BURST ATTACK, make an attack roll with the appropriate skill (as above); if it succeeds you should roll normal damage and make an additional attack roll with the appropriate AUTOMATIC skill (LIGHT if STR-requirement is 16 or less; HEAVY if it's 17 or more). If this roll succeeds, roll normal damage once again. Lose 3 ammo. One single Avoid roll (=one action) can be made for both attacks.

**FULL AUTOMATIC.** A FULL AUTOMATIC ATTACK works exactly as a burst, but make another, third roll if the second roll was successful. Lose 10 ammo. If the target wants to Avoid, separate Avoid roll must be made for each successful attack roll.

**RAPID VOLLEY.** With a RAPID VOLLEY ATTACK, decide how many bullets to fire (min.: 2; max: 5). For each bullet, you make a separate single-round attack, executed as normal. For each bullet, you MAY move your aiming one square, i. e. five bullets could cover a five square width. For the first bullet in the volley you get a -2 penalty and for each additional bullet another -2 penalty to your CS (i. e. 2 bullets: -4, 5 bullets: -10). This modifier applies to ALL the attack rolls. If the target wants to Avoid, separate Avoid roll must be made for each successful attack roll. The attacker MUST finish the volley, i. e. fire as many bullets as announced in the beginning.

**AREA SPRAY.** With an AREA SPRAY ATTACK,

decide how large an area you want to cover (min: one target; max: 90°). All combatants within line of sight in the chosen area are each subject to ONE attack roll with the appropriate Automatic skill (Light or Heavy) with -3 on CS. Avoiding characters have +3 on their Avoid SV if they try to avoid this type of attack. Lose 20 ammo. This attack cannot be aimed.

## PERFECT HITS AND FUMBLES

A PERFECT HIT can never be avoided. It automatically inflicts maximum damage (can not be less than 3) without any deductions for Armor Value. For grenades, incinerators, and other weapons that affect multiple combatants, only one of them takes maximum damage, the others take normal damage but may not avoid. A perfect hit with an automatic attack means that only THAT attack roll inflicts maximum damage, not the subsequent, and only against one target.

A FUMBLE is always a miss, even if the barrel is inside the mouth of an unconscious victim or the blade rests against his throat. The result is that you automatically lose your following 1d6 actions, even if they span into subsequent rounds. During this time, you may not perform ANY actions at all, not even Avoiding or taking cover. Also, see Weapon Jams and special rules for fumbling hand grenades.

## RELOADING

You may not execute an attack unless you have sufficient ammo, and when you are out of ammo, you must reload. Reloading time depends on the weapon, and the figure given under «Reloading time» (see «Weapons»-chapter) is the number of actions it takes to switch magazines or belts or to fill an internal magazine completely. During these actions you may not do anything else.

To reload, make a skill roll in the appropriate skill (light automatics for SMGs, etc.). If it succeeds, everything is fine and the weapon is ready to be used after the given number of actions. If it fails, you must try again during the next action. If you fumble, you drop the magazine (use the Grenade chart to see where it lands) and must spend actions to go and get it, and then you may start all over.

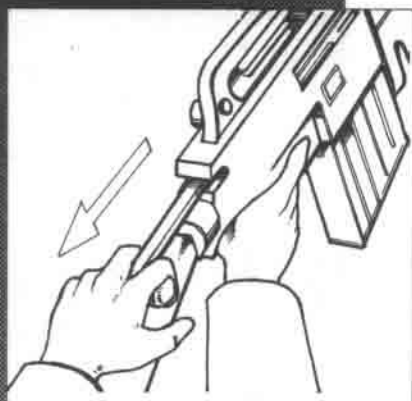

## WEAPON JAMS

If you're fumbling with a firearm, roll another d10. If the result is HIGHER THAN the Jamming factor of your weapon, it is jammed. If the weapon is not jammed, you only lose the «normal» d6 actions.

To fix a jam, you must succeed with two skill rolls in

the most appropriate skill (Heavy Automatics for carbines and machine guns, etc.). Each skill roll takes one entire Combat Round, during which you may not do anything else. If the skill roll fails, the CR is lost. The weapon may not be used for missile attacks in the meantime.

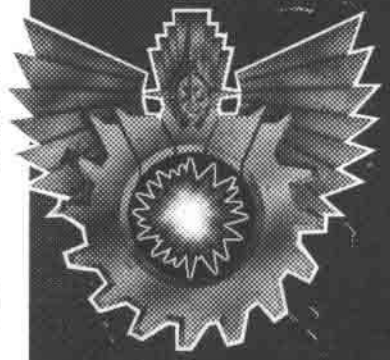

## CALCULATING THE ATTACK RESULT

If an attack succeeds and is not avoided, it inflicts damage, i. e. the target is hit.

- 1 Roll a d20 to determine hit location/target area
- 2 Roll the proper damage dice for the weapon
- 3 Subtract the target's Armor Value
- 4 The result is the number of hits the target takes from the BPs in the Target area
- 5 Apply the effects of the damage immediately

### HIT LOCATION

There are two tables to determine where the attack hits, one used in missile combat and one used in melee combat. Roll a d20 and find the value in the correct column. Follow the line to the right and read the hit

#### HIT LOCATION TABLE

Close combat	Missile combat	Hit location
1-3	1-3	Left leg
4-5	4-6	Right leg
7-9	7-8	Left arm
10-12	9-10	Right arm
13-15	11-14	Stomach
16-18	15-19	Chest
19-20	20	Head

location. Special actions (such as aiming), weapons (like hand-grenades and incinerators) have special rules for this (see below).

### FIRING AGAINST OBJECTS

Making attacks against vehicles and buildings works almost like ordinary combat, except that the GM may have to make his own table for hit locations. Also, it is possible to fire through walls and shelters, which in that case works as extra armor. The AV:s for different materials are given below.

Material	AV
Wood	1 per inch
Stone	3 per inch
Steel	5 per inch
Normal indoor wall	6
Normal outdoor wall	15

If firing against a moving vehicle, the GM should apply a negative modifier of -3 to -15.

## SPECIAL WEAPONS DAMAGE

### GRENADES

Grenades are either thrown (hand-grenades) or fired with a barrel-mounted grenade launcher. It takes one action to LAUNCH a grenade and it always explodes on impact (=immediately).

The hand-grenades take two actions to use; one to arm it and one to attack (this second action may be a Charge), and it explodes at the end of the second action. It is possible to throw it in the first action to avoid losing your hand in a fumble, but you get -5 on the attack roll and the grenade will, if possible, continue 1d4 squares (1d6 meters) in a straight line after it has landed.

All grenade damage may be avoided as normal, but separate Avoid-rolls must be made for each piece of shrapnel that hits.

When using a grenade, choose one target square. The line of sight may be traced through squares blocked by miniatures, but not through walls and other obstructing

objects. If the attack roll succeeds the grenade lands and explodes in the intended square. If the attack roll is unsuccessful, roll a d10 and refer to the chart to see where the grenade explodes. If this is impossible (something is blocking), it explodes on impact with the blocking structure.

Everyone within shrapnel range (SR) and line of sight of the detonation are subject to grenade shrapnel. Depending on the grenade, between 1 and 1d10 shrapnel will hit, EACH inflicting the given damage. Separate hit locations are rolled for EACH shrapnel (damage roll), and it is quite possible to get multiple hits

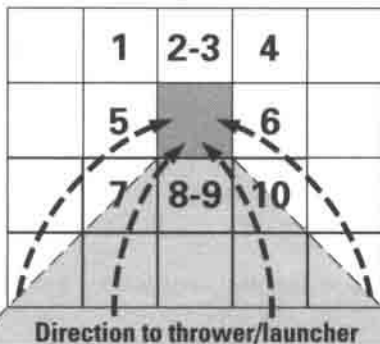

If the skill roll fails, roll 1d10 and refer to the diagram to see where the grenade detonates.



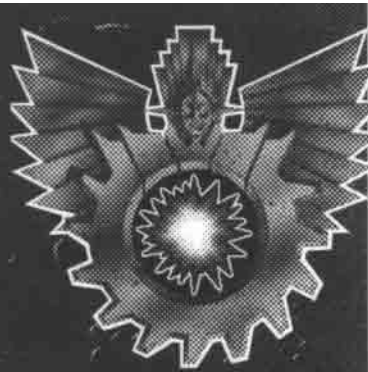

in the same body part.  
*Example: The GL-240 grenade launcher has the following stats:*

#TA (# Target Areas): 1d3

SR (Shrapnel Range): 1

DAM (Damage): 1d6+1

*This means that all targets within range 1 (squares adjacent to detonation) take 1d6+1 points of damage in 1d3 Body Parts.*

**FUMBLING A HAND GRENADE.**

There are two ways to release a hand grenade, in one or two actions (see special rules for hand grenades). If you chose the «slow» method, roll another d10 and consult the Grenade chart to determine where it explodes. Results «9» and «0» means it explodes at your feet (in the center square).

If you've chosen the quick way to get rid of it, in one action, you can cancel the fumble by spending another action (provided you have one left) and try again,



making a new «quick release» in action number two. However, if this is also a fumble, see above.

**INCINERATORS**

Incinerators emit a stream of fire which is directed against one target. All targets in the line of sight between the attacker and the target square take normal damage in 1d4 body parts. Armor protects as it does against fire.

Incinerator fire can be avoided as normal, one Avoid-roll is made for the entire attack. The damage rolled is decreased with one per every second square of range (round down); if the range is 7, the damage is reduced by 3.

**SHOTGUNS**

Shotgun attacks are made as normal, but hit location and damage is rolled and applied twice. Another difference is in avoiding; even a successful Avoid-roll won't fend off all the small fragments inside the shotgun cartridges, but only halves the damage (round down; not less than 1). «Slugs» (a special kind of ammunition with only a few, very sharp fragments) are avoided as normal.

*Example: McBride is subject to a successful shotgun attack, the damage rolls were 6 in the chest and 3 in the head. However, McBride makes his Avoid-roll, and therefore the damage is reduced to 3 in the chest and 1 in the head.*

**EFFECTS OF DAMAGE**

**ARMS.** When you have only ONE HIT LEFT in an arm, you have -5 on your CS in all attacks and all skill rolls where you have to use that arm. When you have NO HITS LEFT, you may not use that arm at all.

**LEGS.** When you have only ONE HIT LEFT in a leg, you move one step less per action than normal. When you have NO HITS LEFT, you move two steps less than normal. The effects are cumulative, so if both legs are out, you move four steps less than normal.

**STOMACH, CHEST AND HEAD.** When you have only ONE HIT LEFT in the stomach, the chest or the head, you may make one action less than normal each round. When you have NO HITS LEFT, the pain is so intense that you pass out and are rendered unconscious. The effects are cumulative, so if both chest and stomach only have one hit left, you may make two actions less than normal.

critically wounded limb bleeds so much that you must lose one body point from your CHEST every second CR, so eventually you will bleed to death unless you're attended to. The bleeding can be stopped with a successful Medicine skill roll (takes three entire CRs and requires first aid kit or equivalent).

If the head, chest or stomach is critically wounded, you die.

**HEALING & MEDICAL CARE**

Natural healing for normal damages is TWO BPs every day in all damaged body parts, provided you're under medical care (i. e. lying like a parcel in a hospital bed with kind nurses and skilled doctors running all around you). If you're only resting as usual at home, you heal ONE BP per day. If you have to get up and move around, you heal ONE BP EVERY SECOND day.

Critical wounds heal at half this rate (they are considered critical until the body part has reached zero BPs).

All these healing rates can be boosted by drugs and surgery.

*Example: A critically wounded leg (normal BP 8, currently at -6), will take 10 days to be completely restored in the hospital (6 days to reach zero, 4 days to reach eight). If you're lying low in a sewer as to avoid inquisitive doctors, it will take 20 days, and if you're on the run and must change your shelter twice every day, it will take 40 days.*

**CRITICAL WOUNDS & BLEEDING**

In short, a body part with zero body points left is useless due to pain and shock. When the body points in a body part go below zero, it has become seriously wounded.

An arm or a leg which has taken TWICE AS MANY body points as its maximum is considered CRITICALLY WOUNDED and must come under qualified medical care within the hour, or else it will be permanently useless. Also, a

## SPECIAL SITUATIONS

### DAMAGE FROM FIRE AND HEAT

Natural fire causes 1 BP of damage per CR in all exposed body parts. Non fire-proof armor protect with their normal AV, but the AV is decreased by one every CR. When AV reaches zero, the armor is destroyed by the fire and doesn't protect any more. Fire-proof armor works similarly, but are considered to have AV 10, and they don't lose any AV.

Being exposed to extreme heat, for example standing in a burning room without being in contact with the flames, causes 1 BP of damage every third CR. Non fire-proof armor protects as against fire, fire-proof armor gives full protection.

### DAMAGE FROM FALLS

A falling character takes 1d6 BPs in damage from a three meter fall (determine hit location with the melee table or logically). After the first three meters, add +1 to the damage and one body part per meter. Armor does not protect against falling damage, except helmets, which only protect the head.

*Example: McBride falls five meters out of a window. According to the rules, he takes three times 1d6+3 BPs of damage. McBride struggles and tries to land on his feet, and the GM allows him to make an Agility roll to see if he makes it. The roll succeeds, McBride lands on his feet, and the GM decides that he only takes two damage rolls, one in each leg. McBride rolls (9) and (5); the GM decides that the left leg is broken and the right ankle is sprained.*

### POISONS, DISEASES & GASES

There are billions of different poisons, diseases and gases in the world of *Mutant Chronicles*, and even describing a small portion of them would be waste of

space. Let's be satisfied with a description of how to check if they have an effect or not.

All poisons, diseases and gases have a Difficulty level (DL), which is compared with the victim's PHY on the Resistance table. If the STUFF «wins», the character suffers its full effects. If the CHARACTER «wins», he only suffers half the effect. If the result is an «automatic success», nothing happens.

### EFFECTS OF ARMOR

#### PENETRATION ON VEHICLES

If you fire against a vehicle, hit and penetrate its armor, this can have several more or less bad consequences. For each penetrating hit (i. e. at least 1 «body point» of damage after AV is deducted), make one roll on the Vehicle Damage Table. Add the number of «body points» of damage inflicted to the 1d10-roll.

**NOTE: Heat-seeking missiles add +10 to Chance of Success on «To hit-roll» AND +1 to ALL «1d10»-rolls on the Vehicle Damage Table.**

*Example: McBride makes a full automatic attack against a «Grapeshot» Assault Helicopter with a Southpaw automatic rocket launcher. The GM decides that firing against this distant, small, moving target gives him a modification to CS of -10. He makes the first Shoulder-launched weapons skill-roll, but fails the second (Heavy automatics) skill roll, and therefore can't make a third roll. He loses 10 grenades.*

The «Grapeshot», of course, can't Avoid. The «#Target areas»-roll (1d6) is (3). McBride rolls 3 times 1d10+6 to determine the damage: (8), (14) and (9). Deducting the «Grapeshot's» AV of 6 means that the modifiers to the three rolls on the Vehicle Damage Table are +2, +8 and +3, respectively. Should the «Grapeshot» have had AV 10, only one roll would have been made, with a +4 modification.

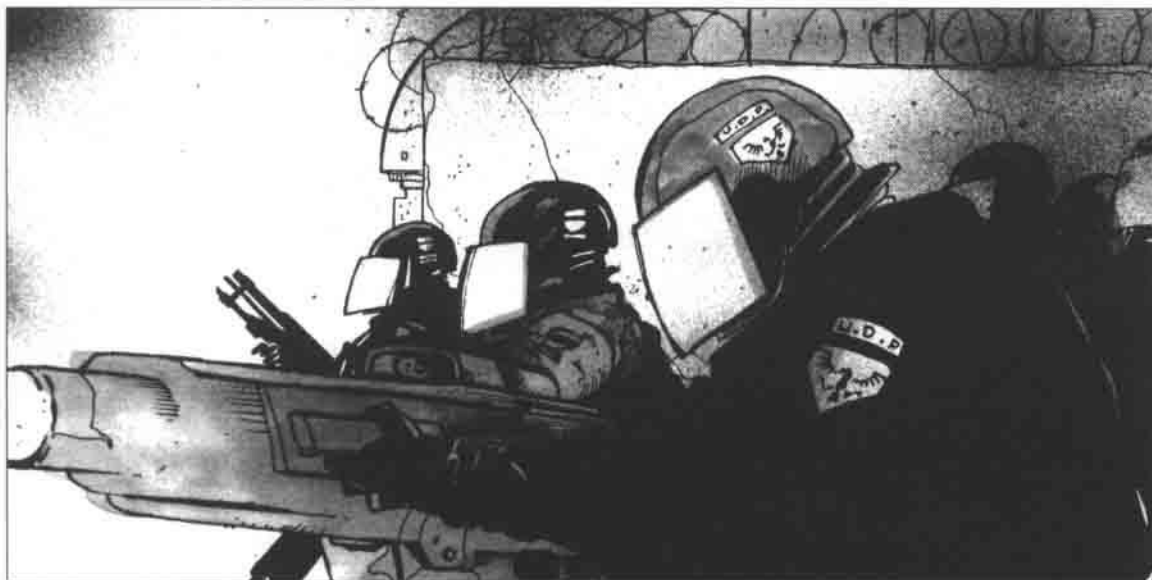
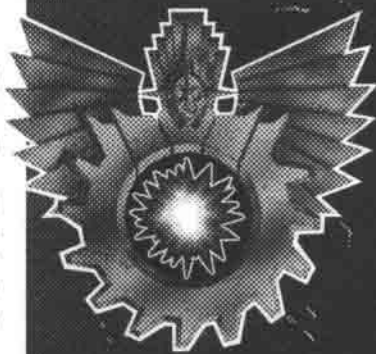



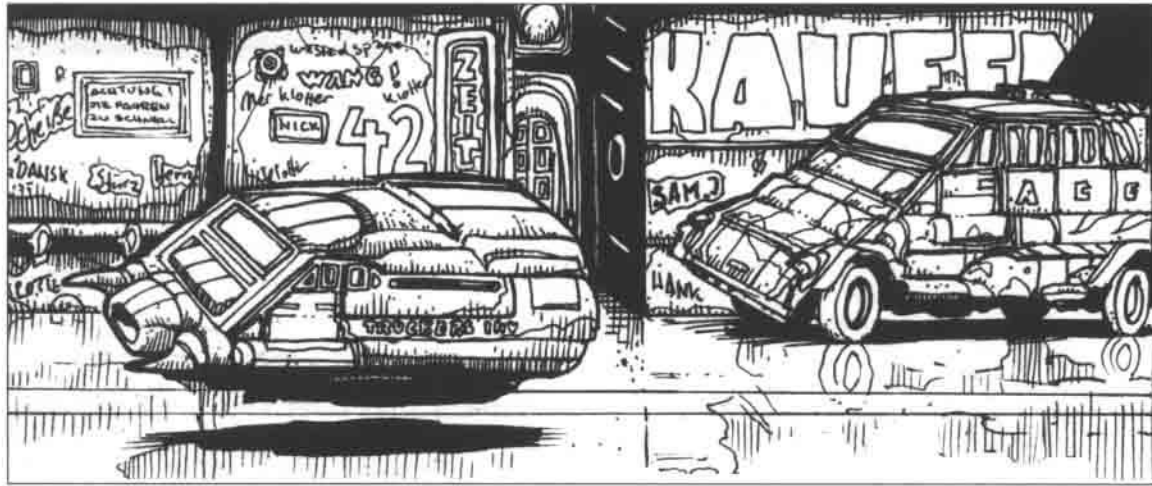

### VEHICLE DAMAGE TABLE

1d10+mod	Effect
1-9	No damage.
10-15	Minor damage. Make a second 1d10-roll to see what is damaged: <ol style="list-style-type: none"> <li>(1) COMMUNICATION GEAR.</li> <li>(2) A WEAPON. Will be jammed until it is taken to the shop.</li> <li>(3) FUEL HOSE. The vehicle will run out of fuel in one minute.</li> <li>(4) A WINDSCREEN. The vehicle must reduce speed to max 30 mph.</li> <li>(5) TIRE/LANDING GEAR. A ground vehicle must reduce its speed to max 30 mph; an aircraft will suffer a 10% risk of crashing at landing.</li> <li>(6) BRAKES. From now on, the vehicle can only slow down naturally, or by running into something.</li> <li>(7) EXHAUST PIPE. The engine will choke and suffer result «8» below in one minute.</li> <li>(8) ENGINES. Engine breakdown; a ground vehicle will stop on the spot, an aircraft must make an emergency landing.</li> <li>(9) reroll twice, ignoring results of 9 and 10.</li> <li>(10) reroll three times, ignoring results of 9 and 10.</li> </ol>
16-17	Clean hit. One of the crew/passengers takes 1d10 points of damage in 1d6 body parts, determine randomly who, and calculate the effects logically (i. e. if it's the pilot or driver; tough luck).
18-19	Very clean hit. One of the crew/passengers is killed, determine randomly who, and calculate the effects logically.
20+	Critical damage. Make a second 1d10-roll to see what is destroyed: <ol style="list-style-type: none"> <li>(1) COMMUNICATION GEAR. Also, see result «16-17».</li> <li>(2) A WEAPON. Ammunition storage explodes. Everyone in the vehicle suffer the effects of result «16-17».</li> <li>(3) FUEL TANK. The entire vehicle explodes immediately. Everyone in the vehicle suffers the effects of result «16-17».</li> <li>(4) A WINDSCREEN. The vehicle must reduce speed to max 30 mph, also see result «16-17» 1d6 times.</li> <li>(5) WHEEL/LANDING GEAR. A ground vehicle crashes; an aircraft will immediately crash upon landing.</li> <li>(6) GAS REGULATOR AND BRAKES. From now on, there's only one way of stopping the vehicle—crashing.</li> <li>(7) EXHAUST PIPE. Engine breakdown; a ground vehicle will stop on the spot, an aircraft must make an emergency landing.</li> <li>(8) ENGINES. Engine and fuel and ammo storage explodes immediately. Everyone within 15 meters of the vehicle suffers the effects of result «16-17».</li> <li>(9) TOTAL ARMAGEDDON. Everyone within 15 meters of the vehicle suffers the effects of result «18-19».</li> <li>(10) reroll twice, ignoring results of 10.</li> </ol>

## COMBAT MODIFIERS

The following are modifiers specific for combat situations. Also, see the general modifiers given in the «Fields of expertise»-section of the rules.

Situation	Attack roll modifier
Rapid volley attack	-4 to -10
Area Spray	-3
Charging (missile)	x0,5 (rounded up)
Charging (melee)	-4 or -8
Aimed attack	+3 to CS OR ±5 to hit location roll
Attacking someone covering up	-5
Running target	-3
Rapidly moving target	-5
Dark (dusk, dawn, shady alley)	-1
Very dark	-5
Target static (unconscious, etc.)	+2
Attacker wounded	-1
1 hit left in «attack arm»	-5
Range	varies

Situation	# Avoid rolls allowed/required
Single round attack	1 avoid roll
Burst attack	1 avoid roll goes for both attack rolls
Full automatic attack	Separate avoid rolls must be made for each successful attack roll
Rapid volley attack	Separate avoid rolls must be made for each successful attack roll
Area spray attack	1 avoid roll with +3
Grenades	1 avoid roll must be made against each shrapnel
Incinerators	1 avoid roll goes for entire attack
Shotguns	Successful avoid roll halves the damage, but doesn't avoid the attack
Taking cover	Any number of avoid rolls may be made during the round, but NOTHING else
Covering up	As normal

## COMBAT EXAMPLE



McBride and his two friends Martin and Bentoni are ambushed by four gangsters in an alley (all combatants have three actions and no armor). The players roll for initiative and GM rolls for the crooks, and the results are:

McBride	26
Crook #1	24 (8)
Martin	24 (5)
Crook #2	23
Crook #3	19
Bentoni	18
Crook #4	15

Since both Crook #1 and Martin had the same result, they rerolled 1d10 each, and since Crook #1 had a higher result, he got the initiative over Martin. McBride, with the highest initiative, is supposed to act first, but instead he chooses to move last of all, so that he can wait and see what happens.

1. Crook #1 makes his three actions (moves, fires at McBride, and moves again). The attack is successful despite the -2 penalty for range, and McBride spends one action trying to avoid the attack. He makes the Avoid-roll, and nothing happens except that McBride loses one action.



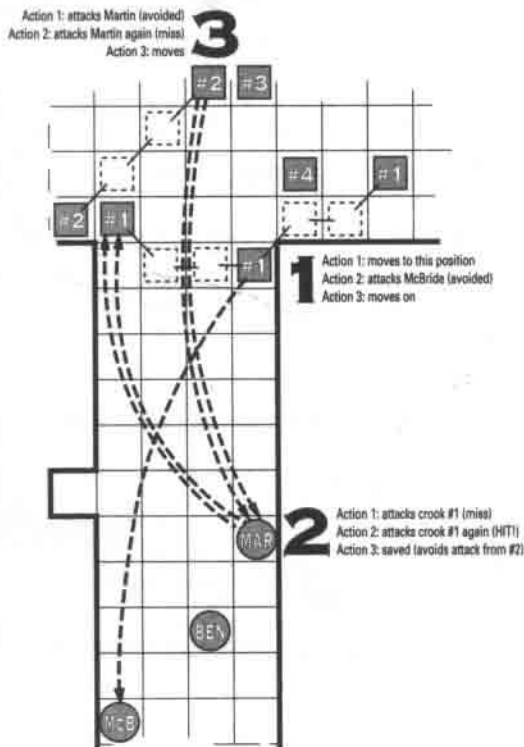

2. Martin also has three actions; he fires twice at Crook #1 and saves his last action for later. He has a -1 penalty for range (7 squares). The second attack is successful, and since Crook #1 has already used all his actions, he may not avoid. Martin rolls hit location, a <20>! Crook #1 takes 4 hits in the head and passes out.

3. Crook #2 fires once at Martin, who is closest, hits, and Martin uses his single saved action to avoid. He makes the roll, so nothing happens. The crook fires another time, misses, and spends his third action moving into cover behind a corner.

4. Crook #3 makes a full automatic attack at Martin, who may not avoid any more. The first roll (with the «Pistol»-skill, since he holds his CAR-24 in one hand) hits, and Martin takes 3 hits in the chest. Also the second roll (skill:Light automatics, since the CAR-24 only has STR-requirement 15) succeeds, 4 hits in the right arm, but the third roll fails. Crook #3 continues with his second action, another full automatic attack at Martin. The first roll is a hit, another 3 hits in the chest, but the second roll misses (and therefore no third roll is made). Martin, who only saved one action for avoiding, is now badly wounded. Crook #3 uses his last action to move away from the player characters' line of sight.

5. Bentoni hasn't done anything so far. He spends his first two actions to move up to a good position to fire at both Crook #3 and #4, who stand in adjacent squares, and spends his third action to make a rapid volley attack with four bullets, two at each target, which means he has -8 on all his attack rolls (no range penalty, though). The first bullet hits Crook #3 in the right arm inflicting 6 hits, rendering it useless. The second hits Crook

#4, who spends his first action of the round to avoid it, easily. The third bullet, aimed at Crook #3, misses, and the fourth hits Crook #4, who spends his second action, trying to avoid it. He fails and takes 5 hits in the stomach, meaning he has only one hit left.

6. This means that Crook #4 loses one action per CR, and since he has already spent two actions on avoiding, he may not do anything more this round.

7. It's finally McBride's turn. He has spent one action on avoiding and has two left. He is last and can summarize the skirmish so far; Crook #1 has passed out, #2 is OK, standing behind the left corner, Crook #3 got his right arm shot off, even though he covered up behind the right corner, and Crook #4 is seriously damaged in the stomach. McBride decides this is a good opportunity to use his Tirpitz shrapnel grenade. He aims at the square immediately left of Crook #3 but fails with his skill roll. The GM rolls a d10, a <4>, and consults the grenade chart to see where it lands—at Crook #4's feet!

8. The grenade inflicts 1d6+1 of damage in 1d4 body parts on both Crook #3 and Crook #4, and none of them may avoid (they have no actions left)! McBride rolls damage for Crook #3—3 hit locations: 4 hits in right leg, 2 hits in the stomach, and another 6 hits in the right arm, making it critically wounded. As for Crook #4, McBride rolls a <1> when rolling 1d4 to determine the number of hit locations, meaning that only one body part is damaged. He rolls hit location, a <12>! Another 3 hits in the stomach, and Crook #4 is also out.

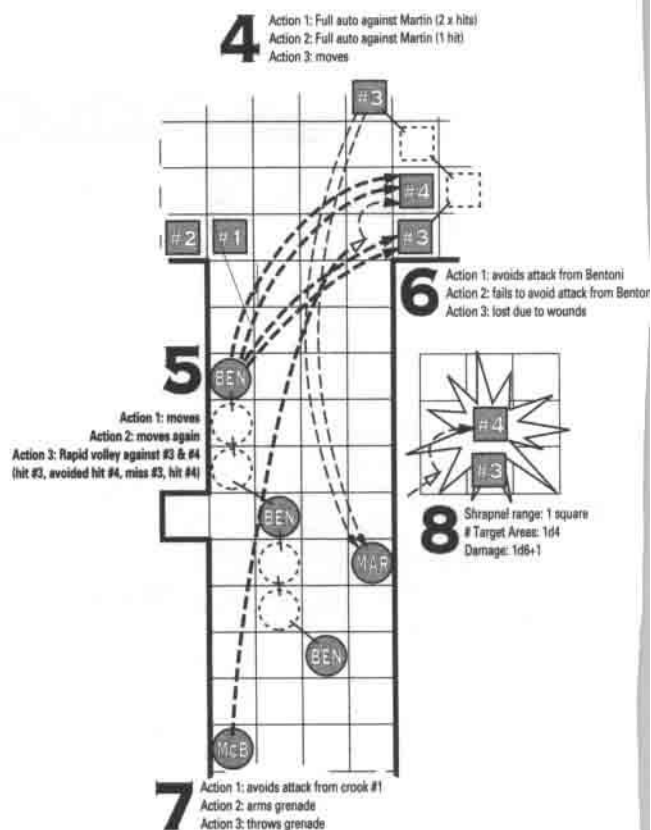

# THE ART

**THE ART** is the merchants' name for the mystical astral powers that, with the proper training, can be used to manipulate reality.

The Art was given to the Cardinal Nathaniel so that he could do battle against the Dark Legion. It is a sacred source of power, and under the guidance of the Cardinal it has been researched and attempts to control it have been made. So far only some aspects of the Art are understood. It is known that it can be controlled by men pure of thought and soul and shaped through the use of the **ART OF KINETICS**, both for attack and for defense.

But it is not only for war and destruction that the power can be used. The Seers, who perform the **ART OF PREMONITION**, spy on the Darkness, gazing out across the void and into the swirling clouds that shroud our past and our future.

The Mystics that devote their studies solely to the **ART OF CHANGELING** become the masters of interrogation and mind-reading, of illusion and exorcism.

The Art is often described and visualized as the **WHITE LIGHT**. By reflecting, focusing, breaking and dividing the white light into colors and patterns, it creates effects beyond the normal laws of nature.

— *The Sixth Chronicle, The Crusades and the Inquisition \ Galileo Achrostidies*

## THE DIRECTORATE OF THE MYSTICS

The First Directorate of the Brotherhood is a mysterious organization devoted solely to studying the Art and finding ways of using it for the benefit of the Brotherhood.

In enormous halls the apprentices sit, going through the **TOMES OF CONTROL**, studying the flow of the light and ways of shaping it into spells. The older brothers help in their education, sharing their power and experience with their younger adepts.

Within the First Directorate there are three larger cells, each devoted to one dominant aspect of the Art; the **CELL OF THE DISTORTERS** (the Art of Kinetics), the **CELL OF THE SEER** (the Art of Premonition) and the **CELL OF THE CHANGELLORS** (the Art of Changeling).

These three cells all take part in the training of the apprentices, shaping them and preparing them for the future as a Mystic. It is only after the apprenticeship is done and the apprentice has successfully passed the First Trial that he may carry the title of Mystic and use his powers openly.

### THE MASTERS OF THE ART

The art of controlling the powers granted to the Brotherhood is difficult to learn and requires a special talent. The training takes several years and begins at an early age.

Mystics-to-be are recruited from the masses, chosen by the prophets and given a new life with the Brotherhood. They have great opportunities to become powerful users of the Art.

The Inquisitors of the Second Directorate also have the possibility of learning how to master the Art. Apart from their devotion to the Art of War, they may learn the spells of the mystic Arts, even though they can never be as powerful as the devoted Mystics.

**TO THE GAMEMASTER.** For the players this means that the only characters who control the Art are the Mystic and the Inquisitor. These two backgrounds are special and are described separately from the others. Unless the player chooses to play a Mystic or an Inquisitor, his character can never learn the Art. If he wants to use mystic energies the only other option is to join the ranks of Darkness.

### THE LEVELS OF PERFECTION

A Mystic is ranked according to his skills and his control of the Art. This is represented by **LEVELS OF PERFECTION**, which is a measurement of how much power he is able to channel through his body to use on the spells. It has nothing to do with what spells he masters or how he is able to shape them, it is simply a matter of how much power he is physically able to unleash.

For example, even an apprentice without any level of perfection can be able to master all known spells of the Art and also know how to use and manipulate them, but he won't be able to channel the power required to use them. At the first level, he holds just enough power to make the effects perceivable, while at the tenth level, he can move mountains.

The higher the level of perfection, the more power a character holds and the more respected he will be. In theory, there are indefinite levels of power within the Art, but few Mystics ever reach past the tenth. Those who do are some of the most powerful beings in the universe. Mystics who reach levels beyond the tenth often join the secret society of the **KEEPERS OF THE ART**. Not much is known about the Keepers as they only answer to the Cardinal, but they are truly magnificent Mystics and heroes in their own time. Using the **LIGHT-METAPHOR**, your level of perfection determines how much light you are able to channel through your body. Until you reach the first level, you can't even channel the faint glow of a burnt-out match, while at the tenth, you can master the all-consuming rays of a burning sun.

### THE ASPECTS

There are many different approaches to channeling the Art and transform the energies into spells with physical effects. These approaches are fundamentally different and will give different results when used. The aspects might be described as colored windows that transform the White Light into blue, yellow, red and green rays.

Every such method—window—is in itself called an Art. There are many such obscure arts within the Brotherhood but the best known is the **ART OF KINETICS**, used by many Inquisitors and the warbands of the Mystics. The two other major aspects are the **ART OF CHANGELING** and the **ART OF PREMONITION**. The three major aspects are described in detail further on in the text.

### THE SPELLS

Within each Art, there are many different ways of manipulating the power—of reflecting, focusing and dividing the light. Each way is called a **SPELL**. Depending on how much power—light—you use for the spell, it will have different effects.

For example, using the Spell of Striking from the Art of Kinetics, you can do anything from bumping someone's shoulder to crushing his ribcage. Alternatively, you can reduce the impact and use the excess power to create a burning flame to add to the attack.



### THE MYSTICS' POWER STABILIZER

The Mystics, the powerful spell-users of the Brotherhood, hold powers that are difficult to control and master. They unleash enormous flows of power, and it is not known if this may have negative side-effects on the Mystics. It is known, however, that novices have spontaneously disintegrated or combusted, been randomly teleported or simply died from heart-failure when the powers have been allowed to play freely.

Therefore, the theologians of the Brotherhood have developed a machine that can sense the flows of power and absorb the excess flows, thereby reducing the risk of overload—the **Power Stabilizer**. They are mostly carried as a security device, as an insurance against mishaps; most Mystics have full control over their doings.

The Stabilizer is an imposing construction carried like a back-pack. Four or more tubes, all depending on the Mystic's power, protrude like peacock-tails over the neck and shoulders of the Mystic. These tubes catch and channel the power into the complicated and secretive machinery in the middle, the power dynamo.

The Stabilizer can also be used as a detector; if there are any abnormal force fields in the vicinity, the stabilizer will sense these and give the Mystic an idea of direction and type.



### FREE EQUIPMENT

All Mystics are given a copy of the Book of Law, blessed by the Cardinal. This book is sacred for the Mystic and he must at all times carry it with him. Also, he is always given all weapons and equipment he will need during a mission, but this must of course be returned.



## BECOMING A MYSTIC

The only way to become a Mystic is to train from childhood. If the player chooses either Mystic or Inquisitor as a starting background, he will have spent his life as an apprentice and will begin the game as a first level Mystic or Inquisitor. The «Base Skill values» are calculated as normal, but the rest of the adolescence development is skipped.

The apprentice is given comprehensive training in the Art, how to control it and shape it into spells. All apprentices are given training in all three major aspects of the Art, and so learn different ways of approaching the channeling. In their future as Mystics, they can choose either to specialize in one Art, or to attain a limited training in two or more Arts. The only way to become really proficient is to specialize in one Art only.

The limit to how powerful a Mystic or Inquisitor can be depends on how much time and effort he spends, and how specialized he wants to become. Since spells can only be developed with the Free skill picks, this is a fine balance, especially for the Inquisitor.

The Inquisitors rarely attain higher levels than 5 as they spend their time tracking down Heretics and staging the purging trials, but exceptions do exist.

### THE APPRENTICESHIP

Instead of normal elementary education, the Brotherhood apprentices receive FIVE PICKS in the Communications field of expertise and TWO PICKS in Movement. In addition they get FOUR FREE PICKS to be distributed in the Combat, Firearms and Special fields of expertise only (NONE OF THESE PICKS MAY BE SPENT ON SPELLS). This replaces their «elementary education» and their «adulthood events rolls», but they get «Base Skill values» as normal.

As apprentice, you are not allowed to use your powers because of the strain on your body and the risk of the dark powers swaying your mind and turning you into a Heretic. Until you have learned how to protect yourself from this influence, you will not be given the rank of Mystic.

Your apprentice is now 16 years of age and will hopefully soon be elevated to the rank of TRUE MYSTIC (perfection level 1) and begin with the background development. As Inquisitor, you must now choose which of the three Arts that you will be able to master. You may only choose one, and this choice will follow you for the rest of your life. As a Mystic, you may change which Art to be tried in between each background development period.

## BACKGROUNDS

The background development differs slightly from that of the normal freelancer characters. The most important difference is that you can never become unemployed, instead, if you fail the

dice rolls, you will be put in the SCRIPTORIUMS to penetrate the Art more deeply before being eligible for a new trial, two years later.

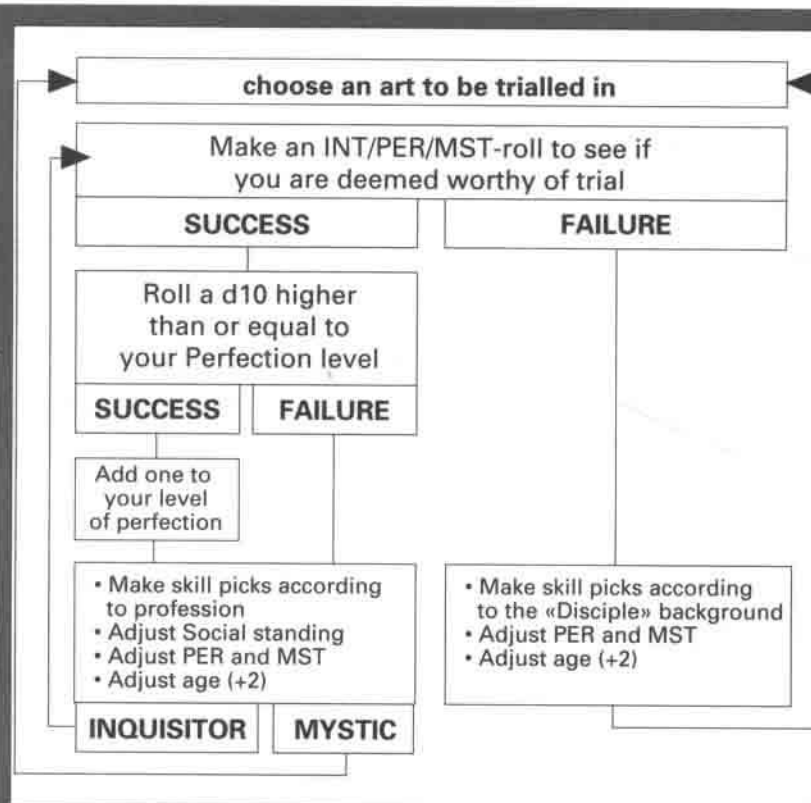

### PROCEDURE

1. Choose an Art in which you want to undergo trial (Kinetics, Changeling or Premonition).
2. Roll a d20. If the result is LOWER THAN OR EQUAL TO your INT, PER and your MST, you may continue, otherwise you are deemed unworthy and must spend another two years of studies before being tried again. See «Studies» below.
3. Roll a d10. If the result is HIGHER THAN OR EQUAL TO your LEVEL OF PERFECTION in the chosen Art, you pass the trial (0 is ALWAYS success). Continue at (4) below. If the roll is LOWER than your level of perfection, you may make the skill picks for your profession, but you are not elevated. Continue at (5).
4. Raise your perfection level in the chosen Art by one.
5. Make your skill picks according to your profession (Inquisitor or Mystic, which

Art you've chosen doesn't matter). Adjust your PER, your MST and your social standard. Add (2) to your age and apply any aging effects.

6. Repeat steps 1 through 5 until your character is ready to be part of the game. Since Inquisitors and Mystics are so special, the Gamemaster has to set a limit to how proficient they may be in his adventure. Remember that only a handful of Mystics have reached over Perfection level 10. It is a good idea to tell the player his limit BEFORE he starts.

**STUDIES.** For each period of studies (always takes two years at a time), make skill picks according to the «disciple» background. This is executed as normal background development, but you don't acquire any perfection level.

## BACKGROUND DESCRIPTIONS

**REQUIREMENTS.** As normal. The requirements only have to be met at the day you enter your life in the Brotherhood.

**FIELDS OF EXPERTISE.** The «Combat & Firearms» picks may be used from any of these fields of expertise. It is only the «Free» picks that may be used for making spell picks. Others are treated as normal.

**SOCIAL STANDING.** A member of the Brotherhood always has Social standing 5 until he reaches level of perfection

6 in any of the Arts. Thereafter, his Social standing is equal to his level of perfection (10 is maximum).

**PER-MODIFICATION.** As normal

**MST-MODIFICATION.** The extraordinary mental training that Inquisitors and Mystics receive is reflected by the fact that they get a modification to their MST-value everytime the background is repeated. This is treated EXACTLY as the PER-modification.

### INQUISITOR

Inquisitors must specialize in one Art only. They may never change their Art between two background developments.

**REQUIREMENTS:** STR 15, PHY 14, COR 16, INT 12, MST 9, PER 9

Combat & Firearms:	3
Communication:	3
Movement:	1
Technical:	—
Free:	4
Social standing	±0
PER-modification	+2
MST-modification	+1



### DISCIPLE

This is the way you HAVE TO go if you don't stand up to a trial for elevation. It is not in any way considered dishonorable, but it surely slows your career to be at school for two years.

**REQUIREMENTS:** As for the profession (Inquisitor or Mystic)

#### Inquisitor Mystic

Combat & Firearms:	3	—
Communication:	2	1
Movement:	1	1
Technical:	—	1
Free:	3	5
Social standing	±0	±0
PER-modification	+0	+0
MST-modification	+1	+2



### MYSTIC

Mystics MAY change which Art to be tried in between background development occasions.

**REQUIREMENTS:** STR 9, PHY 9, COR 12, INT 13, MST 13, PER 9

Combat & Firearms:	—
Communication:	2
Movement:	1
Technical:	1
Free:	6
Social standing	±0
PER-modification	+1
MST-modification	+3



### THE SACRIFICE

A Mystic who gains any form of treasure or possessions during adventuring is pledged to give these to the Brotherhood. This is called «the Sacrifice» and is a sacred tradition within the Brotherhood. Breaking this tradition is equal to heresy and punishable by Inquisition. Most of the assets gained in this way are used for administrating and running the First Directorate.

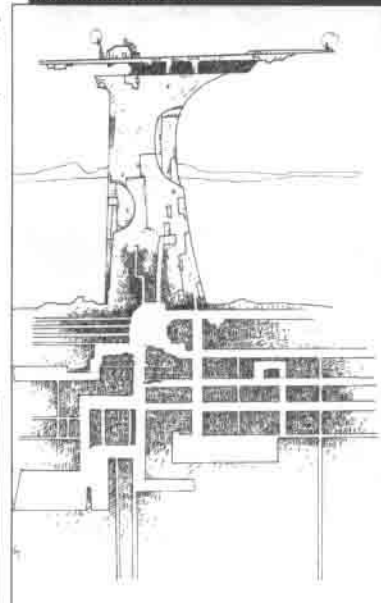



## PERFECTION LEVELS

- 0 Apprentice
- 1 True Mystic
- 2 True Mystic/  
Mysticus Minoris
- 3 True Mystic/  
Mysticus Mediatoris
- 4 True Mystic/  
Mysticus Majoris
- 5 Lord Mystic
- 6 Lord Mystic/  
Mysticus Plebeius
- 7 Lord Mystic/  
Mysticus Autonomus
- 8 Lord Mystic/  
Mysticus Patricius
- 9 Archmystic
- 10 Archmystic/Dominator
- 11 Archmystic/Divinator
- 12 Archmystic/Canonizer
- 13 Princeps Mysticus
- 14 Rex Mysticus
- 15 Grand Mystic
- 16+ Keeper of the Art

**NOTE:** «Mystic» may in all cases be exchanged for Distorter, Changellor, Seer or Inquisitor.



## LEARNING SPELLS

Learning how to use spells is done in two steps—first, you have to learn the SPELLS themselves, the phrases, gestures, patterns, etc.; and second, you have to learn how to control the power, the light, in such a way that the spells are effective.

Each of the three Arts can be described as three different fields of expertise, and in that case, each spell is a skill.

Spells are developed exactly as any normal skill. They can only be purchased with the «Free skill picks». You get a Skill value in all spells, just as normal, and when you use them, you make skill rolls just as normal. The perfection level you have reached only determines the effect of the spell. Perfection levels can never be «purchased», they are only automatically acquired through elevations (=background repetitions).

### USING A SPELL

It takes one action to use a spell, and it takes effect immediately. What effect a spell has depends on how much power you put into it. You have two limits for this—your PERFECTION LEVEL and your MENTAL STRENGTH-value. The power put into a spell is measured in MAGNITUDES (MGs). A spell of the first magnitude is the weakest, and a magnitude 10 spell is more than most Mystics are able to handle. The magnitude can normally not be higher than the perfection level that the Mystic has reached in the Art that the spell belongs to.

Further, each magnitude put into a spell will cause the Mystic to temporarily lose 4 points of MST. Thus, a Mystic with MST 14 will not be able to throw spells of more than the third magnitude. If the MST reaches zero, the Mystic passes out from the mental exhaustion. If he reaches BELOW zero, his soul withers and dies. Temporarily lost MST-points are regained by resting; one point per one hour of undisturbed rest (i. e. sleep or meditation).

### MODIFICATIONS TO THE SKILL ROLL:

- Normal spells:
- The Mystic's perfection level in the Art he is using is ADDED to the chance of success.
  - The magnitude of the spell is always DEDUCTED from the chance of success.
- Normal combat modifications are also used in combat situations, for example modifications for stress or wounds.
- Some spells (i. e. TELEPATHY, DOMINATION, HYPNOSIS, COMMAND, EXORCISM and EMPATHY) affect the mind of the target, and in this case, use the following modifications. (Also, there are special rules for failure; refer to the spell description.)
- The target's MST is DEDUCTED from the chance of success.
  - The magnitude of the spell is ADDED to the chance of success.
  - The Mystic's perfection level in the Art he is using is ADDED to the chance of success.

### INTERPRETING THE SKILL ROLL

Using a spell is done exactly the same as using an ordinary skill.

## DESCRIPTIONS OF THE ARTS

The three major aspects and six spells associated with each are described here. They are all given in the same format:

- AREA OF EFFECT:** How large an area the spell affects. P=Personal; it only affects the Mystic.
- RANGE:** The maximum range of the spell, from user to target. P=Personal; it only affects the Mystic. T=Touch; the Mystic must touch the victim.
- DURATION:** How long the effect lasts. I=Instantaneous, C=Concentration; as long as the Mystic concentrates.
- DAMAGE:** Any damage caused by the spell.
- NOTE:** All stats are for a spell of the first magnitude. In the spell description are given the effects for increasing the magnitude.

**PERFECT SUCCESS.** If you roll a «1» when making the skill roll for the spell, the magnitude is automatically increased by TWO, at no extra «cost» of MST-points. The mystic decides himself what effects the extra magnitudes have.

**SUCCESS.** A successful skill roll means the spell works.

**FAILURE.** A failed skill roll means the spell loses TWO magnitudes. However, it draws 8 MST-points less than normal. The mystic decides himself which effects the lost magnitudes had, i. e. in what way the spell is weakened. A failed spell of the first or second magnitude has no effects at all, and doesn't cost any MST-points.

**FUMBLES.** A roll of «20» means the spell has no effect, and the Mystic must lose the full amount of MST-points.

**EXAMPLES:** Brother Michael throws a STRIKING spell of the first magnitude and the die roll is a «1» This means the spell takes effect as a STRIKE of the third magnitude, but it still only draws 4 MST-points. Michael chooses that the two extra magnitudes causes «extra damage»; 1d6+4 in total.

The next round, Brother Michael tries again, with a STRIKE of the fourth magnitude (3 targets, damage +4), but this time he FAILS. The effect is reduced to the 2nd magnitude, and Michael must lose 8 MST-points (normal cost for a 2nd MG spell). Michael decides that the lost magnitudes were those he put in to increase the damage done, so the total damage is only 1d6. Even though the skill roll failed, the spell hits automatically, but with reduced effect.

Faced with defeat, Michael makes a last desperate try to cripple his opponent. He unleashes another STRIKE of the first magnitude, but FUMBLES! This means he must pay 4 MST-points, even though the spell has no effect at all.

### GAINING MENTAL STRENGTH

During their apprenticeship and through experience, the Mystics develop more and more MST. Every time they make their skill picks, they gain an automatic bonus to the MST-value, as indicated above. Also, in return for one free skill pick, the MST-value may be raised by one. There is no limit to how high the MST-value can be.

*Example:* When Brother Michael (initial MST 16) was elevated to the first perfection level, he gained a +3 bonus to his MST, and he also spent two free skill picks on raising his MST, thereby getting a total MST of 21, enough for throwing five spells of the first magnitude per day without passing out.

The temporary losses of MST are recovered by resting, at the rate of 1 every hour.

# THE ART OF KINETICS

## STRIKE

**AREA OF EFFECT:** 1 target.  
**RANGE:** 10 squares/15 meters  
**DURATION:** 1  
**DAMAGE:** 1d6

This spell strikes a hard blow on the target, like a normal missile attack with a firearm. The strike is shot from the palm of the Mystic, and normal line of sight rules apply. As long as you don't fumble the STRIKE will hit automatically, but it can be Avoided as normal.

Added magnitudes will cause the following:

- Range increases with 20 squares (30 m) per extra magnitude.
- Damage inflicted increases with +2 per extra magnitude.
- One additional target within the range is hit.

By adding two magnitudes, the Mystic can choose one of the following additional effects:

- The STRIKE ignites the air that it passes, creating exactly the same effects as an incinerator.
- The STRIKE can be directed at anyone within the range; the target does not have to be within line of sight, but his presence and approximate location must be known (i. e. what room he is in will be enough).

## SHIELD

**AREA OF EFFECT:** 1 x 1 meter  
**RANGE:** 10 squares  
**DURATION:** C (mobile) or 1 min (static)

Produces a flat, blue-shimmering force-field, with an armor value of 4. A mobile Shield may be moved freely as long as the Mystic concentrates (use the skill Parry), but once the concentration is lost, for example if the Mystic is wounded, the SHIELD disappears. A static SHIELD is immobile, as durable as a normal wooden door and must be broken by brute force.

By adding magnitudes, the Mystic can achieve the following additional effects:

- Increasing the area of effect to MG x MG. (A SHIELD of the fifth magnitude will be 5 x 5 meters large.)
- Adding a third dimension (an MG 2 Shield will create a cube 1 x 1 x 1 meters large).
- Increasing the SHIELD's armor value by 2 per extra magnitude.
- Increasing the duration with 5 minutes per extra magnitude.
- Increasing the duration of a mobile SHIELD to 1 min (the Mystic doesn't have to concentrate; additional magnitudes spent on this purpose

increases the duration with 5 minutes each).

## PHANTASM

**AREA OF EFFECT:** P  
**RANGE:** P  
**DURATION:** 10 min

The Mystic creates a true illusion that allows him to adopt the appearance of another humanoid being. The Mystic's artistic skills and photographic memory determines exactly how close the PHANTASM comes to reality. No physical abilities are changed by the spell.

Each added magnitude creates the following effects:

- Extending the duration by one hour.
- When someone tries to see through the illusion, the magnitudes of the PHANTASM and the «dispelment spell» (for example DISRUPT POWER) are compared. Extra magnitudes will thus make it more difficult to see through the PHANTASM.

By spending two extra magnitudes, the area of effect is extended to 1 person AND range is extended to Touch—meaning the PHANTASM can be thrown on someone

else.

## TELEPORTATION

**AREA OF EFFECT:** 1 kg (2 lbs.)  
**RANGE:** T  
**DURATION:** 1

Moves touched object from one place to another, even through walls if necessary. The destination can be any known location within one kilometer.

For each added magnitude, the effect will increase:

- Area of effect increases by 5 kgs (11 lbs.).
- Range increases by 10 meters (you don't have to touch the object).
- Range of teleportation is increased by 10 kilometers.

## LEVITATION

**AREA OF EFFECT:** P  
**RANGE:** P  
**DURATION:** C

This spell causes the Mystic to levitate through the air at a rate of one meter per action. Added magnitudes will cause the following effects:

- Duration 1 minute (every extra magnitude will increase this duration by 5 minutes)
- The Mystic will move forward with a speed of 10 squares (15 m) per action. Extra magnitudes will increase this speed by 10 squares (15 m)/action. (If needed, count one action as two seconds.)
- Range is changed to Touch. Every extra magnitude on top of this will increase range by 10 squares/15 m (has to be combined with an Area of effect increase).
- Every extra magnitude will increase the area of effect by one victim (has to be combined with a Range increase).

## EXPLOSION

**AREA OF EFFECT:** 1 square  
**RANGE:** 10 squares (15 m)  
**DURATION:** 1  
**DAMAGE:** 1d4 (#TA: 1d4; SR: 0)

With this power the Mystic shapes the air into a swirling ball of gases, which then is ignited and thrown at an enemy from the Mystic's palm, exploding on impact (normal line of sight rules apply). Extra magnitudes will cause the following:

- The shrapnel range (SR) is increased by one square for every extra magnitude.
- The number of targets areas (#TA) is increased by +1 for every extra magnitude.
- The damage is increased by +1 for every extra magnitude.
- Range is increased by 20 squares (30 m) for every extra magnitude.



## THE ART OF KINETICS

The Art of Kinetics focuses on the manipulations of material objects. With their minds they can move or even teleport objects. Their powers are often used in combat, for offensive or defensive purposes, since they have the power to create spheres of dense air which either deflects incoming fire or accelerates to become deadly weapons.

Six ways of using the Art of Kinetics are described here:







## THE ART OF PREMONITION

The past and the future are forever shrouded in dark and turbulent clouds, hiding the truth from our gazing eyes. But among the Brotherhood there walk men and women who have the ability to push aside the curtains of time and look upon our past, like we would gaze out from a mountain on a clear day.

These are the Prophets and the Chroniclers. They are Mystics who have been trained from an early age to use the spying powers of the Art to look into the flow of time.

The task of the Chroniclers is to record our history and events that have passed and in doing so bring order to our world.

Looking through the gate to the future are the Prophets, Mystics of great powers. They gaze into the Darkness of unshaped time and try to predict the flow of fate.

The Prophets and the Chroniclers are given enormous vaults, pillared halls and catacombs in the cathedrals. They scribe everything seen in their visions and their enormous ledgers fill shelf after shelf in their endless libraries, to be interpreted by the Seers to come.

As the Seers grow in skill they become more able to look into time and finally the most worthy are elevated to the ranks of Divinators and Canonizers, serving the Grand Inquisitor and the Cardinal.

# THE ART OF PREMONITION

## TELEPATHY

**AREA OF EFFECT:** 1 victim

**RANGE:** 10 squares (15 m)

**DURATION:** 1

(If the victim is unaware or unwilling, deduct the victim's MST from the CS and add the spell's MG plus the Mystic's perfection level to the CS.)

If the attempt is successful the Mystic may scan the victim's mind and instantly get the answer to a direct question.

*Example: «Did this person participate in the assassination of the Inquisitor Marcus?» A successful attempt will produce a positive or a negative answer, an unsuccessful attempt will not give anything. The answer only shows in the Mystic's mind as a sudden premonition.*

An attempt may not be repeated until 24 hours have passed. The victim is always unaware of the Mystic's efforts. The victim's own memories and thoughts are determining the answer, and thus the Art may not be used to tell the future. Also, memories implanted with the aid of DOMINATION aren't susceptible to this Art.

This Art is often used when the victim, for some reason, can't be hypnotized by a Changellor.

If the attempt is unsuccessful, nothing happens. The victim will not be aware of the fact that someone tried to read his mind.

## ITEM VISION

**AREA OF EFFECT:** 1 item

**RANGE:** T

**DURATION:** 1

This Art allows the Mystic to relate objects to past or future events. When touching the object, the Mystic is able to visualize important events where the object plays a part. The more well-defined the Mystic is, the more well-defined an answer will he get.

Every extra magnitude will:

- Increase the range by 10 squares (15 m)
- Specify the Vision given (GMs judgment).
- Add one item to the area of effect.

*Example: The question «Is this the dagger that will slay Nephrite Alakhai?» will, if the answer is positive, show how the dagger pierces the nephrite's armor between the third and the fourth rib, punctures his lung and slits his aorta.*



## PREMONITION

**AREA OF EFFECT:** 1 victim

**RANGE:** 5 squares (7.5 m)

**DURATION:** 1

This spell gives the Mystic a vague glimpse of some future event where the victim will play a significant part. The Seers' studies are strongly directed towards interpreting these glimpses; it is very rare that they are concise. When using the Art the Mystic must specify a certain date, location or event—the more specified, the more exact the vision.

Every extra magnitude will:

- Increase the range by 10 squares (15 meters)
- Specify the Premonition given (GMs judgment).
- Add one victim to the area of effect.

*Example: The question «Will this man be exposed to any hazards during his mission?» might, at worst, be answered with glimpses of chains, necromutants and black suns, which might be interpreted as that he is going to be captured, transformed into a necromutant and brought to a dimension with a black sun.*

*NOTE that it is always the REAL future that you will see—and the future MUST NOT BE CHANGED! The GM must*

*therefore be careful with very distant events; if a character is seen in the vision, he can't die until the event has passed.*

## PRESENCE

**AREA OF EFFECT:** 50 squares (75 m) or a familiar or visible location

**RANGE:** P

**DURATION:** 1

This Art gives the Mystic an instinctive feeling of all presence of the Dark Legion. By giving the spell three magnitudes the vision will be more specified, for example if the presence derives from a human, a creature, an item or a force field. With magnitude five or more, he is able to determine the exact force.

Every extra magnitude (apart from the above) will increase the area of effect with 100 squares (150 m).

## GAZE

**AREA OF EFFECT:** 2 squares (3 m)

**RANGE:** P

**DURATION:** 1

When using this spell the Mystic can gaze through solid materials. It is stopped by lead or any organic matter, such as wood. The vision is unclear and limited.

Each extra magnitude will:

- Increase the area of effect (how far the Mystic can see) by 10 squares (15 m).
- Provide the Mystic with total darkness-vision (very useful in other situations as well).
- Increase the duration by 1 minute.

## TRUE PATH

**AREA OF EFFECT:** P

**RANGE:** P

**DURATION:** 1

When using this spell the Mystic can instinctively choose the right way when presented with a choice. It can also be used to find out which way is the safest. To find the right way the Mystic must phrase a question in his mind. The answer will be an urge to follow one path or the other. (For example, «Which way did the assassin go?» could be answered with an urge to go back, left or right or even nowhere if the assassin is hiding close by).

The more magnitudes spent on the spell, the more exact will the «answer» be. With five magnitudes or more, glowing foot-prints will show the way.

# THE ART OF CHANGELING

## DOMINATION

**AREA OF EFFECT:** 1 victim

**RANGE:** 3 squares (4.5 m)

**DURATION:** 1 or 6 hours

*(If the victim is unaware or unwilling, deduct the victim's MST from the CS and add the spell's MG plus the Mystic's perfection level to the CS.)*

With this Art, a Mystic may implant or erase memories of a victim. For short, simple memories (eg «Forget this conversation»), only 3 MGs are required, the process is instant and only requires a successful skill roll. For longer or more complicated memories, for example replacing the agonizing memories of three months of torture and interrogation with a holiday trip on Venus, maybe 100 MGs are required. The victim must be hypnotized (see HYPNOSIS below) or drugged during the process (it will probably take several days until enough MGs have been spent on the victim).

This Art is often used to eradicate the memories of interrogations or secret missions.

## HYPNOSIS

**AREA OF EFFECT:** 1 victim

**RANGE:** 3 squares (4.5 m)

**DURATION:** Until cancelled, max 24 hours

*(If the victim is unaware or unwilling, deduct the victim's MST from the CS and add the spell's MG plus the Mystic's perfection level to the CS.)*

If the attempt is successful, the victim will fall into a deep hypnosis. The Mystic can command him to perform tasks that lie within his normal physical abilities and that doesn't expose him to obvious hazards. The Mystic must have constant verbal contact with his victim.

The victim will remember what happened during the hypnosis, provided the memories aren't removed, but he will not automatically be aware of being hypnotized.

If the attempt is unsuccessful, nothing happens. The victim will not be aware of the fact that someone tried to hypnotize him.

This Art is often used when interrogating a victim, forcing him to tell the truth.

## COMMAND

**AREA OF EFFECT:** 1 victim

**RANGE:** 10 squares (15 m)

**DURATION:** 1

*(If the victim is unaware or unwilling, deduct the victim's MST from the CS and add the spell's MG plus the*

*Mystic's perfection level to the CS.)*

With this Art, the Mystic can command a victim to perform a sudden action that doesn't require any explanation (eg «Fire!», «Jump!», «Turn left!» or «Hit the brakes!»). The victim will obey the COMMAND instinctively and instantaneously without the slightest trace of reflecting upon the consequences. The COMMAND is sub-conscious and the victim will not know afterwards what got into him.

The Gamemaster should allow up to 5 points bonus to the victim's MST if the COMMAND is exceptionally awkward, for example if a victim is COMMANDED to kill someone (1-5 points) or to harm himself (5 points).

If the attempt is unsuccessful, nothing happens. The victim will not be aware of the fact that someone tried to command him.

## EXORCISM

**AREA OF EFFECT:** 1 victim

**RANGE:** T

**DURATION:** 1

*(If the victim is unaware or unwilling, deduct the victim's MST from the CS and add the spell's MG plus the Mystic's perfection level to the CS.)*

This Art is used when converting

Heretics back to «normal». The magnitude of the EXORCISM must be higher than the heretic's Rank. A successful attempt will convert the Heretic completely, and he will not show any traces of Dark influence, while an unsuccessful attempt lowers the victim's rank by one. A new attempt may be done after 24 hours.

This Art is also frequently used when removing effects of the Dark symmetry from its victims, curing diseases and other signs of the Darkness.

## MIND-WALL

**AREA OF EFFECT:** P

**RANGE:** P

**DURATION:** C OR 1 min per perfection level

This power will help the Mystic fight any dark forces wishing to enter or manipulate his mind. When using this Art the Mystic may add 2 for every magnitude placed in the Art, AND his perfection level to his MST when rolling on the Resistance table in MST against MST-rolls.

This Art costs only 1 MST-point per magnitude. These are deducted BEFORE the roll on the Resistance table is made.

This Art can be used as an «Avoid-roll», i. e. it may be laid AT ANY TIME as long as the Mystic has at least one action left to perform in the CR. Thus, he is able to use a MIND-WALL if he notices that someone is using Dark symmetry.

*Example: A Mystic of the fourth perfection level with normal MST 15 laying a MIND-WALL of the fifth magnitude will have MST 24 when exposed to dark powers (add his MST of 15 to his level, 4, plus 10 points for a MIND-WALL of MG 5 = 29, minus the five points that the spell itself requires, =24).*

## EMPATHY

**AREA OF EFFECT:** 1 victim

**RANGE:** 10 squares (15 m)

**DURATION:** 1

*(If the victim is unaware or unwilling, deduct the victim's MST from the CS and add the spell's MG plus the Mystic's perfection level to the CS.)*

A successful use of this power will reveal the intentions of the victim. It will tell the Mystic if the victim intends him harm or if he comes in peace. The general state of the victim's mind is also revealed (e. g. rage, hate, love, apathy, health, sickness, domination, dislike, etc. The better the skill roll, the more detailed the information).

A failed skill roll reveals nothing at all. A fumble gives false information.



## THE ART OF CHANGELING

The Changelors, as the Mystics of this Art are often referred to, have the power to look beyond the normal mental barriers of men and understand and manipulate their thoughts, memories, feelings, emotions, subconscious activities, etc.

When using this Art of Changeling there is always a struggle between the wills of the Mystic and the victim, providing the victim isn't hypnotized. Therefore, special modifiers are used.



# THE DARK SYMMETRY

And the howling Legions of Darkness descended upon us and wreaked havoc on our worlds. And around them the dark aura shone like a corrupt torch.

The Legions commanded power from the dark pits of other planes and with this energy they corrupted the lands and twisted the world around us.

Strange were the effects of the sorcerous ways of the Legions. The Mystics of Ilian crossed the star-strewn void to enter our minds. The forever damned Legionnaires felt no pain as they marched through the hail of missiles launched by our troops. The Nepharites called upon forgotten names and shaped destructive balls of fire and brimstone. Pain and death could be inflicted upon our troops from the far citadels and no armor could protect against these attacks. None of our fortresses could stand against the power of the Dark symmetry.

— *The Second Chronicle, Ilian and The Dark symmetry* \ Plinius Varro

## THE DARK GIFTS

The Dark Soul projects an aura of power encompassing all its followers giving them profane knowledge and powers. This aura is known as the Dark symmetry.

All beings who have pledged allegiance to the Dark Soul are infused with the spirit of the Dark symmetry. From the lowly Legionnaires and Heretics to the unforgiving Nepharites, all have their place in the complex pattern of the Dark symmetry.

The Symmetry gives the followers of Darkness certain abilities called THE DARK GIFTS. These are powers received either from the Dark Soul or from the Apostle which the creature has pledged its allegiance to.

In the description of each being is detailed what Gifts, if any, it has been given. The Dark Gifts available to all the followers of the Apostles are described in the general section.

## THE PATTERNS

The Apostles have been given different aspects of the Dark symmetry. These aspects are called PATTERNS and are unique to each individual Apostle. The Gifts that can be received from the pattern are detailed under each Apostle's pattern.

It is uncommon but not impossible for followers of one Apostle to have Gifts originating from another Apostle's pattern. This is possible through bargaining. In such cases the Apostles have struck a deal and exchanged dark secrets. It is most common for the Legions of Algoth to have other Gifts as the Demon of Dark Technology often trades his technology to receive other powers.

## LEARNING THE DARK SYMMETRY

You can't learn the Dark symmetry in the way that you learn skills or spells from the Arts. Instead, the Gifts of the Dark symmetry are bestowed upon you, implanted into your mind by a higher being, such as a Nepharite or a Lord Heretic.

Normally, Heretics and other followers of the Dark Legion have some sort of contact with higher ranking followers of Darkness, who can serve as tutors. In these cases, the Dark Gifts are given as rewards for accomplished missions and completed tasks. Also, at the same time, one or more new tasks are given to determine what the Heretic shall do to be presented with the next gift.

### USING THE DARK SYMMETRY

When a being or a Heretic wants to use a Dark Gift he must mentally invoke the flows of the Dark symmetry. The dark aura will pick up the mental signals and shape the Dark symmetry according to the wishes of the one activating it.

There are no such things as Skill values or magnitudes within the Dark symmetry, it is all a matter of mental strength. For each Gift is given a LEVEL between (1) and (25). The level serves two purposes—first, to determine how difficult it is to use, second, to determine how much power it drains. For most spells, the level is not fixed, but can be increased to enhance the effect of the Gift.

*Example: The Gift of CONFUSING has level (6+), which means it is normally level 6, but can be enhanced to have level 7, 8, 24 or whatever. The invoker decides.*

### USING A GIFT

Make a roll on the Resistance-table with your MST on «Basic Capability Value» and the Gift's level on «Difficulty Level». This can have four results:

**AUTOMATIC SUCCESS:** The Gift has the intended effect and drains half its level's points of MST (round up).

**SUCCESS:** The Gift has the intended effect and drains its level's full points of MST.

**FAILURE:** The Gift has no effect but still drains its level's full points of MST.

**AUTOMATIC FAILURE:** Well, anyone can see it is pointless of even trying this, but it can be attempted anyway, making a SUICIDE INVOCATION. If deciding on this, the user's MST is temporarily increased by +10 for this occasion only, and then the roll is made as usual. If the roll succeeds, the Gift has its intended effect and the user loses all his remaining MST-points but one. If the roll fails, the spell has no effect and the user loses 1d20 MST-points on top of the 10 temporary, which will probably kill him.

*Example: Hoss the Heretic (MST 15) tries to invoke TERROR (lv 5). Referring to the Resistance table, this is an «automatic success», meaning the Gift succeeds and Hoss loses 3 MST-points.*

*The next action, he tries to invoke a DARK FIRE of level 22, and since he only has 12 MST-points left, this is a suicide invocation. Hoss' MST is temporarily raised to 22, and he rolls a (9), success! The spell has the intended effects and Hoss now has one MST-point left. Had he failed, his MST would have been 12-1d20, a 40% chance of dying...*

The MST-points are regained at the rate of 1 every hour. If a being loses all its MST-points the soul withers and dies, and the body will become a host or provide raw material.

All Gifts take one entire action to invoke (not even moving is

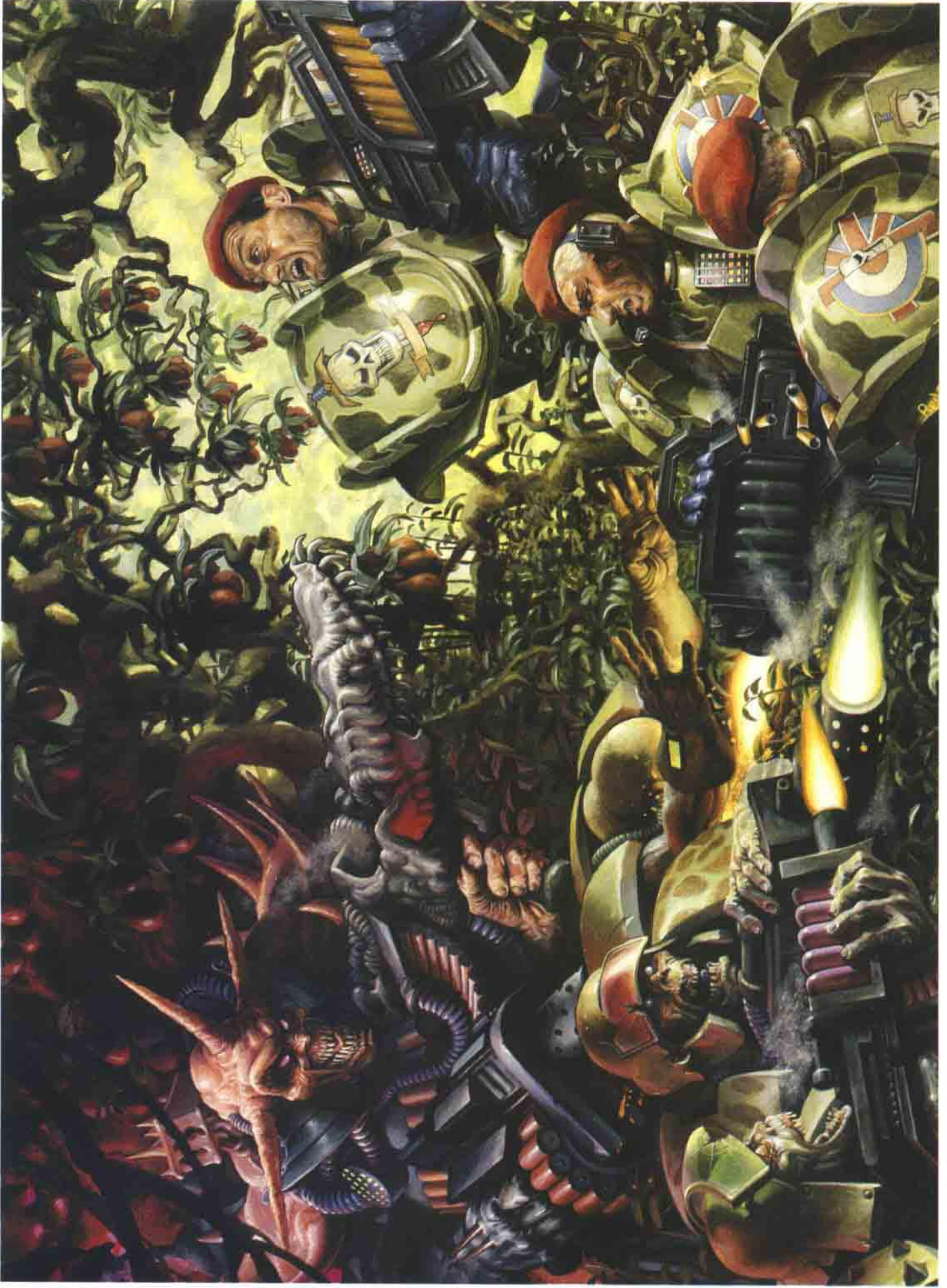

# THE AMBUSH

Copyright © 1993 Target Games AB. All Rights Reserved. MUTANT CHRONICLES and all character names and distinctive likenesses thereof are Trademarks of Target Games AB

## THE PRETORIAN STALKERS

These creatures of the Dark Legion were named by the Blood Berets after their first encounter. The Stalker is a formidable creature without equal among the forces of the Dark Symmetry. They are created by Algeroth's Tekrons, shaped after the Dark lord's visions of the ultimate front line soldier.

The body is a technological marvel, composed of motorized limbs, servos and artificial organs. The Stalker is a war machine with a living, organic brain, and this structure allows it to carry heavy support weapons such as flamers, grenade launchers, any weapon with capacity for large scale destruction. The internal organs and neural connections are protected by layers of armor, and the brain is housed in an armored skull. They are devoid of all emotion and even some basic survival instinct, being the perfect creature of war. Their brain, once human, now in truth nothing more than a biological computer, is programmed only for destruction.

### THE BIRTH OF A STALKER

In the inner depths of the Dark Citadels, the Stalkers are created. Tekrons prepare a Heretic, a human renegade, who will sacrifice himself to Algeroth. With the Tekrons are two Nepharites, one a master of war and the other a master of the Dark Symmetry of Algeroth. The Heretic, hoisted over a pool of active lava, is lowered slowly into the molten minerals, bolts of Dark Symmetry energy coursing over him as he disappears below the surface. After a moment, he is brought up a charred frame, but with the brain very much



**DARK  
LEGION™**



alive thanks to the protective powers of the Dark Symmetry. Immediately, the Tekrons begin to work on the wretched creature, strengthening his joints, replacing his ruined organs, and layering on a hard covering of «skin».

After this is done, the Stalker is to be returned to the fire with a heavier flow of Dark Symmetry influencing the molten flow. The process is repeated again and again, until both the Tekrons and the Nepharite Overlords are satisfied with the results.

As the Pretorian Stalker is given birth, a Tekron blacksmith slaves over the forging of a splendid weapon, a Scythe of Semai, hammering it into perfection. When finished it is given to the Stalker by the Nepharite of war, and the Master of the Dark Symmetry etches a symbol into the creature's forehead. The symbol is a delicate pattern that continually changes, its meaning roughly translates to «Baptized in Fire». After this, the Stalker is introduced to his combat twin.

### THE PRETORIAN TWINS

Pretorian Stalkers almost always appear in pairs. Their bio-computer brains are linked together in order to create a symbiotic battle team. They react in unison, providing backup for each other even more efficiently than the legendary Doomtroopers. If one of the Stalkers should be destroyed, the remaining one becomes totally self-sufficient and is just as capable of wreaking havoc singly.

### WEAPONRY OF THE STALKERS

The standard weaponry of the Pretorian Stalker is the Scythe of Semai, a large autocannon that would take two necromutants to man. This gun not only brings death with massive bursts of a large caliber, high-explosive rounds, it is also equipped with a two and a half feet razor-sharp bayonet for close combat. Flamers and grenade launchers may also be mounted to the weapon. This deadly combination is suitable for both open terrain and city fighting.

allowed) and they take effect the following action taken.

The effects of each gift are detailed in the descriptions that follow.

## GAINING MST-POINTS

Temporary losses of MST are regained at a rate of one per hour. Raising the «permanent» MST can be done by spending hero points and by gaining Flanks within the hierarchy of the Heretics.

## DARK SYMMETRY GIFTS

Here are five detailed Dark Gifts. These are channeled from the energies of the Dark soul and are therefore available to any follower of the Darkness.

All ranges are given in both squares and meters.

### TERROR

**LEVEL:** 5 for AURA or 12 for PROJECTED TERROR  
**RANGE:** 10 sqs/15 m radius (AURA) or 60 sqs/90 m for one target (PROJECTED TERROR)

The user is able to project an AURA OF FEAR around him. It affects all creatures within a 15 meter radius, including those on the same side as the invoker.

The aura strikes a deep fear in the hearts of the victims and those failing an Easy MST-roll must use their following 1d10 actions to flee in a random direction, using their maximum movement allowance. Those remaining will nevertheless have their chance of success modified by -4 in their next attack against the user.

The invoker may choose to project the TERROR on one target only. The victim must make a Normal MST-roll or suffer a heart attack. If the roll fails he takes 1d10 points of damage in the Chest from a heart attack and probably dies horribly unless medical assistance is available. If the roll is successful the victim still has all his chances of success modified by -4 for the following 1d6 rounds. There is a 1 in 6 chance of his hair turning white as well.

This gift does not affect already dead creatures such as the Legionnaires of Algeroth or creatures not possessing intelligence.

### DARK FIRE

**LEVEL:** 4+[3 per die of damage]  
**RANGE:** Touch

As this power is invoked, Dark Fire flows from the hands of the invoker. This fire can also be channeled through a weapon.

The Dark Fire will cause 1d6 points of fire-damage in all attacks the same CR as the invocation is made, on top of normal damage for the attack itself. The Dark Fire will also remain on any targets hit, causing damage as normal fire, being reduced by 1 die per CR. The DARK FIRE disappears from the weapon/the hands the next CR.

Normally, a DARK FIRE invocation causes 1d6 extra damage, but

for every extra three levels invoked, it makes an additional 1d6.

*Example: A Nepharite invokes 16 points of MST for the gift and then directs the power to his sword. The sword will cause 4d6 points of extra damage in all attacks this CR. The next round, the victims will take 3d6 points of fire-damage, the next 2d6, and so on.*

### RESIST PAIN

**LEVEL:** 1 per CR

**RANGE:** Personal

By using this Gift the invoker can resist all pain for one CR. He will ignore all wounds but will still take damage as usual. The pain and effects from wounds and other damage will not go away, merely be postponed for one CR.

### INVOKER PAIN

**LEVEL:** 1 per sq./1.5 m of range

**RANGE:** 1 sq./1.5 m per level

This Gift invokes terrible pain in the victim. Make a roll on the Resistance table, with the invoker's MST BEFORE deducting MST-points for this Gift on «basic capability value», and the victim's MST on «difficulty level». If the roll is successful for the invoker the Gift takes effect immediately.

The pain lasts for the rest of the CR and will completely immobilize the target (=he may not perform any more actions this CR). However, it doesn't cause any physical damage (but would give a +20 modifier to an Interrogation skill roll...).

### BLINDNESS

**LEVEL:** 6

**RANGE:** 10 m

Make a roll on the Resistance table, with the invoker's MST BEFORE deducting MST-points for this Gift on «basic capability value», and the victim's MST on «difficulty level». If the roll is successful for the invoker, the victim is struck blind for 1d6 CR.



## THE DARK PATTERN GIFTS

Detailed below are the Gifts associated with the different Apostles. These Gifts are normally only available to the

followers of the individual Apostle.

## ILIAN

### DIMENSIONAL HOLE

**LEVEL:** 14  
**RANGE:** 50 squares/75 meters

This terrible gift tears the fabric of existence apart and opens up a dimensional hole where specified by the invoker for 1d6 CR:s.

Terrible winds tear and rip unfortunate beings apart. Any victim within 10 squares/15 m of the hole will be attacked by the cold winds, which cause 1d6 points of damage each CR in a random target area (use close combat table to determine hit

location). The victim must make a Normal STR-roll before being able to leave the hazardous area (requires an entire action). Any loose items will be sucked into the Void and are forever lost.

### DISRUPT POWER

**LEVEL:** See below

**RANGE:** Personal

This gift offers protection against other arcane powers, other Dark

Gifts or the terrible energies of the Art. For each level channeled into the Gift, the invoker can add 2 to any MST-rolls called for on the Resistance table (deduct the MST-points spent on this Gift before the check is made).

It can also be used to shape a shield of power which will protect against attacks causing damage. For every level channeled into the shield, damage by any «magical» attacks passing through is reduced by -5.

### HAND OF DEATH

**LEVEL:** 3 per CR

**RANGE:** 50 squares/75 meters

The victim feels a cold hand closing around his heart. Make a roll on the Resistance table, with the invoker's MST BEFORE deducting MST-points for this Gift on «basic capability value», and the victim's MST on «difficulty level». If the invoker is successful the victim takes 1d6 points of damage in the chest. Armor offers no protection.

### TIME-DEATH

**LEVEL:** 9

**RANGE:** Personal

The invoker creates a time-pocket where he himself may act and move freely while everything else is brought to a stand-still. He may perform 1d6 «free actions», before time again gains possession of its domain.

### TRUE GATE

**LEVEL:** 10+

**RANGE:** 50 squares/75 meters

This gift opens up a portal warping time and space in our universe. The invoker may step through the portal and appear anywhere within 75 meters of the original portal. This gift can bypass walls and doors, allowing entry to sealed areas.

By creating additional levels the invoker may bring other creatures with him through the portal. Each additional level allows the passage of one additional creature. If the creature is unwilling, make a roll on the Resistance table, with the invoker's MST BEFORE deducting MST-points for this Gift on «basic capability value» and the victim's MST on «difficulty level». A failure means that the creature resisted the Dark symmetry.

Also, each additional level can multiply the distance by 2, i. e. 4 extra levels would give a range of 1,200 meters.

## MUAWIJHE

### CONFUSE

**LEVEL:** 6+

**RANGE:** 50 squares/75 meters

Make a roll on the Resistance table, with the invoker's MST BEFORE deducting MST-points for this Gift on «basic capability value» and the victim's MST on «difficulty level».

If the victim fails he is overwhelmed by the powers of the screaming lord and is confused. The victim loses all ability to act and think clearly and he is rooted to the spot for 1d6 CR:s. He will still defend himself against attacks on his person (e. g. make Avoid- and Parry-rolls) regardless of who the attacker is, and with CS -5.

For each extra level, one more victim within the range will be CONFUSED.

often nightmares and insane visions.

If the invoker so wishes, the victim will temporarily lose 1d6 points of MST for each night he is affected by the dreams (MST can't go below 1). As no rest is achieved, the victim will not regain any of these points or MST-points lost for some other reason.

This power can also be used to send messages and warnings, either to Heretics or to the enemies of the Dark Soul.

### SLEEP

**LEVEL:** 14+

**RANGE:** 50 squares/75 meters

Make a roll on the Resistance table, with the invoker's MST BEFORE deducting MST-points for this Gift on «basic capability value» and the victim's MST on «difficulty level».

If the victim fails, he will immediately fall asleep. A sleeping creature cannot normally be disturbed for 1d6 hours but may be aroused if violent methods are used.

For each extra level, one more victim within the range will fall asleep.

### WIND OF INSANITY

**LEVEL:** 20+

**RANGE:** 50 squares/75 meters

This powerful Gift conjures up a whirlwind of insanity which can be directed towards the invoker's enemies. The whirlwind will last for one combat round, plus one extra round for each extra level put into the Gift.

The whirlwind has a diameter of 1 square/1.5 meters and can be moved around at the whim of the invoker at a pace of 12 squares/18 m per CR. He must totally concentrate on the wind to be able to control it. If the concentration is broken before the duration of the Gift, the wind dies out.

Anyone caught up in the wind will be onset by hordes of insanely screaming spirits. Screams from all the insane in our universe echo in the ears of the victims.

1d6 points of damage will be caused in the head (armor does not protect) to all victims standing in the way of the whirlwind every CR. This attack can not be Avoided. In addition to this, they must succeed with a Normal INT-roll every time they are affected. If they fail, they go temporarily insane and will fall down on their knees, staring blankly at the sky, mumbling arcane phrases. Nothing will rouse them from this state, but after 1d6 minutes they will regain their senses.

### INSANE DANCE

**LEVEL:** 10+

**RANGE:** 20 squares/30 meters

The invoker is able to command his victim to perform an insane dance, totally out of control. The victim's dance to the unheard music of the Lord of Visions and are totally oblivious to reality.

Make a roll on the Resistance table, with the invoker's MST BEFORE deducting MST-points for this Gift on «basic capability value» and the victim's MST on «difficulty level». If the invoker is successful the victims will dance madly for 2d6 CR:s, ignoring the world around them completely. No attempts at reviving the dancing fools will have any effect.

All missile attacks made against the dancers will have a -4 penalty to CS due to the unpredictable movements.

For each extra level, one more victim within the range will begin an INSANE DANCE.

### SEND DREAMS

**LEVEL:** 12

**RANGE:** special

With this gift, the invoker can establish a link between himself and any sleeping victim within sight. «WITHIN SIGHT» may mean through the use of some scrying device or by the use of the Dark symmetry.

The invoker can specify which dreams to send to the victim.



## SEMAI

### CONTROL MIND

**LEVEL:** 8

**RANGE:** 20 sqs/30 m

The invoker is able to control an intelligent mind by defeating the victim's MST. Make a roll on the Resistance table, with the invoker's MST BEFORE deducting MST-points for this Gift on «basic capability value» and the victim's MST on «difficulty level».

If the invoker wins, he can make the victim perform all actions normally within his ability. He cannot make it act on its own initiative, the commands must be given by the invoker.

The victim will not perform any actions resulting in its own destruction.

### ILLUSION

**LEVEL:** 10

**RANGE:** 60 sqs/90 m

The invoker may create an illusion of something he has previously seen, either in reality, in a dream or a picture. The illusion will be three-dimensional but may not be larger than the invoker. An illusion does not affect the surroundings, it cannot cause damage to living beings. It can indirectly lead unfortunate victims to a premature death if they, for example, step out on an illusionary bridge.

The illusion lasts one hour.

### MIND-MELT

**LEVEL:** 16

**RANGE:** 10 sqs/15 m

The invoker mentally attacks the mind of another being. Make a roll on the Resistance table, with the invoker's MST BEFORE deducting MST-points for this Gift on «basic capability value» and the victim's MST on «difficulty level».

If the invoker is successful the victim will lose 1d6 points of INT and the same amount of BP:s from the head. These points, except for one, can ONLY be regained through extensive brain

surgery, and the last point will be lost forever (the BP of the head will also be permanently reduced by one).

If the INT reaches 0 the brain has melted and the victim dies horribly.

### POSSESS

**LEVEL:** 15+

**RANGE:** 50 sqs/75 m

Make a roll on the Resistance table, with the invoker's MST BEFORE deducting MST-points for this Gift on «basic capability value» and the victim's MST on «difficulty level».

The invoker can with this gift take possession of the soul of a victim. If the invoker is successful he will enter the mind of the victim and take total control of its actions. He can use all skills known by the possessed and may force the host to use special abilities such as Dark Gifts or powers from the Art. The possession lasts one CR, plus one CR for every extra level put into this Gift.

While the victim is possessed the invoker's body is unconscious. It is defenseless but the mind of the invoker will feel any tampering that's done with the body and can at will return to it. If the host is killed while possessed the invoker immediately returns to his own body, but the experience of being killed results in him losing 1 point of MST, permanently.

### SHROUD

**LEVEL:** 4

**RANGE:** 4 sqs/6 m radius

The invoker conjures up swirling shrouds of fog. The visibility within the fog is near to nothing and the creatures in the area of effect are completely hidden from view. All attacks against or by combatants inside the SHROUD are modified by -7.

The fog lasts for 2d6 CR:s and is completely static, unless blown away by ventilation systems or wind.

## ALGEROTH

### INDIGESTION

**LEVEL:** 6+

**RANGE:** 10 sqs/15 m

By concentrating all its mind-powers on a victim the invoker opens up small portals to one of the endless dimensions of Darkness inside the victim's body. From these small but painful dimensional portals immaterial beings emerge and the tension between this dimensional plane and the plane of Darkness generates tremendous heat. The inside of the victim starts heating up and prolonged exposure to this Gift inevitably leads to death when the innards of the victim slowly boil. Damage done is 1d6 per CR, roll hit location as usual (close combat table).

The attack normally lasts 1 CR but is prolonged by one CR per extra level placed in the Gift.

### DIMENSIONAL WARP

**LEVEL:** 20+

**RANGE:** 50 sqs/75 m

The DIMENSIONAL WARP opens up a dark portal to the planes on the other side of the universe. The portal is large enough to suck a human being through it and whoever stands in the center of effect specified by the invoker will suffer that fate.

During seemingly endless time the poor victim will plummet through the dark dimensions brought onto direct contact with the true evil of the Darkness. After 1d6 CR:s the victim will emerge from the dark dimensions, bruised and half insane, or at worst with a withered soul.

For each CR spent in the dark dimensions the victim

permanently loses 1d6 points of MST. Should MST reach below zero, the victim dies from insanity.

The Gift normally lasts 1d6 CR:s, but every extra level put into this gift will prolong it by one CR.

### DISTORT

**LEVEL:** 22

**RANGE:** 50 sqs/75 m

By using this Gift the invoker can warp and distort reality around us. Objects the same size of the invoker or smaller may be affected. Dead material may be warped into any new shape at will, while living beings are allowed to escape the effect by defeating the invokers MST on the Resistance table with their own MST. (Make a roll on the Resistance table, with the invoker's MST BEFORE deducting MST-points for this Gift on «basic capability value» and the victim's MST on «difficulty level».)

If the victim fails, the gift will cause the poor victim's body to twist and bend into new shapes. Bones are broken and flesh remolded like clay. The result is often a quivering heap of living flesh, wracked in painful spasms. The victim also loses 1d10 points from each PHY, COR and STR, and 3d6 from PER. (No capability can become lower than 3.)

### FLOW OF ACID

**LEVEL:** 10+

**RANGE:** 10 sqs/15 m

The invoker opens up a small and limited portal to one of the dark





dimensions. From this portal a flow of thick acid emerges and rushes towards one target selected by the invoker.

As long as the victim remains in sight of the invoker and the Gift is maintained, the acid will attack the victim. Damage done is 1d4, plus one per extra level invoked, in ALL body parts. Armor protects as normal, but will lose as many points from its AV as the acid makes damage (of course, uncovered body parts take full damage).

The acid will remain on the victim's body after the attack has ceased, causing the same damage minus two every CR, until it reaches zero.

*Example: A Nepharite directs a FLOW OF ACID towards a charging trooper. The Nepharite invokes three extra levels, which results in the flow causing 1d4+3 points of damage. The result is rolled, 16.*

*The trooper's armor value is 10, meaning the initial attack reduces it to 4. The next CR, the acid does 4 BP:s of damage, reducing the armor value to nothing, and the third round the acid causes 2 BP:s of damage in all of the trooper's body parts.*

## INVOKE FRENZY

**LEVEL:** 4+

**RANGE:** 30 sqs/45 m

If the victim is unwilling, make a roll on the Resistance table, with the invoker's MST BEFORE deducting MST-points for this Gift on «basic capability value» and the victim's MST on «difficulty level».

The invoker will with this gift infuse his followers with an insane frenzy. At level 4, one creature is affected, but for every extra level invoked in the Gift, one additional combatant can be affected.

Combatants gripped by the frenzy will attack all enemies without heed for their own safety and will ignore all pain until they are killed. They gain a damage bonus of +1d6 on all close combat damage. They fire indiscriminately and all missile attacks they perform are modified by -4. Beings gripped by frenzy never parry or avoid attacks.

The frenzy lasts until the victim is killed or no other enemies are present. The invoker is never attacked.

## DEMNOGONIS

### TIME ROT

**LEVEL:** 21+

**RANGE:** Touch

Make a roll on the Resistance table, with the invoker's MST BEFORE deducting MST-points for this Gift on «basic capability value» and the victim's MST on «difficulty level».

If the invoker is successful, the victim will begin to age at a rate of one year per CR. At level 21 (no extra levels invoked), he will age 1d6 years, but this can be increased by 1d6 years for every extra level invoked in the Gift. However, MST-points spent for these extra levels will be PERMANENTLY lost to the invoker.

Apply any aging effects immediately and don't forget to make the «death-checks» every year after the age of 45.

*Example: A Nepharite invoking 24 levels (three extra) into a Gift of TIME-ROTTING will cause a victim to age 4d6 years, but the Nepharite himself will lose 3 points of MST permanently.*

### ANIMATE DEAD

**LEVEL:** 14+

**RANGE:** Touch

The invoker may animate a dead body and create an undead slave. The slave is totally mindless and will obey all of its invoker's commands to the letter. If no orders are given or if the task is completed the slave will stand motionless until further orders.

The animated dead will retain his STR and PHY from before he died, but COR is halved. Only skills that are tied to any of these

basic capabilities may be retained, but only at half the skill value they had before death.

Combat statistics are calculated as if the «missing» basic capabilities were zero.

STR, PHY, COR and the skill values of all the retained skills may be increased by +1 for each extra level invoked in the Gift.

### DECAY

**LEVEL:** 6+

**RANGE:** 4 sqs/6 m

With this gift the invoker may cause decay in organic and inorganic substances or materials. No sentient beings

may be affected.

The item will decay and decompose in 1d6 rounds. Often used in combat on weapons and armor. Can also be used on cybernetics inside a body, destroying artificial organs or pacemakers.

Normally, the Gift affects a 1 kg mass of inorganic substance, but for every extra level invoked in the Gift, this is increased by 1 additional kg.

### DEFORM

**LEVEL:** 12+

**RANGE:** 10 sqs/15 m

Make a roll on the Resistance table, with the invoker's MST BEFORE deducting MST-points for this Gift on «basic capability value» and the victim's MST on «difficulty level».

This gift will twist and deform a living body. If the victim fails his arms and legs shrivel and he will be prone to uncontrollable fits.

The victim's STR, COR, QUI and all Skills tied to any of these Basic capabilities are halved for the duration of the Gift. This is normally 1d6 minutes, but can be prolonged by one minute for every extra level invoked in the Gift.

After this time the victim reverts to normal.

### INFECTION

**LEVEL:** 4

**RANGE:** 100 m

Make a roll on the Resistance table, with the invoker's MST BEFORE deducting MST-points for this Gift on «basic capability value» and the victim's PHY on «difficulty level».

If the invoker is successful the victim is struck by a fatal disease within 1d6 hours. He is subjected to high fevers and infected wounds all over the body. He will lose 1 Body point per day in the chest until cured or dead. All actions and basic capabilities will be modified by -10 for the duration of the infection.

Persons in physical contact with the infected victim or any items touched by the victim will attract the disease if they fail a Normal PHY-roll.

The infection may be cured by applying medical expertise, but this is normally only available in large cities and not on the battlefields. It can also be cured with an ART OF EXORCISM of the fifth magnitude.

For each extra level, one more victim within the range will be INFECTED.



# WEAPONS

**WEIGHT (W).** The weapon's weight when fully loaded and equipped according to its picture and description.

**SEPARATE WEIGHT (SW).** For detachable weapons accessories, their separate weight.

**LENGTH (L).** Full length. For weapons with a folding or telescopic stock, two lengths are given.

**MAG CAPACITY (MC).** How many rounds the magazine/drum/tube/belt holds. In short, the figure says how many bullets you may fire/how many attacks you may make before having to reload.

**MAX BURST LENGTH (MBL).** For belt-fed weapons, this is the maximum rounds that may be fired during a period of around two minutes, or else the barrel will simply melt because of the heat. Luckily, the barrels are interchangeable (treat as reloading, takes 6 actions).

**BIPOD (BIP).** If you use the weapon lying down and you are AIMING, you get a +2 mod to CS if you have a bipod fitted to your weapon.

**TELESCOPIC SHOULDER SUPPORT (TSS).** Y=yes, N=no, opt=optional (can be fitted, but not standard), det=detachable (standard equipment, but can be removed). Weapons without extended/fixed stocks MAY NOT be used for AIMED attacks if used two-handed, unless red-point sight is used.

**GRENADE LAUNCHER (GL).** N=no, int=integrated (can't be removed), opt=optional (can be fitted, but not standard), det=detachable (standard equipment, but can be removed).

**CHAIN BAYONET (CB).** N=no, int=integrated (can't be removed), opt=optional (can be fitted, but not standard), det=detachable (standard equipment, but can be removed).

**TELESCOPIC SIGHT (TS).** N=no, opt=optional (can be fitted, but not standard), x1-x12=detachable, variable magnification, x4/x10=detachable, either x4 or x10 magnification.

**FUNCTION (FUNC).** The function of the weapon. M=manual (single-round attacks only), S=semi-automatic (single-round attacks and rapid volleys), A=full automatic (all firing modes), 3=semi-automatic with 3-round-burst capability (single-round attack, burst, rapid volley).

**RANGE.** Range in squares and/or meters.

**STRENGTH REQUIREMENT (STR).** This is the strength required if you want to use the weapon *one-handed*. You get a -1 penalty for each point missing. If you use both hands, double your STR-value. Weapons with a «\*» MUST be used with two hands.

**RELOADING TIME (RT).** The number of actions it takes to reload the weapon (usually changing a clip). You also have to make a skill roll.

**JAMMING FACTOR (JF).** If you fumble, roll a d10. If the result is higher than or equal to the JF, the weapon is jammed.

**# OF TARGET AREAS (#TA).** For grenades, the number of target areas they hit.

**SHRAPNEL RANGE (SR).** The shrapnel's range in squares.

**DAMAGE (DAM).** The die-combination rolled when determining damage.

**COST.** Normal cost. Can be lower if «On sale». Can be higher if sold illegally. NA=Not normally available.

## AVAILABILITY

Availability for weapons vary between different places and manufacturers. The general rule on Luna is that weapons have availability «C» (license required), but certain weapons, for example lighter side-arms have availability «B» and heavier weapons, such as rocket launchers, have availability «D». In most places outside Luna, all weapons and their accessories have availability «B», alternatively, «E».

All Brotherhood and Cybertronic weapons have availability «F».

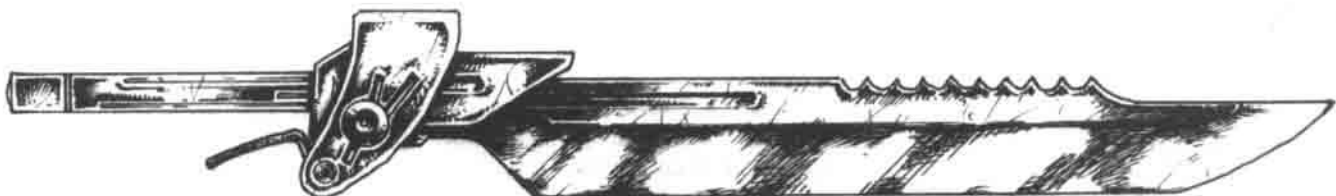

## HANDGUNS

Along with the SMG's, handguns are used as side-arms for all kinds of personnel, primarily those in non-combat positions. Of course, they are also widely used by agents

and civilian personnel since they're relatively easy to conceal.

### SHERMAN .74 MODEL 13 «BOLTER»



This caliber .74 handgun is the civilian version of the M15, without the grenade launcher. Widely used by agents and para-military security squads. Manufactured under license by Capitol-controlled Sherman Inc.

W	L	MC	TSS	GL	CB	TS	FUNC
2,2	36	18	N	N	N	opt	S
RANGE		STR	RT	JF	DAM	COST	
30/45		9	1	4	1d6	1,900	

### SHERMAN .55G MODEL 15 «IRONFIST»

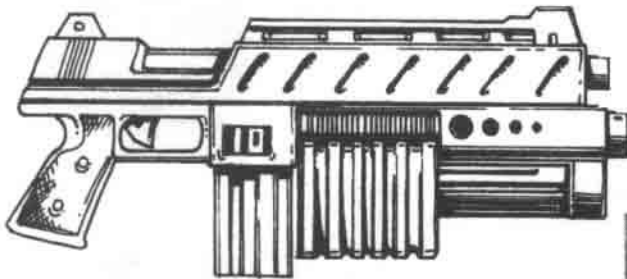

This extremely powerful handgun was originally restricted for use by military special forces only. Similar to the M13, but has smaller calibre and a short range grenade-launcher mounted underneath the barrel. Manufactured under license by Capitol-controlled Sherman Inc.

W	L	MC	TSS	GL	CB	TS	FUNC
2,5	39	25	N	int	N	N	A
RANGE		STR	RT	JF	DAM	COST	
40/60		10	1	3	1d6+1	2,700	

#### GL-240 GRENADE LAUNCHER

SW	MC	FUNC	RANGE	STR	RT	JF	#TA	SR	DAM	COST
—	1	M	50/75	8*	1	5	1d3	1	1d6+1	—

### .45AP NO. 3 «RONIN»



The «Ronin» handgun is designed by Mishima-controlled Tambu Corp, but the popular design has been copied by numerous independent manufacturers. The bullpup design allows for longer barrel and therefore better accuracy.

W	L	MC	TSS	GL	CB	TS	FUNC
1,5	30	15	N	N	N	opt	S
RANGE		STR	RT	JF	DAM	COST	
50/75		4	1	8	1d6	3,000	

### P1000

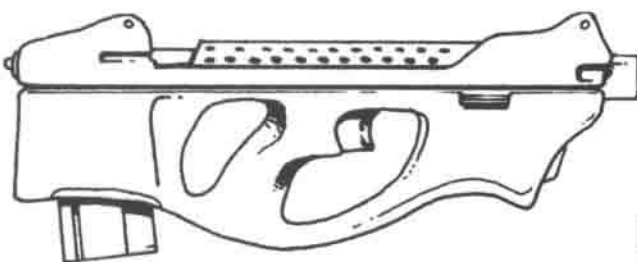

As with all Cybertronic-designed weapons, the P1000 handgun is a masterpiece of craftsmanship, reliability and «user-friendliness». Also, they are very rarely spotted on the street in pirate-versions, since the process of making the semi-plastic material used in the covering is a well kept secret within Cybertronic.

W	L	MC	TSS	GL	CB	TS	FUNC
1,4	39	20	N	N	opt	opt	A
RANGE		STR	RT	JF	DAM	COST	
60/90		7	1	7	1d6	6,200	

### PSA MK. XIV «AGGRESSOR»

The Aggressor personal side-arm is in wide use among Imperial officials, from bodyguards and security officers to personnel in combat units. It is the standard weapon of Imperial's intelligence service, ISC. Manufactured under license by Lyon & Atkinson Arms, Inc.

W	L	MC	TSS	GL	CB	TS	FUNC
2,3	34	26	N	N	N	N	A
RANGE		STR	RT	JF	DAM	COST	
20/30		9	1	4	1d6	2,400	

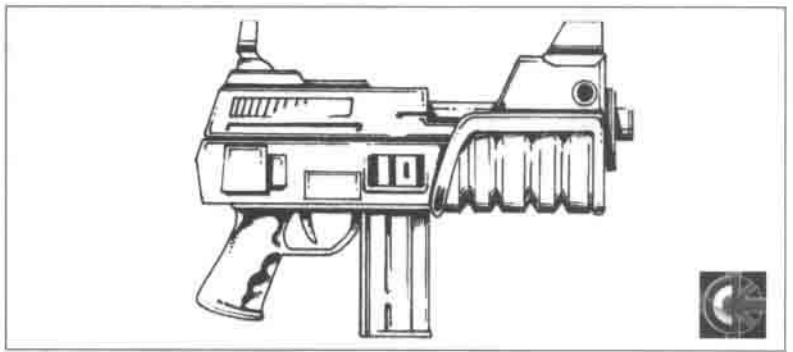

### MP-105

The MP-105 (MP for machine-pistol) is a superb weapon with bad reputation on the street, mainly because of the cumbersome and awkward location of the magazine. Its main advantage is the use of caseless ammunition, resulting in a light weapon with magazine capacity far beyond normal limits.

W	L	MC	TSS	GL	CB	TS	FUNC
1,9	31	58	opt	opt	N	opt	A
RANGE		STR	RT	JF	DAM	COST	
50/75		7	1	9	1d6+1	7,200	

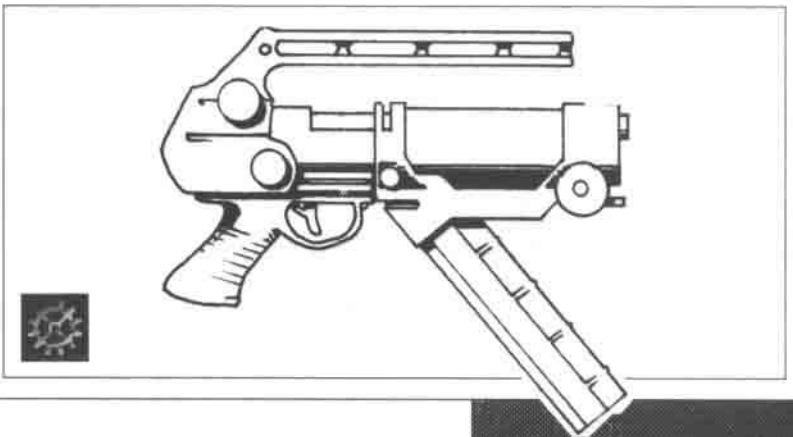

### P60 «PUNISHER»

This fearsome handgun, nicknamed (The Punisher) because of its use by the Inquisition, is probably one of the most popular weapons on the street, both because of its reliability and availability. Extremely powerful for being a handgun, but too large and heavy for the small and weak. Also used by two of the most famous special forces ever, the Doomtroopers and the Imperial Blood Berets.

W	L	MC	TSS	GL	CB	TS	FUNC
2,5	32	13	N	N	N	N	A
RANGE		STR	RT	JF	DAM	COST	
70/105		14	1	7	1d6+2	8,400	

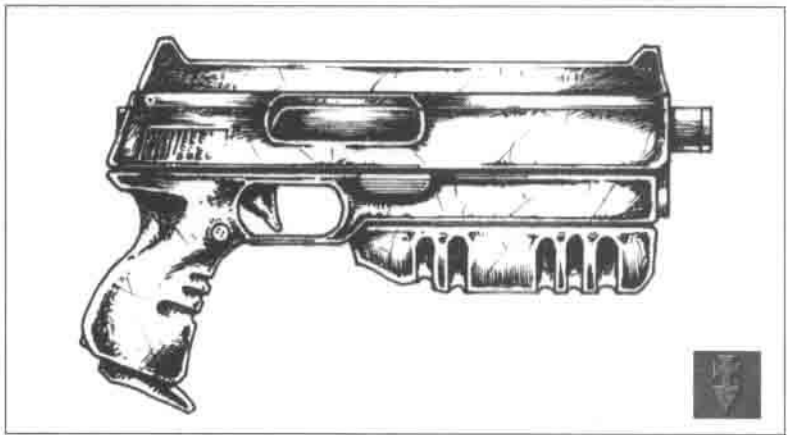

### PIRANHA HANDGUN

This small and easily concealable handgun is a clear favorite among freelancers, corporate bodyguards, Cartel officials and law enforcers all over the solar system. It is not particularly powerful, but a hit will stop an unarmored opponent in most cases. Its major advantage is that it doesn't require a license; instead, its spread on the streets is limited by a high cost.

W	L	MC	TSS	GL	CB	TS	FUNC
1,0	21	11	N	N	N	N	S
RANGE		STR	RT	JF	DAM	COST	
70/105		6	1	3	1d4+1	19,900	



## SUB-MACHINE-GUNS

SUB-MACHINE-GUNS, or SMG:s, are often described as the most popular weapons available. With size and fire-power like a pistol and range, ammo-capacity, grenade

launcher and rate of fire like an assault rifle, they are ideal for almost any environment and mission, apart from all-out field-battles.

### CAR-24



This Sherman-designed weapon is often referred to as a close assault rifle rather than an SMG, because of the integrated grenade launcher. A popular weapon on the street, it is often seen in pirated versions of low quality.

W	L	MC	TSS	GL	CB	TS	FUNC
3,6	65/53	20	Y	int	N	opt	3
RANGE		STR	RT	JF	DAM	COST	
120/180		15	1	3	1d6+1	4,600	

### GL-240 GRENADE LAUNCHER

SW	MC	FUNC	RANGE	STR	RT	JF	#TA	SR	DAM	COST
—	1	M	50/75	8*	1	5	1d3	1	1d6+1	—

### TAMBU NO. 4 «WINDRIDER»

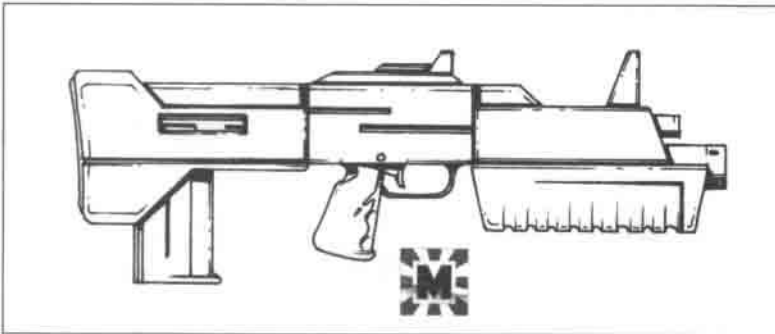

After the success with the Ronin handgun, the Windrider was a hasty-work that didn't prove very successful. The main problem is the detachable grenade launcher, and most users prefer the Windrider without it, as a pure SMG. These problems were solved on the larger version, the Shogun Assault rifle.

W	L	MC	TSS	GL	CB	TS	FUNC
2,7	51	22	N	det	N	N	A
RANGE		STR	RT	JF	DAM	COST	
160/240		7	1	3	1d6	5,500	

### GRENADE LAUNCHER

SW	MC	FUNC	RANGE	STR	RT	JF	#TA	SR	DAM	COST
0,8	1	M	20/30	4*	1	3	1d3	1	1d6	850

### CAW2000

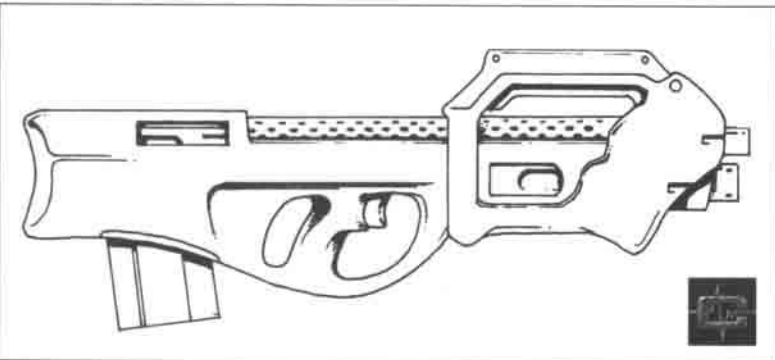

The CAW2000 is, like its equivalents in this category of weapons, more of a close assault rifle with its integrated grenade launcher. Its one major drawback is that the grenade launcher cannot be used when the bayonet (hidden inside the stock) is fixed to the muzzle. A very rare weapon almost only in use within Cybertronic. As all Cybertronic weapons, it is manufactured by Cybercurity Inc.

W	L	MC	TSS	GL	CB	TS	FUNC
3,0	63	30	N	int	opt	opt	A
RANGE		STR	RT	JF	DAM	COST	
180/270		9	1	7	1d6+1	7,800	

### GL2000 GRENADE LAUNCHER

SW	MC	FUNC	RANGE	STR	RT	JF	#TA	SR	DAM	COST
—	1	M	40/60	5*	1	8	1d4	1	1d6+1	—

### SMG MK. IVP «PLASMA INTRUDER»

The manufacturers of this SMG, Lyon & Atkinson, eliminated the need for a grenade launcher by developing the plasma technique. With the lower barrel of the mk. IVP (with 'P' for Plasma), you have the option to fire plasma-filled bullets which on impact have almost the same capabilities as a standard shrapnel grenade, but with considerably better accuracy and range. The weapon is often seen in a larger version, the Mk. 43 Intruder assault rifle, which is identical at a quick glance.

**NOTE:** Plasma ammo attacks are executed as normal but avoided as grenades.

W	L	MC	TSS	GL	CB	TS	FUNC
4,0	64	20	opt	spec.	opt	N	A
RANGE		STR	RT	JF	DAM	COST	
100/150		15	1	2	1d6+1	7,100	

#### PLASMA AMMO

SW	MC	FUNC	RANGE	STR	RT	JF	#TA	SR	DAM	COST
—	20	M	100/150	15	1	2	1d4	1	1d6+1	—

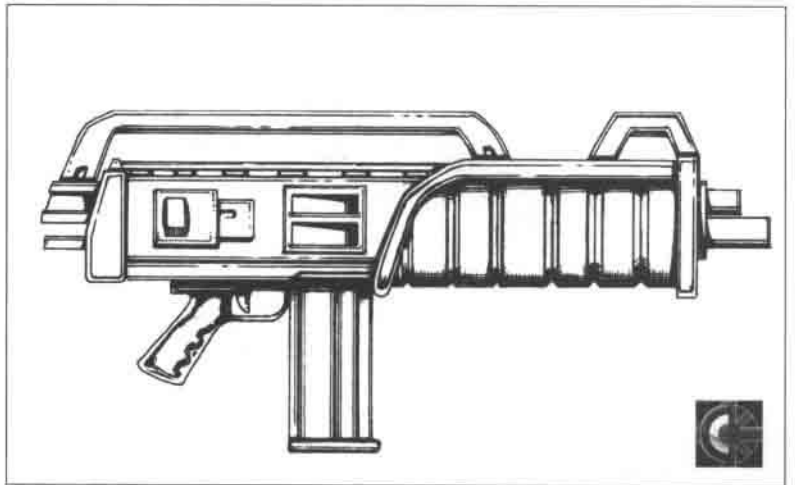

### SMG MK. III «INTERCEPTOR»

The standard SMG of most Imperial armed forces, the Interceptor, is a cloven choice. Some people love it for its feeling of raw power, while other find it far too heavy and bulky for an SMG. It's all a matter of taste, but undoubtedly, the Interceptor is the most powerful of all conventional sub-machine-guns.

W	L	MC	TSS	GL	CB	TS	FUNC
4,6	56	40	opt	int	opt	N	A
RANGE		STR	RT	JF	DAM	COST	
100/150		17	1	5	1d6+2	6,200	

#### GRENADE LAUNCHER

SW	MC	FUNC	RANGE	STR	
—	1	M	40/60	9*	
RT	JF	#TA	SR	DAM	COST
1	5	1d4	1	1d10	—

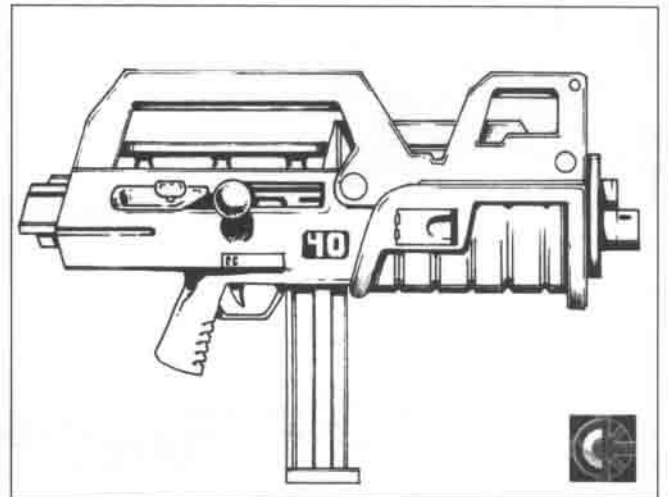

### MP-105GW

Simply a MP-105 handgun adapted for use with a grenade launcher, the GW isn't a favorite on the streets. The only differences between the weapons are the telescopic shoulder stock and a more robust clip design, better suited for field use (the clips are 100% interchangeable, though).

W	L	MC	TSS	GL	CB	TS	FUNC
2,8	65/52	58	det	det	N	opt	A
RANGE		STR	RT	JF	DAM	COST	
120/180		11	1	8	1d6+1	9,400	

#### GW-1055 GRENADE LAUNCHER

SW	MC	FUNC	RANGE	STR	RT	JF	#TA	SR	DAM	COST
1,0	1	M	30/45	6*	1	8	1d4	1	1d6+2	1,700

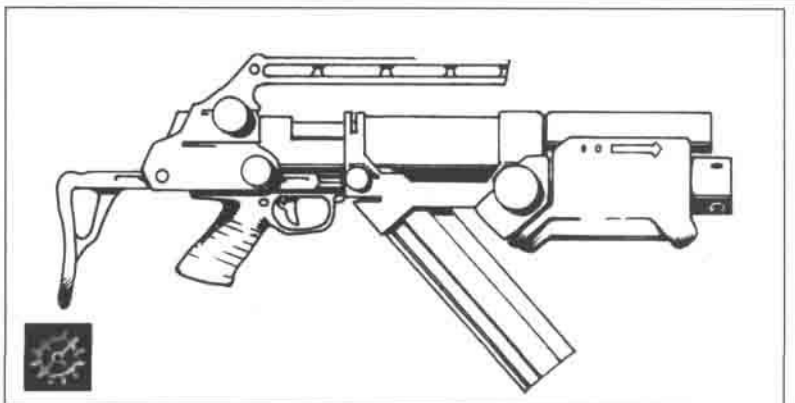

## MP-103 «HELLBLAZER»

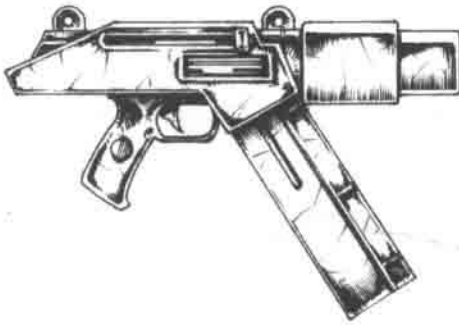

The Hellblazer was an original design for the Doomtrooper strikeforce, later developed into the MP-105. It still has a number of advantages over its predecessor; it is smaller, more robust, more reliable and has a larger handle for better handling. The drawback is that it has shorter range and lower rate of fire. Fits with the GW-1055 grenade launcher.

W	L	MC	TSS	GL	CB	TS	FUNC
2,6	46	34	N	opt	N	N	A
RANGE		STR	RT	JF	DAM	COST	
80/120		9	1	9	1d6+1	9,000	

## ASSAULT RIFLES

Assault rifles are the standard weaponry for common troopers in the ground assault forces. With a standard barrel of medium calibre (ranging from 4.4 to 6.5 mm:s)

combined with a 20 to 30 mm grenade launcher, these weapons are flexible and powerful enough for all kinds of missions and enemies.

## M50

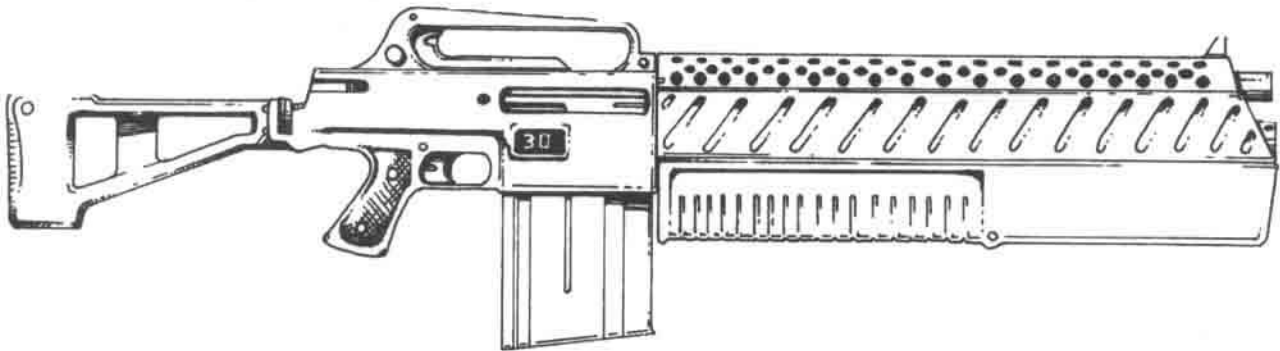

Although not the best weapon in the assault rifle category, the M50 is one of the most widely spread weapons outside the military forces, both because of the numerous pirated copies and because of its versatility. The grenades are loaded one by one in an internal magazine holding six rounds. Stock can be folded.

### M50 ASSAULT RIFLE

W	L	MC	TSS	GL	CB	TS	FUNC	RANGE	STR	RT	JF	DAM	COST
6,1	100/79	30	Y	int	N	opt	3	300/450	23	1	3	1d6+2	6,500

### M509 GRENADE LAUNCHER

SW	MC	FUNC	RANGE	STR	RT	JF	#TA	SR	DAM	COST
—	6	M	100/150	23*	1/rnd	4	1d4	1	1d6+1	—

## TAMBU NO. 1 «SHOGUN»

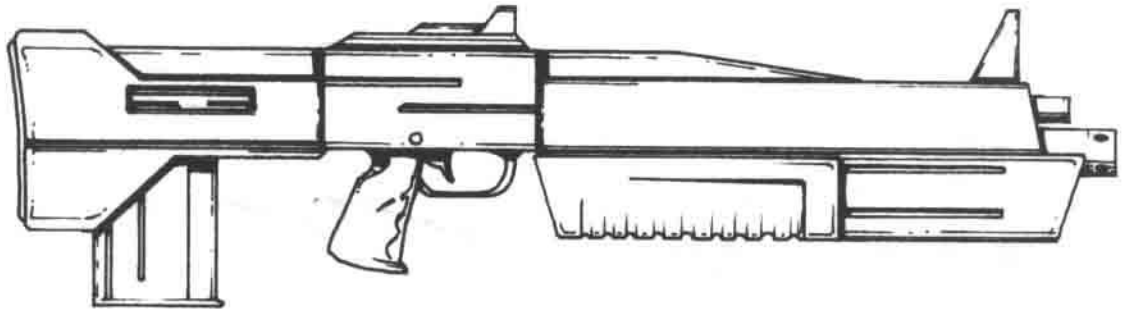

The Shogun assault rifle is a masterpiece of weapon design. Learning from the mistakes with the grenade launcher on the Windrider SMG, the Shogun-version was given a totally different interior. The combination is one of the most compact, reliable and smallest weapons on the market.

### SHOGUN ASSAULT RIFLE

W	L	MC	TSS	GL	CB	TS	FUNC	RANGE	STR	RT	JF	DAM	COST
3,8	67	26	N	det	N	N	A	240/360	15	1	8	1d6+1	7,100

### GRENADE LAUNCHER

SW	MC	FUNC	RANGE	STR	RT	JF	#TA	SR	DAM	COST
0,8	3	M	40/60	15*	1/rnd	8	1d4	1	1d6	1,100

## AR3000

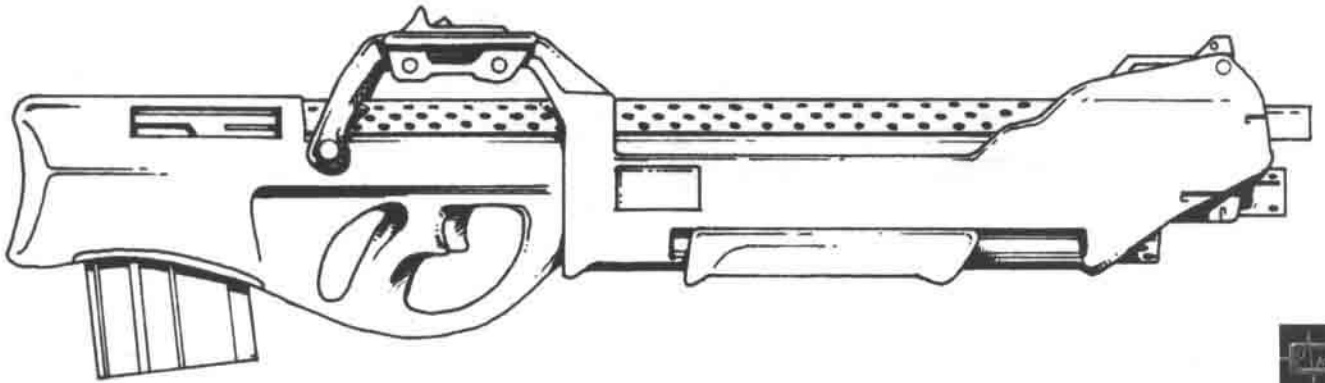

The AR3000 is almost identical with the SR3500 but has a 37 mm integrated grenade launcher below the barrel. As all Cybertronic-designed weapons, the AR3000 has an anatomical grip which along with special balancing measures facilitates one-handed use. However, the grenade launcher requires both hands.

### ASSAULT RIFLE 3000

W	L	MC	TSS	GL	CB	TS	FUNC	RANGE	STR	RT	JF	DAM	COST
5,2	86	25	N	int	opt	opt	A	360/540	15	1	7	1d6+2	12,800

### GL3000 GRENADE LAUNCHER

SW	MC	FUNC	RANGE	STR	RT	JF	#TA	SR	DAM	COST
—	4	M	70/105	15*	1/rnd	8	1d6	1	1d6+1	—



## BAR MK. XIB «INVADER»

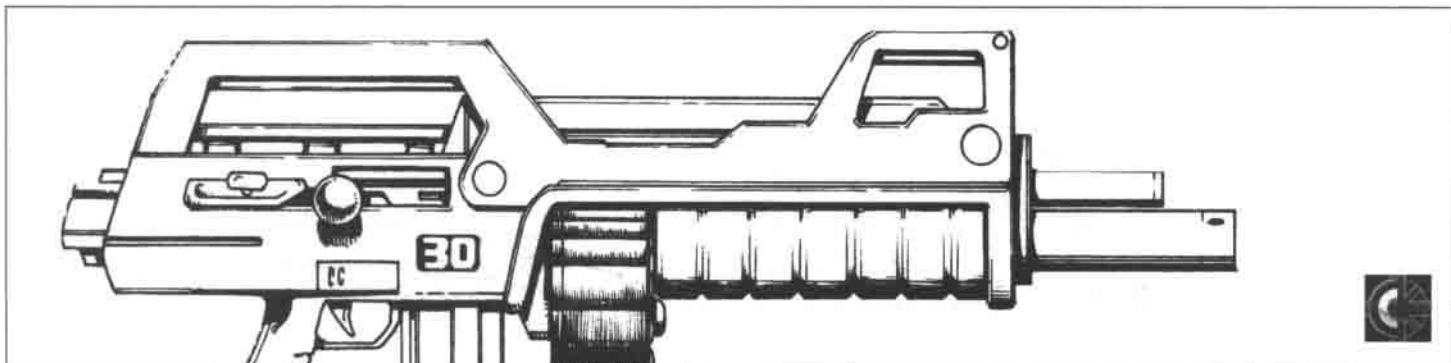

The Invader battle assault rifle is similar in design to the Assailant, but has much better close-combat capabilities due to the 30 mm integrated grenade launcher. It is the only grenade launcher that is drum fed, allowing for great firing endurance but also making the weapon quite bulky. Here shown with stock removed.

### INVADER BATTLE ASSAULT RIFLE (MK. XIB)

W	L	MC	TSS	GL	CB	TS	FUNC	RANGE	STR	RT	JF	DAM	COST
7,1	83	30	opt	int	opt	opt	A	260/390	27	1	5	1d6+3	11,600

### MK. XIK GRENADE LAUNCHER

SW	MC	FUNC	RANGE	STR	RT	JF	#TA	SR	DAM	COST
—	14	S	100/150	27	2	5	1d4	1	1d10	—

## L&A PLASMA CARBINE

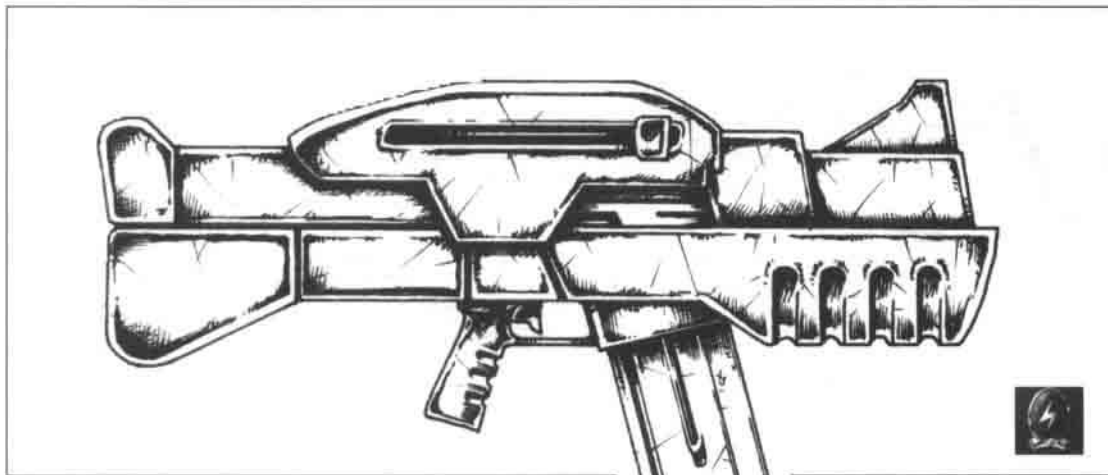

This plasma carbine is similar in its interior design to the Plasma Intruder SMG, also from Lyon & Atkinson, but is considerably more reliable, robust and powerful in order to be a weapon fit for the greatest heroes of our world, the Doomtroopers. The grenade launcher has been substituted by plasma ammo capacity, giving the same effects, if not better.

**NOTE:** When firing plasma ammo, treat as normal missile combat. When avoiding, treat as normal grenade.

### LYON & ATKINSON PLASMA CARBINE

W	L	MC	TSS	GL	CB	TS	FUNC	RANGE	STR	RT	JF	DAM	COST
6,0	61	36	N	N	opt	opt	A	200/300	23	1	9	1d6+4	20,000

### PLASMA AMMO

SW	MC	FUNC	RANGE	STR	RT	JF	#TA	SR	DAM	COST
—	36	S	180/270	23	1	7	1d4	1	1d6+1	—

## AG-17 «PANZERKNACKER»

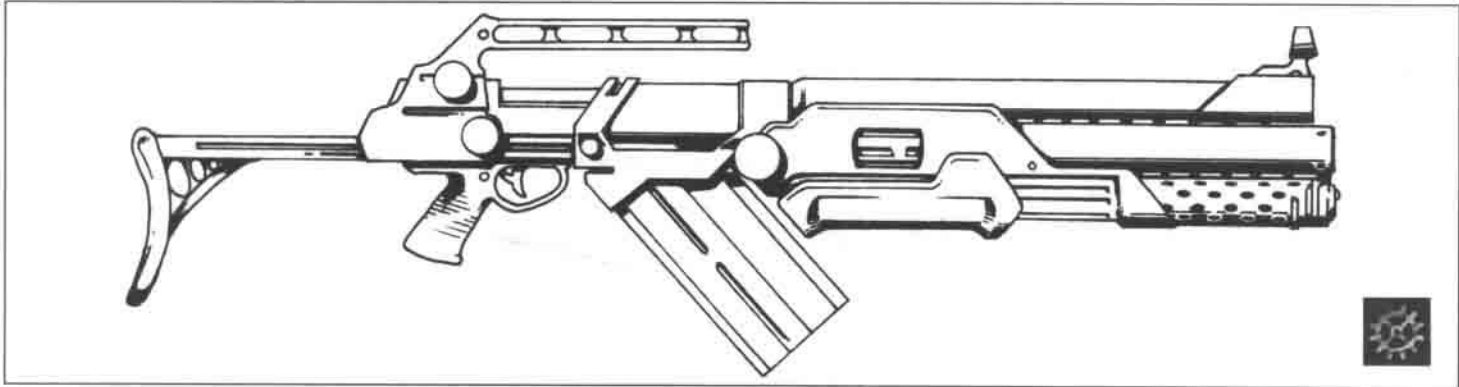

The Panzerknacker's name is derived from its outstanding armor-piercing capabilities, both with the 34 mm HEAT-grenades and with AP-ammunition to the 4.85 mm barrel. Its primary feature is the extreme rate of fire, possible only because of the caseless ammunition mechanism. Folding stock and detachable grenade launcher.

### PANZERKNACKER ASSAULT RIFLE

W	L	MC	TSS	GL	CB	TS	FUNC	RANGE	STR	RT	JF	DAM	COST
4,7	90/72	48	Y	det	N	opt	A	300/450	19	1	7	1d6+2	12,400

### GW-170 GRENADE LAUNCHER

SW	MC	FUNC	RANGE	STR	RT	JF	#TA	SR	DAM	COST
1,0	4	M	50/75	19*	1/rnd	8	1d6	1	1d6+2	2,600

## SNIPER RIFLES

With the SNIPER RIFLES the gap between assault rifles and machine guns is bridged. They have the same range and penetration as machine guns combined with the accuracy of assault rifles. The drawbacks are that they are bulky, very expensive (due to short manufacturing

series) and not as durable as more conventional weapons.

**NOTE:** For the sniper rifles, range is only given in meters.

## SR-50

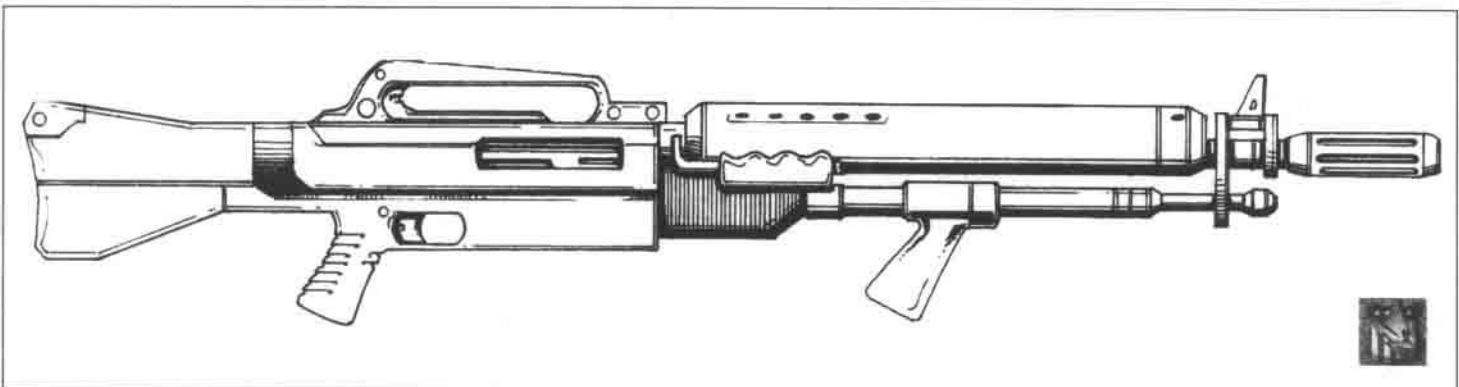

The SR-50 is an extended version of the M50. It is simply a sniper's dream—even while firing calibre .62 bullets, it is totally recoilless and almost dead silent. The detachable nightvision sight allows the skilled shot to hit a five-crown at more than 2000 meters. Simple mechanism assures high reliability. Stock can be folded.

W	L	MC	TSS	GL	BIP	TS	FUNC	RANGE	STR	RT	JF	DAM	COST
5,5	117/95	12	Y	N	opt	x9	S	2000	21	1	9	1d6+4	10,100

## TAMBU NO. 15 «ARCHER»

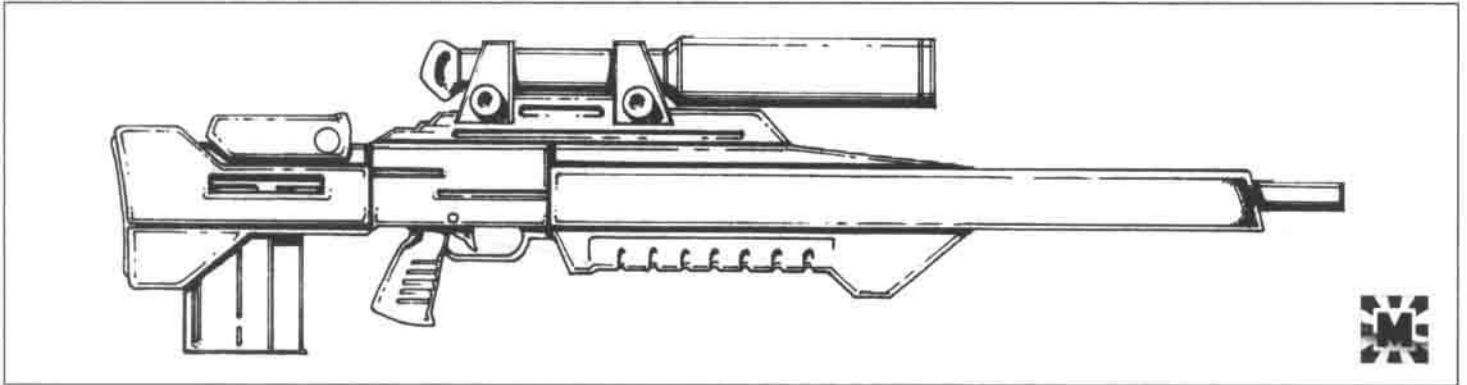

The bullpup design (the mechanism is placed behind the trigger) of this weapon makes it relatively short for being a sniper rifle. The detachable nightvision sight can be set at either x4 or x8 magnification, making it useful at both medium and long ranges. Probably one of the more popular assassin weapons.

W	L	MC	TSS	GL	BIP	TS	FUNC	RANGE	STR	RT	JF	DAM	COST
4,4	93	15	N	N	opt	x4/x8	3	1700	17	1	7	1d6+2	7,100

## SR3500

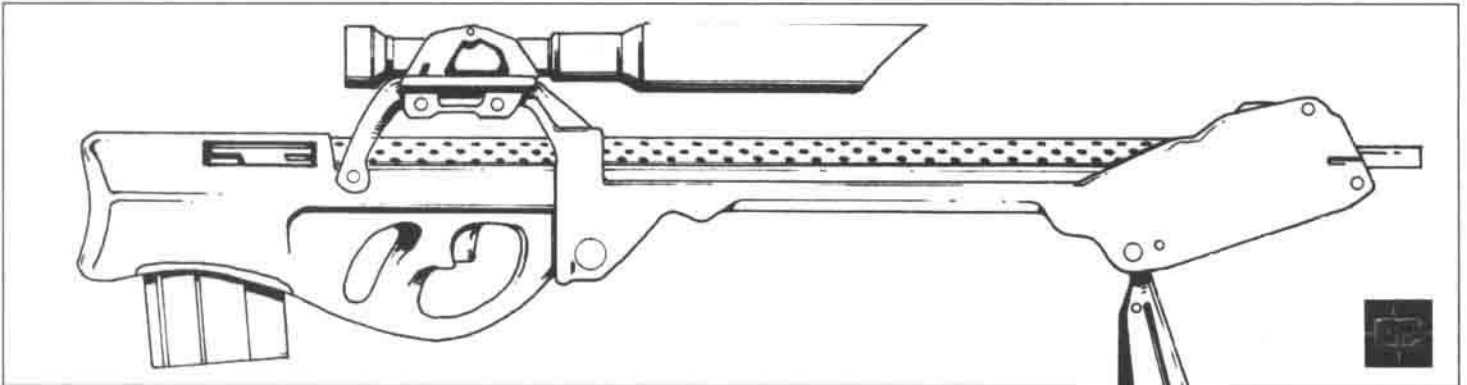

Though looking large and bulky, the SR3500 is extremely light-weight and stable. The «bulb» behind the muzzle contains the motor for the chainsaw-bayonet as well as it provides with «storage space» for the bipod when folded. SR3500 has been produced in few examples and is rare on the street. Detachable nightvision sight.

W	L	MC	TSS	GL	BIP	TS	FUNC	RANGE	STR	RT	JF	DAM	COST
50	102	20	N	N	int	x3-x12	A	2300	17	1	7	1d6+3	16,000

## SR MK. XII «ASSAILANT»

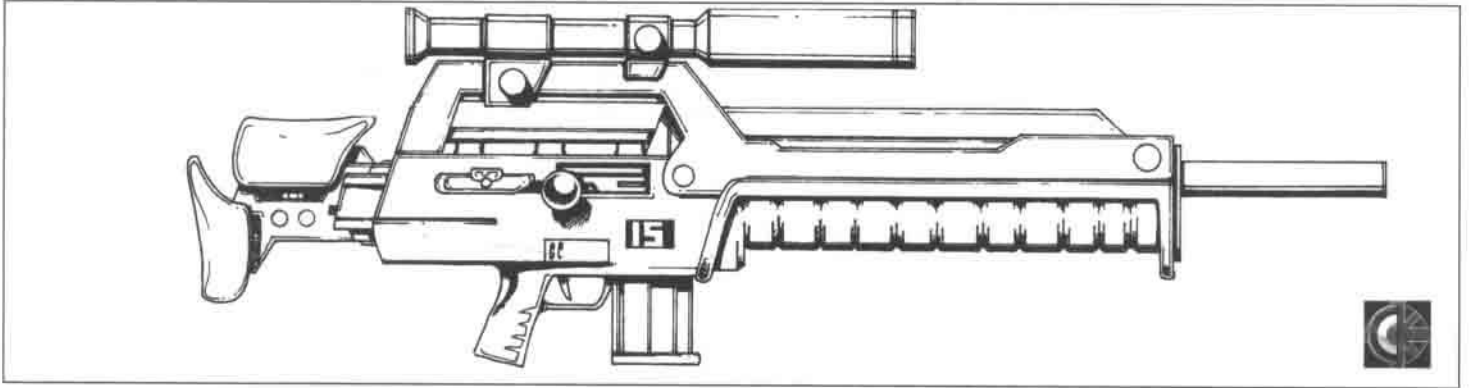

The Assailant sniper rifle, manufactured by Imperial-controlled Fieldhausen Arms, is used by most military forces connected to Imperial. It is a reliable and stable design, a bit too heavy to be popular outside the armed forces. Detachable nightvision sight.

W	L	MC	TSS	GL	BIP	TS	FUNC	RANGE	STR	RT	JF	DAM	COST
6,3	107/94	15	det	N	opt	x5/x10	S	1200	23	1	9	1d6+4	14,400

## PSG-99

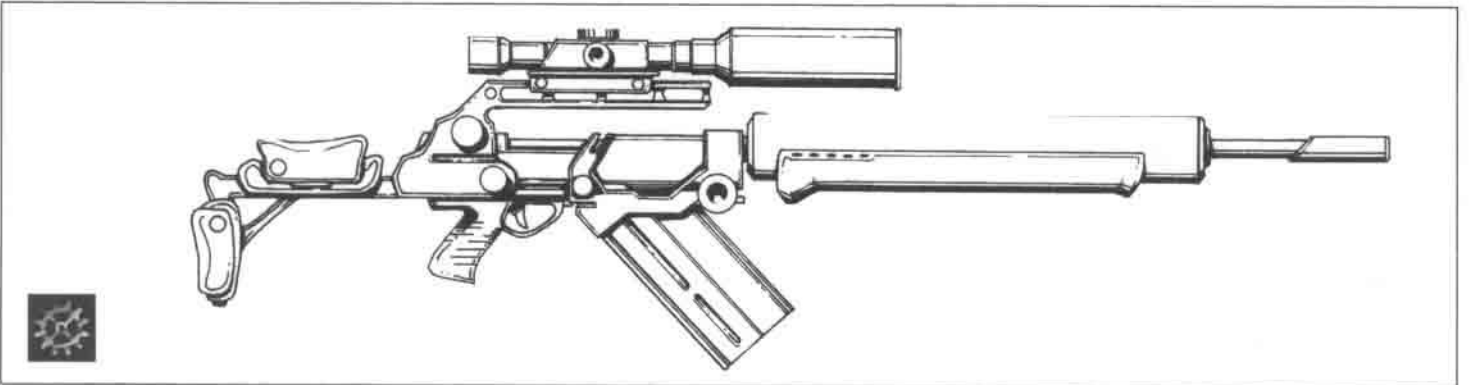

The PSG-99 relies on the same conventional technique as most other Bauhaus-designed weapons, with the critically angled clip necessary for flawless use of caseless ammunition. A master-piece among weapons, the PSG is favored even within special forces of rivaling corporations to Bauhaus. Detachable nightvision sight.

W	L	MC	TSS	GL	BIP	TS	FUNC	RANGE	STR	RT	JF	DAM	COST
5,1	109/90	48	Y	opt	opt	x1-x12	A	2100	19	1	8	1d6+3	18,600

## MEPHISTO SNIPER RIFLE

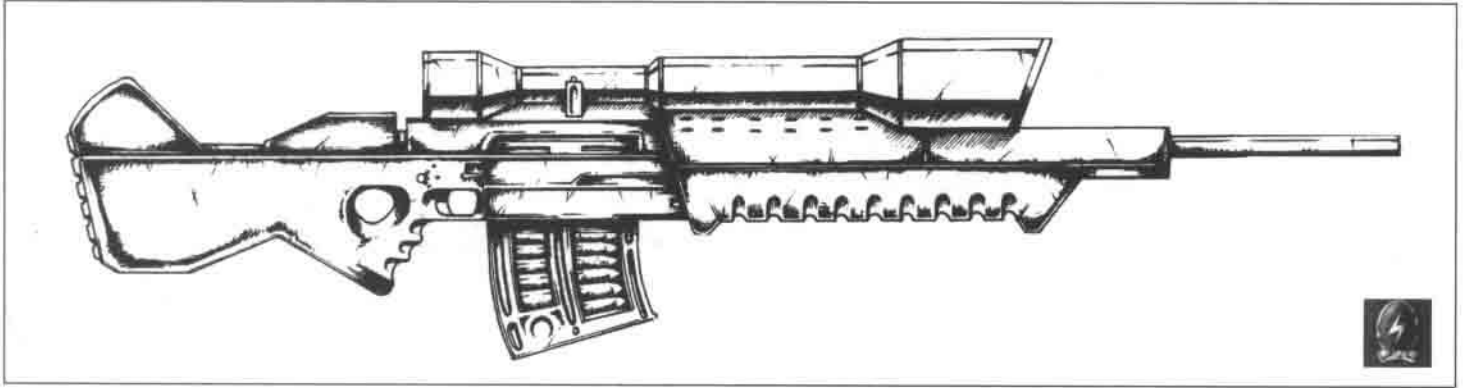

The Mephisto Sniper Rifle is a rather ordinary rifle design with few gadgets and therefore high reliability. It is unusually stable and robust, giving excellent accuracy and range. The detachable nightvision telescopic sight has x3-x15 magnification and includes a red-point emitter for short ranges. The rifle is used by the Doomtroopers.

W	L	MC	TSS	GL	BIP	TS	FUNC	RANGE	STR	RT	JF	DAM	COST
7.0	110	13	N	N	opt	x3-x15	A	2600	25	1	9	1d6+4	24,500

## SHOTGUNS

Shotguns are also referred to as close assault weapons, CAWs, and are mostly used by police and security forces fighting unarmored opponents. They fire a swarm of very fine calibre bullets, often irregularly shaped, and don't have much range. The advantage is that you can't possibly miss.

All shotguns look like they're double-barrelled, but the lower barrel is in fact the internal magazine, usually containing 4-14 rounds.

With the special «slug-ammunition» it is possible to achieve the same range as normal guns while still having a devastating fire-power. The slugs contain maybe ten or twelve very sharp shrapnels that travel in a tight cluster some 150-200 meters.

**NOTE:** Multiply range by 10 for slug ammunition. Add +1 to the damage code. Disregard special shotguns rules: All shotguns except the «Mandible» require two hands for reloading, but not for firing.

## M516S/M516D

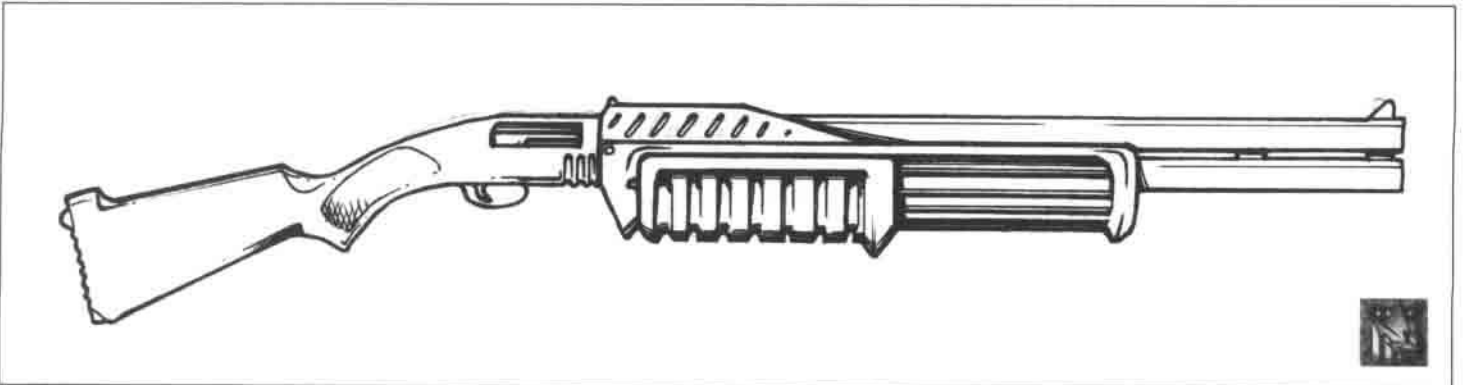

The M516S, SINGLE-model, is Capitol Security Service' standard shotgun, frequently carried both on patrol and on emergency calls. It also comes in a double-barrelled, over-and-under, version (M516D), restricted to military use only. The «516S» is a fairly common weapon—many have been stolen from killed CSS officers—that can boast both full automatic function and long range. Manufactured under license by Colding Arms, Inc.

### M516S

W	L	MC	TSS	GL	CB	TS	FUNC	RANGE	STR	RT	JF	DAM	COST
6.4	94	6	N	N	N	N	S	14/21	15	1/md	3	1d4	8,200

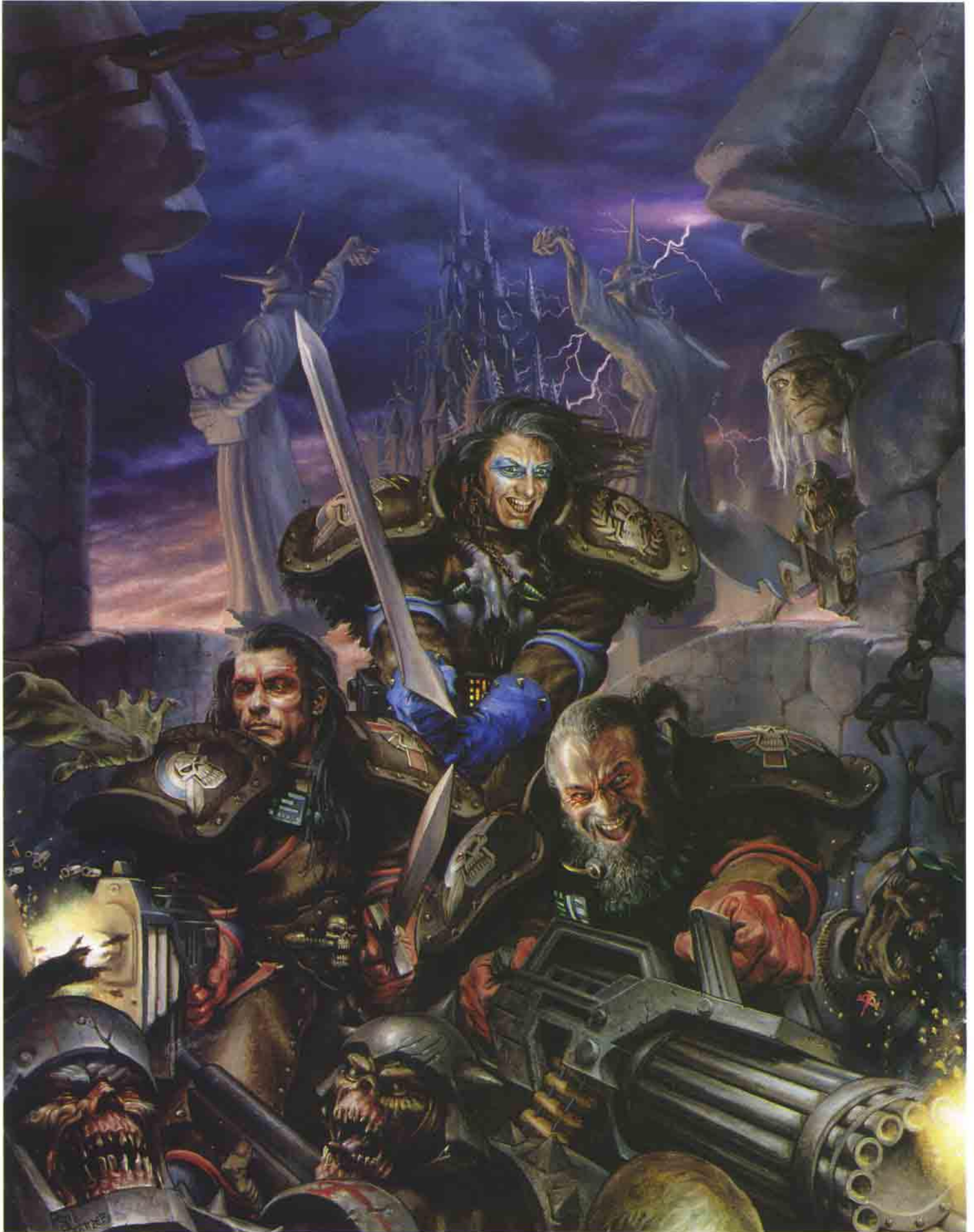

## THE LAST STAND

Copyright © 1993 Target Games AB. All Rights Reserved. MUTANT CHRONICLES and all character names and distinctive likeness (es) thereof are Trademarks of Target Games AB



### NIMROD AUTOCANNON

Two barrels are always better than one, and the Nimrod is the most fearsome weapon in the Doomtrooper arsenal because of its awesome destructive power.

During one attack action, you may make either one attack with a damage of 1d6+6, or two attacks with a damage of 1d6.



### DOOM TROOPERS

### LASER SIGHT

The sight projects a red dot on your target, directing your fire. Can be mounted on virtually any missile weapon with the correct adapter. See special rules in the «Combat»-chapter.



### COAGULANT AUTOINJECTOR

This medical item is saved for the most desperate situations where it can save the life of a user. Immediately restores a total of 5 Body points in one hit location. Must be recharged every time you have used it.



### COMMAND HELMET

An integrated communication system that enables better contact between the trooper and his combat coordinator. If you spend an entire CR making a Computer skill roll, you will have one extra action to spend the next 1d6 CRs.



### PLASMA CARBINE

This plasma carbine is similar in its interior design to the Plasma Intruder SMG, but is considerably more reliable, robust and powerful in order to be a weapon fit for the greatest heroes of our world, the Doomtroopers. The grenade launcher has been substituted by plasma ammo capacity, giving the same effects, if not better. See stats in the «Weapons»-chapter.

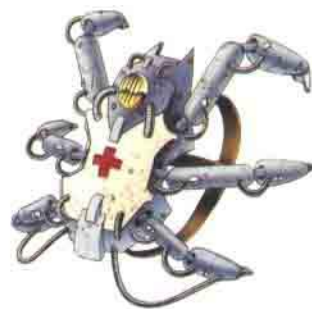

### COMBAT MEDIC UNIT

This trusted servant is a computer robot medic that diagnoses and treats wounds even during combat. Carried like a backpack. When used, it restores a total of 10 Body points. Must be recharged every time you have used



### PUNISHER COMBO

This effective combination of an armor-piercing Punisher shortsword and the reliable Punisher handgun gives the user a deadly flexibility. The combination often used by the close combat specialists of the Doomtrooper squads.

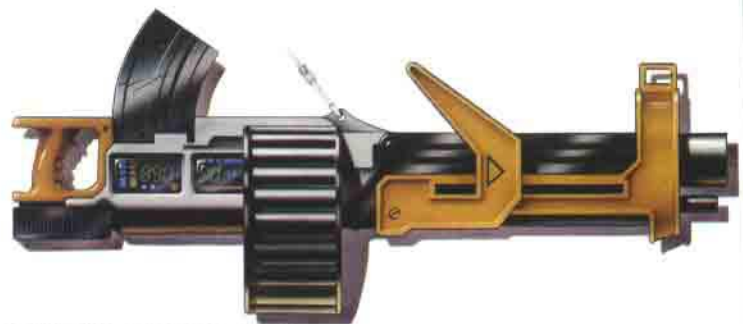

### DEATHLOCKDRUM

This heavy weapon fires high-powered ammo and is feared for its superior ability to destroy anything within its range. Damage: 1d10+1.



### VIOLATOR SWORD

The Violator is an electro-charged battlesword. Its lethal effect often brings down many enemies with one mighty blow. Damage: 1d10. All adjacent squares are attacked with one single action.



### GEHENNA PUKER

This is a high-tech flamethrower that spews out a cloud of ignited plasma that reduces everything in its path to a shining cinder. Damage: 1d6+2

## M516D

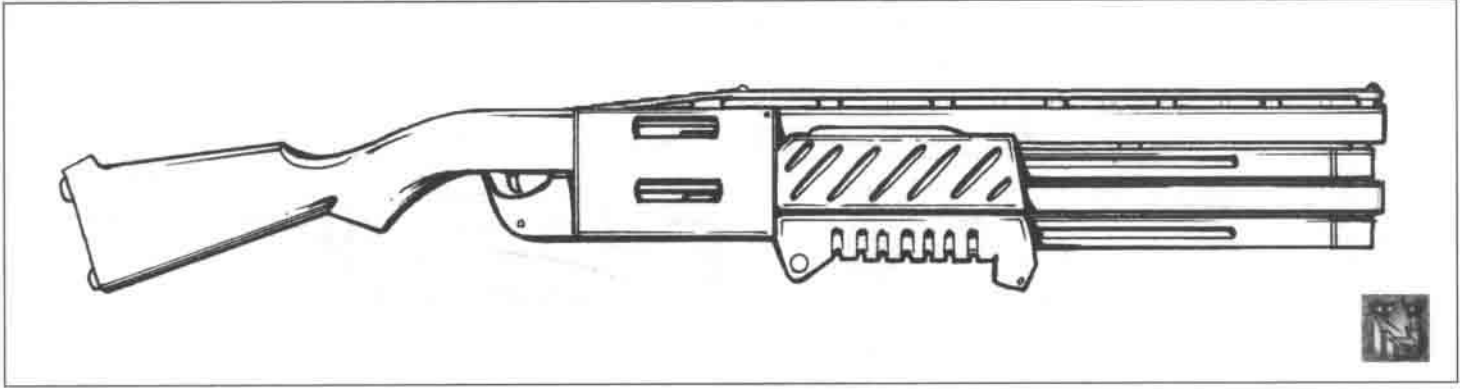

W	L	MC	TSS	GL	CB	TS	FUNC	RANGE	STR	RT	JF	DAM	COST
7,7	88	12	N	N	N	N	A	10/15	21	1/rnd	3	1d4+1	9,600

## TAMBU 50/50 «AIRBRUSH»

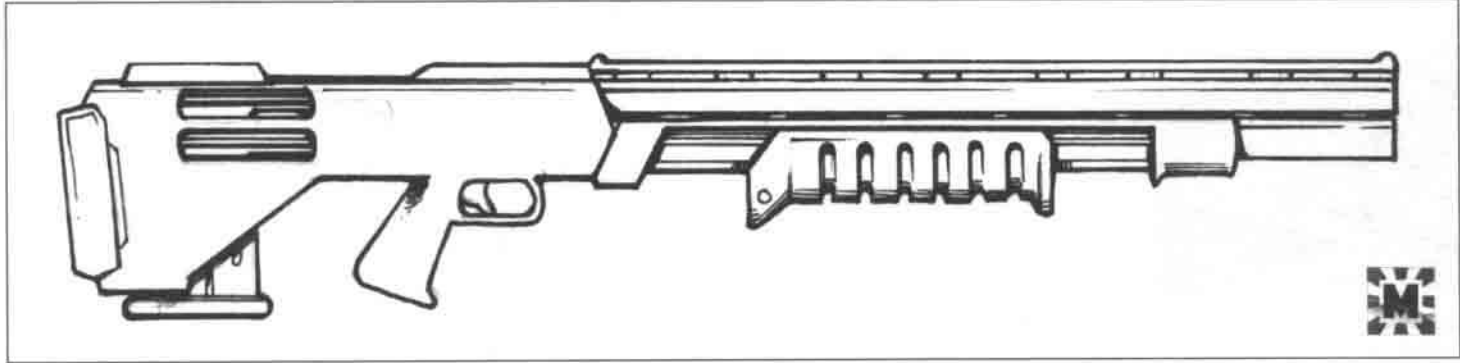

This semi-automatic shotgun is primarily favored for its light weight, large ammo capacity and low cost. However, this is reflected in quality — many reports of too much play in the maneuvering handle, ammo explosions and leaks in the gas regulator have made it impopular among the freelancers. Double barrellled, the barrells go side-by-side, and quite heavy recoil.

W	L	MC	TSS	GL	CB	TS	FUNC	RANGE	STR	RT	JF	DAM	COST
5,0	67	14	N	N	opt	N	S	20/30	19	1/rnd	1	1d4	6,500

## SA-SG7200I

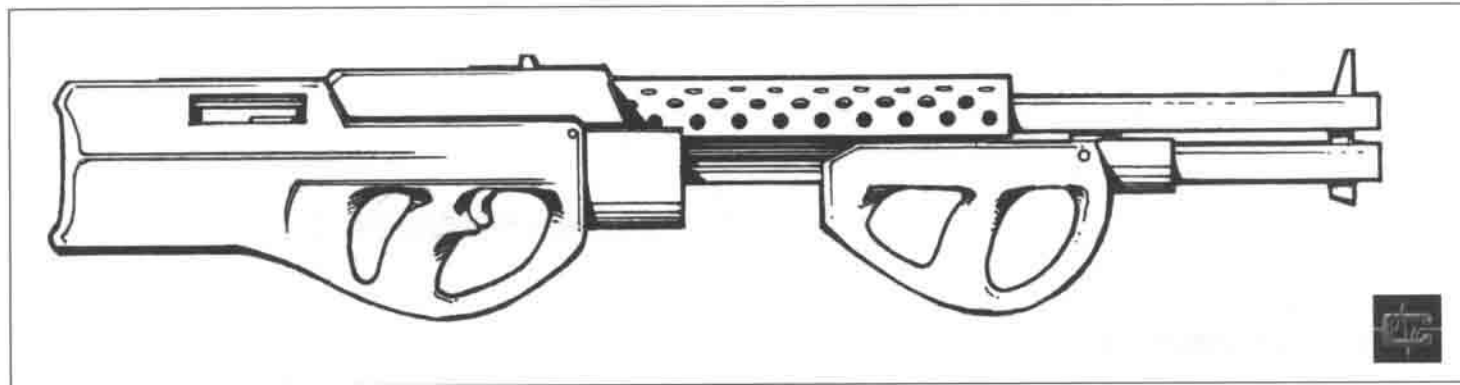

This «improved» 200-version differs from the ordinary Cybercurity SG7000 shotgun in that it has been redesigned for semi-automatic function only. The reasons were mainly that too many jams ocurred with the full automatic version, and with this weapon, which was developed for use in urban areas by Cybercurity Military Police officers, they couldn't afford such failures.

W	L	MC	TSS	GL	CB	TS	FUNC	RANGE	STR	RT	JF	DAM	COST
5,0	78	6	N	N	opt	N	S	40/60	11	1/rnd	9	1d6	13,500



## B&G MK. XIV «MANDIBLE»

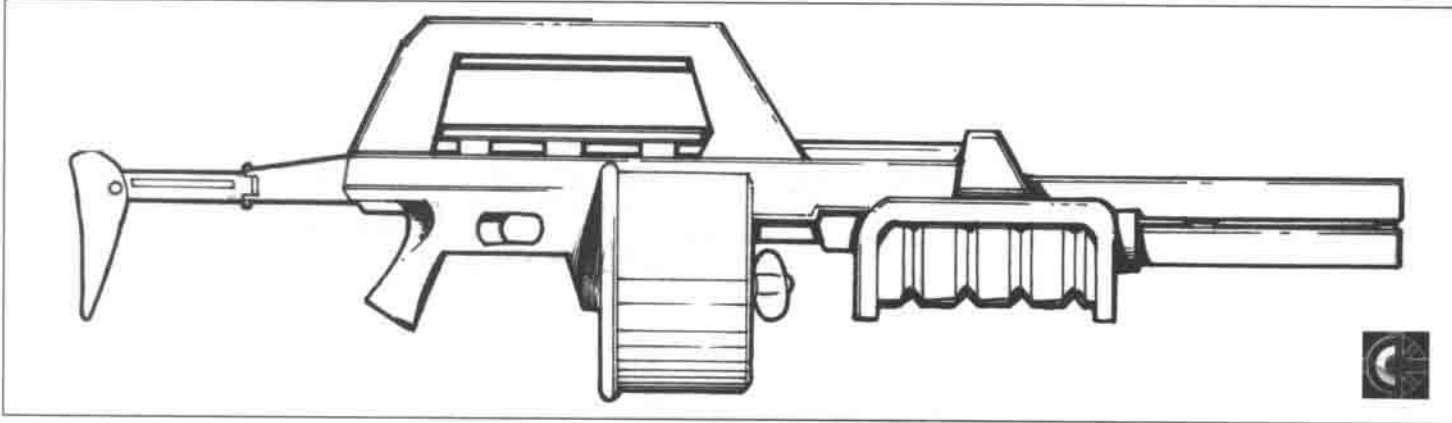

This Bartholomew & Grendel production was their first real success in the weapons branch, and the design soon came to be adopted by other freelancers with close contact with Imperial, such as Lyon & Atkinson. Early on, they realized there was a stable market for really heavy infantry arms, and this standard has become coherent for most Imperial arms. Folding stock.

W	L	MC	TSS	GL	CB	TS	FUNC	RANGE	STR	RT	JF	DAM	COST
7,5	81/64	19	int	N	N	N	A	24/32	25	1	5	1d6+1	11,400

## HG-14

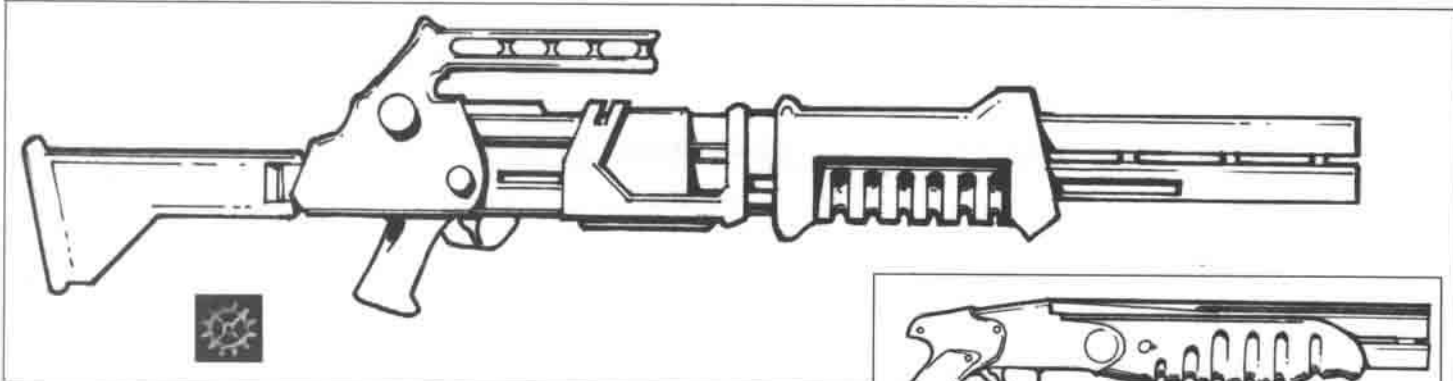

This rather conventional shotgun has been widely spread among freelancing security companies, and the possibility to «streetify» this weapon by sawing stock, scope holder and barrel off has further increased its popularity.

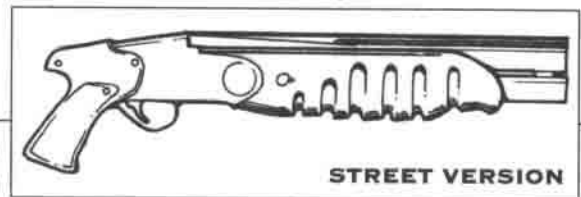

**STREET VERSION**

W	L	MC	TSS	GL	CB	TS	FUNC	RANGE	STR	RT	JF	DAM	COST
6,0	82/66	5	int	N	N	opt	M	30/45	23	1/rnd	8	1d6	14,000

### STREET VERSION

W	L	MC	TSS	GL	CB	TS	FUNC	RANGE	STR	RT	JF	DAM	COST
4,6	64	5	N	N	N	N	M	6/19	13	1/rnd	2	1d4	varies

## LIGHT MACHINE-GUNS

The light machine-guns have slightly more fire power than the assault rifles, but the more solid, heavier design provides with better accuracy when firing automatic

bursts. Also, they are belt fed and have interchangeable barrels, which allows for considerably longer bursts.

**NOTE:** For the LMG:s, range is only given in meters.

### M606

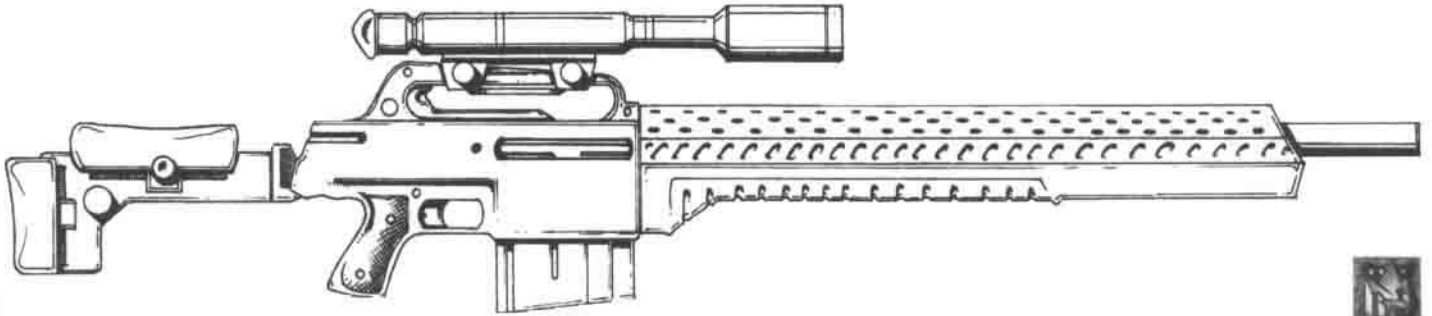

The M606 is one of the most produced LMG:s ever, a popular and convenient weapon for all situations. It is a very light construction, not very accurate or reliable but simple in design and easy to handle. The «trombone» gas regulator (the fore handle) allows for a variable rate of fire between 500 and 1500 rounds per minute (cyclic). Belt fed from the left side.

W	L	MBL	BIP	GL	CB	TS	FUNC	RANGE	STR	RT	JF	DAM	COST
7,2	109	400	N	N	N	opt	A	900	25	2	4	1d6+3	10,500

### TAMBU NO. 11 «KENSAI»

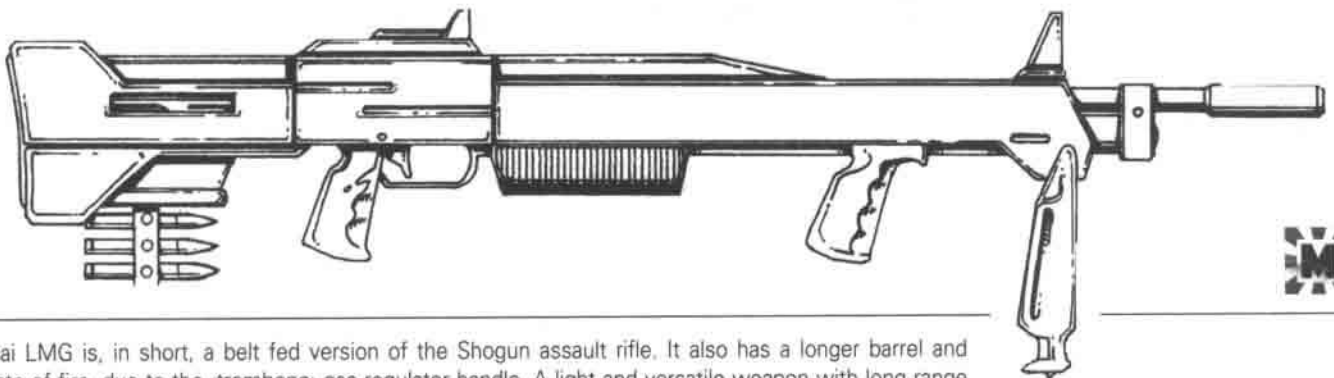

The Kensai LMG is, in short, a belt fed version of the Shogun assault rifle. It also has a longer barrel and variable rate of fire, due to the «trombone» gas regulator handle. A light and versatile weapon with long range and stable characteristics.

## TSW4000

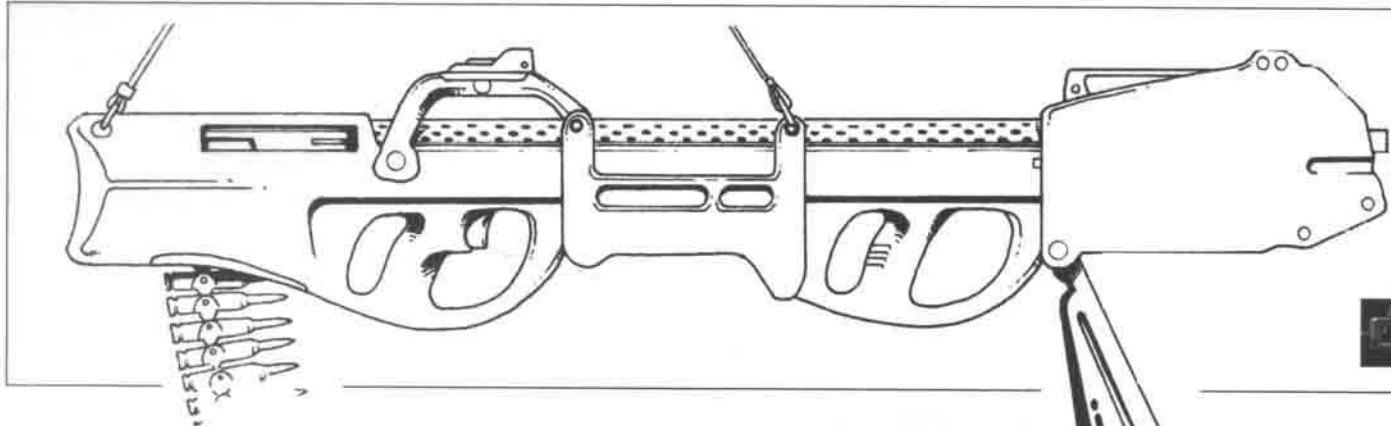

In accordance with all other Cybertronic-designed weapons, the Trooper Support Weapon 4000 is the Rolls Royce of light machine guns. Compact design in unique light-weight materials, combined with superb craftsmanship and leading edge design makes this LMG a pearl in its own right.

W	L	MBL	BIP	GL	CB	TS	FUNC	RANGE	STR	RT	JF	DAM	COST
7,0	97	750	int	N	opt	opt	A	1200	25	3	8	1d6+3	18,000

## LMG MK. XXIII «DESTROYER»

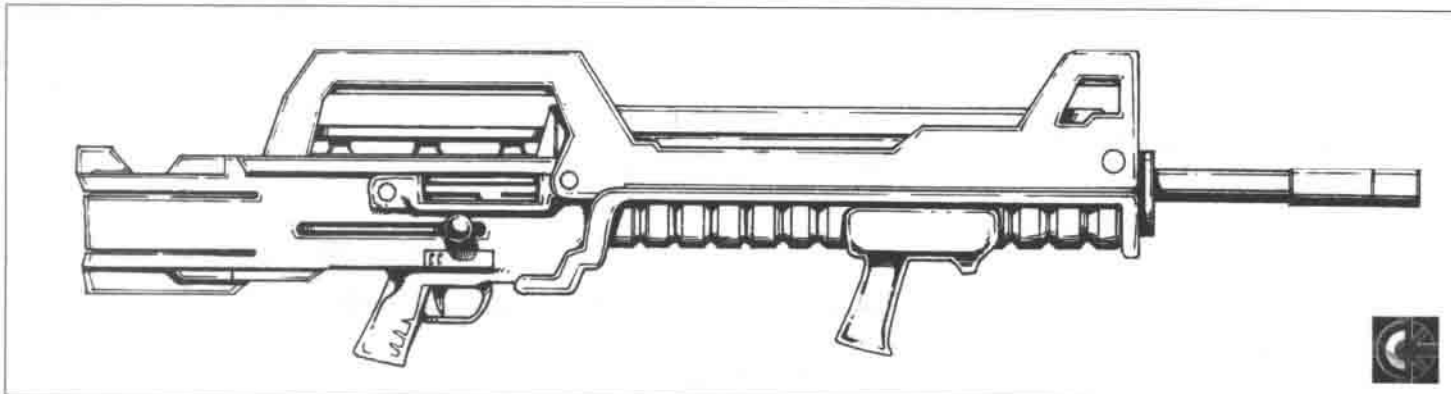

As most other Imperial-designed weapons, the Destroyer LMG is unusually heavy and powerful for its class. And, as most other weapons from the Lyon Atkinson smithy, either you love them or you hate them (or, rather, are too weak to use them). The Destroyer is belt fed from the left side and is feared for having a quite heavy recoil.

W	L	MBL	BIP	GL	CB	TS	FUNC	RANGE	STR	RT	JF	DAM	COST
9,1	109	2000	opt	N	opt	opt	A	900	29	2	5	1d6+4	19,000

## MG-40

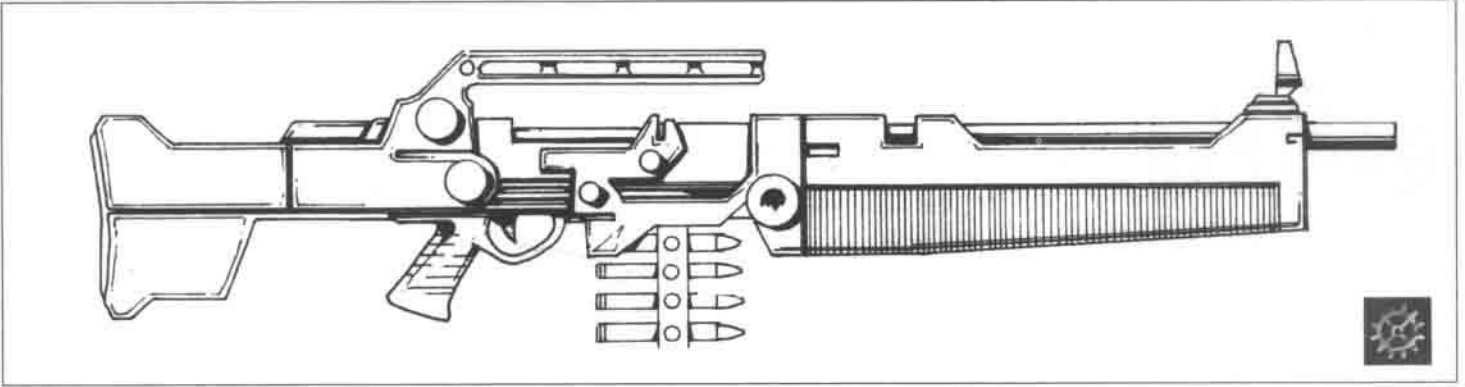

Literally a LIGHT machine gun, the MG-40 is not very much more than a belt fed AG-17 without grenade launcher and a steadier shoulder stock. The weapons are the same calibre, the barrel is only slightly longer, but the construction is more robust due to the greater wear from the longer bursts. A great all-round weapon.

W	L	MBL	BIP	GL	CB	TS	FUNC	RANGE	STR	RT	JF	DAM	COST
6,3	90	300	opt	N	N	opt	A	700	21	3	7	1d6+3	21,500

## AC-40 JUSTIFIER

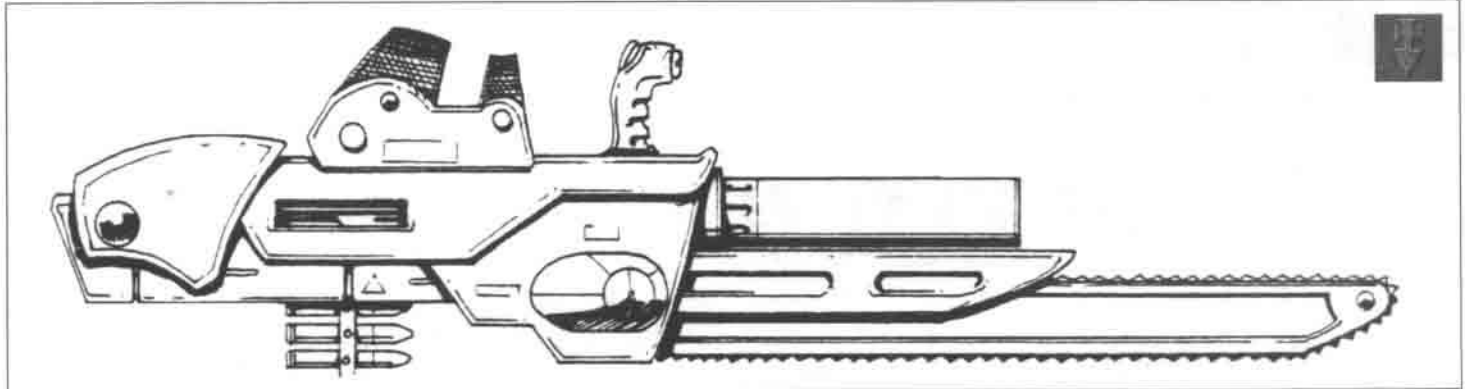

This weapon is called a machine gun since it is exclusively used in that role, as a heavier support weapon on squad-level. The fire-power is equivalent to a light assault rifle, but it is belt fed and actually has an interchangeable barrel. It is held under the fore-arm and fired with the thumb-button. Chain bayonet is standard.

W	L	MBL	BIP	GL	CB	TS	FUNC	RANGE	STR	RT	JF	DAM	COST
6,2	101	400	N	N	int	N	A	100/150	14	3	8	1d6+1	24,000

## HEAVY MACHINE-GUNS

The heavy machine-guns are the most powerful portable automatic weapons available. In order to increase the rate of fire without overheating the weapon, they have multiple barrels and a rotating mechanism, the so called Gatling-construction. While one barrel fires, one is being reloaded and a third ejects an empty case. Their main

advantage is that A LOT of metal lands at a small spot simultaneously and therefore produces enough power to penetrate almost any armor. Described here are the portable versions of these weapons.

**NOTE:** For the HMG:s, range is only given in meters.

### IMPROVED M89

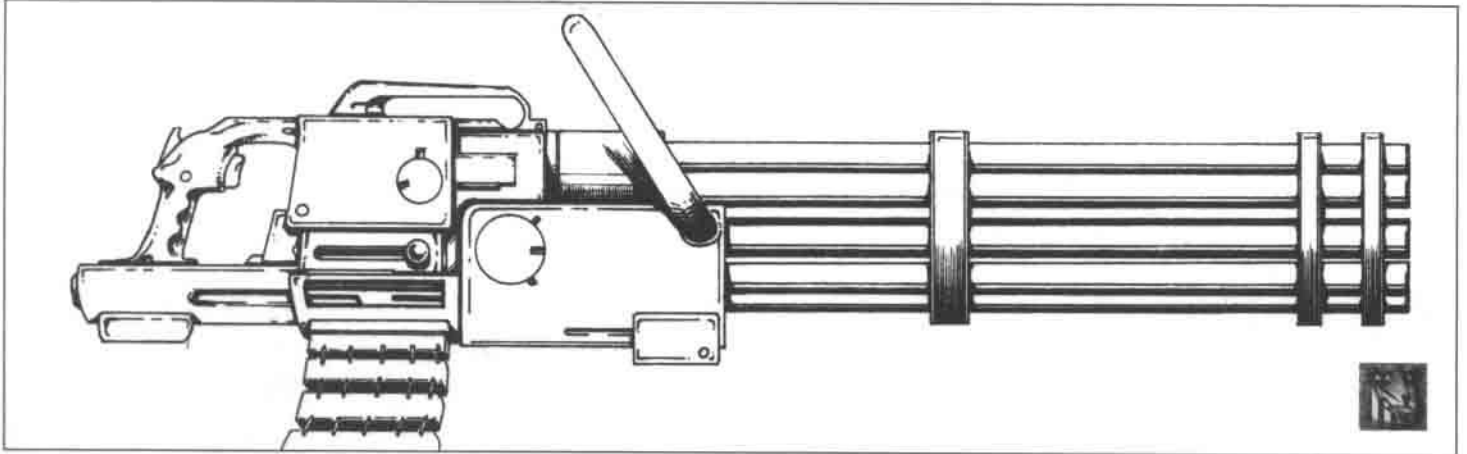

The Improved M89 heavy machine gun is a nine-barreled, Gatling-operated squad support weapon primarily designed for vehicle-mounted use. With the addition of the fore handle and by cutting eight inches off the barrels, it is possible to use it hand-held. The M89 clearly stresses firepower before accuracy.

W	L	MBL	BIP	GL	CB	TS	FUNC	RANGE	STR	RT	JF	DAM	COST
20,0	104	1000	N	N	N	N	A	1000	29*	3	3	1d6+5	21,000

### TAMBU NO. 45 «DRAGONFIRE»

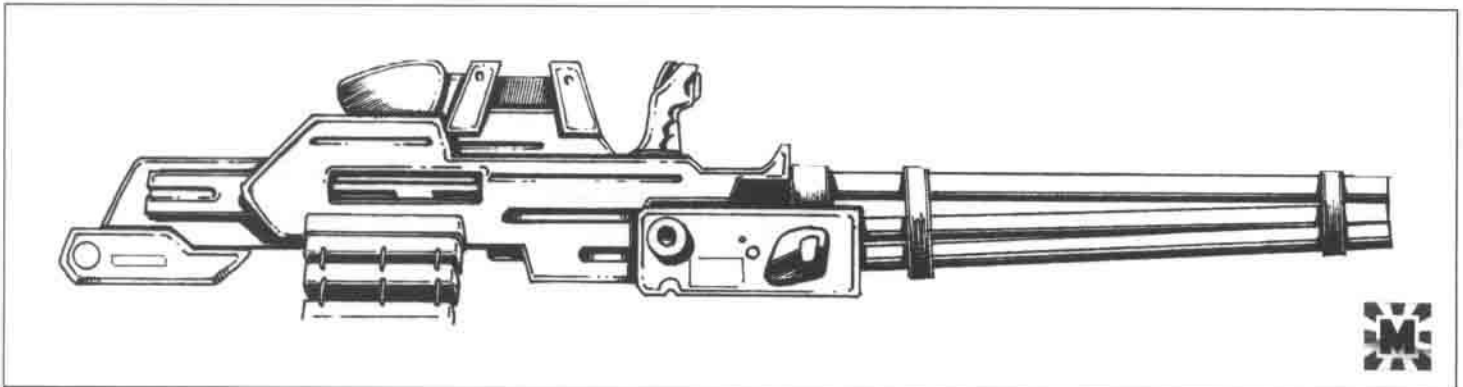

The Dragonfire is a unique experimental design general purpose machine gun, a three-barrel Gatling held under the fore-arm. The problems with aiming this way is eliminated with an extreme rate of fire. The barrels are not parallel, making the weapon slightly more compact.

W	L	MBL	BIP	GL	CB	TS	FUNC	RANGE	STR	RT	JF	DAM	COST
8,6	92	500	N	N	N	N	A	900	16	3	6	1d6+3	16,700

## SSW4200P

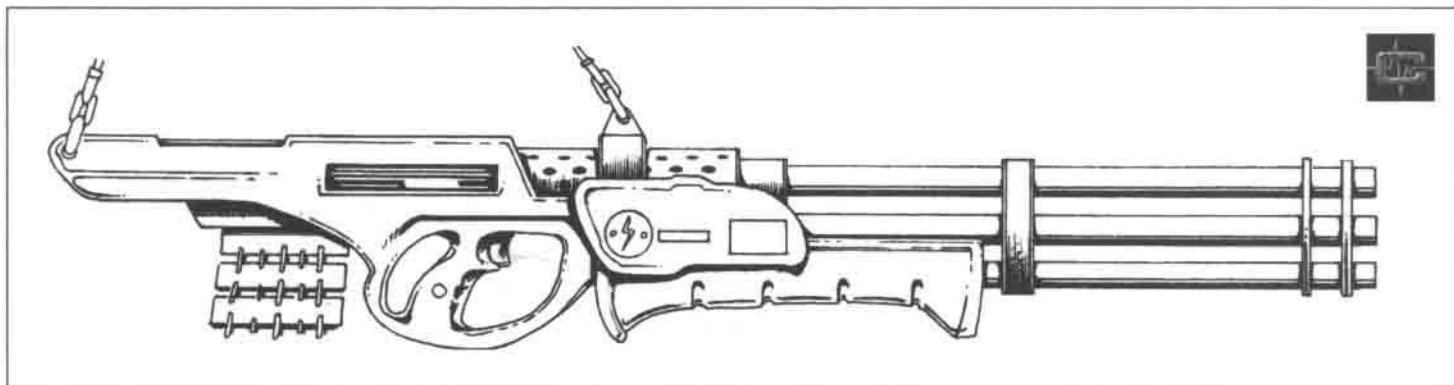

The squad support weapon 4200 is a three-barrel Gatling originally designed to be mounted in a cannon pod or in a vehicle rack, where it has gained reputation for being exceptionally accurate, firing hole-in-hole at up to 2000 meters. The portable version (the 4200P) is, of course, is only as accurate as its user.

W	L	MBL	BIP	GL	CB	TS	FUNC	RANGE	STR	RT	JF	DAM	COST
9,4	99	1000	N	N	N	N	A	1500	21*	3	7	1d6+4	28,500

## HMG MK. XIXB «CHARGER»

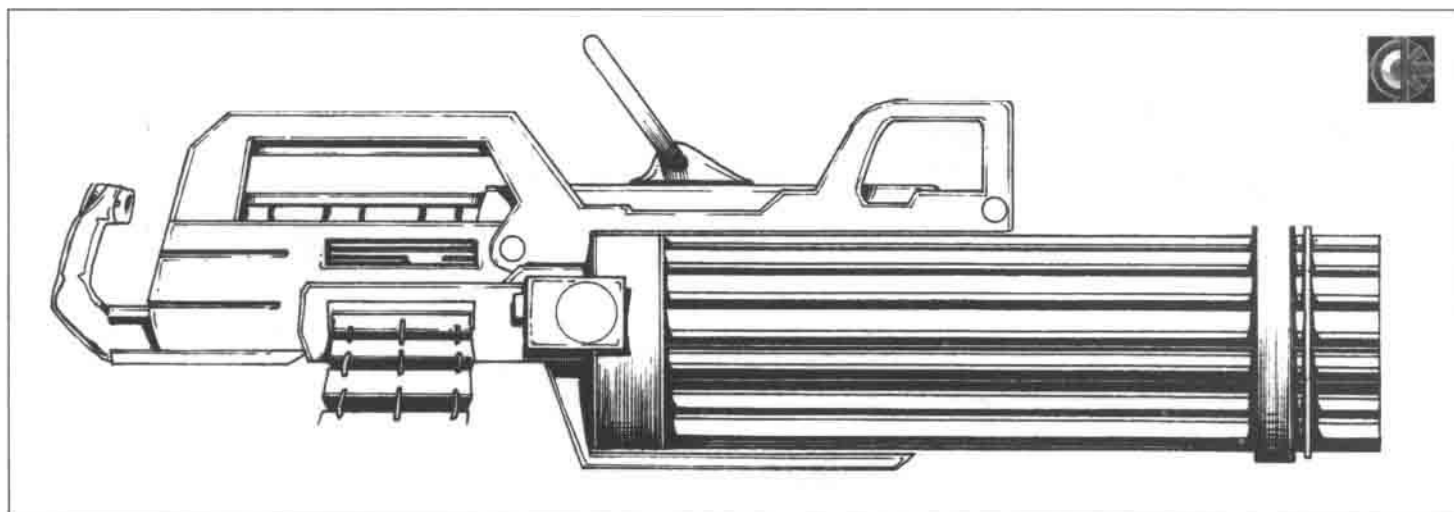

This monster among weapons, the sixteen-barreled Charger HMG, is not a weapon very often seen on the streets, and it is rarely used by military forces without vehicles. The extreme rate of fire (5,600 rpm cyclic) combined with the large calibre (16.7 mm:s) probably makes it the heaviest infantry weapon ever made. Also comes in an eleven-barrel version of larger calibre, reducing range to 60% while adding another +1 to damage.

W	L	MBL	BIP	GL	CB	TS	FUNC	RANGE	STR	RT	JF	DAM	COST
26,4	98	∞	N	N	N	N	A	700	33*	3	4	1d6+6	33,000

## MG-80

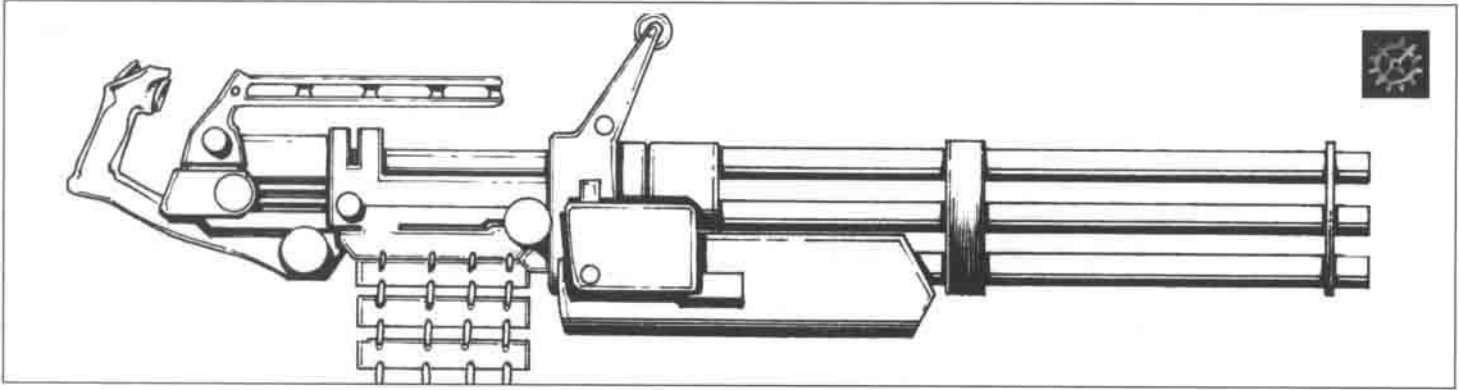

The MG-80 is a three-barreled, Gatling operated heavy machine gun used for infantry close support. As all heavy machine guns, it is most effective at short ranges and in small areas; even while very accurate at long ranges, the weapon is far too heavy to be used for aiming without a vehicle mount or a bipod.

W	L	MBL	BIP	GL	CB	TS	FUNC	RANGE	STR	RT	JF	DAM	COST
10,5	97	750	N	N	N	N	A	1000	23*	3	8	1d6+4	26,000

## AC-41 PURIFIER

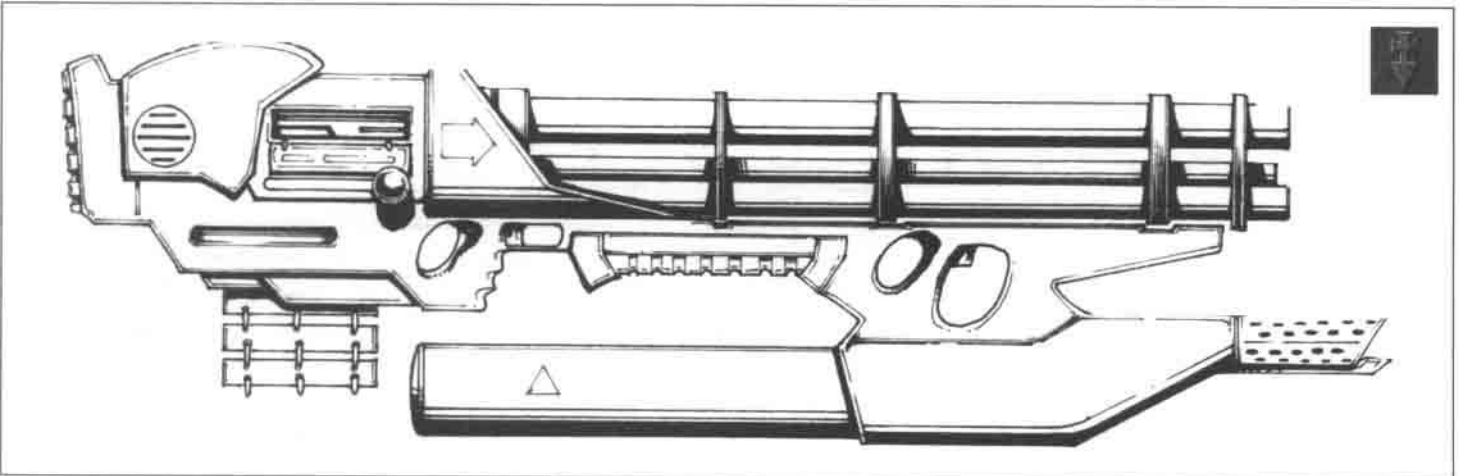

The Purifier is a multipurpose support weapon delivered with a detachable flamethrower. It has been in long use with the Brotherhood's elite forces on both Venus and Mars, and is carried at group level in both assault and guard forces.

W	L	MBL	BIP	GL	CB	TS	FUNC	RANGE	STR	RT	JF	DAM	COST
14,7	98	750	N	N	N	N	A	600	25*	3	7	1d6+4	26,500

### PURIFIER INCINERATOR

SW	MC	FUNC	RANGE	STR	RT	JF	DAM	COST
6,0	14	M	20/30	25*	2	8	1d10+2	8,600



## ROCKET LAUNCHERS

Rocket launchers, also called anti-tank rifles, are multi-purpose weapons used either against armored targets or as common blast grenade launchers (bazookas). They are almost recoilless, and before firing the grenade in the barrel is calibrated to detonate either on impact (armor piercing blast) or after a certain amount of time (high explosive blast). The grenade carries its own «rocket

engine» that propels it and increases its speed all the way to impact.

**NOTE:** On impact, rocket launcher grenades create the same effect as «normal» grenades, but line of sight is traced as in normal missile combat.

### DPAT-9 «DEUCE»

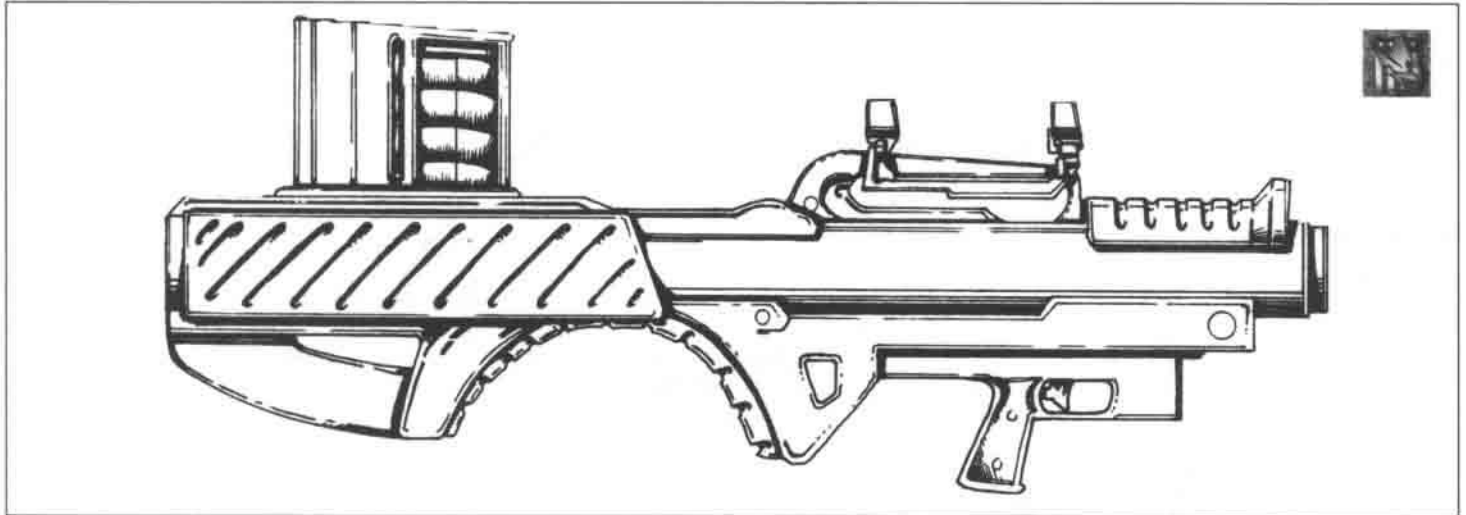

The DEUCE-system was the first successful attempt to design a semi-automatic portable rocket launcher. It has seen better years but is still a brilliant example of the innovative efforts of the Capitol weapon engineers. DEUCE reads «Dual-purpose, Electronically calibrated, Unguided, Chamber fed, Explosive charges».

W	L	MC	TS	FUNC	RANGE	STR	RT	JF	#TA	SR	DAM	COST
12,8	81	6	opt	S	200/300	25*	2	3	1d6	2	1d10+1	18,700

### TAMBU NO. 86A5 «DAIMYO»

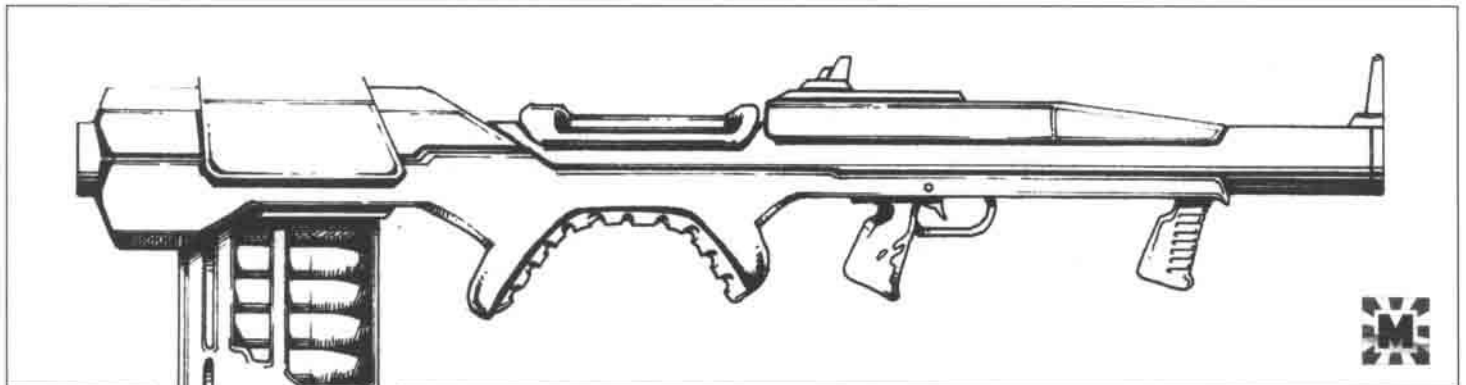

This extremely light and slimmed rocket launcher is quite in accordance with Mishima's philosophy to design light, easy-to-use and easy-to-carry weapons, at a small cost in fire-power and range. The semi-automatic Daimyo is loaded with a hanging magazine carrying 7 grenades.

W	L	MC	TS	FUNC	RANGE	STR	RT	JF	#TA	SR	DAM	COST
9,5	87	7	N	S	200/300	17*	2	8	1d4	2	1d10	17,700



## SSW5500

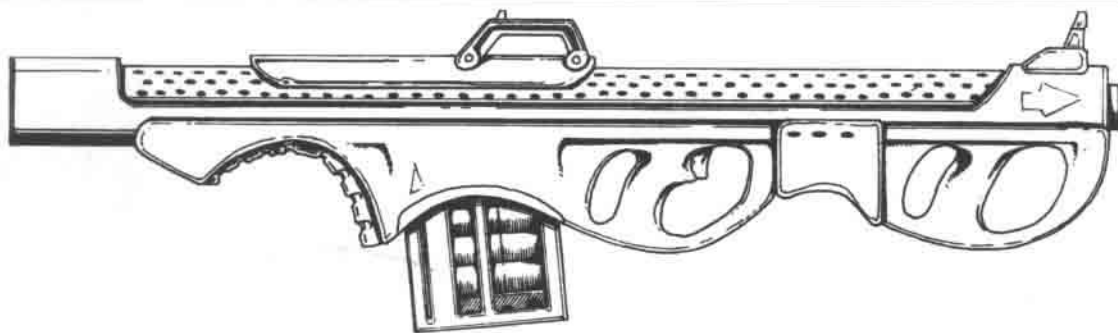

The squad support weapon 5500 is an extremely simple design for being a Cybertronic-financed project. The whole weapon only consists of ten pieces and also differs from other Cybertronic weapons in that that it is pretty awkward to use, especially for people with short or weak arms.

W	L	MC	TS	FUNC	RANGE	STR	RT	JF	#TA	SR	DAM	COST
12,0	93	7	N	S	160/240	23*	2	6	1d6	2	1d10+1	32,000

## RL MK. XIIC «SOUTHPAW»

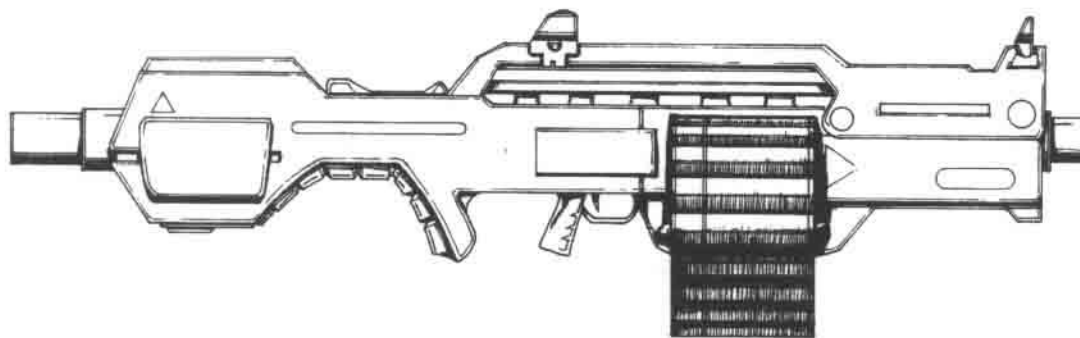

The most powerful of all rocket launchers, the Southpaw is truly a fearsome weapon. The 37 mm grenades accelerate to a speed just below Mach 3 and impact with a force three times that of any other rocket launcher, and as if this is not enough, the Southpaw has full automatic capacity, allowing the user to fire five shells per second.

W	L	MC	TS	FUNC	RANGE	STR	RT	JF	#TA	SR	DAM	COST
19,9	108	19	N	A	60/90	29*	3	5	1d6	2	1d10+6	45,000

## ARG-17

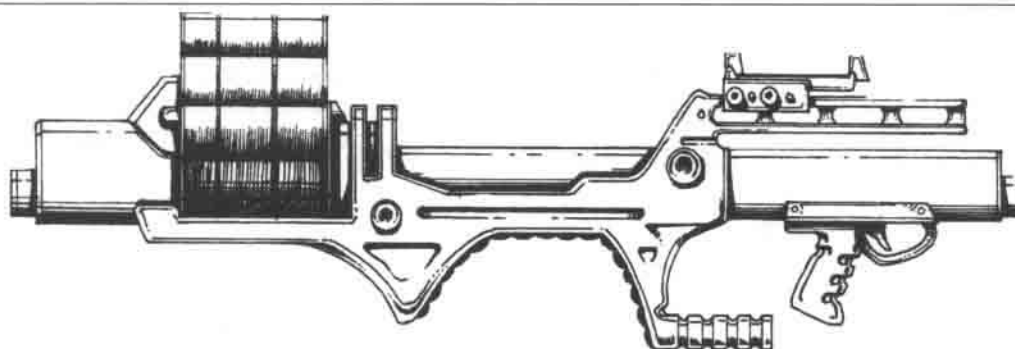

By combining a drum feed and a bull-pup technique, the Bauhaus weaponsmiths once again have succeeded in producing the most user-friendly weapon on the market, in its category. In all aspects, the ARG-17 is almost perfect, as long as you don't look at the price tag...

W	L	MC	TS	FUNC	RANGE	STR	RT	JF	#TA	SR	DAM	COST
10,7	80	11	opt	S	140/210	19*	3	9	1d6	2	1d10+2	43,000

# EQUIPMENT

## ARMOR

Material	Armor Value	Availability	Miscellaneous
Studded cloth	1	A	Inflamable
Impact resistant plastic	1	A	Double damage from fire
Ballistic nylon	2	B	Inflamable
Bullet proof composite	3	B	Non-inflamable
Light combat composite	5	F	Non-inflamable, protects against falls
Heavy combat composite	8	F	Non-inflamable, protects against falls

Place of Clothing	Protects
Helmet	Head against all kinds of attacks
Shoulder pads (military type)	HEAD and WRIST in close combat, CHEST only in missile combat
Vest	CHEST and STOMACH against all kinds of attacks
Leg greaves	LEGS against all kinds of attacks
Arm greaves	ARMS against all kinds of attacks
Gloves	HANDS against all kinds of attacks in 25% of the combat
Jacket	ARMS, CHEST and STOMACH against all kinds of attacks
Pants	LEGS against all kinds of attacks
Trenchcoat	LEGS, ARMS, CHEST and STOMACH against close combat attacks. Legs are only protected in 50% of missile attacks.

### BALLISTIC NYLON

1,800 crowns, availability B

ARMOR VALUE: 2. This material can be made into any kind of protective apparel—jackets, vests, coveralls—and is very flexible. It is very effective against handguns but only has partial protection against automatic fire.

### BULLET PROOF VEST

3,000 crowns, availability B

ARMOR VALUE: 3. Fully concealable under clothes, this multi-woven vest can stop most handguns, but not long range weapons.

### COMBAT ARMOR

35,000 crowns & up, availability F

ARMOR VALUE: 4-8. This is the popular armor of the megacorporations, and is only available through corporate issue. If the adventurer is lucky, he may have picked up one while on assignment with a corporation (if it wasn't reclaimed). Parts such as greaves, breastplates, shoulder pads, and arm guards may be found on the black market in all stages of disrepair.

### COMPOSITE ARMOR

100,000 crowns & up, availability F

ARMOR VALUE: 7-12. Normal combat armor in several layers, or reinforced with other kinds of materials. Only in use within heavy elite units, such as anti-tank rangers. Normal harness weighs around 20 lbs.

### FLAK JACKET

2,400 crowns, availability B

ARMOR VALUE: 2. This is the standard military surplus, sleeveless torso protector. It is bulky and uncomfortable. It won't stop a close range hit or a high powered weapon, but it will protect against that random bullet or shrapnel.

### IMPACT RESISTANT PLASTIC

1,000 crowns, availability A

ARMOR VALUE: 1. Land hockey pads, construction workers' helmets, skateboard protection gear, etc.

## CLOTHING

Everyday street and dress clothes come in a number of styles, fabrics and price tags. But

there are those special occasions when just the right thing is needed to complete the ensemble.

### AIR FILTER

450 crowns, availability A

This is a simple face mask with a charcoal cartridge filter, best used when entering questionable areas where chemical traps may be present, but they are sold everywhere for the average citizen.

### ENVIRONMENTAL SUITS

90,000 crowns, availability F

ARMOR VALUE: 1. This is a complete suit—facemask, filter, gloves and suit—constructed to protect against toxic environments, such as chemical plants, sewers, etc. These are usually corporate issue, but if you don't bring it back, the corporation will deduct it from the paycheck they send to your survivors.

### GAS MASK

900 crowns, availability B

This pull-over rig includes a face plate for vision and its own limited supply (one hour) of air.

### GEAR BELTS

20 to 300 crowns, availability B

Whatever you may have to tote must be properly secured. Belts include holsters, ammo & equipment pouches, and suspenders. They come in a variety of styles and quality, at the GMs discretion.

### HEADGEAR

40 crowns, availability B

Helmets are very suspect on the street, so the average adventurer must rely on more subtle head protection. Cross-woven ballistic cloth can be made into berets and hats that can be folded or converted to hoods and even masks. While the headgear may stop a bullet, there is little it can do against the resulting concussion.

### LINED COAT

24,200 crowns, availability B

ARMOR VALUE: 3. A favorite among freelancers and Cartel agents. This trench coat is made of synthileather but lined with a bullet-stopping plastic weave. It is a little heavier than your average raincoat, but this garment stops more than a few

drops of moisture. It can stand anything up to heavy weapons. Many Cartel agents supplement this with custom protective trauma plates.

### RECLAMATION SUIT

175,000 crowns, availability E

ARMOR VALUE: 1. This is a suit for desert survival. It is constructed like a living cocoon recycling body fluids and cooling the air intake. At one time they were readily available, but now they may only be found in wayward shops, unless custom made.

### SUN GLASSES

48 to 600 crowns, availability A&B

These can range from simple eye protection to tinted shooters glasses, and glasses that polarize instantly against flares.

### VAC-SUIT

200,000 crowns, availability F

ARMOR VALUE: 2. This is a complete space suit. It is used on those occasions when the adventurer must work in the vacuum of space.

### WET SUIT

22,000 crowns, availability B

This includes everything needed for underwater activity: Suit, mask, respirator, oxygen tanks, gloves and fins.

## SURVEILLANCE GEAR

Many of a Freelancer's jobs will require a lot of investigative work. Sometimes special equipment will be needed.

### BINOCULARS

720 crowns, availability B

Standard easy-focus for long range vision. x8 magnification.

### DATA SCOPE

2,700 crowns, availability B

This small hand held device is a range finder, compass, and chronometer all in one.

### EAR

960 crowns, availability B

This is a small but powerful receiver that picks up sound from a distance. It is small and shaped like a radar dish the size of your palm and includes earphones.

### MINI-RECORDER

180 crowns, availability A

This hand held audio recorder comes in handy for recording conversations.

### NIGHT GOGGLES

3,000 crowns, availability F

These are top of the line IR-goggles combined with range finder, binoculars, and a compass attached to a headstrap.

### NIGHT VISION SCOPE

1,800 crowns, availability B

Similar to binoculars, but equipped with IR capabilities for night vision.

### PORTABLE PERISCOPE

600 crowns, availability B

This item fits easily in the hand but can be extended into a periscope for around the corner surveillance.

### SCANNER

5,000 crowns, availability F

Originally military issue, this is your basic motion detection scanner. If available on the common market, there is a 30% chance of failure.



All equipment is rated by the following availability:  
A — readily available at stores.

B — only found at specialty shops.

C — restricted use, you will need a permit, prescription, or license.

D — forbidden, black-market only.

E — rare item, would be hard to find either because of its antiquity or its unavailability.

F — available through corporate channels only (high tech)

It is up to the gamemaster as to which type of equipment is available and how much it will really cost. These are intended as guidelines only.



#### SEISMIC DETECTOR

4,000 crowns, availability F  
The user can preset this device to alert him of the approach of anything, be it human or a freight truck.

#### WIRELESS TRANSMITTER

2,400 crowns, availability C  
A simple bugging device. Wireless pick-ups can be hidden nearly anywhere and a remote receiver can detect sounds within the radius of the pick-up (100-200 meters).

### STREET GEAR

#### AMMUNITION

cost varies, availability varies  
Cost for ammunition to fill one magazine is 1% of the weapon's cost. Machine-guns are considered having a 100 round magazine in this case. Weapons with internal magazines are considered holding 10 rounds. Availability is the same as the weapon's.

#### BATON

312 crowns, availability C  
A standard 24 inch police baton. (Damage 1d4+1.)

#### BAYONET

800 crowns & up, availability B  
Individual for each weapon manufacturer. Normal damage: 1d4 - 1d6; chain bayonet: 1d6 - 1d6+2.

#### BIPOD

300 crowns, availability B  
Accessory to rifles and machine-guns. See «Weapons»-chapter for effects. Individual for each weapon manufacturer.

#### BOOMERANG

60 crowns, availability B  
Boomerangs can be used as a weapon, or—with a whistle attached—will release a shrill screech when thrown. (Damage: 1d3.)

#### CAMERA

400 crowns, availability B  
Single lens, automatic flash. Weight: 2 lbs. Film: 36 shots per roll (18 crowns.).

#### CLIPS

cost varies, availability varies  
Cost for one empty clip (or one empty 50 round belt) is 1% of the weapon's cost. Availability is the same as the weapon's.

#### COMPUTER KIT

8,000 crowns, availability E  
Even with the Dark Forces, there are still some computers out there. This kit allows repair on most of the hardware.

#### CRIME DETECTION KIT

2,000 crowns, availability C  
Everything you need to be an amateur detective. Fingerprint & other tests can be conducted.

#### ELECTRICAL KIT

6,500 crowns, availability A  
This kit will allow the repair of standard electrical items.

#### FILM CAMERA

6,400 crowns, availability B  
Shoulder mounted. Holds fifty minutes of 25 mm film (4 crowns.). Weight: 40 lbs.

#### FIRST AID KIT

150 crowns, availability A  
Simple injuries can be handled with this kit.

#### GRAPPLE HOOK

360 crowns, availability B

This is a folding version that can fit in a large jacket pocket. Comes with one hundred feet of nylon rope.

#### GRENADES

500 crowns & up, availability C or D  
There are shrapnel grenades (SR: 1; damage: 1d4; #TA 1d3), smoke grenades (to blind enemies and cover escape), tear-gas grenades (to smoke enemies out), phosphorous grenades (to illuminate areas or set them on fire). Hand grenades are 500 crowns, grenades for weapons are 5% of weapon's cost.

#### GUN KIT

200 crowns, availability B  
For basic repair and maintenance of firearms. With brush, tools, grease and vital spare parts.

#### RED-POINT SIGHT

Cost varies, availability F  
Enhances accuracy drastically when using firearms. See special rules in «Combat»-chapter. Cost: same as weapon's.

#### LOCK PICK KIT

1,000 crowns, availability D  
An assortment of tools needed to pick all manual and some electronic locks.

#### PORTABLE PHONE

6,000 crowns + about 500 crowns a month, availability A  
This is a cellular phone that can be used anywhere provided you pay your bill.

#### SPRING BILLY CLUB

360 crowns, availability C  
This six inch rod expands to 21 inches, providing the adventurer with a formidable street weapon. (Damage 1d4+1.) Possession = six years hard labor.

#### TELESCOPIC SIGHT

1,400 up availability C  
As described in the «Combat»-chapter, the telescopic sights drastically increase the hit probability in long range battles. Cost: half of weapon's.

#### TOOL KIT

2,200 crowns, availability A  
A basic tool kit. With this kit, the Freelancer can repair almost any mechanical object.

#### ULTRASONIC ZAPPER

2,800 crowns, availability B  
Like the electronic one, this Zapper releases an ultrasonic blast that will knock down an opponent and render him unconscious for about twenty minutes.

#### VIDEO CAMERA

26,800 crowns, availability B  
Shoulder mounted. Battery (rechargeable) for one hour. Cassettes (1 hour) 30 crowns., Weight: 2 lbs.

#### ZAPPER

2,770 crowns, availability C  
Zappers are small boxes with an electronic charge of 120,000 volts. Applied to an opponent, it will render him unconscious for half an hour.

### EXPLOSIVES

#### DEMOLITION KIT

4,500 crowns, availability D  
This is a serious set for anyone trained to arm and defuse explosives.

#### DYNAMITE

60 crowns, availability D  
Sometimes, just plain old TNT does the job when nothing else will. Price is per stick (1/4 lbs) of dynamite.

#### FLARES

150 crowns, availability B  
Standard flares for marking off areas or alerting cohorts of a site. Each cartridge releases a brilliant glow for a couple of minutes.

#### MINES

3,000 crowns, availability D  
Land mines. These are not popular in the *Mutant Chronicles* world, but they do exist. They are usually set to go off when stepped on, but can also have a delay trigger set to explode after being activated. Powerful enough to blow away a leg regardless of boots or armor. (Damage: 1d6+8 in either leg.)

#### PLASTIC EXPLOSIVES

180 crowns per block, availability D  
This is your standard plastic explosive, comes with detonators.

#### SMOKE

150 crowns, availability B  
Just like flares, but each cartridge emits smoke.

### VEHICLES

Everyday vehicles come in a wide variety of brands and models, and below is only a general listing of costs and performance:

#### JUNK PILE

1,000 crowns, availability B  
This car saw its best years a long time ago. Used as an escape vehicle or road-blocker. Failure rate: 20% per start and 100 miles. Max speed: 60 mph.

#### ORDINARY USED CAR

7,500 crowns, availability B  
Used, but still working, this car is some 15 years old and has accumulated 120,000 miles. Max speed: 80 mph.

#### FAMILY CAR

70,000 crowns, availability B  
A new, good, car with all the standard accessories and a little more. Max speed: 110 mph.

#### SPORTS CAR

400,000 crowns, availability E  
A new, really fancy sports car of the latest design with all the latest gadgets. Max speed: 180 mph.

#### MOTORCYCLE

100,000 crowns, availability B  
Not very common because of the hazards of extremely heavy traffic, but convenient for anyone who wants to avoid the traffic jams. Max speed: 120 mph.

#### HELICOPTER

750,000 crowns, availability E  
Used by surveillance and security companies, some cab companies and high executives. 4 passengers. Max speed: 300 mph.

#### SMALL AIRCRAFT

1,000,000 crowns, availability E  
A scarcity of landing strips make these very uncommon in the cities. 10 passengers. Needs 1,500 feet of landing strip (lake or clean, level surface). Max speed: 350 mph.

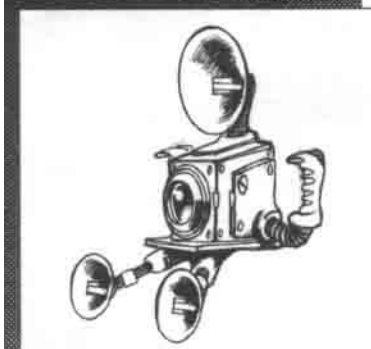
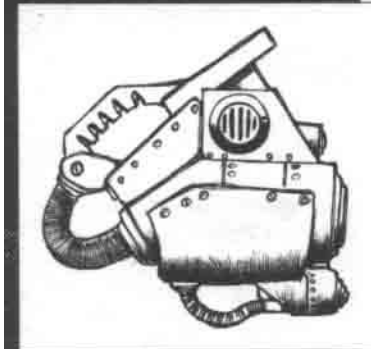
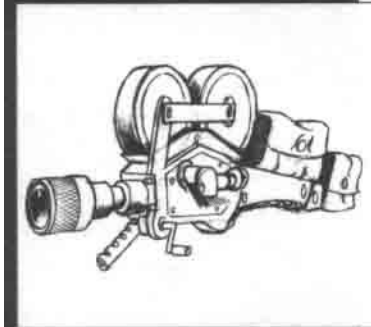





**IT ALL BEGAN IN THE DARKNESS OF THE VOID.**

WE FREED OURSELVES FROM THE HELL WE HAD  
CREATED ON EARTH, BUT FREEDOM HAD A PRICE.

THE WEAK AND THE POOR FELL VICTIM TO THE  
CORPORATIONS, WHO RULE THE SOLAR SYSTEM.

DRIVEN BY THEIR GREED, THE CORPORATIONS LAID  
CLAIM TO THE TENTH PLANET AND WOKE THE SLEEPING  
BEAST, MAY ITS NAME BE FOREVER DESPISED.

THUS DID THE DARK LEGION DESCEND ON US,  
HOWLING FOR OUR DEATH AND DESTRUCTION.

NOW IS THE TIME TO CONQUER OUR FEAR AND STAND  
UP AGAINST THE TIDAL WAVE OF THE DARK SYMMETRY.

**NOW IS THE TIME FOR HEROES.**



ISBN 91-7898-242-1



9 789178 982424

#4001

**Heartbreaker**