

# MANO'WAR™





# THE MAN O' WAR™ GAME

Raging Sea Battles in The World of Warhammer.

BY NIGEL STILLMAN, ANDY JONES AND BILL KING



#### Internal Art and Diagrams

John Blanche, Wayne England, Geoff Taylor,  
Simon Smith, Dave Gallagher, Dave Andrews

#### Game Consultant

Bryan Ansell

### A **GAMES WORKSHOP®** PRODUCT

The Citadel logo, Games Workshop, White Dwarf and the White Dwarf figure and Warhammer are registered trademarks of Games Workshop Ltd. Man O' War, Citadel, Gobbo and Old World are trademarks of Games Workshop Ltd.

All artwork in all Games Workshop products and all the images contained therein have been produced either in-house or as work for hire. The exclusive copyright on the artwork and the images it depicts is the copyright of Games Workshop Ltd.

© Copyright Games Workshop Ltd., 1993. All rights reserved.

Questions on this game should be addressed to: Man O' War Questions, Games Workshop, Howard House, 16 Castle Boulevard, Nottingham, NG7 1FL, England. If you require a reply, you must include a self-addressed stamped envelope (overseas readers should include IRCs). Please phrase your question so that it can be answered yes or no, and leave space on your letter so we can write the answer underneath the question and send the whole thing back to you. Thank you.

Games Workshop Ltd.  
Chewton Street  
Hilltop  
Eastwood  
Notts NG16 3HY  
UK



Games Workshop Inc.  
3431-C Benson Avenue  
Baltimore  
Maryland  
21227-1072  
USA

# CONTENTS

## INTRODUCTION

### GLOSSARY & COMPONENTS

Counters .....	5
Ship Templates .....	6
Cards .....	6
Other Components .....	6
Fleet Lists and Chart Sheet .....	6
Dice .....	6
Terrain Pieces .....	7
Plastic Ships .....	7
How to build your Plastic Wargalleys .....	7

## THE WARHAMMER WORLD

### SETTING UP

Choosing your Fleet .....	10
Ship Templates & Fleet Lists.....	10
Squadrons .....	10
The Battlescape .....	10
Deploying the Fleets .....	11
Crewing your Ships .....	11

### SEQUENCE OF PLAY

Man O' War Turn Sequence.....	12
Initiative Phase .....	12
Magic Phase .....	12
Battle Phase .....	13
End Phase .....	13
The Rule of One .....	13

### MAGIC PHASE

Casting Magic .....	14
How Long do Spells Last?.....	14
Spells of Different Colleges.....	14
Magic Cards .....	14

### MOVEMENT

Basic Movement .....	15
Movement under Sail .....	16
Sailing Against the Wind .....	16
Movement in the Wind .....	16
Ships with Oars .....	16
Ramming .....	17
Obstructions .....	17
Collisions .....	17
Pushing Clear .....	17



## COMBAT AND DAMAGE

The Range Template .....	18
Line of Sight .....	18
Opening Fire .....	19
Aiming high or low .....	19
Saving Throws .....	19
Effects of Damage .....	20
Critical Hits .....	20
Sinking .....	20
Wreckage Markers .....	21
Effects of Ramming .....	21
Critical Damage and Blaze Charts .....	21

## BOARDING ACTIONS

Captured Ships .....	22
Crewing Limits .....	22

## THE END PHASE

Pick up Survivors .....	23
Remove Debris .....	23
See if any Fires Spread .....	23
Move Stragglers .....	23
Scuttle Ships .....	23
Remove Counters .....	23
Pick up Magic Cards .....	24
Deciding Victory using Battle Honours ...	24

---

## • FLEET LISTS •

---

## INTRODUCTION

Points Costs .....	26
--------------------	----

## ADMIRALS

Clinging to the Wreckage .....	27
Battle Honours .....	27

## WIZARDS AND MAGIC

The Colleges of Magic.....	28
Bright .....	28
Jade .....	28
Amethyst .....	29
Gold .....	29
Amber .....	29
Celestial .....	29
Light .....	29
Grey .....	29
Choosing Your Wizard.....	30
What Colour is Your Wizard? .....	30
Clinging to the Wreckage .....	30
Battle Honours .....	30

**MAN O' WAR CARDS****SHIP TYPES**

Men O' War .....	33
Ships of the Line .....	33
Independent Ships .....	33

**IMPERIAL FLEET**

Men O' War .....	34
Greatships .....	34
Ships of the Line .....	34
Wolfships .....	34
Wargalleys .....	34
Special Rules .....	35
Movement .....	35
Ramming .....	35
Imperial Fleet List .....	37

**BRETONNIAN FLEET**

Men O' War .....	38
Galleons .....	38
Ships of the Line .....	38
Corsairs .....	38
Buccaneers .....	38
Special Rules .....	39
Movement .....	39
Catapults .....	40
Bretonnian Fleet List .....	42

**DWARF FLEET**

Men O' War .....	43
Ironclads .....	43
Ships of the Line .....	43
Monitors .....	43
Independents .....	44
Nautilus .....	44
Special Rules .....	44
Dwarfs and Magic .....	44
Steamships .....	45
Ramming .....	45
Engineers .....	45
Armour .....	46
Turrets .....	46
Nautilus Submarines .....	46
Torpedoes .....	46
Dwarf Fleet List .....	47

**ELF FLEET**

Men O' War .....	48
Dragonships .....	48
Eagleships .....	48
Ships of the Line .....	49
Hawkships .....	49
Special Rules .....	49
Elf Seamanship .....	49
Defending against Boarders .....	50
Eagle Claw Bolt Throwers .....	50
Dragonblades .....	51
Wardancers .....	51
Elf Fleet List .....	52

**DARK ELF FLEET**

Men O' War .....	53
Black Arks of Naggaroth .....	53
Monsters .....	55
Sea Dragons .....	55
Doomreavers .....	56
Special Rules .....	57
Black Arks .....	57
Reapers .....	58
Monsters .....	58
Dark Elf Fleet List .....	60

**ORC FLEET**

Men O' War .....	61
Hulks .....	61
Ships of the Line .....	61
Bigchukkas .....	61
Drillakillas .....	61
Special Rules .....	63
Treadwheels .....	63
Iron Clawz .....	63
Bigchukkas .....	64
Smash-Hammers .....	65
Drillakillas .....	65
Ship Templates .....	66

**• CAMPAIGNS •****SCENARIOS**

1: After the Storm .....	68
2: Treacherous Waters .....	68
3: In the Jaws of a Trap .....	68
4: Buried Gold .....	69
5: The Treasure Fleet .....	69
6: Capture the Shore Forts .....	69

**CAMPAIGNS**

Setting up a Campaign .....	71
Deciding on a Scenario .....	71
In the Aftermath of the Battle .....	72
The Benefits of Experience .....	72
Continuity .....	73
Sunken Ships .....	73
Winning the Campaign .....	73
Lily-livered Cowards .....	73

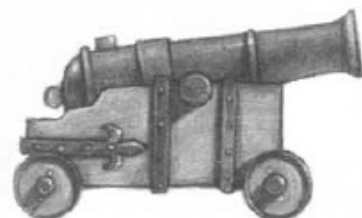
**FLEET CAMPAIGN ROSTER**

# INTRODUCTION

**Man O' War is the game of raging battles across the seas of the Warhammer World. As the admiral of an ocean-going warfleet you must command your ships – squadrons of Ships of the Line and heavily armoured Men O' War – in the battle for supremacy of the high seas.**

In the box you will find everything you need to set up your first battle – ship and turning templates; full-colour card islands, sand bars, headlands and rocky reefs; sails to cut out and stick on your ships; hundreds of counters; magic cards and Man O' War cards; and a dozen plastic wargalleys to start your fleets.

The size of this rulebook may seem imposing at first, but don't be put off. In actual fact, just the first 24 pages contain all the game rules you'll need to know to play your first few games: the rest of the book contains additional material to expand your games of Man O' War once you're ready to go on. With these additional rules, you can go on to increase the size of your fleets, introduce mighty Wizards, play nail-biting campaign games and gain battle honours to promote the crews of your best warships. If you read through the first section once to start with, to familiarise yourself with the contents, then set up a game, looking up rules as you need them, you should have no problems.

When you come to expand your fleet, you'll find a wide range of Citadel Miniatures' ships for all the races in the

Warhammer World. The warfleets of the Elves, Dwarfs, Orcs, Dark Elves, The Empire and Bretonnia, are covered in this rulebook, with future expansions covering all the other sea-faring nations.

Each fleet has its own particular strengths and weaknesses. As the admiral of your chosen battlefleet, you must maximise the strengths of your warships to the best advantage, whilst exploiting the weaknesses of your opponent.

For instance, if your fleet relies heavily upon sail and blistering cannon broadsides, watch out for changes in the wind, and try and keep to the open seas where your sweeping manoeuvres and greater speed will weigh heavily to your advantage.

Of course there is no telling what cunning strategy your opponent is playing out, what powerful magic he has at his command, or what cruel twists of fate may befall you out on the high seas. Only through shrewd tactical skill (and perhaps a little good luck) will the ultimate victory be yours...

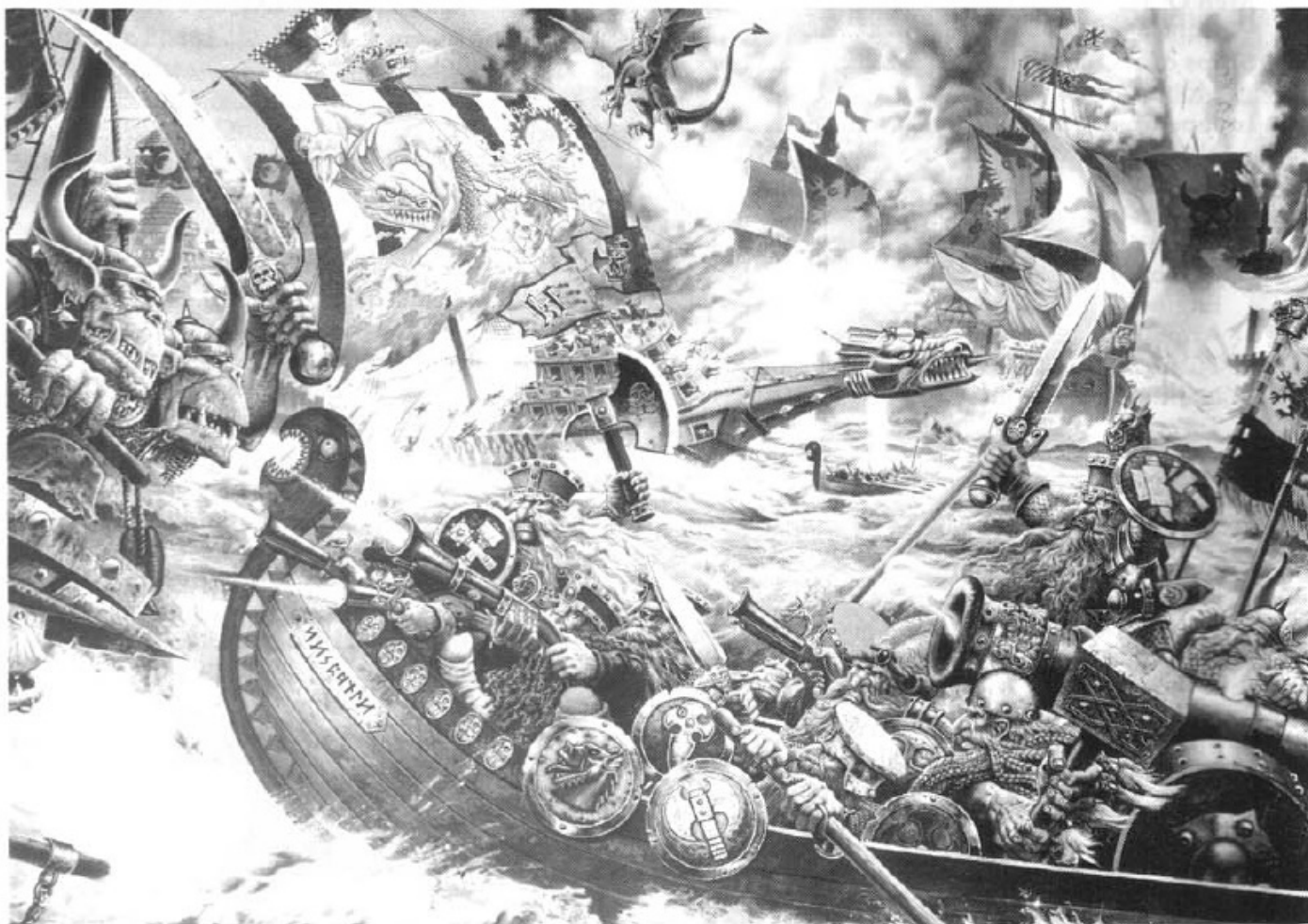

# GLOSSARY & COMPONENTS

Before we go into the rules proper, you might want to take a quick glance through the glossary and the components list. Many of the terms listed here may seem a bit obscure at first, but are explained more fully later in the rules. Don't worry about this for now, all will become clear!

Aft	The rear end of a ship (also referred to as the Stern).
Fore	The front end of a ship (also referred to as the Prow).
Fore Battery	A volley of cannon-fire or other weaponry from the front of a ship.
Aft Battery	A volley of cannon-fire or other weaponry from the rear of a ship.
Broadside	A volley of cannon-fire or other weaponry from the side of a ship.
Starboard	The right hand side of a ship.
Port	The left hand side of a ship.
Lateen	A type of sail that is triangular in shape. Mainly used by Imperial vessels.
Admiral	The overall commander of the fleet.
Yard	Yard arm - a huge cross piece on the mast, from which the sails hang.
Wind Abeam	The ship has the wind coming in from the general direction of Port or Starboard.
Wind Astern	The ship has the wind coming in from the rear.
Grapeshot	Small bore lead shot loaded into the great cannons of a ship and fired at point blank range into the ranks of enemy sailors attempting to board the vessel.

## COMPONENTS

This section lists the components in Man O' War one by one, explaining how they are used. Many things mentioned here won't seem that clear at first, but don't worry as all will be explained later. This section also has detailed instructions on how to assemble your plastic ship models and attach their sails.

### COUNTERS

There are a great number of card counters in Man O' War: crew counters, wound counters, flagship counters, treasure counters, wizard markers, Admiral markers, wizard level counters, damage counters, blaze counters, wizard college counters, wreck markers, debris markers, and so on.

In most cases, these counters are used to indicate the status of something, such as which location has been damaged, or how experienced a particular character is. The exact use of each individual type of counter is explained in the relevant section of the rules.

Notice that not all the counters of the same type are the same size. For instance, there are two different sizes of abandoned counters. This is so that you can place the smaller ones on the table next to the ship in question, whilst the bigger ones can be placed on the ship's template to remind you the ship is abandoned.

		
<p>Left to Right            Admiral Counter - shows the Admiral is aboard.            Abandoned Counter - marks a ship that has been abandoned.            Damage Counter - shows damaged areas of the ship.</p>		
		
<p>Left to Right            Wardancer Counter - indicates a Wardancer Troupe is aboard.            Wound Counter - used to keep track of monsters wounds.            Crew Level Counter - shows crew's level, in this case Cutthroats.</p>		
		
<p>Left to Right            Crew Counter - indicates the number of crew companies aboard.            Captured Counter - marks a ship that has been captured.            Blaze Counter - shows an area of the ship is on fire.</p>		





## HOW TO BUILD YOUR PLASTIC WARGALLEYS

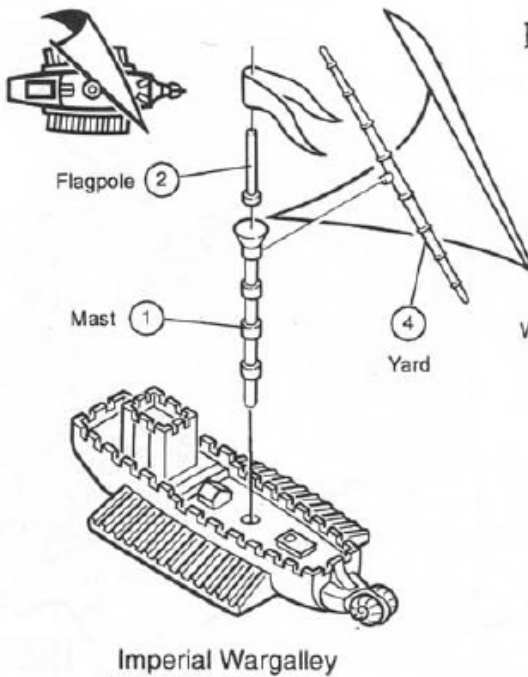

Imperial Wargalley

Imperial Wargalley Mast

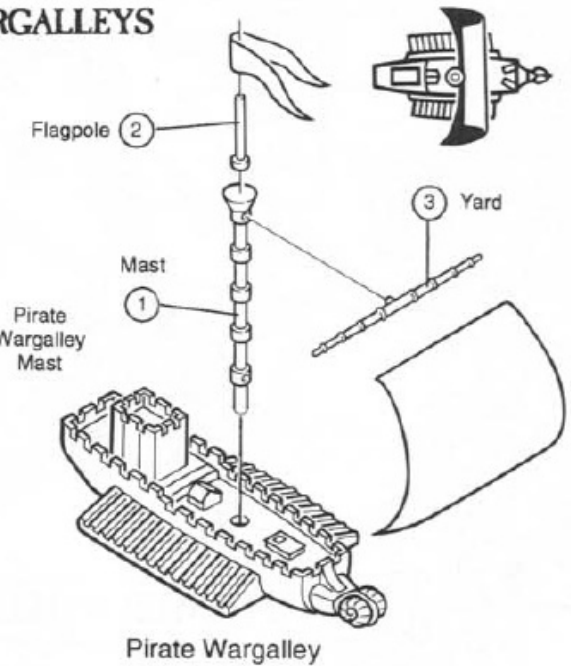

Pirate Wargalley

Pirate Wargalley Mast

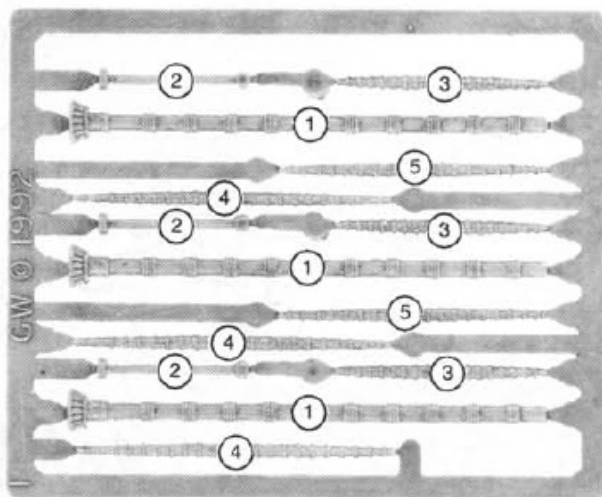

Plastic Mast Sprue

To assemble the plastic Wargalleys, first choose whether to assemble the Pirate or the Imperial fleet. Do not assemble them both at the same time. For the fleet you have chosen, carefully separate the ships, masts, flag poles and correct yards from their sprues using safety snips or a modelling knife. Now cut out the correct sails and pennants from the colour sheet. The diagram above shows you which yards and masts go with which fleets. Once you have cut out all the parts needed to complete a fleet, trim the masts to the correct length as indicated above.

We recommend that you use Citadel polystyrene or superglue to fix the parts together. Glue the mast, yard and flagpole together first. If you intend to paint the model, do so now, before sticking the sails and pennants on. Once completed, the sails and pennants may be attached to the mast and yard assembly which may then be glued into the ship's hull.

Each plastic mast sprue contains enough components to complete three of the ships in this box. The spare yards left over can be used when modelling other ships in the Man O' War range, which are available separately from Citadel Miniatures.

## TERRAIN PIECES

Although Man O' War is best played around three dimensional modelled terrain features, as shown in the colour photographs, we have included a full set of card terrain features so that you can get started straight away.

These include islands, sand bars, headlands, rocks, shoreforts, whirlpools and icebergs. Note that the two headland pieces can also be put together to form a large island.

## PLASTIC SHIPS

Finally, there are the plastic ships: twelve wargalleys, six for each side. These should be assembled as shown above. You can either use the sails we have provided exactly as they are, or use our suggestions as a starting point for painting your own designs.

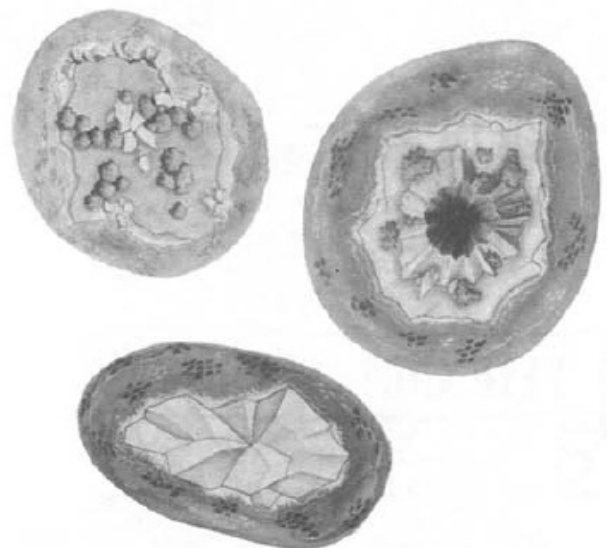

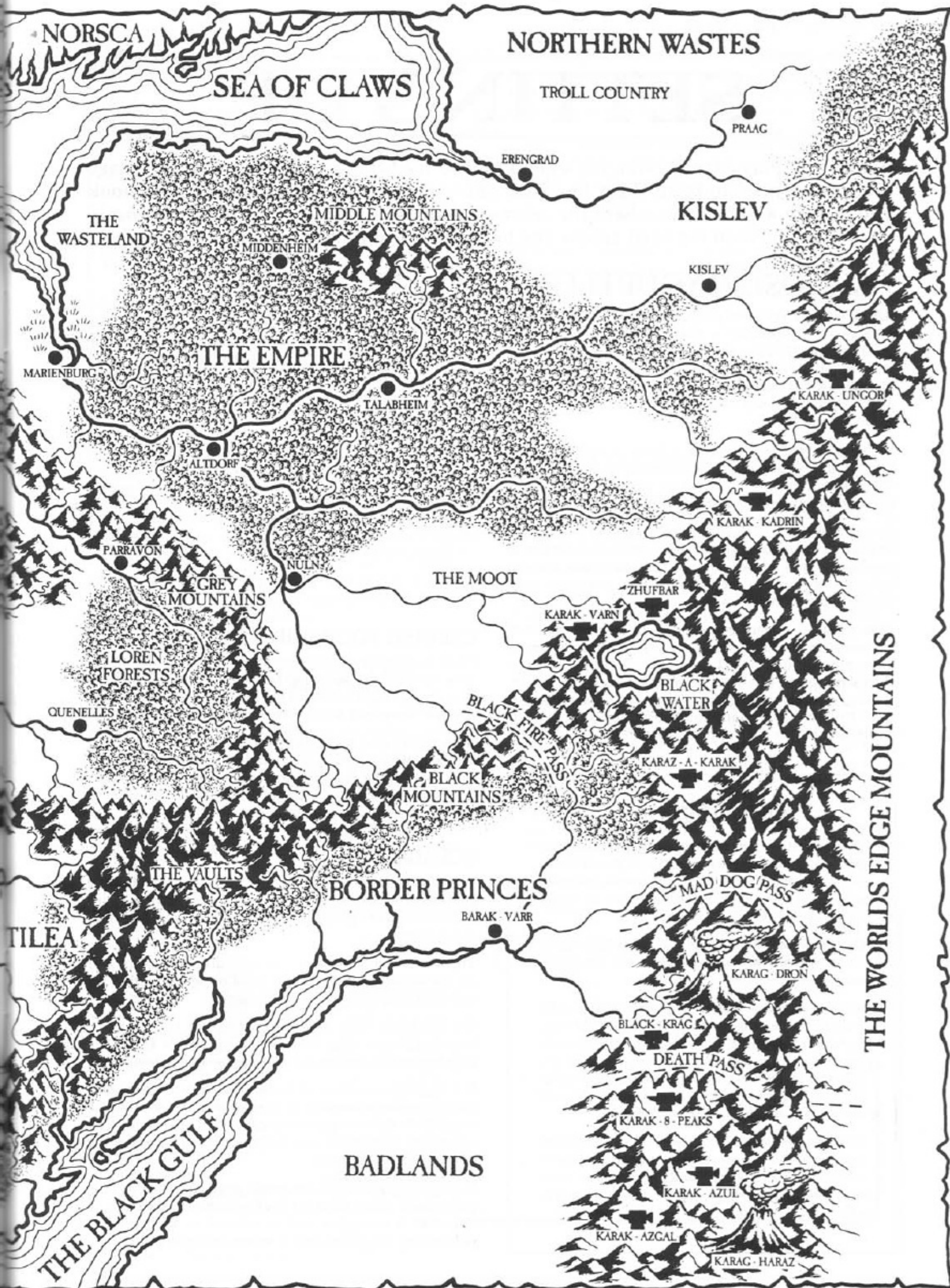

NORSCA

NORTHERN WASTES

SEA OF CLAWS

TROLL COUNTRY

PRAAG

ERENGRAD

KISLEV

THE WASTELAND

MIDDLE MOUNTAINS

MIDDENHEIM

KISLEV

THE EMPIRE

TALABHEIM

KARAK-UNCOR

MARIENBURG

ALTDORF

KARAK-KADRIN

PARRAVON

THE MOOT

ZHUFBAR

GREY MOUNTAINS

KARAK-VARN

LOREN FORESTS

QUENELLES

BLACK FIRE PASS

BLACK WATER

BLACK MOUNTAINS

KARAZ-A-KARAK

THE VAULTS

BORDER PRINCES

BARAK-VARR

MAD DOG PASS

KARAG-DRON

TILEA

BLACK-KRAG

DEATH PASS

KARAK-8-PEAKS

BADLANDS

KARAK-AZUL

KARAK-AZGAL

KARAG-HARAZ

THE BLACK GULF

THE WORLDS EDGE MOUNTAINS



GREAT WESTERN OCEAN



THE OLD WORLD

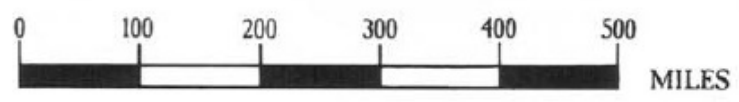

# SETTING UP

Before you play Man O' War, it's a good idea to read through the rules. At this stage there is no need to learn them by heart; once you've glanced through the rulebook you'll have a good idea where the relevant rules sections are, and you can simply refer to them when the need arises. The best way to learn the game is by playing it!

## CHOOSING YOUR FLEET

Before you are ready to play Man O' War, each player will need to choose a fleet. Most races in the Warhammer World have their own fleets, each with an individual character and special rules appropriate to that race. Rules for how to choose your fleet, and a list of the different fleets available are given in the *Fleets* section of this book.

Each player must then choose a Wizard. Full details on how to choose a Wizard are given in the *Wizards and Magic* section of this book, but for your first few games we suggest you use the procedure below.

Sort out all the college colour counters and place them face down on the table. Each player takes one counter at random – this is the college to which his wizard belongs. Take one of the Wizard cards and place your college colour counter on it.

Take a Master Wizard counter and place it on the other box on your Wizard card to show your Wizard's level. Then place your Wizard card next to your command ship's template to show the Wizard is on this ship. Finally, shuffle the magic deck and deal a hand of four cards to each player. You should keep this hand of cards secret, and not let your opponent see them.

## YOUR FIRST GAME

*For your first few games we suggest you play a sea battle between an Imperial fleet and a Pirate fleet. You can choose who commands which fleet by mutual agreement, or by rolling a dice, in which case whoever gets the highest die roll has first choice.*

*Don't worry about choosing ships from the Fleets section for the moment, just take six of the plastic Wargalleys each.*

*The ship templates in the Man O' War box are coded green for the Pirate ships, and red for the Imperial ships. Each ship template corresponds to a particular ship in the example fleets. You will notice that there is a picture of a sail in the top left hand corner of each template, and that this exactly matches one of the sets of cut-out ship sails and pennants provided for the example fleets.*

*When you come to use the blank templates from the Fleets section to design your own fleets, we suggest you paint or draw a copy of the sail or pennant designs you use in the same way, so that you tell which template belongs to which ship.*

## SHIP TEMPLATES & FLEET LISTS

Templates for all the different races' ships are included in the *Fleets* section for you to photocopy and use. You will need one template of the correct type for every ship in your fleet. The *Fleets* section also has a fleet list for each race, which contains additional information about that race's ships and a summary of any special rules that apply. You should keep a copy of it at hand for reference while you play.



## CREWING YOUR SHIPS

Place a number of crew counters equal to the ship's crew strength on each ship template. The crew strength is in the top right corner of the ship template. Each crew counter represents a company of the ship's crew.

Each player now takes an Admiral counter and places it on the template for his command ship. The full rules for admirals can be found at the start of the *Fleets* section. For your first few games, just place the Admiral counter on one of your squadron flagships.

## SQUADRONS

A squadron represents a unit of vessels under the command of one senior leader and responding to his orders. Ships are placed on the table and move and fight as squadrons.

The leader's ship is called the squadron's flagship and all the ships of the squadron must be set up within six inches of it in order to receive orders.

Divide your fleet into squadrons of three ships. Nominate one ship from each squadron to be the flagship and put a flagship counter next to its template.

If a flagship is sunk or so badly damaged that it cannot move then another ship in that squadron becomes the flagship as the next person in command takes over. The remaining ships must now keep within six inches of the new squadron flagship.

If, during the course of the game, any ship ever ends the game turn more than six inches from its flagship, it becomes a straggler and is subject to all the rules concerning stragglers until it rejoins its squadron.

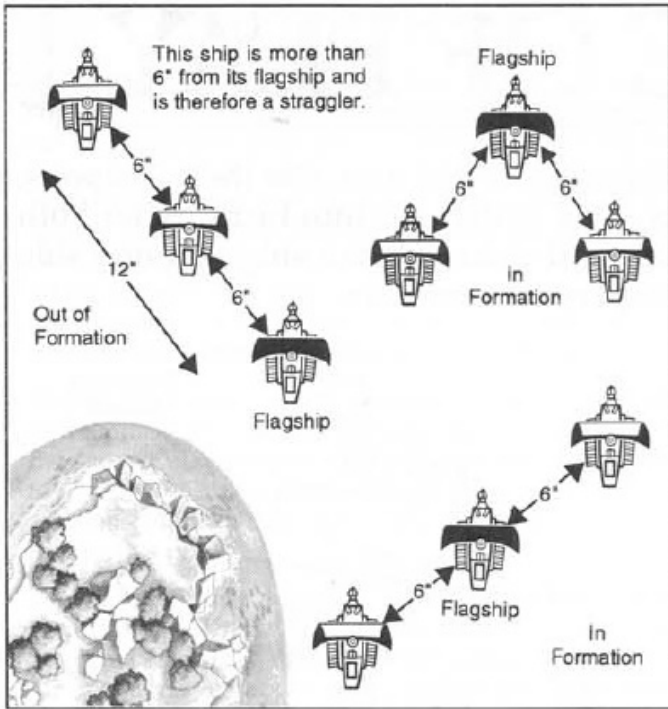

Players are allowed to split up squadrons deliberately, leaving behind ships that are so damaged that they are slowing down the rest of the squadron for instance.

Stragglers are moved during the End Phase of the turn and are unable to fire, ram or initiate boarding actions until they rejoin their squadrons.

## THE BATTLESCAPE

Before the opposing fleets clash you will need to prepare the floor or tabletop area for battle. You will need a clear, flat space of at least four foot by four foot. A large kitchen table is ideal but the floor will do just as well in a pinch. Obviously the larger the battle you wish to fight the larger the playing area should be.

Not all battles take place on the open sea. In fact many sea battles in the Old World take place near the coast so now is the time to place terrain such as stretches of coast, sand banks or islands.

Divide the playing area up into roughly two foot by two foot sections. Roll a dice for each section to determine how many terrain features there are in it:

Roll	Number of Terrain Features Present
1-2	None
3-4	One terrain feature
5	Two terrain features
6	Three terrain features

To remind you how many terrain features are present place a dice in each section turned so the number on the uppermost face shows the number of terrain features.

Each player then rolls a dice, and the person with the highest roll chooses a piece of terrain from the box and places it in the section of his choice. The second player now places a piece of terrain in whatever area he chooses. Players now take turns to place terrain features until each section has its full quota.

## DEPLOYING THE FLEETS

Decide which side of the table is North, and roll a dice. If the result is 2, 4 or 6 the wind is blowing North. If the result is 1, 3 or 5 the wind is blowing South. Place the Wind Compass where it is clearly visible and place the arrow to indicate which direction the wind is blowing.

Both players now roll a dice, and the person with the highest score can choose whether to set his fleet up on the East side or the West side of the table. His opponent must set up on the opposite side. Starting with whoever won choice of entrance side each player takes turns to place a squadron of ships on the playing area. This process continues until all the ships are deployed.

When you are setting up your fleets, your ships must be placed within nine inches of your edge of the table. Also, you may not set up closer than nine inches to the North or South edges of the table. The diagram below makes this clearer.

Place your fleet's ship templates somewhere nearby where you can see them easily. You may find it useful to set up all the templates of a squadron in line together with the flagships at the front.

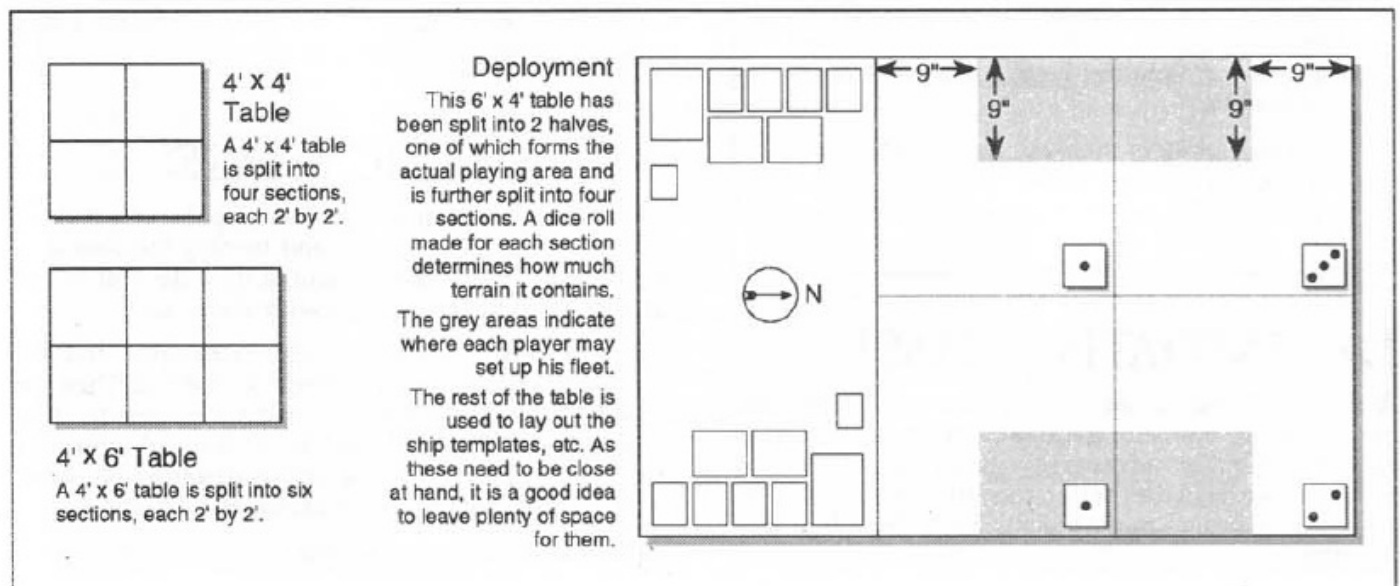

# SEQUENCE OF PLAY

In a sea battle lots of things happen at once: ships move and turn, fire their weapons, and sink. To represent all this furious activity, play is divided into turns. After both players have deployed play proceeds in turns until either all the ships on one side are sunk or have left the play area, or until one player surrenders.

Alternatively, if you have only a limited amount of time available you can play to a time limit. Players can agree how long they are going to play for. At the end of this time they should finish their last turn and then count battle honours (see the *End Phase* section). The person with the highest total is the winner.

Each turn is divided into *phases*. During each phase different aspects of the game are dealt with. The basic turn sequence in *Man O' War* consists of four phases, each of which takes place after the other until the turn is complete.

## MAN O' WAR TURN SEQUENCE

### 1: Initiative Phase

During this phase players roll to determine whether the wind changes and to see who has gained the initiative this turn.

### 2: Magic Phase

The player with the initiative casts whatever spells he is capable of and then the second player does likewise.

### 3: Battle Phase

Starting with the player with the initiative, the players take it in turns to move and fight with individual squadrons of ships.

### 4: End Phase

Players check their record keeping, replenish their magic cards, determine whether any fires that have broken out have spread and move any stragglers.

The rules for all of these things can be found in the relevant sections below.

## INITIATIVE PHASE

As fleets manoeuvre and counter-manoeuve to gain the best position, one side gains a temporary advantage over the other. This advantage is called the *initiative* and represents the Admiral of one fleet thinking and dispatching orders more quickly than the Admiral of the other.

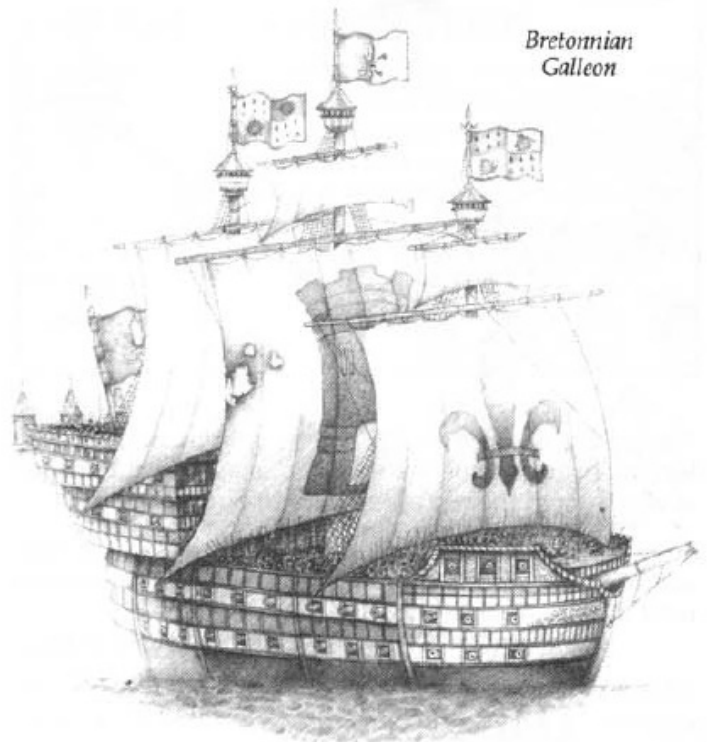

Bretonnian  
Galleon

During the Initiative Phase both players roll a dice. The player with the highest number is the player with the initiative for the turn. If both sides roll the same number the wind changes and both players must roll again.

## CHANGING THE WIND

The wind changes clockwise one position if the double rolled is even, counterclockwise if the double rolled is odd. For example if the wind is blowing North and both players roll 4's then the wind is changed so that it blows East. It is quite possible for the wind to change many times if both players continue to roll doubles.

## MAGIC PHASE

Magic is a powerful and fickle force capable of wrecking ships, summoning monsters and turning the course of battle. Its presence is represented by a deck of magic cards which detail the spells a wizard may cast.

The player with the initiative may cast a spell, and if it works, his opponent may attempt to dispel it. Then the second player may attempt to cast a spell and the first player can try and dispel it. Once a player has attempted to cast a spell the card is discarded, whether the attempt to cast the spell was successful or not.

For full details on magic, see the *Magic Phase* section.

## BATTLE PHASE

In the Battle Phase each player has the chance to move and fight with all his ships. Starting with the player who has the initiative, both players take turns moving and firing with their squadrons. The player with the initiative chooses one squadron and performs all its actions ship by ship. Then the second player chooses one of his squadrons and does the same. They continue taking turns in this way until all squadrons have done their actions for this Battle Phase. No squadron may move or shoot more than once in a Battle Phase.

Players can't save some of a squadron's actions till later in the phase. You cannot partially move a squadron, let the second player move his ships and then return to it, for instance. Once a player has declared his squadron's actions completed it may perform no more actions during this phase.

During this phase a player cannot pass when it is his turn to play. If he wishes he can pick a squadron and say it is performing no actions this phase but that is all. He cannot come back to the squadron later in the phase and then move it.

Each ship in the squadron must move, shoot and perform any boarding actions. Then the next ship does the same until the entire squadron has completed its actions. Ships within a squadron may be moved in any order. Once a player touches a ship he is committed to moving it, and once he has begun to move the ship he must complete its move. You cannot start to move a ship, place it in a new position then change your mind and place it somewhere else. Once a player declares the ship's movement complete he cannot change his mind.

## THE RULE OF ONE

During a Man O' War game a dice roll of 1 represents very bad luck. When you are shooting, a 1 always misses. When you are making a saving roll, 1 always fails. When you cast or dispel a spell a roll of 1 means failure.

Even if you have modifiers on your dice roll (because of magic or Man O' War cards, for instance) a roll of 1 is always a failure.

## END PHASE

During the End Phase, both players do any record keeping that may be necessary and take care of any special circumstances that may have arisen during the turn.

These include picking up new magic cards, checking for fires spreading on their ships, moving stragglers and checking to see what has happened to ships that have sunk.

In fact, anything that isn't covered by the rules for the other three phases generally takes place in the End Phase. For full details of what happens in the End Phase, see the *End Phase* section.

*Standing resolutely on the sweeping foredeck of the Bretonnian Corsair Courageous, Captain Druillet looked out at the approaching Imperial Wolfship. It rushed towards his ship, foam breaking over its mighty brass-beaked ram, smoke-billowing from the multitude of cannon on its foredeck, oars rising and falling in time to the beat of a huge drum. Great plumes of water erupted not twenty feet away as cannonballs slammed into the waves. Salt spray lashed his face and for a moment he smelled the seawater before it was again smothered by the acrid tang of gunpowder. There was a mighty crash as an already weakened mast collapsed. A shrieking sailor fell from its height, arms flailing. His cry cut off with a splash as he disappeared below the hungry waters. All around him Druillet could hear the groans of the wounded and dying and the relentless wet rasping of the ship's surgeon's hacksaw as he took off another limb.*

*To starboard, Resolve and Noblesse, the other ships in his squadron, turned to face the Imperial Wolfships. The main mast on Resolve was already blown off, lying amongst tangled rigging and splintered wood on the deck of the ship. Druillet could just make out the crew as they frenziedly struggled to clear the fallen debris. As he watched, the Corsair shuddered under the impact of another cannon salvo, shattered timbers flying the length of the ship.*

*The Wolfship was so close now that Druillet could see the lions engraved on the fluttering pennants of its bowsprit and the pale but resolute faces of the Imperial boarding party assembled on the foredeck. The taunts of the Emperor's marines drifted across the waves. They clashed their swords against their shields in time to the drumbeat. Druillet knew that it would take a miracle for his depleted crew to hold them off.*

*"Grapeshot!" He roared, his voice already hoarse from having to shout above the clamour of battle. "Grapeshot, Master Gunner! The rest of you dogs get ready to repel boarders."*

*Druillet thought the banks of cannon facing the Wolfship were never going to fire. The Imperial craft was less than a ship's length away and closing rapidly. He could distinguish the coat of arms on the men's shields. Suddenly the Corsair rolled as a great cloud of smoke rushed out over the waves. He heard grapeshot tear through the timbers of the Imperial ship and men scream in agony like dying dogs. Before the smoke cloud could fade there came a sickening crunch as the Imperial ram tore into the hull of the Corsair. He struggled to keep his footing on the blood-slippery decks as the ship keeled over with the impact. Clutching the rail to keep himself from falling, he pushed himself upright just in time to see an armoured figure emerge from the smoke sword upraised.*

*"Bretonnian scum, prepare to die!" bellowed the warrior. Druillet barely had time to rip his sword from its scabbard before the Imperial marine was upon him...*

# MAGIC PHASE

The Known World is rich in magic. Streams of power arc and crackle across the surface of the globe from the Chaos Wastes at the poles, yet they are invisible to all but the most powerful sorcerers. These rare individuals have the power to bend these powerful forces to their will, and are eagerly sought after by clever Admirals.

## CASTING MAGIC

During the Magic Phase the player with the initiative may cast any Magic Card he has in his hand. If the spell works, his opponent may attempt to dispel it. Then the second player may attempt to cast a spell and the first player can try and dispel it.

Once a player has tried to cast a spell, the Magic Card is placed in the discard pile, whether or not the attempt to cast the spell was successful.

The same is true for dispels; if you use a Magic Card to dispel your opponent's spell, you must discard your Magic Card afterwards, whether the dispel attempt succeeded or not.

## HOW LONG DO SPELLS LAST?

Unless otherwise stated on the Magic Card, a spell only lasts for a single turn.

## SPELLS OF DIFFERENT COLLEGES

Each Warfleet has a cabal of Wizards, enabling spells of any colour to be cast throughout the battle. The dominant Wizard in the cabal is the only one you need worry about, and he is the Wizard represented by your Wizard card. Any reference made in the rules to 'your Wizard' are talking about the dominant Wizard.

If your dominant Wizard is lost during the battle, you may assume that the rest of the cabal is also destroyed. This of course means that if the dominant Wizard is lost you will be without magic for the rest of the game.

For game purposes, the college of the dominant Wizard is also considered to be the cabal's dominant college or colour. If your Wizard fails to cast a spell of his own college he may re-roll the dice and try again. This can be done once per turn. Likewise, when he is using a Magic Card of his own college colour to dispel an incoming spell and fails, he may re-roll the dice and attempt to dispel it a second time. He can do this once per turn too.

The diagram shows a Magic Card for 'Storm Force' with the following components and callouts:

- College Colour:** CELESTIAL
- Casting Number:** 5+
- College Symbol:** A circle with a dot inside.
- What the spell may be cast on:** A bar at the bottom of the card.
- Spell's effects:** DISPELS GREY MAGIC
- Spells this card can dispel:** DISPELS GREY MAGIC

**Text on the card:** far over the bows of the ship, the wizard upon his powers to bend the will of the elements and bring down a storm upon his foes. The skies blacken and thunder rolls as stormclouds gather over the battlescape. As the wind rises a violent storm breaks. The torrents of rain reduce visibility to near nothing and extinguish all fires on the seascape.

**Cast on:** The whole seascape.

**Effects:** visibility is reduced to close range. Ramming and boarding is impossible until the storm abates at the end of the turn. All blazes on all ships are put out.

## MAGIC CARDS

Each Magic Card represents one spell and has a header showing the colour of the magical college the spell belongs to. The card describes the effect the spell has, and its duration. Most spell effects last only one turn and affect only one ship.

Each card has a casting number, and the Wizard must roll this number or higher to cast the spell. Spells which affect enemy ships can be cast on any enemy ship on the table. Exceptions are mentioned on the cards. It is important to note that you may not move enemy ships off the table with spells that allow you to move them.

Magic Cards have another important function. They also allow you to dispel Magic Cards of their opposing colour. This colour is shown as a bar along the bottom of the card. To dispel an incoming spell you must roll the casting number or greater on your own spell card. Spells may only dispel incoming spells of their opposing colour.

Once you have attempted a dispel the Magic Card is discarded whether the attempt was successful or not. Note that you do not have to attempt a dispel if you want to keep it for later in the game.



# MOVEMENT

In the Old World there are various ways of propelling a ship, each with its own advantages. Sails move a ship quickly if the wind is with it, but slow it enormously if the wind is against it. Oars are less speedy than sails but enable a ship to move without worrying about the wind direction.

Some ships possess sails and oars giving them the best of both worlds. A ship with two methods of propulsion must state which method it is using at the start of its move.

The ship's template tells you whether it has oars or sails and how fast it can move in one turn. The distances given on the template are the maximum number of inches a vessel can move in a turn – you don't have to move this far if you don't want to.

Some types of damage will affect a ship's speed. If you look at the Bretonnian Corsair in the Fleet Lists section you will see that if a broadside destroys one of the ship's sails then its movement speed under sail will be reduced. How a ship's movement is affected by damage is given on the ship template. For example if a Corsair has one sail location destroyed its speed is reduced by 3 inches to 6 inches. If a Wargalley loses its sail it can no longer move under sail at all.

Normally, all ships may move up to their maximum movement distance during this section of the phase. There are exceptions to this, most notably when a ship under sail turns into the wind and becomes subject to special rules dealt with below.

## BASIC MOVEMENT

Ships usually travel in the direction they are facing. When you want to turn a ship, use the special turning template included in this box. You use it by placing the current position side of the template alongside the ship parallel to the direction in which it is heading.

Move the ship to the new position facing marked on the template. Essentially this template turns the ship up to 45 degrees and moves it two inches forward. When you turn you do not have to move the ship all the way round to face in the new direction (ie. a full 45°) but you do have to move it two inches forward.

Each time a ship turns it uses up two inches of its movement. So, for instance, if your ship has a move rate of 6", you may make a single turn and move forward 4". Alternatively, you could make 2 turns and move forward 2", or any other combination of moves and turns that total 6".

Note that if it has less than 1" of movement left your ship cannot make a turn. So, if your ship has a move of 6", and it has already moved 5" this turn, it may not make a turn until its next Battle Phase.

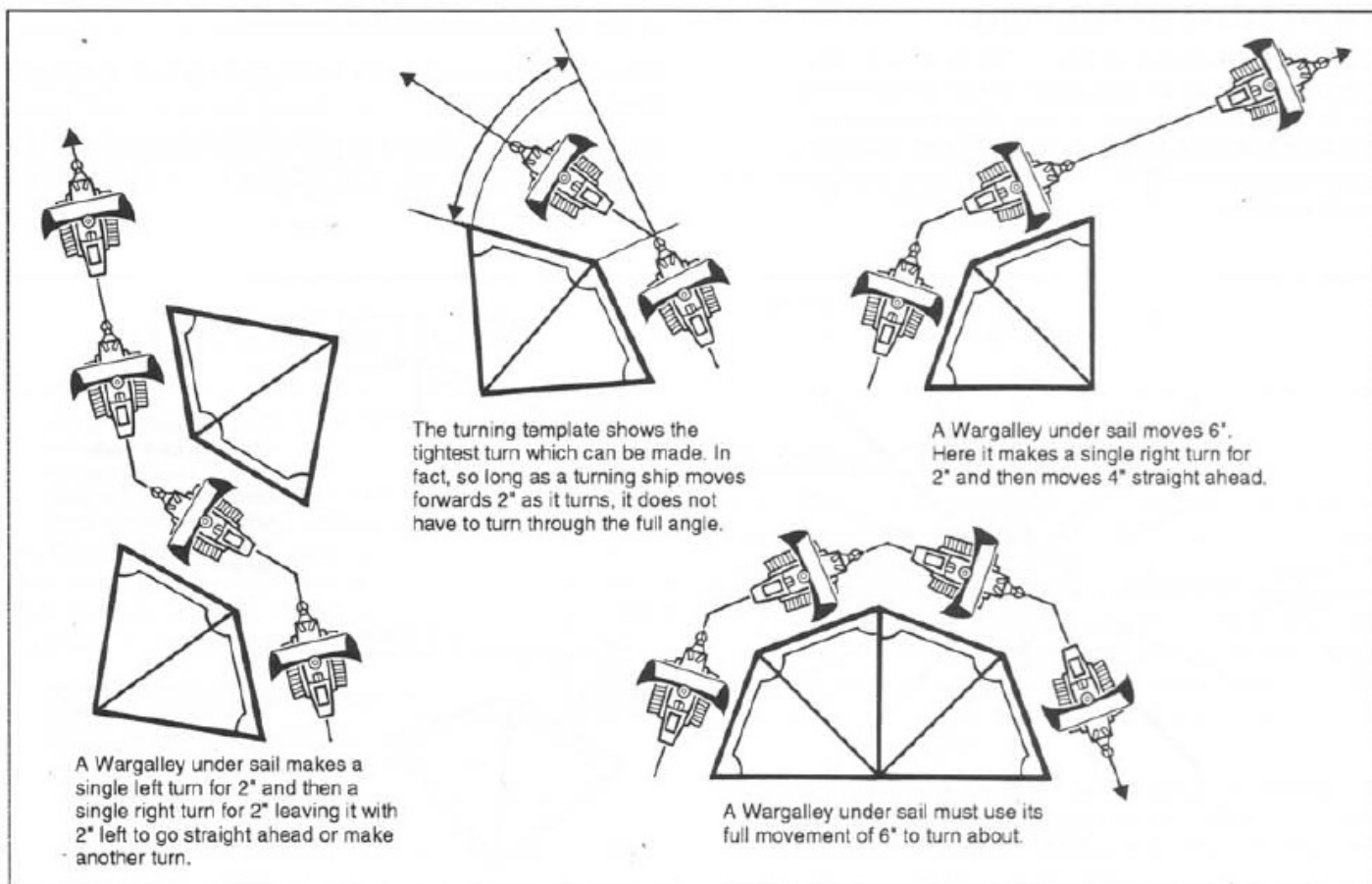

## MOVEMENT UNDER SAIL

The wind can affect movement of ships under sail in several ways. Some ships which can move faster with the wind astern (coming from behind) and all sailing ships are slowed when sailing against the wind.

First of all check to see which direction the wind is blowing in relation to the ship's direction,

### SAILING AGAINST THE WIND

The Wind Compass shows the direction the wind is blowing. If it is pointing North the wind is blowing from the South side of the table towards the North.

A ship may be sailing against the wind if its bows are facing towards the table edge from which the wind is blowing. The wind may be astern if the stern of the ship is pointing towards that table edge.

Nine times out of ten it will be perfectly obvious whether you are sailing against the wind or not, but sometimes it is not so clear. If you or your opponent think you may be sailing against the wind, there is an easy way to check.

Place the turning template alongside your ship, parallel to the direction in which it is heading. Measure a straight line directly to the edge of the table from the bow of your ship. If the line passes through the turning template you are *not* sailing into the wind. If it's still not absolutely clear you should give your opponent the benefit of the doubt.

To check whether the wind is astern place the template so that it is alongside the ship but facing the stern. The procedure for checking is the same.

### MOVEMENT IN THE WIND

Once the direction of the wind is found, the ship is considered to be at that angle to the wind for the whole of its turn. For instance, if your ship starts its move with the wind behind it, any turns made so that the wind is blowing astern will not affect the ship's movement rate until next turn.

The only exception to this rule is that all ships under sail which turn to face into the wind must finish moving immediately. Place the ship at the new position point on the turning template. They may fire their guns or board any ship they are in contact with but their movement for this Battle Phase ends at once.

Any ship under sail that starts its movement against the wind may only make a single turn during this phase so that it is no longer facing into the wind.

Because of their better rigging and greater sail capacity some ships move faster with the wind behind them (wind astern). The wind fills their sails driving them speedily forward. These ships have a separate movement rate for this situation.

## SHIPS WITH OARS

Ships propelled by oars are not affected by the wind direction.

Ships using oars can opt to turn using the normal system described above, or they can choose to use their oars instead to turn on the spot. By expending half of their total movement they can turn 90° on the spot. By expending all of their movement they can turn 180° on the spot.

Oared ships can order their rowers to battlespeed. The men strain to move the ship straight ahead as fast as possible. By doing so they enable the ship to move faster but only in a straight line. When moving at battlespeed a ship can make no turns.

For example, Wargalleys may move 4" under oars and still turn as they move. Alternatively they can move straight ahead 6". This is very handy if you want to ram or are moving straight into the wind.

Oared ships may also row backward up to 2" instead of their normal move.

Of course, if an oared ship has its oars destroyed, or if it is moving under sail, it is subject to all the rules for movement under sail.

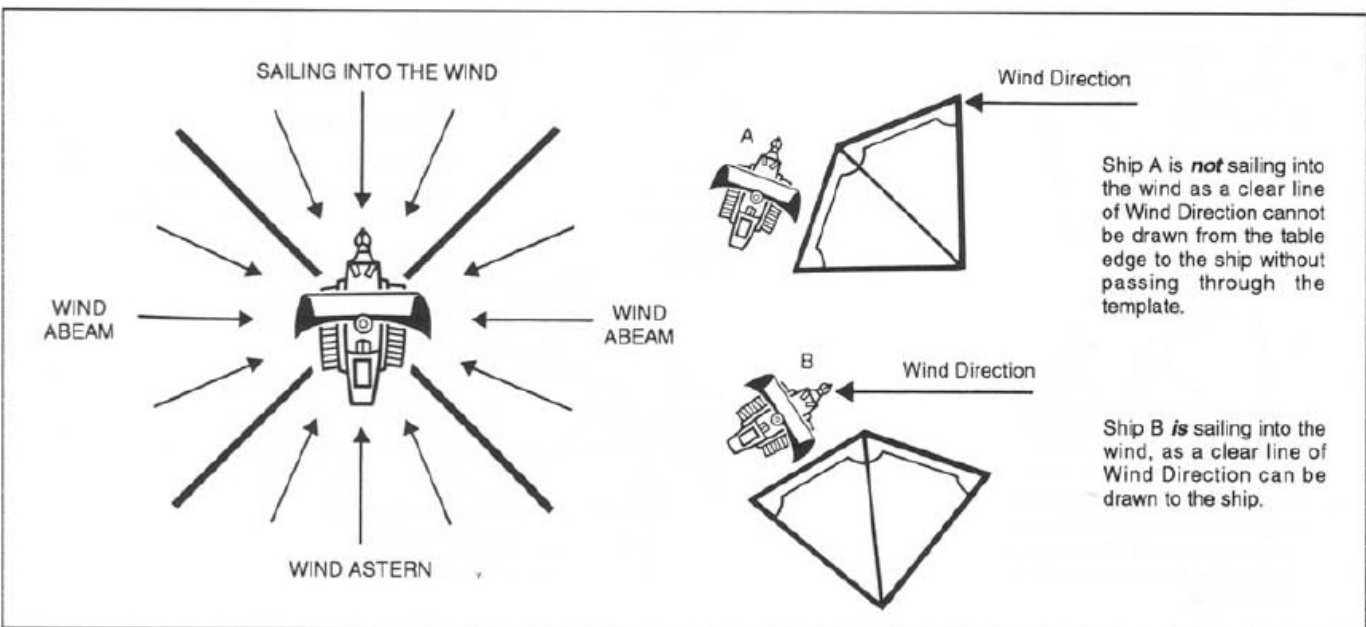

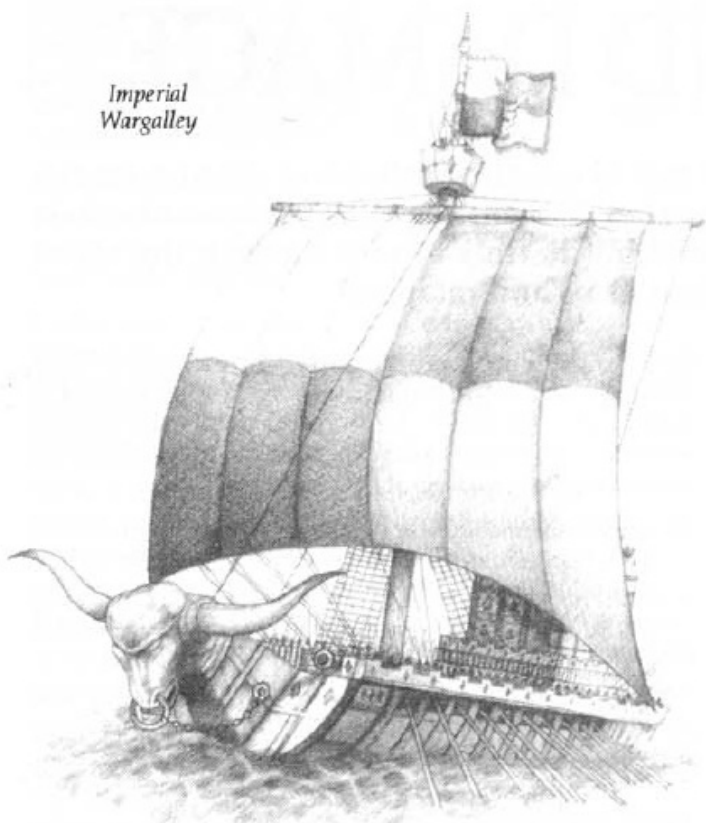
Imperial  
Wargalley

## RAMMING

Ships with oars and rams have a special attack. By ordering their oarsmen to exert themselves to the full they can ram, driving their great iron-prowed ships into the unprotected sides of their foes.

In order to ram a ship has to move at least 3" in a straight line towards its target.

The ship needs to start its ramming move at least 3" away from its target in order to build up speed. Damage from ramming is inflicted immediately. The ship may then fire its cannons and initiate boarding actions normally. For details on what happens after you ram see the *Combat and Damage* section.

## OBSTRUCTIONS

Ships don't always sail on an open sea: sand banks, rocks and even other ships can prove hazardous to a moving vessel.

Any ship passing over any part of a sandbank, rocks, a coastal section or island immediately runs aground, and its movement ends for that turn. It must make a below the waterline saving throw as described in the *Combat and Damage* section. If it fails this saving throw, roll a dice and consult this table.

Roll	Damage taken by the ship
1-2	3 points of below the waterline damage.
3-4	2 points of below the waterline damage.
5-6	1 point of below the waterline damage.

Any ship forced onto such terrain during the Magic Phase must also check for damage as above.

Any ship that starts the Battle Phase aground may attempt to move off. Roll a dice, and if you roll 4 or more your ship may move away normally. If you roll 3 or less the ship is stuck fast and stays where it is. It takes no more damage, and you can try to move off the dangerous terrain again in the next turn.

## COLLISIONS

In the heat of battle, it is quite common for ships to get in each others way and hit each other. This is called a *collision*. This happens when one player makes a miscalculation and finds he hasn't got enough room to turn without making contact with another ship. If this happens the ship stops when it contacts the other ship and its movement ends. Indeed, as a general rule, any time a ship touches another ship its movement ends for that Battle Phase.

On occasions, two or more ships may come into contact deliberately. There are two circumstances under which this can happen.

The first is when one ship rams another. This is a deliberate attack and what happens is dealt with in the *Combat and Damage* section.

The second is when one ship moves into another to instigate a boarding action. This is dealt with in the *Boarding Actions* section.

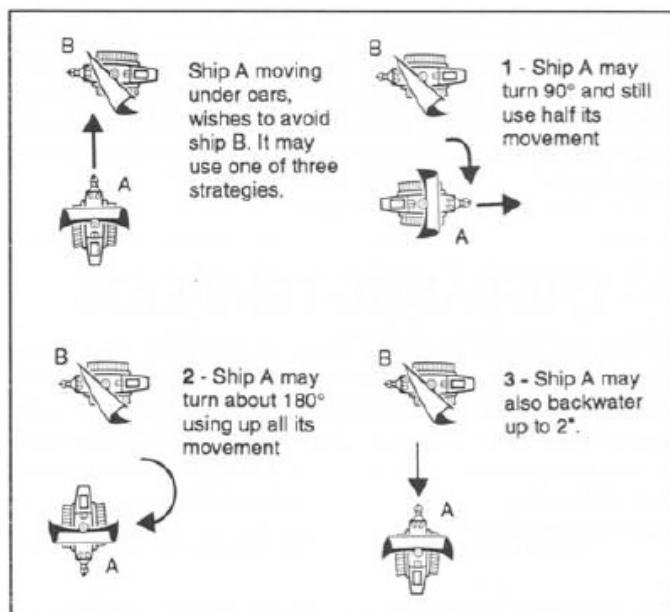

## PUSHING CLEAR

Any ship that starts the Battle Phase with its bows in contact with another ship in such a way that it cannot move can *push clear*. Using long poles and tackle its crew push off the enemy ship, turning their own vessel. The ship may move along the side of the other ship until its path is clear and then can move on normally. Pushing clear costs half the ship's movement. If a ship encounters another obstacle after pushing clear its movement ends as usual.

The edge of the table is a special kind of obstruction. Any ship that sails off the edge of the table is assumed to be leaving the battle and may not return to the table. Do not do this unless you mean to.

# COMBAT AND DAMAGE

The first sign that two opposing fleets have met is usually a plume of cannon smoke and the terrible whistling of cannonballs as they sail through the air towards their targets. The crack of shot as it leaves the smoking barrels echoes through the air as the enemy ships desperately try to line up their guns and retaliate!

Most ships have some form of ranged weapon, usually cannons. Depending on where and how they are mounted these fire either forward, to the side or backwards. Note that even if your ship isn't armed with cannons, then the following rules still generally apply – simply replace the word cannon with whatever is relevant to your ship's fleet.

The first step when firing at the enemy is, as one would expect, to choose your target. Cannons have a maximum range of nine inches; if the distance between your ship and its target is greater than nine inches then the cannons are out of range and your shot is wasted. You are not allowed to measure the range in advance – you must select a target, then measure the range. To see whether the target is within range place the firing template against the side of your ship which is firing. If the enemy ship is wholly or partially under the template then it is within range of your cannons.

Unless stated otherwise, all weapons are fixed, and cannot be turned to point in different directions. Thus forward facing cannons *always* fire directly ahead of the ship, sideways facing cannons *always* fire directly to the side, and rearward firing cannons *always* fire directly backwards.

## THE RANGE TEMPLATE

To use the range template, place it touching the side or end of the ship you are firing from. The template faces directly away from the firing ship, either forwards, backwards, or to one side. The centre mark at the base of the template should touch the centre of the side or end of the ship you are firing from, and line up with the exact centre of the ship.

The range template is divided into three 3" inch sections. Any ship falling under the section nearest to you is at *close range*. Any falling under the middle section is at *medium range*, and any falling under the section furthest away is at *long range*.

Ships with broadside cannons can fire from either side, or from both sides simultaneously if they have targets available. If the broadside cannon battery is lost, the cannons on both sides of the ship have been destroyed, and the ship can fire no more broadsides at all.

Your fleet list has a diagram for each type of ship that shows how many guns it has and in which directions they fire.

## LINE OF SIGHT

Sometimes a ship is prevented from properly sighting its intended target by intervening obstacles such as another ship or a wreck. Terrain also blocks line of sight. A firing ship hits the *first* obstacle that falls under its range template, whether this is an enemy ship or not. It is not possible to fire past an obstacle to an enemy vessel further away. Of course, you can always choose not to shoot, which is a good idea if one of your own ships has accidentally sailed in front of the enemy vessel.

Assuming that the enemy is within range and your line of sight is not obstructed then you can open fire.

## OPENING FIRE

Most ships in Man O' War are armed with cannons. Each cannon in a location represents a vast battery of weapons, not just a single gun. The ship template shows you how many weapons your ship has and in which

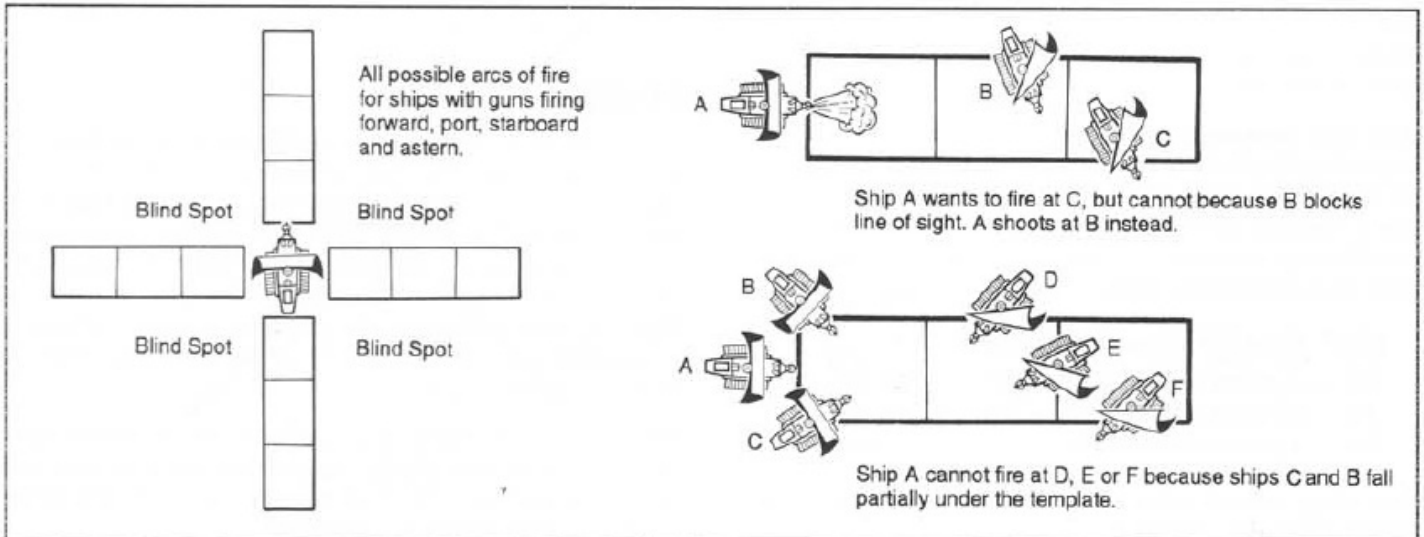

direction they are facing. For example a Wargalley can fire one battery of cannons forward. Larger ships have several batteries of cannon. If you have guns firing in more than one direction, then all of them may fire each turn as long as they have targets within range.

If you have a target available you are ready to fire. You can open fire with all the cannons you have that are facing in a target's direction. They shoot at the nearest target under the range template.

Each cannon may only fire once in each Battle Phase. Ships with cannons firing broadside would seem to be exceptions because their guns fire once on each side. This is not the case, as each cannon represents a pair of batteries firing in opposite directions.

Now it's time to let fly! Look at the template of the enemy ship you're aiming at, and then roll one dice for every cannon you can bring to bear.

A roll of 1 always misses. The number you roll indicates which location you have hit on your foe's ship. If there is no location with that number on the ship's template then you have missed.

For example, on a Wargalley you must roll a 4, 5 or a 6 to hit a location. A roll of 4 hits the mast, a roll of 5 hits the oar deck, and a roll of 6 hits the Forecastle. Any other score is a miss.

For example: you are the Imperial player sailing along in your Wolfship, the Sigmar. You can bring three guns to bear on a Bretonnian Corsair. You open fire, aiming high, and roll a 1, a 5 and a 3. Looking at the Corsair's template shows that the 1 has missed, the 5 has hit his aft mast and the 3 has hit the main deck. Well done!

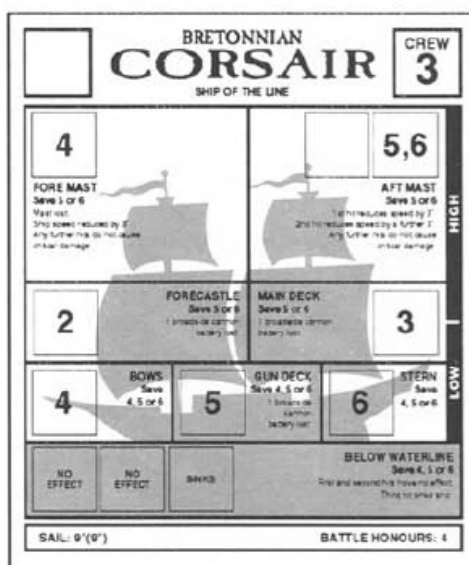

**AIMING HIGH OR LOW**

Some ships are so large that they are divided up into two areas: high and low. This means that when you fire you must state which area you are firing at.

Aiming high means that you look at the numbered sections on the top of the template; aiming low means you might hit the low sections.

If you look at the template for a large ship like a Bretonnian Corsair you will see that it is possible to hit the ship in the mid-section aiming either high or low. This is because there is some overlap when the guns are fired.

Notice that you cannot split cannons firing in the same direction so that some aim high and some aim low.

**SAVING THROWS**

When you have fired, your opponent can try and save himself from damage. Ships are big, strong structures and don't automatically fall to pieces just because they have been hit. To represent this, the player whose ship has been shot can make a saving throw for each location hit. The number he needs to roll to save each location on a dice is given on the ship template. If he succeeds in rolling this number or above then the location takes no damage. If he fails then a damage marker is placed on that section of the template to indicate that the area has been destroyed. If it is hit again the ship could be in big trouble.

It is very important to remember that each ship in a fleet has its own template which is used to record how much damage it has taken.

**SAVING THROW RANGE MODIFIERS**

With most weapons, saving throws are modified by the range from which you shoot. With cannons, for instance, if you are firing from close range then the defender subtracts one from his saving throw. If you are firing from long range then he adds one. This means that it is much harder to avoid taking damage at close range than it is at long range.

For example, at medium range the Pirate Wargalley mentioned above needs to roll a 5 or a 6 to save its oar deck. At close range it would require a 6. At long range any number from 4 to 6 would do.

Cannons are the 'standard' ship-mounted weapon in Man O' War, and are the weapons to which other races' armaments are compared. Other races have unique weapons which may function somewhat differently. The rules for these are covered in the *Fleets* section of the rulebook.

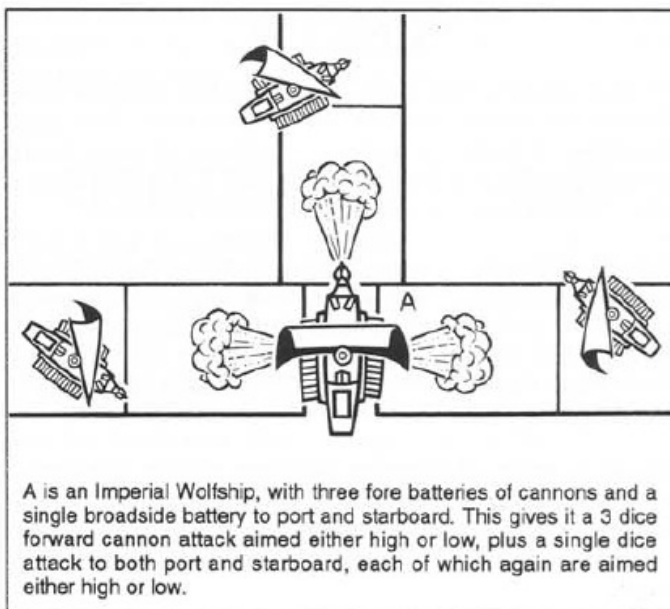

A is an Imperial Wolfship, with three fore batteries of cannons and a single broadside battery to port and starboard. This gives it a 3 dice forward cannon attack aimed either high or low, plus a single dice attack to both port and starboard, each of which again are aimed either high or low.

Imperial  
Greatship

## EFFECTS OF DAMAGE

If a location is hit and fails its saving throw, the area is usually destroyed. Place a damage marker in that location of the ship template. On larger ships some locations can take two or more points of damage. These are shown in the *Fleets* section with the relevant ships.

If a location is destroyed there are often side effects. Hitting a ship's oars usually stops it from moving under oar or ramming. Destroying a ship's sails can reduce its speed. The exact effects are explained on the ship template. Some locations do not contain cannons, sails, oars, or anything else vital to the running of the ship and only ever take structural damage. This represents general damage to the hull but has little effect on play unless a critical hit is scored in that area.

If a location containing a weapon is hit, the weapon is destroyed and may not be used for the rest of the game.

If an area containing cannons that can fire broadside is destroyed, the ship loses its ability to fire on both sides with those guns. This is because the gun decks are large open areas and the damage has blasted right through the ship and destroyed all the cannons in that location.

A location can sometimes absorb more than one hit before it is destroyed, and this is shown on the ship's template. If this is the case the effects of each hit will be shown on the template. For example, it takes two hits to destroy the forward gun deck on the Imperial Wolfship. Each hit destroys one cannon battery. Once such a location has taken all its hits it is destroyed. Each time such a location is hit and fails its saving throw place a damage marker until it has taken enough hits to destroy it. Only then will that location start taking critical hits.

## CRITICAL HITS

Each time a destroyed area is hit again and fails its saving throw then a critical hit occurs. These can be incredibly nasty! Roll a dice, consult the Critical Hit Table, and apply the results.

Some areas, most notably sails, don't take critical hits once they are destroyed. This indicates that it is not possible to sink a ship by hitting it there repeatedly. Putting more holes in a ship's sails won't send it to the bottom for instance. Such areas are always indicated on the ship template.

If a critical hit indicates that a fire has broken out in that location replace the damage marker with a blaze marker to indicate that the area is on fire. Fires aboard ship are very dangerous mainly because they can spread, causing even more havoc. This happens during the End Phase, so see the rules below.

If the critical hit indicates that a crew counter has been lost then remove one from that ship's template. If a ship's crew strength is ever reduced to zero then the ship is abandoned. Place an abandoned marker on its template. The ship may no longer move, fire or board. Any ship boarding it captures it automatically.

If the Critical Hit Table indicates that you should look up another entry on the Captain's Chart then do so and apply the results. Some of these results say that the ship cannot move or that it cannot fire. One result says that it can neither move nor fire. Place a 'no movement' and/or a 'no firing' counter on the ship's template, as appropriate. If the ship has already performed actions this turn these results have no effect. If a ship that is part of a squadron has already moved then the player can make it a straggler and move the rest of the squadron.

If the Critical Hit Table indicates that the target has taken one or more below the waterline hits then the player places the appropriate number of damage markers on the below the waterline location of the ship's template. Then he should pray. It is important to note that the ship does not get its below the waterline saving throw for damage taken in this way.

## SINKING

A ship usually only sinks because it has suffered more below the waterline hits than it can take. The exact number of hits needed to do this is shown on its template. Once a ship's below the waterline area is destroyed it sinks. It never takes critical hits there.

Usually the only ways a ship can take hits below the waterline are as a result of a critical hit, a ram or sailing into some particularly nasty obstruction like rocks. If the Critical Hit Table indicates that the ship takes damage here place the number of damage markers indicated on the ship template.

If the number of damage markers equals or exceeds what it takes to sink the ship it goes down to the ocean's dark depths. Place a 'sunk' counter on the ship's template to indicate the ship is at the bottom of the briny.

## CRITICAL HIT TABLE

- 1 Panic spreads through the ship as the enemy shots strike home inflicting terrible damage on men and equipment. The crew call upon the Captain to guide them through the danger. Make a roll on the *Captain's Chart*.
- 2 The tar-saturated wood catches light and flames start to spread across the ship. Replace the damage marker on this location with a blaze marker. Test on the *Blaze Spreading Table* in the end phase.
- 3 A great chunk of the ship is torn away, washing men and goods overboard. The ship loses 1 crew counter. If the ship is left without any crew counters, it is abandoned.
- 4 With an ominous creak, the seams of the boat start to split. The ship takes 1 Below the Waterline hit.
- 5 A great gash appears in the side of the ship as the sea floods the lower decks. The ship takes 2 Below the Waterline hits.
- 6 The hull gives way with a resounding crack. The ship takes 3 Below the Waterline hits.

## BLAZE SPREADING TABLE

During the end phase, roll on this table for each blaze marker.

- 1 Blaze goes out. Remove the blaze marker.
- 2 Blaze doesn't spread. Roll again next end phase.
- 3 Blaze doesn't spread. Roll again next end phase.
- 4 Blaze spreads forward. Place another blaze marker.
- 5 Blaze spreads upward. Place another blaze marker.
- 6 Blaze spreads backwards. Place another blaze marker.

## CAPTAIN'S CHART

- 1 The Captain's maps and charts are burnt to a crisp. The ship may not move this turn if it hasn't already done so as the Captain has to replot its course. Place a 'no movement' counter next to the ship. Remove the counter at the end of the turn.
- 2 The Captain's treasure chest is split open, spraying the deck with gold. The ship may not fire this turn as the crew are too busy picking up the fallen booty. Place a 'no firing' counter next to the ship. Remove the counter at the end of the turn.
- 3 The Captain is caught by a stray shot and killed outright. The ship may do nothing but defend itself until the end of the turn, when a new Captain is elected. Place a 'no movement' counter and a 'no firing' counter next to the ship. Remove the counters at the end of the turn.
- 4 The Captain is washed overboard by a freak wave. Roll a dice.
  - 1-2 Ship must make a 2" left turn to pick him up.
  - 3-4 Ship must make a 2" right turn to pick him up.
  - 5-6 Ship must move straight ahead 2" to pick him up.
- 5 The Captain's secret rum stash is hit. The decks are awash with alcohol. Roll a dice for each crew counter: on a 6 they are drunk and fall overboard. Remove any drunk crew counters from the ship.
- 6 Mutiny! Roll a dice for each crew counter: on a 5 or 6 they take to the boats and abandon ship. Remove the mutineers from the ship.

## WRECKAGE MARKERS

On the turn a ship sinks remove the ship model from the table and place a wreckage marker where it was. Any character counter that was on the ship (for example, an Admiral or a Wizard) may cling to the wreckage and debris as long as there is some there. This allows for a friendly ship to rescue him before he goes down! Rescuing characters is covered in more detail in the *End Phase* section.

A wreckage marker obstructs movement and line of sight as if it were a ship – see the rules on collisions in the *Movement* section.

During the End Phase of the turn remove the wreckage marker and replace it with a debris marker. Debris does not obstruct line of sight or movement. At the end of the next turn, the debris counter is removed.

## EFFECTS OF RAMMING

Once a ship has moved into contact with its target the opposing player must make a saving throw against a below the waterline hit. If he fails the target ship takes a number of below the waterline hits.

The amount of damage varies, depending on the size and effectiveness of the ramming ship – look at your fleet list for details. This damage will usually put most ships well on the way to sinking. Place the damage markers on the below the waterline location. The ramming player may now board the ship if he wants and has a crew counter available.



# BOARDING ACTIONS

Once a ship has made contact with its enemy it may, if it has any crew left, launch a boarding action. Frenzied, maniacal swordsmen swarm aboard the enemy craft seeking to over-run any opposition. Equally blood-mad opponents attempt to stop them. Gunners will fill their cannons with grapeshot to discourage the attackers.

The most important factors in boarding actions are the number of men involved and the number of cannons that the defender can bring to bear. Cannons can be used to repel boarders only if they have line of sight to the boarding ship. You cannot use a broadside cannon to repel enemies boarding from the stern, for example.

Both sides roll a dice and add the number of crew counters on their ship. The defender adds the number of remaining cannons he has pointing in the direction of the attacker. The player with the highest score wins. The loser loses a crew counter.

If the attacker wins, he can press on with his attack or break off if he likes. If the defender wins he can continue the fight or cut grapples. If he opts to cut grapples then the boarding action ends. If he opts to continue then *he* is now the attacker, trying to board his opponent's ship. He can no longer add the number of cannons he has to the number of his crew. His opponent does, since he is now repelling boarders. The fight can thus see-saw back and forth for some time.

## FOR EXAMPLE

An Imperial Wargalley moves in to attack a Pirate Wargalley head on. The Imperial player moves his ship 4" in a straight line under oars towards his prey until the bows of his ship are touching the pirate vessel, a head on ram. Having finished his move, he fires his cannon at the Pirate ship, hitting the mast. The Pirate rolls a dice for his saving throw, subtracting one from his dice roll as it is close range. He fails his saving throw, and the mast is destroyed.

The Imperial player now works out the damage for the ram. The Pirate player rolls his below the waterline saving roll, needing a 5 or 6. He rolls a 6 so the ram fails.

However, the Imperial player then decides to board the Pirate Wargalley. He rolls a dice and adds 2 (1 for each crew counter onboard the galley). The Pirate defends, rolling a dice and adding three (one for each crew member aboard the Pirate Wargalley, and one for his forward cannon, which may fire grapeshot). The Imperial player rolls a  $4+2=6$ . The Pirate player rolls  $4+3=7$ . The Pirate player wins and the Imperial player loses a crew counter.

The initiative now passes to the Pirate player, who decides to counterboard. He rolls a dice and adds 2, one for each crew. The Imperial player rolls a dice and adds 2, one for his remaining crew and one for his cannon which can fire grapeshot this round. The Pirate rolls a  $5+2=7$  and the Imperial player rolls a  $3+2=5$ . The Pirate wins! The Imperial player loses his final crew counter and the Pirate captures the ship.

If the attackers' and defenders' totals are the same then both sides lose a crew counter and the defender chooses whether to continue or cut grapples.

A ship which has no crew counters left has lost the boarding action. Place an abandoned marker on the ship's template and an abandoned counter beside the ship. Any boarding action launched against an abandoned ship will succeed automatically. An abandoned ship does not move, and will constitute an obstruction to line of sight.

If the winning player wants to take the ship as a prize he moves as many crew counters as he wishes from the capturing ship to the enemy ship. The prize is his!

Note that if your ship is in contact with two or more enemy vessels, you may only initiate a boarding action against one of them per turn.

## CAPTURED SHIPS

If a ship has been captured as a result of a boarding action then it is considered a prize ship. Place a captured marker on the ship's template and a captured counter next to the ship.

Because your crew are unfamiliar with how the enemy ship works, they cannot sail it or use its weapons, so prize ships cannot move or fire. The crew left aboard the prize ship may repel boarders, but they cannot use the captured ship's cannons to fight off attackers.

If you don't wish to keep a captured ship afloat, you may order your men to scuttle it. This happens during the End Phase, giving the ship's original owner a chance to recapture it if he hasn't moved all his squadrons yet.

If you have recaptured a ship of your own nationality then you may recrew the captured ship. Place crew companies from the ship that re-captured it onto the recaptured ship's template, reclaim the ship template from your opponent, and give thanks to the gods of battle.

For this turn the recaptured ship is a straggler, and moves during the End Phase. It can rejoin its original squadron if any of these ships are still afloat, and then it will be able to move and fire normally.

## CREWING LIMITS

A ship cannot carry more crew companies than its original crew strength indicates. So if you captured a Wargalley with a Galleon (which has 4 crew companies) or recaptured it with a Greatship (which has 5!), you still could not place more than two crew companies on the Wargalley's template.



# THE END PHASE

Once both players have moved and fired with all their ships the Battle Phase is over and it is time for the End Phase. Any record keeping that must be done is taken care of now.

## PICK UP SURVIVORS

If you have any ships in contact with debris or wreckage that has characters clinging to it (see the *Fleets* section), you may rescue them. Place their counters on the ship's template to show they have climbed aboard.

## REMOVE DEBRIS

Remove any debris markers that are on the table. Any characters that are clinging to the debris are lost and are also removed.

Any wreckage markers on the table are now changed to debris markers, ready to be taken off in the End Phase next turn.

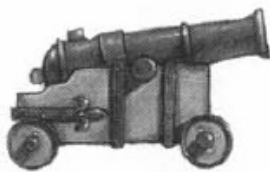

## SEE IF ANY FIRES SPREAD

If an area of a ship is ablaze then there is a chance that the fire may spread. Roll once for each area on fire on the enemy ship.

### Roll Effect

- 1 Blaze goes out
- 2 Blaze does not spread
- 3 Blaze does not spread
- 4 Blaze spreads prow-ward
- 5 Blaze spreads upward
- 6 Blaze spreads stern-ward

If a fire goes out remove the blaze marker and replace it with a damage marker. If the fire spreads prow-ward or stern-ward then place a blaze marker in the location to the left or right of the blazing location as appropriate (prow-ward is usually to the left on a template). If the fire spreads upward place a blaze marker in the location above the blazing location.

If a fire cannot spread because there is no area above or to the right or left or because that area is already alight then nothing happens. The fire continues to burn in the original location.

Blazing locations are treated exactly as destroyed locations. If a sailing ship's sails are ablaze then its movement will be reduced. If a shot hits a blazing location then critical hits occur as normal. There is no saving throw against fires spreading to a new location.

If there is a fire in a location that can take two hits, and only one is ablaze, then any result that says the fire spreads means that the second part of the area is now on fire too. Place another blaze marker on that location.

When a fire spreads upward there will sometimes be a choice of two locations to which it can spread. Roll a dice. If the result is 1, 2 or 3 the blaze spreads to the left hand location. On a roll of 4, 5 or 6 the fire spreads to the right.

If a blaze spreads to an area that has already been damaged, it does not cause a critical hit: the area is simply set on fire.

## MOVE STRAGGLERS

Stragglers are ships that started the turn more than 6" from their squadron's flagship. They may not move or fire in the Battle Phase although they may defend themselves as usual if boarded. In the End Phase they may move normally but may not fire cannons or board other ships.

Now is the time to move your stragglers. Ships that have taken a 'no movement' critical hit on the Captain's Chart cannot move now.

## SCUTTLE SHIPS

If you want to scuttle a captured ship now is the time to do it. Scuttling a ship means that the crew plant explosive charges or knock holes in the bilges and then leave the ship to sink.

If the ship from which they came is still in contact with the prize, increase the crew strength by one. The lads are now back aboard their original vessel.

If the original vessel is no longer in contact then the lads take to the boats and are out of the game. The crew company is lost.

Place a wreckage marker where the ship was. It will become debris during the End Phase of the next turn. The ship is now sunk.

If you want to scuttle any of your own ships, feel free. The ship sinks with all hands!

## REMOVE COUNTERS

Now is the time to remove any no movement and no firing counters that your ship may have picked up as a result of critical hits.

## PICK UP MAGIC CARDS

If your Wizard is still alive in the End Phase, you may discard any Magic Cards you do not want and then replenish your hand, bringing it back up to full strength. You must discard any spells you do not want *before* drawing any more, and may not discard any you draw now until the End Phase next turn.

A Wizard who is clinging to the wreckage (see the *Wizards and Magic* section) may not discard or pick up any Magic Cards in the End Phase.

Any spells played during this turn which have a duration of one turn are removed. When all the Magic Cards have been used, shuffle the discard deck and start again.

The turn is now over and play proceeds to the next turn. If all of one side's ships are sunk or captured then the game ends. The player who still has ships afloat and uncaptured is the winner.

## DECIDING VICTORY USING BATTLE HONOURS

If you wish to play to a time limit, victory can be decided by counting up the number of battle honours you have gained during the game. This is calculated in the End Phase of the last turn.

Total the number of below the waterline hits for all the enemy ships you have sunk or captured. Any enemy ships scuttled, or abandoned at the end of the game, count as ships sunk. This is the number of battle honours you have.

The player with the highest total of battle honours is the winner.

Capturing or killing Admirals and Wizards also counts towards the battle honours. See the *Admirals and Wizards and Magic* sections for details on how many battle honours such characters are worth.

*Admiral Koenig adjusted the range of the telescope. The Bretonnian Fleet jumped into view, strung out in long lines across the treacherous waters of Marienburg Sound. He made out the giant shape of the Grande Roi, Where the Galleon towered over its flock of Corsairs. Even the hardened old Imperial seadog admitted it was a sight to stir the heart; with its flags fluttering many-coloured in the wind and the beautifully cast brasswork surrounding its high aftcastle glittering in the sun. It was going to be a pity to sink it, he thought. The Bretonnians built fine ships.*

*The grace of their flagship made the hard lines of the Altdorf seem almost brutal by contrast. Compared to the Bretonnian it was but a floating gun platform, functional and basic. The Greatship lacked the speed and beauty of the other ship but on the other hand it did possess firepower in abundance. Koenig did not doubt that the stout hearted Imperial soldiers clustered on the foredecks would prove more than a match for the spoiled Bretonnian noblemen on the Grande Roi. They were professionals, hardened soldiers, veterans of many a campaign. Fighting was their trade, not their amusement.*

*The Imperial Wolfships that surrounded the Altdorf, like hunting hounds at the heel of their master, were inspiring in their way. They were long and sleek and low in their water. Their great iron-beaked rams bit the waves. Koenig knew that the rams turned the entire ship into a weapon. When driven forward by the steel muscled arms of their oarsmen the Wolfships became spears aimed at the very heart of an enemy ship. And if that weren't enough, their great batteries of forward facing guns would certainly finish their foes. Koenig felt certain that no Bretonnian Corsair would prove a match for them.*

*Behind the Wolfships waited the smaller Wargalleys, arranged in hunting pack formations to catch any stray Bretonnians that should escape his net of steel. Koenig placed great stead in the small ramships, respecting their strength, manoeuvrability and firepower, not to mention the renowned courage of the Wargalley crews. He knew that the Wargalley squadrons would do their duty, their prime targets the smaller Bretonnian vessels. He also knew that the gallant Wargalley captains would not hesitate to attack a vessel many times the size of their ships, for their strength lay in fighting as a squadron, not as single warships.*

*From his position on the Aftcastle of the Grande Roi, Admiral Le Fevre of the Bretonnian Fleet regarded his assembled ships with pride. Sails and banners emblazoned with the heraldic devices and crests of the Bretonnian nobility stretched before him in a wash of bold colours. His Corsair and Buccaneer squadrons were ready to fight, and the battle lines drawn up according to plan. The vast Galleons Invincible, Indomitable and Redoubt held the centre of the Bretonnian fleet, each rivalling the Grande Roi for size, firepower and elegant beauty.*

*On the maindeck of the Grande Roi, feverish preparations were underway, making ready for the battle to come. Some washed down the decks, damping the timbers to lessen the chance of fire. Others sharpened their swords and adjusted their armour in readiness for fierce boarding actions - an inevitable part of any large scale sea battle. The gunners wheeled powder kegs and shot below, to feed the appetites of the rows upon rows of heavy cannons. Signal flags fluttered from the main mast, and the Bretonnian warships glided into their allotted positions with a grace that belied their ferocity in battle.*

*Today was a day long planned for, and Le Fevre firmly believed that the evening would see the sun set on the fleeing remnants of the Imperial Warfleet. Careful manoeuvring had placed the Bretonnian ships with the wind in their sails, and his Wizards scryed no change in the wind for the rest of the day. Yet Le Fevre knew that to underestimate the assembled Imperial warfleet that lay before him would be stupidity of the highest order. He had repeated again and again to his often reckless barons that although sailing into the heart of the tight Imperial formations would doubtless lead to an honourable and heroic death, it would not win the battle. This was a battle to be fought with cold precision, all elements of the fleet acting their pre-determined part. For Le Fevre knew the fearsome reputation of Admiral Koenig, and knew that the Imperial Admiral would ruthlessly exploit any opportunity presented to him by reckless or foolhardy Bretonnians. Le Fevre knew that Koenig regarded them as little more than spoiled, foppish noblemen, whose only interests lay in carousing and drinking at the Kings court in Ouisillion. He also knew that this was not so, and that today's battle was an unrepeatable chance to teach the disrespectful Imperial dullards a lesson in sailing and warfare that they would never forget.*

# FLEET LISTS



# INTRODUCTION

In the pages that follow you will find the Fleet Lists of many nations and races of the Known World. Each list describes the type of ships that are available to that fleet and the points cost of buying them. It also contains any special rules that may apply to the fleet concerning such things as weapons and methods of propulsion. This is important since each fleet has its own advantages and disadvantages.

In each Fleet List you will also find templates for that race's ships. These may be photocopied, mounted on thin card, and cut out. You will need one template for each ship in your fleet.

## POINTS COSTS

When choosing a fleet, you will see that each type of vessel has a points cost. The bigger ships cost more points than the smaller ones. In a typical battle, both players will have the same number of points to spend on their fleets. Thus, from game to game, you may vary your fleet within known limits, alter your strategy and tactics, yet still retain a balanced game.

The fleets you have been playing with so far have a total points value of 400 points for each player: six Wargalleys at 150 points per squadron of three, and one Wizard at 100 points.

In a normal game of Man O' War, each player has 1000 points available to buy his fleet with. You should choose the national fleet you want to play and look at its Fleet List, which will tell you how many points it costs to purchase each sort of ship. Certain types of ship must be bought in squadrons, so you will have to buy three of them at once. As you select your ships deduct the number of points from your total. Keep choosing until all your points are gone.

The Fleet Lists contain certain limits on the number and type of ships you can buy. Sometimes you will have to buy a minimum number of a particular ship type. Sometimes there will be a maximum number you are allowed to purchase.

These constraints are to simulate the unique composition of each nation's naval forces. You must select all your ships from the same Fleet List. You cannot have Elven ships in an Orc fleet, for instance.

You can also use your points to buy a Wizard (see the Magic section) and to customise your ships by buying Man O' War Cards.



## FOR EXAMPLE

*You have chosen an Empire Fleet. According to the Empire Fleet List, the fleet must contain one Greatship to be the Admiral's Flagship. It must also include one squadron of Wargalleys and one squadron of Wolfships. Since you must have these, it's time to spend some points. A Greatship costs 150 points, a squadron of Wolfships costs 300 points and a squadron of Wargalleys costs 150 points.*

*You think it's a good idea to have a Wizard, and choose a Master Wizard at 100 points. This leaves you with 300 points so you purchase another squadron of Wolfships. You could have purchased two more squadrons of Wargalleys. Alternatively you could have had two more Greatships or one more Greatship and a squadron of Wargalleys.*

Since each ship has its own strengths and weaknesses you should give very careful consideration to the exact make-up of your force. A balanced fleet is essential to victory.

Wargalleys are small and fast and good at boarding actions against weakened enemies. Their ram is a powerful attack if they can make it. However, they are not so good in a long range firefight and would be hard put to win a boarding action against an undamaged Corsair.

It is essential for the Empire Player to have a Greatship or a squadron of Wolfships to provide firepower to soften up the Wargalleys' targets.

In the later stages of the game, when there are many damaged or crippled enemy ships, Wargalleys can really come into their own picking on stragglers and the weak. Until then they should be held back unless an ideal opportunity to ram presents itself.

Once you know the strengths and weaknesses of the various ships you'll be in a good position to pick the best combination of forces for your fleet.

If players wish to play with larger or smaller fleets then they should agree on a different points value before the game. We find 1000 points a good size for an enjoyable evening's play but it's perfectly possible to do battle with squadrons of 2000 or even 5000 points if you have the time and the ships available.

# ADMIRALS

An Admiral is in overall command of a fleet. His Man O' War is the flagship for the whole force, and it is to him that all the other commanders turn to receive their orders.

The Admiral costs no points and comes automatically with your fleet. He goes on the Man O' War of your choice since it would be beneath his dignity to travel on any lesser ship. Once you have chosen his ship place the Admiral's counter on that ship's template. The Admiral's ship is automatically dealt one Man O' War Card before the game begins. This costs no points.

## BOARDING ACTIONS

The ship carrying the Admiral gets +1 added to its dice roll during a boarding action, as his presence heartens the men and inspires them to greater effort.

If the ship loses the boarding action and all the crew are killed, the Admiral is also killed.

## CLINGING TO THE WRECKAGE

If the ship carrying the Admiral sinks, he will cling on to the wreckage. Place his counter on the wreck or debris marker. During the End Phase players may attempt to rescue him.

To effect a rescue a player's ship must be touching the wreck or debris marker. If both players have ships touching the wreck or debris marker the Admiral swims to the ship of his own fleet.

## BATTLE HONOURS

If the Admiral is picked up by the enemy he is captured. This represents a considerable humiliation for the owning player and will give his foe extra battle honours at the end of the game.

If the Admiral is picked up by his own player's ship, place his counter on the appropriate ship template. He can now be used again as normal.

An Admiral is worth 5 Battle Honours.



# WIZARDS AND MAGIC

In the Old World the raw energy of magic exists as a palpable, elemental force. Its unfettered power can trigger awesome catastrophies on an unimaginable scale that completely overshadow natural disasters. Wizards are that rare breed that can turn this awesome power towards their own ends.

The Elves were the first race to master the capricious forces of magic. They discovered the magical flux of power which permeates the world and learned how to bend it to their will.

In the distant past the Elves taught some of their knowledge to men so that they could fight back against the incursions of Chaos which threatened to overrun the Old World. Men were poor pupils in comparison to the Elves, lacking the lifespans necessary to learn all of the intricacies and disciplines of magery.

To aid them the Elves taught men how the Winds of Magic blow throughout the world, gusts of raw energy which blow out through the collapsed warp gate hanging over the North Pole.

The Elves told their pupils how the winds of raw magic are polarized by contact with the material world into eight 'colours' of magic. By studying a single magical colour for much of their lives men could master and manipulate it with a fraction of the skill of the Elven lords.

## THE COLLEGES OF MAGIC

In this way eight Colleges of Magic developed, each one dedicated to the study of a particular colour of magic, its adepts learning to draw power from their own magical colour and manipulate it with form and purpose.

Ordinary men can't perceive the flux of energy or see its startling colours. Wizards, however, can feel the flow of power and see the colours of magic as they swirl and billow across the world. They see the roiling polychromatic clouds which twist across the sky forming fantastic shapes and giddy patterns, and feel the thundering energies that writhe through the earth.

The eight Colours of Magic are Bright, Jade, Amethyst, Gold, Amber, Celestial, Light and Grey. Each colour has its own peculiar properties which affect the kind of magic it can be used for and the personality of the Wizard who studies it.

In addition, there is the High Magic of the Elves, which uses all eight colours combined, and Dark Magic, which manipulates the raw, seething energy of magic before it is polarized. Dark Magic is a wild and dangerous form of wizardry pursued only by the most twisted and power hungry Sorcerers.

### Bright

Bright Magic is closely associated with heat and flames and is drawn into whirling vortices of power over flames or fiery phenomena such as volcanoes. Bright Wizards can manipulate fire and create flames with ease, making them very effective battle wizards with many destructive long range spells to destroy the enemy with fireballs, flamestorms and the like.

Bright Wizards have fiery tempers and a warlike disposition, they are constantly active and animated by a purpose or idea. Traditionally, Bright Wizards dress in red or orange robes and bear the sign of a stylised key, symbolising the knowledge of Bright Magic as the way of unbaring the unknown.

### Jade

Jade Magic is intimately tied to nature and its power waxes and wanes with the seasons, making Jade Wizards tired and reluctant to use magic during winter but vibrant and full of energy during the spring and summer. Some Jade Wizards worshipped the darker side of nature's power - disease and decay. Few believe such practices still occur but many people still regard Jade Wizards with not a little suspicion and fear. Jade Wizards wear green or turquoise robes and often bear a sickle as a symbol of the harvesting of nature's energy.



## THE COLLEGES OF MAGIC

Although the eight Colleges of Magic are equally powerful when viewed in isolation, their relative positions on the colour wheel are very important when Wizards fight.

Each College of Magic is superior to that which lies directly clockwise of its own position; equally, each college is inferior to its immediate neighbour in an anticlockwise direction.

These relationships allow a Wizard of each college to dispel incoming attacks of certain colours, as explained in the *Magic Phase* section.

Notice that although we talk about Wizards being of opposing colours, they do not lie opposite to each other on the colour wheel: they in fact lie next to each other, with the stronger colour on the left.

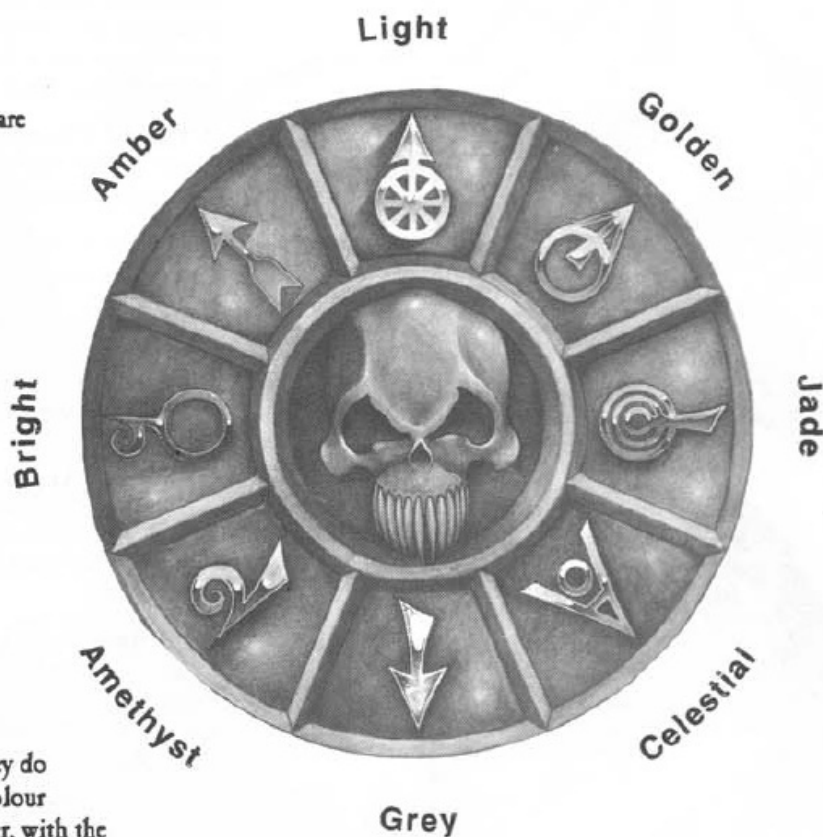

### Amethyst

Amethyst Magic is perhaps the strangest and most indefinable of all of the eight colours. Amethyst Wizards are forbidding figures, hooded and cowed in deep magenta vestments and frequently wearing skull masked helms. They bear great scythes, supposedly as a symbol of mortality, and huge, leather bound books which are symbolic of Fate. They never speak, instead communicating when they must by projected thought. Popular superstition states that the words of an Amethyst Wizard are the last thing a mortal ever hears.

### Gold

Gold Magic is a particularly heavy and dense form of energy which quickly sinks to the ground and seeps into the earth. There it is attracted to the heavier, more precious metals – most obviously gold itself. It is said that this goes some way to explaining the almost magical effect that gold has on most of the intelligent races, inciting greed, murder and insanity. Gold Wizards use a stylised eagle's head motif representing the soaring aspiration which motivates their College.

### Amber

Amber Magic is most easily manipulated to affect plants and wild animals, being wild and undisciplined by its very nature. Amber Wizards are big, burly individuals with wild hair and unkempt beards. They dress in furs and animal skins adorned with bones and feathers. The Amber College is most frequently associated with the symbol of an arrow, representing the Wizards' place as huntsmen of knowledge.

### Celestial

Celestial Wizards spend much of their time stargazing and recording the astral conjunctions to foretell the future, and it is commonly accepted that their predictions are absolutely accurate. In battle Celestial Wizards command the power of the heavens so they are able to call down great sheets of lightning and savage winds against their foes, in addition to casting portents and divinations to aid their own forces. They dress in deep blue robes adorned with stars and crescent moons. The College of Celestial Magic is commonly represented by the symbol of the comet as the herald of celestial knowledge.

### Light

Light Magic is notoriously difficult to control and channel, so the rituals used by Light Wizards are particularly complex and difficult to master. The symbol of the Light College is an arrow jutting up from the wheel of magic, symbolising intellectual endeavour raising the individual above the majority.

### Grey

Like Celestial Wizards, Grey Wizards are potent weather-mages much sought after by Admirals who want to ensure their journeys remain safe from storms. Grey Wizards invariably carry a great, gnarled staff and cultivate a wild, slightly wolfish appearance by wearing wild animal skins. The symbol of the Grey College is a downward pointing arrow: a stylised rendition of the Sword of Judgement, symbolising the college's legendary good judgement.



## CHOOSING YOUR WIZARD

Before you start playing, you will need to decide what sort of Wizard you are going to include in your fleet. Of course, you don't have to take a Wizard, but being unable to cast or dispel spells will put you at a considerable disadvantage.

There are three Mastery Levels of Wizard to choose from, and each costs a number of points which must be taken from the 1000 points you have to buy your fleet with (see the *Fleets* section).

Each Wizard starts the game with a certain number of Magic Cards. Magic Cards are discarded after they have been used, and can be replenished in the End Phase, but your Wizard may never hold more than his original quota.

The death or capture of an enemy Wizard is worth a number of battle honours, according to his Mastery Level. The more powerful a Wizard is, the more battle honours he is worth!

Mastery Level	Points Cost	Magic Cards	Battle Honours
Wizard Champion	50	2	1
Master Wizard	100	4	2
Wizard Lord *	150	6	3

\* Note: The Wizard Lord can add +1 to his dice roll when casting or dispelling any spell.

This means that you can purchase a less competent Wizard cheaply and have a hand of two Magic Cards, or you can buy a truly mighty Wizard Lord for more points and get a larger hand of six cards. Note that you can only ever have one Wizard in your fleet.

A Wizard Champion is only allowed to hold two Magic Cards at any time. This represents the fact that they are less competent than the usual fleet Wizards.

A Master Wizard starts the game with four Magic Cards and is the standard level for sea-faring Wizards.

An Wizard Lord is the most powerful Wizard of all, and holds a comparatively massive hand of six Magic Cards. In addition, when casting or dispelling any spell an Archmage can add one to his dice roll.

## WHAT COLOUR IS YOUR WIZARD?

When you have chosen what sort of Wizard you want, you will have to find out which College of Magic he comes from.

Place the college colour counters (there should be eight in all, one for each college) face down in front of you. Each player takes one counter at random to see what colour his Wizard is. If you drew a gold counter, for example, your Wizard would be a Gold Wizard.

Of course, if both players agree you may choose your Wizard rather than select him randomly.

Put your college counter and level counter on your Wizard's card to act as a reminder during the game.

## BOARDING ACTIONS

A Wizard has no effect on boarding action dice rolls. However, when the last crew counter is removed during a boarding action, the Wizard is also assumed to be killed and his counter is removed as well.

## CLINGING TO THE WRECKAGE

If the ship carrying the Wizard sinks, he will cling on to the wreckage. Place his counter on the debris marker. During the End Phase players may attempt to rescue him.

While the Wizard is adrift, clinging to the wreckage, he may not cast any spells. As soon as the Wizard goes overboard, discard all of your Magic Cards.

To effect a rescue a player's ship must be touching the wreck or debris marker. If both players have ships touching the wreck or debris marker the Wizard will swim to the ship of his own fleet.

## BATTLE HONOURS

If the Wizard is picked up by the enemy he is captured. This represents a considerable humiliation for the owning player and will give his foe extra Battle Honours at the end of the game.

If he is picked up by his own player's ship, place the Wizard's counter on the appropriate ship template. He can now be used again as normal. Replenish your hand of Magic Cards in the End Phase as usual.





John Blanche

# MAN O' WAR CARDS

The careers of the great Men O' War of the ocean-going warfleets are long and glorious. As they fight their way through many battles and campaigns, they are often modified as battle damage is repaired, or as they are awarded the best new weapons available to the fleet. Over the years, each ship gains its own fearsome reputation.

Down through the long years, the great Men O' War of a nation's fleets are refitted and improved, and become quite distinct from other vessels of the same class. They acquire individual characters and formidable reputations. Some have magical banners, the legacy of potent Wizards who once took to the sea on them. Others have their hulls specially reinforced and covered in metal armour. Some gain such a fearsome reputation that their foes fear to face them in battle.

In the box you will find a pack of Man O' War Cards. These cards represent the individual abilities of the Men O' War in the fleet. Some increase a ship's saving throw for certain areas. Some will give you more guns. Others have more unusual powers. Their exact use is explained on each card.

Man O' War cards cost 25 points each and are chosen randomly when selecting your fleet.

Before the game, shuffle the deck of Man O' War Cards and deal the appropriate number to each player. Each fleet will start with at least one Man O' War Card, as you get one at no points cost with your flagship.

Once the cards have been drawn, you should allocate them to whatever Man O' War you want. Place the cards next to the template of the ship it affects. On the top of each card you will see a symbol (a cannon, an anchor, a shield or a captain's hat).

## Hull Cards

Man O' War Cards with an anchor symbol at the top affect the ship itself, perhaps giving it thicker timbers or faster sails.

## Gun Cards

Man O' War Cards with a cannon symbol on them give bonuses to the weapons of the ship.

## Crew Cards

Man O' War Cards with a shield symbol on them give bonuses to the crew in boarding actions.

## Special Cards

Man O' War Cards with the captain's hat symbol on them are special cards that give an unusual benefit to the ship.

No Man O' War may have more than one card with the same symbol on it. Otherwise, there are no other limits to the number of Man O' War Cards a ship may have.

It is important to note that although the cards talk specifically about cannons etc, they may be used generally even where the fleet choosing them does not have, for instance, that type of weaponry. So if an Elf ship gains the Man O' War card 'Heavy Cannon', which gives a -1 to any target's saving rolls, then the Elf player can still use the card even though his ship does not have cannon - he may think of it as a special heavy ballista.

Likewise, if an Elf player gets a card which increases the long range of his weapons from 9" to 12", in his case his weapons already fire 12", so his new maximum range is 15". In most cases the cards will be self explanatory, but if there is any doubt as to whether the card can be applied to your Man O' War, and if your opponent agrees, you may put the card down and pick another.

Some Man O' War Cards are placed at a specific location on the ship. If that location is destroyed then the Man O' War Card is also lost, along with any benefits it may give to the ship. If no location is given on the card then the abilities and benefits it gives the Man O' War are not lost until the ship is sunk.

If you have purchased more Man O' War cards than you can use, then you must discard the ones you cannot use. This can sometimes happen if you end up with more cards of the same symbol than you have Men O' War to use them. You do not get any points back for the discarded cards - it's just tough luck!

It is worth noting that some Man O' War Cards may increase the saving throw on a particular area. These can be applied cumulatively, but remember that a saving throw always fails on a roll of a 1.



# SHIP TYPES

There are three categories of ship in Man O' War. The first are the Men O' War themselves, the largest and most powerful ships of the fleet. Second come the Ships of the Line, who form the bulk of any force. Finally come the independent ships, less powerful than Men O' War but still taking to the sea as individual vessels.

## MEN O' WAR

Men O' War are huge warships. Each Man O' War carries as many guns as a whole squadron of lesser ships, and will be crewed by the best sailors in the fleet.

Men O' War are the largest and most powerful class of ship, and are able to operate independently: when deploying your fleet, you place them on the table individually and move them on their own. They do not form squadrons. If a ship is a Man O' War it will say so on its template.

During set up you place each Man O' War on the table as if you were deploying a separate squadron.

During the Battle Phase you move each Man O' War as if it were a separate squadron.

To further characterise your Men O' War, you may purchase special cards for them. These cards give the ships a range of special abilities, turning these already formidable fighting ships into near-invincible opponents. These are called *Man O' War Cards*, and you will find the rules for them on the opposite page.

The Admiral of the fleet will always be found onboard the Man O' War with the longest and most glorious battle history. This ship is the flagship of the entire fleet, and is the vessel that all other commanders in the fleet look to.

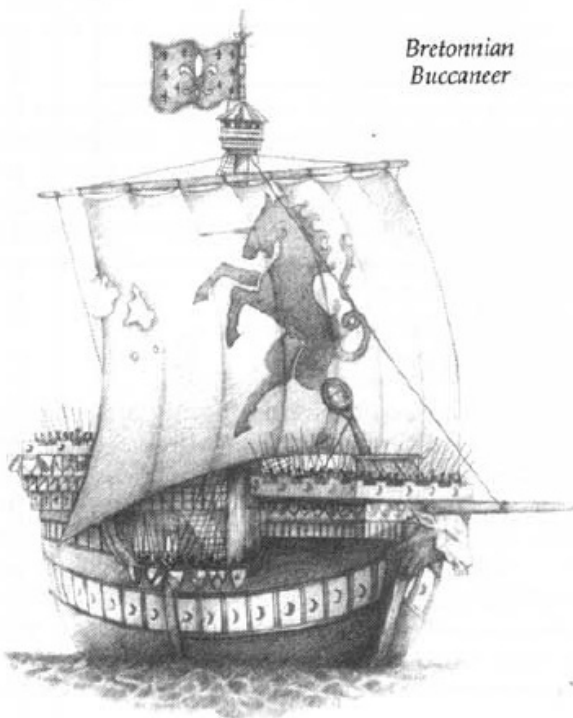

Bretonnian  
Buccaneer

Dwarf  
Ironclad

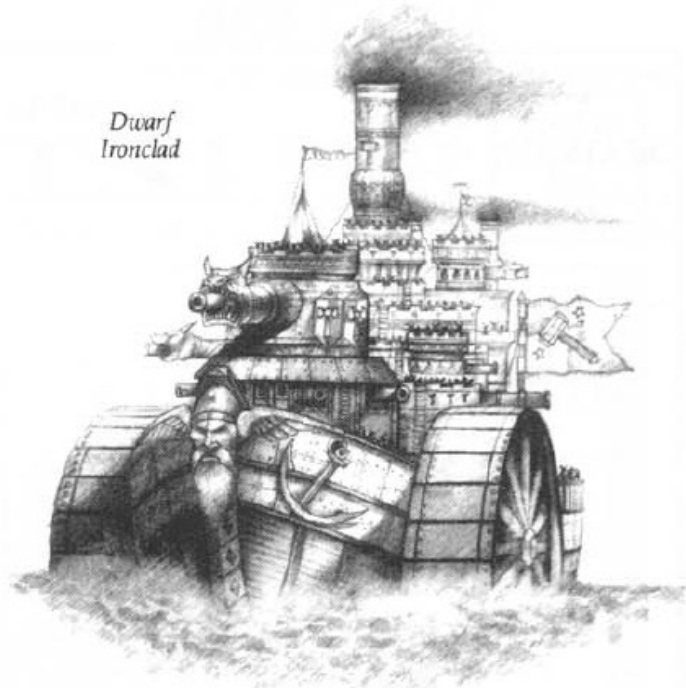

## SHIPS OF THE LINE

Ships of the Line are the backbone of any fleet, and operate in squadrons for mutual support. Within their class, the ships can vary enormously between the different sea-going races, or even within the same fleet. Some Ships of the Line are fairly small vessels, whilst others are almost as powerful as the Men O' War.

Ships of the Line are always purchased as squadrons of three ships. You buy them as a group and deploy them according to the squadron rules. They always move and fire as a squadron.

## INDEPENDENT SHIPS

Some ships behave like Men O' War, in that they move and fire independently, and are never found as part of a squadron. However, they are usually less powerful than Men O' War and lack their long proud histories. Such ships are termed *Independents*.

During set up you may place Independent ships on the table as if you were deploying a separate squadron. In the *Battle Phase* you can move Independent ships as if they were a separate squadron.

Unlike Men O' War, Independent ships cannot be given Men O' War cards.

The Dwarf Nautilus submarine is a good example of an Independent ship.

# IMPERIAL FLEET

Characterised by its fast moving ramships and its mighty Greatships, the Imperial or Empire fleet is one of the most powerful fleets in the Old World. It relies on long range support from its Men O' War while its swift moving ramships close with and destroy the enemy.

## MEN O' WAR

The Empire fleet has the following Man O' War.

## GREATSHIPS

Developed in response to the Bretonnian Galleon, the mighty Greatship is a floating arsenal bristling with

guns and packed with heavily armed Imperial soldiers. It has a thunderous broadside of three batteries of cannon as well as forward and rear-firing guns. Although it has no oars and cannot ram, the Greatship is still formidable at close range since it is crammed full of fighting men eager to get to grips with the foe.

The Imperial Admiral has a commanding view of his fleet from the Greatship's high aftcastle, and the signals fluttering from its masts can be easily read by even the most distant Imperial ships.

## IMPERIAL FLEET

An Imperial Fleet may consist of the following:

### Men O' War: 1+

The fleet must have at least one Greatship to be your Admiral's Flagship.

An Imperial fleet can't have more Greatships than it has Ship of the Line squadrons. The Admiral's ship does not count towards this total.

Cost: 150 points per Greatship.

### Ship of the Line Squadrons: 2+

At least one squadron of three Wolfships.

Cost: 300 points per squadron.

At least one squadron of three Wargalleys.

For every Greatship you may have 2 Wargalley squadrons. For every Wolfship squadron you may have 2 Wargalley squadrons.

Cost: 150 points per squadron.

### Wizard: 1

Cost: Variable - See *Wizards and Magic*.

### Admiral: 1

Cost: Free.

### Men O' War Cards: 1+

Cost: 1st card free with the Admiral, subsequent cards at 25 points per card.

## SHIPS OF THE LINE

The Imperial fleet has the following Ships of the Line.

## WOLFSHIPS

The sleek Wolfship is the most powerful Imperial ship of the line. Great batteries of cannon jut from its high forecastle, overlooking the titanic ram with which it spears its foes. Powered by the wind and dedicated oarsmen selected from the strongest soldiers it seeks out the Empire's seaborne foes.

Wolfships are organised in squadrons which makes them triply dangerous. The squadron is capable of moving with a drilled precision that lets it bring an enormous amount of firepower to bear on its targets. Once the enemy is crippled the Wolfships close and board. Their gun-lined forecastles make them particularly dangerous when doing this since their enemy must make any counterattack in the teeth of many cannon.

Drummers man the aft castle beating time for the rowers. The terrifying sound of their drumming mingles with blasts from the ships' brazen warhorns as they enter battle. All this din serves another purpose in letting the Wargalleys know each other's position in the dense clouds of powder smoke once the cannonades begin.

## WARGALLEYS

Wargalleys are swift-moving, lightly armed ramships used for patrolling the river Reik and the Empire's dangerous coasts. Their crews are generally wild, free spirited adventurers ever ready to risk all in furious attacks against the odds. Balanced against the crews' love of battle and pillage is their commanders' need to preserve their ships. Wargalley captains and officers are picked from experienced veterans who know when to hold their ships back out of range of the enemy guns and when to order their vessels forward into the fray.

# IMPERIAL SPECIAL RULES

The following special rules apply to ships in the Imperial fleet.

## MOVEMENT

Under sail, Imperial ships can move 9" with the wind behind them and 6" when the wind is coming from the side. If they start a Battle Phase moving against the wind they are better moving under oars.

Under oars, Imperial ships can move 4". They can use half this movement allowance to turn ninety degrees on the spot or all of it to turn 180 degrees on the spot. Alternatively they can choose to move 6" in a straight line making no turns of any sort.

## RAMMING

Any oared Imperial vessel with a ram may make a ramming attack. See the Fleet List for the damage inflicted by each type of ship.

	<b>EMPIRE</b>						
GREATSHIP						<b>CREW</b> <b>5</b>	
MAN O' WAR							
4	<b>FORE MAST</b> Save 5 or 6 First hit has no effect. Second hit destroys mast. Ship speed reduced by 2" (3") Any further hits do not cause critical damage.	5	<b>MAIN MAST</b> Save 5 or 6 First hit has no effect. Second hit destroys mast. Ship speed reduced by 2" (3") Any further hits do not cause critical damage.	6	<b>AFT MAST</b> Save 5 or 6 First hit has no effect. Second hit destroys mast. Ship speed reduced by 2" (3") Any further hits do not cause critical damage.	HIGH	
[Ship Silhouette]							
2	<b>FORECASTLE</b> Save 4, 5 or 6 Each hit destroys 1 fore cannon battery.		<b>AFTCASTLE</b> Save 4, 5 or 6 Each hit destroys 1 aft cannon battery.		3	LOW	
4	<b>BOWS</b> Save 4, 5 or 6 1 broadside cannon battery lost.	5	<b>GUN DECK</b> Save 4, 5 or 6 1 broadside cannon battery lost.	6	<b>STERN</b> Save 4, 5 or 6 1 broadside cannon battery lost.		
NO EFFECT	NO EFFECT	NO EFFECT	SINKS	<b>BELOW WATERLINE</b> Save 4, 5 or 6 First, second and third hits have no effect. Fourth hit sinks ship.			
<b>SAIL: 6"(9")</b>		<b>BATTLE HONOURS: 6</b>		<b>NAME:</b>			

Permission granted to photocopy for personal use only. © Copyright Games Workshop Ltd, 1992

	<b>EMPIRE WARGALLEY</b>			<b>CREW 2</b>
<b>SHIP OF THE LINE</b>				
<b>4</b>				<b>MAST</b> Save 5 or 6 Mast lost. Cannot move under sail. Any further hits do not cause critical damage.
<b>5</b>	<b>FORE CASTLE</b> Save 4, 5 or 6 Cannon destroyed. May not fire.	<b>OAR DECK</b> Save 5 or 6 Oars lost. Cannot move under oars.	<b>6</b>	
<b>BELOW WATERLINE</b> Save 5 or 6 First hit has no effect. Second hit sinks ship.				
<b>NO EFFECT</b> <b>SINKS</b>				
<b>OARS: 4"(6")    SAIL: 6"(9")    BATTLE HONOURS: 2</b>				

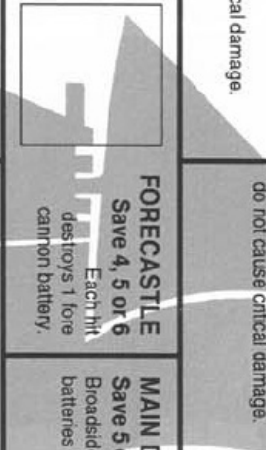
	<b>EMPIRE WOLFSHIP</b>			<b>CREW 3</b>
<b>SHIP OF THE LINE</b>				
<b>4</b>				<b>4</b>
<b>FORECASTLE</b> Save 4, 5 or 6 Each hit destroys 1 fore cannon battery.				
<b>MAIN MAST</b> Save 5 or 6 Ship speed reduced by 2" (3"). Any further hits do not cause critical damage.				
<b>MAST</b> Save 5 or 6 Mast lost. Ship speed reduced by 2" (3"). Any further hits do not cause critical damage.				
<b>MAIN DECK</b> Save 5 or 6 Broadside cannon batteries lost.				
<b>3</b>				
<b>LOW</b> ————— <b>HIGH</b>				
<b>FORECASTLE</b> Save 4, 5 or 6 Cannon destroyed. May not fire.				
<b>OAR DECK</b> Save 4, 5 or 6 Oars lost. Cannot move under oars.				
<b>5</b>				
<b>BOWS</b> Save 4, 5 or 6 1 fore cannon battery lost.				
<b>4</b>				
<b>BELOW WATERLINE</b> Save 4, 5 or 6 First and second hits have no effect. Third hit sinks ship.				
<b>NO EFFECT</b> <b>NO EFFECT</b> <b>SINKS</b>				
<b>OARS: 4"(6")    SAIL: 6"(9")    BATTLE HONOURS: 4</b>				

# EMPIRE FLEET

The Empire fleet is one of the most powerful fleets in the Old World. It is characterised by its fast moving ramships and mighty Greatships. Long range support is provided by the Greatships while swift moving Wargalleys and Wolfships close with and destroy the enemy.

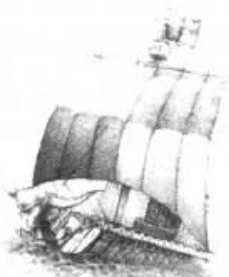

## EMPIRE WARGALLEY

Crew: 2

Wargalleys are swift-moving, lightly armed ramships used for patrolling the river Reik and the Empire's dangerous coasts.

### MOVE

Oars: 4" (6" straight with no turns). May turn on spot. Uses 1/2 move per 90° turn. May reverse up to 2".

Sail: 6" normally, 9" with wind behind.

### WEAPONS

1 cannon firing ahead. Cannon may repel boarders.

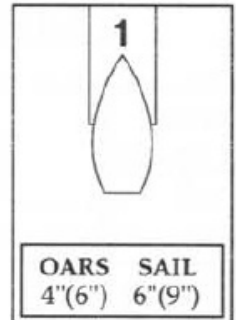

### SPECIAL RULES

May ram. Must move at least 3" towards foe under oars in straight line with no turns. If contact is made, foe must make a below the waterline save - if he fails roll a dice:

- |     |  |
|-----|--|
| 1-3 | 1 point of below the waterline damage  |
| 4-5 | 2 points of below the waterline damage |
| 6   | 3 points of below the waterline damage |



## EMPIRE WOLFSHIP

Crew: 3

The sleek Wolfship is the most powerful Imperial ship of the line. Hunting in packs and armed with great batteries of cannon which jut from its high forecastle, it uses its titanic ram to spear its foes.

### MOVE

Oars: 4" (6" straight with no turns). May turn on spot. Uses 1/2 move per 90° turn. May reverse up to 2".

Sail: 6" normally, 9" with wind behind.

### WEAPONS

3 cannons firing ahead. 1 cannon broadside. Cannons may repel boarders.

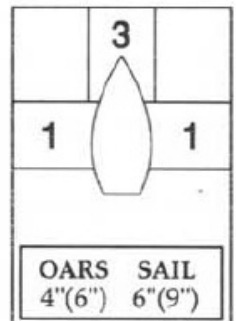

### SPECIAL RULES

May ram. To make a ram, ship must move at least 3" under oars in a straight line towards its foe. If contact is made, foe must make a below the waterline save - if he fails roll a dice:

- |     |  |
|-----|--|
| 1-2 | 1 point of below the waterline damage  |
| 3-4 | 2 points of below the waterline damage |
| 5-6 | 3 points of below the waterline damage |



## EMPIRE GREATSHIP

Crew: 5

Developed in response to the Bretonnian Galleon, the mighty Greatship is a great floating arsenal bristling with guns and packed with heavily armed Empire soldiers.

### MOVE

Sail: 6" normally, 9" with wind behind.

### WEAPONS

2 cannons firing ahead. 3 cannons broadside. 2 cannons firing rearward. Cannons may repel boarders.

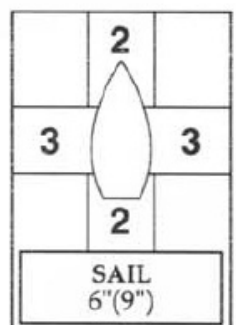

# BRETONNIAN FLEET

The Bretonnians are arguably the best human sailors in the world. With their great sails billowing in the wind their ships are majestic sight on the high seas. Relying on sail for speed and manoeuvrability they try to outgun their enemies with mighty broadsides.

## MEN O' WAR

The Bretonnian fleet has the following Man O' War.

## GALLEONS

The Bretonnian fleets are led by proud Galleons, huge Men O' War rivalling Imperial Greatships in size.

## BRETONNIAN FLEET

A Bretonnian Fleet may consist of:

### Men O' War: 1+

The fleet must have at least one Galleon to be your Admiral's Flagship.

A Bretonnian fleet can't have more Galleons than it has Ship of the Line squadrons. The Admiral's ship does not count towards this total.

Cost: 150 points per Galleon.

### Ship of the Line Squadrons: 2+

At least one squadron of three Corsairs.

Cost: 300 points per squadron.

At least one squadron of three Buccaneers.

For every Galleon you may have 2 Buccaneer squadrons. For every Corsair squadron you may have 2 Buccaneer squadrons.

Cost: 75 points per squadron.

### Wizard: 1

Cost: Variable - See *Wizards and Magic*.

### Admiral: 1

Cost: Free.

### Men O' War Cards: 1+

Cost: 1st card free with the Admiral, subsequent cards at 25 points per card.

Galleons are built in the King's shipyard from carefully selected oak timbers. The laying of each keel is a notable occasion marked by a great religious service as the keel is blessed. When the ships are launched there is much feasting and a holiday is declared. The Bretonnians love their Galleons and are intensely proud of them.

Despite their size Galleons are swift, the skill of their crew enabling them to manoeuvre as well as many smaller vessels.

By tradition each Bretonnian Galleon is crewed by volunteers, carefully selected from the ranks of the Bretonnian Navy; they are an elite crew, proud of their ship and their skill in handling her. Their captains are dashing, flamboyant individuals much given to attempting showy manoeuvres to prove their skill and courage.

Given the enormous firepower of these vessels and their tremendous resilience they can often survive seemingly suicidal tactics such as sailing into the middle of an opposing fleet.

## SHIPS OF THE LINE

The Bretonnian fleet has the following Ships of the Line.

## CORSAIRS

Corsairs are the greatest Bretonnian ship of the line. They are swift heavily armed craft ideal for long sea voyages and deadly combat. In battle their thunderous broadsides strike terror into the hearts of Bretonnia's enemies.

Each ship's crew is taught to respect their captain and believe their ship is the finest craft that has ever sailed. This means there is tremendous rivalry among the crews to prove their valour and skill, and each ship in a squadron will vie to sink the most enemy ships. Almost in contradiction to this rivalry is each squadron's fond belief that it is the finest unit of the Bretonnian Navy and, in spite of any rivalry between crews, they will always aid their fellows in combat.

In battle Corsairs sail in long lines astern, hoping to find a gap in the enemy line and sail into it, firing broadsides on both sides simultaneously.

## BUCCANEERS

Buccaneers patrol the coast of Bretonnia. They are small craft crewed by private individuals who are chartered by the Bretonnian King to keep the sea lanes clear. In times of war these small, catapult-armed ships are used to swell the numbers of the Bretonnian fleet. The crews



of Buccaneers tend to be villainous individuals, lacking the discipline and élan of Corsair crews. Many are condemned criminals, spared the gallows if they will sign on the crew of a Buccaneer. The officers on these ships are amongst the hardest men afloat, maintaining discipline among their men with fear and the lash.

On Buccaneers, weapons are only broken out before battle. Bretonnian Admirals don't think twice before sending Buccaneers to their doom in combat, often using them to block other ships reaching the Galleons.

## SPECIAL RULES

The following rules apply to the Bretonnian fleet.

### MOVEMENT

Because their crews are the finest human sailors in the Old World, and because of their excellent design, Bretonnian sailing ships can move 9" during their Battle Phase whether the wind is astern or coming from the side. Only sailing against the wind makes any difference to them.

	<b>BRETONNIAN GALLEON</b>				<b>CREW 4</b>
<b>MAN O' WAR</b>					
<b>4</b>	<b>FORE MAST</b> Save 5 or 6 First hit has no effect. Second hit destroys mast. Ship speed reduced by 3" (3"). Any further hits do not cause critical damage.	<b>5</b>	<b>MAIN MAST</b> Save 5 or 6 First hit has no effect. Second hit destroys mast. Ship speed reduced by 3" (3"). Any further hits do not cause critical damage.	<b>6</b>	<b>AFT MAST</b> Save 5 or 6 First hit has no effect. Second hit destroys mast. Ship speed reduced by 3" (3"). Any further hits do not cause critical damage.
<b>HIGH</b>					
<b>2</b>	<b>FORECASTLE</b> Save 4, 5 or 6 Broadside cannon battery destroyed.	<b>AFTCASTLE</b> Save 4, 5 or 6 Broadside cannon battery destroyed.	<b>3</b>		
<b>LOW</b>					
<b>4</b>	<b>BOWS</b> Save 4, 5 or 6	<b>5</b>	<b>GUN DECK</b> Save 4, 5 or 6 Each hit destroys 1 broadside cannon battery.	<b>6</b>	<b>STERN</b> Save 4, 5 or 6
NO EFFECT	NO EFFECT	NO EFFECT	SINKS	<b>BELOW WATERLINE</b> Save 4, 5 or 6 First, second and third hits have no effect. Fourth hit sinks ship.	
<b>SAIL: 9" (9")</b>		<b>BATTLE HONOURS: 6</b>		<b>NAME:</b>	

Permission granted to photocopy for personal use only. © Copyright Games Workshop Ltd., 1992

## CATAPULTS

Buccaneers are armed with catapults - large mechanical devices which can lob huge rocks enormous distances. All normal rules for line of sight apply to ships armed with catapults. However, catapults cannot be fired at close range because of their high angle of fire, and shots lobbed from a catapult simply pass over targets within this range band. Ships at close range may still block line of sight to ships further away, even though they themselves cannot be targets because they are far too close.

Catapults are always aimed high - you cannot choose to fire low with them. If the target ship has no high and low areas on its template (for example, a Wargalley) the whole ship may be fired at as normal.

Catapults however do have an advantage: because they throw such enormously large boulders, and because these boulders descend from above, they can smash down through obstructions. The target gets no saving throw modifier because of the long range. However, unlike cannons, catapults don't add to the defender's total during boarding actions because a catapult cannot be loaded with grapeshot.

A target hit by a catapult gets a saving throw in the usual way. If the saving throw fails the location is destroyed and the rock crashes on down to the location directly below. This location also gets a saving throw, adding one to the die roll because of the diminished force of the rock. If it fails the area is destroyed. The rock will continue downward until a location makes its saving throw or until it reaches the below the waterline location. Every location the rock plummets through gets an additional plus one to its saving throw. Eventually the rock may reach the below the waterline location. If it fails its saving throw the ship takes a point of damage below the waterline.

If there is a choice between two areas as the rock falls roll a dice. On a 1, 2 or 3 the rock hits the left hand area; on a 4, 5 or 6 it hits the right hand area. If the rock hits an area which has already been destroyed it passes straight through. That area does not take a critical hit. On the other hand it does not give the target any modification to its saving throw either.

For example, a Buccaneer fires its catapult at the Sigmar, an Imperial Wolfship. The Bretonnian Player rolls a 6 and hits the Wolfship on the mainmast. The range is 8",

<b>BRETONNIAN</b>		<b>CREW</b>	
<b>CORSAIR</b>		<b>3</b>	
<b>SHIP OF THE LINE</b>			
<div style="border: 1px solid black; width: 40px; height: 40px; margin: 0 auto; display: flex; align-items: center; justify-content: center; font-size: 24px; font-weight: bold;">4</div> <p><b>FORE MAST</b> Save 5 or 6 Mast lost. Ship speed reduced by 3" Any further hits do not cause critical damage.</p>	<div style="border: 1px solid black; width: 40px; height: 40px; margin: 0 auto; display: flex; align-items: center; justify-content: center; font-size: 24px; font-weight: bold;">5,6</div> <p><b>AFT MAST</b> Save 5 or 6 1st hit reduces speed by 3". 2nd hit reduces speed by a further 3". Any further hits do not cause critical damage.</p>	<b>HIGH</b>	
<div style="border: 1px solid black; width: 40px; height: 40px; margin: 0 auto; display: flex; align-items: center; justify-content: center; font-size: 24px; font-weight: bold;">2</div> <p><b>FORECASTLE</b> Save 5 or 6 1 broadside cannon battery lost.</p>	<div style="border: 1px solid black; width: 40px; height: 40px; margin: 0 auto; display: flex; align-items: center; justify-content: center; font-size: 24px; font-weight: bold;">3</div> <p><b>MAIN DECK</b> Save 5 or 6 1 broadside cannon battery lost.</p>	<b>LOW</b>	
<div style="border: 1px solid black; width: 40px; height: 40px; margin: 0 auto; display: flex; align-items: center; justify-content: center; font-size: 24px; font-weight: bold;">4</div> <p><b>BOWS</b> Save 4, 5 or 6</p>	<div style="border: 1px solid black; width: 40px; height: 40px; margin: 0 auto; display: flex; align-items: center; justify-content: center; font-size: 24px; font-weight: bold;">5</div> <p><b>GUN DECK</b> Save 4, 5 or 6 1 broadside cannon battery lost.</p>	<div style="border: 1px solid black; width: 40px; height: 40px; margin: 0 auto; display: flex; align-items: center; justify-content: center; font-size: 24px; font-weight: bold;">6</div> <p><b>STERN</b> Save 4, 5 or 6</p>	
<div style="border: 1px solid black; width: 40px; height: 40px; margin: 0 auto; display: flex; align-items: center; justify-content: center; font-size: 12px; font-weight: bold;">NO EFFECT</div>	<div style="border: 1px solid black; width: 40px; height: 40px; margin: 0 auto; display: flex; align-items: center; justify-content: center; font-size: 12px; font-weight: bold;">NO EFFECT</div>	<div style="border: 1px solid black; width: 40px; height: 40px; margin: 0 auto; display: flex; align-items: center; justify-content: center; font-size: 12px; font-weight: bold;">SINKS</div>	<p><b>BELOW WATERLINE</b> Save 4, 5 or 6 First and second hits have no effect. Third hit sinks ship.</p>
<b>SAIL: 9"(9")</b>		<b>BATTLE HONOURS: 4</b>	

Permission granted to photocopy for personal use only. © Copyright Games Workshop Ltd., 1992

but there is no modification for long range, so the Sigmar's owner must roll a 5 or 6. He fails and the rock falls through. Below location 6 high are locations 2 and 3. The Bretonnian rolls a 2 and location 3 is hit since it is on the left. It usually takes a 4, 5 or a 6 to damage the forecannon but because the stone has already fallen one deck the Imperial Player adds one to his saving throw. Unfortunately he rolls a 1 which always fails. The rock inflicts one point of damage and falls on through.

It could now go to location 4 or location 6. The Bretonnian rolls a 5 so the rock falls to the right and hits location 6. Unfortunately for the Sigmar location 6 was destroyed earlier so the rock passes on through doing no additional damage. It lands in the below the waterline area. It has fallen down three levels now but since the last one was destroyed it does not modify the saving throw, so the Imperial Player only adds two to his die roll. Fortunately for him the Sigmar has a below the waterline save of 4, 5 or 6, so any throw other than 1 will save.

Permission granted to photocopy for personal use only. © Copyright Games Workshop Ltd, 1992

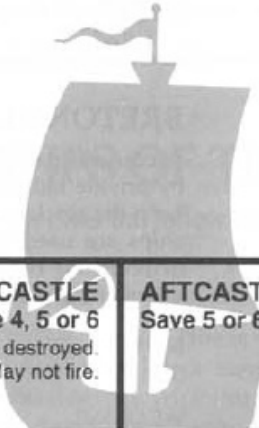
	<b>BRETONNIAN BUCCANEER</b>		<b>CREW 2</b>
<b>SHIP OF THE LINE</b>			
<b>4</b>			<b>MAST</b> Save 5 or 6 Mast lost. Cannot move. Any further hits do not cause critical damage.
<b>5</b>	<b>FORE CASTLE</b> Save 4, 5 or 6 Catapult destroyed. May not fire.	<b>AFTCASTLE</b> Save 5 or 6	<b>6</b>
<b>SINKS</b>	<b>BELOW WATERLINE</b> Save 5 or 6 First hit sinks ship.		
<b>SAIL: 9"(9")</b>		<b>BATTLE HONOURS: 1</b>	

*The storm faded just after dawn. The wind diminished to a strong breeze, carrying the scent of land. The ship rolled in a gentle swell. Gulls soared overhead, white specks on the grey backdrop of the sky. Gerard, Comte de Maldemer, stood on the sterncastle of The Pride of L'Anguille and welcomed their cries. For three long days mountainous waves had tossed the ship. Howling winds had threatened to topple the masts. Now the worst was over.*

*"We're in the Sea Of Claws, near the entrance to the Marienburg Sound," he said to Francois. "Don't worry, lad. Your father and I sailed these waters when we were whelps scarce older than you. A few more days will see us home."*

*Just as well, Gerard thought, rubbing one white-stubbed cheek. His fleet, which had sailed so proudly from Villeneuve only a month before, looked more like squalid Orc Hulks than sleek Bretonnian Corsairs. The exquisite banners that once fluttered from the masts had been torn away by the storm's giant claws. Spars had broken and lines snapped as the monstrous seas roared over them. Now nine ships remained, straggled out into the distance and holding no pattern or formation.*

*"Tis not the delay that worries me, uncle. What if that Elf trader we hailed off Albion Point was correct? What if his majesty has indeed declared war on the Empire? Are we not close to their fleet's main port?"*

*"Whoever believed an Elf sea-tinker," said Gerard, with just the right amount of contempt for the merchant class. "You fret too much, my boy."*

*Behind his bluff facade Gerard was worried. The problem with spending the winter on his estates in the Southland was that anything could happen back home and it might take weeks, or even months, for word to reach him. While he had been consolidating his power in the colonies, war could indeed have erupted between Bretonnia and the Empire. The Gods only knew, there had been enough border disputes recently. The old man felt suddenly afraid; by all rights he should have been home by now, enjoying a quiet country life, not half dead from lack of sleep and constant wave-buffeting. In a better time he might have ordered the fleet to put in at Marienburg for rest and refitting. Now, with a hold half full of ivory and lion skins, he could not consider it. If war it was then their cargo was too precious.*

*"Ships ahoy!" cried the lookout from the crow's nest. The elite warriors of Gerard's bodyguard thundered onto the deck, strapping on swordbelts and lifting shields from their racks. Gerard took his telescope and adjusted the eyepiece.*

*Imperial ships leapt into view. He counted nine of them. Swift Wolfships, their prows bristling with cannon, oars slipping smoothly across the water like the legs of huge surface-skimming insects. On their masts fluttered the rampant griffon pennant of Heinz Schillman. Even as Gerard watched a signal was hoisted aloft.*

*"He wants us to surrender!", said Gerard, "I'll see that upstart in hell before I hand the Pride of L'Anguille over to him. Unfurl the sails! Ready the cannons! Signal the rest of the fleet to do the same!"*

*The bell sounded. Weary sailors took up their battle positions. Marines formed up in squads on the deck.*

*"It's war then?" said Francois.*

*"It is now," Gerard replied.*

# BRETONNIAN FLEET

The Bretonnians are arguably the best human sailors in the world. With their great sails billowing in the wind their ships are majestic sight on the high seas. Relying on sail for speed and manoeuvrability they try to outgun their enemies with mighty broadsides.



## BRETONNIAN BUCCANEER

Crew: 2

Buccaneers patrol the coast of Bretonnia. They are small craft crewed by private individuals who are chartered by the Bretonnian King to keep the sea lanes clear. In times of war these small, catapult-armed ships are used to swell the numbers of the Bretonnian fleet. The officers on these ships are amongst the hardest men afloat, maintaining discipline among their men with fear and the lash.

**MOVE**  
Sail: 9"

**WEAPONS**  
1 catapult firing ahead.

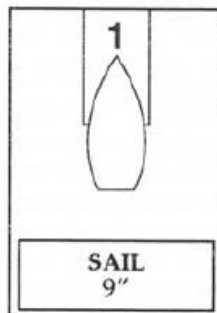

### SPECIAL RULES

Catapult may not fire at close range. Does not add to defender's total when being boarded. May not be aimed low. Target does not get save modifier for long range. If target fails his saving throw, the location directly below must also make a save, with a +1 save modifier, as the rock falls through; the rock will continue until a saving throw is made or it passes through ship. Any location already destroyed does not count, and does not sustain a critical hit.



## BRETONNIAN CORSAIR

Crew: 3

Corsairs are the greatest Bretonnian ship of the line. They are swift heavily armed craft ideal for long sea voyages and deadly combat. In battle their thunderous broadsides strike terror into the hearts of Bretonnia's enemies. In battle Corsairs sail in long lines astern, hoping to find a gap in the enemy line and sail into it, firing broadsides on both sides simultaneously.

**MOVE**  
Sail: 9"

**WEAPONS**  
3 cannons broadside. Cannons may repel boarders.

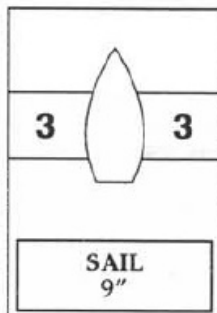

## BRETONNIAN GALLEON

Crew: 4

The Bretonnian fleets are led by proud Galleons, huge Men O' War that race across the sea propelled by acres of sail. Despite their size Galleons are swift, the skill of their crew enabling them to manoeuvre as well as many smaller vessels. By tradition each Bretonnian Galleon is crewed by volunteers, carefully selected from the ranks of the Bretonnian Navy. Their captains are flamboyant individuals much given to attempting showy manoeuvres to prove their skill and courage. Given the enormous firepower of these vessels and their tremendous resilience they can often survive seemingly suicidal tactics such as sailing into the middle of an opposing fleet.

**MOVE**  
Sail: 9"

**WEAPONS**  
4 cannons broadside. Cannons may repel boarders.

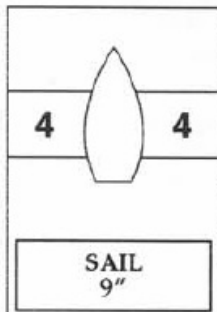

# DWARF FLEET

Dwarfs are masters of steam technology and metalworking and their fleets reflect this. Their ships are massive armoured craft covered in baroque and intricate wrought ironwork. Crewed by highly trained sailors and very skilled engineers, each Dwarf ship carries many spare parts for carrying out field repairs, making them virtually unsinkable.

Sea Dwarfs are not common in the Old World, but their technological prowess more than makes up for their lack of numbers.

Before he is allowed to command a ship, a Dwarf captain must prove himself skilled in engineering as well as battle. He is expected to know all the guild secrets concerning all types of Dwarf ships and to memorise the Book of Armaments and the Book of Charts in their entirety.

These great ironbound tomes are written in secret glyphs and circulated among all members of the Sea Engineers guild. The Book of Armaments deals with the weapons and engines of each and every Dwarf ship ever built. The Book of Charts contains all the maps and sealore the Dwarfs have accumulated down the centuries.

Only once he has proved himself a master of the Books will the Dwarf captain be taught the rune-codes that open the hatches of Dwarf ships.

## MEN O' WAR

The Dwarf fleet has the following Men O' War.

## IRONCLADS

The pride of the Dwarf fleet are the Ironclads, great smoke-belching paddle steamers covered in thick metal armour plates.

Each Ironclad has numerous turrets containing enormous guns which can swivel to come to bear on approaching targets. Each Ironclad is manned by Dwarfs from the same clan. Down the long years they repair and improve the ships, adding their own special modifications, tinkering with the controls and adding their own chapter to the Book of Armaments concerning their craft, its weapons and history. Each crew member is filled with pride in his ship and is convinced that it is the greatest fighting vessel afloat.

The design of Ironclads echoes that of the Monitor. The success of these small ships in battle has led the more experimentally inclined Dwarfs of the Engineers Guild to improve and update their designs.

The Ironclad is the result of many years of endless toil, the aim being the creation of a vessel that betters the ocean-going warships of other races. The Dwarf Admirals feel that as probably the toughest ship afloat, the Ironclad fulfills this criteria comfortably.

## SHIPS OF THE LINE

The Dwarf fleet has the following Ships of the Line.

### MONITORS

The core of the Dwarf fleets are the squadrons of Monitors. Armed with a single turret capable of traversing 360 degrees, Monitors are the oldest form of Dwarf ship, dating back many centuries. They were designed to operate in groups harassing an enemy from afar then closing to ram. Humans claim this was inspired by the Wargalleys of the Empire, but the truth is in fact just the opposite.

## DWARF FLEET

A Dwarf Fleet may consist of the following:

### Men O' War: 1+

The fleet must have at least one Ironclad to be your Admiral's Flagship.

Cost: 150 points per Ironclad.

### Ship of the Line Squadrons: 1+

At least one squadron of three Monitors. You may have a maximum of two squadrons of Monitors for every Ironclad in your fleet.

Cost: 150 points per squadron.

### Independents: 1+

At least one Nautilus. You cannot have more Nautilus submarines than you have Ironclads.

Cost: 75 points per Nautilus.

### Admiral: 1

Cost: Free.

### Men O' War Cards: 1+

Cost: 1st card free with the Admiral, subsequent cards at 25 points per card.

Although used to achieve decisive victories over many years, the Engineers Guild still regard most things nautical as untried technologies, not really the sort of things a sensible engineer should get involved in. As a consequence their crews are often somewhat reckless, desiring an opportunity to prove the worth of their craft and add to its tally in the Book of Armaments. Monitor crews in particular are known for their headstrong habit of closing swiftly with the foe in order to ram.

## INDEPENDENTS

The Dwarf fleet has the following Independents.

### NAUTILUS

The great secret weapon in the Dwarf arsenal is the experimental Nautilus: a prototype submarine armed with deadly torpedoes. It is capable of sailing underwater for short distances, much to the consternation of the Dwarfs' enemies.

Dwarfs are known for their dislike of water, and are wary of sailing on normal surface ships so it is widely accepted that to join a Nautilus crew you must be mad. Suicidal young Sea Dwarfs, touched by tragedy, often volunteer for Nautilus duty as an alternative to a career as a Trollslayer. Casualties among Nautilus crews are high but there is no shortage of volunteers.

## DWARF SPECIAL RULES

The following special rules apply to the Dwarf fleet.

### DWARFS AND MAGIC

As a race Dwarfs are almost completely unmagical and cannot cast spells. This means that a Dwarf fleet can never purchase magicians, and therefore has no facility to cast any spells when in battle.

Dwarfs are also amazingly resistant to magic. Because of this, if an enemy casts a spell, the Dwarf player may roll a dice, and on the result of a 6 the spell has no effect.

### STEAMSHIPS

Dwarf ships are steam powered, and use great wave-churning paddlewheels to drive them through the sea. Since it relies exclusively on its paddlewheels for propulsion a Dwarf ship which has its paddles or boiler destroyed may not move.

Steamships move 6" per phase. If they turn on the spot a 90 degree turn uses up half their move, and a 180 degree turn uses up their whole move. They can move backwards up to 3" instead of their normal move. They can use the normal turn template if they want.

Most Dwarf steamships may ram by moving at least 3" in a straight line into an enemy ship.

DWARF IRONCLAD				CREW 3	
MAN O' WAR					
<div style="border: 1px solid black; width: 40px; height: 40px; margin: 0 auto; display: flex; align-items: center; justify-content: center; font-size: 2em; font-weight: bold;">3</div> <p><b>FORE TURRET</b> Save 3, 4, 5 or 6 <small>Fore turret guns lost.</small></p>	<div style="border: 1px solid black; width: 40px; height: 40px; margin: 0 auto; display: flex; align-items: center; justify-content: center; font-size: 2em; font-weight: bold;">4</div> <p><b>BRIDGE</b> Save 4, 5 or 6</p>	<div style="border: 1px solid black; width: 40px; height: 40px; margin: 0 auto; display: flex; align-items: center; justify-content: center; font-size: 2em; font-weight: bold;">5</div> <p><b>FUNNEL</b> Save 5 or 6</p>	<div style="border: 1px solid black; width: 40px; height: 40px; margin: 0 auto; display: flex; align-items: center; justify-content: center; font-size: 2em; font-weight: bold;">6</div> <p><b>AFT TURRET</b> Save 3, 4, 5 or 6 <small>Aft turret guns lost.</small></p>	HIGH	
<div style="border: 1px solid black; width: 40px; height: 40px; margin: 0 auto; display: flex; align-items: center; justify-content: center; font-size: 2em; font-weight: bold;">2</div> <p><b>BOWS</b> Save 3, 4, 5 or 6 <small>Ram lost. May not ram</small></p>	<div style="border: 1px solid black; width: 40px; height: 40px; margin: 0 auto; display: flex; align-items: center; justify-content: center; font-size: 2em; font-weight: bold;">3</div> <p><b>GUN DECK</b> Save 3, 4, 5 or 6 <small>Broadside battery lost.</small></p>	<div style="border: 1px solid black; width: 40px; height: 40px; margin: 0 auto; display: flex; align-items: center; justify-content: center; font-size: 2em; font-weight: bold;">4</div> <p><b>PADDLE</b> Save 4, 5 or 6 <small>Immobilised.</small></p>	<div style="border: 1px solid black; width: 40px; height: 40px; margin: 0 auto; display: flex; align-items: center; justify-content: center; font-size: 2em; font-weight: bold;">5</div> <p><b>BOILER</b> Save 3, 4, 5 or 6 <small>Immobilised.</small></p>	<div style="border: 1px solid black; width: 40px; height: 40px; margin: 0 auto; display: flex; align-items: center; justify-content: center; font-size: 2em; font-weight: bold;">6</div> <p><b>STERN</b> Save 4, 5 or 6</p>	LOW
NO EFFECT	NO EFFECT	SINKS	<b>BELOW WATERLINE</b> Save 3, 4, 5 or 6 <small>First and second hits have no effect. Third hit sinks ship.</small>		
<b>STEAM: 6"(6")</b>			<b>BATTLE HONOURS: 6</b>		

Permission granted to photocopy for personal use only. © Copyright Games Workshop Ltd., 1992

### RAMMING

Both the Monitor and the Ironclad may ram. See the Fleet List for the damage inflicted by each type of ship when it does so.

### ENGINEERS

Dwarf Engineers are masters of their art, and are particularly adept at repairing engines and paddles. These surly, dour, pessimistic but extremely skilled and competent individuals can do wonders with engines or paddlewheels given half an opportunity, some tools, a bit of oil and three pieces of string.

Engineers can be found on the most unlikely places in ships constantly tapping things with their hammers, making checks and last second adjustments. In battle they perform heroic feats, often crawling out over the surface of the ship in the teeth of enemy fire to repair the ships they love.

Each ship has its own team of Engineers who will heroically maintain and repair it so long as the ship remains afloat and crewed. During the End Phase of each turn, after you've checked for fires spreading, the Dwarf player rolls a dice for a destroyed area of his choice on each of his ships. On a roll of 5 or 6 field repairs have been effected and the damage marker is removed. Obviously Engineers cannot repair areas that are on fire although they can repair such areas after the fire has gone out. Engineers cannot repair below the waterline damage in battle.

### ARMOUR

All Dwarf steamships are heavily armoured. This means they cannot be boarded unless they have taken damage since the enemy must knock a hole in them somewhere in order to board. Dwarf crews are capable of boarding Dwarf ships even if they have taken no damage because all Dwarf captains know the secret combinations for opening the hatches.

### TURRETS

Some Dwarf ships have turrets: great hydraulic weapon mounts filled with batteries of cannons that can be rotated to fire in almost any direction.

<div style="display: flex; justify-content: space-between; align-items: center;"> <div style="border: 1px solid black; width: 40px; height: 40px; margin: 0 auto;"></div> <div style="text-align: center;"> <h2 style="margin: 0;">DWARF MONITOR</h2> <p style="margin: 0;">SHIP OF THE LINE</p> </div> <div style="border: 1px solid black; padding: 5px; margin: 0 auto;"> <p style="margin: 0;">CREW</p> <h1 style="margin: 0;">2</h1> </div> </div>		
<div style="border: 1px solid black; width: 60px; height: 60px; margin: 0 auto; display: flex; align-items: center; justify-content: center; font-size: 2em;">3</div>	<div style="border: 1px solid black; width: 60px; height: 60px; margin: 0 auto; display: flex; align-items: center; justify-content: center; font-size: 2em;">4</div> <p style="margin-top: 5px;"><b>TURRET</b> Save 4, 5 or 6 Gun lost.</p>	<div style="border: 1px solid black; width: 60px; height: 60px; margin: 0 auto; display: flex; align-items: center; justify-content: center; font-size: 2em;">6</div>
<p style="margin: 0;"><b>BOWS</b> Save 4, 5 or 6 Ram lost. May not ram.</p>	<div style="border: 1px solid black; width: 60px; height: 60px; margin: 0 auto; display: flex; align-items: center; justify-content: center; font-size: 2em;">5</div> <p style="margin-top: 5px;"><b>HULL</b> Save 4, 5 or 6</p>	<p style="margin: 0;"><b>PADDLE WHEEL</b> Save 5 or 6 Immobilised.</p>
<div style="display: flex; justify-content: space-between; align-items: center;"> <div style="border: 1px solid black; padding: 5px; width: 100px;">SINKS</div> <div style="text-align: right;"> <p style="margin: 0;"><b>BELOW WATERLINE</b> Save 4, 5 or 6 First hit sinks ship.</p> </div> </div>		
<p style="margin: 0;"><b>STEAM: 6"(6")</b></p>		<p style="margin: 0;"><b>BATTLE HONOURS: 3</b></p>

<div style="display: flex; justify-content: space-between; align-items: center;"> <div style="border: 1px solid black; width: 40px; height: 40px; margin: 0 auto;"></div> <div style="text-align: center;"> <h2 style="margin: 0;">DWARF NAUTILUS</h2> <p style="margin: 0;">INDEPENDENT</p> </div> <div style="border: 1px solid black; padding: 5px; margin: 0 auto;"> <p style="margin: 0;">CREW</p> <h1 style="margin: 0;">1</h1> </div> </div>		
<div style="border: 1px solid black; width: 60px; height: 60px; margin: 0 auto; display: flex; align-items: center; justify-content: center; font-size: 2em;">3</div>	<div style="border: 1px solid black; width: 60px; height: 60px; margin: 0 auto; display: flex; align-items: center; justify-content: center; font-size: 2em;">4</div> <p style="margin-top: 5px;"><b>CONNING TOWER</b> Save 5 or 6 Turret gun lost.</p>	<div style="border: 1px solid black; width: 60px; height: 60px; margin: 0 auto; display: flex; align-items: center; justify-content: center; font-size: 2em;">6</div>
<p style="margin: 0;"><b>BOWS</b> Save 5 or 6 Torpedo tubes lost.</p>	<div style="border: 1px solid black; width: 60px; height: 60px; margin: 0 auto; display: flex; align-items: center; justify-content: center; font-size: 2em;">5</div> <p style="margin-top: 5px;"><b>HULL</b> Save 5 or 6</p>	<p style="margin: 0;"><b>ENGINES</b> Save 5 or 6 Immobilised.</p>
<div style="display: flex; justify-content: space-between; align-items: center;"> <div style="border: 1px solid black; padding: 5px; width: 100px;">SINKS</div> <div style="text-align: right;"> <p style="margin: 0;"><b>BELOW WATERLINE</b> Save 6 First hit sinks ship.</p> </div> </div>		
<p style="margin: 0;"><b>STEAM: 6"(6")</b></p>		<p style="margin: 0;"><b>BATTLE HONOURS: 3</b></p>

The Dwarf player is thus not limited to firing straight ahead or directly left or right. He can place the firing template to point in almost any direction.

Some turrets have line of sight blocked by their ship's own superstructure and may only fire in a 180 degree arc forward or backward.

Others can fire almost through 360 degrees. How far a turret can traverse and in what direction is shown on the ship template.

**FOR EXAMPLE**

The ship below has the following armament: 1 fore turret and a single broadside to left and right. The turret traverses 180°. This means it could either:

1. Fire a 1 dice turret attack anywhere within its forward arc of fire, a 1 dice broadside right, and a 1 dice broadside left. Or:
2. Rotate the turret to the right and fire a combined 2 dice broadside attack to the right (1 dice for the turret and 1 dice for the broadside), plus a 1 dice broadside left. Or:
3. Rotate the turret to the left and fire a combined 2 dice broadside attack to the left (1 dice for the turret and 1 dice for the broadside), plus a 1 dice broadside right.

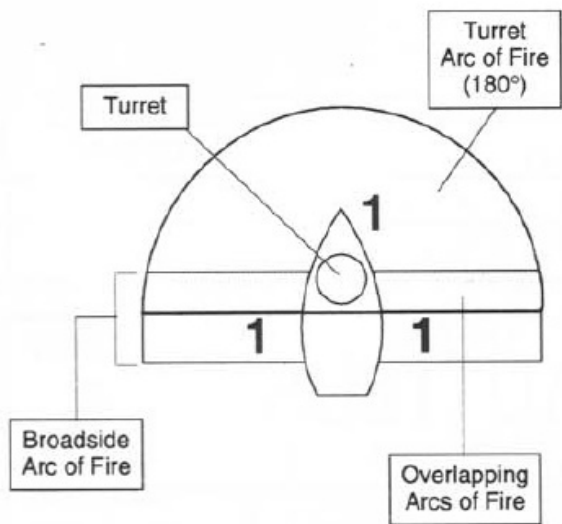

**NAUTILUS SUBMARINES**

The Nautilus is another masterpiece of Dwarf engineering. On the surface it behaves like any other steam powered vessel, but its real strength lies in its ability to spend limited periods under the surface of the sea before its crew and boilers once more require air.

At the start of its Battle Phase the player can order a Nautilus to dive. For the rest of its turn it is submerged and cannot be detected. A submerged Nautilus cannot be fired upon or boarded. It does not interfere with line of sight, and can pass under surface ships. It cannot end its turn below another ship. Once a Nautilus has dived the player places a 'submerged' marker next to it.

At the start of the submarine's next Battle Phase the Nautilus must surface immediately and spend its entire turn on the surface in order to replenish its air supplies.

It is dangerous for a damaged submarine to dive. Despite the best efforts of its crew to plug any leaks it may well sink. If a damaged submarine decides to dive roll a dice for every destroyed location on its template. If any of these dice rolls is a 1 the Nautilus will sink.

**TORPEDOES**

The Nautilus is armed with the dreaded Dwarf clockwork torpedo: a spring-driven tube of copper with an explosive warhead capable of crippling any foes it hits. This is a lethal device and only slightly unreliable.

A Nautilus may only fire torpedoes when submerged. They are fired when the Nautilus has finished its movement. Only one torpedo can be fired by a submarine during each Battle Phase. To fire a torpedo place the torpedo template at the submarine's prow and roll a dice. The template shows the direction the torpedo will go in. It may go straight ahead or deviate left or right; the number rolled on the dice indicates which direction the torpedo travels.

Now roll two dice and add the scores together to give you the distance the torpedo will travel in a straight line along the direction indicated on the torpedo template. The torpedo will hit the first ship it encounters along this line. If there is no victim within range, the torpedo runs out of power and sinks. If it does strike something the victim must make a below the waterline save. If he fails roll a dice and consult the table below.

Roll	Damage Taken by Target
1-2	1 point of below the waterline damage
3-4	2 points of below the waterline damage
5-6	3 points of below the waterline damage

*Returning his one good eye to the lens of the periscope, Grungni Firebeard turned the crank handle that raised the Nautilus' copper vision tube above the waves. Scarcely three ships lengths away sat the Bretonnian merchant convoy. As far as he could make out, it was protected by a lone Galleon. Far too tempting a target to ignore.*

*"Fire torpedoes one and two, range 200, bearing 30-30," he grunted into the voice tube.*

*The Bretonnians didn't even notice the twin trails leading towards the proud Galleon until it was far too late - the huge ship was suddenly wracked by great explosions from stem to stern.*

*"Okay lads, it's a good one," Firebeard shouted. "Take her up."*

*The Nautilus emerged into the sunlight on the port side of the crippled Galleon. Opening the conning tower and stepping out, Firebeard noted with satisfaction that the Galleon was blazing fiercely, already settling in the rolling swell.*

*Then Firebeard spotted something that chilled his blood. From behind the clustered merchant ships, where they had been hidden, came three Bretonnian Corsairs, flying their battle flags and obviously intent on revenge.*

*Sticking his head down the hatch to the stinking interior of the Nautilus, Firebeard took note of the clouds of oily smoke still rising from the vent holes.*

*"Er... how long before we can dive again Mr Mate?"*



# DWARF FLEET

Dwarfs are masters of steam technology and metalworking and their fleets reflect this. Their ships are massive armoured craft covered in baroque and intricate wrought ironwork. Crewed by highly trained sailors and very skilled engineers, each Dwarf ship is virtually unsinkable.

## DWARF NAUTILUS

Crew: 1

The great secret weapon in the Dwarf arsenal is the experimental Nautilus: a prototype submarine armed with deadly torpedoes. It is capable of sailing underwater for short distances, much to the consternation of the Dwarfs' enemies.

### MOVE

Steam: 6". May turn on spot. Uses  $\frac{1}{2}$  move per 90° turn. May reverse up to 3".

### WEAPONS

Torpedoes firing ahead (when submerged). 1 cannon turret firing 360°. Cannon may repel boarders.

### SPECIAL RULES

Engineer on board may repair 1 location by rolling 5 or 6 the End Phase. May submerge. When submerged may not be attacked or have spells cast at it. Must surface at start of next Battle Phase. May fire torpedoes when submerged: use torpedo template, roll 2 dice for range. If target is hit, foe must make a below the waterline save - if he fails roll a dice:

1-2	1 point of below the waterline damage
3-4	2 points of below the waterline damage
5	3 points of below the waterline damage
6	Roll a dice. Target takes that many points of below the waterline damage

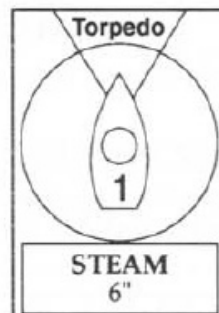

## DWARF IRONCLAD

Crew: 2

The pride of the Dwarf fleet are the Ironclads, great smoke-belching paddle steamers covered in metal plates. Each Ironclad has turrets that can swivel to come to bear on approaching targets.

### MOVE

Steam: 6". May turn on spot. Uses  $\frac{1}{2}$  move per 90° turn. May reverse up to 3".

### WEAPONS

2 cannon turrets, front and back, firing 180°. 1 cannon broadside. Cannons may repel boarders.

### SPECIAL RULES

May ram. To make a ram, ship must move at least 3" in a straight line towards its foe. If contact is made, foe must make a below the waterline save - if he fails roll a dice:

1-2	1 point of below the waterline damage
3-4	2 points of below the waterline damage
5-6	3 points of below the waterline damage

Turrets may rotate to fire cannon within 180°. Engineer on board may repair 1 location by rolling 5 or 6 in the End Phase.

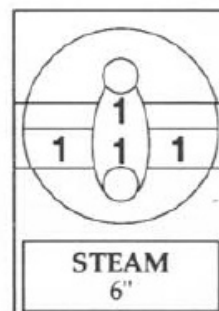

## DWARF MONITOR

Crew: 2

Monitors are smaller steamships with a single turret capable of traversing nearly 360°. They were designed to operate in groups harassing an enemy from afar then closing to ram.

### MOVE

Steam: 6". May turn on spot. Uses  $\frac{1}{2}$  move per 90° turn. May reverse up to 3".

### WEAPONS

1 cannon turret firing 360°. Cannon may repel boarders.

### SPECIAL RULES

May ram. To make a ram, ship must move at least 3" in a straight line towards its foe. If contact is made, foe must make a below the waterline save - if he fails roll a dice:

1-3	1 point of below the waterline damage
4-5	2 points of below the waterline damage
6	3 points of below the waterline damage

Turret may rotate to fire cannons through 360°. Engineer on board may repair 1 location by rolling 5 or 6 in the End Phase.

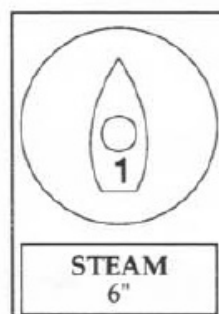

# ELF FLEET

The Elves are the greatest seafarers in the Old World. No other nation can match their deep knowledge of the sea and all its mysteries. No other race can match the speed of Elf warships, the skill of the Elf sailors or the long range of their devastating weapons.

## MEN O' WAR

The Elf fleet has the following Men O' War.

## DRAGONSHIPS

Dragonships are the mightiest of Elf warships – twin-hulled catamarans with sweeping sails.

## ELF FLEET

An Elf Fleet may consist of the following:

### Men O' War: 2+

The fleet must have at least one Dragonship to be your Admiral's Flagship.

You may have one Dragonship for every Eagleship.

Cost: 200 points per Dragonship

At least one Eagleship.

Cost: 150 points per ship.

### Ship of the Line Squadrons: 1+

At least one squadron of three Hawkships.

You may have a maximum of two squadrons of Hawkships for every Man O' War.

Cost: 150 points per squadron.

### Wizard: 1

Cost: Variable – See *Wizards and Magic*.

### Admiral: 1

Cost: Free.

### Men O' War Cards: 1+

Cost: 1st card free with the Admiral, subsequent cards at 25 points per card.

### Wardancers: 1 troupe per ship in fleet

Cost: 25 points per troupe

Dragonships were carved from Starwood grown in Anhara Draconis, where the trees grew twice as thick and half again as tall as normal Starwood. The resin bled into a distinctive shimmering gold which glittered like the scales of dragonships. Sadly Anhara Draconis was destroyed, burned to the ground by the Dark Elves of Naggaroth during the time of the Sundering.

No more ships of this size can be built and the loss of one is a tragedy about which epic sagas are sung.

Dragonships never sail forth on missions of peace. When a Dragonship puts to sea it means the Elves are going to war. They are crewed by majestic, silver-helmeted Elf nobles who vie for their place on board in ritual contests of arms. They tower above even the mighty Eagleships and are armed with a weapon the rumour of which causes the sailors of other races to shudder: the Dragonblade.

The Dragonblades were forged in ancient days before the Sundering. They were made from truesilver, an alloy of adamant and steel, heated in the breath of dragons and moulded by the spells of the mightiest of mages. It is possibly the hardest substance in the world. Each Dragonblade is inlaid with potent runes from the elder days, and such is their power that men can go mad with terror merely by looking upon them.

Dragonblades are set in the twin prows of Dragonships and are capable of slicing other ships in two, shattering them completely. In addition to the Dragonblades, the Dragonship carries two forward-firing Eagle Claw bolt thrower batteries.

## EAGLESHIPS

The cornerstone of the fleets of Ulthuan are the Eagleships: massive, fast and deadly ocean-going craft armed with broadside batteries of deadly Eagle Claws. These huge, sleek, streamlined ships can outrace Bretonnian Corsairs and are even more manoeuvrable.

Like all Elf ships the hulls of Eagleships are carved from the trunk of a single mighty Starwood tree grown specially for this purpose by the Master Shipwrights of Ulthuan. The Shipwrights lovingly tend groves of Starwood for the lifetimes of many men, carefully selecting only the strongest and most flawless of these magical trees for their purposes. Once each tree is uprooted, spells are used to keep the plant alive and the masts are actually branches grown out of the hulls. Sculptors shape the craft as it grows, always working with the wood to maintain its strength and integrity.

The sails are woven from spidersilk and the hair of shriven Elven Priestesses each ensorcelled, each a tapestry of enchanting beauty, a work of art in itself.

Finally, before the ship is launched, the trunks are bled. The sap of the living tree is tapped and allowed to flow out and over the hull. By a process known only to the Master Shipwrights the resin is hardened till it is as strong as steel and watertight. Then the ship is blessed by the High King and allowed to go to sea.

## SHIPS OF THE LINE

The Elf fleet has the following Ships of the Line.

### HAWKSHIPS

Hawkships were created to meet the threat of Norse raiders and were initially meant to patrol the rocky coastlines of Ulthuan against incursions by raiders. They are swift and highly manoeuvrable, intended to be able to perform hit and run attacks against larger ships and then escape to bring warning back to the Elf ports. Their crews are tough and hardy young seafarers who relish the danger of their task and take delight in performing the most alarming and seemingly foolhardy of manoeuvres. Each ship is armed with two forward-batteries of Eagle Claw bolt throwers.

Hawkships are so manoeuvrable that they can turn very tightly indeed. To represent this they use the special Hawkship turn template. Photocopy the template and stick it onto stiff card. Using the template costs 2" of movement. The ship must move the full 2" but does not have to turn through the whole angle. They may also use the normal turn template if you want.

All an Elf ship's attacks must be made at the end of the same move. They can't move and fire then move and board, for instance. You can't move one Elf ship, move a different Elf ship then come back to the first one and say you are taking its second move. All moves must be made in the ship's Battle Phase.

The ability to take two moves makes all sorts of things possible for Elf ships. For example, if an Elf ship turns into the wind on its first move that move automatically ends, but it can then use its second move to make another turn, as all sailing ships that start a move into the wind can. If an Elf ship hits an obstruction or another ship on its first move then it can move off using the normal rules on its second move.

### HAWKSHIP TURN TEMPLATE

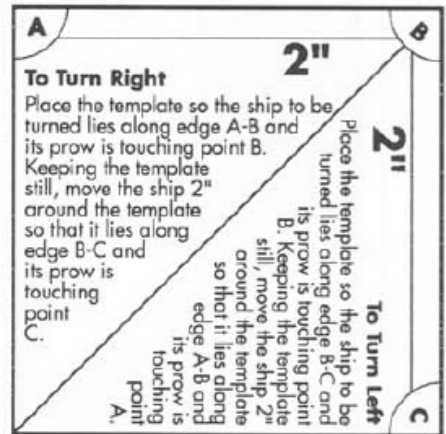

Permission granted to photocopy for personal use only.  
© Copyright Games Workshop Ltd., 1992

## SPECIAL RULES

The following special rules apply to the Elf fleet.

### ELF SEAMANSHIP

Because their crews are such extraordinary seamen Elf ships are able to make two moves in their Battle Phase. Each ship can move, attack, and then move again. Alternatively they can move twice then attack. However, they cannot attack then move twice.

Elf ships can only attack or board once per phase and must do so at the end of a move. They could attack then move once, in which case it is assumed they don't use their first move.

For example, an Eagleship which starts its Battle Phase 18" from the enemy fleet can move 6" towards the foe, bringing it within 12", and fire. (The long range bolt throwers that the ship is armed with can reach the enemy from this distance.) The Eagleship lets fly a volley of 3 Eagle Claws. It may now move a further 6" away, placing itself 18" away from the enemy and therefore out of range.

	<b>ELF HAWKSHIP</b>		<b>CREW 1</b>
<b>SHIP OF THE LINE</b>			
<b>3</b>			<b>MAST</b> Save 6 First hit has no-effect. Second hit destroys mast - cannot move. Further hits do not cause critical damage.
<b>4</b>	<b>5</b>	<b>6</b>	
<b>FORE CASTLE</b> Save 5 or 6 1 fore Eagle Claw lost.	<b>MIDSHIPS</b> Save 4, 5 or 6 1 fore Eagle Claw lost.	<b>AFT CASTLE</b> Save 5 or 6	
<b>SINKS</b>		<b>BELOW WATERLINE</b> Save 4, 5 or 6 First hit sinks ship.	
<b>SAIL: 6"(6") - 2 moves each Battle Phase</b>			<b>BATTLE HONOURS: 2</b>



them hurtling over the water towards their targets before ploughing into the enemy's sides.

Eagle Claw bolt throwers have a range of 12" and use the longer range ruler provided with the game. They have no saving throw modifiers for range. Their target gets his standard saving throw at any distance.

### DRAGONBLADES

Dragonblades are a special form of ram, combining great force with a razor-sharp cutting edge - a deadly weapon with the full weight of a Dragonship behind it.

A ship with a Dragonblade does not need to make a normal ramming move, but can simply move up to an enemy vessel and attempt to shear through its hull with its superhard prow. A Dragonblade inflicts D6 below the waterline hits on any enemy ship that fails its below the waterline saving throw. If the enemy ship takes enough damage to sink it, the Dragonship sails right through it and may continue to move normally. It can keep on moving and make another attack with the Dragonblade if it can move up to another target.

Using the Dragonblade does not count as an attack. It is part of the Dragonship's movement.

If the enemy vessel makes its below the waterline saving throw the Dragonblade has failed to penetrate its hull. When this happens, the Dragonship's move ends.

If the Dragonship has its second move left it can drift out of contact and move on.

If the Dragonship hits a ship with its Dragonblade but does not cause enough damage to sink it, the enemy vessel becomes impaled on the Dragonblade. Since the Dragonship is a sailing ship it cannot back water, and it is locked in place by the enemy ship until that ship is sunk. The Dragonship might be able to do this by using its Eagle Claws or it may send out boarding parties, capture the enemy and scuttle it. Neither it nor the impaled ship can move again until the impaled ship rests on the ocean bed or the Dragonship is destroyed.

A ship with a Dragonblade may move through wreckage at no cost to its movement rate.

### WARDANCERS

Wardancers are Elf warriors skilled in an amazingly acrobatic and athletic style of warfare. Wardancers can be purchased for any Elf ship. An Elf ship that has Wardancers aboard can, if the player wishes, roll its dice throw again during a boarding action. If you decide to do this, you must take the result of the second roll.

Wardancers can be purchased for 25 points per troupe when the fleet is bought. Each troupe must be assigned to a specific ship, and there can be no more than one troupe on any ship. For each troupe you buy, place a Wardancer counter on the ship's template.

Permission granted to photocopy for personal use only. © Copyright Games Workshop Ltd., 1992

		<b>ELF EAGLESHIP</b>				<b>CREW 3</b>		
		<b>MAN O' WAR</b>						
<b>4,5</b>		<b>SAIL</b> Save 5 or 6 Each hit reduces movement by 2". Further hits do not cause criticals.	<b>6</b>	<b>BATTLE TOWERS</b> Save 5 or 6			HIGH	
<b>2</b>		<b>SAIL</b> Save 4, 5 or 6 First hit has no effect. Second hit reduces movement by 2". Further hits do not cause criticals.	<b>3</b>	<b>BRIDGE</b> Save 5 or 6				
<b>4</b>	<b>BOWS</b> Save 4, 5 or 6 1 broadside Eagle Claw lost.	<b>5</b>	<b>MIDSHIPS</b> Save 4, 5 or 6 1 broadside Eagle Claw lost.	<b>6</b>	<b>OUTRIGGER</b> Save 4, 5 or 6 1 broadside Eagle Claw lost.			LOW
NO EFFECT	NO EFFECT	SINKS		<b>BELOW WATERLINE</b> Save 4, 5 or 6 First and second hits have no effect. Third hit sinks ship.				
<b>SAIL: 6"(6") - 2 moves each Battle Phase</b>				<b>BATTLE HONOURS: 6</b>				

# ELF FLEET

The Elves are the greatest seafarers in the Old World. No other nation can match their deep knowledge of the sea and all its mysteries. No other race can match the speed of Elf Hawkships or the skill of the Elf sailors.

## ELF HAWKSHIP

**Crew: 1**

Hawkships are the smallest of Elf warships. They were created to meet the threat of Norse raiders and were initially meant to patrol the rocky coastlines of eastern Ulthuan against incursions by human raiders. They are swift and highly manoeuvrable, intended to be able to perform hit and run attacks against larger ships and then escape to bring warning back to the Elf ports.

### MOVE

Sail: 6". May move twice during each Battle Phase.

### WEAPONS

2 Eagle Claw bolt throwers firing ahead.

### SPECIAL RULES

Uses special 90° turn template. Eagle Claws have a range of 12" and target's saving throw is not modified for range.

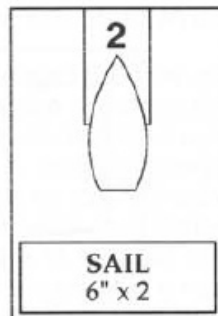

## ELF EAGLESHIP

**Crew: 3**

The cornerstone of the fleets of Ulthuan are the Eagleships: massive, fast and deadly ocean-going craft armed with broadside batteries of deadly Eagle Claw bolt throwers. These huge, sleek, streamlined ships can outrace Bretonnian Corsairs and are even more manoeuvrable.

### MOVE

Sail: 6". May move twice during each Battle Phase.

### WEAPONS

3 Eagle Claw broadsides.

### SPECIAL RULES

Eagle Claws have a range of 12" and target's saving throw is not modified for range.

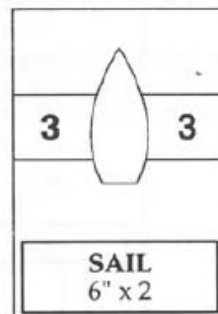

## ELF DRAGONSHIP

**Crew: 5**

Dragonships never sail forth on missions of peace. When a Dragon puts to sea it means the Elves are going to war. They tower above even the mighty Sea Eagles and are armed with weapons the rumour of which causes the sailors of other races to shudder: the Dragonblades.

Dragonblades are set in the prows of Dragonships and are capable of slicing other ships in two, shattering them completely. They transform the great Elf warships into potentially the greatest engine of destruction upon the seas.

In addition to the Dragonblades, the Dragon carries numerous batteries of Eagle Claw bolt throwers.

### MOVE

Sail: 6". May move twice during each Battle Phase.

### WEAPONS

2 Eagle Claws firing ahead. 1 Eagle Claw broadside. 2 Dragonblades mounted on prow.

### SPECIAL RULES

Eagle Claws have a range of 12" and target's saving throw is not modified for range.

May ram. Must move at least 3" towards foe in straight line with no turns. If contact is made, foe must make a below the waterline save - if he fails roll a dice: the target takes that many below the waterline hits. If the target takes enough damage to sink him, the Dragonship sails on through the wreckage. This ram does not count as an attack, but as part of the ship's move.

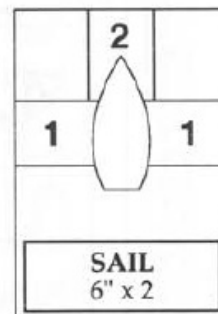

# DARK ELF FLEET

The Dark Elves are the evil kinsfolk of the Elves of Ulthuan, driven away during the Elf civil war in the far distant past. Many fled to Naggaroth but others, mighty mages in the service of Chaos, stayed and fought to the bitter end. They unleashed spells of such awesome destructive energy that they turned the area now known as the Shadowlands into a wasteland.

So great was the destruction that much of the area sank under a gigantic tidal wave, but the Dark Elf Archmages were not daunted. As the mighty flood swept over their land they cast powerful spells on their fortress-palaces, shielding them from the deluge. The castles tore themselves from the bedrock of the land and floated free on the roiling waters, held together by titanic binding enchantments. These spells allowed them not only to float but to be navigated.

The sinking of the Shadowlands also cast up many monsters that had previously dwelled on the sea-bottoms. Sensing their malice and terrible evil, the Archmages summoned these monsters and bound them in their service, keeping them in caverns excavated below their homes along with many other evil things that dwelled only in their now sunken homelands. These creatures were cross-bred until the Archmages had created living engines of destruction.

## DARK ELF FLEET

A Dark Elf Fleet may consist of the following:

### Men O' War: 1

The fleet must have one Black Ark to be your Admiral's Flagship.

A Dark Elf fleet only ever has one Black Ark.

Cost: 250 points.

### Ship of the Line Squadrons: 1+

At least one squadron of three Doomreavers.

Cost: 150 points per squadron.

### Independents: 1+

As many Death Fortresses as the Dark Elf player has squadrons. The Black Ark counts as a squadron for this purpose.

Cost: 100 points each.

### Wizard: 1

Cost: Variable – See *Wizards and Magic*.

### Admiral: 1

Cost: Free.

### Men O' War Cards: 1+

Cost: 1st card free with the Admiral, subsequent cards at 25 points per card.

## MEN O' WAR

The Dark Elf fleet has the following Men O' War.

### BLACK ARKS OF NAGGAROTH

Mightiest of all sea-going vessels are the Black Arks of Naggaroth. These are the ancient homes of the Dark Elf magicians populated by their depraved distant descendants. They are enormous craft: sinister floating fortresses, covered in eldritch carvings which hurt the eye when gazed upon. Down the years they have been sculpted by their owners until they resemble great ships. They are regarded by the Elves as being the furthest outposts of Naggaroth and they range the wide seas performing inscrutable errands in the service of their Daemon God.

In battle the Arks are terrible. As they sail inexorably closer to their foes the waters around them seethe with a horde of monsters which swarm around the enemy ships.

The Arks are surrounded by shifting mist and shimmering spells of illusion. As an enemy ship approaches the crew is bewildered by magic. The men see phantoms emerge from the fog, they hear insane laughter and awful screams which break into unwholesome groans of pleasure. The monstrous presence which is the Black Ark looms above their ship, tower upon tower, spire upon spire of living rock, unnaturally afloat on the surface of the sea.

It takes a very brave crew to proceed further. If they do they are greeted by raking Reaper ballista fire from emplacements within the stone. The Reapers fire six foot long bolts tipped with rune-encrusted black-iron heads that cleave through the air towards them. Should the enemy manage to set foot on the Ark they must proceed through a maze of traps and magic to the very heart of darkness, for the Arks are bigger than they appear. Like icebergs, much of their bulk is below the surface. In the rock below are dark, dismal caverns, lit by eerie green witchlights, wherein dwell monsters.

The wind was howling, piling the waves into cold black walls hundreds of feet high. The storm had sprung up less than an hour ago, sheets of driving rain turning the azure sky grey-black. Since then, the sturdy Dwarf steam ships had been buffeted by rising winds and ever higher waves, throwing even the mighty Ironclads about as though they were toy ships on a millpond. The Monitors wallowed almost uncontrollably in the troughs between the towering waves, paddles churning to get a grip on the raging waters. The ships spread out over several leagues, ostensibly to avoid collisions, but in truth because the captains had little option but to be driven at the whim of the ferocious storm. Every so often a signal lamp flashed, maintaining some form of communication between the scattered elements of the fleet.

In his thirty years at sea, Admiral Dramgrim Thunderbrow had never seen such a storm in these waters, and harboured secret doubts about its origin. Standing on the bridge of his flagship, Anvil of Justice, Thunderbrow could sense the tension amongst his battle-hardened crew. To an outsider, they might appear stolid and unmoved by the wild forces plucking and tearing at the ship, but Thunderbrow had sailed with them for too many years not to recognise the tell-tale signs of fear. He could sense the uncontrolled tick of a muscle in a bearded face and the tense silence as the crew willed the Anvil to pull herself free from the grip of the sea. Thunderbrow knew the signs, and they did not bode well. Already he heard the ship creak when she shouldn't, her hull complaining at the titanic battering she was receiving at the hands of the cruel sea. He didn't know how long she could stand up to such punishment without breaking in two. For the tenth time in as many minutes he silently praised the workmanship of the Dwarfish shipwrights; other nations' ships would have foundered and sunk within minutes of encountering a storm such as this.

Thunderbrow braced himself against a bulkhead as the Ironclad reached the crest of another wave. She hung there for a moment, poised on the brink of an abyss, before she sped down into the trough beside yet another towering mountain of water. It was like a descent into hell, he mused. At the bottom of the trough was a rippling valley of black-green water, and high above them rose the rolling slopes of the next oncoming wave. A violent cross current tried to twist the ship so that it presented its flank to the wave. The helmsmen struggled to keep the bows ahead. Thunderbrow knew that to be caught side on by waves such as these meant destruction, sure and certain. And here, in the black vale between one mountainous wave and the next, they could see no sign of the rest of the Dwarf fleet.

• • •

In the eye of the storm a black shadow sat, a vast monstrous bulk swathed in mists. Towers rose to sharp spires, piercing the sky. From the topmost tower lightning flashed and flickered. Around the base of the monstrosity, barely seen dark things moved with a sinuous grace through the water.

"They come. They come. By all that is unholy, they come," cursed Ushrival Iceblood, dark sorcerer of Slaanesh, Dark Elf champion and Lord of the Black Ark of Naggaroth that sat unmoving as a black shadow isle on the still waters.

The Ark had travelled far over the last months, hidden from spying eyes by mazes, spells and dark clouds which hid the awful truth of its presence from view. On its travels across the ocean it had encountered many small ships, and even a sizeable pirate warfleet; the beasts lurking deep within the Ark's labyrinthine caverns destroyed them all. Rumours of monsters went before the Ark, and stories of strange seas through which none could sail unharmed. The authorities of the established sea faring nations chose to ignore the warnings. And so the Monstrous Ark – nomadic home of the Dark Elves – lay within 100 leagues of the shores of the Old World, undetected and unsuspected by all.

Ushrival had intended to appear with total surprise, crushing the fleets of his enemies and destroying their armies to establish a new kingdom in the Old World. He had planned long and carefully, and his emissaries had been abroad in the Old World for many years. But now a Dwarf warfleet threatened Ushrival's carefully laid plans by prying where they should not. His efforts at maintaining the storm had drained his powers severely, and yet the Dwarfs came on. It seemed that despite his efforts to maintain secrecy, the cursed Dwarfs would ruin his schemes. Unless he could swiftly crush them in a decisive sea battle.

"So be it," Ushrival snarled in barely controlled rage as he pulled on his sword belt and strode from his chamber.

"Release the beasts and ready the Reapers for the dark harvest," he shouted, his thin voice echoing down the dark corridors of the ark.

A thousand voices answered, and the Ark reverberated with their cry. "To war. We go to war!"

• • •

On the bridge of the Anvil Of Vigilance, the storm abated as quickly as it had begun. Thunderbrow barely had time to register just how scattered the powerful ships of his warfleet were, before the strident alarm bell began to sound action stations. Raising his telescope, Thunderbrow swept the horizon, looking for the cause of the alarm. When he found it, he almost dropped his telescope in horror. In clipped tones, he quickly gave the ship's captain new orders.

"Rally the fleet. Battle stations. Make it quick. Tight formation. Box of iron. Monitors to close the box. Nautilus to sweep wide."

Noting the surprise on the captain's face, Thunderbrow's voice raised to his customary gravelly growl as he pointed with his telescope to starboard.

"Must I repeat myself? Look yonder for reasons why – the Dark Elves are upon us, and unless we act fast, we are undoubtedly lost!"



# MONSTERS

Dark Elves scorn the use of ships, relying instead upon powerful sea monsters and magic to destroy their foes. These creatures take the place of other races' Ships of the Line. Some monsters act independently, while others act in squadrons of three, with each monster in the squadron being of the same type.

Dark Elves have the following monsters available to their fleets.

# DEATH FORTRESS

From deep within the Black Arks issue forth the Death Fortresses - huge, spired castles mounted atop the backs of immense Sea Dragons.

Sea Dragons are the largest of the Dark Elves' sea-going monsters. Once, long ago they were true dragons, ridden by the ancestors of the Dark Elves, but down the centuries they have become infused with the evil magics that permeates the Arks. They have mutated, becoming something less than true dragons and yet more.

**CREW**  
**6**

# DARK ELF BLACK ARK OF NAGGAROTH

MAN O' WAR

<b>HIGH</b>		<b>LOW</b>	
<b>4</b>	<b>FORE MAST</b> Save 4, 5 or 6 First hit has no effect. Second hit destroys mast. Ship speed reduced by 3" (3'). Any further hits do not cause critical damage.	<b>5</b>	<b>MAIN MAST</b> Save 4, 5 or 6 First hit has no effect. Second hit destroys mast. Ship speed reduced by 3" (3'). Any further hits do not cause critical damage.
<b>6</b>	<b>AFT MAST</b> Save 4, 5 or 6 First hit has no effect. Second hit destroys mast. Ship speed reduced by 3" (3'). Any further hits do not cause critical damage.	<b>3</b>	<b>BEAST-PORTAL</b> Save 4, 5 or 6 Roll a dice for each Squadron inside. On a 4, 5 or 6 they escape.
<b>2</b>	<b>FORWARD BATTLE TOWERS</b> Save 4, 5 or 6 Fore reaper battery lost.	<b>5</b>	<b>BATTLE PLATFORMS</b> Save 4, 5 or 6 Broadside reaper battery lost.
<b>4</b>	<b>REAR BATTLE TOWERS</b> Save 4, 5 or 6 Aft reaper battery lost.	<b>6</b>	<b>BELOW WATERLINE</b> Save 4, 5 or 6 First, second, third, fourth and fifth hits have no effect. Sixth hit sinks ship.
<b>NO EFFECT</b>	<b>NO EFFECT</b>	<b>NO EFFECT</b>	<b>SINKS</b>

**SAIL: 9"(9")**    **MAGIC: 6"(6")**    **BATTLE HONOURS: 10**    **NAME:**

Permission granted to photocopy for personal use only. © Copyright Games Workshop Ltd, 1992



The Helldrakes are harnessed to the Doomreaver's towers. These are crewed by a small number of specially trained beast-handlers that have raised their Helldrakes from birth, and are the only ones that can control these ferocious beasts. They guide the Helldrakes with magical lances that send explosive bursts of agony ripping through the creatures if they disobey.

Helldrakes are so fierce that they will attack anything that is not of their own pack. All the Doomreavers in a squadron are pulled by Helldrakes raised from the same clutch of eggs, but even they will sometimes attack each other in the fervour of battle.

## DARK ELF SPECIAL RULES

The following special rules apply to the Dark Elf fleet.

### BLACK ARKS

Each Dark Elf fleet may only have one Black Ark. However, if you are playing a very large game of Man O' War and both players agree, the Dark Elf player may have another Black Ark for every full 1000 points spent on the fleet. So, for instance, a 3000 point fleet may have three Black Arks.

These mighty vessels can move 9" under sail, or 6" using the energy of the magical spells that keep them afloat. When they use magical movement they don't have to use the turn template. They can move in any direction they want and can end up facing in any direction they choose. Because the spells binding the Ark weaken as it takes damage the Ark loses 1" of its magical movement for each below the waterline hit it takes. The Dark Elf player must decide whether he is moving using sails or magic at the start of the Ark's Battle Phase. He cannot switch between them while moving.

Lesser ships and monsters can lurk within the Black Ark if they choose. At the start of the game the Dark Elf player can announce which of his forces are within the Ark. While they are protected by the Ark, they cannot be attacked or have spells cast on them. These remain off the table until the Dark Elf player chooses to unleash them. When he does so they emerge into the water anywhere within 6" of the Ark. This takes up all their movement for that Battle Phase.

The monsters in a squadron must be unleashed together. They can attack any foe within range. If the Ark is sunk everything within it is lost. If the Portal hit location on the Black Ark is destroyed then any Death Fortress or Doomreaver squadron within the Ark must roll a 4, 5 or 6 to find a path to the water and erupt from the rubble of the portal. Once the Ark has moved nothing within it may be unleashed in that Battle Phase.

Any wounded monster that returns to the Black Ark during its Battle Phase can re-enter the Portal if that location has not been destroyed. Remove its model from the table. In the End Phase roll a dice. On a score of 1 the monster is too badly wounded to continue and is considered destroyed. On a roll of 6 it is completely healed and may be unleashed again next turn. On any other result it regains 1 wound and may be unleashed again next turn if the player wishes.

Any Dark Elf straggler within 6" of the Black Ark may move and attack as an independent unit. As soon as its squadron's flagship is within 6" it once more becomes part of its squadron. If it has already moved this turn it cannot move again.

If you have more than one Black Ark, the monsters within the fleet may enter and leave them at will.

### The Maze of Spells

Arks are surrounded by a Maze of Spells. This means that any enemy trying to attack must attempt to find the target through the mist and the illusions. Any ship wanting to attack the Black Ark must roll a dice. Do this after the ship has moved and before it attacks. On a roll of 1 or 2 the crew are baffled by the illusions and cannot ram, fire at or board the Black Ark this turn. Because of their natural resistance to spells of illusion Dwarfs can add 1 to this roll. Any ship with a wizard aboard can ignore the Maze of Spells since he can scry the location of the Ark.

If an enemy does succeed in seeing the Ark and decides to board it, roll a dice for each crew counter in the attempt: on a roll of 1 they are killed by the Maze of Traps. Any remaining crew counters may be used to carry out a boarding action as usual.

### Moving the Ark

Because Arks are so massive nothing can slow their inexorable progress across the table. They are immune to spells like Blizzard and Wind Blast which move ships and can brush aside other ships in their path. When moving the Black Ark slide it gently across the table. If it pushes aside any ships that get in its way that's fine. Just leave the ships in their new position; they have been displaced by the swell of waves surrounding the Ark as it moves.

*Coat of Arms  
of the Bretonnian  
Grand Admiralty*



## SPECIAL WEAPONS

Like the Elves, the Dark Elves rely on magically powered projectile weapons rather than gunpowder.

### Reapers

The Reaper is the most powerful of the Dark Elves' enchanted ballista. It has a magazine of mystically powered ballista bolts and can fire a number of projectiles at once. They don't fire grapeshot and cannot be used to repel boarders.

The Reaper uses the normal range template and the same saving throw modifiers for range as cannon. Whenever you fire, roll a D6. On a roll of 1 the Reaper has jammed and cannot fire this turn while the crew unjam it. Otherwise the number on the dice is the number of bolts the Reaper can fire this turn. Roll that number of dice to see which locations you have hit. If you aimed high all the bolts are aimed high. If you aimed low then all the bolts are aimed low.

## MONSTERS

There are many sinister things lurking in the caverns of the Black Arks, monstrous creatures who rose from the depths during the sinking of the Shadow Lands. These monsters have been trained by Dark Elf Beastmasters to fight in their wars.

Apart from special rules for damage, monsters work in the same way as ships of the line; all the rules for squadrons, formations, flagships and movement apply. They also have a template, fire and block line of sight in exactly the same way as ships.

### Crew

Monsters are crewed by Dark Elves trained to guide them. These crews ride in specially constructed vessels that put them in a position to control their beasts. If these vessels are destroyed the monster goes out of control, and plunges down to the depths of the ocean for the rest of the battle. Eventually, they will return to the Ark, drawn back by ancient spells of binding.

Any monster leaving the table in this way counts as destroyed when it comes to awarding Battle Honours. The Death Fortress and Doomreaver can only take one point of damage, so if they are hit and fail their saving throw the monster goes out of control and is lost.

Monsters have no below the waterline location, and take damage in a different way to ships. Instead they can take a certain number of wounds. Once they have lost all their wounds they are dead.

### Wounding Monsters

Monsters can be hit with weapons. When shooting at a monster roll dice to hit as normal. If it is hit and fails its saving throw for that location it loses one wound.

Monsters never take critical hits and are never set on fire. Any spell or weapon that would set a ship alight or

*Heraldic Crest  
of the Imperial  
Sea Lords*



inflict below the waterline damage instead causes the same number of wounds.

Every time a monster takes a wound, place a wound counter on the next empty space on the wound track. Once all the spaces in the wound track are filled the monster is dead.

A rammed monster gets the saving throw shown on its template. If it fails the ramming ship inflicts the same amount of wounds as it would below the waterline hits.

### Boarding Actions

Monsters have no crew as such. The Dark Elves that are on board take refuge in the towering fortifications, let the monster do the fighting for them, and take no part in boarding actions. If they are hit by a weapon or spell that destroys a crew company then the Dark Elves are killed, and the monster goes out of control and is removed.

Boarding actions are instead fought against the monster when it come into contact with ships. If a ship attacks a monster, turn the monster model to face the ship. The ship's crew roll a dice and add the number of crew companies and any modifiers as usual.

Hissing and spitting the monster strikes back. Roll a dice and add the number of wounds it has left; to tell how many wounds the monster has left, count the number of unfilled spaces on the wound track.

If the monster's total is higher then the ship loses one crew company, devoured by the monster. If the ship's total is higher then the monster loses one wound under the crew's relentless attack.

If the result is a draw then the crew loses a company and the monster loses a wound. The monster can decide whether it wants to press on with its attack if it is winning or the result is a draw. If it decides to break off the attack it must retreat 1" away from the ship in any direction and its phase ends.

If the crew wins they can decide whether to press the attack or drive the monster off. If they press on then combat continues as usual. If they drive the monster off the crew's player moves it 1" in any direction. In either case the monster cannot move through or onto another ship or monster.

### Moving Monsters

Monsters can move up to 6" per turn. They do not have to worry about turning templates. They can change facing as often as they like as they move and can end their move facing in any direction they wish. They don't have to worry about running aground as they can simply pull their legs up to avoid the undersea rocks that litter the shoreline. If during a game, a situation arises where a monster would end up running aground, perhaps driven into an island by a spell, the monster simply stops at the edge of the island and suffers no ill effects.

When monsters lose wounds they lose a certain amount of movement as shown on their template. Even the mightiest of monsters is slowed by its wounds.

These basic rules apply to all monsters. Each type also has a number of special rules that apply only to it.

### Death Fortresses

Death Fortresses are towering castles mounted on top of powerful Sea Dragons; they cost 100 points each and each one is treated as a squadron in its own right.

For every wound a Sea Dragon takes it loses 1" of movement.

### Doomreavers

Doomreavers are pulled by Helldrakes, and are bought as a squadron of three vessels for a total of 150 points.

For every wound a Helldrake takes it loses 2" of movement.

Once a Helldrake moves into contact with an enemy ship it can either make a boarding attack or the drivers can goad the Beasts into a frenzy. If they choose to do so then roll a dice and consult the Frenzy Table.

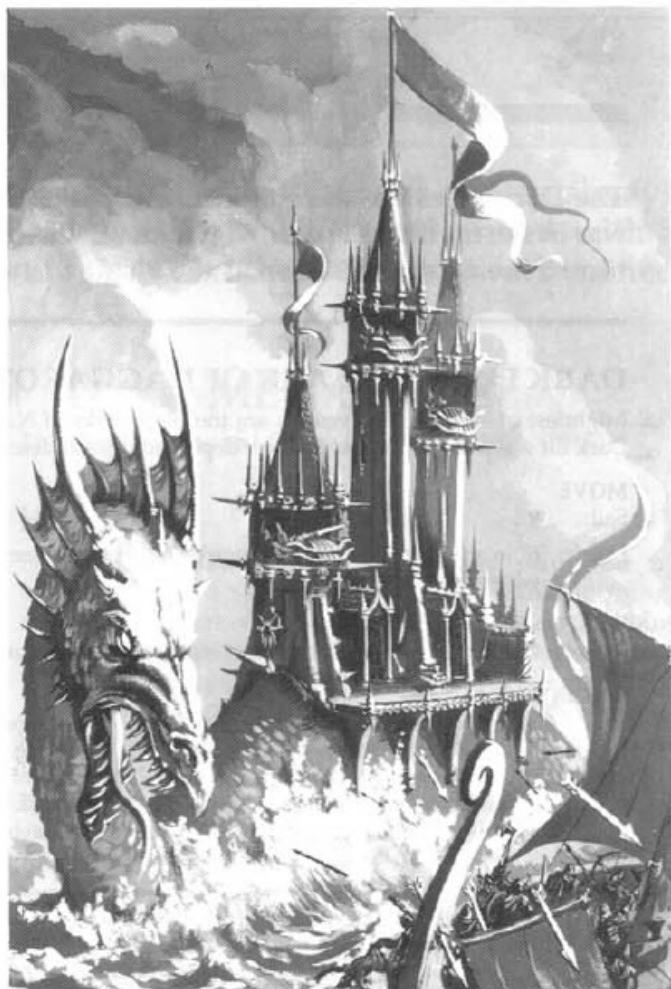

*Dark Elf Death Fortress*

### FRENZY TABLE

- 1 The Helldrake goes completely out of control. The other player can immediately move it 6" and attack anything it is in contact with. This attack must also use this table.
- 2 The Helldrake becomes surly and intractable. It refuses to attack this turn.
- 3 The Helldrake attacks a location of your choice. Pick a location. Your opponent must make a saving throw.
- 4 The Helldrake attacks two different locations of your choice. Your opponent must make two saving throws, one for each location.
- 5 The Helldrake attacks the same location twice. Pick a location. Your opponent must make two saving throws for it. Critical hits are a possibility.
- 6 The Helldrake goes into a berserk feeding frenzy. Roll a dice and add 1: this is the number of attacks it makes. Roll this number of dice to determine locations hit. All these hits will be aimed at low locations. Your opponent must make saving throws for each location hit. These savings throws are at -1.

At the end of the feeding frenzy roll a dice. If the result is a 1 then the Helldrake sinks into digestive torpor and is removed from the game.

Any time a Helldrake hits an area that is on fire it loses 1 wound.

# DARK ELF FLEET

The Dark Elves are the evil kinsfolk of the Elves of Ulthuan, driven away during the Elf civil war in the far distant past. They unleashed spells of such awesome destructive energy that they turned the area now known as the Shadowlands into a wasteland.

## DARK ELF BLACK ARK OF NAGGAROTH

Crew: 6

Mightiest of all sea-going vessels are the Black Arks of Naggaroth. They are the ancient homes of Dark Elf wizards, populated by their depraved distant descendants.

### MOVE

Sail: 9".

Magic: 6" in any direction. May change facing at will. Loses 1" of magical movement per below the waterline hit taken.

### WEAPONS

1 reaper battery firing ahead. 1 reaper battery firing rearward. 1 reaper battery broadside.

### SPECIAL RULES

Roll a dice each time a Reaper battery is fired - the Reaper makes that many shots at once. If the roll is a 1, the Reaper battery is jammed and may not fire again this Battle Phase. The Black Ark may hold monsters within itself; these monsters may not be fired at or have spells cast at them. The Maze of Spells surrounding the ship means an opponent must roll a dice before attacking the ship - on a roll of 1 or 2 the attack fails automatically. The Maze of Traps on the ship means an opponent trying to board the ship must roll a dice for each attacking crew counter - on a roll of 1 the crew counter is lost. The Black Ark may push foes aside if it wishes to move past them.



## DARK ELF DEATH FORTRESS

Crew: 0

The largest of the Dark Elves' sea-going vessels, the Death Fortress is carried by a mighty Sea Dragon, a creature descended from true dragons but that has been tainted by dark magics.

### MOVE

Sea Dragon: 6". May change facing and position during a move at will.

### WEAPONS

1 Reaper battery turret, firing through 360°.

### SPECIAL RULES

Roll a dice each time a reaper battery is fired - the reaper makes that many shots at once. If the roll is a 1, the reaper battery is jammed and may not fire again this Battle Phase. May fight using a value of 1 dice plus its remaining wounds when attacked in a boarding action. Loses 1" of movement per wound lost. See the special rules for boarding actions and crew.

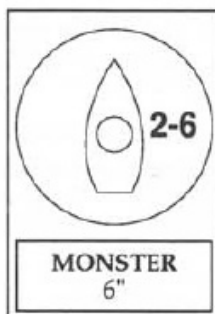

## DARK ELF DOOMREAVERS

Crew: 0

Doomreavers are pulled through the waves by Helldrakes. Bred by evil sorcerers for ferocity, the Helldrakes combine the might of a dragon and the temperament of a rabid wolverine.

### MOVE

Monster: 6". May change facing and position during a move at will.

### WEAPONS

See special rules.

### SPECIAL RULES

Once the Helldrake moves into contact with an enemy ship it may either make a boarding attack using a value of 1 dice plus its remaining wounds, or roll on the following table:

- 1 May move up to 6" and attack another target. Roll again.
- 2 Refuses to attack this turn.
- 3 Attacks a location of your choice. Your opponent must make a saving throw.
- 4 Attacks two locations of your choice. Your opponent must make a saving throw for each.
- 5 Attacks a location of your choice twice. Your opponent must make two saving throws for it.
- 6 Roll a dice and add 1. The Helldrake makes this many attacks. Roll a dice for each attack to find location hit. Opponent's saves are at -1. At the end of the attack roll a dice - on a 1 the Helldrake is removed from the game.

See the special rules for boarding actions and crew. Loses 2" of movement per wound lost.



# ORC FLEET

Orc fleets consist of gigantic Hulks, huge makeshift craft that are nearly always seaworthy. These ships are propelled by treadwheels and sails, and armed with a variety of unique weapons dreamed up by the Orcs and their Chaos Dwarf trained shipwrights.

The largest Orc ships are the Hulks, great clunking monstrosities packed full to the gunwhales with howling battle-frenzied Orc warriors.

Next come the Chukkas, large treadwheel-powered rafts armed with the dreaded Bigchukka, a catapult of awesome power.

Last but not least are the shark-like Drillakillas, a uniquely Orky weapon, capable of sinking almost anything – including itself.

## ORC FLEET

An Orc Fleet may consist of the following:

### Men O' War: 1+

The fleet must have at least one Hulk to be your Admiral's Flagship.

An Orc fleet can't have more Hulks than it has Ship of the Line squadrons. The Admiral's ship does not count towards this total.

Cost: 150 points per Hulk.

### Ship of the Line Squadrons: 2+

At least one squadron of three Drillakillas.

Cost: 150 points per squadron.

At least one squadron of three Bigchukkas. You may have a maximum of two squadrons of Bigchukkas for every one squadron of Drillakillas in your fleet.

Cost: 75 points per squadron.

### Wizard: 1

Cost: Variable – See *Wizards and Magic*.

### Admiral: 1

Cost: Free.

### Men O' War Cards: 1+

Cost: 1st card free with the Admiral, subsequent cards at 25 points per card.

## MEN O' WAR

The Orc fleet has the following Men O' War.

### HULKS

Hulks are vast floating fortresses powered by treadwheels and sails. They are huge, clanking things more reminiscent of siege machines than sleek sea-going craft. From within them can be heard the continual grinding of cogs and shouts of encouragement and dispute. Over the parapets of their high towers leer bestial green faces. On high platforms huge catapults sit, loaded with enormous rocks fed into them by conveyor belts. On the front are the Iron Claws: enormous grapnels fired from specially modified catapults which are used to grab foes and then wind them in.

At the prow of the craft is the dreaded Smash-hammer: an enormous iron-headed hammer mounted on a crane-like arm. The head of the Smash-hammer weighs many tons and is capable of demolishing even the largest of enemy ships.

Hulkbosses are the strongest and bravest of Orc warriors and are not particularly known for their seamanship. Their tactics consist of "Chukkin' roks at da gitz" at long range, and "Gettin' up close an' givin da' gitz a good seeing to" as quickly as possible.

## SHIPS OF THE LINE

The Orc fleet has the following Ships of the Line.

### BIGCHUKKAS

Bigchukkas look like small Hulks, and are only armed with a single Bigchukka catapult. They use a complex system of gearing to wind and load their Bigchukka catapults. Unfortunately, this system of gearing is also used to power the treadwheel. This means that they cannot move and fire in the same Battle Phase, they can do only one or the other. Bigchukkas are sometimes towed to the area of a battle by Hulks and then loosed to "Do da bizness," as Orcs would put it.

### DRILLAKILLAS

Drillakillas are smaller vessels, which look similar to Hulks. They are powered by treadwheels which have a special, experimental system of chain gearing attached to a drill. The gears are very erratic and constantly need to be adjusted in motion (this is done by thumping them with a hammer).

### Moving Drillakillas

Because of the complex gearing system the crew of Drillakillas tend to need more rest than others and work in spurts, which means that Drillakilla movement can be very erratic.

Each Drillakilla rolls three dice at the start of its Battle Phase, and can move up to this distance. On a roll of three 1's the drill disappears below the surface and pulls

the ship down with it - the Drillakilla becomes a submarine. Unfortunately it was not designed for this role and rapidly plummets to the icy depths of the ocean.

Drillakillas operate in squadrons of three and their uncertain movement often proves a problem when trying to maintain squadron formation.

<b>ORC HULK</b>					<b>CREW 5</b>
<b>MAN O' WAR</b>					
<b>4</b>	<b>SMASH-HAMMERS</b> Save 4, 5 or 6 Smash-hammers lost	<b>5</b>	<b>MAIN MAST</b> Save 5 or 6 First hit has no effect. Second hit destroys mast. Ship may not move under sail. Further hits do not cause critical damage.	<b>6</b>	<b>SHOOTY BITZ</b> Save 4, 5 or 6 Fore big chukka battery lost.
	<b>SHOOTY BITZ</b> Save 4, 5 or 6 Aft big chukka battery lost.	<b>ORK PLAYER CHOOSES WHICH CATAPULT IS LOST FIRST</b>			
HIGH					
<b>2</b>	<b>IRON CLAWZ</b> Save 4, 5 or 6 Iron claws lost	<b>3</b>	<b>GUBBINZ</b> Save 4, 5 or 6		
<b>4</b>	<b>FRUNT</b> Save 5 or 6	<b>5</b>	<b>SHOOTY BITZ</b> Save 4, 5 or 6 Broadside big chukka battery lost.	<b>6</b>	<b>TREADWHEEL</b> Save 4, 5 or 6 Wheel lost - ship may only move under sail.
LOW					
NO EFFECT	NO EFFECT	NO EFFECT	NO EFFECT	SINKS	<b>BELOW WATERLINE</b> Save 4, 5 or 6 First, second, third and fourth hits have no effect. Fifth hit sinks ship.
<b>SAIL: 4"(6")</b>			<b>WHEEL: 4"</b>		<b>BATTLE HONOURS: 6</b>
<b>NAME:</b>					

Permission granted to photocopy for personal use only. © Copyright Games Workshop Ltd., 1992



## ORC SPECIAL RULES

The following special rules apply to ships in the Orc fleet.

### TREADWHEELS

Orc Hulks are partially powered by treadwheels. The motive power from these comes from squads of captives taken on the high seas or very fit Orc ladz. They stand within the wheels and run on the spot sending the wheel going in the appropriate direction.

At the start of his turn an Orc player must declare whether he is using treadwheel power or sail, if his ship still has one. If he moves under treadwheel power he can ignore wind-direction. Because the Orcs have rather stupidly placed their treadwheels at the back of the ship they cannot turn on the spot as Dwarf ships can.

Ships using treadwheels move 4" per turn. They can reverse up to 2".

### IRON CLAWZ

Iron Clawz are a uniquely Orky weapon designed to let the ladz get to grips with their enemies as quickly as possible. They are giant claw arms which shoot out from the prow of the Hulk, grabbing their target in a vice-like grip while the Smash-hammers do their work.

In order to hit with the Iron Clawz the Orc player needs a clear line of sight to the target. If he can roll over the range in inches to the target on a D6 he scores a hit. So if a target is 4" away the Orc player must roll a 5 or a 6 to grapple.

Once a hit is scored the ladz winch like mad, drawing the enemy ship closer. If the enemy model is bigger than the Orc ship then the Orc ship moves up into contact with it.

If the enemy ship model is smaller than the Orc model then it is dragged to the Orc ship.

In either case the target will end up in contact with the Orc Hulk and boarding actions may begin. If the

	<b>ORC BIGCHUKKA</b>		<b>CREW 2</b>
	SHIP OF THE LINE		
<b>4</b>			<b>CHUKKA</b> Save 5 or 6 Catapult lost.
<b>5</b>	<b>WORKY BITZ</b> Save 5 or 6	<b>TREAD WHEEL</b> Save 5 or 6 Ship immobilised.	<b>6</b>
<b>SINKS</b>	<b>BELOW WATERLINE</b> Save 5 or 6 First hit sinks ship.		
<b>TREADWHEEL: 4"</b>		<b>BATTLE HONOURS: 1</b>	

	<b>ORC DRILLAKILLA</b>		<b>CREW 2</b>
	SHIP OF THE LINE		
<b>4</b>	<b>5</b>	<b>6</b>	
<b>DRILL</b> Save 4, 5 or 6 Drill lost.	<b>WORKY BITZ</b> Save 4, 5 or 6 Ship immobilised.	<b>TREAD WHEEL</b> Save 4, 5 or 6 Ship immobilised.	
<b>SINKS</b>	<b>BELOW WATERLINE</b> Save 4, 5 or 6 First hit sinks ship.		
<b>TREADWHEEL: 3 DICE"</b>		<b>BATTLE HONOURS: 2</b>	

Permission granted to photocopy for personal use only. © Copyright Games Workshop Ltd., 1992

models are the same size or you can't decide which ship is the biggest then roll a dice. The player with the highest dice roll decides. It should be pretty obvious though.

Once grabbed by Iron Clawz the enemy vessel is held in place till the Orc player decides to release it. If the captured ship wants to break free the enemy player must roll a dice at the start of its next move, and on a roll of 5 or 6 it breaks loose. The captured ship can also attempt to break free if it managed to repel boarders in a boarding action. If the enemy player doesn't manage to roll 5 or 6 after winning a close combat the ship has failed to cut the grappnels. The Orcs can continue to attempt to board the enemy ship if they want.

## BIGCHUKKAS

Some Orc craft are armed with Bigchukkas: large mechanical devices which can lob huge rocks enormous distances. These weapons cannot be fired at close range because of their high angle of fire, so shots lobbed from a Bigchukka simply pass over nearby ships. Their line of sight is still blocked by ships at close range (because they can't see through them). Bigchukka fire strength is not added to the defenders' total during boarding actions.

Because of the way the rock falls from the sky there is no saving throw modifier for long range against a Bigchukka. In fact, since the rocks are so large, any ship hit by one has -1 subtracted from its saving throw.

*The Drillakillas cut a swathe through the choppy waters, their massive treadwheels churning the blue waves into white froth. Their movement was erratic at best; their ungainly methods of propulsion strained to keep a constant speed and failed dismally. It was enough to realise that they were travelling fast – very fast indeed.*

*From the battletowers of his Dragonship, Admiral Elthwe Eltharion watched their ridiculous approach with a mixture of amused contempt and unease. They were way ahead of the lumbering Hulks and Big Chukkas, throwing caution to the wind in their headlong rush towards the assembled might of the Elf Warfleet.*

*The Drillakillas moved with a speed rivaling the Elf vessels, but there any comparison ended. Whilst the Eagleships, Dragonships and Hawks of the Elf fleet danced across the waves, the Drillakillas forced a chaotic path straight through them. Eltharion knew the fearsome reputation of these ugly crafts but in this, his first encounter with them, he could not bring himself to take the small vessels seriously. How could such a small, unlikely looking vessel have a chance of damaging the great warships of the Elf Fleet?*

*The nose of the nearest Drillakilla broke the surface of the water for a moment, and a long metal drill clawed viciously at the air before biting into the sea again. Imagining what such a drill could do to his proud ships, Eltharion experienced a gnawing doubt for the first time in his long career. Stepping down from the ornately carved balustrade, the Elf admiral turned to his waiting officers.*

*"Wind of Death," he said calmly, gesturing to the Eagleships to port and starboard.*

*"Stormstrike," he added, indicating the Hawkships with a nod of his head.*

*The officers looked a little surprised; surely their Lord saw no threat in the small, comical Orc vessels? Why spoil a perfect formation for battling the real threat of the distant Hulks?*

*Still, theirs was not to question their Lord's commands, so they sent signals to the other Elf vessels. With cold, precise elegance the ships peeled away from their flagship, taking up new positions in response to the Drillakillas' impending attack. As soon as they moved within range, they fired.*

*The ships' Eagle Claws sang, sending clouds of barbed ballista bolts towards the Orc vessels. They were not easy targets by any means: small, fast-moving, and of a sturdy, if brutal, construction. Only a handful of the vicious bolts managed to hit the ships, and only one or two of those did any real damage. The best shot – a well aimed battery from Wraithlord, the lead Eagleship – turned over a Drillakilla. Its treadwheel thrashed the waters crazily for a moment before it vanished.*

*The other Drillakillas relentlessly came on, barbs sticking out from them like porcupine spines. The wind carried the Orc's stench to the decks of the Elf ships, the warriors onboard flinching involuntarily at the disgusting odour. Above the wind, the faint sounds of the Orc war-cries reached their ears. The waiting Wardancers aboard the Dragonship grinned in anticipation.*

*The Drillakillas looked set to crash head on into the towering majesty of the Dragonship, to be smashed to a pulp on its Dragonblades. Then, at the last minute, the unpredictable craft swerved violently aside and thundered into the Eagleships that were showering them with ballista fire.*

*One Drillakilla smashed into Wraithlord with a grinding of gears and showering of sparks. The ship reeled under the impact, a gaping hole torn in its side. The Drillakilla carried on, driven by unstoppable momentum, and plunged below the waves, taking its unfortunate Orc crew with it.*

*The other Drillakilla vanished inside the second Eagleship, Doomsinger. Violent crunching and gratings could be heard from within its hull as the Orc ship tore it apart. Sawn off at the stem, the great starwood mast toppled over into the battle towers, smashing weapon mounts and battle platforms. With an explosion of brightly painted wood, the Drillakilla emerged from the other side of the stricken Eagleship and collided with a Hawkship. As soon as they made contact, the Orcs abandoned their vessel and swarmed over the small Elf ship. It was readily apparent to the rest of the Elf fleet that they were locked in a death struggle, and neither would take any further part in the battle.*

*As the Hulks approached firing range, the first stones from the Bigchukkas hit the waves, showering spray in all directions. Doomsinger was sinking fast, the cold ocean waters already covering her foredecks. The two remaining hawkships circled to pick up survivors before returning to their battle positions.*

*Turning from the ruin of his fleet, he stared for a moment in silence at the ugly, hulking Orc fleet. Then, a blind fury overtook his serene countenance; his features contorted with rage and his words, when they came, were ice cold, carried the length of the ship.*

*"Bring me my war-mage. Unsheath the Dragonblades and sing the last battlesong. This Dragonship goes to war!"*

Bigchukkas are always aimed high; you cannot choose to fire low with them. However, they do have an advantage. Because they throw enormously large boulders, and because these descend from above, they can smash down through obstructions. If the location fails its saving throw it is destroyed and the rock crashes down to the location below. This location also gets a saving throw, adding one to the die roll because of the diminished force of the rock. If it fails the area is destroyed, and the rock crashes on down, continuing in this way until a location makes its saving throw or until the rock reaches the below the waterline location.

Each time the rock plummets downward the location below gets an additional plus one to its saving throw. If the ship fails its below the waterline saving throw the ship takes a point of damage there.

If there is a choice between two areas as the rock falls roll a dice. On a 1, 2 or 3 the rock hits the left hand area; and on a 4, 5 or 6 it hits the right hand area. If the rock goes through an area already destroyed it passes straight through, and that area does not take a critical hit. On the other hand it does not give the target any modification to its saving throw either since the stone has fallen straight through this level.

For example an Orc Hulk fires on an Imperial Wolfship, and rolls a 5 High. The Imperial vessel normally needs a saving throw of 5 or 6 but because of the Bigchukka's save modifier of -1 he now needs a 6. He fails to save and the rock falls down to location 2 High. This would normally need a 5 or a 6 but the Imperial player can add one because the rock has fallen one level. He also subtracts one because it was a huge rock fired from a Bigchukka, so he still needs to roll a 5 or a 6. The Imperial player fails. The Orc player rolls 4 and the rock falls to the right, hitting location 5 Low instead of 6 Low. This usually needs four or above to save itself from being damaged, but the Imperial player can now add two since the rock has fallen two levels and then subtract one because it came from a Bigchukka. This means he needs 3 or more.

## SMASH-HAMMERS

In olden times when the Orcs first took to sea they heard about ramships smashing into other ships and destroying them. Since this sounded good and violent and Orky they decided they wanted them too, and set about fitting battering rams onto their ships. Unfortunately these were the exactly the same as the ones they used for assaulting castles, and the Orcs quickly found out that they didn't have enough room to swing them aboard a ship.

To get round this problem, the Orcs built great wooden frames and dangled the rams from them on the end of chains or mounted them on huge crane-like arms so that they could be swung easily out over the front of the ships. Tragically this led to the loss of many Orc lives as the small ships they were attached to overbalanced and capsized. Undaunted, the survivors built bigger ships but new problems arose. These bigger ships moved slowly and their foes, unlike castles, very unsportingly moved out of the way.

Frustrated now and getting a bit angry the Orcs devised Iron Clawz, so that they could hold their opponents in

place while they pulverised them with the Smash-hammers. And at last they were greeted with success. Let the humies claim that a ramship should rush at its foes and damage them. The Orcs had a better way. They brought their foes to them and reduced them to shattered timbers. And very successful it is too.

An Orc Hulk can only use its Smash-hammer when its bows are in contact with an enemy vessel. It rolls to hit as usual and always aims low. There is no saving throw modifier because of close range. A 1 is always a miss. Because a Smash-hammer can be swung back and forth many times in a phase it inflicts 1 dice of hits to whatever location it smashes into, and the opponent must make that number of saving throws for the location. If the location is destroyed then any succeeding hits cause critical damage.

## DRILLAKILLAS

Once a Drillakilla comes into contact with an enemy ship the drill starts to dig into its enemy. If the target makes a below the waterline save well and good. The Drillakilla stops moving and nothing happens this turn. The Drillakilla stays in place ready to start drilling again next turn unless the target moves away. If the target fails its below the waterline saving throw then roll a dice and consult the table below.

### Roll Result

- 1 Drillakilla's nose turns down in the water and it sinks. The brave Orc ladz go down with their ship.
- 2 The drive wheel breaks loose from the back of the drilla and rolls across the deck destroying everything in its path. The Drillakilla sinks. The wheel crashes into the other ship destroying one location; roll for location as usual. No saving throw is possible.
- 3 The drill bites deep. One point of below the waterline damage is inflicted.
- 4 The Drillakilla smashes into its target, causing immense damage to itself as it does so. The crew abandon ship, swimming through the hole made in their target's hull. The target takes 1 point of damage to a low area; roll a hit as usual. No saving throw is possible. The Drillakilla's crew can now fight a boarding action with the crew of the other ship. No cannons can be used to repel boarders since the Orcs are coming from inside.

If the Orcs win they drill their way out of the other side in the next Battle Phase, sinking the enemy ship.

If they lose, bits of their drilla remain lodged within their foe preventing it from leaking. If the target is a Beast it dives to the sea bottom in agony, and both the Beast and the Drillakilla are lost.

- 5 As above except that the drill comes in at an angle. The target ship takes one point of below the waterline damage. Whether the Orcs win or lose the target may continue to take damage each End Phase.

If the Orcs lose leave their Drillakilla on the target's template to remind you of the damage which may be inflicted. During each End Phase, after fires spread, roll a dice. If you roll 1, 2 or 3 the target ship takes another point of below the waterline damage and the Drillakilla model remains in place on the target's ship template. If you roll 4 or more its crew has succeeded in caulking the damage. Remove the model from the template.

If the target is a Beast then it dies, mortally wounded by the drill. The Drillakilla remains in play but its movement ends.

- 6 The frenzied efforts of the Drillakilla crew pay off. Roll a dice - the target takes that many below the waterline hits. If you have done enough damage to sink the ship and have any movement left your Drillakilla moves on through the wreckage and may attack again. If you don't do enough damage to sink the foe your Drillakilla ends up within him as above. Follow the procedure for result 5.

# ORC FLEET

Orc Fleets consist of gigantic Hulks, huge makeshift vessels that are barely seaworthy. These ships are propelled by treadwheels and sails, and armed with a variety of unique weapons dreamed up by the Orcs and their Chaos Dwarf trained shipwrights.



## ORK HULK

Crew: 5

Hulks are vast floating fortresses, towering structures of wood and iron, packed with Orc warriors and mounting many weapons

### MOVE

Treadwheel: 4". May not turn on spot. May reverse up to 2".

Sail: 4" normally, 6" with wind behind.

### WEAPONS

1 Big Chukka firing ahead. 1 Big Chukka firing behind. 1 Big Chukka broadside. Iron Clawz and Smash-hammers to fore.

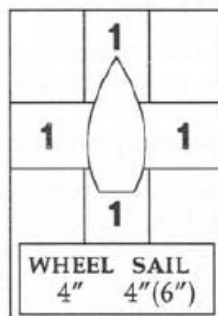

### SPECIAL RULES

Grabs with **Iron Clawz** - roll over the range in inches to target on a dice to grab foe. Move models into contact. Models may only break away from Iron Clawz if they roll a 5 or 6 on a dice during boarding action or at the start of the next turn. Models grabbed or contacted head on to the hulk may be attacked with **Smash-hammers**. Always aims low. Roll a dice to see how many attacks it makes. Roll for location. All attacks hit the same location. Target must make that many saving rolls. Multiple hits can cause critical damage. Hulk fires **Bigchukkas**, using the same rules as catapults, with -1 to saving roll.

## DRILLAKILLA

Crew: 1

As its name suggests, this is a giant floating drill, designed to move at speed and rip right through its target's hull.

### MOVE

Treadwheel. Roll 3 dice each turn to see how far it moves in inches.

### WEAPONS

The Drill.

### SPECIAL RULES

Move into contact with target. Roll a dice:

- 1 - Drillakilla sinks, remove it from play.
- 2 - Drillakilla destroys one random low location on target. Then Drillakilla sinks.
- 3 - Drillakilla causes one point of below the waterline damage. No save allowed.
- 4 - Drillakilla bores into the enemy ship. Fight boarding action. If Orcs win, ship is sunk, Drillakilla carries on next turn.
- 5 - As above, but target also takes 1 point of below the waterline damage. Target may also leak. See rules for details.
- 6 - Drillakilla rolls a dice and does that much damage below the waterline. May go straight through target. See rules.



## ORC BIGCHUKKA

Crew: 2

The Bigchukka is a floating catapult platform, capable of firing huge rocks over a great distance.

### MOVE

4" by treadwheel.

### WEAPONS

1 Bigchukka catapult firing to fore - all catapult rules apply.

### SPECIAL RULES

The Bigchukka may not fire and move. -1 to target's saving roll.

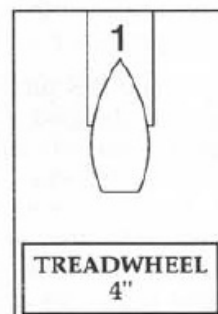

# CAMPAIGNS



# SCENARIOS

Once you've played a few games of Man O' War, you may want to try some of the scenarios given in this section. Scenarios add an extra level of excitement to your games, because they give you objectives to fight towards, quite apart from the ultimate goal of destroying your opponents fleet.

Scenarios sometimes change the rules of the game a little to provide a storyline for your battles. Each scenario that follows places you in a new situation with different dilemmas and tactical problems. Some present the players with objectives other than the simple destruction of their foe's fleet and provide more battle honours for achieving those objectives.

Some scenarios present new rules, and once you've played a few of these you might want to have a go at making up your own scenarios and special rules. You may want to combine some of the ones below. Providing both players agree on these before play begins this is perfectly acceptable.

Except where the scenarios special rules state differently, both sides should begin play with 1000 point fleets. Players should select ships, wizards and Man O' War cards up to that limit. If both players agree, these scenarios can be played using different points limits.

## 1: AFTER THE STORM

Just before this battle began both fleets were caught up in a great storm. Howling winds and mountainous seas scattered the ships. Once the tempest had passed both sides frantically tried to re-assemble their fleets. More by luck than judgement they have ended up in the same area and must hastily form up for battle.

This scenario is exactly as the basic game with one exception. Your opponent sets up your fleet and you set up his. You must follow all the normal set-up rules. You place a squadron at a time within nine inches of the table edge. You can set up ships facing in any direction. You cannot place them within 2" of terrain or the table edge. Ships in squadrons must be within six inches of their flagship. Within these limits you can set them up how you like. Battle Honours are earned as usual.

## 2: TREACHEROUS WATERS

One fleet has finally brought the other to battle in the estuary of the mighty River Reik. This is a dangerous area full of treacherous shoals and rocks. Captains will have to be more careful than usual while sailing here.

This scenario is exactly as the basic game except for the fact that all the quadrants of the table must have the maximum amount of terrain on them. In fact you may place all the terrain in the box if both players agree. Play proceeds as normal.

A particularly nasty variation on this theme is to combine this scenario with the setting up rules from After The Storm. Only use this variant if both players agree.



## 3: IN THE JAWS OF A TRAP

One fleet has managed to isolate and ambush a sizeable section of the other. The smaller fleet is doomed unless it can fight its way off the table and out of the jaws of the trap.

Roll a dice. The player with the lowest score has been trapped. His fleet may only be half the points cost of his opponents. He sets up on the east or west side of the table and can exit from the table only on the opposite side.

The other player must split his fleet into two equal halves. One half sets up within nine inches of the north edge of the table and the other sets up within nine inches of the south edge of the table.

Play now proceeds as normal.

The trapped player gains battle honours as usual for enemy ships sunk or captured. Additionally, every ship he gets off the opposite edge of the table he gets Battle Honours for. The game ends when he surrenders or has no more ships on the table.

The ambushing player gets Battle Honours for sinking or capturing enemy ships as usual.

## 4: BURIED GOLD.

One admiral has acquired a map containing the location of buried treasure. Spies have informed the admiral of the enemy fleet of this and he has put to sea in hot pursuit. Unfortunately the map was not very accurate. The island must be scoured for treasure since it would be bad form to return empty-handed.

During set up, when terrain is placed, choose one island to be the treasure island. This terrain piece is put in the centre of the table. Terrain set up and play can now proceed normal.

A ship which ends its movement within one inch of the central island can anchor and send landing parties ashore. Take as many crew companies as you like from the ship's Template and place them on the island. These are your landing parties. You should place the landing parties in separate piles and put them near the ship they came from. This will let you know which ship they return to. If that ship sails off in the next movement phase they take to the boats and go off with it. If the ship is attacked while at anchor they will return to defend it.

In the End Phase they may search for the treasure. For each landing party roll a dice and consult the following table:

Roll	Result
1	The landing party is consumed by fearsome monsters.
2-5	No treasure to be found, try again next turn.
6	They have found the treasure!

Once the treasure has been located no more searches can be made. During the movement phase of the next turn the landing party can return to the ship and it can sail away. Place the treasure chest on its template. If the ship is captured in a boarding action its captor seizes the chest and places it on his ship's template.

If both sides manage to place landing parties on the island, then in the End Phase a massive battle ensues. Both players roll a dice and add the total number of landing parties on their side. Highest total is the winner. The loser loses one crew company. If it's a draw both sides lose one crew company. If crew companies from more than one ship are involved then the losing player gets to pick from which ship they come. There is no retreat from this battle; it carries on until one side has been slaughtered. Their red-handed foes get to search the island in the End Phase of the next turn if they are not attacked again.

Both sides receive Battle Honours for enemies sunk and captured. The player who manages to get the ship with the treasure chest off the table gains a further five Battle Honours.



## 5: THE TREASURE FLEET

The treasure fleet is returning home, groaning under the weight of gold in its hold. Enemy spies have found out the fleet's course and a strong force has been dispatched to intercept it. The treasure fleet must fight its way through or its admiral will face disgrace or worse on his return home.

Roll a dice. The player with the highest score is the treasure fleet. He takes three treasure chest counters and places them on the templates of three of his ships, one on each ship. Now both sides place ships and terrain and play proceeds as usual.

When a treasure ship is captured during a boarding action the winning player can transfer a treasure chest to his own ship's Template.

Battle Honours are awarded as usual. In addition, for each ship with a treasure chest counter he manages to get off the opposite side of the table, the Treasure Fleet player receives 3 Battle Honours. For each ship carrying a treasure chest he manages to get off his own table edge the intercepting player gets 3 Battle Honours.

## 6: STORM THE SHORE FORTS

The sixth scenario includes a new piece of scenery - the Shorefort. The seascape represents bordering territorial waters between two nations at war. The waters are guarded by Shoreforts, and the fleets of the nations are determined to destroy their opponent's Shorefort as quickly as possible.

Set up the terrain as usual. Choose table edge as usual.

Choose your fleets as usual, except that each player gets a Shorefort, at no points cost, which he places as a squadron when the fleets are deployed. The Shorefort is treated exactly like an extra squadron in your fleet, subject to the rules below.

### Victory conditions

The first player to reduce his opponent's Shorefort to rubble is the winner, and gains 15 Battle Honours. There are no other Battle Honours gained in any other way in this scenario - ie. you get no Battle Honours for sinking or capturing enemy ships. Note that if you are buying a Shorefort for your fleet under normal circumstances, it is only worth 5 Battle Honours. The extra 10 in this case is due to the fact that they are the only Battle Honours in the scenario.

### Shorefort Templates

The Shorefort template is just like that of a ship - a sideview split into areas. Each area houses a cannon battery. It has no high or low areas.

### Moving

A Shorefort cannot move. It is a vast construction built on a rocky outcrop, towering out of the sea, and somewhat immobile by its very nature.

### Firing at a Shorefort

When firing at a Shorefort, you do not aim high or low, simply fire at the Shorefort. Roll the correct number of

dice, depending on the number of weapons which your ships have. Any that score a 1, 2 or 3 miss, any other score is a hit. The Shorefort must then make the saving throws for the hits it has taken.

### Saving Rolls

The Shorefort is very tough. It cannot be sunk, and is immune to rams or below the waterline hits. In fact, anyone trying to ram the Shorefort runs aground. To reflect its four foot thick walls of granite construction (stronger than the sturdiest ironclad), all locations on a shorefort have a saving roll of 3+. Normal save modifiers apply.

### Taking Damage

If a Shorefort takes damage, it loses a gun battery. Each location has a damage box in it. Each damage box represents a gun battery. When the damage box in a location is destroyed, then the Shorefort may no longer fire that gun, and subsequent successful hits in that area which fail their saving roll will cause 1 point of structural damage and kill 1 crew counter, crushed by falling masonry.

### Destroying A Shorefort

When a Shorefort has taken three points of structural damage, it is destroyed.

### Firing From a Shorefort

The cannons on the Shorefort have 360° arcs of fire, which represents the fact that they can be swiveled in their mountings to be brought to bear on moving targets. All the cannons in the Shorefort are fired at the

same target in every turn, using the standard cannon firing template. The Shorefort has 3 batteries of guns, giving it a 3 dice cannon attack in any one direction, once per turn.

### Capturing a shorefort

To capture a Shorefort, move your ship so that it is touching the Shorefort template. Roll a dice. On a 1 or 2 you have miscalculated your manoeuvre and run aground

Whether or not you have run aground, you may conduct a boarding action as normal. The Shorefort fires its guns in defence. The Shorefort also adds +1 to his dice rolls as the defenders are protected by huge stone walls.

### SHOREFORTS IN OTHER GAMES

The following information allows you to write your own scenarios using Shoreforts.

One or both sides can buy Shoreforts at 100 points each. Deploy them as squadrons in your fleet, but they can be placed anywhere within a section on your side of the table.

**Weapons:** 3 cannon batteries: 360 degree arc of fire

**Battle Honours:** 5

**Crew:** 3

**Points cost:** 100

You may have no more Shoreforts in your fleet than you have Ships of the Line squadrons.

# SHOREFORT

INDEPENDENT TERRAIN PIECE

CREW

## 3

4

**LEFT CANNON BATTERY**  
Save 3, 4, 5 or 6  
1 cannon battery destroyed.  
Further hits cause structural damage.

5

**CENTRE CANNON BATTERY**  
Save 3, 4, 5 or 6  
1 cannon battery destroyed.  
Further hits cause structural damage.

6

**RIGHT CANNON BATTERY**  
Save 3, 4, 5 or 6  
1 cannon battery destroyed.  
Further hits cause structural damage.

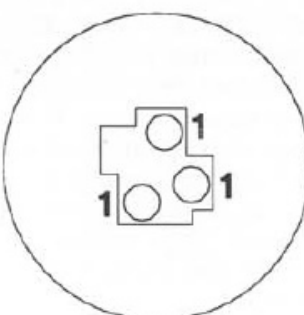

**Capturing a Shorefort**  
Move your ship so that it touches the Shorefort. Roll a dice. On a 5 or 6 you have run aground.  
Whether or not you have run aground, you may conduct a boarding action. The Shorefort fires its guns in defence, adding +1 to its dice rolls.

**MAY NOT MOVE**  
**POINTS COST: 100**  
**BATTLE HONOURS: 5**

REMOVE  
1 CREW  
COUNTER

REMOVE  
1 CREW  
COUNTER

SHOREFORT  
DESTROYED

**STRUCTURAL DAMAGE**  
Immune against rams:  
rammers run aground  
Each hit reduces number  
of crew counters by 1.



# CAMPAIGNS

Campaigns give more structure to your games of Man O' War. Your ships will earn battle honours, gain experience, and become more powerful in future battles. A campaign can create a string of epic battles at sea, from the shores of the Southlands to the estuary of the Reik.

## SETTING UP A CAMPAIGN

A Campaign is a linked series of battles between two fleets. Each player starts off with a fleet straight from the Fleet Lists, and as scenarios are played, they will accumulate Battle Honours. Not only do these give an indication of who wins each battle, they can be spent on improving your ships throughout the campaign.

The first thing you must do is decide the number of points both players will have to purchase their fleets: 1000 points is a good amount to begin with. Having done this you buy your ships as described in the Fleets section.

It is perfectly permissible, if both players agree, for you to increase the points values of your fleet during the course of the campaign. This will allow you to incorporate any new models you have acquired into your force. The points totals of both fleets should be equal, however.

Now you must decide on how many scenarios the campaign will run for – we recommend that you start with six. You are now ready to start the campaign. It's time for the first battle.

## DECIDING ON A SCENARIO

Before you fight you'll need to decide which scenario you're playing. We run our campaigns using the scenarios from the rulebook. Roll a dice. If the result is 1, 2 or 3 then play a normal battle, otherwise roll on the table below.

Roll	Scenario
1	After the Storm
2	Treacherous Waters
3	In the Jaws of a trap
4	Buried Gold
5	The Treasure Fleet
6	Storm the Shoreforts.

If both players agree then you may substitute scenarios of your own design for any of those on this table. You may even want to write a set of fixed scenarios for a specific campaign, which are played in a set order and which tell a heroic saga of battle.

If a scenario calls for you to use less than the normal number of points you don't have to do this exactly. It may prove impossible for one player to choose exactly 500 points' worth of vessels from his fleet. Don't worry – try to get as near to the total points required as possible. The game will be better if you are a little over the points value required rather than a little under.

## FOR EXAMPLE

*The players have rolled up scenario 3, In the Jaws of a Trap. For the campaign the first player, with an Imperial fleet, has chosen to have a Master Wizard, a Greatship, two squadrons of Wolfships and one squadron of Wargalleys, which comes to a total of 1000 points. He is the player springing the trap.*

*The scenario calls for him to divide his force into two equal halves. He can choose to have the Wargalleys (points value 150) start on the North Edge with a squadron of Wolfships (points value 300). This leaves the Greatship, with the Master Wizard aboard (points value 150+100) and the other squadron of Wolfships (points value 300) coming on from the South. This means that the Imperial Player has 450 points coming on one table edge and 550 points coming on the other. Given his fleet this is about as close to dividing it into two equal halves as he can get.*

*The second opponent, choosing a Bretonnian fleet, takes a Galleon, two squadrons of Corsairs, two squadrons of Buccaneers and a Master Wizard. The scenario calls for him to use only half his fleet. He could choose to field his Galleon (150 points), his Master Wizard (100 points) and a squadron of Corsairs (300 points). This would give about as close to half his fleet as he can manage.*

*Having picked a scenario you then proceed to the game, following any special rules that may apply to the scenario. The battle is fought exactly as normal.*

Elf Merchant  
Ship



## IN THE AFTERMATH OF THE BATTLE

Once the battle is over both players should total up the Battle Honours they have accumulated. These can be divided up among the surviving ships in any way you want within the limits mentioned below.

Once a ship has acquired enough Battle Honours, the crew will improve, progressing from being mere inexperienced crewmen to hardened sailors or beyond.

- Once the crew has acquired 4 Battle Honours its crew will become experienced **sailors**. They are a level one crew.
- Once they have acquired 12 Battle Honours they will become grizzled **veterans**. They are now a level two crew.
- Once they've acquired 24 Battle Honours they are stalwart **seadogs**. This makes them a level three crew.
- Once they've earned 40 Battle Honours they are fearless **cutthroats**. They are a level four crew.
- On a total of 60 Battle Honours they are **elite**. They have achieved the dizzying heights of a level five crew.

Battle Honours	Crew Title	Crew Level
4	Sailors	1
12	Veterans	2
24	Seadogs	3
40	Cutthroats	4
60	Elite	5

Once you've allocated Battle Honours you should check to see whether a ship has acquired a new level. In any event you should note the number of earned Battle Honours on the campaign record sheet.

After any battle you can only allocate enough Battle Honours to a ship to take it to the next level of experience. This means that you can give a maximum of four Battle Honours to an inexperienced crew or a maximum of eight to crew of sailors. Any Battle Honours not allocated for any reason are lost.

You should note all the details on the campaign record. In this way you will be able to keep track of the progress of your ships. During battles, place a crew level counter of the correct rank on the template of any ships which have gained enough experience to be promoted.

### FOR EXAMPLE

*After a particularly hard fought battle the Imperial Player finds himself with 21 Battle Honours. He has six surviving ships, all with starting crews. He can give 4 Battle Honours each to five of the ships making them all sailors. He can assign the last to the sixth ship which will make it slightly easier for it to progress next time. If only five ships on the Imperial side had survived then the last Battle Honour would have been lost.*

## THE BENEFITS OF EXPERIENCE

Once a crew has achieved a new level of ability it gains many benefits.

### Superior Commander

The captain may be experienced enough to act independently even if separated from his squadron flagship by more than six inches at the start of a turn. At the start of his squadron's Battle Phase you can make a navigation check. Roll a dice adding the ship's crew level. If the result is greater than 7 then the ship is not a straggler and may move and fight normally that phase.

### Master Gunners

Because of their experience your crew may make an Inspired Gunnery check. When you come to fire roll a dice and add the ship's crew level. If the result is greater than 7 then they can fire twice this phase.

### Battle hardened crew

Because of their greater morale and proven fighting ability an experienced crew gets to add their crew level to their die roll during any boarding actions they take part in.

However, if you use a company from an experienced crew as a prize crew on a captured ship it does not gain any bonus. The lads are obviously demoralised by the unfamiliarity of their surroundings and separation from their trusty shipmates. They'll be fine once they return to their original ship though.

### FOR EXAMPLE

*The Sigmar, an Imperial Wolfship, has acquired 12 Battle Honours, making it a level two ship with a crew of veterans. It is approaching the l'Honneur, a Bretonnian Corsair with an inexperienced crew who have not yet achieved level one.*

*Once the Sigmar makes contact with the l'Honneur its movement ends. The Imperial Player fires all three of the Sigmar's forward guns.*

*First he checks to see if his gunners feel inspired. He rolls a dice, adding his level. He gets a 5 on the dice. 5+2 is 7 so the check is a success. He fires the guns twice, raking the Bretonnian with 6 dice of cannon fire.*

*Having knocked out all the Corsair's guns with this mighty salvo the Sigmar's crew decide it's time to get to grips with the dazed Bretonnians. The boarding action begins. The Sigmar has three crew counters and the l'Honneur only has two. With a mighty shout the Imperial soldiers storm aboard rolling a 3 on their dice. To this they add their 3 boarding parties and the crew's level of 2. This makes their total 8.*

*The Bretonnians, unable to load their cannon with grapeshot because they have no undamaged guns, roll a 5. To this they add their 2 crew for a total of 7. Despite heroic Bretonnian resistance the Empire's finest soldiers cut their way to victory. The Bretonnian loses a crew counter. Imperial victory looks almost assured.*

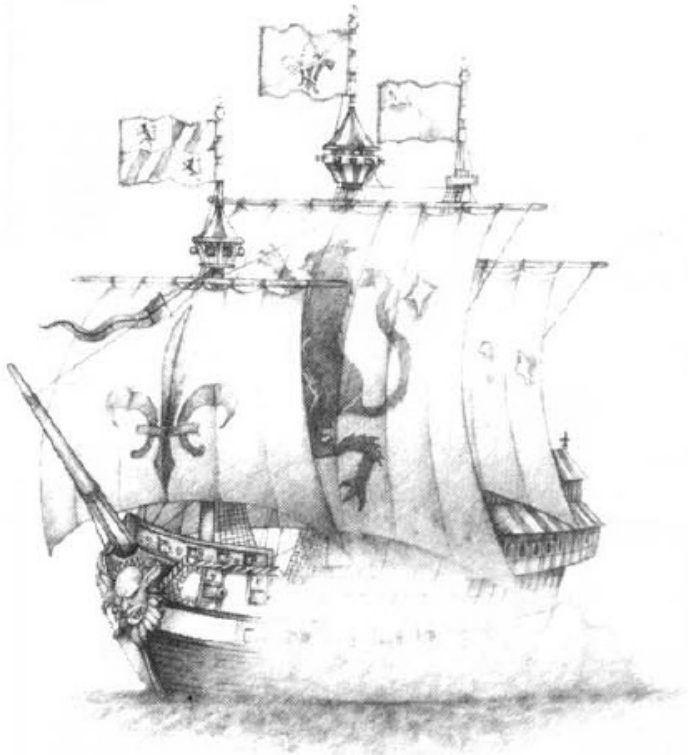
*Brettonian Corsair*

## CONTINUITY

One of the greatest benefits of the campaign is continuity. The player is using the same ships and fleet and watching them grow in power and experience. During a Campaign, you should keep note of the colour of your fleet's wizard. It will remain the same from game to game. If the wizard is lost during a battle his College will replace him with a wizard of the same mastery level before the next battle.

You should also note which Man O' War cards a ship has assigned to it. These will be the same from game to game unless the ship is sunk.

## SUNKEN SHIPS

Any ships sunk, captured or scuttled during the course of the campaign are lost, and all their battle honours and levels of experience go too. This can be a real tragedy when you've watched a ship develop from a fresh crew to Cutthroat heroes.

If a ship is lost your fleet will commission a new one before the next battle. The sunken ship will be replaced with one of the same type. If the sunken ship had any Man O' War cards draw the same number of new ones and assign them to that ship. If the original ship had any Engineers or Wardancers or other special troops aboard then the new ship will have them too.

This ship will have a fresh crew and no Battle Honours although it may earn them in the same way as any other ship. The ship will be assigned to the same squadron as the ship it replaces. In this way you will always start each battle with the same number of squadrons and ships as you began the campaign with, although they will probably be of different levels of experience.

## WINNING THE CAMPAIGN

After the first battle you should roll on the scenario table to find out what your next battle will be. Place the appropriate counters telling you the level of your crew on the templates of any ships which have gained a new level of experience.

After the next battle, tally up your battle honours and award them as before. Repeat this process until you have fought the agreed number of battles.

After the last battle each player should add up the total Battle Honours acquired by all his surviving ships over the duration of the entire campaign.

The winner of the campaign is the person whose surviving ships have the most Battle Honours.

## LILY LIVERED COWARDS

Any player who sails his fleet directly off the table without firing a shot, with no intention of fighting the enemy or achieving the scenario objective, is obviously a lily livered coward.

His opponent is immediately awarded the value of the coward's entire fleet in Battle Honours since his lads are heartened by facing a fleet whose admiral is such a yellow bellied dog.

Any fleet which does this twice in a campaign has its admiral executed and automatically loses the campaign.

This rule is meant to stop one player from winning a battle and then never fighting again thus winning a campaign by default. It does not apply to any scenario that specifically calls for one player to flee a superior force for example.



# EMPIRE WARSHIPS

## IMPERIAL GREATSHIP

AN IMPERIAL GREATSHIP CONSISTS OF:  
 1 x HULL  
 1 x AFT CASTLE  
 1 x FORE CASTLE

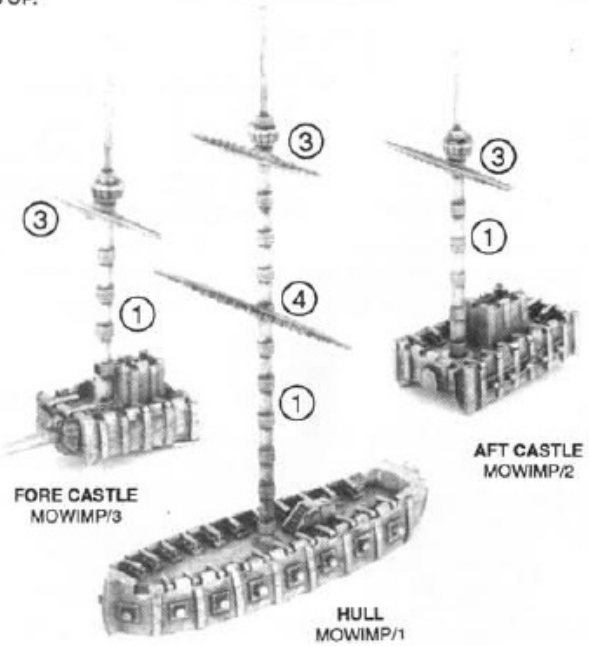
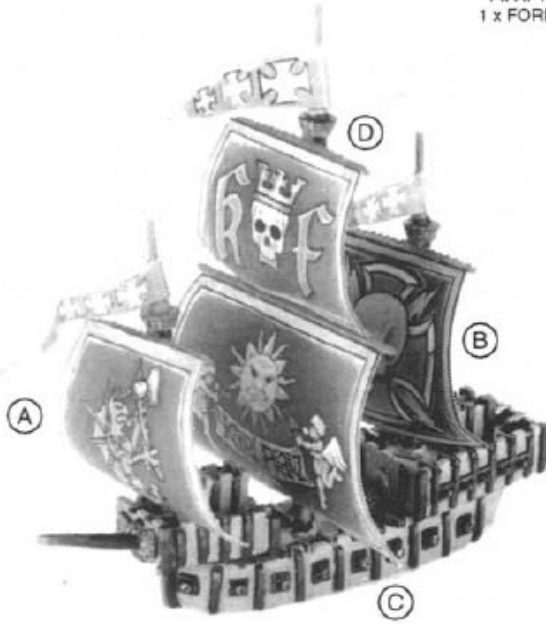

EXAMPLE OF COMPLETED AND FULLY PAINTED GREATSHIP

NOTE THAT SOME OF THESE SHIPS' MASTS HAVE BEEN SHORTENED TO MAKE THEM THE CORRECT LENGTH FOR EACH TYPE OF SHIP; REFER TO THE MAN O' WAR PAINTING GUIDE FOR MORE DETAILS ON HOW TO DO THIS.

## IMPERIAL WOLFSHIP

AN IMPERIAL WOLFSHIP CONSISTS OF:  
 1 x HULL  
 1 x AFT CASTLE

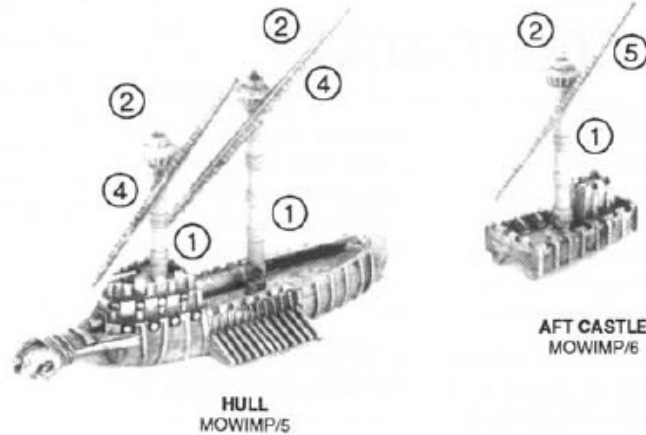
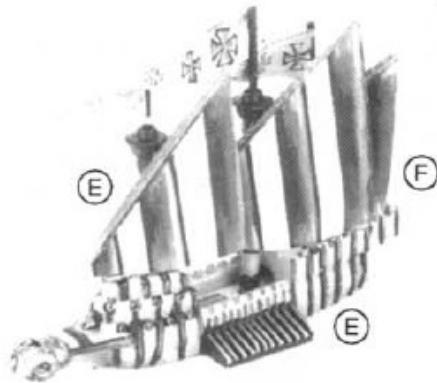

EXAMPLE OF COMPLETED AND FULLY PAINTED WOLFSHIP

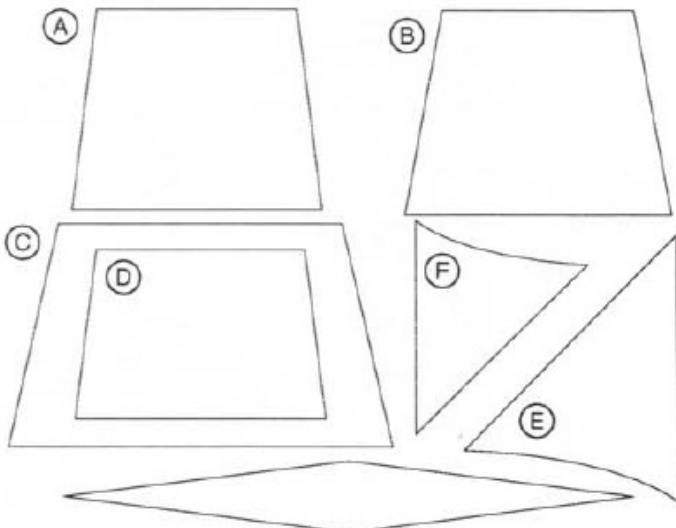

THESE SAILS AND PENNANTS MAY BE PHOTOCOPIED, CUT OUT, PAINTED AND STUCK ONTO YOUR MINIATURES. PERMISSION GRANTED TO PHOTOCOPY FOR PERSONAL USE ONLY.

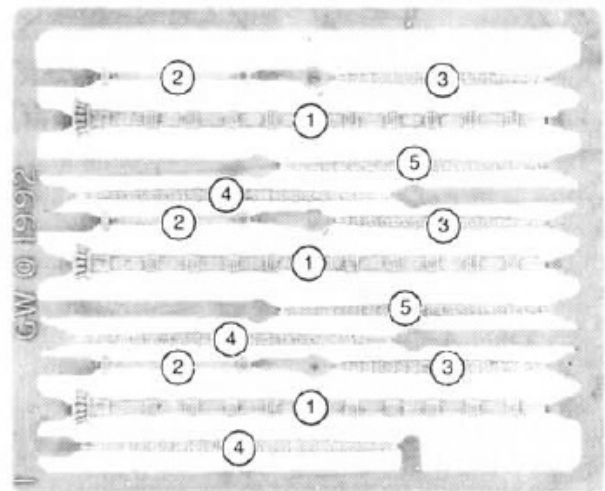

MAN O' WAR PLASTIC MAST SPRUE  
 MOWPLA/2

THESE MODELS ARE SUPPLIED WITH ONE OR MORE MAST SPRUES WHERE NECESSARY.

Miniatures supplied unpainted. **WARNING:** This product contains lead which may be harmful if chewed or swallowed. Citadel Miniatures are not recommended for children under 14 years of age. © Copyright Games Workshop Ltd 1993. All rights reserved.



# EMPIRE WARSHIPS

## IMPERIAL WARGALLEY

EXAMPLE OF COMPLETED AND FULLY PAINTED PLASTIC WARGALLEY

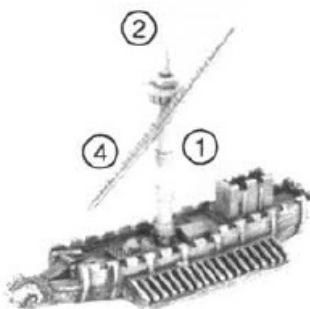
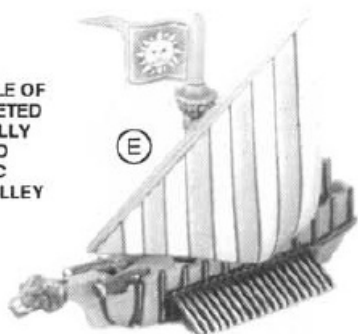

WARGALLEY  
MOWIMP/7

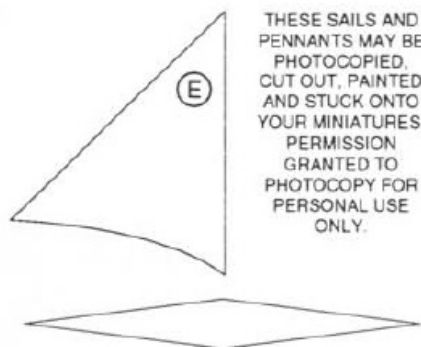

THESE SAILS AND PENNANTS MAY BE PHOTOCOPIED, CUT OUT, PAINTED AND STUCK ONTO YOUR MINIATURES. PERMISSION GRANTED TO PHOTOCOPY FOR PERSONAL USE ONLY.

## PLASTIC WARGALLEY SPRUE (MOWPLA/1)

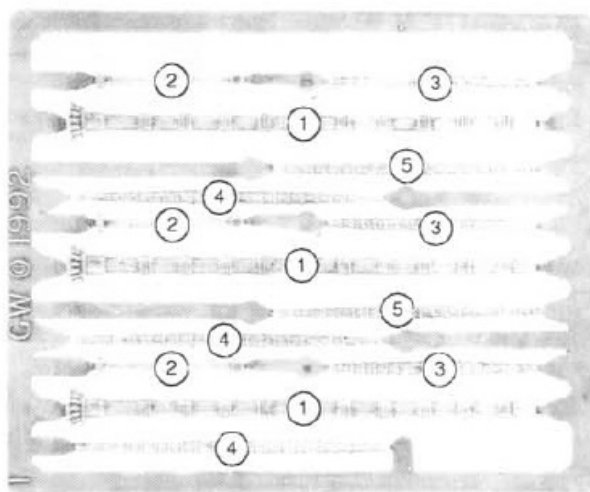
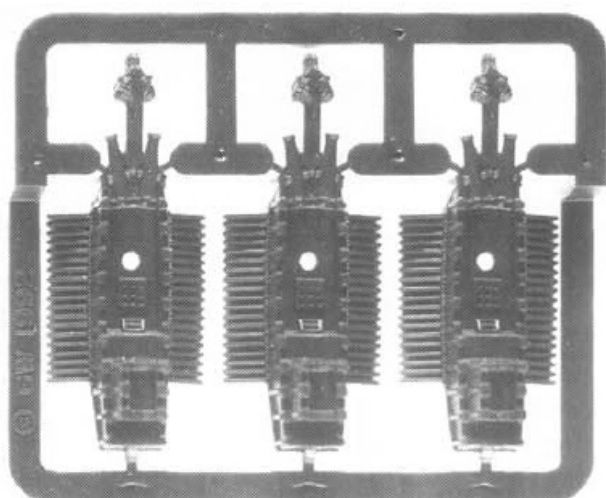

MAN O' WAR PLASTIC MAST SPRUE  
MOWPLA/2

THESE MODELS ARE SUPPLIED WITH ONE OR MORE MAST SPRUES WHERE NECESSARY.

# BRETONNIAN WARSHIPS

## BRETONNIAN CORSAIR

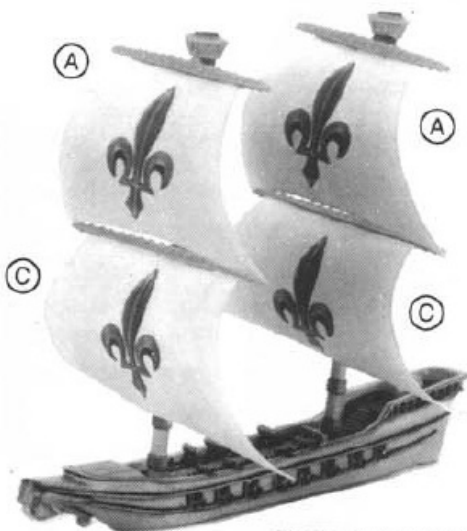

EXAMPLE OF COMPLETED AND FULLY PAINTED CORSAIR

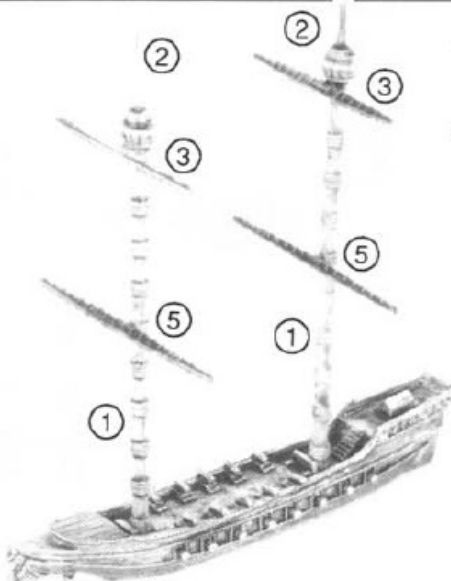

CORSAIR  
MOWBRT/4

THESE SAILS AND PENNANTS MAY BE PHOTOCOPIED, CUT OUT, PAINTED AND STUCK ONTO YOUR MINIATURES. PERMISSION GRANTED TO PHOTOCOPY FOR PERSONAL USE ONLY.

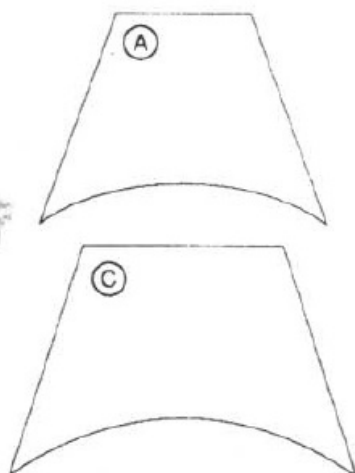

Designed by Norman Swales

NOTE THAT SOME OF THESE SHIPS' MASTS HAVE BEEN SHORTENED TO MAKE THEM THE CORRECT LENGTH FOR EACH TYPE OF SHIP; REFER TO THE MAN O' WAR PAINTING GUIDE FOR MORE DETAILS ON HOW TO DO THIS.

# BRETONNIAN WARSHIPS

## BRETONNIAN GALLEON

A BRETONNIAN GALLEON CONSISTS OF:

- 1 X HULL
- 1 X AFT CASTLE
- 1 X FORE CASTLE

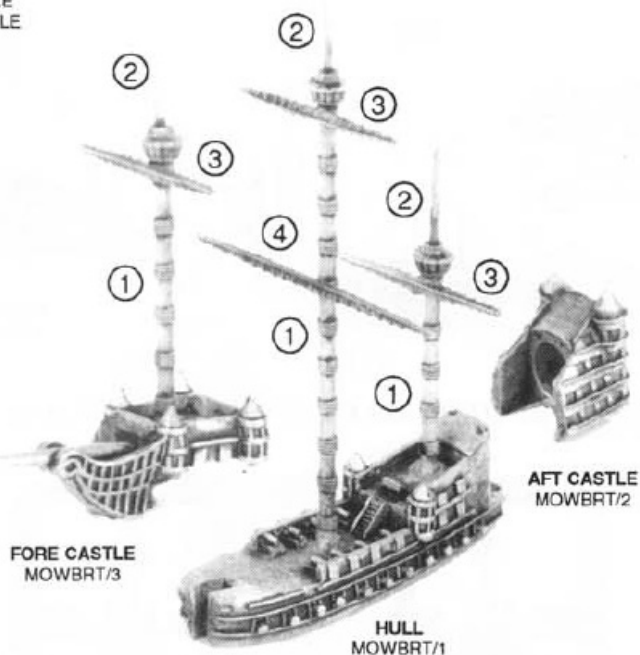
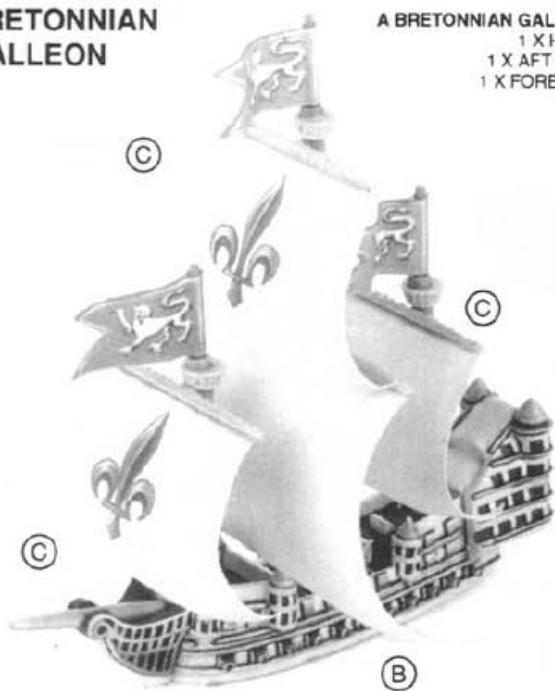

EXAMPLE OF COMPLETED AND FULLY PAINTED GALLEON

## BRETONNIAN BUCCANEER

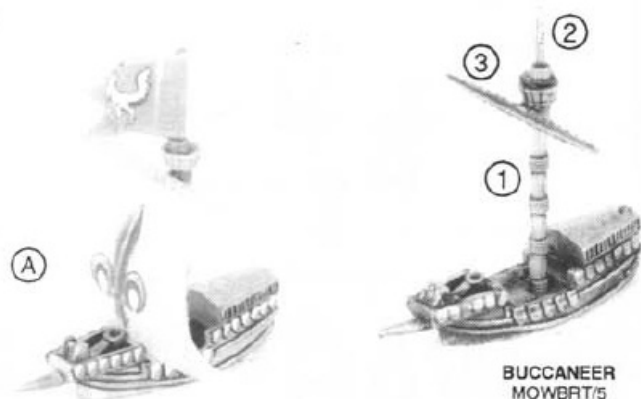

NOTE THAT SOME OF THESE SHIPS' MASTS HAVE BEEN SHORTENED TO MAKE THEM THE CORRECT LENGTH FOR EACH TYPE OF SHIP; REFER TO THE MAN O' WAR PAINTING GUIDE FOR MORE DETAILS ON HOW TO DO THIS.



EXAMPLE OF COMPLETED AND FULLY PAINTED BUCCANEER

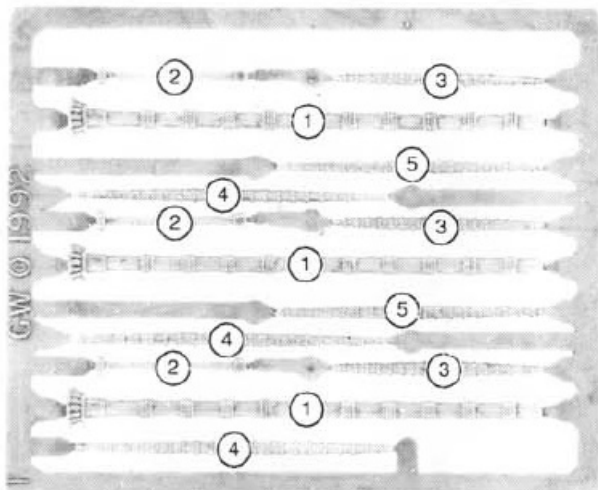
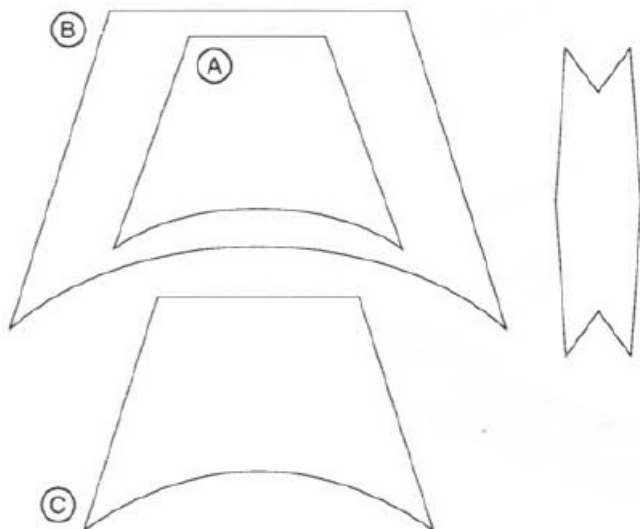

THESE SAILS AND PENNANTS MAY BE PHOTOCOPIED, CUT OUT, PAINTED AND STUCK ONTO YOUR MINIATURES. PERMISSION GRANTED TO PHOTOCOPY FOR PERSONAL USE ONLY.

MAN O' WAR PLASTIC MAST SPRUE  
MOWPLA/2

THESE MODELS ARE SUPPLIED WITH ONE OR MORE MAST SPRUES WHERE NECESSARY.

# DWARF WARSHIPS

## DWARF IRONCLAD

A DWARF IRONCLAD CONSISTS OF:  
1 X HULL  
1 X FUNNELS  
1 X BRIDGE

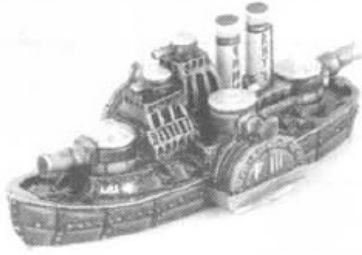

EXAMPLE OF COMPLETED AND FULLY PAINTED IRONCLAD



BRIDGE  
MOWDWA/3



HULL  
MOWDWA/1



FUNNELS  
MOWDWA/2

## DWARF MONITOR

A DWARF MONITOR CONSISTS OF:  
1 X HULL  
1 X BRIDGE

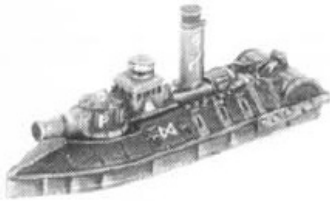

EXAMPLE OF COMPLETED AND FULLY PAINTED MONITOR



BRIDGE  
MOWDWA/5



HULL  
MOWDWA/4

## DWARF NAUTILUS



DWARF NAUTILUS  
MOWDWA/6

# DARK ELF MONSTERS

## DARK ELF DOOMREAPER

DOOMREAPER  
MOWDEL/1



## DARK ELF DEATH FORTRESS

DEATH FORTRESS  
MOWDEL/2

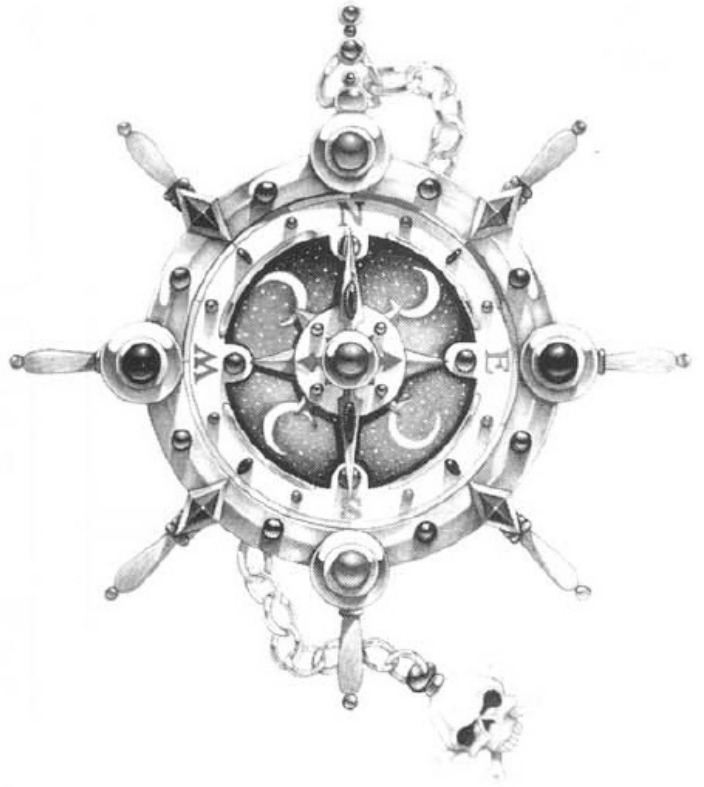
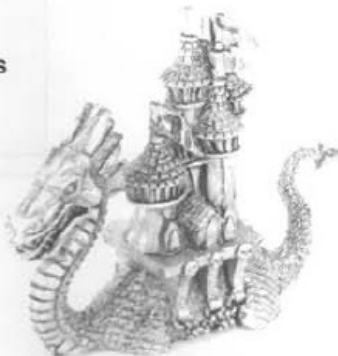

# FLEET CAMPAIGN ROSTER

<b>RACE:</b>	
--------------	--

<b>TOTAL POINTS VALUE</b>	
---------------------------	--

<b>ADMIRAL:</b>	
-----------------	--

WIZARD	
College:	Notes
Level:	
Points Value:	

MEN O' WAR	
Name:	Notes
Ship Type:	
Points Value:	
Man O' War Cards	
Admiral <input type="checkbox"/> Wizard <input type="checkbox"/>	

Name:	Notes
Ship Type:	
Points Value:	
Man O' War Cards	

Name:	Notes
Ship Type:	
Points Value:	
Man O' War Cards	

Name:	Notes
Ship Type:	
Points Value:	
Man O' War Cards	

## SHIPS OF THE LINE

Squadron:	Notes
Ship Type:	
Points Value:	
Ship 1:	
Ship 2:	
Ship 3:	

Squadron:	Notes
Ship Type:	
Points Value:	
Ship 1:	
Ship 2:	
Ship 3:	

Squadron:	Notes
Ship Type:	
Points Value:	
Ship 1:	
Ship 2:	
Ship 3:	

Squadron:	Notes
Ship Type:	
Points Value:	
Ship 1:	
Ship 2:	
Ship 3:	

## OTHER VESSELS

Ship Type:	Notes
Points Value:	

Ship Type:	Notes
Points Value:	