

Zuflwaffe  
1946

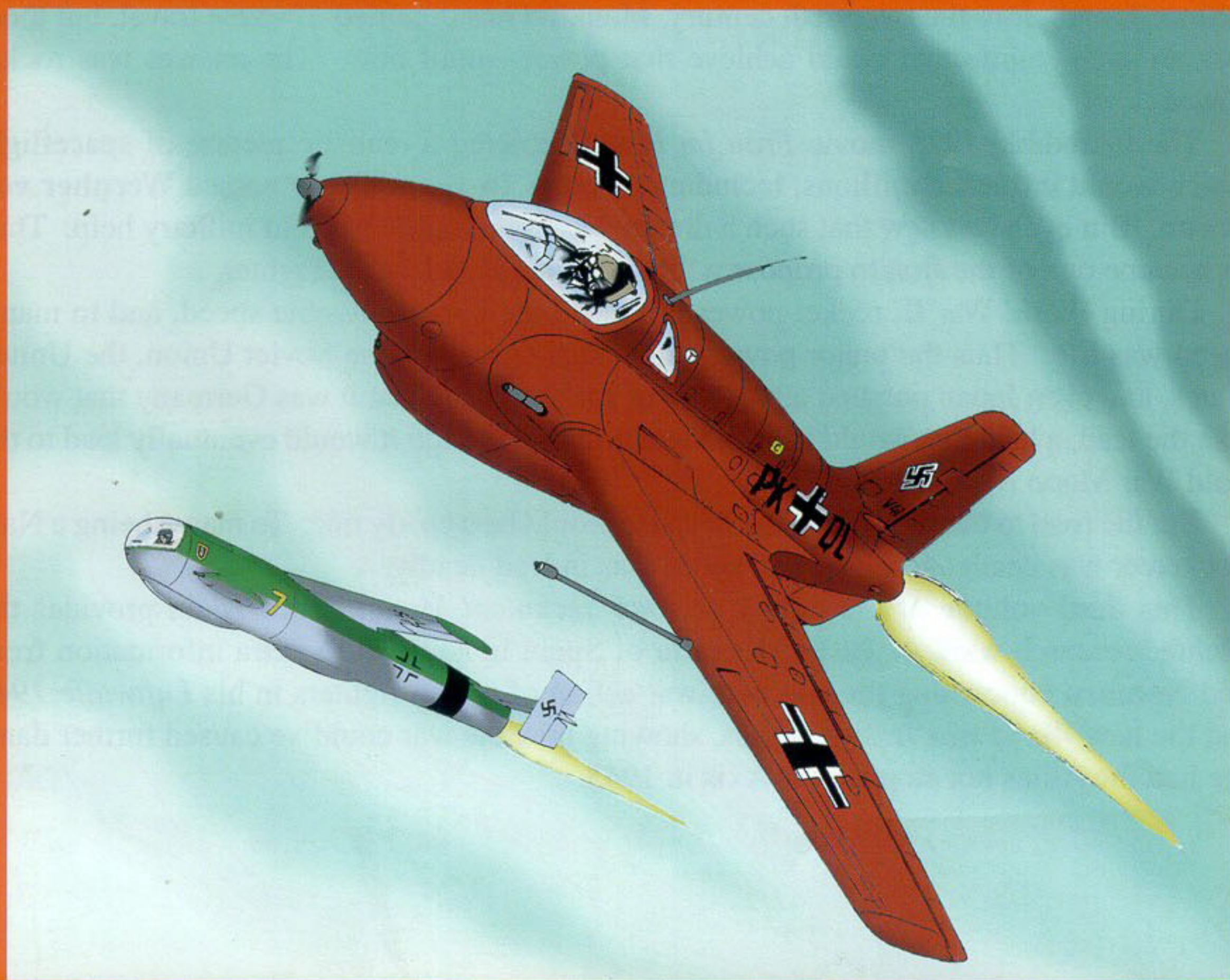

# TECHNICAL MANUAL



Rocket



Fighters

The Space Cadets of Germany wanted to conquer space! Unfortunately, there was a war to fight first!

Since long before the twentieth century, Mankind has dreamed of space travel, but there was no such engine that could achieve that power—until now. The answer was rocket power.

The incredible 1928 movie *Frau im Mond* depicted a realistic picture of spaceflight which would influence millions, including a young 16-year-old boy named **Wernher von Braun**. But even he knew that such a dream was not possible without military help. Thus he became one of the first to propose a “Raketenjager”, a Rocket Fighter.

During World War II, rocket power promised the fastest possible speed, and to many, speed was life. Thus the major powers, like Nazi Germany, the Soviet Union, the United States, and even Japan pursued a program of rocket planes, but it was Germany that would take the lead, a lead that would benefit them nothing, though it would eventually lead to the Cold War Moon Race.

But the road to the final conquest of space would be a costly one. To many, being a Nazi Rocketeer was death and glory, and speed was indeed deadly.

This third volume of the *Luftwaffe:1946 Technical Manual* once again provides the talented research work of **Justo Miranda** of Spain in addition to extra information from **Ted Nomura** concerning the alternate-war action of rocket fighters in his *Luftwaffe:1946* and the new *World War II:1946* series, showing how the war could've caused further damage had the Allies not stopped the Axis in 1945.

# **Luftwaffe**



# **1946**

## **TECHNICAL MANUAL**

### **Band 3**

## **The Rocket Fighters**

**Justo Miranda**

**Ted Nomura**

# TABLE OF CONTENTS

Introduction (Ted Nomura) .....	3
Reichdreams Concept (Justo Miranda) .....	7
Von Braun Interceptor (Justo Miranda) .....	8
Raketenjäger .....	14
Allied Rocket Planes .....	15
Heinkel He 112 V5 .....	16
Fieseler Fi 166 "Hohenjäger" .....	17
DFS 228V1 .....	18
Blohm und Voss MGRP .....	19
EMW A6 .....	23
The First Missiles .....	24
R4M/Hs 217 .....	25
SG 113 .....	26
Ruhrstahl-Kramer X-1 "Fritz X" .....	27
Henschel Hs 293 Series .....	29
Henschel "Zitterrochen" .....	30
Henschel Hs 298 .....	31
Ruhrstahl-Kramer X4 .....	34
Ruhrstahl-Kramer X7 "Rotkäppchen" .....	37
Blohm und Voss BV 143, Henschel G.T, 1200 and Other Gliding Torpedos .....	38
Luftwaffe:1946—X-Profiles (Ted Nomura) .....	41
Product Review .....	42

Art and Text  
**Justo Miranda**  
**Ted Nomura**

Cover Coloring and  
Assembly  
**Ben Dunn**

Interior Assembly  
**Doug Dlin**

Editing  
**Ted Nomura**  
**Doug Dlin**

*Luftwaffe:1946* ©1996, 1997, 1998 and 1999 Ted Nomura and Ben Dunn  
*Reichdreams* material ©1997,1998, and 1999 Justo Miranda and Paula Mercado  
*World War II: 1946* material ©1982, 1985 and ©1999 Ted Nomura  
All other materials ©1999 Antarctic Press

# INTRODUCTION

History, however fragmented it may be, has taught us that as soon as Man (or Woman) invents something, application for the invention's military use is not far behind. After all, military power means survival of its ideology and protection of its imperialistic domain. Even today, history is written according to "Might is Right" mentality.

One of the earliest recording of "rocket"-powered flight was a wooden pigeon model constructed by Greek philosopher and a mathematician **Archytas of Tarentum** (428-347 B.C.). It was flown around 360 B.C. (or B.C.E.), powered by steam or compressed air coming out from a hole in the tail. This unique demonstration of equilibrium was achieved by a suspended string and a counterweight balancer.

Unfortunately, this advanced thought was somewhat suppressed during the religious crusade of the first millenium, and by the year 1277, **Etien Tempier**, the Bishop of Paris, under the authority of **Pope John XXI**, officially condemned any thought of another world, or plurality of worlds, thus maintaining Earth as God's one and only world and discouraging any adventure of "bird-like" ascent or flight under the punishment of death. But in a land far, far away, the Chinese were already using the gunpowder that they had discovered in 850 for military rockets in combat against the Mongols in a battle to defending the town of Kai-Fung-Fu in 1232. And in 1249, Arabs also learned to use rockets in combat at the siege of Damietta. The genie with the power to eventually help men reach outer space was already out of the bottle.

In 1815, **Edward Francesca Burney** wrote a comical story called *Journey to the Moon* suggesting a one-man space capsule launched by a triple "spacegun" to the Moon, along with a special protective suit and breathing gear for the passenger, a format later much updated for the famous 1865 novel **From Earth to the Moon** by **Jules Verne**. But it wasn't until 1928 that science fiction came so close to science-fact.

The German cinema film *Frau im Mond* (*Girl in the Moon*) was a moon-flight epic more than three hours long directed by **Fritz Lang** (of *Metropolis* movie fame) that depicted a highly authentic scénario of rocketry not surpassed until the American *Destination Moon* in 1950. Practically every space enthusiast who saw the movie was affected and certainly encouraged to pursuit the dream of making science fiction into science fact. This group included rocketeer, then only 16 years old, named **Wernher von Braun**, who would later be known for his work on the A4 (V-2) rocket and ultimately the American Saturn V that would propel the astronauts to the Moon.

But the space pioneers had difficulty getting accepted even by their colleagues. Like the religious institutions, the scientific community often refused to accept a new concept simply because it couldn't absorb the possibility and/or because the concept threatened the stability of its ideology. Many great men like **Tsiolkovsky** and **Goddard** spent nearly as much time rebutting criticisms from narrow-minded and often jealous revisionist deniers and debunkers than they spent on their own research. Fortunately, history later corrected this defect and gave credit where it was due. Tsiolkovsky is now regarded as the "Father of Spaceflight," and *Time* magazine finally apologized to Goddard in 1969 for

denouncing his theory of manned flight using liquid fuels. Unfortunately for Goddard, he'd been dead since 1945, but he is regarded as the "Father of American Rocketry." Even **Korolev** was finally recognized as the "Father of Soviet Rocketry" after his death. Unfortunately his years of hardship and false imprisonment that resulted in his early death robbed the Soviet Union of a chance to be the first on the Moon.

As for von Braun, he adapted as the political climate changed. He accepted the offer from the Army, but still joined the Luftwaffe to get his pilot's license. No doubt he was planning to be among the first men to achieve spaceflight. His deep interest in manned spaceships was adapted to the needs of the military, from which most of the funds were available. Like the American nuclear scientists of the 1940's, he brushed aside the moral question of his creation possibly being used as a weapon, giving priority to the possibility of making theory into fact. On July 6, 1939, he submitted his plan for a rocket fighter to the Reich Air Ministry. It was bullet-shaped and powered by a liquid-fuel combination of nitric acid and Visol. Like the Bachem Natter of 1944-45, it was to be launched vertically. It was armed with four machine-guns and was thought to be capable of reaching the speed of sound. The RLM, swamped with conventional warplanes in production gearing up for war, did not need another wild idea to drain their R&D resources, so his design, along with the updated version, was rejected. But von Braun never gave up on the possibility of building a manned spaceship. As soon as his A-4 missile design was proved to be a sound one, he sketched out a manned version, conveniently replacing the 2000-lb. warhead nose with a manned capsule. But by then Germany had gone into "Total War," and such civilian applications were forbidden by the order of the SS. Still, von Braun kept his dream machine a secret, hoping that someday he could fly this configuration himself.

Meanwhile, thanks to the dedicated pre-war work of people like like **Max Valier**, **Fritz von Opel** and **Alexander Lippisch**, the development of the manned rocket plane continued. Although Valier spent much time designing and promoting giant ideas, his results were minimal due to lack of funds. Yet many of his designs were highly advanced. His Valier R-F1 trans-channel crosser, for instance, looked like the DFS manned glider-bomb design of the *Luftwaffe: 1946* scenario. Meanwhile, Opel flew his Hatry/Opel rocket plane on September 30, 1929 at Rabstock, near Frankfurt, Germany. It was powered by nineteen 50-lb.-thrust solid rocket motors and (unlike the Wright Brothers' flyer of 1903) took off without a catapult. It flew for 75 seconds and reached a distance of 5000 feet at a max speed of 95 mph. But this was to be Opel's last experimental rocket flight. During April and May of 1930, the lesser-known **Godfried Espenlaub** test-flew his rocket-powered glider, with its revolutionary swept wings, at the Lohausen Dusseldorf flying field. It was launched with a rubber catapult assisted by a single 150-lb.-thrust rocket motor, then after it reached an altitude of 30 feet, a second rocket motor was fired for more speed. But the plane later crashed after the firing of a third rocket which caused the pilot to lose control. During the early 1930s, Dr. Lippisch began his series of similarly configured flying wings—first with conventionally powered variants like the Delta III and Delta IV, then a new approach with the secret-sounding name of "Project X," which was to be a delta-winged aircraft powered by a single liquid-fueled rocket motor. Using a modified Delta IVc as a testbed, its new designation became the DFS 194. After many successful flights, Lippisch and his small team joined the Messerschmitt firm in January 1939 for much needed R&D funding, and the

improved version became the start of the famous Me 163 series. Although the Me 163 became the most (and often only) known rocket fighter in the history, there were many pioneers and many "firsts" from other countries, especially the Soviet Union.

On February 28, 1940, a Soviet military aircraft, the Polikarpov P-5, towed the RP-318-1 rocket-powered glider, piloted by **V.P. Fyodorov**, and released it at altitude of 2600 meters. Upon ignition, the glider's speed increased from 80-140 kph in 5-6 seconds. The modified SK-9 two-seater glider was fitted with an ORM-65 rocket engine by **Sergei Korolev**. Korolev himself was destined to be the Soviet Union's greatest rocket engineer, but like the Soviet country itself, he faced a very bumpy future.

Back in Germany, a study of a two-stage A9/A10 rocket capable of reaching America had already been initiated at Peenemunde on July 29, 1941 when only two weeks later, test pilot **Heini Dittmar** flew the first prototype of the Me 163V1 on August 13th. This model, however, was still unarmed. Then, on September 10, 1941, the world's first rocket fighter configured as such, the BI-I, designed by **A. YaBereznak** and **A.M. Isayev**, was test-flown. First it was towed as a glider by a two-engined bomber, then propelled by a 2200-lb.-thrust RNII D-1-A-1100 nitric acid/kerosene-powered rocket engine. On October 2nd, Dittmar's Me 163V1 achieved a speed of 623.85 mph, becoming the first manned aircraft to reach the magic velocity of 1000 kph. The rocket race was on.

## Families of ALTERED WARS

# Luftwaffe 1946

Ted  
Nomura

Ben  
Dunn

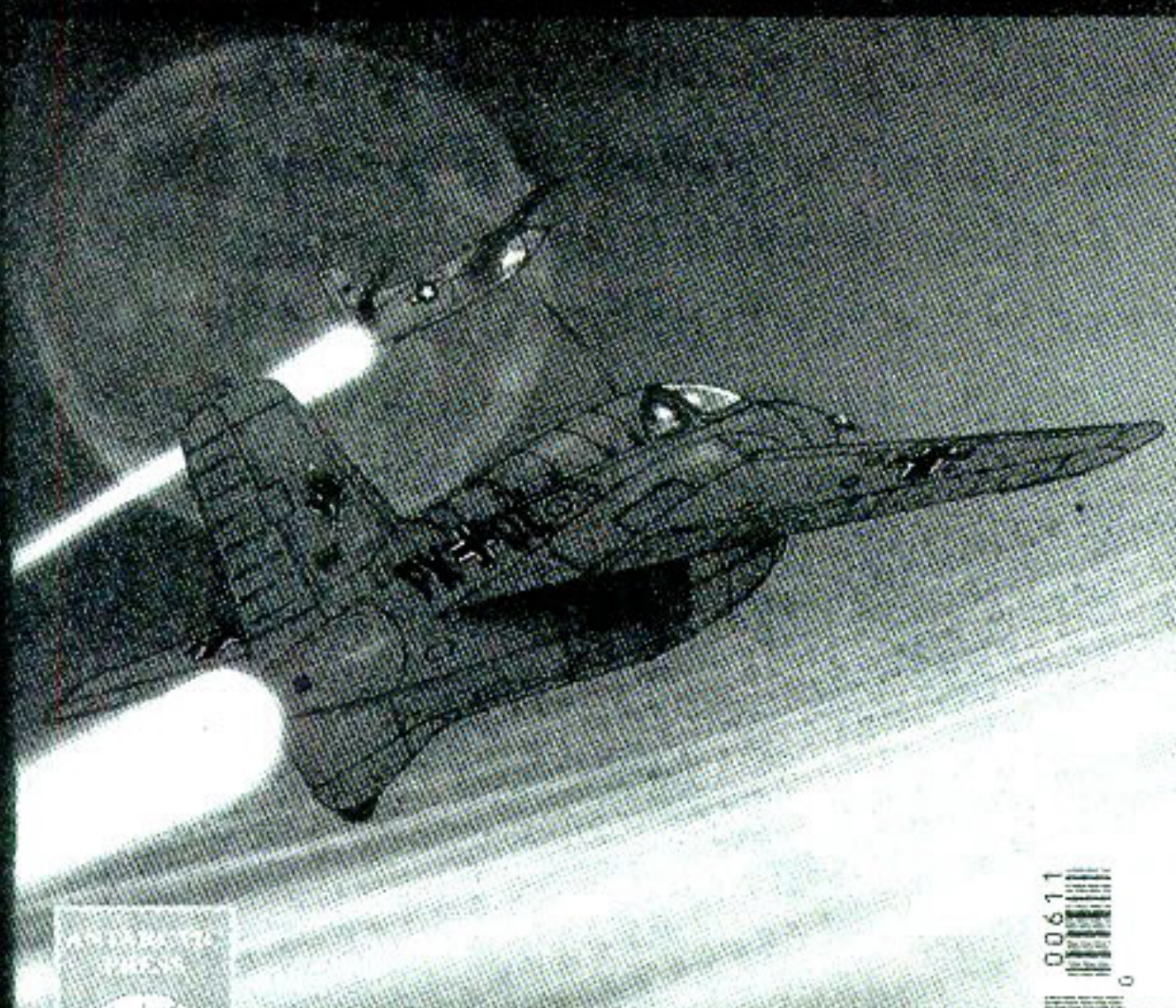

## Projekt Saucer



In the United States, rocket-powered aircraft were slow in coming, but **Northrop** began their study in 1942, and by July 5, 1945, the MX-324 rocket-powered flying wing had made its first flight. By that time, the war was coming to an end, and the scientists were already focusing their studies on civilian applications. While military necessity required von Braun to design a manned A9/A10 for possible reconnaissance over America, **Dr. Eugen Sänger** was designing a highly advanced "Silver Bird" antipodal bomber variant that started as a high-speed testbed in the 1930s. The Japanese started to use their "Ôka" rocket-powered suicide craft as a desperation measure while the Japanese version of the Me 163 was being manufactured as a J8M1 "Shusui" point-defense interceptor. In the same category, the Germans went further by creating the Bachem Natters and others that were never made operational, like the Arado E-381, Heinkel P-1077 and

Junkers EF-127. In Great Britain, the rocket studies remained nearly at a stand-still during the war years, but the British Interplanetary Society (BIS, not to be confused with

the banking institution) made a realistic study of a manned rocketship capable of reaching the Moon based on available data before the war. The 1939 version was to be powered by multiple clusters of solid-fuel rockets until the sixth stage could use the hydrogen peroxide rocket engines. After the war, the BIS designed a manned rocket based on V-2 technology not unlike the von Braun's study years earlier, and by 1947, they had designed an atomic-powered manned moonship. Germany lost the war, but it helped to start a space race, one that turned into a Cold-War Moon race that would ultimately cause the Americans to reach the Moon first.

Many of the rocket fighters that could have been included in this issue were already featured in the last issue, *Hitler's Kamikaze*, and much of the Me 163 developments and even the E381/P-1077/EF-127 series have already been featured in many books and magazines, and thus will be kept to a minimum in this issue, which is actually the second *Tech Manual* featuring rocket aircrafts. Bigger projects, like the manned A9/A10 and Sanger's spaceplane, are planned to be featured in the next issue, titled *The Amerika Bombers*. Some rocket-powered missile armaments carried by aircraft are featured in this issue as a supplement. Other series of rocket fighters that were never built, like the Focke-Wulf Ta-283, Horton Ho-XIIB and Lippisch P.13, will be covered in detail in a future issues, like *Mach Fighters* and *Ramjet Fighters*. In addition, the rocket-powered variant of the Me-262 will be covered in the *Stormbird Special*, plus an extensive profile of the Me-163 series is planned for the *Komet Special*.

As the *Luftwaffe: 1946 series* has evolved into the current *World War II: 1946 series*, future plans will include this new format.

As before, much of the information in this issue came from the highly talented team of **Justo Miranda** and **Paula Mercado**. Being readers of both series, they were generous enough to provide us with a bulkload of materials that helped this series greatly. Their work has already appeared in many aviation books and magazines around the world, including the famous ones like the German *Flugzeug* magazines and America's Monogram aviation books. As they expand their research to wider scopes, the *Luftwaffe/World War II: 1946 series* will be right behind them.

Rocket fighters were made by the men and women who dreamed of reaching the stars. Our space shuttle and the upcoming space station can trace their roots back to the war rockets of yesterday. One should remember but never blame the past and look to the benefits of the future.

Ted Nomura  
September 1999



# THE REICHDREAMS CONCEPT

When the balance of military power began to tilt in favor of the Allies during the last months of 1942, the Axis powers had to change their "conquer and consolidate" strategy for another of "defense of the metropolitan territory."

The industrial reorganization derived from this sudden change of political objectives proved to be of such a magnitude that Germany could only comply with it partially.

It was carried out by burying whole factories under armored tunnels, scattering industries to make enemy bombardments more difficult, developing new chemical technologies to compensate for the loss of raw materials such as rubber and oil, and exploring physics in all directions in the hopes of finding alternative industrial procedures, detection systems, new materials for engineering or...the final weapon.

Geographical imperatives forced the Allies to depend on aviation to "carry the war" to the German metropolitan territory. Bombing raids actually did only little damage to the Reich industry, but had a devastating effect upon the population. This was the reason why top priority was given to antiaircraft defense: artillery, missiles, radar and high-performance fighters.

In this way, German scientists and engineers, working under high pressure and having the right resources and motivation, created a huge dossier of projects without equal in the history of aeronautical technology, as much for the variety and ingenuity of designs as for the limited human resources and short span of time (five years) available to produce these amazing scientific and technological achievements.

Contemporary engineers' fantasy is strongly determined by such conservative terms as profit, safety, etc., all very reasonable in peaceful times. Exotic ideas which are not turned down in the computer are eliminated in the wind tunnel. Their German colleagues of 1943 had nothing to lose. They tested everything and...succeeded many times, as the winning powers confirmed in the post-war years.

Justo Miranda  
Madrid, Spain



## VON BRAUN INTERCEPTOR

In 1932, the Heereswaffenamt (The Armament Office of the German Army) created a scientific section for the research of rockets. Its activity ended in 1934 for lack of funding. The civil association "Verien für Raumschiffahrt" and some of its most important members (von Braun, Klaus Riedel) went into the Heereswaffenamt as engineers under Captain Walter Dornberger's direction.

The first rocket produced by the new team, named the A1 (Aggregate 1), failed at launching due to the deficient design of the engine, which was designed to burn liquid oxygen and alcohol. The rocket was stabilized by means of gyroscopes installed in the nose.

The next model, the A2, was equipped with a gyro-flywheel at the center of gravity and flew successfully up to a height of 2400 m in December 1934.

The A3 incorporated decisive novelties, introducing the concept of nozzle vanes for stabilization during takeoff. Several launchings were performed in the on the isle of Greifswalder Oie during 1937, and some deficiencies were found in the gyroscopic control device.

It was with the A5 in 1939 that the right balance was met among the different systems of propulsion, stabilization and control, allowing the construction of the giant bomber rocket A4 (V-2).

Besides cooperating with the Army, Wernher von Braun was interested in the application of rocket propulsion to conventional aircraft to improve their performance.

At the end of June 1937, he flew a conventional fighter of the Heinkel 112 type equipped with a rocket engine burning liquid oxygen and alcohol. On July 6, 1939, he presented to the Reichsluftfahrtministerium (RLM) a project for a vertical takeoff rocket interceptor based on the technology acquired with the A3.

The aircraft was stored in a hangar in a vertical position, hanging from two rails separated 6 meters from each other. A wheeling system, with an electric remote control, was used to take it out of the hangar and position it for launching over a blast deflector. Once the target was found by means of land-based FuMG 39T "Würzburg A"-type radar, the flight control center worked out the optimum interception trajectory and launched the aircraft by remote control.

During the climbing path, the gyro control unit automatically stabilized the device during the first 53 seconds, using the exhaust nozzle vanes. The pilot took manual control upon reaching 8000 meters, changing the propulsion to the auxiliary combustion chamber (less powerful, but also more fuel-efficient) and performing a classic interception at 700 km/h.

The drawings show this machine equipped with a parabolic radar antenna in the nose, similar to the one in the FuG 240/1 "Berlin N-1" of 1945. This could very well mean that it was intended to be part of an advanced system of all-weather interception—in 1939!

It was planned to fit it with some type of telescopic sight, most probably a predecessor of the "Spanner" infrared detectors of 1941.

The pilot was positioned in a pressurized cockpit with a double windscreen. The outer part, an enveloping type, provided aerodynamic coverage. The inner part, reinforced and probably armored, was integrated with the pressurized cockpit. The flight back to the base was gliding, then landing on a retractable skid, like the Me 163. This design was highly similar to that of the Bell X-1 rocket aircraft, which performed the first supersonic flight on October 14, 1947.

It was a very advanced concept for the time, and the RLM considered it impractical to carry out such an exotic project. One of the reasons given was the difficulty to store, handle and transport the cryogenic propellants, with preference going to the development of the Walter HWK R I-203 rocket engine (less powerful, but safer). This worked with non-cryogenic propellants, which were cheaper than liquid oxygen and easier to obtain by the chemists of the time.

After this decision, Wernher von Braun had to reconsider his offer, presenting to the RLM on May 25, 1941 an improved version of the original interceptor, based on the technology of the A8 missile. It was propelled by a rocket with two combustion chambers which worked with a mixture of Visol and SV-Stoff, both of which were easy to store at a standard temperature. It could also be launched from the same truck used to transport it.

Although the idea was never officially accepted by the Luftwaffe, it attracted the attention of the qualified engineer Erich Bachem, technical manager of the company Gerhard Fieseler Werke and author of two designs of vertical takeoff rocket interceptors in 1941.

The first one, known as the Fi 166 Höhenjäger I, was inspired by the Messerschmitt BF109 TL. It consisted of a rocket very similar to the A5 appended to the belly of a jet fighter with two turbo engines under the wings. The second one, the Fi 166 Höhenjäger II, was a big two-seater rocket aircraft very similar to the first design of the von Braun interceptor.

In the spring of 1944, the RLM requested a fighter for local defense, and the manufacturers considered again the idea of a rocket-propelled aircraft. This is how Heinkels' P1077 "Julia", Junkers' EF127 "Dolly" and Erich Bachem's BP-102 "Natter" projects were born. The latter had already founded his own aircraft company by this time.

The "Dolly" was designed for a conventional takeoff by means of a trolley with accelerator rockets. The "Julia" had two different versions. In the Julia I, the pilot was in a prone position to avoid the loss of consciousness caused by high-speed maneuvers. In the Julia II, which was launched from an almost vertical ramp, the pilot was seated to better withstand the takeoff acceleration. This is the usual position adopted during the launching of manned spaceships today.

The BP-20 was very similar, but showed an unpleasant tendency to become dismantled during flight, necessitating the recovery of the most valuable parts by means of parachutes.

# VON BRAUN INTERCEPTOR

## Technical Data (Stage I)

**Stage:** Project

**Structure:** Metallic

**Engine:** A liquid-propellant rocket based in the A3 missile's with two combustion chambers. It was hoped to obtain a thrust of 10,000 kg for the vertical flight with the main one, 725 kg with the cruising one.

**Propellant Tanks:** Three in the fuselage: one of A-Stoff (liquid oxygen), another of M-Stoff (75% methyl alcohol) and one of pressurizer (nitrogen)

**Guidance System:** Gyroscopic stabilizers during vertical flight, with nozzle vanes acting over the main nozzle

**Armament:** Four machine guns installed in pairs in the wing roots

**Wingspan:** 8.5 m

**Length:** 9.3 m

**Height:** 3.02 m

**Weight Loaded:** 5000 kg

**Cruising Speed:** 700 km/h

**Climbing Speed:** 151 m/s

**Range:** 15 min.

**Ceiling:** 8000 m

## Technical Data (Stage II)

**Stage:** Project

**Structure:** Metallic

**Engine:** A liquid-oxygen rocket based in the A6 missile's with two combustion chambers. It was hoped to obtain a thrust of 10,160 kg for the vertical flight with the main one, 770 kg with the cruising one.

**Propellant Tanks:** Four in the fuselage: one of SV-Stoff (94% nitric acid, 6% nitrogen dioxide), another of Visol (isobutyl-vinyl compound) and two for pressurizers T-Stoff (highly concentrated hydrogen peroxide) and Z-Stoff (watery solution of sodium or calcium as a catalyzer for the T-Stoff).

**Fixed Armament:** Four machine guns installed in the wing roots

**Wingspan:** 8.6 m

**Length:** 9.3 m

**Height:** 3.2 m

**Weight Loaded:** 5080 kg

**Cruising Speed:** 690 km/h

**Climbing Speed:** 143 m/s

**Range:** 15 min.

**Ceiling:** 8000 m

Abbildung und Startanordnung für Rückstoßjäger

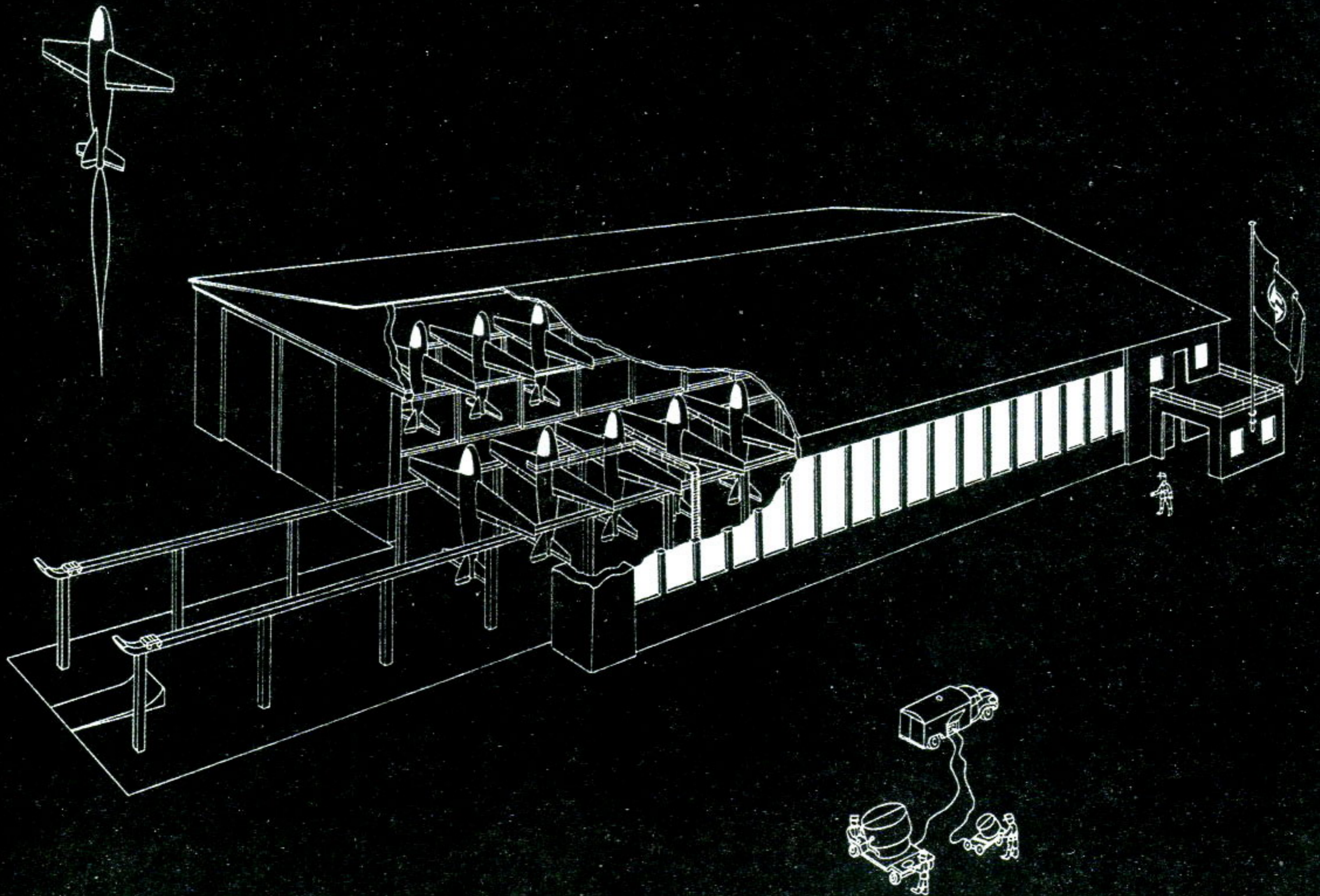

Von Braun Interceptor (Stage 1)

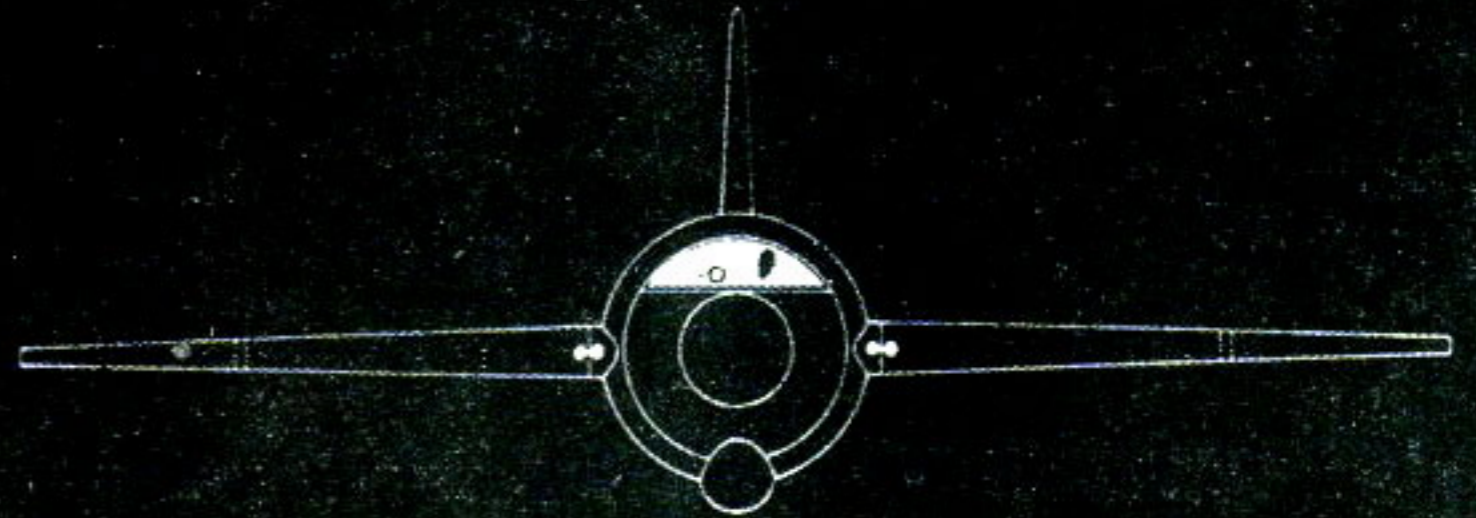
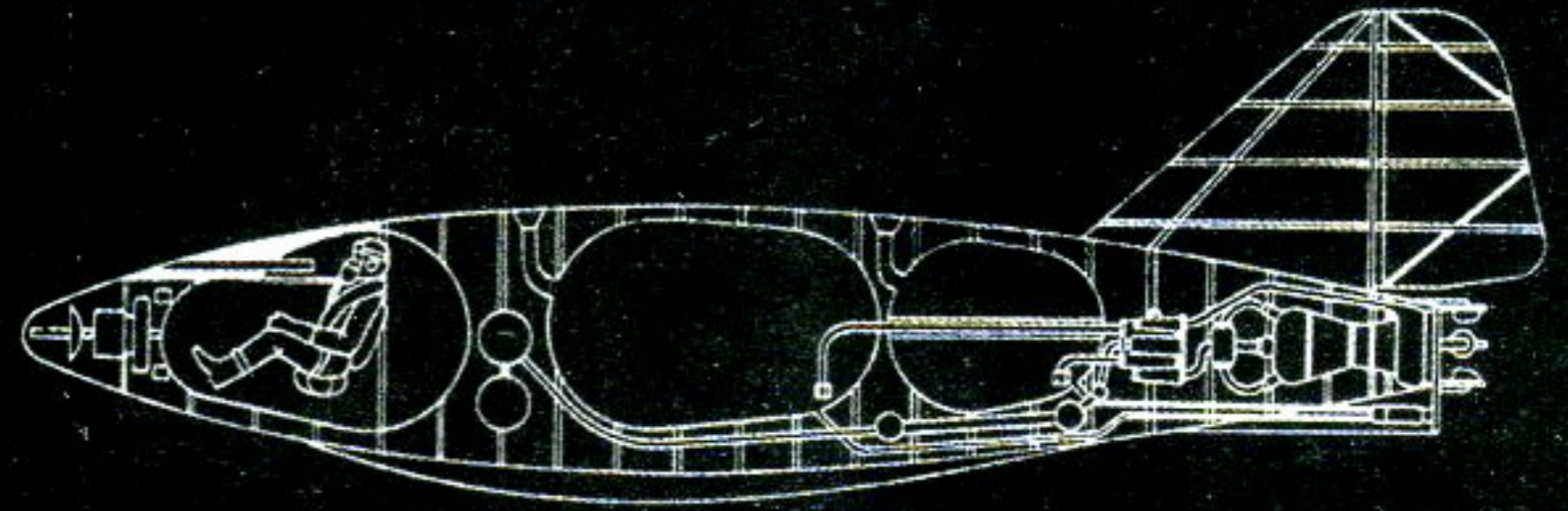
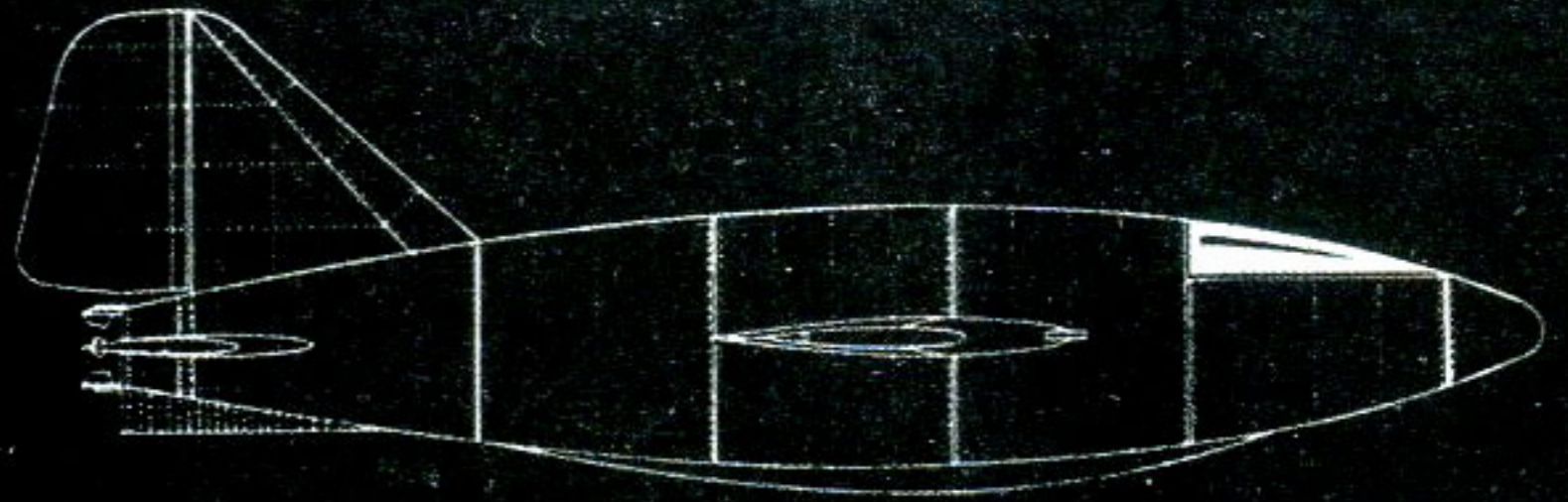
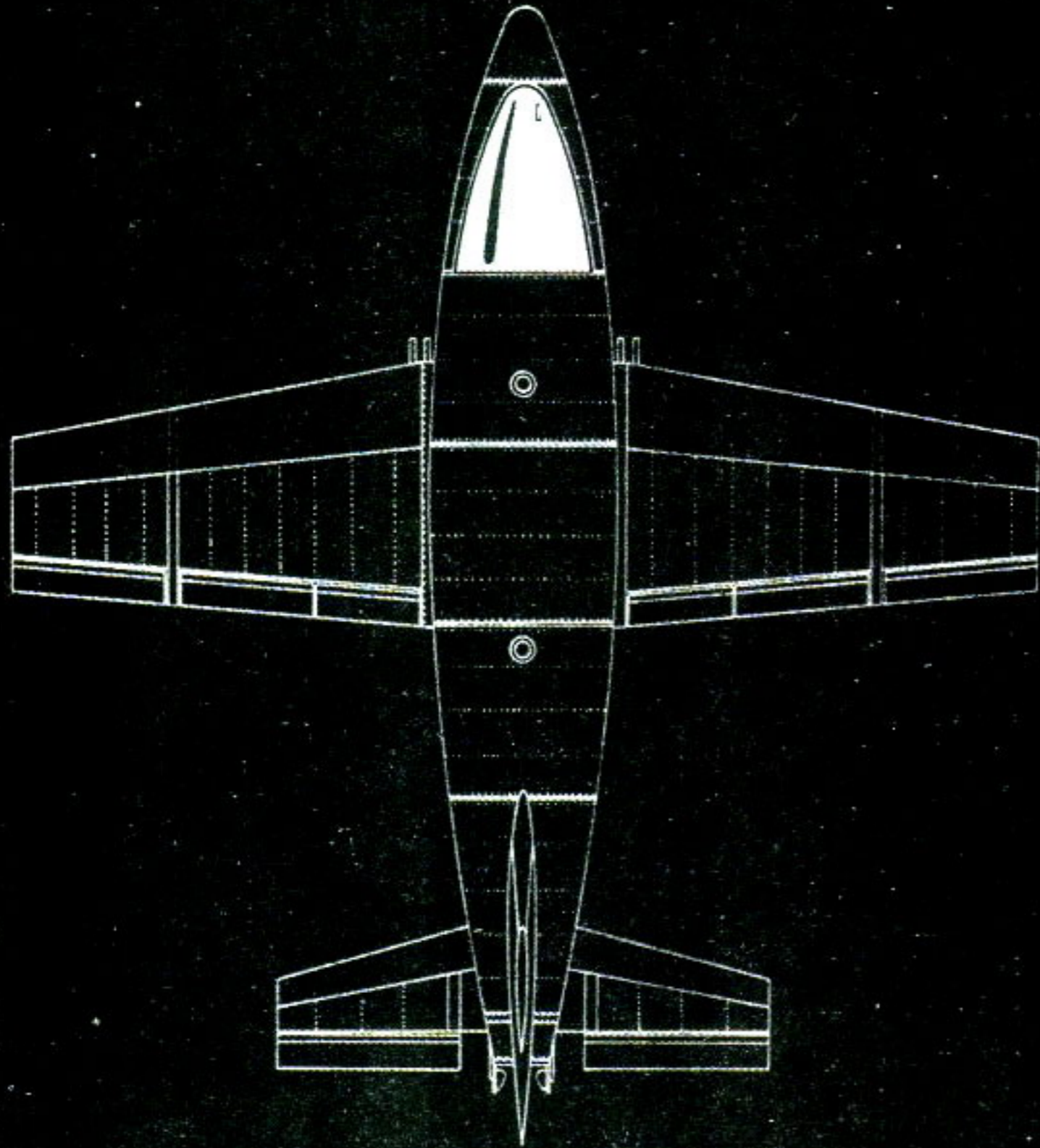

Von Braun Interceptor (Stage II)

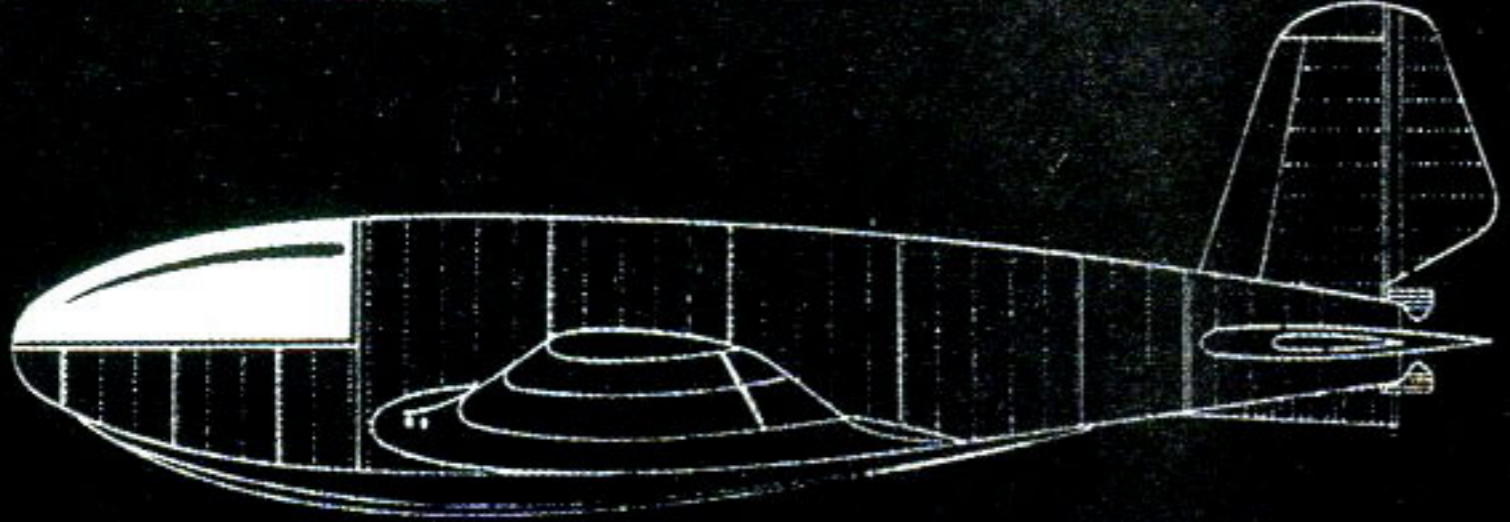
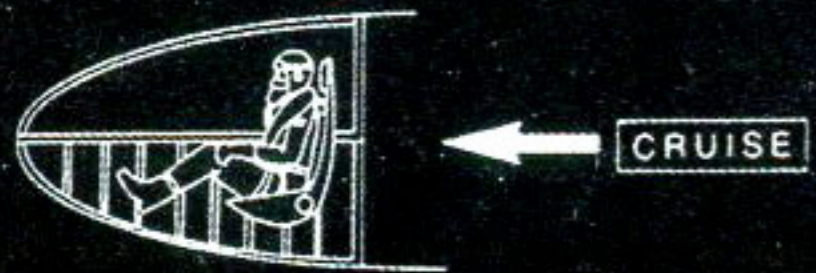

TAKEOFF

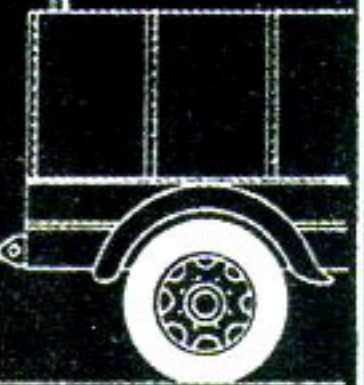
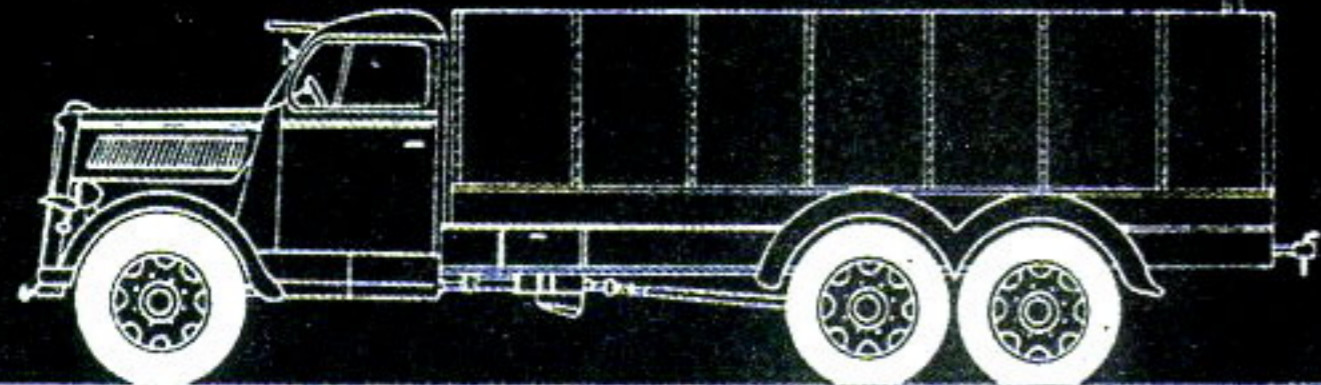
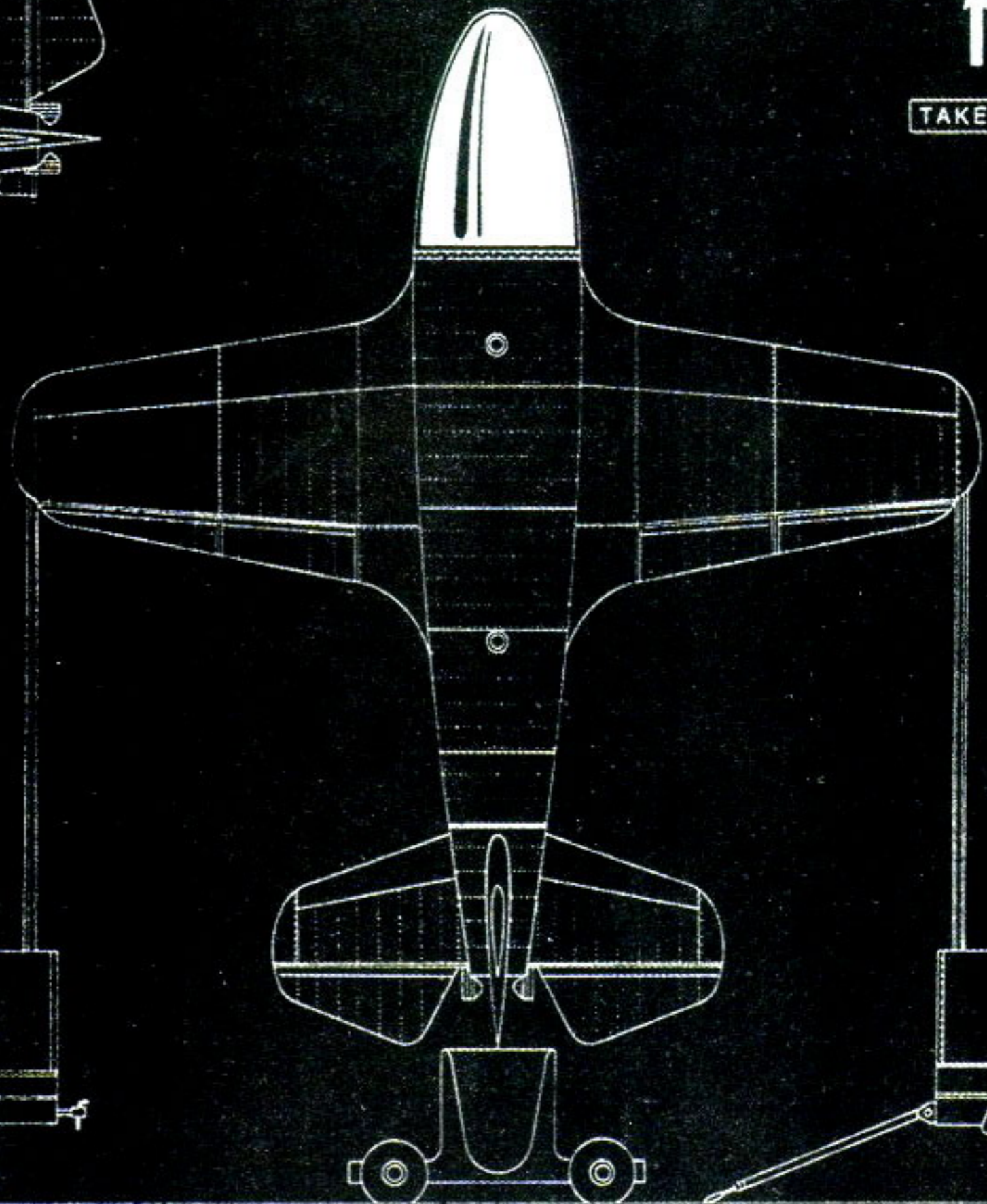

RAKETENJÄGER

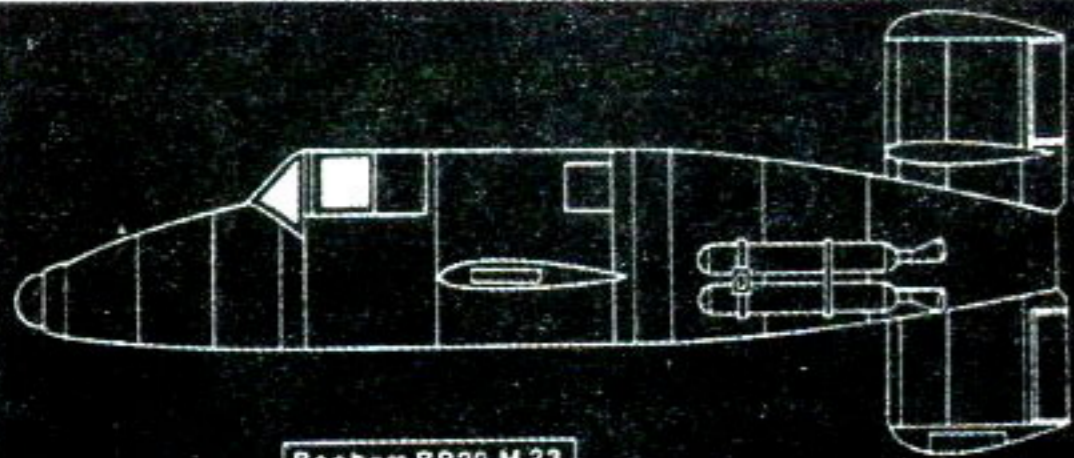

Bachem BP20 M 23

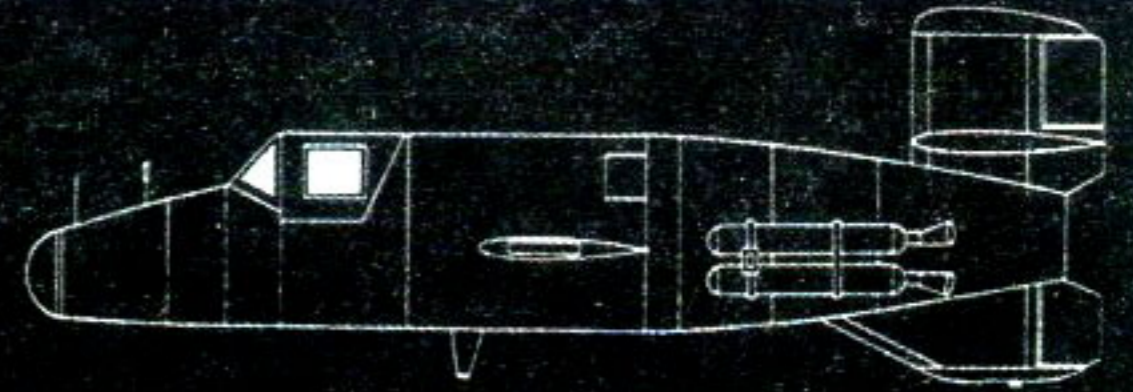

Bachem Ba 349 A



★ Arado E 381 (first version)



★ Arado E 381 (second version)



★ Arado E 381 (third version)

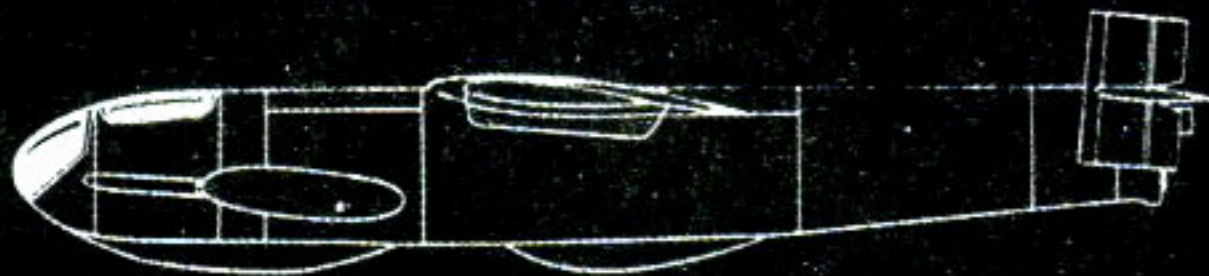

★ Heinkel P 1077 'Julia I'



★ Heinkel P 1077 'Julia II'

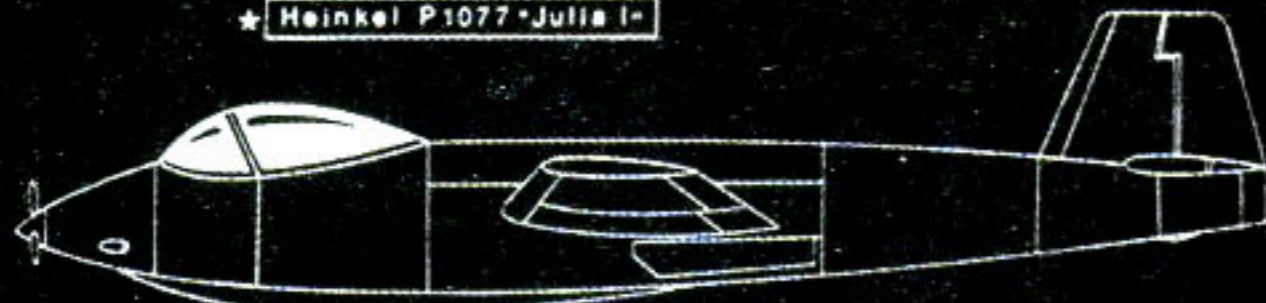

★ Junkers EF 126 'Elly'

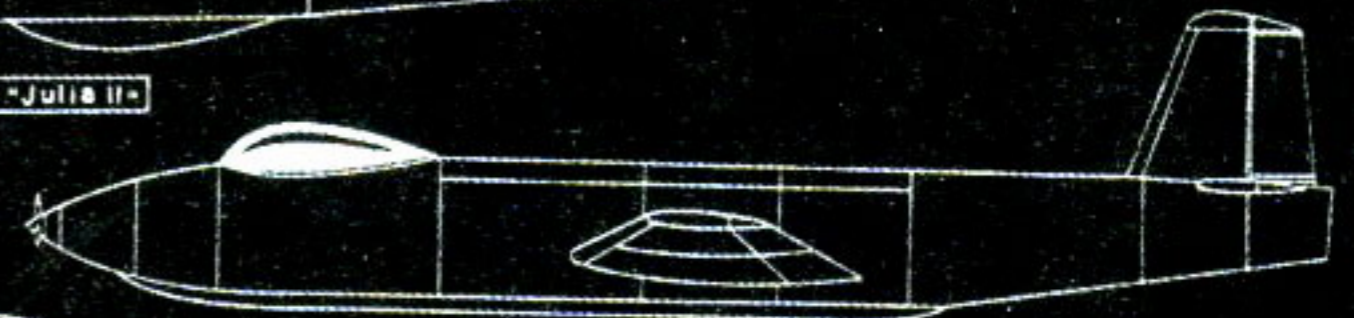

★ Junkers EF 127 'Wally'

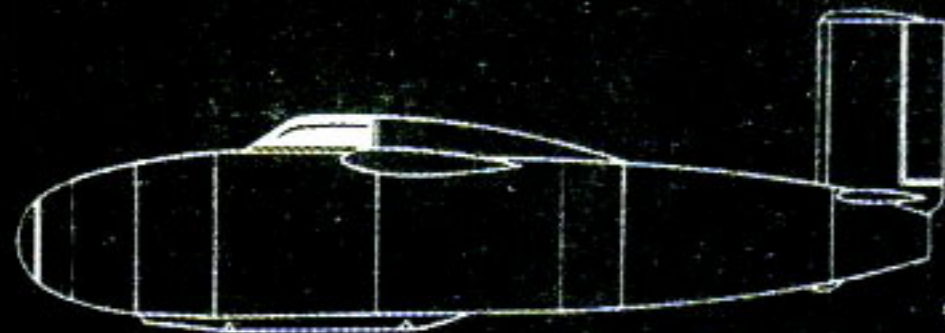

★ Messerschmitt P 1104 (22-9-44)



★ Messerschmitt P 1103 (6-7-44)

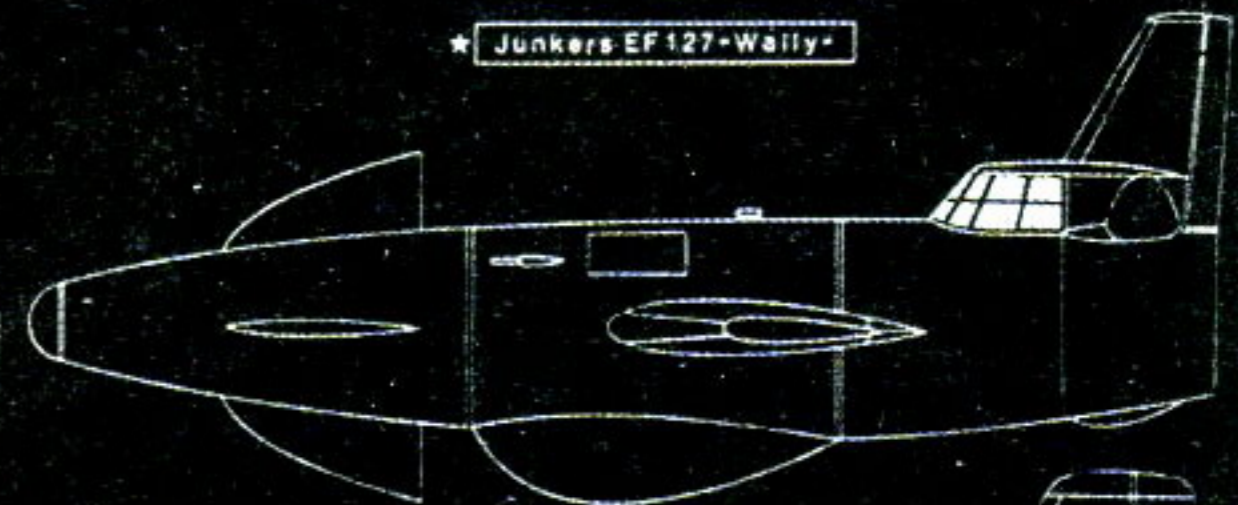

★ Sombold So 344

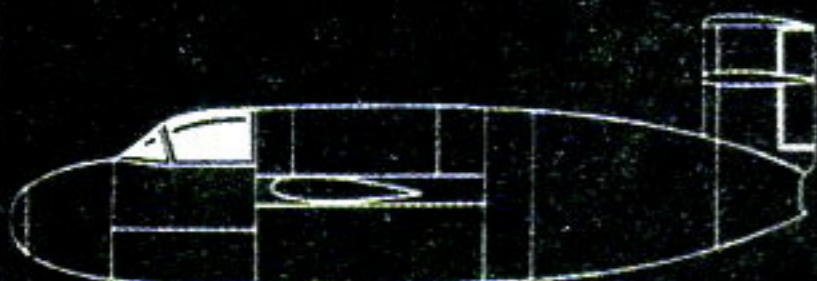

★ Messerschmitt P 1104 (10-8-44)



★ Zeppelin-Fliegende Panzerfaust



★ Zeppelin-Rammer



Messerschmitt Me 163 C



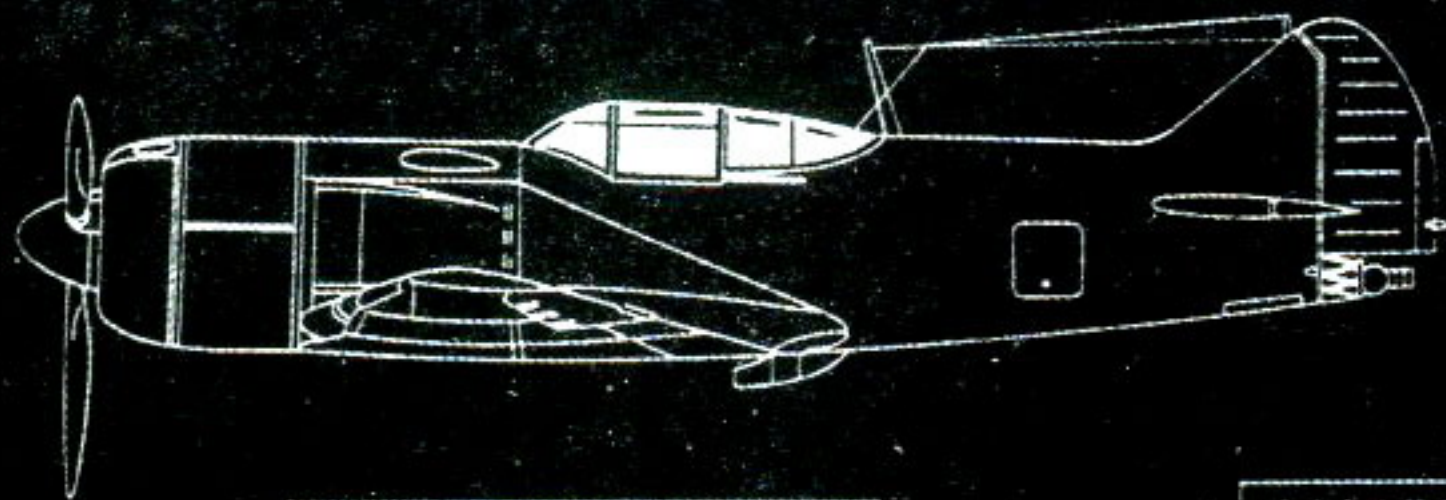

Lavochkin La-7R october 1944

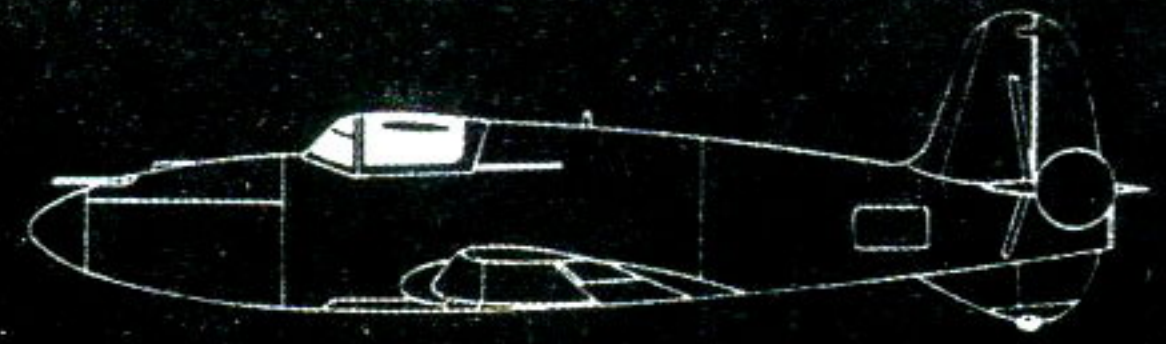

Berznyak-Iseev BI-1 may 1942

ALLIED ROCKET PLANES  
1936-1944

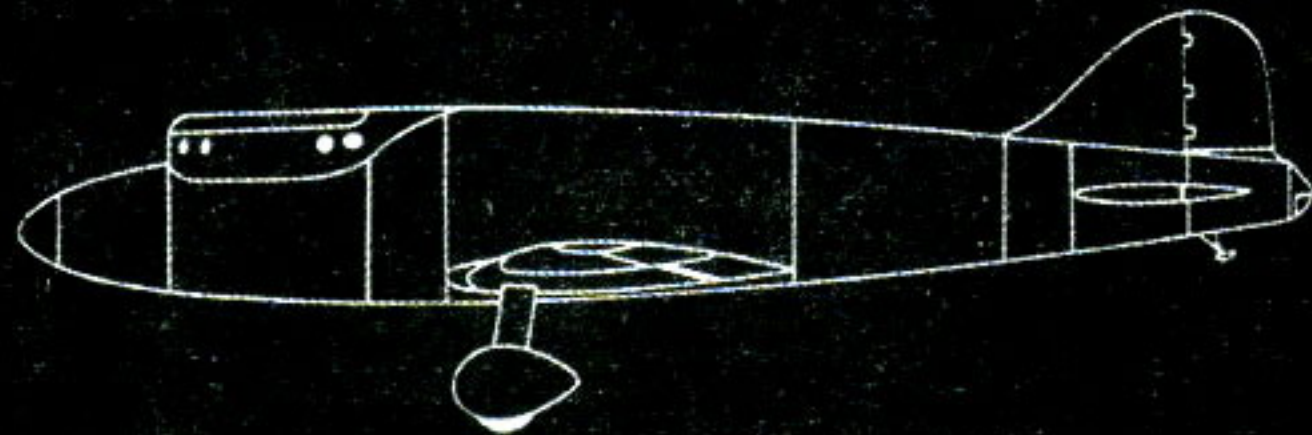

★ Korolev-Shchetnikov RP-218 1936



Polikarpov-Malyutka-1944

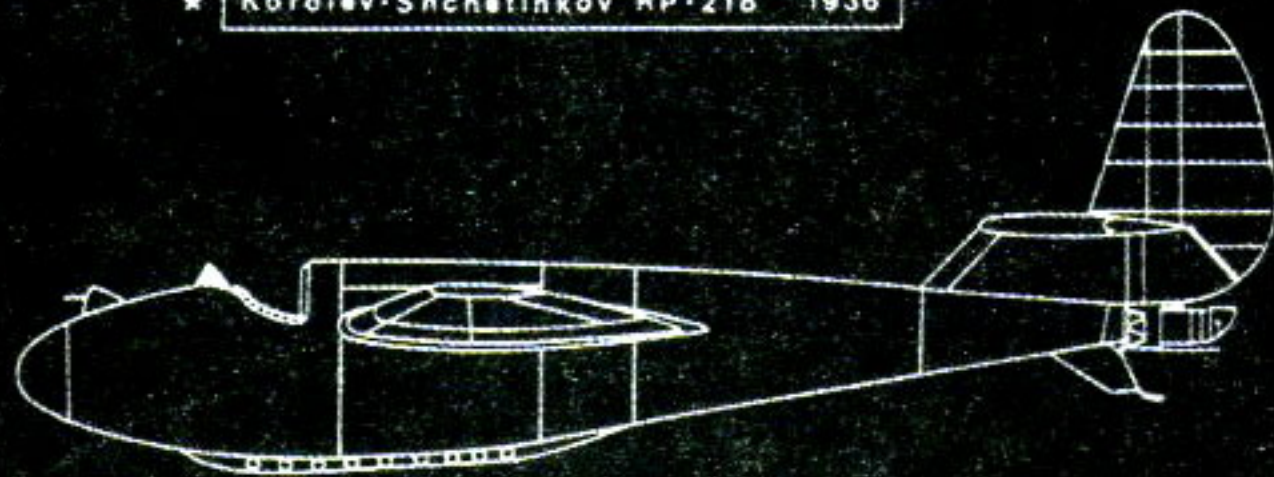

Korolev RP-318 28th february 1940

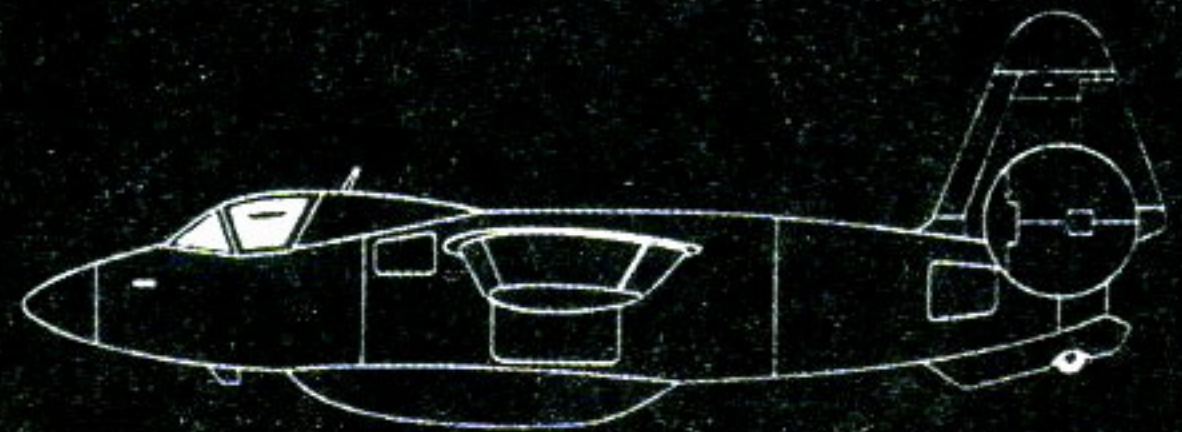

Florov N.4302 1944

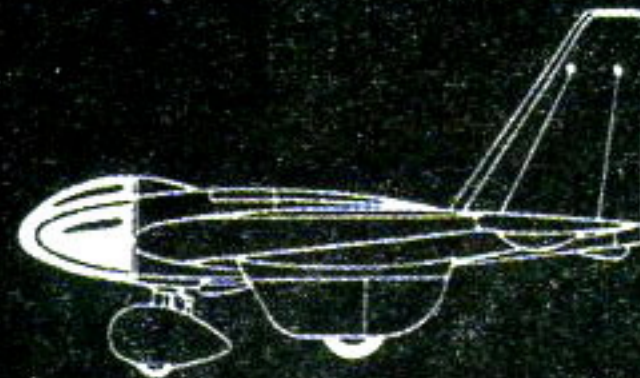

Northrop MX-324 2nd october 1943



★ Northrop XP-79

★ DESIGN ONLY

## Technical Data

**Stage:** Flight tests

**Type:** Experimental rocket aircraft

**Wings:** Metallic structure and coating with flaps and two propellant tanks located between the landing gear housing and the fuselage

**Fuselage:** Metallic structure and coating, containing a tank of liquid oxygen in front of the cockpit, one of methyl alcohol behind it, and another of petrol under the pilot's seat, as well as several bottles of compressed air and the rocket engine

**Empennages:** Metallic structure and coating, with braced horizontal plane

**Landing Gear:** Retractable, fixed tail wheel

**Engines:** A 600-Hp Junkers 12-cylinder Jumo 210C with the liquid-refrigerated cylinders in an inverse V, and an EMW rocket engine working with liquid oxygen and methyl alcohol to provide a thrust of 300 Kp for 90 seconds

**Propeller:** A three-bladed VDM, metallic, with a constant speed and a diameter of 1580mm.

**Wingspan:** 11.79 m

**Length:** 8.96 m

**Height:** 3.24 m

**Wing Area:** 21 m<sup>2</sup>

**Maximum Speed:** 480 km/h with a 90-second rocket burn time

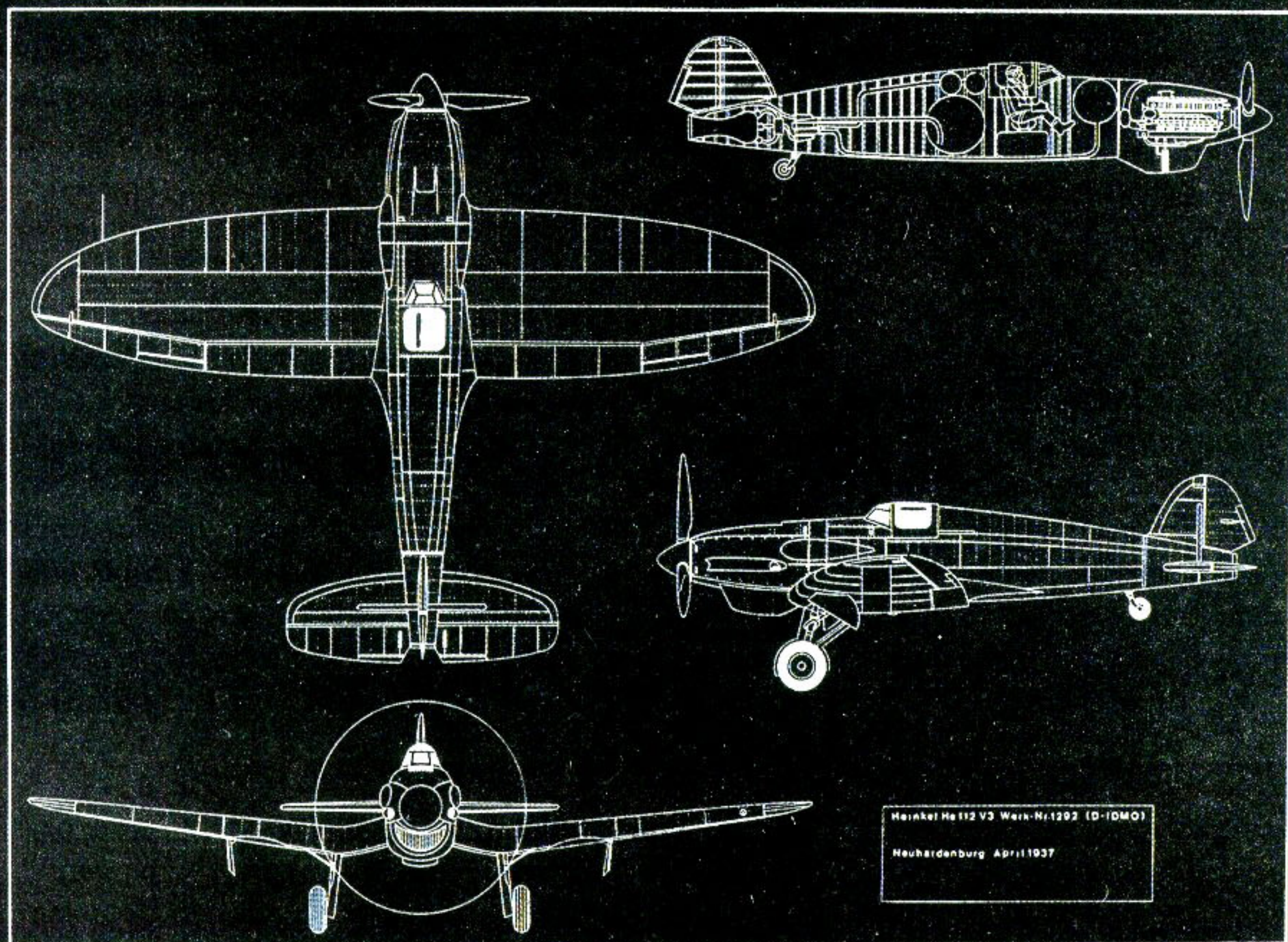

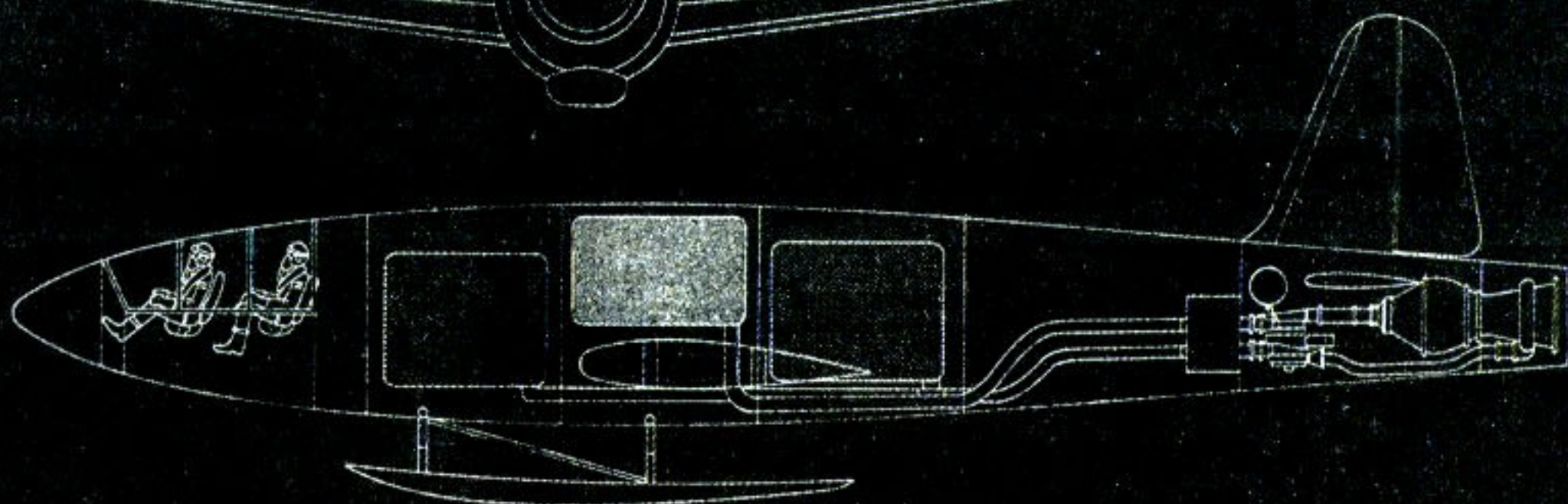
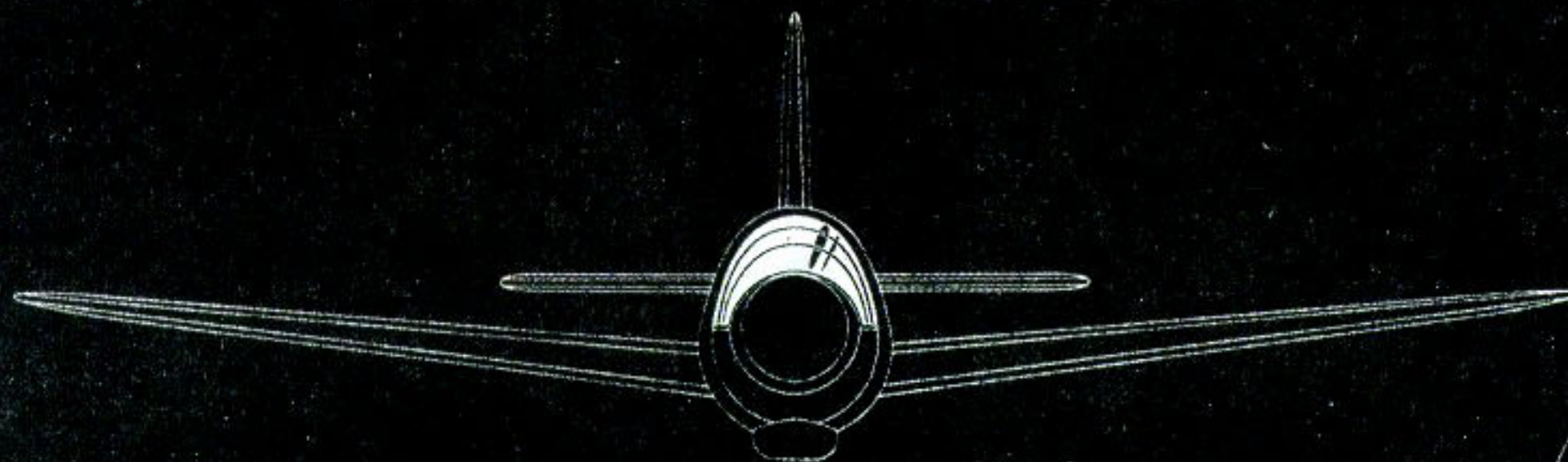
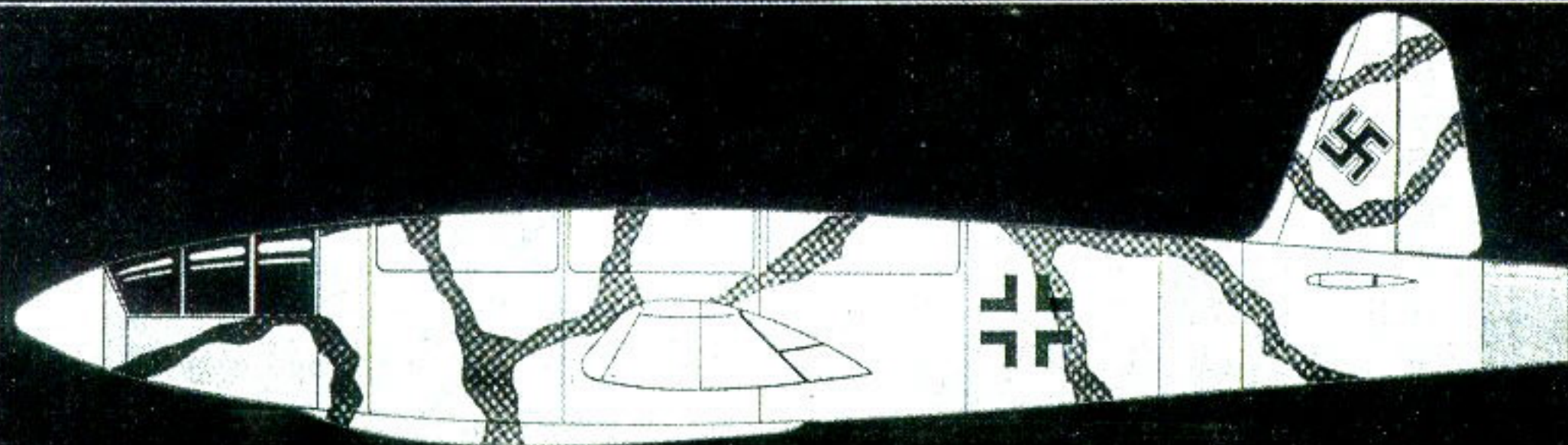

Fieseler F. 156 «Hohenjäger»

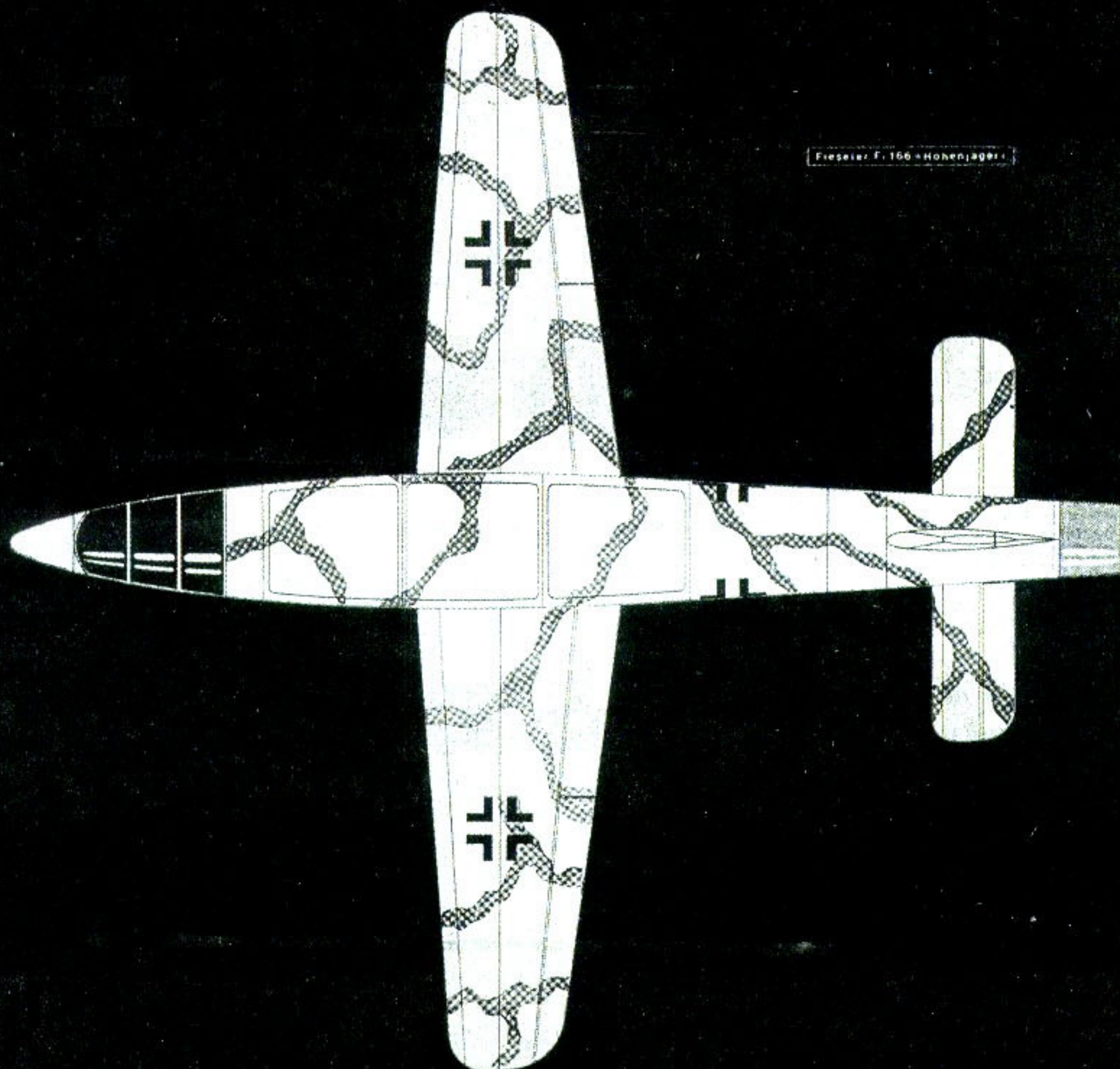

DFS 228 V1

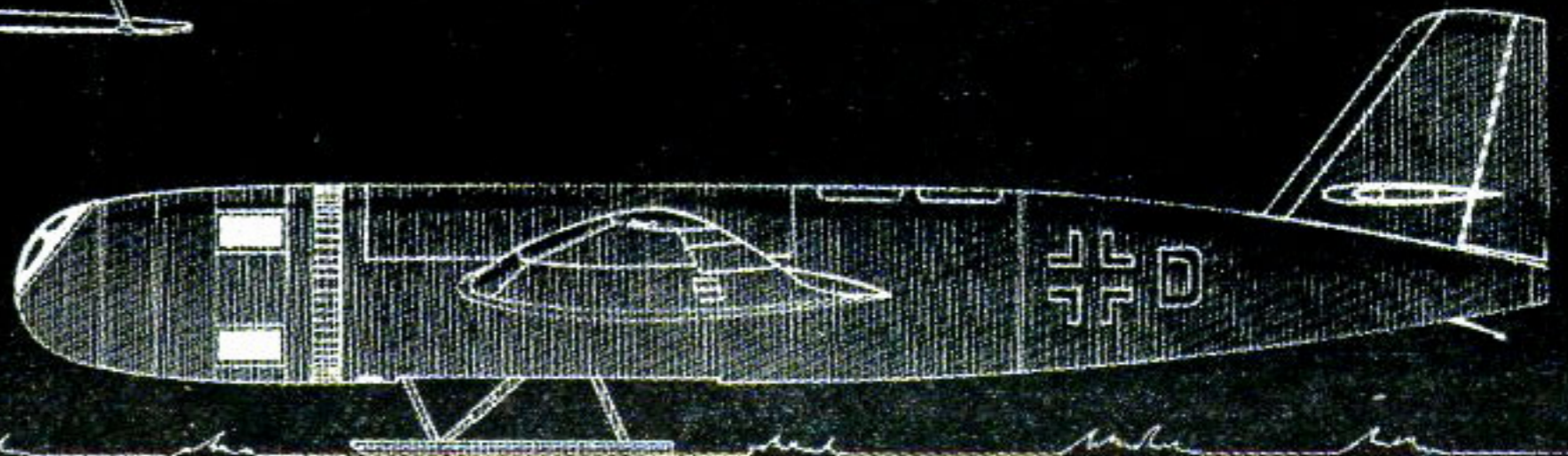
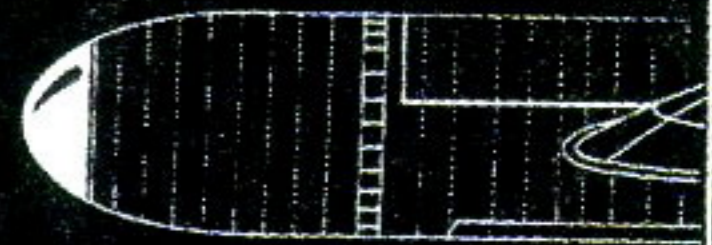
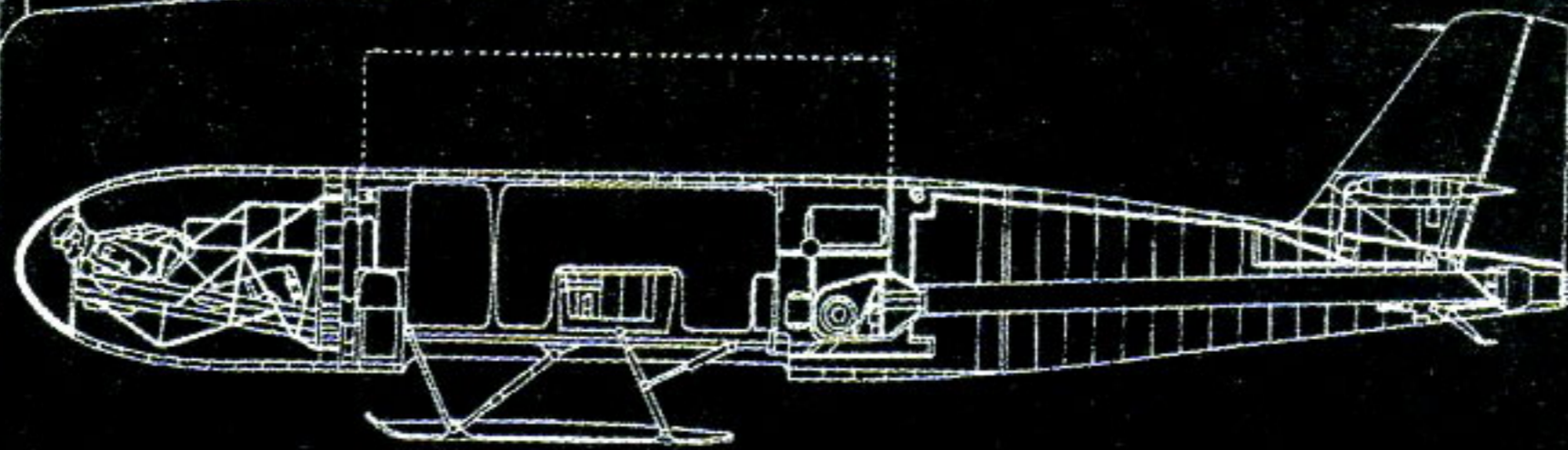
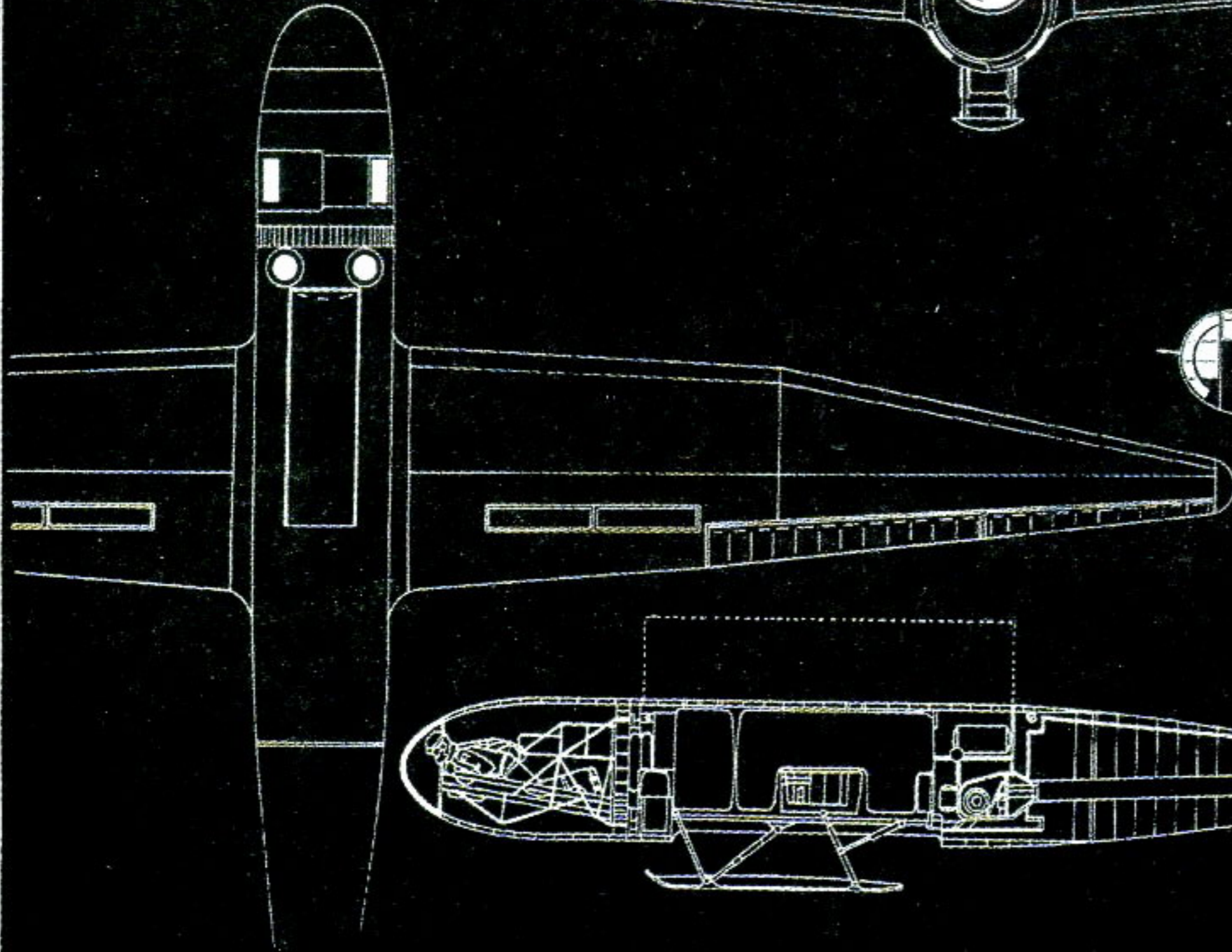
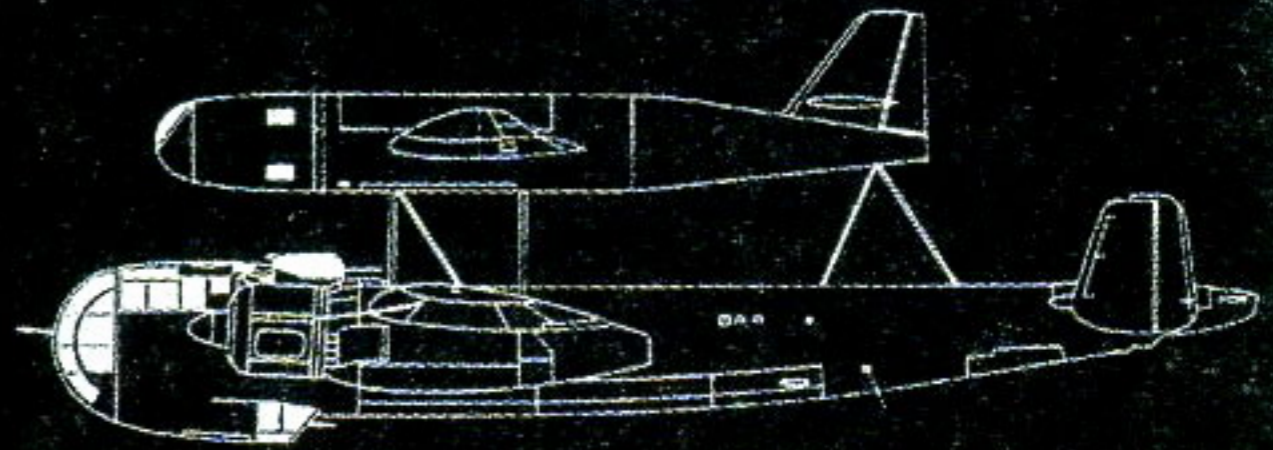
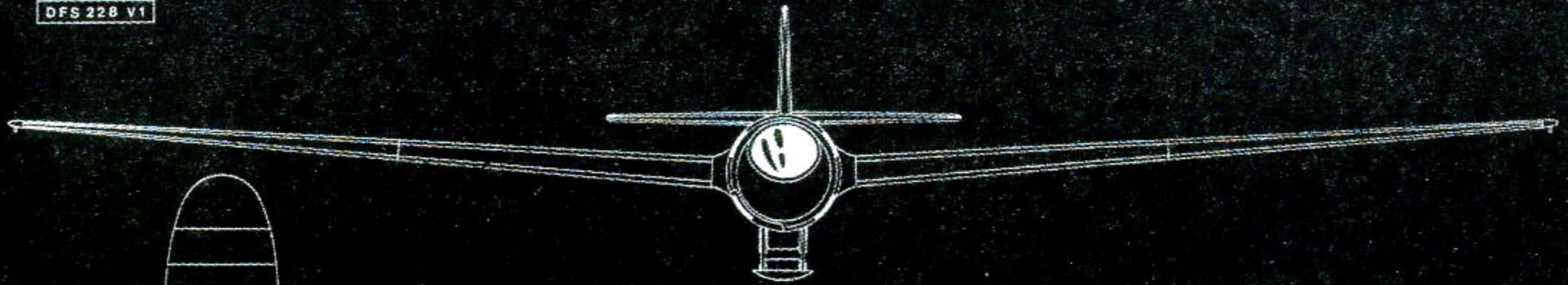

*Handwritten signature or text at the bottom of the drawing.*

## BLOHM UND VOSS MGRP (Manuell Gesteuertes Raketen Projektil)

This was a project for a bombing rocket to be guided close to the target by a parasite plane.

The weapon and parasite plane were carried up to 180 miles from the target (a city) on the back of a Dornier Do 217 which, before release, went into a shallow dive to allow the ignition of the ramjet. This quickly climbed to a stratospheric height, from which the pilot located the target by radar and released the main rocket in a ballistic trajectory with a maneuver of an estimated 20 G's.

To compensate for some of the G-force effects, the pilot travelled in a prone position over a shock-absorber harness.

After release, the ramjet of the parasite plane ignited. The plane kept its tanks full for its way back.

### Technical Data (Parasite plane data in parentheses)

**Stage:** Project

**Structure:** Metallic

**Landing Gear:** (Skids)

**Power Plant:** Ramjet Lorin (Ramjet Lorin)

**Guidance System:** Inertial (Piloted)

**Span:** (6 m/19 ft. 8 1/8 in.)

**Length:** 8 m/26 ft. 2 7/8 in. (5 m/16ft. 3 5/8 in.)

**Height:** 1 m/3 ft. 6 1/2 in. (1.62 m/5 ft. 3 3/4 in.)

**Launch Weight:** 1200 kg/2640 lb. (500 kg/1102 lb.)

**Propellant Weight:** 2300 kg/5060 lb.

**Maximum Compound Speed:** 1000 km/h/556 mph

**Maximum Parasite Speed:** 720 km/h/403 mph

**Range with Carrier:** 1000 km/621 mi.

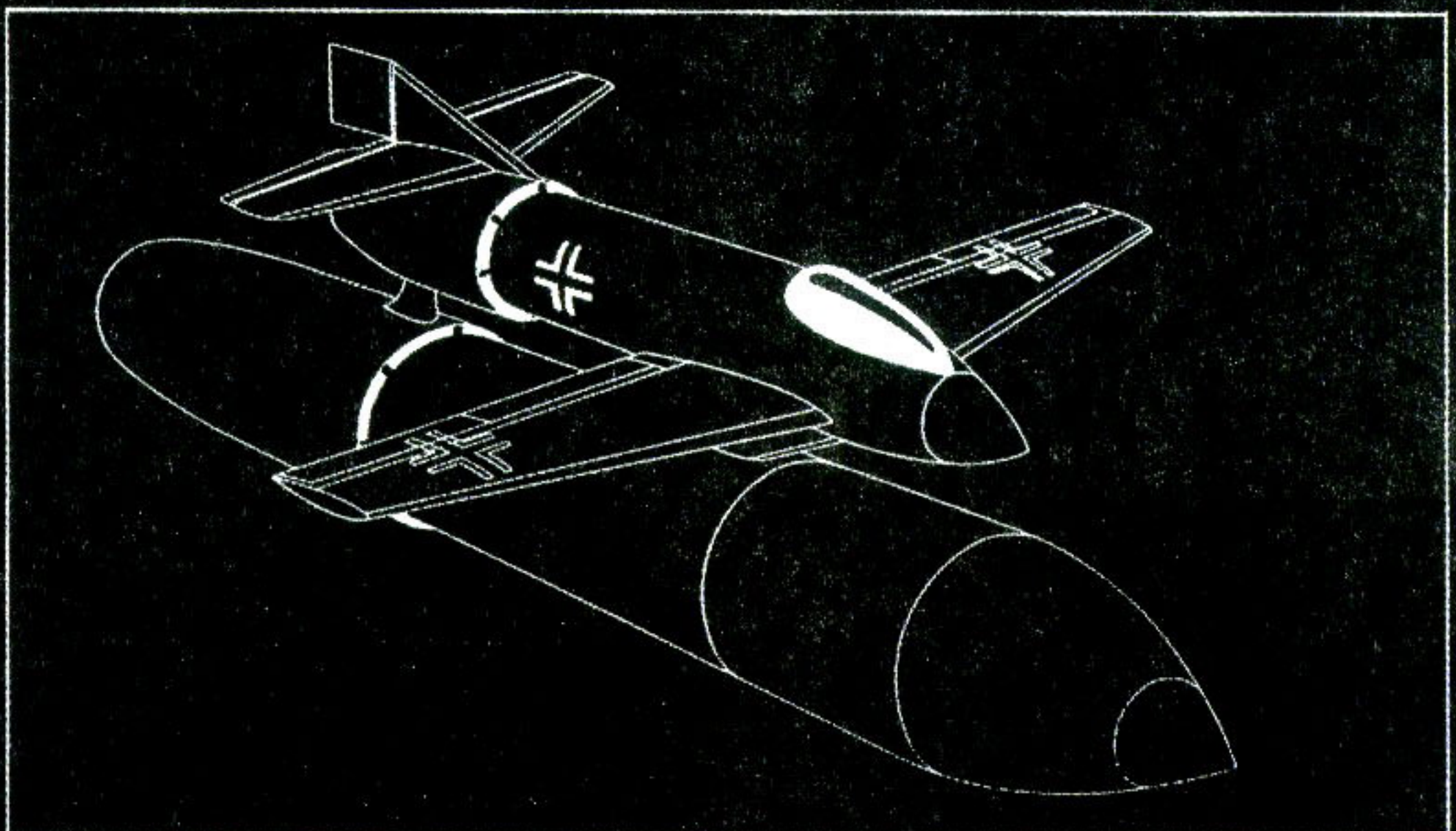

BLOHM UND VOSS MGRP

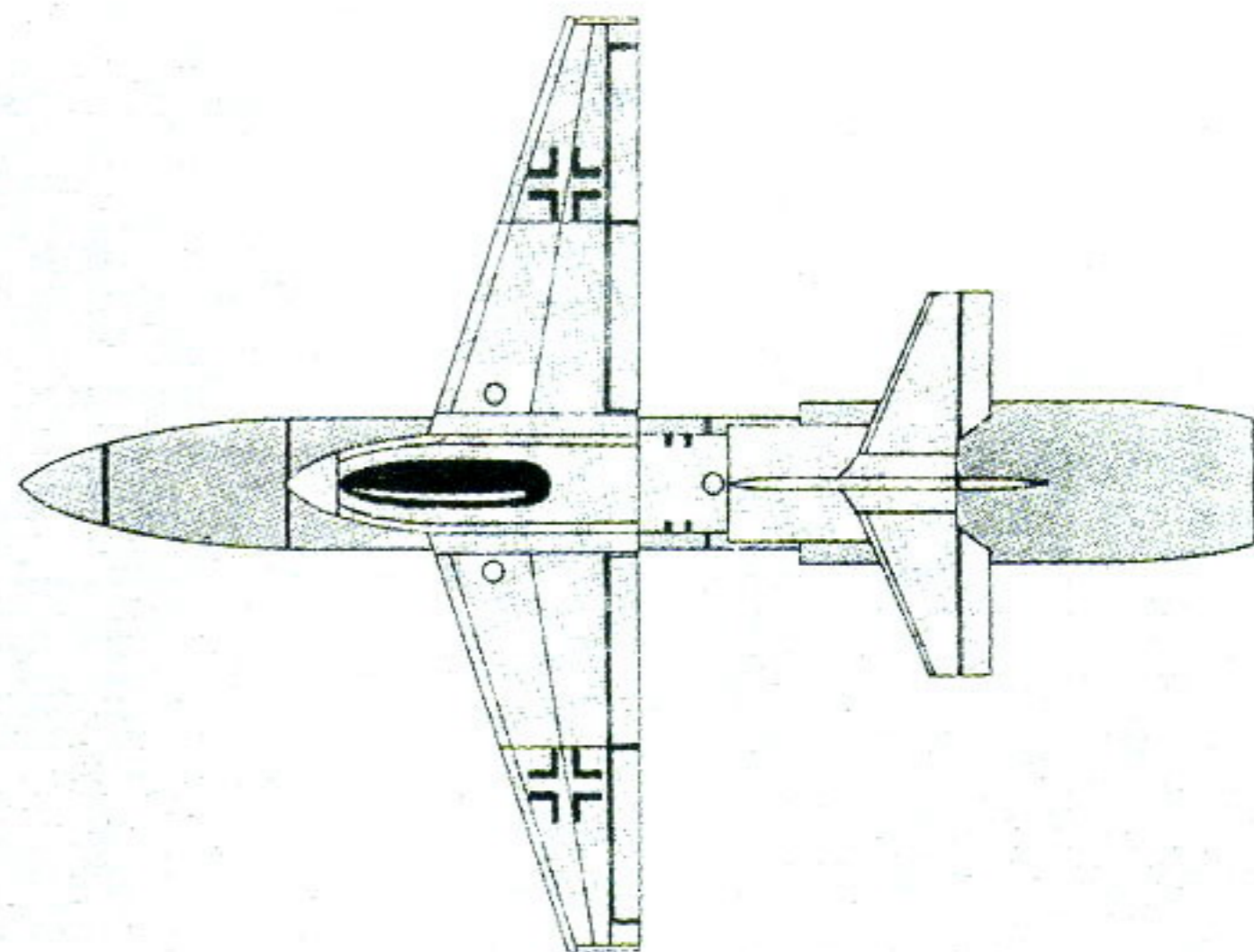
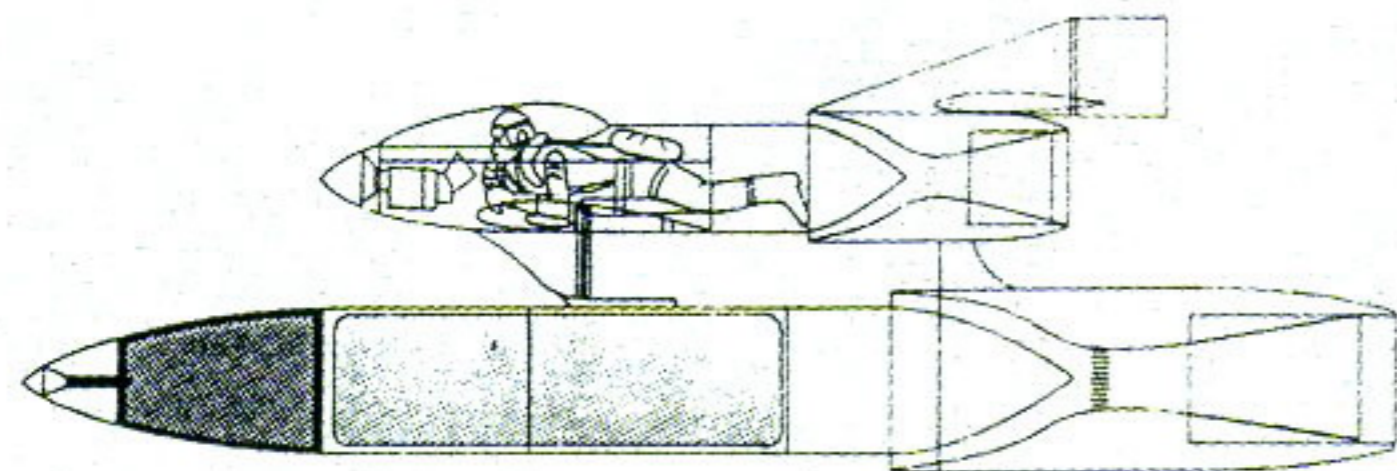
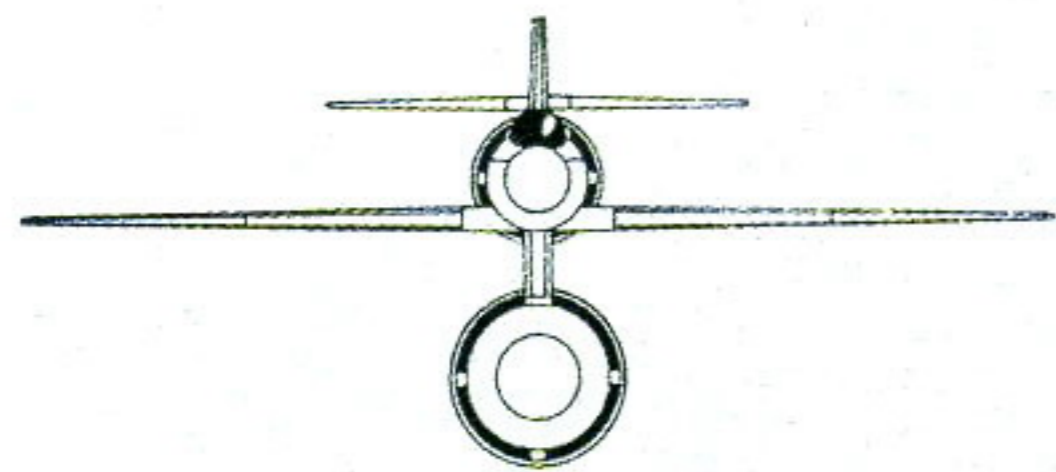
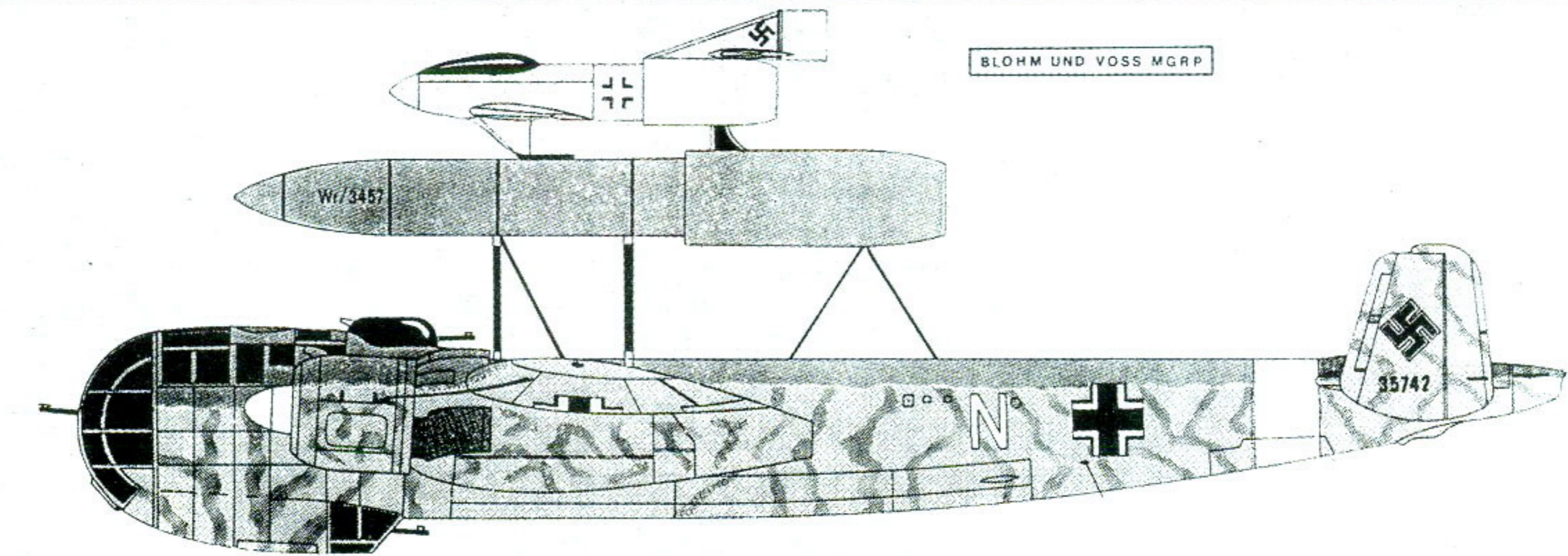

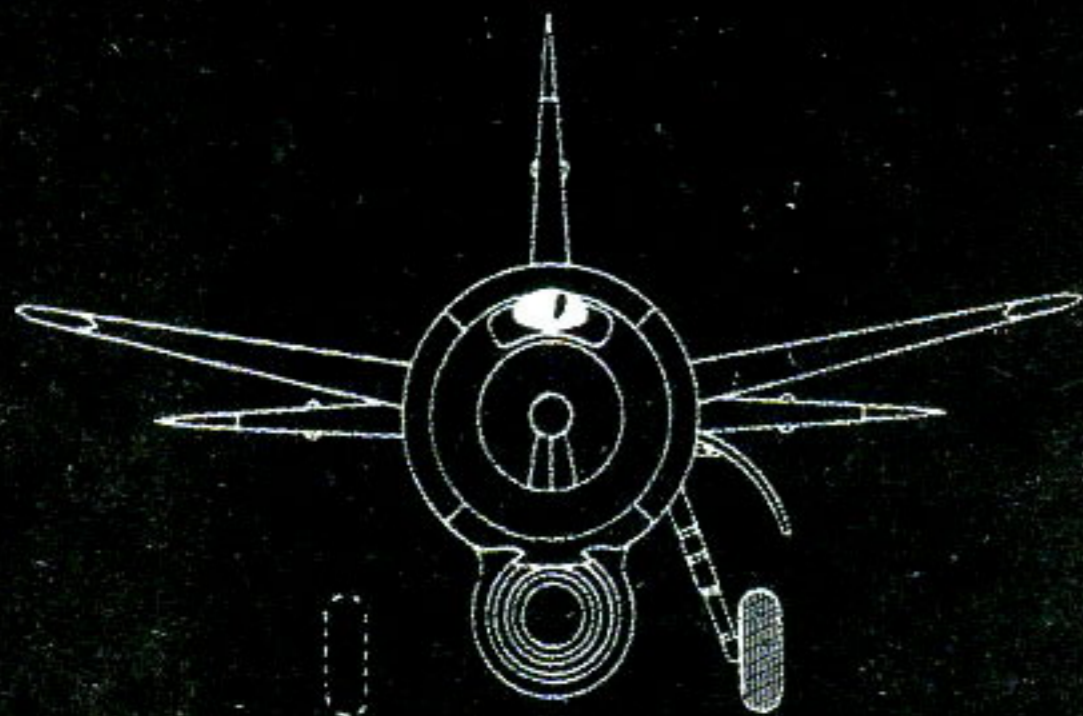
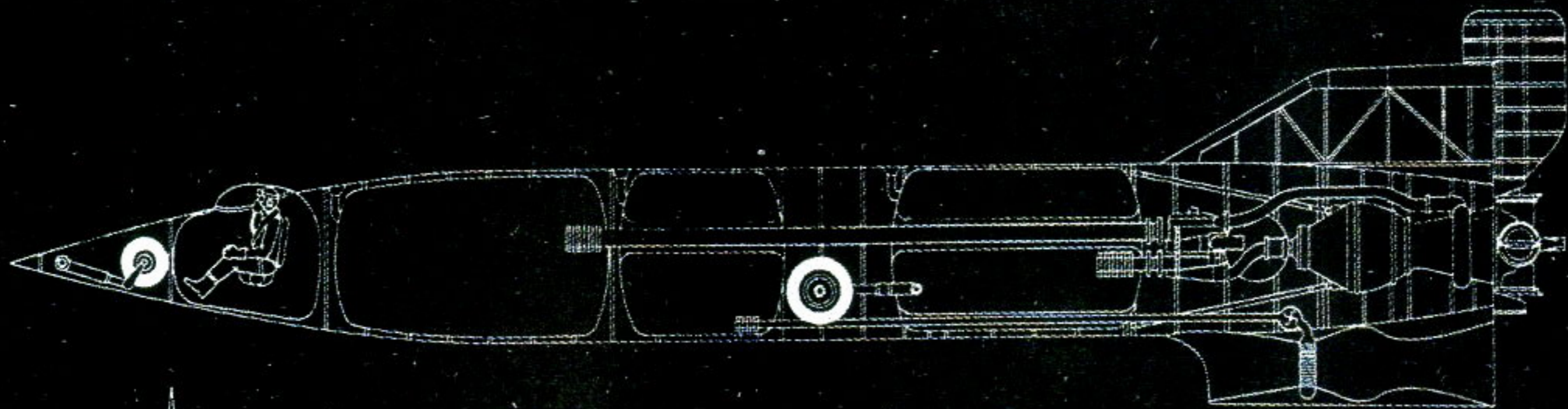

★ Wernher von Braun / EMW A6

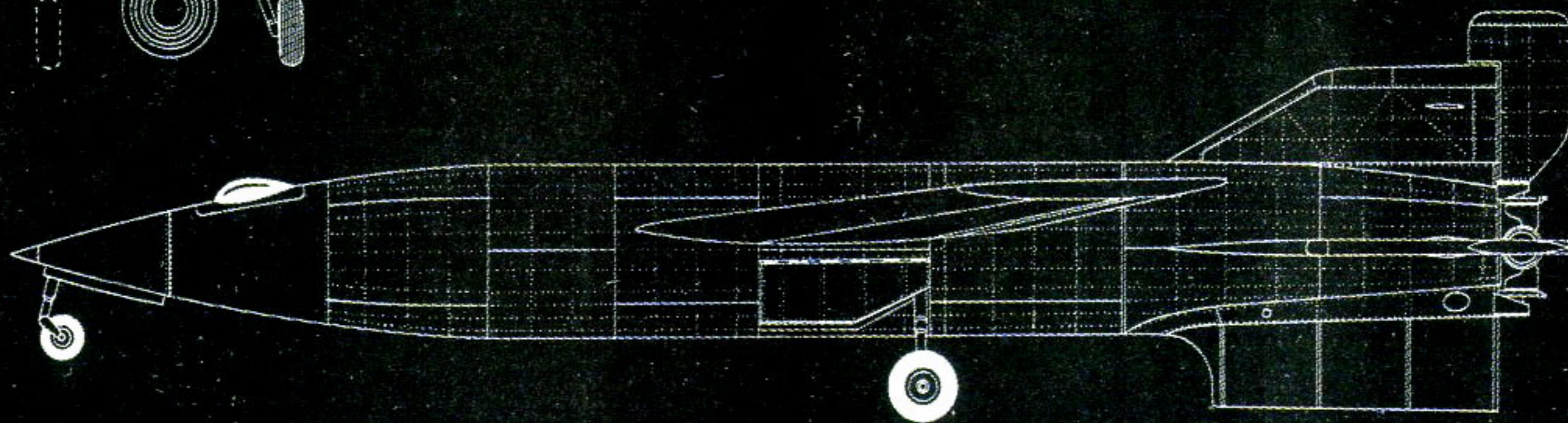

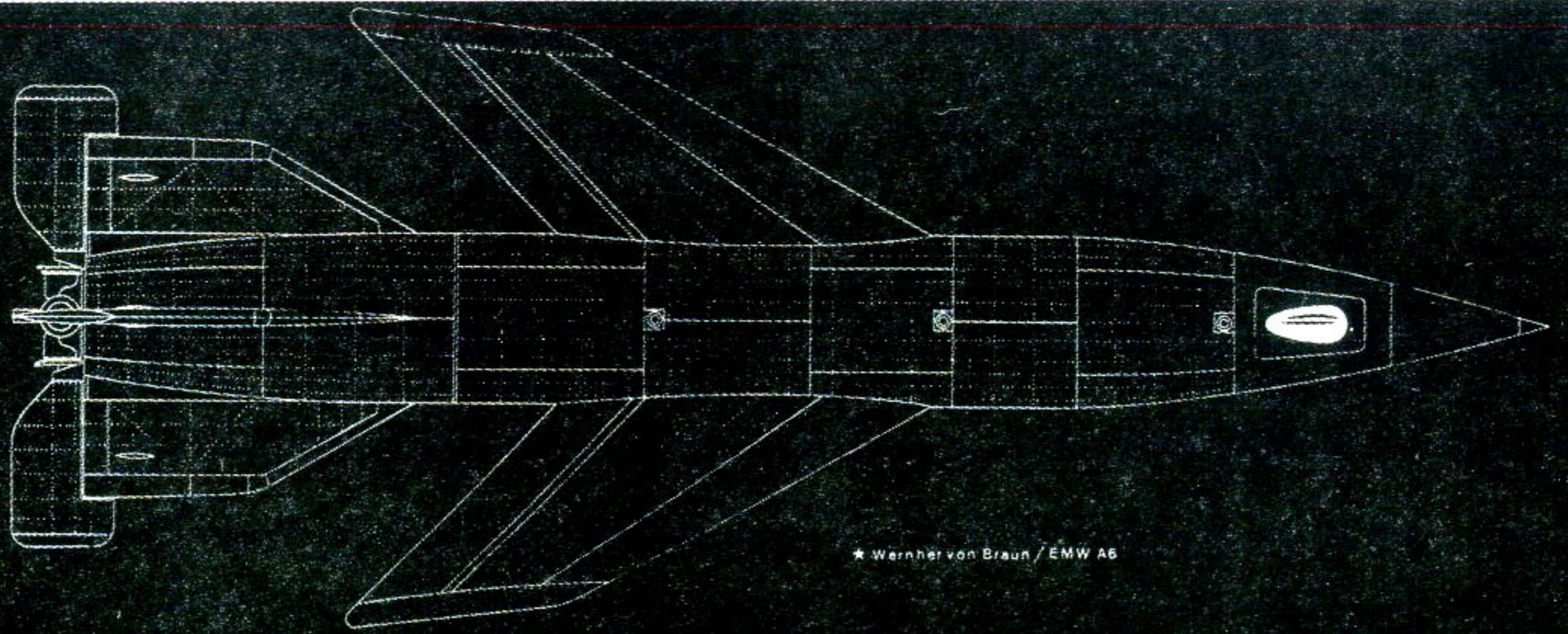

★ Werner von Braun / EMW A6

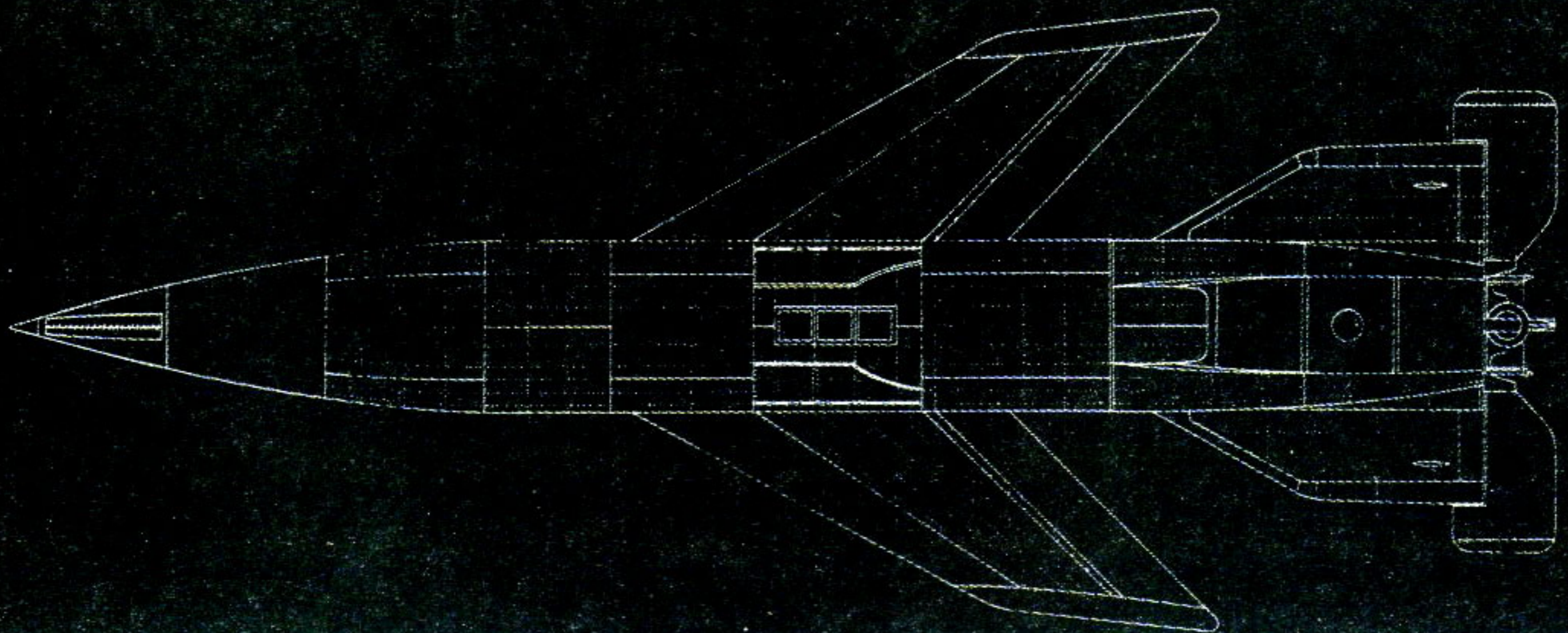



## EMW A6

The exceptional increase of range obtained from installing gliding wings in the A4 (V2) missile induced von Braun to design three crewed variants: the A4b, piloted as an aerodynamic research aircraft; the A9, as an intercontinental bomber; and the A6, as a "reconnaissance aircraft at a high speed and height."

Actually, they were scientific research projects of which the military applications were emphasized to obtain the necessary resources, considering the wartime circumstances.

The A6 would have been a hypersonic research aircraft, equipped with an auxiliary engine of ramjet type which could only be started at very high speeds. This could be possible in this type of airship at the highest point of its trajectory, flying at a very high speed and with the propellants of the main rocket exhausted. Under these circumstances, the ramjet engine (working with synthetic petrol) would give the ramjet the ability to continue flight for fifteen to twenty minutes without any loss of speed or height.

As a reconnaissance airplane, the A6 would have been impossible to detect. However, its flying characteristics exceeded the OKL needs and the project was let down.

The A6 was equipped with a pressurized cockpit, landing gear and braking parachutes. It was vertically launched as an A4 and landed on a conventional landing strip by its own means.

The concept was considered by the Americans during the building and test program for the North American X-15 research aircraft.

Although the content and purpose of every flight within the X-15 program have not been published, due to security reasons, there are pictures of one of them with a ramjet engine installed in the same position as the one chosen by von Braun for his A6.

### A6 Technical Data

**Stage:** Design

**Type:** Hypersonic experimental aircraft

**Wings:** Metallic structure and coating

**Fuselage:** Metallic structure and coating. It contained, from nose to tail, the forward landing gear, the pressurized cockpit, the methyl alcohol tank, the petrol tank (Br-Stoff) for the ramjet, the housing for the main landing gear, and the payload (instruments, cameras, etc.). Also in the fuselage were the liquid oxygen tank, the housing for the rocket's mechanisms and the combustion chamber for the rocket.

**Empennages:** Metallic structure and coating. For takeoff, they received some help from the small tailfins installed near the nozzle. It was necessary to remove the ventral tailfin, used on the A4 and A4b, to be able to install the ramjet.

**Landing Gear:** Tricycle

**Power Plant:** An EMW with a thrust of 27,500 kp and an acceleration of up to 6 G, and a ramjet of nonspecified type and thrust

**Propellants:** A-Stoff (liquid oxygen) and M-Stoff (methanol)

**Pressurizers:** T-Stoff (hydrogen peroxide) and Z-Stoff (watery solution of calcium or sodium as a catalyst for the T-Stoff) actuating a 730-hp turbopump. There were also nitrogen bottles and pressurized air.

**Length:** 15.75 m

**Wingspan:** 6.33 m

**Height:** 4.07 m

**Maximum Diameter:** 1.73 m

**Maximum Speed:** 2900 km/h

**Ceiling:** 95,000 m

## THE FIRST MISSILES

In 1940, "the biggest target in the world," where any German pilot could easily strike with his bombs, was the great city of London. But which one was the tiniest and most difficult? No doubt it was a small English destroyer desperately maneuvering to avoid the attacks of the Stukas.

Naval objectives were so difficult to hit that on July 12, 1940, during a series of aerial attacks by the Italians against the big, sluggish British battleship HMS Warspite, not one of the 300 bombs dropped from between 8.50 and 11.50 hit their target. Only the courage shown by German and Japanese pilots when diving during their attacks provided any tactical results. However, the price paid to the flak and the fighters of the Allied fleet was usually too high in lives and airplanes.

The Japanese believed they had found the answer with the sacrifice of the pilots in their "Kamikaze" and "Tokubetsu" special attack units. The Germans created guided missiles which could be launched from planes at a great distance, thus not exposing the planes to the efficient anti-aircraft machinery of the enemy.

At first, they consisted of already existing weapons which had been tested in combat. Made by adding wings and fins to normal bombs and torpedos, they were capable of gliding until their impact against ships. They were guided to the target by a cable, a radio beam, or by means of rudimentary passive radar sensors, infrared rays, or a magnetic or acoustic field installed on board.

From May 1944 on, the Germans also used converted "Mistel" bombers, which were thrown against a target on a collision path under autopilot control.

In contrast, there were two unpowered German airplanes so designed from the beginning: the Arado E 377 and the Fieseler Fi 103. The first, assigned to replace early "Misteln" models, followed the concept of being launched inside visual range of the target and guided by a gyroscopic plant. The second was the first operational cruise missile in history able to fly while correcting variations of path and altitude to the target, thanks to a gyroscopic plant and magnetic compass. The weapon came into service in June 1944 under the propagandistic name of "Vergeltungswaffe Ein" (V-1), thus beginning a new type of war which would change strategic concepts for decades.

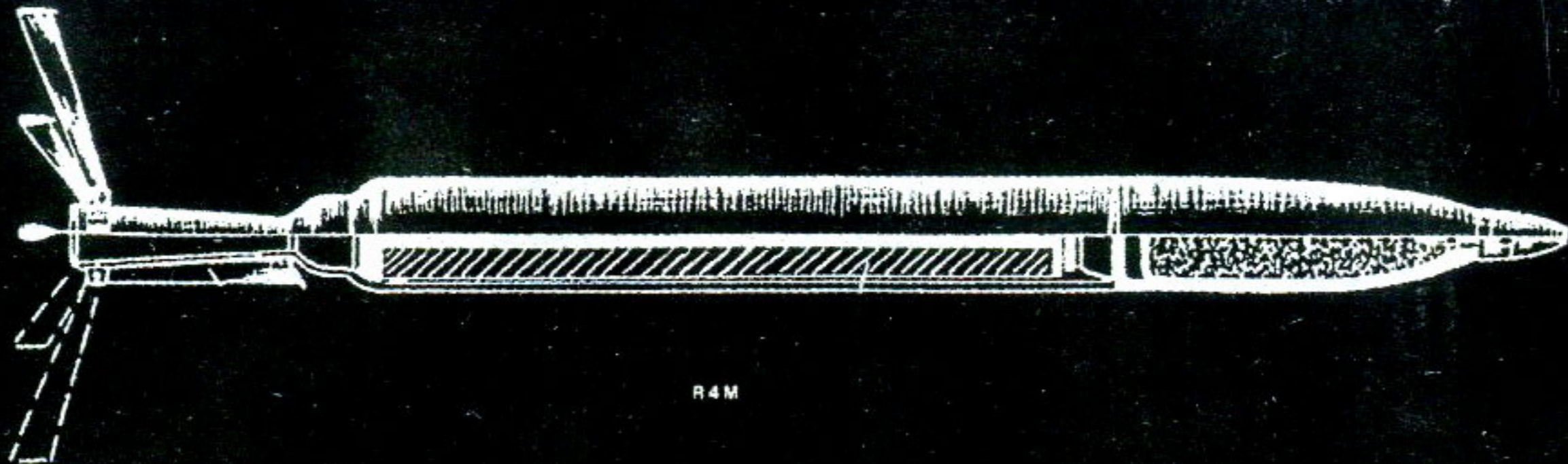

R4M

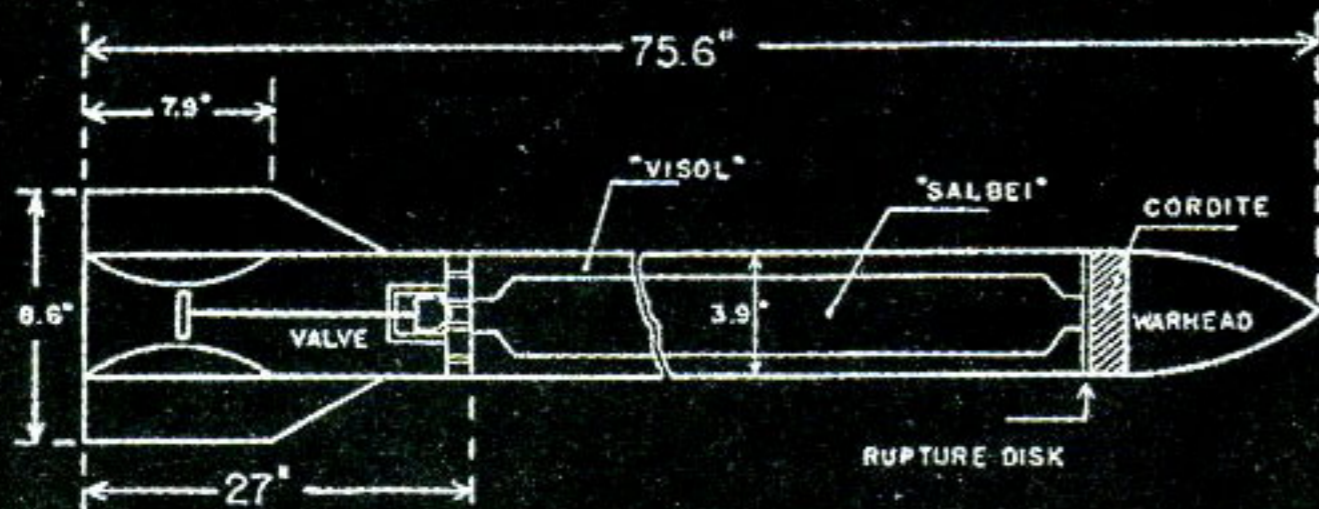

Antiaircraft rocket Taifun (Typhoon). The smallest rocket developed at Peenemünde, holding the two liquid propellants in concentrically arranged tanks. Tank pressure was developed by burning a disk of cordite. This rocket was to be used for antiaircraft barrages but the development was not finished.

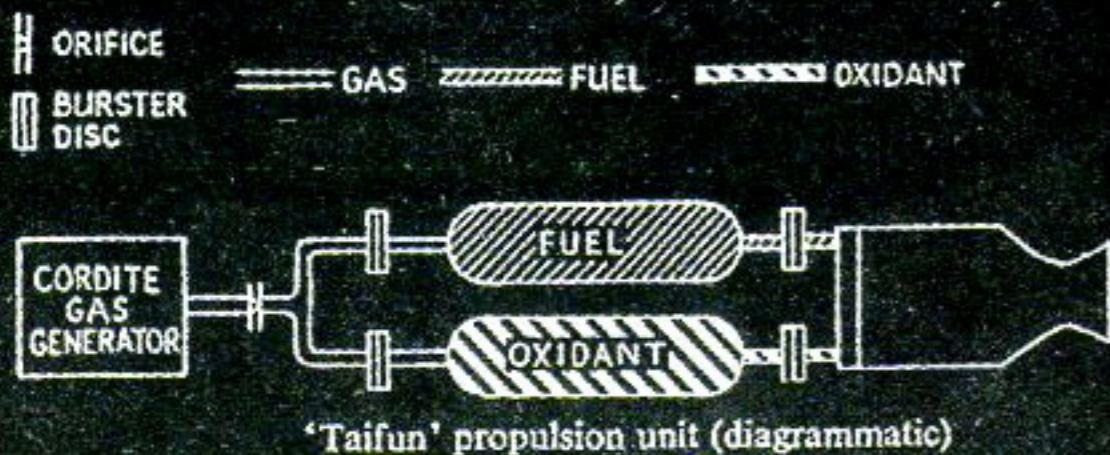

German projectile rockets, Second World War (dimensions in millimeters).  
 Top: Projectile of Nebelwerfer 41.  
 Center: The larger Nebelwerfer.  
 Bottom: Projectile of the Wurfgerät.

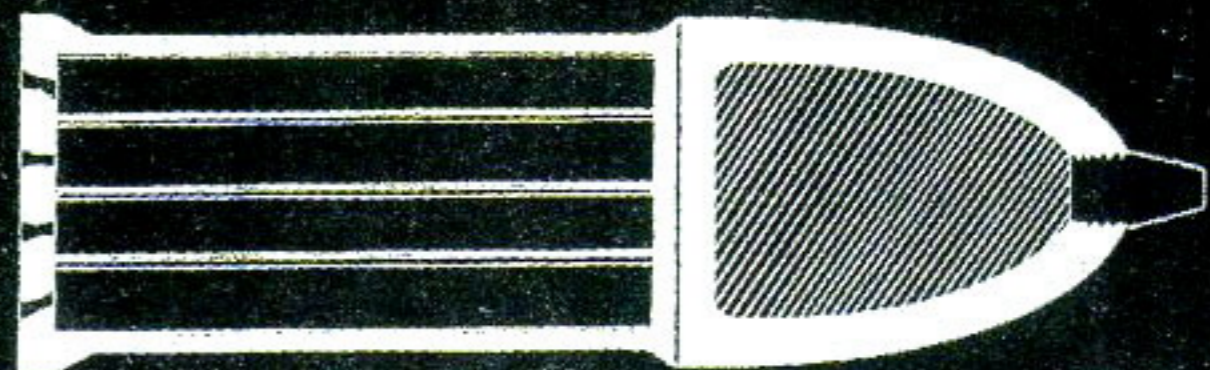
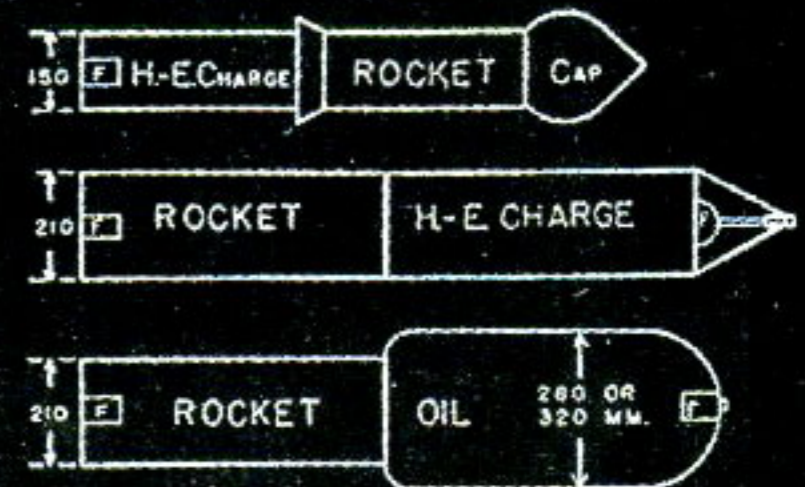

Hs 217 "Föhn"



## RUHRSTAHL-KRAMER X-1 "Fritz-X"

Officially designated the PC 1400X, it was an improvement of the armor-piercing PC 1400 "Fritz" bomb, used by the Luftwaffe against great battleships. It had a piercing head and thick steel revetment to absorb the impact against the ship, and housed 300 kg of "Amatol" explosive. A radio receiver and an electromechanical device were installed inside its fuselage, behind the explosive head, to transmit driving impulses to the fins in front, thus controlling the descent trajectory.

The "Fritz" was launched as a normal bomb from a plane flying at high altitude. To make it more visible during the dive, some flares were ignited on its tail. Then a very well-trained operator, positioned at the launch airplane's nose, rectified the bomb's trajectory by means of very gentle radio impulses until the target and missile trajectory coincided.

### Operational Development.

The "Fritz-X" operated in the Mediterranean on September 8, 1943, together with the Do-217 K-2 and K-3 of the II/KG-100, sinking the Italian battleship Roma and damaging the Italia. As for the Allied ships, they sank the destroyer Janus and damaged the battleship Warspite and the cruisers Savannah and Uganda.

Bearing in mind the most conservative statistics of the time, 5000 conventional bombs would have been necessary to achieve the same result!

The "Fritz-X" was also used over land against the bridges over the river Oder in April 1945.

### Technical Data

**Designer Office:** Dr. Kramer's DVL (Deutsche Versuchsanstalt für Luftfahrt)

**Stage:** Operational

**Structure:** Special antiarmor steel of great thickness

**Tail Unit:** Cruciform section strengthened by a twelve-sided perimeter. It had two-axis guidable fins, actuated by Wagner electronic controls.

**Power Plant:** None in the first versions. Several solid-propellant accelerator rockets were planned.

**Equipment:** Kehl/Strassburg radio-link system (FuG203 and FuG230)

**Warhead:** 320 kg of Amatol

**Length:** 3.26 m (10 ft. 8 1/2 in.)

**Span (Elevator):** 1.35 m (4 ft. 5 in.)

**Maximum Diameter:** 0.56 m (1 ft. 10 in.)

**Launch Weight (Unpropelled Version):** 1570 kg (3454 lb.)

**Maximum Speed:** 1035 km/h (630 mph)

**Range:** 5 km (2.69 n.mi.)

**Number of Units Built:** 1386

Arado Ar 234 C-5 ★

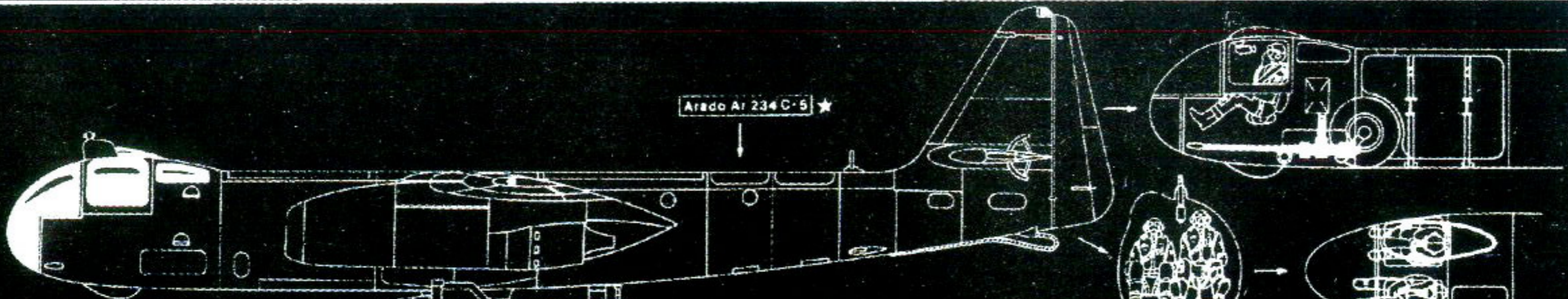

Ruhrstahl-Kramer X-1  
(PC 1400-Fritz-X-1)

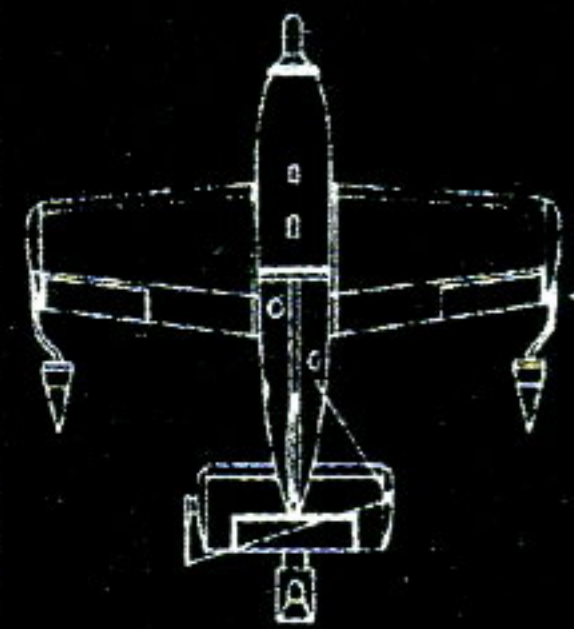
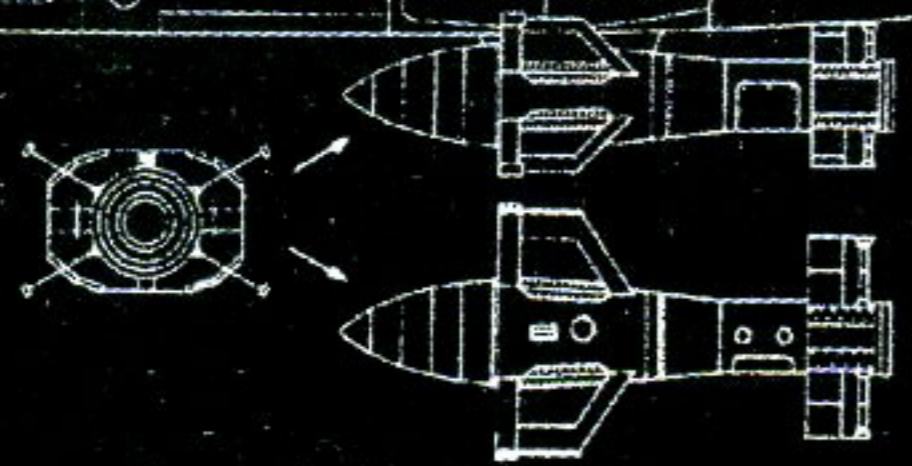

Henschel Hs 293 A

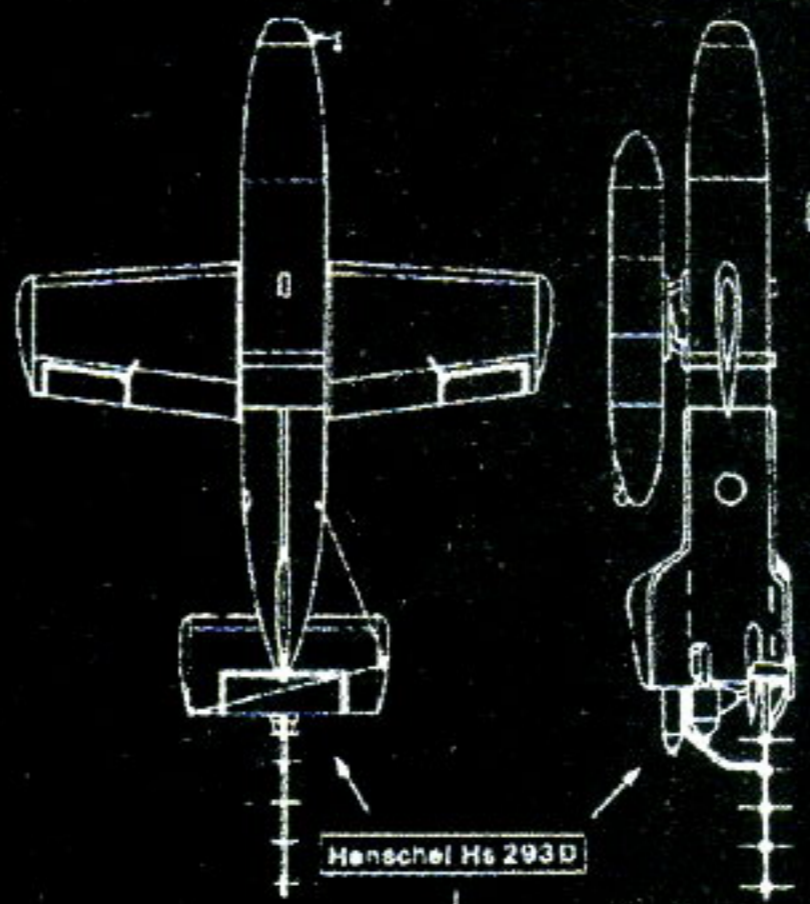
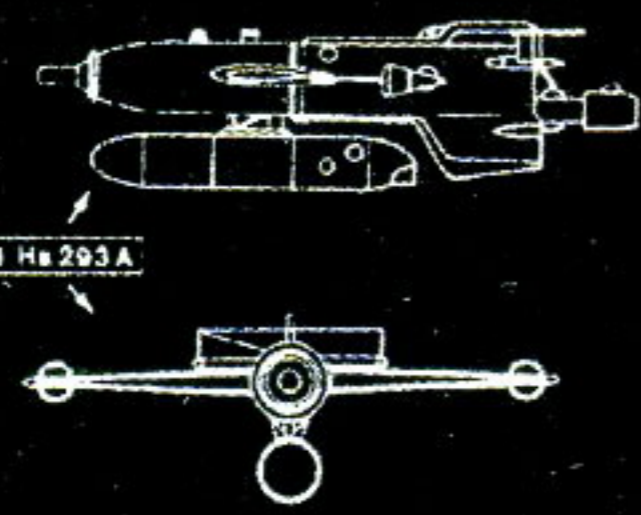

Henschel Hs 293 D



Henschel Hs 293 H



Henschel  
"Zitterrochen" ★

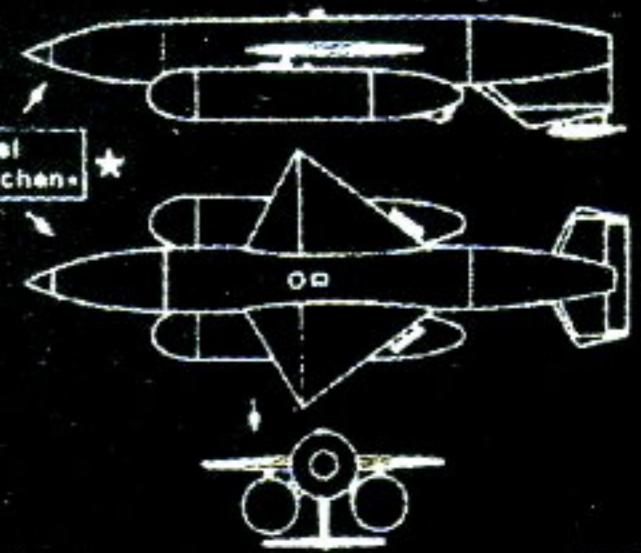

Henschel Hs 293 C-3



Henschel Hs 293 C-1

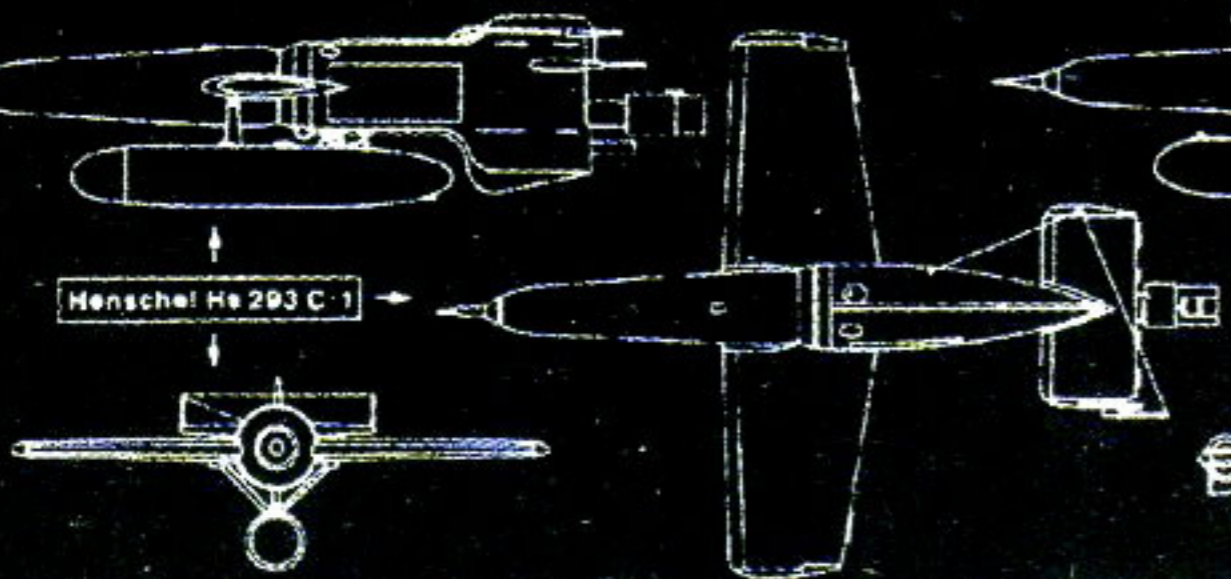

Henschel Hs 293 C-4

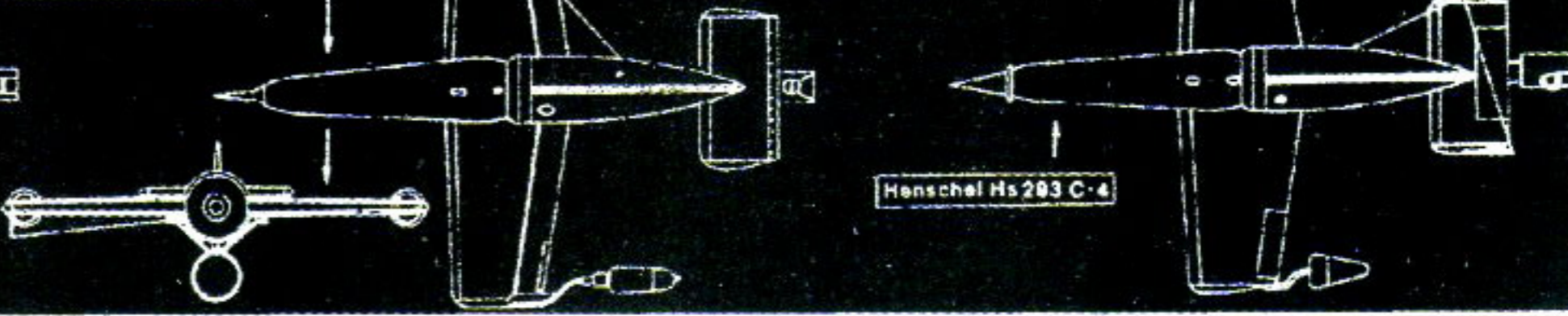

## HENSCHEL Hs 293 SERIES

The Hs 293 was based upon the normal SC500 bomb, with wings and fins added and an engine suspended from the main body.

It was tested with different guidance systems. Models V-4 and C-1 were guided by radio, like the Fritz-X, but when it was found out that the beam could be interfered with, models C-3, C-4 and A-0 were equipped with a wire-guidance system. During the bomb's fall, two wired coils on the wingtips unwound, maintaining the link with the launch plane and allowing the transmission of electrical impulses for guidance. "A" models possessed an ogival armor-piercing head. "C" models had a conical shape to cleanly pass through the sea's surface, close to boardside, and strike under the water line. Also built were a "D" model, which transmitted television images of the target to the controller, and an "H" model, which was supplied with an acoustic/magnetic detector to attack bomber formations.

### Operational Development

The Fritz-X and Henschel Hs 293 A-1 were the only ones used in combat with great success. They really meant a step forward to the new age of "smart" weapons.

Eighteen Dornier Do 217 E-5's from the experimental unit II/KG 100 attacked an Allied naval formation with the Hs 293 in August 1943, sinking the sloop Egret and seriously damaging the Athabaskan in the waters of Biscay Bay.

They were used a little later in the Atlantic by the III/KG 40, who usually flew the He 177 A-5's and FW 200 C-4's against merchant convoys. They damaged several of these merchants and the destroyer Jervis.

In the Mediterranean, they operated with the II/KG 40 (He 177 A-5), sinking the destroyers Inglefield, Boadicea, Intrepid, Culverton and Vasilissa Olga, as well as the battleship Valiant. Some transports were also seriously damaged.

This success eased the way to the development of the heavy versions, the Hs 294 and Hs 295.

### Technical Data (Hs 293 A)

**Designer Office:** Henschel Flugzeugwerke, Dr. Wagner's team

**Stage:** Operational

**Structure:** An SC500 bomb

**Wings and Tail Unit:** Aluminum structure and coating. Movable surfaces actuated by electrical controls.

**Power Plant:** A Walter 109-507 B with 600 kg (1320 lb.) of thrust

**Propellants:** T-Stoff and Z-Stoff

**Pressurizer:** Compressed air

**Warhead Weight:** 295 kg of HE

**Guidance System:** A wire-guided Dortmund/Duisburg (FuG207 and FuG237)

**Length:** 3.82 m (12 ft. 6 3/8 in.)

**Span:** 3.10 m (10 ft. 2 in.)

**Launch Weight:** 1045 kg (2299 lb.)

**Range:** 18 km (9.7 n.mi.)

## HENSCHEL "ZITTERROCHEN"

Whereas the Hs 294 and Hs 295 projects had the purpose of increasing the warhead's weight at the expense of a double power plant, the "Zitterrochen" was designed to fly at supersonic speeds. This was done due to the fact that its destructive power was intended to rest more in its impacting kinetic energy than in its explosive charge (about 200 kg). The project was canceled before mass production, scheduled for 1944, could begin.

### Technical Data (Zitterrochen)

**Designer Office:** Henschel Flugzeugwerke, Dr. Voepf's team

**Stage:** Design

**Structure:** Light alloy

**Wings and Tail Unit:** Light alloy structure and coating. Lifting controlled by elevator actuated by electrical controls. Roll control by Wagner bars.

**Power Plant:** Two Walter 109's of advanced design

**Propellants:** T-Stoff and Z-Stoff

**Guidance System:** Unknown

**Length:** 3.47 m (11 ft. 4 1/2 in.)

**Span:** 1.51 m (4 ft. 11 2/5 in.)

**Maximum Diameter:** 0.37 m (1 ft. 2 1/2 in.)

**Launch Weight:** Unknown

**Maximum Speed:** Mach 1.5

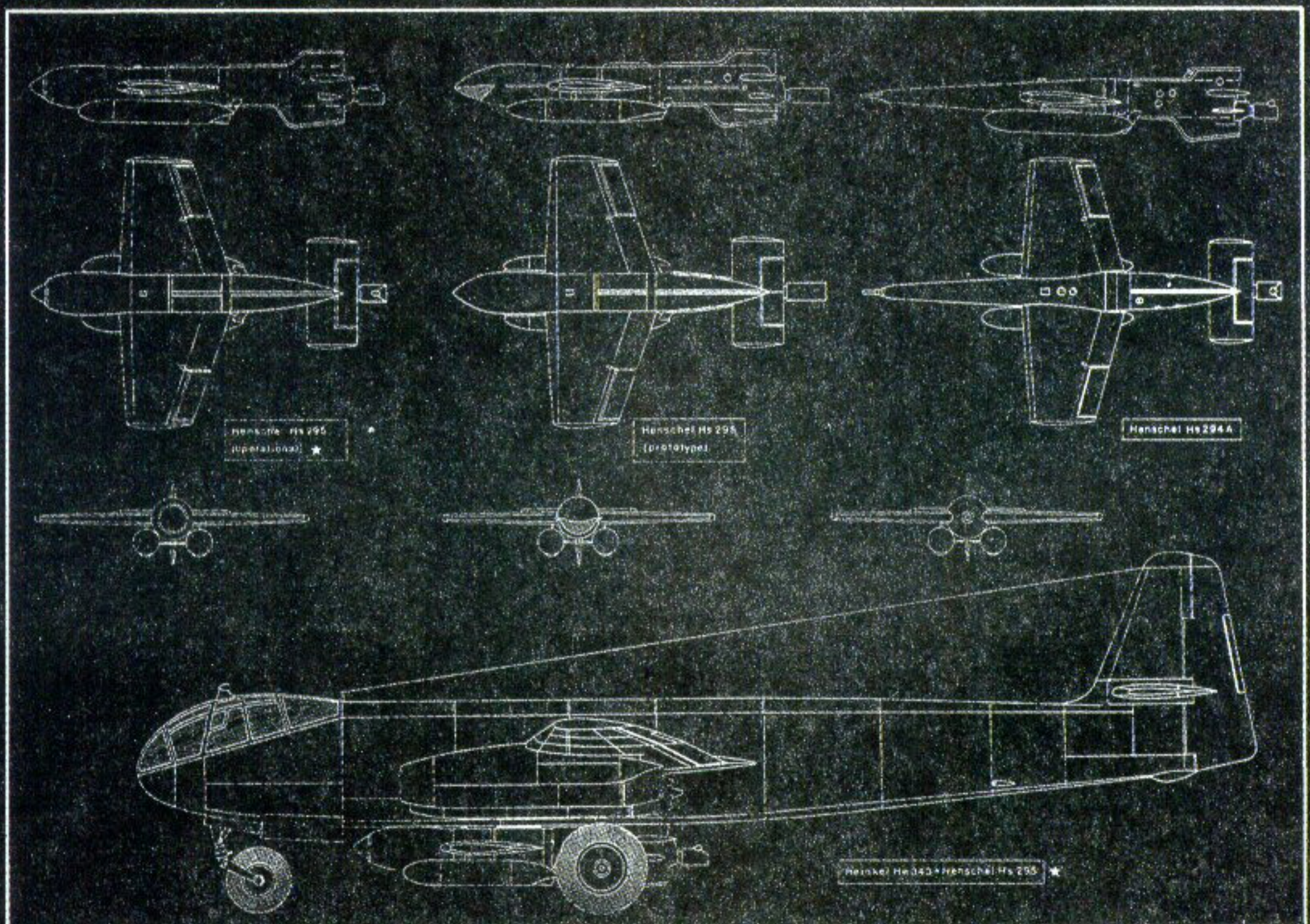



## HENSCHEL Hs 298

This remotely controlled air-to-air missile was based on a project by Dr. Wagner in 1941. It was rejected then and proposed again in 1943. Series manufacture began that same year in the Henschel factory at Schönefeld, near Berlin, under direction of engineer Hesky. However, readiness was delayed due to a late delivery of the "Rüssel" proximity fuse.

The first launch was made from a Junkers Ju 88 A-4 on December 22, 1944. For its operational evaluation, three hundred missiles had to be launched from the experimental site of Karlshagen, using the Junkers Ju 88 G-1 and Ju 388 J-01 and Dornier Do 217J heavy night fighters. Some were probably launched against true targets.

Tests showed that the optimum launch should be made from behind the target with a maximum deflection of 30 degrees.

The missile was radio-guided from the launch plane and was vulnerable to electronic counter-measures. A more powerful and heavier version was proposed to be wire-guided. Some test units of this version, which was called the Hs 298 V2, were manufactured before the end of the war.

A stock of 135 freshly finished first-version missiles was destroyed during an attack by the Soviet Air Force on the Wansdorf factory, where they had been stored.

### Technical Data (V2 in parentheses)

**Stage:** Operational tests

**Type:** Air-to-air short-range missile

**Wings:** Wood structure and coating. Ailerons.

**Fuselage:** Light alloy coating with double nose containing the proximity fuse and the electric generator

**Tail Unit:** Metallic structure and coating. Only movable part was the elevator.

**Power Plant:** A solid-propellant (Diglycol) Schmidding SG 32/109-543

**Warhead:** 25 kg/55 lb. (48 kg/105.6 lb.) of HE

**Proximity Fuse:** "Rüssel". It could also be detonated by radio using a coded impulse.

**Guidance System:** Wire-guided FuG 203 "Kehl"/FuG 230 "Strassburg" (FuG 512/FuG 530 "Kogge").

**Wingspan:** 1.29 m/4 ft. 2 3/4 in. (1.29 m/4 ft. 2 3/4 in.)

**Length:** 2.003 m/6 ft. 6 3/4 in. (2.477 m/8ft. 1 1/2 in.)

**Launch Weight:** 95 kg/209 lb.

**Maximum Speed:** 842 km/h/455 mph

**Range:** 1600 m/5248 ft. (2500 m/8200 ft.)

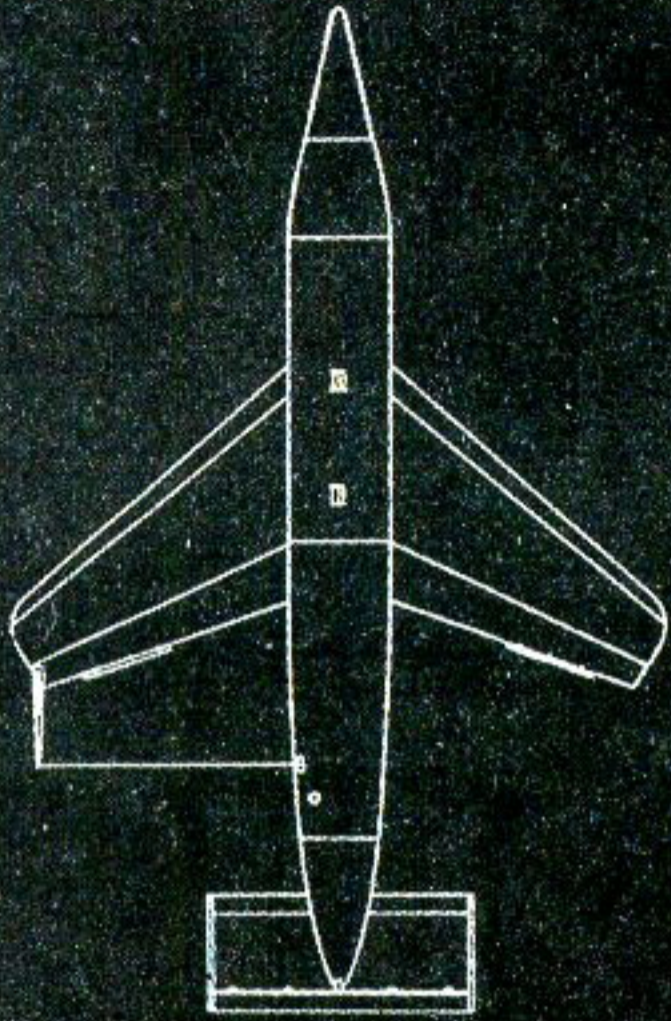

Hs 298 V1

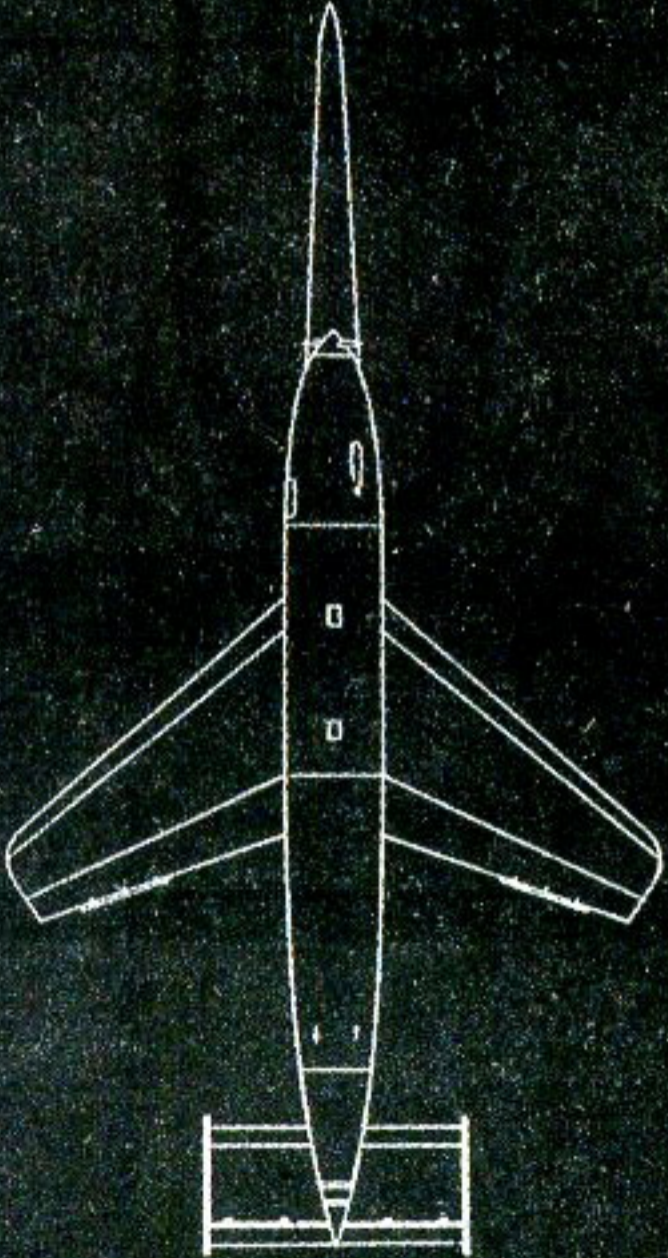
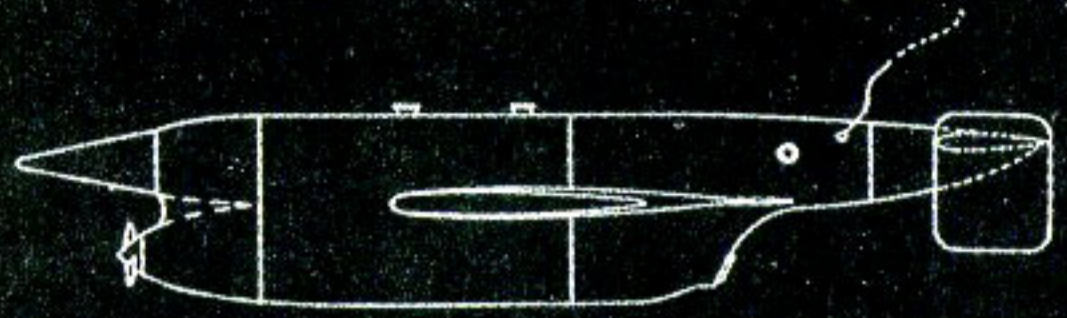

Hs 298 V2

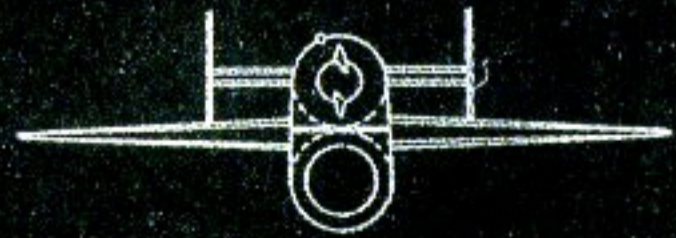
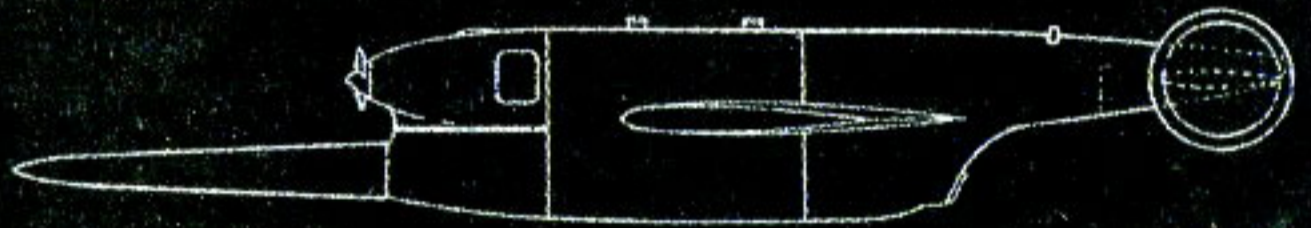

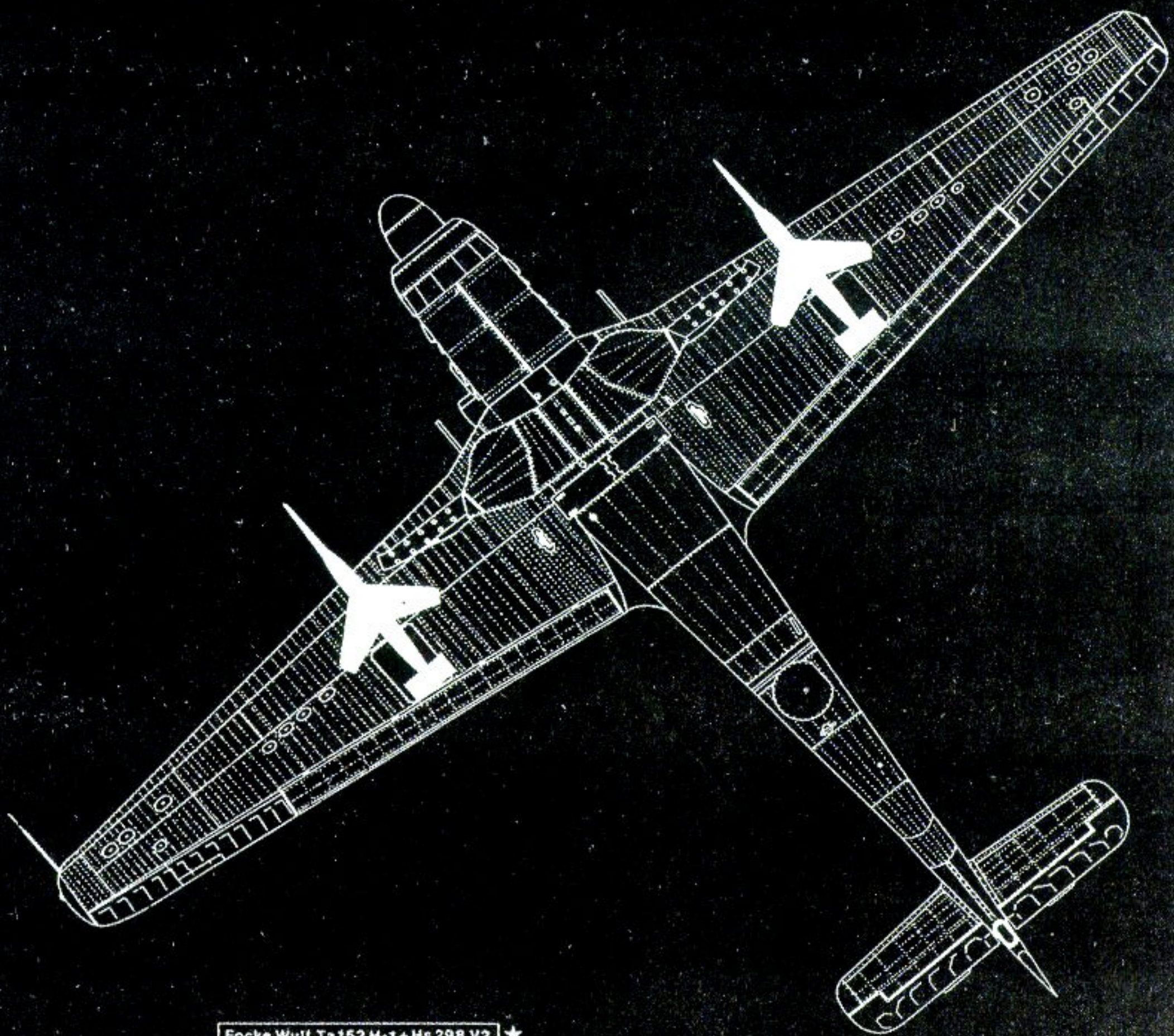

Focke Wulf Ta152 H-1+Hs 298 V2 ★

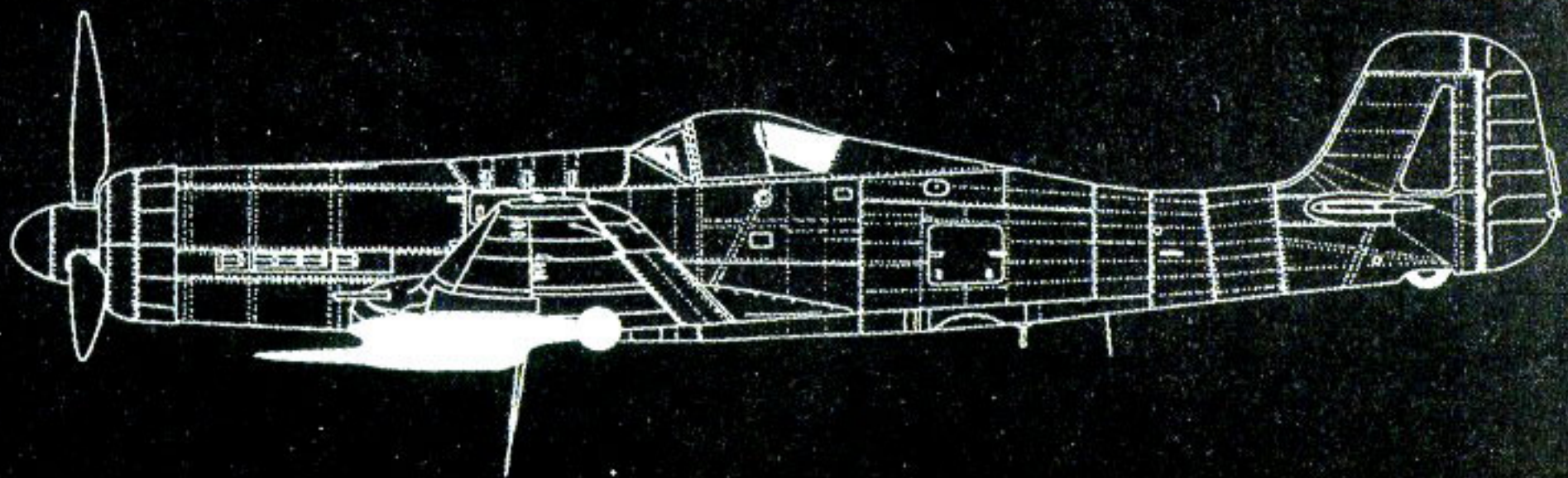

## RUHRSTAHL-KRAMER X4

The first guided missile with air-to-air capability successfully used during the Second World War, the X4 was developed by Dr. Kramer's team to be launched from high-performance day fighters against American bomber formations from a safe distance. The basic design (at the beginning of 1943) was fitted with straight wings, but the final version for serial production had arrowed wings to decrease air resistance when the missile was carried by jet planes.

The X4 was wire-guided from the carrier fighter to the target proximity, where it automatically exploded by means of an acoustic fuse. At the end of the war, 13,000 missiles had been manufactured. Most of them never received their engines, as the BMW factory in Stargard, where they were produced, had been seriously damaged by the Allied bombers.

A great number of the test flights were made during the second half of 1944, using X4 missiles provisionally equipped with solid-propellant Schmidding engines. Junkers Ju88G's and Ju188L's, as well as three Focke Wulf 190 F-8's and an Fw 190 V69 were used as evaluation launch planes. They were planned for operational use by the most advanced day version of the Me 262.

It is believed that during the last weeks of war in Europe, several launches, included in the test program, were made against enemy bombers. The X4 was never delivered to the Luftwaffe.

### Technical Data

**Stage:** Operational tests

**Type:** Short-range air-to-air missile

**Wings:** Plywood

**Fuselage:** Aluminum coating

**Tail Unit:** Aluminum coating

**Power Plant:** Liquid-propellant BMW with a thrust between 30 and 140 kg (66 to 308 lb.)

**Propellants:** Tonka 250 (1.6 kg/3.5 lb.) and S-Stoff (6.4 kg/14.1 lb.)

**Pressurizer:** Compressed air

**Fuel Tank:** Spiral, installed around the engine and with a piston actuated by compressed air running through it

**Warhead:** 20 kg (44 lb) of HE with "Dogge" and "Meise" proximity fuses activated by the noise of target bombers

**Guidance System:** Wire-guided by the FuG810 system with a "Düsseldorf" transmitter and "Detmold" receiver. The guidance wires lodged in two coils fixed to the wingtips and automatically unwound in flight.

**Wingpan:** 0.725 m (2 ft. 4 5/8 in.)

**Length:** 2 m (6 ft. 6 3/4 in.)

**Maximum Diameter:** 0.222 m (8 5/8 in.)

**Launch Weight:** 60 kg (132 lb.)

**Maximum Speed:** 893 km/h (482 mph)

**Range:** 3200 m (10,496 ft.)

Ruhrstahl-Kramer - X4 -

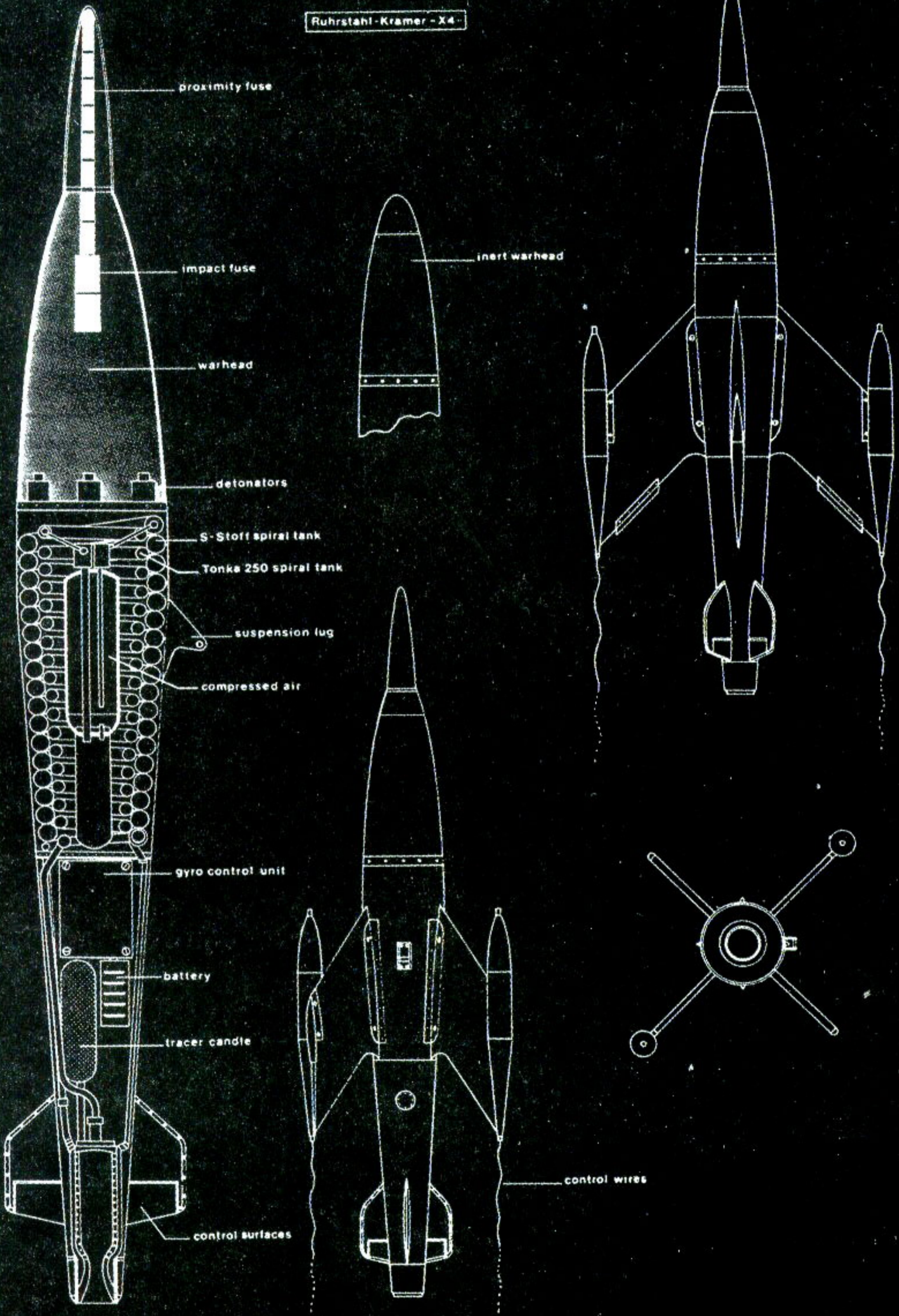

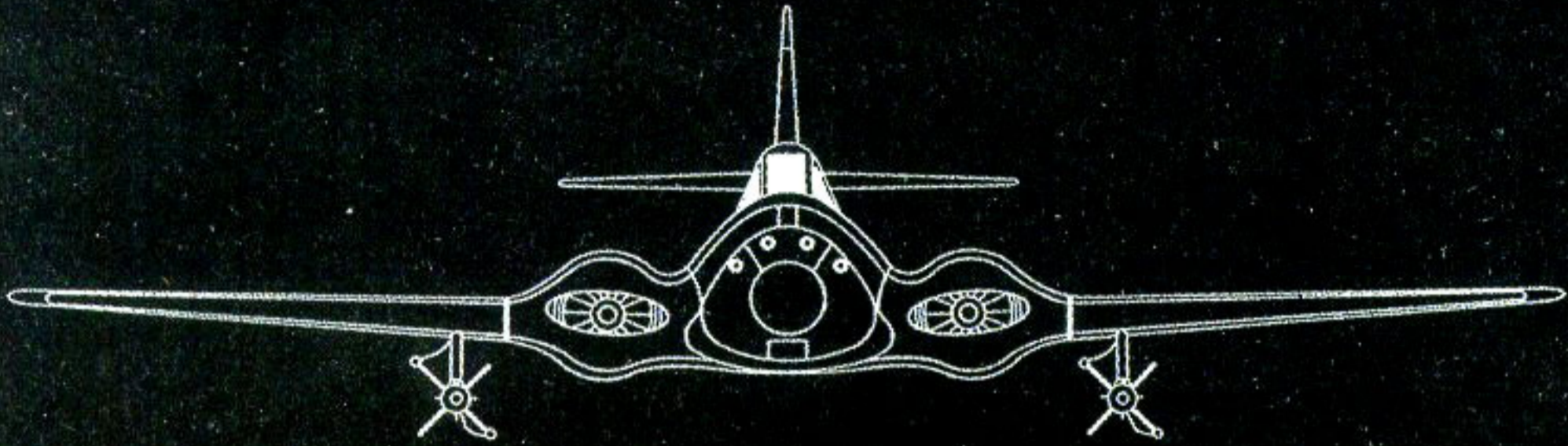
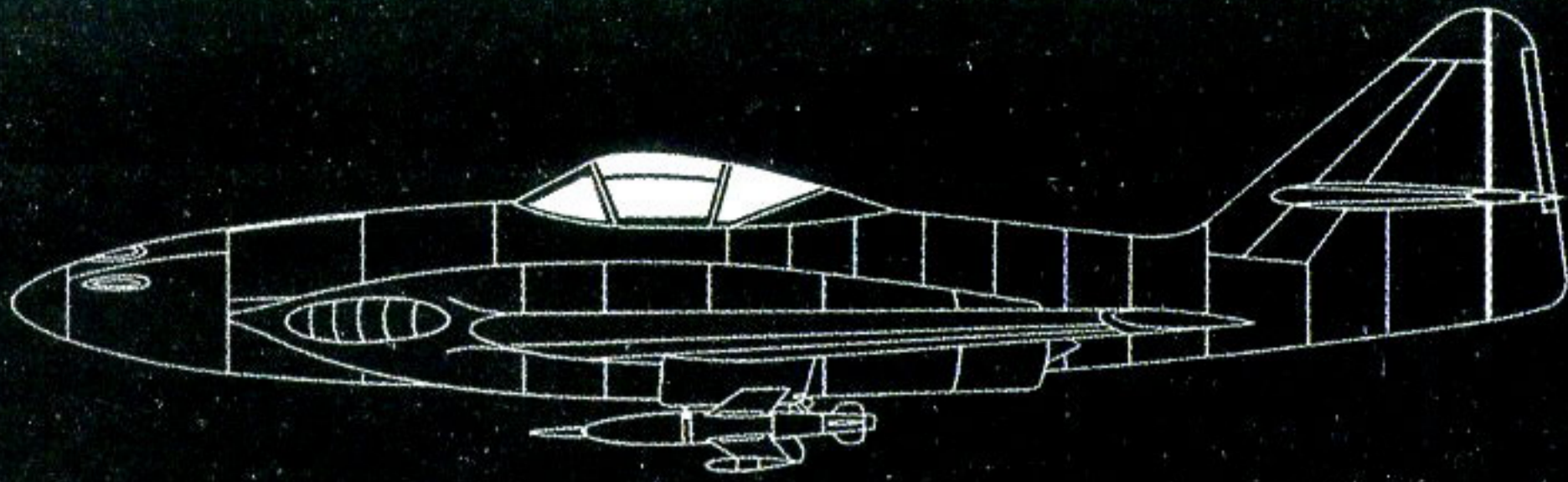

Messerschmitt Me 262 HG III + X4- ★

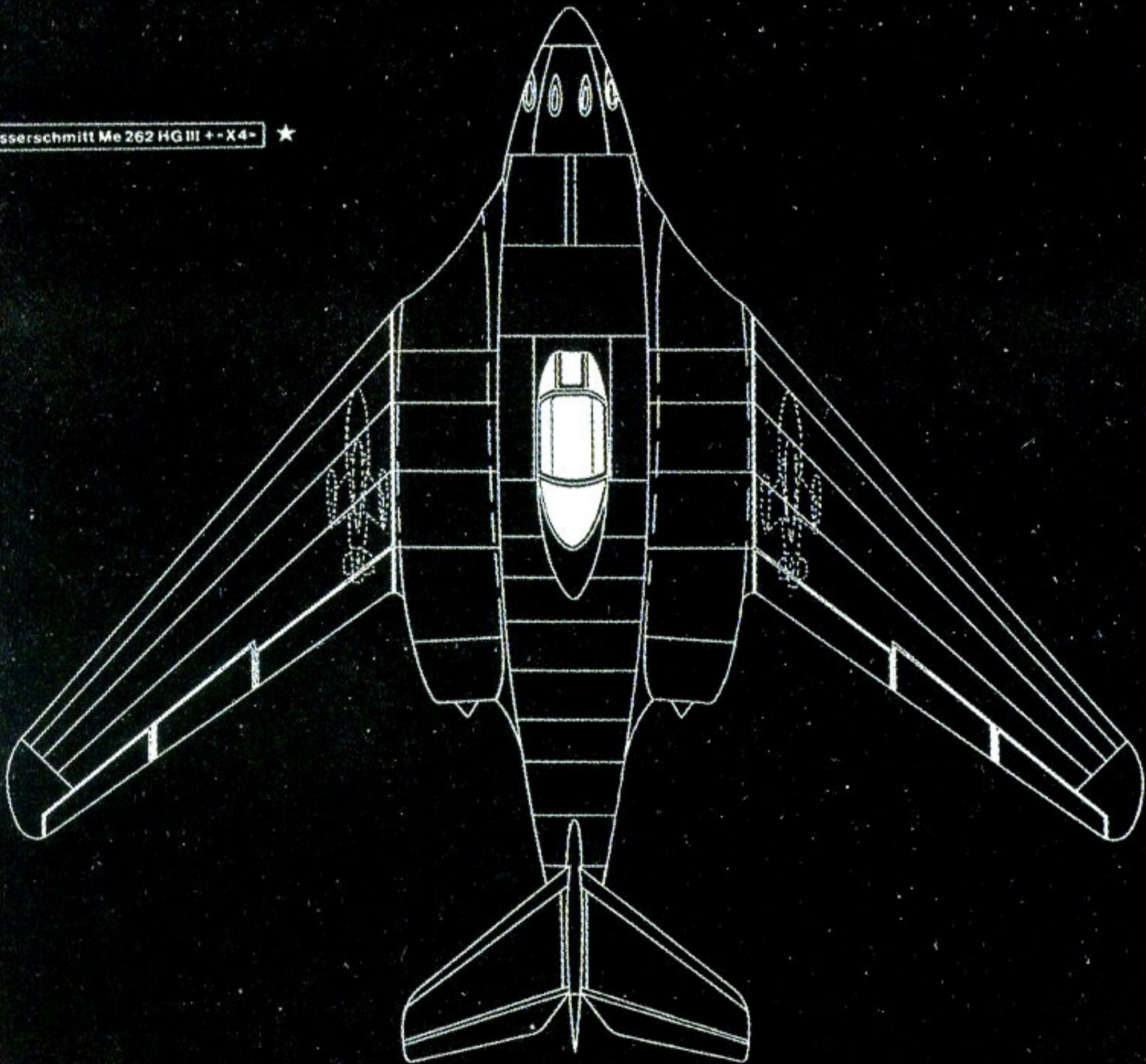

## RUHRSTAHL-KRAMER X7 "ROTKÄPPCHEN"

This was the first antitank guided missile in history, born from an order made by the Heereswaffenamt to Dr. Kramer at the beginning of 1944.

A considerable amount were built in the Brackwede factory and delivered to the Army for their operational evaluation before the war.

The main variant was wire-guided. Other tested versions were equipped with the "Steinbock" automatic infrared guidance system and with the "Pfeifenkopf" and "Pinsel" electro-optic guidances, which used vidicon cameras able to detect the difference between target and background. Different airborne guidances were tested for antitank and anti-aircraft purposes.

### Technical Data

**Stage:** Operational evaluation

**Structure:** Metallic

**Rocket Motor:** Wasag 109-506 with two-stage solid propellant (Diglycol) and a boost thrust of 150 lb.

**Guidance System:** wire-guided, infrared or electro-optical

**Warhead:** 2.5 kg (5.5 lb.) of HE shaped charge

**Span:** 600 mm (1 ft. 11 1/2 in.)

**Length:** 950 mm (3 ft. 1 1/2 in.)

**Maximum Diameter:** 150 mm (5 7/8 in.)

**Launch Weight:** 9 kg (19.8 lb.)

**Range:** 1200 m (3,936 ft.)

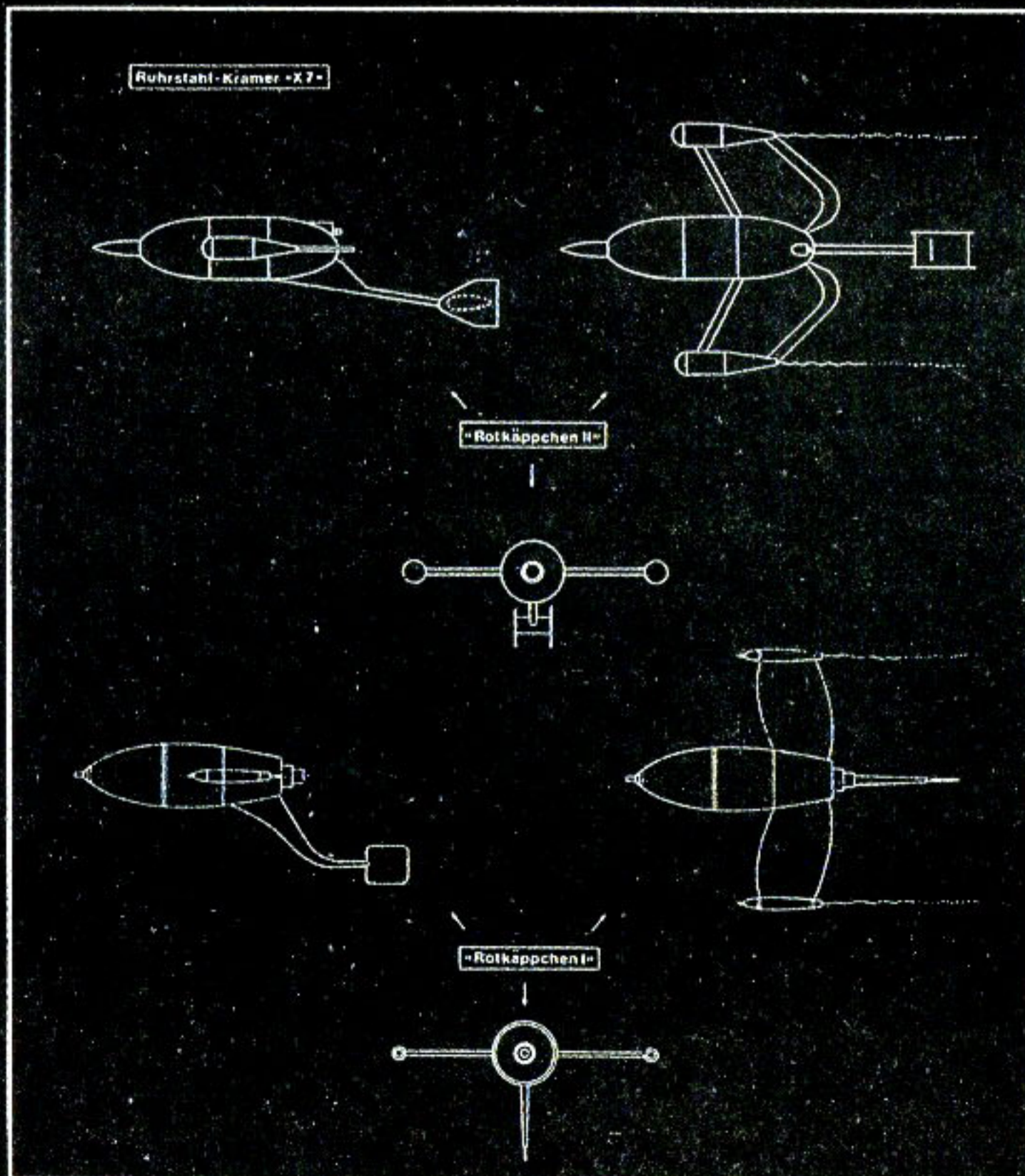

## BLOHM UND VOSS BV143, HENSCHEL GT 1200 AND OTHER GLIDING TORPEDOS

In the period between the wars, British airborne torpedos were fitted with rear aerodynamic surfaces at a fixed angle in order to make it easier to repair the launch airplane and reach a more suitable dropping angle.

In Germany, as an extension of this concept, the Reichsluftfahrtministerium (RLM) encouraged the development in 1936 of torpedos with lifting surfaces which, by means of gliding flight, allowed a safe launch distance.

The Luft-Torpedo LT 9.2 "Frosch" was the first practical model. It consisted of a normal airborne torpedo, suspended from a small glider with a span of 6 ft. 4 3/8 in., which was released upon touching the water. The total length of the device (unguided) was 16 ft. 8 3/4 in.

The next glider model, designated the L.10 "Friedensengel", could be coupled to the LT.1 and LT 950D torpedos and was fitted with an autopilot to correct the gliding angle.

### LT. 1 Technical Data (LT 950D in parentheses)

**Stage:** Operational

**Structure:** Metallic

**Guidance System:** Inertial (Inertial)

**Span:** 31.0 m/10 ft. 2 in. (4 ft. 11 2/5 in.)

**Length:** 3.47 m (3.30 m/10 ft. 9 7/8 in.)

**Height:** 0.79 m/2 ft. 7 1/8 in. (0.94 m/3 ft. 1 in.)

**Launch Weight:** (L.10) 218 kg/480 lb. (218 kg/480 lb.)

**Launch Height:** (2500 m/7500 ft.)

**Gliding Range:** (9000 m/4.8 mi.)

**Gliding Speed:** 8.7 m/sec/285 ft./sec

A more advanced variant was the L.11 "Schneewittchen", based on the same principle but with the difference being that, when impacting with the water, two halves opened and released the torpedo.

### L. 11 Technical Data

**Stage:** Flying tests

**Structure:** Metallic

**Span:** 3.53 m (11 ft. 7 in.)

**Length:** 6.34 m (20 ft. 9 5/8 in.)

**Height:** 0.72 m (2 ft. 4 3/8 in.)

**Launch Weight:** 1048 kg (2306 lb.)

**Gliding Speed:** 120 m/sec (394 ft./sec)

**Gliding Range:** (1100 m/3608 ft.)



Propelled models, such as the BV 143 and Hs GT 1200, were also designed.

The BV 143 behaved like previous devices in gliding flight, but when the ventral articulated arm touched the waves' surface, a rocket engine ignited and a high-speed levelled flight sequence began until impact was made.

The system never worked properly because the stabilizers did not have the necessary time to adjust the path at such a low height. Different versions, fitted with new equipment, were tested. The A-2 had double tailfins and vertical stabilizers on the wingtips, being similar in appearance to the L.10. It was also equipped with a double-chamber rocket engine (cruise and high speed) and with a very efficient radioaltimeter instead of the hinged arm.

Version "B" was conceived to be launched from a pneumatic ramp, similar to the one used by the Fieseler Fi 103, in order to be used as a coast artillery weapon. It possessed a dolphinlike hydrodynamic nose, suggesting that it used some kind of "bounce bombing."

### **BV 143 Technical Data**

**Stage:** Flying tests

**Structure:** Metallic

**Guidance System:** Inertial autopilot

**Power Plant:** Walter 109-502

**Span:** 3.17 m (10 ft. 4 4/5 in.)

**Length:** 5.98 m (19 ft. 7 1/2 in.)

**Height (Unfolded Arm):** 3.02 m (9 ft. 10 4/5 in.)

**Launch Weight:** 1055 kg (2326 lb.)

**Gliding Speed:** 115 m/sec (258 mph)

**Range:** 8 km (5 mi.)

The Henschel GT 1200 used a low-powered rocket to extend the gliding range. When touching the water, the wings and empennages loosened and a more powerful second rocket ignited in order to propel the device underwater and, thanks to a magnetic fuse, automatically exploded when under the vessel's hull.

### **GT 1200 Technical Data**

**Stage:** Project

**Structure:** Metallic fuselage, wooden wings and tail unit

**Guidance System:** Inertial, inside a container located in the nose

**Power Plant:** Two of unspecified type, solid propellant

**Span:** 4.2 m (13 ft. 1 1/4 in.)

**Length:** 7.35 m (24 ft. 1 in.)

**Height:** 1.1 m (3 ft. 9 1/4 in.)

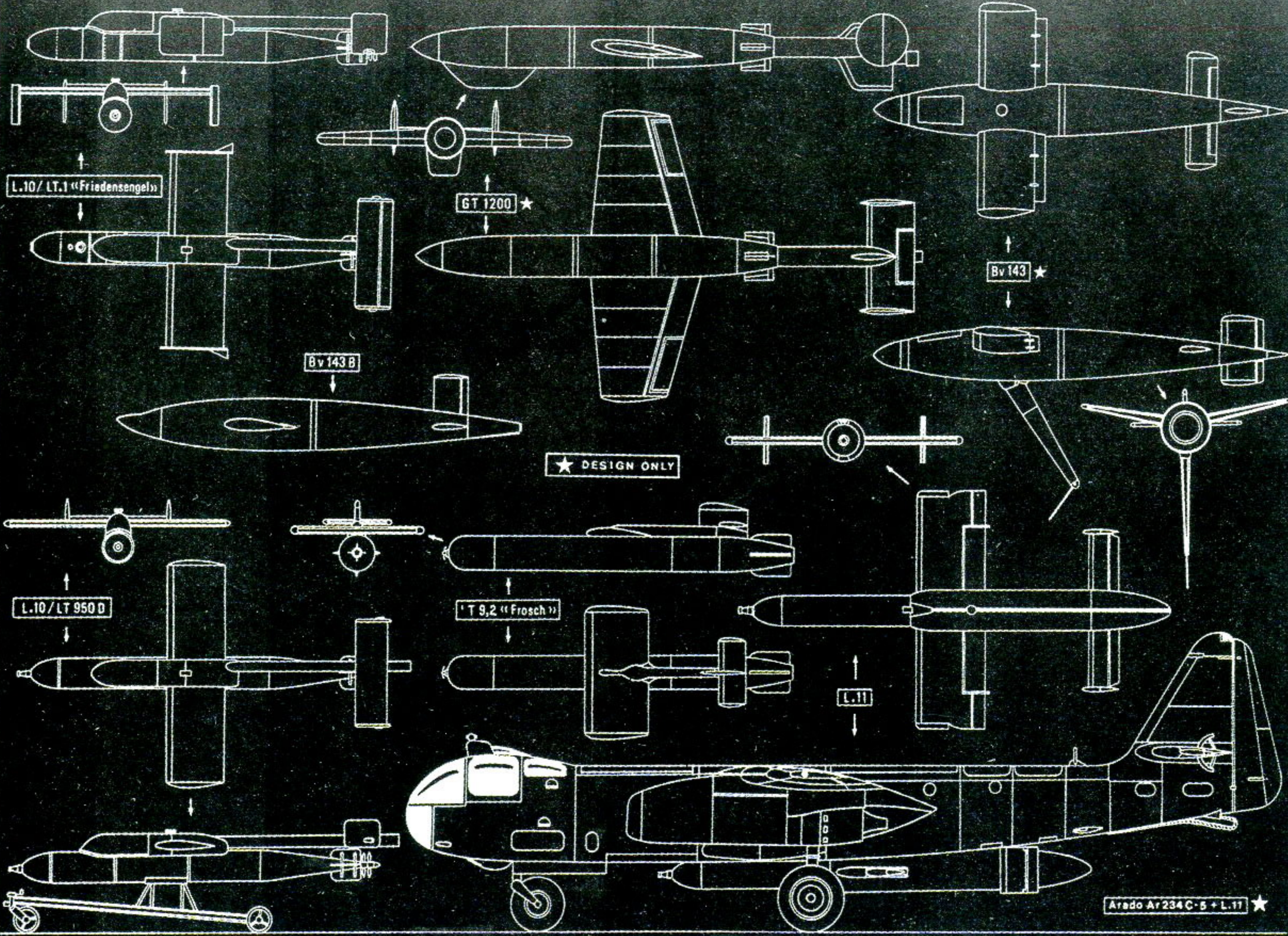

L.10/LT.1 "Friedensengel"

GT 1200 ★

Bv 143 ★

Bv 143 B

★ DESIGN ONLY

L.10/LT 950 D

T 9,2 "Frosch"

L.11

Arado Ar 234C-5 + L.11 ★

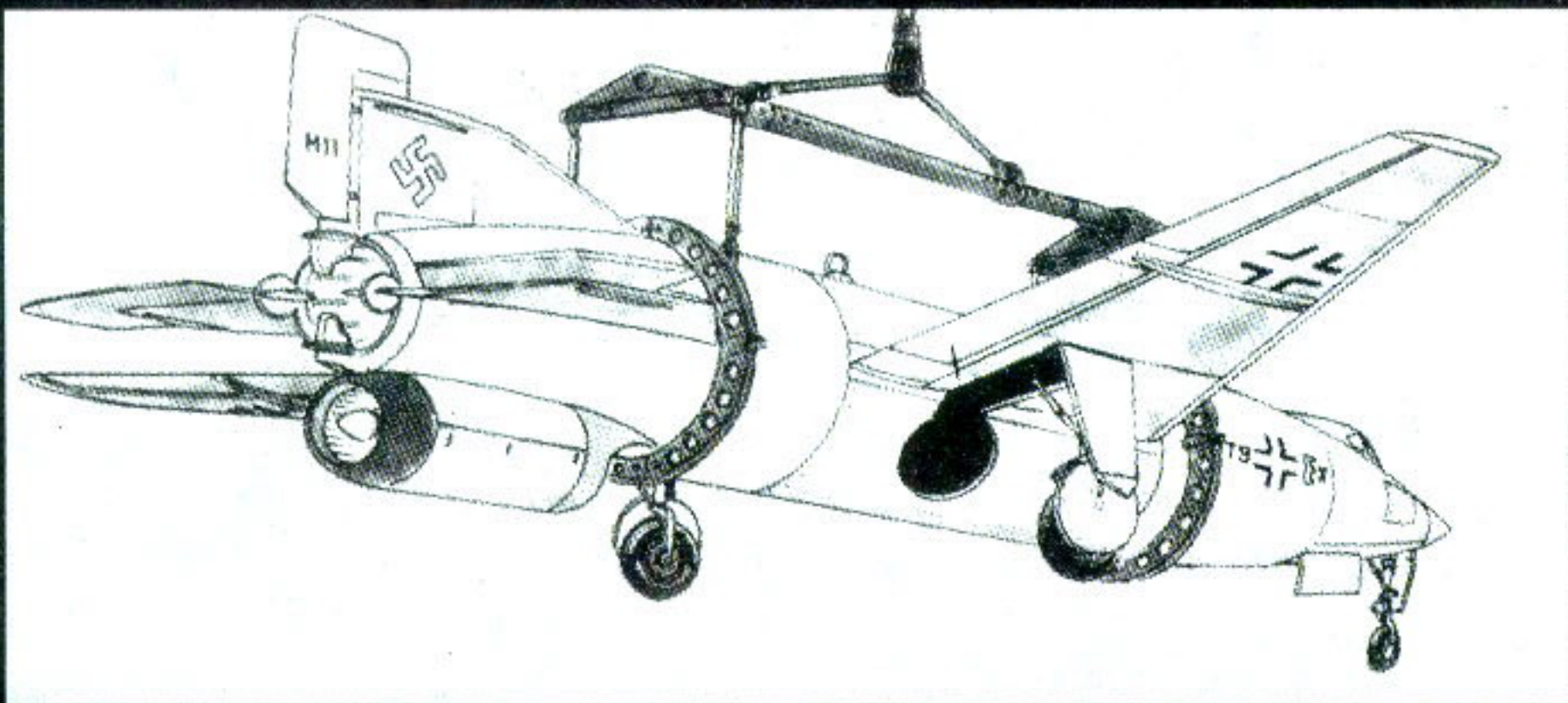

## LUFTWAFFE: 1946—X-PROFILES

A manned A4b variant, originally shown in *Tigers of Terra* V2 #8 (January 1995) in a story titled "Projekt: Mars," was based on the limited information this author had at the time. In this fictional story, the 11th prototype (shown as the M11) is being transported inside the secret Iglinger complex on October 31, 1945. Goebbles has just shown Hitler his latest film depicting a Nazi manned mission to Mars using the von Braun-style spaceplane. The film was also meant to mislead the Allies into thinking that the Nazis were really planning such an unbelievable mission. But in this story, Hitler would later take this joke seriously.

This A4b variant, given the fictional designation A4m, for "manner" (manned), was intended as a testbed using a single jet engine for conventional takeoff and landing tests, then finally a full-load test flight by vertical takeoff using the main rocket engine, after which, upon reaching about 30-40,000 meters altitude, the jet engine would take over for conservative cruising. It was intended to be used as a high-speed reconnaissance aircraft with jet engines, allowing for additional landing options and taxiing to a hardened bunker. A fighter version, with the fictional designation A4j, for jäger (hunter), is armed with up to 24 R4M rockets on the wing and cluster of four 30 mm cannons on the nose. Due to the high-speed nature and a lack of real maneuverability, this version could only be logically used as a point defense interceptor, a role for which other fighters, like the Me-263, Ta-283, Ho XIIB and even the futuristic Li-13 might have been better suited. But in this alternate universe, von Braun himself will test the A4m and unofficially become the first man to break the sound barrier in 1946. Further stories appeared in *Luftwaffe: 1946* V1#3, and more are planned in future issues of the new full-color *World War II: 1946*, to be titled "Destination: Space" and "Raumkrieg". Also planned is a special "Rocket Fighter" issue.

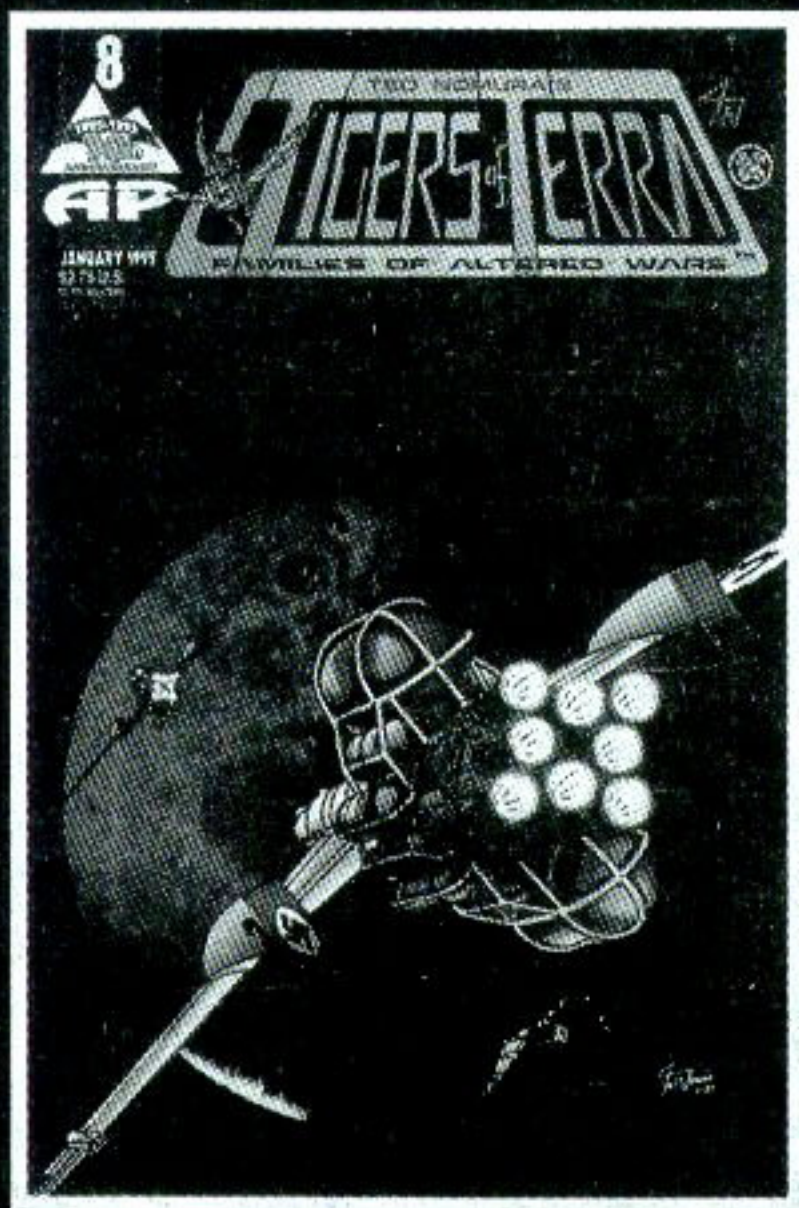

In late 1997, after the second *Luftwaffe: 1946* series began, this author was given far more detailed data and drawings of the manned V2 variants from aviation researcher Justo Miranda of Madrid, Spain. Thanks to his effort, many questions were answered, which greatly helped to make this series and the current new version more authentic. According to his data, the manned reconnaissance variant was designated as the A-6 and, not surprisingly, a manned A-9/A-10 was studied for a possible sonic-speed reconnaissance mission over America. This scenario will appear in future issues, along with the data from the Miranda/Mecardo team in the next technical manual.

# PRODUCT REVIEW

Once again this author will review some of his reference materials that he gathered since the mid-1960s that helped him create his current series or just for laughs.

## BOOKS

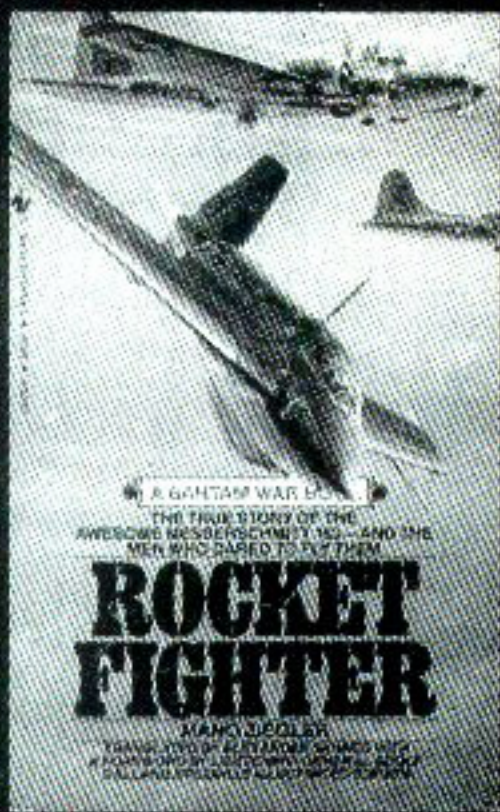

*Rocket Fighter*  
by Mano Ziegler  
Published by Bantam Books, Inc.  
Book size: 6.75" x 4.2", 194 pages  
Price: \$2.95 in 1984 (softback)

I purchased this paperback book during early 1990s from a used bookstore for \$1.75 to add to my collection. Originally published in 1961 in Germany under the title *Raketenjäger Me-163*, this book basically relates the personal experiences of pilots but provides no real dates or data to double-check. Since this book was published only 15 years after the war and much information about this secret project was slow in coming, the lack of information is understandable. Still, the author mentions many interesting stories about the conditions and people (including Hanna Reitsch) that make the book a good buy.



*Rocket Fighter*  
by William Green  
Published by Ballantine Books, Inc.  
Book size: 8.2" x 5.3", 160 pages  
Price: \$1 in 1971 (softback)

Another book with a same title, this one was written by a famous British author (who also wrote the classic *Warplanes of the Third Reich*) and is packed with information that reinforces his well-respected reputation. This book covers nearly all the rocket fighters then known, including lesser-known research types and even Russian and American types. But since even the great Mr. Green must rely on information direct from the original source—the Germans—some of the information is now dated or misleading. Still, this book is one of the best buys for the money. Due to the recent popularity of World War II-related subjects, some used books like this one have jumped in price. I recently saw one selling for \$8, while not too long before I'd seen many all selling for of \$1.

**TOP SECRET BIRD** The Luftwaffe's Me-163 COMET



*Top Secret Bird*  
by Wolfgang Späte  
Published by Pictorial Histories Publishing Co.  
Book size: 10" x 7", 270 pages  
Price: \$11.95 in 1990 (softback)

Written by an actual commander of the Me163 unit, this latest book about the Me163 operation is the best yet. Using all the available data, the book explains all the operational feats and provides heavy insights about how the special "Rocket Fighter" units operated. It includes interesting stories about how the author faced against the famous Hanna Reitsch and the difficulties that he saw in how the RLM handled the war. Eventually, he ended the war as an ace flying the Me-262 jet fighter. This book contains much information, including German documents of advanced types, and even many color photos of the current surviving Komets. Highly recommended for any aviation fan.

*German Jets in W.W.II*  
illustrated by Shigeru Nohara  
Published by Model Art Co., Ltd.  
Book size: 10" x 7.1", 180 pages  
Price: ¥2060 in 1991 (softback)



The Japanese have a reputation for love of detailed tech-books, and this book certainly fills the bill. Packed with more information than you'd know what to do with, the book covers many aircraft types, such the He178, He280, Me163A/B/C/D, Ar234, He162, Ho229 and much more. Many are depicted in beautiful 1/48-scale drawings done by famed illustrator Shigeru Nohara. Although this book contains many chapters covering the Rocket Fighters, the most interesting section was the chapter covering advanced Luftwaffe projects, which certainly helped this author to develop his *Luftwaffe: 1946* series. Even though it's written in Japanese text, this book is highly recommended if you can locate one.

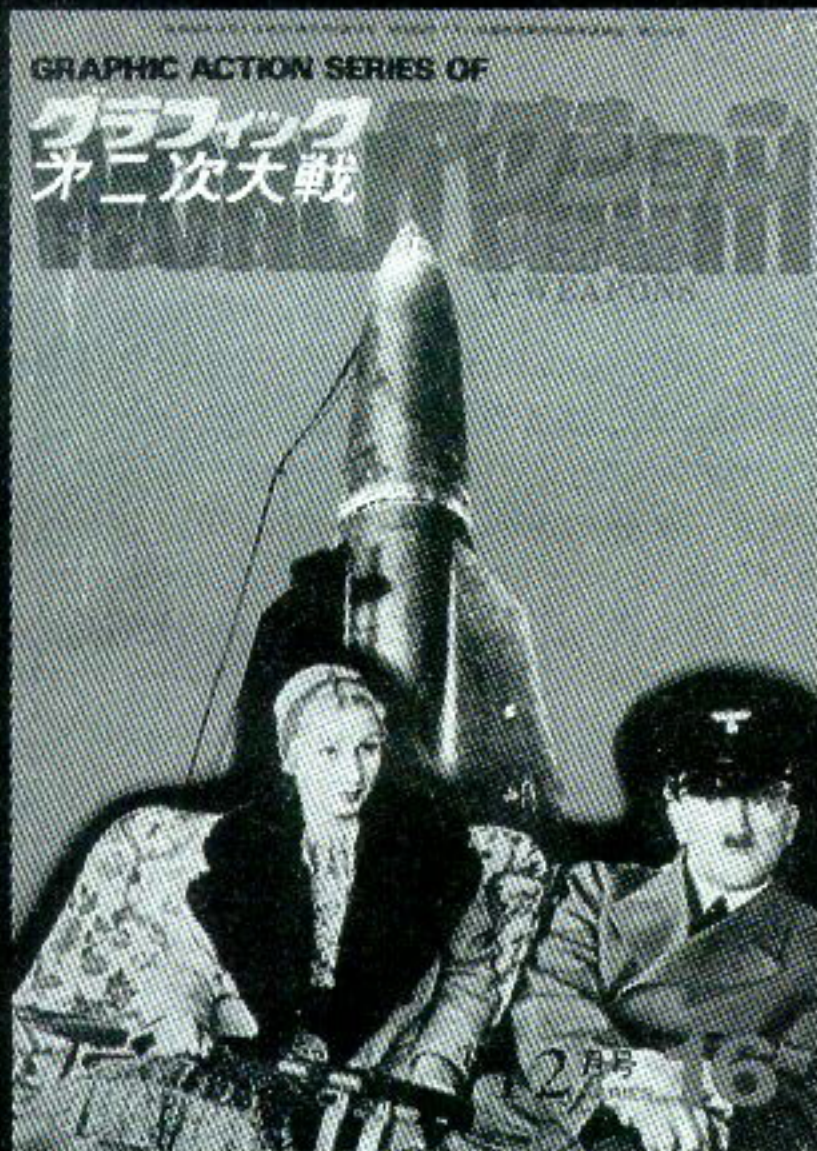

**German V-rocket and V-weapons: Graphic Action Series #16**

Published by Bunrin-Do Co., Ltd.

Book size : 10" x 7.2", 102 pages

Price: 450 Yen in 1975 (softback)

This interesting addition to my collection was given to me as a gift by a friend of mine. Covering a series of war-related subjects (mostly German), this *Graphic Action Series* was popular during the 1970s, and a much-improved version began in the 1990s. Much like Ballantine's *Illustrated History of World War II* series from England, the Japanese textbook contains many photos and diagrams from the war years, but the data is somewhat generalized, since this volume contains nearly all the German weapons that were considered unique or secret.

**BOOKLETS**

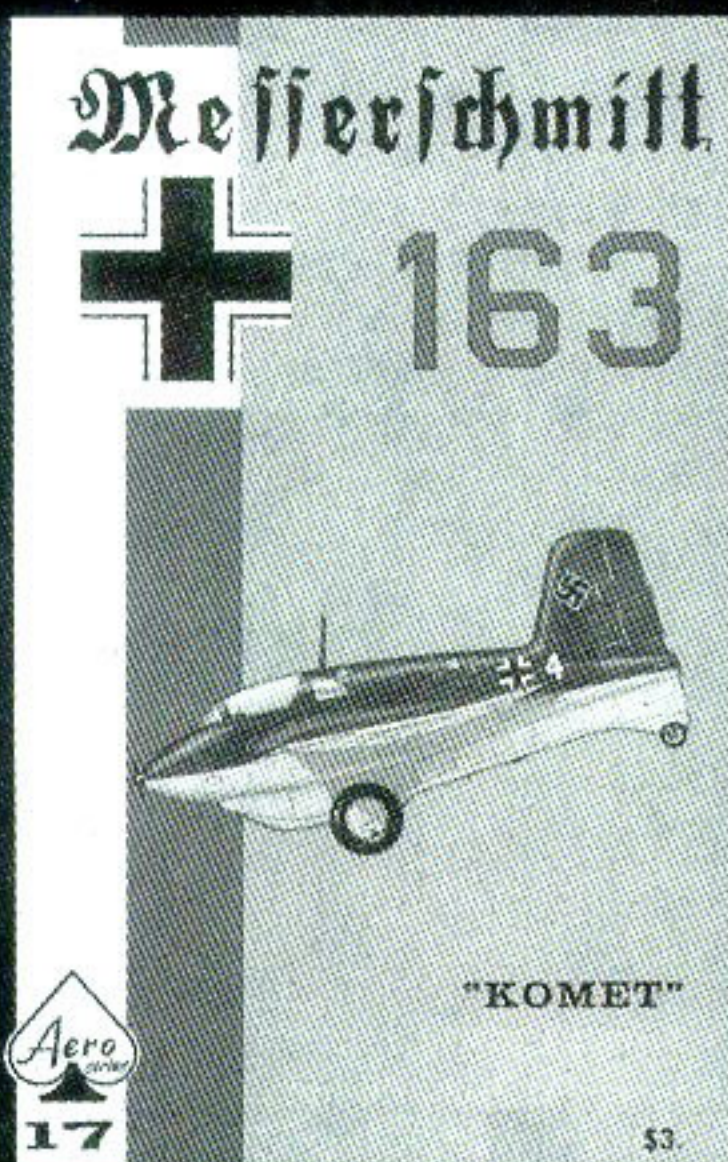

**Messerschmitt 163 "Komet": Aero Series #17**

by Edward T. Maloney and Uwe Feist

Published by Aero Publishers Inc.

Book size: 10.6" X 7.25", 52 pages

Price: \$3.00 in 1968

Another one of the easy-to-afford aircraft reference books written by Mr. Maloney, of aviation author/collector fame. This book includes a good amount of detailed information, if not somewhat outdated due to the times, about the world's most famous rocket fighter. Many of the photos are actually postwar types taken in the United States, but many wartime photos are also shown while the development and war years are explained. The Japanese version is also shown in good detail. The art (mostly in color) is done by an excellent and famous aviation artist, Uwe Feist. I purchased this copy during the late 1970s at the Edwards AFB mini-exchange for two dollars, brand new, and it was and is well worth it.

**Messerschmitt Me163 Komet: Schiffer Military History Vol. 20**

by Mano Ziegler

Published by Schiffer Publishing Ltd.

Book size: 11" x 8.2", 48 pages

Price: \$7.95 in 1990

Originally published in 1979 by Podzun-Pallas, Verlag, Germany, this English language version is done in the same manner as the United States' *Squadron in Action* series (minus the color center fold-out). Somewhat dated by the current wealth of updated information, the book nevertheless adds much to this subject, which the Squadron series has not yet covered. Mostly well-known black-and-white photos and diagrams from the war years, the subject was written by Mano Ziegler, who wrote the *Rocket Fighter* book mentioned earlier.



**Luftwaffe 1946: Wydawnictwo Militaria Series #12**

by Janusz Ledwoch

Published by Wydawnictwo Militaria, Poland

Book size: 11.5" x 8.25", 42 pages

Price: \$9.95 in 1997



When this book was announced in late 1996, this author wondered if it was rushed into production in response to our own *Luftwaffe: 1946* series, which had begun six months earlier. Finally becoming available in early 1997, this 12th book of their otherwise excellent *Squadron in Action*-format series, like the masterful *Fw200 Condor: Wydawnictwo Militaria Series #7*, includes many drawings that look like they were taken from Justo Miranda's files (although uncredited). The cover includes excellent art (dated September 1996, after our *Luftwaffe: 1946 V1 #2* had come out) done by Jaroslaw Wrobel. The inside and back cover include some nicely done color profiles, except two include the inaccurate (and highly suspect) Defense of the Reich band that was used only in the fictional carrier markings shown in our *Luftwaffe: 1946 V1#2*!

## COMICS

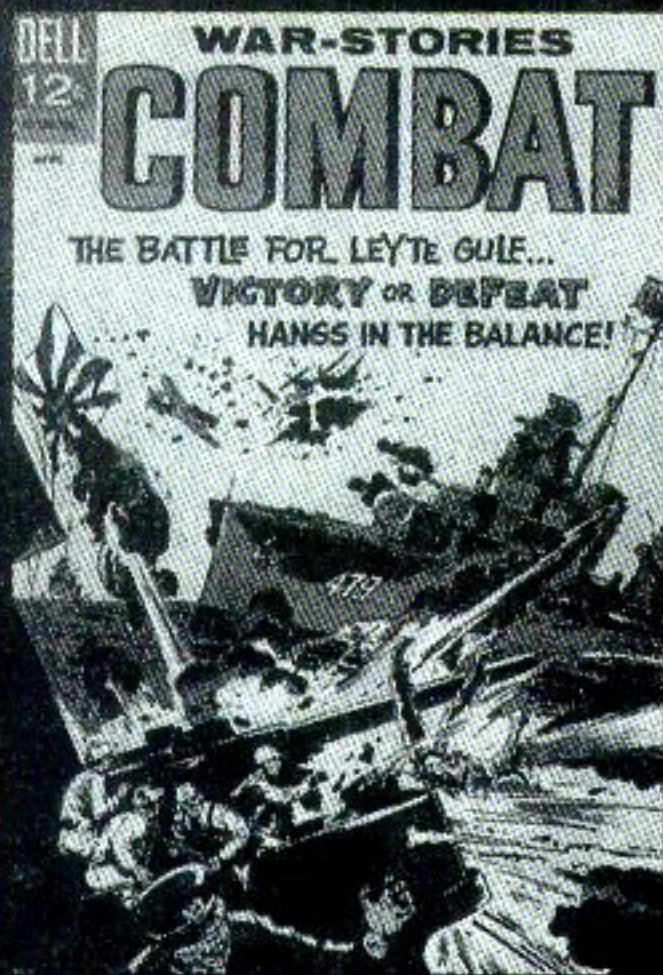

*Combat* #24 (Apr 1967)  
Published by Dell Publishing Co.

Another masterful documentary war comic from Dell, this issue covers the Battle of Leyte Gulf, a battle that this author himself did not know of until he read it. Although, in retrospect, this issue includes some inaccuracies (like the carrier *Shoho* accompanying the *Yamato* group), it was still good enough to inspire this author to pursue his studies of World War II battles in detail, including practicing drawing using this comic as a guide. Some faults were obvious for this author, like the Japanese characters being stereotypes with faces not matching those of real people, while the Americans are naturally well drawn and look less menacing. The Japanese kanji used in the issue are totally useless, even though some effort was made on the map for accuracy. The back-up story is a true story of an F4U Corsair pilot who got shot down and managed to escape by dressing up as a Japanese!



*Our Army at War* #151 (Feb 1965)  
Published by National Periodical Publications, Inc.

Although this issue still featured Sgt. Rock for the main story, the *Our Army at War* title was still shown in large bold letters, even though he was introduced in back #81. However, this issue is a milestone because another famous title, *Enemy Ace*, debuted here as a back-up story. In the main Sgt. Rock story, "War Party!", Rock makes a pow-wow with an American Indian soldier named "Little Sureshot" (rather odd being named after a famous little white girl of the late 1800s) in which they both beat the crap out of Nazis by shooting down a Stuka and knocking down two Tiger tanks. In the "Enemy Ace" back-up story, Rittmeister von Hammer, who has just shot down his 50th victim, is feeling depressed (he shouldn't be flying in his condition, but war is hell), but still manages to fly so he can kill more. Overall, a great entertaining war comic!

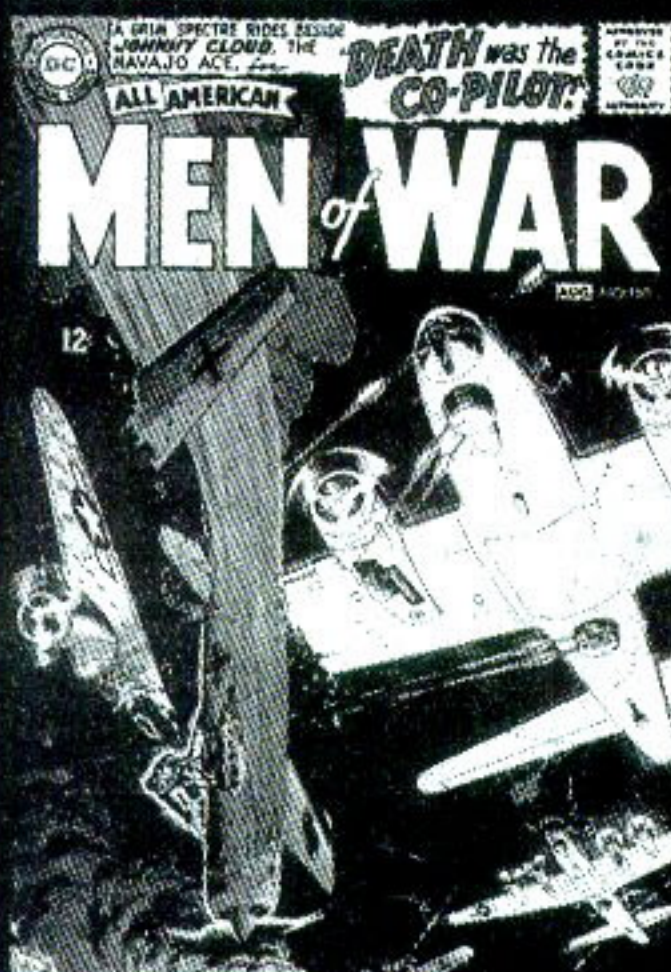

*All American Men of War* #110 (Jul-Aug 1965)

This cover made a great impression on me because it's not every day you see a German Fw190 making a kamikaze attack against a B-17. But as it turned out, in the main story, "The Co-pilot was Death!", two American Indian heroes, Johnny Cloud and Silent Bear, are competing for the love of nurse Running Deer while flying P-51s (with USAF markings!) and end up in a Nazi POW camp with a commandant who looks like a mean version of Col. Klink. Then they find out that the Nazis are going to use some of the captured B-17's to bomb an Allied radar station, and Johnny and other crew escape from execution and fly an Me109 (not the Fw190 shown in cover) with which Silent Bear bravely rams the Nazi B-17. A back-up World War I aviation story called "Aces of Dread" shows twins competing in battle. An American propaganda comic at its best!

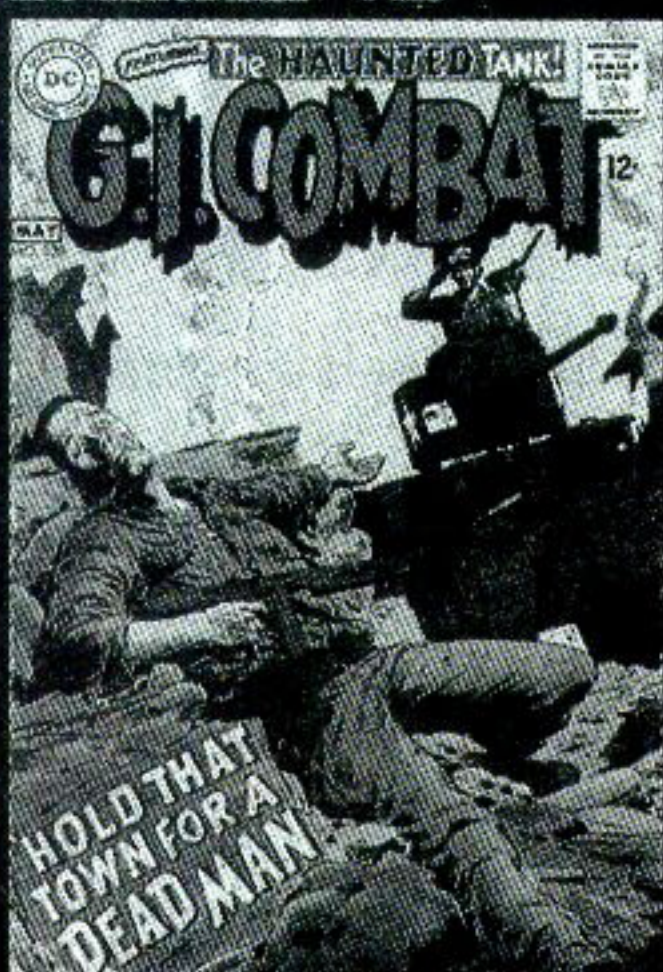

*G.I. Combat* #129 (Apr-May 1968)

When I saw the movie 'Saving Private Ryan', the latter part was awfully familiar until the smoking gun came out in Capt. Miller's death scene! It looked exactly like the death scene of an Army Captain of the Fox company that just got wiped out by German Tigers while desperately trying to hold the town in *G.I. Combat* #129's 'Hold That Town for a Dead Man', a scene begins at what looked like the ending scene of 'Ryan' movie. The Stuart tank crew came too late to save the Fox company and end up fighting the two surviving Tiger tanks. But it turned out to be the dead Captain that saves the day. I would not be bit surprised if Mr. Spielberg read this issue and was influenced by it. It was for me. Another excellent issue drawn by Russ Heath. Oh, the back-up story drawn by Jack Abel called 'Combat Nightmare!' was cool too, if you could get used to his style of art.

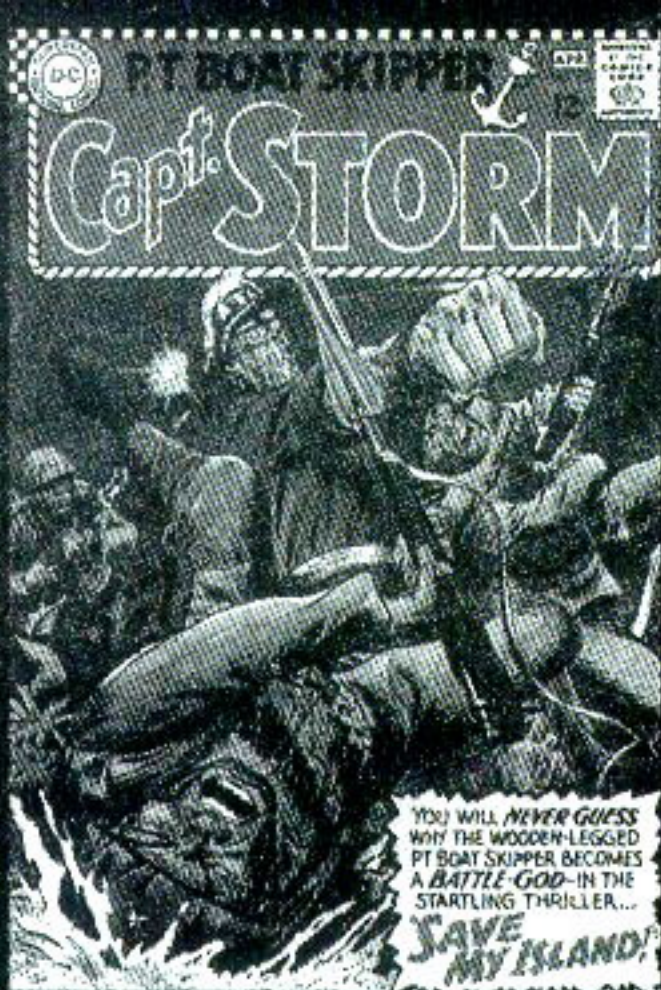

Capt. Storm #18 (Mar-Apr 1967)

Obviously inspired by JFK's wartime adventure aboard the PT-109, this DC variant included a skipper with a wooden leg, replacing the leg he lost when a Jap sub with tiger-shark markings rammed his ship. Unfortunately, it was too close to the JFK story, so unknown to this author, the first issue that he picked up (#18) turned out to be the last issue published! Capt. Storm, determined to take revenge for loss of his first crew, hunts down the tiger-shark sub and sinks it, only to find out that there's more than one! (The tiger shark is probably a squadron marking.) After he sinks another one (actually forcing a Zero to ram it) and a cruiser, he's never sure which sub really killed his crew, and that's how the story ends. Aside from the stereotypical drawing of Japanese, this author enjoyed it and wished for more. The back-up story, "Which One Has My Name On It?," was extremely well done and gave a more realistic view of the soldier's peril.

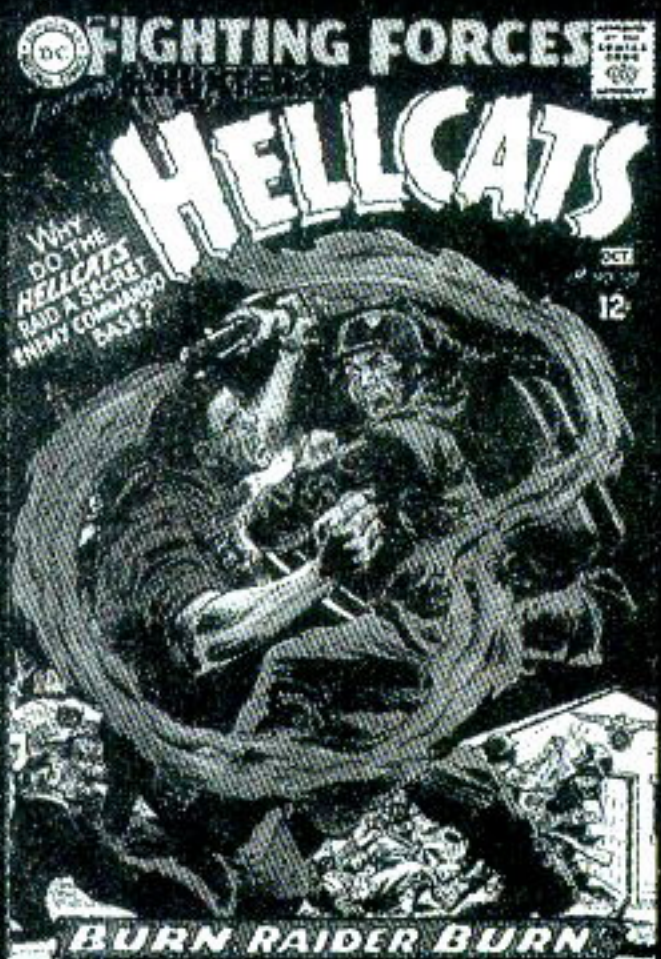

Lt. Hunter's Hellcats #109 (Sep-Oct 1967)

Another movie-inspired series by DC, *Hellcats* is DC's version of *The Dirty Dozen*. It's pretty much what you'd expect from a war comic, except this crew seems to be desperately trying to compete against much the more interesting *Sgt. Fury* from Marvel. In this issue's main story, titled "Burn, Raiders, Burn" (based on the "Burn, baby, burn" motto popular during the time) and drawn by Jack Abel, the Hellcats join the French circus so they can whip the naughty Nazis. Actually, the back-up story, "The Unsinkable Subs," also drawn by Jack Abel, was more interesting. A US frogman finds a secret Jap sub base that's causing much chaos among the US fleet. This author had little trouble getting used to Jack Abel's art, mainly due to the lack of technical accuracy present from Russ Heath, but after he saw several excellent issues of *Superman/Supergirl* also drawn by Abel, he started to enjoy that artist's style much more.

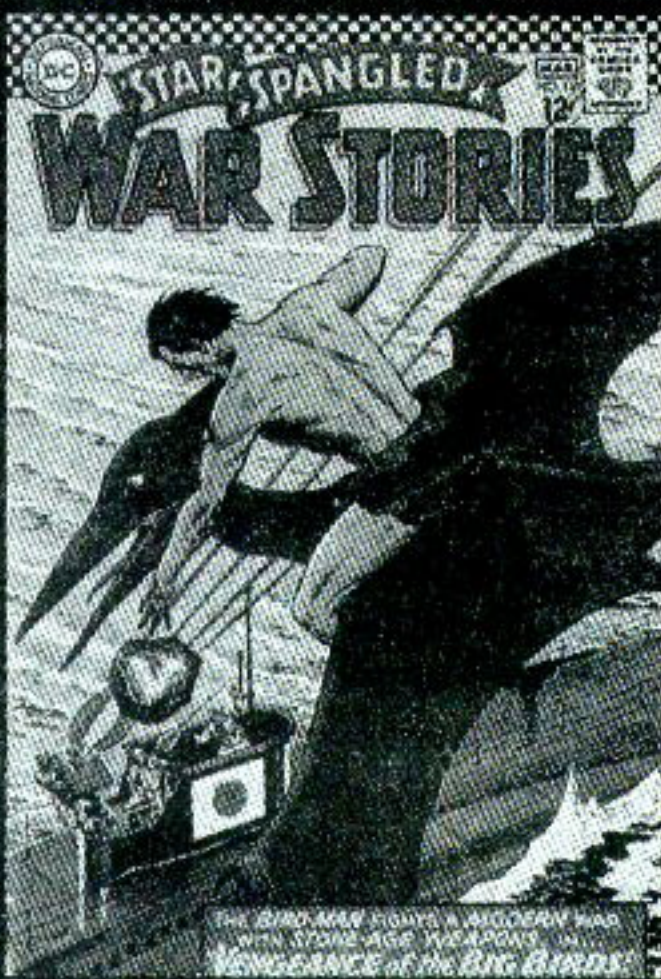

Star Spangled War Stories #131 (Feb-Mar 1967)

For some reason, monster-inspired war stories were very popular in the United States during the 1960s, allowing many top-notch artists like Russ Heath and Neal Adams to venture into this arena. In the story "Revenge of the Big Birds!", an F4U Corsair pilot returns to the island where he grew up and learns to use the "Big Birds" that live there against the Japanese. Although this author was born and spent his elementary school years in Japan, he never saw the attraction for giant monsters, thus this issue would've been ignored had it not been for more masterful art by Russ Heath. The back-up story, "The Last Booby Trap!", is drawn by Jack Abel and is one of this author's favorites drawn by that artist. A demolition expert trying to mine a city to hold the tide of a German Tiger tank advance is himself injured in the head and can't remember where he set all the booby traps! It's good stories like this that made the DC war comics this author's favorite brand during the late 1960s/early 1970s.

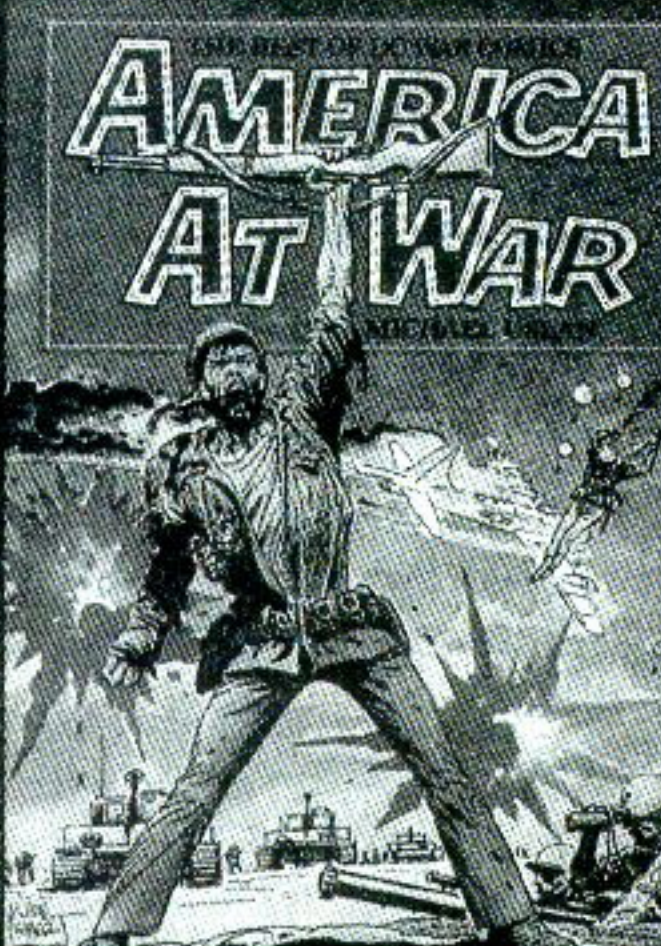

America at War: the Best of DC War Comics  
Published by Simon & Schuster

Sometimes you get lucky, very lucky. When this author was visiting a bookstore during the mid-1980s, he found this book in the clearance section. No longer taking war comics seriously, he purchased this book purely based on its price of \$5.00. The book, written by Michael Uslan, shows an excellent chronological history of DC war comics, with reprints of many hard-to-find first appearances of main characters on better quality paper. Uslan gives excellent deductions regarding the propaganda value of war comics, a statement with which this author fully agrees. The real gems are the reprinted stories themselves, from the first appearances of Blackhawk, the Boy Commandoes, Sgt. Rock and others, to some later ones this author already has in their original printings, to a story that explains why Superman failed a wartime physical, to master storytelling like the "USS Stevens" episode "Kamikaze". This book is highly recommended if you can find it.

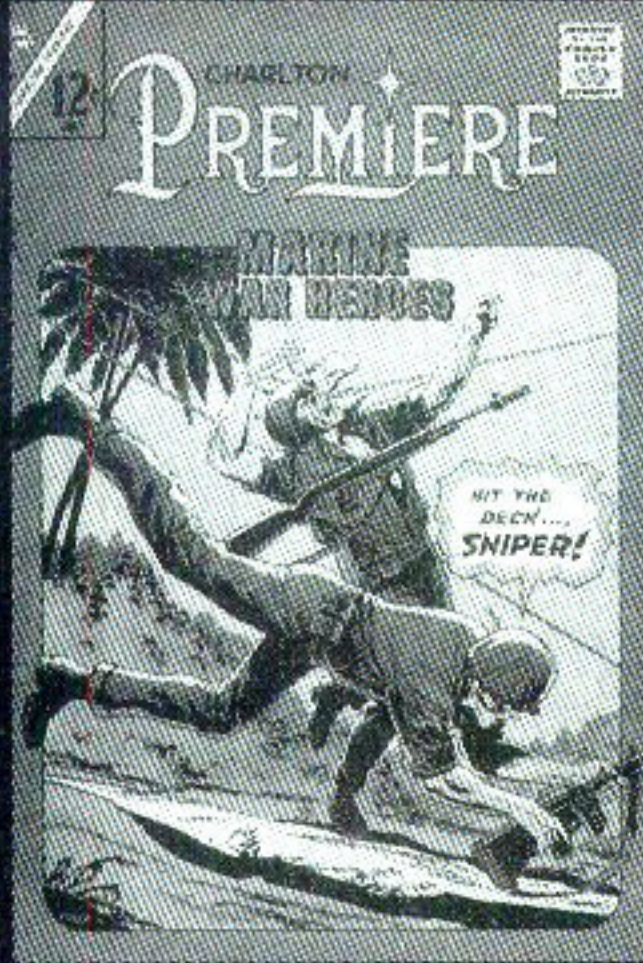

Charlton Premiere #19 (Jul 1967)  
Published by Charlton Comics Group

Charlton war comics made the best effort to provide alternative choice, often focusing on realistic characters and/or events. This issue starts with a good World War I story titled "The Devil Dogs of Chateau Thierry," in which the Americans are fighting against a tough German attack in 1918. Despite the artist's excellent efforts towards accuracy, the Germans are wearing outdated 1914 "spike" helmets rather than the flat 1917 type. Then there's a one-page propaganda short titled "What Makes a Marine?", then a fictional story titled "Bandage Brigade," in which the Japanese take over an American medical compound and capture a pretty blond nurse (fortunately, the Japs don't stereotypically try to rape her). Naturally, the injured Americans outsmart them and overpower the entire group without killing anybody. In the last story, "The Darkness of War," a US Lieutenant in the Vietnam War gets shot in the head and loses his eyesight, and tries to escape the top-gun Viet Cong by outsmarting him.

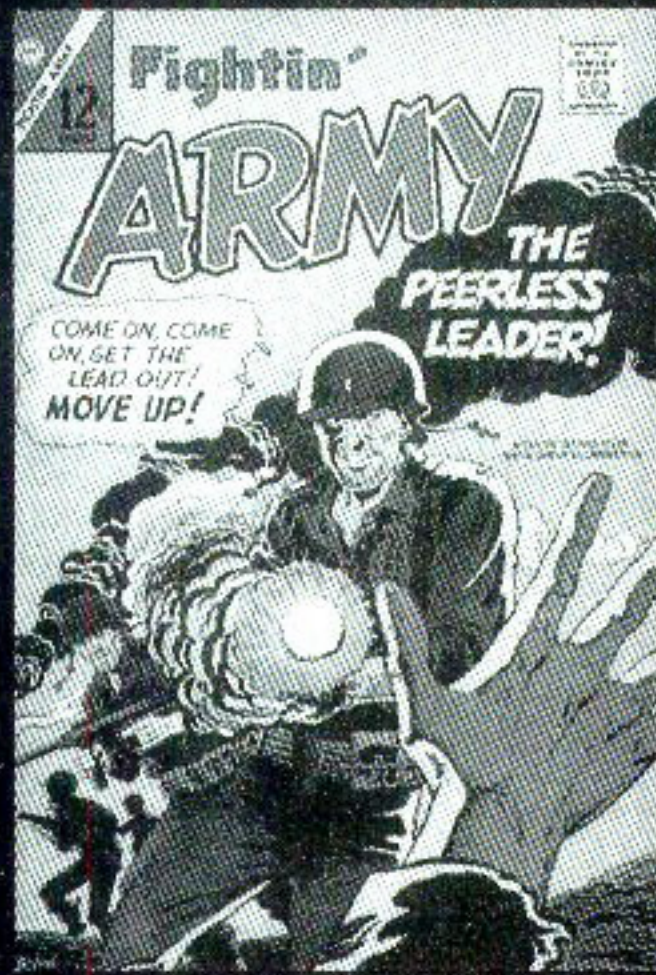

Fightin' Army #75 (Aug 1967)

This issue starts off with a "A Turning Point/ Sicily: July 10, 1943" in which US parachuters land right in the middle of German guns and escape only thanks to a strafing P-38. The parachuters then befriend a little Italian kid and later capture an Italian soldier (who naturally hates the Germans) and win a battle against the Germans. The second story, "Fortress Sicily," is actually Part II of the first. German officer get mad at the Italians' lack of enthusiasm, so one pulls a gun on one of the Italian officers(!) and takes control. Using Tiger tanks and Focke-Wulf 190's, they're still beaten by the Americans, and the American officer gets a nice-looking Italian girl in the end. (The little Italian kid looks suspiciously happy, too.) A different story, "The Peerless Leader," is set in Korea, where the Americans fight against the Communists and blow up a T-34 tank (very well drawn). After a long struggle, they eventually emerge victorious (of course). I just love propaganda.

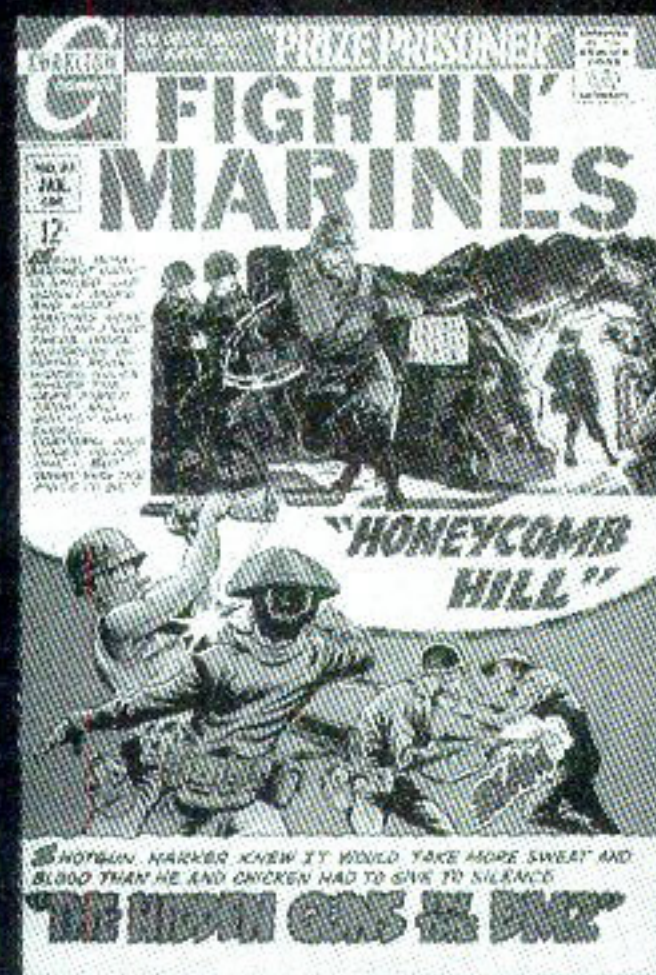

Fightin' Marines #83 (Jan 1969)

The first story, "Honeycomb Hill," was somewhat pleasantly surprising, because the Japanese soldiers actually speak Japanese! The entire art had an Asian look to it, which was not surprising, since the artist credited is named Sanho Kim. In this story, the American is still a hero who penetrates inside a Japanese fortress and blows them up using yet more American ingenuity. Then there's a one-page story titled "The Divine Wind," then a Vietnam story titled "Shotgun Harker," in which a Sgt. Fury-type character is beating the crap out of the Viet Congs. Finally, there's "Prize Prisoner," in which another F4U Corsair is shot down (maybe they shouldn't fly them so low) and captured by the Japanese. The American pilot bravely defies his Japanese captors, the American commando team easily rescues pilot and blows up the building, and the Japanese Colonel quickly surrenders and is actually happy! Makes me wonder how many young Marines really believed this until they faced the real Viet Cong.

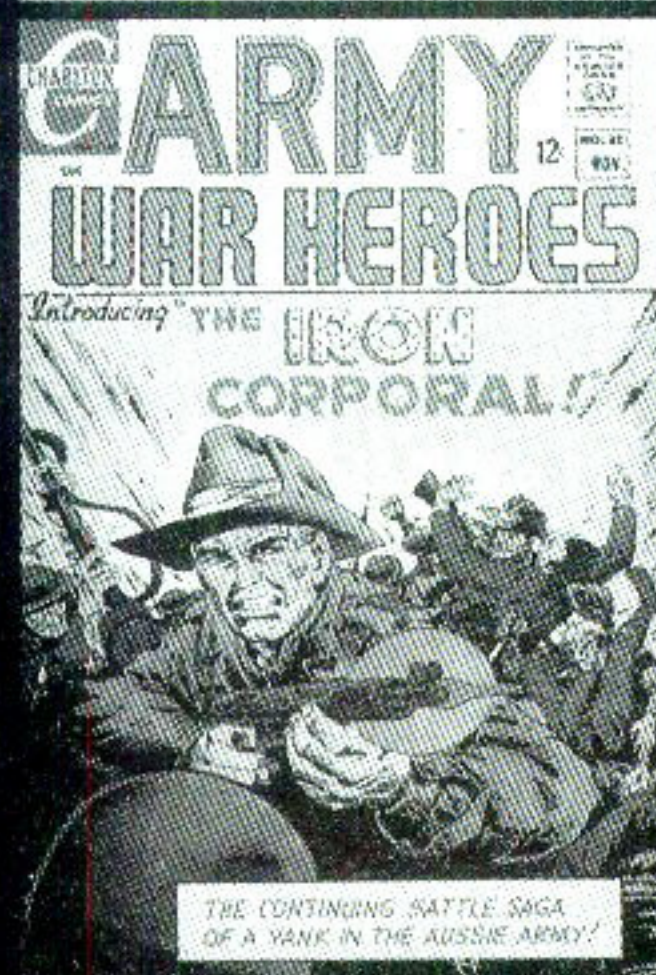

Army War Heroes #22 (Nov 1967)

It begins with "Bushwhacker Pass," which this author, who couldn't read English that well then, thought was a story about the Battle of Bulge when he read it as a child, but careful reading years later revealed that this battle is fought in Northern Italy. Although extremely well drawn (the lousy coloring job does no justice), it fits the typical format of Americans facing tough Germans but beating them in the end, except this time the Americans have the overwhelming firepower. Tanks like Shermans and Ju-88 aircraft are very accurate, and the usually uncredited artist wisely signed his name as "Dalfiume" to leave his mark. "The Loner" is a story of a lone G.I. who takes on the entire German army himself until help arrives, at which point another Col. Klink type character surrenders. "The Iron Corporal!", on the other hand, is extremely well written. An American volunteer fighter with the Australian army in New Guinea is fighting against a very tough Japanese army. Although the Allies win in the end as usual, it's still a good story. I just wished the American was actually an Australian.



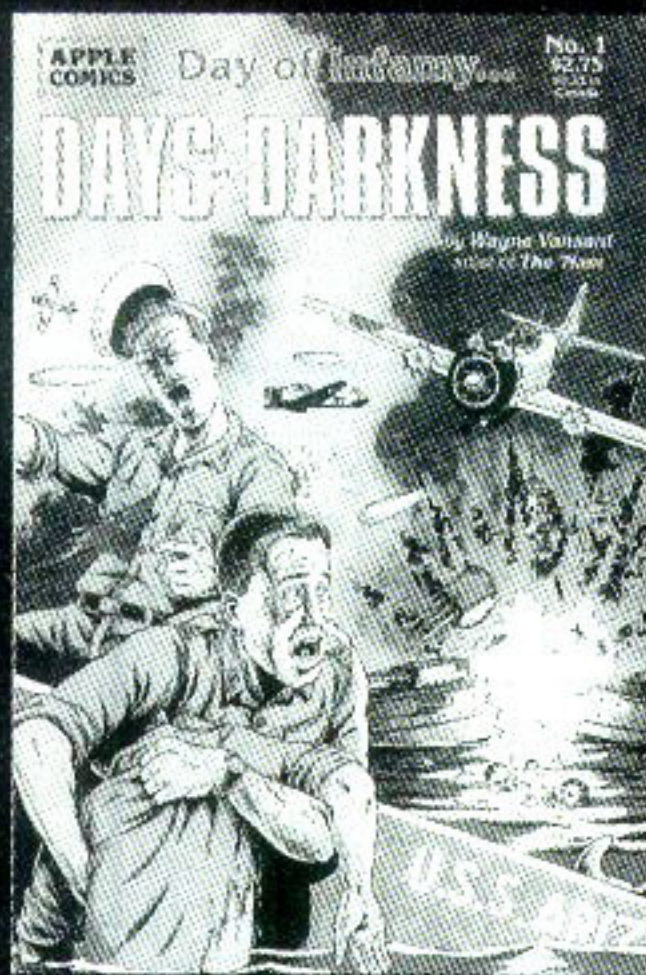

*Days of Darkness #1* (Mar 1992)  
Published by Apple Press Inc.

Even though this is another one of the “fictional characters in real history” format (like *Winds of War/War and Remembrance*), Wayne Vansant makes up a lot by showing his usual talent for historical and technical accuracy. Much in the all-American ideological style, the story focuses on an American family from southern Texas who is forced to fight a war when the Japanese attack Pearl Harbor. It begins a day earlier, when a character named Dan (who obviously looks like Humphrey Bogart) is troubled by his sister marrying a Japanese, and a typical plot thickens. The Japanese attack on Pearl Harbor is well researched and depicted, although due to the format, the Japanese view of the war is minimal, if not non-existent. Also, it is still not clear if the Japanese Zeroes really spent their precious fuel and ammo chasing after and strafing women and children, but it was still a good yarn. It is also one of very few war comics that came out in the U.S. in this decade.

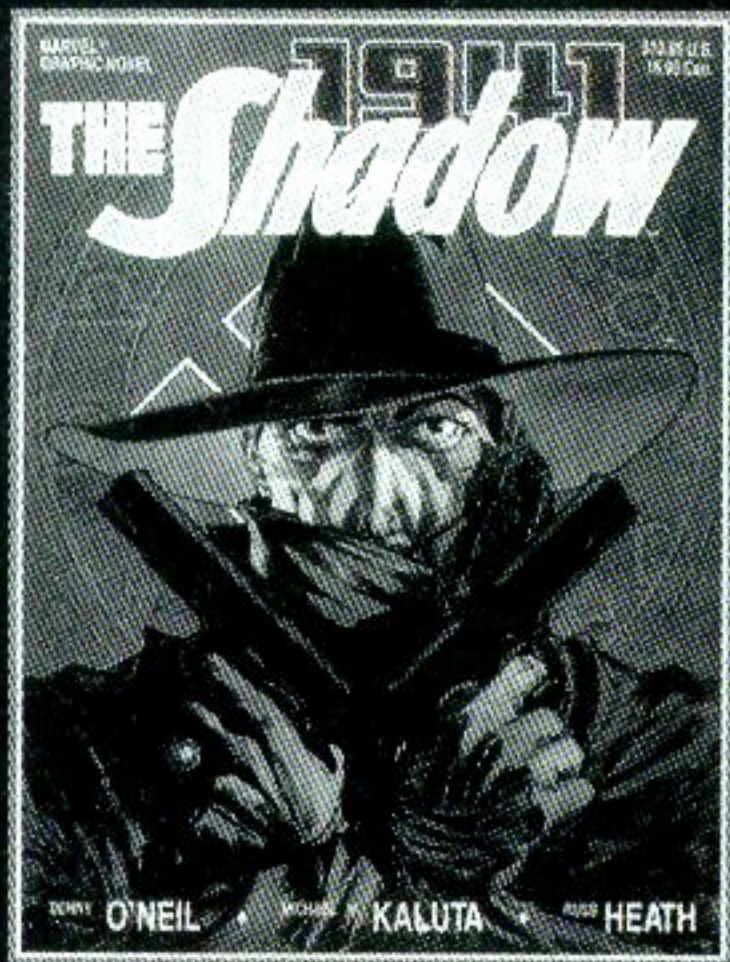

*The Shadow: Marvel Graphic Novel* (1988)  
Published by Marvel Comics, A New World Company.

This hardbound book was discovered by accident at the Bud Plant booth at the Comic Con International in San Diego this past August. Being not much of a superhero enthusiast, the author knew nothing of this book when it was originally released in 1988, even though he was and is a Russ Heath art fan. Heath's obvious art style caught the author's eye and led to the discovery that this is one of his finest works. Back in the 1980s, Marvel Comics was making a serious effort to make high-quality war comics, a niche DC had held for decades. Their *The 'Nam* series and *High Adventure* anthology were good examples, but this book nearly tops all of them. The story is based on Hess's obsession with astrology (recently made less of a case but still a good subject) and tells how Hitler and his cronies figure out how to fight a war based on predictions. Naturally, *The Shadow* influences the final outcome, and a female German astrologer is shown wearing a male-type uniform, oddly enough. Despite these points, this book is still highly recommended.



*Deep Blue Fleet Vol 1* (1992)  
*Shonen Champion Comics Special*

This series, which came out during the 50th-anniversary reflections on the “Pacific War” exemplifies the Japanese obsession with altering World War II to run their favor—far, far in their favor. At the beginning, Admiral Yamamoto's Betty-bomber is shot down in 1943 and the Admiral is killed, or so we think. In this “simulation war,” the Admiral is reincarnated as a different junior officer 38 years in the past(!), and with his knowledge of the future, he is determined to avoid the mistakes and change the course of history to favor the Japanese. Later, other high-ranking Japanese are reincarnated back into the past (oddly, no other races), create a monster military higher in technology than everybody else, and beat the crap out of the Americans, British (who give up too easily) and eventually the Germans (who're mad because the nice Japanese got Einstein to work freely with them and gave all the Jews sanctuary). Whenever this author thinks his own *Luftwaffe/World War II: 1946* is stretching reality too far, he remembers *Deep Blue Fleet* and realizes he's not even close!

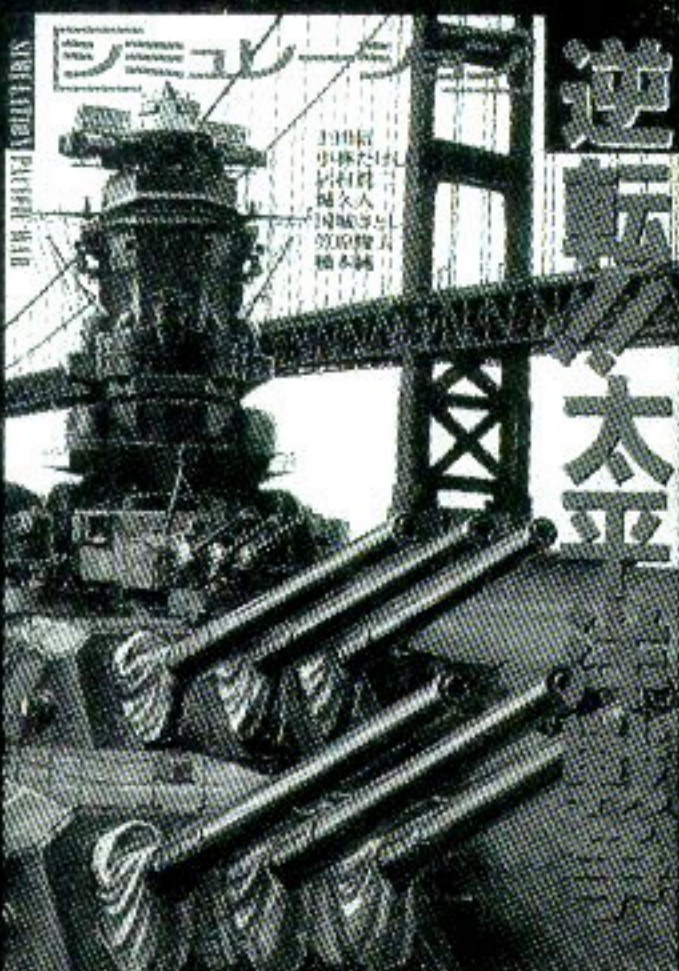

*Simulation Pacific War* (1992)  
Bomb Comics

Published during the Japanese revisionist craze period of the early 1990s, this volume is a collection of selected stories that first appeared in the monthly *Combat Comic* series during 1991. A wealth of talents is included in this format. The first story is a “simulated” Japanese victory in Leyte Gulf, similar to the story shown in *Tigers of Terra VI#10* a little earlier, but with more blood and guts facing the Americans. The second story is about how the Japanese chased and sank the USS Enterprise on December 7th, 1941. The third is a fictional story about the British fighting the Japanese in 1942. The fourth is about jungle fighting, the fifth about a US pilot getting killed fighting the Japanese, and the sixth...well, you get the idea. If you can swallow your national pride and think the Japanese can whip their enemy by clever thinking (just like the American war comics mentality of decades past, only in reverse), then this book can be highly believable. If not, like me, just think of it as entertainment with lots of fun facts.

# REICH DREAMS

Unknown Airplanes of the Second World War  
 Experimental Airplanes Since 1945 (238 types)  
 Vertical Takeoff Airplanes (65 types)  
 Circular Wing Airplanes (36 types)  
 Spanish Civil War Airplanes (287 types)  
 Spaceships (Fictional) (551 types)  
 Unusual Vehicles (Fictional ) (76 types)  
 Spaceship Interiors (Fictional) (143 types)  
 Flying Clothing and Uniforms (1913-1996)  
 Ejectable Seats (1943-1996)  
 Spacesuits (Fictional) (128 types)  
 Robots (49 types)

Please write requesting a list of items. Price will be settled upon receipt of order. Send 2 IRCs to:  
 Justo Miranda  
 C/ Tutor 53 Bj-C  
 28008 Madrid  
 SPAIN

## TIGERS OF TERRA/LUFTWAFFE: 1946 BACK ISSUES

available from the author as of September, 1999

### TIGERS OF TERRA, INDIVIDUAL ISSUES

- |  |         |  |        |
|--|---------|--|--------|
| <input type="checkbox"/> Book One (Vol. 1, #1 & 2), AP ed. | \$16.00 | <input type="checkbox"/> Vol. 1, #10, Mindvision ed. | \$6.00 |
| <input type="checkbox"/> Vol. 1, #3, Mindvision ed.        | \$6.00  | <input type="checkbox"/> Vol. 1, #11, A.P. ed.       | \$6.00 |
| <input type="checkbox"/> Vol. 1, #4, Mindvision ed.        | \$6.00  | <input type="checkbox"/> Vol. 1, #12, A.P. ed.       | \$6.00 |
| <input type="checkbox"/> Vol. 1, #5, Mindvision ed.        | \$6.00  | <input type="checkbox"/> Vol. 2, #1, A.P. ed.        | \$4.00 |
| <input type="checkbox"/> Vol. 1, #6, Mindvision ed.        | \$6.00  | <input type="checkbox"/> Vol. 2, #3, A.P. ed.        | \$4.00 |
| <input type="checkbox"/> Vol. 1, #7, Mindvision ed.        | \$6.00  | <input type="checkbox"/> Vol. 2, #5, A.P. ed.        | \$4.00 |
| <input type="checkbox"/> Vol. 1, #8, Mindvision ed.        | \$6.00  | <input type="checkbox"/> Vol. 2, #8, A.P. ed.        | \$4.00 |
| <input type="checkbox"/> Vol. 1, #9, Mindvision ed.        | \$6.00  | <input type="checkbox"/> Vol. 2, #15, A.P. ed.       | \$4.00 |

### TIGERS OF TERRA, VOL. 1 12-PACK SPECIAL

- Vol. 1, #1-12 \$100.00

### LUFTWAFFE: 1946, VOL. 1 4-PACK SPECIAL

- Vol. 1, #1-4 \$20.00

## ALL ISSUES ARE LIMITED IN STOCK

Supplies of some issues are extremely limited. Please send your U.S. check or money order to: Ted Nomura, 7272 Wurzbach, Suite 204, San Antonio, TX 78240. Prices are for U.S. orders only. Canadian orders add \$0.25 orders per book, Mexican orders add \$0.50 per book, overseas orders add \$1.50 per book.

Total Order Name: \_\_\_\_\_  
 \$ \_\_\_\_\_ Address: \_\_\_\_\_  
 City: \_\_\_\_\_ State: \_\_\_\_\_ ZIP: \_\_\_\_\_

For other books  
 check the Antarctic  
 Press order section.

# UNKNOWN!

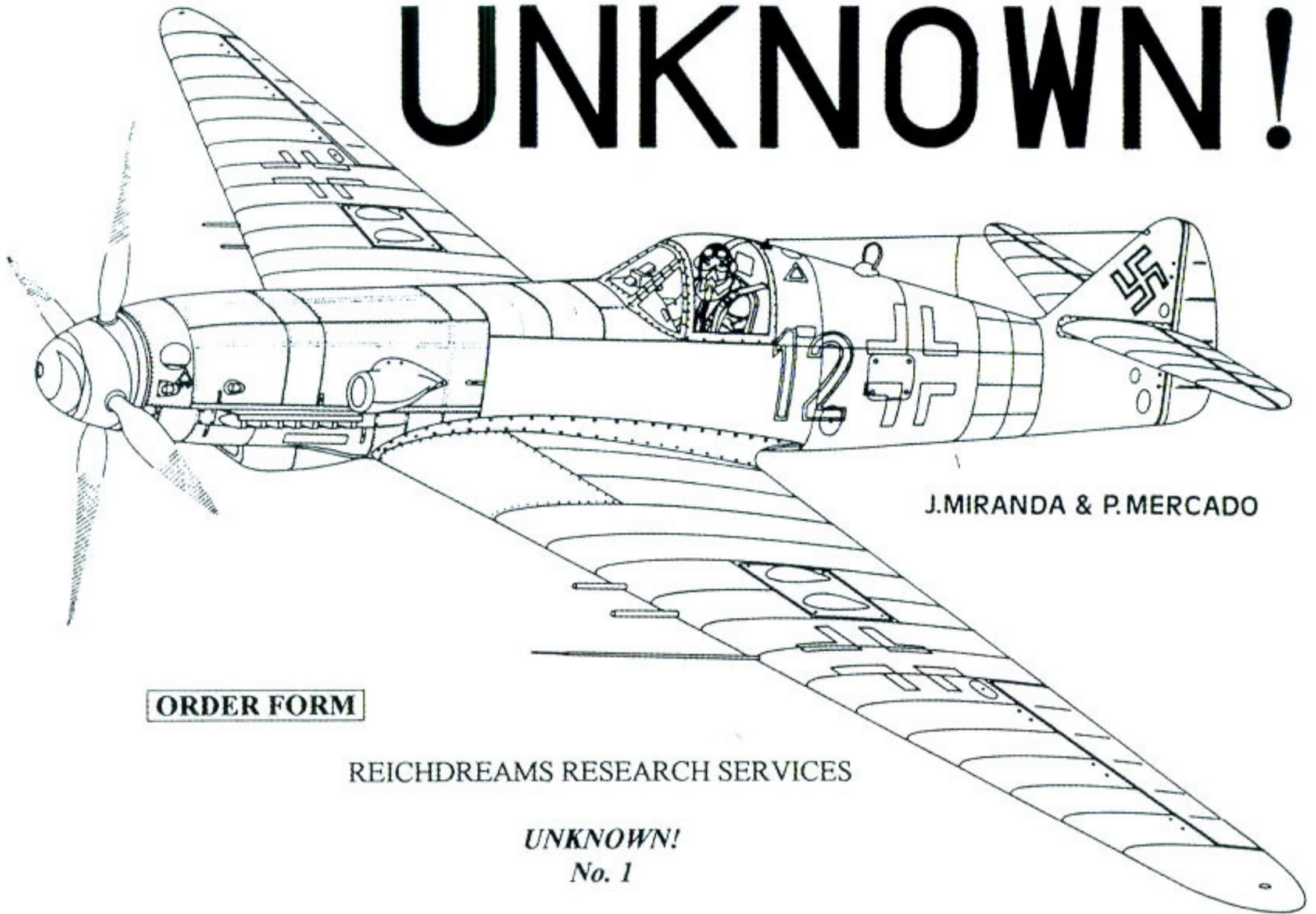

**ORDER FORM**

REICHDREAMS RESEARCH SERVICES

**UNKNOWN!**  
*No. 1*

36 pages including 1/72 scale drawings of 23 unknown WWII airplanes together with a brief history and technical data (English text). Coloured cover and back cover.

<b>PRICE</b>		\$25
<b>POSTAL COST</b>	Europe	\$ 4
	America	\$ 8
	Far East	\$10

Name

---

Address

---

**PAYMENT MAY BE MADE BY:**

- CHECK (to the name of Justo Miranda)
  - International Money Order (Europe only)
- NO CREDIT CARDS, PLEASE

**PLEASE SEND YOUR ORDERS TO:**

*Justo Miranda*  
*C/Tutor 53 Bj C*  
*28008 MADRID*  
*SPAIN*  
*pmercado@fujitsu.es*



The Space Cadets of Germany wanted to conquer space! Unfortunately, there was a war to fight first!

Since long before the twentieth century, Mankind has dreamed of space travel, but there was no such engine that could achieve that power—until now. The answer was rocket power.

The incredible 1928 movie *Frau im Mond* depicted a realistic picture of space-flight which would influence millions, including a young 16-year-old boy named **Wernher von Braun**. But even he knew that such a dream was not possible without military help. Thus he became one of the first to propose a “Raketenjager”, a Rocket Fighter.

During World War II, rocket power promised the fastest possible speed, and to many, speed was life. Thus the major powers, like Nazi Germany, the Soviet Union, the United States, and even Japan pursued a program of rocket planes, but it was Germany that would take the lead, a lead that would benefit them nothing, though it would eventually lead to the Cold War Moon Race.

But the road to the final conquest of space would be a costly one. To many, being a Nazi Rocketeer was death and glory, and speed was indeed deadly.

This third volume of the *Luftwaffe:1946 Technical Manual* once again provides the talented research work of **Justo Miranda** of Spain in addition to extra information from **Ted Nomura** concerning the alternate-war action of rocket fighters in his *Luftwaffe:1946* and the new *World War II:1946* series, showing how the war could've caused further damage had the Allies not stopped the Axis in 1945.

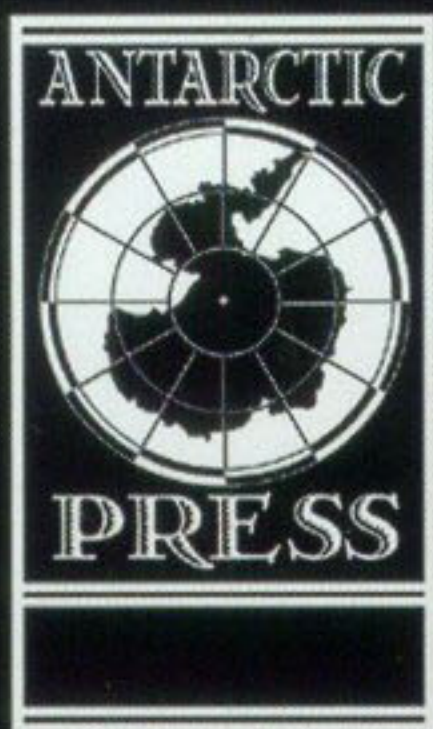
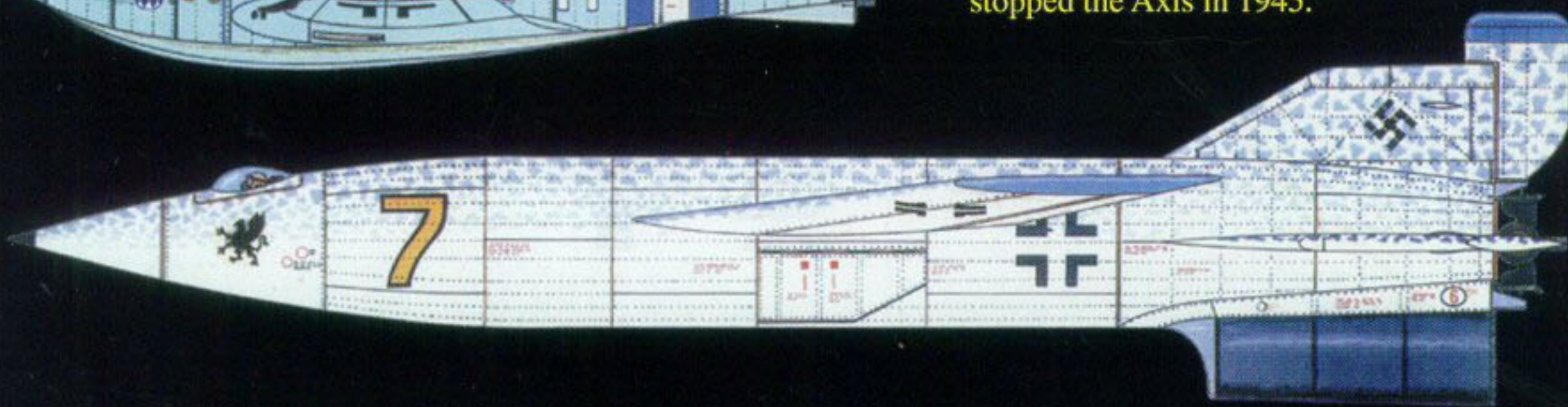
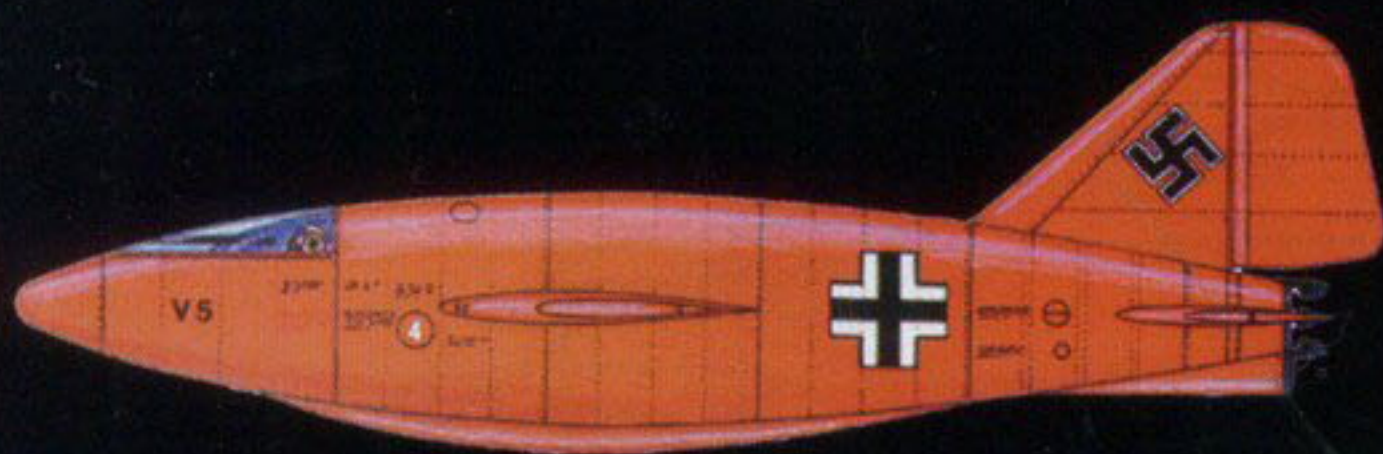

**No.3**  
**OCT 1999**  
**\$3.99 U.S.**  
**\$6.00 Can.**

