



RINNALDI

SUPPLEMENT FOR IRONCLAW

Being Both a Historical Account of the First Noble House of Triskellian and a Dramatic Play of Madness and Tragedy



“Yet, I glory more in the cunning purchase of my wealth, than in the glad possession; since I gain no common way.”

— Volpone, from Ben Jonson’s play of the same name (I, i)

RINALDI

Being Both a Historical Account of the First Noble House of Triskellian and a Dramatic Play of Madness and Tragedy

Created by: Jason Holmgren

Written by: Erik Coons, Jason Holmgren

Additional Contributions by: Richard Stewart, Ted Wadsworth, Alexander Williams

Edited by: Adam Lindberg

Illustrated by: Chris Goodwin, Jason Holmgren, Mary Lai, N. David Martin, Jonas Silver, Conrad Wong

Play-tested by: Our Fearless Adventurers (David Besselivre, Denson Conn, Steve Villing, L.H. White)

Special Thanks to: The Ironclaw Mailing List

Table of Contents

History	6
Mounted Combat	12
City of Triskellian	21
The Lost Heir	28
Appendix: Further Adventures	50
Index.....	52

Dedication

This book is dedicated to Jolly Blackburn, who gave me my first break into professional publishing. It’s been a long, bumpy road, Jolly, but thanks for starting the ride.

What’s Changed in This Edition?

This is a reprint of *Rinaldi*, the first supplement for *Ironclaw*. The attached materials have been updated to match the latest version of the core rules. The material has been condensed to fit in this new format. Two sections were removed: the calendar (because that is included in the latest *Ironclaw*) and “The Closing of the City Gates” (which was expanded and presented, again, in *Ironclaw*). All other material is here.



MY QUANDARY IS ... **UNUSUAL**, AND PARTICULAR TO OUR CITY OF TRISKELLIAN. AS YOU ARE NO DOUBT AWARE, OUR CITY IS A **HUB OF COMMERCE AND TRADE**...

THROUGHOUT CALABRIA, THE COIN OF THE HOUSE RINALDI, THE **DENAR**, IS FREELY ACCEPTED FROM THE COLD NORTH COAST OF **EPINIAN** TO THE SOUTHERN **VIA SALUTIS**...

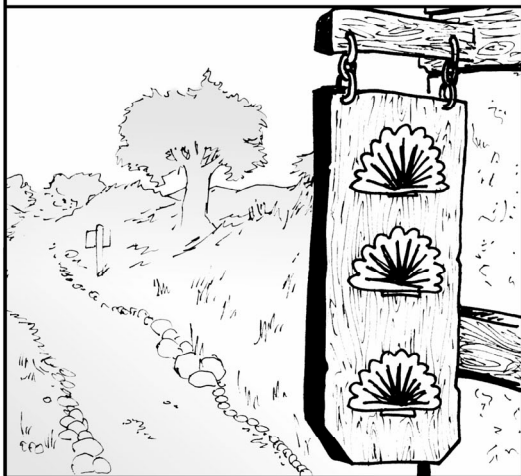

BUT AS THE SHIPS COME AND GO, AND **MORE** PEOPLE ATTEND THESE SHORES, MERCHANTS FIND THEMSELVES IN **GREATER NEED** OF COINS. TRUE DENARII HAVE BECOME RARE.



I HAVE ALWAYS BEEN ONE OF **FORESIGHT**. USING MY WITS AND A SHREWD DEAL OR TWO, I WAS ABLE TO OBTAIN ONE OF THE RARE **MONEY-LENDER LICENSES** AUTHORIZED TO THE COMMONERS OF TRISKELLIAN.



IT WAS SIMPLE AT FIRST, IF YOU HAVE A **KEEN WIT** FOR CIPHERING, THE **SAGACITY** TO JUDGE SOMEONE'S CHARACTER, AND THE STRENGTH IN YOUR HEART TO FOLLOW THROUGH WITH THE **PROSECUTION** FOR OATH-BREAKERS AND THE LIKE.



I CONFESS, I HAD BECOME VERY **SELF-CONFIDENT** IN MY SUCCESS, SO MUCH SO THAT I WAS **UNPREPARED** FOR WHAT WAS TO COME. ... LIKE MOST OTHERS IN THIS CITY, I WAS ONE OF THE REVELERS AT THE WEDDING CELEBRATION OF **DON FIDELIO DE RINALDI**.



IT WAS NOT **TRANSPARENT** FROM HIS DISPLAY AT THE PARADE JUST HOW FAR THE RINALDI HAD FALLEN FROM GLORY. OUR GLORIOUS DON HAD MARRIED A **FOREIGN PRINCESS** IN HOPES OF SECURING OFF-SHORE ALLIES.



HIS NEW BRIDE, THE COMELY **AMALSAND JAKOBA**, HAD ARTFUL EYES THAT HINTED OF HER OWN DESIGNS, THE NATURE OF WHICH WAS NOT FOR POLITE SPECULATION ... BUT I **DIGRESS**.

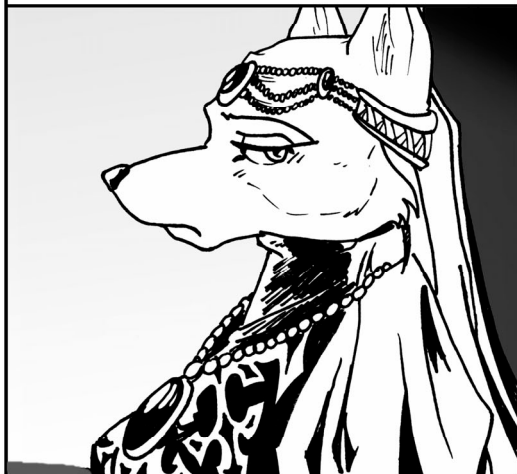

THE COMMON FOLK **REVELLED** IN THE STREETS, FOR THE PARADE BROUGHT WITH IT MUCH VIANDS AND MUCH WINE, SPONSORED BY THEIR LORD AND HIS NEW LADY. I, HOWEVER, CELEBRATED SOMETHING MORE **PERSONAL** TO ME...



FOR IT SEEMS OUR LORD WAS NOT AS **AFFLUENT** AS HE LET ON. TO FINANCE HIS WEDDING PARADE, HE HAD TO BORROW MONEY, FROM A COMMONER ... FROM ME, **TAMURELLO**.



MY GLORY WAS *FLEETING*. IT WAS ONLY A MONTH LATER THAT THE *DIRE NEWS* REACHED MY EARS... OUR LORD HAD DECLARED *DIVORCE* FROM HIS NEW BRIDE ...



AND DAYS LATER, HE HAD BEEN DISCOVERED *SLAIN* IN HIS OWN MANOR HOUSE. *COULD SUCH THINGS BE?*



I AM NOT WITHOUT *INFLUENCE* OR *MEANS*. MY COUSIN WAS ABLE TO SECURE ENTRANCE TO THE MANOR FOR ME . I PERSONALLY NEEDED TO DISCOVER WHAT *REMAINED* OF THE *CENTURIES-OLD* DYNASTY.



I AM NO *SPIRITUALIST* OR *SEER*, BUT EVEN MY UNTRAINED SENSES COULD DETECT THAT SOMETHING *BEYOND THIS MUNDANE* WORLD HAD HAPPENED HERE, AND THAT PART OF IT STILL *LINGERED* IN THE SHADOWS. *EARNESTNESS* BIDS ME TO DECLARE THAT I HAD NEVER BEEN MORE *TERRIFIED*.



THE BLOODSTAINS YET REMAINED. I WAS INFORMED BY THE CONSTABLES PRESENT THAT *TWO BODIES* HAD BEEN FOUND -- ONE WAS *OUR LORD'S*, AND THE OTHER HIS *FIRST-BORN SON*.



RUMORS WERE REPLACED BY *FACT*. A *DIRE* REVENGE HAD BEEN EXACTED. ALTHOUGH I SAW THE BODIES WITH MY OWN EYES, TWISTED AND LIFELESS, I DARESAY THAT IT IS THE COUNTEenance OF THE *LADY AMALSAND* THAT HAUNTS ME EVEN *MORE*.



A PALL FELL OVER THE CITY. WHAT WOULD THE FUTURE HOLD FOR US? THE CONSTABULARY ASSURED US THAT JUSTICE WOULD BE SERVED ... AND THAT THE SOUL OF OUR LAST LORD WOULD BE PUT TO REST. THAT, HOWEVER, IS ONLY THE *SURFACE* OF THE ISSUE...



FOR THE COMMON CONCEIT WAS INCORRECT. THE RINALDI DYNASTY HAD *NOT* ENDED -- THE *SECOND-BORN SON, FABRIZIO*, WAS NOT FOUND DEAD AT THE MANOR. I KNOW THIS TO BE TRUE, FOR WE SEARCHED THE ENTIRE GROUNDS WITH NO SIGN OF HIM.



THE *OTHER NOBLE HOUSES* DESCENDED UPON THE REMNANTS OF THE HOUSE. THEY WOULD HOPE TO *STRENGTHEN* THEMSELVES BY BUYING THE LAND. SO THEY CAME TO THE MAN WHO OWNED THE LIENS -- WHO IS ME, *TAMURELLO*.



WOULD IT BE AS SIMPLE FOR ME TO *FORE-CLOSE* ON THE ESTATE! ALAS, THE LENDING LAWS ARE *QUITE CLEAR*. I AM NOT *BLOODED*, NOR AM I *ENFRANCHISED* -- I AM BUT A COMMONER. AS LONG AS THE HEIR TO THE RINALDI THRONE IS THOUGHT TO LIVE, *HE AND HE ALONE* CAN SIGN OVER THE ESTATE.



THUS MY MONEY REMAINS OWED, AND I AM *POWERLESS* TO ACT. AND SO, BY QUIRK OF FATE, A COMMON MAN SUCH AS MYSELF HAS BECOME A PLAYER IN A *MOST STRANGE GAME...*





"It is one thing to bring people under your yoke with a hand so strong that it makes them fear to break the word of your law. It is quite another office to convince them to travel your roads, even on the darkest night, under the aegis of your rule. The Rinaldi created a covenant of trust rather than of fear, and Calabria stands alone among all places of the world as a testament to the wisdom of these folk."

— Alyosha Yenot, *Being a True History of the Rinaldi*

HISTORY

Being a Summary of Events of Note of the Long and Varied Tale of the Rinaldi Dynasty

The Rinaldi family is said to come from an ancient stock. Their family records have no mention of their arrival in Calabria. The Rinaldi maintain that they are the only "true" inhabitants of the island and that they are single-handedly responsible for the demise of the Autarchs. As might be expected, the other great houses doubt this claim. However, this assertion does give the Rinaldi a certain credibility with the common people. Their business sense has brought them more wealth than any conquest could.

The founder of the Rinaldi dynasty, *Jon the Wise*, was a monarch to be respected and feared. Rumors abound that he knew something of the Autarch's magics and he may have been one of their lineal descendents. Centuries ago, a number of small noble land holdings rested gently in the area at the mouth of the Granvert river. These communities grew rapidly as the commerce between one another expanded. Jon was a merchant-king with an eye to growing his lands. He set out to convince the other vulpine nobles to join him. Those who saw the wisdom of his actions complied; those who did not were compelled. With those families further up river, whom he could not reach easily, he established a mutual trading alliance.

The locale of the Rinaldi House allowed them to concentrate the wealth of Calabria. Jon's small fiefdom quickly grew to include large land holdings and a fleet of ships that traveled up and down river. The rich farmland and mercantile finesse of the Rinaldi soon became legendary, their dynasty growing and prospering for many years. Early in their dominance of Calabria, the Rinaldi befriended many a minor house. By doing so, they created a network of those who believed in them and who would do business with them. It was rare to see a minor house with whom the Rinaldi would not strike a bargain and bring into their fold.

Thanks to their openness of commerce, their location, and their many allies, the 10th Don of the Rinaldi, *Ambrosi de Rinaldi*, was able to found the city of Triskellian. The city's simple marketplace and docks grew rapidly as Calabria's wealth flowed downriver into their coffers.

Triskellian was threatened early on by a then minor house of the north, the *Doloreaux*. They did not wish to see the Rinaldi gain control of the other, older city of Calabria, the northern port of *Epinian*, which controlled the richest mines of the island. Silver, gold, and gems produced in *Epinian* were legendary. The *Doloreaux* attempt to assault Triskellian failed horribly when the *Chevernaise* of the *Rothos Mountains* banded together to control the pass. (Some say the *Chevernaise* were urged to this action with Rinaldi coin.)

Once the Rothos Pass was secure, the Rinaldi control of the Granvert and the Bay of Auvrich insured their destiny as the key shippers from *Epinian* to Triskellian and vice versa. The influx of northern wealth fueled the city's growth and attracted all manner of followers. Minor houses begged for Rinaldi favor and even the *Doloreaux* opted for a war of money rather than a war of arms. For over a hundred years, the Rinaldi basked in the warmth of success. Triskellian grew to be a city worthy of great songs and monuments. To meet the needs of the growing populace, the Rinaldi engineered and constructed a sophisticated system of sewers and aqueducts. The Rinaldi's power was such that they guaranteed the safety of any traveler from the Walls of Calabria to Triskellian along the "Safe Road," or *Via Salutis*.

The Time of Weeping (*Tempestatas Lacrimosus*)

Though Triskellian prospered, there was a spectre looming over the Rinaldi clan. In the last years of the 14th Don, *Rafael de Rinaldi*, the city fell into disrepair and the citizens began to lose faith in the ruling



House. Frequent storms off the eastern coast brought the shipping from Epinian to a halt. Sailors spoke of a sickness among the minor houses of the eastern plains. Gradually, the shipments of foodstuffs and grain diminished to a mere trickle. Banditry and looting became commonplace; the name “Via Salutis” became a cynical joke. A plague spread throughout the land, leaving its victims in writhing pain, and claiming the lives of many. The people of the surrounding fiefdoms became refugees, seeking shelter within the city.



The Martyrdom of Helloise

Don Rafael passed on, unpopular in death as he was in life. What is more interesting than his death, however, is the history of his nurse, Helloise. On the night of her master’s death, she experienced a revelation, which she perceived as a glowing white light that surrounded her body.

Don Rafael’s heir, the young *Constantin*, lay sick in his mother’s arms, crying for release from the plague that wracked his body. Nothing the apothecaries and scholars could produce could alleviate his affliction. The nurse Helloise gathered up the suffering child, and then glowed with the same white light that had touched her body once before. The child was cured.

Helloise wandered through the streets of Triskellian, curing all whom she touched in the same way. She walked from house to house for four days, healing all whom she could, but each day she felt her strength ebb. On the fifth day, she collapsed from exhaustion. When she awoke, she started again, knowing that every moment more people were dying from this plague that only she could stop.

That evening, she sank to her knees in sorrow and enervation, sick with the knowledge that, in this way, she would be unable to save everyone. Consumed with pity and selflessness, she prayed that this glowing white light should take her life in exchange for all the innocents who would perish by the plague. With that act, her body was wreathed in a flame that did not burn but rather it spread from where she knelt throughout the entire city. All who were touched by this miraculous flame found themselves cured. Once all were saved, Helloise collapsed and perished in the knowledge that her death brought others life.

It was by this act that ignited the worship of *S'allumer*, the life-giving luminance. All who had been touched by the altruistic Helloise began to come together under the banner of the young Don. Don Constantin’s mother was declared the first Arch-Cardinal of the Church of *S'allumer*, and she spread the church’s work



beyond the lands of Rinaldi. The Don commanded that a great Cathedrale be built upon the spot of Helloise's ultimate sacrifice. The construction of the Cathedrale is the most ambitious engineering project in all of Calabria, beyond anything undertaken by the Rinaldi before or since. To support the great dome, a great spell was woven by the first apostles of the church, the power of which lasts to this day.

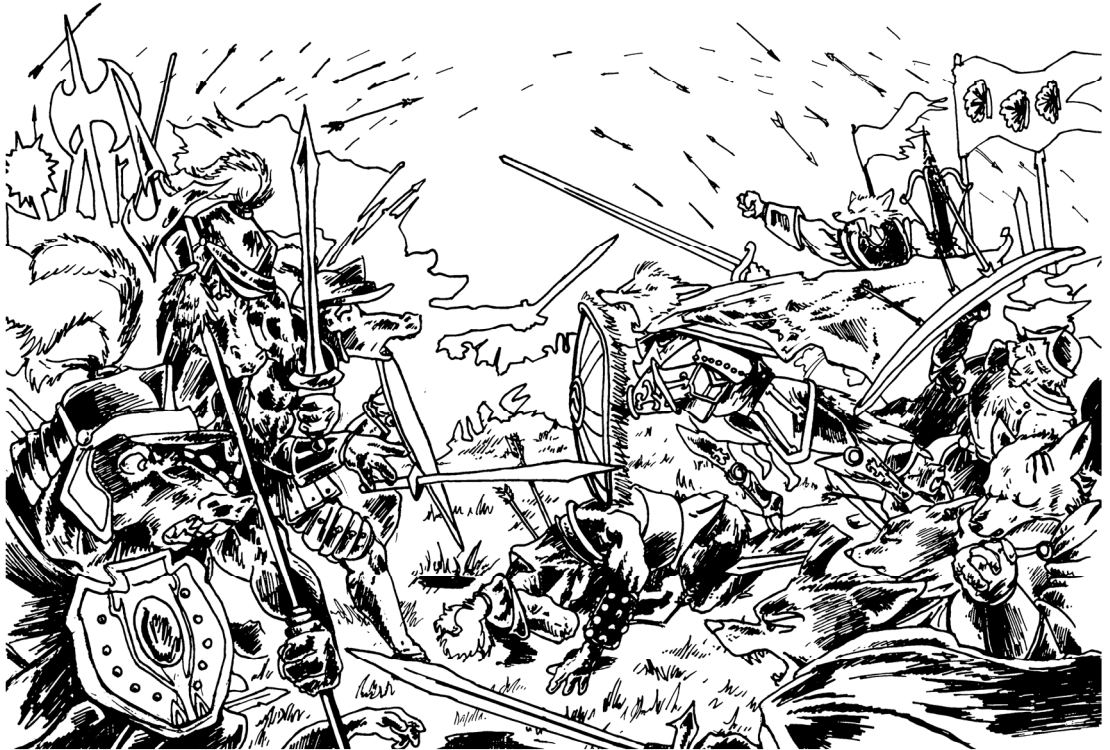

A Threat from the East

Fifty years later, the Avoirdupois made their challenge against the Rinaldi. During the decline of the Rinaldi's ability to police the landscape and to levy taxes, the Avoirdupois had become a military power to be reckoned with, with sophisticated strongholds and quality arms. King Etienne d'Avoirdupois had consolidated his hold over the lands to the east of the Paludestris with his capitol at *Chalon su Sauldre*. At this time, Etienne's army was nigh-unstoppable in the plains, and his dominance over the River Sauldre was indisputable. His eyes turned to the wealth of Triskellian and its control of the Granvert and then back again to his own kingdom whose resources were limited to mere foodstuffs and soldiers.

With prudence and with force, the Avoirdupois swept down upon the Rinaldi, intent on the city. The Rinaldi troops were well-advised and well-prepared for the onslaught. The young Don Constantin led an alliance of the Rinaldi and a host of minor houses in the defense of Triskellian. The use of magic figured prominently - Elementalists were found in the ranks on both sides, and the Church of S'allumer lent their services to the Rinaldi defenders.

The relentless Avoirdupois pushed towards the city, undaunted by the Rinaldi defense, until their lines were within a league of the north and east gates, where they camped and began their siege. On the fifth day, King Etienne met with the Chamberlain of the Rinaldi court, *Corrado*. The Chamberlain had orders to forestall the king and his plans to invade from the west, as it was evident even before the parley that nothing less than total surrender of the city would satisfy the Avoirdupois. However, there were strange portents in evidence.

For several nights before the parley, Etienne had dreams of a vulpine maiden dressed in purple robes standing in a field of emerald green. The vixen radiated a light that was as pure as the noon sun over the Avoirdupois plains. At his banquet table one night, Etienne happened to mention the dream in passing, and Corrado replied that these dreams must surely be visions of Saint Helloise who had saved Triskellian from ruin half a century before. The chamberlain further suggested that this must be a good omen and





that he and theirs would agree on a peace soon. That night, the king received word that his wife had fallen ill, and that his unborn child might be lost as all means to save her had been ineffective. Unable to sleep, the king broke off negotiation with the chamberlain and sent him back to Triskellian.

Word spread quickly throughout the city that the Queen of Avoirdupois had fallen ill and might not survive. Upon hearing the news, the *High Pontiff, Her Excellency Luzia*, mother of Don Constantine, left the safety of the walls of Triskellian and entered the camp of King Etienne. Dazed by the glow of her presence, the knights of Avoirdupois dropped their weapons and stood clear of the path of Luzia. She entered the tent of the king, and what was spoken between them is unknown and unrecorded in the annals of history. What is known is that the next day, the siege was lifted and the Avoirdupois army had begun the long march back to the plains. The dawn of his arrival at Chalon su Saudre, the Avoirdupois King and Queen (who had recovered) declared their conversion to the Church of S'allumer and their fealty to its greater good.

Years of Plenty, and Years of Strife

With the allegiance of the Avoirdupois as an ally in commerce as well as in arms, the Rinaldi consolidated their position as the leaders of Calabria in both wealth and power. Increased commerce posed new difficulties. The Rinaldi commissioned the *Guild of Merchants* to construct for them a system of exchange that insured transactions in the capitals of Avoirdupois, Doloreaux, and Rinaldi. This new banking system allowed a trader to deposit money at one capitol in exchange for a *writ*, which they could then redeem at any other capitol for the same amount of money. In addition, Rinaldi law for both nobles and commoners was recorded and made available in libraries, as well as records of court cases, verdicts, precedents, and sentences. The Rinaldi, in their typical grandiose way, referred to this system as “*rex una, res populi*”, or “one rule for all people.”

The banking system, along with Rinaldi action in the courts of Triskellian, made contracts binding. Merchants could then expect that their shipments would be met with buyers and would be protected along the “safe roads” to and from the Doloreaux and Avoirdupois lands. There was still considerable risk in shipment, but that risk could easily be defrayed by the price of goods commanded at market.

Increased commerce meant increased influence and a rise in the power of the city Guilds. The Guildsmen established a council so they could exchange ideas and information with one another. *Don Frederico*, thirty-fifth Don of the Rinaldi, often called upon the Master Guildsmen to advise him on matters of commerce and to keep him abreast of new ventures. (In effect, the Don was relying on commoners in matters of state — a portent of things to come.) Many businesses profited with the infusion of Rinaldi gold. With the strength of the *lex una* behind the Rinaldi’s coin, the denar, monetary institutions such as banks, money-lenders, and investors came into being.

Throughout the reign of Constantin and his successors, the power of the Rinaldi grew and prospered. Their wealth made them the envy of the world and they turned their time to amusements and to achieving the dreams that only the wealthiest can have. *Don Matteo*, twentieth Don to the Rinaldi, expanded the palace and grounds of the central villa of the clan. The fountains amongst the gardens within became legendary. Don Matteo earnestly sought and enjoyed all things artistic and philosophic. He entertained the brightest minds of his day and showered them with praise and support. His patronage brought thinkers and artists from all over Calabria to Triskellian.

Under the auspices of the Church of S'allumer, Don Matteo established a college of medical arts and a college of letters. Here the fine art of healing could be promoted and the history of the world could be recorded. Since the Church was very selective of the membership of its clergy, other healers were needed to serve the burgeoning populace, so the Church encouraged the study of “mundane” medicine to support demand. Many scholars came to seclude themselves within the halls of the vast Library of Matteo there. The Guild of Navigators contributed a section of maps of all the known places in and around Calabria and expounded such new theories as a “round world.” Explorers and merchants alike came to find the keys to fortunes there.



New Arrivals in the West

In the Rinaldi court, rumors circulated that a clan of Wolves had been challenging the minor houses of the western woods. The Rinaldi lords at first ignored these rumors since it was common knowledge that the wolves of Calabria were ignorant savages who fought with primitive arms and no tactics. Agents brought back reports of the sophisticated fortifications that had sprung up almost overnight around *Harrougate*, which was the seat of power of these new challengers. Don Fabroni sent many messengers, agents, and spies to make further inquiries. Few returned, but those that did told incredible stories of armored wolves who appeared from nowhere and struck quickly, demanding surrender and oaths of fealty to their clan and their clan alone, known now to be called the Bisclavret.

The Don and his court were in disarray. Spies could not give him an adequate count of the number of fighters the Bisclavret controlled, but it was certain they employed mercenaries from outside of Calabria. In a display of power, the Don marched columns of troops up and down the *Via Salutis*; his troops limped back home, handily defeated and broken. The Bisclavret warriors were highly mobile, roving over large stretches of land and able to form en masse anywhere in the wood in a matter of days. Don Fabroni sent emissaries to the Western houses to ask of their loyalty. The Don's agents returned with vague and evasive answers. He became despondent, lost in an attempt to control a land that no longer appeared to be his.

Gradually, the flow of western resources, such as lumber and medicines, dried up. Within two seasons, the Bisclavret were the unquestioned masters of the woods; only then did the Bisclavret High Counsel appear, formally requesting audience with the Rinaldi court.

High Counsel Wissian de Bisclavret came to the city of Triskellian with only a small guard of Bisclavret footmen. At the same time, companies of mercenaries lined up and took positions along the River Granvert. Wissian's audience with Don Fabroni was perfunctory and promising. Both he and Don agreed that the Bisclavret controlled the woods and would continue to do so. Wissian was very pleased and somewhat stunned that the first meeting had gone so well. His letter to *Lord Aldred* of the Bisclavret reflected his enthusiasm, and it was in this letter that Lord Aldred was first referred to as "King of the Woods". Lord Aldred tempered his militant stance and withdrew his mercenaries from the river.

The ambassadors of the Avoirdupois and the Doloreaux were displeased by the Don's weak display. They sent word to their respective monarchs requesting quick action. Don Fabroni knew that the ire of his two strongest allies was rising, and he set to work on a plan to mitigate this new imbalance of power. He also knew that nearly every trade depended upon wood. Without wood the city would suffer dearly. The Don called for an assembly of the Guild Masters who had the greatest interest in lumber: the Sawyers, the Shipwrights, the Coopers, the Cabinet-Makers, and the Drovers (who took a large part of their earnings in shipping logs and finished products to and from Triskellian).

The Guildmasters were persuaded by their fellow Council members to enlist the aid of the western guildhalls of Thanon, Harrougate and others in maintaining a steady supply of goods. With the aid of a bit of coin, the Rinaldi and their allies in the Guilds reestablished the flow of materials. Lord Aldred was likewise convinced that a more reasonable course was one of continued commerce.

The Decline of the Rinaldi, and the Rise of the Guild Masters

With the end of Rinaldi control of the city guard and of the banks, it became the Guild Masters who truly wielded the power within the walls of Triskellian ... and whoever controls the city controls most of the trade in Calabria.

At first, organizations and alliances were uneasy. For a time, the Guilds regarded one another with suspicion. Mercenaries were employed by each house to protect their "interests"; it was not unusual for important guildsmen to be bullied or beaten by armed thugs. At the same time, tax collections failed to be met, and public works fell into disrepair, since clear leadership was lacking.

This practice continued for many years, and Triskellian earned a reputation off-shore for a place where mercenaries and thugs could get work. The racketeering came to a swift halt with the founding of the Sailor's Guild – almost overnight, the balkanized foreign warriors had their own organization to coordinate their activities. With the rise of hired muscle came a rise in racketeering, banditry, and theft. Clearly something had to be done.



Masters from all Guilds held a moot at the Customs House. All agreed that there must be order, and all agreed that the order they wanted was not one of “blooded gentry” and their entourages holding sway over the citizens. But who could make decisions and who could not? Who was really in charge?

After a spirited debate of eight days, eventually the *Compact of Guilds* was signed by all recognized Guild Masters. The Compact established that, four times a year, each Guild would meet to dictate policy, to entitle vote new Magistrates to the Constabulary, and to vote for changes in commoner law.

It did not escape the notice of the Avoirdupois, Bisclavret, and Doloreaux houses that the public policy of the city was now being dictated by commoners instead of lords. The Avoirdupois sent strongly-worded letters of disapproval of the state of the city to the Rinaldi; they were not answered. The Doloreaux, for a time, refused to acknowledge the right of Constables to collect entrance and docking fees. They later discovered that fighting the Constabulary wasn’t worth it, as gates could be closed, gentry could be “mistakenly imprisoned”, and numerous other inconveniences generated by the commoners would severely hurt their economic relations. The Bisclavret made no strong remonstrations; in fact, many Bisclavret lords developed strong ties to the Sailor’s Guild, hiring long-term mercenaries to expand their own holdings.

Over the next few generations, a grudging alliance formed between the Guild Masters and the Noble Houses. Despite the Noble House’s claims to their superior status, no single house possessed the military might to challenge the stone walls and the garrisons of Triskellian. Given the differences of each house, an alliance seems unlikely ... but that doesn’t stop some of the more ambitious lords from trying. The lords are aware that the city is dependent on foodstuffs and raw materials from the rest of the island; an organized boycott (effectively a siege) could severely weaken the city ... but then who would conquer it? If one house steps up to the role as conqueror, the other two would oppose. The Guild Masters are well aware that it is in their best interests to play each house off one another, and until they forget this, the rule of commoners within the city is assured.

The technology of trade and commerce has continued to advance. Ships now sail farther and faster, with larger hulls and greater cargoes. The ports of Triskellian are inhabited by stranger and stranger folk from farther shores. Recently there has been a rise in traffic from the mysterious land of Zhong Gou, their large painted sails with lettering in an obscure language and the crests of unknown houses. At first they were a curiosity, but now larger and larger fleets settle into port, with such exotic goods as spices and silk being unloaded into the hands of an affluent populace. The Guild Masters view such items with envy, wondering at the strange techniques required to make them. The Noble Houses wonder how best to parley with these foreigners, always eager for any changes that may tip the scales of power in their own favor, away from the commoner upstarts.





“Knights should take coursers to joust and to go to tourneys, to hold an open table, to hunt for wild beasts, for in doing these things, the knights exercise their arms.... For to maintain the order of knighthood, the knight must at all times pursue the virtues of justice, wisdom, charity, loyalty, verity, humility, strength, hope, swiftness, and all other virtues that are semblance to the noble franchise of knighthood.... For honor is worth more than gold or silver, without any comparison.”

— Attributed to Don Constantin de Rinaldi in *On the Discipline of Chivalry*

MOUNTED COMBAT

Being a Concise History of the Practice of Chivalry and a Delineation of the Proper Rules of Engagement

The care and maintenance of riding animals is no trivial task. It takes years of training, often starting in early adulthood, for someone to become a skilled cavalier. A *knight* undertakes an apprentice of sorts, called a *squire*, who is usually only 6 or 7 years old at the start of their career. The squire performs menial chores and endures lots of hard practice. They develop thick skins from falling off their mounts over and over again and from the buffers from wooden practice-weapons that they fail to parry.

It also takes a fair amount of money to support a knight and squire. The knight is supported by a social structure known as *feudalism*. Knights own the land; their subordinates, the *vassals*, till the land and are permitted to live upon it, in return for paying taxes and for serving the knight in time of war. The knight was also the owner of such social institutions as the mill, the baker's oven, and the kiln, since these were expensive stone buildings that had to be built on the land that knight owned. Social mobility is nearly impossible: the vassals make goods that can't be exported or require unusual skills, so they are only of value to their lord.

To prepare for the inevitable times of war, the knight was trained from youth in the difficult art of fighting while mounted. With the most expensive equipment and a lifetime of combat training, knights command heavy respect on the battlefield, especially when the bulk of many forces are made up of untrained peasants.

The Rinaldi, having been wealthy for hundreds of years, developed a strong culture around the knight and the idea of *chivalry*, that knights should not just be trained in combat but also in personal character. Chivalry was just a general idea in Triskellian, the sort of display one expects from the nobility, and its principles differed from locale to locale. It wasn't until after Don Constantin fought the Avoirdupois that a formal definition was laid down in writing, and later passed into law by royal decree. Apparently, Constantin was highly impressed with the co-ordination and discipline of the Avoirdupois ranks. He attributed this discipline to the Avoirdupois notion of franchise, that nobles derive their right to rule from their lord and at all times must strive to be true in virtue and deed. Although the book *On the Discipline of Chivalry* bears Constantin's name as author, many scholars agree that the content is largely lifted from Avoirdupois texts.

The other major houses follow similar definitions. The Bisclavret, being eager modernists, can often recite passages from *Chivalry* by rote, although they claim to be using Bisclavret sources for theirs. The Doloreaux also have their own order of knighthood, although they concentrate less on the combative strength and swiftness, and more on charity and loyalty. The other, lesser houses are largely indifferent. The Chevernaise care little for the ways of outsiders, and the Phelan have a very different social order.

Chivalry is over 20,000 words in length in its complete edition, but its major principles can be summed up in a few points:

- **A knight is just.** A knight always honors surrender. When called upon to mete out justice, a knight follows the law first and the heart second, and is unmoved by personal concerns. Knights always keep their word.
- **A knight is loyal.** Knights swear by their superiors, and they follow their tasks willingly and with discernment. It is better to die by duty than to live by disobedience.



- 
- **A knight is humble.** Knights do not lie or play anyone falsely. They do not demand their subordinates' loyalty unconditionally, and they heed the counsel of others.

In game terms, most chivalrous folk have the Flaw of Honorable, since they will often put themselves at risk to uphold their ideals. Those who are especially chivalrous may earn a Good Reputation. Those who claim to be knights yet fail to behave by the code may have a Bad Reputation.

Many knights would like to think of themselves as the top of the social order. Unfortunately, Triskellian has been maintaining its own armed forces for several years. Inside the city walls, guilds and trade organizations have established their own rules, protocols, offices, and hierarchy. Ironically, the strength of the denar, the coin that brought the Rinaldi to power, is now being used by the common folk to further their own interests. The technology of gunpowder and the dissemination of magic have weakened the effectiveness of the mounted warrior in full plate. The sun is setting on the knight.

Optional Rules for Riding Combat

Fighting while seated on a mount is a difficult undertaking. To use most weapons effectively, one needs good footwork and balance; the saddle is less than ideal. The constant motion of the mount provides an unsteady platform, and sometimes the mount itself is in the way of a good swing! To represent the difficulties of fighting while riding, the Game Host is encouraged to use the following optional rules.

When Riding, use the Mount's Move instead of the Rider's Move

The major advantage a riding combatant has is speed. Instead of the rider's Dash and Stride, use the mount's. The mount suffers Encumbrance just like any other combatant, as it must carry both the rider and the rider's equipment, and anything else such as mount furniture.

Example: Darda has a Lift Bonus of +4, a Dash of 8, and a size of 11. She normally carries about 9 stone worth of gear. She's Encumbered by 5 stone, so her move is penalized by 5, to a mere 3 paces for Dash and 1 for Stride.

Darda, however, rides a Courser that has a Lift Bonus of +12 and a Dash of 20. Darda and her equipment weigh a total of 20 stone. That's 8 stone over the Courser's Lift Bonus. The mount's Dash drops to 12. The mount's stride, being $\frac{1}{4}$ of the Dash, drops from 5 to 3.

When Riding, your Skill Dice are limited by your largest Riding Die

Fighting while mounted is a tricky business. When making To-Hit Rolls and Defense Rolls, none of your dice may be larger than your single largest Riding Die (your *Riding Limit*). Reduce all dice larger than your Riding Limit to the size of your Riding Limit.

The Riding Limit can be from your Skill Dice, or from a Career Die that applies to Riding. If you don't have *any* Riding Dice at all, your To-Hit Dice and Defense Dice are limited to only d4 in size.

Example 1: Anton d'Avoirdupois has a Cavalier Trait of d10, which applies to Riding, his only applicable die. Since his Speed is d10 and his Sword skill is d12, he normally rolls d12 & d10. Unfortunately, since his Riding Limit is d10, his d12 drops to d10. While Riding, Anton will roll 2d10 for To-Hit Rolls and Defense Rolls.

Example 2: Prewitt has a Riding Skill of d6, so his Riding Limit is d6. With his Speed of d10, his Career of Dilettante of d4, and his Fencing Skill of d12, he normally rolls d12, d10, & d4 for To-Hit Rolls with his Foil. Unfortunately, since his Riding Limit is d6, all dice larger than d6 must be reduced to d6. While Riding, Prewitt will roll 2d6 & d4.

Example 3: Mavra has no Riding dice at all. When Riding, none of her dice may be larger than d4. When fighting with her sword, she normally rolls d10 & d4. Because of her Riding Limit, when fighting from a mount she only rolls 2d4.

Note that this Riding Limit only limits die size before Bonus and Penalties are figured. A Riding combatant can use a Bonus to increase die size, as usual.



Example 4: Mavra, while seated on her rouncy, chooses to Strike Sure for one Bonus to hit. Her effective d4 Skill Die improves to d6. She will roll d6 & d4 for her To-Hit Roll.

Example 5: Prewitt chooses to Focus one round, then Strike Sure in the next, using Focus To-Hit. That's good enough for a +2 bonus. His effective Fencing Skill Die of d6 goes up two sizes. He will roll d10, d6, & d4 To-Hit.

Also, note that while all Defense rolls are reduced, including Parries, Blocks, and Dodges, *the Cover Dice from shields is unaffected.*

For Ranged Combat, all Ranges are one step worse when Galloping

Whenever your mount is moving at a gallop (that is, moving at a rate of the mount's Dash per Round, or greater speed), it becomes difficult to hold weapons steady. When galloping, treat all ranges as one band worse. Point-Blank becomes Short, Short becomes Medium, Medium becomes Long, Long becomes eXtreme, and shots beyond eXtreme become impossible.

With both the Riding Dice Limit and the Range Band handicap, using missile weapons while seated on a mount is very difficult.

Use your own Initiative Dice and choose your own Maneuvers

As long as you are in control of the mount, you choose the Maneuver for the round. For simplicity's sake, the major advantage when Riding is the increased movement. Choose what you want to do as normal, substituting the mount's Dash and Stride for your own, while allowing for Riding Limits and Range Band changes.

If you are rolling Mind & Speed Dice for Initiative, as per the Advanced Combat System, use the rider's dice, not the mount's. (This Test is not limited by Riding dice.)

Special Maneuvers for Riding Combatants

Moving at Full-Tilt

The word tilt refers to a thrust with a lance by a rider. To gain the full advantage of a thrusting weapon, such as a lance, the mount must achieve a fair amount of speed.

A mount is considered to be at full tilt when moving 12 paces or more in a single round. Thus, if a courser moves only 11 paces in one Round, it does not achieve a full-tilt speed. Full-Tilt is necessary for certain special results for certain weapons (see below).

Tilting with a Lance

The lance is specifically designed to benefit from the mount's speed and size. The lance has an improved Special result when used by a rider moving at full tilt.

Example: Anton d'Avoirdupois, riding on his destrier, *Monstre*, lowers his lance and speeds forward to meet a bandit's charge. Not only does he hit, but also he manages to score an Overwhelming Success on his To-Hit Roll. Since he was moving at Full-Tilt, he may use the Special: Tilting result of his weapon.

Anton's personal Strength Die is d12 but his Destrier has a Strength of 3d12. His Lance Damage, instead of being d12 & 2d6, will be 3d12 & 2d6.

Running Down your Foes: Trampling

Sometimes, a combatant will try to move through the space of another combatant. This is called a Trample. For a rider to attempt to Trample a foe, the mount must be combat-trained. Mounts that aren't will refuse, sidestepping if possible, slowing down and stopping otherwise. (Squirmy bodies are bad footing, after all).





To resolve a trample, roll the Rider's Riding Skill Dice and the Mount's Speed Dice vs. the Target's Speed Dice and Dodge Dice. (Note that some mounts have an Animal Die that applies to Tramples; some do not.)

Tramples can only be Dodged they cannot be Parried or Blocked. The target may Retreat for an extra d8 Defense die, as usual (q.v.).

Targets that are Trampled suffer Damage: the Mount's Strength Damage and Claws/Hooves (d6) vs. the Target's Soak and Armor Dice. In addition, view the Damage as a Simple Roll, if the trampler Overwhelmingly Succeeds, then the target is automatically knocked down, and the trampler may keep on riding past the target. If they do not, the trampler must stop where they are. The target may also fall down if they Overwhelmingly Fail their Resolve Roll.

Example: Caerdwyn d'Bisclavret rides down a brigand with his courser, Longtail. He attempts a Trample. Longtail is a seasoned mount, well-accustomed to battle and the taste of blood; in other words, she is combat trained and willing to Trample.

Caerdwyn has a Riding skill of d10 and a Career of Cavalier (good for another d10). Longtail has a Courser Trait of d8. The brigand has a Speed of d8 and a Dodge of d6. Caerdwyn rolls 2d10 & d8 vs. the brigand's d8 & d6. Caerdwyn's highest die reads 9, the brigand's reads 6. That's a success for Caerdwyn; the thunderous clamor of gravid hooves fills the brigand's ears as they pummel his body.

Longtail's trampling damage is its Strength (2d12 & d6) and its Hooves (d6). The brigand counters with his Soak (d8) and his Armor of Light Leather (d6). Longtail's dice come up 9, 5, 4 and 1. The brigand's come up 4 and 2.

As a Damage Roll, Longtail has scored four hits. As a Simple Roll, Longtail has Overwhelmed the target and thus knocks him down and rides over him.

The brigand rolls his Resolve Dice (a lone d8) vs. the Damage. He scores a 5, which is a Failure, so he is sent Reeling. Normally, he'd still be standing, but since he was Overwhelmed on the Damage Roll, he's automatically knocked down.

Targeting either Rider or Mount

When attacking a mounted combatant, you have the choice of striking at either the rider or the mount. When attacking the rider, they defend normally, with a Parry, Block, or Dodge. When attacking the mount, it may Dodge. Mounts can Retreat from an attack, just like other combatants; a Skittish mount will *always* Retreat, if possible.

If a mount is sent Reeling or falls down for some reason, the rider must make a Riding Test to avoid dire circumstances; see the entry under Riding Tests, below.

Riding Tests

For simplicity sake, mounts may be assumed to start and stop on a dime, and can turn freely. This isn't exactly realistic; one rule of thumb is that any mount that runs at Full-Tilt must move at least 3 paces in the next round. As usual, the Game Host is the final judge on how mounts can move.

Game Hosts may call for Riding Tests when a mount must stop suddenly or otherwise runs afoul of something. Here are some suggestions:

Mounts can wear Armor just like other combatants

One problem with putting Armor on a mount is the issue of construction. Mounts can't talk, and aren't that bright in the first place; an armorer has to be very careful when fitting to make sure the parts won't chafe or scrape, which can cause lasting injury to the beast. To represent this, all Armor for a riding mount is an Expensive item.

The other problem with putting Armor on a mount is that all mounts are massive—so large, in fact, that they're off the Armor Table in the Ironclaw book. To find their Armor's weight: (1) Divide their size by four, (2) Read the Size/4 off the "Size" column; (3) Multiply the weight of the stone by four.



Example: Anton’s destrier has a size of 64 stone. Since there’s no “64” column on the Armor Table, we divide 64 by 4 to get 16. For Chain Mail, the weight is 4 ¾. Multiplied by 4, it becomes 19 stone for a combatant of size 64.

Anton considers that he himself, with gear, weighs 28 stone, the combined load of 47 stone is an Encumbrance penalty of 32, far more than his mount can bear. He’ll either have to lighten his own gear or choose lighter armor for his destrier.

If you’re using an Availability Test (q.v.), assume that the mount’s is one step harder to find than the beast itself was. Following the above example, for Anton to find armor for a (Rare) destrier, he’d have to test for Availability vs. the Very Rare difficulty of 2d10.

Miniatures

For those using miniatures, a mount is three paces long: one pace in front of the rider (the head and forequarters), one pace where the rider sits, and one pace behind the rider (the hindquarters and tail.) This means that attackers must use their weapon’s Reach to cover that distance if they want to assault a rider from the direct front or back, and that a rider will want to keep their foes at bay, if possible.

Statistics for Riding Animals

Because mounts have been specifically bred and raised to carry a rider, and by dint of their sturdy construction, most animals used for transport have the *Mount* Gift. Mount allows the animal to add Speed and Race when computing its Dash. Stride is computed as usual after that (as ¼ Dash).

Notice that no riding animals have a Mind Trait. Not being sentient, they don’t have the ability to reason like the Races of *Ironclaw*. Riding at night is not recommended as most mounts have poor vision and run the risk of stepping in holes and breaking their legs.

Courser



For those who can’t afford destriers and would prefer a creature of more substance than the jennet, the courser is a name applied to many of the breeds of war-mount found on Calabria. While they can’t be trained as well as other, more “refined” breeds, they also don’t cost as much. They are herbivores and have good long-range stamina, for those in need of practical transportation. The statistics provided here are of a typical courser, but breeds vary considerably.

Body 2d12, Speed d10, Mind none, Will d8

Courser d10

Weapons: Hooves, Teeth

Habitat: Plains

Sense Tests: Listen, Smell

Skills (with Favorite Use)

d8	d8	Dodge (while on the Plains)
d8	d8	Hiking (through Plains)
	d10	Observation (for finding foes)

Gifts: Extra Hit Point +1, Hooves, Mount (add Race Trait to Move, double normal size), Strength +2, Teeth

Flaws: Skittish

Armor: None (Soak 2d12)

Weapons: Teeth (d6 & Strength 2d12, d6)





Destrier

In their heyday, the Rinaldi were famous for their highly trained war-mounts, the destriers. This type of mount is very rare and very expensive, the product of selective breeding and extensive training. A destrier is combat-trained and won't spook at the sound of gunfire or magic. It can also be coaxed into attacking and trampling foes. Unfortunately, destriers are known to be irritable, and skilled handlers are required for their upkeep. They are also omnivorous, requiring a high-protein diet to keep up their muscle tone, in other words, a fair amount of meat, which makes their upkeep far costlier than most mounts. Many are temperamental and can't be kept in a stable with other mounts, even other destriers, as they will bite and kick. The process of breaking a destrier in and learning to ride one is not for the faint of heart or thin of skin.

Body 3d12, Speed d10, Mind *none*, Will d10

Destrier d12 *Weapons:* Claws, Trample, Teeth *Habitat:* Plains *Sense Tests:* Listen, Smell

		Skills (with Favorite Use)
d12	d10	Dodge (while on the Plains)
d12	d8	Hiking (through Plains)
	d6	Observation (to find foes)
	d10	Resolve (when being ridden)

Gifts: Claws, Extra Hit Point +1, Mount (add Race Trait to Move, double normal size), Teeth

Flaws: Skittish

Armor: None (Soak 3d12)

Weapons: Hooves (d6 & Strength 3d12)

Size: 64 stone

Dash: 22

Stride: 5

Lift: +15 stone

Dray



Squat, foul-smelling, and generally unpleasant, the dray is a beast-of-burden good for heavy labor, such as wagon-hauling or field-plowing, provided one isn't in any hurry. Drays will eat most any vegetative matter, and they vary in personality from docile to downright ornery. Few will attempt to ride one; in fact, many will balk at first-time riders and shy away from saddles and the like, but they can be driven at a slow and ponderous pace for hours.



Body 3d12, Speed d4, Mind none, Will d4

Dray d8

Weapons: Hooves

Habitat: Plains

Sense Tests: Listen, Smell

Skills (with Favorite Use)		
d8		Dodge
d8	d12	Hiking (through Plains)
	d8	Resolve (vs. blunt attacks)

Gifts: Extra Hit Point +2, Hooves, Mount (add Race Trait to Move, double normal size), Strength +3

Flaws: Stubborn

Armor: None (Soak 2d12)

Weapons: Teeth (d6 & Strength 2d12, d6)

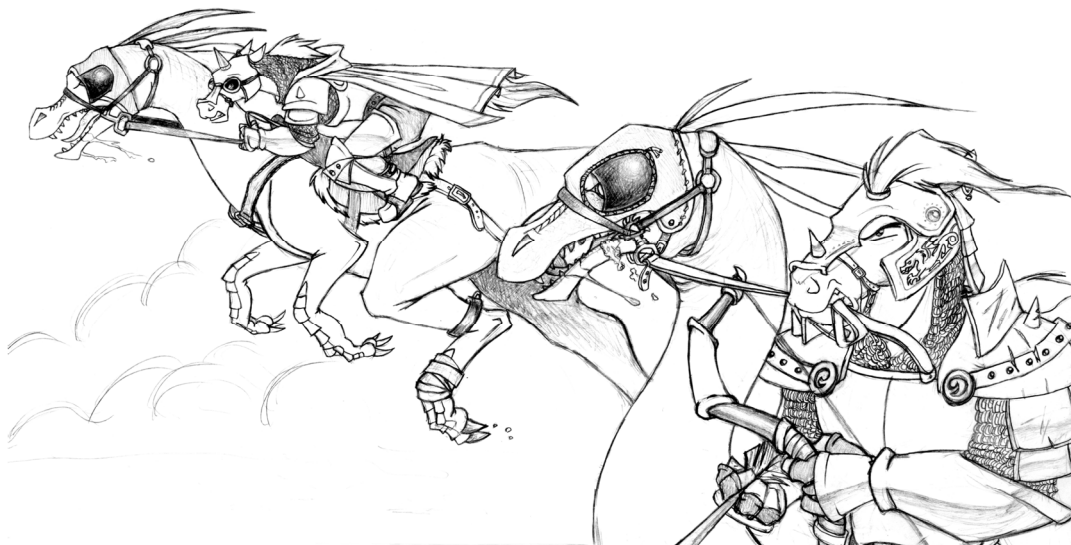

Jennet

The mount preferred by the Avoirdupois, the jennet is long of leg and swift in stride. They can be combat-trained, but they would still prefer to run than to stand and fight. They are an excellent choice for outriders or skirmishers, as they are smart enough to learn formation-fighting. Their speed makes them a good choice for lancers, as well. They are herbivorous and will eat most any scrub or plant matter, but better-quality food keeps them in their best shape.

Body 2d12 & d6, Speed d12 & d8, Mind none, Will d8

Jennet d12

Weapons: Hooves, Trample

Habitat: Plains

Sense Tests: Listen, Smell

Skills (with Favorite Use)		
d12	d10	Dodge (while on the Plains)
d12	d8	Hiking (through Plains)
	d6	Observation (to find foes)
	d10	Resolve (when being ridden)

Gifts: Extra Hit Point +1, Hooves, Mount (add Race Trait to Move, double normal size)

Flaws: Skittish

Armor: None (Soak 2d12, d6)

Weapons: Claws (d6 & Strength 2d12, d6)

Size: 48 stone

Dash: 30

Stride: 7

Lift: +12 stone



Palfrey



A generic term for a higher-class breed, the palfrey is the mount owned by those who are of distinction but not necessarily of a fighting nature, such as clergy or noble-women. While omnivorous like the destriers, palfreys are smaller and leaner and have less demanding dietary preferences. Palfreys can be trained to tolerate magic and gunfire and can be urged to strike out at footmen, but they lack the ferocity of their destrier cousins.

Body 2d12, Speed d8, Mind none, Will d6

Palfrey d12

Weapons: Hooves, Trample

Habitat: Plains

Sense Tests: Listen, Smell

Skills (with Favorite Use)

d12	d10	Dodge (while on the Plains)
d12	d8	Hiking (through Plains)
	d8	Observation (finding the best ground to walk on)
	d10	Resolve (when being ridden)

Gifts: Extra Hit Point +1, Hooves, Mount (add Race Trait to Move, double normal size), Strength +2

Flaws: Skittish

Armor: None (Soak 2d12)

Weapons: Hooves (d6 & Strength 2d12)

Size: 44 stone

Dash: 20

Stride: 5

Lift: +10 stone

Rouncy



For those mounts of no particular breeding or training, the term rouncy is used as a catch-all. Rouncies won't fight or trample, and they will spook at loud noises such as gunfire and the more brutal magics. But they will take their riders from one point to another, they will work in teams, and they are far more tractable than other, nastier mounts. Use the statistics for a rouncy when the players encounter a riding mount that's not war-worthy.



Body 2d12, Speed d8, Mind none, Will d6

Rouncy d8

Weapons: Hooves

Habitat: Plains

Sense Tests: Listen, Smell

Skills (with Favorite Use)

d8	d8	Dodge (while on the Plains)
d8	d8	Hiking (through Plains)

Gifts: Extra Hit Point +1, Hooves, Mount (add Race Trait to Move, double normal size), Strength +2

Flaws: Skittish

Armor: None (Soak 2d12)

Weapons: Hooves (d6 & Strength 2d12, d6)

Size: 48 stone

Dash: 16 **Stride:** 4

Lift: +12 stone

Special Items and Equipment

The Lance

The lance is a long weapon, consisting of a long shaft or handle and a steel blade or head. The Spear Skill is used with a lance. A lance weighs $\frac{3}{4}$ stone, has a Reach of 3 paces, and does 2d6 Damage. It requires a Lift Bonus of +4 to use “1-Easy”, and a Lift Bonus of +3 to use in one hand, Awkwardly. Lances may not be used in two hands. Lances may not Parry.

When rolling To-Hit, a combatant wielding a lance who scores an Overwhelming Success gets the following special result:

Special: Tilting. If the attacker is mounted and moving at “full tilt” (12 paces or more in one Round), the attacker may substitute the mount’s Strength for their own Strength for determining damage.

The Billhook

The billhook is a special weapon designed for unseating mounted combatants. It is a type of spear that has a curved hook on the end, for dragging the target down.

The billhook has the exact same statistics as a Spear from the Ironclaw rule book, and it uses the same Spear combat skill. The only exception is its Special result for a Overwhelming Success, which changes to the text below:

Special: Upset. The hook of your weapon has become ensnared in the target, in its clothing or armor or even part of its body. If your target is mounted, they become unseated as you yank them off their mount, falling to the ground and suffering d8 damage vs. Soak and Armor. If your target is standing, they fall down automatically.

Mount Furniture

While there are those who would ride bare back, there is equipment for making a ride easier. Such items are called furniture.

A mount should be fitted with a *harness*, which includes a bit that goes in the mouth of the mount, possibly even a nose-ring. For game purposes, a harness weighs $\frac{1}{4}$ stone and is an Average Cost, Commonly Available item (12 denarii).

A *saddle* is padded part of a harness which is worn on a mount’s back, being fastened in place with a girth. It includes stirrups for the rider’s feet, for extra stability. (While stirrups are not necessary, note the increased difficulty of staying mounted without them.) A saddle weighs $\frac{3}{4}$ stone and is typically an Average Cost, Rarely Available item (18 denarii), but really nice ones may be Expensive.





“At the docks, coarse stevedores did not divert from their task to make way for two dignitaries dressed in silks and gilded finery. An hour later, I witnessed an agitator on a pile of boxes, fists waving and voice booming against a myriad of perceived injustices, while a small group of refreshed guildsmen emerged from a bath-house door, bemused by the spectacle. It was like a dozen countries surrounded by one wall, this city, and I have yet to see its like anywhere else in the world.”

— Ethelinde van Altbusser, in a private letter to her sister Dagmar van Cavell

CITY OF TRISKELLIAN

*Being Both an Accurate Map of the City and Environs
and a Gazetteer of Note-Worthy Places and Personages*

The largest city of Calabria, Triskellian is on the southern coast of the island, at the mouths of the three major rivers. Its population is in the tens of thousands, and many ships come to call at all times of day from ports hundreds of miles away. What follows is an itemized listing of major points of interest within the city.

1. The Don's Palace

When living within the city, the former Don set up residence in this magnificent but aging structure. Now it is currently under the care of his former advisors and members of the Guild Council. In his absence, the Guild Council has been using the house for its official functions, such as holding court. There is also a small standing garrison of watchmen. Often, the Magistrate Umberto (q.v. Ironclaw rulebook) can be found here.

2. New Town

Built within the last few hundred years, the architecture of this street shows the two- and three-story buildings constructed in the modern style. Most noticeable are the windows; the richer dwellings have panes of milky-white glass, while others make do with wax paper. All windows have shutters. Where possible, the bricks have been coated with plaster, though some places show cracks of wear. This is where the shops of “artisans” and skilled laborers can be found.

3. Old Town

Inside the old walls is the crumbling architecture of a thousand years. As the Guilds concentrate more on building new places rather than restoring the old ones, much of this district is in disrepair. Deteriorating arches and dark alleyways are everywhere. Most places are falling ruins, either abandoned or now home to the desperate or the criminal. The few well-to-do who inhabit Old Town have their own “companies” of bravos and strong-arms to defend their “turf”; the businesses they traffic in are the more unsavory ones, such as brothels and gambling houses. The Constabulary generally assumes that anyone found in Old Town after dark is either a scofflaw or a fool.

4. Dock Town

Here can be found all sorts of folks, from unskilled laborers making poor wages as dock-workers, to sailors from a dozen different lands on a brief shore-leave, to the middlemen who maintain the warehouses and counting houses. The sight of armed Constables is not uncommon, as Triskellian makes much of its revenue from dock fees and shipping taxes, so they want to be sure to make prominent displays of power. At all times of the year, ships of all sizes and styles will be docked here. Dock Town is also a good place to find foreign mercenaries who won't ask questions, who will do all sorts of jobs for pay in anonymous coins, and who won't be around a month from now.

At least three times a year, ships from faraway lands will arrive for an improvised slave auction. Hapless folk in chains and stocks will be paraded without dignity and sold to the highest bidder. Recently, however, some antipathy towards slavery has developed among the folk of Triskellian. The anti-slavery or "Eleutherian" cause was first started by educated commoners as a "rebellion against injustice", but



unskilled laborers have also joined their ranks (since slaves who work "for free" are a threat to their meager wages). The Guilds continue to tolerate slavery, but they do not encourage the practice.

5. Shipyards

Triskellian is not just interested in foreign commerce. The rise of local shipping companies has created a need for more ships. The felled trees float down the river, to be caught in a special net that must be strung out to catch them as they arrive, yet must still be closed when river traffic approaches. (The rumors that a special gibbet was constructed to hang the poor sawyer's apprentice who lets one too many log escape into the Bay of Auvrich have never been substantiated.) At present, no noble house owns a ship-building company, although the Bisclavret are easily the strongest customers at this point. Members of the Guild Council have expressed concern that a new city wall should be constructed to safeguard the shipyards from a land assault.

6. Aqueducts and Bath-Houses

The pride of Rinaldi engineers, and still a monument of civil engineering despite its age, the canals and sewers that run through the city of Triskellian provide fresh water and sanitation to the citizenry. Shown on the map are the main branches of the aqueducts, which are often seven to ten paces wide. At numerous junctions, they split off into various tributaries and side-channels about a pace wide.

During the day, one can often see press-gangs wading in the water to break up the jams of refuse and other unpleasantness, a grim reminder to those who would commit petty crimes. There are rumors that a gang of thieves uses the sewers to pass undetected in and out of the city, but the Constabulary has been unable to find any tunnels that would allow such escape. The large round "dead-ends" mark the location of the city's bath-houses. Although officially "owned" by the Rinaldi family, the licenses to maintain these houses falls upon the hands of the Guild Masters; often the title of "Keeper of the Baths" is given out as a favor to some wealthy person, as a sort of status. In truth, the bath-houses run themselves with minimal interference.

The architecture of each bath-house varies wildly, some being more classical whereas others have been built up in a more modern style. In the past, communal bathing was an affair that took up most of the day, where folks were attended by many servants or slaves. In this modern age, most folks enter the foyer, move on to another room to disrobe, then enter the caladarium (heated baths), clean themselves in either plain water or with expensive perfumes, and then towel off, all for a flat fee of one denar or more. Of course, peddlers selling scented oils and fine towels are never far away. The bath-houses are also a likely place to find barbers, physicians, herbalists, and other types who cater to the hygiene and well-being of the middle class.

Those of advanced wealth seeking a more enjoyable bathing experience prefer to patronize the Three Spears Inn (see #9, below).

7. Old Tower

Opinions differ on what the Old Tower was used for. Some speculate it was a watch-tower when the city had yet to have walls. Others think it was a light-house. Presently, the tower is crumbling and unsafe, and there is talk of having it torn down.

8. Dunwasser College

The rise of literacy among the middle-class has created a need for "greater learning," the study of history, linguistics, geography, and the like. Many years ago, the Dunwasser shipping company started a correspondence service, copying notes and maps and cataloging them for reference. Although they are still active in shipping (owning stakes in about three ships), today most of their trade is in information. For a hefty sum, the Dunwasser College staff can make information about all sorts of things available, and they have full-time copyists to produce maps, navigation charts, and mathematical aids such as logarithm tables (which are invaluable to the Navigator's Guild). The College is also home to one of the few printing presses. There are those who believe that the Dunwasser employees are also maintaining a spy network, since their agents travel to the most remote places and have deep pockets. Dunwasser academics deny such allegations.



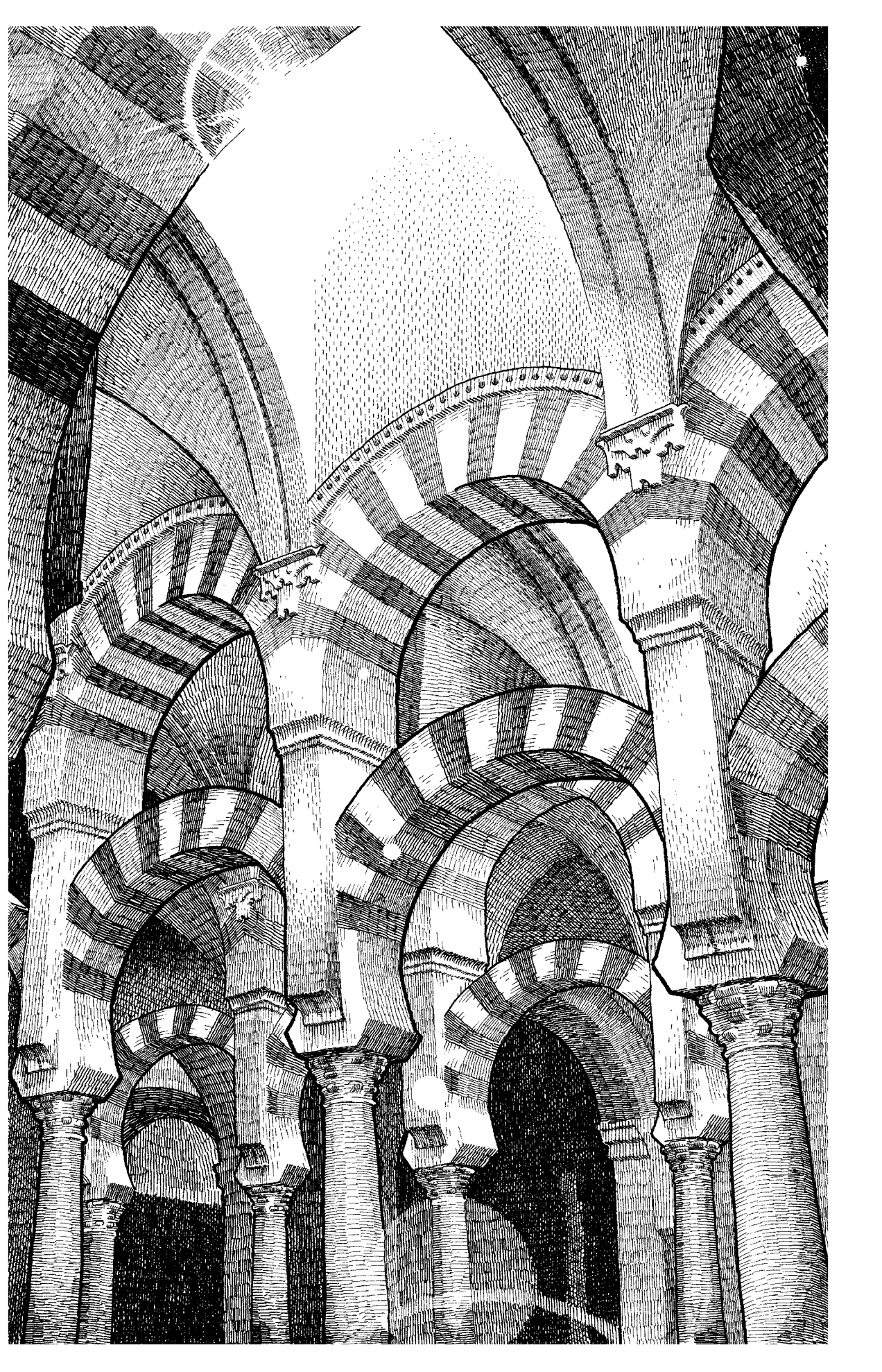



The Three Spears is the most expensive inn of Triskellian. Comprised of two stone buildings and a wooden stable, this is the only inn with indoor plumbing, and a sumptuous indoor bath. The nouveau riche and the nobility are known to spend their time here. The service is impeccable, the food is gourmet, and the prices are in the "if you need to ask, you can't afford them" category.

10. North Gate; 11. West Gate; 12. East Gate

The three gates of the city are nearly identical. They consist of two heavy doors that are barred from inside, plus a smaller door to permit folks to enter one at a time, which is also barred.

The people who live in the city pay taxes on their dwellings. The shipping companies pay taxes on their goods and shipments, plus docking fees, inspections, and other such excises. Random travelers who come in and out of the gates pay neither, and as such place a burden on the Constabulary, since as free-men they are entitled to justice and police protection. To deter the indigents and low-lives, gate fees are imposed, of one denar for entering (no fee for exiting.) This fee can go up depending on the nature of the person entering (after all, folks in plate-mail with swords are obviously more likely to cause trouble, and in any event look rich enough to afford greater fees) or the whims of the guards watching the gate (depending on whether they are not above using their authority for bribes and personal gain, which is rare but not unheard of.)

Magistrates and other high-ranking commoners are known to sign "chits" that allow commoners to pass freely through the gates; most expire after a certain date, but sometimes a "golden" one is given out as a reward for some service. Nobles can write letters of recommendation or passage which, by Triskellian law, will allow for passage (though once again, unscrupulous watchmen may ask for "extra fees".)

The buildings found outside the gate are built on land owned, in name, by the Rinaldi, but administrated through the Constabulary. The land is inhabited by a few farmers, some stables, and the cheaper hostels.

13. Main Barracks

Spartan but comfortable, the barracks are where off-duty guards can be found sleeping, preparing their armor, or training in the courtyards. The two-story campus on top is of recent, wooden construction. The armory is well-stocked with spears and pikes, and a fair number of swords given only to officers. Currently, the Constabulary only has four half-stone guns, of which almost no one has field experience and are only to be used for emergencies.

During the day, at least one Journeyman Cleric can be found on the grounds, tending to any injuries and generally offering moral support. Some Clerics train in combat with the watchmen.

Below, there are older, lime-encrusted dungeons and cells, where prisoners are temporarily jailed until their hearings. (The concept of keeping prisoners housed for long periods at the expense of the state is unknown to the people of Calabria.) There is a hole in one of the basement floors leading to an "oubliette", a cell with an opening only at the top, where prisoners are presumably dropped and left to die. The Constabulary maintains that it hasn't been used for such a purpose in over five hundred years.

14. Cathedrale de Temoin

The crowning glory of the city, the magnificent Cathedrale de Temoin, is a stone and plaster edifice that takes up nearly as much space as the Market Plaza it is next to. Domes and spires are supported with arches and keystones, rather than the "flying buttress" typical of more modern cathedrals.

The wings are long dormitories and halls for the numerous Penitents studying to advance from acolytes to vested priests. Many also choose to study White Magic, although not all have the patience for it. If one is looking for Master Clerics, the Cathedrale is the place to look first, although the folk of such exalted rank concern themselves with administration of the church and conducting rites of worship on the holidays, and their calendars are very full.

Being a place for those of a scholarly nature, the Cathedral de Temoin has a comprehensive, centuries-old library, with maps to guide pilgrims, copies of correspondence from far off lands, star-charts for proper navigation and for synchronizing clocks, and histories of the practice of magic of all kinds. The only comparable library in Triskellian can be found at the Dunwasser College (q.v.). The





major difference is that Dunwasser will dispense information for a consulting fees; the Cathedrale de Temoin only opens its doors to lay-folk when they feel it is in S'allumer's best interest.

15. Merchants Guild Hall

A two-story affair in the latest style, complete with shuttered, glass windows and indoor plumbing, the Merchants Guild Hall is enfranchised by the Constabulary to monitor the taxation practices and to issue a limited number of money-lending licenses, among other issues. The Merchants Guild is currently playing "catch-up" with the Dunwasser College (see #8), trying to expand their library of maps, lexicons, and gazetteers.

16. Sailors Guild Hall

A recent development, the Sailors Guild was granted enfranchisement by the Guild Masters to preside over loading dock fees and shipping licenses. However, ships often need marines and fighters to keep their shipments safe. Over time, an informal list of body-guards has become a network for hiring mercenaries, both for travel at sea and travel by land. The Sailors Guild charges a referral fee of one denar or more, and they are not likely to help out scofflaws or other unsavory types.

17. Other Guild Halls

Residency of which Guild has which hall actually changes pretty quickly, as some Guilds move out, some are dissolved, some change names, etc.

18. West Lighthouse Tower; 19. East Lighthouse Tower

These two lighthouses mark the edges of the city, and help offshore navigators find the extents of the city at night. They are maintained by the Sailors Guild.

20. Breakwater Island; 21. Lighthouse

This lighthouse is the tallest building in Triskellian, nearly a "chain" or twenty-paces tall. It is also maintained by the Sailor's Guild. In times of crisis, should the ports need be closed, two lights and not one would burn in the tower, but this has yet to occur since the Sailors Guild began.

22. Town Water Gate

The oldest, and thus hardest-to-maintain, engineering structure in the city, the water gate can be opened and closed to moderate the flow of water from the east side of the city to the west side. The gate is mostly closed, usually only opened four times a day to let the water flow out to sea, but it can be left open in times of heavy rainfall.

23. Customs House

Maintained by the Guild Masters, the Customs house is a large, circular tower that houses the "official" copies of all shipping licenses and transactions. (The Sailors Guild maintains their own copies, as well.) During the day, a small garrison of town watchmen can be found in, in case there's trouble at the docks for one reason or another. On the third floor is a bell that can be rung in case of emergencies, and above that is the town clock.

24. Tamurello's Counting House

A tidy, neat house of brick and plaster, the shop of Tamurello the Money-Lender has a new, lacquered sign out front, depicting a scale with coins stacked on either side. The windows are only narrow slits, the walls are thick to prevent damage, and one or two body-guards can be found at all hours. Tamurello is the most successful money-lender in all of Triskellian, but currently his business has a small problem.... See the included adventure for more details.

25. Malthus Shipping Company

This is a warehouse of modest age, with a painted sign bearing a stylized "M," run by Malthus the rat and his cousins. It is much like the other warehouses and shipping companies in this district.

River
Granvert

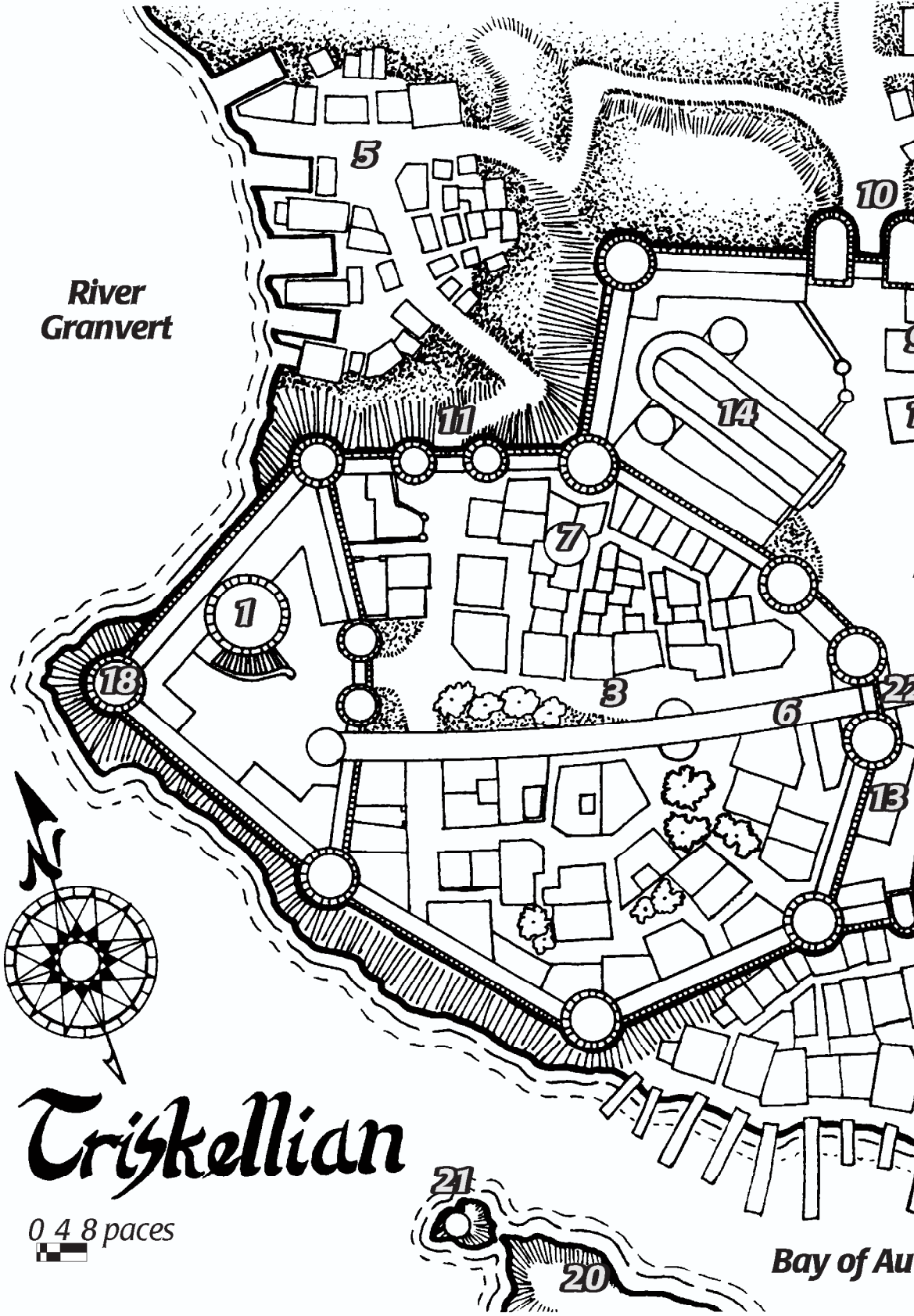

Triskellian

0 4 8 paces



Bay of Au



Market Plaza

Wrich

1/24/05



“In a thousand years, this city will be dust, and all who dwell here will be reduced to squabbling simpletons, scraping the ground to dig up the gold teeth from the generations of corpses that will be all that remain of their bloated, misbegotten patriarchs. The material concerns of this Triskellian rabble disgust me, the stink of this place nearly moves me to vomit with each of my tedious visitations. It will not be my fate to be the bird trussed up in a gilded cage for these moon-calves to gawk at. My destiny is writ in larger letters.”

—quote attributed to the Lady Amalsand, never authenticated

THE LOST HEIR

*Being a Tragic Tale of Betrayal and Madness,
and a Search for the Lost Heir of the Rinaldi*

Attention! The text that follows explains in detail an adventure involving mystery, deceit, and even violence. This section is for the purview of the Game Host only. Those players planning to experience the adventure must avert their eyes and must not read this section, lest they spoil their own enjoyment.

What Has Gone On Before

Master Rinaldi, patriarch of the Rinaldi clan, marries Amalsand Jakoba, a widow of some repute from the mainland. She is joined by her son and daughter. The marriage is pretty much one of convenience – Master Rinaldi needs the dowry, and Amalsand needs a new place to live, although the reasons are not discussed in polite society.

Amalsand is a practicing Necromancer, something that’s made her unpopular in her homeland. She thinks only of herself first, her children second. She was hoping to use the remote, quiet estate to pursue her studies.

Unfortunately, she hadn’t counted upon the high level of gossip that surrounds the Rinaldi estate, nor the tense infighting of the surrounding houses. Master Rinaldi became worried. Tensions rose. He demanded that she stop her “diabolic practices”. She refused. He threatened to evict her. She threatened to expose his “parties”. They were at a stalemate.

In the course of her studies, Amalsand used a forbidden Necromantic spell to raise the corpses of three warriors. Unfortunately, something in the ritual must have gone wrong, for these undead horrors had thoughts only of slaying all that lives. In a desperate move, Amalsand had the basement boarded up.

This atrocity was too much for the Master Rinaldi. He issued a proclamation for divorce, with his first-born son as witness. Things went downhill from there.

Shortly before she left, she staged a final display of her ire. Their last night together, Amalsand and her children staged a brutal attack, slaying the Master Rinaldi and his first-born son. The second son, Fabrizio, barely escaped with his life ... only to suffer a guttural curse from the wrathful Amalsand – “May the vision of your family’s folly haunt you for the rest of your days!”

Fabrizio was struck mad by a Curse. He now can no longer speak coherently, and he is in a constant state of tremulous fear. He fled the manor into the night, and he lived in the woods as a wild-man.

Knowing that she was an unpopular figure, Amalsand and her family fled the manor for the dangerous Paludestris swamps. There she continues her research in the forbidden arts of Necromancy.

Two months ago, the weasel Recondite came to Triskellian, looking for opportunities. She heard the rumors of the missing heir, and decided she could use this to his advantage. In secret, she has contacted the three major houses of Triskellian (Avoirdupois, Bisclavret, and Doloreaux)





and asked each one for their bid to the heir of the Rinaldi throne. Her plan is to capture the heir and ransom him to whoever will pay the most.

Unfortunately for her, the otter Lystragones the Athanasian has other plans. Rather than search all over for a missing heir who is presumed mad and perhaps dead, he has instead found another gray fox to pose as the heir!

The reason for this search for the heir is that the estate of the Rinaldi is in great debt. In particular, Tamurello the money-lender would like to “foreclose” upon the estate.

Unfortunately, to do that he would need someone to sign over the estate to him ... and that requires the heir! Without concrete proof of Fabrizio’s demise, there’s no legal way for the estate to be released.

As our adventure begins, Recondite is following up on a lead to Fabrizio’s whereabouts, Lystragones is coaching his pretender, Salmalin the slaver has custody of Fabrizio, and Tamurello is sorely vexed.

Getting the Players Involved

Every gaming group is different. Some parties concentrate on militancy and combat, while others prefer to solve their problems through reason and other methods. Most groups are somewhere in between. You, as Game Host, know your Players and Characters better than we do, and it’s up to you to find a way to get them involved in this escapade.

Hooks

In order to “hook” your Player Characters into this plot, there has to be something that would involve the players in the upcoming events. Get to know your player’s Characters, and their motivations.

Here are some suggested hooks:

- Do any of your PCs have Investiture or Duties to uphold the law? They will probably be charged with the apprehension of Salmalin, to end his slaving practices.
- Are any of your PCs members of the Nobility? They will probably have heard the gossip of the decline of the Rinaldi.
- Are any of your PCs of a criminal bent? The news that the Rinaldi manor is currently abandoned would be of interest.
- Wizard PCs (and Witch-Hunter PCs) might take interest that there are two strange spell-casters in town. They are more likely to notice the ostentatious Lystragones than the secretive Recondite.
- Some of your PCs may have done business with Tamurello the money-lender, and may be curious about his current predicament. Or perhaps Tamurello may hire the PCs to find this missing heir, once and for all.

If your players are the typical “itinerant adventurers”, one possible hook is to have them deliver a package to the Malthus Shipping Company.

The PCs start somewhere outside of the city, and are hired to deliver a cedar box to the Malthus Shipping Company. The PCs should be promised some exorbitant sum of money upon delivery, such as 4 aureals apiece.

This adventure hook works best if the players start outside of town, such as in the port of Epinian or Omigre-Haudie. (This adventure could easily serve as a bridge from the Adventure in Omigre-Haudie from the Ironclaw game system book.)

You can stretch this introductory part of the adventure out, mostly by adding stops along the way. Some suggestions:

- The PCs are stopped by a “toll-scam” – some ruffians refuse to let the players pass over a bridge unless they pay a “toll”. Depending on your Players, they may hand over the money, try to talk their way out of it, or they may get into a fight.



- A wagon pulled by two drays has thrown a wheel. The PCs could offer to help repair the wagon (a simple Repair Test, taking one hour with a difficulty of about 2d6.)
- The PCs stop to rest at the same point as two pilgrim Ascetics, Ameth the female badger and Cadolf the male black fox, who are travelling in the opposite direction. They will be talkative and eager for news.

The players will deliver their box to Malthus himself, whose offices are in the southern shipyards. Malthus the old cat will be happy to receive them, to pour them some tea, and generally to be a very gracious host.

Unfortunately, when it comes time to pay the PCs, Malthus will try to sign over a “promissory note” – basically an IOU until Malthus obtains the lucre he needs to pay the PCs. He’ll explain patiently that he’d love to hand over “honest coin”, but that he can’t until Tamurello the money-lender pays him the money he’s owed. No, Malthus doesn’t know why Tamurello hasn’t paid yet, but Malthus is an easy-going patient type and is “in no rush.”

The PCs can threaten, cajole, or otherwise haggle with Malthus all they want – the fact is he simply doesn’t have the money. The PCs will likely want to ask Tamurello what the hold-up is.

How to Run This Adventure

As Game Host, your job is to make sure the adventure runs smoothly, that all the PCs are getting “screen time” and contributing to the game experience.

- *Episodes in the game should be tailored to your group.* Many of the episodes in this game won’t happen until the Player Characters actually “show up” at the places where they take place. The trick is to encourage your Players to want to solve whatever dilemma the episode causes, and then to be eager to move on to the next one.
- Choose the episodes that you think your Players will enjoy — skip the ones they don’t. For example, if your Players don’t like combat and other such dire situations, then don’t use the encounter with Recondite at the mill. You should also feel free to improvise new episodes or make major changes.
- Let the Players exercise their free will. Never force your PCs to participate in encounters — your best bet is to be familiar with your PC’s Gifts, Flaws, and other motivations and then tweak the episodes to play on those. It will make the Players feel more involved and it will make for a more satisfying game.
- Watch for the portraits in circles. When you see these, this means there’s a write-up for the NPC.

The game host should note this adventure is not a traditional “treasure and glory” scenario. Instead it is intended to clearly show the players the cost of political infighting and blood feuds on the part of the Bisclavret. The Baron and his household will scheme and plot, even as the enemy batters the gates and supplies grow short. The players will, at best, be able to achieve a kind of pyrrhic victory simply by staying alive and learning a few valuable lessons.

Tamurello the Money-Lender, and the Liens on the Estate

Tamurello owns an office near the shipping yards, not far from the Malthus Shipping Company. He is a business-like rat, and in the booming economy of Triskellian, he is doing quite well.

Tamurello dresses in custom-tailored clothes, although he doesn’t wear jewelry or anything showy, preferring to carry himself with an air of dignity that “befits the gentleman of today.”

He will gladly entertain the PCs when they arrive. As to the matter of the Rinaldi, Tamurello will bite his lip, and will give the soliloquy duplicated in the included comic vignette.

If the players came from Malthus, Tamurello will add: “And only then will I have the coin to pay out to those to whom I have made promissory notes.”





Questions the Player-Characters may ask Tamurello

Tamurello knows more of the story, but he won't think to mention it unless the PCs make direct inquiries. Here are some of the more common responses.



“Why haven't you hired someone to look for the heir?”

“I am in no rush. I have standing in this community, and I am confident that the House of Lords will pass a waiver, allowing me to fore-close.”

(Tamurello won't admit this, but he expects that the other noble houses, eager to buy the Rinaldi land, will fix this through legal action.)

“What happened to the Master Rinaldi and his first born son?”

“There was .. unpleasantness. These matters are certainly not for light conversation.”

(Tamurello, like everyone else, is spooked by Amalsand and doesn't want to talk about her out loud.)

“Can you loan me some money?”

He will be very happy to offer them loans, at some “usury” rate of “one-third compounded monthly” (33.3%) or the like. Most PCs will decline. Any who accept will be treated to a battery of legal forms that will be incomprehensible to those without Literacy and Law skill. Tamurello has standing in the community and is an old hand at this sort of thing, so he's no one to be trifled with in financial matters. Those who are a flight risk or generally look like bad investments (such as anyone with the “Scofflaw” Flaw) will probably be turned down.

“Who could tell us more about the Rinaldi?”

“At present, the estate is unoccupied. The former help have been dismissed, but since they were born and raised here all their lives, I can't think they've traveled far. You may be able to find them in the city. No, I'm afraid I don't have references or other information to help you find them.”

The Constabulary and the Town Guard

Player characters may want to ask the Constabulary what they are doing about the grisly murder. If they visit the Don's Palace in the city, they will find it filled with bureaucrats and town watchmen. If the Characters have anyone of note with them, they may gain audience with someone of importance, like Magistrate Umberto. Otherwise, they're more likely to chat with a captain.

Questions the Player-Characters may ask the Town Guard

“What are you doing to find the missing heir?”

“You can be assured that we are doing everything we can to restore the good patriarch of our glorious free city.”

(In truth, the Constabulary runs things just fine without royal interference.)



“Some people think that some of the Constabulary have hidden the heir away, or worse. Is it true?”

“Such charges are, at best, baseless and in poor taste. You are fortunate that I have a generous nature; someone less friendly than myself might accuse you of calumny.”

(Constables will threaten the PCs with all sorts of minor charges if they try to spread rumors that they are responsible for the heir's disappearance.)



“Have you seen any suspicious characters?”

“This is Triskellian. Strangers are everywhere, folk who speak a dozen different languages and who hail from a hundred lands. It is our duty to maintain the peace over such a motley crowd.”

(PCs may be able to use Gossip Tests to get more information. Once on “friendly terms,” some Constables will admit they’re watching out for “a mysterious weasel dressed in red and black robes, who does not speak much and then only in whispers.”)

The Abandoned Manor House

The Rinaldi manor is outside the city, surrounded by unkempt farmland. The house is an old villa, surrounded on all sides by a stone wall.

The house is guarded day and night by Tamurello’s six cousins, with three of them around at any one time. They’re all armed with maces and a single half-stone gun (in which none of them have any skill.) Their job is to keep anyone from looting the manor or from going inside without a writ, warrant, or other such charge.

None of them go into the house. They’re all convinced it’s haunted, because at night, strange sounds come from inside.

The Inside

The house has been abandoned for a while. There are no drop-sheets over anything, so all furniture is covered in dust. There are signs of a scuffle or a fight, as some things are in disarray. However, obviously portable and valuable items, such as silver candlesticks and silverware, still remain.

Except for the cellar (as detailed below), the house isn’t very interesting. Feel free to improvise details of the creepy rooms.

The Wine Cellar, and something beyond it.

Those who trespass downstairs may find a gruesome secret. Those with Keen Ears (or who can make a 2d8 Listen Roll, or the like) will hear scratching noises coming from behind the rack of fermenting wines. If the rack is removed, a secret door will be revealed! It is a small wooden door, about 12 hands high, and it has been boarded up on this side. The scratching sounds come from behind the door.

The Secret Workroom

If the boards are removed, the three Skeletons waiting within will attack! They ask no quarter and give none. They are the botched result of a magic spell Amalsand cast long ago, and are possessed with mindless, evil spirits that think of nothing but smiting the living.

Inside is a medical lab. Jars have been smashed, lamps have been destroyed, notes are shredded and scattered. The only thing intact is a podium with an open book on it, entitled *Ye Book of Black Magick* by Frater Perphredo, dusty but remarkably free of damage in a devastated room. Anyone who reads the book can start spending Experience on the “Necromancer” Career Trait, the pre-requisite for the Black Magic Apprentice List. Necromancer applies to Black Magic Lore, Meditation, and Literacy.

Salmalin the Slaver

In the mountains of the north lurks Salmalin the slaver, who has been patrolling the woods looking for squatters, outlaws, and the like whom he could seize and enslave. The current state of skirmishes and lawlessness in border territories has proved a boon to slave-takers.

Salmalin will camp in his box canyon hideaway for a week before moving on again. He will try to pass through the Chevernaise mountains – usually he has good luck at that, as the Chevernaise have little use for slaves, preferring material wealth or rare goods, and Salmalin’s fighters have good morale and considerable ability.





One of Salmalin's raids has turned up a surprising find: the lost Fabrizio de Rinaldi, heir to the Rinaldi throne. Poor Fabrizio has been living in the woods, foraging and scrabbling about in a furtive, mad existence, constantly menaced by imagined horrors. Salmalin has no idea that Fabrizio is the heir, but he hopes to fetch a good price in a foreign market for him.

However, Salmalin's opinions of Fabrizio will change once Recondite shows up. The tiger, deciding Recondite was a person of means and education, quoted her a price of two dozen aureals ... and when Recondite agreed to pay it in a week's time, Salmalin's suspicions were aroused. He sent emissaries into town to ask around. In the meantime, he's in no hurry.

Ambushing Salmalin

The PCs may try to sneak up on Salmalin's camp. Those with Tracking or Area Knowledge may find out about the box canyon. Those with Streetwise may have heard rumors about "some large, foreign cat who hires braves for dirty work – it's dangerous but the money's good – and he hides out in the mountains."

The box canyon camp can only be sieged from the front. The sides slope so as to be seen from below, and all the good rocks have already been felled. In addition, Salmalin has an escape route – a rubble-covered "chimney" passage that leads into the cave complex below. (Only Salmalin knows about this escape route; he will use it if he becomes desperate.)

If attacked outright, Salmalin will put up a fierce battle. If the PCs look formidable, Salmalin will seize Fabrizio from the cage and escape through the tunnel. Fabrizio, in his frightened state of mind, will follow anyone who holds his wrist tightly enough.

Negotiating with Salmalin

Some PCs may try to negotiate with Salmalin for Fabrizio's release. If asked, Salmalin will say that he's already had an offer made for "this little fox, here." He will attempt to "stretch the truth" and say that the offer was 3 dozen aureals (not 2); a Haggles Test (q.v.) will change his offer. If the PCs are unable (or unwilling) to turn over such money, they'll have to try another angle, such as combat (see Ambushing, above) or a challenge (see Challenging, below).

Appealing to Salmalin's "civilized nature" will fail. To him, these slaves are property, and attempts to convince him to release Fabrizio on "humanitarian" grounds will not work.

The first threat of violence or capture against Salmalin will be met with a hearty laugh of disbelief. The second threat will be met with an icy stare, and a growling rebuttal. The third threat will be met with a fight.

Any hostile magicks cast in Salmalin's presence will start a fight instantly.

Challenging Salmalin

Salmalin is a proud tiger. He is a formidable combatant, and can't resist showing that off at a good opportunity. Should any PCs challenge him, he will accept. "My terms are simple: if you win, I will surrender the fox. If I win, then you must go in the cage with the others, a spoil of war for the invincible tiger from another shore."

As the challenged party, Salmalin will be able to choose the arms and armor – and as an Atavist, Salmalin will choose "no arms or armor at all." (He will smile when he says that, too.)

Salmalin will fight until he suffers –6 hits or more, thus forcing Death Tests. If he thinks he can get away with it, he'll try to invoke the Atavist Power of "Reserves of Strength"; otherwise, he'll surrender, muttering that "this little one is not worth my life."

Resolving the Encounter

If Salmalin yields Fabrizio to the PCs, for one reason or another, and he's able to leave, he will do so. Recondite, who has been thwarted, will be quite angry and will seek revenge! Salmalin will flee to the north, to the port of Epinian where a ship is waiting for him and his slaves.

If Salmalin was attacked, and he was forced to flee, but he fled with Fabrizio, he will attempt to leave to the north. The PCs can chase him through the caves (as a Chase Test, but note Salmalin has



strong advantages). Without his retinue, Salmalin will have a harder time passing through the Chevernaise mountains.

Recondite the Wizard, and the Old Mill

If Recondite successfully flees the scene, she will attempt to make for her secret hideaway, the Old Mill near the Paludestris, which is a popular thieves' hangout. There are also a few other hangers-on, mostly burglars and the like waiting for the trails on them to run cold.

If she obtains Fabrizio, Recondite's plan is to store the heir here, in the subterranean caves. She has prepared letters to the masters of all three houses, which she will send out and await their replies, using messengers that she's threatened into silence upon fear of "their flesh boiling from the inside out by means of a geas." (Recondite knows no such spell, but the three messengers she chooses will be too gullible to know that.)

There is a lookout posted to watch the mill; he will hang around the front gate, and he will use Stealth to sneak away and warn those inside if strangers approach.

Attacking Recondite

Seiging the Mill is probably a bad idea. There is only one entrance, from the front, and people can try to flee out the windows. Recondite may have a quick temper, but she has little reason to fight the PCs. She will order her minions to attack while she herself falls back.

If she has the heir, she will flee if the PCs seige the tower and it looks like they are winning. See "The Old Mill" later in this text for details on such a fight.

Negotiating with Recondite

PCs may send one of their own to the Mill to ask for audience with Recondite. Or they may find some other means.

Recondite will not reveal herself to PCs if she can help it. She will prefer to shout through the high mill window, shrouded in darkness. (Or, better yet, to whisper her orders to one of her minions and have that minion shout for her.)

Recondite won't release the heir for anything less than an absurd sum of money, or some priceless artifact or magic book. She knows the other noble houses will pay a lot to obtain him.

A pragmatist to her very core, Recondite won't stand up to any formal challenges, and in fact won't "fight fair" for any reason.

Questions the Player-Characters may ask Recondite

"Who are you?"

"My name is not important. If you must have some label, you may use 'Recondite'. It is a good as any other."



"What do you want with that fox?"

"My issues are my own affair. Unless you are blooded nobility, it is not your concern."

"I am of noble blood, and I can prove it. Now, tell me what you want with that fox."

"He is the heir to the throne of Rinaldi, the last of many generations. I am to ransom him to the noble houses, who are eager for his favor."

"I demand that you turn that fox over to us. What are your terms?"

"I am one of few words. Five dozen aureals is my ransom, and no less."

(Recondite, however, is open to Haggling, as per a Hagggle Test [q.v.])





“We will take the fox from you by force, if you don’t hand him over. How could you stop us?”

“I have means.”

(Recondite does not like showy displays of power. She finds them in bad taste.)

Fight at the Old Mill

As Game Host, you should try to make conflict exciting and risky, without either overwhelming your Players with “unfair odds” or losing their interest with a “cake-walk” combat that they finish almost without effort.

For this dramatic purpose, the number of mercenaries Recondite has hired will be proportional to how many you think will give your PCs a “good fight”. Sample combatants can be found in your Ironclaw rulebook on p. 288.

- If your PCs tend to be combat-weak, then there should be one Thug per PC.
- If your PCs are more dangerous and combative, we recommend two Thugs per PC, or one Minion per PC.
- If there’s one PC in your book who lives for nothing but combat, add a Hero: “Xing Ho” the Monkey Mercenary from a foreign shore, armed with a “Mau Chan” spear that “only an expert can use”. Have him on the Third Floor, with Recondite, and he will wait until a “worthy” opponent appears, who he will challenge to single combat.

The Windmill

The mill faces the southern shore, looking lonely and forlorn. The road that leads up to it is in ruin. Each story is four paces tall, and the mill stands 18 paces high. Recondite will have at least two lookouts on watch, looking at the approaches both from land and from sky.

First Floor

Once filled with sacks of grain and other goods, this floor is now empty except for two large barrels, 2 paces wide and 3 paces tall, with trap doors in the ceiling above. (If the Game Host thinks it’s appropriate, he could hide a combatant or two in the barrels, to have them jump out at a dramatic moment.) The only way up to the next floor is via the ladder.

Second Floor

The axle from the windmill is in the middle of the room, with two millstones on either side. Currently, the axle is held in place by wooden blocks, though those could become dislodged during combat (or they could be deliberately pulled). Someone who falls through and open trapdoor will fall 4 paces into an empty barrel.

If the axle is freed, the sail will begin to turn the grindstones. They turn so slowly, only some helpless and lying on the stone is in any danger. (This would include the unconscious, those grappled and pinned there, those Paralyzed by magic, etc.) The grindstone does 4d12 damage.

Third Floor

A large square hole, five paces wide on each side, overlooks the grindstones below. If anyone is unfortunate enough to be knocked off the edge (from Reeling, perhaps?) or pushed, they will fall 1 pace onto the large wooden “spur wheel”. The spur wheel won’t spin unless the pegs on the floor below are removed, and when it does, it moves any combatant one pace counter-clockwise at the end of the Round, and is “bad footing”.

This is where Recondite would make her stand. She will use Ignite Fire to harass lightly-armored types (like wizards), hoping to force Resolve Tests. For armored types, she will use Pilum of Fire. Recondite won’t use a Fireball if her own mercenaries would get caught in the Cluster. In the ocean air, the damp wood won’t ignite easily.

The Old Windmill

Scale

0 1 2 3 paces

First Floor

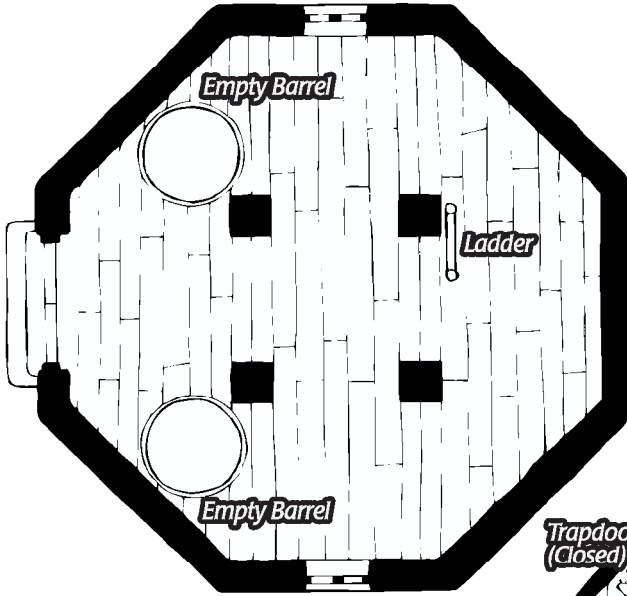

Second Floor

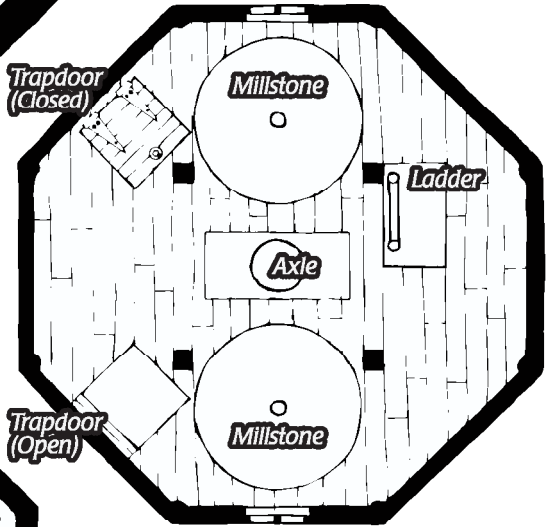

Third Floor

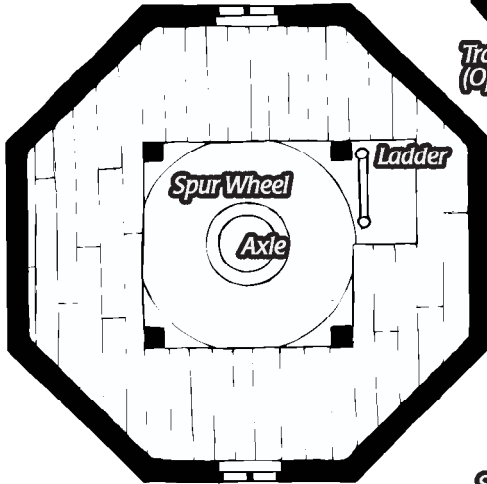

Fourth Floor

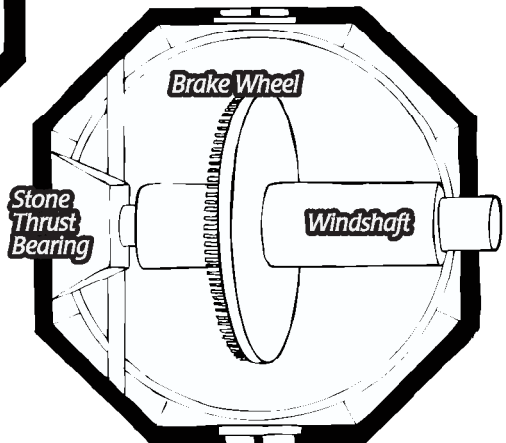



Fourth Floor

This “attic” of sorts is not reachable from the lower floor – the only way in is through the windows in the roof, or just behind the sails on the big “propeller” outside. The room is very dark even with the windows open (at least -2 Penalty on visibility).

A large stone-work fills up the far side of the room – a “thrust bearing” to hold the windshaft in place. Close inspection will reveal that one of the stones in the bearing isn’t cemented in, and can be removed with some kind of lever or crowbar. Inside is a hollow space with the original mill-owner’s heirlooms: a set of Chain Mail for size 8 that has gone rusty (Armor of d10, weighs 3 stone), a well-oiled Three-Quarter Stone Sword in its scabbard, and a letter detailing the mill owner’s honorable discharge from the Rinaldi army. All these items must be more than sixty years old or more.

Players may want to hide in here, or try to sneak in for ambush. The only ways to the third floor from here is to either smash through the floor (which would take several Rounds with an axe or the like) or to climb outside onto the sail and into the third-floor window. (The latter method would require a 2d8 Climbing Test to make it, and a Sneak Test to enter unheard.)

A Surprise Upon Return

Whether the PCs fail to recover the heir or not, if the PCs return to Tamurello’s place they will be witness to a strange scene.

Then apprentice will ask them to wait in the foyer while “the master Tamurello finishes his business with his appointment”. From behind the curtain there will be murmurs, followed by brief stints of cheerful laughter. (Those with Keen Ears or good Listen Rolls can make out at least three voices, one of them Tamurello’s, speaking in amiable terms.

After a time, the voices will die down, and the curtain will be brushed aside by the head of a curious staff, and Lystragones the Athanasian will step through. He will glance briefly at the PCs, with a veiled look of disdain. (If the PCs have the heir with them, he will try to conceal his surprise and anger.)

Right on his heels will be the Pretender. He will bow at the PCs but will otherwise attempt to leave without saying anything to them. (After all, in his own mind, he’s nobility and the PCs are commoners.) If the PCs have the real Fabrizio with them, the Pretender will stare at him briefly, then blink and go on his way, a bit shaken but otherwise in denial.

They will both leave in haste. Tamurello will come out to greet the PCs, a smile on his face. If they are here to collect Malthus’ check, then he will tell them, “Good news, my friends, good news! Please, if you would produce your paperwork, I will render unto you the moneys which you are so rightfully deserving!”

What has happened?

Shortly before the PCs arrived, Lystragones and his Pretender have used their stolen signet ring to sign over the lien on the estate over to Tamurello. They have, in effect, become his tenants on land that Tamurello now owns. This makes the money-lender the owner of the richest parcel of land outside of Triskellian – and he’s a commoner, to boot! Tamurello will be riding on a wave of glee that he can barely contain.

New Questions the Player-Characters may have for Tamurello

“Do you think (or do you know) that wasn’t the real Fabrizio de Rinaldi?”

“Pardon me? You must speak in jest. I have no doubt that was he – he spoke truly on noble matters, and produced the signet ring without delay. I have met forgers and charlatans before, and I know what tricks they play. The lord who just left here was without art or shame, and you would be wise to hold your tongue rather than speak such calumny.”

(In truth, Tamurello doesn’t care if that was the real heir or not. Their credentials were good enough, and if they prove false, he can just say he was duped. His goal is to sell off as much of the land as he can for as much as he can.)



“Who was that otter?”

“Hmm? Oh, the curious vizier.... I suspect he is a lawyer or solicitor of some kind. That was ‘Lystragones the Athanasian.’ I surmise he acts as advisor to the heir – their family has had difficult times, you know.”

“No, I’m afraid I don’t know where he hails from, or what an ‘Athanasian’ is.”

(Tamurello doesn’t know anything about Lystragones, really... and since he looks like a wizardly type, he won’t offer any opinions, either, since wizards are subtle and quick to anger.)

“Do you know who this gray fox that we found is?”

“I’m afraid I’ve no idea. I’ve never seen him before in my life. Frankly, he appears to be some sort of indigent. You would be best served to remand him to a poor-house.”

(Tamurello has no idea who that guy is, and frankly isn’t really concerned at the moment. The contract he has is strong enough to be valid in court, and he has an estate to sell.)

Lystragones and his Pretender

Lystragones has been using repeated applications of the Lesser Mesmerism spell to brain-wash this gray fox into thinking that he’s really Fabrizio de Rinaldi. In reality, he’s a ne’er-do-well scofflaw, who knows enough of fast-talk and busking to get by.

The Pretender has gaps in his memory, but he will bluster over those with a show of self-confidence. (Have you ever been challenged on something you don’t know, only to make up some excuse and stand by it? That’s how the Pretender behaves all the time.)

Lystragones himself is always cool and confident. He never loses his temper. He will smile politely at the PCs, and he will speak with a cultured accent. Lystragones thinks nothing is more noble than the pursuit of magic, and he will be eager to talk with other wizards. “Brutes” such as warriors hold little interest for him.

Questions the Player-Characters may have for Lystragones

“Who are you?”

“I am Lystragones the Anathasian. I am the advisor to Don Rinaldi. He is eager to once more dispense his wise rule throughout the land.”



“Where did you find this fox?”

“He is not a ‘fox’, he is none other than Don Fabrizio de Rinaldi, ruler of Triskellian. You would be wise to conceal your uncouthness by remaining silent in his presence.”

“What is an Anathasian?”

“If only I had time to make up for the lack of years worth of schooling on your part... In the interest of brevity, I will sum up: the Anathasians are a hoary and mostly forgotten order of magicians who knew the secrets of everlasting life. What has become of them is a mystery that I will unravel.”

“Yes, Don Rinaldi is my patron in my quest for this knowledge.”







Dénouement

So ... the estate got signed over, the PCs got paid, and everyone's happy. Right? Well, there will probably be numerous "loose ends". We discuss some of those below.

Curing Fabrizio of his madness?

If the PCs wound up with Fabrizio in their custody, they have an incoherent fox who is spooked by his own shadow on their hands. Only the most callous of characters would just dump him in the street.

The PCs might try taking him to the Church of S'allumer. A Journeyman Cleric on hand could try using the Cure II spell to remove the Curse III – roll a contest of the Cure's 4d10 vs. the 3d12 of the curse. (Remember that since Black Magic is involved, if either roll winds up showing three or more 6's, something bad happens – one suggestion is that Fabrizio becomes possessed.) Only PCs of unusually high status and standing with the Church would be able to gain audience with a Master Cleric.

Given enough time and care, Fabrizio might recover from his madness. He may "calm down" and become a skittish mute, eager to help his friends but still too spooked by inner demons to be too useful. Perhaps some "great event" that requires him to be brave to save one of his friends might drive the curse away.

Lystragones – Friend or foe?

The mysterious otter has set himself up as a puppet-master to rule the manor house, with the Pretender as his puppet. Lystragones' first goal is to sign off enough loans and property to stave away creditors. His second goal is to gain wealth enough so that he can seek out the forgotten lore of the Anathasians, who he is convinced were some of the Autarchs of the Age of High Magic.

Lystragones knows that keeping the Avoirdupois, Bisclavret, and Doloreaux arguing with one another will keep them any one of them from seizing the land (and the throne) by force. He will ingratiate himself into their social circles, only hinting but never outright saying that he is the power behind the throne. This thread may never come up again during play, if the PCs aren't very politically active ... but if they are, they will meet Lystragones again.

If the PCs try to "expose" Lystragones' Pretender as a fake, he will have them silenced. First, he'll try to buy them off with money – at most, six aureals. Failing that, he'll have them killed by hired mercenaries.

It is worth noting that the former chamberlain of the House Rinaldi is a Wild Dog bloodhound with a Keen Nose; he could certainly identify who is the true heir and who is not. If the plot direction calls for finding him, he is currently drowning his sorrows in alcohol at some bar. Lystragones will be interested in finding this person, to either bribe him or permanently silence him.

Amalsand's Revenge?

The necromancer of the swamps will not take kindly to the restoration of the house that she sought to destroy. Her vengeance will most likely manifest in the form of nasty Undead minions made with the spell Vessel of Unlife.

Recondite?

Recondite will attempt to disappear when all this is over. If she got paid, great! If she didn't make any money, then she'll be miffed and will only leave that much sooner.

Dramatis Personae

What follows is a list of the relevant gaming information for the prominent NPCs in this adventure. Each write-up includes a brief description of the character, their rules and statistics, and their personal "list" of priorities, ranked in order of importance. As Game Host, when you are playing the role of an NPC, check the NPC's list of Motivations to see what their priorities are, to better help you decide how the character would behave.

Lystragones the Anathasian



Tall and lanky, dressed in a hat and cloak, Lystragones peers out from under the wide brim of his hat with suspicious eyes. His fur is sleek and short, and he keeps his claws trimmed and clean. When silent, he remains very still; when he speaks, he gestures with exaggerated emotion. His voice is deep and sure. He may make sarcastic comments, but he never jokes or smiles. His staff bears the Anathasian symbol.

Body d8, Speed d8, Mind d12, Will d10

Otter d8

Weapons: Claws

Habitat: Plains

Sense Tests: Listen

Cleric d6

Green & Purple Mage d10

Skills (with Favorite Use)

d8		Breath-Holding
d8		Contortionist
	d6	Cryptography (when deciphering ancient manuscripts)
	d8	Diplomacy (with educated folk)
	d6	Disguise (with regard to passing someone off as nobility)
	d6	Etiquette (when hosting a dinner party)
	d8	Fast Talk (by confusing the target using big words and obscure history)
d8		Fishing
	d10	Forgery (royal documents)
	d6	d10 Literacy
		d10 Lore: Green & Purple Magic
	d6	d10 Meditation
		d12 Psychology (to judge someone's level of education)
		d8 Staff (with his Favorite Staff "Aeigenês")
d8		Swimming
	d6	d8 Theology (Anathasian doctrine)

Gifts: Claws, Luck

Flaws: Proud; Stubborn; Wrathful

Armor: Reinforced Leather (d8, d4 & Soak d8)

Weapons: Half-Stone Staff "Aeigenês" (To-Hit 2d8; Damage d10 & Strength d8)

Magic Points: 26 (but only 22, as 4 are Delayed in a *Lazarus Heart* on himself and another on the Pretender)

Spell Lists: White Magic Apprentice; White Magic Journeyman; Green & Purple Apprentice; Green and Purple Journeyman

Spell-Casting	Benediction 2 (Adept)	Ivory Tower 2 (Adept)	Scry Spirit 1 (Adept)
Skills:	Blind I 3 (Adept)	Lazarus Heart 2 (Adept)	Thought Reading I 5 (Adept)
	Confuse I 3 (Adept)	Lesser Mesmerism 3 (Adept)	Thought-Sending I 5 (Adept)
	Flesh Ward I 4 (Adept)	Life's Whisper 2 (Adept)	Turn Unholy I 4 (Adept)
	Green & Purple Journeyman's Privilege 1 (Adept)	Paralyze I 5 (Adept)	White Magic Journeyman's Privilege 1 (Adept)
	Healing I 3 (Adept)	Scry Mind 1 (Adept)	

Lystragones' Motivations:

1. Survive.
2. Divine the secrets of the Anathasians.
3. Maintain control over the Rinaldi estate, most likely by controlling the Pretender.

The Pretender ("Fabrizio di Rinaldi," née Fast Jack)

Carefully groomed (and a little brain-washed) for his role as "Fabrizio de Rinaldi", the Pretender dresses in the most expensive, ostentatious clothes he can afford and have fitted. Previous to his role, he was known as Fast Jack, working the dockyards of the Bisclavret ports as a gambler and a cut-throat; the memories of this life have been blotted from his mind by frequent uses of Mesmerism. When challenged by questions he cannot answer, the Pretender will become annoyed and angry; he may jabber angrily, or he may even challenge the object of his ire to a duel.

Body d8, Speed d8, Mind d8, Will d4

Grey Fox d6 Weapons: Claws, Teeth Habitat: Forest Sense Tests: Listen, Smell

Charlatan d10

Dilletante d4

Skills (with Favorite Use)

d6		Climbing
	d8	Cloak (with my Favorite Cloak)
	d4	d8 Etiquette (witty remarks)
	d10	Fast-Talk
	d4	Fencing
	d10	Forgery
	d4	Literacy
	d4	Lore: Heraldry
	d10	Psychology
d6		d8 Sixth Sense (when in the city)
d6		Stealth
	d10	Streetwise
		d8 Sword (with my favorite Sword)
d6		Tracking



- Gifts:** Claws, Keen Ears, Teeth
- Flaws:** Brainwashed (Common, Strong), Proud
- Armor:** Reinforced Leather (d8, d4 & Soak d8)
- Shield:** Cloak (Extra d6 Cover Defense Die, & Block 2d8)
- Weapons:** Quarter-Stone Sword "Veloce" (To-Hit 2d8; Damage d12 & Strength d8)

The Pretender's Motivations:

1. Survive.
2. Maintain that he is the true Fabrizio di Rinaldi, to the point of delusion.
3. Make money.

Tamurello the Money-Lender



A studious shrew, Tamurello looks pleasant enough and approachable, but his conversation will quickly reveal his "to the point", no-nonsense attitude. He is "upper-middle class" and does well for himself, dressing in custom-tailored clothes, although he doesn't wear jewelry or anything showy, preferring to carry himself with an air of dignity that "befits the gentleman of today."

Body d6, Speed d4, Mind d10, Will d10

Shrew d6 Weapons: Claws, Teeth Habitat: Plains Sense Tests: Listen, Smell

Merchant d8	
	Skills (with Favorite Use)
d8	d8 Administration (money-lending)
d8	d8 Bribery (in Triskellian)
d8	d8 Ciphering (counting money)
	d8 Diplomacy (about money)
	d8 Fast-Talk (about money)
d8	d8 Literacy (contracts)
d6	Resolve
d6	Stealth

- Gifts:** Claws, Robustness +1, Teeth, Wealth
- Flaws:** Corpulent -1
- Armor:** Padded Clothes (d4 & Soak d8)
- Weapons:** Pistol "Compensatore" (To-Hit d4; Damage d12)

Tamurello's Motivations:

1. Survive.
2. Make money.
3. Maintain good status in the community of Triskellian.

Fabrizio di Rinaldi, True Heir to the Rinaldi Throne



A poor young fox consumed by madness, Fabrizio shares the sharp features of his father. His eyes are largely white, and he constantly shivers no matter how warm it is in the room. He wears only rags, the remnants of the clothes he had on when he first fled. He will probably latch on to the Player Character who scares him the least.

Should Fabrizio be cured of his madness, raise his Will to d10, add Career: Dilettante: d8, and remove the Passion of Fear.

Body d8, Speed d8, Mind d8, Will *none*

Grey Fox d8 Weapons: Claws, Teeth Habitat: Forest Sense Tests: Listen, Smell

Passion: Fear d12

Skills (*with Favorite Use*)

d8		Climbing
d8	d8	Sixth Sense (vs. Magic)
d8		Stealth
d8		Tracking
	d8	Observation (finding escape routes)

Gifts: Claws; Keen Ears; Nobility (Heir-Apparent to Rinaldi throne); Teeth

Flaws: Coward; Foe: Amalsand Jakoba; Mad with Fear (Common, Extreme; can't speak coherently, sees things that aren't there); Poverty; Skittish

Armor: None (Soak d8)

Weapons: Claws (To Hit 2d8; Damage d6 & Strength d8)

Notes: Include Passion: Fear d12 with all Chase Tests to escape, and to resist all Influence and Magic to avoid feeling Fear

Fabrizio's Motivations:

1. Survive.
2. Run away from things that frighten him.

Salmalin the Slaver



Preferring to wear only a loincloth in all but the most extreme weather, Salmalin stands tall, shoulders back, with one of two expressions: calculated scrutiny of a foe, or a self-satisfied, toothy smile. His thick coat of fur is marred by old battle wounds, almost all caused by claws or teeth. Salmalin carries no weapons or other items, preferring those duties to his henchmen. He thinks little of the Calabrese, most of whom have been made soft by the trappings of “civilization”, and he has no qualms of selling captured folks to a life of hardship and misery.

Body d12, Speed d10, Mind d4, Will d6

Tiger d12

Weapons: Claws, Teeth

Habitat: Forest

Sense Tests: Listen

Bounty Hunter d8

Skills (with Favorite Use)

d12		Acrobatics
d12	d12, d8	Atavism: Reserves of Strength (when in front of a crowd; Roll 2d12, d8 vs. d12, d4; see <i>Ironclaw</i> , p. 249)
	d10	Brawling (with Claws)
d12		Climbing
	d10	Dodge (vs. natural weapons and wrestling)
	d8	d10 Haggling (over slaves)
	d8	Intimidation
	d8	Psychology
	d10	Resolve (when fighting a duel)
d12		Stealth
	d8	Torture
	d10	Wrestling (when in front of a crowd)

Gifts: Atavist, Claws, Night Vision, Teeth, Very Robust (+2)

Flaws: Coarse; Proud; Scofflaw; Showoff

Armor: None (Soak d12, d6)

Weapons: Claws (To Hit d12, 2d10; Damage d12, d6)

Wrestling (To Hit 2d10; Grapples foe)

Salmalin's Motivations:

1. Survive.
2. Show everyone how much better a fighter he is than them.
3. Make money.

Recondite, the Mysterious Wizard



When drawn up, her dark red cloak conceals her features. Rarely does she draw the hood back and reveal her surprisingly short and delicate face. Before speaking, she will often take deep breaths like a trained speaker would, arching her shoulders for correct posture so that her voice goes farther. She does not holster her mace; rather she keeps it in her hand, concealed below her cloak. Her mace glows with the radiant energy of the Fire Elemental Bound within.

Body d10, Speed d6, Mind d8, Will d12

Weasel d8

Weapons: Claws, Teeth

Habitat: Plains

Sense Tests: Smell

Elementalist d4

Thaumaturge d4

Skills (with Favorite Use)

		d12	Cloak (with her Favorite Cloak)
d8			Contortionist
d8		d8	Dodge (vs. Magic)
	d4	d4	Literacy
	d4		Lore: Elementalism
		d4	Lore: Magic
		d12	Mace (with her Favorite Mace "Perdu")
	d4	d4	Meditation
		d12	Spell-Throwing (with Pilum of Fire)
d8		d10	Stealth (into the night)
d8			Tracking

Gifts: Claws; Luck; Teeth

Flaws: Eerie; Greedy; Taciturn

Armor: Reinforced Leather (d8, d4 & Soak d10)

Shield: Cloak (Extra d6 Cover Defense Die, & Block d12, d6)

Weapons: Half-Stone Mace "Perdu" (To Hit d12, d6; Damage d10, d4 & Strength d10; has a Bound Fire Elemental, so Special Hits now cause 1 Fatigue of concussion and set the target on fire for 2d6 damage)

Magic Points: 20 (but only 17, due to Bound Salamander inside Mace)

Spell Lists: Basic Elementalism; Fire Magic Journeyman; Fire Magic Master; Apprentice Thaumaturgy



Spell-Casting	Avert Fire 1 (Adept)	Destroy Fire 1 (Adept)	Mold Fire 1 (Adept)
Skills:	Bind Salamander 3 (Adept)	Dispel Magic 3 (Adept)	Pilum of Fire 3 (Adept)
	Call Salamander 4 (Adept)	Fire Ball 4 (Adept)	Scry Fire 1 (Adept)
	Command Salamander 4 (Adept)	Fire Magic Journeyman's Privilege 1 (Adept)	Silence I 5 (Adept)
	Cooling the Fires Within 3 (Adept)	Fire Magic Master's Privilege 1 (Adept)	Tongues of Flame 5 (Adept)
	Create Fire 1 (Adept)		

Recondite's Motivations:

1. Survive.
2. Learn the secrets of the universe, mostly via magic.
3. Make money.

The Skeletons of the Rinaldi Manse

A former cat, rat, and shrew, these are former servants dug up by Lady Jakoba for her dark conjuring. Rather than become instruments of her will, however, the maleficent spirits that inhabit these bodies think of nothing but killing and destroying.

Body d6, Speed d10, Mind none, Will none

Undead d12 *Weapons:* None *Habitat:* Graveyard *Sense Tests:* None

Skills (with Favorite Use)		
d12	d8	Resolve (vs. piercing weapons)
	d8	Spear (in the dark)
d12	d8	Stealth (lying very still and not breathing)

Gifts: Echolocation, Flight, Prehensile Feet, Nobility (1pt)

Flaws: Single-Minded

Armor: None (& Soak d6)

Weapons: Spear (2d4 & Strength d6)

Special Qualities: Undead (do not eat or breathe; can see magic, using Undead d8 as Second Sight)

Unholy (vulnerable to *Turn Undead* spells and the like)

The Skeleton's Motivations:

1. Smite all that lives.

Amalсанд Jakoba (née Rinaldi)



Perhaps, in her younger days, she was the model of the young princess waiting for her fairy-tale escort to take her away. Today, the mysterious Lady Jakoba is in her late middle age, her features lean and angular. Her smile is no longer pleasant and disarming, it always has hints of malice and guile. Now that her marriage is dissolved, the Lady Jakoba prefers spare clothing that does not hinder her movements. To those who are not foxes, she often appears mad; to her own brethren, they recognize a certain kind of cleverness behind those wild eyes.

Body d4, Speed d8, Mind d12, Will d12

Grey Fox d8 *Weapons:* Claws, Teeth *Habitat:* Forest *Sense Tests:* Smell, Listen

Elementalist d8

Necromancer d12

Thaumaturge d8

Skills (*with Favorite Use*)

				d10	Area Knowledge: the Paludestris Swamps
d8					Climbing
				d10	Intimidation (when using Magic)
				d10	Leadership (with an iron fist)
	d8	d12	d8		Literacy
		d12			Lore: Black Magic
	d8				Lore: Elementalism
			d8		Lore: Magic
	d8	d12	d8		Meditation
				d10	Research (forbidden texts)
				d10	Resolve (vs. Magic)
d8					Sixth Sense
d8					Stealth
				d10	Stealth (in the swamps)
d8					Tracking



Gifts:	Claws; Keen Ears; Luck; Reputation: Necromancer (causes fear and respect, Uncommon, Strong); Nobility (Noble Blood); Teeth		
Flaws:	Envious; Overconfident; Reputation: Necromancer (causes hatred and exile, Common, Strong); Scofflaw		
Armor:	Light Leather (d6 & Soak d4)		
Weapons:	Claws (To Hit 2d8; Damage d6 & Strength d4)		
Magic Points:	40 (but only 31, as 9 are Delayed within the three skeletons locked up in the basement of Rinaldi Manor)		
Magic Lists:	Basic Elementalism; Water Magic Journeyman; Thaumaturge Apprentice; Thaumaturge Journeyman; Black Magic Apprentice; Black Magic Journeyman; Black Magic Master.		
Spell-Casting Skills:	Avert Water 1 (Adept)	Dispel Magic 3 (Adept)	Protection I 2 (Adept)
	Black Bargain 3 (d12, d6)	Drain the Soul 3 (Adept)	Scry Magic I 1 (Adept)
	Black Magic Journeyman's Privilege 1 (Adept)	Freeze Arrow 3 (Adept)	Scry Spirit 1 (Adept)
	Black Magic Master's Privilege 1 (Adept)	Instrument of Vengeance 3 (Adept)	Scry Water 1 (Adept)
	Create Undead 3 (Adept)	Lesser Counter-Spell 3 (Adept)	Silence I 5 (Adept)
	Create Water 1 (Adept)	Lesser Unmaking 5 (Adept)	Speak with the Dead 4 (Adept)
	Curse I 5 (Adept)	Locate 3 (Adept)	Steal Strength 3 (Adept)
	Curse III 3 (Adept)	Maelstrom 4 (Adept)	Water Magic Journeyman's Privilege 1 (Adept)
	Death's Whisper 3 (Adept)	Mold Water 1 (Adept)	Wrack 3 (Adept)
	Destroy Water 1 (Adept)		

Lady Amalsand's Motivations:

1. Survive.
2. Wreak terrible revenge on those who incite her fury.
3. Learn and gather terrible magics.
4. Protect the children of her own blood.

APPENDIX: FURTHER ADVENTURES

*Being the Seeds of Additional Escapades, to be Embellished at
the Discretion of the Game Host*

The Ring-Faller

While wandering the streets of Triskellian, one of the Player Characters (probably a Greedy one, or at least one that doesn't "look too bright") finds a ring with a set jewel sitting in the street. When they try to pick it up, they bump heads with Giacomo, a grey fox who claims that he found the ring at the same time the PC did. He will insist that the ring is his, and that he found it first. If the PC concedes, Giacomo leaves with the ring.

If the PC counters that they "found it first", Giacomo will argue for a bit, until arriving at the idea of a compromise: the PC can keep the ring if they pay Giacomo half its value. This can either prompt a Hagggle Test to find its true value, or they can go to a conveniently-close jewelry shop owned by Thorley the bear.

However, this is all just a scam. The ring is brass shined to look like gold, with a cheap glass bead instead of a stone, worth only one denar. To see through this sham, the PC must win an Appraisal Test vs. 2d6 Thorley's Forgery of d10 (*Ironclaw*, p. 128). Giacomo has been "casing" the crowd and arranged to drop the ring in front of the PC most likely to fall for this scam (low Mind Dice, etc.). Giacomo will use his Fast-Talk of 2d10 (with a Favored Use of this ring-falling scam) to talk the PC out of four denarii or more. Thorley will corroborate Giacomo's story, as he gets half of whatever Giacomo makes. The scene of Giacomo's subterfuge and Thorley's exaggerated "appraisal" is a good opportunity for role-playing.

If the PC walks away with the ring, a week or so later it will begin to show its true value, by tarnishing and losing its luster. If they try to sell it at other jewelry shops, shop owners (with Skill rolls of at least 2d10) will see the ring as a false imitation. Depending on the PC, their reaction may vary from shrugging it off to blood-boiling rage.

A Jury of One's Peers

Alroy Doloreaux may be of noble blood, but he often fails himself with the dignity that befits the higher classes. Last night, he got caught in a drunken brawl inside the Golden Sun beer-hall and dished out quite a bit of damage. Normally, the Constables would arrest him and press him into community service, but since Alroy is blooded, he is entitled to "high justice" and a court of his peers.

The PCs may become involved as mercenaries hired by the Doloreaux to escort Alroy from the jail in Triskellian to their capital at Bruges. They will be given a letter stamped with the House Doloreaux that entitles them to escort Alroy from the city. Travel by road is often eventful, given bad weather, assault by bandits, and other things you as the Game Host decide are appropriate.

As an additional complication, Mynogan de Bisclavret sees an opportunity to take advantage of Alroy's misfortune. His goal is to capture Alroy and ransom him to House Doloreaux. To do that, he has to get Alroy out of the PCs' custody. Of course, brute force will work, but that involves risk of life and limb, not to mention that other houses would take umbrage. A subtler technique is to steal or destroy the PC's letter — without it, they will have no franchise to act as Alroy's escorts, and that duty could only be filled by Alroy's "peers" ... such as Mynogan himself, a landed lord. Despite his Proud nature, Mynogan may also try to bribe or otherwise influence the PCs to turn Alroy over to himself.

If your PCs are a combative lot, assume that Mynogan is a Wolf Cavalier Captain (see "Sample Opponents," *Ironclaw*, p. 288) with one Minion per PC. On the open road, if the Players are nearing Bruges, he may be daring enough to try a mounted assault. If you want to use the included Mounted





Combat rules, Mynogan would find jennets for himself and one or two others and would try to run the PCs down. Remember that Mynogan's goal is to apprehend Alroy with the minimum amount of force. The PCs will most likely be lower-classes and thus "beneath" Lord Mynogan, so he would give them small quarter.

The Mystery of the Coin Shavers

During the evening, a Journeyman of the Sailors Guild, Hawthorne the porcupine, pays a visit to one or more of the PCs. He has a letter from the Master of the Guild, empowering him to investigate one or more of the PCs for evidence of "coin-shaving". The City of Triskellian, enfranchised by the Rinaldi estate, controls commerce by limiting the number of denarii in circulation. A coin-shaver is a counterfeiter who makes more coins by shaving off bits of true coin, then melts down the shavings into new dies.

Hawthorne is exploring a rumor that one of the PCs may be this shaver. This can be a good opportunity for role-playing – as Game Host, you should pick the PC who is accused to be the one for either the most comic value or the most plausibility. Hawthorne is a jovial sort, who keeps his cool and his sense of humor.

Turns out there have been a rash of shaved coins lately. The Minters Guild and the Sailors Guild are up in arms – the former because they have guaranteed the coins in circulation to be of a fixed value, and the latter because several of the foreign merchants are arguing for changes in the exchange rate. Hawthorne is one of many investigators calmly attempting to sort things out. There is a reward of six aureals for finding the culprits. If the PCs choose to investigate, they will find Hawthorne a willing ally. (He may or may not make it clear that, as a Guildsman, he's entitled to three shares of the reward, whereas the PCs would each get one share.)

The forgeries are being created by an infernal device, a noisy contraption inside the basement of some building. The exact location is up to you, but it has to be powered by something. If you didn't use the windmill in the Rinaldi adventure, you could put the machine on the second floor, in place of the grindstones. Another location could be in Old Town, with a water-wheel in the canal. The designer of the machine, Doctor Tyndareus the ocelot, is an ex-apprentice of the Dunwasser Academy who found the plans for such a machine in a forgotten book. The resolution of the adventure depends on your Players. If they prefer diplomacy, the Doctor could try to reason with them, or even bribe them. If your Players prefer combat, the Doctor will hire mercenaries to deal with them, either to scare them off or to rub them out. If possible, the Minters Guild will have the machine destroyed and the plans for it burned.

The Monster of the Sewers

Normally, the loss of a few ne'er-do-wells is nothing to worry the Constabulary. But when their comrades come back with stories of dark monsters inhabiting the bowels of the city, such accusations must be taken seriously. And it becomes impossible to discount the rumors when a body of a beggar turns up mutilated at one of the flood gates.

The Player Characters may be mercenaries hired by the Constables to help find the culprit behind the slaying. Unsavory, scowling PCs who have been arrested may be put in a press-gang and forced into the sewers to find out the source of the brutal killings!

The sewers of Triskellian are hundreds of years old, and accurate maps are hard to find, if non-existent. The subterranean complexes are pitch-black; without personal lighting, the only way to navigate is Echolocation. Listen Tests and Smell (ugh!) Tests may be called for, as well.

The source of the brutal murders is up to you. There could be a pack of rheumy-eyed, pallid mastiffs, as detailed on page 25 of this book, have made their home in the dark. Or this could be the work of a gang of thieves who, having found a secret way in and out of the city, have killed anyone who has found out about it. Maybe Lady Amalsand has found a way to direct her undead monstrosities into the tunnels under the city; see page 50 for the details on these foul creatures.

The Builders of the Shipyard Walls

The Constabulary has finally voted to extend the city walls around the Shipyards. While it may sound like a common-sense idea, it is not without controversy. The labor for such a large undertaking will cost a lot of money, unless slave-labor and press-gangs are used ... and the unskilled laborers and

Stonecutters Guilds have very definite opinions on these issues. The wall must also be designed, and the consulting fees for engineers do not come cheaply.

The major Noble Houses are also opposed to the project, as they gain nothing by such walls being built, and it would only diminish their power to threaten the city. As the wall project is underway, the Houses will sabotage its construction. Carts bringing stone from the quarries will be waylaid. Workers will be beaten by "roving brigands", secret mercenaries in the employ of the Houses. If Recondite is still around, her magic can be contracted to start fires or unleash elementals, additional distractions in the building.

The Player Characters may be contracted by the city to oversee the construction and put an end to these incidents. If Lystragones and his Pretender are still in power, then hiring the PCs to watch over the walls is an ideal distraction to keep them away from investigating the whereabouts of the true heir.

Alternatively, the Player Characters may be hired by a Noble House as saboteurs. The mischief that your Players can cause is probably great and only limited by their imaginations. In this scenario, the PCs must be careful to not get caught by the Constabulary. They can expect no help from the Noble Houses, who will disavow any knowledge of such subversive activities.

INDEX

- | | | | |
|------------------------------------|----------------------------------|----------------------------------|--------------------------------|
| Ambrosi de Rinaldi, 6 | East Lighthouse Tower, 25 | Main Barracks, 24 | Sailors Guild Hall, 25 |
| Appendix 1: Further Adventures, 50 | Epinian, 6 | Malthus Shipping Company, 25 | Salmalin the Slaver, 48 |
| Aqueducts, 22 | Equipment for Riding Animals, 20 | Martyrdom of Helloise, 7 | Shipyards, 22 |
| Avoirdupois, 8 | Etienne d'Avoirdupois, 8 | Matteo di Rinaldi, 9 | Slaver Salmalin, 48 |
| Bath-Houses, 22 | Frederico di Rinaldi, 9 | Merchants Guild, 9 | Special Items, 20 |
| Billhook, 20 | Full-Tilt, 14 | Merchants Guild Hall, 25 | Tamurello the Money-Lender, 47 |
| Bisclavret, 10 | Further Adventures, 50 | Miniatures for Riding Combat, 16 | Tamurello's Counting House, 25 |
| Breakwater Island, 25 | Gallop, 14 | Money-Lender Tamurello, 47 | Tempestas Lacrimosus, 6 |
| Cathedrale de Temoin, 24 | Getting the Players Involved, 29 | Mount Furniture, 20 | Three Spears Inn, 23 |
| chivalry, 17 | Guild Halls, 25 | Mounted Combat, 12 | Time of Weeping, The, 6 |
| Constantin di Rinaldi, 7 | Guild of Merchants, 9 | New Town, 21 | Trampling, 14 |
| Corrado, 8 | Harness, 20 | North Gate, 24 | Water Gate, 25 |
| Counting House, 25 | Harrowgate, 10 | Old Tower, 22 | West Gate, 24 |
| Courser, 16 | Helloise, 7 | Old Town, 21 | West Lighthouse Tower, 25 |
| Customs House, 25 | Hooks, 29 | Palfrey, 19 | What Has Gone On Before, 28 |
| Destrier, 17 | How to Run the Adventure, 30 | Riding Limit, 13 | Wissian de Bisclavret, 10 |
| Dock Town, 21 | Jennet, 18 | Rouncy, 19 | Writ, 9 |
| Don's Palace, 21 | Jon the Wise, 6 | Rules for Riding Combat, 13 | |
| Dray, 17 | Lance, 14, 20 | S'allumer, 7 | |
| Dunwasser College, 22 | Lighthouse Towers, 25 | Saddle, 20 | |
| East Gate, 24 | | | |

All material within this book Copyright ©1999, 2000, 2004 Sanguine Productions Limited. No material may be reproduced without written permission. All rights reserved. Printed in the United States.



THESE YOUNG LORDS, CLAD IN THEIR SHINING, UNPROVEN ARMOR AND SWASHING THEIR UNTESTED SWORDS, WILL GO HOME TO THEIR FAMILIES BOASTING THAT THEY COWED THE FOXES WITH THEIR BRAZEN DISPLAYS. YET THE HEAVY PURSES THEY CARRY HOME ARE FILLED WITH COINS STAMPED WITH MY SEAL, AND NO ONE CAN BE PUT BEFORE THE RINALDI AS THE SEAT OF ALL COMMERCE. THIS, THIS IS THE ROOT OF POWER.

—Letter from Don Fabroni to his court, after the concession to Lord Aldred de Bisclavret

Through their cleverness and guile, the ancient Rinaldi made themselves the unquestioned rulers of Calabria. Their city of Triskellian became a haven of culture, technology, and commerce.

But all things change with time. Generations of misrule and neglect have reduced the once-proud bloodline to fops and schemers. Now the Guild Masters rule the city, playing each Noble House off one another for their own advantage. But the title of nobility still carries certain privileges...

This supplement for the *IRONCLAW Gaming System* describes House Rinaldi, from their humble beginnings, to their peak of power, to their degenerate state today. It also contains an adventure involving the fate of the true heir — a strange turn of events that will decide the future of Rinaldi rule. Also included is a map of the city of Triskellian; descriptions of the people, locations, and history; and details on mounted combat and the code of chivalry, as befits the landed gentry.

You will need a copy of IRONCLAW: Anthropomorphic Fantasy Role-Play to use this book.



Sanguine Productions Ltd.

Copyright ©2000,2003 Sanguine Productions Limited.
Product SGP-1002-CP.