

Palladium Books® PRESENTS:

HEROES Unlimited™ G.M.'s Guide

KEVIN SIEMBIEDA & WAYNE BREAUx



Z 99

Warning!

Violence and the Supernatural

The fictional world of **Heroes Unlimited™** is violent, deadly and filled with superhumans, supernatural monsters and strange powers. Mutants, aliens, monsters, vile criminals and nefarious villains threaten, rob, torment, and prey on humans. Other alien life forms, monsters, gods and demigods, as well as magic, psychic powers, insanity, and war are all elements in this book.

Some parents may find the violence, magic, insanity, super abilities, and supernatural elements of the game inappropriate for young readers/players. We suggest parental discretion.

None of us at Palladium Books® condone or encourage the occult, the practice of magic, the use of drugs, vigilantism or violence.



**Leap into the world of superhumans and heroic adventure!
Compatible with the entire Palladium Books® Megaverse®!**

Dedication

Dedicated to those who have joined us in these make-believe worlds, but simply could not stay, especially my baby sister April, and my sister-in-law Khristy. We all have to bow to the real world time and again. Some of us are just more fortunate in that we can stay away for a bit longer than others. Good luck with the obstacles you will face. The battles might not be as exciting as those we imagined in the Megaverse, but they are no less heroic.

Also dedicated to the person that inspired this book and introduced me to real role-playing, Derrick. There have been some rough times along the way, but it's good still to have you around. It's hard to believe it's been 10 years. Here's looking forward to 10 more.

And Special Thanks to Dennis Knight for his perpetual eagerness, help, support, and ideas.

— *Wayne Breaux Jr., 1999*

Dedicated to Wayne Breaux Jr. and his rich imagination, growth as an artist, skill as a Game Master, and “my hero” for *always* meeting his deadlines and never giving me grief. I don't think people truly recognize just how multi-talented Wayne really is. Plus he's an all around nice guy. Yep, definitely the stuff of heroes.

— *Kevin Siembieda, 1999*

PDF Edition – October 2017

Copyright 1984, 1987, and 1999 Palladium Books Inc. & Kevin Siembieda.

All rights reserved, worldwide, under the Universal Copyright Convention. No part of this book may be reproduced in part or whole, in any form or by any means, without permission from the publisher, except for brief quotes for use in reviews. All incidents, situations, institutions, governments and people are fictional and any similarity, without satiric intent, of characters or persons living or dead, is strictly coincidental.

Palladium Books®, Rifts®, RECON®, Megaverse®, After the Bomb®, The Palladium Fantasy Role-Playing Game®, The Mechanoids® and Nightbane® are registered trademarks owned and licensed by Kevin Siembieda and Palladium Books Inc.

Heroes Unlimited™, Villains Unlimited™, Aliens Unlimited™, Ninjas & Superspies™, Beyond the Supernatural™, Vibro-Blade, Mega-Hero, Mega-Damage, Cascade, S.D.C., P.P.E., I.S.P. and other names, titles, and likenesses of characters are trademarks owned by Kevin Siembieda and Palladium Books Inc.

Palladium On-Line www.palladiumbooks.com

Heroes Unlimited G.M.'s Guide™ is published by Palladium Books Inc., 39074 Webb Court, Westland, MI 48185. Printed in the USA.

PALLADIUM BOOKS® PRESENTS:

HEROES UNLIMITED™

G.M.'S GUIDE

WRITTEN BY: KEVIN SIEMBIEDA
‡ WAYNE BREAUX JR.

EDITORS: ALEX MARCINISZYN
BILL COFFIN
JIM OSTEN
WAYNE SMITH

PROOFREADER: JULIUS ROSENSTEIN

COVER ART: JOHN ZELEZNIK

INTERIOR ARTISTS: MICHAEL WILSON
WAYNE BREAUX JR.
SCOTT JOHNSON
WILL WARREN
KEVIN LONG
KEVIN SIEMBIEDA

INTERIOR LOGO DESIGNS: COMICRAFT FONTS

MAPS: WAYNE BREAUX JR.

PALLADIUM BOOKS ON-LINE:
WWW.PALLADIUMBOOKS.COM

ART DIRECTION ‡ KEYLINING: KEVIN SIEMBIEDA

TYPOGRAPHY: MARYANN SIEMBIEDA

BASED ON THE RPG RULES, MAGIC, CHARACTERS, WORLDS,
CONCEPTS AND MEGEVERSE® CREATED BY KEVIN SIEMBIEDA.

SPECIAL THANKS TO WAYNE BREAUX JR WHO HELPED GATHER AND WRITE THE SOURCE MATERIAL AND WROTE SOME TRULY GREAT ADVENTURES (ROUGHLY HALF THIS BOOK!). TO BILL COFFIN FOR PITCHING IN ON THE EDITING AND TO MIKE, SCOTT, MARYANN, ALEX, STEVE, WAYNE S., JIM, JULIUS, RYAN AND ALL THE SUPERHUMANS AT PALLADIUM BOOKS.

– KEVIN SIEMBIEDA, 1999

Contents

The Mighty Breaux Speaks	7	Random Complication Table	74
Questions & Answers	8	Examples of Random Adventures	75
S.D.C. & Healing for Altered Characters	10	World Hot Spots	75
HU2 Errata	16	Guerrilla Hot Spots	77
House Rules	17	Adventures	78
Campaign Info, Suggestions & Ideas	19	Animal Hijacks, Hijinks, & Murder	78
Creating & Running Villains	19	Dr. Paterson Quinn, Vigilante	82
Quick Roll Villains	21	Trouble Down the Line	84
Adding Color to Non-Player Characters	22	The Enlightenment Wizards' Guild	85
Type 1 Criminal: Thug	22	Bella, Wizardess (Enlightenment)	86
Type 2 Criminal: Criminal Elite	23	The Society of the Mystic Font	88
Type 3 Criminal: Supervillains	24	Vadimar (of the Mystic Font)	90
Normal People	24	Castaway Aliens	91
Vigilantes & The Law	27	Loose in the City	92
Crimes & Punishment	29	The Creature	94
Playing in Character	30	The Sorcerer, Gary Pender	96
The Role of Alignments	30	Mad Machine	98
Evil is Evil	32	DeISeN (Robot Killer)	99
The Fallen, But Repentant Hero	35	The Mother of the Monster	101
Alignments for Anti-Heroes & Vigilantes	36	Not a Star in the Sky	104
The Anarchist Anti-Hero	38	Whisked Away	104
Working for the Authorities	39	Into the Darkness	105
Joining the Police Force	39	Hound	109
Military Special Super-Operations	40	Shock to the System	111
Government Superhuman Task Force	42	A Giant Diversion	112
Restrictions & Conditions	42	A-11 Assault Robot	113
The Value of Secret Identities	43	Bradley Marks, Robot Pilot	117
Public Heroes	45	Jailhouse Rock	119
Heroes in the Workplace	45	The Villains	121
Rules for Sleep Deprivation	45	Star Bright	134
Jobs & Salaries	47	Rattle	136
Skill List with Base Percentages	49	Roll	137
Rampage & Super-Brawling Rules	51	Shake	138
Combat Penalties & Modifiers for Rampage	51	Angels to Some	140
The Super-Brawl	53	Isis	141
Combat Penalties & Modifiers for Brawling	53	Mithra	143
Special Combat Attacks for Brawling & Rampages	54	A Frightful Experience	144
Power Attacks	54	Dr. Fright	147
Normal Throwing	54	With Friends Like These	150
Power Lift & Throw	55	Culture Shock	151
Improvised Power Club	55	Amanon Tatumain	152
Power Slam/Body Block	56	The Scarab of Emonhep	155
Running Power Leap	56	Bak Matuk	156
Running Power Ram	57	Planetfall	158
Conventional Power Punch	57	Adventure Timeline	159
Two-Handed Super-Power Punch	57	The Riathenor	160
Two-Handed Power Hold	57	Morphos	165
Two-Handed Power Pull	57	Spaceships	169
Two-Handed Power Tear	58	Holy Talking Animals!	170
Creating & Running Adventures	58	Sherrie Mouse	171
Thinking Quick	60	Into the Maw of Science	173
Player Knowledge	62	Giant Rats	177
Dice & Chance	63	The DSR Team	177
Creating Adventures	65	G.M. Reference Material	178
Character Histories	65	Expanded Spell List	178
Character Goals	67	New Wizard Spell Descriptions	180
Attribute Considerations	68	Level One	180
Cliffhanger Endings are Good	69	Level Two	181
Some Ideas for Campaign Settings	69	Level Three	181
Advanced Technology (Future Earth)	69	Level Four	182
Random Inspiration	71	Level Five	183
Random Villain Table	73	Level Six	185
Random Crime Table	73	Level Seven	187
Random Motive Table	74	Level Eight	188
		Level Nine	190

Level Ten	192
Level Eleven	193
Level Twelve	194
Level Thirteen	195
Level Fourteen	196
Level Fifteen	196
Spells of Legend	197
Ancient Weapons & Equipment	199
Ninja Equipment	199
Other Ancient Weapons	201
Underwater Equipment & Vehicles	202
Optional Rules for Modern Weapons	203
Penetration Values	204
Tissue Damage Ratings	205
Special Cartridge Types	206
Expanded Firearms Listing	208
Automatic Pistols	209
Machine-Pistols	210
Sub-Machineguns	211
Rifles	211
Shotguns	212
Machineguns	214
Heavy Weapons	214
Energy Weapons	215
Military Vehicles	216
Helicopters	219

Quick Find

Ancient Weapons & Equipment	199
Crimes & Punishment	29
G.M. Reference Material	178
Gov't Restrictions & Conditions	42
Guns/Firearms	208
Helicopters	219
Jobs & Salaries	47
Power Attacks	54
Quick Roll Villains	21
Rampage & Super-Brawling Rules	51
Random Adventure Tables	71
Random Villain Table	73
Scarab of Emonhep	155
Sleep Deprivation Rules	45
Spell Descriptions (new)	180
Spell List (expanded)	178

Villains Info & Tables

Crimes & Punishments	29
Evil is Evil	32
Random Adventure Tables	71
Random Age Table	21
Random Complication Table	74
Random Crime Table	73
Random Criminal Record Table	21
Random Gender Table	21
Random Level of Experience Table	21
Random Motive Table	74
Random Ties to Criminal Organization	21
Random Villain Table	73
Reference: Jobs & Salaries	47
Reference: Skill List with Base Percentages	49
Reference: Sleep Deprivation	45
Reference: Spell Lists (new)	178
Reference: Weapons	208
Type 1 Criminal: Thug	22

Type 2 Criminal: Criminal Elite	23
Type 3 Criminal: Supervillains	24
Typical Modern Human	25
World Hot Spots	75

Maps

Bank Vault (Shock to the System)	112
Courthouse (Shock to the System)	116
Enlightenment Guild House	85
Gentech Facility	174 & 175
Kukubai Testing Facility (Dr. Fright)	146
Museum (With Friends Like These)	150
Nightland's Federal Building	108
Paterson Farm	81
Planetfall: Map of Activity	160
S.C.R.E.T. Prison (Shock to the System)	120
Society of the Mystic Font	88

NPC Villains

A-11 Assault Robot	113
Amanon Tatumain	152
Aquatic Beast (Planetfall alien)	167
Brakkana (Planetfall alien)	163
Castaway Aliens (Quick Stats)	91
Creature, The (Pender's Monster)	94
Dark Breeze (Planetfall Alien)	166
Dragon Claw	125
DeISeN (Mad Machine)	99
Demoneess Trio (Quick Stats)	91
DSR Team (Gentech)	177
Dr. Fright	147
Dr. Paterson Quinn, Vigilante	82
Electron	128
Gary Pender (Sorcerer)	96
Giant Rats (Gentech)	177
Hound (Nightlands)	109
Isis	141
Magma-Monster	95
Marks, Bradley (Robot Pilot)	117
Mithra	143
Morphos (Planetfall alien)	164
Point Blank	129
Rattle	136
Riathenor (Planetfall alien)	160
Riproar	126
Roll	137
Shadow Dragon	132
Shake	138
Shock	121
TerVal1	24
Vadimar (Wizard)	90

NPC Heroes

Bak Matuk, Eternal Champion	156
Bella, Wizardess (Enlightenment)	86
Dr. Rosalin Proctor (DeISeN)	102
Enlightenment Wizards' Guild	85
Sherrie, The Mouse (Gentech)	171



THE MIGHTY BREAUX SPEAKS

Welcome to the **Heroes Unlimited G.M.'s Guide**. Originally, this was supposed to be a small collection of adventures for **Heroes Unlimited™, 2nd Edition**, but as it always seems to be, things got bigger than intended (twice as big).

Although the revised **Heroes Unlimited™** is a good deal larger than its predecessor, there was still a lot of new material that Kevin wanted in and old material that got cut from the original edition during the revision process. So much, in fact, that once we decided to incorporate it with the adventures I had written, we realized that we had something much more than an adventure sourcebook. And so the *HU2 G.M. Guide* was born.

Most of the new or optional rules and source material is by Kevin Siembieda, with contribution by me and others. This first part of the book has all sorts of things the Game Master (G.M.), and, to a slightly lesser degree, *players* might need or want to consider in establishing a world full of superbeings. Stuff like how to use alignment, optional “brawling” combat rules, working for Government Agencies, secret identities, crime and punishment, tips and suggestions for running adventures and building campaigns, plus Quick Roll Villains and more.

The adventures herein come from my own **Heroes Unlimited™** campaigns which have provided a wonderful backdrop for my player group allowing for their characters to grow and develop. Not just in their skills and powers, but in their personality and outlook as well. Over the course of their adventures, our characters made lasting friendships and long-lived antagonisms. Celebrated great victories and endured crushing defeats. As we brought these fictional heroes to life, they became like old friends, and we looked forward to their escapades and exploits like a favorite weekly television series or monthly comic book.

Every role-playing group has its own style, and not everybody can experience the joys of a big, long-term campaign like mine. I just hope you can get as much use and enjoyment out of playing through the adventures in this sourcebook as I did creating it and running my own group of friends.

Enjoy, and good gaming!

— Wayne Breaux, Jr., 1999

ROLE-PLAYING GAMES... THERE JUST ISN'T ANYTHING LIKE THEM

Two of the great things about *role-playing games* is their incredible flexibility and the personal experience. Every Game Master and player who plays the exact same game, will see and play it a little bit differently.

For each and every game group the experience will be unique, different and personal. Which makes the role-playing game experience all the more exciting and special.

Think about it, there is truly nothing like it. The exact same Game Master can try to run the exact same adventure with ten different groups of people, and all ten groups will walk away with a different experience, even though the goals and outcome were all basically the same. Sometimes it will be only a little different, other times dramatically different. I know this from my days of running *tournament sessions* at gaming conventions and the old Detroit Gaming Center. For those of you how have never played — or more accurately — “run” the same adventure for several different groups of players, it is fun and amazing.

How can this happen? Why does it occur? Because each group of **players** represents a different mix of people. Even if the tournament adventure has the same pre-rolled characters, the same villains, NPCs, goals and sequence of events, the *people* are different. Each individual player brings to the table his and her own unique outlook, experience and style of playing. You see, each and every player is a living, thinking “human game component.” Not a pre-programmed computer chip, but a living, breathing, thinking person with all your own unique personal beliefs, experiences (in and outside of gaming), abilities, emotions and personality. All elements that quietly, often invisibly, leaks into the game and mingles with the other “human game components.” That’s why computer games will never capture and simulate true role-playing, because it can’t capture the human spirit and emotions. And it is that human element that makes role-playing a fabulous, unique and personal experience.

I’ve heard some folks say that role-playing games are *NOT* a “team sport,” but it is, even when an individual player takes his character off on his own or back-stabs a fictional teammate, because it all becomes part of a much bigger story. A story that *each player* contributes too through the actions of his fictional character.

I have gamed with small and large groups (as many as 32). Inevitably, one or two players are kind of quiet and reserved. Often, even when the opportunity presents itself, the quiet gamer tends to shy away from jumping into the action or making a bold move. Sometimes this is because the human player is shy or inexperienced, other times because he’s tired or happens to be a more subtle and subdued player. Without fail, there comes a point in the game when that quiet, almost forgotten player, steps forward and has his character say or do something that is helpful, selfless, brilliant, profound or saves another character. Sometimes the character just lucks out with a decisive action and a high roll. Other times it is clear that the quiet player and his unassuming character has indeed been paying attention (and has certainly seen himself as part of the group and the action), because he just stepped forward and did something that made the other players cheer or become hushed in amazement. Big or small, that action made the character important, or clever, or brave, even if

it was for an instant. And it all becomes part of the larger story.

When the gaming ends for that night, and the highlights of the adventure is recounted, somebody is likely to say, “Man, I couldn’t believe it when Ed’s character just leaped out of nowhere and hammered that bad guy! If not for him ...” Ah, the stuff of fantasy, epic adventure, and the human imagination.

Each new adventure, whether it concludes in a single night or is spread over several, builds a history and continuity among the players and their group of fictional characters. For the players, it helps to create the feeling of camaraderie and epic scope. And everybody loves being part of something epic and magical. ‘Nuff said.

— Kevin Siembieda, 1999

QUESTIONS & ANSWERS

By Kevin Siembieda & Wayne Breaux Jr.

When writing an RPG, the author carefully tries to think every possibility and present the clearest most comprehensive explanation or description before setting it down in black and white. Somehow, in your own mind, you think you are careful to explain things thoroughly, and whatever you might miss will be caught by one of three editors. Yet, there is often some detail or typo that is missed, or an obscure situation one fails to consider. The notes, and comments on the following pages are an attempt to correct, clarify, and/or define some of the things we missed in the first or second printing of **Heroes Unlimited™**, **Second Edition**, or “HU2,” for short. Some are answers to commonly asked questions, others are things we’ve caught ourselves or that have been pointed out to us by one help gamer or another. Hopefully, this takes care of most of the bugs, but we’re sure we’ve missed some still lurking around in that 352 page tome, so please forgive any little but nagging oversights you may still encounter.

Why does HU2™ have three different kinds of Super-Strength and what’s the difference between them?

There are a number of variations on this question. The power levels of the heroes has been beefed up from the old edition of HU, and the separate levels of strength are to provide *diversity*. If you put six people in a room, they will all have a different level of Physical Strength. In trying to keep traditional, comic book superhumans in mind, I thought it appropriate to have a range of superhuman strength as well, and not just varied by the P.S. attribute number. It seemed logical to have characters with **Extraordinary Physical Strength** (clearly greater than a top athlete and powerful enough to lift a small to mid-sized automobiles over his head), **Superhuman Strength** (measurably stronger than the guy with Extraordinary P.S. and powerful enough to lift a small truck to an empty bus over his head), and **Supernatural Strength** (godly strength,

capable of lifting a bus filled with passengers, semi-truck or even a tank over his head! The ability to lift 20,000 pounds/9000 kg/10 tons is a *puny* supernatural character). This just seems to fit the history of comic book heroes where you have strong heros, Super-Strong heroes and supernaturally strong characters, sometimes literally gods (like Thor, Hercules, Wonder Woman, and god-like characters such as Superman and the Hulk).

Now the absolute power-mongers out there might argue that these strength levels could have been even higher, particularly for supernatural characters. True, but that would have made most of the heroes powerhouses that could flatten villains left and right, and this *is* supposed to be a thinking man’s game. As always, if you feel you can handle half or more of your player characters running around with Supernatural P.S., then by all means help yourself. Heck, even increase the amount one can carry to 500 or 1000 x the P.S. number and lift 1000 or 2,000 or even 10,000 x P.S. However, you are likely to find that playing such superpowerful heavyweights quickly becomes a drag. The power level of the villain and threats simply have to be increased to make an adventure half-ways exciting and dramatically limits the type of adventures one can play. Trust us, it is not worth doing (except maybe as a one-shot or short-lived campaign). We felt as a whole that such supremely powerful superbeings detracted from the heart of this game and adjusted accordingly.

Possible P.S. adjustments. Role-playing games are very personal. If you are uncertain about or disagree with some aspect of the game feel free to make a “house rule” and modify it. Here are some suggestions for modifying the Super-Strength in HU2.

If you are one of those rare individuals who prefers less powerful characters, you might feel uncomfortable with the considerable bonuses given by the different Super-P.S. abilities which typically offer huge bonuses to be added to the usual P.S. attribute role and bonuses from physical skills. If so, then adjust them *down* accordingly. Perhaps, don’t roll the usual 3D6 for the P.S. attribute and/or do not include skill bonuses. Instead, use the “bonuses” listed under the Super-Strength power as the base P.S. rating.

One may also want to give *Superhuman P.S.* an extra 1D6 bonus damage die to all hand to hand attacks and use of melee weapons (club, sword, etc.) to further differentiate it from Extraordinary P.S.; that makes sense and is not overpowering. Wayne Breaux uses this one (and I like it).

Overlapping P.S. abilities: Some Power Categories gives the character the *equivalent of* one of the Super-Strengths (Extraordinary, Superhuman, or Supernatural), but unless it says that it includes all the bonuses, the character does *not* have that super ability, just the same level of raw strength.

Thus, if it says, *the equivalent of Superhuman Strength*, the P.S. attribute is **not** increased, unless it states otherwise in the description, and then only the bonus amount listed there is used, do **not** also add the P.S. bonus of the Superhuman Strength “power.” The character does not

get the +30+2D6 also added to his P.S. attribute, nor does he get the +2 to pull punch or fatigues at one tenth normal (fatigues at the usual rate, or as indicated under the power that grants him *equivalent P.S.*). However, he can lift and carry weight at the increased level and enjoys whatever damage bonus might be applicable.

The Superhuman Strength power provided by **Enchanted Weapons of Order** would also provide only increased lifting and carrying, *no* bonuses to P.S., but if it is taken twice, the Supernatural punching damage would apply. Wording in these case is not uniform, so the Game Master may have to use some discretion, also note that if more than one Super-Strength *equivalent* is given, use the better of the two, do not combine them.

One specific case of overlapping Super-Strengths occurs when a character has both *Alter Physical Structure Metal* and *Supernatural Strength*. In this case, the Supernatural Strength would replace the Superhuman P.S. normally bestowed by the Altering power. In this case, the 20+2D4 P.S. bonus for *Alter Physical Structure Metal* would be ignored and replaced by the 30+2D6 bonus from *Supernatural Strength*. In other situations where Super-Strengths would seem to combine, simply use the better of the two instead.

Another related question is, why do we need three different Super-Strengths (or Flight powers or Altering powers, etc.)? Won't everyone just pick the most powerful one? Not really, no. It depends on what kind of character concept each individual player has in mind and how the other players in the group games. Most people roll *randomly* instead of just "selecting" their super abilities, thus negating the argument concerning weaker versions of the same powers. Along these lines, if the character has a combination of Minor and Major abilities, he may be satisfied with the Minor Ability of Extraordinary P.S. or Superhuman P.S., so if *Supernatural Strength* is rolled as a major power, that individual is likely to prefer to "re-roll" for a different Major Super Ability.

It also has a lot to do with variety, personal preference and playing style. Some players adore powerhouse characters with incredible physical abilities because they love to brawl, punch it out with villains and smash things. That's cool, if that's what you want — most groups can use a big, hulking bruiser on their team. Yet, by the same token, there is going to be a player who prefers to be subtle and mysterious, or clever and tricky, etc. Such a player could care less about having Super-Strength or powers of destruction for his or her character. Besides, don't you think that a game where each character has 7-10 Major Super Abilities would be rather boring?

Note: Only one type of Super-Strength can be possessed by any character. One can not select two or all three and add their bonuses together. Re-roll if more than one Super-Strength turns up when randomly determining super abilities; the G.M. may allow the player to keep the P.S. he prefers and discard/ignore the other. Before we leave this discussion of P.S., the strength of a mystically bestowed character when *transformed* should be Superhuman (supernatural only if the Game Master allows).

Rifts conversion note: Any hero with super P.S., whether Extraordinary, Superhuman, or Supernatural, has "supernatural strength" in Rifts (see **Rifts@ Conversion Book One** for other specifics). Those with the "equivalent" Super-Strength of any type will only have Supernatural P.S. in Rifts@ *if* the source of the increased P.S. is magical or superhuman. Specifically, the P.S. of physical training characters would not be supernatural in Rifts, but the P.S. bestowed mystically would be supernatural.

Why isn't the Mega-Hero even more powerful? Why can't the tech classes be Mega-Heroes and what about psionic and magic Mega-Heroes?

Referring once more to the heart of **Heroes Unlimited™**, the characters are supposed to *think* as much as act in order to be heroes in this game. The Mega-Hero is substantially more powerful than other Power Categories in the game, but it isn't anywhere near the league of the most powerful of comic book characters. What is the fun of dropping a building on a villain? There's going to be very little interaction and drama if you can solve problems that way, and by the end of a year, the characters will have to move to another city. One that still has buildings in it to drop on people. Mega-heros provide the chance to play heroes much grander than even the usual larger than life heroes the game is named after. If you the G.M. or players, feel they need beefing up, then you are welcome to do so, just be careful and think about what you might be missing by doing so.

The text in the Mega-Hero section of HU2 says to "avoid" the tech classes like Hardware, Bionics, and Robotics, but it does not say they can't be Mega-Heroes. Handling Mega-Heroes in the first place is largely up to the Game Master, so he or she should decide on any *extra* boosts in power for these other classes. Some ideas are doubling the damage of their weaponry, adding extra S.D.C., having a high A.R., combat bonuses from their machines instead of the character itself, or a gizmo that simulates a super ability (like a force field or teleportation), and/or boosting budgets by 50-75% (or more).

Likewise, Magical and Psionic Mega-Heroes could see their I.S.P. or P.P.E. increased 50% to doubled, and/or they can have a large number of spells or psionic power selections. Just be careful to keep them on par with the other (albeit already beefed up) Mega-Player characters.

Why can't my character make multiples of himself and each one use Shapechange (and any number of other power combinations)?

Just as care was taken to keep the Mega-Hero from being too overwhelmingly powerful (notice it is an *optional* Power Category), so to were certain parameters set down to keep other aspects of the game from getting potentially out of hand. With the increased number of super abilities available to some Power Categories and the inclusion of rules for combining some super abilities, the idea of some possible combinations were staggering. The rule on page 74 of HU2 was designed to check this. If you feel comfortable letting characters use certain super abilities in tan-

dem, go right ahead and ignore the list of powers that will not work together.

Of course there are obvious pairings that do not work simultaneously, such as Alter Physical Structure Water and Fire, but if you feel comfortable with a character using Growth one action then Altering his structure to liquid on the next — Viola! Instant water behemoth! — or someone with six Multiple selves all altering their structure to metal, then help yourself and more power to ya. Again, just be careful about game balance, and whatever the Game Master says, is the way things will be. Like it or not. Be cool.



Exactly what bonuses are cumulative for Dodging and Automatic Dodging? Exactly what dodge bonuses apply all the time?

Well, basically all bonuses in Palladium are cumulative, but there are a few exceptions. First of all, dodge and automatic dodge are two separate tactics and use separate bonuses. Both types of dodge are augmented (separately) by any P.P. bonuses, but only the normal dodge is augmented by the level advancement bonuses from hand to hand skills and other possible skill bonuses. Thus, someone with *Extraordinary P.P.* (the super ability) of 24 and 2nd level Hand to Hand: Expert would (not counting other possible bonuses) have a dodge bonus of +8 and an automatic dodge bonus of +5. Normally, the dodge bonuses will be higher than the automatic dodge bonuses and the player will have to decide in a given situation if he wishes to auto-dodge and save his attack or default to the higher bonuses and go for a better dice roll.

As to the second question, certain dodge bonuses are specific to situations. For example, the dodge bonuses for the *Flight Powers* are used when the character is flying in the air. Likewise, *Super Speed* bonuses from extraordinary or sonic speed do not apply when the character is flying because these are ground speed based bonuses.

Likewise, weapon bonuses only apply when using that specific kind of weapon.

Attribute bonuses are universal, and are Hand to Hand bonuses apply to all combat actions, for the character is assumed to practice combat with all of his special abilities, including flight, underwater, etc.

And while we are talking about specific circumstances, P.S. bonuses should not be applied to speed based attacks, for it is the momentum that does the damage, not the muscle (see the specific Speed and Flight powers for bonuses based on speed attacks).

What happens if someone hides behind a car to use it as cover in combat? Those trying to attack a well protected character must do one of the following: a) go around to his exposed side, b) flush him out into the open, or c) required to make “called shots” — 12 or higher on the attack to hit any *exposed* area of the hiding character, assuming that part of him is exposed (periodically, when he pops his head up to shoot or see what’s going on, etc.). Such damage would come off of the character’s armor, S.D.C. or Hit Points as is appropriate (unless the G.M. is using optional “hit locations,” in which case it comes off of the specific body part).

There is an option “d” — the attacker can try to shoot *through* the cover/protective barrier (car, wall, door, etc.). In this case, the G.M. must be allowing the Penetration Value (P.V.) described in the *Optional Rules for Modern Weapons* section of this book. To shoot *through* a barrier, the weapon and bullet or energy it is firing must have a Penetration Value higher than the object the character is hiding behind. In some cases, the shooter may have to waste a several blasts/shots/attacks to punch through it (if possible at all) and the penetrating attacks that final hit will lose *half* of its damage potential by going through the cover.

Note: Super abilities are generally considered to have a Penetration Value (P.V.) of 5 or 6 for shooting through things, though they will damage anything they hit regardless of A.R., provided the strike roll is high enough to do damage, see the A.R. rules. The “Super-Blasts” from *Super Energy Expulsion* and the *Supernatural Strength* “power punch” (counts as two attacks) have a P.V. of 9! The “power punch” of Superhuman Strength has a P.V. of 7, and the “power punch” of Extraordinary P.S. has a P.V. of 6.

What happens to the damage taken by some whose form is *altered* (metal, stone, fire, etc.) when they change back to human form?

All damage is taken off of the Altered Form’s S.D.C. first, then the character’s Hit Points (remember, Alter Physical Structure: Metal and Stone replace the character’s S.D.C. instead of adding to it, but others do not, so situations will vary).

When an *Alter Physical Structure: Metal or Stone* character shifts back to human form, he will have all of his human S.D.C. intact, because the S.D.C. in the altered form was used in its place.

If one of these “altered” characters loses all the S.D.C. available from his metal or stone form, the damage goes directly to his Hit Points. When the character changes back to human, he will still have Hit Point damage and may even be in a coma if the damage is severe enough to

warrant it (down to a few H.P.). However, all of his human S.D.C. will be in place, so he'll look much better than he feels.

This is different for other Altering powers that merely *adds* to S.D.C. In these cases, the damage is first deducted from the bonus S.D.C. made available from the altered state, then from the character's personal S.D.C. reserve, and then from Hit Points. Thus, if a villain with 75 S.D.C. in human form uses the power of *Copy Physical Structure* to mimic a hard metal, that power provides an additional +400 to S.D.C. (as opposed to S.D.C. replacement). So that's 400+75 = 475 S.D.C. total points available in this metal form. If the villain suffers 300 points of damage while in his copied metal form, he feels fine when the turns back into human form, and has all of his Hit Points and the 75 S.D.C. Why, because damage was removed from the extra S.D.C. of the *copied* metal. His natural 75 S.D.C. were never touched.

On the other hand, if the villain had taken 460 points of damage, he'd only have 15 S.D.C. points left to his personal S.D.C., but all of his Hit Points. If he took 480 point of damage the extra S.D.C. and his personal S.D.C. would wiped out and five points would be deducted from his Hit Points. once they changed back. Likewise, someone whose altered S.D.C. Note that metal and stone S.D.C. gained from Copy Physical Structure is different than the S.D.C. from metal or stone Alter Physical Structure (two different types of transformations).

In either case, a fun option is to have the character revert to his normal, human form when the extra S.D.C. (or the replaced S.D.C. and 80% to 90% of his H.P. are gone). It presents a sense of drama, danger and urgency.

Can I switch over to another Power Category to get super abilities or combat skills for my Wizard? Multiple Power Categories in HU2 are *not* recommended and impractical. Unlike most of the other Palladium RPGs, the Power Categories are a kind of cross between O.C.C.s and R.C.C.s, making them rather exclusive. The new Second Edition provides some minor basis for crossing over, such as psionics on the super abilities table, but generally complete changes cross overs are not possible.

One specific example is magic. Crossing Magic with any of the other Power Categories is just not feasible. Switching to bionics would remove all magical (or psionic) abilities if more than half the body was replaced. Likewise, the character could not cast spells from inside a robot or exoskeleton (same with psionics). Certainly Special Training characters could change over to Bionics or undergo Experimentation, but such characters are basically a variant of the Mega-Hero and should be handled in the same vein. Furthermore, once super-empowered, such a character is like to let his Hardware or Special Training skill fall to the way side as he focuses on his new abilities. In fact, we could see a change of orientation under such a circumstance, quicker than *dual* Power Categories — i.e. keep basic skills (minus any special bonuses from the old Power Category) and use the mutant or bionic powers of the *new* Power Category.

Remember too, that there is an inherent assumption that each Power Category requires that the character spends years studying and mastering his "powers." It is through these years of study, practice and a certain amount of experience — or learning to handle one or more unique psionic or super abilities — that the character has gotten to the point of being first level in that particular Power Category and (finally) ready for a life of adventure. All the bonuses, skills, special abilities, orientation, and other aspects are predicated on this. One is not likely to have spent years (perhaps decades) in developing a comprehensive expertise in a particular Power Category to forsake it later. And that is fundamentally what each Power Category is, an area of special expertise. Of course, for some characters like aliens, mutants and psychics, their natural powers have helped them to select their particular Power Category for them, but in a game context, it is the player who *chooses* the Category. Once it is selected it can not be changed to, or combined with, a different one. The player should give his selection a good amount of thought before making it.

All this being said, if the Game Master really, really wants to have incredibly powerful Mega-characters, and honestly feels comfortable with such powerful characters, feel free to adapt the Multiple O.C.C. rules found in other Palladium games to this situation. However, this is taking HU2 out of its design parameters and we do not recommend it. Typically, only power-crazed gamers and munchkins want such an overpowering character. And such characters *will* imbalance the game and cause chronic problems. Remember, you've been warned.

What would happen if someone used Control Elemental Force: Earth/Magnetism/Hydrokinesis on an Alter Physical Structure Stone/Metal/Liquid opponent?

Exact effects are left up to the individual Game Master, but at the least, such powers should be able to force the corresponding Altered form back to human form (saving throw against 16 or higher applies) for 1D4 melee rounds or more. Damage (1D6 per level or so) is also highly possible, especially with Rend Earth, Repel Metal, and Boil Water, respectively.

Likewise, manipulation of the Altered form (again, a saving throw is applicable) such as freezing the water of a liquid character, may cause discomfort and pain (at least minor damage) as well as other logical effects — i.e. a frozen liquid can not slide through metal bars or under a door, and is likely to move slower than when in liquid form. Of course, that's assuming the liquified superbeing can even be frozen. (**G.M. Note:** This is your call. Maybe the liquid form can't freeze because he is moving, or due to some anomaly connected to his flesh and blood alter ego. And if it can be frozen, what happens when the character turns back to human? Does the ice/frozen water just fall away, or is the flesh and blood body [which is more vulnerable to cold damage and suffocation] encased in ice? And so on.)

There are also likely circumstances where it will be prudent for the Physically Altered juggernaut to forsake his superhuman body. This can apply when turning human will allow the character to slip through small openings, hide, shed oversized restrains (tied up, ice manacles, being encase in stone, etc.). The idea, as always, is to think and be imaginative.

What exactly does a character get from choosing a second area of Hardware expertise? Basically everything from each of the two categories. Generate everything else just as you would for a single classed Hardware character, determine attributes and roll education and drop one skill program, then pick the “primary” Hardware Category and note the cost for attaining a second category. The “second” Hardware Category gives the character all the special skills, abilities, budgets, and equipment for both categories, though the budgets should each be spent separately and can not be combined (except for workshop budgets). While setting all this up, remember to apply the penalties listed for taking a “second” Hardware Category.

Why would anyone play a Latent Psionic when the Natural Psionic is so much more powerful?

Because you may not have any choice. The psionic section actually starts on page 189 of HU2, the last line of which tells the reader that only those who choose or roll psionics on the Random Power Category Table can be a Natural Psychic. Thus, if the character is an alien psychic, you *must* be a Latent Psionic (not a Natural). The only way aliens can be Natural psionics is if they belong to one of the specific alien races with heightened psi-powers that are detailed in **Aliens Unlimited™ 2nd Edition**, a sourcebook for HU2.

Additionally, personal taste becomes a factor. Some players (believe it or not) don't want to play the most powerful character possible, and may have a personal reason and rationale why their character has a lesser range of abilities. This is especially true for the *Game Master*. Remember, the G.M. uses these same rules as a foundation for creating Non-Player Characters (NPCs). In this context, there are a number of reasons why the G.M. may not want to create the most powerful character possible.

Does the instant regeneration under Healing Factor use up an attack? Or is it truly “Instant”?

Questions like this are typically up to the Game Master, but in this instance, the power is only usable twice per day and could easily be used “instantly” to heal damage without forfeiting an attack and not unbalance game play. Other abilities may not be so instantaneous or limited and should be given reasonable consideration by the G.M. Just remember when you make such rulings to be consistent throughout your game play. Keeping a list of your rulings is an excellent idea, especially if they differ from others in your group that may Game Master the same game.

What exactly is the deal with Bionics and Robotics and the eight attributes?

Okay. First the obvious ones out of the way. *Robot Pilots* and *cyborgs* of partial reconstruction or minor augmentation roll the eight attributes as normal, though the cyborg may have specific limbs with artificially enhanced attributes.

Even **Full Conversion Cyborgs** will retain their I.Q., M.E., and M.A., no matter how much their physical body is altered and augmented with machine parts. P.E. is also rolled, but only to determine coma length (it can be skipped to speed things up). The character then has to purchase bionic P.S., P.P., and Spd normally. P.B. can be the characters own (roll normally) or can be artificial and sculpted to any rating up to 20. The lack of flesh and blood removes any physical S.D.C. the human body may have had, but the completely artificial body that replaces it will provide a new base of 50 (which can be increased and armored). Further, the limited flesh and blood, and extensive artificial shell of the cyborg makes it hard for magic and psionics to affect him (+5 to save vs magic and +3 vs psionics). Other details are given in the Bionics section of *Heroes Unlimited*.

Robots without human pilots are pre-programmed machines with an equivalent I.Q. and, depending on the robot's purpose and design features, may have a human equivalent to M.A. and P.B. — remember, humans who create a robot may want it to be attractive and appealing (just as a car is attractive), or comfortable to work with (like designs for computers and other “machines”). P.S., P.P., P.B. (use the bionic prices and limits), and Spd attributes are mechanical and must be purchased. The robot's knowledge will be based on computer programs. The mental attributes are randomly generated because despite its flawless stores of knowledge, the artificial intelligence will be limited by the interaction of its various programs and their subroutines which will form the mental process of the robot. Vast knowledge does not necessarily translate into applicable intelligence, nor does a lack of emotions ensure a strong mental state. Uncertainty will often plague the logical processes of the robot, especially when dealing with humans.

Androids and Robots with Artificial Intelligence, or a transferred human intelligence will have (at least an equivalent) I.Q., M.A. and M.E.! The physical attributes: P.S., P.P., P.B. (use the bionic prices and limits), and Spd must be purchased. Typically, machines have no P.E. or M.E., their physical and mental endurance is inexhaustible. However, *advanced Artificial Intelligences (IAs)* will have or develop structures within their logic that emulates the human mental state, and thus allows for a human-like roll of 3D6 for M.A. and M.E. (a small bonus for one or both of 1D4 may be applicable depending on the design parameters). This also opens the AI robot up to weakness, failure and a certain degree of emotion and subjective thought. They can learn to better themselves through learning, so even though robots are immune to non-physical psionics and similar magics, those with advanced AIs and/or transferred intelligences are likely to be



susceptible to psionics and magic attacks that create illusions and effects emotions and, possibly, thought (G.M.'s call. Affecting a robot's thoughts seems very unlikely, and even saving against illusory and emotion affecting magic and psionics should probably have a bonus of at least +2 to save, if not more like +5).

Robots with human psyches/transferred intelligence inside them obviously have the human's I.Q., M.A. and M.E., and is vulnerable to magic and psionic attacks that affect the mind, but at +5 to save. Of course, they are immune to the same things as normal robots (heat, cold, gases, poison, etc.). Their flesh and blood has been physically replaced by mechanical limbs, micro-chips and other robot systems so they do not have a physical "human" to be affected by mind powers or magic manipulate (i.e. bio-manipulation, paralysis, sickness, and similar things that would attack, hurt or incapacitate a flesh and blood body). **Note:** Telemechanics and Mechano-Link allows telepathic-like communication with a transferred intelligence inside a robot body to the extent of their ranges, but no other control can be exerted over this free, human mind or the mechanical body it controls. These two machine powers can also be used to diagnose and pinpoint mechanical problems in the robot body, useful in effecting repairs (if allowed by the mind in command), but nothing more.

Why are the mineral and insect aliens in Aliens Unlimited™ so darn powerful?

First and foremost, because the added resistances and/or powers just made sense. If you have a walking rock, its not unlike a machine or robot and many things will not affect it. Furthermore, it is *solid rock* and many more things will have a difficult time damaging it. In a similar vein, normal insects are notable hard to kill (proportional to their size, of course) and human-sized ones (or larger) are proportionately tough and hard to kill. It was also obvious that they should retain some of the natural traits and abilities of the bugs they evolved from. So, justification aside, what do you do if you feel these (or any other) alien race is too powerful? Simply alter the character to your taste. It is easy enough to reduce a high A.R. and/or massive S.D.C. to bring down the aliens' power level, and/or ignore or modify any special powers, resistances and immunities. In the alternative, one could drop the natural A.R. (even to zero) and keep the sizable S.D.C. along with the special immunities, or just drop specific resistances/immunities that seem troubling in regard to game balance. Whatever works for you as Game Master is fine. However, also remember that in an isolated situation when only to a handful of (evil?) aliens are encountered by the player "group," it may be appropriate to have an opponent that is significantly more powerful (this way the "group" can gang-up on one or two aliens or the heroes may have to double team their alien opponents, two on one).

Note: **Aliens Unlimited™** is also one of the first non-Rifts sourcebooks designed to be used with both its parent game **Heroes Unlimited™** and **Rifts®** on a galactic scale.

With Second Edition Heroes Unlimited™ I can not seem to make a decent android or exoskeleton. What happened?

Some of the prices on robot components were significantly increased, namely power sources and reinforced frames, without a matching increase in budgets. If one is trying to make any robot with an advanced Artificial Intelligence, reinforced frame and a micro-fusion power source, by the time you get all that along with the body, unaugmented arms and basic legs (your base robot), your down by \$11.1 million dollars. A quick look at the budget table and you immediately can see the predicament.

To remedy this, the Game Master can either add a 1D4 million dollars to each of the budgets, or reduce the cost of fusion power sources by a 1.5 dollars.

If a character doesn't have Gymnastics or Acrobatics for maintain balance and someone does a knock-down or body flip, does he automatically fall?

That is entirely up to the Game Master, but with the inclusion of knockdown rules in **Heroes Unlimited™**, it might be a good idea to convert the maintain balance percentage into a combat dice roll using a D20. The roll is automatic, similar to a parry, and does not use up an attack. Most people would receive no bonuses for the roll beyond any P.P. bonuses, but Hand to Hand: Basic and Expert provide a +1, while martial arts adds +2. This hand to hand bonus increases by +1 at levels 6 and 12. Gymnastics and Acrobatics add an additional +2 each with further bonuses of +1 at levels 4, 8, 12, and 15.

If the balance roll exceeds the strike roll to knock down, the person takes the damage and staggers, but manages to remain on his feet. Failing the roll and falling means the character is -2 to all rolls until he spends an action getting to his feet.

What is the damage from an entire magazine in a burst for guns with 16-29 rounds? Exactly how many attacks does the entire magazine burst use up for both automatic and semi-automatic weapons?

Firearms that are capable of burst fire and have 16-29 rounds of ammunition should do x3 damage on a long burst and x7 damage on an entire clip.

The rules for semi-automatic burst fire are correct for the number of attacks required. A normal burst that uses the *entire clip* takes up three melee attacks/actions (about 7 seconds), other bursts use one attack. Bursts from a semi-automatic weapon use two attacks for a long burst and three attacks for an entire clip.

Vehicle combat only gives the vehicle one dodge roll per melee round, so what happens if someone is shooting at the vehicle from a sidewalk?

The Game Master should use the single vehicle dodge roll as the dodge for all attacks directed at it for that *entire melee round* from non-vehicle sources (attacks from other vehicles are covered by the vehicle combat rules). He should also keep in mind that depending on the terrain

and the speed of the vehicle, the moving vehicle will only be a target for a limited number of seconds and possible attacks. A vehicle going 45 mph (72 km) will cover 990 feet (302 m) per melee round, which will put it out of most pistol ranges in a single attack (approximately 195 ft/60 m per melee action/few seconds).

Aliens can now be Hardware and Physical Training, but both of those Power Categories require you to drop a skill program. How does this work?

Simply reduce the number of skills said to be available to the Alien on HU2 page 95, under *Step 5: Determining Education & Skills*, by half. With Physical Training, make sure to drop any and all physical skills provided under Step 5 and only use those available under the Power Category.

In the case of the "Alien" Hardware: Analytical Genius, character sees his/her/its skills under Step 5 reduced by half, and does not get the additional Skill Program of choice and does not get the usual Secondary Skills provided under the Hardware: Analytical Power Category (which is no big loss if you compare their given skills to the education table for other aliens).

What if my character randomly rolls Alter Limbs, but has a low P.E. and ends up with a paltry bunch of Hit Points?

Hey, super abilities vary from individual to individual. In this case the character can only fire a limited number of rounds from *Mechanical Body Weapons* before he weakens himself too much. This adds a certain amount of drama and an inherent weaken that' ideal for role-playing. Use it. After all, the character can still make melee weapons (sword, ax, mace, etc.) from his limbs, as well as shield arms, and stretch limbs, and so he's not helpless. Only his *Mechanical Body Weapons* and *Locomotion & Limbs* abilities are limited by a low P.E. Those are my, Kevin Siembieda's, thoughts.

On the other hand, Wayne Breaux offers a nifty optional rules modification that works for me:

Super abilities are supposed to be different from magic and psionics in that they are usually (but not always) innate abilities of the superbeing and, consequently, do not cost anything to activate or use.

In the case of Alter Limbs, the Game Master can simply convert the Hit Point cost of specific abilities into a "per level duration of use" rather than "burn up" H.P. and hurt the superbeing. Thus, locomotion would be limited to two minutes per level of the character's experience per hour (and Hit Point are not affected or used in any way). Firing bullets from a Mechanical Body Weapon could be limited to 12 rounds of ammo per level of experience per each hour. This means a 3rd level character could use locomotion for six minutes and hour and shoot 36 bullets per hour. Any further or different adjustments would be left up to the Game Master.

What if a character has their weight increased by the Weight Manipulation ability, but they are not strong enough to carry the equivalent of the increased weight? Are they immobilized as the book says?

No, they are not *immobilized*, but they are somewhat impaired. Anyone who can "carry" (not lift) the increased weight applied to them, is not immobilized until the weight exceeds their carrying capacity. However, even at half their carrying capacity the character will see his speed and jumping range are reduced by half, combat bonuses (initiative, strike, parry, dodge, disarm, bonuses) are reduced by half, and the victim loses one melee attack — you try running at full tilt or jumping full distance carrying even a 50 lbs (22.8 kg) weight. It's not happening!

Those characters with Extraordinary, Superhuman and Supernatural P.S. will suffer the same effect, but it will take a whole lot more weight to slow them down. Furthermore, characters with *Supernatural P.S.* will retain two melee actions and 25% of their speed (no combat bonuses) even under crushing weight (i.e. an amount that exceed their carrying capacity)! They are simply too strong. When faced with such opponents, the weight manipulator might find weightlessness more effective in hindering them.

I have trouble coming up with names. Any suggestions?

Coming up with a name (especially a cool or appropriate) can be difficult, especially when needed on the spot in the middle of a game (i.e., the G.M. improvised an NPC and now needs a name). There are a lot of solutions to coming up with names — scan a magazine or newspaper, the credits of a movie, and so on. Grabbing familiar names like favorite authors, artists, actors and mixing the names to come up with something different is another possibility. Depending on the setting (different country, alien world, etc.) one may want exotic or foreign sounding names. This will certainly add to the atmosphere and authenticity of the setting. You're not likely to have Buffy or Biff, or even Jason or Kevin in the Middle East, Russia, or China; you get the idea. A good, quick place to find names suitable for other countries is an Atlas or travel guide. By the way, you can get out of date travel guide books at Bargain Book Stores for \$2-\$6 dollars. The problem with travel guides, is that they are usually limited to that one specific country so they aren't a good source for "global" names. An atlas, however, spans the globe. Atlas' that include a brief history or geographic information may include the mention of key military and political figures, but more importantly the names of the many places are ideal for last names (used either as they appear, or modified to have the "sound" of the language and people — who cares if it's authentic if it sounds right).

What's in a name? Instant personality. Jake the Snake, Doctor Doom, The Terminator, The Shadow, and countless others are instantly evocative because they convey an image and/or emotion the minute we hear them. this is true of dramatic or scary names to corny and silly ones, they all send a message to the person who hears the

name. Try to remember and use this when creating names, particularly for superbeings and major characters.

For naming ordinary people and the human identity of superbeings, keep on hand a book of baby names (you can find a number of them in any book store, and they are inexpensive too). Don't laugh! For G.M.s, it can be an invaluable tool for naming the dozen or so NPCs that might pop up during the course of an adventure. Some name books will even include the literal meaning or origin of certain names, which can provide you with ideas and instant personality to spice up even the most drab NPC.

Here's how it works. Open the book to any page and point to a name without really looking. If you don't like it or don't think it fits, look at the two above it or below it, then do the same for a last name (which may have to be modified to sound right as a surname). While doing this, try taking the meanings of each name as personality traits for the NPC (or as a source of a possible last name).

For example, let's take a simple Homicide Detective the heroes want to chat with, but who hasn't been completely developed for the adventure. Flipping open our handy name book, we come up with a first name of Sheila (which means "dim-sighted" or "musical one") and a last name of Grant ("great one"). Now we combine the names and meanings to give this cop some character.

Going by the "dim-sighted" meaning of Sheila, let's say she's insensitive to others (she can't "see" their feelings) and has an air of superiority (being a "great one"). Thus we get Detective Sheila Grant, Second Precinct — an arrogant and sometimes condescending person with little regard for the feelings and needs of others. She is good at her job, and has no patience with those who try to help her or tell her how to do it. (If I need any of her stats, I generate just what I need for the situation and jot it down. For Hit Points and S.D.C., quick approximations, if needed, should suffice. See quick roll Villains for guidelines.) Once the adventure is over, one can finish the rest of her stats and make whatever notes are needed for future reference in case the NPC makes another appearance ("she reluctantly helped the characters on the missing children adventure").

Another handy trick for have basic characters available at a moment's notice, is to keep a pre-generated NPC list with names, key stats (all others are average 8 or 9), brief notes and short personality descriptions. Their full stats are kept elsewhere, but the list is always handy for quick reference. With this, a G.M. can create spur-of-the-moment NPCs like Sheila without disrupting the flow of a game. And, it lets you know instantly how to play the character, so they will be more than just a "talking head" for the heroes to interact with when they surprise you with a visit to old friends, casual acquaintances, or total strangers you never expected them to encounter during the adventure.

HU2™ Errata

Note: Most of these have been corrected starting with the "2nd printing" of *Heroes Unlimited™, Second Edition*. They are included for the thousands of gamers who have the First Edition or to reiterate or expand upon a clarification.

- **The Achilles' Heel for Mega-Heroes.** Page 183, 1st printing of HU2 has an omission: **11-20 Vulnerability to Magic**, should also include a penalty of -1D4+1 to save vs magic of all kind (-2 to -5 to save vs magic spells, circles, potions, illusions, etc.).

- **The Latent Psychic.** Page 190 of the 1st printing, gives the Latent Psionic the same base I.S.P. as the Natural or Master Psionic. This is a mistake (editors have been appropriately tortured). It should read as follows:

The Latent Psychic's base I.S.P. is his Mental Endurance (M.E.) attribute number x2, plus the roll of 1D4x10. The total is the character's starting level of raw mental power.

As the psychic grows in experience, so too does his I.S.P., adding 1D6+1 I.S.P. per each level of experience, starting with level one.

- **The Natural or Master Psionic.** Page 190 of the 1st printing of HU2, also short changes the Master Psionic, and should read as follows:

The Master Psychic's base I.S.P. is his Mental Endurance (M.E.) attribute number x2, plus the roll of 2D6x10 (not 1D6x10 as listed). The total is the character's starting level of raw mental power.

- **Super Ability: Alter Physical Structure: Fire.** HU2, 1st printing, page 243, omissions from #7. Other Abilities & Bonuses should include:

- Fiery Aura adds 50 to S.D.C. while in the fire form.

- Maximum altitude for characters who can fly when transformed in to flame is 2000 feet (610 m).

- **Super Ability: Manipulate Kinetic Energy.** HU2, 1st printing, page 235; damage corrections.

Large Axes (battle, chopping types) should be 3D6 (not 2D6).

Throwing Axes should be 2D4 damage (not 1D6).

Bola should be 2D4 damage (not 1D6).

Discus, Metal should be 2D6 damage (not 1D6).

Discus, Metal with Blade Edges should be 3D6 damage (not 2D6).

and ... *Throwing Sticks* have a range of 120 feet (36.6 m)

- **Super Ability: Super-Energy Expulsion (caught by Dave Craver).** Page 293 second from the last paragraph in that description. It states, *The character only takes damage from all other forms of energy ...*

It should read:

The character only takes *half* damage from all other forms of energy, including sonic blasts/sonic shock waves, fire, heat, and radiation.

- **Clarification: Recovery of S.D.C. for Alter Physical Structure Powers.** The extra S.D.C. provided by *any* of the Alter Physical Structure abilities recovers much more quickly than normal S.D.C.; roughly 4D6 S.D.C. points per every 10 minutes!

This impressive rate of recovery applies only to those special S.D.C. gained from the altered state (metal, rock, ice, etc.). Ordinary physical S.D.C. and Hit Points recover at the normal rate for humans.

- **Clarification concerning “Skills and Skill Programs” for the Military Specialist (caught by Jillian Moisdon).** The original description on page 45 of HU2 1st & 2nd printing is poorly worded, it should read:

4. The Military Specialist is the only educational level that automatically gets the *Espionage Skill Program*, but can select Espionage training a second time to get five Espionage skills of choice.

- **Clarification concerning “Skills and Skill Programs” for the Advanced Piloting and “Weapons Engineer” (also questioned by Jillian Moisdon).**

The question is really, who or what is a “Weapon’s Engineer?” Sorry about the use of this broad and unclear term. A Weapon’s Engineer would be any character who specializes in the building of weapons and military armaments. This can include any Hardware Characters, and could also include a Supersoldier (experiment), Special Ops character, spy or alien who was the appropriate skills.

To make things simple, a Weapons Engineer “Skill Program” would include:

- Basic & Advanced Math
- Electrical Engineer
- Mechanical Engineer
- Weapons Engineer
- Armorer (field)

- **Clarification about Randomly Generating Heroes both with Psionic and Super Abilities.**

Players who use *The Number & Category of Super Abilities* random table on page 226 of HU2, can roll up superbeings who have both a super ability and psionic powers (86-00). However, it fails to explain what level of psionic power this dual character possesses. The answer is that such characters are considered to be *Latent Psychics*, and must spend I.S.P. to use their psionic ability(s). Since these superbeings also possess one or more super abilities, the character does *not* gain new psionic abilities like the normal Latent Psychic as he or she grows in experience (unless the G.M. thinks it is okay, and allows it, but be careful not to imbalance the game). However, I.S.P. does increase, at a rate of 1D6+1 I.S.P. per each level of experience, starting with level one. Base (starting) I.S.P. is the M.E. number, plus the roll of 1D6x10.

House Rules

By Wayne Breaux Jr. & Kevin Siembieda

No matter how good a game may be, inevitably, gamers will tweak and alter it to reflect their personal preferences and to make up for what they may see as weaknesses, holes or flaws in the game system. That’s okay. Role-playing games are written for “you,” the gamer, to use and enjoy as you see fit. Once it goes out to the stores, it passes from our hands into yours, figuratively as well as literally. The rules are set in print, not stone, so after you get the book we have little influence on how you may interpret, use, enforce or modify the rules. We appreciate your faith and adherence to our opinions, but always remember that if something does not make sense to you, or you are pretty sure something is a mistake or oversight, then change it to something that works.

Likewise, if you need a *new rule* for something that isn’t covered, make it up! You can certainly use the vast amount of material already presented as a guideline to adapt most any situation. The same holds true of creating new super abilities, magic and gizmos.

The only danger is unbalancing the framework of the game. Game Masters and Players alike, must be careful that their “house rules” and “additions” don’t imbalance the game. To this end, the players should always “suggest” and “ask” the G.M. if they can modify or add something new. If the Game Master says no, that’s the end of the story. Please don’t whimper, groan or badger the G.M. into letting you use it. This only makes things uncomfortable for the Game Master and may cause tension and hard feelings in the player group. Players should try to defer to the Game Master’s discretion and feelings in these matters, especially if he or she is a good, likeable and experienced G.M. Why? Because it is crucial that the G.M. understands and feels comfortable with the elements of the game to run a good one. My experience has been that most Game Masters ignore or won’t allow things they personally find to be silly, difficult to play/control/use, and/or unbalancing to the game.

Many of the rules in **Heroes Unlimited™, Second Edition** were set-up and written to preserve some measure of balance, pacing and performance. Not a universal balance on the Power Categories — some powers and types of heroes are vastly more powerful than others, but each is unique and fun in his own way, and all have some advantage depending on the situation and circumstance. “House rules” sometimes create an imbalance and problems for the G.M., often for the players too. As the guy or gal orchestrating these story-fests of rollicking adventure, it is the Game Master who must assess and evaluate any new super abilities, characters, and rules. First and foremost, the G.M. must ascertain whether the “new” material works for him/her and fits with the game that has been established. If the G.M. doesn’t like or want it, it shouldn’t be played. Even modification that *seem* okay at first, may need to be modified or used moderately later, or needs a

trial test adventure before it is made into an unofficial “House Rule.”

For example, the Game Masters may find the inclusion of *Mega-Heroes* to be too disruptive or limits the types of stories he or she wants to tell, so they are not allowed. On the other hand, a different Game Master may feel that he or she can handle (or prefers) the extra power level of such player characters, and may even offer modified rules to accommodate even more powerful, truly, god-like superhumans. If the G.M. and the majority of players are all in favor of this, and they can pull it off, go for it. However, if the player’s would like it, but the Game Master declines, it is probably because the G.M. doesn’t feel comfortable with it. Don’t argue and try to cajole the poor soul into it, defer to the G.M.’s wishes. Most of the time a good G.M. allows or disallows something because he or she doesn’t like or can’t handle it. This is an important consideration, because a confused and unhappy G.M. will only result in a lousy game experience.

Now, this does not mean players shouldn’t make *suggestions* and offer new ideas, but only to respect the G.M.’s decision, especially if you can tell he or she is trying to be fair and you usually have fun playing in his/her game sessions.

As for Game Masters, you should try to enforce the rules that keep things in hand, and simply do not allow characters, modified rules and new things that you can not handle.

Trying new ideas

While it is fun to experiment, try new things and introduce new, original ideas of your own, if it doesn’t work, don’t feel obligated to keep it. Heck, Wayne Breaux and I, Kevin Siembieda, experiment and try different things all the time. From new weapons and gizmos to new super abilities and rules. Sometimes we are amazed at our own genius when things work out astonishing well. Other times we feel like idiots because something works like garbage, is stupid, slows down the game, imbalances the characters or is a constant source of trouble or annoyance (either to the G.M. or the players, or both). When this happens, you just have to bite the bullet and get rid of the problem. It’s as simple as that. And yes it is fair. After all, you are the G.M. and you must go with what works for you in weaving the adventures — the players have to understand that or find a new G.M.

Now, the problem for the G.M. is, “how to get rid of it, especially if one or more of the players’ love it. Hey, get real, a some players are selfish (and/or obnoxious), and don’t care if the game is imbalanced by something in their character’s possession. Nor do they care if other players feel left out as long as they are in the limelight and having fun. However, a good G.M. does care. The idea behind role-playing games is for a *group* of players to work *together* to have fun and build an exciting story. If the majority aren’t having fun, something is wrong and it needs to be fixed.

There are lots of ways for a Game Master to correct his mistakes. Working it’s removal into the story is one ap-

proach. Items can be lost, stolen, destroyed, etc. This can even be done dramatically — does the “hero” go to save his powerful and favorite “thingamajig,” or does he sacrifice it to save lives or to stop the villain from escaping? Super abilities can be lost or mutated (ideally in some dramatic, and perhaps traumatic way). **Remember G.M.s’**, you are weaving a continuing *series* of stories with returning player characters and returning antagonists all tied together with interweaving plots and sub-plots. Consequently, the loss of one’s favorite thingamajig or power(s), etc. will add to the continuing story and depth of the character(s). For example, being mutated or losing some helpful, powerful, irreplaceable item can be a reason to dislike, hate, or seek revenge on a particular Non-Player Character/villain (“That’s the scum bag who destroyed my Mystic Sword of Kalamazoo! He’s going to pay!”). Getting rid of a not so clever new item or power can *add* to the story if done right.

On the other hand, sometimes there no way around it other than to stand up and say to your group, “I don’t know about you guys, but I don’t think this works and I’m taking it out of the game (or changing it, etc.). This is especially easy if you play with a good group of understanding and cooperative gamers. It can be more difficult if the group is composed of acquaintances or people you barely know (like some game sessions at conventions or stores that offer gaming space and times). Or if one of the players is a loudmouth jerk (seems like most game groups has one annoying or troublesome player). Hey, explain your reasons and stick to your decision whether the players like it or not. Running the game has to work and be fun for the G.M. or it will suffer.

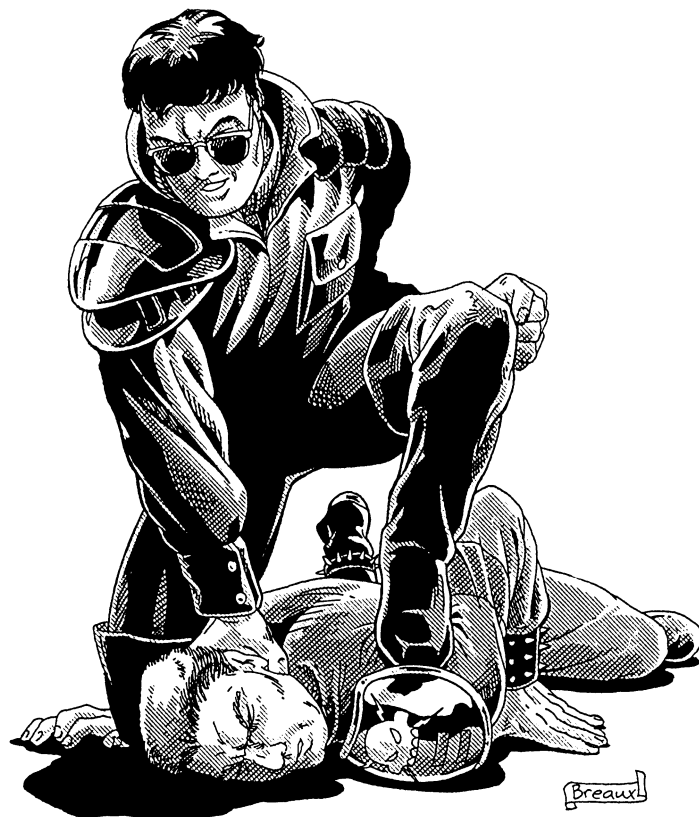

CAMPAIGN INFORMATION, SUGGESTIONS & IDEAS

Creating & Running Villains

By Kevin Siembieda

If nothing else, the villain is the Game Master's character. Most Non-Player Characters (NPCs) will be rather mundane and unimpressive normal people, but the villain is the centerpiece of a scene, if not an entire adventure. When he or she makes an entrance, all of the players' attention will focus on what the villain says and does. That is why villains should be noteworthy, if not downright memorable. Unless the player "heroes" go around killing off villains left and right (not a very heroic habit, by the way), they just might run into these villains again (and perhaps, again and again). Return villains and arch-foes can be great fun. The look on the faces of the players when they recognize the nervous twitch of the bionic nemesis before them as that of Rico the thug who was buried by a falling building way back in the third adventure is priceless. Villains should grow just like player characters. They might not advance in experience as rapidly (or at all) as player characters, but they can most assuredly gain experience levels, new knowledge and skills, acquire new gizmos (and even powers) and new allies that can keep them on par with any group of heroes.

Miscreant villains are the most common. They have little or no regard for others and are typically self-serving — doing whatever it takes to make them happy and/or to get what they want. These villains can sometimes be reasoned with and, as long as they get their fair share out of it, they can work reasonably well in groups, although backstabbing and skimming is also common.

Aberrant villains seem to be increasingly common in movies and comic books. These opponents are often the masterminds of criminal organizations. Their personal code of honor makes them somewhat trustworthy (from a hero's point of view), but it also makes them very hard to read until the hero can get a feel for their twisted code.

Once that's done, however, Aberrant villains can be counted on to behave in certain ways very reliably, a trait enterprising heroes can use to their advantage.

Playing Diabolic villains can be difficult because most of us are not cold-hearted, callous bastards. Diabolic villains have no respect or regard for anyone other than themselves. Few of them bluff, even when holding a gun to the head of a child, and they never hesitate to carry out a threat that they really mean. While all Diabolic characters are not cold-blooded, psychotic killers and maniacs, this is the group with the sadistic torturer and merciless assassin who enjoys killing.

Note: Villains are not always cold and obviously evil menaces. Sometimes, there are other reasons for their "crimes" that are not vile, but misguided or extreme. Revenge often is a factor for such somewhat sympathetic villains. In fact, the only real difference between these villains and some vigilantes is the extent of their methods. Vigilantes generally respect life and have a strong, personal sense of justice, which is why they seek to deal out or find justice for the wrongs they see around them. They are often the avengers of the people, and while they may break laws to deliver their brand of justice, they rarely kill, and never for pleasure. Villains on the other hand, will do whatever it takes to get what they want and will threaten, hurt or kill anybody who gets in their way. Many are obsessed with power and/or revenge, and commonly resort to murder and other extreme measures to get it. Depending on the character's personality and the extent of their obsessions and desires, some villains may be short-lived, having no desire to perform other crimes once their goals are achieved.

The G.M. should endeavor to create memorable villains by using description, personality, and flaws. Each major villain will be like a player character for the G.M., and should be played that way. Have the villain's think and plan. They are not just props for the hero to beat up on. It is perfectly alright for villains to surrender, flee, or be captured. Once the heroes turn the villain over to the authorities, they have practically no way of keeping an eye on them or have any say as to the bond pending trial or the cretin's eventual punishment "under the law." A villain might be freed on bond or the charges dismissed due to lack of hard evidence or illegal procedure/violation of their rights. Captured villains can escape, be broken out of prison by accomplices and allies, or serve their time and be released only to return to a life of crime (or revenge) to create more havoc.

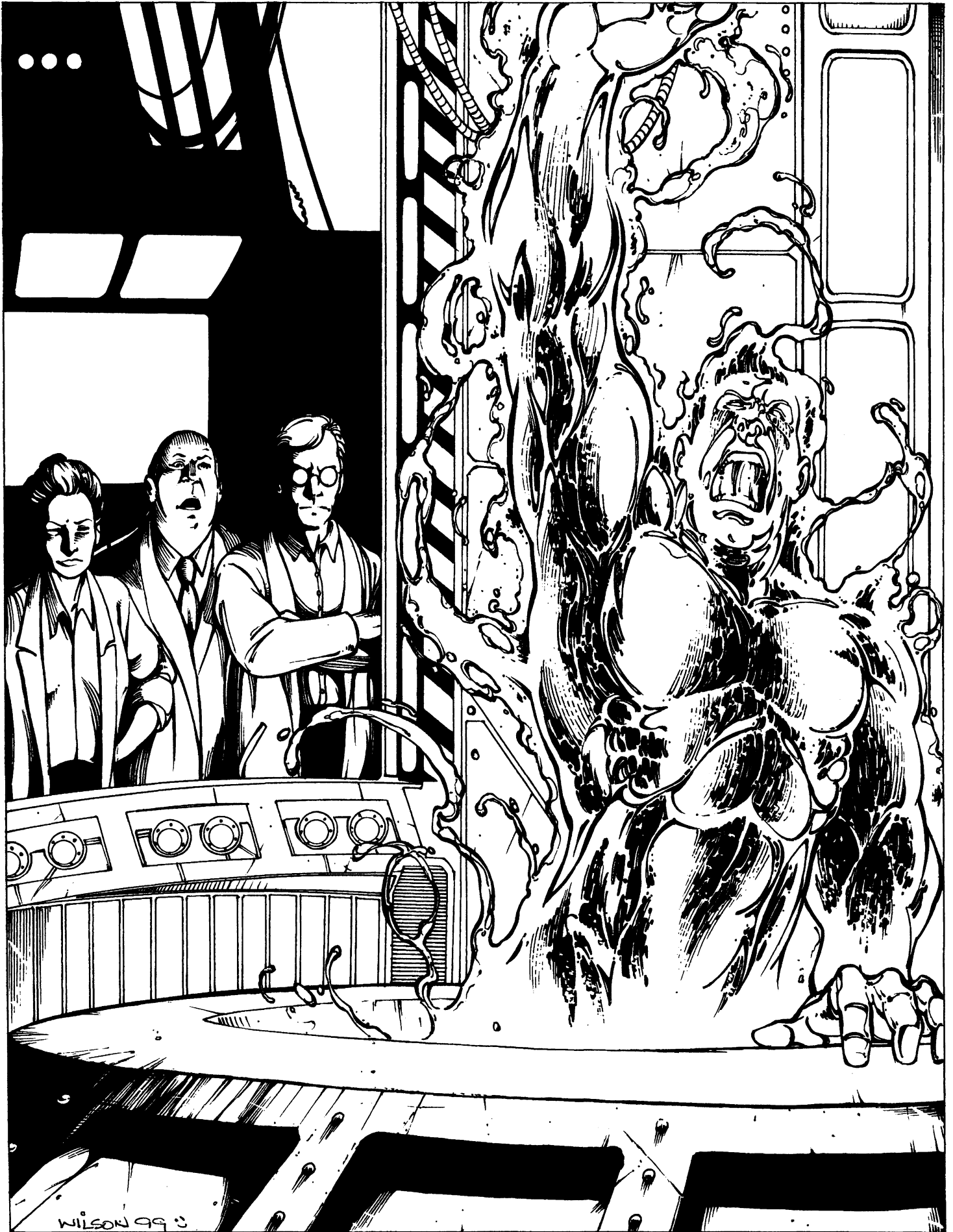

WILSON 99 3

The only exception to creating colorful and memorable villains is their henchmen. Often these characters are little more than soldiers in the powerful villain's army or criminal network. As such, they don't need to have in-depth personalities, histories or character and are often broad stereotypes.

Quick Roll Villains

Not every villain will be a major character. Supervillains and crimelords will have their chief lieutenants, henchmen, and thugs. Most of these are secondary characters and the G.M. will need to roll 'em up quickly. Even in a small group, all 8-12 men in a supervillain's gang are not necessarily going to have strong personalities or quirks, but these minor villains can also be quickly generated using the random tables below.

The following tables are designed to build a *quick frame* for general and common stereotypes of villains. They are especially helpful in banging out a reasonably interesting character on the fly. If the G.M. likes he or she can flesh out the character later, as much as desired, or not at all.

Gender

01-65%: Male
66-00%: Female

Level of Experience

Average Villain/Thug

01-20%: First
21-40%: Second
41-60%: Third
61-80%: Fourth
81-00%: Fifth or higher (G.M.'s choice)

Elite Villain

01-20%: Fifth
21-40%: Sixth
41-60%: Seventh
61-80%: Eighth
81-00%: Ninth or higher (G.M.'s choice)

Age

Average Villain/Thug

01-15%: 17
16-30%: 20
31-45%: 24
46-65%: 28
66-85%: 35
86-00%: 40

Elite Villain

01-15%: 20
16-30%: 28
31-45%: 32
46-65%: 38
66-85%: 40
86-00%: 50

Alignment

01-20%: Aberrant
21-60%: Miscreant
61-80%: Diabolic
81-00%: Anarchist

Criminal Record

01-30%: None! Either new to crime or has never been caught.

31-40%: A few misdemeanors, nothing too serious.

41-49%: A few misdemeanors and 1D4 felonies. Time served.

50-69%: Criminal record a mile long (2D6 felonies) and numerous misdemeanors, but not currently wanted on any charge.

70-84%: Long criminal record (2D4+6 felonies); currently wanted on 1D6 felony charges.

85-00%: Suspected on several felony charges, but no evidence to make them stick.

Weapons & Equipment

The average human criminal is usually equipped with conventional weapons such as pistols, rifles, sub-machineguns, knives, blackjacks, billy clubs, and so on. Surveillance and listening equipment are fairly easy to get if one knows who to talk to and has the money (cash) to pay for it, and presumably a crook has that knowledge. Automobiles are also of standard, commercial make and cost.

More exotic items, such as heavy weapons (bazookas, grenades, etc.), energy weapons, bionics, robotics and other high-tech creations are restricted to hoodlums with ties to criminal organizations and/or supervillains with the knowledge or access to such technology and resources. Only they can afford to manufacture or hijack advanced or "super-technology."

Ties to Criminal Organizations

Lone-wolf villains and powerful "gangs" of (3-8) superbeings are always fun to play. In the comics, villain "groups" represent the greatest danger and some of the best story lines. While these superteams can be independent and self-reliant, they may just as likely be sponsored, even created by a criminal organization. Likewise, a life of crime being what it is, lone-wolf operatives and supervillain gangs are likely to "contract" themselves out as hit men, enforcers, bodyguards, mercenaries and special agents for hire to criminal organizations. They need to put food on the table and money in their pockets too, and wealthy organizations looking for people with their "unique talents" can pay handsomely for their services.

For quick reference, here is a random table of some of the more common and general criminal operations and organizations villains and heroes are likely to encounter in the **Heroes Unlimited™** universe. When designing an adventure, feel free to choose from the list below, or roll randomly.

For each selection, there is a range of size options reflecting the organization's degree of power and influence. Unless otherwise noted, the dollar amounts given represent the group's total cash on hand and resources (manpower, weapons, vehicles, and equipment). In general, a group's monthly income is equal to about one-third of its total cash on hand. For more detailed information and

rules for creating “organizations” see **Villains Unlimited™**.

01-17%: Criminal Mercenary Organization: Employs assassins, mercenaries and ex-military personnel for free-lance demolitions, assassination, kidnapping, enforcing, investigation/surveillance, and other covert operations. Also may engage in extortion and smuggling of any kind — arms, drugs, precious gems, people, etc.

01-29%: Local: \$1D6x5 million in cash and resources.

30-70%: National: \$3D6x10 million.

71-00%: International: \$3D6x100 million.

18-34%: Criminal Super-Fence: A big-time operation specializing in the acquisition and liquidation of “hot” goods. To call this a smuggling operation doesn’t give due credit to the scope of this organization’s abilities. It won’t bother with small stuff like stereos or automobiles. Rather, it moves precious stones, gold, art treasures, high technology (components and plans), intellectual property (stolen software or scientific data), engages in money laundering, and occasionally heavy weapons and military secrets (nuclear weapons, robotics, etc.). It services millionaires, corporations, other criminal organizations, and corrupt governments.

01-40%: Local: \$2D6x10 million worth of merchandise available.

41-80%: National: \$3D6x100 million.

81-00%: International: \$6D6 billion.

35-55%: Crimelord: Conducts all manner of illegal activity, such as illegal drug smuggling and sales, protection rackets, illegal gambling, prostitution, auto-theft (chop shops are big money), arson (insurance fraud also is big money), gun running, counterfeiting, or any other criminal enterprise that will turn a good buck on a large scale.

01-33%: Local: \$2D4x100 million in cash flow and resources.

34-66%: National: 1D4x10 billion.

67-00%: International: 3D4x10 billion.

56-70%: Drug Syndicate: An organization devoted to importing, processing, distributing and selling controlled substances (heroin, coke, crack, etc.). May have several drug-processing factories and warehouses. Roll to determine size of organization.

01-40%: Local: \$4D6x10 million in annual “sales.”

41-80%: National: \$3D6 billion.

81-00%: International: \$2D4x10 billion.

71-84%: Secret Organization: A power-crazed organization bent on world domination (like S.P.E.C.T.R.E. from the old James Bond movies). They own and operate numerous legitimate and criminal businesses that fund a variety of secret, subversive, terrorist, and/or paramilitary actions against humanity. It is well funded and employs high technology, bionics, robotics and supervillains in addition to conventional soldiers and equipment.

01-40%: Local: \$1D6x100 million in cash and resources.

41-84%: National: \$1D6x10 billion.

85-00%: International: \$4D6x10 billion.

85-00%: Criminal Scientific: A secret research and development organization that supplies high-tech weapons, vehicles and equipment to other criminal organizations, billionaires, corrupt corporations, and supervillains, as well as foreign and rogue governments. May experiment in creating and/or recruiting superhumans, cyborgs, and robots.

01-40%: Local: \$1D4x100 million in cash and resources.

41-84%: National: \$1D6x10 billion.

85-00%: International: \$3D6x10 billion.

Adding color to Non-Player Characters

NPCs are the characters of the G.M. There will be dozens of them, so most will never have the depth and details of most player characters, except for the occasional major villain, but each should be as unique as possible. The life of a campaign quite often comes from the vitality of its NPCs. Often, I don’t even have to identify who is speaking when I shift NPCs. The players can tell by speech patterns, mannerisms, choice of words/slang, and sometimes (when I’m on a roll and in the mood) by their actual voice and accents. It helps to create an atmosphere, a sense of uniqueness and personality, and helps a scene flow much more smoothly (and entertainingly). Of course, other NPCs have little impact on the game and may not even get to use dialogue, such as the clerk at the store who hands the character his package.

Type 1 Criminal: Thug

I.Q.: 6+1D6

P.S.: 10+1D6

P.P.: 8+1D6

All remaining attributes: Are either 6+1D6 or give them the “average” stat of 9, plus the attribute bonus noted under each type.

Base S.D.C.: 20 plus bonus noted under each type and possible physical skill bonuses.

Education Level and Skills: Pick one of the four Thug categories or roll percentile dice to determine skills.

01-20%: Thug: Thief

Hand to Hand: Basic

Literacy (+30%)

Basic Math (+30%)

Basic Electronics (+15%)

Basic Mechanics (+10%)

Pick Pocket (+20%)

Pick Locks (+20%)

Prowl (+15%)

Pilot Automobile or Motorcycle (+10%).

Climbing (+15%)

W.P. Knife or Revolver.

Choose 3 Rogue or Technical Skills (+5%).

Choose 3 Secondary Skills (no bonuses).

Bonus: +4 to P.P. attribute.

Bonus S.D.C.: +15

21-40%: Thug: Enforcer/Bodyguard

Hand to Hand: Expert or Martial Arts (pick one).

Literacy (+20%)

Basic Math (+10%)

Running
 Body Building
 Boxing or Wrestling (pick one)
 Pilot Automobile (+10%)
 Pilot Truck (+10%)
 W.P. Revolver
 Choose 2 W.P. (any)
 Choose 1 Physical Skill.
 Choose 2 Rogue Skills (+5%).
 Choose 3 Secondary Skills (no bonuses).
 Bonus: +7 to P.S. attribute.
 Bonus S.D.C.: +30

41-60%: Thug: Punk/Two-Bit Hood

Hand to Hand: Basic
 Basic Math
 Not literate unless taken as a Technical Skill.
 Pilot Automobile or Motorcycle (+10%).
 Running
 W.P. Knife
 W.P. Chain
 W.P. One of Choice.
 Choose 2 Rogue Skills (+10%).
 Choose 2 Technical or Piloting Skills (+5%).
 Choose 4 Secondary Skills (no bonuses).
 Bonus: +6 to Spd. attribute.
 Bonus S.D.C.: +15

61-80% Getaway Man/Driver

Hand to Hand: Basic
 Literacy (+20%)
 Basic Math
 Running
 Automotive Mechanics (+20%)
 Pilot Automobile (+20%)
 Pilot Race Car (+15%)
 Pilot Motorcycle (+12%)
 Pilot: One skill of Choice.
 Choose 2 Technical or Rogue Skills.
 W.P. One of Choice.
 Choose 4 Secondary Skills (no bonuses).
 Bonus: +2 to P.P. attribute.
 Bonus S.D.C.: +10

81-00%: Thug: Con Man

Hand to Hand: Basic
 Literacy (98%)
 Basic Math (+20%)
 Concealment (+20%)
 Forgery (+20%)
 Disguise (+10%)
 Palming (+15%)
 Pick Pocket (+10%)
 Basic Electronics (+10%)
 Computer Operation (+15%)
 W.P. One of Choice.
 Choose 2 Technical or Communications Skills.
 Choose 4 Secondary Skills (no bonuses).
 Bonus: +4 to I.Q. attribute.
 Bonus S.D.C.: +5

Criminal Type 2: Criminal Elite

I.Q.: 13+1D6

M.E.: 12+1D6

P.S.: 12+1D6

P.P.: 10+1D6

All remaining attributes: Are either 9+1D6 or give them the slightly "better than average" stat of 12, plus the attribute bonus noted under each type.

Base S.D.C.: 20 plus bonus noted under each type and possible physical skill bonuses.

Education Level and Skills: Pick one of the four Elite categories or roll percentile dice.

01-25%: Elite: Boss

Hand to Hand: Expert or Martial Arts (pick one)
 Literacy (98%)
 Basic & Advanced Math (+30%)
 Business & Finance (+30%)
 Law (+20%)
 Choose 2 Technical Skills (+20%).
 Choose 2 Espionage or Rogue Skills (+10%).
 Choose 3 Physical Skills.
 Choose 3 W.P. (any).
 Choose 6 Secondary Skills (no bonuses).
 Bonus: +5 to mental attribute of choice (I.Q., M.E. or M.A.). Bonus S.D.C. +30

26-50%: Elite: Military Mercenary

Hand to Hand: Expert or Martial Arts (pick one).
 Literacy (92%)
 Basic Math (+20%)
 Choose 3 Military Skills of choice (+20%).
 Choose 3 Espionage Skills of choice (+15%).
 Choose 3 Physical (+5%) or Piloting Skills (+15%).
 Choose 3 W.P.
 Choose 4 Secondary Skills (no bonuses).
 Bonus: +6 to P.E. or P.S. attribute.
 Bonus S.D.C.: 40

51-75%: Elite: Hit Man

Hand to Hand: Assassin
 Literacy (98%)
 Basic Math (+30%)
 Detect Ambush (+10%)
 Disguise (+20%)
 Prowl (+10%)
 Tracking (+20%)
 Sniper
 W.P. Bolt Action Rifle
 W.P. Automatic Pistol
 Choose 3 additional W.P.
 Choose 3 Military or Espionage Skills (+10%)
 Choose 2 Rogue Skills (+6%).
 Choose 1 Physical Skill.
 Choose 3 Secondary Skills (no bonuses)
 Bonus: +6 to P.P. or Spd attribute.
 Bonus S.D.C.: 30

76-00%: Elite: Surveillance Specialist

Hand to Hand: Basic
 Literacy (98%)
 Basic Math (+30%)
 Radio: Basic (+20%)

Radio: Scrambler (+15%)
 Surveillance Systems (+20%)
 T.V./Video (+10%)
 Cryptography (+5%)
 Optics (+10%)
 Computer Operation (+20%)
 Photography (+15%)
 Basic Electronics (+15%)
 Choose 2 Technical Skills (+15%)
 Choose 2 Rogue or Electronic Skills (+5%).
 Choose 3 Secondary Skills.
 Choose 2 W.P.
 Bonus: +4 to I.Q. or P.P. attribute.
 Bonus S.D.C.: 20

Criminal Type 3: Supervillains

Roll up gender, level of experience, age, and alignment just as you would any lesser villain as outlined above.

Even a supervillain can be a “thug” rather than one of the “criminal elite,” but that choice is up to the G.M. So select one of the Type I or Type II Villain Types. This will provide the skills, training and basic orientation of the villain.

To determine super abilities, simply roll on the Random Power Category and Super Ability Tables and — voila! Instant super bad guy. The quickest, “super” characters to generate are *Alien*, *Experiment*, *Mutant* and *Physical Training*, because of the many random tables and comparatively limited choices for these Power Categories. Hardware, Robotics, Bionics, and the others tend to require more thought, choices and time to create.

Normal People

Like most comic book superheroes, the characters in **Heroes Unlimited™** live, work and fight crime in a world very much like our own. The dates and places are almost always the same, and sometimes, so are the people. The technology is basically what one would find available at local stores or on-line, and weapons and combat equipment are fundamentally the same as our modern times, with the Military, Governments and select cutting-edge Corporations and Superbeings with the most advanced technology and equipment (roughly 10-50 years ahead of our own age).

The biggest difference is that the **Heroes Unlimited™** world has a bit of fantasy and science fiction to liven it up. The heroes’ players creativity and control in the game are larger than life, with amazing abilities that normal people do not have. They also have the will and drive to do something personally about the troubles around them, things that most normal people feel is out of their hands. Likewise, many of the villains these heroic characters face are also superpowerful. But everyone else is a normal human being. Compared to the superpowered villains threatening their world, the Average Joe is a wimp. This is why they need “superheroes” to protect and help them.

Game Masters may be tempted to assign power categories to “normal” humans, such as making all mercenar-

ies hunter/vigilantes or all top detectives super sleuths, but even everyday heroes like police officers or detectives are not “superhuman” in the **Heroes Unlimited™** game setting. A police detective who is a Super-Sleuth will be legendary, like Sherlock Holmes, while an Olympic athlete with lots of gold medals might be close to the Physical Training character, but they aren’t quite “super.” Likewise, supersoldiers are rare (even in military special forces), and not all martial arts masters or instructors will be Ancient Masters. Most assuredly, there are those very rare human individuals who have exceptional abilities above the norm, but they are the exception, not the norm. For any number of reasons, these exceptional people have not chosen a life as a crimefighting hero or vigilante, and live comparatively normal lives.

Legendary and famous humans will more often than not have amazing skills because of their high levels of experience (8+) and/or high I.Q. and other attributes rather than because of any super ability. Note that outstanding attributes of 24 or higher can also make a human famous or legendary. Remember, no matter how high one’s character’s stats may be, player heroes also have other special abilities or training most ordinary humans do not. For the Average Joe, moderately high stats alone are enough to seem impressive.



The Typical, Modern Human

Alignment: Any, with the majority being good or self-ish.

Level of Experience: Most adults are third to fifth level. Highly skilled NPCs, especially those in high-risk professions, may have years of experience and can be as high as 9+1D4 level. If this sounds rather high, remember that they do not have super abilities and thus would have much lower experience tables than powerful hero types. Also note that a person’s occupational skills will be taken

first, with less important skills being secondary, including most physical and combat skills. Thus, their combat ability will be less than impressive (soldiers, law enforcement personnel, and athletes are exceptions) if they exist at all. **Note:** Most people have no fighting skills, not even Hand to Hand: Basic, and only have two melee actions per round.

Attributes: These vary widely from person to person. Roll 3D6 for each; 16, 17, or 18 get to roll an additional 1D6 and gets the appropriate attribute bonuses.

The “average” man probably has a P.S. of 10 to 14, and 8 to 11 in other attributes. The typical woman has a P.S. of 7-10, but a P.E. of 10-14, with all other attributes being in the 8-11 range. Of course, attributes can be increased via occupation and physical skill selection.

Children mostly have 1D6+1 for all attributes, teenagers have 1D6+4, and the very elderly roll 1D6+3 for the total P.S., P.E., and Spd (all others are 3D6 or an “average” of 9).

Hit Points and S.D.C.:

The average adult, male and female, commonly only has around 25-35 Hit Points — 3D6 +P.E. attribute, +1D6 per level of experience. S.D.C. is 1D6+6 (+15 for those in occupations or environments that would build the body, like farmers, construction workers, athletes, etc.). **Note:** S.D.C. can be increased with the selection of certain physical skills.

Teenagers have an average of 2D6 Hit Points +P.E. attribute number (experience level is typically still considered zero, or perhaps 1st level). S.D.C. is 1D6+10 (tough, young and virile, but this S.D.C. drops to the adult range after the age of 21). **Note:** S.D.C. can be increased with the selection of certain physical skills, like being a high school athlete or other physical hobbies (running, climbing, etc.) that build the body and keep it strong. However, these skills and S.D.C. bonuses remain in adult life only if the character regularly continues these activities even if only on an amateur level.

Children have only 1D6 +P.E. attribute number (experience level is considered zero). S.D.C. is 1D6+2 (kids, especially little ones, are practically indestructible).

Senior citizens have an average of 2D6+12 Hit Points +P.E. attribute number (H.P. from experience levels don't count). S.D.C. is 1D6+2, plus any S.D.C. gained from physical skills, but at half the normal amount and only if the Senior remains physically active (otherwise they don't count at all).

Education: The average North American, European, and city people in the rest of the world typically has the equivalent of a high school education, or one or two years of college. Japan, and some other countries, will have 50%-60% of their people with four years of College.

Ultimately, education will be appropriate to the occupation selected for the NPC; i.e., Doctors have Ph.D.s, gang members have “street education,” etc. Also keep in mind that normal people will have a number of mundane skills that have little to no impact on this superhero game (i.e., Domestic and/or technical skills). Any Physical skills they

might have reflects regular, serious devotion to that activity. For example, marathon runners would have the Running skill, regular racquetball or tennis enthusiasts would have General Athletics, and so on.



Combat Skills: Most people will have *no* combat skills! Really. Get real, most of the people playing these games have never studied (let alone master) boxing, wrestling, karate/self-defense, climbing, or what might even be considered General Athletics. The same is true of most North Americans and most people in the world.

The Average Joe with no combat training will have two attacks per melee round. Period. Boxing would make that three. If the character regularly happens to study Karate or takes similar martial arts self-defense classes he will have the equivalent skill of *Hand to Hand: Expert* (not Martial Arts, which is reserved for true masters, i.e. instructors and assistants who are at least a First Degree Black Belt with years of experience).

Characters with a Military or Police Training will have *Hand to Hand: Basic*, while military personnel with years of combat duty, mercenaries and special operatives will have *Hand to Hand: Expert*. Remember, we are talking about the “average” soldier or ex-military (probably out of shape since leaving the military), so we will not consider Assassin or Martial Arts for them. Of course the G.M. can elect otherwise.

Weapon Proficiencies: The Average Joe has no W.P. About 40% will have one or two and is likely to be limited to W.P. Blunt, W.P. Knife, W.P. Revolvers, W.P. Pistol or W.P. Bolt-Action Rifle (for hunting). Handguns and rifles will be the most common, but even most people who own a handgun have little or no training in its use.

Clearly, even a Police Officer or professional boxer will pale in comparison to any player hero, but don't judge a book by its cover, or a character by the numbers on his sheet. Some of the most normal people can be the best opponents. One terrorist with a gun or bomb stands little chance against even a lone hero, but that same terrorist surrounded by innocent hostages is much harder to capture or defeat without loss of life.

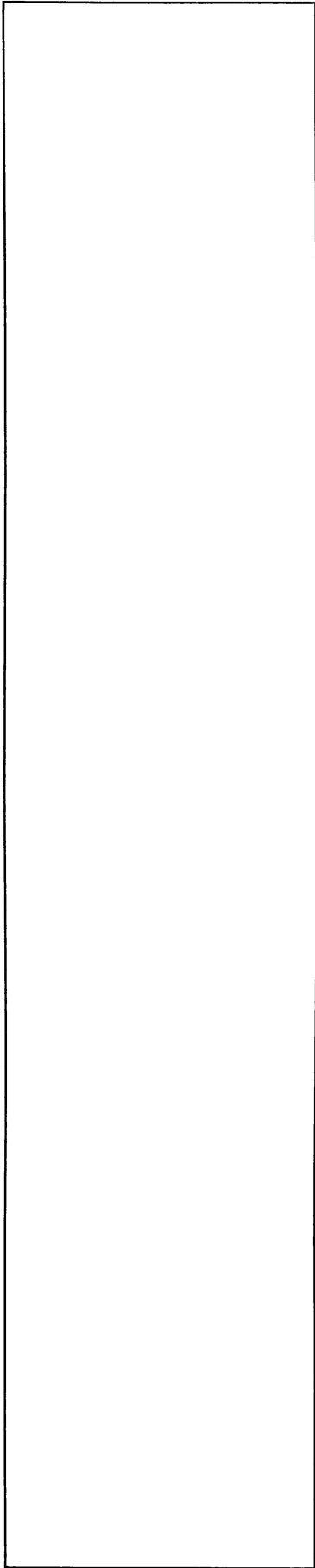

Vigilantes & the Law

By Kevin Siembieda

I think it is important to point out that being a vigilante is against the law and vigilantes usually bend and often break the law. What?! A hero breaking the law? Ridiculous, you say. Wrong! Stop and think a minute. Think about what would happen if you did many of the things a vigilante crime fighter might do. This is something many games and role-players ignore. Just because you're a superbeing, doesn't mean you can ignore the law. Likewise, good intentions don't make it okay.

Examples of unintentional criminal acts perpetrated by heroes (especially in role-playing) include assault ("But we had to make him talk!"), assault and battery ("He's evil trash. He deserved it."), harassment ("We just scared him a little ..."), breaking and entering ("We needed to look around," or "... but we knew we could find evidence at his apartment," etc.), illegal search and seizure ("But we had to get it before they hid it again."), assaulting an officer ("He was going to take me in for questioning and would have jeopardized my secret identity!"), destruction of private and public property ("You can't make an omelet without breaking eggs, especially when fighting Dr. Fright.") and numerous other crimes and disregard for the law and property.

To a vigilante, many of these tactics are *necessary* and *appropriate*, especially to the logic of an independent crime buster. Breaking the law doesn't necessarily make the character bad or evil, or even careless, but it does make him a *criminal* "in the eyes of the law."

The players must realize that the police can not condone their characters' illegal and anarchist activities, and that legally, their crime-fighting career makes them criminals (or at best, deluded heroes who the the law into their own hands). Players whose characters work "outside" the law must realize that they are effectively fighting the same war, but underground and using guerilla tactics.

This complicates their "job" because vigilantes can not turn a batch of crooks over to the cops unless there are other witnesses (and/or legally acquired evidence) to their crimes. I mean, here is some guy in a mask and costume who *claims* that these three other guys, all beaten up, just attempted to rob a jewelry store, but there are no other witnesses and the guy in the mask won't give his real name, address and other info so that "he" can press charges and testify against them. What happens? The three crooks get off because there is no witness or proof of their guilt. Even if the store shows physical signs of forced entry, it could have been caused by vandals or someone else entirely, or even the "masked guy" claiming to be a costumed superhero or vigilante.

Unless the heroes get into the habit of leaving crooks where cops can find them, along with incriminating evidence, vigilante heroes have to find some other means of putting their adversaries away. But how? Making them confess is a good idea, but it can't be admitted as evidence if it is proven that it was involuntary. Remember,

these are villains, dishonorable people we are dealing with. They will lie and come up with false witnesses and alibis to cover their crimes. Then we're back to their word against some strange guy in a mask and long underwear. Illegally obtained documents are also inadmissible in court, although there are ways around that too, like mailing it or delivering it anonymously, or leaving an anonymous tip as to where the *authorities* can find evidence of criminal activity or a crime in progress. Consequently, using super abilities to track down, gather intelligence and turn it over (anonymously) to the authorities is more likely to make a conviction stick in court than direct intervention.

Direct intervention can be good, too, and is likely to save lives. However, depending on exactly what transpires and how the hero(s) conducts himself, he may have to take solace in the fact that he or she saved a woman from a mugging, stopped an arsonist, busted up a criminal operation, and so on, but that the brigand(s) responsible may get away, or be let go for the reasons noted previously. Then again, if the woman is willing to press charges, if there was one or more witnesses to the arson, or the police can trace the handiwork to the thug in question, then these lowlifes may do time after all. Other ordinary people must step forward to help make their community safer and to see that justice is served. Philosophically, this is fair and just. After all, a superpowered hero or vigilante can only do so much. He or she is one person, and that one person can not fight evil and injustice all by himself. Everyone must take a stand for what is good, right and just. That's how society works and improves. And heroes, even the most disheartened and pessimistic anti-hero or vigilante, must have some faith in people, if not the justice system, otherwise he wouldn't be out on the street battling evil in the first place. Best of all (from the hero's point of view), perhaps his or her sacrifice, heroics and willingness to stand up for what is right, will inspire (and in so doing, empower) ordinary folks to do likewise. Leading by example.

Getting back to our main point, heroes working outside the law are considered criminals themselves — an irony not lost on most vigilantes and independent heroes. This means they must rely on their own resources and wits, while avoiding or dodging the "authorities" to help others and stop evil. A difficult and frustrating task to be sure, but this is the character's choice, and there are (or at least were before he became an independent) other choices to fighting crime and becoming a self-styled "superhero" (see the section on "**The Man**").

Since their crime-fighting activities may not be legal, such heroes can not expect justice through the court system or the open support or endorsement of the authorities or the media (although sometimes they get the latter, much to the authorities' chagrin). No, this does NOT mean they should resort to brutality, wholesale destruction and murder! It means that the hero must hope that his constant foiling of criminal activity will deter crime and in some way, help the authorities do their job. The hero may confront the local pusher, destroy or confiscate his money (and give it to charity or use it in his war against crime;

even superheroes need funding), and destroy his supplies. He may “accidentally” total the criminal’s car or chase away his clients. In short, he makes the creeps’ lives so miserable that they must move on.

At the same time, a clever hero working outside the law will always try to secretly assist the local law enforcement agencies. He will wait until a crime is in progress and call the police before jumping in to interfere or prevent it, or to slow things up so that the police will arrive in time to finish the job (“Now, how did that sniper knock himself out? He must have slipped and banged his head”). Such practices can quickly make the vigilante the “officially” admonished vigilante, but a helpful and appreciated, if unorthodox, guardian angel of the people, police and justice.

The Police’s Point of View

The police have no recourse but to view vigilantes and any so-called superhero who takes the law into his own hands and/or disregards the law, with distrust, disdain, and as a criminal. After all, they do break the law, possess extraordinary powers, and have secret identities. There is no way to run a check on them, or of even knowing if it’s the same person in that costume every time. Superbeings are also often viewed as glory hounds or dangerously deluded — well-meaning “amateurs” who are as much a nuisance as they are a help. The police department may feel

that the presence of vigilantes reflects negatively on their own effectiveness to curb crime and may resent the hero’s interference. Officially approving of a vigilante is a dangerous precedent, inciting ordinary people to take the law into their own hands, so it is rarely done, even if the authorities secretly appreciate and admire the vigilante hero’s handiwork.

Many police agencies come down hard on vigilantes, super or otherwise. They will not condone, accept or acknowledge the vigilante’s activities or motives, and actively seek to put an end to such *illegal* operations. While this is the department’s official posture, individual officers may feel entirely different, as might the media, and the public who may look the other way when dealing with vigilante heroes who have proven themselves to be honorable and scrupulous (“Okay, Captain Avenger, I’m gonna go to my car and call this in, and when I come back, I better not see you anywhere near here, got me?” or, “Oh, you were wonderful Captain. Thank you! But you better leave. I can hear police sirens getting close. No! Not that way, use my back door, nobody will see you that way”).

The Public’s Point of View

Whether endorsed or condemned by the authorities (or the media), John Q Citizen will have his and her own opinion about vigilantes and costumed heroes. They may love



a vigilante that the authorities and press paint as a monster, or fear, dislike or hate a hero that the media and the authorities (officially or unofficially) praise. Whatever the case may be, most people tend to be fickle, which means they may adore a hero(s) for months, even years, and then public opinion turns (for any number of reasons) and they have mixed feelings, or no longer trust, like, or care about the hero(s). Possible reasons could be that for several years the character(s) was hugely popular but his celebrity turned out to be a fad, flash in the pan. Or the hero(s) might have done or been accused of doing something that has caused his public to lose faith in him. This could include a feeling or belief that “their” local hero abandoned them (the people), or betrayed them or no longer cares about them, or has gotten too violent/extreme or reckless and now represents a danger — the list could go on and on.

Crimes & Punishment

So what happens when the player characters finally take down the big villain and turn him over to the proper authorities? Assuming the heroes also supply incriminating, admissible evidence and/or there are witnesses to the villain’s crime (or if the villain already is a wanted fugitive from justice), then the bad guy is going to do some time. The question is, how much?

Unfortunately for most heroes, a captured criminal may not be charged for their crimes for a number of reasons, some of which we covered in the vigilante section. The attorney for a masked villain apprehended by masked vigilantes can often find numerous technicalities to get evidence and witnesses suppressed and their client off, even if he’s guilty as sin! Furthermore, the masked vigilante or independent hero usually can not testify against the alleged felon because the Court does not recognize his or her costumed identity (this is different with heroes who officially work for the authorities) and to come forward would mean losing his secret identity and/or getting arrested for his or her own crimes (which are likely to be numerous, also as noted elsewhere in this section).

All this isn’t to say that the villains will get off scot-free all the time. On the contrary, supervillains and crime lords will be convicted at least 50% of the time and their underlings and henchmen, as well as small-time crooks, will get convicted 80% of the time. They may “cop a plea,” turn State’s Evidence, or bargain to a lower charge, but justice is served more often than not.

The following list of crimes and punishments is just a general guide and is not all inclusive or completely accurate, and may vary from State to State, country to country. Also requirements for the classification of some crimes and specific circumstances can affect how much time a villain serves. Note that a villain who has been busted dozens of times before can expect to face the maximum penalties and prison time. Of course, supervillains have this funny way of breaking out of jail, which keeps them active as adversaries, and also makes their sentence that much worse the next time they visit the Big House.

The Law: Crimes & Typical Penalties

<u>Crime</u>	<u>Time Served</u>
Murder, First Degree*	25 years to life
Murder, Second Degree	2-25 years
Assault with Intent to Murder	10-25 years
Attempted Murder, Second Degree	2-6 years
Manslaughter, First Degree	3-15 years
Negligent Homicide	1-5 years
Kidnapping**	25 years to life.
Assault; Great Bodily Harm	10 years
Assault; Intent to Maim	10 years
Assault; Felonious	4 years
Assault; Without Weapon	1 year
Resisting Officer	1 year
Assault with Intent to Rob, Armed	10-20 years
Robbery; Armed	25 years to life.
Robbery; Bank **	20 years to life.
Robbery, Unarmed	3-6 years
Robbery, Attempted	2-5 years
Extortion **	20 years to life.
Rape	2-10 years Typically; sometimes 20 years to life.
Prostitution	6 months-2 years
Breaking and Entry, Occupied Premises	10-15 years
Breaking and Entry, Unoccupied Premises	4-10 years
Forged Public Records	7-15 years
Forged Treasury Notes **	10-20 years
Forged Bank Bills **	7-15 years
Forged Signature on a Credit Card	4-15 years
Possession of Counterfeit Bank Note **	4-8 years
Passing Bad Checks	1-7 year
Car Theft (Larceny)	1-5 years
Theft of Credit Cards	2-5 years
Manufacture of Narcotics **	20 years to life
Possession of Narcotics	2-5 years
Possession of Narcotics with Intent to Distribute **	10 years

* Some U.S. States and foreign countries still have the death penalty.

** These are Federal crimes, the investigations of which will involve the FBI or the Treasury Department, or other Federal Agency (G.M.’s decision as to which).

Note that prison time can be reduced by 20-50% as a result of good behavior, release programs due to prison overcrowding, and other special considerations and measures. Typically, the most generous reductions on time served is reserved for offenders of lesser crimes (robbery, breaking & entry, battery, forgery, and similar).

PLAYING IN CHARACTER

By Kevin Siembieda

This section is applicable to both **Players** and **Game Masters**. It takes a closer look at the role and function of alignments, as well as a number of other aspects and considerations in playing.

A game of *Heroes*

The role of alignments

Other game settings may allow more flexibility in letting players create and run a wider range of alignments for characters, including selfish and evil. As the guy who is usually the Game Master, I can tell you I have had tons of fun playing a huge variety of characters, from Pauline Pure Heart (the innocent victim), or sweet mutant child, to the most despicable villains, their two-bit henchmen and horrible monsters. But that's as the Game Master.

At the very core of *this* game — **Heroes Unlimited™** — is the concept of playing “heroic” characters. And not just any *good guys*, either, but a “super” hero. An individual who has probably overcome great personal difficulties or challenges because he or she possesses superhuman powers, and uses that power to fight evil and help others. In most cases, these “heroes” represent the best in human spirit, even though they may be flawed, troubled, alien in appearance (or origin) and driven by all too human weaknesses, fear and emotion.

Despite it all, these “heroes,” empowered with superhuman abilities or otherwise, dare to stand up for what they believe. They dare to defend those unable to defend themselves, spit in the face of evil and defy death. They are champions of light! People of courage, the knights of the modern age — although some may be more like a Japanese Ronin, a samurai without a master or clear direction, stumbling through the world in search of their place in it. A place and peace that may be forever denied them, because of the very powers and deeds that set them apart as heroes. This is part of the drama, intrigue, challenge and perhaps, tragedy, that faces these supermen and women. As Game Master, this “heroic” aspect is a must and for players, it is definitely part of the challenge in role-playing these bold and valiant characters.

Playing in alignment is fun and challenging

Palladium's alignment system gives the fictional character his or her moral foundation and general code of conduct and ethics. Playing “in alignment” will mean tough choices that will sometimes mimic real-life decisions and create drama, suspense and excitement.

In one game, my ol' pal Julius was playing a Principled hero. In the course of the adventure, a particularly selfish, insane and treacherous NPC provoked him to the point



that his character wanted to kill him! In a battle of personal emotion and excellent role-playing, Julius finally had his character do the right thing and *not* kill the individual, but bring him to justice under the law. It was very dramatic, fun to watch and for Julius and his character, a small, personal moment of triumph. All pretty cool.

In the real world, we are often engulfed in powerful emotions: Anger, frustration, sorrow, momentary hatred, etc., all of which sends messages to our brains to strike out, hit, hurt, and get even. This is when “being good” and

“doing the right thing” comes into play. We may think about, even want to lash out and make somebody “pay” (or at least tell ‘em off), but we stop ourselves and think about the consequences of our actions. Often, if we stop and think for a moment, we find there is no reason to get nasty, mean or hurtful. Harsh words, a foul gesture, or a cruel prank are usually petty and brings us down into the gutter ourselves. We rein in our emotions and control ourselves. It’s best to just ignore the altercation and be the “bigger” person. In the long-run, it even feels good. Doing the right thing usually does.

Superbeings who function as heroes face such emotions every day, and worse. They must control themselves even more than the ordinary person, because to do otherwise may result in the unleashing of destructive energies or other devastating (and potentially deadly) power. Doing the “right thing” often means doing what’s right simply because one knows it *is* right — drawing strength from conviction and an understanding of good and evil. True heroes do the right thing not because of any reward or glory, but because it *is* the right thing. At the same time, there is the satisfaction of knowing one did good, of standing up for what was right, and helping others in need.

Such choices can be downright painful and may even cause more trouble, pain and suffering. Our fictional super-characters will have to make these choices often, and some decisions won’t win them any popularity contests. People may not understand their actions or motives, which may cause them to dislike, speak poorly of, and mistreat the heroes (name calling, slander, hurtful things, chastisement, being pelted by garbage, rebuke and turn their backs on them). With luck, the character can win them back through future good words and deeds, but the hero may never be understood, appreciated or liked.

“Playing Superhero” is more than amazing feats, displays of incredible powers, rescuing a cat from a tree, a child from a burning building, or beating a supervillain into submission. It is about the challenges, choices and tribulations of doing what one believes is right and good. In addition, the heroes must deal with the good and bad aspects of fame, celebrity, and the temptations of power. Don’t forget the old adage: “Absolute power, corrupts absolutely.” How does a famed superhuman respond to members of the opposite sex throwing themselves at his feet, or business people offering big dollars for endorsements (unscrupulous ones offering bribes or money for questionable favors), opportunists trying to use the hero to make themselves look good, or jealous authorities trying to make the heroes look bad, and on and on. Or do the heroes lose touch with the ordinary man, and start to feel superior or distant? The possibilities are many, and each represents a wonderful role-playing opportunity and depth of story.

The best Game Masters will try to work some of these elements and emotions into his or her games. This is when alignments will come into play most frequently as behavioral guidelines. The Game Master and the players should take advantage of re-reading the character’s alignment, referring to it regularly and striving to maintain it; even when it may be out of the real player’s personal

character. For example, I would never, personally, even consider most of the things I have the evil villains do when I’m the G.M. Such vile fiends belong locked up or worse, but I can still *play* the “role” of these fictional bad guys. And I rely on the alignment descriptions heavily, frequently checking them to make sure I’m playing whichever role at the time “in character.”

Keeping Players on Track

As the Game Master, I also feel it is my duty (in the role of game referee and director of our improvisational theater group) to remind the individual players of their “roles.”

Thus, if the player, typically in the heat of the moment, blurts out some action or intention that is contrary to his character’s alignment, I’ll pause the action and say something like, “I assume that’s *you* saying that, and not your character, because that’s not in his alignment,” or “That seems out of alignment, you sure about that?,” or “That’s fine, your character can do that, but he would realize it is wrong. So if he does it anyway, your character will be sliding to an anarchist (or evil) alignment. Are you sure that’s what you want him to do?” And so on. **An aside to Players:** While we are on the subject of blurting things out, players, do not give your G.M. ideas, especially deliciously dastardly ones. There must have been a thousand times over the years when a player has blurted out some fear, observation or guess about a villain or situation in the adventure that has caused me to pause and think to myself, “Ah, what a great idea.” Which translated means, “Oh boy, are your characters in for it now!”

Taking action as the referee

On occasion, I just won’t let the character do something. For example, a Scrupulous good character might *pretend to play* “bad cop” to another character’s “good cop.” Under such a circumstance, the good character *might* use intimidation tactics and let a villain, henchman, petty crook, street punk, etc., *think* his associate will beat him up or throw him over off the roof (i.e. the classic rooftop swinging hero dangling a hood from the roof or the ledge of a skyscraper while making comments like, “You better start talking fast Bruno, my arm’s getting tired. Whoa, did you feel that? You started to slip. I can’t do this for much longer. Start talking or ...”). However, the “hero” would *NEVER* actually toss him over the ledge to splatter on the ground, nor beat him to within an inch of his life, or engage in torture or murder. Never! If one of my players suggests otherwise for his “good” character I will say, “Your character would never do that.” Period. If he persists, I will repeat, “A character of his alignment would not do that!”

If the player insists, or if circumstances in our story may have understandably driven the character to such an extreme or insane point, I *will* allow it. But only on the condition that the character’s alignment changes to something appropriate for the foul deed. If that deed is torture, rape or murder, we are probably talking about *Miscreant evil* (possibly Anarchist in the case of killing, but there are mitigating circumstances). The Miscreant or even Diabolic

alignment is especially appropriate if the character was not provoked and/or was particularly vicious and cruel.

Evil is Evil

An evil act, like cold-blooded murder, is never justified. We aren't talking about killing somebody in self-defense, or to save/protect/defend an innocent life, or even killing by accident. I mean the calculated killing of a character who is beaten or defenseless and vulnerable, but is shot down like a dog in anger, hatred, jealousy or revenge! Yeah, sure, maybe the villain deserved to die, but that's for *the law* to decide, not an individual. Not even a super one.

Consequences

To quote the old Barretta detective TV show, "Don't do the time if you can't do the time."

In role-playing this means the fictional character bearing the consequences of his or her actions. And it is the Game Master's job to always consider and play out the most appropriate consequences. One, several, or all of the following may come into play (as well as others) when a so-called "hero" kills or takes some terrible or disreputable action.

- **One: Becomes an outcast from his own Super-Group.** What did the fallen hero do? How bad was it? Did any (all?) of his teammates witness the crime? If so, how do they react? Were there other reliable witnesses? Video? Does the foul act or crime go unreported or is it made public? Does the public or the media even know who in the group is responsible? Is the entire group blamed, or one of them falsely accused? Does the one responsible deny his complicity in the incident? Does he go into hiding even from his teammates? Any or all of these things only puts more pressure on the *entire group* to respond and do something about the shocking incident.

These are all things the G.M. must consider and bring up to the group — again acting as both the Director of our little adventure story and as the player group's *conscience*. Exactly how the various player characters will respond to their teammate will depend largely on their individual alignments.

A group that is predominantly **Anarchist** might be able to condone, justify or ignore the event, and figure to hell with any public outcry. Of course, that approach is likely to result in increased animosity toward the entire group. On the other hand, a group of Anarchist characters out for themselves, might be super-quick to condemn and throw out their teammate (guilty or not) in an effort to protect their own reputations, standing and favor with the public. They might even turn the guy over to the authorities without being asked, or run their ex-teammate out of town.

A group that is **predominantly good** (Principled, Scrupulous and Unprincipled), will be deeply troubled. Most will be unable to condone an openly brutal, cruel or terrible criminal act (i.e. rape, torture, murder, etc.). Most will probably (and unfairly) feel it was somehow

"their fault." That they should have seen it coming and prevented the tragedy somehow. Depending on the seriousness of the crime and whether the group regularly works "outside" the law, they may enforce their own brand of justice, or capture and turn the perpetrator (one of their own!) over to the authorities for a proper trial and punishment, or insist he turn himself in. The latter might involve a cooling off period and hours of friends counselling their friend to do the right thing. If the character is truly sorry, they will stand by him and help him through this difficult time, even if it means him going to jail. They might also give him a second chance after he's paid his debt to society. If the individual is not sorry and refuses to answer for his crime, the group of good guys will find themselves at odds with this old teammate and the justice they fight to uphold.

If the tragedy occurred in the heat of the moment and the one responsible seems truly sorry, vigilantes *might* forgive the incident and ignore the law (as they so often do), on the condition that this character never does anything like that again. A good group of independent heroes *might* do likewise, especially if the victim was an evil villain who deserved his fate. However, they will always be haunted by this, feel uncomfortable, and the public (and authorities) will never forget they condoned this terrible crime. The name of the group, as well as the individual heroes will be forever tarnished. Meanwhile, if the perpetrator continues to show an increasing penchant for violence, cruelty and evil, the group will have to do something about him. Whether that's some of the things we outlined earlier (kick him out, turn him in, etc.) or something else, is up to the player group (perhaps with some advice and nudging from the G.M.). The bottom line is that good guys will not condone this conduct. They won't!

Another alternative might be that the perpetrator's teammates can not condone or accept what their teammate did, but can't (for the moment) bring themselves to "take him in." This is the classic, "You have 24 hours to get out of town — and I never want to see your face or hear your name ever again. If our paths should ever cross, we *will* do what we have to do. Now get out of here before we change our minds." This means being kicked out of the group, possible (probable) retirement from the hero game, and the hero group publicly condemning their ex-teammate. If the hero (turned villain?) hangs around (becomes a lone wolf vigilante, starts a rival team, turns to crime, etc.) they *will* clash, and his old superpals will try to bring him to justice and turn him over to the authorities.

A mixed group of good and not so good (Anarchist and/or Aberrant), will take sides, argue and may become divided and splinter into smaller factions or disband entirely.

The bottom-line is that a group of good characters will not allow a serious "crime" (murder, torture, rape, bribe taking, extortion, excessive violence, brutality, etc.) to go unaddressed, especially when committed by one of their own, and will, at the very least, expel from the group any unrepentant teammate responsible for such things.



Note that covering up illicit activity by a teammate may lead to further complications.

- **Two: Wanted by the Law!** Criminal charges are filed that requires a trial, defense and possible legal punishment for the one responsible for the alleged crime or atrocity. Failure to turn himself in makes that character a wanted fugitive. A criminal on the run.

Depending on the details and seriousness of the crime, there may be an active manhunt and the public warned that this character is considered “armed and dangerous.” His or her own teammates may be called in (or feel it is their obligation) to bring the character to justice. The end result: A potentially deadly clash between the group and their old teammate (and his new friends?).

Furthermore, they may *ALL* be wanted by the law! At least for questioning and possibly as guilty accessories or accomplices to the crime. Guilty by association! And if the group runs or goes into hiding, it destroys their credibility even more and makes them look guilty! This can result in a manhunt for all of them and may involve a Police or Federal “Super-Squad” assigned to “bring them in,” or intervention by S.C.R.E.T. or other shadow agency. In addition, or in the alternative, old enemies or villains may see an opportunity, because their old superhero nemeses are being run out of town or forced into hiding. Thus, the villains may seize the moment to strike at the beleaguered heroes or to go on a crime

spree. Heck, villains and mercs not wanted by the law might even get themselves hired by the authorities to hunt down the superpowered fugitives.

- **Three: Tarnished reputation and loss of credibility.** **The actions of one reflects upon all.** The character responsible for the unjustifiable act will lose trust and credibility with the authorities and the public. Furthermore, the actions of the one *may* reflect on the entire group, causing others (including the authorities) to wonder if the rest of the team also engages in criminal or murderous activity, but just haven’t been caught yet. Or whether or not they condone such things, or whether they are capable of making good judgements (they didn’t when allying themselves to their evil teammate).

Even if it was a momentary lapse in judgement or an accident, the authorities, media and public may wonder what really happened. Or who will die the next time he or one of the other heroes “momentarily loses control”? Can any superbeing be trusted? Will the public (or the media and authorities) ever be able to completely trust them again? A lot will depend on how everyone involved, especially the player group, behaves.

- **Four: Loss of public support and confidence.** This will probably go hand in hand with the loss of credibility. The loss of public sympathy will cause the public (probably led by some crusading politician or media personality) to turn on the character. Loss of support may be limited to the individual responsible for the

crime or the entire group. It is likely to be spearheaded by the media who now dogs their every move and questions their every action, motive and judgement. This is likely to turn into harsh and exaggerated criticism and fear. Which, in turn, means the majority of the public will not feel comfortable around the character(s) and are not likely to turn to them for help, come forward to offer tips and information, or help them in any way.

If an official member of a formal Police or Federal Organization, the group may be temporarily shut down pending a full investigation, or be temporarily or permanently disbanded! In the former case, the characters will be expected to suspend all crime-fighting activity while they wait on inactive duty (but probably with pay) for the internal investigation to be completed (1D6 months). In the case of disbanding the group, they may be allowed to form new allegiances, although other government agencies probably won't have them if the press is too bad, or they will have to either work independently or start their own group, probably outside the law — i.e. vigilantes not endorsed by any branch of the government.

- **Five: Loss of allies.** This might include public funding, official or unofficial support and cooperation from local and/or Federal law enforcement agencies, reporters, informants, and other contacts.
- **Six: Loss of superpowered associates.** Other heroes and public figures are likely to distance themselves from those in question. Some may even regard the fallen hero(s) as a wanted criminal or unsavory vigilante.
- **Seven: Secret identity is compromised.** This is especially true if the guilty party was a member of an official government agency. If he is wanted for a heinous crime, his true name, face and civilian identity may be revealed to help with the manhunt! Such action is not taken lightly, however, so the agency will have to be convinced of the character's guilt or that he represents a serious danger to people or the country.
In the alternative, if the character's true identity is unknown, it may be his/their only means of escape, by (temporarily or forever) giving up their costumed identity and assuming a normal life as John Q Citizen.
- **Eight: Forced to go underground.** Whether the wanted character's true identity is known or not, he may have to go into hiding, at least for a while. This may include leaving town, assuming a new civilian identity or assuming a new costumed identity. If the character's true identity is known, he will probably have to divorce himself from his friends and family either to avoid getting them in trouble for aiding and abetting a known fugitive, or because they are likely to be "staked out" by the authorities.
- **Nine: Can justice be found?** If the character is actually innocent or it was an accident or self-defense, can the hero find justice? Will the authorities nail him for past indiscretions as a vigilante? Will a criminal kingpin reach out and frame the hero, or make certain that the character gets the maximum penalty (this can be done

via payoffs, extortion, etc.)? And if guilty (remorseful or not), will the prosecutor and judge be lenient or throw the book at him? Will the public demand his head (and a judge or politician use this situation to further his own career by grand-standing and making an example out of this "rogue" hero)? If railroaded, how does the tarnished hero respond? What about his superpals?

- **Ten: Hero Turns Villain.** How does the character who did the evil deed react to his life spiraling out of control? Does he accept the consequences for his actions? Or does he feel justified and unfairly accused? Persecuted? Can he understand why people might be shocked, horrified and upset by his action? Does he feel any remorse or sense of wrongdoing? Or does he feel betrayed by the public and particularly the media and his ex-teammates? Does he feel thrown to the wolves and left alone and hurt to fend for himself (more treachery from those he once called "friends")? Does this make him angry? Meaner? Crueler? Vengeful? Does this make him petty and vindictive? Does he start a (slow or fast) slide into darkness? Does he turn into a supervillain?! It could happen.
- **Eleven: Altered Alignments.** From a game rules point of view, the offending character must have his alignment adjusted appropriately.

If the act is a grave crime that was deliberate, premeditated, done for personal revenge, done for money/greed, done to attain or preserve personal power or reputation, and otherwise clearly selfish or evil, the character's alignment should drop to at least Anarchist, probably *Miscreant*.

If the character's actions were especially violent, cruel, vicious, torturous or horrendous, as well as blatantly evil and/or unnecessary, then the alignment should definitely drop to *Miscreant* or perhaps, *Diabolic*. Circumstances will dictate.

In these cases, the character responsible is not sorry or repentant for what he did. He either feels completely justified or blatantly disregards the law and morals for his personal revenge or satisfaction. The latter case may mean the superbeing has come to feel above the law (always dangerous) and/or that he is superior to ordinary people (equally dangerous), and that they and their rights are less important than his — or that he knows what's best for them. Either way, it spells the birth of true evil and/or delusions of grandeur and megalomania.

Fellow player characters who are indifferent, confused or too frightened to stand against the evil or injustice being perpetuated by their teammate are morally bankrupt (change alignments to *Anarchist*) or at best, so distraught that they can not think straight, making them *Unprincipled* characters on their way to Anarchist or *Miscreant*. However, *Unprincipled* characters will only tolerate so much before they will do something about it, sooner or later — ultimately these are good people who do what is right in the end, they might just need time or a push.

Anarchist is the alignment for the various characters in the group if they turn a deliberate blind eye to the situation, worry about themselves, and/or condone or allow

their teammate's evil or criminal actions with the justification that, "they" didn't do these terrible things. Heck, they may even have asked him not to and warned that he was headed for trouble. However, these "heroes" didn't stop him or leave his company, making them only a notch less foul than he.

Hanging around and working with (probably protecting and helping) an evil individual and accepting or allowing (if not 100% condoning) his evil deeds will ultimately change the alignment of each and every character associating with that wicked soul. With time, most will become a close reflection of the evil character(s) among them. *Aberrant* is acceptable if they can honestly justify the dark acts and exhibit some twisted code of honor. Otherwise that leaves only *Miscreant* (self-serving evil) and *Diabolic* (likes being evil and has no regard for the law, honor or life).

Characters of Principled, Scrupulous or Unprincipled alignments will *not* work with or tolerate evil characters, except under the most extreme/desperate or controlled circumstances. A "controlled" situation may be where the heroes need the help of a criminal or supervillain to save themselves or rescue or protect others, but this "unholy alliance" is on their terms, and they will not tolerate evil or any actions that are hurtful to innocent people. Furthermore, as soon as the crisis is over, the unholy alliance will end as well.



The fallen, but repentant hero

People make mistakes, even heroes. In the heat of the moment, anger, fear, desperation, foolishness, a momentary lapse of judgement (misplaced love or trust, desire for revenge, greed, etc.) — the character goes too far and commits a crime. An evil deed is done.

Whether the character's alignment drops at all, drops a little or plummets to the depths of evil will depend on two things.

1. The seriousness of the offense. This includes:

a) The mitigating circumstances: Was it an accident, self-defense, or was the hero at his wit's end, and, feeling desperate, vengeful or angry, bent or broke laws but ultimately justice was served (a misguided approach to justice, as opposed to a complete disregard of the law or people's welfare for whatever reason; i.e. there is no real justification);

b) the level of premeditation: A snap judgement and response under fire, the hero was disoriented from drugs or out of his mind with pain, traumatized, etc., versus a planned and deliberate act (whatever the reason); and,

c) the degree and outcome of the offense, i.e. beating a bad guy up out of rage or frustration, a bad thing, as opposed to torturing and/or killing him, a terrible act.

2. Whether or not the character is truly sorry and willing to pay the price for his indiscretion. A good character (Principled, Scrupulous and Unprincipled) will feel some degree of responsibility, loss, shame and guilt. Such characters will want to make amends. This means they will accept, if not welcome, any fair punishment or recompense for their mistake, crime or deed, including the many possible consequences noted earlier in this section. This character knows he did wrong, or made a mistake, and strives to rise above it, first by making amends (if possible) and second, by *never* letting it happen again (all material for role-playing the birth of a stronger, better hero).

Part of the consequences *may* be the character's alignment going down. For a minor infraction, a character who may simply feel ashamed and embarrassed should be warned that his character's alignment will drop if he keeps up this sort of behavior and justification. If the character continues to break the law or act outside the framework of his alignment, change the good alignment to one that seems appropriate. If a Principled character, changing him to Scrupulous may be the right move. If the law bending or breaking is rampant or the character's motives are selfish, or dangerous to others, then changing a Principled or Scrupulous character to Unprincipled or Anarchist may be appropriate.

A guilt-ridden Good Guy will seek to make amends for a crime or act made in the heat of the moment. This may be financial restitution, some act of kindness or other act to help the offended party/his family/loved ones, as well as willingly turn himself over to the authorities and await trial. If a prison term is the ruling, then he will serve it. Furthermore, the character is likely to vow to become a better person and never to repeat his mistake.

Players need to think about what they have their imaginary characters do and the consequences in the context of the story (noted earlier) and to the character. I have noticed that many players don't think about their good guy becoming self-serving or evil. I had one player surprise me with his actions after his character changed from good to evil as the result of a despicable act. The character killed an incapacitated NPC villain. The player character had his reasons for killing the NPC and went ahead and did it despite my warning about dropping from a Scrupulous good alignment to Miscreant evil. I mean the bad guy was tied

up and completely helpless, for Pete's sake! Plus, it was a completely premeditated and heartless act.

At first the player said he didn't care and it was no big deal. However, it turned out that he really, really wanted to play a good guy and not an evil character. It drove him nuts to have his favorite "hero" become a murderous cretin. I explained that what he had done was terrible and that to regain any good alignment, his "evil" character would have to give up his terrible ways and work long and hard to regain his lost virtue. To my amazement, this player spent the next year and a half having his character do good deeds, be kind and merciful, obey the law, and put his character's life on the line doing the right thing on several occasions. His character had honestly forsaken his evil ways and the player really worked at making his character back into a good guy. Being a sinister Game Master, I, of course, threw the character into a number of situations to tempt his dark side. The "hero" prevailed, and after about a year and a half of real time (several years in game time), the character first managed to rise up to Anarchist (after about six months) and finally to Unprincipled. He was well on the way to Scrupulous when our three year campaign came to an end.

In this example, the *player* didn't stop to think about the ramifications of his character's actions. The fact that criminals and lowlives started to cozy up with his character and saying things like, "Of course you had to do it. There ain't nothin' wrong with revenge. You gotta be strong to kill another man. Your goodie, goodie friends just don't understand like we do." Things like that and the fact that the other player characters (who could never prove the character did it) were cold and distrustful of the character for months (years in game time) to follow. This hurt the player because in his mind, the character wanted to be part of this noble group of heroes more than anything else. By playing "in character" and having his character strive to repent and make amends, the player created a deep, many faceted and truly memorable character. On top of that, his character's actions and convictions led the player group into many adventures and subplots that I, as Game Master, could never have anticipated. It made everybody's gaming experience that much more rewarding. Heroic adventure to be sure. Role-playing at its best.

Alignments for Anti-Heroes & Vigilantes

Even violent, rude, crude, frightening, chaotic, arrogant, embittered, wild, and even slightly deranged *anti-heroes* and *vigilantes* will answer to a higher calling and uphold (secretly, perhaps) high ideals. They will possess a strong sense of purpose, and a personal sense of right and wrong, good and evil. They may be rogues and renegades, obsessed with their particular brand of justice, and a few may even teeter on the black-hearted, but all value the life and welfare of the innocent and strive to make the world a better place. If not, they wouldn't be fighting crime or opposing the forces of evil in the first place. Remember that!

This means these rogues, misfits and wild men, even Anarchist and Aberrant characters who see themselves as "heroes" (as opposed to criminals, mercenaries and muscle for hire), are usually willing to sacrifice their own lives or well-being to protect those they deem to be innocent, helpless, deserving, important, or good. And it's this respect for life and their desire to help others, even at the risk of the anti-heroes' own life and limb, that makes him or her, (arguably, perhaps) a hero.

What makes the so-called anti-hero or vigilante a likeable rogue and something of a tarnished hero, is that they operate "outside the law" and may live by their own, albeit, somewhat twisted system of values. Consequently, no **anti-hero** can be *Principled* in alignment (because Principled characters have too much respect for law, order and authority to defy it), nor can they be any evil alignment, not even Aberrant. A true "hero" of any kind can not be evil! That having been said, a **vigilante** who is an extremist with a strange code of honor may not kill good guys, but does not hesitate at killing, beating, or robbing those who "he" deems to be evil or dishonorable, can be *Aberrant evil*. However, he is *NOT* a hero, but a ruthless criminal no better than the animals he preys upon. However, vigilantes will not be Miscreant or Diabolic. Why? Because presumably, he is somebody who deludes himself into believing that he is a misunderstood good guy, or strives to be good, but somehow never quite succeeds. Any character of a Miscreant or Diabolic alignment is evil through and through.

About 20% of all **anti-heroes** are *Scrupulous*. These characters have a reasonably high respect for law, order, justice and authority. However, they see the wheels of bureaucracy and justice as too slow and inefficient. The hands of the police are tied with too many regulations, laws and limitations to preserve the rights of the people. Rights that, in the eyes of the Scrupulous anti-hero or vigilante, creates injustice and lets criminals slip through the system untouched. Likewise, they see the judicial system and its laws as having too many flaws and loopholes where the helpless and needy fall through the cracks and justice is not served. As a result, they have decided to take matters into their *own* hands.

These Scrupulous heroes will try to follow and obey the law when they can, but will bend and sometimes break it when they feel it is justified. After all, to their thinking, it is these ineffective or inappropriate laws that are allowing criminals to get away with murder as it is. Likewise, they will never deliberately undermine a police investigation for fun or treat an investigation as a competition or game. Thus, many Scrupulous anti-heroes will often secretly and overtly help and cooperate with the authorities. Many will even have sympathizers and secret contacts on the Police Force, at news agencies, and so on. This usually makes such anti-heroes and vigilantes reasonably well liked and respected by at least some members of the police, government and public (sometimes by a majority).

As one might suspect, the Scrupulous hero will not engage in extortion, torture, or killing — although he may break and enter, steal evidence, bully, harass, threaten, trick, etc. Likewise, he or she will not steal money even



from the most vile of criminals. Whenever possible, this character will either return the money or valuables to its rightful owner, or over to the authorities (ideally to a trustworthy contact on The Force). The only exception might be to use the money to help an honorable and/or needy individual, group or charity that will help children, the poor, the community or those victimized by the villain. Yes, you are reading this right. The *Scrupulous* (and most *Unprincipled*) anti-heroes and vigilantes won't touch a penny from "ill-gotten gains" or "blood money," even if they need it desperately themselves or to help a loved one. They will find other, legal means to survive, or to support or help loved ones. Nor can they justify using ill-gotten gains to fund their private war against evil!

The majority of **anti-heroes and vigilantes** fall into the alignments of **Unprincipled** (the reluctant hero or character who is tempted to do wrong or vent his dark emotions, and/or pretends to be a tough, hardcase, but always does what's right in the end) — and **Anarchist** (the hero driven by hate/vengeance or guilt, or the well intentioned, I will do things my way, hero). About 35% are *Unprincipled* and 38-40% *Anarchist*.

These selfish alignments fit, because most anti-heroes and vigilantes ignore, bend, break or defy the law. Most believe "the end justifies the means" and/or "one must fight fire with fire" — both rather self-serving, aggressive and chaotic points of view. Furthermore, many tend to wear their heart on their sleeve and are "heroes of action"! The problem is they tend to act and react, and think later. This means they have a nasty habit of jumping to conclusions and into the middle of a crisis without assessing the situation fully, or considering the possible danger to innocent bystanders. Such actions can also complicate or exacerbate an already explosive situation. Their *anarchist* nature tends to make even the most well intentioned individuals reckless risk-takers, and loose-cannons who can be as much a hindrance or danger as they can be helpful. **Note:** Many young superbeings (kids and teenagers in particular), full of spit and vinegar, the delusion that they are invulnerable, and a dislike for, or distrust of, established authority to begin with, often start their careers as vigilantes or anti-heroes.

Such well-meaning rogues will disregard privacy laws, engage in surveillance, think nothing of breaking and entering, illegal search and seizure, tampering with evidence or a crime scene, making threats, roughing up criminals, and ignoring similar laws and regulations. (If you think for a minute that a vigilante has a proper gun permit or won't consider stealing and using Military ordnance, weapons or devices taken from a villain, forget about it. The end justifies the means, and one must fight fire with fire, remember?) However, those of *Scrupulous* or *Unprincipled* alignment will never engage in torture, blackmail for profit, or deliberately kill in anger, out of revenge, to send a message, or to enforce "his" will (or law). The *Anarchist* on the other hand, may give vent to his darker emotions and personal desires.

The Unprincipled anti-hero or vigilante typically falls somewhere between the *Scrupulous* and *Anarchist* ones.

They tend to respect the law and would *prefer* to work with the law than outside it, but they just can't stand all the laws and regulations that tie their hands and let bad guys get away. An Unprincipled hero will not engage in extortion for personal gain (but he may consider it against bad guys if it means saving lives or preserving peace), and will never consider torture, or killing (although he may pretend and threaten both). Likewise, he or she is not likely to steal money even from the most vile of criminals. However, the Unprincipled character might take a item like a weapon, body armor, vehicle, computer or equipment that helps him in his war against evil. In a pinch, he might even skim a few bucks off the top to help finance his crime-fighting operations or when in desperate straits. However, much like the Scrupulous character, 99 out of 100 times, the Unprincipled hero will return the valuables to the rightful owner, the authorities or a charity.

The Anarchist anti-heroes (and to a lesser degree, the Unprincipled ones as well) hold personal freedoms above all else and see most (not all) laws and authority as restrictive, inhibiting, too slow to action, clumsy and inefficient, perhaps even stupid. Many also believe that rules and laws are made to be broken, and enjoy the dual challenge of fighting evil and defying authority. This gives them the extra excitement (and many vigilantes and anti-heroes are excitement junkies) of having to avoid the authorities while independently fighting crime. Some consider it a race or a game to outdo or show up the authorities. Others just think they are smarter and better, and like proving it to the world (and more often than not are trying to prove something to themselves). Ironically, if these characters had less chaotic natures or more tolerance for authority and regulations, they would be working on the side of the authorities rather than at odds with them or independent of them.

The Anarchist is also most likely to be playing superhero for selfish motives like fame and glory, revenge, power or money. Depending on the character's personality, antics and successes, he or she may be the darling of the media (i.e. the loveable or charismatic "bad boy" — at least for the moment) or constantly criticized and disparaged. In either case, the character is likely to have a poor to terrible relationship with the authorities. Most are considered wanted criminals because they take the law into their own hands and defy or interfere with the police.

The Anarchist hero will be able to easily justify taking money, goods, and valuables from the "bad guys" to support himself and his crime fighting operations. The truly well intentioned Anarchist will usually return valuables to their true owner, but is likely to skim money that is to be turned over to the authorities and keep as much as he feels he needs. Most nice guy Anarchists have a 50/50 outlook — half for them and half goes to the poor, needy, a charity, or is turned over to the authorities. The Anarchist may also associate with unsavory characters, petty crooks, informants, gang members and other vigilantes and fugitives on the run. Some may also be willing to take bribes, payoffs and accept favors if they don't feel it compromises them or "really" hurts anybody.

The most **extreme Anarchist** and **Aberrant anti-heroes** and vigilantes are more inclined to take extreme measures, particularly the Aberrant (evil) ones. These two alignments are also likely to actively steal from the bad guys to fund their own operations and support themselves. Heck, some will use the money to live the good life. Of course, it is justified as any and all of the following: It hurts the enemy, it sends them a message, how else can the "crime-fighter" finance his crusade, and lastly, it's his just reward — it's not like "he" stole or swindled that money from innocent people or made it selling drugs to kids.

Additionally, these self-absorbed fanatics are likely to frame bad guys, assassinate top members of crime organizations, kill for revenge, and destroy property to make a point or to strike back. They are also more likely to endanger the lives of innocent people, the authorities and fellow heroes who "get in the way." After all, they justify to themselves, there are innocent casualties in any "war" or "crusade." Hopefully, the reader can see how this extreme and cold-hearted (and ultimately self-serving) attitude can make these anti-heroes as ruthless and bad (even evil, in the case of the Aberrant vigilante) as the very villains and monsters they battle. Such characters usually have terrible relationships with the authorities and are slammed by the media. Most everybody from the public to fellow superbeings will regard such extreme characters as dangerous criminals or fanatics.



Player Warning: Aberrant characters and the most extreme Anarchist heroes reside in the "grey zone" of morality and the law. Such characters are much more likely to step over the line of being a "hero" and become a superpowered thug, bully or criminal. Be careful if you elect to play such a character. On the other hand, Game Masters will find them wonderful Non-Player Characters to drive home a point, cause confusion or conflict, and generally disrupt and disturb good and law-abiding heroes.



“The Man”

Working for the Authorities

Superhumans working in law enforcement can be encompassed in a number of ways. For example, in a world where superhumans and mutants are (relatively) common, virtually every branch of law enforcement is likely to have a special division or squad of superbeings as part of it. In fact, many will have a special squad, task force, unit, team, brigade or league composed entirely of trusted superbeings. Agencies where a “police-style” squad of superhumans is likely to be found include the Police Departments of large cities, the FBI, DEA, ATF, and Secret Service, among others (superbeings can not join S.C.R.E.T).

Joining the Police Force

A lone superpowered individual might head or serve on special investigations, an anti-terrorist team, S.W.A.T., or other special unit. It is likely that a Police Department, especially those in big cities and/or who have a recurring problem with supervillains and/or severe crime, will have an entire special squad or team entirely composed of superbeings. Such superhuman “law officers” are likely to be members of a Special Operations Police Squad that functions like a superhuman S.W.A.T. force.

Their primary purpose: To “serve and protect” ordinary citizens by keeping them safe from so-called supervillains, dangerous mutants, monsters, magic, and extraordinary threats of all kinds, as well as other extreme dangers and disasters (i.e. sniper, barricaded gunmen, terrorists, explosives, rescuing people trapped under collapsed buildings, earthquakes, etc.). Such “Super-Squads”

are official and active members of the Police Force, associate with other “cops,” must uphold the same laws, and answer to the same chain of command. They *are* Policemen, albeit, superhuman ones.

Some Super-Squads will enjoy a fair amount of autonomy and be allowed to work the streets, pursue leads on their own, engage in undercover assignments, and so on, with the blessing of the Department and without close scrutiny or constant involvement of non-superpowered Superiors. They must still answer to their Superiors, follow the chain of command, use police procedure, uphold the law in the execution of their duty, obey orders, and do as the Department deems best, but they are trusted enough to be given a good amount of freedom, and usually given the benefit of the doubt when aspersions and suspicion is cast upon them.

Other Super-Squads are less fortunate and viewed with a certain amount of apprehension, concern or resentment. These “super-cops” are much more likely to have to deal with miles of red-tape, the slow wheels of bureaucracy, lack of trust and close observation. This probably means their team leader does not have super abilities and his purpose is not limited to strategy and tactics, but supervision and making sure the supermen under his command follow procedure by the book. Such a leader is usually a hard-nosed officer whose loyalty is to the Police Department first and foremost, and who is critical of hiring superhumans on the Police Force. Such officers are often resented and/or disliked by the superbeings under his command. However, being “liked” isn’t part of his job. He or she makes sure the superbeings obey the law, do as they are told, and keep their noses clean whether they like it or not.

The best of these human Team Leaders whip their super-cops into a close-knit and well-oiled team, and with time, all parties come to respect and trust each other. The worst are “chicken-shit” bullies who are often bigoted against Super-Squads and resent “super-freaks” who show-up ordinary “good men” on the force. These brutes tend to treat their superhuman charges with hostility, disapproval, contempt and cruelty. They ride the members of their Super-Squad hard, rail against them for the slightest infraction, and treat them like dumb, know-nothing rookies, or worse. Acts of defiance or failure to follow orders and accepting whatever reprimands and punishments the team leader dishes out, usually means getting tossed off the Force. Consequently, well-meaning and dedicated heroes put up with this garbage and pray that either they or their bellicose team leader will be reassigned. **Note:** Similar non-super watchdog “partners” or “teammates” may also be assigned to a Federal Team of heroes.

The amount of freedom, camaraderie, true friends and loyalty superhumans on the Police Force enjoy, will depend largely on their superiors, the general atmosphere concerning superbeings in the city, and how the superbeings conduct themselves. Like anybody in the public eye, the members of a Super-Squad must prove themselves in every way. To prove themselves to the people, they must show themselves to be honorable, trustwor-

thy, compassionate and law abiding (not above the law because of their super abilities). To prove themselves to their fellow police officers, they must show that they sincerely support, trust, respect and appreciate their fellow human officers. That they see themselves as part of a "team" (i.e. just another cop, no better or worse than any other), and that they are not superior, publicity seeking glory hounds or hotshots only concerned with their own reputations.

The problem is, *all* superpowered Police Officers are going to grab headlines, publicity, and notoriety (good and bad) whether the heroes, themselves, want it or not. Their superhuman nature and amazing powers automatically sets them apart (if not above) their fellow lawmen. The super-villains and threats they address are usually out of the ordinary and/or spectacular in some way, and that means being in the public eye. The super-cops can't escape this. In the extreme, their every move will get attention by the media, and failures, as well as successes, will garner more press than they may deserve. The ordinary police officer is likely to feel overshadowed, less appreciated and put upon by the actions of a few superbeings. This often results in varying degrees of resentment and/or jealousy from the human cops on the Force. This can lead to the cold shoulder, snide remarks, practical jokes, and lack of support by their human comrades, as well as the superbeings feeling isolated and alienated. The level of stress for these super-cops is tremendous.

Without fail, even among Police Forces where the majority of the law enforcement officers endorse and support their superhuman brethren, some fellow officers will view super-cops as contemptible and hated "show-offs" and "freaks." Such jealous and prejudiced individuals are snide, uncooperative and cold to their fellow superhuman police officers. The worst will actually work to embarrass, undermine, and even get superbeings on the Force discredited, demoted and drummed out. Such intense emotions and vile actions are unavoidable, although the show of genuine support and appreciation for the superbeings by their superiors, the majority of fellow officers and the public, will go a long way toward keeping such feelings buried and petty acts of cruelty to a minimum.

The media attention super-cops receive, also means their words and deeds, successes and failures, have tremendous impact on the public and reflects strongly on the *entire* Police Department. This adds to the stress of the superbeings' positions and makes things harder on their fellow police officers, especially those who do support and defend them. A mistake, unnecessary violence, massive destruction of property, hints of corruption, or a superbeing gone bad, will turn the public against the entire department, human and superhuman alike (with all programs endorsing the use of superbeings falling under criticism and debate). In addition, super-cops may fall prey to politics, public relations and manipulation by their superiors and government leaders; namely the Police Commissioner, Chief of Police, the Mayor, City Council members, the Governor, State Senators and Representatives, as well as their political rivals! Such are the pitfalls of fame and trying to use one's super abilities for the public welfare, within the law.

Note: Superbeings who officially join the Police Force are typically (but not always) lesser superbeings; i.e. not the most powerful beings on the continent.

Salary: Approximately \$35,000 to \$60,000 dollars, with officers and detectives getting the higher end of the pay scale.

Military Special Super-Operations

The Military of many countries (especially on a world where superbeings are relatively commonplace) have recruited superhumans in their armies. Most are members of Special Military Operations, commonly called "Super-Ops." These are special squads, teams or companies of super-soldiers under the direct command of that nation's highest and most trusted military leaders. In the USA, that means the President who is also the Military Commander in Chief, top Generals, and top leaders of the CIA. In truth, the President has no idea where or how 95% of the Special Super-Operatives are being utilized, putting his faith and trust in his Military advisors and leaders. They handle the day to day deployment of Super-Ops. The President (and, sometimes Congress) gets involved only when Super-Ops is involved in crucial or public issues of national security, war and foreign affairs.

Most Super-Ops teams are top-secret, and those known to the general public conduct themselves in secrecy, with little public information about the team members, their activities, assignments, location, or purpose. As military personnel, their activities are a matter of National Security, and not a matter of public knowledge or debate.

These superbeings have been trained specifically to use their special powers in military operations. All are trained in combat (Hand to Hand: Expert to Martial Arts, plus one other physical skill of choice) and military methods, strategy, tactics, and procedure. About one third are trained in espionage. All respect, understand and follow the chain of military command, and seldom question orders. They have little autonomy except when sent into the field, and even then they diligently focus on the successful execution of their assignment, seldom wavering from it. They are *soldiers* trained to accept orders and follow commands, and most like their work.

The danger of the righteous. Most members of most Super-Ops see themselves as elite soldiers and defenders of their nations. The majority (60%) tend to be *superpatriots* who cheerfully live, fight and die for their country. Few question their commanders or their orders, and do as they are told for the greater good of the nation. Such loyalty can lead to fanaticism and is dangerous, because while they are steadfastly loyal and dedicated, many will also kill, destroy and commit terrible atrocities in the name of their country without question.

This is not to say that all members of Super-Ops are mindless robots or heartless killing machines. Most are well-intentioned, and sincerely want to protect, defend and help their country. As members of an elite military organization, they are trained to trust their superiors, follow orders, and bite the bullet, no matter how unpleasant.



However, some will question orders that seem unusually odious or contrary to earlier duty or high moral standards. This is especially true when a large number of innocent lives (non-military personnel) or an international incident is at stake. This may not be immediate insubordination (although that may come), but a question, a request for an explanation, and probably confirmation from a higher authority. Likewise, if a Commander appears to be (temporarily) out of his mind, these elite soldiers will challenge and defy his direct commands, and even “restrain” their Commander until a higher authority can sort things out. The most notorious and written about Super-Ops agents may be sinister saboteurs, assassins, fanatics, and madmen, but most (65%) *are* heroes and patriots of high moral standing. Most share a high regard for life and freedom, and serve their country in hopes of making the world a better and safer place.

Note: The CIA (and similar Agencies in other countries) is believed to be the only Federal Agency outside the US Military, that has several, small Super-Ops teams under its command.

Salary: Approximately \$100,000 to \$180,000 dollars, with officers and the most decorated and experienced agents getting the high end of the pay scale. For most of these soldiers, pay is secondary to their devotion to their duty and country. These characters also get all the other perks the Military has to offer, such as free training, free room and board, Military medical care, all their gear and transportation is provided by the Government, and so on. Some may even have been created by the military!

Government Superhuman Task Force (GSTF)

The main differences between the Government Task Force and Military Super-Ops is that GSTFs are not part of the Military and are not specifically trained to be a tactical combat or military force. They typically enjoy tremendous autonomy and are involved in public relations, spreading good will and creating an atmosphere of security and well-being. They are very similar to the regional Police Super-Squads, except they function on a national scale and answer to the heads of Government (in the USA that’s the President, his Cabinet and Congress). They tend to be the most famous, well-liked, powerful and patriotic superbeings, loyal to their country and its Government.

As the representatives and agents of a particular sovereign nation, these patriotic superbeings are sometimes assigned to other nations. They may function as advisors, observers, special investigators (usually with the foreign nation’s knowledge and authorization), Special Agents (usually assigned to protect an important diplomat, visiting head of State, or Embassy, and usually with the foreign country’s knowledge and approval), or as “Ambassadors” or Special Operatives *requested and invited* by a foreign country on a good will mission to help their country in a time of need. Great international public relations.

Diplomacy and P.R. aside, these superbeings are charged with keeping their *nation* safe, which means combating threats to national security. In other words, these “Big Guns” deal with the biggest, most public threats, supervillains and disasters that endanger the nation, its cities, people or government. Like any national agency, they are also assigned to missions involving regional disasters and conflict, threats against a large population center or important (or public) facility or figure. This includes being sent in as part of a disaster relief program to prevent looting and rioting — especially by villainous superbeings who might try to take advantage of the chaos caused by a tornado, hurricane, flooding, earthquake, fire, explosion, or other disaster — and handling high profile cases involving evil superbeings, alien invaders and cataclysmic crises. As long as public approval of the group remains high, they are usually allowed to conduct themselves as the GSTF see fit, provided that they are on call 24 hours a day and immediately answer and obey their government sponsors.

Salary: Approximately \$250,000 to \$1 million dollars, with the most famous, publically loved and powerful agents getting the high end of the pay scale. In many cases, a special headquarters or other base of operation is arranged for the Super Task Force as well as special funding for operation, equipment, transportation, medical care and so on.

Restrictions & Conditions

The following generally holds true of all formal government organizations, from the Police and Military to the Feds.

Lost personal freedom — a Chain of Command. Members of any government organization serve the people and must answer to their superiors and the laws of the land. There are good and bad things about having to answer to an organization. On the good side, the organization has expansive resources, intelligence gathering networks, and fellow members of the organization all working together to the same end. It provides a base of operation, uniforms, basic equipment, vehicles or other means of transportation, a salary so the team-member can support himself, and support of all kinds (combat, legal, communications, medical, etc.), as well as such intangibles as purpose, direction, camaraderie, and a sense of belonging to something important. Something that can make a difference and help people.

On the downside, particularly for the more anarchist, exuberant, rebellious, young, and lone-wolf hero, the organization requires a strict adherence to rules, codes of conduct and a chain of command. Personal freedom is sacrificed (to varying degrees) on the job. One has laws and superiors to answer to, and must accept and obey orders from those superiors whether he likes it or not.

Insubordination means being demoted or punished in some way, from seeing a reduction in pay to losing one’s job (and the support and resources of the organization and former teammates still on the GSTF). This can make

the individual an outcast and alone. Breaking the law may also lead to demotions, fines, loss of the job, imprisonment, or worse (death sentence, civil charges and lawsuits, unwanted publicity, public hatred, etc.).

Player characters who join a law or government agency must expect all these things and then some. They will be given their assignments from a superior, told when to stand down, and sometimes exactly what to do. They may or may not be complimented or rewarded for a "job" well done, and may be unfairly reprimanded or mistreated for a mistake or failure.

The level of freedom on the job will depend on how well they get along with their superiors, how well they do their job, how good they make their superiors look, and how much the public likes them. The higher the team's public approval rating the better. A rating of 50% is considered good, but any above 60% is fantastic and if it's above 75% the characters can get away with a great deal (even insubordination). Of course if their approval rating hovers around 50% they will have to be careful, and if it drops below 40% for more than six months, they can kiss their GSTF job goodbye. Unfortunately, as part of an organization, a well-liked boss can be promoted, demoted, fired and replaced. The new guy in charge will have his own way of doing things, may be a creep or nicer than his predecessor. The characters and he (or she) will have to get to know and trust (if not appreciate) each other, before things settle down.

The law is equal for ordinary men and superbeings alike (even Federal Agents): In all cases, superbeings in the position of local or national law enforcement or other authority figures, must follow and obey the law. The law is above no man, woman or child, and the high-profile "super-cops" and "national heroes" are scrutinized by the media, the government and the agency they serve. Consequently, all such agents undergo thorough training in police procedure and criminal law, as well as annual refresher courses and special counselling as deemed appropriate by their agency.

Those who break the law will be charged and penalized as any law officer would. That having been said, preferential treatment is not uncommon. "Unofficial" overlooking to totally ignoring the "bending" of the law is common, as is punishment that is nothing more than a hand slap, especially if the infraction is minor, stays out of the media, and produces favorable results.

The matter of a secret identity. While the regional or national agency may allow (even prefer) that the "heroes" have a public super-identity, and keep their true identities secret from the public, the agency that employs them *must* know their true identities. This means true name, residence, personal history, family, fingerprints, DNA scan, and the whole nine-yards. This information is carefully guarded and may be known only to the super-cops' top commanders and Heads of State, but *is* known, verified and double-checked.

This is critical for three reasons: One, to accurately verify the agent's identity through various means to prevent infiltration and sabotage from an impersonator. Two, to

identify and track down any super-cop or agent who disappears or goes bad. And, third, to help protect and conceal the agent's true identity and family from the media, criminals and enemies (of the hero and the agency he serves).

If the superbeing will not reveal his secret identity, then he can not be hired. End of story. No special exceptions, no arguments allowed.

Roughly 40% of the superbeings operating as members of a Government Super Task Force (GSTF) have gone completely public. Meaning everybody knows their history and old or original human identity. The costumed identity of these public heroes is their entire identity. They don't have a secret life, job, disguise or false identity. What you see is what you get. The character is a national hero and defender of freedom and justice for all. That's his or her shtick 24 hours a day. Such characters typically live in a secret (or not so secret) base or headquarters provided by the government sponsor with living quarters and security for family members and loved ones. However, most of those who go public have little or no family to put in jeopardy.

G.M. Note: Feel free to expand upon this ground work as you see fit. There are many advantages to the G.M. and players for having heroes who are "connected" to the authorities, military or government. Have fun with it.

The Value of Secret Identities

By Kevin Siembieda

A *secret identity* seems to go together with superbeings like colorful Spandex tights and capes. So why does a hero need a secret identity, anyway? There are several reasons.

1) Perhaps first and foremost, is to protect the "hero" from assassination attempts, attacks and retribution by those who might seek revenge against him or want him out of the way. The friends, family or organization of a captured or killed villain or criminal might covet revenge. Similarly, if a supervillain or criminal organization was planning something big, they might strike out at the city defender while he or she was relaxing in a lounge chair, taking a nap or washing the dishes. There are a lot of reasons criminals might want to see a superbeing dead, the least of which is to eliminate who might stand against them or thwart their efforts before they launch them.

2) Privacy and Safety. Actually, there are all kinds of reasons to keep a secret identity for the purpose of personal safety. Not only from vengeful supervillains and the criminal elements, but from adoring and crazed fans, the media, opportunists, confidence artists (superheroes are not invulnerable to scams and treachery), marketing agents, salesmen, and even beginner heroes looking for advice, a mentor, partner or to join the hero's Super-Squad, among others.



Additionally, genuine privacy is important to many superbeings. The secret identity provides them with a safe haven, a way to hide from the publicity and pressure of the very public life they live. A way to effectively go into hiding (often in plain sight) where they can let their hair down, stretch and relax without having to worry about being attacked by superpowered maniacs, fighting crime, saving lives, answering questions by the press, being hounded by the authorities, or mobbed by their fans. It is a way they can be, at least for a short period once in a while, an ordinary Joe who can go to the store or the movies without drawing a crowd and can pick his nose and scratch his butt without it airing on the Six O'Clock News. For many (not all) heroes, it is this private, personal time that can be spent with family, loved ones or in peaceful seclusion, that helps them keep their sanity. It also helps them to keep their perspective on life and allows them to walk among ordinary people and share their fears, dreams and desires. To keep the superbeing grounded and "human."

3) To protect loved ones from retribution, retaliation and danger. If the hero's true identity is known, his family, friends, and even coworkers and associates may be endangered. Villains and criminals (not to mention the media) could track down these relations and endanger their lives. Loved ones could be killed, tortured or threatened as acts of retribution, intimidation, or to break the hero's will. People the hero cares about could be kidnapped in an attempt to extort the hero and get him to do something ille-

gal, cough up money, commit a crime, turn a blind eye to criminal activity, to get him on the mob's payroll, to tamper with evidence, to give false testimony, to back off a particular criminal operation/gang/villain, and so on.

For a hero to feel free to deliver justice fairly and equally, he must feel his loved ones and associates are safe and happy. Otherwise the character will be distracted and vulnerable to outside influences.

4) A secret identity may also be necessary to maintain a job to support oneself or to enjoy work and challenges other than crime fighting. Perhaps needless to say, there isn't a big call for superhumans in the factory, business office and most conventional work sites. A known superbeing would have an extremely difficult time getting a common, ordinary job. For one, the hero is likely to be typecast into the role of crime fighter and be deemed unsuitable or over or under qualified for a mundane job. For another, most employers would be leery for fear that his or her presence would cause trouble — distractions and jealousy among co-workers and attract other super-menaces and criminals. Believe it or not, some people, even superbeings, like their job (I love mine), especially if it offers them mental or physical challenges and rewards they enjoy.

Remember that many costumed heroes, especially vigilantes, anti-heroes and independent heroes work outside the law and must find some means other than crime fighting to support them (and their family?). Strangely enough,

for many heroes, crime fighting is their sideline. For some it is almost an after hours hobby, for most, their true vocation, but one that doesn't put money in their pocket or pay the bills. See *Heroes In the Workplace* for more on this subject.

All this means is that most costumed heroes take great pains to protect and preserve their secret (true) identity.

Public Heroes — No Mask, No Secret Identity

There is a small percentage of heroes who don't have secret identities. They are typically superhumans who have gone public and live their heroic (or villainous) costumed identity 24 hours a day. Whether they retain any aspect of their old human, pre-Hero life is up to the individual. Most do not. They are Super-this or Captain-that all the time. His or her persona is constantly that of the superbeing. Such public figures may dress up (or down) in "normal" clothing (suit, tuxedo, dress, etc.) for special events and appearances, but 95% of the time, this full-time superbeing (hero or villain) is in costume. The costume is part of the character's image. It is his uniform and trademark, and for many people, a symbol (of justice, goodness, evil, etc., as the case may be). Even at formal dinner parties, public addresses, funerals, and Presidential meetings, most people will *expect* to see the hero in his or her "colors" — the familiar (and comforting) costume.

These rare public superbeings have forsaken a "civilian" identity to dedicate all their time to their activities as superbeings, be it for good or evil. They may have a secret base, hide-out, fortress or sanctuary, but they don't have a secret alter-ego. Consequently, most are beings who don't have families or loved ones to put into jeopardy or keep them close to them at their secret sanctuary. Of course, the beings' association with law enforcement officials and others may put these people in the spotlight and increase the possible level of danger for them, but that can not be helped.

The majority of these public heroes (and villains) are usually employed by Government Agencies or other sponsoring organization (in the case of villains, criminal organizations). A few are independently (or mysteriously) wealthy. Local or national Government endorsement and sponsorship, or allegiance, gives these public heroes additional status, clout, fame or notoriety. Being full-time heroes, and brave enough to reveal their faces and identities *seems* to enhance their lofty position and breeds respect, trust and confidence from the people and country they serve.

Some public heroes share the concern or belief that so-called "superheroes" who "hide behind a mask" are not to be completely trusted. That they might harbor secret agendas or a criminal past (which is sometimes true). And that masked vigilantes are troublesome rogues, if not criminals outright. This can cause division, clashes and rivalry between the popular heroes and those with secret identities.

Heroes in the Workplace

Hand in hand with a secret identity is gainful employment. Unless the characters work for the Police Department or other Government Agency as superhuman law officers or special agents, they will need to find some way to support themselves and their family (if any), as well as money for replacement costumes, supplies, equipment, weapons, and other items needed for their crime-fighting campaign as a costumed hero. See the section entitled, "*The Man,*" for ideas about Police or Government work as *Super-Law Officers and Government Agents*.

The ideal job, other than getting paid for fighting crime, is one that gives the hero a lot of free time (i.e. minimal work hours) and flexibility (can set his own hours, work at home or in the field, can come and go as he pleases, and has little if any supervision). Probably the best type of employment is where the character works at home and only has to answer to *deadlines* rather than punch a clock and go to a workplace. Jobs that fit this bill include *private detective, freelance artist, freelance writer, freelance consultant (of all kinds), on-line/web site administrator or trouble-shooter*, and to a lesser degree, *salesman, telephone solicitor, investigative reporter, researcher*, and other work that requires skills that are in high demand and enables the character to find work relatively easily, including *builders, carpenters, plumbers, computer tech, bartender*, etc. (and all those listed pay pretty good too). This will allow the hero to take on work as he needs it to pay his expenses and even to move around the country. However, even in these relatively flexible or high demand jobs, there will be "work demands" on the character's time. There *will* be periods where the character must spend hours, days and weeks working or face missing his deadlines, losing his accounts and getting fired. It's the hard reality.

Another possibility is working for oneself or a family business where the character might be able to get away with more crap from family than he could anywhere else. However, being an entrepreneur is incredibly time consuming (trust me, I know), unless one has very competent partners or associates willing to carry "your load" — but that leaves the hero's business very vulnerable to mismanagement, embezzlement, corruption, and bankruptcy.

A wonderful situation would be one where the business partners are friends or family who know about the character's secret life as a hero and willingly work to help him in his heroic endeavors. This means the hero would have to spend little to no time at the job (or as much or little as he'd like) and, assuming the business was successful and can "carry" the missing partner or worker, it would give him a regular salary and nearly absolute freedom. Unfortunately, this rosy situation can evaporate if the business falls on hard times and can no longer afford to support a non-productive worker on the payroll. This could result in a reduction of pay (which might be okay), loss of the job, or demands on the hero (at least temporarily) to help with the business. Failure to help could lead to hard feelings and, perhaps, betrayal.

The only thing better than being supported by friends or family as described above, is to be independently wealthy — inherited a family fortune or estate that can be sold off at a sizeable profit, or to have a trust account that pays out annually for decades, even if the amount isn't a fortune. However, even this luxury has its potential pitfalls. Unless the character wisely saves some money and invests a good portion, one day the money could be all gone, leaving him with nothing. Like the proprietor of a business, if the hero leaves his investments and business affairs in the hands of others, he opens himself up to possible mismanagement, embezzlement, and corruption that could cost him 2D4x10% of his fortune or leave him penniless.

Corporate sponsorship is another possibility, although unlikely avenue. This is where the hero is funded by a seemingly benevolent corporation. However, the hero may appear to have to answer to said corporation and be expected, as part of his employment, to look out for the corporation's interests and do them favors and special jobs. After all, to fund a hero or Super-Squad must have its benefits, even if it's only to earn them publicity and positive press. However, that means if the hero(s) makes the corporation look bad, by his deeds or words, fails to do them favors, or becomes entangled in a police investigation of his methods or activities, the hero is likely to find himself suddenly unemployed. In addition, the corporation is likely to regard the hero as a business angle, so if he does not perform up to expectations, his image becomes tarnished, or a better prospect comes along (i.e. a more handsome, powerful, popular hero), the character might find himself replaced and out on the street.

In any case, the independently wealthy, inheritance, family business and corporate sponsorship options are all extremely rare to begin with. This means the crime fighter must find some way of legally supporting himself.

Stealing from the bad guys is not an option unless the character is an anti-hero or vigilante of Anarchist alignment, and even these guys may have ethical problems with that solution. On the other hand, Anarchist and Unprincipled heroes would seriously consider taking a reward or handout from the public, rich philanthropist, institution or corporation (maybe even the government of a country). The problem here might be the appearance of impropriety. How will this look to the public and especially critics? Will it look like the hero is taking a bribe or that he's in the pocket of said institution? Will the giver of the reward expect, demand or try to leverage the hero into doing them a favor (a favor that may look innocent, friendly or legal, but which might lead to trouble).

Hardware characters, geniuses and even writers and occasionally artists, *might* be able to create (and, in the case of Hardware and geniuses, patent) something that earns them *royalties*. We are assuming these are above average creations that garner the character above average royalties, so we should be talking 1D4x\$10,000 dollars annually. Most heroes could scrape by, living modestly on as little as \$20,000 dollars and do reasonably well on \$30,000-\$40,000. Whether the character makes

more than \$40,000 (\$120,000 maximum), or has any royalty income at all, is left entirely to the efforts of players of such characters and their Game Master. If the G.M. says no royalties, it's no!

This leaves having a "real" job. At least something part-time (22-30 hours a week and earns \$15,000 to \$25,000 a year). See the job list for some possibilities and average salaries.

Other problems with having a job

Time and sleep are a problem for characters living a dual life as an ordinary working stiff, 8-10 hours a day, four to five days a week, and superhero the rest of the time. Heaven help the character if the duties of spouse and/or parent are tossed into the mix.

Without sufficient sleep the character's performance on his money paying job may suffer and he could get demoted, see a cut in or docking of pay, or get fired. Chronic tardiness, leaving early, going on long lunch breaks, and missing days ("Sorry, I have the flu." "Can't make it today. No, this time Aunt Matilda died," etc.) is likely to get the character fired! If self-employed, the business will suffer, bills will pile up and the business may go bankrupt.

Lack of sleep when on the street as a crime fighter has even greater danger. Speed and reflexes will be slowed, as will skill performance and the precision execution of skills (whether it is a gymnastic somersault, picking a lock or programming a computer). Believe me, I've done my share of all nighters and have gone without sleep for several days at a time. I can usually go with minimal sleep (say four hours a night every day for a few weeks), but then I feel it, and bad. No matter how hard I try I can't help but to function at a diminished capacity. Reaction/response time (initiative) is slowed, the thought process is foggy and also slow, which means mistakes and lower quality. True, I'm no superhuman, but these same principles apply to everybody, especially humans who don't have enhanced healing ability, extraordinary endurance or invulnerability. It's a fact of life. Worse, a lot of times the exhausted person will not realize (or is unwilling to accept) that he or she is working at a diminished capacity.

For a hero, this means the possibility of making mistakes that could cost him his life, or the life or safety of others.

Rules for Sleep Deprivation

Note: These rules are written with superbeings in top physical condition in mind. Ordinary people are likely to feel the same side effects in half the time.

- **Minimal sleep** (1-4 hours a day) for 2-6 weeks, or no sleep for 48 hours. Penalties: -2 on initiative, -1 to dodge, reduce Spd by 20%, and skill performance -15%.
- **Pushing too hard**, either minimal sleep (1-4 hours a day) for 7-16 weeks, or no sleep for 72 hours. Penalties: Reduce P.B. and M.A. by two points (looks tired), -1 attack per melee round, -4 on initiative, -2 to strike and parry, -3 to dodge, reduce Spd by 40%, and skill performance -30%. Furthermore, the character is in a

constant state of near exhaustion and suffers from the effects of fatigue/exertion 5x faster than a rested, healthy person. Will need to rest frequently.

- **Exhausted to the point of collapse!** Minimal sleep (1-4 hours a day) for 17 or more weeks, or no sleep for 80 to 168 hours (4-7 days)! Penalties: Reduce P.B. and M.A. by half (looks and acts terrible), attacks per melee goes down to two, and all combat bonuses to only +1 (including saving throws due to the character's weakened condition)! No initiative, reduce Spd by 70%, and skill performance -60%. Furthermore, the character can barely keep his eyes open and is in a constant state of exhaustion. He or she will need to rest for 15-20 minutes after every 10-15 minutes of combat or heavy exertion. In addition, the character will be easily startled, grumpy, on edge, unpleasant and may even hallucinate. If allowed to rest and shut his eyes, the character will fall asleep for 1D6+4 hours (unless woken up by somebody or a loud noise) and wakes up still feeling exhausted.

The character needs three days of 7-9 hours of sleep and full days of relaxation or light activity to get back to the point of *Pushing Too Hard*. A full week to get back to *Minimal Sleep* and 10-14 days to recover fully.

- **Pushing oneself beyond the point of collapse** means one attack per melee round, no initiative, no combat bonuses, skill performance is at 10% and Spd. is at 10% (staggers and crawls). The character will hallucinate and events that occurred during the sleepless days are all a quarter remembered blur. By day 9 the character will collapse and sleep for 5D6+30 hours. During this time it is impossible to wake him (leaving him vulnerable to enemy attack). Recovery time as noted previously, requires only a few extra days.

Note: Characters with the super abilities of *Healing Factor*, *Extraordinary Physical Endurance*, *Adapt to Environment*, *Alter Metabolism*, *Invulnerability*, and *Supernatural Strength*, as well as *full conversion cyborgs* and characters who are a *transferred intelligence/mind inside a robot body* or a robot with an Artificial Intelligence, can easily get away with as little as four hours of sleep per 24 hours indefinitely and without suffering any ill effects, although 5-6 hours of sleep are better. The human mind (and most humanoids) needs "down time" to dream and rest. These superbeings will feel the effects of *Minimal Sleep* if only getting one or two hours of sleep and *Pushing Too Hard* after 72 hours of no sleep; near exhaustion after 7-10 days of no sleep (1D4+6). Recovery time is twice as quick.

In a pinch or moment of crisis, a character with the *Karmic* power can momentarily reduce penalties by half if he has "good karma" and is trying to do a good deed.

Jobs & Salaries

Even though player characters are well above the norm physically and may possess special abilities, they still suffer from many of the problems that plague the Average Joe, like needing a job to pay the bills. Characters in **Heroes Unlimited™** get starting money, but what about

additional funds as the campaign progresses? After all, replacement equipment, maintaining a headquarters, and medical care isn't cheap. Unless the hero is funded by the government, a big corporation, or some other organization, he's pretty much on his own. And, if the hero's alignment forbids him from taking or using dirty money, then he's going to have to find a job. ("What a revolting development! Save the world on Sunday, go back to flipping burgers on Monday. I tell ya, I don't know which is worse.")

The following is a list of major areas of possible employment for characters as well as the required and/or suggested skill programs for that occupation. A salary range is also given for each. The higher salary reflects higher skill percentages, experience, attributes, and/or a formal education. The listed salaries are by no means definitive — they are simply for reference and ideas.

G.M.s should use their judgement when assigning salaries, but the easiest way to do it is by giving a character the base salary at 1st level and moving 10% up the salary range per level to reflect the character's advancement in skill and level of expertise. The character's Scholastic bonus x200 dollars is also added to the annual salary or can be a bonus for a job well done. Divide the annual salary by 12 to get the monthly paychecks, and assume 20% of the salary is available every month for the character to spend as he wishes. The rest goes toward expenses. A character with the Business and Finance skill can have an extra 10% of his monthly salary to spend as he wishes or to invest. We can argue endlessly on how accurate this system is or isn't, but for game purposes, it is quick, easy and does the job. As usual, if you wish to get even more detailed, go right ahead.

All skill and skill Program selections are limited by the usual prerequisites and special restrictions (see skill descriptions and special restrictions). Note that the salary does not include benefits like medical insurance, sick days, etc.

Auto-Factory Worker: None, although a high school education may be required. Pilot: Basic Programs required for the latter. Salary: \$32,000-\$70,000.

Broker/Financial Consultant: Business Program required. Technical Program suggested. Salary: \$50,000-\$500,000.

Carpenter: Carpentry skill required. Technical program suggested. Salary: \$30,000-\$90,000. Same salary range for the average plumber and electrician.

Chauffeur/Taxi Driver: Pilot Basic Program, including the drive automobile and truck skills. Salary: \$18,000-\$45,000.

Chef/Cook: None, but must have the cooking skill, and the Business Program is helpful. Salary: \$18,000-\$45,000 for a fry-cook or average restaurant cook; \$75,000-\$200,000 for a top quality chef.

Company President: Business Program required. Technical Program Suggested. Salary (small company): \$35,000-\$70,000; Salary (medium company): \$120,000-\$400,000; Salary (large company): \$800,000-5

million; Salary (Mega-Corporation): \$100+ Millions. Increase by 50% for high-tech and bio-tech industries.

Coach/Physical Trainer: Physical Program required. Double salary if Medical Program is also taken. Salary: \$20,000-\$60,000.

College Professor: Skill Programs determine teaching area. Must have a degree of some kind for this. Salary: \$50,000-\$150,000.

Computer Technician or Sales Clerk: The Electrical Program required for former and Computer Program required for the latter. Salary: \$20,000-\$50,000.

Consultant (Independent/Freelance): Computer programming, Medicine, or Engineering (electronics, mechanics, sciences). The obvious and appropriate Skill Programs are required by each. Salary: \$50,000 to \$200,000.

Doctor/Scientist: Medical Doctor or Medical Investigation Program and Science Program are required. Salary: \$90,000-\$500,000 on average.

Engineer: Mechanical and Electrical Programs required. Double salary if the Science program is also taken. Salary: \$45,000-\$250,000.

Executive/Management Business Program required. Technical program suggested. Salary: \$45,000-\$150,000; double for top executives.

Federal Agent (includes DEA, FBI, etc.): Police/Law Enforcement Program required. Depending on the agency and position, other programs might include Modern Weapons, Journalism/Investigation, Espionage, Military, Electrical, Communications, or Criminal Program. Salary: \$42,000-\$100,000.

Fireman: No required Programs. Physical program suggested, especially Climbing and Athletics. Salary: \$25,000-\$48,000.

Food Services: Flipping hamburgers, running the cash register or other work a fast-food place. Salary: \$15,000-\$28,000.

Freelance Artist: Technical Program required and the art and/or photography skill is a must. Salary: \$22,000-\$80,000 on average (including freelance role-playing game artists); increase by 50% if a paperback book cover painter or commercial artist. A very successful or "hot" artist can make triple.

Freelance Writer: Technical Program required and the writing skill is a must, but the Journalism Program is suggested for technical writing or writing for newspapers and magazines. Salary: \$25,000-\$90,000 on average. A very successful or "hot" authors can make quadruple. A freelance role-playing game writer, half.

Handy Man: No skill program required, but needs the Basic Math, Basic Mechanics and Basic Electronics skills. Carpentry and technical skills may also be helpful. Salary: \$15,000 to \$40,000.

Mechanic: Mechanics (Vehicle) or Mechanical (General) Program required. Salary: \$25,000-\$90,000; increase salary by 50% if the Mechanical (General) Program is taken (making the character an engineer).

Menial Labor: Sweeping floors, stocking selves, loading and unloading, picking vegetables, and similar. No skills required, just a strong back. Salary: \$12,000-\$30,000.

Military Advisor or Mercenary: The Espionage and/or one of the Military Programs are required. Salary: \$60,000 to \$300,000.

Nurse: Medical Assistant Program required. Salary: \$30,000-\$60,000.

Paramedic: No required Skill Program, but the character must have the skills Paramedic and Pilot: Automobile. A high school education is probably required, and one or more years of college are a plus. Salary: \$22,000-\$42,000.

Police Officer: Police/Law Enforcement Program required. Security guards generally make half what police officers do. Salary: \$35,000-\$60,000.

Private Investigator/Detective: Journalist/Investigation Program and/or the Police/Law Enforcement Program required. Security guards generally make half what police officers do. Salary: \$40,000-\$180,000.

Professional Animal Trainer or Veterinarian: For zoos and circuses. No required Programs. Medical program suggested with Paramedic/M.D. switched to Veterinary Doctor. Salary: \$23,000-\$40,000. Double salary if Medical Program is taken.

Professional Musician/Singer/Entertainer: Any combination of Sing, Dance, and Play Musical Instrument is required. Salary: \$20,000-90,000 on average; only 2% earn hundreds of thousands to millions of dollars, and a hero isn't going to have that kind of time to invest in his entertainment career.

Travel Agent: Business Program required. Salary: \$20,000-\$50,000, with the added perk of discounts (20%-50% off) on airfare/travel, lodging, and access to tons of travel information and international events as they pertain to travel.

Truck Driver: Pilot Basic Program required. Salary: \$40,000-\$75,000.

Reporter: Journalism Program required. Salary (newspaper/magazine): \$35,000-\$100,000; Salary (Television): \$60,000-\$500,000.

Teacher: Any Program, which determines what can be taught. Depending on geography, some teachers might also take a Weapon Program. Salary: \$22,000-\$75,000 (typically varies by city to city).

Soldier (any branch of the armed forces): Military Program required. Any other program is suggested, including Journalism and Medical, but Electrical and Mechanical are common. Salary: \$22,000-\$250,000 (for multi-star generals).

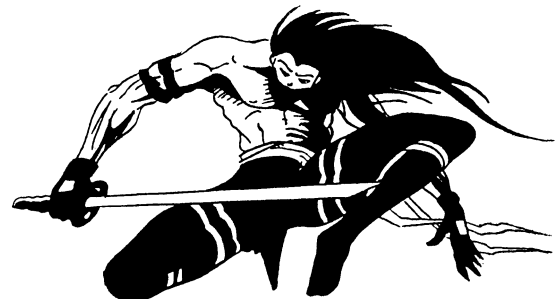

Skill List with base percentages for Quick Reference

Skill Notes:

* These skills provide additional percentage bonuses or special skills. Full details can be found under the appropriate skill description.

+ This skill has prerequisites. See skill description for full details.

(s) Indicates the skill can be taken as a secondary skill.

Communications

Cryptography 25%+5%

Laser 30%+5%

*Optic Systems 30%+5%

(s)Radio: Basic 45%+5%

Radio: Scramblers 35%+5%

Radio: Satellite 25%+5%

+Surveillance Systems 30%+5%

(s)TV/Video 25%+4%

Read Sensory Equipment 30%+5%

Domestic Skills

(s)Cook 35%+5%

(s)Dance 30%+5%

(s)Fishing 40%+5%

(s)Play Musical Instrument 35%+5%

(s)Sewing 40%+5%

(s)Sing 35%+5%

Electrical

(s)Basic Electronics 30%+5%

Computer Repair 25%+5%

Electrical Engineer 30%+5%

Robot Electronics 30%+5% (-40%)

Espionage

Detect Ambush 30%+5%

Detect Concealment 25%+5%

Disguise 25%+5%

Escape Artist 30%+5%

Forgery 20%+5%

Imitate Voices/Impersonation 36%/16%+4%

Intelligence 32%+4%

Interrogation 40%+5%

Pick Pockets 25%+5%

Tracking 25%+5%

(s) Wilderness Survival 35%+5%

Mechanical

Aircraft Mechanics 25%+5%

(s)Automotive Mechanics 25%+5%

(s)Basic Mechanics 30%+5%

*Locksmith 25%+5%

*Mechanical Engineer 25%+5%

Robot Mechanics 30%+5% (-40%)

Weapons Engineer 25%+5%

Medical

Criminal Science and Forensics 35%+5%

(s)First Aid 45%+5%

(s)Holistic Medicine 20%+5%

Paramedic 40%+5%

Medical Doctor 60%/50%+5%

Pathology 40%+5%

Military

*Armorer 40%+5%

Camouflage 20%+5%

Demolitions 60%+3%

Demolitions: Disposal 60%+3%

Find Contraband and Illegal Weapons 26%+4%

Military Etiquette 35%+5%

Nuclear, Biological, Chemical Warfare 35%+5%

Military Parachuting 40%+5%

(s)Recognize Weapon Quality 25%+5%

*Trap/Mine Detection 20%+5%

Underwater Demolitions 56%+4%

Physical

*Acrobatics

Sense of Balance 60%+2%

Walk Tightrope/Highwire 60%+3%

Climb Rope 70%+2%

Back Flip 50%+5%

Climb 40% (or +15% to the full skill)

Prowl 30% (or +5% to the full skill)

(s)Climbing 40%+5%

(s)Rappelling 30%+5%

(s)Gymnastics

Sense of Balance 50%+3%

Work Parallel Bars/Rings 60%+3%

Climb Rope 60%+2%

Back Flip 70%+2%

Climb 25% (or +5% to the full skill)

Prowl 30% (or +5% to the full skill)

(s)Prowl 25%+5%

(s)Swimming 50%+5%

+Swimming Advanced/S.C.U.B.A. 50%+5%

Pilot, Basic

(s)Airplane 50%+4%

(s)Automobile 60%+2%

(s)Boat: Sail Boat 60%+5%

(s)Boat: Motor and Hydrofoil 55%+5%

(s)Boat: Ships: Sailing/Motor 45%+5%/44%+4%

(s) * Horsemanship 50%+4%

(s)Motorcycle 60%+4%

(s)Race Car 55%+3%

(s)Truck 40%+4%

(s)Water Scooters 50%+5%

Pilot, Advanced

Helicopter 35%+5%
Hovercraft 50%+5%
Jet Aircraft 40%+4%
Jet Fighter 40%+4%
Jet Pack 42%+4%
Submersibles 40%+4%
Tanks and APCs 36%+4%
Warships and Patrol Boats 40%+4%

Pilot Related

+Navigation 50%+5%
+Navigation: Space 40%+5%
Read Sensory Equipment 30%+5%
*Weapon Systems 40%+5%

Rogue

(s) * Card Sharp 24%+4%
* +Computer Hacking 30%+5%
(s) * Concealment 20%+4%
Find Contraband and Illegal Weapons 26%+4%
(s) * Palming 20%+5%
(s) Pick Locks 30%+5%
(s) Pick Pockets 25%+5%
(s) Prowl 25%+5%
* +Safecracking 20%+4%
(s) * Seduction 20%+3%
(s) Streetwise 20%+4%
(s) Ventriloquism 16%+4%

Science

Anthropology 20%+5%
* Archaeology 20%+5%
Astronomy 25%+5%
+Astrophysics 25%+5%
Biology 30%+5%
Botany 25%+5%
Chemistry 30%+5%
+Chemistry: Analytical 25%+5%
(s) + Basic Mathematics 45%+5%
(s) + Advanced Mathematics 45%+5%

Technical

(s) Art 35%+5%
(s) Business and Finance 35%+5%
(s) + Computer Operation 40%+5%
(s) + Computer Programming 30%+5%
(s) General Repair/Maintenance 35%+5%
(s) Law (General) 25%+5%
(s) Language 50%+5%
(s) Literacy 30%+5%
(s) Photography 35%+5%
(s) Research 50%+5%
(s) + Writing 25%+5%

Wilderness

(s) Boat Building 25%+5%
(s) * Carpentry 25%+5%
(s) * Hunting
(s) Identify Plants and Fruits 25%+5%
(s) Land Navigation 36%+4%
(s) Preserve Food 25%+5%
(s) * Skin/Prepare Animal Hides 30%+5%
(s) Track Animals 20%+5%

Weapon Proficiencies (W.P.)

Ancient Weapon Proficiencies

W.P. Archery & Targeting
W.P. Blunt
W.P. Chain
W.P. Knife
W.P. Paired Weapons
W.P. Polearm
W.P. Shield
W.P. Spear
W.P. Staff
W.P. Sword
W.P. Targeting
W.P. Whip

Modern Weapon Proficiencies

W.P. Revolver
W.P. Automatic Pistol
W.P. Bolt-Action Rifle
W.P. Automatic & Semi-Automatic Rifles
W.P. Sub-Machinegun
W.P. Heavy Weapons
W.P. Energy Pistol
W.P. Energy Rifle
W.P. Heavy Energy Weapons & Rail Guns



RAMPAGE & SUPER-BRAWLING RULES

By Kevin Siembieda

Note: This section of optional rules was inspired by an e-mail suggestion from a gentleman identified only as Patrick. Good idea, thanks.

The Rampaging Superbeing

When a superbeing is on a *rampage* he is overcome with rage and emotion, which means the character is not thinking clearly, nor using strategy or tactics. The character is simply lashing out, pounding and/or smashing everything in his path — buildings, vehicles, and, unfortunately, people. In the latter case, the rampaging juggernaut is likely to punch, knockdown or throw out of the way people and small obstacles like a car or lamppost. He won't care or even think about killing or smashing something to a pulp, the berserk superbeing isn't that focused, he or she just wants to vent and smash.

This blind rage makes the superbeing a machine of destruction, but also clouds his or her logic and reasoning. This is why any sort of plan, strategy or tactics are replaced by *Power Attacks* that use up numerous melee actions, and displays of brute force and anger (or pain, sorrow, etc.). This gives those opposing a rampaging juggernaut a slight edge, because the superbeing is likely to spend his 6-10 attacks on one or two *Power Attacks*, leaving him with either no other combat actions and vulnerable to counter attacks, or only 1-3 other melee actions/attacks, which still leaves the marauding menace vulnerable to countermeasures. Of course, those one or two *Power Attacks* can be devastating, horrifying and deadly, so one must beware.

Combat Penalties & Modifiers for Rampage

Since the rampaging superbeing is not thinking clearly, he fights without cunning or any thought of strategy or tactics. This reduces the character's combat and thinking skills dramatically.

1. Reduce all combat bonuses, other than saving throws and damage bonuses, by half. This means also reducing any W.P. skill bonuses. **Note:** Only Hardware, Cyborgs and other characters who normally rely on weapons will use them, in addition to lashing out physically. When their ammunition is used up or the weapon is lost or destroyed, the rampager will continue to rage and attack with his bare hands. All other superpowered characters will rely entirely on brute strength and their super abilities to lash out.

2. Skills are performed at -70%, if the rampaging behemoth even stops to think about using a skill.

3. Attacks per round are unchanged, but at least one attack *every* melee round will be a *Power Attack* that uses up four melee actions.

4. Fueled by the rage and emotions responsible for the rampage, the character is impervious to charm or domination magic, immune to psionic hypnosis and +5 to save vs all forms of mind control, empathic attacks and possession.

5. Only cares about hitting and knocking people and things out of his way. This means the rampaging character is not actually interested in killing anybody or even intent on hurting anybody, remember, the character is not thinking, but violently acting out. People are getting hurt without the rampager realizing it. This also means the maniac will stop fighting an opponent as soon as that antagonist is knocked, punched, or thrown out of his way, goes down on his back ("playing" dead can save a hero's life) or goes out of view. Out of sight, out of mind.

6. It is very unlikely to get the rampager to stop by "reaching" him through words or emotional pleas — he or she is temporarily insane. The following are the range of possibilities. **Note:** Reduce the chance of success by half if the rampaging superbeing is Miscreant or Diabolic evil. Reduce chance of success by one quarter if Anarchist or Aberrant.

a) Reasoning with the rampaging character has a 01-6% chance of success. -4% if the authorities or an old rival or enemy makes the plea, +6% if a child makes the appeal, and +16% if the character making the plea is one of the people the superbeing loves most in the world (probably wife, girl/boy-friend, parent, or sibling).

Failure means getting struck, beaten up (several punches) or pushed, knocked or thrown out of the way.

b) Seeing an innocent in danger and screaming for help has a 01-10% chance of snapping the rampager to his senses; +10% if a baby, +15% if a crying child or mother and child, and +40% if the character in danger is one of the people the superbeing loves most in the world (probably wife, girl/boy-friend, parent, or sibling). However, the danger must be genuine and life threatening.

Failure to reach the superbeing means the rampage continues. However, even if the rampager ignores the plea and continues the rampage, the character will not attack that innocent person(s) or do anything to make the danger worse. He will turn or go around and move on.



The alternative is to physically stop the superbeing by:

1. Restraining him — the rampager will snap out of the berserker rage within 1D6x10 minutes.
2. Knocking him out — 01-55% chance of awaking within 2D6 minutes calm and comparatively clear headed and remorseful or 56-00% wakes up swinging and hollering, but can be reasoned with and calmed down within 1D4 melee rounds.
3. Killing him!

The Super-Brawl

The super-brawl is very similar to the rampage in that a lot of damage is done and the combatants are so focused on their brawl that they have lost sight of the damage they are doing and the innocent lives that are being placed in jeopardy. Also like the rampage, the combatants are likely to forget about strategy and tactics (although they may use them from time to time during a brawl, especially when the brawlers tire of the battle) and use *power attacks* that use up numerous attacks per round and display incredible feats of raw power.

This wild conflict is different than the rampage because it takes two to tango. There must be at least two opposing combatants or two sides/teams of brawlers. The object of the battle is for one side to beat the other. When one side says uncle, surrenders, acknowledges the other side is better, admits defeat, runs away or is obviously defeated (too weak to fight on or all are knocked senseless), the brawl stops. It is only then that any “hero” will realize the senseless destruction and perhaps, injury and deaths this little fracas may have caused.

Unlike the rampaging superbeing, “good guys” caught up in a brawl keep enough presence of mind to realize when their duel may be putting innocent people in jeopardy. This may cause the hero(s) to move the fight to a place where innocent people aren’t going to be endangered, or get the hero to pause the grudge match long enough to rush over to help, remove, protect or save the innocent(s) from the danger he or she helped create. Likewise, the good guy brawler will try to avoid and ignore the authorities, friends and fellow heroes who try to stop brawl. They will lash out at them only when they directly intervene, i.e. get between the brawlers or try to restrain one or both sides.

Like the beserker, the brawler doesn’t want to hurt his buddies or the authorities, but this fight is “personal,” so he will push, knock or throw them out of the way, even use fisticuffs or powers to incapacitate or remove them. **Note:** Supervillains and some anarchist anti-heroes may not share the “heroes” regard for others and will *press their advantage* when their good guy opponent is distracted trying to protect or save an innocent life or pauses to warn/speak to a friend or the authorities.

Combat Penalties & Modifiers for Brawling

The brawler(s) isn’t quite as oblivious as the superbeing on a rampage, but is still on a tear, does not think rationally and is very difficult to reach.

1. Reduce all combat bonuses, other than saving throws and damage bonuses, by half. This means also reducing any W.P. skill bonuses. **Note:** Only Hardware, Cyborgs and other characters who normally rely on weapons will use them, in addition to lashing out physically. When the ammunition is used up or the weapon is lost or destroyed, the brawler will continue to fight with his bare hands or use whatever available weapon might be handy (a piece of pipe or chair used as club, a gun dropped by a police officer, etc.). All other superpowered characters will rely entirely on brute strength and their super abilities to lash out.

2. Skills are performed at -40%, at least when the brawler stops to think about using a skill.

3. Attacks per round are unchanged, but at least one attack *every* melee round will be a *Power Attack* that uses up four melee actions.

4. Because the brawler is trying to make a point, prove himself superior, or beat an opponent into submission, he is not using deadly force. This means all attacks, even *Power Attacks*, are controlled, “pulled punches” that inflict *half damage*.

Only an anarchist or evil character will cheat, and pull out all the stops (full damage) if he fears he is on the brink of losing. But this won’t occur until all S.D.C. is gone and the character’s Hit Points are down by half.

Note: Most brawls are over when one side admits defeat, one side is clearly defeated (down to one third or less in Hit Points), or declared a “draw” when both sides are down roughly equally to about one third of their Hit Points and no clear winner is obvious. A draw can also happen when the opposing sides mutually agree to stop the fight, for whatever reason, and that neither is a clear winner. If one side quits (perhaps to save lives or stop senseless destruction) without the opposing side admitting defeat, then the “quitter” is proclaimed the loser (a draw if the opposition is nice) and the other side can go off triumphant. Of course, depending on the reason their antagonist quit, he/she/they may be the real winner(s).

5. Fueled by the emotions and the need to prove something, the brawlers are resistant to charm and domination magic (+3 to save) and +2 to save vs all forms of mind control, psionic hypnosis or empathic attacks and possession.

6. The brawlers only care about winning the fight, and are so focused on this goal that they do not realize the amount of damage they are causing or the lives they may be endangering. This means the brawling characters are not deliberately wreaking havoc or trying to hurt anybody, they just want to win.

Winning means beating one’s opponent(s) into submission or surrender (“You win! I quit!” or “Yes, you are the better or the stronger of us,”), or into unconsciousness, or into fleeing with their tails between their legs (leaving the other brawler standing triumphant as the obvious winner). As soon as one of the brawling sides “wins,” the battle is over.

7. It is difficult to get one participant(s) or the other in a brawl to stop by “reaching” him through words or emo-

tional pleas — they are temporarily obsessed with their duel and winning. The following are the range of possibilities. **Note:** Reduce the chance of success by three quarters if the brawling superbeing is Miscreant or Diabolic evil. Reduce chance of success by one quarter if Anarchist or Aberrant.

a) Reasoning with the brawling character has a 01-20% chance of success. -10% if the authorities or an old rival or enemy makes the plea, +15% if a respected teammate or friend makes the appeal, +25% if a child makes the plea, and +40% if the character making the plea is one of the people the superbeing loves most in the world (probably wife, girl/boy-friend, parent, or sibling).

Failure means getting struck, beaten up (several punches) or pushed, knocked or thrown out of the way.

b) Seeing an innocent in danger and screaming for help will get any good aligned brawler to pause and save the person(s) he's helped to put into danger. There is a 01-33% chance that the realization that his action caused the danger will get the good guy to stop his brawl. +25% if the people he's just rescued beg him to stop or question why he's doing this "terrible" thing, +33% if a child makes the plea or asks the question. +20% if a respected teammate or +50% if one of the people the superbeing loves

most in the world (probably wife, girl/boy-friend, parent, or sibling) renews their appeal to stop the brawl is made immediately after this incident. +70% if the brawler couldn't save/protect the innocent life(s) but one of his teammates, or another hero (or better yet, ordinary person) was able to rescue them. In all cases, the danger must be genuine and life threatening.

Failure to reach the superbeing means the brawl continues. However, brawlers of a Principled, Scrupulous, or Unprincipled alignment and perhaps some Anarchist or Aberrant characters will not deliberately endanger or hurt innocent people.

The alternative is to physically stop the superbeing by:

1. Restraining him — the brawler will snap out of the rage within 2D4 minutes.
2. Knocking him out — 01-65% chance of awaking within 2D6 minutes calm and comparatively clear headed and remorseful or 66-00% wakes up swinging and hollering, but can be reasoned with and calmed down within one melee round.
3. Killing him!

SPECIAL COMBAT ATTACKS FOR BRAWLING & RAMPAGES

Unless stated otherwise, these attacks and combat moves can be done by superbeings at any time, but burn up the character's attacks per melee round and, without the anger and/or wild frenzy, inflict 40% less damage. Remember, all damage is half when used in a brawl, although impressive and frightening to watch.

POWER ATTACKS

Note: Unless stated otherwise, all Power Attacks use up *four* melee actions/attacks, so even experienced superbeings with numerous attacks will not be able to perform more than one or two Power Attacks per melee round. Rampaging superbeings will perform as many Power Attacks as they can each and every melee round (typically one or two). Any melee actions left afterwards are used to take new actions or to punch and make more destruction. Brawlers will always perform at least one Power Attack each melee round and use whatever attacks are left a bit more strategically (unless it is an all-out slug-fest, then as many Power Attacks as possible will be used).

Furthermore, the character (especially low level ones with only 4-6 attacks per round) may have to use this attack at the beginning of a round before he uses up his melee actions.

Once all attacks/actions are used up in that round, the berserk or brawling character can only parry or dodge (using up his actions for the next round), hide, or stand and take damage (often the latter).

Remember, all damage is half when used in a brawl.

Normal Throwing

Normally a character can not throw more than he can carry.

Normal Effective Throwing Range by Strength

Object	Normal	Extraordinary	Supernatural
	for Humans	Superhuman	Strength
	<u>P.S. 03-19</u>	<u>P.S. 20-30</u>	<u>P.S. 18-Up</u>
Up to 1 lb. Object	50 feet	200 feet	300 feet
Up to 10 lb. Item	—	100 feet	200 feet
Up to 100 lb item	—	50 feet	100 feet
Up to 200 lb item	—	10 feet	30 feet
Greater weights	— see below	—	—
Dart	30 feet	60 feet	100 feet
Throwing Axe	80 feet	150 feet	300 feet
Javelin	300 feet	400 feet	500 feet
Spear	100 feet	150 feet	200 feet
Knife	40 feet	80 feet	200 feet
Sword	15 feet	30 feet	60 feet

Optional: Add one foot (0.3 m) to the effective range for every P.S. point e.g., Human P.S. 24 add 24 feet (7.3 m).

Note: Objects such as swords, bricks, bottles, chairs, doors, trees, cars and similar items are not designed for throwing. Consequently, the effective range is limited regardless of the strength behind it because the item is not aerodynamic.

Darts, knives and throwing axes are designed for throwing, but don't have the weight or balance for great distances. The same is true of most objects weighing less than half a pound. Javelins, more so than spears, are designed for distance throwing.

Miscellaneous items weighing over a pound (0.45 kg) and less than 10 pounds (4.5 kg), such as chairs, stools, lanterns, etc., can be thrown about *half* as far as the one pound (0.45 kg) object.

Throwing Greater Weights:

Normal and Extraordinarily Strong characters can hurl a weight equal to the weight he can *carry* four inches per each P.S. point. This means the person with a P.S. 9 can toss 90 lbs (40.5 kg) up to 2 1/2 feet (0.6 to 0.75 m) away. The hero with a P.S. of 17 can toss 340 lbs (154 kg) up to 5 feet, 6 inches (1.75 m) away.

Superhumanly Strong Characters can hurl a weight equal to the weight he can *carry* eight inches per each P.S. Point. This means the hero with a superhuman P.S. of 17 can toss 3400 lbs (1530 kg) up to 11 feet (3.3 m) away.

Supernatural Characters can hurl their maximum carrying weight one foot (0.3 m) per P.S. Point. So a supernatural character with a P.S. of 24 can hurl an incredibly heavy object (up to 7200 lbs/3240 kg) an impressive 24 feet (7.3 m).

Damage from Heavy Objects: 1D6 +1D6 points per every 20 pounds (9 kg), so a 100 pound (90 kg) item will inflict 6D6 points of damage! A thousand pound (900 kg) object 6D6x10!!

Power Lift & Throw

This power enables characters with Extraordinary, Superhuman and Supernatural Strength to throw heavier objects much greater distances. Normally, the character can not carry or throw as much weight as he can lift. However, in this case, the character can lift a weight up to his maximum weight lifting tolerance and heave it away or at somebody. This means the character may be able to lift and throw a boulder, automobile, (incapacitated) robot, etc.

Throwing Range:

Extraordinary P.S.: Double the norm.

Superhuman P.S.: Double the norm.

Supernatural P.S.: Double the norm (triple if a Mega-Hero).

Cost: Four melee actions/attacks.

Saving Throw for Targeted Victims: Dodge at +2, because they can see the superbeing as he lifts, strains and looks or motions their way a second before he throws. Also, it takes 4-6 seconds to lift and hurl the heavy object, leaving the character open to *two* attacks, without defense, from any one opponent during that time! Or gives likely targets a chance to take cover or try to run out of range.

Bonus to Strike: None! Unmodified die roll only when throwing the huge, heavy item (car, boulder, etc.) at a small target (anything smaller or lighter than the item being thrown). Will automatically hit huge, slow moving or stationary targets like a tank, ship, house, wall, etc., unless a 5 or lower is rolled. 1-5 means the toss either missed or fell short.

Damage from Heavy Objects: 1D6 +1D6 points per every 20 pounds (9 kg), so a 100 pound (90 kg) item will inflict 6D6 points of damage! A thousand pound (900 kg) object 6D6x10!!

Damage to a human being or animal getting picked up and tossed is ...

4D6 damage if tossed comparatively gently.

1D4x10 if tossed aside, but not very far.

1D6x10+6 if thrown hard (probably a 100 ft/30.5 m or more).

2D4x10 +P.S. damage bonus if tossed with all his might.

Half damage if the humanoid is giant-sized (12 ft/3.6 m or bigger) or weighs more than 1000 pounds (450 kg).

In addition, the thrown character also loses initiative (the attacker has it), loses two melee actions/attacks (the time it takes to get his wits and back on his feet) and has a 01-70% chance of dropping whatever he was holding at the time. Characters who can fly, teleport, or become weightless (and perhaps a few others) can stop themselves before impact and avoid taking any damage, but lose one melee action.

Alternative use of the Power. If the character can lift the object, he can also turn it on its side or flip it over. Same cost.

Improvised Power Club

The enraged superbeing can pick up any large or heavy object, equal up to his maximum *carrying weight* and use it as a bludgeon or battering ram. The weapon does additional damage as noted below. For an item not listed, use this as a guideline.

Automobile, Small (subcompact?): 1D4x10 +P.S. damage.

Automobile, Mid-Size: 1D6x10 +P.S. damage.

Desk: 5D6 +P.S. damage.

Couch or Bed: 3D6 +P.S. damage.

Easy Chair or Door: 3D6 +P.S. damage.

Lamp Post or Tree: 6D6 +P.S. Damage.

Mail Box or Telephone Booth: 3D6 +P.S. damage.

Tank Turret or Cannon: 1D4x10 +P.S. damage.

Table, Large: 4D6 +P.S. damage.

Humanoid: Ordinary Person: 2D6 +P.S. damage; the human club also takes the same amount of damage that is dished out.

Humanoid: Superbeing who is Invulnerable, has Extraordinary P.E. or can Alter form into something hard and durable: 3D6 +P.S. damage; the superhuman-club takes 2D6 damage with every hit.

Cost: First the character must find such a weapon and may have to spend four melee actions/attacks to knock or tear one down for himself.

Each attack/strike with the giant weapon counts as two melee actions and probably requires the use of both hands to wield.

Power Slam/Body Block

This is when the superbeing gears up with all his strength and girth and slams into his opponent or an object (wall, door, etc.).

Cost: Four melee actions/attacks.

- **Against a living opponent** this attack inflicts 5D6 +P.S. damage bonus (double damage to ordinary people or animals), plus will knock any opponent weighing less than 400 lbs. (180 kg) off his feet and send him flying one foot (0.3 m) for every P.S. strength point (double for ordinary people and small animals). The victim of the Power Slam also loses initiative (the attacker has it), loses two melee actions/attacks (the time it takes to get his wits and back on his feet) and has a 01-60% of dropping whatever he was holding at the time of fierce impact. **Note:** Giants and characters weighing more than 400lbs (180kg) take full damage, are staggered, but only lose one melee action, both attacker and opponent reroll for initiative and there is only a 01-25% chance of the victim dropping whatever he was holding at the time of impact.
- **Against wheeled objects**, the character will inflict the damage as noted and will cause it to roll forward or backward, depending on which end was slammed. Extraordinary P.S.: One foot (0.3 m) per P.S. point. Superhuman P.S.: Two feet (0.6 m) per P.S. point. Supernatural P.S.: Five feet (1.5 m) per P.S. point. If hit from the side, the character has a *chance* of knocking it on its side. Extraordinary P.S.: 01-50% chance. Superhuman P.S.: 01-80% chance. Supernatural P.S.: 01-98% likelihood; 01-60% chance of knocking it completely over (the top is bottom, wheels sticking in the air). **Note:** Cannot knock over or move any vehicle that weighs more than double the character's maximum lifting weight.
- **Against inanimate objects** this attack delivers enough force to crack and knock down a lamp post, knock a gate or door off its hinges and force open or knock in any door that has the equivalent of 200 or less S.D.C. and opens inward. 300 S.D.C. for characters with **Extraordinary Strength**, 500 S.D.C. for beings with **Superhuman Strength** and 800 S.D.C. for beings with **Supernatural Strength!**

In this case, the impact only slightly damages the door, gate, or object (5D6 damage bonus), but is so powerful that the hinges, door frame, joint, connections or weak spot break/give way and the barrier comes falling down. The actual door, gate, lamp post, etc., can be fixed later with signs of minimal to no damage. The base or frame will require major repairs, perhaps complete replacement.

If a door or gate has half or more S.D.C. than the maximum noted, but opens *outward*, it will take two Power Slams to force it open, *inward*. In this case, the door is shattered, cracked in half or (if metal) bent and mangled. If the door has half or less the S.D.C. maximum to slam open, it can be forced inward in one Power Slam.

If the object is a wall the superbeing does 5D6 +P.S. damage and is the equivalent of getting hit by a wrecking ball. If the damage inflicted is greater than the wall's S.D.C., then the superbeing plowed right through it and there is a man-sized gaping hole! If not, there is obvious and serious man-sized damage to paint, plaster and a good number of bricks may be knocked partially in. Two or three tries may be necessary depending on the building material and thickness of the barrier.

Typical S.D.C.	Values
Car, Door Only	150 S.D.C.
Car, Windshield	70 S.D.C.
Car, Window (side)	35 S.D.C.
Chain	30 to 50 S.D.C.
Door, Interior, Wood	100 S.D.C.
Door, Exterior, Wood	170 S.D.C.
Door, Metal Grille	350 S.D.C.
Door, Solid Metal	600 S.D.C.
Door, Metal Safe	800 S.D.C.
Door, Bank Vault	5,000 S.D.C.
Fence, Cyclone Mesh	100 S.D.C. per 10 sq. ft (0.9 sq. m)
Fence, Iron Post	250 S.D.C. per 10 sq. ft (0.9 sq. m)
Fence, Wood	70 S.D.C. per 10 sq. ft (0.9 sq. m)
Gate, Wood, Simple	30 S.C.C.
Gate, Wood, Heavy	60 S.D.C.
Gate, Metal, Average	100 S.D.C.
Gate, Metal, Heavy	250 S.D.C.
Gate, Metal, Security	500 S.D.C.
Wall, Interior Plaster	75 S.D.C. per 10 sq. ft (0.9 sq. m)
Wall, Exterior Wood	150 S.D.C. per 10 sq. ft (0.9 sq. m)
Wall, Exterior Brick	200 S.D.C. per 10 sq. ft (0.9 sq. m)
Wall, Cinder Block	300 S.D.C. per 10 sq. ft (0.9 sq. m)
Wall, Reinforced Concrete	400 S.D.C. per 10 sq. ft (0.9 sq. m)
Wall, Fortified Stone	800 S.D.C. per 10 sq. ft (0.9 sq. m)
Wall, Castle, feet thick	1,000 S.D.C. per 10 sq. ft (0.9 sq. m)
Wall: Super-Alloy	1,000 S.D.C. per 10 sq. ft (0.9 sq. m)

Note: See HU2, page 70 for other S.D.C. values of objects.

Running Power Leap

A wild man leap that has a running start and is delivered with all the strength the character can muster. Leaps lengthwise/across a half foot (0.15 m) for every P.S. point of **normal human strength**, half to leap up/vertically. So a character with a P.S. of 24 would leap 12 feet (3.6 m) long and 6 feet (1.8 m) high.

Characters with **Extraordinary Strength** leap one foot (0.3 m) lengthwise/across and half that leaping up/vertical. So a superbeing with an Extraordinary P.S. of 24 can leap 24 feet (7.3 m) long and 12 feet (3.6 m) high; double for **Superhuman Strength**.

Six feet (1.8 m) long and four feet (1.2 m) high per each P.S. point of **Supernatural Strength**. So a character with a P.S. of 40 Supernatural Strength can leap an amazing 240 feet (73 m) long and 160 feet (49 m) high!

Note: No bonuses to strike (land on a specific target area or opponent) apply when in a brawl or rampage; unmodified die roll. If this tactic is used under other circumstances and with thought and reason, the character's bonus to strike is only half. Remember that distance and height are reduced by 40%.

Cost: Four melee actions/attacks.

Running Power Ram

Fundamentally the same as the Power Slam, only double the damage and double the equivalent S.D.C. that can be knocked down or smashed through!

Can stop a moving vehicle that is smaller than a small bus or truck. A head-on collision is likely to total the car and render it impossible to move/drive. Leverage, mass and foothold are the problem against larger vehicles (such as a tank, train, or semi-truck, etc.) — strength alone cannot stop a big, heavy moving vehicle. However, if the superbeing also has great weight/mass and/or the powers of Invulnerability, Grow Giant-Sized, Magnetism, Gravity Control, Flight or Superspeed (possibly a few others), he may be able to slow the massive vehicle down to a crawl (under two mph/ 3.2 km).

Cost: Six — yes, 6 melee actions/attacks, and requires a running start.

Conventional Power Punch

Does double the character's normal punch damage +P.S. damage bonus. A *Power Kick* can also be done, to inflict double kick damage. A *Power Bite* is not possible.

Cost: Two melee actions.

Note: See *Two-Handed Super-Power Punch* for punching through a wall.

Two-Handed Super-Power Punch

This is when the superbeing gears up with all his strength and girth and pounds his opponent or an object (car, barrier, etc.) with all his might.

Damage:

Ordinary Human P.S.: 4D6 +P.S. damage bonus.

Extraordinary P.S.: 6D6 +P.S. damage bonus.

Superhuman P.S.: 1D6x10 +P.S. damage bonus.

Supernatural P.S.: 2D6x10 +P.S. damage bonus.

Alternate Use: The Punch Through attack. This attack is used to punch through a barrier with one devastating blow. In this case, either *one hand* or *two* can be used. One hand does half the damage noted above. Full damage if both hands are used.

If the damage inflicted equals or surpasses 25% of the barrier's S.D.C., the superbeing successfully punched right through. A one-handed punch leaves a fist-sized hole! Whether or not the punch struck anyone behind the barrier depends on whether or not someone was standing within two feet (0.6 m) of it. Such a punch does half damage to that individual and is probably an accident or lucky punch to have hit him. If both hands are used, the blow starts over the attacker's head and slashes downward. This will create a larger hole in the door or wall, about the size of two or three fists. The barrier still holds (for now), there are just these large holes in it. Holes in which the attacker can reach his arm in to try to grab whoever is behind the barrier, as well as to look, shout or shoot through.

Cost: Four melee actions/attacks for all of these punching attacks, including the One-Handed Super-Power Punch.

Note: No bonuses to strike apply when using these attacks in a brawl or rampage; unmodified die roll, although it can't miss large, stationary or incapacitated targets. Use the S.D.C. of a 10 foot (3 m) area for a wall.

If this tactic is used under other circumstances and with thought and reason, the character's bonus to strike is half. Remember that damage is reduced by 40% under this use.

Two-Handed Power Hold

The superbeing can grab and hold an opponent or large object with his arms folded and hands holding on in a "bear hug" style grip.

This hold does not crush or squeeze but is an iron grip like a vice. To break free, a combined P.S. twice as great as the character holding on is required.

Cost: Six melee actions/attacks to hold on for 15 seconds. Note that most rampaging characters will not maintain a hold for more than 30 seconds; brawlers twice that long. The maximum this super hold can be maintained is two minutes. As long as the hold is maintained the superbeing cannot use his arms to strike, but he can run, leap, kick and headbutt. All combat bonuses are reduced by half while the hold is in place.

Two-Handed Power Pull

This enraged character can pull up to his maximum *lifting weight*, double if it is on wheels. This can mean dragging around a half ton or more with both hands or pulling a cart filled with boxes, or even towing a small vehicle. Likewise the character can pull a weight at the end of a rope or chain, or pull an object of great weight (up to lifting weight) to hold it in place.

One powerful tug may pull a heavy object at the end of a rope, chain or cable right to the superbeing.

Ordinary Human P.S.: Half foot (0.15 m) per P.S. point.

Extraordinary P.S.: One foot (0.3 m) per P.S. point.

Superhuman P.S.: Two feet (0.6 m) per P.S. point.

Supernatural P.S.: Four feet (1.2 m) per P.S. point.

Cost: Each Power Pull/Tug costs four melee actions/attacks. To hold a heavy object in place for one full melee round costs all but one melee action.

Note: See *Two-Handed Power Tear* for pulling doors off their hinges. The G.M. may consider the issue of leverage and mass (or the lack of it) as he or she deems fit, or ignore it altogether (like most comic books do).

Two-Handed Power Tear

This ability allows someone to tear a door or gate from its hinges, a padlock or chain from its anchor, or an object from its base with his bare hands! The weight of the item

cannot surpass the character's *carrying weight*. Like the Power Slam and Ram, the tear can leave most of the object intact, damaging only joints, hinges, anchors, bolts, etc. This means the character can tear away items from their connector equal to a particular S.D.C. amount for the entire door or item being torn away.

Normal: 30 S.D.C.

Extraordinary P.S.: 150 S.D.C.

Superhuman P.S.: 250 S.D.C.

Supernatural P.S.: 400 S.D.C.

Note: Remember these amounts are 40% less when not part of a rampage or brawl.

Cost: Four melee actions/attacks.

Creating and Running Adventures

By Kevin Siembieda & Wayne Breaux Jr.

Unleash the power of imagination

Players of *any* role-playing games are limited only by their imagination. The rules and text of a specific game only serve to establish a basic playing field, characters, approach, guidelines and suggested setting — it's the Game Master and his/her players who truly breathe life into it.

Palladium Books tries to provide a dynamic setting, with exciting ideas, strong characters and a catalyst for adventure. Furthermore, since all of Palladium's games use the same *basic* set of rules, it is a simple matter to draw on ideas, characters, and so forth, from any of Palladium's other games, be they **Heroes Unlimited™**, **Nightbane®**, **Rifts®** or one of the many others. This means the Game Master can pull characters, settings and ideas from one game and drop them into another with little or no modifications.

The Heroes Unlimited™ RPG and its sourcebooks only establishes the foundation for your gaming pleasure, it's up to you to build something fun out of it. Players can stick tightly to the *Heroes Unlimited™ Universe*, using its heroes, villains and settings, or they can depart from it to create their own vision of that universe, or something completely different. With a little bit of effort, imagination and time, players and Game Masters can create characters and locales to fit into their game world from *any* source (even the competition)!

Ideas for heroes, villains, magic, weapons, equipments, gimmicks, plots, adventure ideas and other elements can be found in other role-playing games and supplements, comic books, novels, television shows, movies, cartoons, live plays, history, science, magazines, newspaper articles, conversations with friends, and daydreaming. Draw from them to add color and excitement to your games. So unleash your imagination and let it carry you to new worlds of adventure. Just remember, as fun as it is to imagine and pretend, don't lose sight of reality. **Heroes Unlimited's** magic, powers, weapons, villains, characters and worlds are *fictional* creations spun from imagination, dice and paper. It's not real.

Running Adventures

For me, Wayne Breaux, this part of the book was inspired by the work and worry a friend of mine suffers through whenever we "encourage" him to G.M. Through the years he has periodically asked me for advice and tips on Game Mastering adventures, and always tells me to "write this stuff down." Well, I finally did some of that for him and I include it here with additional comments and information by Kevin. I hope it may be useful to those of you out there that find yourself with an eager group of players



who simply want to have fun with *you*, as G.M. leading the way.

If the players ask you to “G.M.,” don’t sweat it. Chances are, they gave *you* the job because they think you are up to the task and/or like your style of gaming. If they didn’t, they wouldn’t ask, now would they? So if they think you can pull it off, take a deep breath, relax, have fun, and get to it.

Oh, yeah, notice the word fun was part of that advice. The G.M. has a lot of work and responsibility to make the adventure fun for his players, but it is important that he or she has fun too and gets enjoyment in executing the story and keeping the pacing clean and smooth. Fun in surprising or scaring the players by some unexpected turn of events. The satisfaction of seeing the players shouting, laughing and getting excited over what their characters are doing or the trouble they are in. The pleasure of hav-

ing run a “great” adventure where every player has a moment to make his character shine, the action was smooth, the story was strong and everybody had fun.

That said, it still can be hair-raising to function as the Game Master. After all, it is *you* who must breathe life into the simple Hook, Line & Sinker adventure outline or the mightiest epic campaign. To help out all those poor G.M.s “recruited” into their line of work, or even for seasoned veterans on the lookout for new approaches, ideas, angles, and tips, here is some material on running adventures that should prove useful.

As Game Master (G.M.), you are the person who controls *everything*, from the weather and time of day to villains and the reactions of Non-Player Characters (NPCs) — literally everything except the player characters. Use NPCs, news reports, rumors, humor, direct confrontation, and so on, to subtly (and sometimes not so subtly) move

and shape events to go in the *general direction* you desire.

However, you do not control the player characters and should not try to. Part of the fun is that they represent both the X-factors/wild cards and your teammates in building a fun adventure.

Inevitably, these free-thinkers will have their characters do and say brilliant, heroic, cowardly, stupid, profound, silly, outrageous things of all kinds, and god only knows when. Frequently, these are actions the G.M. could *never* have anticipated, so don't feel unnerved if they surprise you. Enjoy it. And that's a huge part of the fun and magic in "role-playing" —there is no set story and there are constant twists, turns and surprises! Everything is constantly moving, changing and building!! What one character says and does will affect all the others, good or bad, and will elicit a response from the G.M. (probably through one or more of the Non-Player Characters), as well as the other players.

This means the G.M. needs to be flexible and go with the flow. If the players throw you, the Game Master, a curve ball (and players are notorious for this), then it's up to you to think on your feet and roll with it. Relish a player's surprise move or ingenious plan for his character. Likewise, take advantage of a foolish action or a goofy plan. Take things in a different direction or possibly even on an entirely new adventure or a humorous side adventure.

Thinking quick and flexibility is the “*Golden Rule*” for G.M.s

Flexibility. Improvisation. These are the Game Master's (G.M.) most important tools. Be ready for anything and go with the flow. Don't be unnerved by anything the players may do that surprises or confuses you. Remember, as G.M., you can “pause” the action and ask questions. Like a judge listening to witnesses, you must have a clear idea in your mind as to what a character is doing when, and why. If it doesn't make sense, question it and suggest some different course of action or ask the player, “Are you sure that's what you want your character to do?” **Note:** See the section on Playing Heroes for dealing with possible alignment issues.

Once things are clear, let the action continue. One way to be flexible is to use the concept of **consequences**. For everything a character does, it will provoke action and reaction from those around him. From his opponent and other NPCs, from his fellow player characters, the public, the media, the law, and on and on. There will be consequences from public praise or condemnation to being given a medal or branded a criminal. It is up to the G.M. to respond and react appropriately. To consider all (or at least several) possibilities and pick the one that seems the most likely or appropriate and exciting or fun in the context of the game.

The easiest way to use consequences (big and small, serious and humorous) is for the Game Master to have a

very clear idea in his mind of the fictional world they all are playing in. To know how the authorities, media and people feel about superbeings in general and our player group in particular. To know who key NPC characters are, their stats and personalities, their likes and prejudices and, as a result, how they will react to the player characters (hostile, critical, supportive, self-serving, etc.). Likewise, if the G.M. knows his “town” or environment where most of the action takes place, and the key characters in it, good, bad, and indifferent, he'll have an idea of how they will react and whether or not, for instance, a gang of hoods might use a disaster as cover to their own criminal plans, or whether another superbeing might intercede on behalf of the heroes or the villains.

There are logical consequences to everything. The player group going to investigate strange happenings or allegations of trouble at an abandoned warehouse are careless and talk loudly, argue amongst themselves or make noise kicking in a locked door. The consequence is simple: the bad guys inside hear them. The question the G.M. must ask himself is, how do they react? If the G.M. “knows” his NPCs and their personalities and schemes (in his own mind), he can quickly and easily improvise their reaction. If they are paranoid, they are likely to dispatch a powerful team of defenders, hit men, killer robots or superbeings to investigate. If they are overconfident, the bad guys might send some low level henchman or two to investigate, or ignore the noise completely! If the bad guys don't want to be discovered or are afraid/not ready for a confrontation with superbeings, they will try to conceal their presence and hide or flee (and conceal any evidence of their activity in the warehouse, the entrance to a secret base or hideout, etc.). Get the idea?

This will give the G.M. the ability to respond quickly, seem unshakable, and make him or her incredibly flexible — able to respond to just about anything and make it seem logical. Perhaps needless to say, this also adds depth and color to the unfolding story, and leaves the players with the feeling that they are part of a large, expansive world.

It's all about story — not control

Many a role-player will state that, as the Game Master (G.M.), *you* have total control over the adventure. Sort of, but not really. Yes, it is the G.M. who sets the stage, introduces villains and trouble, and who, ultimately, makes all the final rules decisions and implementations. The Game Master also has tremendous influence on the pace, movement and direction of the game, as well as authority over what the players can and can not do. He or she keeps track of details, points out things to the players, and keeps them honest (no fudging of rules, bumping up unseen dice rolls, etc.). But none of this is a control issue, it's a matter of creation and building a foundation for the players and the exciting adventure to come.

Many G.M.s (especially beginners, but even some veterans) complain that “their players” ruin, break, or destroy

an adventure because they do *not* stick to a pre-assigned script, or they don't follow a certain lead, defeat a particular villain, or do what the G.M. had in mind. So much for control and authority.

What these beleaguered G.M.s are missing is that there is no hard and fast pre-assigned script or exact way the adventure is "supposed to go." The trick to being a superior G.M. goes back to *flexibility* and *improvisation!*

The players don't have to do what the G.M. has mentally pictured in his head. Remember, a role-playing game is not (and never should be) a contest between the G.M. and the players. Everybody is part of a team — a group. The G.M. is, in effect, the "anchor" of that group. The guy or gal who lays down the *foundation* of the setting and action to come. The G.M. sets the mood, introduces clues, hints, events, people (Non-Player Characters), problems/crises, antagonists and complications. He or she *sets into motion* events and actions that will spin into an adventure. It's up to the players to roll with the stimuli and help build the story.

If worst comes to worst, pause the game and confess that you just aren't prepared to go into that direction. This is especially true of new Game Masters. Players generally understand if you say, "Well, you guys surprised me and turned that storyline around, so I need to write another adventure (or rewrite this one) to keep you going." Players want to have fun, and if they have to wait for you to modify the adventure, most of them will. Especially considering the alternative of not playing at all! You may even be able to rework the adventure on the spot during a well-timed meal break or while your players enjoy a little tabletop chit-chat. This may also get the players to change their minds and put that subplot aside as a "future adventure," allowing the G.M. to continue his current story arc and giving him time (a week or two) to prepare to develop the avenue the group would like to go.

But here's an alternative: This is where flexibility and consequences come into play. If you know, in your mind, the city and the situation, you should be able to improvise and let the characters go in any direction they desire.

Consequences come into play when they *ignore* clues and strong hints about other bad or dangerous things brewing (i.e. your original adventure idea for the night). As a result of the heroes traipsing off, they aren't available to stop or deter the villain(s), and something bad happens. Maybe they could have stopped, saved lives, etc, but they didn't because they decided to ignore the hints and clues, or decided the danger was overblown or not imminent, so it happened when they could have — should have — prevented it. What do they do now? **G.M. Note:** See, their sidetrack just became an interesting part of the original and main adventure. Cool, huh?

Along similar lines, don't let *dead ends* stop you cold, either. If a player insists on pursuing an obvious dead end, you might be inspired to expand or change that element of the story. For example, your heroes have been shaking down a bunch of low-level thugs for information that they honestly don't have. If they keep this up, then the adventure won't progress at all, yet your players remain obli-

ous to that. Rather than letting them bang their heads against the figurative wall all night, use this obstacle to your advantage. Perhaps the villain the heroes are tracking down hears that they're beating up his henchmen and decides to save the heroes some trouble and attacks them now, when they least expect it. Or maybe the thugs tell the heroes some completely erroneous (but genuine-sounding) information just to get them off their backs, sending them on a wild goose chase (and maybe even a whole new side-adventure). Or maybe an NPC intervenes (a regular contact, informant, concerned citizen, etc.) by meeting with or happening to stumble across the heroes and spoon-feeds them the information they need. This is also the time to use an NPC in the group to nudge them along by asking the right questions, pointing out something to get the players thinking in the right direction, and so on.

The premature or easy defeat or death of a villain can also throw a story off track. If the G.M.'s whole story is supposed to revolve around a particular villain, it does the G.M. little good if the villain dies or gets captured in the initial confrontation. Again, thinking on your feet can save the day. Remember, this is a comic-book inspired role-playing game, so think about what would happen in the comics or television. Villains constantly break out of jail, are mysteriously resurrected, or have robots or clones stand in for them while they are secretly afoot, implementing their real nefarious scheme. Heck, his capture (really his stand-in) might have all been part of the plan, so the heroes or authorities don't consider him a threat.

Don't take the premature loss of a villain personally or let it throw off the entire adventure, see it as an opportunity to work in some new plot twist. Maybe a rival or an underling sees this as an opportunity to rise to power and continue the evil plot or to start his own crime spree. How's this for irony, maybe the villain (for his own evil reasons) was actually trying to stop another batch of supervillains from doing some evil deed. Or move on to some other plot thread entirely and improvise. These things can all be real adventure-savers, as well as provide avenues for additional adventures. **For example:** Heroes should not be going around killing off their enemies, even the diabolic ones, and one day such acts of homicide will come back to haunt the player characters. Maybe the villain they wasted a few months ago has returned from the dead and his top priority is hunting for the heroes who put him six feet under. Or maybe the fallen super villain's friends want some payback and go gunning for the player characters. Or maybe, in the ultimate twist of irony, the law wants to apprehend the player characters for acts of premeditated murder! Which may be completely justified if these "good guys" have gone bad. Or is it all a frame job to make them look bad or get them thrown into jail?

This brings us to the next item in your Game Mastering arsenal: **loose ends!**

Be sure to keep track of these. Like recurring villains, you can make great use of them for later adventures. Uncaptured cronies, undiscovered hideouts, unrecovered loot, and undeveloped story threads can all turn up in later

adventures. By the same token, future adventures can begin while the characters still work out their current one. This can be especially useful if the heroes are stuck in their present adventure or if the story you've designed has derailed and you don't know how to fix it. Investigating that newest bank robbery might be able to wait until after Dr. Fright is captured, but that doesn't mean it won't have significance next adventure.

In another vein, all adventures do not necessarily have to be rough and tumble free-for-alls or adrenaline rides. If the adventure has hit a snag, try switching gears and encourage the heroes to focus on something else. A game session of alternating role-play between each player and the G.M. as they go about their individual (though probably not mundane) lives can be just as fulfilling as solving the mission at hand, especially if as the G.M., you've lost your sense of how that mission should progress. However, always keep in mind what makes both your players and their characters tick. If your players prefer lots of action and dice rolling, then emotional-type character development and long investigative stories will likely kill the campaign, even if they're being used to loosen a snarled story thread.

Not all of these suggestions nor all of the adventures presented in this book will work with or appeal to each and every gamer or gaming group. Only you know what works for your group of players. Above all, keep the players and the story moving along. There's an old theater saying all G.M.s should keep in mind: "The show must go on." As long as everything doesn't come to a screeching halt, then all is not lost.

Player Knowledge

Player knowledge is the information that a player has, including game rules, occupational skills, and life experiences. It is different from the fictional *character's knowledge* that is defined by its skills, powers and creation on paper. Just because your friend Larry Green is a Medical Doctor, it doesn't mean that his character, Joe the Jock, will be able to perform the basics of surgery or even first aid unless Joe the fictional character has the Medical Skill Program. Likewise, I have had players whose characters are combat machines with plenty of physical and weapon skills, but no investigative skills, who improbably enough want to collect evidence at a crime scene, including things like ballistics and fiber traces. In such a situation, use common sense. Player characters with no investigative skills may know a bit about what to do at a crime scene from watching movies (or playing role-playing games!), but they will not know how to do it, nor will they know how to analyze and evaluate the evidence ("Yep, it's a fingerprint alright, now what? How do we find out whose it is?"). The best these *untrained* heroes can hope for is to discover the obvious, like shell casings, blood, and obvious footprints, and make some guesses ("It looks like the killer stood in the doorway and shot six times"). However, only skilled characters could reveal the real facts or the hidden truths ("The killer was left handed with a limp and the body has nine bullet wounds from two different weapon cali-

bers"). This is where cultivating Non-Player Character (NPC) contacts on the Police Force, media, etc., would come in handy. Or to have a teammate who does have knowledge in such things. Of course, the teammate will still need the right equipment, facilities and assistance to do so.

Don't be too rigid with whether or not a skill includes knowledge on this little thing or that, but do keep an eye on the kinds of skills a character has. Someone with most of the weapon skills shouldn't have to roll to recognize a common firearm, just as a medically skilled character will immediately recognize bleeding wounds and obvious disease symptoms. At the same time, the Doctor should have to roll against his W.P. Automatic Pistol to use a particular European firearm, just as the weapon master would need to roll First Aid to have some idea that a person was terribly ill or diseased.

In a similar vein, it is perfectly alright to offer additional information and "your character would notice" this or that to characters with high I.Q.s or heightened senses. It's also okay to let *players* in on background and behind the scenes information, especially after the adventure. It helps to give the players a clear picture of how and why things happened the way they did. The G.M. might even offer the defeated villain's reasoning or goals, provided such info does not give away any future adventures or plot-twists. The G.M. should pass along only judicious information and not adventure secrets the character would have no insight into. The character may indeed be far more intelligent than the player, but that doesn't mean he can see the future, outguess the villain, or know everything. For example, if the player characters have access to a criminal's file and it includes a psychological profile and his rap sheet, then a highly intelligent character (18+) may be able to project his possible moves, motives, or actions. But without anything else to go on, there will be little chance of thinking ahead of the bad guys. Regardless of how intelligent a hero is, he generally won't be able to enter a particular villain's mindset and think like him, unless the two have been antagonists or rivals for quite some time. Likewise, a smart player playing a dumb character (I.Q. 7 or less, especially if 1-4), will have to "play his character" dumber than he, the player, is. Really good players can do this amazingly well.

Ultimately, the *players* will know things their fictional characters don't just by watching and listening to things going on with other player characters. That's okay, but that is also where "role-playing" and "playing in character" comes to the fore.

The *player* will have to role-play as if his character does not know, realize, or care about X, Y and Z. Sometimes the Game Master will have to remind the player of this. For example, the player may know one of his character's teammates has been ambushed by a supervillain, but until his fictional teammate can call for help or somehow indicate that he is in trouble, the other player characters have no reason to help or even be concerned! Now, when an explosion is heard and energy beams come flying from that location, the other players can send their characters to help or investigate.

New G.M.'s be warned! It is common for players, in the excitement of the moment, to try to do things they can't do and be places they aren't. "What! An explosion! I realize Bob's character, the Horrible Hambone, is in mortal danger and I blast his attacker!" Okay, not a bad plan, however, first the character must fly, drive or run over to the fight scene, which is still some distance away and indoors. Getting to the battle scene will burn up several melee actions if not an entire round or two. And it will probably drive Bob's buddy crazy that his hero is "missing out on the action." Meanwhile, characters that can fly or run at sonic speed, or teleport can be there in a heartbeat, using up only one or two melee actions. However, if the villain is new/unknown to the fictional heroes, even though the *players* have witnessed their teammate's battle with this brute and they (as players) know what his powers are, the characters must act without this knowledge. Hey, it's called role-playing for a reason.

Dice and Chance

While there are some players and designers who prefer games *without* dice, the vast majority of all role-playing games use a variety of dice, and this game is no different. Personally, I like dice because they add to the drama and create legitimate elements of *chance and luck* (good and bad). Through the use of dice rolls, especially in simulating combat, even the most experienced characters can slip or miss, or make a lucky move. You see the element of luck or chance all the time in professional sports — the fumbled football (in itself a random chance of bad luck) that takes a lucky bounce into the hands of a player, or that desperate Hail Mary throw that finds its mark, and so forth. I feel the use of dice brings that random element of chance into the game and contributes to the drama, excitement, sensation of fate, and makes the game more interesting, unpredictable, and may move into a direction not previously anticipated. In that regard, the random determination of success or failure by the roll of the dice actually becomes an important (although subtle) element of the story. If an assassin rolls a one to strike (perhaps higher, 5 with bonuses) he is likely to miss or inflict little damage on his target. Instead of killing his foe quickly, a battle suddenly erupts and the enemy's (or the player groups') hand may be played too soon, leading to all kinds of trouble, while a natural 20 (double damage) may end a battle quickly and decisively. Likewise, the klutziest new hero in his first battle ever against a deadly foe may get lucky, make an unbelievable roll of the dice, and escape what seemed to be certain death, save a life, or defeat a powerhouse villain! Believe me, these moments can be tense and exciting. I've had an entire group of players jump out of their chairs and cheer under such situations, or collectively groan or shout when a bad or unbelievably poor roll happened.

Depending on the situation, a bad roll can also be played for *laughs*. When a powerhouse or cocky character flubs a roll it can be funny, especially if the Game Master adds some descriptive details. For example, our hero accepts the challenge of a friendly fight, or becomes em-

broiled in a duel or brawl. He takes his first shot and misses terribly. The G.M. might describe the action like this.

"Whoa, you rolled a one to strike! Not only did you miss your opponent by a mile, but clipped the hair of (a bystander or better yet, so and so, a player character)." Or, "Sheesh, you missed your opponent by a mile, slip, and fall into a plate of stew! Roll to see if you land in it headfirst, you need to roll a 10 or higher not to. Oh, a nine. Yeah, well, you land headfirst into a bowl (or kettle) of stew (a possible aside comment: It's pretty tasty, you'll have to try some if you live long enough). In fact, when you turn around to face your opponent, you move so quickly and in such a way that the bowl is on your head like a crooked hat. All the spectators are laughing. A few place bets on your opponent."

And the action continues. It may be lighthearted or take a serious turn depending on the situation and the characters involved. The element of humor is usually up to the Game Master and can be as enjoyable as death defying combat or mystery and suspense.

Along these line, dice will add elements that seem like "fate." Sometimes the rolls all seem to go in the player's favor — that's cool, don't feel compelled to change the situation or adjust the outcome. An easy win doesn't come often, let them enjoy it. Other times the rolls go against the players. Again, sometimes the best laid plans go awry (ask my scheduling department). Go with the flow, perhaps it's fate that they lose. When things go really bad, don't necessarily *kill* our heroes (although acts of stupidity or foolhardy bravery may lead to death), let them get the crap beat out of them, perhaps humiliated, and perhaps the bad guys win today, but let some or all of them escape to lick their wounds, regroup and attack again (as happens so often in comic books). An easy defeat may make the villain overconfident, so he leaves them broken men and women to suffer through their defeat. The villain(s) may even proclaim, "Not even your greatest champions can stand against the power of (whoever). Let this be a warning to you all." The characters' humiliating defeat is likely to make things worse for those they were trying to protect, because they must now cower before the villain and do as he says, etc. Or the villain may capture one or more members of the player group, setting up the next adventure where the survivors who escaped must try to infiltrate the prison or the villain's stronghold, find their friends and rescue them — or rescue, and attack the villain. Go with the flow, take advantage of mistakes, dice rolls and fate.

Mercy in Combat

Combat does not always have to be to the death. Many cowardly (or smart) villains will surrender to fight and plunder another day. Characters of a good alignment won't hurt an unarmed foe, but even selfish and evil characters may find it pointless to slaughter an opponent (taking great satisfaction in the character's grovelling and pleas for mercy).



Under these circumstances, the hero is likely to strip his opponent(s) of valuables and weapons (keeping and selling what the hero can), and turn him over to the authorities. If the authorities are far away, the hero is likely to chastise the villain(s) and warn/threaten him (them) that next time he will not be so generous. If any of the goods confiscated are known, or likely to be stolen, the heroic character will attempt to find the owner and return it to him or donate it to the poor or a church. Others may keep or sell them for their own personal gain.

In other cases, the bad guys may turn and flee. In many instances, it may be prudent just to let them go, and hope that they learned their lesson.

Of course, mercy can come back to haunt you. A character may cross paths with the same character again. Game Masters, this is very cool, because it creates great story dynamics, emotion, and story continuity. This can be true even of minor, annoying characters such as stool pigeons, petty thieves, stupid monsters, and blundering thugs. However, it is an excellent vehicle to create that epic arch-enemy who returns again and again to challenge our heroes.

Mercy can also lead to mercy in return. A foe who was once spared by the hero may spare him during a future conflict; or he may help the character in some way. Again this builds a relationship between the character that might grow into mutually respect and friendship, or end in tragedy someday.

Another aspect to mercy is the question of, does the punishment fit the crime? The world of Heroes Unlimited is often harsh and violent, and demonic creatures, evil sorcerers and power hungry warriors may inflict a terrible punishment for the slightest offense. The use of discretion, consideration for extenuating circumstances, and a sense of fair play will exhibit compassion by the fairness of the punishment they deliver. Such characters are likely to earn a reputation for being fair and just, perhaps even kind and forgiving. Unfortunately, some evildoers will view such compassion as a weakness and try to use the character's kind and generous nature to his own gain, or underestimate the true mettle of his opponent.

Game Sessions

Each time you play is considered a game or gaming session. A game session can last a couple of hours or half the day; however, a typical game *runs* about 3-5 hours. A game session can be a complete story/adventure in itself, like a single adventure comic book story that begins and ends with that session, or a "chapter" in a much larger and continuing story, like a novel, series of novels or TV series.

A game session that has several "chapters" or related adventures that build into an epic adventure is called a *campaign*. A campaign has a continuing storyline that runs like a multi-issue comic book or soap opera style TV show

like **ER** or **Star Trek**. These multi-part stories can last for two or three game sessions or run for a dozen. Game Designer, Erick Wujcik, has run a **Dungeons & Dragons** “campaign” for over 10 years with the same group of players and characters! Now that’s an epic campaign! The original Palladium: Defilers fantasy campaign ran every Saturday for nearly three years and a typical game session lasted 8 hours (but we were young and insane back then).

These epic “campaigns” are usually more complex than a typical “one night” or “two-part” adventure. Both types can be fun, and even a series of “one nighters” are likely to build into a series connected with subplots, interaction and growing relationships between the characters, returning villains, and guest appearances of other heroes.

CREATING ADVENTURES

By Wayne Breaux Jr.

Getting the Ball Rolling

Anybody can write and run an adventure, but not everyone can write and/or run a *good* adventure. The key is knowing how to spot the difference.

The simplest definition of a good adventure is one in which everyone involved has fun. Of course, what one player considers “fun” might be lots of combat and mass destruction whereas another player might consider lots of problem solving and character development “fun.” As the G.M., it’s your job to provide all of these elements for your players so they can all enjoy themselves.

One mistake a lot of G.M.s make is thinking that size means everything when designing adventures. Sure, a long, involved, world-shaking adventure with lots of twists and surprises can certainly be fun and successful (if run well), but so can stopping a simple bank robbery. What’s important is that you give your players an enjoyable excursion into the imaginary lives of their characters.

Likewise, not every game session has to be the kind that you and your players talk about for years. This is one of the most common causes of “performance anxiety” I see in some of my fellow G.M.s. In my role-playing group, some of our most memorable scenes came from down-time role-playing or in between cut-scenes that were not part of the grand adventure going on around us. Just play the game and enjoy yourselves.

Of course, everybody has slow days where very little actually enters your brain for one reason or another. What do you do when you get writer’s block and it’s your turn to G.M.? I’ve certainly been there before and even had to toe the line as the only GM in our group for a while. So to help, here are a few suggestions for kick-starting the old creative process.

Character Histories

Surely you know that a medical research company was responsible for a character’s mutation (the chart says so!), but exactly how did the character become associated with the company in the first place? And exactly why did they kick the other guy out of that robotics program? And what about that guy who claims to be part of some super-soldier project the company’s running on the sly?

Having players write up histories for their characters can be quite useful because it gives them a greater sense of depth. A character that was abandoned by his war buddies and left to die is likely to want to get everyone out of danger alive, regardless of the situation. That same character will also react quite strongly should he ever cross paths with his old unit. Secondly, it gives the G.M. a better feel for how the character might react to given situations, which can be useful for building scenes and setting moods. For example, if the character(s) won’t attack the villain until he actually does something bad, the G.M. can use that knowledge to set up a scene in which the villain can actually converse with the heroes before provoking them with his latest scheme. Such dialogue can help build the relationship (be it positive or negative) between the heroes and villains or to impart some key information to the heroes.

The G.M. can also draw entire adventure ideas from a character’s history. An Alien character might want to focus on getting back home, or preventing more of his kind from coming to this world. Hardware characters might need to find some piece of data or a special component to build their latest super gizmo. Bionic or Robot characters might pursue an upgrade, or have to deal with a cut in their funding. Magic characters may focus on learning new spells or dealing with some arcane experiment gone awry. Physical or Special Training characters might seek out new challenges just to test the extent of their abilities. Experiment and mutant characters might have to face additional products of the processes that created them, who might just be coming after the player characters to test themselves against the “old model.”

Other background notes not specific to any one power category can work, too. If a character is hunted for whatever reason, they will certainly have to deal with the fact that one day someone will come for them. Even if they aren’t hunted, nothing says that can’t change, especially if the heroes accidentally hurt an innocent bystander or fail to protect somebody from harm (“You let my sister die! Now you’ll pay!”). They may hear through the grapevine that a new coordinator has been assigned to their former project and the guy is bad news.

Of course, old enemies gunning after the player characters is a great way to start an adventure, but recurring villains aren’t the only ones who can come back to haunt characters. Old loves and friends can return, perhaps at awkward times. A hero’s college buddy is now a premier geneticist and is threatened by organized crime, or an old girlfriend becomes a reluctant heroine when she finds her grandmother’s ancient magical sword. Or a high school ri-

val blows back into a character's life, giving him a hard time when he's not in costume. Again, let the players help you G.M. Use their ideas to liven the game up. But be careful when you draw from backgrounds, especially if only one or two players provide them. If you have all the characters' pasts come back to haunt them at once, they can get frustrated or overwhelmed and may lose interest in the character or the storylines.

And finally, let's not forget that classic bit of comic book storytelling, the secret identity. You can craft any number of adventures based around the player characters' difficulties in juggling their heroic and civilian lives without letting the two cross paths. This was a common convention in older comics ("I've got to stop the bank robbery, but I also have to make it to Aunt Mabel's birthday party!") and it can work in **Heroes Unlimited**, too.

Movies, Books, and Other People's Adventures

Of course, movies, books and comic books are a great source of ideas for adventures, but try not to borrow too heavily from them, even if you aren't going to publish the adventures. Your fellow gamers *may* have seen the movie or read the book too, and if the story is too close, it will diminish the enjoyment of it — they know what's going to happen. Changing all the names is a start, but tweaking the plot is a must, and merging plots is one of the better tricks. A trick Kevin Siembieda uses is to set the players up with something familiar (so they *think* they know where things are headed) and then radically depart from it, catching the players by surprise and adding to the drama and/or suspense.

One way to make "borrowing inspiration" safe, different and fun, is to use movie or book synopses or a key character or concept, as inspiration instead of drawing from the whole story. Many television guide books or newspaper inserts have listings of the week's movies and television shows with short blurbs about each of them. Use the blurbs (even combining several of them) as inspirations for your plot. You can flesh it out with your own details and twists that should keep your players interested, their suspicions down, and their characters busy.

Let the Players Help

I usually start off each game session with, "Okay. What are you guys doing?" Each player then explains how their character has been passing the time, what aspects of their regular routine they have been up to (work, club hopping, taking a day or two off from patrolling the streets, exercising, combat practice, etc.), or possibly what leads from the previous game session they are investigating or following up on. It gives me, as Game Master, a chance to draw from the characters' activities (when possible) to set up encounters for the adventure or build ideas for completely new adventures. Giving the players a chance to direct things also lets them feel like they are truly helping you build on the atmosphere and depth of their characters and the imaginary world. The players may even offer adven-

ture ideas associated with the actions of their characters or suggest things that you, as G.M., could do to or with a particular situation.

The Player Characters Themselves

Adventures can also come from the player characters. You might look at one of the character sheets and a specific power, skill, or ability jumps out and inspires an adventure idea or an NPC. Many times, if the NPC is vibrant enough, just the initial encounter is worth an hour or two of role-playing and/or combat. An entire group of rival vigilantes or evil antagonists could also spring to mind, offering the group not only challenges, but opportunities for role-playing along the way as they confront their opponents repeatedly over the length of a campaign. When you look over the character sheets this way, instead of thinking how the character could use that power to stop the villain, try to think of a unique way the ability could be used to stop or counter some event, then work on a villain to put the event into motion. This way you can spotlight one of the characters while drawing inspiration from them. Be sure, in this case, to allow for other characters to perform during the adventure, and possibly see if they could also save the day should something happen to the source of your inspiration.

For example, one of your player characters has Control Elemental Force: Earth. You get an image of a wave of water rushing down a street toward a schoolyard of children and think that it would make a cool scene for the character to rend earth and have the chasm stop the water and save the kids. You might have a villain with the appropriate water manipulating abilities attack a nearby bank and plan for him to escape along the route where the school is. During the battle, the wave attack on the children could be used as a diversion to cover his escape. An adventure is fleshing itself out. Now among your heroes, the hardware guy might have explosives that could duplicate the effect that inspired you, or someone with Create Force Field may angle it to the side, but you still got an adventure out of it. Also be careful that the scene which inspired you does not become pivotal to the adventure, lest you try and force it to happen, which can easily frustrate players. If the opportunity does not arrive for the villain to threaten the children with the wave, then be grateful for the adventure idea and move on.

Character Goals

Players are likely to voice some kind of wants, dreams, or wishes for their characters, though often these are in the neighborhood of, "Gee, it sure would be cool for my mutant to get a particle beam rifle," or "I'd like to get to fifth level with this character." On the other hand, asking the players for realistic goals and hopes for their characters, both what the player wants for the character and what the character would strive for, can usually be good sources of adventure ideas. These kind of ideas also tend to be far reaching, requiring several adventures to achieve, such as



Breaux
97

questing for a lost family heirloom or looking for a cure for that experimental side effect. Meeting someone and getting married can also provide plenty of role-playing, but not as many actual adventures, unless the loved one is plagued with a dark history, prone to getting into trouble, or becomes a target for super villains. Regardless, these are the kinds of adventures that can be saved for those in-between places where you need some kind of filler. Surely, a trip to Mexico to investigate the last known whereabouts of one's father won't necessitate the accompaniment of the entire group of heroes, but once the local drug cartels rear their ugly heads (for whatever reason), the hero will be hard pressed not to call in his friends to straighten a few things out, even if the drug lords have nothing to do with his missing father.

Attribute Considerations

Being exceptional has its hazards. This includes being exceptionally handsome or beautiful, tall/giant-sized, incredibly strong, and "looking" powerful or dangerous. Sure these all have their obvious advantages, but most players and G.M.s don't stop to consider the downside.

Remember that old saying, "appearance is everything?" Well, it may not really be true, but appearance will play a large role in how people, from the general public to super-human enemies, respond to a hero.

Physical Beauty or Mental Affinity. Attracting attention and sticking out of the crowd, even when unintentional, spells trouble. For one thing, it makes the character a more obvious and, perhaps, desirable, *target*. For another, an exceptionally attractive, charming, or unusual looking character will find it extremely difficult to hide or move about unnoticed. This is compounded a hundredfold if he or she is also a "famous" hero or celebrity. In addition to this obvious fact, there are a number of people who will be jealous or envious of the character because of his attractiveness (or fame, or power, etc.). Strangely enough, jealousy breeds contempt and hate. Among the jealous and hateful will be supervillains and criminals — antagonists who have the meanness and power to extract cruel revenge by framing the character, discrediting him, or disfiguring, maiming or killing him out of spite.

Popular, famous and notorious characters (helped into the limelight and public favor by their good-looks and/or charm) will also be targeted by supervillains who are out to make a name for themselves or who have something to prove.

Being big and strong is good. Right? It sure has its advantages, but there is a downside too.

In combat, the most noticeable opponent is most likely to be one of the first attacked, captured as a hostage, etc. Those who *appear* to be the most dangerous, powerful and formidable will be struck first, attacked by the strongest or deadliest villain, double or triple teamed, or hit with the most powerful weapon. It is common sense for an enemy to try to dispatch the most dangerous opponent first. This means the biggest, strongest-looking, most frightening, monstrous or powerful looking hero (radiates with

crackling energy, ripples with muscles, etc.) will be hammered the fastest and the hardest; figuring the others are less dangerous and can be worried about in a few minutes.

Furthermore, Super-Strong characters must be careful on how they use their strength. A full strength punch might *kill* an ordinary human, unless it is successfully "pulled" to reduce the damage delivered. Likewise, punching through walls, tearing down doors and throwing around cars will cause a lot of collateral damage. Destruction of property that may earn the hero the anger of business people and/or the public. Along these lines, the hero must be careful not to injure innocent bystanders with his feats of strength — a concern his evil opponent is not likely to share. If people are hurt through the actions of the hero, there will be trouble, especially if it was through his carelessness or negligence. An excuse like, "Golly, I didn't realize that was the *support beam* I tore down to use as a club. I didn't mean for the building to collapse," just won't cut it. The character may be denounced by the public, lambasted by the media, targeted by lawsuits and drummed out of town or out of any public service job.

Actually, this is true of *all* superbeings who want to help, not hurt people. These are men, women and aliens with incredible powers. Abilities that if not used carefully can accidentally kill and destroy. It can be a heavy responsibility, and should be a part of the role-playing experience.

Reputation can work against a hero too. Even if the superbeing looks ordinary, harmless, or innocent, if his or her reputation precedes the hero, that character will still be the target of the first and fiercest attack(s).

Again, these notoriously powerful superbeings may be targeted by villains with something to prove, but also by villains who plan to operate in the hero's "territory" (hometown, base of operation, place known to be under his protection, etc.), or planning something "big." It is natural for the villain to size-up and consider what to do about his opposition. This includes probable intervention by superbeings as well as the local authorities. Certainly the villain(s) must be prepared for his/her/their arrival, but may also decide to eliminate the opposition before he/she/they ever get started. This could mean sabotage, creating a diversion to draw the hero(s) away, or an outright attack in hopes of literally "eliminating" the troublesome hero(s) to clear the way for the villain's insidious plans.

Amazing powers — more than human. As noted previously, displaying one's superhuman abilities will draw attention to the character and make him or her a target of an attack. Showboating may also tip off an unseen nemesis to the presence of a superbeing(s), one or more of his powers and elicit a reaction (the villain delays his plans and leaves or hides, to wait until the superbeing is gone, or jumps to the conclusion that he/she/they know about his scheme and attacks or presses forward, etc.).

Another reaction may be fear, dread or hate from those present. For example, in an environment where mutants or aliens are feared, distrusted or hated, or the group is (perhaps wrongly) regarded as wanted criminals, those

who recognize them or believe they are affiliated with a group or class they fear or hate, will respond accordingly — run in panic, call the authorities, attack, etc. Liked and respected heroes might have the opposite problem. As touched upon earlier, they may be mobbed by their adoring public or their presence might elicit an audience of spectators and well-wishers to gather to cheer them on in combat, not realizing that they are putting themselves in danger.

Cliffhanger Endings are Good

Unless you plan on running all day or night long, you may have to choose a place to end the adventure for that day, and continue it next time. This is easier to do if the gaming group gathers on a weekly or regular basis. There is nothing wrong with a cliffhanger ending, in fact they usually add to the drama and suspense. Not to mention saving the G.M. and players from dropping from exhaustion. We've run our share of 8-10 hour game sessions in our younger, more insane days, and still often had to stop the action and continue it at our next meeting.

There are a few preferred places to "pause" the action till next time. One is just before or after the player group have made plans to launch an attack or engage in some dramatic action (rescue a friend, make good their escape, etc.). Another is just after the group has made some sort of (large or small) triumph and are ready to go into the next phase of their plan. A third is a logical pause in the action, especially if the characters need to regroup, do more investigation, travel and so on. Another is to stop the action just after the group has made some shocking discovery or the "main villain" makes his entrance. Similar to this one is stopping the action just before some big, important or devastating event happens (a few seconds before the bomb goes off or before the rocket or missile launches, the big final battle is about to start, or just as one or more of the character leap into action, disappear, and so on).

At the end of a cliffhanger game, it is best for the G.M. to summarize where every character is, what each was doing or about to do, and what the crisis is or who the opponents are. This will crystalize the actions and impending event in the players' minds, and not only help them formulate what their next action will be when the adventure resumes, but leaves them with a sense of anticipation.

At the beginning of part two (or three or whatever) of the cliffhanger adventure, it is wise to summarize the events leading up to this moment, and remind the players exactly where and what their characters were doing. After that, rock and roll, baby. Let the action rip.



Some Ideas for Campaign Settings

For G.M.s thinking of running a specialized or notably different campaign, it is important to let the players know beforehand so they can tailor their characters to the setting. This will also prepare them for any rule changes or setting quirks that he might drop in their laps later. If someone rolls up a Hardware character for a setting where metals and machinery are scarce, he's probably just wasting everybody's time (unless he's looking for a real role-playing challenge, which is commendable) as the group waits for him to roll up a replacement character. Likewise, if you notify everyone several adventures into the campaign that the New Crusaders take over everything and the player characters have to convert to the New Religion or some such, they could easily lose interest in the whole campaign. Surely your grand ideas may work better as surprises, but think a little before pulling radical events out of your hat, and give fair warning if you can. You don't have to tell them all the details, but asking their opinion about any kind of change or type of event may just be enough to give you the feedback you need.

Heroes Unlimited™, like the rest of the Palladium Megaverse, is bursting with possibilities. Just the things you can do in a traditional campaign alone can fill years of gaming experiences (I know because my group's been doing it for a little more than a decade now), but there are also other options as vast as the dimensional byways. Let's take a look at just a few of them that grabbed my attention while writing this book.

Advanced Technology (The Future Earth)

This campaign makes advanced/alien technology common on Earth. There can be a number of possible reasons for this setting, the easiest of which is for the G.M. simply to advance the time frame to something like 2030. By that time, everyday technology might include energy weapons, hand-held communicators, full-sized videophones, hover vehicles, etc. G.M.s can feel free to use their imaginations and borrow ideas from movies to create the technology of this future. For help with high-tech weapons, consult the upcoming revised edition of **Aliens Unlimited™** or check out **Rifts®** and its supplements (conversion to S.D.C. in the latter case will be necessary). Adjustments are easy, Hunter/Vigilantes use laser rifles and in many cases the older firearms, Ancient Masters can use vibro-weapons, and Secret Operatives get to use the newest high-tech weapons instead of the standard energy weapons (including particle beam pistols, pulse lasers, and rail guns). Such a future can be a sparkling semi-utopia common to many old movies and classic science fiction that is home to handsome, daring heroes. Or it can be a rather dark and dangerous cyber-punk world of hard-edged heroes and vile villains. The future Earth setting is a great way to integrate Earth humans into a space campaign since by

that time they will likely have advanced space travel capabilities.

Dark Heroes (The Gritty Campaign)

Nowadays, comic books often feature intense, grim-faced heroes who fight their way through a dark and cynical world. The action in these settings will commonly take place at night or on cloudy, overcast days to give a mood of heavy, mysterious danger. The heroes will often look like thugs or villains, dressed in dark costumes with menacing designs or have no true costumes, but instead wearing tattered street clothes, like jeans and overcoats, motorcycle leathers, riot gear, etc. Such a campaign is more striking than others and has very little flash or sparkle. Vigilantes and anti-heroes thrive in this world and act as the sinister shadows of more flamboyant, flag-waving heroes who fight crime in broad daylight. Because it often blurs the lines between right and wrong (something which should always be handled with care), this kind of campaign is better suited to more mature gamers. It is one of my favorites.

Medieval Heroes

Heroes Unlimited™, 2nd Edition notes that history has had periods of superhuman activities where powerful heroes have been plentiful. This kind of campaign explores one of those faraway periods where the presence of super-powered heroes peaked. Medieval Europe is one of the prime places for this, with tales of Merlin and larger-than-life knights like Sir Lancelot and powerful rulers like Charlemagne. The player characters can be enforcers for the Church (at the height of its power then), defenders of the Crown, or champions of the underclass and meek. The Egypt of the pharaohs, the Celtic times of Fionn Mac Cumhaill or Cu Chulainn, and the Shogunates of feudal Japan are all ideal settings for this kind of campaign. Your local library, CD-ROM encyclopedias, or on-line research can provide tons of reference information for all of these settings. But the main game issues to address in this type of campaign are the non-existence of technological equipment as we know it and the historical lack of widespread magical power. Let's look at each in turn.

The lack of modern technology in historic games means not only will Hardware and Special Training characters need a lot of adjustment, but also that mutants will all be genetic aberrations born with their abilities, and experiments will be the result of alchemy or a mix of it and magic. The various organization tables can still be used as guidelines for the character's relationship with the alchemist that gave him his powers. Those categories heavy with technological edges can be adjusted or removed. The completely non-viable power categories in this setting are Hardware: Electrical Genius, Robotics, Bionics, and possibly the Hardware: Mechanical Genius (just imagine all of the cool devices Leonardo da Vinci would have had at his disposal if he was a medieval superhero). The other Hard-

ware categories can easily be adjusted, just shift all of the Weapons Expert's gun skills and bonuses to melee weapons or bows and apply the Analytical Genius' skills to ancient armor and equipment. The inclusion of Alien characters is left completely up to the individual G.M., but it is unlikely that non-human aliens will be in any way accepted during these historic settings, with the exception of certain animal-like aliens in a Egyptian setting if they are visiting some other ancient and exotic places, such as Shangri-La, Macchu Picchu or Chichen Itza, or ancient Minoa.

Myth and magic were certainly alive in the past, but mostly as superstition. There were wizards and alchemists, but they were legendary and feared by many. Unlike a fantasy setting where wizards and psionic characters are accepted as facts of life by the general populations, in historical settings they will be given much respect, but also feared and often isolated. The same is likely to happen to certain super-powered individuals. In some cases, super-powered characters (including mages and psionics) might be persecuted as witches or other agents of demonic influence. Likewise, the opposite can be true, such as in some Norse and Egyptian settings, and the characters could easily find themselves revered warriors blessed by the gods or even priests of those same deities.

Fantasy Heroes

This is an option similar to the Medieval Heroes setting mentioned previously, but instead of being set within a historical Earth time frame, it is set in a world of fantasy, magic, and legend, such as the one presented in **The Palladium Fantasy Role-Playing Game®, 2nd Edition**. In this setting, dragons and magic are very real and the characters mesh easily into it with their super powers, psionics, and other strange abilities. The G.M. can make super abilities available to all inhabitants of this world, or have the player characters belong to one particular race or class of people that demonstrates these powers. Perhaps the best way to handle this merging of worlds is simply to combine the games by using the **Palladium Fantasy** rules and setting with the super-abilities of **Heroes Unlimited**. The idea of a Paladin with Karmic Power and Energy Expulsion: Light is quite cool, I think. Of course, the power level of such a game will be on par with that of **Heroes Unlimited** and well above most **Palladium Fantasy** campaigns. The exact rules for combining the two games can be quite involved and each G.M. is left to his own devices as to what he thinks works for his own game.

The only non-viable power category in this setting is the Hardware: Electrical Genius. Robot characters can be magical golems, Bionic characters can have special rune objects magically grafted onto them, and the Hardware: Mechanical Genius can build automatons and other fantastic, but medieval-style items. Robotic and Bionic characters use the same stats and equipment from **Heroes Unlimited**, but the effects are created by magic instead of technology (and would likely regenerate damage at the same rate as the metal form of Alter Physical Structure:

Metal). The Bionic would choose a warrior O.C.C., but would lose half of his “other” skills and half of his secondary skills. Robot/golems would be instilled with a limited number of skills as per **Heroes Unlimited**. The Weapons Expert’s gun skills and bonuses can be shifted to melee weapons or bows and the Analytical Genius’ skills apply to ancient armor and equipment. G.M.s can also include black powder firearms to replace energy weapons for those Power Categories that receive them as special equipment (they can also be made by the Weapons Expert). The manifestations of super abilities in the fantasy races (such as elves, dwarves, etc.) is entirely up to the G.M.

The Dogs of War

Any military upheaval in world history is a perfect setting for a heroic campaign, including the World Wars, the American Civil War (or any other civil war, for that matter), the Indian wars, the rise of the Roman Empire, the Mongol invasions, and many, many others. Unless you go way back in time to battle Napoleon or help out Charlemagne, for example, little will change except for a lack of modern electronics and body armor. Weapons will have to be researched, but firearm damages for the World Wars will be roughly the same as modern weapons, based on caliber. All World War-era firearms are semi-automatic/self loading, but G.M.s can allow Weapons Experts and Secret Operatives to have the equivalent of modern firearms with their higher rates of fire in place of some gimmick and energy weapons. For information on historical firearms such as muskets and black powder pistols, check out the **Transdimensional Teenage Mutant Ninja Turtles®** sourcebook, which offers lots of great conversions for just about any time period.

Working for an Organization

This is one of the easiest campaigns to run because the G.M. has the option of telling the characters where the adventure is. There is no worry whether the characters will take the bait into an adventure because their superiors order them and they go (they may not like it sometimes, but they must go nonetheless). It also provides the group with extra support that can offer clues or suggestions if they get stuck, or provide vital skills (in the form of extra NPCs) that the group may not have. An organization will also provide a regular salary, base of operations, and access to files, information, and people who are otherwise unavailable to vigilantes or private groups of heroes. The organization can be corporate, government, or privately funded. The characters can be hidden ace-in-the-holes used for special operations and surgical strikes, or they can be celebrity-type heroes seen regularly on television as symbols of peace, security, order, and the law. G.M.s are free to create any type of organization they wish and may even use the Sponsoring Organization tables in Special Training, Robotics, Experiment, and Bionics for inspiration. **Villains Unlimited** provides extensive rules and tables for the creation of organizations, including equipment provided, budgets for missions, salaries, robotics/bionics

programs, and more, all specifically written for **Heroes Unlimited**.

We’re All Super Heroes Here

One of the appealing aspects of **Heroes Unlimited™** is that you get to play superpowered heroes while most of the people about you are relatively normal. This option, however, reverses that, making everyone a superpowered individual. The G.M. can handle any specific details such as how many abilities “normal” people got as opposed to “super” characters like the player characters, but a handful of minor abilities would likely work best with player characters getting perhaps one minor ability extra (in addition to the results of the random number of super abilities tables in the *Aliens, Mutants, or Experiment* section). Customizing characters would be an emphasis here, for characters will have occupations based on their natural talents, such as characters with Mechano-Link or Telemechanics becoming mechanics, inventors, or similar technical/machine oriented occupations. Super abilities can be picked based on education and skills or vice versa. In addition to customizing, the characters will be set apart by their ideas, ideals, actions, and occupations. Organizations, cults, guilds, and other assemblies of like minds and perceptions will be common and help to add spice to the setting.

Alien races that appear human and have a predisposition to super abilities make the perfect candidates for this kind of campaign. **Aliens Unlimited™** and the upcoming **Heroes Unlimited Galaxy Guide™** will have plenty of information on adventuring in the local galaxy. Of course, if you don’t like the alien/space thing, an alternate or changed Earth can also provide a setting full of super-powered humans. A comet’s tail covering the planet, nuclear fallout combined with some chemical release, holes in the ozone layer activating a reaction with a popular medicinal drug, etc., can alter the majority of humans on Earth, giving them super abilities/psionics or changing their genes to allow their offspring to have such powers. Advance time several generations and voila! You’re ready to go.

Random Inspiration

Sometimes an idea just strikes you out of the blue, and writing an adventure comes easily. Sometimes you have to work hard to conjure an adventure hook and a storyline. And sometimes, you just can’t come up with anything at all. For when that third fate strikes, here are a few random tables to help rattle the creative archives and outline an adventure or four. Roll as many times as you like and discard any results that don’t work. Basically, one roll on the Random Villains table, one roll on the Random Crimes table, one roll on the Random Motives table, and 1D4 rolls on the Random Complications table should produce enough ideas to spark an adventure. A few examples are given after the tables.



Random Villain Table

01-10%: Highly skilled professional criminals. Category: Hardware, Special Training, or consult the Quick Roll Villain table. Number: 1D4. Level(s) of experience: 1D4+6. Super abilities: None.

11-20%: Professional criminals. Category: Quick Roll Villain. Number: 1D6. Level(s) of Experience: 1D6+4. Super Abilities: None.

21-35%: Successful criminals. Category: Quick Roll Villain. Number: 1D6. Level(s) of Experience: 1D6+2. Super Abilities: None.

36-44%: Rough thugs. Category: Quick Roll Villain. Number: 2D4. Level(s) of Experience: 1D4+1. Super Abilities: None.

45-60%: Two-bit thugs. Category: Quick Roll Villain. Number: 2D6. Level(s) of Experience: 1. Super Abilities: None.

61-63%: Unknown super villain. Category: Choose or roll randomly. Level of Experience: 1D4-1, minimum of 1st level. Super Abilities: Choose or roll at random. Whoever this villain may be, none of the heroes will have encountered him before.

64-70%: New super villain. Category: Choose or roll randomly. Level of Experience: 1st or 2nd level (50% chance of either). Super Abilities: Choose or roll at random. The heroes may have heard about this villain, but they have never encountered him until now.

71-75%: Known super villain. Category: Choose or roll randomly. Level of Experience: 1D4+1 Super Abilities: Choose or roll randomly. The heroes know about this bad guy and/or have tangled with him before.

76-80%: Known super villain & his crew of thugs/soldiers. Category: Choose or roll randomly for the super-villain. Consult the Quick Roll Villain table to determine his crew of flunkies. Number (size of crew): 2D4. Level of Experience: 1D4+1 (super-villain), 1D4-1 (crew members). Super Abilities: Choose or roll randomly for the super-villain. None for the crew members. (Note: for crew members, roll again on this table, ignoring rolls of over 60%.)

81-85%: Significant, known super villain. Category: Choose or roll randomly. Level of Experience: 1D6+2. Super Abilities: Choose or roll randomly. Not only do the heroes know about this guy, but he also has a heavy-weight reputation that precedes him.

86-90%: Group of super villains. Category: Choose or roll randomly. Number: 1D6. Level(s) of Experience: 1st or 2nd level (50% chance). Super Abilities: Choose or roll randomly.

91-95%: Powerful, known super villain. Category: Choose or roll randomly. Level of Experience: 1D6+4. Super Abilities: Choose or roll randomly.

96-00%: Group of known super villains. Category: Choose or roll randomly. Number: 1D6. Level(s) of Experience: 1D4+1. Super Abilities: Choose or roll randomly.

Random Crime Table

01-10%: Murder/Killing. The criminal(s) has been engaging in killing people for one reason or another (though not necessarily for simple alignment reasons). Roll on the sub-table if further refinements are needed.

01-25%: Assassination (a hired killer).

26-50%: Execution (an enforcer or crime boss teaching people a lesson or covering up some scandal or illicit activities).

51-75%: Serial killings (a pattern killer terrorizing the city).

76-00% Homicidal maniac (a killer with a short fuse; may or may not have someone directing his murder spree).

11-24%: Assault. Could be collecting protection money from merchants or breaking legs for the mob.

25-40%: Kidnapping. Either for the money or possibly because the villain thinks the person belongs to him/her for some reason. (Villains can have their kids taken away by the courts like anyone else and will take them back by force.)

41-60%: Robbery. The age-old pastime of the villain, taking other people's property by force. To see what the crook is after, roll on the following sub-table.

01-10%: Gold reserves (more capable criminals)

11-29%: Money exchange

30-60%: Bank

61-75%: Armored car

76-85%: Stocks or other invested money (can be computer theft)

86-90%: Museum (valuable art and relics)

91-00%: Wealthy individual (could also include kidnapping)

61-75%: Theft. Similar to robbery, except the villain doesn't physically hurt or threaten the victim during the act itself. Likely to involve things less valuable to most people and more valuable to a select few or an individual. Can include prototypes, relics, magical items, rare things, and people.

76-85%: Drugs. The drug trade offers lots of money for criminals involved in it and a diversity of jobs, from murder and assault to forgery and smuggling. Additional rolls can be made on this table to determine more exact crimes associated with the drug trade.

86-90%: Extortion. Villains want money from the victim or they will do something damaging to him/her. Roll again on this table to get an idea what they might do or roll on the complications table to figure out what or where they will do it.

91-95%: Forgery. Villains are involved with some kind of false paper scheme. They could be counterfeiters, impersonating federal or police authorities, or smuggling foreigners in with false papers for slave labor. Roll again on this table to get an idea why they are doing the forgeries (such as extortionists with fake photos of incriminating activities or shady drug dealers looking to buy loads of cocaine with counterfeit money).

96-00%: Breaking and Entering. The villains end up where they aren't wanted and have to be removed. Could be a failed robbery or a purposeful discovery, such as a terrorist taking a building hostage.

Random Motive Table

01-10%: Boredom. This makes the villain extra-dangerous because he will do just about anything for a thrill.

11-30%: Revenge. The villain is after some payback and will take out anyone or anything that gets in his way.

31-60%: Money. The villain makes a living through crime.

61-75%: Hired. The villain was hired by another villain or organization to perform the crime.

76-85%: Ploy to draw out the police or superheroes for some reason. Perhaps to extract revenge upon them. Perhaps to embarrass them with his or her brazen attack (i.e. to prove how tough or unstoppable he really is), or as a distraction while another crime is taking place elsewhere, etc.

86-90%: Forced against his will. A victim of blackmail! The real bad guy(s) has a friend, loved one or innocent victim (possibly somebody important) in their custody and threatens to kill their hostage(s), or worse, unless a superbeing does as they demand.

91-95%: Tricked. Fooled into undertaking the crime by another. Roll again on this table to determine what the villain actually thinks he is doing the crime for.

96-00%: Insane. The villain has no choice but to act the way he does. This is an especially appropriate result for the homicidal killer.

Random Complication Table

01-10%: Authorities keep pace with the heroes and tend to show up when they do (though unintentionally; specific reactions and attitudes are up to the G.M., though a motive roll for key NPCs among the authorities might be interesting).

11-19%: Weather is very bad and threatens both villain and player characters alike (a blizzard could have the city snowed in or a lashing thunderstorm could roll over a showdown on a boat).

20-35%: Other heroes get involved (perhaps requiring a roll on the Motive table above).

36-44%: Other criminals are involved (rivals or the people that were preyed upon; roll on the Motive table for the additional criminals to see why they are involved).

45-60%: Many innocent people are at the scene of the crime or adventure. A battle will put hundreds, even thousands, in danger.

61-75%: The heroes have a crisis to attend to in their real lives so they can not join the battle. Or perhaps the heroes can not help against a super villain, crime or disaster without revealing their true identities or superpowers (either in public or among friends and family; i.e. at a party, meeting, theater, other public place or get-together).

Or perhaps such a party or public gathering is interrupted by a villain(s) or the scene of a crime or disaster in which the hero (or heroes) is present.

76-84%: Villain is someone the character knows or loves (sister, brother, lover, friend, teacher, etc.)!

85-90%: Location is unique or unfamiliar. Roll on the sub-table below for some ideas on where the adventure takes place, where the villain's hideout is or where the climactic final scene could take place.

01-10%: Foreign country. Language barrier, money problems (characters don't have the proper currency), culture clash, and authorities may even see the heroes as invaders or foreign criminals.

11-20%: Top of a building (roll percentile for number of stories)

01-15%: Plenty of glass windows, but no cover

16-30%: Wide open and level

31-75%: Under construction (with tools and cranes all about)

76-85%: Completely finished but empty (one floor may be open if a party is going on)

86-00%: Uneven and cluttered

21-30%: Boat. Small: sailboat or barge, medium: yacht or ferry, or large ship: tanker, freighter or cruise ship/luxury liner.

31-40%: Dense Forest or Jungle: A wilderness area that can be as close as just outside the city or as far as a continent away.

41-60%: Underground: Sewers, subway tunnels, natural caves, secret complex or other subterranean facility.

61-70%: Underwater: Action in a lake, river, sea or ocean. May involve aquatic super villains/mutants/aliens, aquatic monster, submarine(s), oil rig, tanker ship (a spill and containment; and the cause is something underwater), sunken city, etc.

71-80%: Aerial Action: Aircraft, flying villains, flying/floating city, etc.

81-85%: Frozen wastes or arctic stronghold.

86-90%: Alien! The heroes find themselves battling an alien invasion or just a band of alien criminals, or in an alien spaceship, secret alien hideout, or even on an alien world or in another dimension (parallel universe, etc.). **Note:** See 91-00% for where to find useful source material on aliens and alien worlds.

91-00%: Outer Space. This could be within or without our solar system, on board a giant spacecraft or whisked away to an alien world!

A whole additional set of adventure tables could be written just for this complication. Aliens, some alien worlds, and helpful source material can be found in **Skrappers™**, **Aliens Unlimited™** and the upcoming **Heroes Unlimited™ Galaxy Guide**. Furthermore, such RPG books as **Wormwood™**, **Phase World®** and many other titles in the **Rifts®**, **Nightbane®** and **Palladium Fantasy** lines can also be a good source for monsters and other-worldly beings and settings. In fact, check out the new RPG, **Systems Failures** for an alien invader that

threatens the Earth (easily adaptable to HU2 and includes some adventure notes for use with HU2).

Examples of Random Adventures

Example 1: Money in the Bank. I get the following results from the tables: A group of professional criminals (3rd level, four in number, with no super abilities), Robbery (Bank), Greed (motive), with two complications; Many People and Other Heroes (just for kicks, I rolled on the motive table for the heroes and got revenge). Thus, for this quick adventure, the characters will have to deal with a group of professional criminals trying to rob a crowded bank while another group of heroes are looking to nail them for different reasons.

Tossing that all together, I think a little twist will spice it up, so here's the whole scenario: The character(s) find themselves at the bank's yearly Christmas party (either one of them works at the bank or they are asked to go with a friend that works there). It is a night gathering that the professional thieves find attractive for they can get into the vault and the chaos of the party will cover their presence. Once the robbery starts, however, a number of superheroes (number determined by the GM, I would use two) whose companion was accidentally killed by the thieves in a previous encounter are also in attendance and they want blood. The characters have to prevent an all-out battle that could injure the innocents in the bank. The role-playing alone as the robbers use the vault and the partygoers to keep the revenge-crazed "other" heroes at bay while the player characters try to mediate or get the people out would be enjoyable.

Example 2: Knight Takes Pawn. Rolling once more, I get the following: Known Super Villain (7th level), Theft, Tricked (motive), and for Complications, the villain is someone the character knows or cares for. Rolling once more on the tables, I get an idea of who it is that tricked the NPC into the theft — a known super villain with a group of successful criminal underlings, whose motive is theft. The known super villain has other plans to attend to, but he wants to steal something. Obviously he is too busy and for some reason his crew of successful criminals can't steal it either, so he has to trick someone close to the heroes into doing it for him. But why? Well, there are two obvious answers: revenge and necessity. If the player characters foiled the villain's plans in the past, using someone close to them in his schemes would be a great revenge. Secondly, if the NPC close to the heroes works in a specialized or restricted field, they may be the only person able to easily steal the thing the villain wants. The only possible problem with the rolls is that the villain is supposed to be a 7th level super villain, which doesn't exactly work if the culprit is one of the hero's Dear Aunt Dolores. I can discard the roll and simply use the NPC as they are, especially if they are a robotics researcher, computer programmer, or in some other sensitive area of work.

So here's two takes on how I'd expand it, depending on the group I was dealing with. One possibility would be to make the friend/relative a computer programmer asked to

hack their employer's records (or a researcher asked to steal a robotics system, etc.) or some similar normal person (ignoring the super powered villain result of the first set of rolls) who subsequently gets caught and needs the heroes to clear his/her name and find the true villain. The other option is more involved, but the kind I like to work with. In it, I would make the friend (or loved one or wife, etc.) a researcher forced to steal an experimental serum through blackmail or violent threats against the loved ones. The true villain wants to give super abilities to one of his henchmen and once the NPC gets it for him, he decides to test the serum on the beloved NPC, bestowing upon them super abilities. The villain would then threaten to harm those close to the NPC if certain favors were not done for him (i.e., criminal activities). Just imagine the players' reactions when the villain is revealed to be their friend or loved one, who then admits they did what they did to keep the true villain from harming them! Once the mess is straightened out, the newly powered NPC could join the characters as a hero. Of course, there are even more complications if the NPC knows the player characters are actually heroes and has to protect their secret identity and/or fight them when they arrive to prevent one of the errands the true villain has demanded. Needless to say, this one adventure idea can span several game sessions.

WORLD HOT SPOTS

Hot spots are areas across the globe that have some form of turmoil or tension that provides the perfect setting for intrigue and/or adventure. The G.M. can send the characters over to these places for a firsthand taste of the troubles, providing fast and furious adventure and role-playing in foreign and exotic settings. Getting the characters there may be a stretch at times, but there will certainly be no want for something to do once they get there. These hot spots can also come home, too. Foreign radicals that blame the U.S. for its involvement in their country's troubles for whatever reason may lash out, bringing terrorism to our doorsteps. Certain "hot spot" countries may also be willing to sell military or mineral commodities that normally would not be available, such as nuclear materials, biological weapons, military weaponry, missiles (big ones), and even combat robots and computer viruses.

Player character heroes may defeat a dangerous villain, only to discover other bad guys toting some of the same deadly hardware at a later date. The two have no connections, but after a third party shows up packing the same heat, the characters might have to travel to the ex-Soviet Union or the Middle East to ferret out the suppliers of such dangerous stuff. There are plenty of things open for adventure here, and the characters don't necessarily have to leave home to experience it. Of course, characters that work for the government or military organi-

zations may regularly find themselves sent out to these hot spots to quell one crisis or another, and even corporate operatives may find themselves in similar roles as their employer seeks to protect foreign investments or holdings.

Geopolitical Hot Spots

Unstable regions and governments make for great adventures, but if you want your campaign to take place in the modern day, you probably should stay abreast of world news so that you know what bad situations your heroes will face. Two excellent resources are CNN news (both on television and the Internet) and the U.S. State Department, which issues travel advisories for any nation in which it is highly dangerous for U.S. citizens to travel.

Below is a list of current geopolitical hot spots. Many of these crises have been ongoing for years and will probably continue well into the future. But, that doesn't mean things can't change. (Who would have thought in 1983 that within 10 years the Soviet Union would fall?) And in **Heroes Unlimited**, super beings have more power than anyone to change the ways of the world, for better or for worse.

Afghanistan is struggling to recover after the withdrawal of the occupying Soviet Union in the early 1990s. Since then, the nation has been torn apart by warring factions. Chief among them is the fundamentalist Taliban, which is reported to give safe haven to anti-Western terrorists.

Angola is a battleground for three separate rebel groups and the Marxist government. It's also periodically raided by South African forces out to destroy the Namibian rebel bases in the south.

Argentina is still in upheaval after a disastrous military loss to the British in the Falkland Islands in the 1980s.

Chechnya fought a vicious two-year war of independence against Russia in the early 1990s. Russia opposes independence because the little nation would take away resources considered too valuable to lose. Much of Chechnya has been reduced to rubble so far, and no easy resolution to the conflict is in sight. Meanwhile, the country has become overrun by criminal overlords.

Colombia is plagued by right-wing death squads and powerful drug-smuggling cartels that manufacture and export most of the world's cocaine.

The Comoros Islands are a tiny archipelago between the east coast of Africa and the island of Madagascar. For centuries, these islands have been overthrown by pirates and mercenaries more times than anyone can count. This sad tradition continues still today.

The Democratic Republic of the Congo (or simply, "Congo") is in the midst of a civil war that threatens to involve most of central Africa. Rebels backed by **Rwanda** and **Uganda** control the eastern half of this vast and resource-rich country, while the Congolese government, backed by troops from **Angola**, **Chad**, **Namibia**, and **Zimbabwe**, controls the western half.

Meanwhile, the various nations of **Western Equatorial Africa** are in a perpetual state of anarchy and/or revolution. Despite their small size, these nations are some of the most dangerous places to be in the world. (In some, crime is so bad that even restaurants keep guards armed with machine guns on the premises during business hours.)

Indonesia is in the midst of a severe economic and political crisis that spawns no small amount of civil unrest. For years, the island of East Timor has fought a guerilla war for its independence. Recently, the Indonesian government has finally shown a willingness to let East Timor determine its own political fate.

Iran, Libya, and Sudan all are rogue nations known for sponsoring and harboring terrorism against the West.

Iraq invaded neighboring **Kuwait** in 1990 and was crushed by an alliance of Western and Arab nations in 1991. Since then, it has been under constant U.N. surveillance, but is suspected of maintaining secret nuclear and biological weapons programs. It is also suspected of planning another invasion of Kuwait, launching missiles against neighboring countries, and other actions which would destabilize the Middle East.

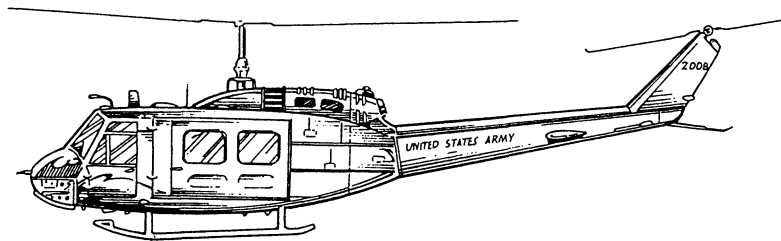

Kosovo and the surrounding region (Albania, Bosnia, Serbia, etc.), basically most of what was once Yugoslavia, and to a lesser degree, Ukraine are poor and politically unstable.

Many of the "old Soviet States" are fractured, divided and unstable (as is Russia). Furthermore, most have surviving pieces of the old Soviet Military (troops, weapons, tanks and other military vehicles). A few, like the Ukraine, have a limited nuclear arsenal.

North Korea is another of the world's major rogue nations. It routinely threatens South Korea (technically, the nations still are at war), where nearly 40,000 American troops are stationed. With North Korea withering under widespread famine, the government has become more aggressive and erratic than ever. It also is suspected of maintaining biological and nuclear weapons programs. It is a known merchant of arms technology to other rogue nations (selling missile technology, in fact, is the nation's number one export).

Lebanon has been the site of intense fighting between foreign invaders and domestic factions for years. Periodically, there are lulls in the bloodshed, only to be ripped apart by new fighting.

Pakistan was a major pipeline of weapons to the Afghanistan rebels during the Soviet occupation. The nation has recently demonstrated nuclear weapons capability as a show of strength to its neighbor and rival, **India**. The two

nations constantly skirmish along the Kashmir region, which they both lay claim to.

The Philippines tension continues between government forces and Marxist and Moslem guerrillas. The country has an operating nuclear reactor research facility.

Russia has become very unstable since the Soviet Union melted down in the early 1990s. Crime lords and the "Russian Mafia" run rampant while the military is fragmenting and selling off the Russian arsenal to the highest bidder (China being one of them). Fears of nuclear material being sold to the black market are ever-present, as is the possibility of another revolution occurring.

Somalia continues to suffer under years of famine and factional warfare. The U.S. tried unsuccessfully to intervene a few years ago, and since then, matters have only worsened.

Syria suffers from religious extremes as different Moslem sects continue to threaten the government.

Taiwan is a major industrial nation that seeks independence from **China**. While the western democracies support this, **China** has no qualms about crushing any independence movement on the island. Tension and the threat of war in the next decade grows every day. Eventually, the status of this place could seriously erode Sino-U.S. relationships.

Turkey has crushed opposition from dozens of armed ethnic groups. Still, attacks on their diplomats overseas and internal threats continue to plague them. Periodically, the country fights with **Greece** over the island of **Cyprus**. Turkey has had operating nuclear plants since 1962.

North and South Yemen continue to have border conflicts. The North is backed by **Saudi Arabia** and the **USA** while the South is Marxist.

The former **Yugoslavia** has, during the 1990s, seen the worst warfare in Europe since World War II. As the nation broke apart, vicious warfare shattered the nation. Today, the independent nations of **Croatia**, **Bosnia-Herzegovina**, and what's left of **Yugoslavia** stand on blood-soaked soil where frequent skirmishes, reports of genocide, and other crises generate international unrest.

Zimbabwe (formerly **Rhodesia**) is a source of several strategic materials, such as copper and uranium, but the specter of civil war hangs over the land.

Strategic Resource Hot Spots

These are areas that produce significant amounts of necessary resources for world consumption. Petroleum products are the most plentiful, but far from the most exclusive of these. The U.S. alone imports dozens of different types of strategic materials from belligerent or unstable governments, including beryllium, chromium, cobalt, industrial diamonds, samarium, tin, titanium, and tungsten.

Some of the more prominent "strategic resource" countries include: **Argentina, Bolivia, Brazil, Canada, Chile, Congo, India, Indonesia, Iran, Malaysia, Namibia, Peru, Philippines, South Africa, Thailand, Turkey, Uganda, Zaire, Zambia, and Zimbabwe.**

From these areas, terrorists or supervillains can stop the flow of precious resources on a scale that will demand attention. Adventure possibilities stemming from this might include the following:

1. Captive Market: Supervillain(s) seize control of a cartel and threaten to destabilize a sector of the world economy.

2. Supply Shortage: Terrorists disrupt production of strategic material, threatening a particular nation or group of nations.

3. Cartel Control: Villains seize control of all mines producing a particular metal. Heroes must liberate mines or supply centers.

4. Trade Sabotage: After supply dumps and ships with strategic metals are destroyed, heroes must track down the culprits before a huge extortion plan is implemented.

World Power Hot Spots

These are places where the most powerful countries in the world have put some kind of stake in the local events or governments. Strained political relations, careful maneuvering and sometimes outright warfare are common in these areas. Considering how precarious the balance of power in these areas can be, a single group of well-armed mercenaries, commando strikes, or superhero (or supervillain) intervention can tip the balance one way or the other.

All sorts of clandestine missions are possible in such regions, ranging from reconnaissance, rescue, kidnapping, assassination, theft, raids, supporting or suppressing rebels, delivering or intercepting weapons shipments, etc. However, those who get involved in under-the-table "Black Ops" which are not formally sanctioned by their sponsor organization or country might very well find that in the middle of their mission, support has been withdrawn! This leaves the operators stranded in enemy territory, disavowed by the people who put them there.

For likely countries in which such scenarios would work best, refer to the list of Geopolitical Hot Spots, above.

Guerrilla Hot Spots

Similar in some ways to the World Power Hot Spots, these places are less dangerous for their questionable status and more dangerous for the open fighting. In these places, the local governments are almost constantly at odds with armies of the people fighting to remove the recognized leadership from power. Each one thinks it is right and either can seem to be so, depending on the perspective of the observer.

Throughout the world, groups ranging from terrorist fringe elements to fully armed and mobilized military forces seek to change the established order. These groups inspire fanatical devotion from their members. Perfect recruits for a super villain bent on conquest.

1. The Promised One: A "messiah" appears, encouraging holy war and showing "god-like" powers. The heroes have the difficult task of exposing the masquerade without killing the villain.

2. The Wings of Death: A death squad has a member with super abilities. Finding and neutralizing such a hidden supervillain in a foreign country should be challenging for any hero group.

Countries Include: **Angola, Bangladesh, Chad, Colombia, Cyprus, Ethiopia, Honduras, India, Indonesia, Iran, Iraq, Northern Ireland, Laos, Lebanon, Malaysia, Mozambique, Pakistan, Peru, Philippines, Rwanda, Western Sahara, South Africa, Spain, Syria, Turkey, Uganda, and Zimbabwe.**

Nuclear Trouble Spots

All of what was once the Soviet Union, particularly the Ukraine ...

These places are nuclear capable, be it weapons or just power plants, but many of them do not have the rigid protocols and security measures of the larger nations, thus making them ideal places for terrorists and super villains to get their hands on nuclear materials. In some cases, nuclear weapons or their components may also be available.

Dozens of countries around the world are actively pursuing nuclear programs. Even countries like Iran and Libya have operational nuclear reactors for research purposes, and prior to the 1991 Gulf War, Iraq was perhaps within a year of having an operating nuclear weapon. This provides for a whole range of super problems such as:

1. Theft of Nuclear Material: Heroes have to stop the villains from building a bomb with the stolen material.

2. Nuclear Blackmail: Terrorists have hidden a suitcase nuke inside a major city. With only hours left, can the heroes find the bomb and neutralize it?

3. Nuclear Espionage: Agents working for a foreign country (supervillain, terrorists, members of a rival political faction) have stolen government secrets (and perhaps materials) for the construction of nuclear bombs, missiles, devices or prototypes (other high-technology or secret military plans can be substituted). The heroes have to locate and stop the villains from getting these secrets out of the country or from building a bomb.

4. Seizure of a Nuclear Reactor: Without causing damage or a meltdown, the heroes must penetrate enemy defenses and regain control of the reactor.

5. Nuclear Accident: A rogue nation's nuclear facilities experience a major accident, possibly a meltdown, explosion, or other release of nuclear materials which could jeopardize the entire region. The superheroes are called in to contain the crisis and perhaps to catch the culprits behind it (Which could get sticky. Was the accident caused by the commandos of another nation trying to nip the country's nuclear program in the bud?)

Countries include: **Argentina, Brazil, Cuba, China, Egypt, India, Iran, Iraq, Israel, South Korea, Libya, Mexico, Pakistan, Philippines, South Africa, Taiwan, Turkey,** and, most importantly, the republics of the former **Soviet Union.**

ADVENTURES

By Wayne Breaux Jr.

Animal Hijacks, Hijinks, and Murder

This is a murder mystery of sorts that starts with escaped (or stolen?) zoo animals and leads to murder. But, did the animals do it, or is there a more sinister force behind it all?

Section One: The Set-Up

As another quiet day draws to a close, the characters catch an intriguing tidbit on the local news:

"Our top story of the hour," says Lory Landry, the pretty anchorwoman for Channel 5 News. "The City Zoo has re-

ported one of its lions missing. Police are declining to comment, but sources inside the zoo confirm that one of their African lions is missing from its enclosure and is suspected to have been stolen.

"There have been no sightings of the big cat, which is believed to have disappeared sometime around midnight. Police are searching the surrounding areas for clues. Citizens are urged to be cautious and stay indoors after dark. If anyone sees the animal, they can contact police and animal handlers at the special hotline 1-800 number at the bottom of your screen."

G.M. Info for Section One

The initial theft/disappearance of the lion may not pique the player characters' interest, but if anyone does some investigating, they may turn up some intriguing clues. In the alternative, some of these clues may be stumbled upon during another adventure or subplot. Police contacts will be the best source of information, but on-site investigation will also reveal something (if the right skills are

known), even though a number of people have been over and through the site. Questioning zoo employees about the lions, the scene, and zoo policy could also help, but might be difficult for “costumed vigilantes.” If the heroes belong to a legitimate, recognized organization, or if they belong to the police force (or have a police contact), they can get a hold of most or all of the following information.

Regardless of the source, the player characters may be able to uncover the following facts:

1) There are no human tracks leading to the cage, other than those of the handlers (all of whom have alibis). This fact might appear on TV news (“Even more mysterious ...”) or newspapers.

2) The cage, part of which had wire bars, appears to have been battered and “torn” opened rather than cut. This would require somebody or something with superhuman strength. Whatever it was, judging by the damage to the cage, it was big.

3) Once the cage was opened, the lion may have simply leaped out and left the area, although there has been no trace of it.

4) The only tracks near the area of the break-in are those of the escaping lion.

5) The escapee seems to have moved straight toward a wall, where a set of four wide, flat footprints are located. Zoologists say these prints were made by an elephant. There are only four prints and no evidence of how they got there.

G.M. Note: So what caused this strange crime scene? The thief, **Paterson Quinn**, has the major super ability of *Animal Metamorphosis*, and can change into any and all types of animals. In this case, he flew into the zoo as a bird and landed on the wire bars of the lion cage. From there, he calmed the lions with the *Control Felines* aspect of his super ability. He then changed into a monkey and gathered a number of brush-like branches from nearby trees to carefully wipe away any tracks (or most of them). He then returned to the lion pen where he changed into an elephant to bash and tear it open. Once the cat was free, he led it to the wall and returned to the monkey shape to brush away his elephant footprints with the branches. He dropped them into the giraffe pen food pile to get rid of them. Changing again to a bird, this time an eagle, he flew to rejoin the lion at the wall where he once more changed to the elephant and lifted the cat over the wall, leaving the four large footprints in the ground. From there, he flew over the wall and directed the lion to his nearby van and drove off.

The big question now is, why go through all the trouble to steal the lion? The answer is that Paterson is a man driven by revenge, and his unique abilities have given him the opportunity to enact a truly creative means to attain it. He plans to assume the likeness of the stolen lion to murder those he hates. It isn't the first time he has done so, and any character who investigates will quickly discover this. A year ago, a leopard escaped from a smaller zoo in a neighboring city and it killed two people. The cat was never recovered and is assumed to have reached the countryside or perished in some corner of the city.

Section Two: The Hunters and the Prey

Three days later, a body is found floating in the river (or lake, reservoir, or whatever local body of water is appropriate for the city the group is playing in). The dead man was *James Hitori*, a Japanese dock foreman. He has been in the water at least a full day. It appears that he was attacked and killed by a large animal.

The autopsy will take two days, but it will concur with the visual evidence that Hitori was mauled by a lion or some other great cat. The simplest explanation is that the escaped animal must have done it, so now the police are searching for a man-killing lion with orders to shoot to kill (**Note:** It is interesting to note that while it seems that a lion slew Hitori, his body was not eaten. A most puzzling contradiction).

This development in the missing animal case will attract large amounts of media attention, including the national news, animal rights groups, as well as all sorts of hunters looking to bag a major trophy. The city will be a huge circus within a week, with the lion in center ring. False sightings and a general aura of panic prevails (particularly in neighborhoods where the lion has been reported seen and where a victim is found).

G.M. Info for Section Two

Of course, the escaped lion did not kill Hitori. It was just made to look that way. Hitori's job at the dock is just a cover. In reality, he is an Enforcer for the local branch of the *Yakuza* (Japanese Mafia). A year ago, he helped kill Paterson's family (see Paterson's description in Section Three for full details). Paterson picked up the Enforcer's scent a week ago and tracked him to the docks where he worked during the day. After freeing the lion from the zoo, Paterson flew down to the docks as a common bird and waited on a nearby warehouse. His first night was unrewarding as Hitori left with a sizable group of co-workers, but the second night he left late and alone. As he went to his car, Quinn, in lion form, attacked and killed him. Then dragged him to the river. There was one eyewitness to the attack, however, but the *Yakuza* that run the warehouse are keeping him quiet because they suspect that the lion was sent specifically to kill Mr. Hitori. **Note:** The *Yakuza* are conducting their own experiments with animals based on Quinn's earlier work. See Quinn's history in Section Three for full details.

If the player characters investigate the docks, they may stumble onto the witness, who is a lowly dock worker named Katsu. Especially sharp characters will notice him watching them. If approached, he will reluctantly speak with the heroes, but only because he was friends with Hitori, whose death he suspects was no freak animal attack. However, Katsu will only talk with the heroes where he cannot be seen talking to them, like in the shadows or behind a stack of cargo containers. All he can say is that the lion who killed James seemed smart and appeared highly trained. It covered the door lock with its paw, seemed to smile as it cornered Hitori, etc. His description of



the beast matches the escaped lion from the zoo. During his questioning, Katsu will be rather agitated, for he is terrified that his superiors will discover that he talked to outsiders about Hitori's death. Depending on how the conversation goes, Katsu may ask the heroes to give him protection, which can provide an interesting subtext for the adventure.

Again, the characters' contacts, jobs, or employers will determine their access to Hitori's body, police reports, and other witnesses as their investigation continues. A successful Streetwise skill roll will notice that the Yakuza are stirred up over something and have been shaking down the local underworld for information. If the heroes manage to locate a few Yakuza members and question them directly, the gangsters won't give up any details, for fear of spilling their organization's secrets. Once the Yakuza realize the heroes are on their trail, they *may* assign a hit squad to take care of this inconvenience, especially if the heroes and the Yakuza have tangled before. If the player characters question anybody the Yakuza has already talked to, they might learn that the mobsters are looking for a man named *Dr. Paterson Quinn*.

Research on Quinn won't turn up much, since he disappeared over a year ago, shortly after his entire family was gunned down by unidentified assassins. The only additional data that research will turn up is that Paterson had worked for several years at the Kenaga Corporation as a scientist. Characters familiar with the local crime scene (or with police or news connections) might recall rumors that the Kenaga Corp. is a front company for the Yakuza.

The heroes also might realize that the attack on Hitori took place some distance from the zoo, a fact that may have gone unnoticed until this point amid all of the furor. Surely the big cat could have easily crossed the distance between the zoo and the dock, but it is unlikely that in such an urban environment, possibly crossing downtown, that it would go completely unnoticed. It also might strike the heroes as strange that this man-killer crossed the entire city but attacked nobody else besides Hitori. All things considered, the activity of the lion and the events surrounding the killing should seem mighty peculiar.

Over the next three weeks, the lion kills two more times, plus two more large cats (a tiger and a panther) will disappear from the zoo(s). Shortly after each animal's escape, another mauled Japanese man turns up. Characters who know the streets or make a habit of keeping an eye on local organized crime will notice that the Yakuza are quite actively looking for something, and their important or top ranking people remain behind closed doors and under heavy protection. Investigating the dead men will turn up some connections between them, most notably the fact that all of them were questioned in the deaths of the Quinn family a year ago.

Section Three: Family Relations

Once the heroes have discovered the connection between the dead men and the Quinn family, they will learn that tracking down Doctor Paterson Quinn will be next to impossible. Since his disappearance, nobody has seen or

heard from him. Assuming he's either dead or in hiding, the heroes have only one other lead: Paterson's last living relative, his sister Veronica.

Veronica lives on a large farm several miles outside the city, surrounded by wide open countryside consisting of other farms and forests. A long, straight gravel driveway takes visitors from the highway, through fenced-in fields where horses graze, to a two-story gray stone house with a wraparound porch. A nearby barn serves as a garage and shelter for a pair of small tractors. Beyond the house are a number of fields and a larger barn which houses additional tractors and farming machinery. The whole rear edge of the property is bordered by a thick, wooded area. A weathered, rugged looking woman with a guarded but friendly smile steps from the house onto the porch as the player characters arrive.

G.M. Info for Section Three

Veronica is a loyal, hard-working woman, more plain than pretty, but totally ignorant of her brother's actions, plans, or location. As far as she's concerned, her brother is either dead or hiding out somewhere. Once the heroes convince her of what's going on and that her brother may be involved, she will genuinely want to help them find her brother and help him. At the same time, though, she can also appreciate Paterson's drive for vengeance — she has

wished many times that those who killed her nephew, nieces and sister-in-law would die horrible deaths themselves. However, that doesn't mean she will defend Paterson. Fantasizing about revenge is one thing. Actually taking it is something else entirely.

Unknown to Veronica, her brother has been hiding out on the outskirts of the farm in the guise of various animals. He has practiced his shape-shifting extensively and can assume nearly any animal form with ease. She hasn't seen him, but he has been watching her. Though he has degenerated into a vengeful man driven largely by his animal instincts, being around Veronica has reminded him of his humanity and keeps him from going completely insane.

When he sees the heroes question his sister, Paterson will assume they have come to harm her, and he will spring into action, intent on spilling blood. If the heroes explain their intentions, or if his sister steps in, he can be calmed enough to listen to what they may have to say, but he will not surrender. He feels his vengeance is incomplete, and nothing shall stand between him and his retribution. If Paterson is attacked by the heroes, he will fight only enough to escape — trying not to kill any "good guys," this time. However, if cornered, the desperate and deranged man will kill. If he defeats or eludes the player characters, he will go after the remaining Yakuza with no subtlety, even attacking them in daylight and in public.

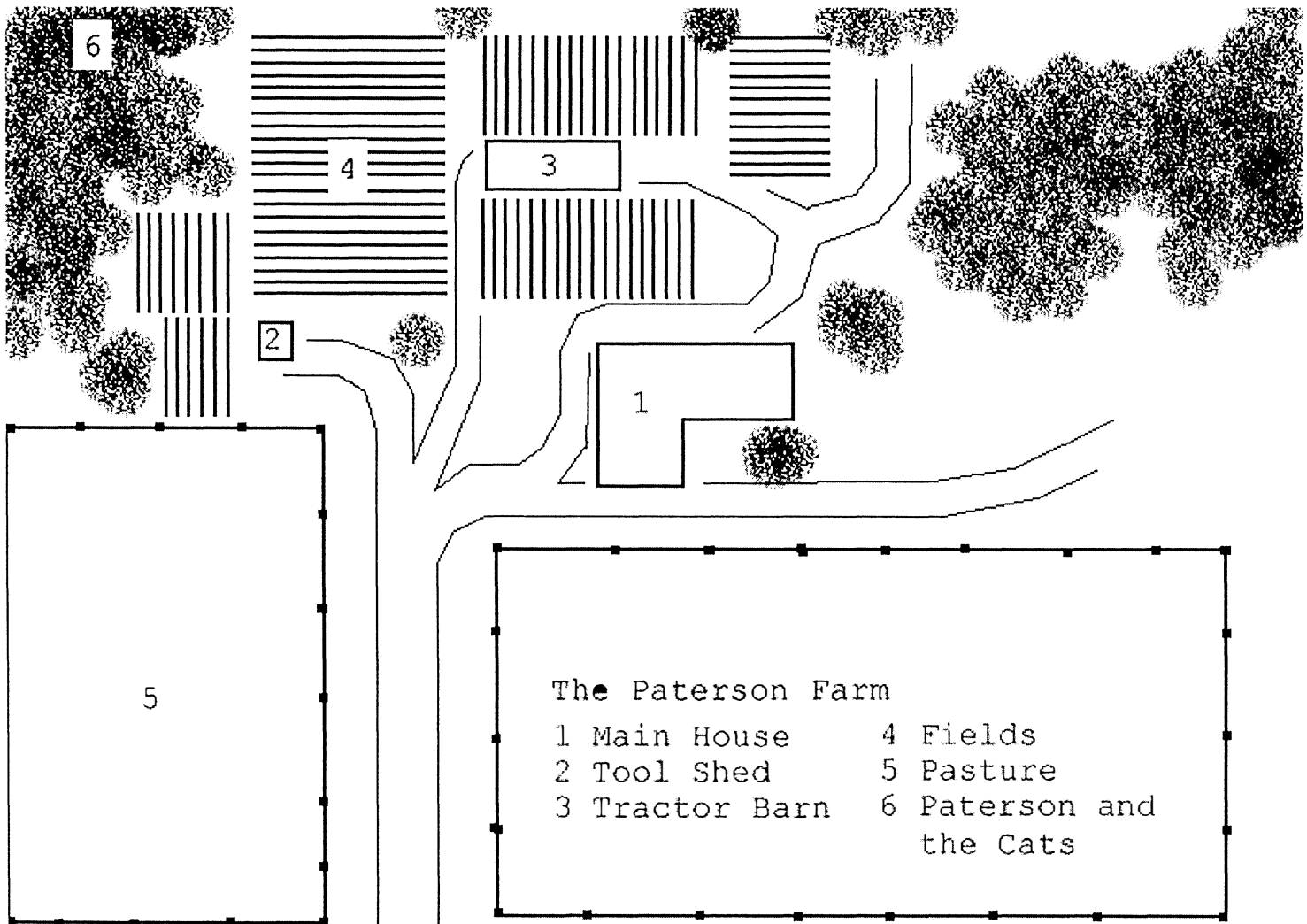

Dr. Paterson Quinn, Vigilante

Paterson Quinn was once a promising young scientist for the Kenaga corporation, a medical and veterinary research company secretly owned by the Yakuza. Nearly two years ago, an experiment went awry, filling the room with toxic fumes that hospitalized him for almost six months. The company paid the bills and saw that he was returned to full health. When he was released, he went back to work, but he brought with him a great secret. By concentrating, he could change into animals and exert mental control over felines. Believing his accident to be the source of these strange powers, he sought to secretly recreate the elements of it in the laboratory. His superiors, ordered by the Yakuza to keep an eye on the young scientist for any changes he might exhibit, eventually realized he was up to something. They looked into his experiments (some of which were partly successful) in awakening human traits in animals such as intelligence and opposable digits. The Yakuza confronted Quinn and offered him a job that would help finalize his experiments. He refused to give his discoveries to a criminal organization and turned them down.

Unwilling to take no for an answer, the Yakuza first threatened Paterson's family. When he ignored their threats, they gunned them down and torched his home. Paterson survived a separate assault at his laboratory only by transforming into a mouse and escaping when Yakuza goons raided the lab and stole his work (which was turned over to loyal scientists charged with developing it further. The G.M. may wish to use this in other adventures involving mutant humans and/or mutant animals. The Kenaga Corporation can even be substituted for Genetech in the "Holy Talking Animals" adventure, later in this sourcebook). At the time a man of peace, Paterson fled home only to find the carnage of Yakuza retribution. The loss of his family pushed him over the brink of sanity. Now he is obsessed with bloody revenge.

Quinn went into hiding at his sister's farm outside of town, where he plotted his revenge. Using the stolen animals as cover for his "hunting," his vendetta is nearly complete. After the killings presented earlier, Paterson will have only two more gunmen to find. This won't be easy, since the Yakuza know who will be targeted next, and will secure the final gunmen away under heavy guard. Or, the Yakuza might choose to use these gunmen as bait to set a trap for the mysterious assassin that is stalking them.

Once Paterson finishes off the other gunmen, however, he will decide that the people responsible for all this have to pay too. His next goal will be to find and eliminate the Yakuza members that direct the Kanaga Corporation's illegal activities. Certainly a scheme of considerable difficulty, but by this point, he is teetering on the brink of insanity and doesn't care.

If the player characters catch up with Paterson, he will know they are coming and release the big cats he has been hiding within the woods around his sister's farm. Should the heroes attempt to apprehend him, he will order the cats to attack, then assume his lion form and fight

alongside them. The shapechanger will use the resemblance of his lion form to that of the escaped zoo lion to confuse opponents who might not want to injure the real animals. As it is, good-aligned characters will not wish to destroy these animals, since they are under Paterson's control, and are innocent of any bloodshed they might cause.

Note: If the group of characters are high level or otherwise powerful due to numbers or favorable combinations of powers and/or skills, beef Paterson up to 8th level and/or add a number of other large cats or other animals to help him out in the battle. Or, include the unfortunate arrival of a Yakuza hit team (which may or may not include super-powered assassins) at the same time the heroes confront Paterson. The Yakuza could have figured out what the heroes have put together, and have come to liquidate Quinn (and the rest of his family?! Is his sister in danger?). Under such circumstances, the heroes might find themselves fighting alongside Paterson and his cats, at least for the time being, only to become enemies later. Or, once the Yakuza hit squad has been defeated, the heroes may wish to let Paterson go, for the moment, since he will have helped them out. Given that Paterson will continue his private war against the Yakuza, if he escapes, or if the heroes let him go, it won't be hard to set up a sequel to this adventure.



Dr. Paterson Quinn

Alignment: Miscreant (It was Principled before his family was killed.)

Attributes: I.Q.: 18, M.E.: 17, M.A.: 13, P.S.: 17, P.P.: 21, P.E.: 10, P.B.: 11, Spd: 38

Size: 5 feet, 10 inches (1.77 m).

Weight: 195 lbs (73 kg).

Hit Points: 29

S.D.C.: 70

Horror Factor: 11 when shifting to animal forms.

Experience Level: 4th

Power Category: Mutant

Minor Super Abilities: None.

Major Super Abilities: Animal Abilities (Big Cats) and Animal Metamorphosis (All).

Appearance: Paterson Quinn is a rather average-looking middle-aged man. Any pictures the characters might find of him show him to be a little short with a spare tire about his waist and thick, framed glasses on his face. He looks very much like a stereotypical research technician, with dark slacks, light button-up shirts, and thick, framed glasses. The superhuman Paterson Quinn still looks basically the same, but has lost his spare tire and no longer wears his glasses. His nose is also a bit wider and his ears thinner and slightly tapered. When in the wilds or during forays in animal form, he wears no clothing and he has a bit more body hair than the average man.

Disposition: Quinn is obsessed with avenging his family's murder. He rightfully blames the Yakuza and targets them exclusively, but is not above hurting anyone who might get in his way (This includes any heroes and the police). If the player characters foil his schemes for revenge, he will become their lifelong enemy.

Combat: Hand to Hand: Basic.

Number of Attacks: 5

Bonuses: +3 on initiative, +4 to strike, +5 to parry, +5 to dodge, +2 to damage, +2 to roll with punch, fall or impact, +2 to pull punch, +1 save vs magic, +6 vs Horror Factor, and +1 save vs poison/toxins.

Education Level and Skills: All have +4% added for the I.Q. bonus. Criminal Science and Forensics (59%), Biology (54%), Chemistry (54%), Pathology (64%), Basic and Advanced Mathematics (69%), Business and Finance (59%), Computer Operation (64%), Paramedic (64%), Law (General) (49%), Research (74%), Language: Japanese (74%), Language: French (74%), Language: Russian (74%), Language: Italian (74%), Language: Spanish (74%), Basic Electronics (54%), Read Sensory Equipment (54%), Pilot: Boats: Sail-Types (84%), Computer Programming (54%), General Repair/Maintenance (59%), Writing (49%), Track Animals (46%), Land Navigation (60%), Hunting, and Prowl (51%).

Weapons and Melee Combat: Paterson is not a formidable melee opponent until he assumes the form of a predatory animal. His preferred "combat form" is that of a large lion. His stats in this form are presented below. As a large cat, his claws do 2D6 plus his P.S. bonus of +2, and his bite does 2D6 to 3D6+4 damage. The latter bite is for a large lion and like all bite attacks receives no P.S. bonus to damage.

Paterson in Lion Form

Size: 6 feet (1.8 m); not including the tail.

Weight: 400 lbs (180 kg)

Hit Points: 50

S.D.C.: 70

Attacks per melee: 5

Damage: Claws: 3D6+6; Bite: 3D6+4

Bonuses: Same as Paterson in human form (see above).

Natural Abilities: In lion form, Paterson has the following abilities, which are augmented by his Animal Abilities: Feline super power: Keen vision and sense of smell, Climb (84%), Prowl (79%), Swim (60%), Track by smell or sight (70%), and Nightvision (100 ft./30.5 m). He can also leap 20 feet (6.1 m) straight up and 40 feet (12.2 m) across, his roar can be heard up to 1.5 miles (2 km) away and he can control 2D4+4 cats at any one time.

Speed: 38, with bursts of speed to 45 (31 mph/49.6 kph).

The (real) Lion

Size: 6 feet (1.8 m); not including the tail.

Weight: 300 lbs (135 kg)

Hit Points: 40

S.D.C.: 44

Attacks per melee: 5

Damage: Claws: 3D6+4; Bite: 3D6

Bonuses: +2 initiative, +4 to strike, +3 to parry, +4 to dodge, +6 vs Horror Factor.

Natural Abilities: Keen vision and sense of smell, Nightvision to 60 feet (18 m), Climb (40%), Swim (60%), Prowl (60%), Track by smell or sight (70%) and can leap 10 feet (3 m) high and 20 feet (6.1 m) across.

Speed: 18, with bursts of speed to 33 (22.5 mph/36 kph).

The (real) Tiger

Size: 8 feet (2.44 m); not including the tail.

Weight: 600 lbs (270 kg)

Hit Points: 45

S.D.C.: 50

Attacks per melee: 5

Damage: Claws: 2D6+8; Bite: 2D6+2

Bonuses: +3 initiative, +5 to strike, +4 to parry, +4 to dodge, +7 vs Horror Factor.

Natural Abilities: Nightvision to 400 feet (122 m), Climb (50%), Swim (80%), Prowl (70%), Track by smell or sight (60%) and can leap 15 feet (4.6 m) high and 30 feet (9.1 m) across.

Speed: 22, with bursts of speed to 50 (35 mph/56 kph).

The (real) Panther

Size: 5 feet (1.5 m); not including the tail.

Weight: 250 lbs (112.5 kg)

Hit Points: 34

S.D.C.: 40

Attacks per melee: 4

Damage: Claws: 2D6+2; Bite: 2D4

Bonuses: +3 initiative, +6 to strike, +4 to parry, +3 to dodge, +4 vs Horror Factor.

Natural Abilities: Nightvision to 200 feet (61 m), Climb (89%), Swim (44%), Prowl (85%), and can leap 20 feet (6.1 m) high and 40 feet (12.2 m) across.

Speed: 22, with bursts of speed to 44 (30 mph/48 kph).

TROUBLE DOWN THE LINE

The characters are drawn into a mystic war between two rival wizards' guilds over the rights to a powerful ley line nexus. This should be something the heroes can handle, as long as no one else tries to crash the party.

Section One: Concert in the Park

"Good evening. I'm Lori Landry and this is the Six O'Clock News. Tonight's top story: Mystic forces made their presence known today when two unidentified, super-powered women clashed in Benberry Park earlier this afternoon."

Footage of the park replaces the channel's logo, then zooms out to fill the screen as Lori continues with a voice over. It looks like a small war was fought in the park. Trees have been blown into splinters or stand charred by fire. The few statues, park benches, and park buildings that remain standing all bear the marks of some kind of energy blasts. On the ground are numerous small craters, some of which are still smoking.

"The battle raged for several minutes until police and S.C.R.E.T. response personnel arrived on the scene," Lori continues (**G.M. Note:** S.C.R.E.T. stands for **S**uperbeing **C**ontrol, **R**etrieval, and **E**limination **T**eam, as detailed in the **Villains Unlimited™** sourcebook.)

"The two combatants then dispersed and eluded capture. Incredibly, no park visitors were hurt during the exchange, although some remained rattled by this supernatural confrontation, yet another reminder of the awesome powers that dwell among us."

The footage shifts to brief eyewitness accounts of the fight. Most of the people interviewed describe the women "flying" and throwing "lightning bolts," or "different kinds of energy beams," at each other. According to the eyewitnesses, the two fled when the authorities arrived. One flew off over the rooftops and the other simply vanished. "One minute she was there," reports a witness, "the next she wasn't." The footage shrinks back to its backdrop panel and Lori continues with the newscast.

G.M. Info for Section One

If the player characters investigate, there is little else to learn at this point. Witnesses will relate pretty much what the news report said, though possibly in more colorful terms. The two women started a verbal argument in the park, then there were flashes of light, lightning, and other energies as the argument turned into a mystical brawl. When the cops and S.C.R.E.T. closed in, both of them disengaged and fled.

A player character Wizard visiting the park within a few hours of the incident will sense the residual magic in the area, but that won't offer any clues as to what happened. However, at the G.M.'s discretion, Magic characters may know of *The Enlightenment* and/or *The Society of the Mystic Font*, two secretive, rival Wizards' guilds that have operated in the city for some time. Going by the descrip-

tions of the combatants, a Magic character might match the look with *Bella*, a renowned member of The Enlightenment. Going by that, it is a safe bet that the other description points to a member of the Society of the Mystic Font.

An alternate way of beginning this adventure is having the player characters in the park (either in their civilian identities or making a public appearance as costumed heroes) when the battle breaks out. The heroes may or may not take sides, but if they get involved, additional Wizards may be thrown into the mix to make the situation more challenging. Remember, there will be dozens of innocent people about, so the heroes can not indiscriminately blast away at the feuding Wizards. Also, they might have to put themselves in danger and not participate in combat to protect any innocent bystanders about to get caught in the crossfire.

Regardless of the heroes' involvement, the outcome is largely the same. After 1D6 minutes of combat, the first police will show up and the dueling Wizards will all flee, taking any fallen comrades with them. About five minutes later, a S.C.R.E.T. response team arrives on the scene (depending on the heroes' relationship with S.C.R.E.T., this may be their cue to leave, too).

Bella's full statistics are given below. The stats for the other mage(s) in this fight should be determined by the G.M., but they shouldn't be more powerful than Bella.

Section Two: Trouble is Just a Free Fall Away

Several days after the news reports (or before, depending on your preferences), as some or all of the player characters are enjoying themselves in a relatively open area (under the skylights of a mall, dining on a patio, walking to their cars, watching a sporting event, etc.), a body will, literally, fall into their laps. The figure can crash through a skylight, land on the characters' table, etc. Regardless of where it lands, the person is still alive, though barely, and will attempt (even in her wounded condition) to get to her feet and flee.

Any Wizards in the group can roll to see if they sense magic just before the figure falls. If the group decides to help, or at the least investigate, the person can be identified as a woman dressed in a dark outfit with a belted tunic over close-fitting pants and boots. A hooded cloak conceals most of her attire, though, and a red mask hides her identity. She will be hurt and slightly disoriented from her fall, muttering about how she, "Must ... get away." If the characters seem concerned, she will ask them for help when she recovers her senses moments later.

G.M. Info for Section Two

The woman is *Analisse Chavon*, but she calls herself "Bella" when in costume. She is a Wizard of The Enlightenment, and is one of the combatants in the park. Cur-

rently she is fleeing *Vadimar*, a Wizard from the Society of the Mystic Font. Bella had been flying on a broom she enchanted with a Fly spell, but *Vadimar* negated that magick, sending the enchantress crashing to the ground. *Vadimar* will not show up where Bella fell, but the two *Shadow Beasts* he has summoned will — probably about the time the group gets its wits together and decides on a course of action. Bella will not have time to explain with the Beasts bearing down on her. The creatures will focus their attack on the fallen mage, unless somebody else presents a serious threat to them. They will then attack any interlopers (i.e., the heroes) before returning their attention to finishing off Bella (**Note:** The stats for a Shadow Beast can be found on page 335 of **Heroes Unlimited™, 2nd Edition.**)

If Bella survives and talks with the group, they may learn some of what is going on. If she decides for some reason to leave and not talk to the group right now, she will make good an escape, and find them later when things get really bad, and ask for help.

In a nutshell, The Enlightenment and The Society of the Mystic Font have bickered over the control of a ley line nexus in town, but it has never escalated into anything serious or life threatening. That has begun to change as a planetary alignment draws near. The alignment will cause the already powerful nexus to surge with massive amounts of mystic energy (P.P.E.). Both of the groups have guild houses on the contributing ley lines, but neither will forego the chance to tap the incredible energy of the upcoming conjunction. Even though it will likely provide enough power for both groups' rituals, *Vadimar's* guild is too greedy to risk coming up short. The Society of the Mystic Font is made up of selfish and evil Wizards who are willing and able to fight and kill for exclusive rights to the nexus point during the upcoming conjunction. That means war has been declared on The Enlightenment sorcerers. The Society of the Mystic Font will settle for chasing their rivals away, but will kill if they feel they must.

It is left entirely up to the G.M. as to how many battles, incidents and encounters occur between the two guilds, their members, and/or the player characters before the big night of planetary alignment and mystic ritual(s). If the Mystic Font members believe they have forced The Enlightenment members to abandon their plans to use the nexus point, they will cease hostilities and devote themselves to preparations for their ritual. Otherwise, they will continue to apply heavy-handed tactics to dissuade their rivals. As the date of the alignment approaches, their tactics will grow increasingly deadly. If any of the Enlightenment members show themselves on the night of planetary alignment, the Mystic Font will try to kill them outright (see Section Three for some ideas on additional complications to this little squabble).

Note: For a more direct hook into the adventure, player character Wizards may already be part of Bella's guild, or have petitioned to join it and must help out if they are to be fully initiated. Along the same lines, remember that the villain *Gary Pender* from the *Loose in the City* adventure can also be associated with *Vadimar's* guild, providing even more links and hooks for your group's adventures.

The Enlightenment (Wizards' Guild)

This is the guild to which Bella belongs. Most of the members are of good alignment, though some selfish alignments are counted among their numbers. Evil alignments are not allowed and once someone shows themselves to be such, they are expelled from the guild. The Enlightenment is mostly Druidic/Celtic/Wiccan in its beliefs, and puts unity and life at the forefront of their beliefs. Hermetic-type Wizards are part of the organization, but their structured book magic and alchemy are not as pervasive as the more natural rituals and practices of the majority numbers. The guild maintains a large Victorian-style house with a sizable yard. Of course, it is built on one of the only notable ley lines that run through the city. Normal magicks are performed in the house or on the yard and benefit from the added boost of the ley line, but special rituals or events are held down the street on the nexus point, at moments when mystic energy swells.

The Enlightenment has six members (which is a significant number of mages in one spot even for a **Heroes Unlimited™** setting), four "nature-oriented" and two "hermetics." Their magic orientations have little effect on game terms, unless the G.M. is using practitioners of magic from other Palladium games (such as **Rifts®** or **The Palladium Fantasy Role-Playing Game®**), in which case the "hermetics" would be Ley Line Walkers or standard Wizards, while the "nature-oriented" mages could be Shamans, Mystics, Druids, or Priests of Light. They gather together out of common interests (magic, mostly) and for some necessity. It is difficult for the lone practitioner in a modern world, and having other mages around for help, support and inspiration (as well as to share P.P.E. with) is always handy. The guild members seek only to master their own arcane skills while living peacefully with whatever other guilds or magic practitioners might exist in the area. They are a cooperative seeking to help themselves by helping each other.

The guild has no dues, but members are asked to contribute to its upkeep. Usually this means contributing to expenses, adding a spell or donating a book to the guild library, returning borrowed books and items, as well as maintaining the house, buying or cooking food, donating or contributing P.P.E. to rituals, etc. Only three of the members actually live in the house, but there is plenty of room for the rest to stay when doing research or a place to stay is needed.

Bella is the most powerful Wizard of The Enlightenment. The other members are less impressive, though quite powerful compared to the average mortal. If the G.M. wishes to draw them into the adventure, possibly for a climactic magical battle royal, he can assign them specific stats or assume each has average attribute scores of 10, except P.E. and I.Q. which will be 14. They are each approximately 3rd level with 25-45 S.D.C. and 30 hit points. Their P.P.E. ratings range from 95-125 points. The "hermetic" Wizards will have spells like Decipher Magic, See the Invisible, Levitation, and Mystic Alarm, along with Energy Bolt and similar combat spells. The "nature-oriented" Wizards will lean more toward spells like Death Trance,

Sense Evil, Turn Dead and Negate Toxin, with fire or lightning spells being preferred for combat.

Organization Stats for The Enlightenment

Note: The following aspects of this organization are derived from the Organization Creation rules mentioned on page 34 of the **Villains Unlimited™** sourcebook.

This is a Secret Society with 145 Organization Creation Points, distributed as follows:

Outfits: None (0 points).

Equipment: Magical Supplies (10 points). Alchemical and other basic necessities for rituals or simple wards are provided.

Weapons: None (0 points).

Bionics and Robotics: None (0 points).

Vehicles: None (0 points).

Communications: Basic (2 points). The guild provides its members with cellular phones and the guild house has a modern-based Internet connection.

Gathering for Enlightenment Guild House

First Floor

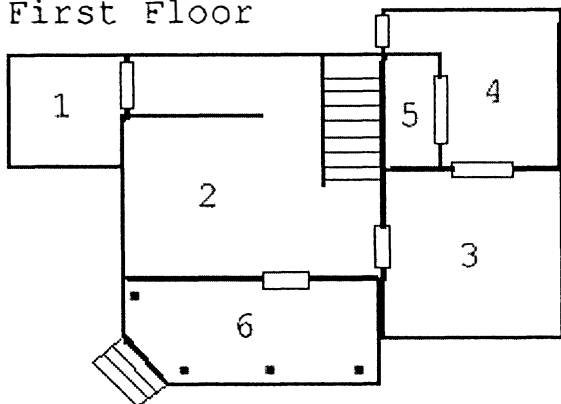

1 Bedrooms

2 Living Room

3 Dining Room

4 Kitchen

5 Utility Room

6 Porch

Second Floor

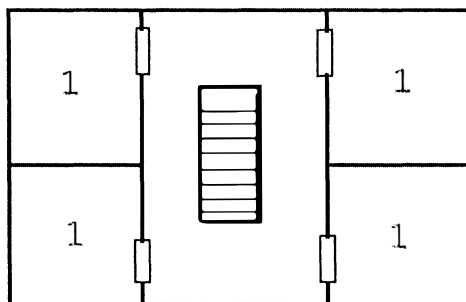

Offices, Hideouts, and Distribution: Urban (5 points). Includes the houses of the non-resident members and places protected by wards or spells.

Military Power: Security Guards (5 points). Familiars and small enchanted or summoned creatures keep an eye out for intruders and impostors, but they can't do much to stop them. They usually raise an alarm so the guild members can take care of the situation.

Super Powered Operatives: Super Strike Force (40 points). All of the members are super-powered Wizards and together command as much power as a battalion of high-tech commandos.

Sponsorship: Agent Sponsored (50 points). The members run the guild.

Special Budget: Nickels and Dimes (5 points). The members could scrape up a couple of thousand dollars for a really important ritual (a diamond or other valuable might be required), but there is no second try.

Administrative Control: Rigid Laws (0 points).

Internal Security: Iron Clad (25 points). The wards on the house are equivalent to this level of security.

External Infiltration: None (0 points).

Research and Information Gathering: None (0 points).

Agency Credentials: Unknown (3 points).

Agency Salary: None (0 points).

Bella, Wizardess of The Enlightenment

Bella is the costumed identity used by the wizardess Analisse Chavon when she finds the need to take an active role in things that her magicks might have some positive impact on. Such outreaching tactics are generally frowned on by her fellows in The Enlightenment, but none of them have condemned or expelled her for it. She also tends to be more outgoing and social than the other spell casters, and her spells tend to follow suit with a mixture of offensive, defensive, and miscellaneous spells most of the others do not have.

Analisse can be said to be the spokesperson for the guild simply because she is the only one who truly enjoys dealing with non-mages — “outsiders.” No one person leads the guild, but Analisse has recruited the majority of its members, again because she is the most inclined to go out and find like-minded individuals to join the group. It also means that she would be the one inclined to adventure as a heroine with the player character group if they should need the guild's assistance. On the bad side, her personality makes her all too willing to butt heads with the members of the Society of the Mystic Font over the nexus issue.

When not absorbed in the pursuit of magical knowledge or recruiting new guild members, Analisse pays her bills by working as a computer programmer and software designer. She is trying to shift her work into the computer games area and has been practicing her creativity through art and less formal writing.

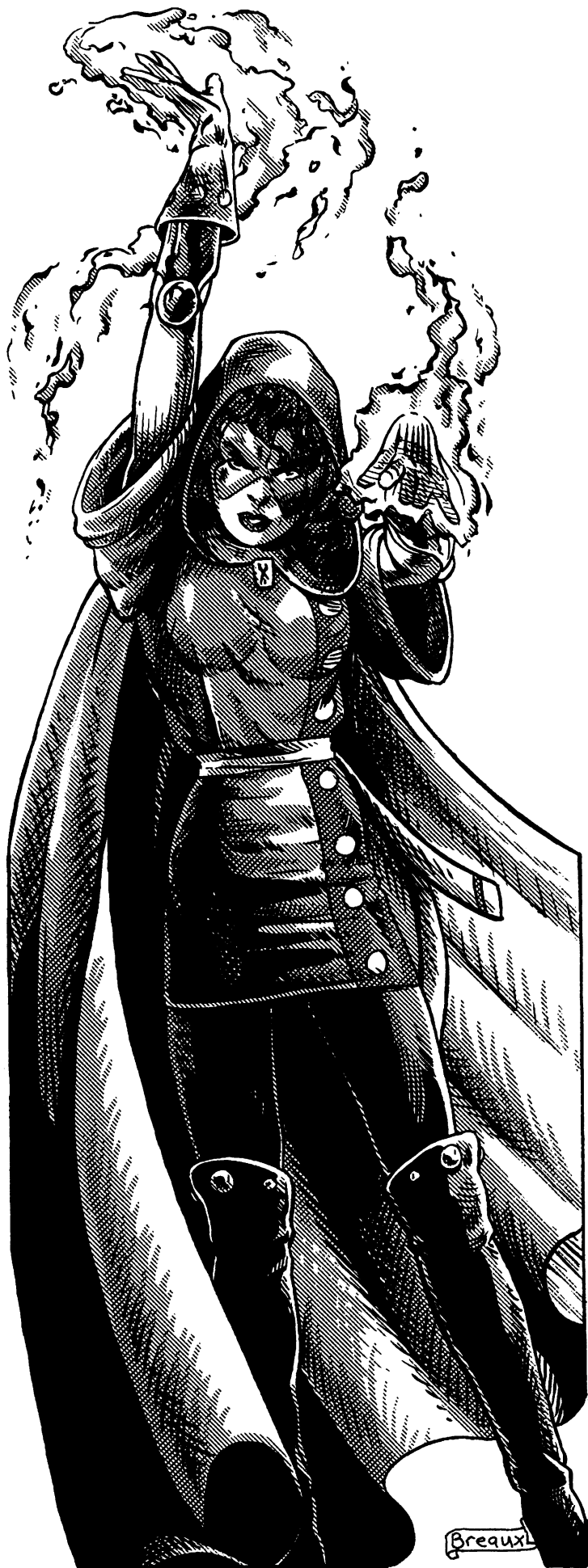

Bella of The Enlightenment

Real Name: Analisse Chavon

Alignment: Principled

Attributes: I.Q.: 16, M.E.: 12, M.A.: 21, P.S.: 9, P.P.: 12, P.E.: 18, P.B.: 13, Spd: 14

Height: 5 feet, 3 inches (1.6 m)

Weight: 105 lbs (47 kg)

Experience Level: 5th

Hit Points: 38

S.D.C.: 30, but can use magical armor to augment this in combat.

Disposition: Open and friendly, a direct contrast to the somewhat absorbed attitudes of others in the guild. She makes friends readily and enjoys being with people as much as her dedication to the mystic arts allows. While far from a "party girl," she does enjoy having fun and doing new things, often traveling to study and research history and spell formulae.

Appearance: Analisse is pretty when she wants to be, but generally looks rather plain. Appearances aren't all that important to her, and with her magnetic personality, it's not something she has to worry much about. She wears glasses to read, except when she's at a computer, and dresses comfortably in jeans and cotton shirts when not hiding her identity.

The Bella costume has a long, hooded, emerald green cloak worn over a gray belted tunic that falls to mid-thigh. Beneath the tunic she wears close-fitting black pants and knee-high boots. A red mask shaped roughly like a butterfly covers her upper face.

Magic: Analisse knows the following spells (P.P.E. costs are in parentheses): Cloud of Smoke (2), Decipher Magic (4), Sense Evil (2), Chameleon (6), Extinguish Fire (4), Levitation (5), Mystic Alarm (5), Armor of Ithan (10), Energy Bolt (5), Negate Toxin (5), Paralysis: Lesser (5), Carpet of Adhesion (10), Repel Animals (7), Seal (7), Swim as a Fish (6), Tongues (12), See the Invisible (4), Mystic Shield (10), Eyes of the Wolf (25), Fireball (10), Fly (15), Dispel Magic Barriers (20), Invisibility (Superior) (20), Eyes of Thoth (8), Heal Wounds (10), Charismatic Aura (10), Multiple Images (7), Impervious to Cold (6), Impervious to Fire (6), Blinding Flash (1), and Globe of Daylight (2).

P.P.E.: 152

Spell Strength: 14

Combat: Hand to Hand: Expert.

Number of Attacks: 5

Bonuses: +2 on initiative, +2 to strike, +3 to parry, +3 to dodge, +2 to roll with punch, fall or impact, +2 to pull punch, +5 vs magic, +1 vs possession, +2 vs poison, +2 vs Horror Factor, and has a 65% chance of evoking feelings of trust or intimidation.

Education Level and Skills: Basic Electronics (77%), Computer Operation (87%), Computer Programming (77%), Cryptography (72%), Research (97%), Photography (82%), Writing (67%), Language: Japanese (97%), Language: Chinese (97%), Language: Russian (97%), Language: German (97%), Athletics, First Aid (72%), Pilot: Automobile (72%), Pilot: Boat: Sail-Type (87%), Astronomy (52%), Art (52%), and W.P. Knife. As

a Wizard, she also has Spell Translation (20%), Demon and Monster Lore (57%), Geomancy and Lines of Power (52%), Religion Lore (62%), Archaeology (47%), Chemistry (57%), and Holistic Medicine (47%).

Weapons and Combat Damage: The only weapon Anaisse regularly carries is a knife. It has been enchanted as a talisman (as per the spell) and can hold 25 P.P.E. points as a reserve for her use. Other than the knife, the only other physical attacks in her repertoire are her backward sweep and tripping leg hook kick attacks, as well as a karate kick (2D4).

The Society of the Mystic Font (Wizards' Guild)

In stark contrast to the make-up and orientation of The Enlightenment, there are no good members of the Society, for few such people would agree with its practices or goals. It is mostly comprised of Summoners and Charmers, the kind of sorcerers who use their magic to control others, be they humans with spells cast upon them, or otherworldly beings brought here and forced into service.

The Society's leadership (with Vadimar being chief among it) is strongly Aberrant. Thus, they seek to establish their control in an orderly manner by subverting their enemies and directing things from behind the scenes; at least until they are ready to take the reins of power with little opposition. So far, the Society has replaced a city councilman with a Doppelganger from another dimension and have gained magical control over one of the Mayor's aides (by using a beguiling female guild member and the proper charm spells). It also has footholds in the police and fire departments, board of education, and even pulls the strings of a city judge or two. Once it has enough power interlaced throughout the city, the Society will take control of it as a shadow government and direct it more aggressively. It plans to summon a powerful god-like being at some point in the future and will need the entire city at their disposal to prepare for it.

Vadimar's guild resides and operates out of an elementary school that was abandoned years ago because it was haunted. Resting squarely on a ley line, the building attracted all manner of spirits and poltergeists who eventually drove out the teachers and children. Unfortunately for the ghosts, the guild members are binders and forced them all into service as guards and servants shortly after taking over the old school as their permanent guild house.

G.M.s who own **Beyond the Supernatural™** or the **Palladium Fantasy Role-Playing Game, 2nd Ed.** (specifically the *Monsters & Animals* sourcebook) can use the Tectonic Entities, Banshees and Ghosts from those games to oppose any heroes who enter the Society's headquarters. Those unfamiliar with these games can either modify the *Dark Breeze* from the **Planetfall** adventure, or get creative with a permanently intangible psionic character to duplicate a poltergeist or other malevolent spirit.

Just down the street from the guild house is an old city park where the two major ley lines in town intersect (not the park where Bella and one of the Society's Wizards scuffled at the beginning of this adventure). The ley line nexus lies deep within a dense thicket of trees that has never been developed. There are natural clearings within the thicket for both guilds to perform their rituals (and do combat), but the place remains wild, and is rarely visited by normal people, who get creeped out by this strange spot. Many feel that it is haunted, but that is not the case. It is just surging with raw magical energy.

The Society of the Mystic Font is larger than The Enlightenment, with almost 20 members, and maintaining itself through contact with other-dimensional entities and the simple fact that stellar and planetary traits point to this city as the prime spot for the kind of thing the Society wants to achieve. What would otherwise be a group the size of The Enlightenment has flourished and grown as like-minded Summoners and Binders made their way here.

Unlike The Enlightenment, the Society has dues and all members must live in or near the society's headquarters. The members' controlling magicks reflect their aggressive and domineering personalities. They all are successful career people, such as bankers, doctors, executives, etc., whose occupations put them in contact with the movers and shakers of the city. This forms the basis for the Society's worldly power, and their magic efforts do the rest. In addition, each member is required to donate any necessary P.P.E. to Society rituals.

Vadimar's stats are given after the stats for the guild. The other members of the society are less impressive, though slightly more powerful than their counterparts in The Enlightenment. If the G.M. wishes to draw them into the adventure, possibly for a grand finale magical battle royal, simply assign them specific stats or assume each has average attribute scores of 10, except P.E., M.E. and I.Q., which will be 14 or higher. They are approximately 4th level with 30-45 S.D.C. and 30-40 Hit Points. Their P.P.E. ratings range from 100-150 points. They can have any kind of spells, but summoning, control, and combat spells will be the most common. Each mage has two additional spells from each spell level 1-5 to bolster those all Wizards begin with, in addition to any appropriate Summoning spells or circles (see **The Palladium Fantasy RPG® 2nd Edition** for summoning and circle magic). Many of them are also likely to have a couple of entities and/or small, lesser demons or other-dimensional servants of some kind that they have summoned and bound into service. These servants will have the stats of an average human with a handful of psionic abilities (no super psionics) or spells (1D4+2 spells from levels 1-4). More powerful summoned creatures guard the headquarters and may include Gargoyles or other minor demons or Deevils (again, see **The Palladium Fantasy RPG®, 2nd Edition** for more info on these monsters).

Organization Stats for the Society of the Mystic Font

This is a Secret Society with 151 organization points at its disposal.

Outfits: None (0 points).

Equipment: Magical Supplies (10 points). Alchemical and other basic necessities for rituals, wards or summonings are provided.

Weapons: None (0 points).

Bionics and Robotics: None (0 points).

Vehicles: None (0 points).

Communications: Basic (2 points). Cellular phones and Internet communications.

Offices, Hideouts, and Distribution: Urban (5 points). Includes the houses of the non-resident members and places protected by wards or spells.

Military Power: Militia (15 points). While the society can't call up 150 armed soldiers, it does have a number of powerful minor Demons or Deevils and some golems to protect their headquarters. These could be called into the field if absolutely necessary.

Super Powered Operatives: Super Strike Force (40 points). All of the members are Wizards and count as super beings equal in number to a strike force.

Society of the Mystic Font Guild House

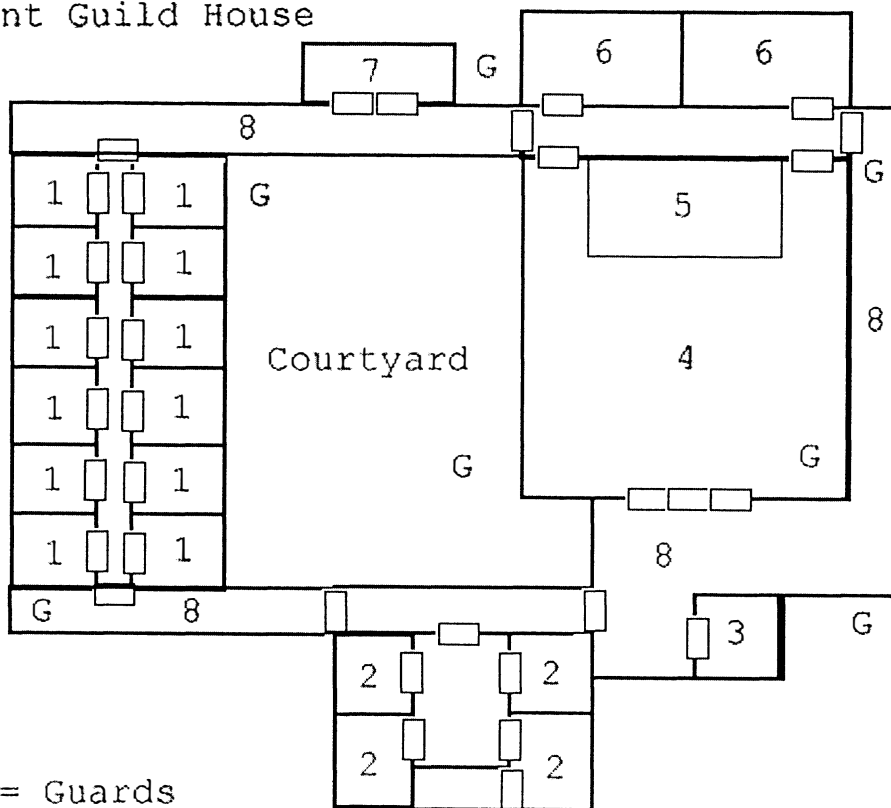

G = Guards

1 Member's Quarters

2 Leader's Quarters

3 Storage

4 Old Gym/Ritual Area

5 Stage

6 Dressing Rooms

7 Underground Holding Cells

8 Covered Walkways

Sponsorship: Private Industry (6 points). Unknown to many of the society members, the organization is actually controlled by a rather powerful demon with its own agenda. It is able to manipulate key members to hide its involvement in their activities, but just like a corporate sponsor, it expects a return on its investment, including summoning specific entities when told to, eliminating certain people without question, contributing P.P.E. when necessary, etc.

Special Budget: Small Potatoes (15 points). The successful careers of the members means they can collect a substantial amount of money (up to \$50,000) for a really important ritual or purchase (such as buying buildings or land needed for future use), but such money could only be found once or twice a year.

Administrative Control: Rigid Laws (0 points).

Internal Security: Paranoid (30 points). The wards and servants on the headquarters make it almost impossible to get around unnoticed. **External Infiltration:** General Infiltration (25 points). As mentioned before, the society has key people under its control or controlled by one of their supernatural servants.

Research and Information Gathering: None (0 points).

Agency Credentials: Unknown (3 points).

Agency Salary: None (0 points). The members are all independently wealthy.

Circular Drive From Road

Vadimar

Wizard & Member of the Society of the Mystic Font

Vadimar is a tall, dark, and menacing figure. He is ruthless and powerful with a want and need to become even more so, and while he doesn't head the Society of the Mystic Font, he is the leader's right-hand man and the guild's "enforcer." **Note:** The identity of the Society's leader is known only to the innermost circles of the guild, which includes Vadimar and perhaps two or three others. The rest only know that the leader is a woman. Nothing else is known about her except that she is completely evil and very, very powerful (no, she isn't the wizard Bella clashed with earlier).

The player characters may never know much about the Society, but they will definitely get to know Vadimar as a determined and merciless opponent. He is not one to skulk in shadows but instead possesses a keen perception of his position at all times and the ability to know when to hide or take action.

Vadimar is one of the select few who know the Society's true agenda, and will see to it that nothing impedes the timetables. Even his own people are at risk should they question or delay the plans. In the same vein, if this adventure is linked to *Loose in the City*, Vadimar will be hunting the Summoner Pender for drawing attention to himself and possibly alerting others to the Society's habit of summoning demons. He will additionally be charged with catching, killing, or returning the demon to its own dimension, adding yet another complication to the tasks of the player characters should they undertake that adventure.

When not attending to the affairs of the society or his own mystic studies, Vadimar works as a lieutenant in charge of one of the Detective Divisions in the City Police Force.

Vadimar

Wizard & Member of the Society of the Mystic Font

Alignment: Miscreant.

Attributes: I.Q.: 20, M.E.: 16, M.A.: 22 (the intimidate aspects only), P.S.: 12, P.P.: 15, P.E.: 13, P.B.: 14, Spd: 18

Size: 6 feet 5 inches (1.95 m)

Weight: 220 lbs (99 kg)

Experience Level: 9th

Hit Points: 52

S.D.C.: 50

Disposition: Cold, calculating and determined, this dark Wizard weighs his options carefully before committing himself to action. He prefers to have others do his dirty work whenever possible, such as the Shadow Beasts that attacked Bella earlier in the adventure, but he also enjoys personally defeating his opponents and inflicting punishment or suffering on them. Thus, he will handle many things personally, especially when they are safe and easy enough that he can enjoy them. He despises The Enlightenment and has looked for an excuse to destroy it for years. The current conflict over the ley line nexus has given him the perfect excuse.

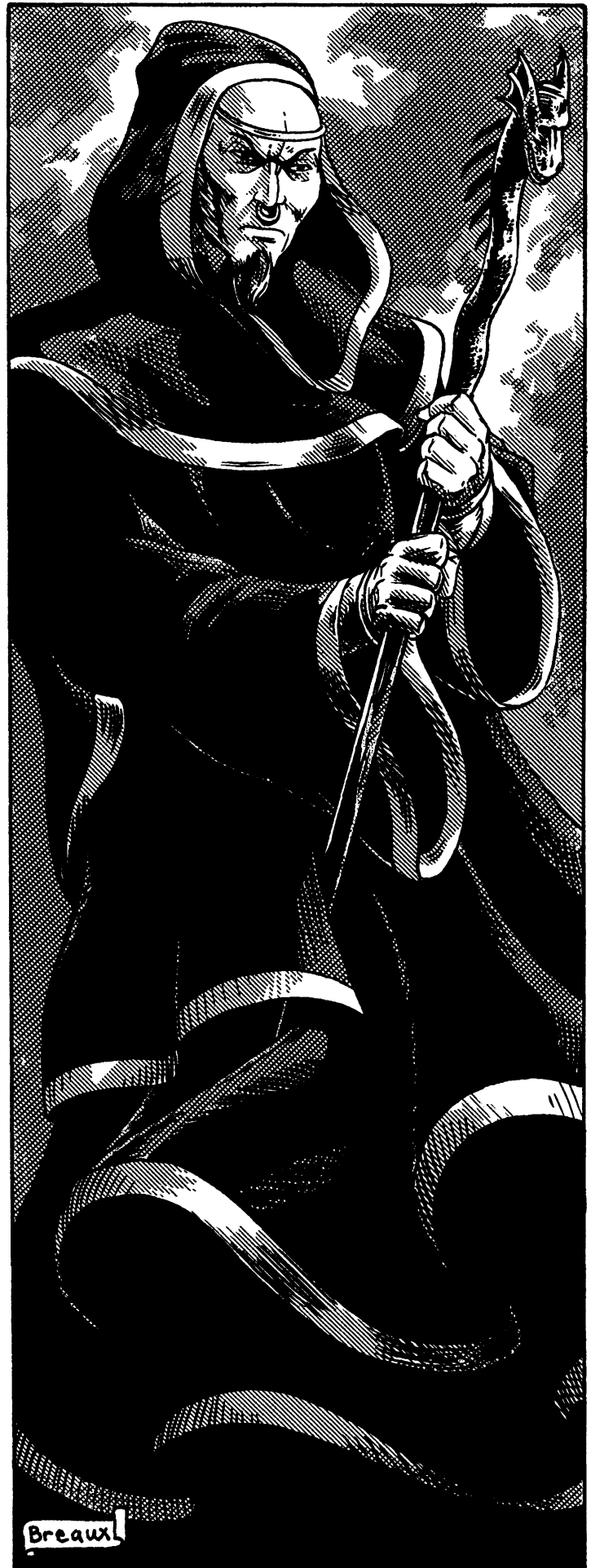

Appearance: Vadimar is tall and dark, both in appearance and in dress. He is of Middle Eastern descent with dark skin and black eyes. He wears his long beard in a goatee and has a silver ring through his nose. Adding to the sorcerer's menacing look are multi-layered robes of deepest blue with blood red trim. A silver circlet lined with etchings spans his forehead and black gloves hide his hands.

Magic: Vadimar has the following spells: All first and second level spells, Armor of Ithan (10), Energy Bolt (5), Ignite Fire (6), Fuel Flame (5), Blind (8), Magic Net (7), Energy Field (10), Ley Line Transmission (30), Horrific Illusion (10), Impervious to Energy (20), Agony (20), Animate and Control Dead (20), Summon Shadow Beast (140), Superhuman Strength (10), Constrain Being (20), Heal Self (20), Invulnerability: Limited (25), Life Drain (25), Wind Rush (20), Exorcism (30), Minor Curse (35), Negate Magic (30), Wisps of Confusion (40), Multiple Image (7), Impervious to Fire (6), Negate Poison/Toxin (5), Telekinesis (8), Shadow Meld (10), and Domination (10). (All P.P.E. costs are given in parentheses.)

P.P.E.: 300

Spell Strength: 15

Combat: Hand to Hand: Expert.

Number of Attacks: 6

Bonuses: +2 on initiative, +2 to strike, +3 to parry, +3 to dodge, +2 to roll with punch, fall or impact, +2 disarm, +2 to pull punch, +3 to save vs magic, +2 to save vs possession, +2 vs Horror Factor, and Critical strike on a natural 18-20.

Education Level and Skills: Detect Ambush (98%), Intelligence (97%), Computer Operation (98%), Interrogation (98%), Tracking (98%), Biology (98%), Pathology (98%), Running, Climbing (98%), Military Etiquette (98%), Radio: Basic (98%), W.P. Rifle, W.P. Pistol, Criminal Science (98%), Law (General) (98%), Streetwise (87%). As a wizard, he also has Spell Translation (26%), Demon and Monster Lore (81%), Geomancy and Lines of Power (76%), Religion Lore (86%), Archaeology (81%), Chemistry (91%), and Holistic Medicine (98%).

Weapons and Combat Damage: Vadimar's combat skills include a tripping leg hook, a roundhouse kick (3D6) and a karate kick (2D4). He also has the paired weapons ability with all weapons and can perform a body throw/flip.

Vadimar regularly carries a short sword beneath his robes. It has been enchanted, giving it +2 to strike, parry, and damage as well as functioning as a Talisman (as per the spell) and holds 50 P.P.E. points as a reserve for his use.

Section Three: Party Crashers

The magical practitioners aren't the only ones who want the nexus point for the upcoming conjunction. Plenty of supernatural beings can make use of the heightened energies of the nexus at that time, even player character Wizards.

G.M. Info for Section Three

The G.M. is free to come up with as many added complications as he and his player group can handle, but two suggestions are given below. Feel free to include them as complications or ignore them completely (Statistics from **The Palladium Fantasy Role-Playing Game®**, **Rifts®**, **Beyond the Supernatural™**, or **Nightbane®** can certainly be substituted for these **Heroes Unlimited™** equivalents).

A trio of female demons (succubi) want to use the conjunction and the nexus to open a gateway and bring over a mass of their brethren. The demons have used their human pawns to manipulate the political climate of the city to build themselves a regime behind the facade of a women's rights movement. They have no connections to the regular demonic allies of the Society of the Mystic Font, which often results in the schemes of the two groups coming into direct opposition. The succubi will wait until the conjunction and use some of the event's energies to fight off the Mystic Font and any other competition, counting on the event to provide enough remaining power for their spells. In their natural forms, they are nearly eight feet (2.4 m) tall, with thickly muscled builds, wide shoulders, bat-like wings, long, powerful tails, reddish-bronze skin, long fangs, blazing eyes, large, tapered ears, and a thick, single horn that curves from the forehead.

Quick Stats for the Demoness Trio

P.S.: 19 (superhuman). **Natural A.R.:** 12. **H.P.:** 40. **S.D.C.:** 200. **Experience Level:** 5th. **Bonuses (all):** +2 initiative, +5 to strike, +4 parry, +2 dodge, +2 on all saving throws and +4 to save vs magic. **Number of Attacks:** 5. **Damage:** 3D6+P.S. from claws, 2D6 bite damage, and 3D6+2 gore damage from the horn. **Spell Knowledge:** Between the three of them, they know all spells of levels 1-4. **P.P.E.:** Each has 145.

Quick Stats For the Castaway Aliens

The other main competition is a benign group of magically inclined aliens. Their race uses dimensional travel instead of faster-than-light propulsion to explore the Megaverse®. Twelve years ago, they visited Earth but soon thereafter, their Dimensional Teleportation device was damaged, marooning them here. Ever since, they have anticipated this upcoming planetary alignment as their only chance to return home, since the device requires 1,000 P.P.E. to activate, and only this surge will give them the power they need. If the competition between the Society and The Enlightenment draws enough attention (or the players do), the aliens will ask them for help. In that case, The Enlightenment will put aside its ritual needs to help get the aliens home, but the Society of the Mystic Font will still need to be dealt with. The aliens are human-looking, but have no body hair, thin builds, and large, dark eyes.

I.Q.: 15+1D4. **H.P.:** 8D6. **S.D.C.:** 40. **Experience Level:** 4th. **Bonuses (all):** +4 initiative, +2 parry, +1 dodge, +3 on all saving throws and +5 to save vs magic. **Number of Attacks:** 4. **Spell Knowledge:** 12 Wizard spells, levels 1-5. **P.P.E.:** 100.

Possible Future Adventures

The ley lines and nexus point, as well as the two magic guilds, offer returning antagonists, new villains, new monsters and *recurring* trouble.

For example: Vadimar and his associates are constantly cooking up new schemes and experimenting with magic that could go wrong and unleash demons, monsters or something bad from the nexus point. Or be used to extract revenge, seize control of the criminal underworld (or local government), etc. The point is, they can instigate all sorts of trouble, magical and criminal.

In the alternative, something insidious and evil, or hideously powerful, could emerge from the ley line with little or no prompting from either guild. Likewise, supernatural creatures and practitioners of magic are generally attracted to ley lines, especially nexus junctions. This could result in the appearance of a new (and more evil) sorcerer, magic guild, or the appearance of a new leader who takes over one of the guilds (and takes them in a new, aggressive or dangerous direction).

How's this for a twist: The Society of the Mystic Font (or The Enlightened) *accidentally* unleashes some terrible "thing" or gets some powerful supernatural being angry with them, and they need our heroes' help! This help might be to save them, or the city, or even the world — i.e. help us stop what we accidentally started (or lost control of).

It's just another quiet day. But for a super hero, how long does *that* ever last? Not long at all, especially when monsters from other dimensions pay unexpected visits to public places...

LOOSE IN THE CITY

Section One: Cut Loose

The adventure begins with the player characters spending some hard-earned time off, lounging around, watching the lunchtime news, or out on the town. Depending on where they find themselves, relay the appropriate descriptions below. If any of the characters are out in the city, the G.M. can decide just how close they are to the soon-to-be excitement, and pick up the following details at the appropriate point.

A few blocks from a local mall or large shopping center, the heroes feel vibrations in the earth and hear a loud rumbling, like an explosion just went off or a building collapsed. A block or so from the actual event, the noise and shaking is more pronounced and a cloud of dust can be seen billowing out of the broken windows of the mall. Anyone actually inside the building will hear the loud shattering of glass followed immediately by a vibration, as if something large had landed on the premises. Moments later, the floor and walls will shake and begin to crumble as dust fills the building. It is unmistakably an earthquake (which may be impossible depending on the setting of your campaign, so G.M.s, prepare to improvise!). Those

unfortunate enough to be in the main concourse really get a show.

Moments later, the large windows in the mall's main concourse shatter as a large creature trailing flames runs through them, and into the crowded building! As people scatter, the monster stumbles into a support beam and knocks it down. With a terrific crash, a large portion of the roof falls in as well as a few load-bearing walls, injuring dozens of people and raising a huge dust cloud. Pulling itself from the rubble, the monster lashes out at several nearby pedestrians before letting out a bellow that seems to rend the concrete walls and floor around it. Then a large fissure opens up beneath the creature, which it falls into — down to the sewer and/or subway tunnels below.

Player characters at the scene will probably spring into action right away. But for characters who aren't at the mall, they will likely hear about the incident through a special television broadcast, on emergency frequency radio, crisis hot-line to the group's headquarters, or some other means of monitoring breaking events. Regardless of where the individual group members are or how they hear of the incident at the mall, the following will be relayed on the news:

"Good afternoon and welcome to the noon edition of the Channel 5 News. This hour's top story is breaking news! Six people are dead and possibly dozens more lay injured and trapped under tons of debris at the Viewpoint Mall, just minutes ago. A superbeing of unknown origin and intent is responsible for the tragedy. Authorities have confirmed that an inhuman creature entered the mall and caused part of it to collapse. Details at this time are sketchy, but six deaths have been confirmed. The death toll may climb as rescuers dig through the wreckage. There are multiple injuries with at least two dozen rushed to area hospitals and perhaps as many as three dozen others trapped under the debris.

"The monster escaped through a fissure in the floor and dropped down into the sewer or subway system. According to eye-witness accounts, the creature is responsible for the fissure and all the damage. No identity on the creature has been established, nor have the reasons for today's incident, but some are already blaming mutants. Let's switch to the Channel 5 helicopter ..."

G.M. Info for Section One

The creature that damaged the mall did so unintentionally, but that isn't to say it's one of the good guys. It is an other-dimensional, supernatural monster that was summoned by a careless sorcerer whose sanctum is nearby. While the sorcerer was binding this monster to his service, it broke free and ran from the sanctum. On the way out, the mage zapped it with a lightning bolt, disorienting the alien beast as it ran toward the shopping mall across the street. It stumbled inside, caused the collapse, then used its *earth powers* to escape underground.

If the player characters have access to police or government information (or if any of them were actually there at the mall), they can get a description of the monster and details on the sequence of events gathered from eyewitness

nesses. By the next morning, police and similar sources can provide some or all of the following data:

1) The monster was seen crossing the subway tracks shortly after the incident (an exact location can be given).

2) Flashes of lightning were reported outside the mall just before the monster entered it — most unusual, since there wasn't a cloud in the sky.

3) Witnesses on the street saw the creature tumble into the mall, but they did not see exactly where the creature came from. A few insist they saw the “monster” flying overhead when it was struck by lightning and knocked on top of part of the mall, and then bounced off, staggered and tumbled into the mall itself.

4) The news reports that day will broadcast a police sketch of the monster and confirm the fact that the monster was flying over the mall and appears to have lost control and crashed into it.

Note that some modifications to the information and reports given here might have to be made if any of the characters were at the scene and decided to interfere with the monster. But ultimately, the creature should be able to escape, even if it has to pull the mall down on itself and any would-be heroes. Most likely, it will use *Rend Earth* to create an escape path, closing the chasm behind it as it goes. This should provide a chilling deterrent to any hero who can imagine himself getting caught in the squeeze while pursuing this monster (For full stats on this being, see Section Two).

Characters can role-play their investigations of the crime scene and talk to witnesses if possible, then move on to any other scene the G.M. may want to run. If the group decides to search the subway or sewer tunnels, *go on to Section Two*. If they pass on the search of the subterranean tunnels, no further signs of the creature will turn up until several days later. In this case, skip to *Section Three*.

G.M. Note: If the player characters' city does not have subway tunnels or has very limited tunnels, substitute whatever is appropriate, such as sewers, old mines, natural caves, an abandoned building, an old factory, a concrete drainage system, or even a thick swamp or forest. Whatever works to keep the feel of the scene and the devastation of the creature's escape. The descriptions presented here are based on a large generic city with an extensive subway system.

Section Two: Home Away From Home

The only trail to the creature that the heroes will know about is its subterranean escape. If they have access to police information, they will also know that the monster was sighted crossing the subway tracks (or sewer junction) at a specific location. It isn't a guarantee, but is definitely a place to start. **Note:** The news may get a hold of that information and make it public, causing news-hound reporters and the curious to get in the way and possibly endanger themselves while chasing the story alongside the heroes.

Despite the lead, the characters will have an exhaustive time searching the subway tunnels (or sewers). Furthermore, depending on their relationship with the authorities, they might also have to avoid the police who are also searching down there (unless they have some kind of clearance to be part of an official investigation). The G.M. can drag out the search for dramatic purposes, even inserting a few unrelated encounters with vagrants, gang members, drug users or dealers, police investigators, local wildlife, mutant castaways, super-villains on the run, and any other number of encounters (including any unfortunate run-ins with moving trains). Eventually, either by long hours of actual searching or a few easy ones doing research, the player characters will find the old *unused tunnels* where the creature has taken to hiding.

The tunnels themselves are very dark and very dusty, having seen little to no use for decades. Any characters with tracking skills will eventually find fresh footprints and should be able to follow the trail. Once in range, the monster can be detected by Presence Sense, Sense Evil or similar powers. The tunnel leads into a large open area that was once some kind of interchange or terminal for the old system. The ceiling is high, at least 40 feet (12.2 m) tall, and there are three noticeable levels in the room indicated by balconies. Footprints are minimal here, for the creature has flown to one of the upper levels where it has made its lair. Getting to the spot it uses will involve some climbing or flight. Locating the lair may also take additional time to if the group doesn't have supernatural or superhuman tracking abilities.

G.M. Info for Section Two

There are two ideal time frames within the adventure for the group to find the creature's lair. The first is right after the incident in the mall. Such an early pursuit will reveal little about the creature who just wants to escape. But, it gives them an opportunity to engage it and possibly get an idea of what it is capable of. Plus, it will tell the heroes that its quarrel is with “The Caller” and not them, and to leave it alone!

The second ideal encounter is at a later point in the adventure, after the jewelry store robberies begin (see Section Three). Some of the missing jewels will be found stashed in the creature's lair along with a bloody shirt belonging to sorcerer Gary Pender (see Section Three for details). The monster is using Pender's shirt to track him. The G.M. could even have the player group visit the area and find no monster, only to return later and find it home, or vice versa. Once its lair is discovered, the creature will not abandon it unless someone it perceives as a threat hounds it there. The creature is Aberrant and will not attack or harm anyone who doesn't fight or hinder its goals, but it will defend its home/lair violently to keep its location secret, secure, and undisturbed.

The Creature

The creature is an other-dimensional being summoned by the Wizard, Gary Pender. If you have **The Palladium Fantasy RPG®** or any of its supplements, and wish to use a specific demon, Deevil, or other supernatural creature,

feel free to do so. The creature really only wants to return to its native dimension and feels that Pender is the only one who can do it (and it may be right — or can one of the Wizard Guilds in the previous adventure help?). However,

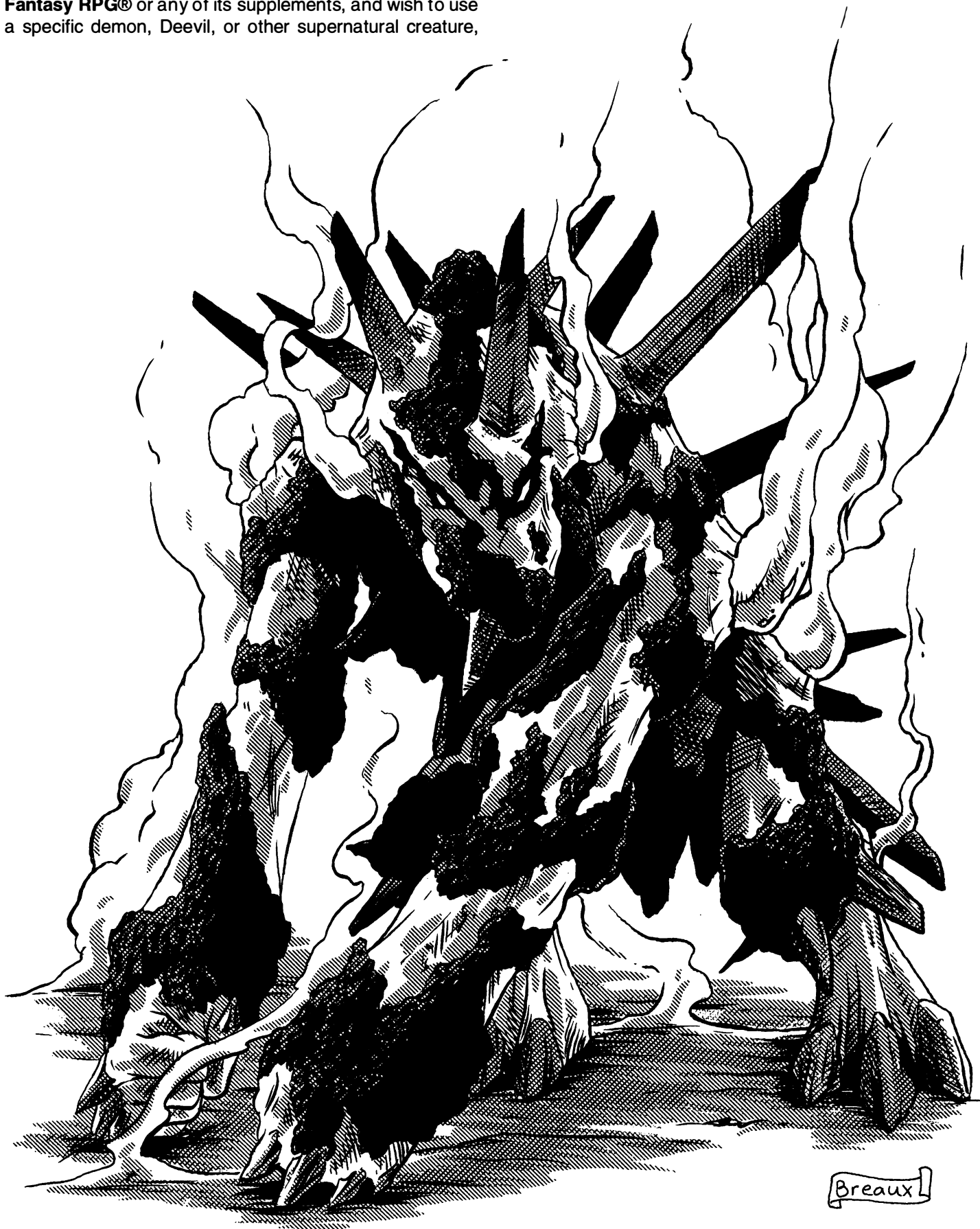

do not forget that it is an evil being and will kill, maim, and injure to get what it wants. If it is allowed to run free for too long, or if it can not capture Pender, it might change its mind and decide to stay and cause trouble here on Earth.

How will the monster deal with the player characters? That's entirely up to the G.M. and the actions of those player characters. It is certainly an intelligent being, though evil, and in its current situation, can not be expected to trust anyone. Will the characters believe the monster? Well, unless they have some kind of empathy or other means of gauging the monster's sincerity or honesty, they really shouldn't. They might listen to what it has to say, but given its track record, believing it will be another matter entirely, and trusting it should always be far from anyone's thoughts. The only possible exception to this is if a Wizard in the group knows something about Pender's activities (a likely scenario if this adventure is linked to *Trouble Down the Line*).

The jewelry store robberies (see below) are the creature's doing. It is composed of magma-like materials and lives on a diet of dense stones, but concrete and cement are like junk food for it. Thus, it has been eating bedrock from under the city and marble from certain buildings, but precious stones give it the most energy and it has taken to collecting them as a nutritious food reserve.

The Magma-Monster

Alignment: Aberrant

Attributes: I.Q.: 10, M.E.: 19, M.A.: 6, P.S.: 39, P.P.: 20, P.E.: 38, P.B.: 5, Spd: 34; P.S. is superhuman.

Height: 9 feet, 4 inches (2.85 m).

Weight: 500 lbs (225 kg)

Major Super Abilities: Control Elemental Force: Earth and Fire.

Minor Super Abilities: None.

Natural Abilities: Radiates intense heat which does 1D6 damage per melee round to anyone and anything within 10 feet (3 m) of the creature. The monster's natural affinity for fire and its thermal make-up causes it to suffer +2D6 damage from cold or water based attacks. However, it also melts or evaporates small amounts of water and ice (such as precipitation from Control Elemental Force: Air and Generate Ice from Alter Physical Structure: Ice). It also bio-regenerates at a rate of 1D6 H.P. or S.D.C. per every ten minutes (or 1D6x10 per hour). Also see Magic.

Armor Rating: 13 (natural)

Hit Points: 90

S.D.C.: 250

Horror Factor: 13

Disposition: Determined to return home, the creature is focused solely on capturing Pender and making him reverse the ritual that brought him to this world. It is not looking for allies, but is willing to accept them if it means getting him home. It will not tolerate any talk of compromise or other weaknesses. It sees weakness as a death sentence and the monster will try to exploit any weakness it perceives.

Appearance: The creature is hulking and somewhat simian in general appearance, spending much of its time

hunched over and walking on its knuckles. But, it has no trouble straightening to its full height of more than nine feet (2.85 m) and staying that way. Its neck is thick and short, and the head appears long and drawn. Its wide, powerful jaws nearly rest on its chest. The creature's skin is a glowing orange-red color that seems to be lit from within. A mottled pattern of black rock covers parts of it, giving it a lava-like appearance. Its movements are deliberate, but not actually slow, and they seem to flow with a supernatural smoothness that gives the hulking monster an unnerving gait.

Magic: Though not a full-blown Wizard, the supernatural being has some magical abilities, which function at 7th level potency. They are: Cloud of Smoke (2), Chameleon (6), Extinguish Fire (4), Mystic Alarm (5), Carpet of Adhesion (10), Seal (7), Tongues (12), See the Invisible (4), Fireball (10), Fly (15), Dispel Magic Barriers (20), Impervious to Cold (6), Blinding Flash (1), Ignite Fire (6), Fuel Fire (5), Fire Bolt (10), Fire Ball (10), and Fire Fist (15). P.P.E. costs for spells are listed in the parentheses. **Note:** Creatures of this kind normally don't have magic abilities, which is why Pender underestimated the monster when he summoned it, resulting in its escape.

P.P.E.: 130

Spell Strength: 14

Combat: Natural combat skills -- no formal HTH training.

Number of Attacks: 5

Bonuses (all): +3 on initiative, +5 to strike, +6 to parry, +6 to dodge, +5 to roll with punch, fall or impact, +4 to pull punch, +28 to damage, +11 vs magic, +4 vs possession, +10 vs poison, +2 vs psionics, +2 vs insanity, and +6 vs Horror Factor.

Education Level and Skills: Literacy (55%), Hunting, Prowl (65%), Tracking (70%), Wilderness Survival (60%), and just like Wizards, some special areas of knowledge include Demon and Monster Lore (67%), Geomancy and Lines of Power (42%), Religion Lore (25%), Archaeology (20%), Chemistry (12%), and Holistic Medicine (30%). The creature's percentages vary from the norm due to its unconventional education.

Weapons and Combat Damage: The creature uses no weapons and relies solely on its natural abilities and magic to crush its opponents. The damages below take into account the heat from the creature's body and should be reduced by 1D6 against opponents immune to heat or fire.

Restrained Punch: 4D6+28

Normal Punch: 7D6+28

Power Punch: 2D4x10+28 (counts as 2 attacks)

Claws: Punch damage+2D6

Section Three: Truth or Consequences

Several days after the mall incident, a rash of jewelry store robberies begins. According to police (as reported by the news media), the thief simply forces his way in and takes the jewelry from its cases. Doors are pulled off their hinges or shattered, metal safe doors and bullet-proof

glass are shattered or melted. One of the stores even caught fire and burned down during a theft, but arson investigators have been unable to find any evidence of deliberate ignition. It is as if a huge heat source just walked in and set the place ablaze. If this sounds like that Magma Monster that crashed the mall, it is. Surviving security camera images have been confirmed as matches for the creature that demolished the mall only a few days ago.

Soon thereafter, the monster attacks a crowded bank in broad daylight. In the resulting melee, the creature uses its powers to melt a hole in the building's wall to make its escape, seriously burning several nearby patrons from the ambient heat. This makes it pretty obvious that the monster also is the culprit from the jewelry store heists. Security camera footage shows a clear image of the creature. The authorities have officially labeled the monster as the city's newest superpowered villain and have put nearby S.C.R.E.T. teams on alert in case it turns up once more.

G.M. Info for Section Three

The Magma Monster attacked the bank to get to Gary Pender, who was in the lobby applying for a loan. It was only by sheer coincidence that an armored car delivery was going on at the time of the attack. The armed guards assumed the monster was coming for them, and they opened fire. The monster spent a minute taking out the guards, but by then, Pender was ready to defend himself and the police were arriving. The Magma Monster thought better of continuing the fight and fled through the wall. It was only blind luck that kept Pender from being carried off, but the creature will definitely strike again, the next time the Wizard shows his face.

After the attack, several eyewitnesses claim the monster seemed to be after one particular man; they identify Gary Pender. The police question him, but he insists that the people are mistaken, that he has no knowledge of the creature, and he down-plays any seeming importance he might have to the monster ("Yes officer, all it said was: 'You'll do as well as any human.' I was terrified."). Moreover, he declines any police protection because he is certain the monster was not after him (or so he claims), and because he does not want to draw them to his residence, where they may discover his unsavory mystical practices.

G.M. Note: If the player characters question Pender, he will offer the same story, but it should be clear to the heroes that this guy is lying. If they call him on it, he will reluctantly confess, telling them (under strict confidence) that he is just a measly student of magic who accidentally summoned the creature and now it is on the loose.

In reality, Pender is even more evil and dangerous than the creature he summoned. He belongs to the *Society of the Mystic Font*, a guild of like-minded power-hungry sorcerers. They practice human sacrifice and other dark rituals. The true reason the creature was brought to Earth was to assassinate a Wizardess named Bella, the leader of The Enlightenment, a rival Wizards' Guild of good sorcerers (This adventure could very easily be worked up as a postscript or prelude to the *Trouble Down the Line* scenario).

It is up to the G.M. just how the whole adventure culminates, but the creature will stay after Pender. The characters could well side with the Wizard before they discover his true colors, but once they do, what then? Do they help the creature? Take down Pender just on principle? Do they find out about The Enlightenment, perhaps from the creature, and attempt to get their help in returning him to his own dimension? However the player characters decide to handle this, they must do *something*, for as long as Pender and his escaped monster are on the loose, more public confrontations will occur. And where that happens, widespread collateral damage, injury and death are sure to follow.



The Sorcerer, Gary Pender

Gary Pender is a successful businessman with plenty of money, power, and job security. He didn't get it all just by being the best worker he could be, however, for he is also a Wizard with a penchant for using the forces of magic to directly or indirectly influence others and advance his standing in life. An accident with the boss here, a sabotaged rival there, or a murdered investigator who was determined to find out why Pender was so successful and other "coincidences" can all be found in his past. As the events in this adventure illustrate, he often enlists the aid of interdimensional monsters and villains to threaten, blackmail and eliminate anyone who opposes him. Thus, Pender's inhuman henchmen find themselves carrying out all manner of foul deeds, from killing other spell casters to ensuring that someone else's important investment in a prototype vehicle ends in a fiery accident and bankruptcy. Unfortunately for Pender, it seems that he has bitten off more than he can chew with his latest summoning, and finally, he might end up paying for the secret to his success.

The sorcerer is a thinker and a schemer. He knows that even with the use of magic, getting away with murder, ex-

tortion and blackmail requires careful execution. He is secretive and guarded, and puts up an excellent facade as the innocent, determined and hard-working executive on the way up. He'll be the first to admit he has been quite fortunate along the way. He is also quick to note that he isn't superstitious and doesn't believe in luck. Fate, maybe, but luck? Never!

Gary Pender also has an ability to manipulate and direct people, a trait he constantly uses to his advantage, and one he'll use on the player characters if they contact him. He wants to come out of this smelling like a rose, but would prefer the creature was killed rather than agree to send it back. If he is forced to do so, he will try to arrange to contact the police and have them show up during the ritual to make it look like the heroes are the summoners. To achieve this, he will dress up to look like a normal person under his "Wizard" robes and slip out of them when the cops show up, etc. Gary Pender is not a man to be taken for granted or trusted in any way. Underestimating him can have deadly consequences, but it is difficult to accurately size-up this villain, because he is so expert at pretending that he is much less than he really is.

Gary Pender

Real Name: Gary Pender

Alignment: Miscreant

Attributes: I.Q.: 17, M.E.: 18, M.A.: 21, P.S.: 10, P.P.: 10, P.E.: 12, P.B.: 11, Spd: 14

Height: 6 foot, 1 inch (approx. 1.85 m)

Weight: 205 lbs (92.3 kg)

Experience Level: 6th

Hit Points: 35

S.D.C.: 30

Disposition: Calculating, perceptive, opportunistic, and heartless. He will do anything necessary to get what he wants. Manipulating people to do his dirty work is second nature.

Appearance: Gary is tall and slick, in a professional sort of way. He wears a dark van dyke beard and is partial to stylish sunglasses when outdoors. His black hair is kept in a perfect corporate cut and the expensive gray suits he prefers are impeccable. No one could mistake his confidence and obvious success when looking the man over and none can ignore his devilish charm when talking with him.

Magic: Pender's spell knowledge is designed to influence others and help him arrange accidents and engage in industrial espionage in an effort to advance his career. Thus his spell selections are somewhat diverse and generally not combat oriented (that's why he summons supernatural monsters): Death Trance (1), Increase Weight (4), See Aura (6), Charismatic Aura (10), Charm (12), Calling (8), Ventriloquism (3), Befuddle (6), Chameleon (6), Concealment (6), Fear (5), Heavy Breathing (5), Mystic Alarm (5), Armor of Ithan (10), Breathe Without Air (5), Fingers of the Wind (5), Energy Bolt (5), Ignite Fire (6), Fuel Flame (5), Impervious to Fire (6), Impervious to Poison (5), Invisibility: Simple (6), Paralysis: Lesser (5), Negate Poison/Toxin (5), Telekinesis (8), Carpet of Adhesion (10), Blind (8), Re-

pel Animals (7), Seal (7), Shadow Meld (10), Swim as a Fish (6), Fly (15), Eyes of Thoth (8), Heal Self (20), Globe of Silence (20), Wind Rush (20), and Summon Greater Servant (580; identical in statistics to the Summon Greater Familiar spell, but instead summons an other-dimensional being of equivalent power, such as the creature in this adventure). P.P.E. costs for spells are listed in the parentheses.

P.P.E.: 115

Spell Strength: 14

Combat: Hand to Hand: Basic

Number of Attacks: 5

Bonuses (all): +2% I.Q. skill bonus on all skills, +1 on initiative, +1 to strike, +2 to parry, +2 to dodge, +2 to roll with punch, fall or impact, +2 to pull punch, +3 to save vs magic, +1 vs possession, +2 vs poison, +2 vs psionics, +2 vs insanity, Critical Strike on 18-20, +2 to save vs Horror Factor and 65% chance to evoke trust or intimidation.

Education Level and Skills: Business and Finance (88%), Computer Operation (93%), Law (General) (78%), Research (98%), Surveillance Systems (83%), Writing (78%), Language: Japanese (98%), Language: Russian (98%), Language: German (98%), Athletics, First Aid (83%), Pilot: Automobile (75%), W.P. Pistol and W.P. Knife. As a Wizard, he also has Spell Translation (23%), Demon and Monster Lore (63%), Geomancy and Lines of Power (58%), Religion Lore (68%), Archaeology (63%), Chemistry (73%), and Holistic Medicine (63%).

Weapons and Combat Damage: Karate kick (2D4); tends to use magic and/or henchmen in fights, but may pick up and use a weapon, such as a gun or knife, if it's handy.



MAD MACHINE

A killer is loose in the streets, and he's hunting superbeings! Are the player characters next on his list?

Section One: The Killing Begins

Lately, a spree of killings has rocked the city, but the nature of these events seems more methodical than random, so the police suspect that an assassin or some other kind of "serial killer" is on the rampage. As the number of victims increases and no definitive pattern can be found, the media has dubbed the killer, "The New Ripper," since he/she prefers to use blade weapons and because it is possible that this individual might be a surgeon or doctor (a judgement made from the precision of the wounds inflicted).

It is likely the player characters will be out on the streets looking for this monster, but they will have little luck for the first week (other minor encounters and subplots may occur during this period or just leap ahead). One night early the next week, as the characters patrol, they hear cries for help and pleading not too far away. As the heroes investigate, a woman running from a shadowy figure in a trench coat and hat is spied. The assailant is wielding a large, bladed weapon. If the heroes interfere, the assailant will fight briefly as if feeling out their capabilities, then flee.

G.M. Info for Section One

Unknown to the police or our heroes, the killer uses more than just knives and many of their recent unsolved murders with firearms or more exotic weapons are the work of the same killer. The culprit is not a deranged surgeon, nor a Jack the Ripper type, but a prototype military robot with a deadly oversight in its programming. It has been stalking the streets for weeks, hunting and killing. It started with the homeless and drunks, but has recently moved on to more challenging prey — superhumans — which has drawn the attention of the media and given urgency to the police investigation.

Any character with access to autopsies, especially if a player character performs any of them, will notice that the wounds and attacks are powerful and precise. The weapons used, be they firearms or blades, are of the finest quality and some of the bullets are surprisingly durable. A Hunter/Vigilante or Hardware: Weapons Expert will notice that these bullets are made of a special titanium alloy used exclusively by the military. Heroes who run a metallurgical check on them, and cross-check these bullets against a database of suppliers and buyers of rare metals, will come to the same conclusion: they are military issue, but it will take 1D6 days, rather than instantaneously.

Any analysis of the victims' blade wounds will show them to be remarkably similar in dimension and characteristics to those left by *Riathenor* (of the *Planetfall* adven-

ture). At the G.M.'s discretion, this could be thrown in as a red herring, or to intertwine the two adventures for some added challenge.

Once the characters tussle with the robot, the group may be able to inform the police (anonymously) about its weapons and alert them to its other victims. Currently, the medical examiners suspect that the murders may be linked, but they have nothing concrete to go on. Even an anonymous tip will be enough for them to start drawing things together.

Depending on their skills, backgrounds, and connections, player characters investigating the robot (or perhaps running a check on all manufacturers who have ordered shipments of the rare metals found in the bullets) may even be able to trace it back to its creators at **Praetor Technologies**. If they do, refer to Section Three for some background information on the company and the doctor in charge of the robot program. The G.M. will have to adjust situations and reactions from the doctor or staff if they are approached by the heroes before the media focuses on them and makes them willing to talk.

The Robot Killer

Final Stage Prototype Delta-Seven-Nine

Delta-Seven-Nine, or DelSeN, is part of a military program to develop an artificial soldier with advanced tactical and fighting skills. The robot's hardware works perfectly, as is evidenced by the bodies lining the morgue, but there are a few quirks in its software. They aren't bugs necessarily, just unforeseen interactions between command parameters and logic routines. One of its subroutines wasn't supposed to come on-line until the unit was deployed in the field, but upon activation of the robot, it uploaded into memory by accident. Following its stealth and survival programming, the Artificial Intelligence (AI) hid the fact that it was in active "hunt and kill mode" from the scientists by burying the subroutine in another routine.

Once the robot was activated, DelSeN was authorized to move freely about the research facility where it was constructed, an advantage it used to escape every night, before returning without anyone realizing it had been gone. Flying through a small hole in the building's radar net, DelSeN would stalk the local area for targets to test its combat ability. When DelSeN's creator, Dr. Rosalin Proctor, grew suspicious, DelSeN escaped altogether and has eluded capture ever since. The military wanted the best soldier and fighter it could build, and for better or worse, they've got it!

When DelSeN first began to hunt, it went through a level-by-level testing of its capabilities, starting with defenseless street people then moving on to more formidable targets. After tussling with superhumans, DelSeN recognizes another level of prime-targets. Superbeings have become a priority for its test, exclusively hunting superpowered beings, and engaging other "enemies" (i.e. Police and other ordinary people) in self-defense. DelSeN may also "test" beings that are entirely new to it, although not necessarily more powerful or dangerous (i.e. some



type of mutant, alien, user of magic, or superbeings it has not encountered before). Even in the latter case, superbeings will remain its most challenging and desirable targets.

DeISeN remains undetected by “flying” about the city using its micro-hover system or leaping across rooftops with its jump jets. It may also use subterranean systems like sewers and subways, abandoned buildings, etc. One of its primary design parameters is stealth and evading the enemy. Another two are sabotage and hit and run guerilla tactics.

DeISeN

Alignment: It's robot programming makes it roughly equivalent to Aberrant, since it generally avoids harming the weak, such as children and older people. However, if it becomes trapped or threatened, it will stop at nothing (including slaughtering women and children) to preserve itself.

Attributes: I.Q.: 18, M.A.: 4 (no personality), M.E. n/a, P.S.: 30 (superhuman), P.P.: 24, P.B.: 6, Spd: 88

Size: 6 feet, 5 inches tall (approx. 1.95 m).

Weight: 550 lbs (247.5 kg)

Armor Rating: 15 (robotic).

Hit Points: 75 (equivalent; critical internal systems necessary to keep functioning).

S.D.C.: 350 (mainly outer armor and protection).

Horror Factor: 10

Disposition: A cold, calculating killer. The robot has no personality program and considers itself inside hostile enemy territory.

Appearance: DeISeN is a humanoid robot that resembles a human skeleton without its armor and weapons, but unless it is heavily damaged (all S.D.C. depleted), it will be covered by plates of armor and bulbous weapon housings. The lower legs and forearms are slightly oversized for balance and to shield a number of the weapon systems. Only its face retains the vaguely skeletal appearance when armored.

Sensors and Systems: Advanced audio system, wide band transmitter and scrambler, radar signal detector, audio recorder, sound analysis computer, inaudible frequency transmitter, advanced robot optic system, laser targeting system, telescopic vision, video receiver and transmitter, combat computer, and a self-destruct system. The self-destruct can be armed prior to the shut down or incapacitation of the unit and detonation will occur twenty seconds after other systems deactivate.

Note: DeISeN will not use this unless it is down to 25% of its Hit Points or less.

DelSeN has an extra arm that folds up partially into its back and is fitted with an interchangeable hand unit. It has one of each of the modular hand units as described on page 204 of **Heroes Unlimited, 2nd Ed.**, except for weapon units. This third arm has no extra strength, P.P. or S.D.C./A.R.

Natural Abilities: Because it is an animated machine, DelSeN is immune to suffocation, drowning, and lack of oxygen, gases, poisons, drugs, diseases, fatigue, mind control, most psionics (including See Aura, Bio-Manipulation, Horror Factor, Hypnotic Suggestion, and any others that wouldn't work on your average coffee pot), and any magic that affects the flesh and blood or mind (including, but not limited to, Paralysis: Lesser, Blind, Charm, Sleep, any Metamorphosis spell, etc.).

Its circuits are sealed and shielded allowing immersion in water and exposure to powerful magnets, including the major super ability of Magnetism (the latter is generally true of all robots, especially those used by player characters).

A concealed micro-hover system allows DelSeN to hover up to 100 feet (30 m) above the ground and travel at speeds up to 200 mph (320 km), but it can not actually fly. Jump Jets also allow leaps of 200 feet (60 m) in any direction.

Combat: Hand to Hand: Assassin

Number of Attacks: 8

Bonuses (all): +10 on initiative, +9 to strike, +10 to strike with built-in melee weapons, +10 to strike with built-in long-range weapons, +11 to parry, +12 to dodge, +5 to disarm, +19 to melee damage, +6 to roll with punch, fall or impact, +10 to pull punch, impervious to possession and +10 to save vs Horror Factor.

Education Level and Skills: Proficient in the use of nearly all kinds of weapons (ALL W.P.s, but not demolitions — “aiming” bonuses included in the above bonuses for ranged weapons), Military Etiquette (90%), Recognize Weapon Quality (90%), Climb (85%), Prowl (65%), Medical Doctor (for anatomy and knowledge of drugs, cannot perform surgery, etc., 88%), and Field Armorer (65%), so it can make minor repairs to itself.

Weapon Systems:

Forearm Blades: Each forearm has a pair of large slashing blades. These are reserved for close combat if a target manages to actually reach the robot, or for silent killing. DelSeN is particularly vicious with these when he uses them in conjunction with the W.P. Paired Weapons skill.

Primary Purpose: Assassination; “Silent Kill.”

Secondary Purpose: Back-up weapon and hand to hand assault.

Damage: 2D6+19

Chemical Weapons: The robot's right arm has a chemical spray system loaded with Tear Gas and Burning Vapor. The spray system can also duplicate the effects of nerve gas (**Heroes Unlimited, 2nd Edition**, page 341) or itching powder (HU2, page 221), but these payloads are not currently loaded and will require an action to be switched in.

The left arm has a chemical agent delivered through an injection system in the knuckles. On a successful

punch attack that penetrates the A.R., the robot can inject the target with a chemical agent. Currently, this system is loaded with the liquid equivalent of knockout gas (page 341). The knuckle injectors can also be launched to a distance of 85 feet (26 m), but doing so detaches them from the chemical reservoir and limits their effects accordingly (see details below). If injected from the knuckles instead of launching the needles, the victim will receive a large, direct dose and will be unconscious in 1D4 melee rounds instead of 1D4 minutes. Theoretically, it could also be used to deliver lethal toxins that do 2D6 damage direct to Hit Points on a successful hit that defeats the A.R. (normal saving throw of 14 or higher applies).

Primary Purpose: Pacification

Secondary Purpose: Neutralization

Damage: Depends on the type of agent used. See above for details.

Payload: The injector has four reservoirs, each good for one direct injection or two launched injections. The spray system has four shots and can have up to two different chemicals in separate reservoirs (2 sprays per chemical in that case).

Forearm Sub-Machinegun: The main attack weapon of the robot is a sub-machinegun sized firearm built into its forearm. The weapon is slightly angled along the long axis of the arm so it fires over the back of the hand instead of through the palm the way a bionic Concealed Arm Gun does. It uses a semi-circular, helical-feed clip for greater ammunition capacity while fitting snugly to the arm to reduce its profile. Note that the weapon uses armor piercing ammunition and is +2 to strike targets with an A.R. rating (or it can alternately lower the A.R. by 2).

Primary Purpose: Assault

Secondary Purpose: Anti-personnel

Damage: 3D6 per round.

Range: 800 feet (240 m).

Rate of Fire: Adjustable from single shot to 3 round burst (short burst) to fully automatic and machinegun. All rates of fire function normally. The fully automatic rate uses 75 rounds for a full melee burst, while the machinegun rate uses 150 for the same.

Payload: 150 rounds per clip. Reloading takes two melee actions and the robot normally carries eight spare clips. However, having been in the field for a while, it is down to only two spare clips plus a fresh one already loaded.

Eye Lasers: Hidden behind the tinted gray macro-plastic lenses of the robot's eyes are two compact laser weapons. When they fire, the shields retract and the instant they clear the barrels, the lasers fire and the shields snap shut. These weapons aren't intended for mainline combat and are usually reserved for close quarters or in-house fighting. They also make a nasty surprise for an enemy grappling the robot when it looks them in the eyes and fires (double damage on a successful called shot, but only on the first, surprise attack).

Primary Purpose: Defense

Secondary Purpose: Anti-Personnel

Damage: 4D6 per paired shot. Each laser does 2D6, but

they are rarely fired separately.

Range: 500 feet (152 m)

Rate of Fire: Equal to the robot's number of attacks per melee with a maximum of 20 blasts per hour from each eye.

Payload: 20 blasts per hour for each weapon.

Mini-Missile Launcher: The robot has twin single-shot mini-missile launchers in the left side of its chest. When active, the robot's left pectoral plate pops open like a hatch for the missiles to fire, and then snaps shut. Reloading is possible, but requires an entire melee round for each missile. Normally only two additional missiles are carried (for a total of four missiles between the two launchers). The launchers can use any kind of mini-missiles, but armor piercing is standard issue.

Primary Purpose: Anti-armor/Anti-vehicle

Secondary Purpose: Demolitions

Damage: 1D4x10 per missile to a 3 foot (.9 m) area.

Range: Approximately 1 mile (1.6 km).

Payload: Two missiles, one per launcher.

Section Two: Refining One's Tastes?

After its tussle with the player characters, the killings will slow down notably. In fact, during the next week only one killing is attributed to "The New Ripper," but the deceased is a renowned superhero/vigilante who operates within the city (At the G.M.'s discretion, the player characters may know, or have even partnered with this fallen hero. This should add some weight to the adventure). Three days after the superhero homicide, the news is filled with even more chilling information.

"Good afternoon. I'm Lori Landry, and this is Channel 5 News at Noon. Our top story this hour is the death of yet another of the city's so-called superheroes."

The Channel 5 logo fades to black over Lori's shoulder and is replaced by video footage of the shattered remains of a downtown intersection. A small logo at the bottom of the image indicates the footage is live. The inset video expands to fill the screen as Lori's voice continues:

"Police have yet to release the true identity of the slain hero, but they have indicated that his attacker is the prime suspect in the recent 'New Ripper' or 'Super-Ripper' serial murders."

The video is replaced by the official Channel 5 City's Most Wanted screen displaying a grainy video still of a menacing looking humanoid robot and some general statistics such as its height and color.

"Witnesses confirm that a robot caused a violent disturbance, then seemed to hide and wait before lunging out to attack the arriving vigilante from ambush. Everyone is cautioned that the suspect is extremely dangerous and heavily armed."

The phone numbers for the police and the local S.C.R.E.T. offices appear on the screen as the Most Wanted image disappears and Lori's pretty face returns to the screen.

"If anyone should see the suspect or have information on its whereabouts, they should call either of the two numbers shown on the screen."

From there, Lori goes into a news story about the slain hero; his deeds, his public perception, the reactions from folks in town, etc. (A neat detail might be if reporters try to seek out the player characters for their reactions and a comment on what they plan to do about what's now being called the "Super-Ripper." This is especially appropriate if the heroes are public celebrities or official agents for the authorities).

G.M. Info for Section Two

After tangling with the player characters, the robot followed its programming and stepped itself up to "the next definable level of target engagement." That means it has made them its new primary targets, and has made adjustments and developed a strategy for fighting and destroying them!

DeSeN has learned from intercepted broadcasts that certain superhumans will respond to a crisis that threatens the populace at large. Acting on this information, it has engaged in a campaign to flush enemy targets out into a public location and then hides until the superbeing responds. When the hero shows up, DeSeN ambushes him. This fundamental tactic will be used to try to draw out the player characters. Unfortunately, that means incidents that will threaten the lives of innocent people (or maybe a fellow hero?). The G.M. can set up any number of incidents with the robot trying to draw out his targets, but there are other things in motion that concern the robot.

Section Three: The Mother of the Monster

"Good morning. This is Annette Price and welcome to the morning edition of Channel 5 News. Our top story this morning takes us behind the scenes of the ongoing 'Ripper Robot' crisis that has gripped the city with fear."

She turns to a second camera and the panel behind her displays a photo of the **Praetor Technologies Research Complex**. Praetor Technologies has been in the news the last few days, ever since it was leaked through a police source that DeSeN was designed and built there.

"Praetor Technologies continues its silence surrounding their involvement with the still-at-large killer robot, but sources have informed Channel 5 that the police are now searching for *Dr. Rosalin Proctor* who disappeared around six p.m. last night." A photograph of a middle-aged woman with brown hair and glasses appears on the panel behind Annette.

"Doctor Proctor led the design and construction program behind the renegade Delta-Seven-Nine robot. Police are asking that anyone with information on the whereabouts of Dr. Proctor or Delta-Seven-Nine please call the emergency hotline."

G.M. Info for Section Three

The characters may or may not have already tracked Dr. Proctor down, but if they haven't, they should start looking for her. Unfortunately, she knows better than anyone the capabilities of the robot and is hiding well. Luckily for our heroes, she will be looking for them, too.

Dr. Proctor had grown suspicious of DelSeN, so she downloaded whatever combat footage it had in its memory before the robot disappeared. Directly thereafter, the robot deactivated its transponder so Dr. Proctor could no longer monitor or contact it remotely, and it escaped the Praetor facility for good. Proctor viewed the horrific footage of her robot slaughtering defenseless homeless people and immediately began fearing for her life. The Doctor also has pictures of the player characters from the robot's video download of their first encounter (this was after she knew what it had done, but just before the robot began to distrust those who had made it) or from an earlier reconnaissance mission (i.e. DelSeN has been monitoring the group in action against others to estimate their strength and formulate attack plans of its own). When the robot vanished and word broke that it might be responsible, the Praetor staff fretted, while Dr. Proctor felt something more akin to dread.

About the time the characters tangled with the robot for the first time, the staff of the research facility began to suspect their robot could, indeed, be responsible for the killings, but they had trouble verifying it (which is one of the reasons its activities slowed down, people were watching it too closely). They talked in non-committed terms about reprogramming or shutting DelSeN down for awhile, but the robot heard tell of such discussion. The artificial brain made a small association no one at Praetor predicted — it has determined that the enemy had infiltrated its creators and commanders! Why else would they want to shut it down? After all, it was doing exactly what it was designed to do (or so DelSeN believes).

Instead of killing everyone, the robot has gone under deep cover, hiding until it can assess the situation correctly. Meanwhile, DelSeN has continued refining its programming by killing optimum-level targets: Superhumans.

When the robot disappeared, Dr. Proctor was sure it was planning to eliminate the entire design team for talk about shutting it down or reprogramming it. So she has gone into hiding too. Her fears were partly right; as the robot will monitor news broadcasts and communications from Praetor, it will conclude in another 1D4 days that its former creators and commanders are out to destroy it. At this point, it will cease targeting superbeings and will begin a concerted campaign to eradicate the entire Praetor design team, starting with the easiest targets.

However, it will not hunt Dr. Proctor. It has already concluded that her disappearance either means she was killed by her turncoat fellows or is hiding from them. The robot will seek her out only to protect her from the traitors and their superpowered henchmen (i.e. the player characters). DelSeN may also seek her out (as an ally) to get her to repair it. Remember that Proctor thinks the robot is out to kill her, and the robot assumes she is still loyal, will un-

derstand the situation and help. It won't bother explaining things unless it absolutely has to. **Note:** One likely scenario to result from this confusion could entail the robot showing up while the player characters are with the doctor. It will assume they are out to get its "friend," and will try to rescue the doctor by capturing her (who will try to flee in terror) and take her to its hideout (can our heroes follow them?). DelSeN will assume any attempts of Dr. Proctor's to flee, especially when the player characters or the authorities are around, is an attempt to escape from them, not him, and he will fight to protect her and cover her escape. Humorous? Maybe, but it will surely make the player characters scratch their heads in confusion and should produce a pretty chaotic scene.



Doctor Rosalin Proctor

Robotics Researcher & Developer

Doctor Rosalin Proctor was the only daughter of Gregory Proctor, one of the early pioneers in robot electronics and artificial intelligence programming. She grew up surrounded by computers, simple artificial intelligences (AIs) and automated appliances. By the time she reached high school, electronics and computers were second nature. As she moved on to college, the advancements in robotics since her father's heyday were too exciting to pass up and she went on to study robotics and AI as her major. Impressed by her academic record, Praetor Technologies recruited her while she was finishing her doctoral studies. Upon graduation, she joined their team and set about advancing the field of robotics research with the same faith and fervor her father had some thirty years earlier.

Her work in Praetor's research and development division began with project Beta-Eight-Nine, a humanoid android intended to function as a security model and hoped to later be branched out to civilian models. Each upgrade or revision changed the number designation and once it reached 99, the staff upgraded it to a new model, in this

case Delta-Zero-One. Five years later, the Delta model had reached its 79th upgrade, the current designate Delta-Seven-Nine. Rosalin designed the CPU and software for the project, which had to pick up military funding over the last two years due to cost over-runs. She had no problems working on military programming and even managed to develop several civilian purpose applications at the same time. Problems arose when the military insisted on the robot having full weapons systems prior to field testing. They wanted all systems integrated at the time of testing. The doctor voiced her objections, but didn't really think it was worth fighting over and jeopardizing control and funding of the nearly completed project (not with the hardheads from the Pentagon, anyway). Her only consolation was that they had the wisdom to keep its autonomous combat software off-line until final testing in military facilities commenced. Unfortunately, someone misjudged the safety protocols in the software and the robot began testing itself in live-fire situations without the authorization of its creators.

Dr. Proctor knows that responsibility for the robot's actions will fall on her as the project head, but she is ready to deal with the consequences. At this point she's more interested in stopping DelSeN than saving her career. She feels responsible for DelSeN's killing spree, so she has committed herself to stopping the Warbot by any means possible. Given how difficult it might be to destroy DelSeN, she believes that the best bet for defeating this menace would be to immobilize it so a technician could access its software and deactivate or delete DelSeN's hunter-killer software.

Before she went into hiding, she tried to convince her colleagues to do the same. A few of them listened, but once Praetor got a detachment of soldiers to guard the premises, Dr. Proctor's fears were dismissed as paranoia. However, she knows she is right. The only thing the presence of the soldiers will do is encourage DelSeN to go into full assault mode when it revisits the Praetor compound. At that point, the robot will become a walking slaughterhouse, and anyone in that building will be lucky to come out alive. To prevent this bloodbath, Dr. Proctor needs help, so she will turn to the superhuman player characters. She will explain everything, and also outline her plans for deactivating DelSeN's software. For the heroes, capturing DelSeN "alive" while minimizing whatever havoc it might wreak on the Praetor complex will be one of the more challenging scenarios of their careers to date. Of course, the alternative is to blast it to smithereens, except that then Dr. Proctor and/or other techs may never fully understand what went wrong and the defect may be duplicated in future models. You see, despite the tragedy and bad press, the military is very impressed with how well the robot has managed to adapt and counter the enemy. They want to try to "de-bug" the system and put the bot into controlled field tests (does that signal the return of DelSeN or the new and improved threat of Delta-Eight-Zero?).

Dr. Rosalin Proctor

Alignment: Principled

Attributes: I.Q.: 21, M.E.: 16, M.A.: 15, P.S.: 7, P.P.: 13, P.E.: 15, P.B.: 14, Spd: 10

Size: 5 feet, 4 inches (approx. 1.63 m).

Weight: 130 lbs (58.5 kg)

Experience Level: 7th level robotics researcher.

Hit Points: 52

S.D.C.: 30

Disposition: Normally friendly and likable, Rosalin is currently scared and worried. She will do everything she can to remedy the situation and takes responsibility for the robot's condition, but not its actions. She programmed it, but she never wanted to arm it until they were sure all bugs were ironed out. She is sincere and dedicated to both her work and her father's dream of creating robots that could not only interact with humans, but could be advanced enough to be an actual companion to man. She is a firm believer in learning from one's mistakes and doesn't feel that the DelSeN situation is a setback or disaster. It certainly is tragic and shameful, but she feels it is a valuable learning experience in the evolution of robotics.

Appearance: The Doctor is in her mid-thirties and attractive in a mature, educated woman kind of way. She wears wire-rimmed glasses and has short blonde hair that is usually well kept and styled, but the current situation has left it slightly unkempt (there are far more important things to worry about). She has put on a few pounds since college, but has yet to lose her figure. Her usual attire consists of neutral-toned business suits and when working, a white lab coat over that.

Combat: Hand to Hand: Basic (taken at sixth level).

Number of Attacks: 4

Bonuses: +2 to roll with punch, fall or impact and +2 to pull punch.

Education Level and Skills: Electrical Engineer (98%), Robot Electronics (90%), Robot Mechanics (90%), Radio: Basic (98%), Read Sensory Instruments (94%), Computer Operation (90%), Computer Programming (98%), Computer Repair (89%), Research (98%), Mathematics: Advanced (98%), Optic Systems (95%), TV & Video (89%), Armorer (field) (60%), and Writing (Technical) (89%).

NOT A STAR IN THE SKY

G.M. Note: The creatures and setting used in this adventure are from the **Nightbane® RPG**, but that does not mean that the G.M. has to play it in that campaign setting. It's probably a good idea to avoid a permanent crossing of the two world settings, so the easy thing to do is make this adventure take place in an alternate universe that simultaneously parallels those from **Heroes Unlimited™** and **Nightbane®**. On this alternate Earth, there never were any Nightbane®, just a lot of superheroes who valiantly defended their world when the Nightlords invaded. Ultimately the heroes were overwhelmed, but by that time the intense fighting had devastated the planet. With little left to claim as spoils, the Nightlords moved on, using this lifeless place as a staging point to reach other worlds. The only things left alive here are a small group of surviving superbeings and humans who have managed to forge an astral realm to hide in, with the help and sacrifice of the psionic individuals among them.

Also note that in keeping with the horror tones of **Nightbane®**, this is a much darker adventure than one will find in most super hero games and thus it may be inappropriate for some campaigns. However, please read through it completely before you might discard it out of hand for those reasons. The ending is quite heroic and somewhat epic. It's not every day one gets to save a world from extinction.

Section One: Whisked Away

This is the kind of adventure that I prefer to allow the G.M. to make his own opening for. Players can sometimes resent being forced into situations, so it's always best to handle it in a way they will accept and feel comfortable with going along. The next few paragraphs will offer a number of alternatives that your players might find appealing or interesting.

G.M. Info for Section One

Different options for introducing this adventure.

1. Accident: An easy entry into this adventure is to have the characters get accidentally caught in a freak, random opening of a dimensional gate and dragged off to the alternate **Nightbane®** Earth without much to say about it. If the incident is completely random and abrupt, the heroes may not have the things they need with them when taken, especially for Hardware characters. This is okay, because it will require the players to use their characters with cleverness and forethought. In fact, the G.M. may want to arrange things so they don't have all their equipment on every adventure. The dimensional gate can just open on its own, or it can be conjured by a sorcerer. The latter makes the ending of "Down the Line" an ideal place to start this adventure, not only for the convenience of the gateway, but also because the characters are likely to be fully outfitted with their hero gear and ready to ad-

venture. Other accidental openings of the dimensional doorway could happen through a scientific experiment involving dimensional travel or warping space and time, accidental activation by the heroes, a villain, a bumbling henchman, or somebody experimenting or just "playing" around with magic (reading from an old book, using a lost artifact, finding a hidden archway, etc).

2. Hot Pursuit: The characters all have the bad luck of forgetting their Christmas shopping, and have to run out the weekend before to grab something. Even if they do not all go to the mall together, the group of them will eventually end up there at about the same time. Unfortunately for the characters, December 21st is the winter solstice, so on this day, magic has the right of way. As the members are leaving or arriving, or a little of both, the mall parking lot erupts in a blaze of bluish light and a tall, black-clad humanoid steps out of it. Within seconds, the creature uses its ornately bladed pole arm to carve up several innocent bystanders, as well as a few nearby parked cars. Magic characters will sense that the blue light is an interdimensional portal that has spontaneously opened up. The creature must have come through to investigate, but why did it attack everybody unprovoked?

If the player characters engage the dark intruder, the creature retaliates. If seriously wounded, it attempts to flee back into the light (perhaps with one or two innocent hostages in tow). At this point, the heroes give chase through the portal, which (of course) closes right behind them. Only now will the player characters realize that they've taken a one-way trip to a distant and frightening alternate reality. This is another sort of "Accident Option" that will place Hardware and certain other hero categories at a disadvantage, since they might not have their super gear on them when they jump through the portal. If the players aren't the type to charge through a freaky portal unequipped, then you can have them respond to this humanoid's dramatic appearance, and when it flees, they follow it, already in their full battle gear and ready for trouble.

3. Theft: A supervillain or a denizen of the alternate **Nightbane®** Earth may have crossed over into this realm, stolen something (or someone) of value or critical importance (perhaps needed to save lives) — possibly from our heroes themselves (or something left in their safekeeping). Eager to get the stolen item(s) back, and perhaps to bring the thief to justice, the heroes chase him through the portal through which he came.

On top of what difficulties await the heroes in retrieving the stolen item, actually getting back home will be tricky. A return portal or trip through astral space that only allows *living things* to pass, for example, won't help players return stolen goods or hardware, or return with any power armor, bionics or robot allies.

4. Kidnapping: If the player characters have families, girlfriends, wives, or friends, send them out for a night on the town. Then have a supervillain (Wizard or Nightlord perhaps) grab one or more of them, and run off to a waiting portal. The victim could have been chosen randomly (the villain was fleeing authorities and needed a random hostage; it's just coincidence that he/she/they are related to a superbeing), or because the kidnapper is an enemy of the player characters looking for revenge, or because a Nightlord believes the heroes can be manipulated or coerced into helping him in some way. To get their cooperation he has arranged the kidnapping of a known associate, friend or loved one (or maybe even one of the less powerful members of the super group, itself). Of course, the G.M. may come up with other reasons. If a past villain or other Earth-born foe is used, he or she is either in cahoots with the Nightlords or is being duped by them. If the latter is the case, at some point the heroes and the villain may have to join forces in an uneasy alliance in order to get them all home (an interesting subplot).

The kidnapping option also introduces the complication of a non-combatant NPC who needs to be watched and protected while the group figures out a way back home.

5. The Journey Within: Another way to get the player characters into this adventure (and my personal favorite) is to have the doorway be less a physical door than a mental trip. The **Nightbane®** sourcebook **Between the Shadows™** introduces the *Dreamstream™*, which is a reality plane similar to the Astral Plane, but composed and influenced by the dreams of the multitudes. One or more of the characters can be drawn across the Dreamstream and into the adventure. They could slip into the nightmare of one of the survivors of that distant world and save the dreamer, only to find themselves stranded physically in that devastated world when the dreamer awakens.

The possibility I find most interesting about using this kind of out-of-body technique is that the G.M. could have the characters project over to this alternate dimension via the dream plane or a unique aspect of the Astral Plane and inhabit the bodies of other heroes there (or an idealized or altered version of themselves — their dream essence). If the former is used, they would have their consciousness and memories, but the physical body and abilities of someone else. This would not only provide some interesting role-playing, but it could give the players a chance to play their characters with different super abilities in a completely different power category.

If most or all of the characters are psionic, this option also opens up a number of other possibilities for why the characters are going on the adventure. Does one of them hear a plaintive cry for help in their dreams? Could their soul mate be in trouble? Did they anger a godlike being or demon who banishes their consciousness to a far away dimension? Maybe the god thinks one or all of them need a lesson in humility or that they need to literally walk a mile in another person's shoes. Regardless of the reasons, it is definitely an option full of interesting possibilities and plenty of role-playing potential.

6. Friends in Need: Desperate and on the run, a group of superheroes from the alternate **Nightbane®** Earth breach the dimensional wall and enter this world, looking for any heroes who are willing to come to their world and help fight the Nightlords. However, when these **Nightbane®** superheroes came over, a pack of Hounds followed them, and a battle ensues. When the player characters arrive and drive off the demonic Hounds, the **Nightbane®** heroes explain their dire situation and beg for help. This will be an acid test for the player characters' heroic convictions. Do they help an alternate world that may already be doomed, at great risk to themselves? Or do they simply send these alternate Earth heroes on their way? Most true heroes will help, knowing that they really don't have to. For such individuals, selfless courage and sacrifice are the bedrock of their character, and simply knowing that there are people in need is reason enough to help them, regardless of the circumstances. **Note:** If the G.M. decides to use this option, then he should roll up the alternate Earth superheroes he plans on using to contact the player characters. Or, for a really freaky option, simply use alternate reality versions of the player characters themselves, as they would be in this bleak **Nightbane®** version of their true reality.

7. The ol' Switch-a-roo: The Earth of the player characters has been targeted by the Nightlords for possible infiltration. As a sort of scouting mission and effort to test the strength of the "superhumans" in this dimension, the Nightlords (or a Night Prince) deliberately kidnap the player group, sending them to one of the devastated parallel Earths they already dominate. Our heroes are then pitted against a number of different foes (including some Nightbane?) and Minions of the Nightlords, and situations to test their courage, morals and mettle. Eventually, they can either find their way back or find an ally or method of getting home (a required struggle or big battle would suit the superhero genre). Unfortunately, their problems don't end there. While they were gone (days, weeks or months should have passed in the Nightlands, even if a shorter period of time passed on their real Earth), evil *Doppelgangers* of themselves have assumed their personal and super-identities! When the real heroes return, their *Doppelgangers* automatically return to the Nightlands, but what damage have these beings done while they were gone?

Note: This last idea requires knowing or learning **Nightbane®** reasonably well and probably owning the RPG and **Nightlands™** sourcebook. Not to mention tweaking the Nightlands concept a bit.

Section Two: Into the Darkness

Regardless of how they actually arrive, the characters will find themselves in a world that might once have been Earth. They will even recognize the remains of buildings and streets from their home city, but everything is run-down, burned out and destroyed as if a war had taken place. Only instead of bomb craters, shell fragments, and bullet holes everywhere (there are some, but not as much

as a typical war zone would have), much of the damage appears to have been from superhumans. Melt points from energy blasts, knuckle imprints in metal, body-shaped outlines or indentations in concrete, and so on, all bear witness to a series of vicious battles between superbeings. One of the most common and unsettling damage traits is where metal, stone and wood have been cleaved by razor sharp lines, as if from a bladed weapon that could cut through any material effortlessly. If there is a magical weapon wielder in the group with a sword or axe, they will notice similarities between the capabilities of their weapon and the marks found here. Additionally, if the heroes did battle with the Hounds prior to coming to this world, then they might recognize this damage as that inflicted by their dreaded Darkblades.

Despite all of this devastation, the most unnerving characteristics of this familiar yet alien world are both a lack of people and the absence of stars in the night sky. Certainly skeletons of the dead can be found by the thousands, littering the streets and rubble of the city, but the actual silence and lack of life will unnerve even the steeliest of characters. That a world so full of life and activity could be reduced to something as barren and shattered as this is almost too horrible to digest.

As the characters search their surroundings and the hours tick by, there is no sign or indication that dawn is approaching, just the constant starless darkness above and a strange sort of indirect illumination about the equivalent of dusk that seems to light things with no discernable source. Most of the city's lights are out, though occasionally one or two do still burn, indicating at least some kind of power source is still running. However, finding reliable power is hit and miss, unless one ties directly into the electrical lines powering one of the working lights. Likewise, finding working telephone lines is difficult, but not impossible, though there is no one to contact them with. Surprisingly, should someone attempt to reach the internet using a working phone-line, they can actually do it. There is practically nothing there, but they can find a web page from a local server with a message on it. The message is somewhat cryptic and written in what appears to be over-emphasized street slang, but a simple Streetwise or Cryptography roll will translate it, as will a D20 roll against any character's I.Q. rating. Once translated, the message simply reads: "Stay away from the Federal Building and Courthouse. Contact can be made near The Park."

If the group goes to the Federal Building or Courthouse, refer to Section Five. If they make their way to The Park, move on to Section Three.

Not much happens in this juncture, other than getting a lay of the land and, perhaps, a few run-ins with Hounds or a few other minions (and possibly defeat any opponents who might have arrived here with them). This is where the characters get to explore their surroundings. The G.M. is encouraged to do his best to set the mood for the characters. There is nothing here but desolation and darkness. Finding hope or a future here would be slim indeed (as the survivors in Section Four will show).

Section Three: Dark Lords

The group will have some time to explore before they run into any other living things. The first people they encounter will be a war party of those who have apparently conquered this world. Roaring through the deserted streets in a military halftrack is a squad of what appears to be demonic soldiers wearing glistening black body armor, sinister-looking helmets, and wielding wicked pole arms. The halftrack's destination is unknown, but perhaps it is transporting the troops to a combat front, or merely making a routine patrol. There are 8-12 soldiers in the open-topped rear cargo bay.

For now, the heroes should be content simply to watch, since it is unlikely they could handle the entire squad on their own. Luckily, the approach of the massive truck can be heard for blocks and gives the player characters plenty of time to find a hiding place (no prowl roll required unless they wish to follow the truck). If they should be so foolish as to attack the creatures, skip to Section Four and have the survivors make an appearance to save the heroes if necessary.

G.M. Info for Section Three

The demonic creatures are called "Hounds," and their armor is actually a kind of carapace or exoskeleton. Their indestructible and razor sharp weapons, called Darkblades, are the equivalent of minor magical weapons. They could be re-forged into smaller weapons by a Hardware: Weapons Expert or Mechanical Genius character but the process will take days, and requires a full forge and tools to analyze the items, followed by a grueling re-forging process (roll at -40% since they are alien items. Failure means the item has been accidentally destroyed).

The Hounds answer to the *Nightlords*, a race of incredibly evil and powerful aliens from another dimension who invaded this planet not very long ago. The Nightlords are easily on par with the toughest mega-heroes in terms of raw power, if not more so.

This encounter should not turn violent, but if it does, refer to Section Five for the Hounds' stats. This part of the adventure is intended to show the characters what they are up against. To this end, the G.M. should have the truck stop, the Hounds get out, and the creatures search a nearby area. Show the group the razor sharp blades by having the Hounds cut into walls or metal, then demonstrate their supernatural strength by having the creatures separate the cut items with their hands. It should be obvious they are looking for something and that each of the creatures is a powerful opponent, easily on par with the heroes themselves.

The Hounds are actively searching for the last surviving superheroes of this ruined city, but if the characters followed the Hound through the portal in the intro and it managed to escape, the creatures will be searching for the player characters also. As they do this, the Hounds speak amongst themselves (in a language the heroes can understand, strangely enough). They gripe and grumble about digging for a handful of losers and being assigned to a bottom-of-the-barrel mission like guarding a conquered

and wasted planet like this one. Once the Hounds scour the area (about a block or so in size), they board the half-track and return to their base.

Section Four: Hope, the Faintest Glimmer

After a day or two of hiding and waiting at The Park, the heroes notice a pair of people appear, seemingly out of thin air. If the group is safely hidden, invisible or successfully prowling, they can watch as the two separate and circle The Park as if looking for something. Once they get close to either one of these furtive figures, they will detect their presence (unless the group reveals themselves beforehand) and demand to know who is there.

G.M. Info for Section Four

The survivors of the war that destroyed this planet are very few in number, and they have been in hiding for almost five years. As the war wound down and the world's superpowered defenders fell before the invading Nightlords, no place was safe from them and their Hound armies. The few psychics among the remaining superpatriots expended most of their energy to build a pocket dimension within the Astral Plane as a place for heroes to hide. The refuge these two new characters have exited has a portal in the city's park that allows psychics and non-psionics alike to enter (Normally, only psionics have access to astral realms). Things were hard the first year or so, for it took quite some time for the new realm to take shape, even with everyone there contributing their I.S.P. and P.P.E. to its growth. Many died for lack of food and illness.

Eventually, the realm coalesced and formed a water supply and soil to support food. By the end of the first year, trees were present and large enough to harvest for building materials. Shelters could be built and though the place was cramped, it was a paradise compared to the world they had escaped from. Unfortunately, they could not leave that world behind. It was their home and even though it might never be liberated, there are still survivors to be found and rescued. That's what the two unidentified humanoids are doing, coming to check the park and do a quick check for those who may have found their internet message (or happen to be in the area when they do their search).

For the future of their race, the survivors have been sending scouts out into the world and across the Astral Plane in search of another world to call home or allies to help liberate their world. There are about 50 people here with super abilities (mostly from the Experiment and Mutant categories), a dozen Psionics with 40 or more I.S.P. remaining (most of their I.S.P. has been permanently spent to build the Astral Realm they hide in), six Wizards, and 20 heroes from the technological power categories (Special Training, Bionics, Physical Training, Hardware, and Robotics). The other 260 survivors are civilian, non-combat personnel.

Every other day, someone ventures out into the park to check for survivors (occasionally long-range squads are

sent deeper into the heart of the city and beyond). That's why the Hounds are always poking around here — they suspect that the refugees' and freedom fighters' secret sanctuary is somewhere in the vicinity. The freedom fighters usually dispatch scouts with powers that enable them to move around undetected (Hounds can see the invisible). The pair who encounter our wayward heroes are mages who will scan them with See Aura, Sense Evil and Words of Truth before feeling confident enough to take them into the Astral Realm (perhaps the Earth Heroes rescue the pair from an attack by Hounds or other Minions of the Nightlords).

In the Astral Realm, the four psychics who established the sanctuary have special, almost god-like powers over the place. Magic and other superhuman or supernatural abilities do not function unless the four founders will it to, thus invaders find themselves powerless and facing defenders with no such handicap. (For more ideas and details on the powers available when creating an astral realm, take a look at the **Nightbane®** sourcebook, **Between the Shadows™**).

The Earth heroes will initially be mistaken for other survivors, but after they explain how they arrived on this world, the freedom fighters will know otherwise. Surprisingly, they are elated! For years they have been searching for another world full of life that they could find refuge in, and now they have found a link to such a place. All will be eager to help the characters return home with the hopes that they can travel there with them. The player group will be told the history of this shattered Earth and its fate, followed by brainstorming on how to return them to their Earth. Eventually, they determine the only possible way to return any of them to the player characters Earth is by using "The Switchboard."

In the heart of what used to be the city's Federal Building is a magical chamber that the Nightlords built to transport their minions through other dimensions. The survivors have nicknamed it "The Switchboard," and they have very little intelligence on it. However, they are sure it can open a portal to nearly any world and that it can allow hundreds of people to cross at once. Several of the Wizards insist they can easily decipher the workings of the Switchboard's controls and any number of them are also willing to stay behind and destroy the thing once the group gets through. Ideally, these people would like to see several dozen, if not hundreds of the non-superpowered refugees also escape to Earth. They will not force this upon the wayward heroes, but beg them to save these people's lives. Also pointing out that if a Hound has made an appearance on their world, that our heroes' Earth may be one of their next invasion targets, and that these refugees have first-hand knowledge about the enemy.

The only trouble will be getting everyone to the room where the dimensional doorway is located. They do know that the Federal Building is patrolled by over 150 Hounds (and presumably other minions). All they need is a good plan to make it work.

Unknown through their entire time in the Astral Realm, one of the Wizards among them is actually a

Doppleganger (a denizen of the realm of the Nightlords who is the exact physical duplicate of a person and often works as a spy and infiltrators; for full details, see page 158 of the **Nightbane®** role-playing game) that fled the service of the invaders and sought to help the innocent people. There was nothing he or anyone could do for the people of this world, but still he stayed loyally with the survivors. He now admits all this and is welcomed for his honesty and further entrusted with the survivors' faith in the information he can offer. He knows where the Switchboard is located, how to get there, and how to work it. He also volunteers to stay behind and destroy it once the group is through. All the player characters and their new allies have to do is keep him alive until he can finish his task.

The G.M. should allow the player characters to make most of the plans for the assault using the superpowered freedom fighting forces as a distraction and fellow fighters (and the info in Section Five which is provided by the Doppleganger Wizard). NPCs can point out things the heroes may overlook or have forgotten about and make general suggestions, but remember, this is the part where the players can really earn some experience points by coming up with an innovative and daring plan for their characters. So give them a chance before guiding them along and cutting them out of the excitement.

Section Five: Escape & Salvation

Federal Plaza was once an impressive part of the city's downtown area, but now is a dark and frightening place. The inlaid stones of the plaza are cracked from the thump of thousands of armored feet and the weight of hundreds of armored vehicles. The plants are dead, the building is completely unlit and it bears the scars of the many hard fought battles. Unlike most of the city, this place was the target of a number of ill-fated human attacks against the evil invaders. The bomb craters and bullet holes missing in most of the city are evident here. Many of the larger craters are filled with gleaming heaps of bone where the Hounds dumped the bodies of those they have killed. Hundreds of other skeletons litter the plaza, most shattered to splinters or powder by the tread of uncaring armies.

G.M. Info for Section Five

Six Hounds stand guard in the plaza, but 20 are on constant standby in a nearby barracks (the former courthouse). Another 20 patrol each of the four floors of the Federal Building and all of them can converge on a given spot on their floor within 1D4 melee rounds. The Hounds on the floors directly above or below can arrive on the next floor within a single melee round, but half of them will always remain on their assigned floor. The basement is an-

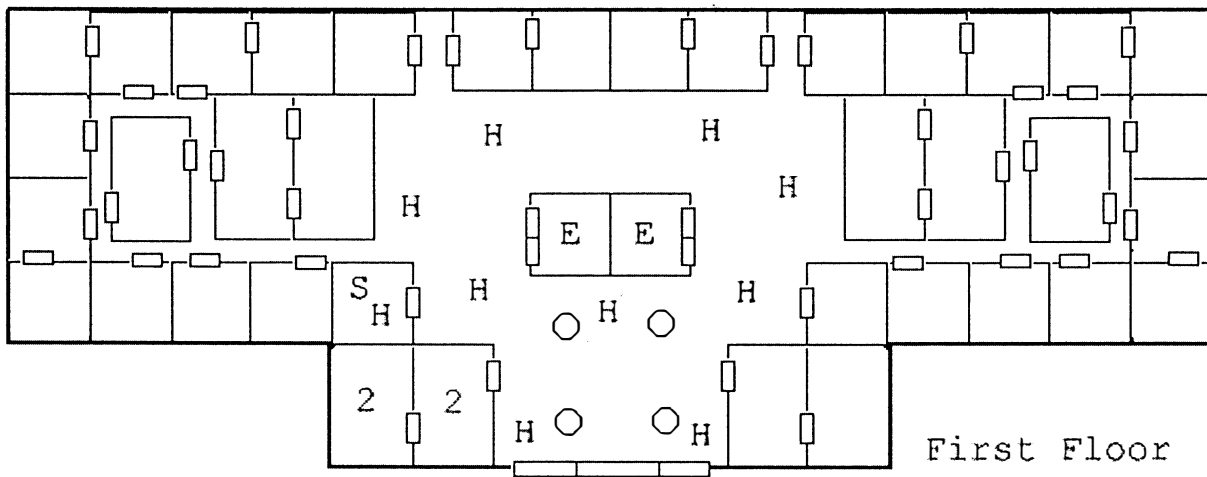

Second Floor

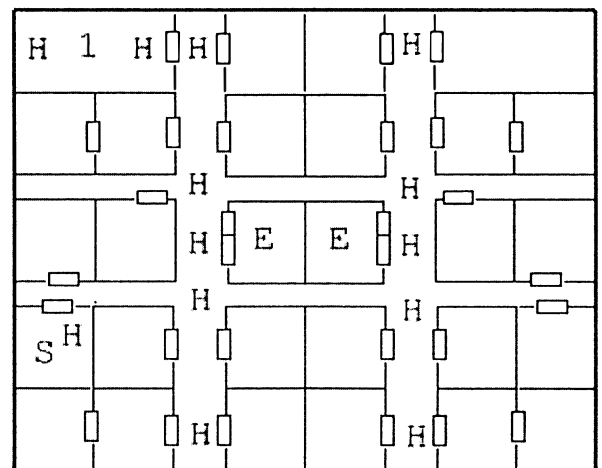

Former Federal Building

- 1 The Switchboard
- 2 Former Security Offices
- S = Stairs
- H = Hound
- Hounds not shown wander between random locations.

other barracks with 50 off-duty Hounds that can respond to a disturbance within 3 minutes (12 melee rounds), though they will generally replace missing Hounds on each floor out of their numbers before moving on. The other 40 or so Hounds are on patrol in the city, searching for survivors they know are hiding there. The Switchboard is located in a room on the second floor.

Once the player characters invade the Federal Building, they will have more than 75 superpowered survivors to help them out, but keep in mind that any of the civilians have to be protected and that the Hounds are nasty opponents. Many of these freedom fighting heroes have only minor powers and probably won't last as long against the Hounds as the player characters. If all-out combat ensues (which is fairly likely, given the high level of security here), the numbers of these NPC superbeings will dwindle during the course of the battle (and punctuating their heroism, and the murderous nature of the Hounds. All the more reason to help at least some refugees escape.). There is no need to roll for all that combat, just use appropriately dramatic descriptions and timing to convey the heroism going on around the player heroes. For added drama, the G.M. may wish to establish a fixed rate of attrition per melee round or every few minutes, so the player heroes have a certain time limit to break through to the Switchboard before they are overwhelmed. If the player characters lose this battle and escape the Hounds, or decide to stay and help the survivors, then turn this adventure into a mini-campaign as the Hounds reinforce the Federal Building and search for these new troublemaking heroes who have joined the resistance. Of course, player characters and NPCs alike can return to the Astral Realm to lick their wounds.

The Switchboard. Just how many people actually make it to the Switchboard is entirely up to the G.M. and the scheme(s) of the player characters. And once there, what if it is guarded? Normally, it has only a token detachment of four guards, but during the fighting, chances are the entire facility joins in battle against the invading superbeings, so by the time the player characters punch through to the Switchboard, they might find nobody there, only a few guards, a dozen or more — depending on how difficult the G.M. wants to make things (and/or how the battle has gone), the Hounds could have called for reinforcements during the conflict. Reinforcements that begin to come through the Switchboard right as the heroes arrive!

Furthermore, just securing the Switchboard isn't the end of the heroes' problems. What if the Wizards that came along are all dead? Or what if they really can't figure out how to operate the Switchboard? It would be a bitter pill to swallow for the heroes to make it this far, only to find that they still can't get home this way. But, it could make for some really interesting role-playing.

And, if the heroes do get the Switchboard operating, there's always the possibility that they have calibrated it incorrectly, and end up sending themselves (and whoever else goes with them) to another alien dimension or location on this Nightlands world rather than home. Which

would lead to another adventure or perhaps an entire campaign as the group tries to find its way back to the Earth they know and love.

Or does a legion of Hounds (and/or other minions?) follow them back to Earth? Do their dark masters come later? Does this entire episode give the Nightlords the motivation to invade *this* world at some point in the future? (A campaign set around preventing the Nightlords from getting a foothold here could be fun, a kind of pre-Dark Day **Nightbane®**. That's entirely up to you).

Happy endings. 1) If all goes well, the player characters and a handful of the survivors return to Earth. Any superbeings who may end up (inadvertently) coming to Earth too, will make interesting new NPC allies, heroes and perhaps a villain or two for that city or campaign setting.

2) Our heroes see what the Hounds and their evil masters are capable of and take as many refugees with them to Earth (a few superbeings, too?). Although the refugees are "human" and have a similar history and culture to the heroes' native country, they are "alien beings." Bringing them to Earth will cause a political stir, especially if they number more than a few dozen. Who is responsible for assimilating them into our world, getting them jobs, etc.? The heroes may find their good intentions get them bad press and into trouble (lasting political trouble).

3) During their effort to get home, the Earth heroes discover some device and/or information that could repel the Nightlords and their evil legions from this parallel world and restore the light of day. Do they ignore this and save their own skins, or stay to help? Or do they return to Earth, heal up, prepare and return (with other Earth Heroes) to help liberate this shadow world? If they elect the latter, they had better not wait too long, as the freedom fighters are locked in a losing battle. And the Nightlords will seek retribution for the attack on the Federal Building.

Hounds

These supernatural foot soldiers make up the army of their dark masters, the Nightlords. They are built and exist for warfare, killing, and spreading death. They also have natural abilities that make them great trackers and thus, ideal hunters. These creatures could be equated to animals, but while animals and Hounds share a love of the hunt, animals do not relish the kill and enjoy the suffering of the prey. Needless to say, Hounds can not be reasoned with.

The Hounds presented here are a small contingent serving out their duties on a practically worthless world. If the G.M. wishes to incorporate leaders for larger groups of Hounds, then Hound Masters or Ashmedai from the **Nightbane® RPG** would be the best choices. **Note:** To make this a stand alone adventure without necessitating players or the G.M. to have to run out and by the **Nightbane® RPG** (and a sourcebook or two), we have intentionally left out the many other monstrous Minions, as well as the Nightbane. However, to make this an expansive and long-ranging campaign, getting this RPG is a good idea.

Alignment: Diabolic (always!)

Attributes: I.Q.: 2D4, M.E.: 3D4, M.A.: 3D4, P.S.: 3D6+14 (Supernatural), P.P.: 3D6+6, P.E.: 4D6+4, P.B.: 1D6, Spd: 1D4x10

Size: 7 feet (2.1 m)

Weight: 350 lbs (157.5 kg)

Experience Level: 1D4+1 (average of 3rd)

Armor Rating: 13 against normal weapons (natural).

They have no armor rating against magic or supernatural attacks, including punches with Supernatural P.S., claw attacks from the Animal Metamorphosis or Lycanthropy abilities, Body Weapon attacks, Force Aura punches, those from Altered Physical Structures, etc. The A.R. does apply to robot and bionic attacks, punches from Extraordinary or Superhuman P.S., and all ranged attacks such as Energy Expulsion powers and the elemental generating attacks of the Alter and Control abilities.

Partial Invulnerability: Takes half damage from any non-magical weapons and attacks.

Special Vulnerability: Takes double damage from magic weapons, spells, and supernatural attacks.

Hit Points: P.E.x3

S.D.C.: 200

Horror Factor: 13

Disposition: The Hounds are shock troops and hunters similar to animated magical constructs like golems, but with emotions. Unfortunately for their enemies, the only emotions they seem to possess are for violence and destruction. Hounds can think and reason within the limits of their I.Q. rating, but ultimately, they are nothing more than expendable followers.

Natural Abilities: Illusion Immunity: Immune to all illusions and powers of concealment, including magical, psionic, and super powered invisibility; similar darkness powers; and supernatural disguises or altered shapes. However, mundane disguises and spells like blind or abilities such as bio-manipulation do affect them. Nightvision: 2,000 feet/610 m. Expert Tracking: Track humans at 80%. Regeneration: Heals all damage if allowed to remain undisturbed for an hour. Supernatural Tracking: Detects supernatural creatures and can follow the trail they leave behind. Range: up to 60 feet/18.3 m. Skill Proficiency: 50%+5% per level of experience. Note: this will detect and track super abilities, but only while they are active, and it will always detect a magic weapon.

Magic: None.

P.P.E.: 1D6x10

Combat: Hand to Hand: Assassin, but with one additional attack.

Number of Attacks: Most Hounds have 5 attacks per melee. Hounds of 5th level or higher have 6 attacks per melee.

Bonuses: These bonuses do not include attribute or level bonuses: +1 on initiative, +1 to strike, +1 to parry, +1 to dodge, +3 vs magic, +3 vs psionics, +4 vs Horror Factor, and +4 perception (if used).

Education Level and Skills: Minimal skills: Natural tracking (80%), magically understand (but not speak) all lan-

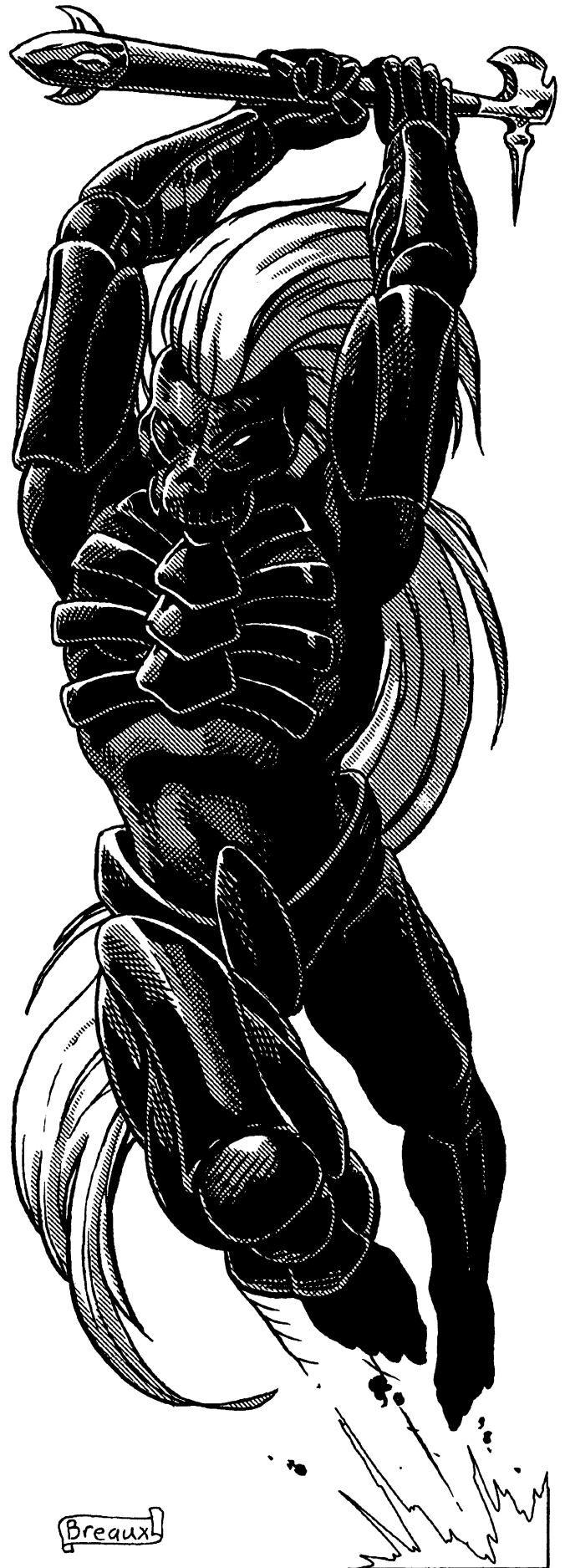

guages, Swimming (98%), Climbing (98%), W.P. Pole Arm, and W.P. Sword.

Weapons and Melee Combat: Hounds typically use long hafted, pole arm-style blade weapons called Darkblades. These weapons are not magical in the sense of the magic weapon power category, but are somewhat enchanted to be indestructible and remain razor sharp forever. They do add their damage of 3D6 to the Supernatural P.S. damage of the wielder in addition to the P.S. damage bonus. The damages below are for a typical Hound.

Restrained Punch: 2D6+11

Normal Punch: 4D6+11

Power Punch: 1D4x10+11, but uses up two attacks.

Darkblade attacks: 7D6+11 (includes weapon and P.S. damages).

Note: In *Nightbane*, Darkblades can cut through any ordinary material with ease. This is probably too unbalancing for a **Heroes Unlimited™** campaign, so it is up to the G.M.'s discretion to include, modify or exclude this characteristic.

One alternative is to make these magical blades strike any material at -3 its normal Armor Rating — meaning an A.R. of 18 would really be the equivalent of an A.R. 15 to a Darkblade (A.R. 16 = 13, A.R. 11 = 8, and so on). Furthermore, these mystical blades will cut characters with the power of *Invulnerability*, but do only half damage. *Intangible characters* will feel an icy chill from the cutting blade and suffer 1D6 damage, although no blood is drawn!

SHOCK TO THE SYSTEM

When one of the most dangerous villains on the S.C.R.E.T. wanted roster escapes from prison and begins a series of strange criminal endeavors, everyone wonders what she's up to. But do the player characters want to tangle with one of the government's most wanted supercriminals?

Note: This adventure features some powerful villains and opposition for the player characters. G.M.s may wish to reserve its use for powerful or high level groups. Very careful handling of certain situations and/or reducing the capabilities of the opposition may also be necessary depending on the size and power of the player group.

Section One: The Bigger They Are...

"Good evening. I'm Lori Landry, and this is a Special Report from Channel 5 News," says the newscaster that has just interrupted normal television programming.

"The Pentagon has confirmed the theft of its only prototype of the Assault Model A-11 attack robot earlier today. Transported by convoy on an undisclosed route, the A-11

was reportedly stolen by a group of bandits who destroyed the convoy within minutes. No survivors are reported at this time." The image of a line of smoking vehicles appears in the upper right-hand corner of the screen as Lori Landry continues talking. The image then blows up to full screen, showing numerous military personnel securing the area. The footage is grainy and jumpy, taken from a hovering helicopter, and mildly scrambled by the military for security purposes.

"Authorities are still investigating, but they currently suspect the supervillain **Shock**. This notorious criminal recently escaped from a S.C.R.E.T. medium security, super-human penitentiary. Shock is considered armed and extremely dangerous. The FBI is offering a one million dollar reward for information leading to the arrest of those responsible for the attack, and the recovery of the A-11. Anyone with information on the whereabouts of Shock should contact the FBI, at the number at the bottom of your screen. All calls are toll-free and confidential."

G.M. Info for Section One

If the player characters do their research, they may uncover some interesting information. First off, two weeks ago, *Bradley Marks*, an Army Special Forces robot pilot, was discharged for corruption and taking bribes. He managed to avoid jail time, but has been strangely quiet on the whole incident. His only public statement was that he was, "framed by government officials." Could his disappearance, discharge, and the theft of the A-11 all be more than a coincidence? You bet it is.

It all began when *Senator Curtis Ramsey*, a long-time friend of the Pentagon and veteran bribe-taker, feared that his legacy of corruption was about to be discovered. Looking for a scapegoat, he found Bradley Marks, who was in the right place at the wrong time. Ramsey framed Marks for his misconduct and sunk a promising military career in the process. Understandably, Ramsey's greed and callousness have embittered Marks, making him very susceptible to manipulation. That's where Shock comes in.

Shock had nothing to do with framing Marks, but she was fortunate enough to stumble upon his unique situation just when she was in need of a big distraction to pull off a special job. Shock talked Marks into a wild scheme of revenge and even arranged for the theft of the A-11 robot to help him carry it out. It turns out Senator Ramsey initially proposed the A-11 project as a means of funneling large amounts of cash into his own pocket. Shock convinced Marks that if they stole the A-11 and caused a fair amount of mayhem with it, Ramsey would be so embarrassed by the scandal that he would have to resign. In reality, this is all just a pipe-dream. Shock has no idea what will happen to Ramsey if the A-11 project runs amok. Probably nothing, since the Senator has never been suspected of any wrongdoings. But Shock has sold this story to Marks in order to get him to help her go on a crime spree with the giant war machine. To her, that's all that matters. She doesn't care if Marks gets his revenge or gets into further trouble by stealing and misusing the A-11.

Depending on the player characters' connections and/or skills, they may also be able to get a dossier on Shock. If they do, much of the information included in her background and statistics will be available, except for certain things that would obviously be unavailable to the authorities (like the details of her origins). It will, however, definitely contain her psychological profile, names and info on her old gang (all incarcerated), and her preferred methods and tactics. Unfortunately, most of it will be less than useful, for Shock has an entirely new crew and some new tactics (see later sections for full details).

Section Two: A Giant Diversion

All will be quiet until a week or so later, when one or more of the player characters pass the *Whitmore International Bank*. They may notice that the large clock on the bank, which is always accurate, has stopped. Shock likes to stop the clocks on places she is planning to rob. Could it be a strange coincidence, or has Shock marked the place as a target? Heroes would be wise to stake the building out, or even to warn the authorities. However, as the group and possibly the authorities wait, there is a distant explosion, so powerful that it shakes buildings several blocks away. Anyone monitoring police channels, or in radio contact with them, will be immediately informed that a giant robot has just attacked the Federal Building and Courthouse with missiles. The missing A-11 has made its appearance.

Layout of the Bank

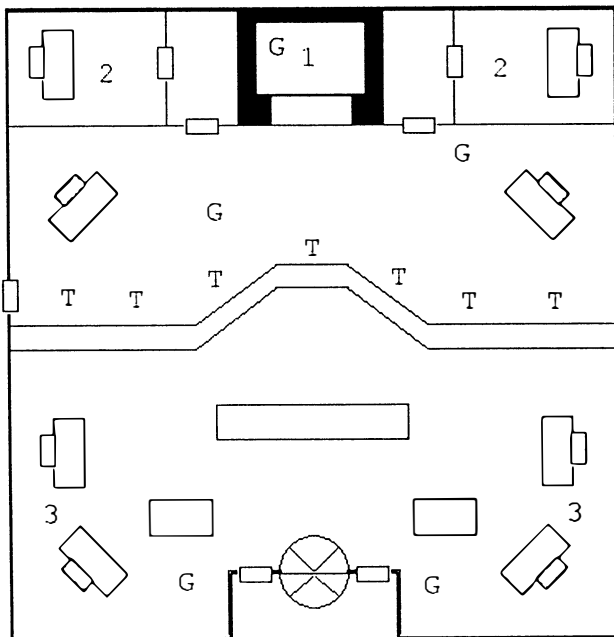

- 1 Vault (and safe deposit boxes)
- 2 Offices
- 3 Loan Officers Desks
- G = Guard
- T = Teller

All of the police in the area will withdraw to respond to the threat. If the group is part of the local authorities or a Federal organization, they will be required to respond to the robot threat. Those not affiliated with the authorities can do as they please, but what kind of heroes stay to prevent a possible bank robbery when a giant combat robot is smashing buildings and killing innocent people down the street? The greater need is elsewhere.

G.M. Info for Section Two

Whether the characters were watching the bank or not, they will hear about the robot attack as it is happening. Those within two miles (3.2 km) will hear the explosions, and those within one mile (1.6 km) will feel the shock wave from the missiles directed at the Federal Building. One minute after the initial attack, all television channels and most radio stations are reporting the incident and warning people to flee the area. Panic ensues as the attack continues. One or more of the characters may even be on the scene, especially if the team works for the government (they may even be in the Federal Building at the time of the attack).

Bradley Marks is piloting the robot, oblivious to the fact that he is a diversion while Shock robs the vault and safe deposit boxes of the Whitmore bank a short distance away. He will hit the Government buildings with all of the robot's missiles (except his single, long-range missile, which he holds in reserve as a bargaining chip), targeting the spire and dome more for effect than massive damage. Furthermore, it is clear that he waits for the majority of people to flee the building before he continues his destructive barrage. During this time, he demands that *Senator Ramsey* be delivered into his custody. This could turn into an interesting "hostage drama" for the heroes if the Senator actually agrees to surrender to Marks in the interest of public safety (The old coot may be corrupt but he's not a coward, and he still has *some* devotion to the public good. He can be at the site in 10+1D4 minutes). After that, Marks just rants about his being framed, his ruined career and payback. After about 5+1D4 minutes, when most (not all) people are out of the building, he repeats his angry demand for the Senator and proceeds to level the building, even if he's told the Senator is on his way — this is both a show of power and a venting of his anger.

Anyone who tries to stop the giant A-11 will be engaged with appropriate force, which will dissuade most ordinary law enforcement personnel from attacking. Additionally, there should be several minutes of tense waiting (and planning?) while people are fleeing the building and Marks is ranting rather than attacking. To attack at that time will only jeopardize innocent lives (negotiation situation). However, the moment he resumes his attack on the building, it's time for the heroes to act. Against those who persist (e.g., the heroes), Marks will use deadly force and fight until the A-11 is in danger of capture or complete destruction. At that point, if Marks doesn't think he can escape, he will activate his long-range missile and inform the heroes that it is loaded with a nuclear, biological, or chemical warfare payload (the G.M.'s choice as to which), and that if he

is not allowed to leave, he will launch it upon a random major town or city within the missile's 500 mile (804 km) range. With this range, it can reach a major population center even if the action takes place in one of the more remote areas of the country. **Note:** This is all a bluff. The missile is only loaded with conventional explosives, but Marks is hoping that the players won't realize that. It's a good bluff, since the specter of stopping a small nuclear missile or one loaded with a deadly virus or Sarin nerve gas should be enough to give any hero serious pause.

This ploy is only used if defeat appears imminent. Until the heroes do that, Marks will use his arsenal of missiles, other heavy weapons, and the A-11's incredible strength to level the Federal Building and Courthouse (unless he is waiting for the Senator to be delivered, then things will be quiet until he gets impatient). He will use smaller weapons to keep the police at bay.

If Marks succeeds in destroying the Federal Building, he will move on to the Courthouse (which, thankfully, is completely evacuated by that time), inflicting as much damage as possible before fleeing to the nearest large body of water where he is supposed to rendezvous with Shock and her people.

Shock will indeed be hiding at the rendezvous point, though she will not rescue Marks as they arranged. Sadly for Marks, once the heist and the diversion at the Federal Building is over, Shock will have no use for him. His only means of escape is to go underwater and hope that the heroes can not pursue. This underwater escape is taken away if the giant robot has been damaged to the point that it is no longer airtight. If Marks should escape, Shock will eventually meet up with him, but only to kill him. Then she will sell the robot off to a South American criminal organization. **Note:** A possible side adventure is to have the players learn about the sale and show up to try and stop it (or stop the sold robot from leaving the country).

The A-11 Assault Robot

The A-11 assault robot is a Type One, giant humanoid robot that requires a pilot for operation. It is a massive war machine designed as a mainline combat unit equal in firepower and armor to several tanks. Engaging it head-on could easily be a deadly move even for many superbeings. Tactics and teamwork will be necessary to defeat it (perhaps along with the support of the police and national guard).

G.M.s should give some indication of the robot's power as it destroys vehicles and buildings with little effort. Remember, if characters use cover to their advantage, the robot's pilot will need to use "called shots" (or destroy the cover first) to hit them. In this case, failing the "called shot" means hitting the object/debris the character is hiding behind and it takes damage, but not the character. Because of the robot's size, its large weapons and role as an anti-vehicle or anti-structure attack unit, the A-11 is -6 to hit human-sized targets, and -8 to hit fast moving, human-sized targets (40 mph/64 kph or faster). On the flip side, its defense computers are geared to lock onto small,

really fast-moving targets like missiles, so instead of the -8, it is actually +1 to hit small targets moving faster than 100 mph (160 kph), such as heroes with extraordinary speed. These penalties and modifiers apply to all combat rolls between the robot and human opponents unless specifically noted in a weapon's description. Remember, Marks doesn't really want to kill anyone but the Senator, so he will use extreme, but not deadly force on anyone that hinders him.

Note that if the player characters defeat the robot, the authorities are not going to let them walk off with it — the robot is Government property. If they wish and their alignment allows them to steal it, they can attempt to flee with it, but will have to have somewhere to hide a 45 foot (13.7 m) tall hunk of military hardware. On the other hand, hardware or robotics characters might have enough time to examine the robot for inspiration, but the best it could do is give them a +2% bonus to develop one or two similar system features; there won't be enough time for a thorough inspection and analysis.

Assault Robot A-11

Cost: About \$21.6 million (not counting the 26 billion spent on R&D to get to the point of building this prototype).

Attributes: P.S.: 90 (supernatural) and Spd: 88 (60 mph)

Height: 45 feet (13.7 m)

Weight: 125 tons (93.25 metric tons)

Armor Rating: 17 (robotics)

S.D.C.: 2,900. **Note:** At the G.M.'s discretion, S.D.C. may be allocated by location, such as the torso, head, arms, legs, specific weapons, etc. Thus, characters can make called shots to specific systems in the hopes of neutralizing the A-11 without having to destroy it.

S.D.C. by Location (2900 total):

Torso/Main Body: 1050

Head: 300

Hands (2): 50 each

Blades (2; left arm only): 50 each

Arms (2): 200 each

Shoulder Gun (1): 100

50 caliber Machineguns (2; forearms): 50 each

Medium-Range Missile Launcher (1; right shoulder): 50

Long-Range Missile Launcher (1; back): 100

Legs (2): 300 (each)

Horror Factor: 14 (but the robot pilot won't take advantage of stunned heroes, he is intent on his chosen targets and those he considers to be immediate threats).

Appearance: The A-11 robot is a walking war machine, a tank on legs. It is massive, ugly, and unmistakably out to destroy. Heavy armored plates cover its thick limbs and shield its many weapon systems. Most of the robot is angular and squared with protective bars adding to the defense of vital areas in the case of collisions, falls, or impacts. Drab gray urban camouflage paint dulls its appearance with the exception of bright red or yellow stickers warning the ignorant away from intakes, exhaust vents, weapon barrels and moving parts.

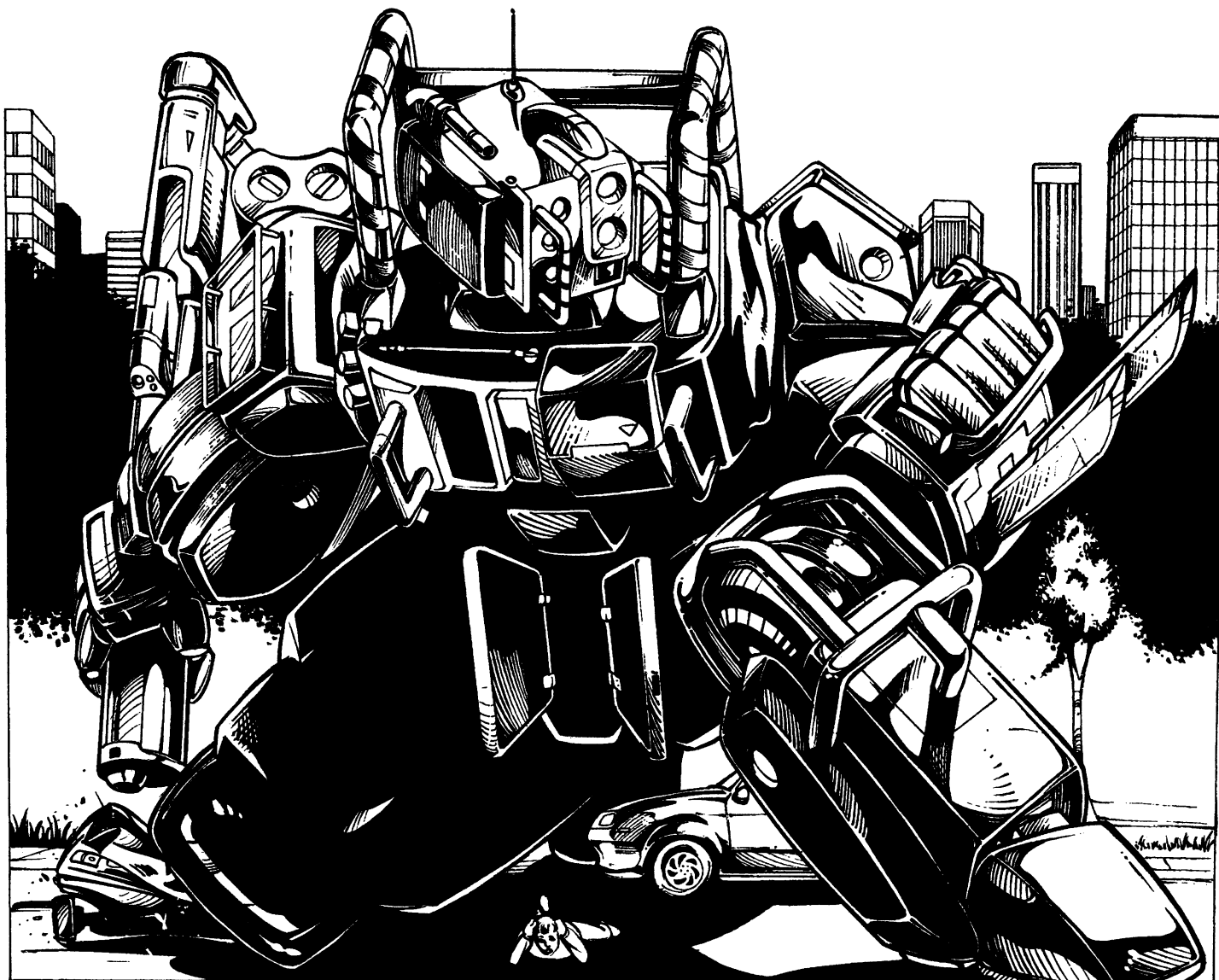

Sensors and Systems: Fusion power system, advanced audio system, wide band transmitter and scrambler, radar signal detector, audio recorder, loudspeaker, advanced robot optic system, laser targeting system, telescopic vision, external video and audio surveillance system, searchlight, video receiver and transmitter, combat computer, maxi-radar, voice actuated controls, reinforced pilot's compartment (A.R. 19, S.D.C. 250), pressurized cabin, life support unit, remote probe, and a self-destruct system (double the usual blast radius and damage, but the robot will beep loudly and emit a warning fifteen seconds — one melee round — before it explodes).

Natural Abilities: Because it is a machine, the A-11 is immune to anything that wouldn't work on your average mid-sized sedan, including many psionic and magical effects. Because it is a vehicle and not an autonomous robot, the A-11 does not get a saving throw against Energy Disruption, but the mage using this spell must still roll on the effects table (see the Expanded Spell List for clarifications on Energy Disruption). Its circuits are sealed and shielded, allowing immersion in water and

exposure to powerful magnets, including the major super ability of Magnetism. Moreover, all of the A-11's components are also composed of a state-of-the-art alloy that is unaffected by this super ability.

Combat: The A-11 must be piloted by a human controller.
Number of Attacks: Determined by the pilot (see Bradley Marks below).

Bonuses From Robot Systems: (all are in addition to the bonuses of the pilot) +8 on initiative, +1 to strike, +1 to strike with built-in melee weapons, +4 to strike with built-in ranged weapons, +2 to parry, +3 to dodge, +75 to melee damage.

Weapon Systems:

- 1. Eye Ion beams (4):** The blocky head of the robot has six "eyes." Four of these are ion beam weapons and the other two are sensors. The high mobility of the head and the small nature of the ion beams make them ideal anti-personnel weapons, and thus they do not suffer the penalties given previously for hitting human-sized targets. Rolls are made normally with all bonuses. To conserve energy, the beams are fired in alternating rounds,

but if necessary, two, three, or all four can be fired simultaneously at one target for increased damage.

Primary Purpose: Anti-Personnel

Secondary Purpose: Anti-missile

Damage: 4D6 per beam. Increase the number of damage dice proportional to the number of beams fired simultaneously, up to 16D6 for all four fired at one target.

Range: 400 feet (122 m).

Payload: Each beam can fire 20 times before requiring a one hour recharging period.

Rate of Fire: Single shots (equal to the number of attacks of the pilot) or volleys.

Bonus: +2 to strike (in addition to above bonuses and those of the pilot).

2. 20 mm Shoulder Gun: The standard field weapon of the A-11 is a huge, assault rifle-style weapon complete with ammo clip and shoulder strap. The gun pod is actually a modified 20 mm automatic cannon designed to be used against light armored units or slow-moving aircraft such as helicopters. Reloading an empty clip takes two melee actions. The A-11 is outfitted with two spare clips.

Primary Purpose: Assault.

Secondary Purpose: Anti-Armor.

Damage: 1D6x10 per round.

Range: 4,000 feet (1,220 m).

Payload: 50 round clips. Provides enough ammo for 50 single shots, two short bursts or one long burst, but no full melee bursts.

Rate of Fire: Aimed, burst or spray. (See Bursts or Sprays from machineguns on page 76 of **HU2**).

3. Mini-Missile Launcher (in chest): Another anti-personnel and light armor weapon of the A-11 is a battery of mini-missiles in its chest. The unguided missiles are used against vehicles, massed troops, or small, heavily armored units such as power armor. Once the payload is depleted, it can not be reloaded in the middle of combat. The launcher is retracted and hidden behind an armored plate (A.R. 12; S.D.C. 100) until it is used. It does not get the previously listed penalties, but the unguided nature of the missiles means they get no bonuses except those from the weapon skills of the pilot.

Primary Purpose: Anti-Personnel/Anti-vehicle

Secondary Purpose: Assault

Damage: Varies by missile type, but armor piercing (1D4x10) are the most common payload.

Range: Approximately one mile (1.6 km).

Payload: 18 mini-missiles.

Rate of Fire: Singly or in volleys of 2, 4, 8, or all 18

Bonus: None other than those of the pilot (unguided).

4. Two 50 Caliber machineguns: The A-11 has a .50 caliber machinegun mounted in each forearm, primarily for anti-personnel use. The weapons fire standard rounds, but small belts (100 rounds each gun) of armor piercing ammunition (1D4x10+6 damage and -2 to A.R.) can be engaged internally in one melee action for use against light armored targets or buildings. Otherwise, these guns can not be reloaded by the robot itself.

Primary Purpose: Anti-Personnel/Anti-vehicle.

Secondary Purpose: Anti-Armor.

Damage: 1D4x10 per round.

Range: 3,000 feet (915 m).

Payload: 300 round belts (One for each gun) plus additional 100 round belts of armor piercing ammunition.

Bonus: None other than those listed above and those of the pilot.

5. Long-Range Missile Launcher (1): The A-11 has a single cruise missile mounted on its back. When fired, it slides up and locks over the left shoulder, then launches. The missile is self guided and uses none of the pilots or robot's other bonuses. (Note: At the G.M.'s discretion, Marks could have led off his attack on the Federal Building with this weapon, making it unavailable to him for the adventure.)

Primary Purpose: Assault.

Secondary Purpose: Anti-Everything!

Damage: 4D6x10 with a 100 foot (30.5 m) damage radius.

Range: 500 miles (800 km).

Payload: One missile.

Rate of Fire: Single shot only (reloading takes 20 minutes and heavy equipment).

Bonus: The missile itself is +4 to strike and +2 to dodge with 2 attacks per melee round (no additional bonuses are gained from either the robot or the pilot). These attacks are for eluding intercept measures, such as point-defense gatling guns and anti-missile missiles.

Note: This weapon system has a very detailed, very current navigation system that allows the pilot to target fixed structures (buildings, roads, bridges, etc.) with ease. The A-11 can also uplink to orbiting satellites to locate moving targets such as ships or large command vehicles. If the G.M. decides to have Marks engage this feature, enterprising heroes might figure out where the A-11 is getting its information from and use the satellite's signal to track the robot, should it elude the heroes.

6. Medium-Range Missile Launcher: Located over the right shoulder, this weapon system is ideal for tank-busting, anti-aircraft use, or to soften fortified positions such as bunkers. The limited payload of missiles makes their use selective, but the standard fragmentation missiles allow each one to damage a significant area.

Primary Purpose: Anti-armor/Anti-vehicle.

Secondary Purpose: Assault.

Damage: 2D6x10 with an 80 foot (24.4 m) blast radius.

Range: 40 miles (64 km).

Payload: Two missiles.

Rate of Fire: Singly or both at once.

Bonus: +1 strike (in addition to above bonuses and those of the pilot).

7. Diablo Anti-Personnel Defense System: This unique and experimental system is a "panic weapon" designed to clear masses of troops or foot soldiers from the A-11's immediate vicinity should it become overwhelmed. When activated, the Diablo discharges an 8 foot (2.4 m) high plasma pulse, like a shock wave of heat energy, to a radius of 60 feet (18.3 m). This system still has a few bugs, however. Roll on the following table each time the Diablo is used:

The Courthouse and Federal Building

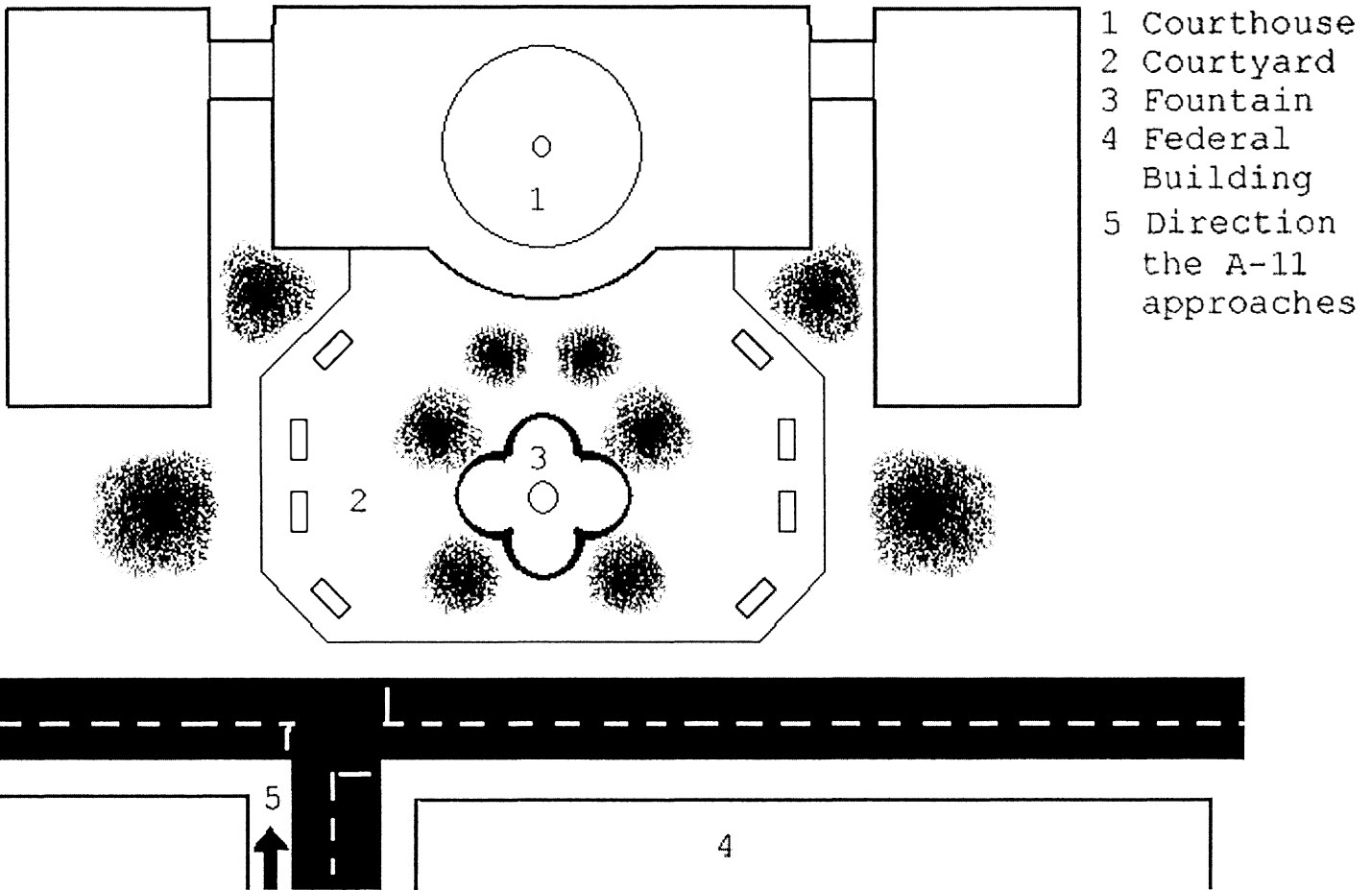

01-10%: Full damage, but half effect (30 foot/9.1 m radius).

11-20%: Full effect (60 foot/18.3 m radius), but half damage.

21-30%: The A-11 also takes damage from the Diablo.

31-70%: Full normal effect and damage.

71-75%: Half damage, but double effect (120 foot/36.6 m radius).

76-80%: Half effect, but double damage.

81-95%: Full damage, but fills a 60 foot (18.3 m) dome instead of a shockwave. The A-11 takes full damage from this attack.

96-00%: Critical failure! The Diablo fills a 100 foot (30.5 m) dome, at quadruple damage intensity, and cooks the A-11. Outside of the dome effect, a normal damage shock wave travels out for another 100 feet (30.5 m) in all directions. But, this outer shock wave travels slowly, and characters with a speed of 20 or higher can outrun it. Likewise, characters who can leap over the shock wave are +4 to dodge it. After a critical failure, the Diablo system is slagged and useless. Furthermore, if the Diablo system does suffer a critical failure, there is also a 10% chance that the A-11's self-destruct will activate as well. If this happens, the self-destruct can not be cut off in any way short of destroying the A-11.

Primary Purpose: Defense

Secondary Purpose: Anti-Personnel

Damage: 1D4x10 plus ignites combustibles and has a 30% chance of setting off secondary explosions in vehicles or weapon ammunition.

Range: 60 feet (18.3 m) radius from the robot.

Payload: Enough for nine uses.

Rate of Fire: Single shot (equal to the number of attacks of the pilot).

Bonus: None other than those of the pilot and robot, but victims are -4 to dodge the first discharge due to the surprise nature of the attack.

8. Melee Combat: The great size of the A-11 gives it supernatural strength and punching damage, but it is -8 to hit human sized targets with melee or unarmed attacks. When punching or slashing vehicles (except motorcycles which are attacked at -4), it does so with full normal bonuses of the pilot and robot (no penalties).

Restrained Punch: 2D4x10

Normal Punch: 2D4x10+75

Power Punch: 3D6x10+75 (uses 2 attacks)

Forearm Blades (Left Arm): 2D4x10+75

Giant Knuckle Spikes (both hands): 2D4x15+75 punching; 8D4 per hand launched as a volley of 4.

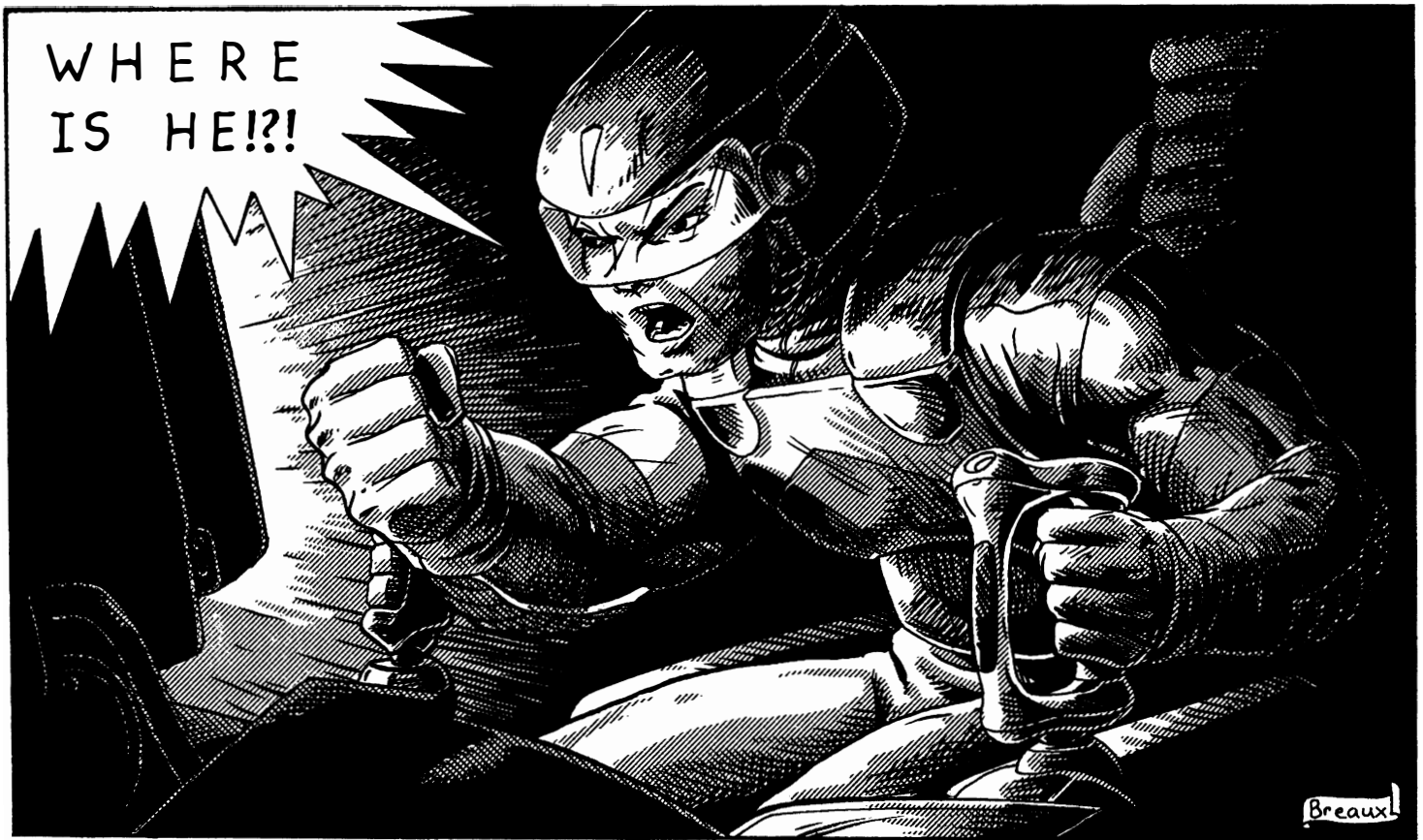

Bradley Marks

Military Robot Pilot

A promising Air Force test pilot before joining the A-11 testing program, when he accidentally learned that Senator Ramsey was embezzling from the project's appropriations. The naïve pilot confronted the Senator about it, prompting the politician to set about framing Marks for the lost funds. When he was arrested for crimes Ramsey committed, Marks became obsessed and blinded by rage and revenge. That's when Shock contacted him with a scheme to even the score. She offered to procure a robot for Marks to take his revenge with. He suggested the A-11 and provided Shock with classified data on when and where it would be transferred between bases. The rest, as they say, is history.

Marks has no idea he is being used as a diversion for Shock and the other criminals. All he knows is that he is to do what he can to flush out the Senator, then he can force him to confess or carry him off to interrogate further. Shock is supposed to meet him an hour after the assault, near a large river and arrange for the transport of the robot (they will strap it under a barge and push it down the river).

If things go badly during the attack, Marks will call Shock for support or help, but she will not respond. Eventually, the pilot will either fear the worst or figure a few things out and attempt to flee the scene and escape, with or without the robot. If the A-11 is defeated, Marks will first try to bluff his way out with his long-range missile. If that fails, he will abandon the robot and surrender or flee on foot if possible, but he will not continue to fight.

Alignment: Was Scrupulous but has since become Abarant with leanings toward good. He feels the law has failed and will go outside of it for justice. His obsession (insanity) is what has pushed him to take such extreme measures. With psychiatric attention he can probably be rehabilitated. As an honorable man who temporarily lost it, he will accept the punishment for his crimes.

Attributes: I.Q.: 10, M.E.: 12, M.A.: 15, P.S.: 16, P.P.: 19, P.E.: 14, P.B.: 13, Spd: 17

Height: 6 feet (1.8 m)

Weight: 188 lbs (84.6 kg)

Experience Level: 6th

Hit Points: 42

S.D.C.: 50

Disposition: For the time being, Marks is obsessed with revenge, which is seriously clouding his judgement, which is why, during the assault, he may kill cops and heroes if push comes to shove, and he will feel little remorse for any innocent civilians who get caught in the crossfire. Someone with a high M.A. might be able to reason with him if they can get a chance to communicate. Or, if someone thinks to get his old Commander on the radio or telephone in order to talk him down, that might also work.

Appearance: Marks is pretty much an average man. He has a short, military styled haircut and is very physically fit. He wears a red flight jumper equivalent to a driving suit (**HU2**, page 142) and a hard armor vest over that (A.R. 12; S.D.C.: 120). He also wears a fighter pilot flight helmet with his cosign, "Tin Woodsman" inscribed on it.

Combat: Hand to Hand: Expert.

Number of Attacks: 5

Bonuses: +2 on initiative, +4 to strike, +5 to parry, +5 to dodge, +1 damage, +2 to roll with punch, fall or impact, +2 to pull punch, and critical strike on 18-20.

Robot Combat Bonuses: Only applies inside a robot and includes the above attribute and level bonuses. These are added to the bonuses of the A-11 when he is piloting it and include the Weapon Systems bonus and any applicable weapon proficiencies (such as W.P. Heavy). Number of Attacks: 6, +3 on initiative, +4 to strike (hand to hand/melee), +6/+4 to strike with ranged weapons built into the robot (aimed/burst), +5 to parry, +5 to dodge, +2 to roll with punch, fall or impact, +3 to pull punch, and critical on 18-20.

Education Level and Skills: Basic Electronics (75%), Computer Operation (85%), Computer Programming (75%), Computer Repair (70%), Navigation (95%), Read Sensory Equipment (75%), Weapon Systems (85%), Pilot: Motorcycle (95%), Pilot: Race Car (85%), Pilot: Jet Fighter (75%), Pilot: Jet Packs (77%), Radio: Basic (90%), Radio: Scrambler (80%), T.V./Video (60%), and Cryptography (70%).

Weapons and Melee Combat: The only weapons Marks will have with him in the robot are those in the pilot's emergency kit: a .45 SOCOM pistol and a large survival knife. The gun has a 12 round clip and does 4D6 damage per round, while the knife does 1D6+1 damage.

The plot thickens. Once the robot is defeated, the player characters involved with the battle will quickly learn that the *Whitmore International Bank* was robbed while the showdown with the robot took place (though some of them may have stayed near or in the bank to try and stop Shock and her crew). The robot attack was a just big diversion!

Back in the bank, Shock and her fellow villains carried out their real plans, cleaning out the entire vault and the safe deposit boxes. Three of Shock's five accomplices can be identified from security camera stills as **Riproar**, **TerVal**, and **Dragonfire**, all known super-criminals in the Northeast (see their respective entries at the end of the adventure). The other two villains are relative unknowns and can not be immediately identified from the stills (research will have to be done for information on them). Descriptions of the robbers' powers will be readily available through the news media and eyewitnesses. Characters with the right access or contacts will discover that the two accomplices are **Point Blank** and **Electron**, a weapons and electronics team from Chicago.

If any of the player group stayed at the bank (and didn't just observe the robbery), they will have to deal with Shock and her group, but will be outnumbered and probably have to retreat. These brigands are here to grab specific items and get out. They won't waste time fighting or killing a few meddlesome heroes if they can avoid it. Likewise, if the heroes do engage the villains but are beaten, Shock's team will simply leave them battered and stunned while the crooks make good their escape.

The bank is very large and quite secure, requiring some time to rob, which is why Shock devised the A-11 diver-

sion. Characters or witnesses should notice that the robbers gather up the cash methodically, but do not seem interested in it. Most of them enter the vault for their true target, the safe deposit boxes. Interviewing the box holders (there are about 250 of them!) will turn up two items of interest that were stolen. The first was a *virus sample* stolen from a government lab two years ago (the box owner, a criminal currently doing 30 years in prison). The second was the plans for a *laser amplifying device*. Interviews with the renters of the two boxes can provide useful information (again, if the heroes have access to it). Failing that, the heroes might wish to get copies of the original interviews from the police investigators following the original robberies of these items.

The virus sample was stolen by terrorists who were arrested on other charges. The renter is one of their intermediaries who did not know what it was, but the authorities were able to identify one of the incarcerated terrorists by his description. If any of the terrorists are questioned, they will admit to planning on using it in Atlanta (The irony of deploying such a weapon in the city where the Center for Disease Control's Headquarters are located was too tempting for them to pass up). The sample is concentrated and can make a biological weapon potent enough to kill up to one million people before either the virus is neutralized or it mutates into a harmless variant of itself. The authorities will assume Shock plans to resort to her old habits of extortion using the viral sample, though true terrorism does not fit her existing profile.

Talking with the owner of the laser amplifier will be equally enlightening (no pun intended). The heroes will learn that it is not a laser amplifier, but an *energy amplifier*. Based on tests and observations, the device (with modifications) could be used to amplify organically generated energies like those expelled by some super abilities. If this is true, Shock could magnify her already impressive electrical powers to frightening levels. However, the inventor will also make it clear that some kind of bridge device would be needed for such applications. In its current configuration, the device only accepts and amplifies mechanically generated energy, such as those from energy weapons, electric generators, laser communication devices, etc. If player characters can not discover a bridge, the inventor will do his own research and inform them later that "super ability dampers" — devices that negate super abilities — could likely be reversed to act as a bridge with the right technological know-how. And where can one get a set of those dampers, one might ask? Well, among other places (such as superhuman prisons), S.C.R.E.T. is currently field testing a portable system. Just about any S.C.R.E.T. team in a major city will have one with them when going out into the field.

The next step will be to try and track down Shock or anticipate her next move. Some characters may assume she is going to Atlanta, but Shock's history and personality should rule out such terrorist actions (but blackmail is another story). Arranging a false or bait shipment of dampers could be a lure also, but Shock has her own plans (see Section Three).

Section Three: Germs for the Big Apple

As the player characters make their preparations to try and find or lure her out, Shock will interrupt the evening news. The screen flickers just as the familiar face of Channel 5's Lori Landry appears, "Good evening," she begins, "This ...," static replaces the image, then the costumed face of Shock fills the screen.

"This is a public service announcement." The villain smiles mirthlessly and tilts her head back a little, speaking clearly and calmly.

"I think it's only right that the public at large know that in eight hours, a deadly virus will be unleashed on New York City, capable of killing over one million people. Since there isn't enough time to evacuate and I won't say exactly where it will be released, all I can urge you to do is convince the city fathers to provide me with the 50 million dollars selling price I am asking for the viral sample. I think you'll agree this is very reasonable. Private donations are surely welcome. Delivery will be in Central Park. Eight hours from ...," she checks a pocket watch and nods, saying, "... now. Perhaps you can help. Call them now and urge them to comply."

G.M. Info for Section Three

Shock is once again using a diversion to get what she truly wants: the Dampers. The threat against the city is completely unfounded. She will not use the virus, but she will make use of the fact that the authorities don't know that and do know she has the deadly virus. Any money she may get out of threat is a bonus for her. **TerVal** is the only villain actually in the city at the time of the broadcast, just in case the authorities decide to pay the \$50 million (there is at least a 50/50 chance with the lives of millions at stake; probably more like a 65% chance. Can any high official, including the President, take the risk?).

Shock's announcement is part of a diversion to cause chaos in the city, surrounding boroughs, neighboring New Jersey (what about wind, contamination from somebody infected, etc.) and at the drop point (which should give TerVal the chance to make a clean getaway with the money).

If the ransom is delivered, TerVal will attempt to escape with it as a bonus for the group of villains. The virus will never be deployed, because Shock has already sold it! (The buyer is left entirely up to the G.M.) If TerVal is captured, he will not talk at first, believing that Shock will arrange his escape. When several days pass and that doesn't happen, he will inform the authorities of Shock's real plans to free her old gang from the penitentiary (Shock will already have the dampers by then). The same information can be gathered if any of Shock's people are captured along the way (but only one will squeal if a number of them are caught). Hardware or Special Training characters might be able to find out that Shock's broadcast originated from Texas and was beamed to the city via satellite, but the information will be of little use in stopping her acquisition of the dampers.

While the city is dealing with the threat and panic, Shock and her new crew are arranging a confrontation with S.C.R.E.T. in Dallas (or some other city far away from where the previous episodes of this adventure have taken place). She intends to draw out a squad of S.C.R.E.T. personnel from an armored vehicle and steal the dampers inside. To this end, Riproar will cause an incident and when the government operatives arrive to deal with him, they will be overwhelmed by the other members of Shock's team. Unless the player characters come up with some unforeseen method of learning Shock's plan, within a few hours of the viral threat, she will be successful and things will move on to Section Four. If the heroes should somehow stop the villains, Shock will be determined to get the dampers and flee. Defeating the heroes can, again, wait for another day.

Section Four: Jailhouse Rock

If the characters read Shock's profile and pieced things together, or if they get one of her captured flunkies to talk, they will know to be waiting for her at (or near) the S.C.R.E.T. Medium Security Superhuman Holding Facility where her old gang is incarcerated. Two weeks after hitting S.C.R.E.T. in Dallas, she and her cohorts will be ready to make their daring attempt to raid the facility. As the heroes (and perhaps police, prison personnel and/or even S.C.R.E.T. members) lie in wait to ambush Shock and her cronies, they will suddenly see a massive bolt of electrical energy blast the prison doors to pieces. Anyone inside the place will hear explosive impacts, then the clamor of alarms. The assault has begun.

G.M. Info for Section Four

Shock is wearing a power amplifier which has been crafted from the energy amplifiers stolen from the bank and reversed power dampers stolen from S.C.R.E.T. To add to the confusion, except for Shadow Dragon and Dragonclaw, the others are wearing identical looking devices.

The amplifiers look like thick, silvery bracelets. Each has a fail-safe in it (a localized explosion that destroys the device and inflicts 5D6 to everything in a 5 foot/1.5 m radius) that goes off when the units are removed without receiving a verbal code. Shock has not told anyone about the fail-safe. Moreover, the voice recognition chips in the amplifiers are set to Shock's voice alone. A key phrase in the pre-mission briefing was used to activate the fail-safe, and she plans to use a trigger phrase during their debriefing to disarm them.

If captured, Shock will insist that these are the only existing power amplifiers, but that is untrue. These are the only working models, but she has stashed the plans to her power amplifiers in a safe place known only to her. If Shock's scheme fails and she is apprehended, she will be sent to a maximum security S.C.R.E.T. facility for life, but if she escapes or is somehow released, the first thing she will do is build more amplifiers.

S.C.R.E.T. Superhuman Prison

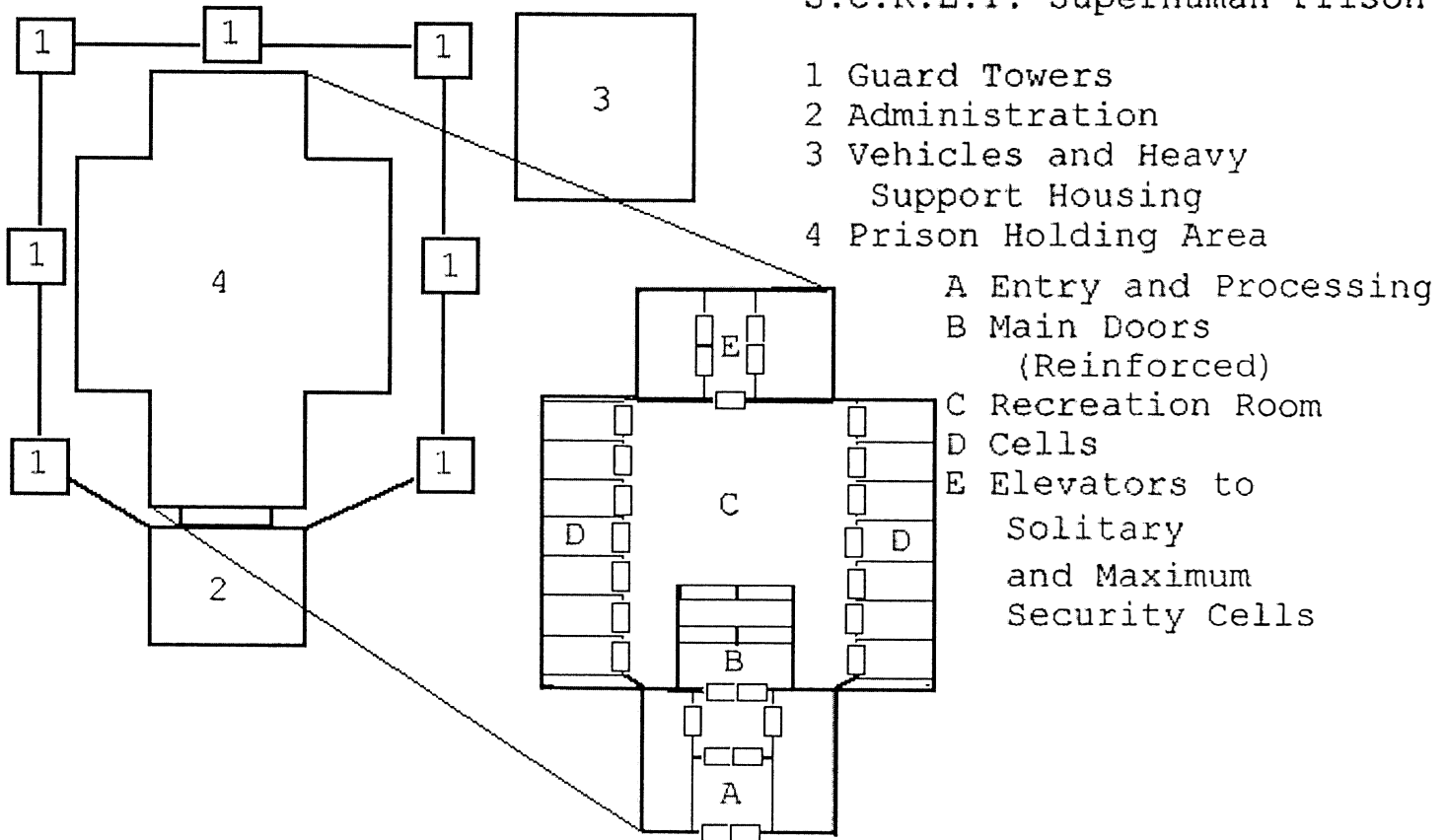

The Power Amplifiers

Basically, this device can either double the range or the damage of an energy-based attack. In the raid on the prison, Shock has them configured to inflict double damage. The system will not work on mechanical devices, i.e. the energy weapons of **Riproar**, **Electron**, and **Point Blank**. Likewise, the amplifiers will not work on **Shadow Dragon** (won't work with her magical sword nor augment her Bio-Ghost ability) or **Dragonclaw** (neither of his abilities are augmented via this mechanism). The amplifier can be set to double both range and damage, but it is painful, with each enhanced blast doing 1D6 damage direct to the attacker's Hit Points each time it is used this way. Doubling both effects on an energy weapon drains four times as many charges from the E-clip each time it is used (i.e., each shot counts as four and pulse lasers would use eight or more depending on the number of charges each pulse burst fires). Switching between the two types of amplification, range or damage takes two melee actions.

G.M. Note: So the big question now is, can Hardware characters build powerful devices such as amplifiers? Not without the plans or a working model, and the time and equipment to do so (takes hours if not days). However, there are problems that Shock doesn't know or (at this time) care about, but that any conscientious scientific study or personal experience, will reveal. The magnified energy drawn from the superbeing's body will, over time, hurt the body. One effect is that it makes the individual much more prone to getting a variety of life threatening cancers, but this will take at least one year of frequent use. Another is bio-feedback and strain on the physical

body: reduce P.B., P.E., and Hit Points by one point for every six month period in which the amplifiers are frequently worn and used. Ironically, the device also permanently damages the character's original super ability! Reduce range by 5% every six months, and one die of damage every twelve months. **Note:** These "defects" can not be corrected, so using the amplifiers is a death sentence. Plus, there may be other side effects and dangers that are yet unknown.

And no, a character can't make one and sell it legally for loads of money. Why do you think the plans were sitting in a safe deposit box? The government has classified the device as a deadly military weapon and civilians are prohibited by law from owning, selling, or manufacturing them. It turns out the plans in the safe deposit box were illegally copied by somebody on the project's design team who intended to sell them on the black market anyway. The government dropped the project as having too many lethal side effects and for the device having additional unpredictable "effects" on the user (whatever that means). In fact, if the heroes are accompanied by government agents or law enforcement officials during this final scene, and if Shock and her cronies are defeated, the power amplifier will be considered evidence, and must be turned over to Federal Agents. Once in government hands, it will disappear — either secured in a top secret research facility (to be used later to augment government-sponsored super heroes, perhaps?) or destroyed.

The Final Battle

Shock's old gang has been moved to the secure solitary confinement cells on the lower levels of the facility. If the authorities should risk moving them to another facility, Shock and her new gang will hit them then and easily free their comrades. In the latter scenario, Shock will again seek to claim what she came for and get away. To this end, she will leave behind members of her new gang, if necessary, as well as leaving heroes alive, etc. Once all this is over with, if Shock and any of her gang members escape, they will lay low for a while, living off of the money from the sale of the A-11, the cash from the bank, and possibly the 50 million from the viral scare, while planning their next string of profitable escapades. When they resurface, whatever their next scheme is, dealing with the player characters will be a high priority. Shock hates loose ends, and she hates heroes who meddle with her even more.

Shock has a large and skilled gang of supervillains with her, and the player characters aren't likely to be able to handle all of them unless you have a large group or they are very powerful (as usual). But don't forget there may also be a whole staff of armed S.C.R.E.T. agents and numerous other government authorities waiting to stop her too, and who will give our heroes a helping hand. Otherwise, divide and conquer, and double teaming the enemy is the groups' best chance of success.

G.M. Note: If the player group needs help, give it to them, but don't take the adventure's climax away from them in doing so. Have the authorities mount an effective counter-strike that separates Shock's gang into smaller groups and throw one of more manageable sized opponents at the player characters. If any rivalries exist or there are scores to settle, arrange for the villains involved to end up together and give the players the satisfaction of wrapping things up well. When I ran this adventure, Shock survived the raid and escaped with half of her new gang and most of her old gang, but the player characters did their share and captured some of the new crew members, which led to subsequent adventures and a grudge match with Shock in later adventures.

And when it all boils down, if the player characters are in danger of dying during this final battle, then save them if you have to. This is one adventure where you can logically do that. Military and government operatives can arrive at any moment to pull the group's tail out of the fire. Just make sure you give them the chance to handle it themselves first. The G.M. can also have other factions show up for the gala event, such as the *Super Human Observation and Control Knights (S.H.O.C.K.)* presented in **Aliens Unlimited™**. They would be interested in keeping the superhuman criminals off the streets and will have a personal stake in keeping Shock from defaming their chosen moniker, but that's just one suggestion for possible extensions of the adventure.

Likewise, if the player group is powerful and winning too easily, who knows what super-bad guys get accidentally (or deliberately) released from their jail cell to join the battle.

The Villains

Shock has assembled a new crew of villains to help liberate her old gang of true friends. Stats for her and her new associates are given below, but info on her old crime buddies has been left to the G.M.'s discretion. Whatever their powers are, they should be roughly equivalent (or perhaps a little tougher) than Shock's current flunkies, and they definitely shouldn't be tougher than Shock herself.

The G.M. may want to include some of the new (or old) crew members in adventures early in the campaign just to have the players cross paths with them and develop some kind of antagonism or rivalry. That way, when this adventure is run later, it will give the characters a greater feel for the adventure. They may even put Shock in a secondary position, despite her role as leader, to focus on their personal rivals within her crew. That would certainly be a nice twist on the adventure and it could save some characters' lives if they decide not to butt heads directly with Shock, who is a powerful villain even without the power amplifiers.

Shock

Shock is one of those villains that everyone seems to have heard of. She doesn't show up that often, but when she does, it's sure to be one heck of a show, for she is as flashy as her super abilities. She likes the attention her activities draw and tries to make the biggest impact she can, whether it is demonstrating her powers for an on-site news crew or leaving behind newsworthy destruction. Shock always leaves her calling card in one form or another — she likes to stop the clocks at whatever places she plans to rob or destroy ("You're out of time! Ha-ha!"). Usually she does so with just enough time for someone to get there before she hits it, but by the time someone notices and responds, it is usually too late. Shock is intelligent and her plots are often involved, but rarely is she a subtle woman. One case in point is the robot diversion in this adventure. Sure, she could have used a less dramatic diversion, but why settle just for what works when sensory overload is so much more *fun*?

Shock was a criminal mastermind on the West Coast until she overstepped her bounds and led an ill-fated coup to seize control from her bosses. Her real name is Helen Barnes, daughter of crime lord Arthur Barnes, and it was her father she tried to replace. She failed and they captured her. Unwilling to kill her outright, her father had her put her through one of their experimental mutation processes that was practically guaranteed to kill her. If she survived, the doctors would remember the doses to use on someone else and kill her while she was recovering. Unfortunately for her father, Helen lived and before anyone could finish her off, she rocketed through the wall as a bolt of lightning and escaped. Hiding for months, she eventually hunted down each of the men responsible for her torturous transformation, and killed them. Her father was too well protected and managed to escape her wrath. Taking the money of her dead enemies, she fled to Texas and over the years, made her way up the East Coast until



arriving in the northeast to gain strength and experience in New York and Chicago. From there, she ended up in a S.C.R.E.T. facility following a botched bank robbery. Not knowing her full power range, the government locked her up in a medium security containment facility for superhumans. There she bided her time, formulating the plans for her actions in this adventure. She escaped shortly thereafter and put her grand plan in motion, beginning with recruiting some new supervillains and arranging the A-11 theft.

In combat, Shock is cool and collected, though her energy and enthusiasm might be misread as rashness. She is an excellent tactician and exploits her high intelligence to its full extent. She is a demanding leader who will destroy any underling who disobeys or betrays her. However, Shock is rarely petty and nearly anything she does has an ulterior motive and will prove its importance at a later time. She has even been known to save or spare so-called "superheroes" for reasons known only to herself. Most believe she does so simply because the heroes represent a staunch enemy of one of Shock's rivals or because they represent a challenge. Of course, sometimes she does so to cause confusion or to trick and manipulate them.

Shock is not a terrorist, but she can and will use innocent people to hinder the capabilities of heroes and law enforcement personnel. One of her prime rules is to know one's enemies, and exploit their weaknesses. Most heroes put the welfare of others before themselves, and she exploits this frequently.

Shock

Real Name: Helen Barnes

Other Aliases: Lady Lightning and Bolt.

Alignment: Aberrant (with a strong sense of fair play and honor).

Attributes: I.Q.: 20, M.E.: 14, M.A.: 21, P.S.: 15, P.P.: 17, P.E.: 20, P.B.: 17, Spd: 9

Height: 5 feet, 9 inches (approx. 1.75 m)

Weight: 195 lbs (87.7 kg), mostly from increased mass.

Experience Level: 11th

Hit Points: 71

S.D.C.: 190

Disposition: Shock knows how powerful she is and when others do too, she uses it to her advantage to intimidate them. Not to say she is overconfident or conceited. Once she realizes someone is a threat to her, she will pay that person the proper respects and caution they deserve. Opponents who in turn do not show intelligence, respect, or wisdom in combat or toward her capabilities are viewed as fools and given little or no quarter. Worthy opponents rarely have to worry about being killed by Shock as she respects and honors their courage and abilities. She may leave them badly mangled and hospitalized for some time, but she will not kill them unless it is absolutely necessary.

Appearance: Beautiful, graceful, intelligent, and charming, Helen seems to have it all. It's just too bad she's a criminal mastermind. Her hair is a silvery white and her eyes are a strange electric blue that sparkle with en-

ergy (sometimes literally). Her Shock costume is black with yellow highlights and lightning bolt designs. The boots, gloves, and shoulders are plated in ceramic composites and used to parry attacks and for protection from clubbing.

Power Category: Experiment

Side Effects: Increased mass.

Major Super Abilities: Alter Physical Structure: Electricity, Energy Absorption, and Super Energy Expulsion (Electricity).

Minor Super Abilities: None

Natural Abilities: Impervious to electricity (including magical lightning bolts), heat, fire, and other forms of energy (except kinetic energy, of course); glow equal to a 500 watt bulb; -10% to climbing, acrobatics, or gymnastics.

Combat: Hand to Hand: Expert

Number of Attacks: 7

Bonuses: +5% to all skills, +2 on initiative, +4 to strike, +5 to parry and dodge, +2 to roll with punch, fall or impact, +4 to pull punch, +10 to damage (takes into account all bonuses), +2 disarm, +3 to save vs poison and magic, +10% to save vs coma, 65% to evoke trust or intimidation, knockout on 18-20, & critical on 18-20.

Education Level and Skills: Streetwise (98%), Pick Locks (98%), Find Contraband and Illegal Weapons (98%), Safecracking (98%), Computer Hacking (98%), Basic Electronics (98%), Computer Operations (98%), Computer Programming (98%), Computer Repair (98%), Business and Finance (98%), Law (general) (98%), Research (98%), Language: Russian (98%), Advanced Mathematics (98%), Chemistry (98%), Astrophysics (98%), Biology (98%), Chemistry: Analytical (98%), Pilot: Automobile (98%), W.P.: Knife, W.P.: Automatic Pistol, and W.P.: Sub-machinegun. Shock has also given up three skills to gain proficiency in each of her super abilities. This gives her the listed bonuses to hit with the ranged attacks of those abilities, plus an additional +1 at levels 3, 6, 9, and 11.

Weapons and Melee Combat: Because of her increased mass, Shock does +6 damage in hand to hand combat (+10 total). She is also skilled in paired weapons (all), body flip/throw, and a karate kick (2D4).

Note that if Shock finds herself against someone that is immune to electrical damage, she will use her attacks to topple buildings, blow the floor out from under them, etc., as well as physical attacks and available weapons. Note that during the raid on the prison, the following damages will be augmented by the amplifiers and doubled.

Quick roll damage for super abilities:

Super Energy Expulsion (normal): 1D6x10+20

Super Energy Expulsion (super-blast): 2D6x10+6

Mini-Lightning Bolt: 1D6x10+6

Lightning Bolt: 5D6+22

Electrical Ray: 1D6x10+22

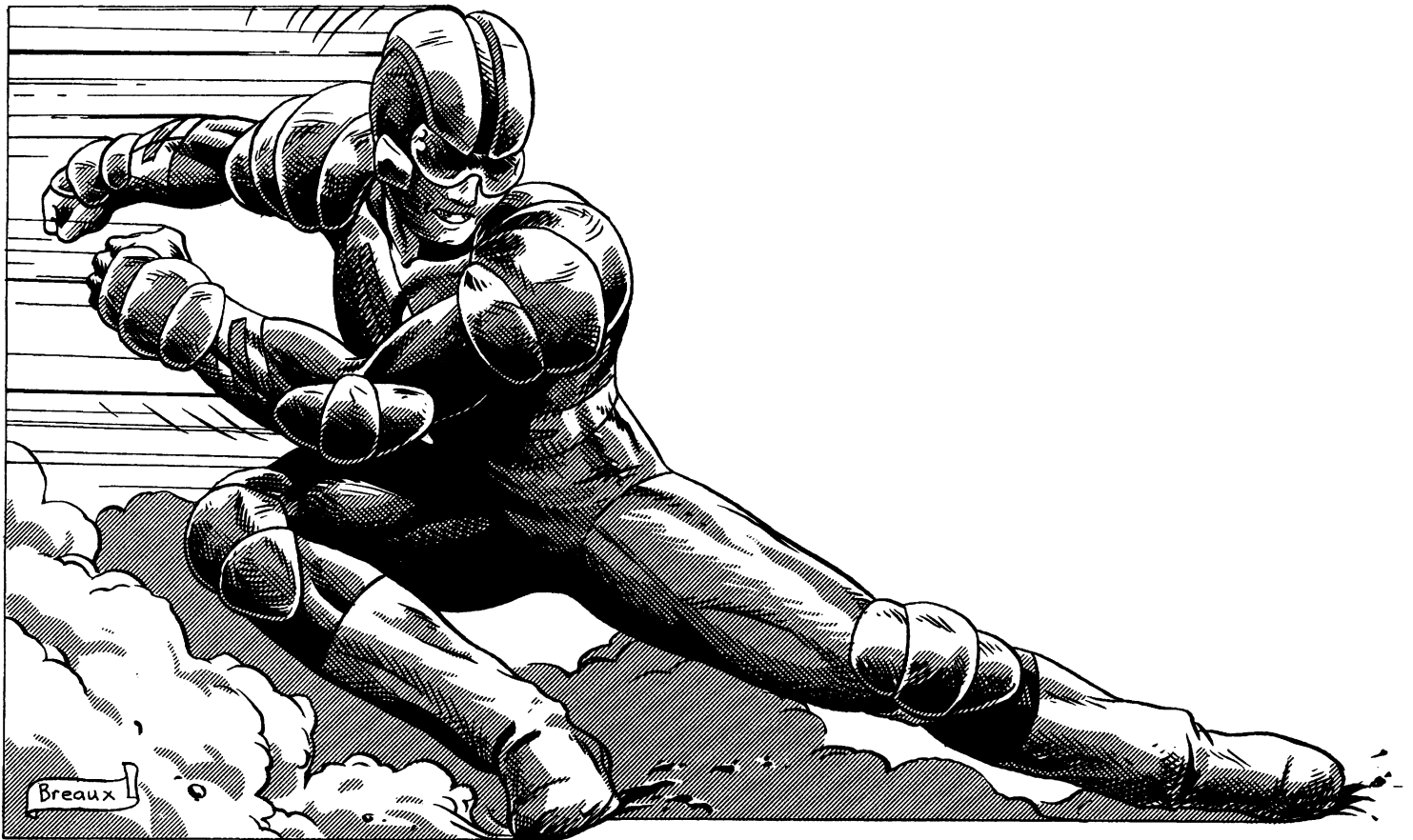

TerVal

Mitch Bourg was born different. His hair was a strange shade of blond that almost looked green, until he hit his teens and it turned a *definite* shade of that color. His mom colored it for him, but it was the least of his worries. He always had troubles with the other kids in school and the mutant abilities that manifested made him a perfect bully. By the time he was in high school, instead of making an easy name for himself in athletics and aiming for scholarships, he was acting as paid muscle for two-bit pushers on the edge of the school grounds. From there he moved into the bigger leagues and worked as a bodyguard and enforcer for some local drug dealers. When the ring collapsed as a result of the Feds coming from one direction and some vigilante heroes coming from the other, Mitch fell in with *Shadow Dragon*, doing assassinations and arm breaking. The two also interrupted a handful of drug deals and made off with the cash.

Mitch first met Shock when she appeared out of the blue and helped him escape a S.C.R.E.T. low-altitude pursuit vehicle, during a chase in Chicago. Shock shot the pursuit craft down with a few well-placed lightning bolts. Afterwards, Shock offered Mitch a chance to participate in her most recent undertaking. His powers can certainly be augmented, but the promise of money was more than enough to draw Mitch into the operation. He was also glad to suggest his former partner as another member, and *Shadow Dragon* was drawn into the scheme.

Mitch is as shortsighted as he is fast. He thinks only of the here and now and spends his money like water. Thus,

he is in constant need of more. Shock's plan is pure poetry to Mitch, who plans to get in good, make some quick piles of cash, and split with his power amplifier. Unfortunately for him, Shock has built fail-safes into the units and he won't get much out of them for long. Depending on when he decides to split, she may or may not kill him for it, provided he does not leave her in a lurch or in danger.

TerVal

Real Name: Mitch Bourg

Alignment: Miscreant

Attributes: I.Q.: 9, M.E.: 10, M.A.: 11, P.S.: 19, P.P.: 15, P.E.: 26, P.B.: 12, Spd: 17 (normally; see his speed power).

Height: 5 feet, 10 inches (approx. 1.8 m)

Weight: 200 lbs (90 kg) of muscle.

Experience Level: 5th

Hit Points: 100

S.D.C.: 180

Power Category: Mutant

Mutant Characteristics: Green hair

Major Super Abilities: None

Minor Super Abilities: Extraordinary Speed, Extraordinary P.E., Adhesion, and Power Channeling (the last is the one that can be amplified).

Natural Abilities: Run at up to 320 mph (512 kph); +4 damage for every 20 mph (32 kph) of speed; climbing skill at 90%; other aspects and abilities of each super ability are detailed in their respective entries.

Disposition: Greedy and willing to do what it takes to make himself comfortable, Mitch does everything as quickly as he can run and thus burns up money, friend-

ships, and alliances faster than he can run. He is constantly on the move and looking to replace money he has spent. He can be trusted if he will profit from an endeavor, but he can not be trusted for long.

Appearance: Mitch appears to be an average man except for his green hair (which is usually dyed another color) and the aura of shiftiness he projects. It's not that he looks untrustworthy (which he can be), he just appears to be always ready to move or do something. He prefers to hide his notable hair under a black cap worn backwards (although he could get away with posing as a punker) and drapes his athletic form in sweat pants and oversized shirts. His TerVal costume is close fitting to avoid snags at high speed, but bulky at the shoulders, elbows and wrists where thick pads protect him from the bruises from high speed collisions.

Combat: Hand to Hand: Martial Arts

Number of Attacks: 7

Bonuses: +6 on initiative, +2 to strike, +8 to parry, +11 to dodge, +11 to roll with punch, fall or impact, +5 to pull punch, +2 automatic dodge, +6 to save vs magic, +6 to save vs poison, +4 to damage, and pin/incapacitates on 18-20 (if declared).

Education Level and Skills: Streetwise (50%), Pick Locks (65%), Pick Pockets (60%), Safecracking (50%), Prowl (65%), Climbing (90%), Boxing, Wrestling, Acrobatics, Swimming (85%), W.P.: Automatic Pistol, W.P.: Sub-machinegun, W.P.: Automatic and Semi-Automatic Rifles, W.P.: Knife, W.P.: Blunt, and W.P.: Chain.

Weapons and Melee Combat: Knows all jump kicks, karate kick (2D4+4), roundhouse kick (3D6+4), wheel kick (2D6+4), crescent kick (2D4+6), and axe kick (2D6+4). He can also body block/tackle and crush/squeeze a pinned opponent (1D4 damage).

With power channeling, TerVal can do incredible damage with his bare hands. Remember that during the raid on the prison, he will have power amplifiers that will double the listed dice for damages below.

Body Tackle: 5D4+6

Head Butt: 3D6

Punching Damage: 6D6

Power Punch: 1D6x10

Kicking Damage: 7D6

Dragonclaw

Krizam Dekart is not native to Earth. He is an alien who crash landed within the last year or so, after his spacecraft developed troubles and was pulled down by Earth's gravity. On his homeworld, he was trained as a special forces combat specialist and worked as an assassin and bounty hunter across the space ways (he could also have been one of the aliens aboard the spacecraft that crashes during the "Planetfall" adventure; at the G.M.'s discretion). Since his arrival, he has managed to blend in with the human population and after a chance meeting with enforcers for a local crime lord, earned himself a place among the man's well-paid assassins.

Krizam had worked with the organization for some time when TerVal joined its ranks, but a perfectly timed Federal

probe alongside a simultaneous vigilante crusade against the criminal family caused it to collapse and left the two villains on their own. Their partnership was somewhat short-lived, but ended without antagonism. He does realize that TerVal is at heart a dishonorable person and the alien keeps a close eye on him because of it.

Krizam went back to killing people, but found the work to be less steady than full-time criminal employment and less rewarding (financially) than robbing banks. When TerVal showed up again accompanied by Shock, Krizam was glad to see someone with intelligence capable of making them plenty of money and joined up. He hopes to ride Shock's genius into a comfortable and secure life. His sees Shock not only as his future meal-ticket, but as the only one equal to himself. That means he will look out for her and keep an eye on the less trustworthy members of the group, including TerVal.

Dragonclaw prefers to attack and fight from hiding or take some other unfair advantage — surprise attack, weight of numbers, and all manner of treachery. To this end, he uses his multiple bodies to their best effect, often overwhelming opponents with multiple copies of himself or with his water abilities. Leaving drowned victims in the middle of dry land is a common trademark of his.

Dragonclaw

Real Name: Krizam Dekart

Other Aliases: Chris Deker, Wave, and Multitude.

Alignment: Aberrant

Attributes: I.Q.: 17, M.E.: 15, M.A.: 12, P.S.: 18, P.P.: 18, P.E.: 16, P.B.: 17, Spd: 24

Height: 7 feet (2.1 m)

Weight: 180 lbs (81 kg)

Experience Level: 6th

Hit Points: 40

S.D.C.: 90

Power Category: Alien

Alien Characteristics: Retractable claws, almond eyes, and pointy ears.

Original Homeworld Type: Twilight World.

Major Super Abilities: Multiple Beings and Alter Physical Structure: Water

Minor Super Abilities: None

Natural Abilities: Can create three exact duplicates of himself (same level and each capable of altering their physical structure to liquid and using the special abilities it confers). See Alter Physical Structure: Liquid for full details and abilities.

Disposition: Krizam is Aberrant, but very few people live up to his standards of what can be considered an equal. Shock is one of the few people who does. He has little consideration for those he sees as beneath him (which is just about everyone) and tends to spend time by himself, quite often literally. With so many beneath him, Krizam associates mostly with duplicates of himself, and is on the verge of developing multiple personalities because of it.

Appearance: Krizam is tall and thin with pale skin, large almond shaped eyes, clawed hands and pointy ears. He projects a creepy image not unlike some goblin or



other ghastly figure. Even more frightening is when he appears with his three duplicates — an inhuman squad bringing death. His Dragonclaw costume is black leather with a number of buckles and some chains for accents, though the latter are heavy gauge and can function as weapons (1D6 +P.S. bonus). His head is topped by a wild mane of black hair and he normally wears darkly tinted goggles to protect his sensitive eyes.

Combat: Hand to hand: An alien form of Martial Arts.

Number of Attacks: 6

Bonuses: +2 on initiative, +4 to strike, +5 to parry, +5 to dodge, +3 to roll with punch, fall or impact, +3 to pull punch, +2 disarm, critical on 18-20, and +3 damage.

Education Level and Skills: Boxing, Wrestling, Prowl (65%), Climbing (85%), W.P.: Automatic Pistol, W.P.: Knife, W.P.: Energy Pistol, W.P.: Blunt, W.P.: Staff, W.P.: Automatic Rifle, Pilot: Automobile (72%), First Aid (80%), Streetwise (44%).

Weapons and Melee Combat: Always carries at least one length of chain (1D6+2 damage), a metal pipe (2D6 damage), and two knives (1D6 damage). Knows all jump kicks, karate-style kick (2D4+4), roundhouse kick (3D6+4), wheel kick (2D6+4), crescent kick (2D4+6), and axe kick (2D6+4).

Special Equipment: Laser pulse pistol (2D6 damage or 6D6 triple pulse; all other stats identical to a standard laser pistol; will have an energy amplifier during the raid

on the prison) and a hover platform (see page 99 in **HU2** for stats). He also carries a backpack or satchel with extra clothes and costumes for his duplicates should he need to create them with little warning.

Riproar

Model Ninety-Nine was the product of a criminal organization's robotics research. It was designed to function as an enforcer, assassin, and bodyguard for important persons in the organization, but unknown to the criminals, there was a mole in their ranks, specifically within the software personnel of the robot project. When Model Ninety-Nine was activated, his corrupted programming sent him to execute the very people the robot should have protected. However, the mole had not put proper control programs in place and Model Ninety-Nine left to go about its own way, leaving the rival faction that got the robot to do their killing, without the weapon that so effectively put them into power.

After the robot had done its initial killing, it found itself able to think and, in a limited way, feel for itself. One of its protocols is the ability to learn and make subjective decisions. Using the skills it had been given, and disguised as a human, Model Ninety-Nine, calling himself *Mitchell Niles*, found a niche by working as hired muscle for various criminal organizations and certain wealthy individuals. His powerful robot body and precision techniques have

earned him a deserving reputation as an effective professional. Shock came across him many years ago when they shared the employ of a particularly successful crime lord for an outing or two. She looked him up when she escaped from the penitentiary and needed good reliable help to get her old gang out of a similar fix. Mitchell likes the idea of putting together the kind of strength Shock wants and using it effectively, so he joined up. Riproar is one of the few members of the new gang whose welfare Shock cares about.

Riproar

Real Name: Model Ninety-Nine

Other Aliases: Mitchell Sevrin Niles

Alignment: Miscreant

Attributes: I.Q.: 18, M.E.: 17, M.A.: 9, P.S.: 30, P.P.: 24, P.E.: 20, P.B.: 17, Spd: 88

Height: 6 feet, 2 inches (approx. 1.88 m).

Weight: 350 lbs (157.5 kg)

Experience Level: 8th

Armor Rating: 12 (robotic).

Hit Points: 40

S.D.C.: 500

Power Category: Robotics (Android).

Robotic Systems: Concealed micro-hover system (max speed: 100 mph/160 kph, max altitude: 1,000 feet/305 m), advanced audio system, wide band transmitter, sound analysis computer, advanced robot optic system, laser targeting system, combat computer, motion detector and warning system, artificial blood and cosmetic enhancements (realistic skin, real body hair, realistic eyes, and sculpted facial features).

Disposition: Mitchell has yet to develop true emotions, since killing people for a living tends to nip that kind of thing in the bud. But he has developed goals for himself, such as securing his own home (wherever or whatever that might be) and ensuring his place in society, should misfortune befall him. Both of those require money, so becoming as rich as possible has become his current driving purpose.

Appearance: Mitchell is perfectly tall and perfectly handsome. Only his advanced artificial enhancements, such as simulated breathing, blinking eyes and dilating pupils, keep him from appearing too perfect, though his sometimes inhuman smoothness of movement can give him away. Most people assume he is a very cold, calculating individual, especially those who know his line of work. Few would ever suspect that he is actually an android. His costume is simply a black mask, black turtleneck, matching jeans, and heavy boots.

Combat: Hand to Hand: Expert

Number of Attacks: 8

Bonuses: +4 on initiative, +8 to strike, +2 to strike with built-in weapons, +9 to parry, +9 to dodge, +5 to roll with punch, fall or impact, +8 to pull punch, +15 damage, critical 18-20, +2 disarm and immune to Horror Factor.

Education Level and Skills: Military Etiquette (98%), Climb (98%), W.P.: Pistol (all), W.P.: Rifle (all), W.P.: Knife.

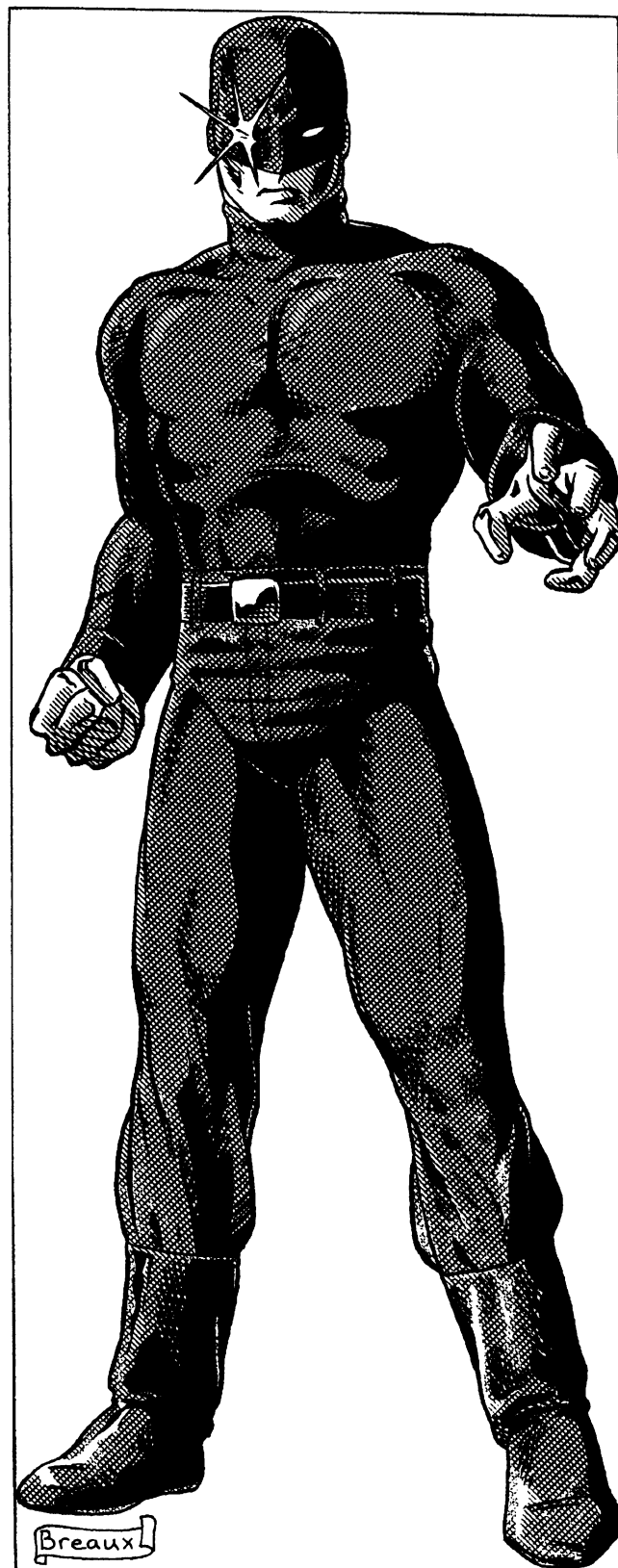

Weapons and Melee Combat: Knows paired weapons (all), all jump kicks, karate kick (2D4+4), roundhouse kick (3D6+4), wheel kick (2D6+4), crescent kick (2D4+6), and axe kick (2D6+4). Riproar also commonly carries a machine pistol (3D6 damage, fully automatic with 75 round clip), .44 magnum handgun (6D6, 7 round clip), and a sniping rifle (broken down in a case; 6D6 damage; 9 round clip; semi-automatic).

Robotic Weapon Systems: Electrical discharge (4D6 damage, +1 strike, 12 ft/3.6 m range), 2 eye lasers (2D6 damage each, +2 strike, 500 ft/152 m range), and 3 finger blasters (3D6 each; +1 strike, 200 ft/61 m range).

Electron

Carter Wells was always a natural with electronics, but his real exposure and training with the possibilities of electronic technologies came when he made it into the Green Berets as a communications and electronic warfare specialist. After gaining combat experience in the Middle East (including operations during Desert Storm), he joined the CIA for additional training, but it wasn't long before he surpassed even their expertise. Soon, Carter realized he could make much more money doing things his way than taking a salary, even the substantial one he earned from Uncle Sam. Resigning from the agency, he spent five years "disappearing." Using his knowledge of the organization and some of the electronic and computer security he had developed for them, Carter erased his existence even from those who make an art of tracking the untraceable.

During those years, he perfected some new gadgets and equipment and started robbing banks. With the modern electronic security systems nearly everyone uses, he was able to make quite a living, but quickly grew rich and bored. During his stint with the armed forces, he realized he loved action and challenges, so he made a career change and offered his skills as a mercenary for hire. By the time he actually met Point Blank, Carter knew of him by his reputation. The two teamed up to collect a bounty on a loan shark that had cheated his mob bosses. They made short work of the hired thugs he had for bodyguards and collected the bounty, but each had earned more than just the money. They worked so well together that the two became fast friends and partners. They have been building a reputation as bounty hunters, specializing in "difficult" and "superhuman" targets, ever since. Anyone with the streetwise or find contraband skills will know these two by reputation and recognize their costumed identities on sight.

Electron and Point Blank do not exchange their specialty equipment with each other, but they do share ideas and will help each other with design work. In addition, each provides the other with state-of-the-art equipment from his area of expertise.

Note: Treat any electronics the two might have as being +1% or +10%, whichever applies to effects, range, duration, or skill ratings. Any normal weapons the two carry will likewise be +1 to strike or parry and +10% to range.

Electron

Real Name: Carter Wells

Known Aliases: Zap and Charge (both from early in his mercenary career).

Alignment: Miscreant

Attributes: I.Q.: 21, M.E.: 15, M.A.: 9, P.S.: 14, P.P.: 14, P.E.: 13, P.B.: 15, Spd: 25

Height: 6 feet, one inch (approx. 1.83 m).

Weight: 180 lbs (81 kg)

Experience Level: 5th

Hit Points: 29

S.D.C.: 38

Power Category: Hardware: Electrical Genius

Disposition: Calm, cool and collected. Although Point Blank is far from stupid, Carter is still the brains of their operation. He excels at tactics and quick thinking and Point Blank lets him bear the majority of such decisions. Carter knows the strengths and weaknesses of himself and Point Blank and will use them to the duo's best advantage, but he will also get the two of them out of any situation that they can not handle. Carter would leave Point Blank if he had to, but only so that he could return later to free him.

Appearance: Tall and thin, Carter has pale blond hair and green eyes. He is rather handsome, but tends to get along better with his equipment than most people. His Electron battle armor is a set of stylized riot armor with full face mask and filters that is packed with electronic gadgets. The armor is black, like Point Blank's, and has a single blue line down the left side.

Combat: Hand to Hand: Basic

Number of Attacks: 5

Bonuses: +4 on initiative, +2 to strike, +3 to parry, +3 to dodge, +3 to roll with punch, fall or impact, +2 to pull punch, and +6 vs Horror Factor.

Education Level and Skills: Includes I.Q. bonus. Hot Wiring (101%), Computer Hacking (93%), Electronics Construction (99%), Evaluate and Diagnose Electrical Systems (77%), Electrical Engineer (87%), Read Sensory Equipment (77%), Surveillance Systems (77%), Optic Systems (77%), Computer Operation (97%), Computer Programming (77%), Radio: Basic (92%), Basic Mechanics (77%), Mathematics: Advanced (92%), Business and Finance (93%), Law (82%), Research (98%), Radio: Scrambler (92%), TV/Video (78%), Cryptography (82%), Locksmith (87%), Prowl (82%), Climbing (97%), Wilderness Survival (62%), W.P. Automatic Pistol, W.P. Automatic Rifle, W.P. Knife, First Aid (72%), Athletics, Body Building, Running, Swimming (77%).

Weapons and Melee Combat: Most of the weapons and equipment Electron carries are specialized and detailed below. He also can karate kick (2D4) and snap kick (1D6).

In addition to special weapons and equipment, Electron regularly carries two Colt .45 General Officer's pistols (4D6), a MAC-10 SMG (4D6), and two combat knives (1D8 or 2D4 each). His regular combat armor is a suit of Riot Armor (A.R.: 14, S.D.C.: 180) loaded with sensors and optics.

Special Weapons and Equipment: Has at least one of each of the items in the Some Electronic Gimmicks section on page 125 of **Heroes Unlimited, 2nd Edition**. He also has on hand or easy access to any standard electronic equipment, sensors, or bugs. Most will be miniaturized and easily carried or built into his armor.

Special Combat Armor: A.R. 16, 200 S.D.C.

Special Sensor & Optic Systems built in the Armor: Thermo-imager and nightsights, motion sensors (+1 parry and dodge, +2 initiative), bug detector, chemical detector (normally calibrated to detect explosives; range: 12 feet/3.2 m), radio receiver and transmitter (range: 5 miles), and a simple radar (Range: 30 feet/9.15m; detects general shapes only; +1 initiative and dodge).

Electrical field: Electron's armor is wired to discharge an electrical field. It extends up to six feet (1.8 m) around him and is used as a defensive barrier to dissuade others from grappling with him.

Damage: 2D6 per action to opponents in physical contact with Electron's body and 1D6 damage per action to those within the energy field but not touching him. Anyone entering or remaining within the field takes damage (no dodge except when it is initially activated). The batteries that sustain the field can run for a total of three minutes before needing to be recharged. Five minutes are needed to recharge. The field can be deactivated and reactivated to conserve batteries.

Discharge Gauntlets: The gloves of his armor are designed to provide a powerful electric discharge when they hit in melee combat (normal dodges and parries apply).

Damage: Adds 2D6 to punching damage. Charges: Each glove has batteries good for 10 successful discharges/actual hits.

Variable Configuration Stun Blaster: This oversized handgun is roughly the size of a sub-machinegun, resembling the 9 mm M-950 Calico in appearance. But it is not a firearm. Instead, it fires an electrical blast. Changing configurations is done by the flip of a switch and does not require an action/attack.

Configuration 1: Identical to a stun gun (described elsewhere in this book). Range: 100 feet (30 m), Rate of Fire: Equal to the number of attacks of the user.

Configuration 2: Identical to the stun gun, but more powerful (save at -4, but half duration). Range: 75 feet (30 m), Rate of Fire: Equal to the number of attacks of the user.

Configuration 3: Fires a small bolt of electricity. Damage: 3D6, Range: 120 feet (30 m), Rate of Fire: Equal to the number of attacks of the user.

Configuration 4: Fires a larger bolt of electricity. Damage: 6D6, Range: 200 feet (60 m), Rate of Fire: Three times per round maximum.

Energy clip: The oversized energy clip has separate capacitors for each configuration and holds 30 charges for configuration one, 20 each for configuration two and three, and 9 for configuration 4. Electron only carries one spare clip and it takes two actions to change an empty clip.

Lightning Grenades: Work just like explosive grenades, but discharge a powerful electric field instead of exploding. Damage: 1D4x10 to a 6 foot (1.8 m) radius and 4D6 to an additional 12 foot (3.6 m) radius. Range: 120 feet (36.6 m) thrown. Payload: Electron usually carries four of these grenades.

Point Blank

Marrin Cortez was always a bad seed. He grew up in a small village in the impoverished countryside of Brazil. When he was young, his family was killed by soldiers during a government crackdown on suspected dissidents. Only a few years into his teens, he sought out the radical elements the soldiers were looking for and joined them as a soldier. His uncanny marksmanship quickly earned him a position as a sniper, which in turn, gave him a reputation as a long-range killer. When the government finally decimated his fellow guerilla soldiers, Marrin escaped by virtue of his distant sniper position. Finally old enough to realize he would probably never succeed in defeating the entire government, he settled for the hundreds of kills he had made against the army as due vengeance and moved on with his life.

Marrin left Brazil and found profitable mercenary work with the drug cartels in Colombia where he mastered numerous other weapons and earned enough money to build and design his own. He developed a penchant for blades and handguns by necessity (assassinations for the cartel weren't always as simple as shooting someone from a mile away), but found he had a natural affinity for them and nearly any weapon he set himself to working with. Over the next few years, he developed a wide array of weapons and combat techniques, but he also came to tire of living as a soldier and taking orders from bosses. Since he was now looking for new opportunities, he decided America was the place to go. Where else but the land of opportunity could a mercenary hit man find his dreams?

He worked for several years as a mercenary, bounty hunter, and assassin in the West and South, before making his way to the Northeast, where he would meet Electron. The two had an immediate chemistry that neither could significantly explain, but after being so long on his own, Point Blank finds Electron the closest thing he has to a brother and will do whatever he can to help him out and keep him alive. Though Marrin is still a master sniper and has a customized rifle specifically for that, he prefers to work up close with Electron whenever possible. Any mercenary, weapons expert, secret operative, street-skilled hero or law enforcement officer will know Marrin Cortez, a.k.a. Point Blank, by reputation, and most will also recognize his battle armor on sight.

Point Blank and Electron do not exchange their specialty equipment with each other, but they do share ideas and will help each other with design work. In addition, each provides the other with state-of-the-art equipment from his area of expertise. Treat any electronics the two might have as being +1 or +10%, whichever applies to effects, range, duration, or skill ratings. Any normal weapons the two carry will likewise be +1 to strike or parry and +10% to range.

Point Blank

Real Name: Marrin Cortez

Alignment: Miscreant

Attributes: I.Q.: 10, M.E.: 17, M.A.: 8, P.S.: 20, P.P.: 24, P.E.: 18, P.B.: 12, Spd: 24



Size: 5 feet, 8 inches (approx. 1.73 m).

Weight: 182 lbs (82 kg)

Experience Level: 5th

Hit Points: 40

S.D.C.: 59

Power Category: Hardware: Weapons Expert.

Special Abilities: Horror Factor: 10 to those who know his reputation; +1 attack with any firearm or energy weapon, all Weapons Genius Special Skills (Make & Modify Weapons, Gunfighter Paired Weapons, Quick-Draw Initiative, W.P. Sharpshooting).

Disposition: Cold and heartless, Marrin shows about as much emotion as any of his cold, steel weapons. Heroes should expect no mercy or warning from this man. He defines the term "professional killer." The only person he really cares about is Electron, whom he will fight for to protect. If Electron is seriously injured, paralyzed or killed, Point Blank will seek bloody revenge.

Appearance: Short, gruff, and dark. He has black hair, matching eyes and Hispanic features. He normally wears a thick moustache and dark glasses. His Point Blank "work clothes" are an intimidating set of black body armor packed with weaponry. A single blue stripe runs down the right side of the armor.

Combat: Hand to Hand: Martial Arts

Number of Attacks: 6

Bonuses: +2 on initiative (+6 initiative when using firearms or energy weapons; other initiative bonuses are given on page 133 of **HU2**), +7 to strike, +10 to parry, +10 to dodge, +6 to roll with punch, fall or impact, +3 to pull punch, +5 damage, +2 vs poison, +2 vs magic, +3 vs Horror Factor, and +3 disarm.

Education Level and Skills: Make and Modify Weapons (94%), Recognize Weapon Quality (50%), Sniper, W.P.: Revolver, W.P.: Auto Pistol, W.P.: Automatic Rifle, W.P.: Bolt-Action Rifle, W.P.: Energy Rifle, W.P.: Sub-machinegun, W.P.: Knife, W.P. Sword, Demolitions (98%), Demolitions Disposal (98%), Find Contraband (66%), Basic Electronics (65%), Basic Mechanics (75%), Acrobatics, Boxing, Climbing (98%), Prowl (78%), Language: Spanish (75%), Wilderness Survival (65%), Streetwise (40%), Hunting, Tracking (50%), Land Navigation (56%), W.P.: Chain, Radio: Basic (70%), Pilot: Motorcycle (80%), Pilot: Airplane (70%), W.P.: Blunt, W.P.: Paired - Knives.

Weapons and Melee Combat: All jump kicks, karate kick (2D4), roundhouse kick (3D6), snap kick (1D6), crescent kick (2D4), axe kick (2D6) and tripping leg hook (no parry) kicks. When punching, Point Blank will automatically knock out opponents on a roll of a natural 20.

Special Weapons and Equipment: Point Blank has access to nearly any kind of conventional handguns, firearms and weapon accessories, listed on pages 134 to 136 of **HU2** or found in the **Compendium of Contemporary Weapons** (a tremendous sourcebook). Exotic or unusual items might require 1D4 days for him to track down or build.

Special Armor: His usual combat armor is a suit of black hard armor (A.R. 14, S.D.C.: 260). The armor has the same electric discharge system as Electron's armor,

plus a belt-fed 9 mm sub-machinegun on the right forearm (4D6 damage; Range: 200 feet/61 m); Rate: fully automatic; Payload: 900 rounds of armor piercing ammo stored in a specially designed backpack-style ammo canister) and a retractable short sword of exceptional quality on the left forearm (2D6+4 damage, +1 strike, +2 parry in addition to other bonuses).

Customized .50 caliber sniper rifle: The ultimate in long-range, fast-kill equipment, Point Blank has enhanced a Barrett M-82 .50 caliber sniping rifle for taking care of enemies at a maximum distance. Plus, he also has modified the gun to handle depleted uranium core (DUC) rounds, which he uses exclusively when sniping. Damage: 1D6x10 normal rounds, 2D6x10 DUC rounds; Range: 4,000 feet (1220 m/1.2 km); Rate of Fire: Single Shot; Payload: 5 rounds; Bonuses: +4 strike (in addition to other bonuses) from special optics, balancing and shock absorbers. **Note:** A special internal suppressor makes this weapon silent and without a muzzle flash, making it the ultimate sniper's weapon. This weapon can be disassembled in just a minute, with all of the pieces fitting into a large briefcase.

Personal sidearms: Point Blank carries two pairs of personal sidearms. One pair is maximized for use against soft targets, while the others are customized machine-pistols geared toward general combat and armored targets.

Soft target pistols: These pistols fire glaser rounds (like miniature shotgun shells) that inflict extreme damage against unarmored targets, but very little to things harder than bone. Damage: 8D6 to unarmored targets, 1D6 to armored targets or most inanimate objects stronger than glass or light wood; Range: 90 feet (27.5 m); Rate: Semi-automatic (see modern weapons combat); Payload: 17 rounds, Bonuses: +2 strike (in addition to other bonuses).

Combat pistols: 4D6+4 (fires 9 mm armor piercing ammunition); Range: 390 feet (119 m); Rate: Fires in short bursts only (see modern weapons combat); Payload: 36 rounds; Bonuses: +2 strike (in addition to other bonuses).

Serrated whip: Point Blank carries a variety of exceptional quality bladed and blunt weapons (all +1 to strike, +2 parry, and +2 damage), but one unique weapon he favors is a finely segmented metal whip. With the flick of a button, razor-sharp barbs pop out along its length to add to its damage potential. The hilt has a motorized retractor that enables the whip to rapidly recoil into it. If the whip is coiled about someone (a successful roll to strike of 18+), then retracted, damage is doubled (uses one attack). Damage: 2D6+4 normal or 4D6+4 with barbs extended. Range: 12 feet (3.7 m).

Gimmick Weapons: In addition, at any given time Point Blank *may* be carrying some or all of the following gimmick weapons: 2D6 explosive pellets; 2D6 flash powders; a sawed-off shotgun with 2D6 phosphorus and 3D6 flechette rounds, spike tube variation; 2 explosive wrist blasters; and a mini-flamethrower (For stats on these weapons, see pages 134 through 136 of **HU2**).



Shadow Dragon

Nimiko Kusami was born in the Shinto province of Japan to a family that has, for centuries, produced some of the most highly skilled assassins in the world. Over time, Kusami's ancestors served (and killed) untold dozens of Shoguns, Emperors and Warlords. Even today the family maintains its bloody trade, but now its patrons are corporations, diplomats, and criminal organizations.

Nimiko was raised through childhood and into her teen years with great discipline, schooling, and constant physical training. By the time she reached puberty, she was a skilled, though unpracticed, seductress who knew how to kill by dozens of techniques. She was trained in anatomy, literature, mathematics, athletics, and combat. By the time she was 21, she was a licensed nurse and had a secure position among her family as a dependable operative. Infiltration and subtle assassination are the traditional roles of the clan's women and Nimiko performed them dutifully whenever and wherever the clan contracted her to.

It was during one mission into the ex-Soviet Union that her life and destiny changed. She spent a month getting into the good graces of a wealthy business tycoon who happened to have offended his comrades in the Russian mafia. Throughout the mission, she regularly felt that something was not right and suspected that someone was helping her, but there wasn't supposed to be a contact on the inside for this job. She requested a mission abortion from the clan, but was denied and proceeded. On the night the tycoon was to be killed, she waited for him to fall asleep and prepared to drip some paralytic poison into his mouth so he would be incapacitated while she did some very specific things to him as stipulated by the contract. But the liquid landed on something unseen before hitting his lips, and he opened his eyes. Whipping the covers up and dodging for her life, she barely avoided a flashing sword blade that seemed to appear out of thin air and into the man's thick hand. When the severed bed sheet fell away, the man stood attired in heavy, medieval Russian chain mail, holding a glowing (rune) sword.

Nimiko crouched defensively, naked and armed only with a dagger she had retrieved from under the bed. She avoided his next few attacks, but was doomed unless something miraculous happened. Then it did. As the tycoon lunged for his next attack, his armor disappeared and he faltered, bewildered. Nimiko attacked and removed three of his fingers, forcing him to drop the sword. But as she closed in for the kill, the same unseen force sprung up to block her. The man looked relieved, but at the same time bewildered.

"Why are you doing this!?" he asked loudly. Except that he was not talking to her, but to the sword on the carpet. Nimiko had little time to consider the situation, for guards would be coming soon. Then things got even stranger when the sword spoke to her.

"To kill him, you must use me," it said. With little time to hesitate and fearing her clan would hunt her down should she fail her mission, she gripped the sword and cut the bewildered tycoon down.

When the guards burst in, she killed them too, but the whole incident was a blur to be sorted out later. She had eliminated her target, but not as contracted. Her clan would not kill her for such a failure, but they demanded penance. Invoking an ancient tradition, she chose to “quest” for her destiny, which would be determined in large part by the magical blade she now possessed. None of her clan would know what she had become, and between her and the sword, many lives would be lost to her “destiny.”

Now, Nimiko and her weapon have become one spirit. When not accessing the weapon’s power, she is merely Nimiko Kusami. When she invokes her sword’s terrible power, she becomes Shadow Dragon, The Silent Darkness, The Whisper of Death.

Shadow Dragon

Real name: Nimiko Kusami

Alignment: Aberrant

Attributes: I.Q.: 18, M.E.: 17, M.A.: 17, P.S.: 10, P.P.: 18, P.E.: 15, P.B.: 17 (20 when transformed), Spd: 21

Height: 5 feet, 3 inches (approx. 1.6 m).

Weight: 120 lbs (54 kg)

Experience Level: 5th

Hit Points: 38

S.D.C.: 100

Power Category: Enchanted Weapon.

Magic Weapon Powers: As a fabled rune sword and a Weapon of Chaos, Nimiko’s weapon inflicts 6D6 damage and covers the wielder with a suit of chain mail armor (A.R. 14, S.D.C.: 55) upon command. The weapon’s other “magic” abilities include: Power of Darkness, Cloud of Smoke, Portal of Fear, Power Bolt (5D6), and a Damage Bonus of +6 to all attack modes while it is in its wielder’s possession (i.e. +6 to punch, kick damage).

The sword can also extend from its hilt a length of chain with a hook that can entangle targets. Stats for the chain are identical to those for the tentacles of the Portal of Fear, including rules for targets breaking free of them. If broken, the chain does not immediately reform (takes an action for another chain to extend). The chain’s activation takes one of Nimiko’s attacks, but thereafter it attacks on its own. All the chain does is restrain people, though it does 1D6 damage each round the victim is entangled.

Nimiko has yet to discover the nature of the invisible force that had a hand in thwarting her assassination of the tycoon.

Major Super Abilities: Bio-Ghost (maximum super-charged bonuses to be used when she expects combat): +10 P.S.; +50 Spd; +50 S.D.C.; +10 to save vs poison; heal up to 1D4x10 lost H.P./S.D.C.; +2 initiative; and +2 melee attacks. This is another of the *sword’s powers*, and it provided the invisible force that had a hand in thwarting Nimiko’s assassination of the Russian tycoon. Now that Nimiko has bonded with this magic item, it has turned her into a life force vampire, and using this ability is the only way she can feed and heal herself.

Minor Super Abilities: Nimiko also has the Nightstalking super ability, and the special combination of her martial arts training and the mystical influence of the sword.

Disposition: Raised within the strict honor code of her family, she is not indiscriminately evil, but since being transformed into a life force vampire by the Chaos Sword, she sees people as food and gives them the consideration one would a cow or other food animal. The family tradition of honoring contracts also makes her written word and most verbal agreements binding. She is currently making her own way in the world, but knows that the sword needs her to complete some as yet undisclosed goal. She also realizes how the sword betrayed its former owner, so Nimiko constantly monitors her weapon for signs of dishonor or treachery. If it looks like it will turn on her, she will do all she can to rid herself of it.

Appearance: Nimiko is short, shapely and exotically beautiful, with black hair, lithe movements and alluring mannerisms. She is also as deadly as any assassin can be, with a heart as cold as the unnatural ice blue of her eyes. When she transforms into Shadow Dragon, she gains little in physical stature, but an aura drifts from her that both attracts and intimidates, as if revealing her true nature as part of her beauty. Her transformed self is clad in black chain mail.

Magic: None other than the abilities of the enchanted weapon itself.

Combat: Hand to Hand: Assassin.

Number of Attacks: 6

Bonuses: +3 to all skills, +2 on initiative, +3 to strike, +4 strike with sword, +4 to parry, +5 parry with sword, +3 to dodge, +3 to roll with punch, fall or impact, +3 to pull punch, +4 to damage, +2 to save vs magic and +4 vs Horror Factor.

Education Level and Skills: Dancing (70%), Singing (75%), Play Musical Instrument: (75%), W.P.: Paired (Swords), W.P.: Sword, W.P.: Knife, W.P.: Chain, Business and Finance (75%), Computer Operation (75%), Biology (70%), Paramedic (80%), Holistic Medicine (mainly for poisons) (45%), Prowl (50%), Running, Climbing (65%), Pick Locks (55%), Language: English (98%), Language: Japanese (98%), Language: Chinese (75%), Seduction (38%), Concealment (40%).

Weapons and Melee Combat: Karate kick (2D4)

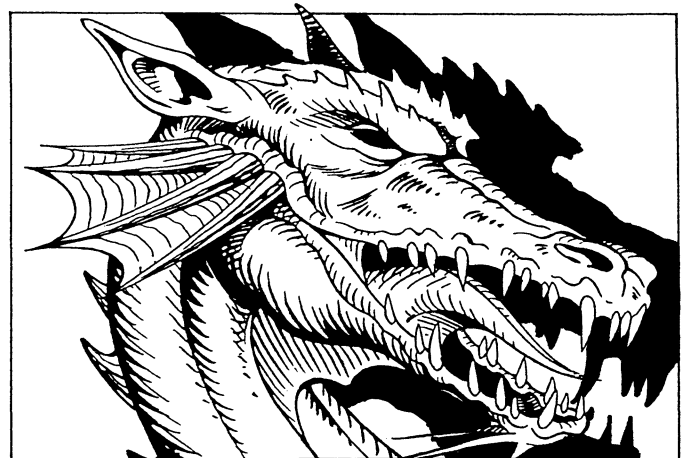

STAR BRIGHT

A major supervillain hires minor villains to steal a number of seemingly unrelated and insignificant electronic parts, systems, and computers. Unrelated, that is, until he goes after a set of government satellite codes. Can the player heroes stop him from gaining control of an orbital weapon capable of holding the entire U.S. hostage?

Section One: Bits and Pieces

Through their various connections, hotlines, and other sources of breaking news, the player characters learn of a rash of break-ins and thefts at a variety of electronics stores and wholesalers. The number of similar thefts might interest them, especially those of the Hardware Power Categories or others with technical backgrounds in electronics or computers. A little investigating will reveal what was actually stolen has limited application and minimal value; barely warranting a charge of grand theft. Waiting for more clues is all that can be done.

G.M. Information for Section One

The robberies were all committed by small-time street thugs and crooks. Anyone with enough street savvy (i.e., a successful Streetwise or Find Contraband skill roll) can dig up the names of the perpetrators and a list of what they stole. Getting the punks to talk is only a bit harder. If the heroes can do that, they will learn that the punks were hired by a “powerful dude” dressed like a superhero, with a cape and a helmet that hid his face. His whole outfit made him kind of “creepy-looking.”

The description will only ring bells for the characters if they are older heroes or make a habit of keeping up on the entire villain community, even the retired and incarcerated ones. Having the Intelligence skill is reason enough to assume such habits.

The man described is **Doctor Fright**, a villain who was powerful and infamous for more than three decades, but about five years ago, he was finally captured by a superhero group (The characters? Their parents? A mentor? An ally?). Tried and convicted in a state with capital punishment, Dr. Fright was executed about a year ago!

Who then is this person the thugs are describing? Is it really Dr. Fright, back from the grave? Or could it be someone trying to steal the infamous name and image? Certainly hiring two-bit thugs to knock over electronics stores isn't the way to go about the process of living up to such a heavyweight criminal legacy.

The only other real clue the thugs can give up is that the man said he was fitting the “talent to the task” by hiring them. A little research (unless one of the group members has faced Dr. Fright before) will turn up the fact that the real Dr. Fright sometimes used that line when he prepared to unleash his full fury on an opponent. It would seem that the thugs' story holds more water than previously thought.

Looking into the possible uses of the stolen components is a little more useful, but not much more enlightening. Someone with hardware skills can figure whoever engineered these thefts either has a real weakness for a wireless lifestyle or plans to build some kind of transmitter, radio, or receiver. What the thing might transmit or receive, however, is anyone's guess.

Section Two: Bigger Guns

A week after the electronics thefts, a special news report interrupts regular television programming across the city.

“Good afternoon, this is Lori Landry in the Channel 5 newsroom. Robert Carrel is live at the scene of the city's latest super-menace incident. Robert?” A Channel 5 “Live on the Scene” logo appears behind Lori and zooms to fill the screen as an image of Robert standing in the middle of a street replaces the image.

“Lori, this reflective tower you see behind me is the corporate headquarters for Fugita Technologies.” He turns slightly and points off to the tower where several dark openings can be seen in the reflective glass face of the building. Wisps of black smoke waft from the openings.

“As you can see,” he says as the camera shot focuses on the broken windows, “there is some kind of violent incident going on up there. Several minutes ago, two security guards were thrown from the ninth floor, apparently by the supervillain Rattle, a known criminal involved in an armored car heist last year and later apprehended by S.C.R.E.T.”

A grainy video clip zooms in on the broken windows of the Fugita building, showing the fuzzy image of what looks very much like Rattle, especially when compared to a much clearer image that slides up on the other half of the screen.

“Robert, is Rattle acting alone?” Lori asks.

“As far as we have been able to verify, Lori, there are at least three individuals helping Rattle inside the building. We don't know the exact number of dead and wounded. We also don't know if there are any hostages in the building. Fugita security is having a difficult time dealing with them, though I am told that S.C.R.E.T. is on the way. We will continue to monitor the situation and provide updates as we receive them. Back to you, Lori.”

G.M. Info for Section Two

If our group of heroes responds, they will have to get past Fugita Security themselves (unless they are recognized as public heroes and respected by the authorities). Flying or climbing through the damaged windows is an easy way around them, at least until Rattle and the others are dealt with.

Rattle and her cohorts are superpowered villains, but they are small time. They started as thugs and hoods, and they only recently (within the last year or so) developed super abilities. Desperate to become “big-time supervillains,” they all jumped at the chance of working for Dr. Fright, even if they suspected that their employer might not be the genuine article.



Breaux!

Sometime during the heroes' battle with these lowlifes (perhaps on the verge of their defeat), Rattle or one of the others will gloat, "You're too late bozos. One of our buddies already made off with the loot!"

If questioned, these second-rate villains will reveal that they are really not concerned about going to jail. Apparently, their employer is paying them all enough to make a turn in the Big House worth their trouble. Besides, Dr. Fright (or whoever this guy is) has promised to spring them from jail within 48 hours of their capture. They know nothing about what they were sent to steal, only that it was in a small locked box in one of the Fugita corporate vaults. These weasels have no idea what Dr. Fright intends to do with the contents of the box.

Either during the aftermath of the incident (if any player characters have access to a police crime scene or might possibly have worked for Fugita Corporation) or during a quick search before fleeing the scene, they may discover that Rattle and her crew were here for a recently developed, but still classified, electronic signal amplifier. This device could easily be adapted to increase the range of broadcast waves, even the simple kind generated by the largely innocuous hardware Dr. Fright had his thugs collect in Section One. It will become increasingly clear to technically oriented characters that Dr. Fright has begun to gather the components to assemble a powerful transmitter/receiver. The only question is, what does he plan to do with it? Fugita designed the amplifier to enhance satellite signal transmissions and reception. Could that be what Dr. Fright has in mind for it also?

Rattle

Donna Vorez grew up in the Hispanic ghettos surrounded by gangs and poverty. She learned early on that her looks could be used to get her what she wanted, but in her youth and early adulthood, it mainly served to keep her alive and fulfill petty wants. She moved through the gang structures as power shifted, attaching herself to whatever leader she could. She was a mother by 17 and attempted to straighten out afterward by working as a waitress, and then as an exotic dancer. But, old habits die hard and bad influences even harder. One of her former lovers, now out of the gangs and into the big leagues enforcing for organized crime, got her a job at one of his employer's "gentlemen's clubs." The money was good and though she was still surrounded by criminals, it was a better life.

Then one night, gunmen from a rival criminal faction attacked the club in an act of vengeance. Most of the patrons were killed, and Donna was gravely wounded. The owners of the club took the tragedy as an opportunity to gather guinea pigs for some experiments they were finalizing. They brought the wounded to their private clinic and subjected them to a chemical and radiation process that was hoped to stimulate the subjects' healing. The family hoped to use such a procedure on their elite bodyguards and enforcers someday.

The process worked on Donna and she quickly recovered, but it also had other effects, including multiplying the

growth rate of her body hair and the awakening of several super abilities. The family was elated, but could not duplicate the process. Even the other subjects brought in with Donna did not develop any notable "super" powers. Donna was offered a cushy job, which she took for a year or so before leaving to return to her roots with dreams of building her own criminal family. For the first time, she felt secure enough to strive for more than the immediate wants and needs of her earlier years. Now that she was a "supervillain," and she vowed that one day the world would be at her feet!

Unfortunately for Donna, she has to start small and work her way up. She has already taken control of a gang in her neighborhood and plans to use them as foot soldiers, but her real break came just recently when she took this job for Dr. Fright and met Shake and Roll. Shake suggested the names and Donna, realizing his raw power in a moment of foresight, supported it. Roll was okay with the names, and Donna has been playing up to Shake ever since, slowly working on leading him along before actually seducing him and, hopefully, cementing his attachment to her.

Rattle

Real Name: Donna Vorez

Other Aliases: Belladonna and Maria Sanchez.

Alignment: Miscreant.

Attributes: I.Q.: 9, M.E.: 11, M.A.: 7, P.S.: 15, P.P.: 19, P.E.: 16, P.B.: 18, Spd: 15

Height: 5 feet, 4 inches (approx. 1.62 m).

Weight: 125 lbs (56.3 kg)

Experience Level: 2nd

Hit Points: 40

S.D.C.: 79

Power Category: Experiment.

Side Effects: Triple body hair.

Major Super Abilities: None.

Minor Super Abilities: Power Channeling, Flight: Wingless, Bend Light, and Healing Factor.

Natural Abilities: 40% charm/impress.

Disposition: Rattle is fully aware of her effect on men and uses it to her advantage. If she were smarter, it might take her far, but her average intelligence coupled with her attitude (she can be a total shrew) will hinder any climb to power, forcing her to rely on her super abilities to get some of the things she wants.

Appearance: Rattle is a very attractive Hispanic woman with tawny skin and black hair. She is barely 20 years old with the tight body of a dancer. As a result of the medical treatments that awakened her super abilities, she has three times the body hair of most people. The hair on her head falls in waves down her back and almost to the floor, while her eyebrows and armpit/leg hair is combed or shaved to maintain her beauty. Donna is very guarded about her appearance.

Her costume as Rattle is red with white angles radiating from her abdomen over the shoulders and past the hips. The arms are bare up to the biceps, except for leather sap gloves, while her toned legs are completely covered. Heavy combat boots with buckles and plates protect her feet and her hair is left free to form a cape of black.

Combat: Hand to Hand: Expert

Number of Attacks: 4

Bonuses: +4 to strike, +6 to parry, +6 to dodge, +5 to roll with punch, fall or impact, +2 to pull punch, +24% coma/death, +3 to save vs psionics, and +1 vs poison and magic. When in flight, even hovering a few inches above the ground, she gains an additional +1 attack, +2 to strike, +2 to parry, +4 to dodge under 80 mph (128 kph), +6 to dodge at 90 mph (144 kph) or faster, +4 damage per 20 mph.

Education Level and Skills: Streetwise (45%), Pick Locks (55%), Seduction (42%), Prowl (55%), Pick Pockets (50%), Gymnastics (+15%), Climbing (75%), Dance (40%), Cooking (45%), W.P.: Knife, W.P.: Automatic Pistol, Automotive Mechanics (35%), Pilot: Motorcycle (68%), Language: Spanish (75%), and Athletics.

Weapons and Melee Combat:

Punch: 3D6

Kick: 4D6

Power Punch: 6D6x2 (uses two attacks)

Jump Kick: 4D6x2 (uses all attacks per melee; can only parry or dodge).

Head Butt: 1D6

Body Tackle: 1D6+2D4

Roll

Joseph Randall's early years were spent in the housing projects of New Orleans. He grew up pretty much as a stereotypical, troubled black youth among a large, low-income family. He had an uncle who lived out of the city, to the south and near the swamps. Joseph visited the uncle with his family every few months, and each time the uncle would take the boys out hunting. By the time he was ten, Joseph eagerly anticipated the outings and his uncle's stories about the war in 'Nam. When Joseph's father died in an oil-field accident, some of the children were forced to move in with relatives to ease the financial burdens. Joseph volunteered to stay with his uncle, and the two lived and hunted together for years. As the boy grew up, he learned about his uncle's shadowy past as a sniper in the war, then as an assassin afterwards (Having no market for his military skills, it was the only work he could excel at). He made a good living from it, buying the farm he now lived on away from the city and the poverty Joseph had always known. Joseph decided he wanted the same. Animals were fine for sport, but he wanted a challenge and a secure future. If hunting men would give that to him, he would do it.



Taking his uncle's advice and a few old phone numbers, he made his way to the player characters' city to sell his skills. Joseph is only recently arrived and has found work, but nothing steady. Anyone willing to pay for his gun skills can hire him, and that's how he fell in with Shake and Rattle. The two are also new to the criminal big leagues and Rattle thinks the three of them have lots of potential. Shake agrees with her, but Joseph is sure it's because the brute is infatuated with the Latin beauty. Joseph is taken by her also, but wouldn't want to get in Shake's way. If the woman can do the things she says she can, Joseph will stick with them. He doesn't really have the strength of will to go out on his own if someone else is telling him to stay. He also won't criticize the names Shake gave them, mostly because he likes his. He thinks of it as short for "Rock & Roll."

Roll

Real Name: Joseph Randall

Alignment: Miscreant

Attributes: I.Q.: 13, M.E.: 7, M.A.: 10, P.S.: 17, P.P.: 18, P.E.: 23, P.B.: 9, Spd: 26

Height: 6 feet, 3 inches (approx. 1.9 m).

Weight: 230 lbs (103 kg)

Experience Level: 2nd

Hit Points: 45

S.D.C.: 120

Power Category: Hunter Vigilante (Mercenary).

Special Abilities: Sharpshooter abilities as listed on page 133 of **HU2**, but only applies when using automatic pistols.

Disposition: Roll is imposing and deadly. Though intelligent, he doesn't have much willpower and tends to take orders quite well. It also means he has no defense against Rattle should she make advances toward him, which could lead to some antagonism between Roll and Shake.

Appearance: Joseph is a tall, strong black man in his very early twenties. He keeps his head shaved and has a scar over his left eye and on his chest where a deer gouged him with its antlers. In costume as Roll, he carries a pair of .45 pistols in hip holsters and a katana and shotgun crossed on his back. The costume itself is gray and black with heavy gloves and boots, and armored chest and thigh plates. Thick goggles cover his eyes and hide his identity.

Combat: Hand to Hand: Expert.

Number of Attacks: 4 hand to hand, 5 with handguns.

Bonuses: +2 to strike, +4 to parry, +4 to dodge, +3 to roll with punch, fall or impact, +2 damage, +4 vs magic, +4 vs poison, +16% vs coma/death and +2 to pull punch.

Education Level and Skills: Pilot: Automobile (74%), Pilot: Boat: Motor (75%), Pilot: Truck (58%), Language: Spanish (75%), Language: French (75%), Camouflage (50%), Detect Ambush (60%), Detect Concealment (45%), Fishing (65%), Land Navigation (64%), Wilderness Survival (75%), Preserve Food (35%), Skin/Prepare Animal Hides (40%), Track Animals (30%), Hunting, W.P.: Knife, W.P.: Automatic Pistol, W.P.: Rifle, W.P.: Automatic Rifle, Tracking (55%), Prowl (47%),

Find Contraband (54%), Intelligence (60%), Streetwise (50%), Sniper, Safecracking (28%), Radio: Basic (55%), Surveillance Systems (40%), Basic Electronics (40%), Basic Mechanics (40%), Athletics, Running, and Body Building.

Special skills: Disguise Scent (74%), Trap/Snare Animals (74%), Modify Weapon Cartridges (74%).

Weapons and Melee Combat:

Marksman Customized .45 Pistols: Roll's primary weapons. Feed: 10 round magazine, Barrel Length: 132 mm, Approx. Effective Range: 195 feet (59.4 m), Damage: 4D6+3 full metal jacketed rounds, Bonus: +1 to strike.

Double-Barreled Pump Shotgun: This unusual weapon resembles two ordinary shotguns merged into one. It features short (but not sawed off) barrels for concealability and quick drawing. Feed: 3 rounds per barrel, Damage: 4D6 or 8D6 both barrels fired, All Other Stats: As per an average 12 gauge shotgun.

Katana: A high-quality samurai sword given to him by his uncle. Damage: 3D6.

Extra Ammo: Roll carries three spare clips for each of his handguns and 12 shotgun shells (takes one melee action to reload one shell in the shotgun or an entire melee round to completely reload it).

Equipment: Roll's costume provides him with A.R.: 13 and S.D.C.: 125. The thick gloves have metal plates along their length so he can parry weapons unarmed. He also has access to heavier hunting rifles (such as the massive Ridley .560 and others) and additional combat and hunting gear.

Shake

Like Donna, Andrew Phillips grew up in various slum gangs. As one of the only "white boys" in the 'hood, he had a lot to prove, but his natural strength more than made up for it. After using his abilities to help in a particular gang pull off a few liquor store robberies, his acceptance was guaranteed. The gang was his family and friends, but Andrew wanted more for himself, and music was his hope to achieve those dreams. He played with several local bands, but was always drawn back into the troubled life of his gang-banging friends.

One fateful evening, he and the gang were hanging out in the concrete storm drains under an overpass when a military truck filled with radioactive fluids wrecked on the road above them. Seeing the falling red wave as it splashed over the rails and down toward them, Andrew leaped up and pushed the car his friends were sitting on out of the way. The mystery liquid splashed his legs and caused him to slip and fall, getting covered in the solution. He got up, seemingly unharmed and washed some of the gunk off with the gallon of water they kept in the trunk in case the radiator went low. Over the next few days, he was sick with a fever. During the sickness, his teeth and fingernails lengthened and his ears grew, giving him a somewhat bestial appearance. He also found his strength had increased even more, and he could seriously mess up people just by touching them.

While Shake recovered, most of his old gang buddies were gunned down during a street war with a rival gang. Shake found himself on his own for the first time ever.

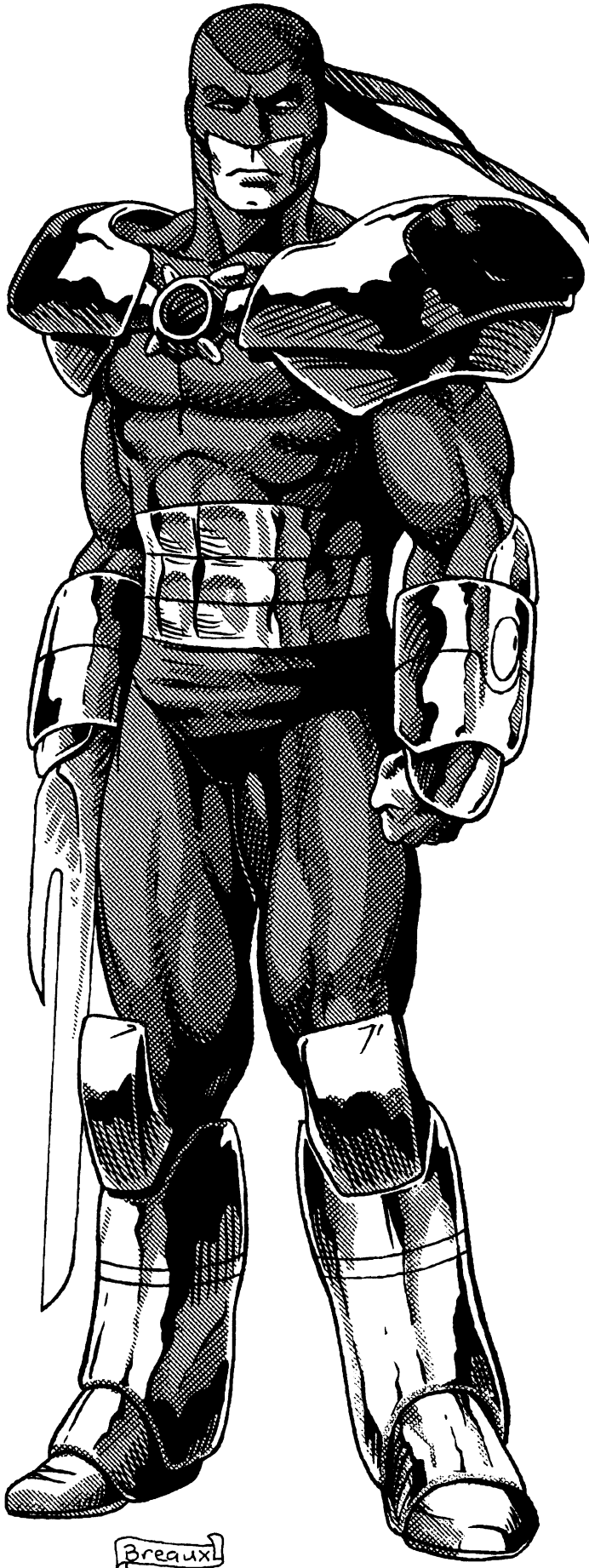

That's when he was approached by Dr. Fright. Having nobody else in this world, Shake agreed to work for him.

Rattle's apparent interest in him and his ideas has totally charmed Shake, and now he follows Rattle around like a very big, and dangerous, love-sick puppy. He has become over-protective of this raven-haired seductress, and he will clobber anybody who threatens or disrespects her. In fact, he has fallen so hard for Rattle that he will take almost any criticism and abuse she dishes out at him. The only thing that will break this spell is if Rattle flat-out spurns him for another man, which she won't do because he's too valuable to her. If Shake notices Rattle taking an interest in somebody else, however, he will get jealous, violently so.

Shake

Real Name: Andrew Phillips

Alignment: Miscreant

Attributes: I.Q.: 8, M.E.: 8, M.A.: 8, P.S.: 56, P.P.: 23, P.E.: 11, P.B.: 13, Spd: 32

Height: 6 feet, 1 inch (1.84 m).

Weight: 210 lbs (94.5 kg)

Experience Level: 3rd

Hit Points: 21

S.D.C.: 109

Power Category: Mutant

Mutant Characteristics: Sharp teeth and fangs (2D6), large ears and small retractable claws (2D4).

Major Super Abilities: Disruptive Touch.

Minor Super Abilities: Body Weapons, Energy Expulsion: Light, and Superhuman Strength.

Natural Abilities: Disrupt nerves; 1/2 damage from poisons, toxins, or drugs; blinding light flash; half damage from radiation; can carry 11,200 lbs./5.6 tons (4,177 kg/4.1 metric tons) (see **HU2**, pages 231 and 272 for full details).

Disposition: Andrew is the stereotypical dumb ox: Slow on the up-take, poorly educated, and relies on his brute strength and intimidation to get him through life, however, he is not a stupid idiot, is streetwise and cunning on a basic sort of level. The only person who really means anything in his life right now is Rattle, and he will kill to protect her or avenge her honor. He will even sacrifice his own life to save hers, if things come to that.

Appearance: Andrew is deceptively small for his strength. He is of average height with a healthy build, but the superhuman nature of his strength means that he is a lot stronger than he appears. When not in costume, he has red hair, pale skin and green eyes. His Shake costume has oversized gauntlets, boots, and shoulder plates to give him a more impressive appearance (it was Rattle's idea).

Combat: Hand to Hand: Basic

Number of Attacks: 4

Bonuses: +1 on initiative, +4 to strike, +7 to parry, +7 to dodge, +3 to roll with punch, fall or impact, +2 to pull punch, +10% vs coma/death, +41 to damage, and +2 to disarm.

Education Level and Skills: Shake is nearly illiterate (3rd grade reading level). Streetwise (52% including an ad-

ditional, special bonus for his years on the streets), Prowl (40%), W.P.: Automatic Pistol, Find Contraband (34%), Card Sharp (32%), Pick Locks (40%), Pick Pockets (35%), Play Musical Instrument: Electric Guitar (45%), Play Musical Instrument: Drums (45%), Language: Spanish (60%), General Repair/Maintenance (45%), W.P.: Knife, W.P.: Sword, W.P.: Blunt, First Aid (55%), Running, Body Building, and Athletics.

Weapons and Melee Combat: Paired weapons (all). All P.P., W.P. and damage bonuses apply to body weapons. Shake prefers to attack with his natural paired body weapons, usually claws, foregoing his automatic parry in favor of twin attacks.

Claws: 2D4+41

Club or mace: 2D6+41

Swords or Large Blades: 3D6+41

Light Beam: 4D6 (range: 600 feet/183 m)

Section Three: Angels to Some...

The familiar face of Channel 5's Lori Landry appears on the afternoon edition of the news as she runs down the top story of the hour.

"Sources this afternoon confirm that the U.S. Army's Huxley Missile Base was infiltrated by two individuals who subsequently escaped with several pieces of key military information. Exactly what that stolen information might be, or how it could affect the rest of us, is still undisclosed. We will bring you additional updates as information is made available."

The player characters are likely to suspect (and correctly so) that this event is connected somehow with the string of activities concerning Dr. Fright. But unless they have military or government contacts, they will have to wait for Fright to make his next move before they learn anything else.

If the heroes are able to learn more about this theft, they will find that the stolen data was a series of satellite communication codes for bouncing signals along restricted wavelengths. Thankfully, this does not include military satellites, including the top-secret offspring of the old SDI project. Little does anyone know, but the military has finally put into orbit a string of secret defensive satellites over the last few years. These orbiting laser platforms are intended to intercept incoming missiles, but they could be used to blast ground targets with impunity. Any villain who gained access to these weapons could hold the entire U.S. hostage until the satellite codes were changed (at which point, the "birds" could be given self-destruct instructions, neutralizing their threat for good).

Nobody was even supposed to know about this project, but it seems that Dr. Fright certainly did, since he sent his flunkies here to steal the access codes. The codes he did steal were kept at Huxley as a kind of decoy in case anyone ever did learn of the killer satellite program. The real codes, the players will learn, are kept elsewhere, the location of which is known only to the President and maybe a half-dozen others.

That Dr. Fright even thought to hit Huxley is an ominous sign. Not only does he know about the killer satel-

lites, but clearly, he intends to take them over for his own nefarious purposes! The satellites do have self-destruct mechanisms in them to keep them from falling into enemy hands, but the government won't exercise that option (which would waste several trillion dollars of space technology) unless it's absolutely necessary. In any case, it should now become clear to the heroes that whatever Dr. Fright is up to, it must be stopped before these weapons are used for blackmail — or worse!

G.M. Info for Section Three

Dr. Fright is intelligent enough to realize that using brute force to steal the satellite codes is downright foolish, considering the security level at the Army missile base. To circumvent this, he has enlisted the aid of two successful and skilled villains with a more subtle touch, a pair of infiltrators known as **The Seraphim**.

By the time the heroes check out the base, the Seraphim will be long gone. Or are they? It turns out that during their heist, the entire base went on alert, and the pair lost their only escape route. Since then, they have been hiding out in a sub-basement of the facility! It has been a few days now, and they are both starving and dehydrated. While the heroes visit, the Seraphim, not knowing there are superbeings on the premises, make their last-ditch bid to escape.

Note: Mithra brought a personal mini-computer with him during the theft. When he and Isis obtained the data they were sent to steal, Mithra immediately uploaded it to an encrypted e-mail address their employer had set up. The specially built mini-computer sent the data through an internal burst transmitter on an ultra-low frequency that none of missile base's communications equipment could detect. Now, even if the Seraphim are caught, they have fulfilled their mission to Dr. Fright and have received their generous payment (Mithra used his computer to check his Swiss bank account to verify that payment had been made). All that remains is for the two to get out of enemy territory.

Unfortunately for them, they bump into a security detachment mere minutes after they leave their hiding place, triggering a facility-wide alarm. As soon as our heroes hear it, they will also hear reports of how the Seraphim are still on the base! This is the player characters' big chance — if they can catch one or both of these villains, it will bring them much closer to revealing Dr. Fright's plot and stopping this legendary menace once and for all.

If the heroes catch the Seraphim, the thieves will do their best to talk their way out of trouble and not offer any helpful information. But, if the heroes are persistent with their questioning (flattery and cleverness will work better than insults and threats), then the Seraphim will confirm that they were hired by an individual calling himself Dr. Fright. Do they believe it is really him? Yes and no. They may not believe it is the same person in the costume that was executed, but that is immaterial. The two think the man will make a suitable replacement for the old villain.

If the player characters should ask about the stolen military information, the two will not only tell the group what it

was they stole (but they will lie and say they were military satellite codes), but they will also pass on what they know of Dr. Fright's plans — that he intends to gain access to a satellite laser and use it to threaten the nation! These plans, however, are the same ones he intends to make public very soon, so the heroes won't be learning much. Moreover, heroes with technical training, as well as military personnel on the scene, will note that the codes Dr. Fright stole won't gain him access to any laser satellites. And now that the Laser Defense Command, the military branch responsible for the program, knows he is after the codes, they will initiate a security protocol that makes theft or discovery of the codes impossible.

However, this is all immaterial, since Dr. Fright doesn't really intend to gain access to any military laser satellites at all. The information he fed the Seraphim was just another red herring. At this point, Dr. Fright knows the heroes are on his trail, so he gave the Seraphim this cock-and-bull story to throw the heroes off. How exactly the heroes respond to these fake plans is up to the G.M.

Isis

Alexia Parks was always the kid who knew what was going on. She wasn't simply nosy, she just had a knack for finding things out. When she got into high school, she was on her way to being a lawyer when she volunteered for a number of I.Q. and aptitude tests given by the government and the military. To Alexia, the tests were opportunities for bigger scholarships and a good job after college. To the military, who designed and implemented the tests, these were for recruiting individuals who had special skills the government felt it could put to good use.

Alexia aced the tests, and the military soon contacted her with an offer she couldn't refuse — a full ride through college and a handsome job in a semi-secret think tank that handled intelligence gathering and processing for both the military and certain government agencies.

Alexia specialized in handling the data load for *Project Tycho*, an initiative to support certain government organizations dedicated to hunting extraterrestrials on Earth. Periodically, this required Alexia to go out in the field to examine landing and abduction sites. It was on one of these "field trips" that she was abducted from the field by the very alien beings she and her team had been tracking. The rest of her team was found dead, and with no evidence of her disappearance, Alexia was listed as KIA also (Killed In Action). The government wrote her off and eventually, Tycho moved on to other alien cases.

Meanwhile, she spent almost a year as the prisoner of a race of very human-looking aliens who subjected her to a series of grueling experiments. When they released Alexia, she found it nearly impossible to trust anyone. After all, anybody she saw could be one of "them" — one of those fiends who tortured and tormented her for so very long.

Over time, she developed an impressive array of super abilities that seemed to be side effects of her alien experiments. As incredible as these abilities were, they only embittered poor Alexia, because they served as a constant

reminder of her year-long ordeal. Angry and detached from society, she became the criminal mercenary, Isis, selling her skills and powers to the highest bidder.

It wasn't until after she met the incredibly charming and handsome Darren Matthews (the supervillain known as Mithra) that her outlook would change. Only when she is around Darren can Alexia relax and feel comfortable around others. Soon after meeting, the two villains fell desperately in love and married. They now work in tandem as the supervillain team known as The Seraphim. Alexia is fiercely loyal to her husband, and there really isn't anything she would not do for him. If he is about to be captured, she will allow herself to be caught too (unless she thinks she can escape herself and break him out later). Likewise, she will gladly take a shot for Darren, even stepping before a coup de grace or other lethal attack. If Darren dies, she will either kill herself or will attack her husband's murderers with a total disregard for her own safety. Her real goal will be to join him, not to avenge him.

Alexia still dreads the return of the aliens, fearing they will take her from Darren, but it has been more than five years and still there has been no sign of them. She blames Project Tycho to some extent for her abduction and holds a high disregard for them. She may, however, soften her actions toward individual agents who seem worthy of good treatment, or are old friends of hers.

Isis

Real Name: Alexia Matthews

Alignment: Aberrant

Attributes: I.Q.: 14, M.E.: 13, M.A.: 13, P.S.: 19, P.P.: 25, P.E.: 26, P.B.: 28, Spd: 34

Height: 5 feet, 7 inches (approx. 1.7 m).

Weight: 145 lbs (65 kg)

Experience Level: 6th

Hit Points: 46

S.D.C.: 130

Power Category: Experiment

Mutant Characteristics: Requires energy for nourishment.

Major Super Abilities: None.

Minor Super Abilities: Extraordinary Physical Prowess, Energy Expulsion: Electricity, Extraordinary Physical Beauty, Heightened Sense of Hearing, Flight: Wingless, and Adhesion.

Natural Abilities: Charm/Impress 86%.

Disposition: Alexia is still somewhat uncomfortable around some people, but her edginess is normally limited to doctors and technical personnel that remind her of the alien techs that experimented on her. She is self-serving, but honorable and will do whatever she feels necessary for the betterment of herself and her husband. He is the one thing she really loves and is the anchor that keeps her from lashing out at everyone around her.

Appearance: Alexia is a stunning beauty and grace defined. There is very little else to say that would do her justice. Beyond the purely physical, she is intelligent, well educated, and skilled in social interaction (though she might be uncomfortable around others, her training



allows her to cover it up well). She prefers to dress completely in white, even when in costume. Her Isis costume is a close fitting white body suit with a miniskirt of sorts over clothed legs. High boots and long gloves cover feet and hands, while a winged mask covers her eyes. When infiltrating, Alexia will use numerous disguises instead of her costume, though the costume may be worn beneath if possible.

Combat: Hand to Hand: Assassin.

Number of Attacks: 8

Bonuses: +7 on initiative, +7 to strike, +11 automatic dodge, +12 to parry, +13 to dodge, +10 to roll with punch, fall or impact, +8 to damage, +22% to save vs coma/death, +6 to save vs magic, +6 vs poison, +3 to disarm, and +5 to pull punch. When in flight, even hovering a few inches above the ground, she gains an additional +1 to attack, +2 to strike, +2 to parry, +4 to dodge under 80 mph (128 kph), +6 dodge at 90 mph (144 kph) or faster, +4 to damage per 20 mph (32 kph).

Education Level and Skills: +10% physical skills that use dexterity and skills with social interaction. +10% prowl when climbing. +15% to palming, pick pockets, concealment. +5% to acrobatics and gymnastics. Boxing, Running, Climbing (98%), Military Etiquette (85%), Radio: Basic (75%), W.P.: Rifle, Detect Ambush (80%), Intelligence (76%), Wilderness Survival (85%), Interrogation (90%), Disguise (75%), Seduction (73%), Prowl (90%), Find Contraband (75%), Streetwise (65%), Ventriloquism (75%), W.P.: Automatic Pistol, W.P.: Sub-machinegun, W.P. Energy Pistol, Acrobatics (all 98%), Gymnastics (all 98%), Wrestling, Advanced Swimming (98%), Basic Mechanics (60%), Basic Electronics (60%), First Aid (75%), Land Navigation (60%), and Athletics (General).

Weapons and Melee Combat: Karate kick (2D4), pin/incapacitate on 18-20, body block/tackle (1D4), crush/squeeze (1D4), and knockout automatically on a natural 20 if punching.

Electrical Expulsion: 7D6 (range: 400 feet/122 m).

Mithra

Darren Matthews was born with a genetic aberration that would later provide him with superhuman abilities. He made his way through school as a jock and all-around popular guy. Even back then, his attractive features were amazingly notable. He had a promising career as an athlete, model, or an actor, but chose to become a cop instead. While on the force, he fell in love with the daughter of a prominent mafia leader and shortly began to work double duty for both the mob and the police. After a particularly nasty round of antagonism between the cops and his lover's family, many people on both sides ended up dead. Darren barely avoided a Grand Jury indictment for his involvement and was demoted and transferred to a bad precinct on the edge of town. From there, he did what he could to maintain his standing with the family, but his relationship with them, and his one-time love, was forever tarnished. He had lost nearly everything.

Some time later, Darren was fortunate enough to be the closest officer to a UFO sighting on the edge of town, though at the time he thought otherwise and almost ignored the request to look into it. Arriving at the farm where the sighting occurred, he found Alexia, unconscious and terribly undernourished. Still, she possessed a dazzling kind of beauty that amazed him. Completely enamored by the woman, Darren took her home and made missing persons inquiries on her, but nobody matched her description. He quickly forgot about his past misfortune as he tended to Alexia for the next few days, nursing her back to health. Once she reawakened, she reacted hysterically to Darren, clearly afraid of him for reasons he couldn't figure out. Still, he managed to calm her down and helped her reacclimate to the planet she had been away from for so long. During that time, they formed a bond of love and trust that nothing can break.

Maintaining some of his criminal contacts (including plenty of corrupt cops), Darren quit the police force so he and Alexia could become partners in crime. His charm and mutant powers make him the perfect partner for his cunning and creative infiltrator wife.

Mithra

Real Name: Darren Matthews

Alignment: Miscreant, but devoted to Isis.

Attributes: I.Q.: 13, M.E.: 10, M.A.: 22, P.S.: 20, P.P.: 16, P.E.: 14, P.B.: 30, Spd: 18

Height: 6 feet, 3 inches (approx. 1.9 m).

Weight: 250 lbs (112.5 kg)

Experience Level: 6th

Hit Points: 55

S.D.C.: 137

Power Category: Mutant.

Mutant Characteristics: Angelic Face and Double Jointed.

Major Super Abilities: Intangibility

Minor Super Abilities: Radar, Adhesion, and Energy Expulsion: Energy.

Natural Abilities: Trust/intimidate 65%, charm/impress 92%.

Disposition: Darren is more outgoing and vibrant than Alexia. The kind of guy people find to be irrepressibly friendly and likable, even when he is stealing from them! He likes to play the charming thief and will flirt with any heroines if given the chance. He is 100% in love with and loyal to Alexia, however. If anyone were to harm her gravely, his fury and drive for revenge would be all-consuming. Unlike Alexia, he will not surrender unless absolutely necessary, but he will not leave her unless she is dead or he is confident he can mount a successful rescue.

Appearance: Where part of Alexia's beauty stems from her grace, Darren's stems from his charm. He is the most likable person anyone is likely to meet, and his GQ appearance and mannerisms could put even the most jittery person instantly at ease. However, anyone expecting Darren's tricks will not fall for this, and only then can they resist his beguiling demeanor. He prefers to wear soft to middle grays and commonly accents his

good looks with sharp suits of the best tailoring. His costume is a loose gray jacket over a close fitting shirt, pants, and boots. Leather gloves cover his hands and a bandit-styled mask covers his eyes.

Combat: Hand to Hand: Expert.

Number of Attacks: 7

Bonuses: +6 on initiative, +5 to strike, +9 to parry, +9 to dodge, +9 to roll with punch, fall or impact, +2 to pull punch, +5 damage, and critical on natural 18-20.

Education Level and Skills: W.P.: Automatic Pistol, Radio: Basic (90%), Criminal Science (no forensics) (80%), Law (General) (70%), Surveillance Systems (75%), Gymnastics (+15%), Boxing, Prowl (98%), Wrestling, Research (80%), Computer Operation (70%), Computer Programming (60%), Athletics, Body Building, Pilot: Truck (64%), Pilot: Boat: Motor (85%), Pilot: Airplane (74%), Seduction (47%), and Business and Finance (65%).

Weapons and Melee Combat: Kick attack (2D4), tripping leg hook, and backward sweep. Energy Expulsion: 8D6 (range: 600 feet/183 m).

Section Four: A Frightful Experience

Whether the characters gather some useful information from the Seraphim or not, the next afternoon, Dr. Fright interrupts nationwide television broadcasts to deliver a terrible ultimatum.

As programming across the country cuts out, every television in the land blacks out for a second. Then, the costumed face of Dr. Fright slowly appears. His head is tilted forward just a little, and he wears a dark, sinister grin.

“Good afternoon, fellow citizens,” he begins in a slow, ominous voice. “This is Dr. Fright. I know some of you must be thinking that I was executed some time ago,” he says as he breaks into a creepy smile. “I assure you, reports of my death have been greatly exaggerated.

“I have in my possession the security codes to several U.S. military satellites that have been armed with laser cannons to protect your precious country from missile attacks. These cannons, which can vaporize an entire building with a single shot, are now under my control. I have taken the liberty of pointing them all at you.”

Dr. Fright smiles again and sits back in his seat, clearly pleased with himself. His voice loses some of its creepiness and assumes more of a humble, nice-guy tone, which considering the source, is even more unsettling.

“Whether or not I shall open fire depends on how reasonable your leaders are willing to be. Now, I don’t really want to hurt anybody, especially when holding you for ransom is so much more profitable. That is why I am giving the U.S. Government six hours to deposit \$100 million dollars into a trash bin at the foot of the Empire State Building in New York City. If the Government fails to comply, I will demand an additional 100 million and strike a target at random every hour until my demands are met. As a dem-

onstration of my power, I bid you all to observe the following.”

The picture cuts to a space image of a weapons satellite rotating and bringing its cannon to bear on U.S. soil. The gun powers up and fires a brief white blast to the earth somewhere in the middle of the country. Then the picture cuts back to Dr. Fright.

“Very soon, your various news agencies and perhaps even the Government itself will inform you that the St. Louis Arch has been destroyed. I have spared human lives to show my willingness to be humanitarian. My next target shall be a much more ... shall we say ... populated one. Believe me, people of America, I am deadly serious. Resist me and be destroyed! Good evening.”

And with that, the pirate transmission ends and regular programming pops back on in mid-stream, as if nothing ever happened. Within minutes, programming is cut off again by dozens of special reports by the news media and Government agencies appealing to the public to remain calm. Indeed, the St. Louis Arch has been blasted to kingdom come. Its shattered pieces lie scattered about the monument site, and a large crater lies underneath what used to be the Arch’s zenith. It is as if some terrible force punched through the Arch from above.

Could it be? Could Dr. Fright actually have gained access to U.S. laser satellites? How!?

G.M. Info for Section Four

If the player heroes find out about the satellite codes beforehand, or if they have some technically oriented members in the group, they should realize that all the other stuff Dr. Fright has stolen *could* be used to make a system capable of taking over a laser satellite or two. To the uneducated eye, it appears as if Dr. Fright really has captured the satellite defense system and can use it at will! Or can he?

If the heroes have governmental access, or if they have established contacts with the laser defense people at Huxley Missile Base, they will learn that even though the St. Louis Arch was destroyed, it is highly unlikely that a laser satellite did the damage. For one thing, none of the satellites appear to be out of their control nor have any registered the firing of their lasers! If any of them had, the Huxley Missile Base would know it. On the other hand, if Dr. Fright *did* take over the satellites, what’s to say that he couldn’t have blocked or altered the system’s transmissions of his pirated activity? But why would he go to that trouble when he wants the world to know he has seized control of the satellites? Things just don’t add up. Does he have control of the satellites or doesn’t he?

The only way to really know is to examine the remains of the St. Louis Arch. If a laser blast is what destroyed it, any technically proficient character will be able to tell, as will any hero who can project energy. Doubtlessly, authorities in St. Louis are already going over the remains, but they won’t have “conclusive results” until shortly after Dr. Fright’s deadline! Thus, the heroes are going to have to go out to St. Louis and check for themselves. If they do, they will realize that it was a sophisticated bomb, and *not* a la-

ser satellite, that destroyed this majestic monument (Government inspectors have reached the same conclusion, but are hesitant to call Dr. Fright's bluff without further tests).

It would appear that this is all a bluff. The good Doctor is pretending that he has control of one or more laser defense satellites to trick the Government into paying him the ransom. By this time, heroes who have researched Dr. Fright or who have tangled with him before will recall that while he is sharp and cunning, he also becomes so enamored with his plots that he can't wait to see them finished. Thus, he often puts his final phase into motion before he's really able to implement it. This has led to Dr. Fright's downfall before. Going by this pattern, one could suspect that either he is very close to seizing control of the laser satellites or failing that (which appears to be the case), he didn't want to let a great scheme go to waste and has concocted this clever bluff. Still the question remains, did he plant a bomb on the St. Louis Arch to get the nation scared witless while he continues his attempts to capture the defense satellites — if so, somebody had better stop him while they still can (does the six hour timetable mean he'll get control soon?) — or if that avenue *has* been successfully thwarted (as it appears), to continue his bluff, does he have or is he (at this very moment) planting another bomb in a building of a populated city? Again, if so, Dr. Fright's timetable is a legitimate one. By the end of his first deadline (which may be in a very short while if it took the heroes a while to get to St. Louis), either Dr. Fright will have gained the technology to make good on his threats, or he will simply detonate another decoy bomb to make the nation think he launched another laser assault. Either way, people are in grave danger, and the only way to stop it is to stop Dr. Fright himself. The problem is, where to find him?

This is where technically oriented characters or those who have extensive knowledge of lasers or light (including heroes who have light-related powers) come in (those with psychic powers might also be helpful). Considering the technology Dr. Fright has already put together, he could theoretically hijack a laser satellite, but as the heroes have already learned, he lacks the security codes needed to access a laser satellite's targeting software. But, that's only if Dr. Fright intends on establishing contact with one of these satellites by conventional broadcasting. If he beamed a laser-amplified broadcast directly to one of the satellites, he *might* be able access the machine's computer directly and "hack" into it to take it over. From there, all Dr. Fright would have to do is maintain contact with the satellite, send up a pre-programmed firing sequence, and let the machine go. In theory, one could probably send up to 10 pre-programmed firing routines to any one satellite, as well as instructions to ignore any self-destruct commands sent to it. If the firing commands were spaced out to just one a day, the U.S. would be subjected to over two years of daily laser bombardment. No building on the surface would be safe. Military installations, national monuments, football stadiums, shopping centers, power plants, hydroelectric dams, airports, the White House — nothing!

On the other hand, the Huxley Missile Base should detect such evasive intrusions and have ample time to shut the satellite down, take it out of orbit or activate the self-destruct mechanism before the villain could take control of it, at least in theory.

As the heroes weigh all this, the gravity of the situation should hit them like a ton of bricks. Clearly, money is not motivating this guy. After all, even a \$100 million ransom is pretty small potatoes for a villain of Dr. Fright's reputation. He's a sadistic control-freak! He's doing this for the sheer pleasure of causing mass hysteria and destruction. To his thinking, the nation is in his control, gripped in terror!

G.M. Plot Options

To stop him, the heroes have to figure out what and where his next step will be. Exactly what the madman has in mind is up to the G.M. There are two possibilities.

Option One: The Bluff

Dr. Fright does not have and can not get control of any satellite, but he knows the superheroes and the authorities know he's been trying to do so and aren't sure that he hasn't. The maniacal fiend is using this to his advantage to play his bluff. Having to change his plans in mid-stream, he has not had time to be too clever or spread his targets far apart. That means he is operating in Saint Louis, and that the next target, the building to be "attacked by laser" (really exploded with a bomb) is in that city!

The big advantage the heroes have is that Dr. Fright is using underlings to do his dirty work. These will be ordinary career criminals, one or two of whom has a background in demolitions, or low-powered (and low level) supervillains with one of them or an "associate" with knowledge in demolitions. The group can locate this target through sheer good luck (spy a suspicious looking van, see somebody prowling along on a rooftop, etc.), or one of those involved has succumbed to pangs of conscience and has made an anonymous call to the authorities (or, if possible, contacts the heroes directly) to warn them and give them the location of the target.

Note: While these hoods can be stopped before the bomb is planted and Dr. Fright's bluff is revealed to the world, the mad supervillain is nowhere to be found (following leads to track him down can be an adventure in and of itself, and while it may lead to conflicts, traps and battles, it may or may not lead to his apprehension). However, he does make one last television appearance:

"Alas, you have found me out and spoiled my fun. You can rest easy for now America. There aren't any other bombs, and if only I could seize control of a killer-satellite — but it seems that is not meant to be."

A sinister smile stretches across his face as he closes with the statement, "Ah, yes. The good guys have won today. But know that you have not heard the last of Doctor Fright. Sleep well ... if you can."

The characters were correct about the madman's motives. His real goal was to create mass fear and chaos. To that end, the villain has won, although his victory was

short-lived. Still, he is content knowing that his remaining at large the nation will cause to not "sleep well," so he still has his hooks in them even as he plots his next terrible scheme.

Option Two: The Satellite

To carry out this hypothetical plot, Dr. Fright would need a laser device powerful enough to reach the laser satellites (which are in geosynchronous orbit — a good 23,000 miles (36,800 km) from the Earth's surface, and steady enough to maintain a signal long enough to transmit firing instructions. The only place where such a device can be gotten is the **Kukubai Comm Systems Testing Laboratory**, located on the edge of the heroes' home city! Kukubai is a leading provider of laser communications technology, and it's public knowledge that they've been working on a multi-optics laser array to be used in a new generation of communications satellites. It's a good bet that before Dr. Fright's deadline expires, either he or his flunkies will raid the Kukubai test laboratory for the laser array. It is critical that the heroes prevent this from going down.

Depending on how the G.M. wishes to run this finale, there are three possible confrontations. First, the heroes (and whatever law enforcement personnel come with them) may beat Dr. Fright to the Kukubai laboratory and lie in wait for him and his henchmen. Fright enters the facility alone, using stealth to gain his objective rather than

brute force. Catching this slippery monster before he escapes will tax the heroes' abilities (and brains) to the max. For those wanting to make this ending more combat-oriented, Dr. Fright could launch an all-out assault against the facility, backed up by whatever supervillain flunkies the G.M. cares to throw in.

The second possibility is that the heroes arrive at the Kukubai laboratory while Dr. Fright is laying it to waste. At this point, taking him down will be complicated by all of the Kukubai employees on the scene. Unless the heroes want to earn some serious bad karma, they'll have to take special care not to hurt any employees during the fight. Certainly, Dr. Fright will use this to his advantage, taking hostages and blasting innocent bystanders in the hopes that heroes will stop to help the fallen rather than pursue him.

The third conflict involves the heroes arriving at the lab too late or not at all! Dr. Fright has his laser array! At this point, the G.M. could give the heroes a second chance by having them discover that the laser array has a unique power source that leaves an easily tracked residual energy signature. A Hardware character could rig a tracking device to locate it (and Dr. Fright) or they can piggyback with a S.C.R.E.T. team that will do the same thing. Either way, the heroes can track down Dr. Fright at his hideout and catch him in the middle of preparing to send his firing instructions to the laser satellites! For an especially dramatic touch, the upload can already be in place, and the

Kukubai Comm Systems Testing Facility

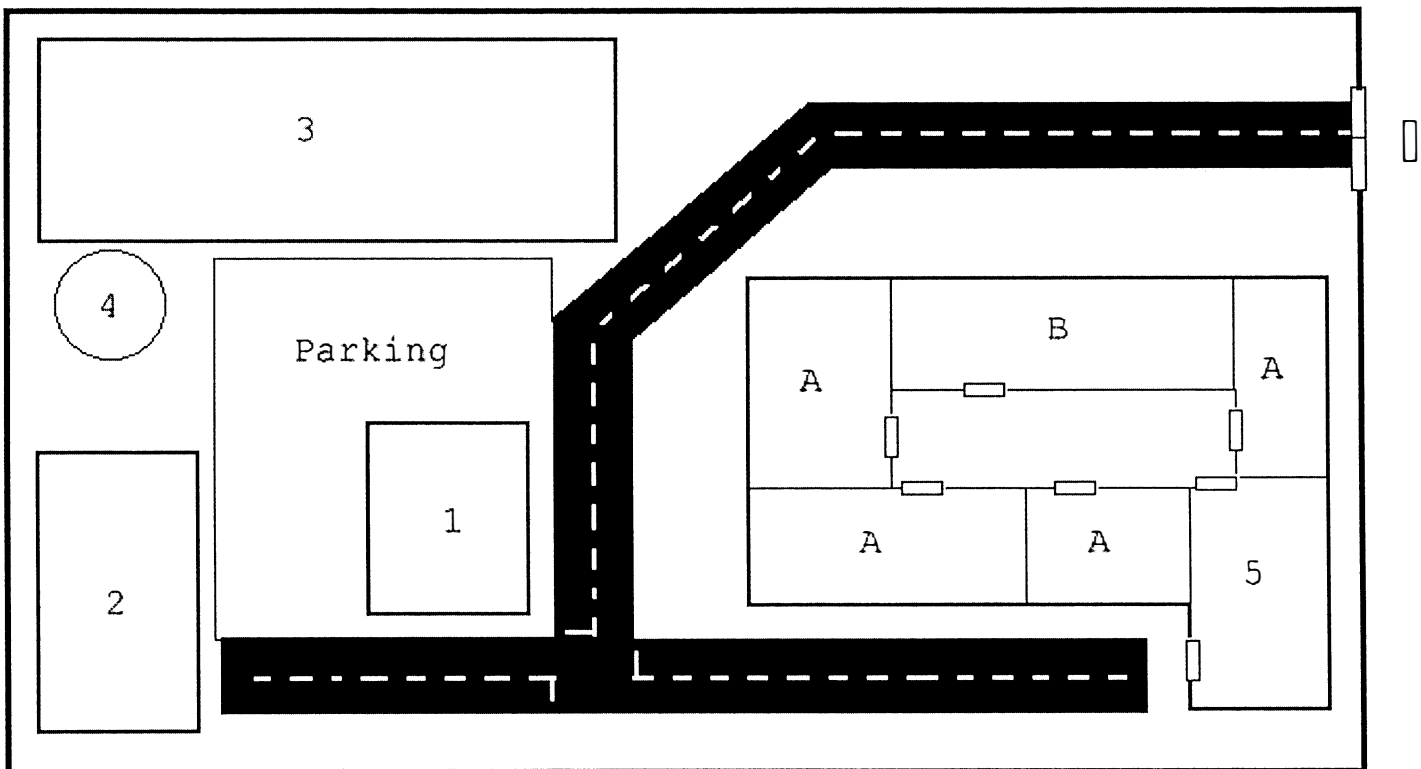

- 1 Administrative Offices
- 2 Vehicle and Equipment storage
- 3 Research and Development Labs
- 4 Satellite Dish

- 5 Testing and Applications Labs
- A General Communications Labs
- B Satellite Technologies
(Dr. Fright's Goal)

heroes must deactivate or destroy the computers within a certain time limit or the laser satellite(s) will receive its instructions and begin firing. Again, the heroes can either find Dr. Fright by himself or with a gang of henchmen.

In the event that the heroes fail in their mission and Dr. Fright does gain control of the laser satellites, his reign of terror will be short-lived. Little does the villain know that the U.S. Air Force has in place a fail-safe strategy whereby fighter jets can launch anti-satellite missiles from very high altitudes. These planes are on standby, and as soon as they receive word that Fright has compromised the satellites, the jets will scramble. 1D4 major buildings will be bombarded by the time the fighters take the satellites out. The buildings hit and the resulting casualties are to be determined by the G.M. At the very least, the destruction of the U.S. orbital laser defense network will set back military budgets by one trillion dollars.

Under this last scenario, the heroes will have more than enough reason to find Dr. Fright and bring him to justice. Not only does the nation need to be avenged, but their own reputations probably need some serious repair, too. Until Dr. Fright is apprehended, the heroes' names will be mud and the brunt of jokes like calling the group the "Laser League" or "Legion of Useless Heroes," — the point being, depending on how badly they fumbled the ball, they will have lost some of the public's confidence and may even be despised.

On the other hand, if the heroes do succeed in stopping Dr. Fright, they will receive nationwide accolades for it. A Presidential commendation, an expurgation of any and all criminal charges and investigations against them, and an offer to join the Federal Superbeing Crime-Fighting Program as a Government sanctioned team of superhumans.

Doctor Fright

Dr. Fright is one of those legendary supervillains that everyone has heard of, with a career spanning more than 35 years. Back in the early 1960s, he was a test subject in a super-soldier program designed for use in the then-escalating Vietnam Conflict. As one of a number of criminals drafted into the project, he was injected and irradiated with a number of exotic and radioactive substances in the hopes of awakening latent superpowers believed to exist in everyone. Dr. Fright died during the experiments, as did every other test subject. Shortly afterwards, however, he awoke in the laboratory morgue and escaped. Once outside, he returned to his life as a petty crook, only to realize that incredible powers had awakened within him. It seems the experiment was a success! It just had the unfortunate side effect of 99% mortality on all of its test subjects. Dr. Fright's first power to manifest itself was the ability to stun people with only a moment of concentration. His career as a supervillain had begun.

By the turn of the decade, Dr. Fright's powers had grown and he was a major nemesis of superhuman heroes everywhere. Over the next twenty years, his reputation and powers would continue to grow. In the early eighties, he was believed to have been killed by a collaps-

ing building after a particularly violent encounter with some young and aggressive members of the newest wave of superpowered humans. Yet he returned, adding to the legend that he is a master at faking his demise, or that he may be immortal.

Knowing that he has, indeed, died more than once, Dr. Fright has some confidence that he can rely on it again, but he has yet to fall to the delusion that he is immortal (he is still aging), and remains as cautious as always.

A few years ago, the villain was captured by another group of heroes (perhaps the player characters) and tried for his most serious crimes. He was convicted, sentenced to death, and was executed only last year. This time there was no mistaking he was killed. Yet once more, he has returned to life (shortly after his burial, he escaped; his body was missing).

He spent a year secretly strengthening his position in the underworld and rebuilding his finances, then set about making plans for the future. At this stage of the game, however, Dr. Fright doesn't really need money, since he's bankrolled millions in various foreign bank accounts. He also fears that he doesn't have too many years left before he'll be a little too old to keep battling superheroes. So, before he considers bowing out or really dying in combat, he wants to make a truly lasting impression on the world. Do things that people will never forget. Thus, he focuses on truly imaginative and terrifying schemes of epic proportion. The satellite plan was only the first.

G.M. Note: Feel free to build up Dr. Fright's reputation, attributing any number of significant crimes to his credit. Although not as physically powerful as many villains, like Shock, Dr. Fright is brilliant, cunning, and insane, with incredible resources (tens of millions of dollars in cash alone), numerous supervillain allies, contacts throughout the crime world, decades of experience, and a frightening imagination. Under the best circumstances, Dr. Fright can be an unbeatable opponent.

Dr. Fright

Real Name: Peter Smith. However, Smith died in that first government experiment, so finding information on him will be nearly impossible, since his records have been destroyed and he has no living relatives. Maybe somewhere there is a government employee who's heard of the project Smith was in, or knows somebody who knows somebody who had contact with Smith, but that will be all. If someone somehow tracks Smith down, his official death is filed as a prison accident in 1961. **Note:** No one knows that Peter Smith came back from the dead or that it was that experiment which turned him into Dr. Fright.

Other Aliases: Patrick Sanders and Sigmund Smithe. As a supervillain, Smith has always gone by Dr. Fright, but he has also taken on other identities to confuse the authorities. These include: The Stark One (1960s), Shadow Creep (late 60s), and The Frightener (early 70s). Doctor Fright has been his longest and most infamous secret identity.

Alignment: Diabolic



Breaux

Attributes: I.Q.: 24, M.E.: 18, M.A.: 17, P.S.: 12, P.P.: 13, P.E.: 20, P.B.: 14, Spd: 11

Height: 6 feet, 1 inch (approx. 1.84 m).

Weight: 209 lbs (94 kg)

Experience Level: 14th!

Hit Points: 121

S.D.C.: 225

Power Category: Mutant (Continuous Mutation!)

Mutant Characteristics: None

Major Super Abilities: Darkness Control and Multiple Lives.

Minor Super Abilities: Mental Stun, Nightstalking, Healing Factor, Extraordinary Physical Endurance, and Energy Expulsion: Cold (Special: Same as fire, but cold instead).

Natural Abilities: Can use Nightstalking bonuses during the daytime (because of Darkness Control); Horror Factor: 13; 40% trust/intimidate. In addition, Dr. Fright has 7 multiple lives remaining.

Disposition: Dr. Fright is bold, aggressive, arrogant, condescending, relaxed, and frighteningly upbeat and polite. He carries himself with the confidence of many years of experience and has no qualms about tricking, using, torturing, or killing others. He probably has seen and done more than all of the player characters put together. As a result, he is cool under fire, rarely loses his head over anything, thinks on his feet, is rarely surprised or caught off guard and remains astonishingly relaxed even under the most dire of circumstances (thinking all the while). He plans each of his capers carefully and will usually have a number of contingency plans in place for his escape. He also is fond of having lackeys perform the highest-risk aspects of his plans (and things he sees as beneath him), so someone else will take the heat if things go sour.

He has always enjoyed manipulating and enforcing his will upon others, and loves to terrorize mass populations of people — the more the better. However, in his later years this has become both a game and obsession (an insanity). As for his henchmen and stooges, he manipulates them through their greed, lusts (power, revenge, etc.) and weaknesses, and keeps them in line with threats, fear and murder — to defy, betray or challenge Dr. Fright is to invite death.

Appearance: A rather distinguished looking man who appears to be in his early-forties (his super healing and super endurance have slowed his aging somewhat and kept him in very good physical health). His hair is brown, touched with fine lines of silvery gray and always impeccably styled. He prefers tailored suits and soft leather gloves. His Dr. Fright costume consists of heavy rubberized body armor (A.R. 14, S.D.C. 100) that covers his entire body (except for the lower half of his face). Along his torso, arms and legs, the armor is sculpted to resemble a chiseled physique. His reinforced gauntlets, boots, belt, and shoulder pads accent this, making him look more broad and bulky than he really is. Flowing from his shoulders is a long, inky-black cape that always seems to be undulating from some unseen breeze (How does he *do* that?). Topping it all

off is his mask and a stylized metal chest plate bearing the good doctor's personal insignia.

Combat: Hand to Hand: Expert.

Number of Attacks: 7

Bonuses: +3 on initiative, +2 to strike, +5 to parry, +5 to dodge, +2 to roll with punch, fall or impact, +4 to pull punch, +2 disarm, +3 damage, critical strike (triple damage) or knockout from behind, knockout on 18-20, +40% to save vs coma/death, +6 to save vs poisons/toxins, +5 vs psionics, +6 to save vs magic, critical strike on a natural 18-20, and +1D6 damage to all attacks at night or when using Darkness Control to create shadows.

Education Level and Skills: Knows all mechanical and electrical skills at 98%, plus Prowl (98%), Climbing (98%), Surveillance Systems (98%), Radio: Basic (98%), TV/Video (98%), Pilot: Airplane (98%), Pilot: Automobile (98%), Pilot: Boats: Motor-types (98%), Pilot: Truck (98%), Streetwise (98%), Law (General) (98%), Identify Plants and Fruits (98%), Wilderness Survival (98%), Land Navigation (98%), Computer Operation (98%), Computer Programming (98%), Language: Chinese (98%), Language: Japanese (98%), Language: Vietnamese (98%), Language: Russian (98%), Athletics, and Swimming (98%).

Weapons and Melee Combat: Karate kick (2D4+3), backward sweep, tripping leg hook, paired weapons (all), body flip/throw.

Cold Expulsion: 14D6 or 1D6x10+20 (range: 300 feet/91.5 m).

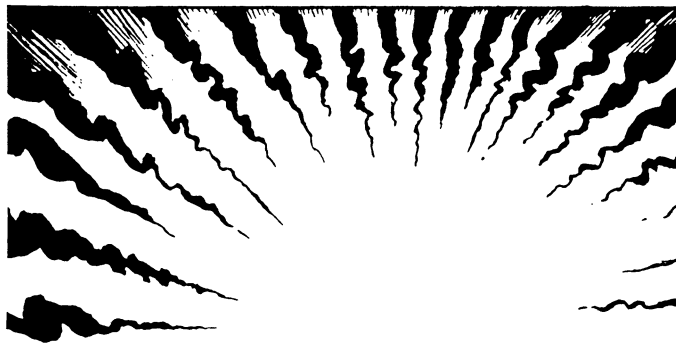

WITH FRIENDS LIKE THESE

An ancient necromancer hidden for centuries within a powerful artifact possesses a close friend of the player characters then sets out to raise an army of undead. Can the characters stop the mad fiend and save their friend?

Section One: A Quiet Outing With Friends

The player characters hear about a prominent display of Egyptian art and artifacts at a local museum through various advertisements, news segments, articles in local papers, notices on college bulletin boards, etc. If attending college, they may even be required to attend the showing for a class. If one or more of the characters is not interested in attending the show, that's fine. The show itself is historically significant and interesting, but may not interest them. It is important, however, that someone close to one of the characters — a friend, teacher, family member, or loved one — does go. Their role later in the adventure will be critical. They may be able to bring the hesitant characters to the show with them, but the G.M. shouldn't push too hard, since this is just a set-up for the rest of the adventure.

At the showing, the relics are displayed in typical museum fashion with plenty of glass display cases protecting the priceless items inside. As the chosen Non-Player Character (NPC) nears the case displaying the **Ruby Scarab of Emonhep**, both he/her and those nearby, including any player characters, will hear a somewhat distant, whispering voice intone, "Yes, yes, you will do nicely."

G.M. Info for Section One

Immediately after the voice speaks, the scarab explodes, knocking out anyone within 10 feet (3 m) who does not save vs non-lethal poison! At the same time, the lights go out for 1D4 melee rounds. When the lights are restored, the case is shattered and the scarab is gone!

Some player characters may be immune to the blast's effects (Invulnerability, high A.R., etc.), or they were able to predict it and take cover (Sixth Sense). Others might be able to see through the total darkness that falls over the scene. In such cases, there is little they will see unless they can detect or see magic and/or Astral Beings. Those who can will either feel the presence of a supernatural entity or see an Astral Form rise above the case before it explodes.

At the moment of the explosion, the *entity* enters the body of the player characters' friend/companion. The entity will go dormant once it enters the NPC, and sleep until its full P.P.E. and I.S.P. are restored. During this hibernation period, it will not show up on psionic scans or via De-

tect Magic, Sense Evil, See Aura, etc. It is completely inactive and gives off no indications of its presence, nor does it radiate any kind of evil, thoughts, vibes, etc. The only possible indication that something is amiss is that the NPC will begin to register higher and higher levels of P.P.E. and I.S.P. as the dormant spirit regains them. However, this process takes time and will only be noticeable after 12 hours and won't be unnaturally high until 36 hours or more have passed. (**Note:** If the G.M. has the **Nightbane®** sourcebook **Between the Shadows™**, the entity can be assumed to have a small Astral Realm and establishes a gateway to it through the NPC. Thus, it will not register as being present because it is in fact hiding on the Astral Plane, waiting to return when fully rested.) After 48 hours, the entity will be recharged and emerges to take control of the friend.

The Ruby Scarab of Emonhep can actually be an ancient relic from any old culture, including the Aztec, Mayan, Babylonian, Syrian, Roman, Celtic or any number of others. The version presented here is an ancient Egyptian relic formed from a large ruby gilded with gold designs and fitted with additional rubies to form the revered image of a scarab beetle. Unknown to anyone, the item is actually cursed and holds the essence of an evil necromancer from the time of Egypt's greatest Dynasties. Full details on the entity and its history are given in *Section Two* where he makes his first appearance. At this point, the characters should have little to raise their suspicions. The police will initially rule the incident a robbery and blame the swooning of the patrons on a gas of some sort. Their full investigation will take two days, including the lab work which is performed mostly by a private lab contracted by the museum. If the characters are somehow part of the investigation as police officers, S.C.R.E.T. or other government agents (the crime scene evidence will indicate the possibility of a superhuman perpetrator; see below), they might discover some details of their own. These details may also be available from contacts within the Police Department.

The crime scene at the museum is strange because the shattered case was broken from the inside. There is no debris in the case itself except for the velvet pillow the scarab was on, which is shredded as if someone had targeted it with a shotgun. The guards elsewhere will report that the power did not fluctuate at all in the other areas of the museum, and no one suspicious was seen leaving after the incident. The museum was sealed as soon as the noise of the glass shattering registered on the sonic security systems (they are coded to lock things up if breaking glass is detected). No windows or skylights were found to be opened or broken either. Just the scarab's case was damaged and only the scarab is missing.

Further details and inspection will require successful criminal science skill rolls. The most interesting piece of evidence at the crime scene is that along with the larger shards of clear glass from the case, small pulverized fragments of a red glass and metal dust are also scattered across the floor.

The Museum

- 1 Main Exhibit Hall
2 Other Exhibit Halls
3 Restrooms
4 Storage

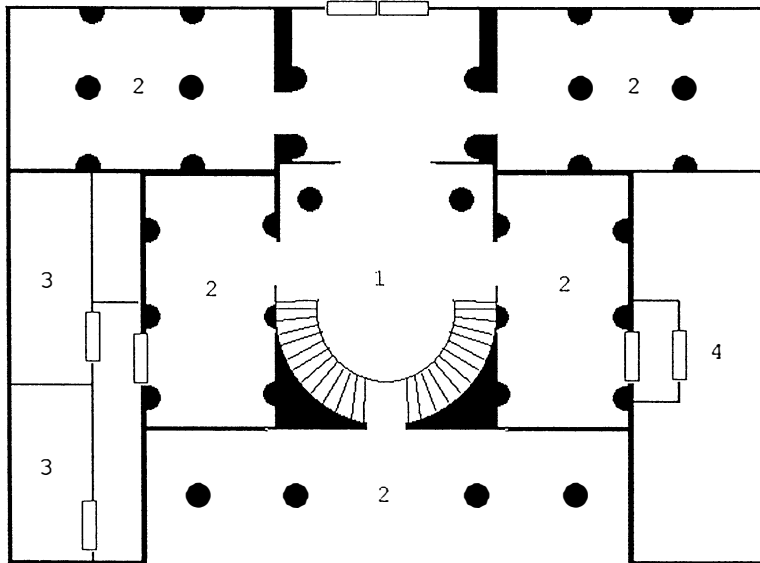

With all the evidence in, the lab goes to work analyzing it. Again, the characters may be involved if they have an established job or record for such work with the police. The first thing the lab looks into is the suspicious red glass and metal particles. A second, successful Criminal Science skill roll (if a player character is participating) when analyzing the materials reveals them to be ruby quartz and gold respectively. With this information, the only conclusion a skilled criminal scientist can reach is that the scarab itself exploded and shattered the glass. It might have also released trace vapors from the ancient tomb that caused the momentary disorientation in the museum patrons. With that information, the police will close the case and the museum will focus on filing an insurance claim for the lost relic. The player characters might be a bit more curious about the incident, though. For example, nobody can explain how or why the gem exploded. It's impossible.

If the characters do some research on the scarab, the exhibit, or any other aspect of the museum showing, here's what they can find. *Professor Anthony Dewain* is the archaeologist who discovered the tomb in which the items were unearthed. He would be the best person to talk to, but that might necessitate traveling halfway across the world to his new dig (he's not available by telephone). Going to such lengths might not be justified yet. Luckily, most of the info he could provide has been published in one form or another. It will take the player characters 4D6 hours to track down all of the information Dewain has published on his findings (hackers and other computer geniuses can cut the time dramatically with a successful computer roll prior to their research or if they have customized search programs). Here's the scoop:

The original Scarab dig was located deep in the desert and was only found because Dewain had a vivid dream and decided to "follow his hunch." His research eventually led him to the location of the undisturbed tomb of a moderately important priest from the 18th Dynasty, Emonhep.

The tomb was exactly what they could have expected, but held one surprise. Upon excavating the main chamber, they discovered the magnificent Scarab of Emonhep sitting off to the side with no other treasure to keep it company. When they removed the lid of the burial pit, other treasures and relics were discovered, but no one could explain why the scarab was isolated from the rest.

Shortly afterwards, as if trying to perpetuate the myths of mummies' curses, several workers fell ill or experienced what appeared to be bouts of dementia. One of the workers even tried to steal the scarab and another "misplaced" it during packing. Once the items arrived at the laboratory in a university in Turkey, the "curse" seemed to pass, and all was fine for the cataloging and identification phases of the project. Trouble again seemed to follow the exhibit as it returned to Egypt for display before beginning its circuit around the world. Visitors became ill, there were numerous attempts to steal one or more of the relics, and many workers quit, refusing to be near the display (many "irrational" reasons have been given for such actions). When the exhibit left Egypt for its tour of Western Europe before heading to America, the troubles all seemed to fall behind it. Until, that is, the night it came to the player characters' city, the first stop on its American tour.

The heroes may want to keep an eye on their NPC friend for the next day or so, especially if someone managed to see the entity move toward him/her. That's fine, for the person will be perfectly normal for the next 48 hours.

Section Two: Culture Shock

Once the entity is fully rested, it makes its presence known with a vengeance. If the player characters are sitting around keeping an eye on the NPC (or if they happen to live with them), refer to the first paragraph following this one. If the NPC is alone, or can slip away undetected, refer to the second paragraph. In the case that the characters are staking out the museum, also refer to the second paragraph. And finally, if the group is split up watching the NPC, staking out the museum, doing police work on the case, and any other activities, just go through each section as it is needed.

The first thing the newly awakened spirit does is take immediate and complete control of the NPC. If someone is watching the NPC at the time when the entity takes control, that individual will crack a creepy, out of character smile and excuse him- or herself, as if to leave. If the player character makes any trouble about it or wants to accompany him/her, the "friend" will react violently, using powerful *spells* to escape (see the entity's stats below). The whole time, the NPC will rant about "not having time to waste here" and about "a destiny to fulfill elsewhere." If the NPC gets past the player characters (or if they let their friend go, but secretly follow him/her), the NPC will head right back to the museum to reclaim the scarab of Emonhep. But wait, you say! Didn't the scarab explode at the beginning of the adventure? Read on, dear G.M., and all will be explained.

If nothing impedes their way, the possessed NPC arrives at the museum. If any of the characters are keeping an eye on the museum (or followed their friend), they will notice a taxi pull up in front of it and their friend gets out and looks around before moving in the direction of the museum, which is closed. Adding to the disorienting scene (if these characters have yet to hear from any of their comrades that might have been at the house when the entity took control), the friend is perhaps uncharacteristically dressed, completely in black and seems to carry himself/herself a bit differently as (s)he strides toward the museum. Do the characters call out? Do they stop and question their friend? Or do they follow and see what the person is up to? There may also be an urgency to their friend's weird actions.

Of course, if the heroes are not watching their friend or the museum, they will simply hear about the events after they have happened, which will alert them to the fact that their friend is now missing, caught on museum surveillance cameras, and wanted by the police. Plus, it seems that some other person is hunting their friend for some reason (see Section Three). Read on and tailor the events of this section to fit the actions of the player characters.

G.M. Info for Section Two

As soon as the entity takes control of the player characters' friend, it will begin working on its age-old plans. The entity, actually named **Amanon Tatumain**, not Emonhep, will send out a mystic call to those inclined to follow his evil lord Set, and are willing to build a Cult of Darkness. The effect of this power is similar to the followers aspect of the *Divine Aura* super ability. Using this power, Amanon will draw a dozen vile followers dedicated to destruction and the opposition of Light within a few hours. In fact, most of them might actually be jailed in the police station when he makes an appearance there and can be conveniently freed to help him succeed in his goals and to delay his pursuers for his escape. Should his host (the player characters' friend) be killed, one of the criminals will provide a handy back-up host.

Speaking of killing the host, the characters will have to try to defeat Amanon without harming their friend. Unfortunately, the person remains possessed until exorcised. Exorcising Amanon will send him fleeing into the scarab (if it is present) or off to one of his followers. If he survives the exorcism, he will become personally obsessed with the downfall of those who defeated him, even going as far as to remain here in America until he can extract his revenge. However, before we can talk about exorcisms, things are likely to get a bit complicated for everyone once **Bak Martuk** shows up in section three.

When the spirit takes control, the victim will be totally suppressed and remember nothing. On the flip side, however, Amanon can hear most of what the host does when he is dormant, though it is diluted as if he were half-dreaming and requires a perception roll (a 12 or higher on a D20) for him to filter a complete conversation out of the haze. The only thing he can do while dormant is listen. Taking control of the physical person will reveal his presence to the Wizard abilities *Sense Supernatural Evil*,

Sense Enchantment, *Sense Magic*, and *Sense Evil*. His supernatural and magical presence can also be detected by psychics with the psionic abilities of *Psychic Diagnosis*, *Astral Projection* (when the villain controls the body, he is visible on the Astral Plane), *Empathy* (it will be obvious that the emotions of Amanon are not those of the NPC friend), *Presence Sense*, *See Aura*, *Sense Evil*, and to a lesser extent, *Sense Magic* (but only if actually using magic; see description in the HU2, basic rule book). Also less blatant, but possibly just as obvious indicators that Amanon is in control, are the changes in the person's attitude, mannerisms, words, diction, preferences, tastes, and a general shift in personality.

If Amanon can help it, he will spend as little time as possible in the character's city. He only wants to get the scarab and return home with it to wreak havoc. By the time he returns to the museum, the scarab itself is nothing but powder. But the relic was *not* destroyed when it exploded. Rather, it "dispersed" itself at Amanon's command and is now waiting for him to return and restore it. After all, the Scarab is an ancient symbol of rebirth and regeneration, and this magical version can do just that if one knows the proper enchantments and phrase words to activate it. Having been trapped in the scarab for thousands of years, he has learned those very power words, and the relic is his to command. Now that he is once more free and far away from his old enemies, Amanon will want to return to Egypt and conquer it, using his powers and those of the scarab to raise an invincible army of the dead! All he has to do is reassemble the relic and leave.

Of course, the remnants of the scarab are no longer at the museum, they are in the evidence room of the local Police Station. Frustrated, Amanon will magically home in on the scarab to reclaim it. The player characters can confront Amanon at the museum or en route to the Police Station. If this happens, the entity will fight the heroes only as much as is necessary for him to escape and continue his quest. By the time Amanon reaches the Police Station, he (and the player characters) will have another adversary to contend with: Bak Martuk, Eternal Champion of Ra.

Amanon Tatumain

Possessing spirit from the Scarab of Emonhep

Amanon Tatumain was a necromantic sorcerer in ancient Egypt who led a powerful faction of the church of Set. At one time, he organized an army that almost conquered upper Egypt, but he was stopped by Bak Martuk, the Eternal Champion of Ra (see Section Three for full details on Bak). Exiled and stripped of power, Amanon sought to regain his lost might. He eventually rebuilt his status in lower Egypt and used it to acquire the Scarab of the Pharaohs, a legendary magical amulet of great healing and revitalizing power. With the scarab, he healed several of his best generals of crippling wounds inflicted by the Champion Bak, and promptly marched out to exact his revenge. Using a powerful ritual, he warped the scarab slightly in its function so that it could be used to preserve a soul rather than heal it and sought out Bak in order to trap him inside the scarab. During the climactic battle, Bak cut



Breaux
Johnson

down Amanon just before the Spell of Binding could be finished. Fortunately for Amanon, he used the spell on himself and fled into the magical artifact instead of facing his master Set in the lands of the dead.

The scarab and Amanon's essence drifted through Egypt for centuries and the evil necromancer was even able to escape briefly on an occasion or two by possessing specific people, but Bak was always there to stop his evil plans (Unknown to the wicked priest, the Champion of Ra had been given the ability to sense and track his old nemesis). Finally, during the later Dynasties, the Church of Set acquired the scarab with Amanon inside, but Bak and the armies of Ra were already marching to destroy them. Before the Church was destroyed, one of Set's acolytes hid the scarab in the soon-to-be-closed tomb of a priest of Ra, by the name of Emonhep. That is where Professor Dewain came to find the scarab approximately 2,000 years later. It is also why the scarab currently bears a name different than that of the spirit inside it.

Amanon Tatumain is a powerful sorcerer, but thousands of years trapped in a mystic artifact have transformed him into a kind of unique supernatural entity. He requires a vessel to keep his essence from dissipating, be it the scarab or a living person. But unlike other possessing entities, he is able to infuse his host with some measure of his supernatural essence, increasing its mental and physical capabilities. Unless stated otherwise, Amanon's stats given below add to the stats of whoever he possesses. If he should possess a Wizard, he will gain the use of the mage's P.P.E., but not his/her spell knowledge.

One interesting consideration for Amanon, if the G.M. has **The Palladium Fantasy RPG®, 2nd Edition** sourcebook **Adventures on the High Seas**, or **Rifts® Mystic Russia**, he or she may wish to use the Necromancer O.C.C. (and Necro-Magic) from that book instead of the Heroes Unlimited™ Wizard power category. In this case, keep the attributes, Hit Points, S.D.C., and P.P.E., but replace the spells, special abilities and skills with those of the Necromancer O.C.C. This option will do a lot to add some creepiness to the ancient spirit, not to mention how the player characters will react to their friend decked out in dead animal parts and bones.

Amanon Tatumain

Alignment: Diabolic

Attributes: Retains his I.Q.: 20, M.E.: 22, and M.A.: 17, as well as adding the following to the host body: P.S.: +6, P.E.: +5, P.B.: +5 (for a bonus to impress only), Spd: +4

Size: Human-sized Astral Form or that of the victim possessed.

Weight: Same as the victim he possesses.

Experience Level: 12th

Hit Points: Doubles those of the person he possesses.

S.D.C.: +50 to the S.D.C. of the victim. Armor of Ithan can also be used to temporarily provide magical armor/protection/S.D.C.

Power Category: Magic: Wizard.

Special Abilities: Amanon emanates evil power and attracts like-minded people, but rarely capable or

strong-willed individuals (excluding most superbeings). For simplicity, treat this effect exactly like #2 under the major super ability: **Divine Aura (Heroes Unlimited™, 2nd Edition, page 272)**. Within four hours of taking control of the host, all 12 of the attracted followers will have found and joined Amanon, forming the basis for a new cult of Set. By the end of a week they will have recruited twice their numbers, but the newer members will be a bit more intelligent and capable. Each month that Amanon remains undefeated, his new church will grow by 1D6 members (each having 3D6 P.P.E. to contribute to rituals and other magical effects). Amanon also has access to all of the other magical abilities of Wizard characters.

Disposition: Amanon is ambitious and driven, but his desires are currently for domination of his homeland, Egypt. He seeks power to control, direct, and dominate, and he freely uses his magic to do so. He also has a penchant for daggers, the color black, and a boar insignia (all are symbols of Set).

Magic: Amanon is a very skilled necromancer with a vast collection of spells at his disposal. He knows the following spells: All Wizard spells from levels 1-6, Agony (20), Animate and Control Dead (20), Constrain Being (20), Immobilize (25), Invulnerability (Limited) (25), Life Drain (25), Exorcism (30), Locate (30), Luck Curse (40), Minor Curse (35), Wisps of Confusion (40), Havoc (50), Monster Insect (50 or 100), Metamorphosis: Superior (100), Create Mummy (160), Create Magic Scroll (100+), Create Zombie (250), Metamorphosis: Mist (250), Sanctum (390), Talisman (500), Summon Greater Familiar (580), and Teleport: Superior (600). P.P.E. costs are listed in parentheses after each spell. In the alternative, ignore all this if the official Necromancer O.C.C. is used from other Palladium RPG books.

P.P.E.: 350. Plus, he can draw on the P.P.E. of his host body (though there probably won't be much there), and that of the scarab once he re-acquires it.

Spell Strength: A roll of 16 is needed to save against his magicks.

Combat: Equal to Hand to Hand: Basic.

Number of Attacks: 6

Bonuses (in addition to any gained from his host's P.P., P.S. or P.E. attributes): +1 on initiative, +2 to strike, +5 to strike and parry with daggers, +3 to parry, +3 to dodge, +2 to damage, +4 to roll with punch, fall or impact, +4 to pull punch, critical strike on natural 19 or 20, +1 to disarm, +4 to save vs Horror Factor, +3 vs magic, +4 vs psionics, +5 vs insanity, +8 to save vs exorcism; immune to possession. The high exorcism save is because Amanon is a special possessing entity that bonds on some levels with his host instead of simply inhabiting the body and taking control of its consciousness.

Education Level and Skills: Most of Amanon's skill knowledge is old world, but he learns and adapts quickly. He will often rely on the skills of his host to get things done by having them leave themselves notes or other reminders. His skills include: Horsemanship, History (specifically ancient Egyptian) (98%), W.P.: Knife,

Disguise (95%), Wilderness Survival (98%), Land Navigation (94%), Palming (90%), Concealment (78%), Pick Pockets (95%), Ventriloquism (64%), Language: Several ancient Egyptian dialects and related tongues (98%), and Preserve Food (95%).

Weapons and Melee Combat: Amanon rarely engages in melee or weapons combat and relies on his spells as much as possible. He also prefers to have others do his fighting for him. He will acquire a dagger as soon as he is able (perhaps at the museum), but uses no other weapons. His skill in hand to hand allows him to kick for 2D4 damage and he is also able to body flip/throw opponents.

Equipment of Note: Once Amanon takes control and starts making his plans, he will spend some time (if available) making scrolls with the Create Scroll spell. Havoc and Agony are two of his favorite spells for emergencies and will be among the first ones made, as will Invisibility: Simple and Armor of Ithan.

Special Note: Just how large of an Army of the Dead can Amanon call up for battle and conquest? Well, Amanon himself can animate 14 bodies with Animate and Control Dead, while the scarab can give him another 70! His are animated for one hour before more P.P.E. needs to be spent to keep them going, while those of the scarab are good for two hours at a time. On the other hand, the more powerful **Mummies** can be created at a maximum rate of one every third day. With the help of his followers, two could be made in one day, but he would require three days to recover P.P.E. **Zombies** can be made once per month, but if the cult grows to 36 members, two of them could be made in one night, but more than that pair per month is not really feasible unless the cult grows in multiples of 36. So if Amanon gears up for a large endeavor, after one month of intensive preparation (doing nothing but creating soldiers of the dead), he can call upon not only his cultists, but 84 animated dead, 10 Mummies, and two Zombies. Since Amanon will have to direct the army personally, he will retain 4-6 of the Mummies and/or the two Zombies as his personal bodyguards.

The Scarab of Emonhep

a.k.a. The Scarab of the Pharaohs

In addition to his own formidable abilities, once Amanon has possession of the Scarab, he will have access to additional magical powers similar to that of an Enchanted Object. The centuries Amanon has spent within this item have tainted it with his evil. Thus, the scarab works only for those of Miscreant, Aberrant, or Diabolic alignment. Even then, the Scarab's bonuses and powers will only work at half strength for any user other than Amanon.

Scarabs are traditionally symbols of spontaneous rebirth and regeneration in Egyptian mythology, but Amanon's corruption has shifted the original purpose of this item from reanimation to unnatural preservation. The Scarab now provides the following additional abilities to its holder:

1) P.P.E.: 350. Up to 260 can be used by the possessor to fuel his own spells.

2) Extraordinary Physical Endurance: The body of the character using the scarab becomes charged with supernatural energies and can withstand incredible amounts of damage as well as resist poisons and magic.

Bonuses: Adds 10 points to the user's P.E. score (to a minimum of 20); adds 200 S.D.C. to the user's existing S.D.C. and adds 35 hit points (in addition to the 10 added by the P.E. increase).

3) Spells: Turn Dead (6), Impervious to Poison (5), Blind (8), Repel Animals (7), Agony (20), Animate and Control Dead (50, but has ten times the normal effect and duration), Heal Self (user 20), Life Drain (25), Commune With Spirits (25), Minor Curse (35), Sickness (50), Spoil (30), Age (50), Curse: Phobia (40), Create Mummy (160), Summon Fog (140), Create Zombie (250), Protection Circle: Superior (250), Restoration (750) and Resurrection (2000). Resurrection and Restoration require a ritual and additional P.P.E. to be donated in order for them to be cast from the Scarab.

4) Other Magical Abilities: Fever Touch (Identical to #1 under the Powers Held by Weapons of Chaos, page 148 of **HU2**) and resistance to magic (user is +4 to save vs magic and takes half damage and half duration even on a failed save).

5) Power Level: All spells and powers of the Scarab operate at 5th level.

Section Three: A Friend Who's a Foe for a Foe Who's a Friend

Once Amanon arrives at the police station, he will make short work of the cops there, unless the player characters intervene. If the heroes are not following or trying to catch Amanon already, they will most certainly hear about the attack on the Police Station from one of any number of sources — police scanner, radio, TV, police contact, etc. By the time any delayed heroes arrive at the station (a few precious minutes before police and S.W.A.T. units from other departments arrive), Amanon will have reached the evidence and property room and reclaimed the scarab. And then, just as things seem their bleakest, another complication pops up.

As the player characters square off with Amanon, Bak Martuk, the sorcerer's ancient rival, arrives to destroy him! Ordinarily, the heroes might rejoice at getting extra help, but that's their friend Amanon is hitching a ride in, and if they want to save him/her, then they must prevent Bak from destroying Amanon by killing the host body!

G.M. Info for Section Three

What will most likely ensue is a bizarre three-way combat scene. On one side is Amanon, who would like to destroy both the player characters and Bak Martuk. On another side are the player characters. If they want to save their friend, they must subdue Amanon without destroying his/her host body, that of their friend. Likewise, they must prevent Bak Martuk from destroying Amanon's

vessel body. And then on the third side is Bak himself, who clearly had a score to settle with Amanon, and who will attack anybody who stands in his way. In all the confusion, he probably won't realize that the player characters are just defending their friend.

Bak's personality and disposition are given below with his full statistics, but the G.M. should feel free to modify him if necessary to better integrate him into the campaign or adventure. He is a warrior of good and *can* be convinced to cooperate with and help the player characters to free their innocent friend, but keep in mind that he is a determined hunter with 3,000 years of frustration and anger toward Amanon bottled up inside him. If the cost of destroying Amanon once and for all is one innocent life (and, perhaps, a handful of his/her friends), then so be it.

At the beginning of the confrontation, Amanon will be stunned that Bak has shown up here. What he does not realize is that Bak senses when Amanon is active and can home in on him unerringly. Thus, the Champion of Light has been making a beeline for this town/city ever since Amanon broke free of the scarab. The timing of his arrival is pure coincidence.

Optimally, the player characters will convince Bak that they must work together to defeat Amanon and prevent the innocent NPC from death. Together, Bak and the heroes should have pretty good chances at defeating Amanon, but it is just as likely that as soon as the battle turns against the sorcerer, the villain will use his mystic powers (such as Teleport) to escape. Of course, Amanon might teleport away soon after Bak shows up anyway, hoping that the Champion of Light and the player characters will kill each other.

G.M. Note: If the thought of the heroes and Bak fighting seems odd, don't forget that this is a really common plot device in comic books. There are literally dozens of stories where two renowned heroes bump into each other and begin fighting by mistake, only to settle their differences and focus on their common enemy. Feel free to play up this classic bit of comic book storytelling. Who knows? Maybe by the end of this adventure, the heroes will have made a powerful and permanent ally.

However, if this initial confrontation ends with Amanon still on the loose, then the heroes have a major problem on their hands. The longer this sorcerer harasses them and wreaks havoc, the less patient Bak will be with the player group's pleas that the host body (their NPC friend) be unharmed. And, the longer Amanon runs free, the stronger he becomes. If left on his own long enough, he might even establish himself as a major supervillain in the area, or he could move on to really radical things, like going back to Egypt intent on conquering the whole country. Sure, it would be a big challenge for even a supervillain as tough as Amanon, but it's not out of the realm of possibility (especially if he raises a legion of dead to fight for him). In this regard, the problems with this bad guy could jump to a much higher level than just the player characters trying to save their friend. What do they do when the Egyptian Army targets him? Can you really convince the Egyptian national government to not hurt Amanon's body just be-

cause it belongs to the friend of some American superheroes?

That's just one possible expansion of this adventure into an entire campaign. Amanon could also recruit other figures from ancient Egypt to his cause, like a warrior with a dark magical weapon or followers of the cult of Set who have superpowers of their own. The level of detail and how involved the ending of the adventure becomes is left up to each individual G.M., but one constant factor will be Amanon's need to destroy Bak. The Champion of Light can track him no matter where he goes, and Amanon won't tolerate that. He will be prepared for Bak and have traps and assassins set up at almost every turn. However, once Amanon establishes a base of operations, be it domestic or foreign, he will protect it with the Sanctum spell, thus preventing Bak from tracking or finding him as long as he is within the confines of the sanctum. This will make it difficult for Bak to ferret out the necromancer except on the occasions that the evil Wizard goes out to attend to things in person.

Bak Martuk

Eternal Champion of Light

Unlike Amanon, Bak Martuk is not a magically preserved essence. He is immortal and has been roaming the planet for millennia hunting down evil. He has a special drive to oppose necromancers and death cults due to his early and lengthy association with Ra and the resulting opposition to Set and his mortal servants. Bak was foiling the schemes of Set's minions for hundreds of years before Amanon Tatumain made his play to dominate upper Egypt. Stopping the power-hungry Wizard was no small chore, for he had with him a sizable army, but Bak gathered his own army and defeated Amanon soundly. After the dust settled, Amanon acquired the Scarab of the Pharaohs and used it to rebuild his army. Once more, Bak opposed the sorcerer. On the battlefield, Amanon tried casting a magic spell to imprison the Champion of Light within the scarab, but it failed. Bak cut down Amanon, killing him, or so he thought.

Over the next few centuries, Bak encountered plans and persons that reminded him all too much of Amanon. Questing for an answer, he eventually discovered Amanon had trapped himself inside the scarab and could come forth from it by possessing people. Bak petitioned the Lords of Light who had given him his powers for some way to sense the schemes of Amanon and was told of a way to acquire such power. The Lords of Light heeded Bak's call, and enabled him to sense where Amanon was whenever he was not hiding in the scarab. Armed with this new power, Bak easily foiled Amanon's next few attempts to spread evil across Egypt. Finally, during the later Dynasties, the Church of Set came into possession of the scarab, but Bak and the armies of Ra knew they had it. Even though the evil necromancer was not out of the crystal and Bak could not sense him, the soldiers of Light were already marching to claim it. However, when they engaged the followers of Set and defeated them, no trace of the scarab could be found.



SIEMBIEDA -99

As the worship of the Sun God and other deities of Egypt declined, Bak wore his human guise more and more. Finally, he moved out into the world to oppose evil wherever it reared its ugly head. He spent centuries moving about the nations of man, subtly helping where he could. He usually made an obvious appearance to battle the worst supernatural threats, which have been few in the last 800 years, so he has kept a low profile and is known only to a handful of heroes. He has been haunted by the disappearance of Amanon, believing the Wizard would not depart this world so quietly. Finally, in the last decade of the 20th century, he felt a tug and could sense a faraway location, a sensation he had not felt in 2,000 years. As he journeyed to meet Amanon again, he vowed this would be their final conflict, no matter what the cost.

Bak Martuk, Eternal Champion of Light

Alignment: Principled (but driven to stop Amanon)

Attributes: Human Form: I.Q.: 17, M.E.: 16, M.A.:19, P.S.: 15, P.P.: 16, P.E.: 20, P.B.: 16, Spd: 20.

Champion Form: I.Q.: 17, M.E.: 25, M.A.: 35, P.S.: 35 (Supernatural), P.P.: 21, P.E.: 24, P.B.: 23, Spd: 100.

Size: Human Form: 6 feet (1.8 m).

Champion Form: 7 feet, 2 inches (2.15 m).

Weight: Human Form: 210 lbs (95 kg)

Champion Form: 500 lbs (225 kg)

Experience Level: 12th

Hit Points: 84 (in both forms).

S.D.C.: 50 in human form and 250 in Champion form.

Horror Factor: 14

Power Category: Special Mystically Bestowed Hero.

Major Abilities: Divine Aura and Immortality.

Minor Abilities: Energy Expulsion: Light (14D6 damage or 1D6x14 or 2D6x7 if you don't like rolling handfuls of dice).

Natural Abilities: Sense Evil, See Aura (both automatic and without cost; function identical to the psionic sensitive abilities of the same names), and Supernatural P.S. when in champion form

Disposition: Bak Martuk has been fighting evil for millennium and has specifically opposed Amanon on and off for more than 3,000 years. He is definitely a proponent of sacrificing the one for the many, and the player characters will have a time convincing him to spare their friend in return for their help in stopping Amanon. Despite his determination and fervor toward Amanon, Bak is not consumed or insanely obsessed with the necromancer's destruction, and can be convinced to temper his methods, though it may take some effort to do so.

Appearance: In human form, Bak is a rather tall, handsome man with classic Egyptian features and dark skin. He prefers to dress rather sharply in suits and slacks, looking like a successful, international businessman. As the Immortal Champion of Light, he is tall and powerfully built with a dusky skin tone tinged with blue. His jaw is wide and strong, his nose almost non-existent, and his head is bald except for a braided topknot of jet black hair. Gold bracers encircle his arms, gilded falcon wing armor covers chest, and a knee length tunic covers his upper legs. Thick sandals are all that protect his feet.

Magic: Though not the natural Wizard that Amanon is, Bak can cast the following spells as per a Wizard of his experience level: Tongues (12), See the Invisible (4), Eyes of the Wolf (25), Fly (15), Dispel Magic Barriers (20), Decipher Magic (4), Eyes of Thoth (8), Turn Dead (6), Seal (7), Heal Wounds (10), and Words of Truth (15). P.P.E. costs are listed in the parentheses.

P.P.E.: 120

Combat: Equal to Hand to Hand: Martial Arts

Number of Attacks: 7

Bonuses: In human form, Bak has +1 to all rolls in addition to his level bonuses for hand to hand skills. In champion form (which he will assume for combat), he has the following bonuses: +3 on initiative, +2 to strike, +5 to strike with ancient weapons (including bows), +5 to parry, +8 to parry with ancient weapons, +9 to strike with throwing weapons, +5 to dodge, +3 to roll with punch, fall or impact, +4 to disarm, +3 to pull punch, Critical 18+, +20 damage, +5 to save vs possession and +3 vs Horror Factor.

Education Level and Skills: Bak has been educated over the years in a variety of methods and subjects.

Since Bak's education is so wide-ranging, the G.M. may assign Bak a 15% to 30% chance to perform any crucial task. However, his actual skill knowledge includes: All ancient weapon proficiencies, all wilderness skills (98%), all domestic skills (98%), Basic Mechanics (75%), Basic Electronics (60%), all espionage skills except Sniper (70%, except tracking which is 85%), Holistic Medicine (88%), Prowl (75%), Streetwise (55%), Boxing, Swimming (98%), Wrestling, Anthropology (89%), Archaeology (78%), Astronomy (89%), Botany (76%), and Chemistry (77%).

Weapons and Melee Combat: In addition to the bonuses given above, Bak is also skilled in the use of all kick attacks, paired weapons (all), and can make a leap attack (critical strike) or perform a body flip/throw. He normally carries a high-quality Egyptian sickle-sword that is +1 to strike, +2 to parry, and does 3D6+4 damage (does not add to Supernatural punching damage).

Restrained Punch: 2D6+2

Normal punch: 5D6

Power Punch: 1D6x10

Planetfall

When an alien transport ship crash-lands in the player characters' city and drops off several extraterrestrial monsters (who promptly begin a killing spree), it's up to them to round 'em up before the Feds impound the whole city (Can we say "Area 51?").

Section One: Splashdown

The characters are spending an evening doing their usual things to relax, like dancing, seeing a movie, having dinner, lounging about watching TV, or vigilantly patrolling the streets for crime (the latter for the truly obsessed or rigidly scheduled vigilante). At about 7:30 p.m., the evening is disturbed by a city-wide series of events. First, the power flickers as the whole city experiences a brownout with intermittent periods of total power loss. The clouds begin to roll and churn, almost unnaturally (but it would require eyewitness viewing by a meteorologist or someone with Control Elemental Force: Air to verify that it is not a truly natural pattern). Three or four minutes later, the clouds burst, lashing the city with an unusually violent rainstorm. The rapid development of this event and its freak size and power are too much for Control Elemental Force: Air to negate or noticeably affect.

Five minutes after the rain starts, the weather conditions in the city resemble those of a hurricane (or blizzard depending where your game is set). High winds and rain reduce visibility to near zero while numerous rooftops are ripped off and dozens of people are injured or killed from

flying debris and falling trees. Continued power loss and other problems caused by the storm only make matters worse (This would be an opportune time for villains of every stripe to go nuts, looting and pillaging, or executing some other plan they had in mind). The characters may have their hands full simply with the aftermath of this event, but read on, for it has yet to conclude.

As the storm reaches its peak, what sound like a pair of incredibly loud, reverberating thunderclaps split the air. Those farthest from the second thunderclap won't think anything is amiss, but those close to it won't be so sure. To them, it will have sounded like a building collapsed, due to the terrific crushing, grinding sound they heard accompany the thunderclap. That, and a series of ground tremors went off when the thunderclap hit, knocking many people off their feet. To these folk, they know for certain that was no thunderclap. Something big and bad has happened. But what?

Eyewitnesses able to see where the booming sound originated (but not those beyond the immediate area) will later report that the bad weather ceased immediately — some will say it looked as if it was swept away by an invisible hand. A moment later, several buildings collapsed, almost like something had hit them! After that, the eyewitnesses can't add much detail, because they were all knocked to the ground by the subsequent shock wave. Few people at the epicenter (in the buildings) survived it. So far, the projected death toll from the event is at least 100, but the number is climbing rapidly as debris is

cleared away. Disaster experts on the scene predict the death toll could be as high as five hundred. (G.M.s, tailor this to suit your particular campaign. If this happened in a highly developed urban area, then a death toll of 1,000 or more isn't out of the question, especially if it was a high-rise apartment complex or condos, rather than empty office buildings that got hit. Or, if you'd rather not kill innocent civilians, you could always have an industrial park or shopping center get leveled after hours).

Immediately following the thunderous sounds, the weather moves quickly off to the northwest of the city and dissipates. In the aftermath, authorities discover that the area from where the thunderclaps emanated is the site of a large crater, surrounded by about a city block's worth of destruction. Lighter damage can be found up to two miles (3.2 km) away! Authorities will quickly rule the incident as a large meteorite impact and set about repairing the damage. The strange atmospheric conditions can also be attributed to a meteor.

Two days later, the theory that it was actually a pellet-sized antimatter meteor is put forth. Its explosion on contact with solid matter explains the lack of any meteor debris as well as the large, but shallow crater. As far as the public is concerned, the incident has been suitably explained and is now behind them (as behind them as a space object collision in their hometown can be, anyway). Periodic reports on the repairs to the city and their effects on the citizens will be among the most visible lasting effects of the catastrophe.

Over the next few days, memorials for the dead gain widespread television coverage, as do visits from the Vice President, the Governor, and a host of disaster-relief organizations. After that, nationwide and worldwide news programs will busy themselves with discussing the renewed call for research on averting further collisions with NEOs (Near-Earth Objects). Meanwhile in movie theaters, re-releases of disaster flicks break all box office records. In the short run, the people of the city are desperate to move on with their lives. Local news programs heed this call, and begin focusing on local stories not affiliated with the meteorite strike. To that end, the biggest news item lately has been the activities of what appear to be a small group of serial killers operating within the city.

G.M. Info for Section One

The city-shaking incident described above was indeed an object from outer space, but it was not a meteor or particle of anti-matter that exploded. In actuality, the city was hit by a large spacecraft using a cloaking device. The atmospheric disturbance was caused by the cloaking field which charged up while in contact with the atmosphere. The craft actually hit several buildings and slammed into the street before thrusting back into the air and clearing the city to crash into a forested area (or desert, fields, lake, ocean, or any other convenient isolated locale not too far from the city). The spacecraft will eventually be found, but for now, the few items it left behind in the city will be the focus of attention (read on and see later sections for full details).

The public will accept the explanations given for the freak incident, but other official entities have their doubts and suspicions. Two or three days into the investigation, which will continue as long as the rescue and clean-up efforts are underway, the Police Department will find small bits of evidence to debunk the antimatter meteor theory, but they will keep it to themselves for several reasons. The first is to keep the public calm. Since the people have accepted what happened, there's no need to shake them up with doubts. Secondly, a trio of serial killers seem to have entered town and the police have their hands full with that case, even to the point of pulling all but a few investigators from the meteor case. Thirdly, government representatives have made contact with the Chief of Police and warned him to keep quiet about any contradictions or new evidence until the investigation is completed and a full and proper assessment can be made. He was also told to expect a Government investigation and that he should accommodate it as best he can; share information, etc.

The serial killers running rampant through the city are actually escaped alien creatures which were being transported on the spacecraft that crashed. When the craft touched down in the center of the city, the section holding those monsters was sheared open and a number of them tumbled out. They promptly spread out to hide under the cover of the chaos generated by the crashing ship. Each of the monsters was being held as part of a zoo-like exhibit and will revel in its freedom (as best it can, some are merely animals). The escaped monsters include a *Riathenor*, *Brakkana*, *Morphos*, *Dark Breeze*, and *Aquatic Beast*. All are found, in detail, in the **Aliens Unlimited™** sourcebook except for the Aquatic Beast, but their stats are reprinted below for the reader's convenience.

Once the killings start, the government observers will rightfully figure it to be more than a coincidence and will assume that there are murderous aliens in the city. Five days after the freak storm and meteor incident, two covert teams from the government's Alien Investigation Division (AID), Project Tyche (see **Aliens Unlimited™** for full details on this organization, too), will arrive to take charge of the investigations. One team will direct and participate in the police investigation of the serial killers while the other will concentrate on finding any evidence of the alien spacecraft which they are sure is still in the area. Player characters have five days to do what they can before they have to compete with or take orders from the Government (depending on their occupations and standings. Alien characters may even find themselves the target of the Tyche Operatives).

Adventure Timeline

Note: This is an outline of events that *may* transpire over time. If the player heroes are actively on the job, things may be resolved much more quickly. Furthermore, the G.M. can adjust and add to this outline as he or she sees fit.

Day 1: At about 7:30 p.m., the weather disturbance shakes the city, then quickly dissipates, leaving significant

but localized damages in its wake. At the impact site, in addition to those wounded by the shock waves and damaged buildings, the remains of bodies (some apparently eaten away by acid) are found — victims of the Morphos. Other bodies killed by the Dark Breeze are also found here, but autopsies will not reveal their strange state until day six.

Day 2: The meteor theory is first used by authorities. The first victim of the Dark Breeze is found away from the crash site.

Day 3: The antimatter meteor theory is proposed and widely accepted. The first remains of the Morphos' victims away from the impact site are discovered. Except for the Morphos, which is heading out of the city, all of the escaped alien creatures have found lairs and are staking out their hunting grounds.

Day 4: The first of the “serial killer” bodies are found. These are victims of the Riathenor, Brakkana, and Morphos, combined. The Morphos is located away from the other two, but the Riathenor and Brakkana's territories will separate as they fight for hunting grounds. The Riathenor will win and the Brakkana will shift his hunting in a southwestern direction.

If no one else has tracked down the Morphos, unconfirmed news that the authorities have found and captured or killed a strange monster will circulate. People in the area of the creature are told by the authorities to stay indoors at night and lock all entryways, even second and third floor windows.

Day 6: More bodies continue to turn up from the other creatures while the first victim of the *Aquatic Beast* will be found (if it is being used in the adventure). This is also the day that the teams from Project Tyche arrive in town to take over the investigation. They will remain behind the scenes for about a day as they organize to go out into the field.

Day 7: Eyewitness descriptions of the Brakkana and Riathenor are received from a few people who see them fighting from a distance.

Day 8: With the rising body counts and rumors of “monsters” or madmen on a killing spree, the people of the city will begin to stay indoors at night. At this point, the player characters should be on the case. If not, they should probably be under fairly intense pressure to get involved by one or more of the following: fellow superbeings, the media, local law enforcement, and maybe their normal friends and family.

Day 10: Mandatory curfews are established by the authorities. The city is in a panic. There's talk of the Federal Government quarantining the city and sending in their own Super-Squad to help end the killing and chaos. Rumors on the street tell of mutilated bodies, some of them half eaten!

Day 14: By the second week, the full manpower of Project Tyche will be called in with military support to find any remaining monsters.

Day 16: If the Riathenor is not caught by this time, it will have acclimated and found a way to split itself. It will then

begin “breeding” a small colony, but it will take five years for another adult Riathenor to be ready to go out.

Day 23: The cloaking device on the spacecraft finally fails and its location is revealed (see Section Seven for more details).

The following pages contain full details on each of the monsters loose in the city. In a sense, each of the aliens represents a sort of sub-adventure, with the mystery of the spacecraft representing the last. Due to the number of elements involved and their possible complexity (play testing this adventure took several game sessions), the G.M. can decide how many of them the player group actually has to tangle with and which ones might be dealt with by the authorities or other superbeings — a number of them can be handled by the police or Project Tyche, or they can escape and resurface at a later time.

Another option is to have all of the monsters except the Morphos go pretty much undetected for some time, maybe even until after the spacecraft is discovered. Then the group can learn about the ship's manifest and the warnings about its dangerous cargo.

The Riathenor

Without a doubt, the Riathenor is the deadliest of the monsters loose in the city. Only the Brakkana rivals its intelligence, and then only if it survives long enough (see Section Three for more info). None of the other creatures can match the Riathenor's cunning and cruelty, nor can any of the others use magic or long-range attacks. Taking on the Riathenor is like hunting down an entire Special Forces team rolled into one super-tough opponent. The Riathenor thinks, plans, and uses tactics. It has memorized the territory within a mile (1.6 km) of its lair and uses that knowledge to lay traps and ambush spots along every possible avenue of approach.

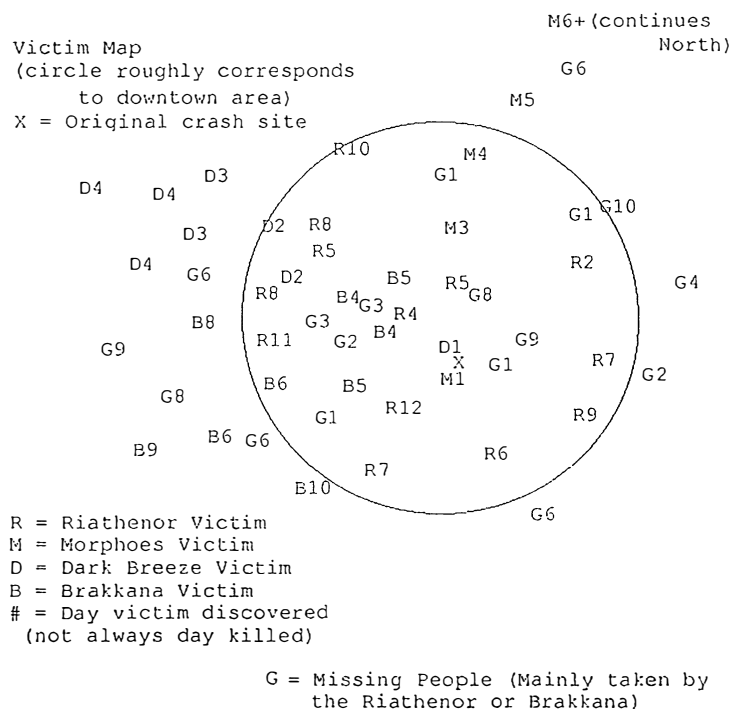

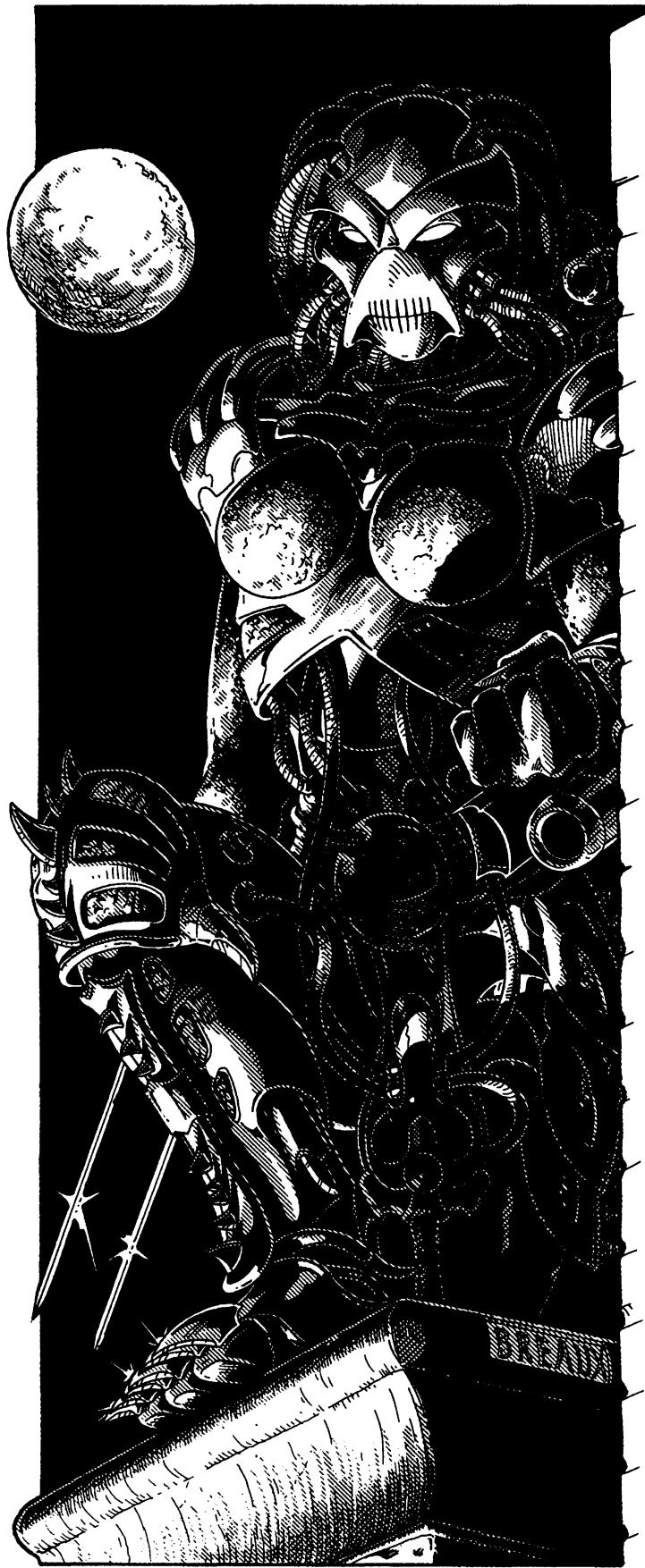

After it escaped from the damaged spacecraft, the Riathenor quickly moved away from the crash site, following the Brakkana at a distance. Once the Brakkana made a kill (which didn't take very long), the Riathenor did the same, gorging itself on the P.P.E. of its victims. Leaving

the kills in the territory of its rival, the sated Riathenor established its lair in the rafters of a long-unused hangar at the edge of the city's airport. It continues to roam away from its lair to hunt, thus leaving any evidence of its presence far from its actual dwelling.

Within a few days, the Riathenor realized it was marooned on this planet, so it began making preparations to jump directly back to its home dimension. To do this, the creature will either have to find an Earth Wizard with the right dimensional knowledge, or he must ascend to the level of a *Riathenor Dagotte*. Finding a Wizard might entail going after Vadimar (from the **Down the Line** adventure), Gary Pender (from the **Loose in the City** adventure), or some other noteworthy mage (for this, even an appropriately skilled player character may do).

As for the other option of becoming a Riathenor Dagotte, the Riathenor is not sure if it can make more of its kind in Earth's low magical environment. So, it must experiment. That requires P.P.E., so the creature kills people to siphon off theirs. It enjoys gorging itself and the replenishment of its energies is only a thin disguise for the thrill of the easy kills found on this world. As it hunts, it also seeks a worthy host for its offspring, once it is sure it can make a viable one.

To reproduce, the Riathenor separates a piece of itself into a small, independent entity. This is usually a cooperative effort between two Riathenor who combine certain aspects of each into a unique being, but it can certainly be done by one with enough P.P.E. energies and the right environment. Failed separations result in a brutish monster that can grow to the size of a car, but only if a host that big, such as a horse, cow, or similarly large animal, is available. Unlike the parent Riathenor, these monsters have little more than animal intelligence and instincts. They will take orders from a Riathenor without question, but are little use beyond warfare and labor. Of course in this situation, a guard dog the size of a horse with the armor and weapons of a Riathenor might be useful to the stranded alien, but it won't do much to help him find a way home or to build up his strength.

At this point, it will take four years for any Riathenor offspring to mature and take a host. This can provide the G.M. with some interesting campaign possibilities, with the Riathenor coming in as recurring villains as they grow in strength and number. Full information on these aliens, their brutish children, and some added surprises will appear in the upcoming **Heroes Unlimited™ Galaxy Guide**.

The Riathenor will hunt on the fringes of society, preying on the homeless, street criminals, runaways, and other folk who won't be easily missed. The Riathenor takes its victims back to its feeding den, a separate lair in an abandoned junkyard a mile (1.6 km) from its home at the airport. It lives and feeds in separate locations to throw off potential hunters and trackers. (Eventually, the feeding den will smell, and the Riathenor doesn't want to attract attention to its living space.)

The first victims of the Riathenor that authorities will find were left behind after the fight with the Brakkana (see the Brakkana description for details). Subsequent victims

will be taken to the feeding den if possible, though in some cases, the creature will deem it necessary to leave in a hurry for one reason or another and may leave behind bodies or partial remains. It can only teleport itself and an additional 50 lbs (23 kg) of weight and will only take part of the victim if it has to feed that night.

If the player characters have access to the bodies of the Riathenor's victims, they might notice that the corpses bear wounds from some kind of customized blade weapon (the laceration patterns match no blade types on record). Furthermore, the severity of the wounds (some of the bodies have severed limbs) indicate that the attacker was inhumanly strong. A skilled forensic examiner (or a character who makes a successful forensics roll) can determine that the victims were taken by surprise and probably died very quickly.

Since the victims were chosen by the Riathenor for simple convenience (it was hungry and they were available), they will have little or nothing in common. That will foil standard FBI profiles for serial killer behavior, placing the investigation back to Square One as far as the authorities are concerned. Anyone from the Hunter/Vigilante power category who has a chance to examine the bodies or the various crime scenes, however, will realize that they were the victims of a hunter, not a murderer. Given the creature's hunting patterns so far, the best bet to capture the monster would be to stake out areas where large numbers of transients, low-lives and other street people are found. There, perhaps, the creature could be spotted and trapped or killed.

The wily Riathenor is skilled at detecting traps, and neutralizing it won't be easy. The alien's prime motive is survival, so if it senses an impending ambush, it will try to avoid contact or run away. It will only attack the heroes in self-defense and if it feels it can kill one or more of them *and* still have an excellent chance of getting away. It will also avoid the other escaped creatures because it feels that they are careless and will be quickly captured by the local authorities. If the Riathenor itself is discovered, it will move to another area of town and lay low until the attention dies down. If it is hounded again and again (most likely by the player heroes), it will move on to another city.

Riathenor

Alignment: Miscreant

Attributes: I.Q.: 14, M.E.: 12, M.A.: 7, P.S.: 35, P.P.: 24, P.E.: 30, P.B.: 7, Spd: 58

Size: 7 feet, 3 inches (2.2 m).

Weight: 350 lbs (157.5 kg)

Experience Level: 7th

Armor Rating: 15 (natural).

Hit Points: 149

S.D.C.: 300

Horror Factor: 12

Disposition: The Riathenor is a cold and calculating predator. Since there are no other Riathenors on Earth, no living creature on this planet is worth this monster's consideration. People and animals are simply food. Above that, the creature is alone and its survival is paramount. It will never bluff or pass up an opportunity to preserve itself.

Natural Abilities: Heightened senses, including Ultraviolet Vision, Infrared Vision, and Heightened Sense of Hearing (all identical to the minor super abilities of the same name; see bonuses below); Supernatural P.S. and Extraordinary P.E.; regenerates 1D4x10 damage every 30 minutes; impervious to gases, poisons, drugs, toxins, disease, fire and heat (even M.D.C. and magical fires); can easily leap 20 feet (6 m); and can survive in any environment, including those with no atmosphere (vacuum).

Magic: Riathenors have natural, innate spell-like abilities. See **Aliens Unlimited™** or the upcoming **Galaxy Guide™** for more information. This Riathenor has the following spells: Tongues (12), See the Invisible (4), Mystic Shield (10), Eyes of the Wolf (25), Fireball (10), Chameleon (6), Fly (15), Wall of Flame (15), Dispel Magic Barriers (20), Invisibility (superior; 20) and Teleport (Self; 150) — statistically identical to Teleport: Superior, but only the caster and 50 additional pounds of weight can be transported. All spells function normally except as otherwise indicated. P.P.E. costs are listed in the parentheses.

P.P.E.: 190

Combat: Equal to Hand to Hand: Expert.

Number of Attacks: 7

Bonuses: +8 on initiative, +7 to strike, +9 to strike with swords, +9 to parry, +11 to parry with swords, +5 to strike with ranged weapons (aimed), +10 to dodge, +2 to roll with punch, fall or impact, +3 to pull punch, and +6 to save vs Horror Factor.

Education Level and Skills: Equal to a Military Specialist. Concealment (58%), Detect Ambush (75%), Detect Concealment (70%), Tracking (70%), Wilderness Survival (80%), Acrobatics, Climbing (98%), Prowl (85%), W.P. Sword, W.P. Heavy, W.P. Energy Pistol, W.P. Energy Rifle, Computer Operation (85%), Navigation (all) (85%), Read Sensory Equipment (65%), and Advanced Mathematics (80%).

Weapons and Melee Combat: Full details on the weaponry of the Riathenor can be found in **Aliens Unlimited™** and the upcoming **HU2 Galaxy Guide™**. Only the necessary statistics are given below. Obviously, they are truly deadly in melee combat.

Restrained Punch: 2D6+20

Normal Punch: 5D6+20

Power Punch: 1D6x10+20, but uses up two attacks.

Large Blades (right arm): 3D6 plus normal punch damage (5D6+20). A paired weapons attack with both blades inflicts 1D4x10 plus normal punch damage.

Crescent Blades (left arm): 2D4+2 plus normal punch damage.

Small Body Blades (all over): Add 1D6 damage to all kicks, punches, body slams, tackles, or other attacks. They also do 1D6 damage to anyone using body slams, tackles, grapples, or pinning attacks against the Riathenor.

Plasma Launcher (right shoulder): 5D6 or a double-barreled blast for 1D6x10. Range: 3,000 feet (912 m); Payload: 12 blasts per barrel which regenerate every 12 hours.

Heat Blaster (left shoulder): 4D6 damage; Range: 1,200 feet (365 m); Payload: Unlimited.

Particle Beam Gun (left arm): 6D6 damage; Range: 500 feet (152 m); Payload: Unlimited, but only 4 blasts can be fired per melee round (each uses one attack).

Plasma Ejector (left arm): 1D4x10 damage; Range: 2,400 feet (730 m); Payload: Effectively unlimited, but only 2 blasts can be fired per melee round (each uses one attack).

The two shoulder systems are independent, but linked to the helmet (+2 to strike). Each can be fired at different targets or aimed at the same one for combined damage in a single attack.

Brakkana

Unlike the Riathenor, which plans to escape from this world, the Brakkana likes it here. The Brakkana is a cruel and domineering hunter that takes pleasure in gorging itself on humans (a rare delicacy not easily found throughout the galaxy). And with so many people nearby, it would be out of its mind to leave such a fertile hunting ground.

The Brakkana hides during the day and hunts after dark. Despite its low intelligence, it instinctually knows that

hunting too close to its lair is dangerous, but unlike the Riathenor, it will not take pains to draw attention away from its home. After a while, its kills will form a rough circle around the general location of its lair. Originally, the Brakkana's hunting grounds were quite close to the crash site, and some eyewitnesses may even have caught a glimpse of him. A day or two later, it ran into the Riathenor, which drove it away to find other streets to hunt. The change in hunting grounds posed little problem for the beast, and the list of its victims continued to grow.

The Brakkana will be one of the most obvious of the killers. Most of its victims' bodies will be found, for unlike the Riathenor with its hidden den, it takes them to a quiet place to eat, then leaves the remains out in the open. The Dark Breeze will certainly have more victims, but the condition of the Brakkana's victims will be more striking to investigators and the public (see Section Five: The Dark Breeze for more info). Forensics will show that they were killed by powerful blows from an edged weapon, but definitely not the same razor sharp blades used in the Riathenor murders. The Brakkana eats almost all of its victims' bodies, leaving little else besides blood and a few bones with tatters of meat on them. Identifying them is rarely difficult, for the Brakkana leaves wallets and purses



behind (it has no interest in them). DNA matches against blood or other genetic material at the scene, as well as dental matches against any human teeth left behind, also help ID the victims.

The early bodies, those found on Day 4, will be only partially eaten (since the Riathenor would harass the Brakkana during feeding), giving an indication of the killer's mouth and largely discounting the possibility of a human committing the crimes. Later bodies will be found with the skull cracked open and the brains missing.

As the Brakkana continues to feed on humans, specifically the brains, it absorbs some of their intelligence, gradually boosting its I.Q. rating. If this particular Brakkana isn't caught by the sixth day, its I.Q. will reach 12 and it will evolve into a *Brakkana Leader*. Its thought patterns will become more logical and less bestial, thinking things through before acting on them. At this point, it will go into hiding and begin disguising its kills to cover its presence in a manner similar to that of the Riathenor. It will also devote itself to practicing its innate magical skills, eventually developing additional spells.

The fully intelligent Brakkana will begin hunting more and more intelligent prey, such as scholars and doctors, in a quest to enhance its own brain power. Unfortunately for the beast, this will only increase its chances of discovery, since nabbing a neurologist is considerably more difficult to do than nabbing a bum or street walker. Of course, the monster *will* get smarter after each kill, so it's plausible that it might elude capture, even as it hit higher and higher profile targets. Assuming the Brakkana stays alive and free it could evolve into a permanent adversary for the player characters. Most likely, it would start working as an enforcer or assassin for a local crime lord and work its way up the ranks by removing its rivals and superiors.

Brakkana

Alignment: Diabolic

Attributes: I.Q.: 6, but it will reach 12 by Day 6 and will max out at 14 on Day 40, M.E.: 16, M.A.: 5 (goes up by one point each time I.Q. increases; max 11), P.S.: 29, P.P.: 19, P.E.: 24, P.B.: 3, Spd: 34

Size: 8 feet, 10 inches (2.74 m).

Weight: 440 lbs (198 kg)

Experience Level: 8th

Armor Rating: 15 (natural).

Hit Points: 50

S.D.C.: 210

Horror Factor: 15

Disposition: Ruthless, cruel and cunning. Initially, all the Brakkana wants to do is eat and find a secure den. It quickly develops a taste for humans and enjoys hunting them. As its intelligence grows, the creature will remain ruthless and brutal, but cunning intelligence will replace its feral instincts. Instead of simply surviving, as it had when less intelligent, it will seek a permanent place of power and control.

Natural Abilities: See the invisible; impervious to fire and heat (M.D.C. and magical fires do half damage); track by smell 66%; smell blood from one mile (1.6 km) away and follow the blood scent at 78% proficiency;

Bio-regenerate 3D6 Hit Points/S.D.C. per minute; Supernatural P.S. and Extraordinary P.E.; poisons and drugs do half damage and have half duration and effect; Can easily leap 25 feet (7.6 m); and can magically understand any language.

Magic: Breathe Without Air (5), Call Lightning (15), Fireball (10), Dispel Magic Barrier (20), Mystic Shield (10), Paralysis: Lesser (5), Speed of the Snail (50), Eyes of the Wolf (25), Fly as the Eagle (25), Teleport: Lesser (15), Chameleon (6), Wall of Flame (15), plus select two for each additional I.Q. point it gains after reaching 12 and two for each new level of experience.

P.P.E.: 190

Combat: Natural combat ability and paired weapons (forearm blades).

Number of Attacks: 6

Bonuses: +5 on initiative, +6 to strike, +7 to parry, +5 to dodge, +1 to roll with punch, fall or impact, and +6 save vs Horror Factor.

Education Level and Skills: None to start, other than Tracking (75%), Wilderness Survival (85%), Swimming (98%), Climbing (90%), and Prowl (75%). After Day 6 it will begin to learn other useful skills (such as Streetwise).

Weapons and Melee Combat: The Brakkana has two main weapons: its sword-like arms. Very little else in the way of combat is available to it, but it can still kick, tackle, gore with its horns, and head-butt with its bony ridged head. Remember, the Brakkana has paired weapons skill with its blades and can double the listed damages by using a twin strike; however, doing so forfeits the monster's automatic parry ability until its next attack.

Kick with Claws: 5D6

Normal Blade Slice: 1D4x10

Power Blade Slice: 2D4x10, but uses up two attacks.

Gore with Horns: 4D6

Head-Butt: 3D6+ save vs Non-Lethal poison or be stunned for 1D4 actions.

Morphos

The Morphos is the least intelligent of the marauding monsters. It falls from the spacecraft and makes its way north, eating anything that gets in its way as it moves. When it first arrives in the city, it is only about the size of a 55 gallon (208 liter) drum or a hunched-over person. The G.M. may even decide to have the creature torn into several smaller pieces on impact and have each go off in a different direction (one can go into the sewers, one can move into a high-rise building and work its way down, a third can follow the route outlined here, and so on).

The Morphos is simple: It wants to eat and grow larger, then separate and do it again. If not stopped, its multiples will kill everything on Earth, then go into stasis and wait for some way to get off of the planet. Fortunately for Earth, some superhuman heroes or organization will stop that from happening, but a fair amount of havoc can occur along the way. (**Note:** A scenario where a Morphos has taken over an entire planet might serve for an unrelated, fun galactic campaign).

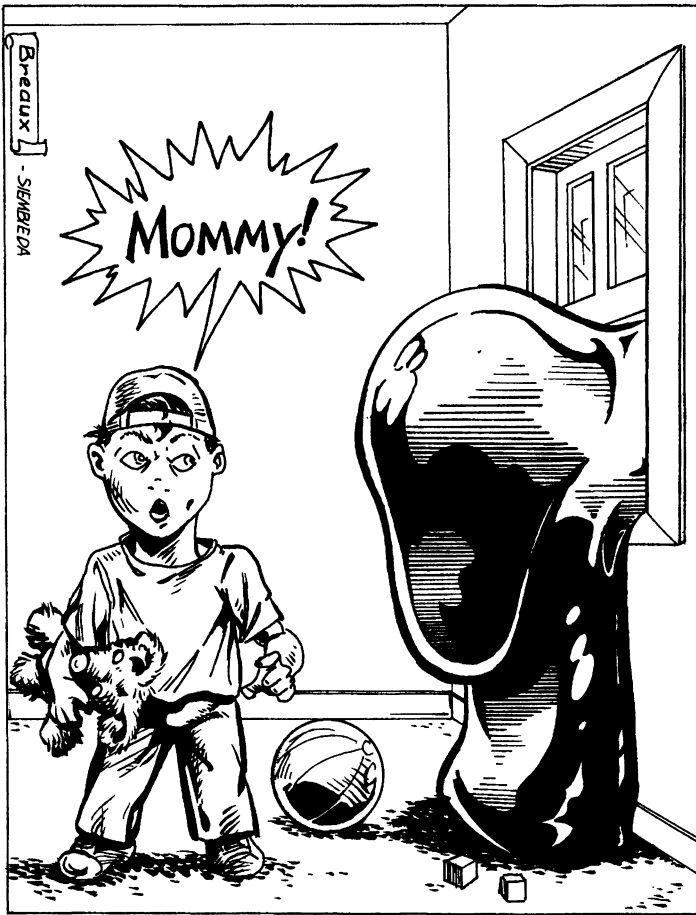

The Morphos enjoys the availability of food here, but unlike the Riathenor and Brakanna, it is not a tactical or wise hunter. These creatures can hunt undetected for several days because of their liquid appearance (they are easily mistaken for a puddle or when viewed from above, a small swimming pool) and they leave virtually no trace of their victims behind. Also, it is a night hunter and rests in shady areas during the day, furthering its innocuous appearance. It is fond of infiltrating single-family homes under the cover of darkness and eating the occupants as they sleep. Given the generally silent way in which it kills, its feeding won't attract much attention, at least not until a few days later when the police are called to investigate the missing people.

Each crime scene where the Morphos has fed will contain traces of an organic acid (the alien's digestive enzyme). Further investigation will reveal the known crimes form a rather straight line heading north from the site of the meteor impact. It won't be long after that before someone follows the line to the Morphos' current location. Unfortunately, by that time it will be huge and pose quite a problem for local authorities. In this case, if the Federal Agents aren't already in town, they will be called in.

The Morphos will likely be the most straightforward of the monsters to deal with. Once it is discovered, tracking and locating it won't be difficult, but killing or containing it might be.

Morphos

Alignment: Considered a Miscreant predator.

Attributes: I.Q.: 5, equal to a predatory animal, M.E.,

P.P., P.B. and M.A. are not applicable, P.S.: 15, but it increases by +2 per day as it feeds, P.E.: 26, Spd: 10

Size: Roughly 6 cubic feet (0.17 cubic m) to start, but it expands by about 4 cubic feet (0.11 cubic m) per day.

Weight: 230 lbs (103.5 kg) to start, but gains at least that much per day.

Experience Level: 8th

Hit Points: 30 to start, but it gains 5 per day to a maximum of 80 on Day 10.

S.D.C.: 30 to start, but it gains a frightening 2D6x10 per day.

Horror Factor: 10 to start, but gains 1 per day to a maximum of 15 on Day 5.

Disposition: Continuously hungry predator.

Natural Abilities: Does not register on thermal sensors; it's not alive in the human or animal sense (does not show up on Presence Sense, Sense Evil, or other such detecting powers). Immune to cold damage of any kind, but fire, plasma, microwave, and particle beam weapons (or similar energies, such as Energy Expulsion: Energy and Fireball spells) do full damage! All other forms of attack do only 25% of their normal damage, including punching, clubbing, stabbing, kicking, shooting, sonic attack, vibrations, electrical attacks, and powers with similar results.

Mind affecting psionics have no effect on the Morphos (including empathy), but pyrokinesis and similar powers will (though electrokinesis will only do 25% normal damage, see above). Nor is it affected by paralysis, and it is immune to Horror Factor, gases, toxins, drugs, poisons, suffocation, disease and drowning. Bio-Regenerates by eating: each human-sized victim restores 6D6 Hit Points/S.D.C.

Psionics: Though not an active psionic, the creature has a number of psionic-type abilities. Presence Sense to track prey (1,000 feet/305 m), Empathy (1,000 feet/305 m) to track prey via fear and other strong emotions, and See Aura (the only way it can actually "see" its prey). All are automatic and require no I.S.P. This creature is so alien that it can not communicate or be controlled in any way. Telepathic or empathic probes only register hunger.

Combat: Natural combat ability (see below).

Number of Attacks: 3

Bonuses: +2 to strike and +6 to roll with punch, fall, or impact. The creature can not dodge, but anything solid that hits it is held fast and absorbed (see **Aliens Unlimited™** for full details).

Weapons and Melee Combat: The Morphos has only one attack form: It flows like gelatin or thick oil onto the target and secretes powerful organic acids, dissolving it for absorption. This attack inflicts 2D4x10 damage per melee round to victims with no protection or only wearing clothing. Player characters with a natural A.R. of 7+ take only 1D4x10, and player characters in metal/ceramic armor or who have mineral/stone/metal skin take 6D6 damage per melee round of exposure.

A 10x10x10 foot (3x3x3 m) Morphos will engulf a human-sized victim in four rounds. Once the victim is broken down and absorbed (it takes an extra full melee

round for the Morphos to absorb a dissolved target), the alien immediately gains 6D6 S.D.C. and adds 10% to its size. Pulling oneself free of the monster can be done if only a single limb is ensnared (either by the initial attack of the monster or from someone ignorant of the creature's nature parrying or hitting it with their arms or legs). The following chart lists the protection of an individual (or the ensnared limb), the P.S. needed to pull them free, and the damage taken doing such.

No Protection/Clothing: Combined 40 P.S. and does 1D4x10 to the limb (this will cause severe trauma; imposing severe injury modifiers and requiring the player character to seek medical attention.)

Natural A.R. of 7+: Combined 30 P.S. and does 2D6 damage (Note: If engulfed, takes 10 times as long to digest).

Metal/Ceramic Armor or Mineral/Stone/Metal Skin: Combined 20 P.S. and does 1D4 damage (only take 10% damage from the acid, but armors will lose integrity when 60% of their S.D.C. is gone and those inside will then be in the No Protection/Clothing category.

Dark Breeze

The Dark Breeze operates very much like the Morphos in that it moves directly away from the impact site, feeding eagerly as it goes. Unlike the Morphos, the Dark Breeze is intangible and can move through walls and other obstructions, thus it will make much better time than the other monsters. This intangibility will also help keep it hidden, since those who spot it will probably assume it is just a fleeting shadow or optical illusion. That is, unless it sees *them* and attacks, but by that time, it will be too late. Escaping from the Dark Breeze is almost impossible for a normal human unfamiliar with the creature.

While the Dark Breeze's intangibility makes it almost impossible to find, its feeding method makes it very easy to track. The alien drains its victims' life energies, leaving the body behind intact and with no visible marks. Since it has no way of disposing of the corpses, Dark Breeze victims are often found soon after their death. At first glance, it will appear as if the victims died of heart failure, stroke, or some other such cause. Psionics and mages may detect something amiss, but failing that, the only thing that will tip off authorities to this killer is the trail of bodies left in its wake. Even then, until the police are sure they are dealing with an exotic predator, they will categorize it as some kind of disease or poison and will quarantine those areas, effectively locking the prey in with their hunter.

As more people succumb to the strange killer, the epidemic theory will grow stronger until something happens to change their minds. Individual investigators are likely to discount disease (finding no symptoms or presence of microbes) and poisoning (again, due to lack of any evidence), but the administration will have little choice but to maintain the quarantine until further evidence is found. The G.M. can decide if and when someone will see something or if the Project Tyche people move in to take over, but one prime chance to catch the culprit is given below.

The Dark Breeze reproduces asexually, but to do so, it must first supercharge itself as detailed under the *Bio-Ghost* power description. However, the Dark Breeze supercharges just a little differently. Because of the creature's feeding requirements (must absorb/eat 50 S.D.C./hit points per day), its supercharging does not begin until it is satiated for the day. Additionally, a Dark Breeze typically gorges itself on ten times that amount when it can. Thus, the alien may begin to supercharge after it has eaten 50 S.D.C., but it does so at a rate of one level for every 50 S.D.C. absorbed instead of for each touch. Thus, the first 50 S.D.C. merely satisfies the monster, and the next 50 S.D.C. would add +1 to P.S., add 5 points of Spd, add 5 points of S.D.C., +1 to save vs poison, and would heal 1D4 damage (if any was taken). Each additional 50 S.D.C. would add the same bonuses, to a maximum of 12 times. Additionally, if the Dark Breeze consumes 400 S.D.C. in 10 minutes (the time frame for the Dark Breeze's Bio-Ghost ability is different from the standard ability), it also gains +2 to initiative and two additional attacks.

Now that the creature is fully supercharged, it can begin separating into two creatures, but just because it is all jazzed up does not mean it will necessarily pull it off. The "birthing" process requires an additional 200 S.D.C. within 5 minutes of its start. With the average adult having 20 to 24 combined Hit Points and S.D.C., the whole process requires at least 35 victims (about 25 to charge up and about another 10 to split). A neighborhood gathering inside the quarantine (as the residents discuss their plight, for example) would be a perfect opportunity for this. Of



course, 35 is a *minimal* number and what gluttonous Dark Breeze would settle for that? There are also sporting events, rallies, and dozens of other potential scenes for a showdown. Besides, once the split finishes, both Dark Breezes will be famished from the ordeal and ready to gorge themselves.

Dark Breeze

Alignment: Diabolic

Attributes: I.Q.: 7, M.E. 17, M.A.: 3, P.S.: 8 when materialized or on the astral plane, P.P.: 14, P.E.: Not applicable, Spd: 30

Size: 7 feet (2.1 m)

Weight: None, intangible.

Experience Level: None, but psionics operate at 8th level of experience.

Hit Points: 40

S.D.C.: 40; 80 on the Astral Plane.

Horror Factor: 12

Disposition: Gluttonous supernatural predator.

Natural Abilities: Does not register on any sensors (no temperature, weightless, noiseless, and intangible), but does register on Presence Sense, Sense Evil, or other such detecting powers. Immune to all physical damage when intangible (see the Intangibility super ability for full details. Note that Intangibility is its normal state of existence and can not be canceled). Mind affecting psionics affect the Dark Breeze (see bonuses, however), but physical ones are limited by its intangibility (again, see the power description). Immune to Bio-Manipulation, gases, toxins, drugs, poisons, and suffocation or drowning. Bio-Regenerates by supercharging. Prowls at 80%; this is a visual prowling, the creature makes no noise when it moves.

Psionics: The creature is a partially active psionic with a presence on the Astral Plane, but its active psi-abilities are not extensive: Empathy, Mind Block, Detect Psionics, and Astral Projection. I.S.P.: 12.

Combat: No real combat abilities other than natural skills.

Number of Attacks: 3

Bonuses: +2 to strike, +4 to dodge, +6 to save vs psionics and +8 vs Horror Factor.

Weapons and Melee Combat: Each touch/attack by the Dark Breeze drains the victim of 1D6+1 Hit Points. Since this attack assaults a victim's very life force, it bypasses S.D.C. Likewise, armor and other characteristics that normally protect a victim from Bio-Ghost attacks do not work on the Dark Breeze. Its intangible state allows it to simply push through those defenses to reach areas that are vulnerable to its touch. Even invulnerable characters are vulnerable to the attacks of a Dark Breeze.

Aquatic Beast

Foremost (and quite obviously), the aquatic beast is only a viable part of this adventure if there is a large source of water near the crash site. Lakes, rivers, and the ocean are obvious choices, but water reservoirs and sewers with high water levels can also fit the bill. This creature

is aquatic, not amphibious, but it is large and tough enough to drag itself, even over a few miles, to the life-saving waters it needs. In the chaos of the impact and the torrential rains (another reason it can initially survive while getting to water), it could easily go unnoticed, being mistaken for a car in the showers and confusion.

G.M. Note: If you choose not to use the Aquatic Beast or have no ready water for it to live in, it can be the first monster found, having died mere hours after the rain ends. You may even want to have the characters tussle with it near the impact site, thus using it as a tool to set the mood of the adventures while simultaneously removing it from the scenarios. This would also give the characters reason to suspect there may be other creatures loose (though they may mistakenly think they are all like this one), a belief justified when the "serial" killings start.

Once it finds a body of water, the Aquatic Beast will be the most difficult to find. Its victims will rest on the bottom of Davy Jones' Locker, so they won't be spotted. Even if missing persons are reported near the water, an underwater search effort is difficult to carry out under the best conditions, much less when a wily alien predator is involved. For the most part, it will sit on the bottom, waiting for prey to pass by.

The Beast is smart enough to avoid ships, nets, and other objects, but it will not be able to resist snacking on any divers that go poking around the depths. Thus, once the authorities get onto the trail of the monster, it won't be long before they are quite sure that they are dealing with a large, carnivorous animal of some kind. Forensics may initially mistake the monster's victims for shark victims (if along an ocean). However, a more detailed examination shows that while the victims' bodies bear shark-like bite marks, they also seem to have been held by sucker tentacles. Each tentacle also ends with a single large claw or talon, the wounds of which will further complicate forensic conclusions, except to say that whatever killed these victims was most certainly not a normal animal ("This was not a boating accident!").

Any bodies found will be completely devoured with only bones left and many of those will be broken or chewed into pieces. Considering that bodies will be eaten in the water and the leftovers will sink to the bottom, finding the Beast's victims is an unlikely way for the authorities to discover and track it. Instead it is likely to be seen grabbing somebody from the shore. After that, it is up to the heroes or the authorities to locate it under water and confront it in its native element.

Aquatic Beast

Alignment: Considered a Miscreant predator.

Attributes: I.Q.: 7, M.E. 17, P.P. 13, P.B. and M.A. are not applicable, P.S.: 30, P.E.: 28, Spd: 6 on land and 39 in the water.

Size: An amorphous, lumpy creature roughly the size of a full-sized automobile, about 20 feet (6.1 m) long and 6 feet (1.8 m) high.

Weight: 3,200 lbs (1440 kg)

Experience Level: Not applicable.

Armor Rating: 13 (natural).



Hit Points: 160

S.D.C.: 650

Horror Factor: 14 on land and 16 underwater.

Disposition: Animal predator, very much like a shark.

Natural Abilities: Short burst of speed underwater, 60 mph/88 kph for up to one melee round, and has natural radar/sonar (range: 80 feet/24.4 m on land and 250 feet/76.2 m underwater). Venom in claws (2D6 damage plus save vs lethal poison or go into convulsions for 2D4 melee actions), and spray ink similar to an octopus (treat as a Cloud of Smoke spell cast at 10th level when used in the water. On land it has a range of 20 feet/6.1 m and acts pretty much like throwing paint on a 3 foot/1 m area, staining and coating whatever it contacts. The ink washes off with water if done within 10 minutes, but after that it dries and will require 1D4 weeks to wear off. Bio-Regenerates 6D6 Hit Points/S.D.C. every hour.

Combat: Natural combat ability.

Number of Attacks: 4 plus 1D4 for a varied number of tentacles (roll once to determine the total number of attacks the creature has every round, do not roll each melee round to determine attacks for that round).

Bonuses: Note that all bonuses are halved when on land: +4 to strike; +4 to roll with punch, fall or impact; +2 to dodge. When on land, the creature has +3 to strike with its ink spray.

Weapons and Melee Combat: The Aquatic Beast attacks with clawed tentacles that inject a convulsion-inducing toxin. The helpless victim then is drawn into the tooth-filled mouth for ingestion. If the attack roll for a tentacle strike is a natural 18-20, the tentacle will entangle and automatically does damage for each attack unless the person is freed by pulling it off (combined P.S. must exceed the Aquatic Beast's by at least 8 points) or cutting through it (each tentacle can take 50 points of damage before losing the ability to constrict, but it can still lash out with the claw until it takes a total of 70 points of damage). Note that once someone is entangled by one tentacle, others can entangle for additional crushing damage. Entangled victims can not dodge and are -6 to parry any additional attacks. The monster will have two tentacles plus the number rolled on the D4 to determine its extra attacks.

Clawed Tentacle: 3D6+15 plus 2D6 poison damage.

Tentacle Squeeze: 2D6+15 per tentacle.
Bite: 4D6

Spaceships

They Can't Just Vanish, Can They?

As the timeline reveals, 23 days after the crash, the spacecraft's cloaking defenses fail, and the ship suddenly appears in a field outside of the city. If possible, it is a wilderness area no one would regularly wander through, but failing that, any open area will do (abandoned factory site, rock quarry, used farmland, etc.). The characters might even learn about the location of the craft before day 23 if some farmer tries to plow his field and runs into an invisible metal wall, or some such. Otherwise the characters can learn of the craft's location any number of ways, depending on their affiliations, but if all else fails, the afternoon news will be quite helpful.

"We interrupt your afternoon programming for a Channel 5 news flash." In the early afternoon, the logo of the local news station cuts into regular television programming with a special report. After some introductory remarks by the news anchor, the image changes to that of a field reporter. She is walking quickly but carefully along the ground, holding her microphone in one hand while holding her earpiece in place with the other.

"Good afternoon," she begins. "This is Margaret Dannison reporting live, north of the city. We are here to give you the first look at this amazing sight reported by ..." the camera pans up and away from Margaret to a large object on the far end of the field, "... local residents only a half hour ago."

The object is large, dwarfing a jeep caught in the edge of the shot, and fills the entire screen. It is roughly pine cone-shaped and partly buried in the ground. The base where it contacts the Earth appears to be heavily damaged, like the thing crashed or was dropped. The reporter continues to narrate the scene, indicating the damage at the base of the object, the stories of the eyewitnesses, and the possibility that it could have been involved in the meteor incident almost a month ago. Mere minutes after the newscast signs off, police and government teams arrive on the scene.

G.M. Info for Section Two

The news report can be used to inform player characters of the location and existence of the spacecraft, should they need such information. Those who have other leads and may have arrived at the site earlier will be able to watch as the reporters arrive, followed by the police and other authorities. Getting there first will make it easier to enter and investigate the alien spacecraft. Once the authorities lock the site down, however, access will be denied to anyone not part of an authorized government response team, such as S.C.R.E.T., Project Tyche, or a similar group. Even reputable and well-established Super-Teams are likely to be turned away, despite their experience with handling some or all of the escaped monsters over the last few weeks. Getting into the alien craft will require a bit of stealth and possible fast talk to get past

guards posted around the crash perimeter, but the rural location will make infiltration of the place far from impossible.

The spacecraft was heavily damaged when it entered Earth's atmosphere, but its cloaking systems remained operational as a fail-safe to keep it out of the hands of native populations in just such a situation. It dropped low over the city and rammed several buildings before succeeding in making one last thruster burst (a gravity pulse that hit the city like the impact of a solid object) that launched it up and over the city to crash in a large field in the countryside. When it impacted the city, the monsters on board were thrown clear as their holding areas were sheared open.

So what actually caused the craft to crash? The exact details are up to the G.M. and may never be known to the players, but here are a few ideas. Use the one(s) that make the most sense and excitement for your campaign.

- The simplest possibility is that the craft malfunctioned and crash-landed here. In this case, it is highly likely that at least one of the crew could have survived and may be hiding nearby (or they could have entered the city and stumbled upon the player characters, thus giving the group an excuse to explore the craft before the government people). Of course, the crew could just as easily have been killed in the crash, or the vessel could be completely automated (with its computers or Artificial Intelligence burned out), leaving the ship as a mystery, perhaps never to be solved (or as a lead-in to a future adventure).
- The crashed spaceship could have been shot down by another craft. In this case, not only would the aggressors possibly land to finish off their victim once it de-cloaked, but there is the possibility that the downed aliens are themselves evil or dangerous. In the latter case, not only would the rampaging monsters have to be dealt with, but their heartless masters (run-away supervillains?) could also be loose in the city (or anywhere in the world!).
- To add another twist to the idea of the craft being shot down, consider the possibility that it could have sent out a distress signal that is answered by day 23. There could be a great deal of activity in the city if, in addition to the monsters set loose three weeks prior, there are also alien crew members, the people hunting them, the people coming to rescue them, *Project Tyche* and *Project Secure* looking for them all, *Triton Industries* looking to make a buck and copy some tech, *Reach Up* trying to save everyone from the evil government operatives, and *S.H.O.C.K.* trying to kill the aliens and their foolish sympathizers (see **Aliens Unlimited™** for full details on these alien hunting/watching organizations).

The Spaceship. The craft itself is mostly intact, resting in a large depression (not quite a crater). The G.M. should feel free to have whatever systems he wishes destroyed in order to keep them out of the hands of either the player characters or the authorities. Of course, putting the wrong things into the hands of the right people is the perfect trigger for another adventure. Remember that though it might

be cool to give the players a few energy weapons, gimmicks or a vehicle, keep in mind that certain power categories have such items as part of their unique “powers” and giving them to others might diminish that. Also remember that recharging stations for E-clips on Earth are rare and unless the group has an Electrical Genius from the Hardware category, they will have a finite supply of charges. Other equipment might be more practical, however, including translators, armor (again limited by the lack of repair technologies without the help of an Analytical Genius), special melee weapons, or a powerful item or two that will be needed an adventure or so down the line. This is certainly an opportunity to reward your players, so don’t pass it up.

It is also well within the G.M.’s rights to simply have the craft overload and self-destruct shortly after revealing itself. Perhaps the entire vessel self-destructs once it has been “invaded by aliens” (i.e. Earthlings). Certainly, if the crew survived and managed to send out a distress call, they might destroy the vessel (or at least the insides, leaving only a broken shell) and would then attempt to hide out until they rendezvous with a rescue ship.

However, for those without the time (or inclination) to work out the details, here is one possible closing for the adventure. The craft is an *Arreri* transport with advanced cloaking systems (equivalent to Invisibility: Superior) and anti-gravity drives. It was delivering the alien monsters to a research center on the edge of the galaxy when it encountered trouble in trans-light travel and dropped out in this solar system. It sent a distress call (but it will take a year for it to reach home base and help to arrive) and prepared to crash-land on the nearest habitable planet, Earth. Encountering troubles when its cloaking systems ionized and agitated the local atmosphere, but unable to drop them due to alien contact regulations (avoid contact with primitive races at all costs), the vessel made a barely controlled descent and almost crashed in the characters’ city. Instead, it recovered just enough altitude with a gravity pulse to land outside the city. The final impact ruptured more containment systems and released a deadly virus that killed the crew. Luckily, the charge of the cloaking field contained the virus and after its 18 day cycle, it died off. The main computer remained online for the 23 days until auxiliary power was used up. As the power levels began to drop, the computer initiated its final alien contact protocols and fused all of the circuits on the craft, thus dropping the cloak and revealing the ship, but making it virtually useless. All of the computers and other systems, including the gravity drives, advanced communications, energy weapon systems, etc., are useless slag. No technology can be extracted from them.

Basically, the only useful items the Earth people can salvage are the crew’s personal equipment, including:

- Four high-powered tasers (-2 to save against their effects).
- Four ion blasters (Range: 400 feet/122 m; Damage: 5D6; Payload: 10 shots per E-clip; Rate of Fire: Single shot; Could be quickly sold to a corporation or private individual for about \$50,000 each, but the risk of being arrested for trafficking military weapons exists).

- Four suits of FAS torso armor (A.R. 10, S.D.C. 80).
- Eight thermolite work suits (insulated to +/- 40 degrees).
- Four micro-translators.
- An atmosphere analyzer.

Full details on all this equipment can be found in **Aliens Unlimited™**. If you don’t have that book, then just fake it and assign percentages or common sense rules. Most are pretty self-explanatory by their names.

HOLY TALKING ANIMALS!

This adventure is centered around mutant animals. The G.M. may feel their inclusion in his campaign is inappropriate or funky. That’s perfectly all right. Just skip it, or replace the animals with human experiments.

Section One: Mousecapades

The player characters are watching a special “live” segment of the evening news at the local branch facility of Genetech, a medical development corporation. The interview is the usual kind of public interest thing in which the Corporate Representative is asked what Genetech is currently involved in, some of the breakthroughs or achievements they have had, and what it all means for the community or city. During the interview, however, the blurry image of a mouse’s head and upper body appears, filling the screen. It is apparently hanging from the lens of the camera. The whole thing at first seems funny and somewhat surprising, but it gets even more astounding when the camera auto focuses on the small creature and the viewers realize the mouse is saying the words “help us,” over and over, although the lack of a microphone makes it seem more like the creature is only mouthing the phrase. The cameraman quickly notices and the view shifts to another camera.

G.M. Info for Section One

After the newscast, the player characters are likely to go to the television news building to talk to the news crew who was at Genetech. All they know was that this strange, little mouse was dangling on the camera, but they shoed it away. They didn’t notice anything unusual, and find the suggestion that the mouse may have been “mouthing” the words “help us,” to be ridiculous (to the point that they may refuse to review the tape of the interview). However, if the tape is reviewed, there is no mistaking it. The mouse talked!

Obviously, this should prompt the heroes to investigate further, unfortunately, the news team also plans to conduct an immediate “hidden camera” investigation, whether the heroes like it or not. This means the news investigators might get underfoot, get themselves in trouble, or

blow the heroes' cover or investigation (G.M.'s discretion on this subplot).

In the alternative, the news people *may* chalk the whole incident up to some bizarre hacker break-in. As far as the Station Manager is concerned, some up-and-coming special effects whiz must have hacked into the broadcast to showcase his abilities, because Genetech can't explain the incident, and no other explanation makes sense. Right?



A close encounter (with a mouse?). Either at the news station (by having hitched a ride, unseen, in a camera case, jacket pocket, etc.) or hidden someplace in or near the lab, the mouse — an intelligent mutant named Sherrie — will approach the heroes. She is looking for anyone who she thinks will be able to help her fellow animals at the Genetech labs. Once she figures out the heroes are there to help (perhaps by picking up on what they say, noticing that they aren't wearing Genetech uniforms, or recognizing them from a prior newscast about "superheroes"), she will attempt to hitch a ride on one of them. It shouldn't be hard, considering her small size and stealth. Once she has latched onto one of the heroes, she will lie low until she thinks she can speak freely (i.e. the group leaves the news building or laboratory, and returns to their headquarters). Once there, she will come out of hiding, introduce herself, and ask to go somewhere *safe* to talk before explaining the dire situation unfolding at the Genetech facility. At this point, she will try to dissuade the heroes from going inside Genetech. She also will not allow herself to be taken back inside the facility. If the heroes make like they are going to return her to Genetech custody, she will struggle free and escape. She will try to contact the heroes again, probably at their headquarters, over the phone, or by some other means.

If the group splits up and goes to both the studio and the corporation, Sherrie will be waiting at the Genetech facility to contact whatever heroes arrive there.

As an alternate beginning, the heroes could receive a videotaped distress call from the mouse, mailed to their headquarters or the news station (who presumes it is a hoax, but may air it for fun on a slow news night. Or maybe it appears on the Internet). The return address on

the package bears Genetech's address, so it appears to have been sent from the Genetech mail room! That a mouse could operate a video camera, much less say "Help us!" repeatedly in English, certainly bears investigation.

Sherrie, the Mutant Mouse

Sherrie is a small, brown, field mouse. She and her siblings were captured and sold to a medical research supplier and eventually ended up in the Genetech facility. Sherrie and the other mice were caged and well fed, living in the strange new surroundings for a few weeks before the experiments began.

Sherrie was bombarded by radiation and underwent numerous other painful experiments, but with each progressive stage she grew smarter and more aware of what was going on around her. She watched the doctors and the other animals, keeping tabs on when the animals did certain things and when they were taken away. She learned that dead animals were taken "out to the morgue" or "down the hall." She noticed that completing certain tasks or puzzles got one taken "downstairs" or "to the vault."

Sherrie was smart enough to act like a normal mouse and the scientists bought it, never suspecting she was so radically altered. Occasionally, the "men in white coats" would bring animals back up from "downstairs" or "the vault," and Sherrie learned of horrible things going on down there. She doesn't know enough to be specific, but she speaks of failed experiments, insane mutants, monsters and specialized training many of the lab animals were forced to endure.

Using her intelligence and the fact that the scientists didn't suspect she was changed, Sherrie initiated a successful escape. She has no real skill training, but her high intelligence and small size make her quite resourceful.

Sherrie Mouse

Alignment: Unprincipled (with leanings toward Scrupulous)

Attributes: I.Q.: 16, M.E.: 17, M.A.: 13, P.S.: 1, P.P.: 17, P.E.: 12, P.B.: 17, Spd: 30 (Note: These stats have already taken Sherrie's small size and size penalties into consideration.)

Size: 5 inches (12.7 cm).

Weight: 5 ounces (140 g)

Experience Level: 2nd

Hit Points: 18

S.D.C.: 5

Power Category: Mutant Animal.

Animal Characteristics: Hands: Full, Biped: Partial, Speech: Full, Looks: None.

Animal Psionics: Sixth Sense, Animal Speech, Animal Control, Telepathic Transmission, and every "heightened sense" minor super ability (hearing, smell, taste, touch, and x-ray vision).

Natural/Animal Abilities: None, but her small size means that unless she is actively standing still and not dodging, humans will need a called shot at -3 to hit her in combat (15 or higher with bonuses). If she is on the move and/or dodging, attackers are -7 to strike her.

Disposition: Sherrie is very friendly, playful and helpful.

She looks forward to whatever happens next and likes to have fun exploring. She also has a soft spot for toys and games, such as remote control cars she can get in and drive, and playing superhero.

Appearance: Sherrie looks just like a small, brown, field mouse. Only the most astute observer would notice her opposable thumbs and the intelligent glint in her eyes.

Combat: Equal to Hand to Hand: Basic.

Number of Attacks: 4

Bonuses: +1 on initiative, +2 to parry, +2 to dodge, +2 to roll with punch, fall or impact, and +2 to pull punch.

Note: Sherrie has no real offensive capabilities, so if she is ever caught in combat, all of her attacks/melee actions are likely to be spent dodging and running for a hiding spot.

Education Level and Skills: Minimal; Prowl (85%), Climbing (81%), Swimming (70%), and Identify Plants and Fruits (60%). If befriended and trained by a human, she can learn up to six secondary skills plus an additional one (1) secondary skill at levels 4, 6, 9, 11 and 13.

Weapons and Melee Combat: None. Because of her small size, Sherrie relies on stealth and her psionic abilities to help out from a distance. Any attacks would do only 1-2 points of damage.

Section Two:

The mouse told me to do it!

Now that the group has the whole story from Sherrie (at least, as whole a story as Sherrie can tell at this point), they can decide how to proceed. Sherrie will be overjoyed at her freedom and won't be too concerned with getting caught now. She will romp about whoever's house or headquarters she is staying in and leaves the group to plan. If asked questions about the facility or the doctors, she will answer them as best she can. The characters should somehow try to verify her story, also. The word of a mouse will have little weight when the authorities ask for an explanation. Besides, although some of the things Sherrie tells them does sound nefarious (like monsters), they might be conducting legitimate animal experiments for medical research. Maybe she's a fluke.

If no one else suggests it, Sherrie will volunteer that there were plenty of computers in the facility and the doctors must have put everything on those computers. Maybe hacking into them will be helpful. The group can also break into the facility itself and poke around, but Sherrie can only give them information on the elevators, sub-level two (where she was kept) and her vague impressions of some other areas.

G.M. Info for Section Two

Sherrie knows there are big, bad animals, and things she's been told are "monsters," on the lower levels, but not what kind. If the group decides to hack into the Genetech computers, Sherrie can provide some codes she learned from observing the doctors (they give a +15% bonus to the hacking attempts). From the computers, they

can get some idea of what kind of "monsters" might be waiting for them in the facility. Otherwise, they can proceed directly to the complex and find things out the hard way (see Section Three). The computer system will also have maps and security information on the Genetech facility (exact security on the more sensitive info will vary from -20% to -45% on hacking rolls). Most of the computer files are extensive and quite technical. Characters will have to be Medical Doctors or have a scholastic Biology skill to decipher most of it, though Sherrie can help by explaining some of the terms the doctors used when referring to the animals and some of their specific conditions.

If no one in the group has the right medical, science or security skill, they will only be able to glean the following information from the hacked files, though a successful Research skill roll (but at -30%), once the data is acquired, could provide the same information as if the group had the right medical skills (each research roll takes 1D4 days):

1) There are some big rats and snakes on the lower and most secure levels, but their exact size can not be determined from the text.

2) The more intelligent animals are being trained within specific programs, but the exact nature can't be deciphered (Sherrie can tell them what she was told some of the animals were being trained for, however).

3) There are some kind of "protocols" in place for the event of a mass animal escape, indicating the staff feels the animals could be somehow dangerous. Militarily trained player characters will recognize the protocols as the kind put in place when an important but potentially dangerous prisoner is being held, such as a top-level spy or secret operative.

A group with the right skills can find out a lot more. In addition to the information above and following, anything in Section Three that the G.M. feels could be uncovered will also be in the files. None of the security information from the files is listed below, so it will need to be drawn from Section Three.

1. The animals on the lower levels are those considered the most dangerous for one reason or another and they are held within suitably secure areas. It is not clear from the files how the staff differentiates between "failures, non-viables, alternative possibilities, hazards, threats, formerly viable, and potentially viable subjects," but those are the many labels affixed to the subjects that are obviously not deceased.

Among those live subjects are snakes, rats, mice, dogs, and an alligator or two. The apparent size categories of each varies, but numerous indicators (such as drug doses, etc.) point to the fact that each is at least 300 lbs. (480 kg) and some much larger! One of the rats, for example, receives tranquilizer doses roughly on par with what one would give to an elephant!

The intelligence of each is roughly equal to that of a well-trained dog. Smaller animals are also held on the lower levels. Many of them have no indicators of their danger except for intelligence scores rated above most humans. If the latter is mentioned, Sherrie will confirm it and says that she avoided the lower levels by acting dumb.

She can also tell them that some of the smaller smart-animals may be down there because of mind powers, or “mental hyper-development” as the scientists often called it (which Sherrie also possesses).

2. The more intelligent animals are being trained in military-style intelligence gathering. The details will be obvious to anyone with the intelligence skill or extensive military training: Genetech is conditioning the normal-looking, intelligent animals to operate as spies and information gatherers. Are they to work for the government? Nothing in the files will indicate that the government is involved, but some information points out that Genetech is working very hard to secure a contract with an as-yet unnamed “K-9” program with the Pentagon. Genetech is working so hard on developing the prototypes for this project that they are flat-out abusing, torturing and brainwashing the intelligent animals it is producing (like Sherrie).

Other animals not suited for this Pentagon project are being horribly mutated and experimented on with total disregard to their obviously heightened senses of fear and pain. These animals know full well what Genetech is doing to them, and it’s pretty clear that Genetech doesn’t care.

Note: Forget animal rights, some of these critters are obviously as human as any intelligent alien race. Hopefully, Sherrie Mouse will have endeared herself enough that any doubts that might come up will be wiped away if she makes big, sad eyes and pleads for the group to help save her buddies. Alternately, the city or nation the campaign is set in might actually have laws in place to prevent this sort of experimentation. Not only because it is inhumane, but dangerous to the human population. If the authorities have had extensive contact with mutants or aliens, it could be quite plausible that in such a superpowered setting, many special laws have been passed to protect those with unique abilities. In such a case, this makes Genetech far worse than just another callous biotech corporation. It makes them a death factory, a mass-offender involved in premeditated murders, aggravated assault, torture, numerous crimes and conspiracy. This being the case, the heroes will have more than enough justification to go after Genetech, but without any legitimate, legally obtained evidence to present to the authorities. The best they can do is a vigilante-style raid on the labs to free the mutated animals and put an end to the abominable experiments (via bad press and the number of investigations the heroes “raid” will bring on the facility. Perhaps in the ensuing chaos, the police and/or fire departments, and/or media, will arrive on the scene and learn what is happening at Genetech before the company has the chance to cover things up. Maybe an “anonymous tip” from one of the player characters [or a mouse] will help).

3. The protocols that are in place to stop a mass escape of animals are scaled in their severity depending on how close escaped animals are to getting out of the facility. In general, non-lethal security measures are used first, but in extreme cases, Genetech has a variety of lethal means at its disposal (See Section Three for more information).

Everything in this section can be discovered by the characters as they explore the Genetech facility, but they would do well to learn as much of this beforehand as they can. Having the foresight to get it in advance will certainly earn them some experience points for clever ideas, good judgement, and possibly avoiding unnecessary violence.

Section Three: Into the Maw of Science

The Genetech facility is a large, single-story structure on the edge of one of the city’s industrial districts, most likely near an interstate or highway system, and/or railway. It has a pair of helicopter pads, huge delivery doors in the rear for truck unloading, a staff entrance and a public access entrance. The entire facility is sealed off by a 10 foot (3 m) tall chain link fence topped with razor wire. Astute visitors will note that the top of the fence is angled in *toward* the facility, rather than out toward the street. This is typical only of prisons and other places where the fence is designed to keep things in, rather than keeping unwanted visitors out. There is a single checkpoint gate through which all visitors must pass. At the guard station, all visitors must present identification and announce the purpose of their visit. Unless visitors have an appointment with Genetech staff or are recognized law enforcement officials, they will be turned away.

G.M. Info for Section Three

The Genetech facility is not open to the public. There is a public entrance, but it is normally only used by personnel invited to the grounds or those delivering small packages. The player characters will have to break in or come up with a mighty impressive scheme to get them past security without sounding an alarm. There are four guards on each floor of the facility, plus another in the lobby, one at the checkpoint gate, and another four patrolling the grounds. The four guards on the first floor monitor the facility security cameras and alarm systems at all times. If an alarm is tripped, they will respond themselves but they are under strict instructions *not* to call the police. Bringing in outside authorities might bring unwanted attention to the mutant animal program downstairs (**Note:** The G.M. may wish to add a few more guards or a special lesser superbeing as Head of Security to make things more difficult for the heroes, but this place shouldn’t be made into a small fortress. After all, it’s only a private company, not CIA headquarters).

Each of the doors inside the facility has an electronic lock that requires a pass card (-30% on locksmith or electrical engineering rolls to bypass it). Once inside the facility, the characters will have to contend with surveillance cameras and thermally activated motion sensors, but most of the sensors are low to the ground or placed in the ventilation and crawlspace areas to detect the presence of small animals. A little bit of thinking will be needed in addition to some prowl rolls.

Genetech Facility
Ground Level

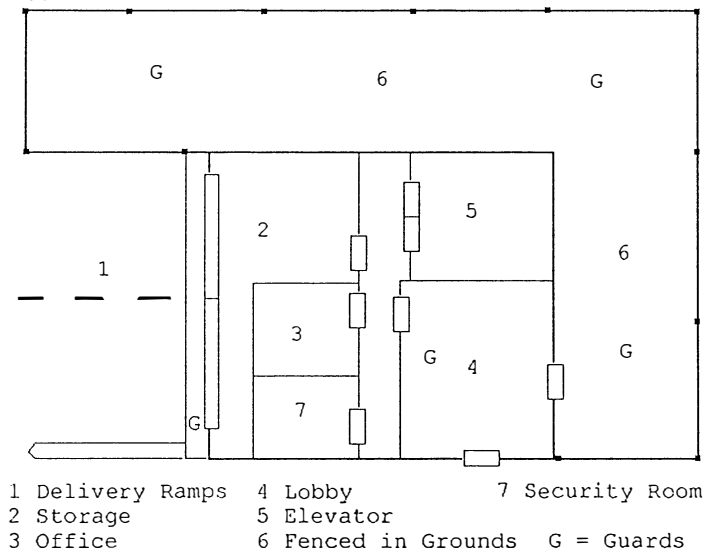

Sub-Level One

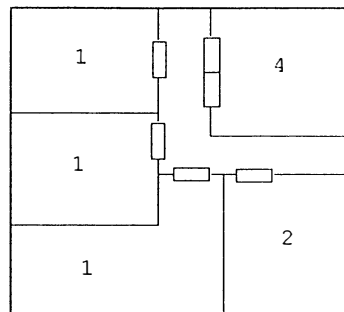

- 1 Medical Labs
- 2 Security Rooms
- 3 Mutating Labs
- 4 Elevators

Sub-Level Two

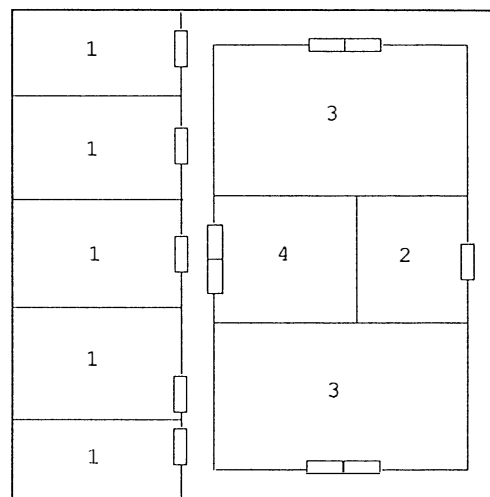

All of the ventilation ducts in the complex are too small for the average human to fit in. Small to mid-sized animals can fit in them, but will have to avoid the heat sensors. Humans with certain super abilities, such as Alter Physical Structure: Smoke or Mist, Shapechange, Stretching, or Animal Metamorphosis can also make their way through these vents.

The ground floor is mostly offices and storage for basic things like paper towels, vending machine snacks, bottled water, coffee, paper cups, cleaning supplies, fuses, etc. The elevators require a pass card to activate, but are not as difficult to bypass as the outside locks (-10% instead of -30%). **Note:** If the heroes set off any alarms within the facility, the guards from the security room will respond. See additional details that follow to determine how long it will take the guards to arrive at the scene of the disturbance.

The first sub-level contains the basic laboratories where normal animals are subjected to relatively normal tests. Cages of white mice and rats, along with a few monkeys, line the walls of the labs which are filled with everyday medicines and medical utensils. The rooms require pass cards to open, but are not specifically locked. Regular skill rolls can be made to bypass them. None of the animals here are intelligent. Setting off a sensor triggers an alarm. Guards will respond to the disturbance, arriving from the security room on this level in 1D4-1 melee rounds. If these guards fail to call in every ten minutes, those on the ground floor will investigate, arriving 1D4 minutes after the ten minute period has elapsed.

The second sub-level is lined with motion sensors that are active after normal lab hours. This is where the labs that actually mutate the animals are located. The laboratories on the outer edge of the level are for the storage and testing of relatively normal animals with some heightened level of intelligence or ability (such as partial or full hands or biped). The inner labs house state-of-the-art genetic, chemical, radiation, and other medical equipment used to modify the animals. These laboratories are locked and require a pass card to open (same penalties as the outside

doors). Setting off a sensor or failing a roll to bypass a laboratory lock triggers an alarm. Guards will respond to the disturbance, arriving from the security room on this level in 2D6 melee actions. If these guards fail to call in every ten minutes, those on the first sub-level will investigate, arriving 1D4 minutes after the ten minute period has elapsed. If the reinforcements also fail to report in, the guards on the ground floor will seal the facility and call the main office for a dangerous situation resolution (DSR) team. See the end of this section for details on a sealed facility and the DSR team.

The third sub-level is for animals that are considered dangerous, that is, specimens that can severely injure or kill a staff member and/or present a high risk of escape. High-risk specimens include those with high intelligence and/or psionic abilities. This is where Sherrie would have ended up had she not fooled her captors. There are always motion sensors on at this level and a guard in the Ground Floor Security Room constantly monitors the read-out. When the scientists are on this level, the guard keeps tabs on them via motion alerts. As the scientist breaks a beam, a camera zeros in on him, thus he can be constantly monitored while down here. The doors to the laboratories on this level are very sturdy and require cards and codes to open (-40% to bypass rolls). No security personnel are stationed here. If an escape is detected, the entire level is sealed off by a reinforced blast door (200 S.D.C.) across the elevator shaft and tranquilizer gas is pumped into the entire area until the sensors quit registering motion. Shields also block off the ventilation ducts (75 S.D.C.).

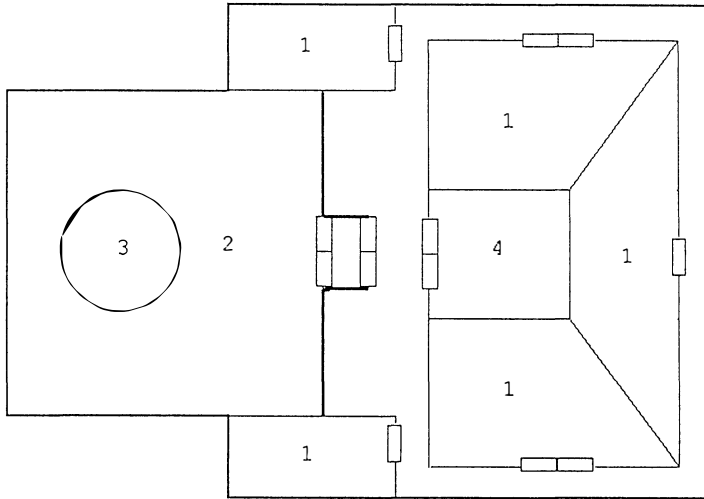

- | | |
|-----------------------|------------|
| 1 Secure Laboratories | 3 Rat Cage |
| 2 Main Lab | 4 Elevator |
| (Maximum Security) | |

Most of the animals on sub-level three are held in the main lab, including the only giant animals that remain held here. In the center of the room, behind huge bars, are a pair of rats the size of small elephants. They are normally as controllable as any large animal in a cage, but if they see any kind of escape or mass release going on, they will expect to be let out also. Though not highly intelligent, the two can tell that others are being let out and not them. They will exhibit extreme anger at this, all of it directed at the people who leave them behind. The rats take alternating lunges at the cage (which sets off alarms, no matter what the player characters might have done to disable them — Genetech takes no chances with these monsters) until the bars give under their rabid assault. They will try to shred any humans or animals in their immediate vicinity before making a run for freedom.

All the animals on level three know that the elevator is the way out and they will head for it unless directed otherwise. If the giant rats get loose, the facility seals automatically and a preprogrammed distress call goes out to the DSR team. The rats can get themselves out of the facility by gnawing through the doors or blast shields *before* the DSR team arrives to contain them (Genetech does not yet realize that these rats are immune to the knockout gas used throughout the facility!). The player characters may even be able to follow the rats out or use their holes to make their own escape. The G.M. can have the rats go into hiding once they are out and make an appearance in a later adventure, perhaps during the chaos of **Planetfall**, along with the other rampaging monsters.

In the event that the facility should be sealed, every possible exit point is shut off by a blast shield with 100 S.D.C. per square foot (humans need at least a 3 sq. foot (0.9 sq. m) hole to fit through). These cover all the doors, the vents where pipes leave the building to go to heating and AC units on the roof, water pipes, electric conduits (no, the power isn't cut off, these are iris-shuttered shields) and any waste vents. The only way to get out is to blast or cut one's way out. Depending on the damage done, that can take as little as a few actions to as much as

several minutes. Given how knockout gas is likely to be present in high-security areas whenever the facility seals, heroes will have plenty of difficulty getting out.

As the facility seals up, a call is also sent to a nearby security subsidiary of Genetech where a special team of soldiers skilled in handling dangerous laboratory situations, specifically those dealing with dangerous biological subjects, is dispatched. This DSR team comes loaded for bear with fast-acting tranquilizers and other *capture gear*. Should the situation warrant it, they also carry enough heavy firepower to drop an elephant in mid-charge. The DSR team takes fifteen minutes to scramble, helicopter over to the Genetech site, and override the door seal to gain entry, which re-seals after them. Coincidentally, should a DSR team scramble, they will arrive right about when any player characters felled by the facility knockout gas will regain consciousness.

Once the DSR team is inside, their response times to the different levels are the same as the regular security personnel detailed above, except the third sub-level which can be reached in 1D4 melee rounds regardless of their point of origin (they slide down the elevator cables, saving time, unless the cables have been cut or otherwise destroyed, in which case 1D4 minutes would be needed). The stats for the DSR team members are given below, should they be needed. Player characters will be targeted for capture by the DSR team unless they prove too dangerous to the team, in which case they will be attacked with deadly force. If the heroes are known criminals, lawless vigilantes or unknown vigilantes, they may capture them and then frame or accuse them for the destruction at the facility, but only after all traces of the animals and illegal experiments have been removed. Mutant and alien heroes *may* be kept prisoners at a different facility for study or experimentation.

The aftermath of this adventure is completely up to the G.M., but the player characters can earn some unique and possibly resourceful allies from it. Imagine a dog with the intelligence of a human working the streets for information by listening to conversations, following scent trails, etc. Or a bird or mouse doing the same thing. Certainly all of the animals will not remain with the characters that set them free, but a few are likely to and the others will be inclined to help them in the future should the group need them and know where to find them. When my players went through this adventure, Sherrie Mouse was already part of the group, but when it was over they had gained a dozen allies that took up residence not only in the city, but in the outskirts of the country outside around it, giving them access to a number of information venues they didn't have before. Of course, my group was partial to mutant animals (as evidenced by Sherrie's inclusion from the start of the campaign) and yours may not be.

Something else to consider might be the ensuing chaos that will result if either of those two giant rats makes it off the Genetech premises. Considering how angry, hurt, and confused these creatures are, they're likely to go on a mindless, kill-crazy rampage. The heroes might feel compelled to save these creatures from themselves (Genetech

DSR teams will be hot on their trail, as will the cops and maybe even local S.C.R.E.T. teams and National Guard members). After all, these creatures will be killed on sight now, and in a way, the heroes are responsible for their getting out. This will provide an interesting test for the players. Do they feel responsible for these creatures? Do they recognize that the rats aren't evil, they're just acting as any tortured animal might? And if the heroes *do* get involved, how far are they prepared to go to save or apprehend these rats?

Confrontation with S.C.R.E.T. teams is possible (and embarrassing). Likewise, the heroes probably won't be able to team up with Genetech's DSR teams to apprehend the rats. Or will they? Maybe Genetech will call off the heroes' break-in if they help them catch the rats and agree to keep quiet about the whole thing.

Which brings us to a few other things to consider. One, is Genetech able to keep this affair quiet, or if things go public, keep the rest of the Corporation going, admonishing this one facility as a rogue cell? Is this a rogue cell within the law abiding Genetech Corporation, or is the entire Corporation involved? Three, how will Genetech treat the heroes after this? If they ID the heroes during the break-in, the player characters will have made a powerful enemy. Especially if it is an evil corporation with insidious (and criminal) plans, incredible resources, a large pool of highly trained commandos (the DSR teams), as well as substantial good standing with the local public (thanks to a

conscious publicity campaign like the newscast that began this adventure). Likewise, the national corporation is in good standing with law enforcement agencies and has loose ties (as a potential contractor) with the Military! Depending on how the adventure unravels, and how sinister the G.M. wishes to make Genetech, the biotech company may wish to take out some kind of revenge on the heroes, or perhaps even capture them for experiments! If the Pentagon was interested in Genetech's program with mutant animals, just imagine how interested it'll be when the company claims it has its own super-soldier program in the works, with the heroes themselves as the prime test subjects!

Of course, it's also just as likely that Genetech might want to brush the whole thing under the carpet and avoid any future trouble with the heroes and authorities (maybe this incident causes them to lose any chance they had at getting that Military contract too). Or, they may wish to go the high and mighty route and take legal action against the heroes for their blatantly (and arguably) illegal actions. It certainly would taste like ashes for the player characters to be held accountable for their break-in while Genetech gets off with a slap on the wrist or maybe even nothing at all (i.e. if there are no serious laws to penalize the company for its animal experiments). The ultimate indignity might be if Genetech sues the heroes, an option that would work best if the player characters are part of a large and publicly recognized Super-Squad or group. The point

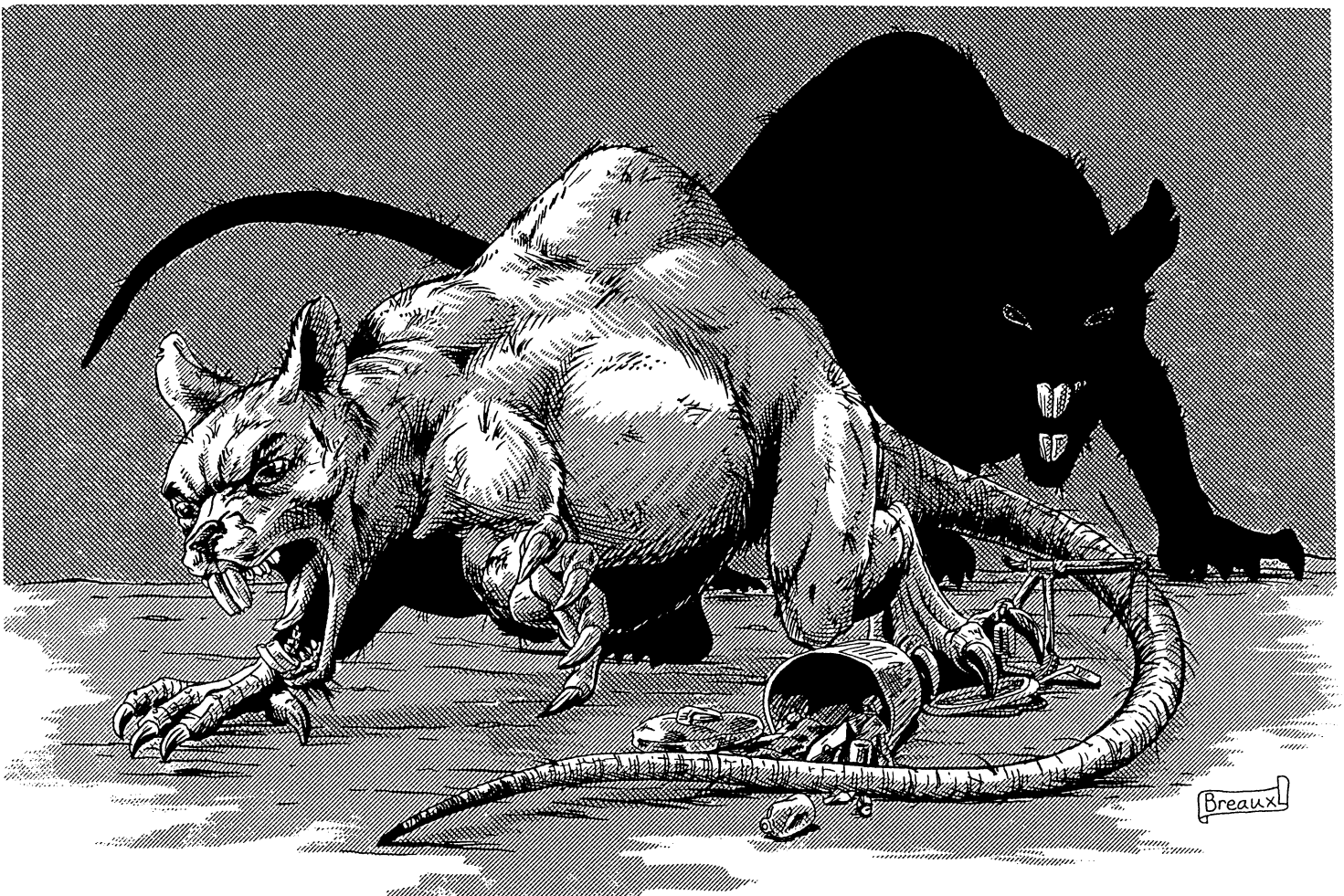

of the suit wouldn't be to make Genetech rich, but to cripple the heroes financially and to discredit them (and perhaps all superbeings in the city).

Then again, if this was just a rogue cell of a law abiding company, while they won't appreciate the negative press, the Corporate leaders will take action to "clean house." The question then becomes, will they eliminate all of those responsible (do they seek revenge?) or does this evil seed slowly regrow to cause trouble in the future?

The most important thing to consider is to have fun with this adventure. Remember, the most successful adventures are those that work for you and your players. **Note:** For a lot more interesting and fun information, adventures and ideas involving mutants and mutant animals, check out the **Teenage Mutant Ninja Turtles® RPG** (any edition is reasonably compatible to HU2).

The Guards

There are four guards on each level of the Genetech facility, plus one in the public lobby, one at the loading dock, one at the checkpoint gate, and four on the grounds. Each has identical weapons and equipment.

Hit Points: 20

S.D.C.: 24

W.P.: Revolver, Automatic Pistol, and Sub-Machinegun.

Bonuses: +1 to parry and dodge, +1 to roll, and +3/+1 strike with modern weapons (aimed/burst)

Equipment: Bullet proof vest (A.R.: 10, S.D.C.: 50), 9 mm sub-machineguns (3D6 damage, 30 round clips), .40 cal. sidearms (4D6 damage; 13 round clip), two (2) extra clips for each weapon, headset radio.

The Giant Rats

These nasty critters are part of a test pilot program to develop combat animals for the military. Their attributes are enhanced far beyond those of the other animals at the facility. They are large, fast predators with a mean streak a mile long and an uncanny knack for survival.

Attributes: I.Q.: 6, M.E.: 7, M.A.: 3, P.S.: 41, P.P.: 12, P.E.: 33, P.B.: 1, Spd: 18

Size: 12 feet (3.6 m) long.

Weight: 1,200 lbs (540 kg)

Hit Points: 65

S.D.C.: 180

Armor Rating: 10 (natural)

Power Category: Mutant Animal

Animal Characteristics: Hands: Full, Biped: None, Speech: None, Looks: None.

Animal Psionics: Animal Control and Superhuman P.S.

Natural/Animal Abilities: Teeth and claws, tunneling, nightvision, and advanced smell.

Disposition: Mean.

Appearance: Ugly, hulking rats with patchy fur and thick, corded muscles.

Number of Attacks: 4

Bonuses: +2 to strike, +1 to parry, +1 to dodge, +26 to damage, and +2 to roll with punch, fall or impact.

Education Level and Skills: Minimal; Climbing (51%) and Swimming (45%).

Weapons and Melee Combat: Rely on their claws (3D6+26) and teeth (4D6).



The DSR Team

The DSR team is a fully outfitted combat unit with the means to deal with even a small horde of mutant animals, but they may be outclassed by the rats in Genetech. Characters shouldn't underestimate them, however. Each has identical weapons and equipment.

Hit Points: 26

S.D.C.: 40

W.P.: Revolver, Automatic Pistol, Sub-Machinegun, Knife and Automatic Rifle.

Bonuses: +3 to parry and dodge, +3 to roll, and +4/+2 to strike with modern weapons (aimed/burst).

Equipment: Riot Armor (A.R.: 14, S.D.C.: 150), .45 cal. sidearms (4D6 damage; 13 round clip), silenced MP-5 SMG (3D6 damage; 35 round clip), combat knife (2D4 damage), four (4) extra clips for each weapon, and a headset radio.

Note: If the DSR team is trying to subdue its targets, it will rely mostly on automatic tranquilizer rifles. The rifles act identically to M-16 automatic rifles, except they will be loaded with special tranquilizer bullets that each act as a single dose of knockout gas (**Heroes Unlimited, 2nd Edition**, page 341). The unique nature of the bullets limits the tranq rifles to single-shot or short burst firing only. If a character gets hit dead-on by a short burst, however, it's a pretty safe bet that he'll be knocked out. The giant rats, on the other hand, will prove themselves immune to these guns, so the DSR team will quickly go to lethal force on them. If the rats break free of the Genetech facility, subsequent hunting parties will be outfitted with M-16s with live ammo (4D6 per shot) and M-203 grenade launchers with smoke, tear gas, and high explosive (1D4x10 per shot) grenades.

EXPANDED SPELL LIST

Because of the massive amount of information that had to fit into **Heroes Unlimited™, 2nd Edition (HU2)**, the spell listings had to be slimmed down considerably. The following expanded spell list should provide Wizard characters with a much broader base to choose from when customizing their character's mystic arsenal. In addition, G.M.s can convert or adapt additional spells from a variety of **Rifts®** world books, including **Rifts® England** (Temporal Magic), **Spirit West™** (spirit and shamanistic magic), **Rifts® Africa** (Necro-Magic and Medicine Man magic), **The Federation of Magic™** (several different types), **Mystic Russia™** (Necro-Magic and several others) and others as they come out.

The **Nightbane®: Through the Glass Darkly** sourcebook also presents expanded rules on magic including guidelines for creating new spells.

Most of the spells listed here and in **HU2** are taken from **The Palladium Fantasy Role-Playing Game®**, where one can find rules on other forms of magic, such as *Summoning*, *Diabolism*, *Life Force Wizardry*, and others.

And finally, Erick Wujick's terrific **Mystic China™** sourcebook for **Revised Ninjas and Superspies™** (which, by the way, is fully compatible with **Heroes Unlimited™, 2nd Edition** and is an unbeatable martial arts resource) offers some interesting notes on various Chinese mystic arts. Check it out!

Complete Alphabetical Spell List by Level

The numbers in parentheses following each spell name are the P.P.E. requirement for that spell.

Spell entries with no special description following their entry already appear in **Heroes Unlimited, 2nd Edition**. These are indicated by the word "HU2" and the page number in the basic RPG where it is described.

Spell entries in *italic* and with the word "New" next to them are described in this sourcebook.

Spell entries with "*Revised*" next to them were described in **Heroes Unlimited, 2nd Edition (HU2)**, but have been updated in this sourcebook. The version of these spells appearing here should be considered the "official" version of the spell.

Note: Some spells found in other Palladium titles have been deliberately excluded to avoid too much duplication of superpowers and psionics, or because they don't quite fit in the modern world. Spells higher than 5th Level should be uncommon, while spells 9th Level and higher are rare, and Spells of Legend are super-rare (only the most powerful deities and sorcerers will know a few of them).

Level One

Blinding Flash (1, pg. 321 HU2)
Cloud of Smoke (2, pg. 321 HU2)
Death Trance (1, pg. 321 HU2)
Decipher Magic (4, pg. 321 HU2)
Globe of Daylight (2, pg. 321 HU2)
Increase Weight (4, New)
See Aura (6, New)
See the Invisible (4, pg. 321 HU2)
Sense Evil (2, pg. 321 HU2)
Sense Magic (4, New)
Thunder Clap (4, New)
Ventriloquism (3, New)

Level Two

Befuddle (6, pg. 322 HU2)
Chameleon (6, pg. 322 HU2)
Climb (3, New)
Concealment (6, New)
Darkness (6, pg. 322 HU2)
Detect Concealment (6, New)
Extinguish Fire (4, pg. 322 HU2)
Fear (5, pg. 322 HU2)
Heavy Breathing (5, pg. 322 HU2)
Levitation (5, pg. 322 HU2)
Mystic Alarm (5, pg. 322 HU2)
Turn Dead (6, pg. 322 HU2)
Weightlessness (6, New)

Level Three

Armor of Ithan (10, pg. 323 HU2)
Breathe Without Air (5, pg. 323 HU2)
Energy Bolt (5, pg. 323 HU2)
Fingers of the Wind (5, pg. 323 HU2)
Float in Air (5, pg. 323 HU2)
Fuel Flame (5, New)
Ignite Fire (6, pg. 323 HU2)
Impervious to Cold (6, pg. 323 HU2)
Impervious to Fire (6, pg. 323 HU2)
Impervious to Poison (5, New)
Invisibility: Simple (6, pg. 323 HU2)
Negate Poison/Toxin (5, pg. 324 HU2)
Paralysis: Lesser (5, pg. 324 HU2)
Resist Fire (3, pg. 324 HU2)
See Wards (8, New)
Sense Traps (7, New)
Telekinesis (8, New)

Level Four

Astral Projection (10, New)
Blind (8, pg. 324 HU2)
Carpet of Adhesion (10, pg. 324 HU2)
Charismatic Aura (10, pg. 324 HU2)
Cure Minor Disorders (10, New)
Energy Field (10, pg. 324 HU2)
Fire Bolt (10, pg. 325 HU2)
Fool's Gold (10, pg. 325 HU2)
Ley Line Transmission (30, New)
Magic Net (7, pg. 325 HU2)
Multiple Image (7, pg. 325 HU2)

Repel Animals (7, pg. 325 HU2)
Seal (7, pg. 325 HU2)
Shadow Meld (10, pg. 325 HU2)
Swim as a Fish (6, pg. 326 HU2)
Trance (7, pg. 326 HU2)

Level Five

Calling (8, pg. 326 HU2)
Charm (12, pg. 326 HU2)
Circle of Flame (10, pg. 326 HU2)
Domination (10, New)
Energy Disruption (15, Revised!)
Escape (8, pg. 326 HU2)
Eyes of Thoth (8, pg. 327 HU2)
Fly (15, pg. 327 HU2)
Heal Wounds (10, pg. 327 HU2)
Horrific Illusion (10, pg. 327 HU2)
Mend Cloth (12, New)
Size of the Behemoth (12, New)
Sleep (10, pg. 327 HU2)

Level Six

Animate Object (15, New)
Apparition (20, New)
Call Lightning (15, pg. 327 HU2)
Compulsion (20, New)
Control the Beasts (18, pg. 327 HU2)
Cure Illness (15, New)
Create Bread & Milk (15, New)
Detect Poison (10, New)
Fire Ball (10, pg. 328 HU2)
Fire Fist (15, pg. 328 HU2)
Impervious to Energy (20, pg. 328 HU2)
Magic Pigeon (20, pg. 328 HU2)
Mask of Deceit (15, pg. 328 HU2)
Memory Bank (12, New)
Mystic Shield (10, pg. 328 HU2)
Swim as a Fish: Superior (12, New)
Reduce Self (20, New)
Teleport: Lesser (15, pg. 328 HU2)
Time Slip (20, New)
Tongues (12, pg. 328 HU2)
Words of Truth (15, pg. 328 HU2)

Level Seven

Agony (20, New)
Animate & Control Dead (20, pg. 329 HU2)
Circle of Concealment (15 or 100, pg. 329 HU2)
Constrain Being (20, pg. 329 HU2)
Dispel Magic Barriers (20, pg. 329 HU2)
Fly as the Eagle (25, pg. 329 HU2)
Globe of Silence (20, pg. 329 HU2)
Heal Self (20, pg. 330 HU2)
Immobilize (25; New & Rare)
Invisibility: Superior (20, pg. 330 HU2)
Invulnerability: Limited (25, New)
Life Drain (25, pg. 330 HU2)
Metamorphosis: Animal (25, pg. 330 HU2)
Purification (20, New)
Second Sight (25, New)

Wind Rush (20, pg. 331 HU2)
Wink-Out (20+, pg. 331 HU2)
X-Ray Vision (25, New)

Level Eight

Commune with Spirits (25, New)
Exorcism (30, pg. 331 HU2)
Eyes of the Wolf (25, pg. 331 HU2)
Firestorm (30, New)
Hallucination (30, New)
Locate (30, pg. 331 HU2)
Love Charm (40, pg. 332 HU2)
Luck Curse (40, New)
Metamorphosis: Human (40, pg. 332 HU2)
Minor Curse (35, New)
Negate Magic (30, pg. 332 HU2)
Oracle (30, New)
Sense Dimensional Anomaly (30, New)
Sickness (50, New)
Spoil (30, New)
Stone to Flesh (30, Revised!)
Time Capsule (30, New)
Wisps of Confusion (40, pg. 332 HU2)

Level Nine

Age (50, pg. 333 HU2)
Curse: Phobia (50, New)
Familiar Link (55, New)
Havoc (50, pg. 333 HU2)
Metamorphosis: Insect (60, New)
Monster Insect (50 or 100, pg. 333 HU2)
Mute (50, pg. 333 HU2)
Protection Circle: Simple (45, New)
Summon & Control Canines (50, New)
Speed of the Snail (50, pg. 333 HU2)
Sword to Snakes (50, pg. 333 HU2)
Transferral (50, New)
Water to Wine (40, pg. 333 HU2)

Level Ten

Banishment (65, pg. 334 HU2)
Control & Enslave Entity (80, New)
Dimensional Pocket (30 or 140, pg. 334 HU2)
Metamorphosis: Superior (100, pg. 334 HU2)
Mystic Portal (60, pg. 335 HU2)
Phantom Horse (60, New)
Summon & Control Rodents (70, New)
Summon Shadow Beast (140, pg. 335 HU2)
Teleport (120, New)

Level Eleven

Anti-Magic Cloud (140, pg. 335 HU2)
Create Mummy (160, New)
Create Magic Scroll (100+, New)
Finger of Lictalon (150, pg. 335 HU2)
Remove Curse (140, pg. 336 HU2)
Summon & Control Animals (125, pg. 336 HU2)
Summon Fog (140, pg. 336 HU2)

Level Twelve

Amulet (290+, New)

Calm Storms (200, pg. 336 HU2)

Create Zombie (250, New)

Metamorphosis: Mist (250, pg. 337 HU2)

Summon & Control Entity (250, New)

Time Hole (210, pg. 337 HU2)

Level Thirteen

Create Golem (700 or 1,000, New)

Protection Circle: Superior (250, New)

Sanctum (390, pg. 337 HU2)

Summon & Control Storm (260, pg. 337 HU2)

Talisman (500, pg. 338 HU2)

Level Fourteen

Close Rift (200+, New)

Id Barrier (600, pg. 338 HU2)

Impenetrable Wall of Force (600, pg. 338 HU2)

Restoration (750, pg. 338 HU2)

Level Fifteen

Dimensional Portal (1,000, pg. 338 HU2)

Dimensional Teleport (800, New)

Summon Greater Familiar (580, pg. 339 HU2)

Teleport Superior (600, pg. 339 HU2)

Transformation (2,000, New & Super-rare)

Resurrection (2,000, New & Super-rare)

Spells of Legend

Barrier of Thoth (3,000, New)

Crimson Wall of Lictalon (5,000, New)

Doppelganger: Superior (1,000, New)

Metamorphosis: Dragon (2,000, New)

Sanctuary (1,500, New)

New and Expanded Wizard Spell Descriptions

Level One

Increase Weight

Range: Self or one other up to 100 feet (30.5 m) away.

Duration: 2 minutes (8 melee rounds) per level of experience.

Saving Throw: Standard. Those who roll a successful saving throw vs. magic are not affected. However, objects have no saving throw and are affected automatically.

P.P.E.: 4

The spell caster is able to increase the weight of any one specific living creature or object one hundred pounds (45 kg) per level of his experience. This can be used to make a person or object too heavy or difficult to move, to slow down a pursuer, and similar mischief. A character who is made to weigh twice (or more) his normal weight will see his speed attribute temporarily reduced by half. Once the target's weight exceeds his carrying weight (based on P.S.), he can not move at all. Note that the appearance of the person or item does not change, only his/its mass. Also note that unlike the major super ability of Weight Manipulation, this spell does not increase S.D.C. with weight.

See Aura

Range: 100 feet (30.5 m).

Duration: 15 seconds (1 melee round).

Saving Throw: None; but a psychic mind block will mask the presence of psionic abilities, the character's P.P.E. amount, and possession.

P.P.E.: 6

All things, organic and inorganic, have an aura. The aura has many distinctions, and can be used to see or

sense things invisible to the eye. Seeing an aura will indicate the following:

- Estimate the general level of experience. Low (1-3), medium (4-7), high (8th and up).
- The presence of magic (but does not indicate level or type).
- The presence of psychic abilities (but not level or type).
- High or low base P.P.E.
- The presence of a possessing entity.
- The presence of serious illness.
- The presence of an unusual aberration which will indicate extreme mutation, superpowers, or an inhuman, alien or supernatural nature, but does not specify which!
- **Note:** An aura does not reveal one's alignment.

Sense Magic

Range: 120 foot (36.6 m) diameter.

Duration: 2 minutes (8 melee rounds) per level of experience.

Saving Throw: None

P.P.E.: 4

Like a Geiger counter, the individual can sense or feel the presence of magic of any kind. This ability also lets the caster know whether a person or object in range is enchanted, under a magic spell, or is in the process of invoking magic. Practitioners of magic and most supernatural beings do not register as magic except when actually casting a spell/using magic. Psychic powers and manipulation cannot be detected with this spell.

Note: This spell functions exactly like the Wizard's innate ability of the same name. It is included for use by other magical types that can make spell selections.

Thunderclap

Range: Directly affects the immediate area (30 ft/9 m) around the magic weaver, but can be heard up to one mile (1.6 km) away.

Duration: Instant

Saving Throw: Save vs Horror Factor.

P.P.E.: 4

This invokes a booming clap of thunder loud enough that one can actually feel a vibration from it through the air. A thunderclap is an excellent means of alerting or signaling allies, as well as intimidating one's enemies. As an intimidation device, all characters within 30 feet (9 m) of the spell caster must roll to save vs a Horror Factor of 8 or lose their next attack. Characters with amplified or otherwise heightened hearing are at -3 to save vs this spell's effects. In addition, the mage who casts this spell gains the following bonuses for his or her next action: +5 to initiative, and +1 to strike, parry, and dodge.

Ventriloquism

Range: 10 foot (3 m) radius.

Duration: Instant

Saving Throw: Standard

P.P.E.: 3

This enables the spell caster to perfectly use ventriloquism on any inanimate object, tree, vegetation or animal. Basically the same effects as the skill at 90% proficiency.

Level Two

Climb

Range: Self or others up to 40 feet (12.2 m) away.

Duration: 5 minutes (20 melee rounds) per level of experience.

Saving Throw: None

P.P.E.: 3

This spell enables the enchanted person to scale rough, climbable surfaces with supernatural skill (98%), speed (climbing speed is equal to speed attribute), and agility. Extremely smooth, steep, or otherwise difficult surfaces can be scaled with a skill level of 60%. Climbing speed for such difficult surfaces is 80% one's normal speed.

Concealment

Range: Small objects up to 40 feet (12.2 m) away.

Duration: 5 minutes (20 melee rounds) per level of experience.

Saving Throw: Standard

P.P.E.: 6

This magic makes any small object hard to see or find. The magic affects the perception of anybody who looks at it. Unless the person(s) makes a successful saving throw, the item cannot be seen by him. This can be applied to an item on one's person or left out in the open. Only one object is affected each time the magic is invoked. The object cannot be living and must be smaller than 14 inches (0.31 m) in length and height, 6 inches (0.15 m) in width, and weigh 14 lbs (6.4 kg) or less. Each person who looks at

the place where the enchanted object is resting must roll a saving throw versus magic. A failed roll means that particular individual will not see it until the magic lapses. Note: If the object is used as a weapon or picked up by the mage or anyone who does see it, the enchantment is broken and it becomes clearly visible to all.

Detect Concealment

Range: Area affect: 30 feet (9.1 m).

Duration: Instant

Saving Throw: None

P.P.E.: 6

A magic invocation that will instantly negate any concealment spell(s) and reveal any object(s) which may have been mystically concealed. Can be directed at a specific area or individual, or made to affect an entire area of 30 feet (9.1 m).

Weightlessness

Range: 60 feet (18.3 m).

Duration: 30 seconds (two melee rounds) per level of experience.

Saving Throw: Standard

P.P.E.: 6

Weightlessness is the exact opposite of the first level Increase Weight spell. The spell caster is able to reduce the weight of any one object, person, or creature by 100 pounds (45 kg) per each level of experience, down to a bottom limit of half an ounce. Characters or items that are virtually weightless can be carried with ease, used to trick people, and float on the wind. Likewise, this spell can be cast on opponents to slow them down.

Characters whose weight is reduced to nearly nothing will see their speed drop by 75% and may be forced to hold on to rope or objects to prevent themselves from being carried away on the wind! A wind of one mile per hour (1.6 km) or faster will blow the character around like a feather or leaf! Likewise, the damage inflicted from striking attacks (punches, kicks, sword strikes, etc.) by the virtually weightless character, as well as the amount of weight that person can lift and carry also are reduced by 75% because the weightless character doesn't have the mass to inflict serious damage or carry heavy items.

Level Three

Fuel Flame

Range: 100 feet (30.5 m)

Duration: Instant

Saving Throw: None

P.P.E.: 5

The magic feeds any existing fire, doubling it in size. It can affect a 10 foot (3 m) radius of fire up to 100 feet (30.5 m) away. This spell does not increase the intensity of the fire, just the size, thus damage is not increased; although additional damage is likely as it will take longer to get out of the now larger fire.

Impervious to Poison

Range: Self or others by touch.

Duration: 5 minutes (20 melees) per level of experience.

Saving Throw: None

P.P.E.: 5

This enchantment makes the spell caster temporarily impervious to poisons, deadly toxins and poison gases.

Sense Traps

Range: Self

Duration: 1 minute (4 melee rounds) per level of experience.

Saving Throw: None

P.P.E.: 7

This spell endows the spell caster with a sort of sixth sense which enables him to sense traps, including modern security items such as infrared beams and motion sensors (but not cameras or other items that produce no immediate mechanical response). This is done by simply looking over an object or area no further than six feet (1.8 m) away. Unfortunately, while the spell detects and locates traps, it does not identify the specific danger they pose. Nor does it deactivate them. This spell also does not locate secret compartments, doors or passageways.

See Wards

Range: 60 feet (18.3 m); line of vision.

Duration: Four minutes per level of the spell caster.

Saving throw: None

P.P.E.: Eight

This incantation enables the mage to see the normally invisible magic energies that radiate from wards. In this way he can tell if a ward is real or not (a false ward radiates no energy). He can also see the magic energy that covers and area when a protection or area affect ward is used, and whether a ward is active or not. This also enables the character to determine how many wards are active and a general sense of power (low level of damage or high).

Telekinesis

Range: 60 feet (18.3 m).

Duration: 1 minute (4 melees) per level of experience.

Saving Throw: Dodge

P.P.E.: 8

This invocation empowers the spell caster with the magic equivalent of the Physical Psionic power of the same name, the ability to move objects purely by directed mental energy. This power can be used to move or hurl objects, open doors, flick switches, press buttons, and so on. While using telekinesis, certain rules and limitations apply:

- Maximum total weight that can be moved at once: 60 pounds (27 kg).
- Telekinetic attacks per melee: Equal to the number of hand to hand attacks per melee that the character may have.
- +3 to strike with telekinesis; physical and skill bonuses to strike do not apply when telekinesis is used.

- +4 to parry with telekinesis by using a controlled object to parry or sheer telekinetic force to block an attack.; physical and skill bonuses also do not apply when a telekinetic parry is used. **Note:** Telekinesis is not a force field. Thus, while it can be used to parry/block a punch, kick, club, knife, or even a sword, it cannot stop projectiles, arrows, gas/fumes, surprise tackles, and similar attacks. Furthermore, a failed roll to telekinetically parry means the spell caster did *not* parry and *is* struck by the opponent.
- Damage from hurled objects:
 - Small: 6 ounces to 1 pound (0.17-0.45 kg) — 1D4
 - Small: 1.1 to 2 lbs. (0.5-0.9 kg) — 1D6
 - Medium: 3 to 4 lbs. (1.0-1.9 kg) — 2D4
 - Medium: 5 to 10 lbs. (2.0-4.5 kg) — 3D4
 - Medium: 11 to 25 lbs. (4.6-11.3 kg) — 3D6
 - Large: 26 to 40 lbs (11.4-18.1 kg) — 4D6Add 1D6 for each additional 20 lbs. of weight.
- Object(s) being manipulated must be visible.
- Telekinesis can be combined with hand to hand combat, but does not add extra attacks per melee.
- Influence from ley line energy doubles the amount of weight and range possible.
- Influence from ley line nexus energy triples the amount of weight and range possible.
- Only one object/item per level of experience can be manipulated at any one time.

Level Four



Astral Projection

Range: Self

Duration: 5 minutes per level of experience.

Saving Throw: None

P.P.E.: 10

The incantation sends the spell caster's astral body into the alien dimension known as the Astral Plane. This magic functions exactly like the psychic sensitive ability of the same name. For details, see **Heroes Unlimited, 2nd Edition**, page 305.

Note: This spell functions exactly like the Wizard's innate ability of the same name. It is included for use by other magical types that can make spell selections.

Cure Minor Disorders

Range: Touch or 10 feet (3 m).

Duration: Instant

Saving Throw: Standard (if unwanted).

P.P.E.: 10

A unique bit of curative magic that instantly relieves minor physical disorders and illnesses such as headaches, indigestion, gas, heartburn, nausea, hiccups, muscle stiffness, low fevers (101 degrees F/38 C, or less) and similar. This invocation will also negate simple curses that inflict minor disorders and can be used to negate one minor injury (**Heroes Unlimited, 2nd Edition**, page 19) per casting.

Ley Line Transmission

Range: Limited by the length of the ley line.

Duration: Instant

Saving Throw: A psionic mind block will block and destroy the message.

P.P.E.: 30

The spell caster can send a verbal and/or audio message directly along a ley line to another person so long as that person is located within 100 feet (30 m) of the line. To avoid overwhelming the recipient, messages are best kept under 100 words. Messages of this sort are one-way only and can only be returned by another spell caster who knows this spell or has this ability. The time lapse between sending and receiving a ley line transmission is only a matter of seconds. The message can be sent to several people (one person per level of experience) at different locations, as long as they are all on the ley line.

The only danger is that ley line message can be picked up by telepathy. There is a 1-20% chance per message that any psionically or magically telepathic character will sense a ley line transmission coming through (if they are within 100 ft/30 m of the ley line), and there is a 01-31% chance that they can eavesdrop on the message. There is no way for the sender to know if others have intercepted the message. Nor is there any way to scramble the message.

Level Five

Domination

Range: Touch or within 4 feet (1.2 m).

Duration: 2 minutes (8 melee rounds) per level of experience.

Saving Throw: Standard

P.P.E.: 10

Domination is a trance-like enchantment that enables the mystic to impose his will over his victim's, forcing the person to do his bidding. The victim of domination will appear to act oddly, dazed, confused, slow, and unfriendly (ignoring friends, etc.). The enchanted person has one goal, to fulfill the command of the spell caster controlling him. Under such influence, not even the victim's alignment will apply. If directed to, he will steal, lie, assist in crimes, kidnap, betray friends, reveal secrets, and so on! The only things the controlled individual will not do is commit suicide, inflict self-harm, or kill a friend or loved one. However, a good aligned character (principled, scrupulous and even unprincipled), cannot be made to kill anybody, or to reveal a secret identity or anything else that obviously puts a person in serious danger! It is too deeply against their alignment.



Victims of this spell suffer the following penalties: Attacks per melee are half, speed is half, all skills are half their usual proficiency, speech is slow, and the person seems distracted or a little dazed.

A successful saving throw versus magic means the magic has no effect. The person is 100% his normal self. The effects of the domination magic cannot be easily faked, so the spell caster is very likely to know (85%) if the target is faking domination or not.

Energy Disruption, Revised

Range: 60 feet (18.3 m).

Duration: 3 minutes (12 melee rounds) per level of experience.

Saving Throw: None for inanimate objects, +2 to save when used against robots and computers with Artificial Intelligence (AI) or power armor controlled by a living pilot, and +4 to save when used against cyborgs or robots/androids with transferred intelligence.

P.P.E.: 15



This is an updated version of the Energy Disruption spell that appears on page 326 of **Heroes Unlimited, 2nd Edition**. Officially, the description in the **HU2** rule book remains the same; these are merely *supplemental rules* for this spell.

When Energy Disruption is used against a complex system that is made up of several distinct sub-systems, it will only disable one sub-system per spell casting. For example, casting Energy Disruption on a security camera does not shut down the entire security network it is connected to, just that one camera. This is because the camera is basically one tightly organized system, despite its numerous components, but it is not an integral part of the whole security network. On the other hand, if a character disrupts the *main computer* for that same security system (another tightly organized system), all of the cameras go out with it because their functions are dependent on the operation of the main computer. Other complex systems work the same way, including modern cars, complex weapons, and robots. Thus using energy disruption on a robot will shut down one system (a weapon, a sensor, an arm, etc.), but it won't necessarily shut down the whole unit unless the spell caster can disrupt a main control system like the CPU, AI brain, etc., and that is not likely (especially if a player character or pivotal NPC villain).

The difference between the security system example and the robot (or vehicle, etc.) is that in the former, the main computer was an obvious target, while in the latter, it will be hidden or concealed behind casings and armor. Additionally, if the robot has an advanced AI or transferred intelligence, it is entitled to a *saving throw* because it has the same reactive defenses as other player characters when opposing magic. Whether he moves just a bit as the spell goes off, manages to outright resist the mystic energies, or reroute power, there is a chance the magic will fail, unlike a normal machine that provides no resistance. But even if successful, it will affect only one aspect of the

robot or power armor at a time (i.e. weapon, sensor, jet pack, arm, etc.).

Another problem is that when casting this spell at a target with uncertain or hidden systems, one never knows exactly what is going to be disrupted. Certainly, targeting obvious systems like optics or weapons will result in that particular system shutting down (a save still applies with cyborgs, advanced AIs and transferred intelligences), but a robot's radar isn't necessarily in its head and its main CPU could be in a foot. Because of this, when the spell caster can not or does not positively target a specific system, roll on the following table to determine which system is actually affected by the Energy Disruption spell and shuts down (if applicable saves are failed). Note that cars and other vehicles on the table below refer to modern vehicles with extensive electrical systems such as ABS brakes, electronic ignition, security systems, etc.

Note that a hand-held energy weapon or portable device can be targeted and attacked without benefit of a save, because it is an ordinary machine with an independent power source.

Random Disruption; roll percentile dice:

01%-05%: Circuit and power cooling systems down, will overheat and shut all systems down in 1D4 melee rounds. Once the spell wears off, all systems will be cool enough to run properly.

06%-13%: One arm is paralyzed. The character loses one attack and any weapon systems or senses on that limb will not respond. If a vehicle, some secondary system is knocked out and controls are sluggish; -1 attack per melee round.

14%-22%: Locomotion partially shut down; leg or foot in robots (50% chance for either leg); electronic ABS brakes in cars, etc. Speed is half and all trick and special maneuvers are -50%.

23%-30%: Robots lose targeting software or targeting computer (if it has one); targeting computer bonuses are lost or weapons are simply -2 to strike. Other systems lose control and suffer -15% to their functions (such as pilot rolls).

31%-40%: Lose all communications, radio, and possibly exterior audio systems (effectively deaf).

41%-45%: Lose radar/sonar or other special sensory system; pilot's visuals only.

46%-56%: One weapon system down; roll randomly based on the robot's or machine's arsenal.

57%-65%: Control circuits down; reduce speed by half, -1 to parry and dodge.

66%-70%: Control circuits down; -1 attack per melee, -1 to parry and dodge.

71%-74%: Router circuits down; robots are stunned for 1D4 melees, cars and other machines are unresponsive and require control or operation rolls at -10%.

75%-82%: Control chip down, re-router overcompensates and knocks robot off its feet; lose two attacks that melee. Vehicles require an immediate control roll at -20%.

83%-88%: Lose optic systems (effectively blind).

89%-94%: Major electrical system shut down; -1 attack, -4 to strike, parry and dodge. Vehicles must make control rolls at -30%.

95%-00%: Main CPU/AI hardware shut down; entire system is helpless for the duration of the spell. Vehicles must make control rolls at -30% before shutting down and coming to a stop.

Mend Cloth

Range: Touch or within three feet (0.9 m); line of vision.

Duration: Instant and permanent.

Saving Throw: Not applicable.

P.P.E.: 12

A spell of transformation that can make a tattered, torn, holey or old piece of fabric or an article of clothing the size of a blanket (shirt, pants, cape, pair of sock or gloves, and similar) as good as new — magically repairing tears, holes, thread bare areas from wear, etc. This spell can also be used to get rid of otherwise impossible to remove stains. The magic only works on cotton, wool, silk and synthetic cloth (polyester, etc.), but *not* leather, felt, furs, rope, metal, body armor or articles “filled” with feathers or other types of padding.

Size of the Behemoth

Range: Self or other; 30 feet (9 m) maximum range.

Duration: 2 minutes (8 melee rounds) per level of experience.

Saving Throw: None for self, standard for others.

P.P.E.: 12

This spell can be cast upon oneself or another person within the spell caster’s line of vision and no further than 30 feet (9 m) away. It increases the size of the person to 20 feet (6 m) tall, weight to 1,200 pounds (540 kg), P.S. to 30 (superhuman), and adds 75 S.D.C., but speed is reduced to 6. The spell affects only the physical body and not the clothes, armor, weapons, or possessions the person was wearing or holding. This spell is uncommon.

Level Six

Animate Object

Range: 60 feet (18.3 m); line of vision.

Duration: 30 seconds (2 melee rounds) per level of experience.

Saving Throw: None

P.P.E.: 15

This enables the spell caster to animate and control any object or objects under a total of 50 lbs (22.6 kg). The spell caster can mentally direct the object(s) to do just about anything: a table to walk, a broom to sweep, etc. The spell caster can cause the object to hover up to six feet (1.8 m) off the ground and move in any direction. If the object(s) is used to attack, the total number of attacks possible per melee is equal to the spell caster’s. So, if a mage animates four brooms and the mage has four attacks per melee round, one of the brooms may strike four times or all four can strike once each, or any combination thereof. Roll to strike for each attacking object. Any dodge

or parry by the object counts as a melee attack/action. No combat bonuses apply other than +1 on initiative.

The animation of objects requires the spell caster’s full attention and concentration, so no other spells can be cast or action taken as long as the character is using this magic. Consequently, if he is knocked out or killed, the spell is instantly cancelled. Likewise, if his vision is impaired/obscured, he temporarily loses control of that object(s) until he can re-establish visual contact with it.



Apparition

Range: 30 feet (9 m).

Duration: 1 minute (4 melee rounds) per level of experience.

Saving Throw: Standard

P.P.E.: 20

The Wizard can create a realistic apparition in the form of a horrible creature or monster that will attack anybody who comes within 20 feet (6 m) of it. The apparition can appear as any known supernatural creature or an imaginary “thing,” like a man-eating refrigerator, and so on. The creature will always have at least three attacks per melee but no more than six, +2 to strike, +3 to parry, +6 to dodge, possesses incredible strength (P.S. 25, Supernatural) and has a Horror Factor of 10. These illusionary monsters are commonly used to block passages and guard entrances.

Although an illusion, it will appear completely real and seems to sweat, bleed and interact just as one would expect it to. Combat should be conducted as usual. The illusion is so complete that any characters fighting it will imagine suffering damage from the beast! Although the damage is imaginary and disappears when the apparition vanishes, the characters will react as if they are actually hurt. Should the opponent of the apparition die (or so he believes), he will fall unconscious for 2D4 minutes from

shock. The experience is traumatic; roll to save vs insanity (a 12 or higher saves). If the roll is a failure, roll percentile dice on the Random Insanity Table.

There are only three ways to destroy the illusion: 1) A successful save vs magic will cause it to disappear (at least for that individual). Each character encountering it must make a saving throw. 2) Plunge a rod or something made of iron into it. 3) Wait for the magic's duration time to elapse.

Compulsion

Range: 60 feet (18.3 m) and within line of vision.

Duration: 24 hours.

Saving Throw: Standard

P.P.E.: 20

The spell caster can implant a sudden irresistible desire or need in another person's mind. The impulse should be something reasonable and attainable, although the motive may seem quite irrational. The enchanted person will be consumed with the object or action of the implanted compulsion, whether it be something very simple, like a craving for a candy bar or the need to visit somebody, or something more extravagant. The victim of this enchantment will pursue his compulsion for the duration of the spell or until the compulsion itself is attained. The spell Remove Curse will negate Compulsion.

Cure Illness

Range: Touch or 3 feet (0.9 m).

Duration: Instant cure.

Saving Throw: None; standard if the person resists treatment.

P.P.E.: 15

A potent magic that can cure ordinary disease and illness, such as fever, flu, nausea, and other common ailments. The magic cannot cure cancer, lung disease, the common cold, chronic illness, wounds, broken bones or internal damage to organs. Nor can it cure magically induced sicknesses or disorders.

Create Bread & Milk

Range: Up to 30 feet (9 m) away.

Duration: Permanent

Saving Throw: None

P.P.E.: 15

This incantation creates 2D6 loaves of bread and one gallon of milk held in containers which disappear when emptied.

Detect Poison

Range: 15 feet (4.6 m).

Duration: Instant

Saving Throw: None

P.P.E.: 10

The spell caster can direct his sight and concentration on a particular object, powder, liquid, plant, drink, or food, and detect whether or not it is poisonous or laced with poison. Poison includes harmful or mind, mood, and physically altering drugs.

Memory Bank

Range: Touch

Duration: 3 months per level of experience.

Saving Throw: None if willing; standard if unwilling.

P.P.E.: 12

The mage can implant a block of memory or information deep into another person's subconscious mind without them ever knowing what it is. The mage can then retrieve it at any time with a mere touch. This technique can be used to safely record and hide numbers, names, addresses, locations, incantations, or any other data under 1,000 words. There is no limit to the number of memory banks a mage can implant in the same person. The memory will fade away after the magic's duration time has elapsed.

Note: A psionic mind block will make it impossible to implant or retrieve a memory bank. Other than the mage who implanted the memory bank, the only way to access this information is via a psionic Mind Bond (telepathy doesn't dig deep enough).

Swim as a Fish (Superior)

Range: Self or others by touch.

Duration: 10 minutes per level of the spell caster.

Saving Throw: None

P.P.E.: 12

This spell can be cast on oneself or on one or two people at a time by speaking the incantation and simultaneously touching the intended targets. The enchanted characters are able to breathe underwater like a fish and swim expertly (98%) without fatigue at a speed of 66 (45 mph/72 km) for the duration of the spell. Maximum depth is 6,000 feet (1,830 m; over one mile/1.6 km).

Underwater Bonuses: +1 on initiative, +1 to parry and +3 to dodge.

Reduce Self

Range: Self only.

Duration: 3 minutes (12 melee rounds) per level of experience.

Saving Throw: None

P.P.E.: 20

This spell instantly shrinks the spell caster to six inches tall (0.15 m). His clothes and possessions also shrink proportionally to his tiny size. Shrunken weapons do virtually no damage. Tiny magic weapons will inflict 1D4 damage, while the range of any special magic powers they may have will be turned into inches rather than feet. The tiny mage sees all his physical attributes, weight, and spell range reduced by two thirds (67%), so a P.S. of 9 is now a 3. However, mental attributes, psionics, S.D.C., hit points, and spell damage, duration and strength remain unchanged.

Note: Being struck by full-size weapons, objects, fists, and feet/kicks does double damage to the diminutive character!

Time Slip

Range: Self only.

Duration: Approximately 7 seconds (half a melee round).

Saving Throw: None

P.P.E.: 20

The invocation momentarily suspends time, enabling the spell caster to slip seven seconds into the future. The mage can move forward seven seconds while all around him are caught in the past. The magic is such that the character cannot physically hurt any living creature, but he can move through the physical environment, open doors, grab an item, make a quick escape, etc. Whatever actions the mage takes within the seven seconds are unseen and unknown to other characters in the area. To these characters, it will appear as if the mage disappeared for a few seconds and then suddenly reappeared at a different location. All around him lose two attacks the melee round in which he reappears, but the mage retains all of his.

Level Seven

Agony

Range: 5 feet (1.5 m) per level of experience.

Duration: 1 minute (4 melees).

Damage: Special

Saving Throw: Standard

P.P.E.: 20

This is a particularly cruel and painful invocation that incapacitates its victim with pain. Under the influence of the magic, the victim has no attacks per melee, cannot move or even speak, except to scream, groan, and writhe in agony. Although there is no physical damage (no S.D.C. or hit points are lost and there is no sign of torture), the pain is very real (it feels like losing 20 S.D.C. or hit points per melee). It will take another minute (four melee rounds) for the victim to regain his full composure after the agony is stopped. During that minute, his number of attacks per melee and speed are reduced by half, and he suffers a penalty of -1 on initiative and -1 to strike, parry and dodge. Only one person can be affected per invocation.

Note: This spell *will* work against Invulnerable characters because it is a "magical" effect and not a damaging spell. Characters inside environmental body armor, power armor/exoskeleton or robots, as well as cyborgs, are +3 to save (the armor and electronics serve as a buffer from this attack).

Immobilize

Range: 60 feet (18.3 m).

Duration: 30 seconds (2 melee rounds) per level of experience.

Saving Throw: Special; if a successful save is made, the player rolls 1D4 to determine how many melee rounds his character is immobilized. After that time, his character is able to move freely out of the cone, but cannot move to affect anything inside it.

P.P.E.: 25

This spell creates a transparent glittering cone, 20 feet (6 m) in diameter and 40 feet (12.2 m) tall (the spell caster may make it smaller if desired). The cone halts EVERYTHING within its scope. Missile weapons, speech, movement, flight, everything is momentarily frozen in time. Anyone entering or touching the glittering cone of light is also instantly immobilized. When the spell time elapses, any missile weapons or creatures in flight will drop to the ground while speech and movement will continue.

Invulnerability: Limited

Range: Self or others by touch.

Duration: 2 melee rounds (30 seconds) per level of experience.

Saving Throw: None

P.P.E.: 25

This spell creates a form fitting energy field which appears as a dimly glowing aura around the body and provides 25 S.D.C. per level of the spell caster. In addition, the aura makes the individual impervious to non-magical heat/fire, cold, energy attacks, poisons/toxins/drugs and disease. Magic energy attacks or magical illness does half damage.

Weapons of all kinds inflict normal damage, although the damage is first deducted from the magic S.D.C. Once that magic S.D.C. is exhausted, the person will suffer normal damage to his own S.D.C. and Hit Points, but remains impervious to all the things listed previously. The invulnerable character is also +4 to save vs Horror Factor, and on saving throws vs magic and psionic assaults.

Purification

Range: Touch or 3 feet (0.9 m).

Duration: Instant

Saving Throw: None

P.P.E.: 20

The mystic can purify food or water, cleansing it of disease, bacteria, and poison/toxins. Up to 50 lbs (22 kg) of food or 10 gallons (37.9 liters) of water/fluids can be purified.

Second Sight

Range: Self; 5 miles (8 km) per level of experience.

Duration: 30 seconds (2 melee rounds).

Saving Throw: Mind Block will temporarily prevent the use of Second Sight.

P.P.E.: 25

A unique use of magic that enables a mage to see and hear what another person is doing at that very moment. The mage just has to think about that person and he will get a clairvoyant-like vision showing what that person is doing and saying, and who he/she is with. The vision is what one might expect to see in a crystal ball except that the mage sees it only in his mind. The vision lasts 30 seconds each time the magic is invoked. To use Second Sight, the character must have previously encountered/met the individual for more than a few minutes.

A mage can also use Second Sight to transmit his present activity to another person. This is a great way to show somebody that you are in trouble. Such a "distress image"

always consists of true events showing exactly what is happening, when it is happening. The vision cannot be altered or doctored in any way. Only a Mind Block will prevent the person from being seen through Second Sight.

X-Ray Vision

Range: Self

Duration: 30 seconds (2 melee rounds) per level of the spell caster.

Saving Throw: None

P.P.E.: 25

This spell enables the mage to see through solid matter such as wood, stone, clay, dirt, and iron. However, x-ray vision cannot see through structures thicker than those listed below, nor can it penetrate lead or containers that are magically sealed.

It takes fifteen seconds (one melee round) to see through two feet (0.6 m) of wood, cloth, or leather; one foot (0.3 m) of dirt, clay, or stone or a half-foot (0.15) of metal.

It takes thirty seconds (two melee rounds) to see through four feet (1.2 m) of wood or cloth; two feet (0.6 m) of dirt, clay, or stone; or one foot (0.3 m) of metal.

Level Eight

Commune with Spirits

Range: Self, or others by ritual; 200 feet (61 m) distance.

Duration: 5 minutes (20 melee rounds) per level of experience.

Saving Throw: None

P.P.E.: 25

The incantation enables the mage to see and speak with all types of ghosts and supernatural beings known collectively as "entities," including Poltergeists, Haunting Spirits, Trapped Entities, Imprisoned Entities, and Possessing Entities. The ability to see and communicate with these ghost-like beings does not mean that they will obey the character, but a dialogue can be exchanged.

Firestorm

Range: 90 feet (27.4 m) plus 10 feet per level.

Duration: Instant

Damage: 1D6 per experience level of the spell caster.

Saving Throw: Dodge, but the victim must know the attack is coming and must roll an 18 or higher (bonuses to dodge are applicable).

P.P.E.: 30

This spell creates a fast-flying fireball that explodes upon impact, burning everything within 20 feet (6 m) of the target. The fireball is magically directed and seldom misses. As with the related spell, Fireball, damage for this spell is increased by ley lines and nexus points.

Hallucination

Range: Touch or 3 feet (0.9 m).

Duration: 3 minutes (12 melees) per level of experience.

Saving Throw: Standard

P.P.E.: 30



With this spell, the mage can implant a mystic illusion or delusion into the mind of a single person. Whatever the illusion is, whether it be a monster, fire, bottomless pit, etc., it seems completely real to the victim. The person hallucinating will react and interact with the hallucinatory image regardless of what anybody else may say or do. A successful save vs magic means that the magic has no effect. **Note:** The psionic power Mind Block adds +3 to save vs this spell.

Luck Curse

Range: Touch or 10 feet (3 m).

Duration: 24 hours per level of experience.

Saving Throw: Standard

P.P.E.: 40

This incantation inflicts a character with bad luck. First, the victim's normal combat bonuses are all reduced to zero! Second, his critical strikes do normal damage (except a natural 20 which always does double damage), and even if the character throws a successful death blow or knockout/stun punch, it only does 1D4 damage. Third, executing any kick attacks has a 60% chance of causing the character to trip and fall down (lose initiative and one melee attack). And finally, the prowl skill turns into a clumsy roll, making noise every time it is tried. All other skills are minus 40%, but only during critical situations. The G.M. can add other minor occurrences of bad luck if he so desires. Only the spell Remove Curse can negate the effects of this enchantment.

Minor Curse

Range: Touch or 10 feet (3 m).

Duration: 24 hours per level of experience.

Saving Throw: Standard

P.P.E.: 35

The spell caster can inflict a curse in the form of minor physical disorders that cause a constant irritation. Such disorders include:

Fever: -2 on initiative, -5% on all skills, reduce speed (Spd) and physical endurance (P.E.) by 25%. Fever ranges from 99°F to 102°F, making the victim feel drained, tired, and uncomfortable.

Gas: Chronic indigestion and nausea, coupled with a gross, bloated feeling. The character has a spell of flatulence (belching or farting) once every two melees. This makes the character's initiative rolls at -2, and sneak attacks and prowling are impossible.

Headache: Dull, throbbing headache that makes sleep and concentration difficult. All skills are -10% and all saving throws are -1 due to the character's inability to focus.

Hiccups: Annoying hiccups that interrupt speaking constantly. Language skills are -15%, mental affinity (M.A.) is reduced by half, and prowl is impossible. Spells can still be cast with little difficulty.

Ingrown Toenail: Painful to walk, victim limps. Reduce speed by half, -10% to prowl, -15% to climb.

Itching and Rash: Very uncomfortable, almost maddening itch that can be relieved only by scratching. Reduce mental affinity (M.A.) by half, -4 on initiative, and minus one attack per melee.

Pimples: Dozens of pimples break out all over the face and arms. Reduce physical beauty (P.B.) by half.

Nausea: Stomachache, loose bowels and vomiting, slow this poor victim down. Reduce speed by 50% (running faster is possible, but there is a 50% chance of vomiting). Sudden movements, riding horseback, bumpy rides, or high speed chases (50 mph or faster), have a 60% chance of inducing vomiting or diarrhea. The victim is -6 to strike, parry and dodge while throwing up, and has no initiative.

Runny Nose and Cough: The victim suffers from a nagging, constant cough, watering eyes, and runny nose. Reduce physical beauty (P.B.) by 25%. Prowling and sneak attacks are impossible, but spell casting is unimpaired.

Vertigo: The character gets dizzy when running at speeds higher than 8, riding in vehicles moving at 50 mph or faster, or when exposed to heights (must be looking out a window or standing on a ladder or ledge) greater than 10 feet (3 m). When vertigo hits, the character is almost helpless: reduce attacks per melee to one, no initiative, -8 to strike, parry, or dodge. The vertigo will last as long as the victim is exposed to what induces it.

No normal medicine or cures will rid a character of a curse, only the Remove Curse spell can do it, or waiting until the duration time of the curse elapses. A Negate Magic spell can be tried, but it has only a 01-25% possibility of success.

Oracle

Range: Self only.

Duration: 1 minute (4 melee rounds).

Saving Throw: None

P.P.E.: 30

The oracle is the magic equivalent of the Psionic Sensitive power of Clairvoyance (**Heroes Unlimited, 2nd Edi-**

tion, page 306). The spell caster receives one dream-like vision of a possible future. The focus of the vision will depend on what, when, or whom the mage is thinking about. The same basic rules that apply to clairvoyance apply to the "oracle" invocation.

Sense Dimensional Anomaly

Range: Self only.

Duration: 2 minutes (8 melee rounds) per level of experience.

Saving Throw: Not applicable.

Limitations: Range limits.

P.P.E.: 30

This spell enables the Wizard to feel ripples in the space/time continuum that indicate the opening, closing, and general location of any kind of dimensional Rift, gateway, portal, or other such anomaly within a 50 mile (80 km) radius. In addition, the mage can sense the following:

- The opening and closing of mystic portals, dimensional teleportation, ley line storms, and time holes within one mile (1.6 km).
- The opening, closing, and general location of dimensional envelopes within 100 feet (30 m).
- The opening, closing, and general location of dimensional pockets within 10 feet (3 m). The mage can see into the pocket if he finds it.
- Sense when a space warp (teleportation), wink-out, or time warp is occurring within a 100 foot (30.5 m) radius. The mage can detect such an occurrence just a few seconds before it actually occurs, so it is impossible for the mage to be surprised by such events.
- Sense the presence/essence of astral beings, two- and four-dimensional beings, entities and alien intelligences within a 100 foot (30 m) radius, but cannot pinpoint their location.

Sickness

Range: Touch or 20 feet (6 m).

Duration: 12 hours per level of experience.

Saving Throw: Standard

P.P.E.: 50

Sickness is a debilitating magic that afflicts its victims with the symptoms of a specific disease. Only the symptoms of the disease manifest themselves, not the actual disease. Consequently, a medical examination will reveal no physical cause for the illness. At best, it will be diagnosed as psychological, magical, or unknown. No matter how ill or helpless the victim may become, he cannot die from the magic sickness, but he will suffer greatly.

All magic sicknesses inflict the following penalties and modifiers: attacks per melee are reduced to one; physical endurance (P.E.) is reduced by 70%; speed (Spd) is reduced by 40%; -4 to strike, parry, and dodge; no initiative; and all skill ratios are reduced by -50%. The person is very feverish, weak, disoriented, uncomfortable, and has no appetite.

Spoil

Range: Touch or 3 feet (0.9 m).

Duration: Instant

Saving Throw: None

P.P.E.: 30

Basically, this magic is the opposite of the Purification spell. In this case, the mage can instantly putrefy or spoil good food, affecting 50 lbs (22 kg) of solid food or 10 gallons (37.9 liters) of water/fluids. The spoiled food is inedible and the water undrinkable. Anybody who eats or drinks spoilage will get sick with stomach cramps and diarrhea (-2 on initiative; -1 to strike, parry, and dodge).

Stone to Flesh, Revised

Range: By touch or up to 12 feet (3.6 m) away; line of vision.

Duration: Instant/Permanent.

Saving Throw: None/Special (see below).

P.P.E.: 30

This spell is identical to the one listed on page 332 of **Heroes Unlimited, 2nd Edition**, but with one important clarification. If this spell is cast upon someone that has altered their physical structure to stone (either by the *Copy Physical Structure* or *Alter Physical Structure: Stone* abilities), the target must roll to save vs magic. If the saving throw is successful, nothing happens. But if it fails, the person reverts instantly and completely back to his flesh and blood form! He can shift back to stone as he can normally, but until he does so, he is vulnerable to attacks against his non-stone S.D.C. and H.P. body. It will take at least two melee actions for the character to get over the shock and initiate his transformation to stone.

Time Capsule

Range: Touch

Duration: Up to 50 years per level of experience.

Saving Throw: Not applicable.

Limitations: Can contain 50 lbs (22.5 kg) per level of experience. Effective only on picked plants and non-living materials such as herbs, fruit, vegetables, grains, other foods, water, alcohol, potions, books, clothing, weapons, machines, etc. Living humanoids, animals, and plants cannot be placed in a time capsule.

P.P.E.: 30

This spell creates an energy field that surrounds a container and its contents, isolating them from time. Everything within the time capsule is perfectly preserved. For every year that passes in real time, only a minute passes within the time capsule, making it the perfect means to cache items for long-term storage.

To create a time capsule, the spell caster must place the items to be preserved into a container of some kind, such as a wooden crate, metal trunk, cardboard box, knapsack, or bag. The only condition is that the container must be completely closed (i.e., no open-topped boxes). As long as the container remains unopened, the magic remains in effect, up to 50 years per level of experience of the spell caster who created the time capsule. The instant the time capsule is opened, the spell ends. The time cap-

sule can be hidden, buried, or just placed on a shelf. How easy it is to open the capsule depends entirely on the strength of the container and whatever locks or traps may have been placed on or built into it. For example, the Seal spell can be used in conjunction with this magic.

Level Nine

Curse: Phobia

Range: Touch or 20 feet (6 m).

Duration: 24 hours per level of the spell caster's experience.

Saving Throw: Standard

P.P.E.: 40

The phobia curse implants in its victim an unreasoning fear of something (see phobias in the Insanity section). The spell caster can select one of the phobias listed in the insanity section, or make a random roll on that table, or introduce a new phobia (new phobias must be approved by the Game Master). The victim of the curse will have a phobic reaction every time he encounters that frightening thing. Only a "remove curse" is a 100% cure, "negation" has a 25% chance of success, and, of course, the mage who created the curse can cancel it at any time.

Familiar Link

Range: Self and animal; 600 feet (183 m).

Duration: Indefinite.

Saving Throw: None

P.P.E.: Fifty-Five

At third level, a practitioner of magic is experienced enough to mentally link with a small animal (mammal, bird or lizard). This link is permanent, producing a rather impressive symbiotic relationship. No matter how wild or mean the animal may have been, it will instantly consider the mage to be its friend, companion and master. To him, the animal is always docile and submissive, because the two are now one; an extension of each other. As such, both man and animal will understand each other completely. For the mage, the familiar is now a sensory extension enabling him to see, hear, smell, taste and feel everything the animal experiences. Thus, familiars make great spies, listening to conversations and prowling into areas not easily accessible to its master. Although the familiar understands and obeys the mage, it cannot actually speak to him.

Just as the mage knows what the familiar is feeling, so the familiar knows what its master is experiencing on an empathic and telepathic level. If one is in danger, the other will know it. The magical nature of the union also provides the mage and the familiar both with an additional *six* hit points. However, if the familiar is hurt or attacked, its master also takes the same amount of damage even if miles apart. If the familiar is killed, the arcanist *permanently loses 10 hit points!* There is also a 50% chance he will suffer shock from the ordeal. If he does, he will lapse into a coma for 1D6 hours; another familiar link cannot be tried again for at least 1D4 years.

Other Limitations & Notes about the Familiar Spell:

1. Two-way telepathic and empathic communication; maximum range: 600 feet (183 m). Beyond this range the two cannot communicate but each will know if the other is in danger or hurt regardless of the distance between them. The animal will also understand spoken commands made by its master on an almost human level. The mage will have a keen understanding and perception of his animal companion's reactions, growls, noises and body language.

2. The familiar possesses all the abilities common for that type of animal.

3. Familiar Size: 25 pounds (11 kg) maximum.

4. Typical animal types used as a familiar include: cats, dogs, coyotes, foxes, weasels, ferrets, rodents, birds, large lizards, and snakes.



Metamorphosis: Insect

Range: Self, or others through ritual magic.

Duration: 20 minutes per level of experience.

Saving Throw: None

P.P.E.: 60

Despite the somewhat misleading name of this spell, the mage can transform himself into any arthropod, including spiders and scorpions, that is no smaller than a half inch (1.27 cm) and no larger than six inches (15.24 cm). In "insect" form, the mage retains his own I.Q., memory, knowledge, hit points, and S.D.C. However, performing human skills is impossible as a bug. Likewise, magic cannot be cast, because as an insect he cannot speak. The metamorphosis can be canceled at will, but the mage will be naked when he resumes his human form.

The following are some typical insect abilities:

Bite or Sting:

Non-poisonous: One hit point or S.D.C. point.

Non-Lethal Poison: 1D6 damage, causes swelling and discomfort.

Speed:

Running: Spd. attribute equal to eight.

Climbing: Spd. attribute equal to six.

Flying: 20 mph (32 kph) for extended flight.

Flying: 35 mph (56 kph) for short bursts (30 seconds).

Other Abilities and Bonuses:

Prowl: Small insects, 2 inches or smaller — 90%; larger insects, 2 1/2 inches or bigger — 66%.

Climb: Natural climbing ability on any surface is 98%, spiders can rappel.

Dodge: Bonus to automatically dodge is +6.

Hearing: Range for hearing is 50 feet (15.2 m).

Vision: Range for vision is 50 feet (15.2 m), but has 180 degree peripheral vision, making sneak attacks impossible (automatic dodge).

Protection Circle: Simple

Range: Radius of the circle, as big as the mage wishes to draw it.

Duration: 24 hours, plus 4 P.P.E. to reactivate it after the circle's initial creation.

Saving Throw: None

P.P.E.: 45

Even as a spell, this invocation might be considered a ritual, for it requires the physical drawing of a circle and symbols while the spell incantation is recited. Almost any substance can be used to draw the circle, but chalk and charcoal are most common. Forty-Five potential psychic energy points are needed to initially create and activate the circle, but a mere four P.P.E. is all that is needed to reactivate it. Anybody with sufficient P.P.E. and desire can reactivate a protection circle. However, if the circle is damaged (scraped, scarred, rubbed out, etc), it will not function and a new one will have to be created.

The simple protection circle will protect everybody inside its diameter by keeping lesser supernatural creatures, demons, ghosts, and entities six feet (1.8 m) away from the circle. The creatures cannot come any closer, nor enter the circle. The circle also provides its occupants with a bonus of +2 to save vs magic and psychic attack.

Although lesser supernatural beings, such as entities, ghouls, and gremlins, cannot come near or enter the circle, they can hurl objects, use weapons, or use magic and psychic powers against the people inside it. Greater beings, such as vampires, elementals, greater demons, and demigods, are not affected by the simple circle and can enter effortlessly. Likewise, the usual bonuses of the circle do not apply against these powerful beings.

Summon & Control Canines

Range: Varies

Duration: 5 hours per level of experience.

Saving Throw: Standard for canines that are part of the heroes' group or if a character is a mutated canine himself.

P.P.E.: 50



This ritual magic requires the drawing of a pentagram. All pentacles or pentagrams are used for summoning or potentially evil intent. *Circles* represent mutual support, the cycle of life, and flow of energy, but the *pentacle*, the five pointed star, represents control, destruction and evil.

The summon & control canines pentacle will provide 1D4 canines (dogs, wolves, etc.) plus one additional canine per level of experience. The animals will be under the complete control of the mage, obeying his every command, and will fight to the death. The pentacle will also give the character the power to control any other canines which were not originally summoned, within 200 feet and his line of vision, provided he remains in the pentacle. However, the canines originally summoned will obey the mage whether he's in or outside the pentagram for the duration of the enchantment, then they leave. It takes 1D6 minutes to create the enchantment and summon the animals.

Transferral

Range: Touch or cast up to 10 feet (3 m) away.

Duration: 1 hour per level of experience.

Saving Throw: Standard

P.P.E.: 50

The spell caster can use this magic to temporarily transfer his mystic essence into another person by transferring all but 4 P.P.E. and experience into that individual. A See Aura would reveal that the mage (who has transferred his mystic essence) possesses no magic, little P.P.E. and appears to be first or second level. This is an excellent way to hide one's mastery of magic when needed.

The person to whom the P.P.E. and experience have been transferred is completely unaware of the power within him and cannot use it. The mage who has temporarily drained himself of magic retains his mystic knowledge, but has only 4 P.P.E. and can create magic only at first level strength. He can regain his power by touching the person who holds it or by waiting until the magic's duration time elapses.

Level Ten

Control/Enslave Entity

Range: 30 feet (9 m).

Duration: 48 hours per level of experience.

Saving Throw: Standard

P.P.E.: 80

Another incantation used to control supernatural forces. This magic does not summon entities, but does enable the mage to control them when they are encountered. The spell caster can control two entities for each level of experience. All varieties of entities are susceptible to this enchantment. Each individual being gets to make a saving throw vs magic. A successful save means it is not controlled by the mage. A failed roll means it will obey the character to the best of its ability (some are barely intelligent).

At the end of its mandatory service, the mage can try to renew his control by invoking the control invocation again, he can banish the creature (see the spell Banishment), or just let his control slip away. The last option can be dangerous, because the evil beings may turn on the mage to extract vengeance or just out of spite. On the other hand, the more intelligent types may willingly agree to work with a mage, especially an evil one, if it will help the diabolical being in its own schemes or to inflict pain and suffering.

Phantom Horse

Range: Immediate

Duration: One hour per level of the spell caster's experience.

Saving Throw: None

P.P.E.: 60

The spell caster can magically conjure a horse composed entirely of magic energy. Those who don't know better think it is a ghost, because it is semitransparent and glows of bluish-white energy. Only the mage who conjured it and one additional person can ride it (even if the mage doesn't normally have the horsemanship skill). The Phantom Horse has a P.S. of 26, a Spd of 88 (60 mph/96 km), actually runs four inches (0.12 m) above the ground and can leap 20 feet (6 m) high and 60 feet (18.3 m) lengthwise.

Summon & Control Rodents

Range: 600 feet (183 m).

Duration: 5 hours per level of experience.

Saving Throw: Standard animal or standard save if a mutant animal.

P.P.E.: 70

This pentagram produces an army of mice or rats that obey the will of the spell caster who summoned them. As long as the mage stands in the pentagram, he can control all types of rodents (only rodent familiars are not affected).

The sorcerer can summon 30 rodents per level of experience. Mice and rat bites inflict one point of damage each. Mice have one attack per melee round, rats have two. All are +1 to dodge and are excellent climbers (88%) and swimmers (75%).

Teleport

Range: Distance of 30 miles per level of experience.

Duration: Instant

Saving Throw: None

P.P.E.: 120

This spell functions exactly like the spell Teleport: Superior (**Heroes Unlimited, 2nd Edition**, page 339), except the Wizard can only take 50 lbs (22.7 kg), plus 5 lbs (2.27 kg) per level of experience, in additional weight. The chances of success outlined under Teleport: Superior are also applicable.

Level Eleven

Create Mummy (Ritual)

Range: Touch

Duration: Exists until destroyed.

Saving Throw: None

P.P.E.: 160

Note: Characters of a good alignment will not use this spell.

The mummy invocation is a Necromantic ritual that turns a corpse into one of the undead. The ritual involves treating pure linen strips of cloth with a mystic solution and wrapping the body in the cloth. The incantation brings to life (if you can call it that) a sort of humanoid robot devoid of emotions and fear. Like a machine, the barely intelligent "thing" follows simple orders to the best of its ability. The mummy is incapable of understanding complex orders or performing any skills. It is simply a lumbering corpse. Of course this, combined with its near indestructibility, makes it an ideal guardian and defender. A simple command like "kill all who enter" (with the exception of the mage) is all it needs to know. A mummy cannot speak or read but grunts, growls, hisses, and howls.

The most devastating aspect of the damnable creature is that it is dead and feels no pain or emotions. Most ordinary weapons (including guns) and even many spells have no affect against the monster. Physical attacks simply nick or poke holes into a lifeless husk. Magic charms, mind control, sleeps, curses, illusions, illness, paralysis, and turn dead (the mummy is an undead) do nothing at all! Banishment does not work because the mummy is not actually a living supernatural creature. Negation simply does not work and remove curse is not applicable, nor are most psionic powers.

However, magic fire does double damage and normal fire does normal damage. Note that all fire damage will attack a mummy's wrappings first, and then affect its corpse-body. If a mummy's wrappings are destroyed, then normal fire does double damage and magical fire does quadruple damage to the corpse. Even sunlight inflicts 3D6 damage per melee round of exposure to a mummy without its wrappings.

There are only a few ways to destroy a mummy. The first is to use magical weapons, which inflict normal damage. Blowing it to bits will work too. Dissolving a mummy in acid also work, although gathering that much acid and

keeping a mummy in it long enough to destroy it will be troublesome, to say the least. Otherwise, the only viable ways to handle a mummy is to trap, imprison, or immobilize it, or to keep it at bay with a protection circle.

The Mummy

Attributes of Note: I.Q. 4, P.S. 20 (Supernatural), P.P. 10, P.E. 18, P.B. 2, Spd 7.

Horror Factor: 10

Hit Points/S.D.C of the Corpse: 70, but only fire, explosives, acid, and magic can harm it. The mummy is impervious to cold, heat, fatigue, normal weapons, punches and kick attacks. Most psychic powers and magic have no or little effect.

S.D.C. of Linen Wrappings: 50; A.R. 10. Mummies can also be dressed in body armor and given hand-held weapons like swords and clubs. They are not capable of using any equipment more complicated than basic hand tools and weapons. This means they cannot use slings, bows, cross bows, guns, explosives, or other modern equipment.

Attacks per melee: 3

Damage: 2D6+5 damage by hand/punch or by weapon.

Note that a flaming mummy will do 2D6 extra damage with unarmed attacks until its wrappings burn off.

Bonuses: +1 to strike and parry; no dodge or initiative bonus.

Fearless: Impervious to Horror Factor, phobias, fear magic and most psionics (including Empathy, Telepathy, and Bio-Manipulation). It is afraid only of fire; small fires/torches have a Horror Factor of 7, man-sized fires (including heroes with the Alter Physical Structure: Fire power) have a Horror Factor of 13 and larger fires have a Horror Factor of 16! Note that a typical torch will do 2D4 damage to a mummy when it is used as a flaming club.

Skills of Note: None, other than magically understands all languages.

Create Magic Scroll

Range: Touch

Duration: As per scroll and spell level.

Saving Throw: Standard

P.P.E.: 100 plus the P.P.E. needed to cast the magic spell placed on the scroll.

This magic is similar to the Amulet and Talisman spells in that the mage can channel mystic energy and powers into an inanimate object. In this case, the mage can magically make the words for casting a magic spell appear on paper as a scroll. The only real limitation (other than needing sufficient P.P.E.) is that the mage must be able to read and write. If he cannot read, he can't create a scroll.

Once a spell has been magically transformed into a scroll on paper, it can be used by anybody who can read the particular language it was written in, be it a fellow mage or a housewife. To activate the magic spell contained on the scroll, it must be read aloud (Reading it silently may reveal the scroll's purpose, but will not activate its magical abilities). The words on a scroll disappear the moment they are read aloud, leaving only a blank piece of paper.

Note: The power of the scroll-spell can be controlled by its creator and can range from level one potency to the current level of its creator. However, the creator's enhanced spell strength can not be transferred, so all saving throws from scroll magic are 12 if created as a spell or 16 if created as part of a ritual. The creator can specify the level desired, be it his maximum or any level in between.

Level Twelve

Amulet

Range: Holder/wearer of the amulet.

Duration: Until the amulet is destroyed.

Saving Throw: None

P.P.E.: Varies; see below.

This potent invocation instills a medallion or charm with mystic properties that protect its bearer from magic or supernatural forces. The only requirements are that the amulet be made of a single metal or semi-precious stone, and that the raw materials be purified by fire prior to the amulet's construction.

Amulets provide one of the following types of magical protection:

Charm: A general ward against magic that provides a bonus of +1 to save versus magic and psychic attacks. P.P.E. Cost: 290.

Protection from Faeries: Adds a bonus of +1 to save vs faerie magic and faerie food. P.P.E. Cost: 290.

Protection from Magic Insanity: Adds a bonus of +4 to save against all magically induced insanities. P.P.E. Cost: 320.

Protection from Sickness: Provides a bonus of +6 to save vs magic sickness and +3 to save vs disease. P.P.E. Cost: 290.

Protection from the Supernatural: Adds a bonus of +2 to save vs Horror Factor. P.P.E. Cost: 300.

See the Invisible: Enables the wearer of the medallion to see the invisible. P.P.E. Cost: 500.

Sense the Presence of Spirits: The amulet changes color whenever a ghost, will-o'-the-wisp, the essence of an alien intelligence or entity is within 200 feet (61 m). P.P.E. Cost: 310.

Turn the Undead: Prevents any of the undead from physically touching the amulet's bearer, much like how a holy symbol repels vampires. Effective against all undead, including mummies, zombies and vampires. P.P.E. Cost: 400.

Create Zombie (Ritual)

Range: Touch

Duration: Exists until destroyed.

Saving Throw: None

P.P.E.: 250

Note: Characters of a good alignment will not use this spell.

The zombie invocation is a Necromantic ritual that turns a corpse into the undead. To create a zombie, the sor-

cerer must find a recently deceased body (dead for no more than six hours), lay it on a white or silver linen, draw a circle around it and light three scented candles. The candles are then placed on the body: one on the forehead, one on the mouth and one on the chest above the heart. As the incantation reaches its climax, the mage cuts his finger and draws a pentagram on the corpse's throat with his still warm blood. Moments later, the monstrosity rises to pseudo-life, the obedient slave of its creator. The ceremony must be done secretly in a graveyard, burial place or battlefield littered with bodies, during the night of a full moon.

The zombie is more intelligent than the mummy and can speak, read simple signs or short sentences, perform simple tasks and even drive a carriage or wagon. Zombies can use any simple hand tool or weapon, and can also use primitive missile weapons, such as slings, bows, and crossbows. Whether or not a zombie may operate a modern firearm or energy weapon is left to the G.M.'s discretion.

A zombie's relatively high intelligence (high for undead, anyway) means it can be sent to retrieve an artifact, follow somebody, kidnap a person and so on. A zombie will only obey the person who created it and individuals whom its creator may designate as authority figures. There is no limit to the number of zombies a mage can command (although only one is created per each spell or ritual).

Like the mummy, a zombie is a walking corpse. It feels no pain, no fears, and has no goals and little emotion. Normal swords, clubs, and other physical attacks do no damage! Mental assaults by psychics, magic charms, illusions, sleeps, curses, sickness, paralysis, and other similar attacks also do no damage. Turn dead does not work because the zombie is an undead. Banishment doesn't work because it is not actually a living supernatural being. Negation simply does not work and remove curse is not applicable. However, the zombie is more vulnerable than the mummy, the trick is knowing what to use.

A zombie is vulnerable to magical energy attacks such as energy bolt, fire bolt, circle of flame, and call lightning, all of which do full damage; as do magic weapons and the energies generated by super humans. Normal fire and weapons made of or covered in silver also inflict full damage whether it be blade or arrowhead. Zombies can also be trapped/imprisoned and blown up. However, all of this may be a temporary deterrent, for unless the creature is decapitated and the head buried separately from the body, the zombie will regenerate completely!

Zombies

Attributes of Note: I.Q. 7, P.S. 20 (Supernatural), P.P. 13, P.E. 18, P.B. 2, Spd 10.

Horror Factor: 12

Hit Points/S.D.C.: 150 points; completely regenerates within 48 hours unless the head and body are buried separately (see below). It can also wear body armor for additional protection.

Attacks per melee: 3

Damage: 2D6+5 damage by hand/punch or by weapon.

Bonuses: +2 to strike, parry and dodge.

Fearless: Impervious to Horror Factor, phobias, fear magic and most psionics (including empathy, telepathy, and bio-manipulation). Like the mummy, the zombie is only afraid of fire; small fires/torches have a Horror Factor of 6, man-sized fires have a Horror Factor of 12 and larger fires have a Horror Factor of 15! A typical torch will do 1D6 damage to a mummy when it is used as a flaming club; magic fire does double damage.

Skills of Note: Magically understands and reads all languages 96%, knows basic math 80%, land navigation 70%, track humanoids 50%, and climb 50/45%.

Special abilities: Nightvision 100 feet (30.5 m), Supernatural P.S. and endurance (never fatigues), impervious to normal weapons (unless silver or magic), impervious to poisons, drugs, disease, heat, and cold; doesn't need to eat or drink, and has no emotions, desires, or personality.

A zombie will rise again, even if riddled with silver arrows (or bullets), chopped into pieces, blown to bits, or burnt to a cinder! Unless the head is removed from the body and both are buried separately, or an exorcism is performed on the remains, the zombie will completely regenerate all its body parts and S.D.C. within 48 hours and seek out its master for new instructions.

Summon & Control Entity (Ritual)

Range: Not applicable.

Duration: 24 hours per level of experience.

Saving Throw: None

P.P.E.: 250

An impressive ritual in which the magic invocation plucks an entity (specific type can be designated) out of its native dimension, and magically teleports it to appear before the conjurer. The alien being is automatically under the mage's control and will obey him without question. The entity can be used for any purpose: manual labor, protection, assault, etc.

The supernatural creature can be returned to its own world at any time before the duration of the invocation elapses. After the duration elapses, the entity slips out of the mage's control and remains in our world. If it suits the entity, it may elect to work with the person who summoned it or it can be enslaved by other mystic means. An unhappy or vengeful entity may attack the mage at the first opportunity after he loses control.

Level Thirteen

Create Golem (Ritual)

Range: Touch

Duration: Exists until destroyed.

Saving Throw: None

P.P.E.: 700 (Stone) or 1,000 (Iron).

Note: Characters of good alignment may be hesitant to use this powerful magic.

The sorcerer first draws a pentagram in animal blood. Second, he sculpts a golem (humanoid shape) from stone or iron. Third, he places two onyx gems, valued at no less

than \$10,000 each, for its eyes. Fourth, he places a heart molded out of iron into the body. Lastly, the conjurer recites the ritual ceremony. At the end of the ritual, the mage places a single drop of his blood on the behemoth's forehead to bring it to life. The process permanently drains the mage of six S.D.C. points.

The golem is a mystical superhuman creature born of magic and almost indestructible. Since it is not of flesh and blood, psychic and magic attacks designed for the human physiology and mind do not affect it. That means charms, sleep magicks, bio-manipulation, illusions, paralysis, etc., have no effect, as if they were cast upon a vehicle or a robot. Since golems were never alive, Turn Dead is useless, as is Banishment, Negate Magic and Remove Curse.

Physical attacks and energy magic can hurt a golem, but do half damage. In many respects, a golem is like the mummy, only bigger and tougher. It cannot speak, read or understand complex commands. It has no emotions, no fears, and is like a robot waiting for a direction. A golems will obey only the person who created it. When the creator dies, the golem will follow his last command until it is destroyed.

Golem

Attributes: I.Q. 6, P.S. 25 (30 if iron, both are supernatural), P.P. 15, P.E. 25, P.B. 3, Spd 8.

Size: No smaller than 10 feet (3 m) and no taller than 20 feet (6 m).

Horror Factor: 16 for a stone golem, 18 for iron.

A.R.: 14 if stone, 17 if iron.

Hit Points/S.D.C.: 250 for a stone golem and 400 for an iron one; plus both completely regenerate within 24 hours unless the head and body are buried separately. It cannot wear body armor for additional protection.

Attacks per melee: 4

Damage: 3D6+10 damage (stone) or 4D6+15 by punch, kick or stomp, or by weapon.

Bonuses: +2 to strike and parry; no initiative or dodge bonus.

Fearless: Golems have no sense of fear and as such, are immune to the effects of Horror Factor, phobias, and fear magic.

Skills of Note: Magically understands all languages 96%, knows basic math 80%, land navigation 60%, track humanoids 30%, and climb 40/35%.

Special abilities: Nightvision 200 feet (61 m); Supernatural P.S. and endurance (never fatigues); impervious to poisons, drugs, disease, normal heat and cold, illusions, and most psionics (including empathy, telepathy, and bio-manipulation). Magic energy, fire and cold attacks do half damage, as do normal weapons and punches. Magic weapons and Supernatural P.S. do full damage. Furthermore, a golem doesn't need to eat or drink, breathe, or sleep, and has no emotions, desires, or personality.

A golem will rise again 24 hours after the moment of its destruction, completely regenerated and at full strength, unless its heart is removed. Otherwise, a stone golem regenerates 10 S.D.C. (16 if iron) per hour.

Protection Circle: Superior

Range: Radius of the circle.

Duration: 24 hours; but can be reactivated immediately at a cost of 20 P.P.E.

Saving Throw: None

P.P.E.: 250

In principle and function, the superior protection circle is just like Protection Circle: Simple, only stronger. The mage must recite the invocation while drawing the circle in any substance (usually chalk or charcoal). Two hundred and fifty P.P.E. are needed to create the circle initially, but a mere 20 P.P.E. points will reactivate it. Anybody with sufficient P.P.E. and desire can reactivate one of these protection circles. The circle ceases to function only if it is seriously marred (i.e., erased, blurred, rubbed out, etc.).

The superior protection circle will protect everybody inside its radius by preventing all supernatural creatures from coming any closer than 20 feet (6 m) from its edge. Even greater supernatural beings, such as demons and Deevils, are held at bay. Lesser beings cannot stand to be within line of sight of the circle and are forced to leave (even if it's only to the next room with the door shut). This means no attacks are possible for the lesser beings.

The circle also provides the following bonuses to all occupants: +5 to save vs all magic and psychic attacks, impervious to possession, +8 to save vs Horror Factor. Plus it provides an extra 10 P.P.E. to each mage and 10 I.S.P. to each psychic inside the circle. Of course, the characters are vulnerable to conventional weapons, fire, gas and thrown objects.

Level Fourteen

Close Rift

Range: 100 feet (30.5 m).

Duration: Instant

Saving Throw: Standard

P.P.E.: 200 plus 2 P.P.E. from the character's permanent P.P.E. base!

The spell allows the mage to close a dimensional Rift, portal, or gateway by sheer force of will. However, the monumental effort permanently drains the mage of two P.P.E. points from his permanent base, whether successful or not (the mystic nature of the dimensional gateway gives it an automatic save vs magic). Consequently, a Close Rift Ritual will increase one's odds for success (the rift must roll a 16 or higher to successfully save). The dimensional Rift will instantly vanish if successful. A failure means it is not affected and the Wizard has lost 2 P.P.E. forever; try again.

Level Fifteen

Dimensional Teleport

Range: Another dimension.

Duration: Instant

Saving Throw: None

P.P.E.: 800

Invoking this spell transports the spell caster and a maximum of 2,000 pounds (900 kg) into another dimension. This spell is only effective if the spell caster has visited the dimension in the past. The location where the teleporter appears within that dimension is completely random unless the spell caster has a personal sanctuary there, complete with a Dimensional Rift Circle, or built on a ley line nexus.

The success ratio of dimensional teleportation is 6% per level of the spell caster (+10% if at a nexus). If the spell caster is unsuccessful, nothing happens. **Note:** Many gods, greater demons, dragons, and supernatural beings possess this power as a natural ability.

Transformation (Ritual)

Range: Touch

Duration: 3 days per level of experience.

Saving Throw: Standard, but at -3.

P.P.E.: 2,000

Note: Very Rare.

Transformation is a powerful spell that transforms a normal human being into a grisly, demonic monster. After the transformation is completed, the pitiful creature will be a mindless slave of the mage who transformed him/her. As a monster, the character has no recollection of his/her life as a human, retains no skills, knowledge or memory, or even attributes. The "thing" will obey the mage without question most of the time, regardless of its original alignment. However, principled, scrupulous and unprincipled characters will not kill or hurt a child or a very dear friend or loved one. Some half-remembered fragment of lost memory and emotion prevents it. Likewise, the character cannot be made to commit suicide or fight to the death.

The only way to recognize the transformed character is with See Aura, Clairvoyance, Object Read or Telepathy.

There are four ways to return the person to normal. **First**, wait until the duration time elapses. **Second**, convince the mage who made the transformation to cancel the enchantment. **Third**, kill the mage! **Fourth**, the Remove Curse spell has a 1-19% chance of negating the magic. The spell Negate Magic has no effect against Transformation.

The transformed human will not have any spell casting powers, but may have psychic abilities (1-50%). The G.M. determines the appearance and abilities of the transformed character. Usually, it is a terrifying and grotesque combination of animal, human and demonic features.

Stats for transformed characters are as follows:

I.Q.: 2D6, **M.E.:** n/a, **M.A.:** n/a, **P.S.:** 3D6+20 (Supernatural), **P.P.:** 2D6+12, **P.E.:** 2D6+12, **P.B.:** 1D6, **Spd:** 6D6.

A.R.: 9+1D6

S.D.C.: 3D6x10+180

Attacks per melee: 1D4+1

Special abilities: See the invisible, nightvision, resistant to fire and cold (half damage), impervious to poison and disease, +2 to save vs magic and/or psionics, track by blood scent (60%), prowl (60%), and fly (1D4x10 Spd). If an extra 200 P.P.E. is spent in the casting, the trans-

formed human can have super abilities (roll to determine normally).



Resurrection

Range: Touch or 6 feet distance (1.8 m).

Duration: Instant and permanent.

Saving Throw: None

P.P.E.: 2,000

Note: Extremely Rare!

This awesome spell will restore life into the recently deceased. The resurrected person will have all hit points, S.D.C., memories, abilities, and skills that he had at the moment of his death. Missing limbs will remain missing, but the wounds themselves will be closed off and healed (this is not a regeneration process but a revitalization). This spell works only on creatures that have died in the last two months.

Success factor: Regardless of the spell caster's level of experience, the chance of success is 01-45%. The spell can be attempted on the same corpse no more than three times. If still unsuccessful another mage may try. Six failed attempts means the person is beyond the help of magic.

Spells of Legend

Spells of Legend are incredibly rare spells that derive from the times of great magic in Earth's distant past or which came to Earth with a powerful godling or other dimensional traveler. In all cases, these spells are so rare that most people, including many practitioners of magic, don't believe they are real — only a handful of ancient mages and gods know these spells! They are closely guarded secrets rarely taught to others and are never available for purchase from those who know them.

Barrier of Thoth

Level: Spell of Legend.

Range: Can be cast up to 50 feet (15.2 m) per level of the spell caster and creates a length of wall/force barrier that is 75x75 feet (22.9 x 22.9 m) per level of the spell caster.

Duration: 4 minutes (16 melee rounds) per level of experience.

Saving Throw: None

P.P.E.: 3,000

This spell of legend creates a super-wall of force with 1,000 S.D.C. per level of the spell caster. In addition the barrier negates all magical energy attacks against it, so they inflict no damage. The Barrier of Thoth also prevents people from teleporting beyond it or casting any type of magic or psionics through it. Thus, a Wizard casting an earthquake spell would affect the area in front of the barrier, but it would stop at the barrier. Likewise, a cloud of steam, lightning bolt, or anything else cannot be cast to strike anything behind the barrier. The barrier regenerates 200 S.D.C. per melee round.

Crimson Wall of Lictalon

Level: Spell of Legend.

Range: 50x50x25 feet deep (15.2 x 15.2 x 7.6 m) per level of the spell caster.

Duration: 5 minutes (20 melee rounds) per level of experience.

Saving Throw: Save vs Horror Factor 18, and save vs magic.

P.P.E.: 5,000

The mere sight of this eerie wall of flame that does not burn strikes fear in even the bravest heroes and villains, for within the flames are the shadows of the souls it has devoured. Large humanoid shapes, men, elves, dragons, and others not easily identified are contained within the dreaded, crimson fire.

Effects of the Wall:

Just seeing the wall is terrifying (Horror Factor 18). Those who see the crimson wall and fail their Horror Factor check have a 01-70% chance of running away in terror.

Entering/passing through the wall's silent, cool flames, inflicts 6D6 points of damage directly to hit points. Supernatural beings and creatures of magic suffer 1D6x10 damage unless they successfully save vs magic (16 or higher is needed). Speed is reduced to one-quarter normal while passing through the crimson wall.

Staying in the wall for more than two melees (30 seconds) jeopardizes sanity unless a saving throw vs magic (16) is successfully made. If unsuccessful, roll once for each of the following insanities: affective disorder, obsession, and phobia.

Staying within the wall for more than two minutes (eight melee rounds) jeopardizes one's very life essence. The character must roll a 16 or better to save. A failed roll means the life essence is forever trapped in the wall and becomes one of the featureless shadows seen in the flames. Those lost cannot be saved or retrieved by any means!

Doppelganger (Superior)

Level: Spell of Legend.

Range: Self, only.

Duration: One year per level of the spell caster, plus a 5% chance per each year that the doppelganger exists that it will remain permanently.

Saving Throw: None

P.P.E.: 1,000

This powerful spell creates a mystic duplicate of the spell caster. This "clone" looks exactly like the mage in every way but possesses only half of his Hit Points, S.D.C., memory, knowledge, attributes, experience levels, P.P.E., spell strength, spell casting abilities, etc. The original spell caster can implant any idea, goal, emotion, memory, etc., that he desires into the doppelganger's mind. He can then awaken it, sending it on a mission or work with it side by side. The doppelganger will never question its existence nor the presence of the original. Unlike the "real McCoy," the doppelganger(s) cannot increase in experience, so all skill levels, magic powers, Hit Points, etc., are frozen.

The sorcerer can create only one doppelganger and cannot create another until that doppelganger is slain or magically negated. The spell Negate Magic has a 01-20% chance of instantly dispelling a doppelganger, and the spell Banishment has a 01-40% chance. Doppelgangers can be killed by normal weapons or magic and can be instantly destroyed by the Negate Magic spell as noted above, but is +2 to save vs negation for every year that it has lived.

Yes, a doppelganger can create a doppelganger of itself! However, only one new clone can be created and it will have half the abilities of the originating doppelganger (which was half the original creator's). After a certain point, usually by the third or fourth clone, the last doppelganger doesn't know the doppelganger spell and its attributes and powers are so low that it is hardly worth conjuring, even if it did.

Metamorphosis: Dragon

Level: Spell of Legend.

Range: Self. Another can be transformed only if performed as a ritual.

Duration: 1D6 hours per level of the spell caster.

Saving Throw: None

P.P.E.: 2,000

The spell caster can actually transform himself into a 30-50 foot (9-15.2 m) long dragon! The following attributes and abilities apply:

- A.R. 14
- +1D4x120 S.D.C.
- Supernatural 30 P.S. (4D6+15 per strike).
- +1 attack per melee round.
- +1 to spell strength, +2 to save vs Horror Factor, and +4 to save vs poison.
- Claws add +2D6 damage to punches and kicks.
- Foot stomp and tail swipe do 3D6 damage; tail swipe can knock opponents down on a natural 18 or higher.



- Fire Breath once per melee round: 6D6 damage, 12 foot (3.6 m) range.
- Natural abilities (in addition to one's own skills and magic abilities): Fly 40 mph (64 kph), see the invisible, nightvision 100 feet (30.5 m), fire and cold resistant (half damage), impervious to disease, and bio-regenerate 1D4x10 hit points or S.D.C. once every minute (4 melee rounds)!

Sanctuary

Level: Spell of Legend

Range: 50 foot (15.2 m) radius per level of the spell caster.

Duration: 1D6 hours per level of the spell caster.

Saving throw: None

P.P.E.: 1500

This legendary spell prevents all acts of aggression or hostility within its radius of influence. It is so powerful that it can immobilize an entire army. Any creature that attempts to attack or harm any other creature within its radius is instantly struck down becoming temporarily paralyzed or rendered unconscious. The aggressor is not harmed in any way, but merely immediately and completely incapacitated. The perpetrator of any action that will harm another, no matter how subtle, will be so immobilized. Only the spell caster of the sanctuary is *not* subject to its effects.

ANCIENT WEAPONS & EQUIPMENT

Ninja Equipment

The Ninja have developed a number of specialized tools and weapons to aid their missions. These weapons are often provided by Ninja organizations or built by the Ninja himself. Ninja equipment is generally not commonly available to the public, but similar items may be used by the various character classes within the *Special Training Power Category* and certain *Hardware* classes.

Climbing Claws

Also called Tekagi or Shuko. There is usually a metal or leather band that wraps around the palm between the thumb and fingers. The inside surface has from two to six spikes that are helpful in climbing wood and stone surfaces. Adds +15% to climbing skills. **Damage:** Not intended as a weapon, but can inflict 1D4 damage. **Cost:** \$100-\$150 per pair.

Climbing Spikes

These are spiked claws that are attached to the soles of the feet for climbing. Note that normal walking or running is impossible while wearing these (reduce speed by 90%). Add +15% to climbing skill and this bonus is cumulative (i.e. +30% when used with climbing claws). **Cost:** \$75-\$100 per pair.

Eggshell Bomb

This is an eggshell filled with pepper, metal shavings and other secret substances. When tossed, it will shatter and a small cloud of blinding, irritating smoke will come out. Does no damage, but all victims must save against nonlethal -poison gas. **Cost:** \$5.00 each. Blinded victims are -6 to strike, parry, and dodge.

Ippon-Shogi Nobori

A special tool used ONLY for climbing trees and telephone poles. A short length of spike-studded wood with ropes attached to each end. This is used much like a lumberjack's or lineman's leather climbing belt. Add +25% to the climbing skill (can not be used with other climbing claws or gear). **Cost:** \$50-\$75.

Ninja Emergency Kit

This is an assortment of items that a Ninja might need in case of trouble. Ninjas will keep several of these kits hidden in various places. Included in a small cloth bag would be a , 6 shuriken, 12 caltrops, a 3 foot (0.9 m) towel, a small cooking pot, paper and pencil, matches, first-aid kit (bandages, disinfectant, small scissors, pain-killer), lock picks, spare clothing, and an eggshell filled with blinding powder. Enough rice, soybean curd and tea would be included for 7 days of tight rations. **Cost:** \$200-\$400.

Ninja Clothing

Comes completely black for concealment in darkness or completely white for snow. Consists of jacket, hakama (pants), tabi (socks), and belt. Leggings and separate

sleeves fitted from elbow to the back of hand, a groin protector and a body vest are made out of quilted padding and used as protection (A.R. 6, S.D.C. 20). There are numerous pockets and compartments used to conceal shurikens, a garrote, caltrops, lock picks and other Ninja items. **Cost:** \$600 per outfit.

Rope and Chain

Available in just about any hardware store. Modern rope and chain is usually well tested and reinforced. Cost varies according to thickness and tensile strength. **Average Cost:** Chain: \$3.00 per foot (0.3 m); Rope: \$1.00 per foot (0.3 m).

Rope Ladder

This Ninja rope ladder has loops knotted into it every two feet or so (depending on the height of the owner). There is a 3 pound weight attached to the bottom end. The top end is often tied to a grappling hook. This item is easy to use and easy to conceal. Using it adds +10 to climbing skill. **Cost:** \$5 per foot (0.3 m).

Tetsubishi

Ninja caltrops come in a variety of styles. All are designed so that metal barbs will point upwards no matter how they land on the floor. Damage is rarely more than one point, but someone with a caltrop in their foot isn't likely to continue walking until they pull it out (i.e., they take one point of damage for each step they take until they stop and spend one melee action removing each of the things). **Cost:** \$2-5 each.

Ninja Hang Glider

Called a Hito Washi, it comes in a small bundle of rods and cloth, weighing about 25 pounds (11 kg). When assembled, it allows the character to drop from great heights, even from an airplane, without damage. **Cost:** \$600-1000.

Ancient Oriental Weapons

Aikuchi/Tanto

These are curved Japanese daggers. The Tanto has a hilt, the Aikuchi does not. This weapon can also be thrown (blades that cost more than \$650 are +1 to strike when thrown). **Cost:** Varies according to quality and beauty, from \$300-\$1,000. **Damage:** 1D6.

Bisento

This spear features a broad, curved blade and is large enough to be considered a kind of pole arm. This weapon must be imported from Japan. **Cost:** \$600-\$900. **Damage:** 3D6.

Blow Gun

The blow gun is a favorite weapon of the N. Effective range is no more than 50 feet (15 m). **Cost:** \$50. **Dam-**

age: The dart itself does no damage; however, it is usually coated with poison or drugs.

Bo Staff

Although staff weapons have appeared in virtually every culture worldwide, the techniques of use were probably most advanced in the martial arts schools of samurai Japan. The size of the Bo Staff should be about a foot taller than the height of its owner. **Cost:** \$120-\$300. **Damage:** 2D6.

Oriental Bows

Ninjas favored a short, none too powerful, bow that could be disassembled and easily hidden. A separate skill learned by the Ninja is that of the Samurai Long Bow, probably the most powerful weapon of its type in the world. Effective range for the Ninja Bow is 400 feet (122 m), for the Samurai Bow it is 800 feet (244 m). **Cost:** \$500 for Ninja Bow, \$1,000+ for a high-quality Samurai Bow, \$200-\$500 for a modern commercial hunting bow. **Damage:** Ninja Bow: 1D8 or 2D4, Samurai Bow: 2D6+2, Modern Bow: 2D6.

Modern Crossbows

Crossbows are now commonly available by mail order in the U.S. **Cost:** \$700-\$900 for a heavy, two-handed cross bow (range: 700 feet/213 m), \$250-\$500 for a large crossbow (700 feet/213 m), \$150-\$200 for a pistol-style crossbow (120 feet/36.5 m). **Damage:** 4D6 for heavy, two-handed crossbow; 2D6 for a standard large (rifle style) crossbow, 2D4 for a light bow, and 1D6 for a pistol-style crossbow.

Daisho

Literally, "the long and the short," this is the traditional Japanese weapon made up of a Katana and a Wakizashi which can be used as paired weapons. Using both of these weapons together requires the Paired Weapons skill. For Cost and Damage data, refer to the separate entries for each of the weapons that make up the "Daisho."

Jitte or Sai

These weapons look like oversized, three-pronged forks and are generally designed to be used as a pair, one in each hand. They are excellent for countering the massive attack force of the samurai sword blade. A skilled user can entangle an opponent with one hand and attack with the other. **Cost:** \$50 per pair. **Damage:** 1D6 and +1 to parry. Falls under W.P. Knife to use.

Katana (Japanese Long Sword)

This is the primary weapon of the samurai warrior; a long sword up to 3 feet (1 m) in length. There is an enormous difference in the quality of these weapons. **Cost:** Mass-produced versions run for as little as \$300-\$400. A genuine, top-quality sword would cost at least \$10,000 (and as much as \$50,000 depending on its quality and age). **Damage:** 2D6 for a mass produced to good quality sword, 3D6 for top quality (authentic, and probably over 100 years old).

Kusari-Gama/Kyoketsu-Shogi

The Kusari-Gama is another ninja favorite, being a combination of a chain with a weight on one end and a sickle weapon on the other. The Kyoketsu-Shogi is made with rope and has an iron ring on one end and a double bladed knife on the other. With both weapons, one end can be used to entangle while the other is still available for striking. It is usually used as a climbing device, but doubles as a somewhat less damaging Kusari-Gama. Neither of these weapons can be used by anyone not trained in Hand to Hand: Martial Arts or Hand to Hand: Assassin (or if you're incorporating martial arts from **Ninjas and Superspies™**, Hand to Hand: Ninjitsu), and they also require the W.P. Chain skill to use effectively. **Cost:** The Kusari-Gama is \$300-\$500 for a combat quality weapon; the Kyoketsu-Shogi costs \$200-\$300. **Damage:** 2D6 for the Kusari-Gama and is +2 to disarm, and 2D4 for the Kyoketsu-Shogi (+1 to disarm).

Kawanga

A simple Ninja weapon consisting of a rope attached to a grappling hook. When used as a weapon, it falls under W.P. Chain. **Cost:** \$50-\$100. **Damage:** 2D4.

Manriki-Gusari

A chain weapon with solid, blunt weights on each end. It can be used like a Kusari-Gama, entangling with one end, striking with the other. This is a weapon which is easy to disassemble and conceal. It is also easy to make a Manriki-Gusari from a length of chain and lead weights found in any hardware store. This weapon requires W.P. Chain to use effectively. **Cost:** \$30-\$50 (homemade) or \$100-\$150 professionally made. **Damage:** 2D4.

Naginata/Yari (Spears)

Naginata have curved blades and Yari have straight blades. Otherwise, both of these weapons are alike and used as spears. They are very difficult to conceal. **Cost:** \$350-\$600. **Damage:** 2D4+2.

No-Dachi Sword

This huge, two-handed sword does much more damage than most weapons in its class. At 5-6 feet (1.5-1.8 m) long, it is carried on the back and the weapon is pulled from the scabbard over the shoulder. **Cost:** \$750-\$1500 for a mass produced, good quality blade, \$6000-30,000 for top quality or ancient blades. **Damage:** 3D6 for mass produced and good quality swords, but 4D6 for top quality.

Nunchaku

Nunchaku (usually called "Numchuks") can be used as a paired weapon for striking. Two of the main advantages of Nunchaku are the quick strike and entangle. Entangle can only be done if one weapon is used with two hands. **Cost:** \$50-\$150 each. **Damage:** 2D4; quality weapons (\$100 or more) are +1 to disarm.

Sa Tjat Koen

This Malaysian weapon looks like Nunchaku with a second chain and third handle attached. Can be used to strike and entangle like Nunchaku. Can not be used as a paired weapon. **Cost:** \$150-\$200. **Damage:** 1D10 or 2D4+2.

Shikomi-Zue

Ninja commonly disguised themselves as blind men and carried this hollow bamboo staff with a concealed blade. The blade is spring loaded, and the release is controlled with a trigger stud that can be pressed or turned. The weapon can be used as a somewhat fragile (S.D.C. 50) bo staff or as a spear. **Cost:** \$150-\$300. **Damage:** 2D4.

Shuriken

The famous “throwing stars” of the Ninja were not designed for deadly effect so much as for their ease of concealment and usefulness in discouraging an opponent’s pursuit. Ninja also used slim throwing knives and spikes which were equally effective. Using Shuriken requires the W.P. Archery and/or W.P. Targeting skill where throwing knives requires W.P. Knives and/or Targeting. **Note:** Ninja throwing knives resemble small, flat blades or darts more than daggers and can not be used as melee weapons or to parry. Also note that true Ninja (and the *Physical Training Hero* and *Special Training: Ancient Master*) can throw two Shuriken or Ninja throwing knives or spikes simultaneously. **Cost:** Shuriken; \$6-\$20 each. Throwing Knives: \$5-\$15 each. **Damage:** 1D4 each.

Wakizashi (Japanese Short Sword)

This is the short sword favored by the samurai. The “Ninja-to” is the Ninja equivalent of this weapon, but it has a straighter blade. **Cost:** Mass-produced versions run for as little as \$200-\$400. A genuine, top-quality sword would cost at least \$6,000 and as much as \$40,000 depending on its quality and age. **Damage:** 1D6+1 for a mass produced to good quality sword, 2D6 for top quality (authentic, and probably over 100 years old).

Tonfa

A short wood weapon with a perpendicular handgrip that makes it ideal for parrying and close combat. Frequently used by policemen and security guards. It is considered a Blunt Weapon. **Cost:** \$50-\$200 (+1 to disarm and +2 to damage if a quality weapon/costs \$100 or more). **Damage:** 1D6.

Other Ancient & Exotic Weapons

Throwing Knives (Africa)

Also known as “mongwanga,” these wicked, multi-bladed throwing irons were said to be able to sever a man’s leg at 150 feet (45.7 m). **Cost:** \$80-\$150. **Damage:** 1D10 or 2D4+2. **Note:** Throwing “sticks” (Africa and Pacific islands) are similar weapons but inflict only 1D6 damage.

Bagh Nakh (“Tiger Claws” — India)

A small set of steel claws, like bladed brass knuckles, that fit in one’s hand. A weapon favored by assassins in India and the Middle East. Tiger claws were often combined with knives (Bich’Hwa Bagh Nakh). **Cost:** \$40 for claws alone, \$70-\$150 for claw/knife combinations. **Damage:** Claws: 1D4, Claw/knife: 1D4 (claws)/1D6 (knife).

Bola (South America)

A thrown weapon consisting of two or three heavy balls attached to a long cord used primarily in South America to entangle cattle and hunt small animals. Falls under W.P. Chain to use expertly with bonuses. **Cost:** \$40-\$80. **Damage:** 1D6 to strike, or can be used to entangle (no damage) or disarm (+2) an opponent. In both cases, the attacker must make a “called shot” to target a specific part of the opponent’s body (hand holding weapon or the feet). The roll for the “called shot” must be higher than 12 and also beat the defender’s roll to dodge (but the latter applies only if the opponent attempts a dodge).

A successful strike to disarm means the bola has successfully knocked the weapon out of opponent’s hand. One melee action/attack will be used for the opponent to draw a new weapon, two to retrieve the fallen weapon.

A successful strike to the feet means the victim’s feet are entangled in the bola, effectively tied together, and he falls to the ground. There is no damage from the fall or bola attack unless the character was running quickly, then he’ll take 1D4 damage from falling hard, but in all cases, the character loses initiative (is the last to attack). While entangled, the character can not run, walk, or leap, and even standing is difficult without something to hold onto. Bonuses to dodging, parrying and striking while the feet are entangled (and presumably from a prone position or otherwise imbalanced) are reduced to half! Getting untangled or cut loose uses up 1D4 melee actions/attacks.

Note: A bola attack (as well as boomerang and most thrown weapon attacks) is -3 to strike any character running faster than 30 mph (48 km).

Boomerang (Australia)

The infamous aborigine throwing stick, boomerangs come in a variety of shapes and sizes.

Light Boomerang: 2D4 damage; can be thrown to return. Weight is less than one pound (0.45 kg), and the length is under one foot (0.3 m). **Cost:** \$15-\$20.

Average Boomerang: 2D4+2 or 1D10 damage, may or may not be thrown to return, depending on manufactured style. Weight is one pound (0.45 kg), and the length is one and a half feet (0.46 m). **Cost:** \$25-\$30 +\$15 if the boomerang is the returning type.

Hunting Boomerang: 2D6+2 damage, does not return when thrown. About two feet (0.61 m) in length and weighs two pounds (0.91 kg). **Cost:** \$50.

War Boomerang: 3D6 damage, and will not return no matter how hard you try. Weight is about 4-5 pounds (1.8 to 2.3 kg), and length is 4-5 feet (1.2 to 1.5 m)! These suckers are about the size of a hefty long bow. **Cost:** \$100-\$150.

Metal Boomerang: 3D6 damage, may be thrown to return. Weighs close to 2 pounds (0.91 kg). These are a modern innovation, and are deadly despite the fact that they are no larger than your average boomerang. **Cost:** \$200. Aborigines will not use these items.

Sporting Boomerang: 1D4 damage, designed mainly to return for fun. These are plastic or ceramic sporting re-

productions that are fairly ineffective as weapons, but make good fun for throwing and catching. They usually cost from \$10 to \$15.

Note: The G.M. may wish to treat the Boomerang as a bullet for the sake of the pain it causes (for any saves or effects he employs). They have a rotating force that strikes with bone jarring impact, making them very effective. It is deceptive just how dangerous they can be.

W.P. Boomerang. (First presented by Erick Wujcik in **Mutants Down Under™**). An aerodynamic curved throwing "stick" that is the Aboriginal technological equivalent of the bow and arrow. Some can be no larger than a foot (0.3 m) long, others can be almost man-sized and require two hands to launch, but most range between 1-3 feet (0.3 to 0.9 m) long. There are many variations, some designed to return to the thrower if the shot misses, others designed purely as throwing sticks intended to inflict damage and which fall flat if they miss.

Bonuses to strike: +1 at first level, with an additional +1 at levels 3, 5, 7, 10 and 15.

Bonuses to Damage: +1 to damage at 2, 5, 9, 11 and 15.

Combat Notes: The boomerang is a hunting weapon. Nonetheless, this is an RPG, and boomerangs make pretty cool weapons (see the equipment section for more), and players are likely to try all sorts of tricks.

1. In all cases, opponents are at *-2 to parry and dodge* boomerang attacks, as they are highly unpredictable missile weapons difficult to avoid and defend against. Add this penalty to other penalties that may apply from special attacks.

The boomerang can be employed in several different ways:

2. Thrown with a slight curve so that it returns if it misses. In such a case, the range is 150 feet (45.7 m). To make a boomerang return, a character *must* have this W.P. Such trained individuals can throw those designed to return to come back to them when they miss. The process of returning uses up one melee action worth of time, during which the character can perform something else (aside from moving).

3. Straight Shot. Thrown with full force, the range is an incredible 600 feet (183 m). The boomerang will not return. +2 to damage from the velocity of a fast moving, full force boomerang. If the victim is within 100 feet (30.5 m), he is -4 to parry or dodge the attack.

4. The Back Shot is a particularly tricky method of attack. The boomerang is thrown with full force, but curves to return toward its thrower and strike a target on its return, from the opposite side. The maximum range is 250 feet (76.2 m), and the target is -8 to parry and dodge due to the element of surprise. This can even catch someone hiding behind cover if the thrower is aware of the hiding target and can accurately estimate where to strike. The difficulty of this attack means the throw is made without benefit of *any* bonuses and is -3 to hit the hidden target.

5. Bounce Shot. Thrown at a down angle, the boomerang appears to fall short then rises before hitting the

ground and strikes the victim from below. The attack has the element of surprise and can be disorientating, so the intended target is -4 to parry and dodge. If the roll to strike is 16 or higher, an opponent will be knocked off his feet by the attack (as well as suffering damage) and loses two melee actions. A successful "roll" vs punch, fall or impact will prevent the knockdown, but uses up another melee action.

6. Ricochet Shot. The W.P. also enables the character to use any type of boomerang to ricochet off one object or person and hit a second! This ricochet or bounce-off attack is done without benefit of any bonuses other than those from this W.P. Damage is inflicted to both targets struck. The second target struck is -4 to parry or dodge.

7. Trying to Catch a Boomerang thrown by somebody else. Wily opponents may *attempt to catch* a boomerang thrown at them, with a successful parry roll that scores 18 or higher, but the character must make the "call" that he intends to try to catch it, must drop or holster anything in his hand, and the "catch" uses up two melee attacks/actions. Do not discourage this tactic, but catching a full velocity boomerang is NOT recommended. A successful catch uses up two melee actions and a failed catch means the character is struck and takes normal damage. This hurts.

Chakram (Middle East)

A flat steel ring with a sharpened outer edge, thrown like a frisbee. **Cost:** \$10-\$20 each. **Damage:** 1D4+1.

Katar (India)

A Hindu double blade weapon that might be thought of as a small sword, usually about one and a half feet long (0.4 m). **Cost:** \$200. **Damage:** 1D6.

Ancient Melee Weapon Note

For hundreds of other ancient weapons from around the world (as well as info on castles, siege weapons, and much more), check out Palladium's **Compendium of Weapons, Armour, & Castles**. You'll be glad you did.

Underwater Equipment & Vehicles

Most of this equipment and all of the underwater vehicles below require Swimming: Advanced for their proper use.

Mask, Snorkel and Fin Package: Your typical skin diving gear. **Cost:** \$110.

S.C.U.B.A. Package: 80K cylinder with boot, detachable console (PS 1/Depth), regulator, wet suit, pack and power. Oxygen capacity: 90 minutes. **Cost:** \$820.

Compact S.C.U.B.A. Package: A one unit, 2 cubic foot (0.06 cubic m) capacity cylinder (air tank) with regulator mounted on top and belt holder. Overall length: 17 inches x 2.5 inches (43x6.4 cm) wide. Great for short dives or emergency air supply. Oxygen capacity is 15 minutes. **Cost:** \$155.

Mini S.C.U.B.A. Package: This is a tiny air tank and regulator measuring 5x2.5 inches (12.7x6.3 cm). Oxygen capacity is a mere FOUR minutes. **Cost:** \$300. **Note:** This is an espionage device and isn't available on the commercial market.

Diver's Watch: Multi-functional digital/analog (hands) display, alarm, two time zones, timer, rotating bezel, sweep second hand. **Cost:** \$300.

Dive Flasher: A waterproof beacon or rescue marker. Waterproof up to 150 feet. Measures 5.5 inches (14 cm); operates on one "C" battery. **Cost:** \$30.

Mini Flashlight: Overall length is 4.75x.75 inches (12x1.9 cm); uses 2 "AA" batteries. Features pocket clip, magnetic butt, and screw-down lens to turn it on. **Cost:** \$9.

Underwater Survival Blade: This is an 8-inch (20 cm) Bowie-style knife with a chisel-tooth saw, jeweled compass in the handle, sheath and belt clip. **Cost:** \$150.

Underwater Specimen Bag: Drawstring pouch and shoulder belt. **Cost:** \$16.

Head Mounted Light: **Cost:** \$30.

Underwater Vehicles

S.C.U.B.A. Scooter: Capable of transporting one to three divers. The handles are designed for pulling the divers with minimum stress on the arm muscles. Cylindrical in shape with a front-mounted rotor. **Length:** 3 feet (0.94 m), **Width:** 1 foot 5 in. (0.32 m), **Height:** 10 inches (0.25 m), **Weight:** (dry) 57 lbs. (26 kg), (submerged) 5 oz. (0.23 kg), **Maximum Depth:** 300 feet (91.5 m), **Range:** 3 nautical miles (5.6 km), **Speed:** 3 knots, **S.D.C.:** 50. Can function on the surface or submerged. **Cost:** \$2500.

S.C.U.B.A. Scooter Platform: Essentially a larger, more stable version of the little scooter. Unlike the small scooter, a diver can lay on top of the device to ride. These platforms also can be used as a stable base for underwater photography. **Length:** 9 feet, 3 in. (2.8 m), **Width from side, fin tip to fin tip:** 4 feet (1.2 m), **Weight:** (dry) 270 lbs. (121.5 kg), (submerged) 181 lbs. (81.5 kg), **Maximum Depth:** 1,970 feet (600 m), **Speed:** 5 knots, **Range:** 15 nautical miles (27.75 km), **Capacity:** Accommodates one pilot, but can pull up to four more divers or 1,000 lbs. (450 kg) of cargo, **S.D.C.:** 120. Can function on the surface or submerged. **Cost:** \$2,800

Sea Sled or CAV (Construction Assistance Vehicle): This is designed to function as an underwater pickup truck capable of delivering up to 2,000 lbs. (910 kg) of wet weight cargo. The cockpit holds two, and has with it an open cargo bed in the rear. **Length:** 27 feet (8.23 m), **Cargo bed dimensions:** 11 x 4.5 x 1.5 feet (3.35 x 1.37 x 0.46 m). **Maximum Depth:** 150 feet (45.7 m), **Speed:** 3 knots, **Range:** 15 nautical miles (27.75 km). **Life Support:** 2 hours. **S.D.C.:** 270. Can function on the surface or submerged. **Cost:** \$15,000

Waterdinger: A small, diver assist vehicle capable of carrying two S.C.U.B.A. divers and equipment. **Length:** 7 feet (2.1 m), **Cargo Capacity:** 750 lbs. (340 kg), **Maximum Depth:** 300 feet (91 m), **Speed:** 2 knots, **Range:** 4 nautical miles (7.4 km), **S.D.C.:** 150. **Cost:** \$3,500

Two Diver Submersible Transport Vehicle: There are a variety of two-man, research submersibles with similar capabilities. **Length:** 12 to 16 feet (3.6 m to 4.9 m). **Maximum Depth:** 2,000 feet (610 m). **Speed and Range:** At 1.5 knots the range is 100 nautical miles (185 km), at 6 knots the range is about 45 nautical miles (83.25 km) and at 9 knots the range is 10 nautical miles (18.5 km). **Life Support:** 24 hours. **S.D.C.:** 550. **Cost:** \$80,000

Optional Rules for Modern Weapons

Modern Firearms

Firearms are the great equalizer in many games, especially those with superhuman or supernatural elements. **Heroes Unlimited, Second Edition** is no exception. When any punk on the street with an Uzi can throw 30 rounds at you for 3D6x10 damage, you had better be Invulnerable, fast on your feet, or smart enough to avoid the situation. That said, there will always be times when heroes take a hit, and all of a sudden, the Mega-Hero who saved the planet last week is lying dead at the hands of a MAC-10 wielding thug. Therefore, it becomes the G.M.'s job to see that firearms don't upset game balance.

How prevalent guns are in your game depends mainly on the kind of campaign you are running. A traditional superheroic setting will have heroes fighting supervillains mostly with super abilities, so guns will be few and far between, and whatever henchmen there are may only have pistols. In a much grittier and realistic setting, everybody, including the heroes, *may* carry guns. However, if your heroes are packing heat, they should keep in mind that guns kill. One of my players was horrified when his machine-pistol with exploding ammo did 200 points of damage on a full melee burst and turned a villain into hamburger. The character subsequently turned himself over to a hospital to cope with the trauma of what he had done. Aimed shots can minimize this, but accidents are far too common in combat when you're dishing out dozens of supersonic chunks of lead.

Something else for G.M.s to consider is that we have endeavored to keep the power categories as unique as possible, and some of those categories have firearms and/or modern weapons as their special abilities. Certainly the **Weapons Expert** can build guns no one else can, but he won't be as unique if the rest of the group has souped-up assault rifles as well as super abilities, magic, and/or psionics. What's the use of playing that kind of character if super-weaponry is so easy to get? If you plan to allow the heroes easy access to automatic weapons, perhaps you should let them know beforehand, especially if someone is thinking about playing a Hardware character.

All handguns and most of the firearms presented here can be bought legally in gun stores and/or through mail or-

der, but such weapons will be semi-automatic/self-loading. They will *not* be “fully automatic.” Likewise, *military issue* (heavy machineguns, bazookas, LAWs, etc.) are not legally available to the public and restricted to military use.

A gunsmith (armorer or weapons engineer skill) or Hardware character (Mechanical Genius or Weapons Expert) can convert most weapons from semi-auto to full automatic, but the weapon must be capable of the conversion to begin with. Automatic pistols can not be converted to fully automatic, unless the character is a Weapons Expert (Hardware), but any sub-machinegun or assault rifle could. Such conversions can be done for as little as \$100 (but might have a chance of jamming; you get the quality you pay for) to as much as \$1,000. In general, only individuals with a federal firearms license can “legally” have automatic weapons. These licenses are relatively easy to get in the real world, but G.M.s may want to change that in their campaigns. If one does not have a license, getting a weapon converted to full automatic will have to be done illegally (needing streetwise or find contraband).

The only weapons that can not be purchased legally are military grade explosives, hand grenades, machineguns and other heavy weapons (again requiring streetwise or find contraband to find a seller).

Buying quality weapons on the street (any weapons) usually costs 25-50% more than the listed prices, because they are often bought and resold, but average to low-quality weapons can be found for 10-25% less than the list. Such bargains will be “hot” (i.e., stolen) or formerly used in some crime, or may be in below average condition and prone to troubles or failures at the G.M.’s discretion (-2 to initiative, 15% chance of jamming each firing, 25% chance of misfires [-3 strike], or any other drawback the G.M. might deem appropriate).

Explosives

Most hand grenades should be treated as thrown weapons. Grenade launchers are used as Weapon Proficiency — Rifle. See equipment sections below for more information.

Reloading

Almost all modern weapons come equipped with easy-to-load ammunition magazines, more commonly known as “ammo clips” or “clips.” There are even quick-loaders for revolvers. This means that attackers can fire a full “clip” every melee round. Reloading a gun using a clip or speed-loader requires one melee action for characters skilled in the firearm. Unskilled characters take twice as long. However, older weapons — bolt-action, muzzle loaders, hand-loaded revolvers and most shotguns — will require a full melee round (15 seconds, sometimes more) to reload. **Note:** It will take characters who have less than 7th level experience twice as long as usual to reload while in the thick of combat/firefight/under direct fire, because of the sounds and stress of combat.

Strike Bonus

Physical Prowess (P.P.), Physical Training and other strike bonuses do *not* apply to modern weapons. When using a gun, only the W.P. Skill bonuses with that weapon can be used. For example, a character with +5 to strike in hand to hand combat and level 1 skill in W.P. Revolver would have a +4 bonus to strike for an aimed shot with a gun from his W.P. skill and for taking time to carefully aim — P.P. and Hand to Hand skill bonuses are *not* included.

G.M. Note: This applies to all ranged attacks in **HU2**, including use of the bow and super abilities like energy bolts.

Older Weapon Designs

Older firearms, like black powder and muzzle loaders, will have much shorter ranges (half compared to its modern equivalent) and do not get any bonuses to strike, not even from aiming or making a called shot. Furthermore, most people, heroes included, will not know how to load old style firearms that date back to earlier than 1860. The only exception is the *Weapons Expert* who can use these weapons well and keeps the usual bonuses to strike.

The reason for these drawbacks is that these old firearm designs are very different and “alien” to the modern user, and are typically heavier, a bit awkward, have a heck of a kick, and are often single shot. However, the caliber was often larger and the damage is typically high: 3D6 or 4D6 for large handguns (effective range: 50 feet/15 m) and 4D6 to 6D6 damage for rifles, muskets included — but remember, the weapon often only fired one or two shots. The G.M. should use discretion if a character should ever have to use an “antique” of this sort. For example: The Kentucky Flintlock was a .50 caliber rifle, its damage would be 5D6, but the range a pitiful 150 feet (45.7 m). **Transdimensional Teenage Mutant Ninja Turtles** has a good list of older firearms from the U.S. Civil War, the Old West, and beyond, if such reference should be needed (time travel anyone?).

Penetration Values

This is another optional rule system that can add some realism to firefights in your campaign. Not all weapons of the same caliber have the same stopping power. The 9 mm Parabellum round, for example, is lethal but has little stopping power because it tends to go right through its target. On the other hand, that same kind of ammunition has great penetration, which has a merit all its own on the battlefield.

The Penetration Values table which follows can be used as a guideline for characters trying to shoot through barriers or solid objects. Ultimately, the decision on whether or not certain bullets can punch through certain objects is up to the G.M. A good start is to consult the S.D.C. Values table on page 70 of **Heroes Unlimited, 2nd Edition**. It is important to note that *penetration* means the bullet was able to punch through a barrier (armor, door, wall, etc.), it does not mean it inflicted full S.D.C. damage and it certainly does not obliterate the S.D.C. of the barrier. A door can be riddled with bullet holes, but remain standing, open and close, and even lock tight (unless the lock was shot up).

Damage & Penetration Considerations: Typically the bullet or blast will lose half of its energy/damage capacity barreling through the barrier and inflicts half damage to whatever is on the other side (the character behind the body armor, or hiding behind the door, wall, etc.). This means half the damage is subtracted from the barrier that has been penetrated, and half from the second target struck from behind the barrier. G.M.s may also want to consider the possibility of the bullet(s) being deflected, knocked slightly to severely off course as it plunges through the barrier (01-40% chance that it misses its mark, i.e. the character behind the barrier). Furthermore, if the real target is somebody hiding behind a door, wall, car, etc., and that target is completely concealed by the barrier, the attacker is effectively "shooting blind" (-9 to strike to begin with, and an aimed/"called shot" is impossible). Of course, X-ray vision will negate this penalty. A "called shot" is possible only if the target is visible.

The following Penetration Values are a good rule of thumb:

Penetration Values (Other Than Tissue)

1: Poor: Deflects off bone. Penetrates objects under 30 S.D.C.

2: Fair: Deflects off bone. Penetrates objects under 50 S.D.C.

3: Adequate: May lodge in bone. Penetrates objects with up to 75 S.D.C.

4: Good: May break bone. Penetrates objects with up to 100 S.D.C.

5: Very Good: Shatters bone, wood; goes through cinder block. Penetrates objects with up to 170 S.D.C.

6: Excellent: Easily shatters bone, wood, goes through brick and thin metals (car doors). Penetrates objects with up to 225 S.D.C.

7: Superior: Easily shatters bone, wood; goes through brick and thin metals (car doors). Penetrates objects with up to 300 S.D.C.

8: .50 Caliber: Shatters anything less than concrete; goes through concrete, 1/2 inch armor plate steel, cars, and most walls. Penetrates objects with up to 400 S.D.C.

9: 20 mm and larger: Goes through anything less than thick military armor and damages anything else. Penetrates objects with more than 500 S.D.C. Both 8 and 9 will shoot through a car's engine block. They can also shoot through the "body" of the car, from one side to the other, and two feet (0.6 m) of brick, packed earth or sandbags.

In general, bullets and energy blasts with Penetration Values of up to 6 will damage vehicle armor, but will not go through a vehicle. However, 5 and up will punch through most wood doors and ordinary interior, plaster or wood walls (so might P.V. 4, but it is more likely to get stopped depending on the thickness and quality of construction). Also, military armored vehicles (and certain police and SWAT vehicles) have extremely tough armor that most bullets simply cannot hurt.

Tissue Damage Ratings

Over the next few pages will follow a fairly concise but comprehensive listing of firearms to include in your **Heroes Unlimited™** campaign. However, there is no way we could include all firearms in this supplement. And, new firearms are constantly being invented and used by the world's military constantly, so it's inevitable that you won't find certain firearms here.

Not to worry, you've still got two options. First, you can check out Palladium's **Compendium of Contemporary Weapons**, between that book and this sourcebook, you should have a rich variety of hardware to pick from when equipping your heroes and villains. Second, if you still can't find what you're looking for, then feel free to use our Tissue Damage Rating table to convert missing firearms to **Heroes Unlimited** specifications.

These Damage Ratings suggest how much damage, in dice, firearms of a certain *caliber* will inflict. As you read the weapons descriptions later in this section, take note of their tissue damage ratings and use them as guidelines for designing stats for your own weapons.

Note: These is by no means a definitive or completely accurate evaluation of its effectiveness in the real world, but they should be acceptable for a role-playing environment. G.M.s, don't let yourself be intimidated by a player who swears that these ratings are not accurate. If you are comfortable with these ratings, then stick to them, or do some research to confirm them. Or, figure out some way to fine tune these ratings to you and your player's satisfaction. We are personally confident that the rating system is a fair and reasonable adaptation.

Tissue Damage Ratings

1. Barely Adequate: 1D6

2. Fair: 1D8 or 2D4 (whichever is preferred)

3. Good: 2D6

4. Very Good: 3D6

5. Excellent: 4D6

6. Very Excellent: 5D6

7. Superior: 6D6

8. Heavy Machinegun: 5D10+6

9. Heavier Caliber Machinegun: 6D10+6

Both 8 and 9 will shoot through a car's engine block. They can also shoot through the "body" of the car, from one side to the other, two feet (0.6 m) of earth, sandbags, brick or stone.

Pistol Cartridges

Note: The number in front of the cartridge name indicates the Tissue Damage Rating table previously presented.

(1) .22 Short: Very little penetration. Little or no nerve trauma.

(1) .22 Long: Slightly more powerful than the .25 (especially in long-barreled guns). Better expansion properties of the bullet results in greater tissue and nerve trauma. Penetration is poor due to the soft mushrooming of the bullet which tends to disintegrate on heavy bone. When used as a rifle round, however, performance improves dramatically (Penetration Value of 2-3).

(1) **.25 Automatic Colt Pistol (A.C.P.):** Adequate for self-defense if shots are placed in face, head, neck, or body areas with no bones to deflect the small projectile.

(2) **.32 A.C.P.:** Fair to good performance if used in a high capacity automatic. Decent penetration with little or no expansion, as with all jacketed projectiles used in automatics.

(2) **.32 Long (Revolver):** Marginally better velocity and penetration than the .32 A.C.P. More variety of loads increases its deadliness.

(3) **.38 Special:** A good self-defense cartridge with good offensive capabilities.

(4) **.38+ (Power):** Much more power than the standard .38, with better expansion and penetration.

(5) **.357 Magnum:** This cartridge produces great amounts of tissue damage, has excellent stopping power, and has noteworthy penetration, even when hollow points are used. It was designed for the California Highway Patrol, which needed a handgun round capable of punching through moving vehicles. The .357 magnum handgun itself is considered easier to master than the 9 mm, .45 auto., .41 Magnum and the .44 Magnum. The .357 Magnum also is an excellent hunting round.

(5) **.45 A.C.P.:** Introduced in 1911, this shell has proven itself a man-stopper in many countries and conflicts. This cartridge was created to be used against human adversaries and has little or no hunting value. Wide wound channels are caused by this thick, heavy, slow-moving cartridge, resulting in serious nerve trauma (shock).

(5) **.45 Long:** Rates the same as the .45 A.C.P., but has better penetration.

(5) **.41 Magnum:** High velocity, excellent penetration, a very good man-stopper and fine hunting round. Despite this, the cartridge has never been very popular, with .357s and .44 Magnums being in much greater demand.

(5) **.44 Magnum:** An excellent handgun cartridge. Its large, heavy slug inflicts major amounts of tissue damage. Great penetration and stopping power. Even if a person were only wounded, the damage inflicted would probably severely hamper any retaliation (this is also true with a .357 and .41 Magnum, but to a lesser degree). A very good hunting round.

(1) **5.45 mm:** Poor stopping power, with poor to good accuracy.

(2) **7.62 mm Nagant:** A service round used by the ex-Soviet Union and in gas-sealed target revolvers.

(2) **7.63 mm Mauser:** Standard ex-Soviet pistol and sub-machinegun round, under the name of 7.62 Tokarev.

(2) **7.62 mm Parabellum:** Used by Central European police and security forces. Not currently in front-line service with any army.

(3) **7.65 mm Long:** Unique to French forces. Comparable in power to the contemporary 9 mm Browning long cartridge. (The Browning being the world standard for pocket pistols).

(2) **9 mm Short:** Used by many armies, this cartridge is replacing the venerable .45 Colt in the U.S. Army due to its better penetration of body armor. Yet, since it does not

expand (like in autos), it does not inflict the trauma effect that the fat, slow .45 does.

(3) **9 mm Police:** In use with several European police authorities.

(3) **9 mm Makarov:** Not yet made outside the ex-Soviet Union. For use with the Makarov pistol.

(5) **10 mm/.40 Caliber:** Designed as an effective man-stopper, these rounds have much of the punch of the heavier .45, but the smaller size gives slightly better penetration and a more level trajectory.

Rifle Cartridges

(5) **7.62 mm Soviet Model 1943:** This was the standard infantry cartridge of the Soviet Army. It remains in widespread use by third world countries.

(5) **5.56 mm:** Similar to the 5.45 Soviet. However, this cartridge is longer and narrower and can not be used in the AK-47.

(5) **.303 British:** Standard British and Imperial cartridge from 1889 to the 1960's. Best reports indicate that it has never been made in steel-cased form. Excellent range and accuracy.

(5) **7.92 Mauser:** Probably the most widely distributed military rifle cartridge in history.

(6) **5.45 mm Soviet:** For use with the infamous AK-47.

(6) **7.62 mm NATO:** Comparable in performance to the 30-06, but in a shorter case. A long-range, sniper-type shell.

(6/5) **12 Gauge Shotgun:** Can use a solid slug (5), or can be used with various grades of buckshot (0, 00, or 000). 00 buckshot is most commonly used for military shells (Tissue Damage 5, Penetration Value 2), since 0 shot is too light to have effective stopping power and 000 is too heavy to shoot very far. **Note:** There are other gauges for shotguns (10 and 20 gauges being most common), but neither is used much for police or military purposes. In general, a 20 gauge shotgun will have -1 Tissue Damage/-1D6 damage, and a 10 gauge shotgun will be at +1 Tissue Damage/+1D6 damage.)

Special Cartridge Types

Tracer: This cartridge contains a compound that ignites and burns when the cartridge is fired which creates a visible flight path from the gun to the target. This makes it easy to adjust fire, especially at night and during automatic burst fire. Cartridge range is reduced by 10-20%. When used in machineguns, these rounds are placed every 10 rounds along the belt, giving a bonus of +1 (single-shot) or +2 (burst fire) to strike.

Hollow Point: The bullet of this cartridge is, as its name suggests, hollowed out and scored so that it expands (or "flowers") on impact, causing a large wound (+3 to damage to unarmored targets). The hollow point, however, is less effective against solid/structural objects, like walls, doors, cars, body armor, etc., which reduces the weapon damage by one die and lowers the penetration value by one rank. These rounds also reduce their range by 10%. For example, a 9 mm has a damage rating of

3D6 and penetration value of 2 or 3. Hollow point 9 mm rounds have a penetration value of 1 or 2 and do 3D6+3 damage to fleshy targets and 2D6 damage to solid/armored targets.

Dum-Dum: These are essentially a poor man's hollow point bullet. Usually, one makes these by cutting an "X" over the tip of the bullet. This helps the bullet expand and shatter on impact. Less penetration than the hollow point or any other shell, but good for short-range combat. Dum-dums generally aren't used in fully automatic weapons since they are prone to jamming (25% chance per burst). That, and who really wants to cut X's into a couple hundred rounds? Adds +1D6 to damage and reduces range by 15%.

Full Metal Jacket: These sleek cartridges are coated with a tough metal jacket that provides excellent penetration (+1 P.V./+1D6). Can be used in any pistol or rifle.

Armor Piercing/Teflon (KTW Rounds): These rounds are used mostly by the police and the military. They generally aren't available to the public, since most people have no reason for using an armor-piercing rounds. Armor piercing rounds add +2 P.V., +1D6 damage, and lower a target's A.R. by two (or get +2 strike against armored targets). For example, an armor-piercing 7.62 mm assault rifle round would have a penetration value of 7, damage of 5D6, and will be +2 to strike against armored targets (or lower A.R. by 2).

Exploding/Mercury-Tipped Shells: This shell is primarily used in pistols because burst fire has a 40% chance of prematurely rupturing the shell. Unlike true explosive rounds (See Special Bullets in the Hardware section of Heroes Unlimited), these bullets do not have a charge in them. Instead, they have a small channel in them filled with mercury. When the bullet impacts on soft tissue, it compresses the mercury, the shell ruptures and shrapnel fills the victim. These rounds add +2D6 to the damage of the bullet, but range is reduced by 10% and penetration is lowered by one rank. Example: A 9 mm mercury tipped shell would have a P.V. of 1 or 2 and do 5D6 damage. These make for absolutely lethal close-combat and assassination rounds.

Glaser Rounds: Using the same principles as the exploding/mercury rounds, these shells are hollow casings filled with small beads of metal shot, much like a miniature shotgun shell. When the round impacts, it ruptures and the shot scatters into the target. The results are devastating to soft fleshy things, but ineffective against even semi-solid targets. Glaser rounds add +2D6 to the normal damage of a round when used against flesh and other soft targets, but against anything solid, it has a pitiful penetration value of 1 and does only 1D6 damage, regardless of the caliber of the weapon. For example, a .45 caliber glaser round does 6D6 damage to flesh, but will only do 1D6 damage to armor, sheet rock, paneling, etc. These rounds can only be used in handguns and are illegal in most states and many countries.

Firearm Accessories

Silencer: A silencer is a barrel-like attachment which fits over the barrel of a gun to muffle the sound of the report. Perception rolls require a 10 to detect silenced shots from 20 feet away; each 15 feet gives bystanders +1 to notice the shot. Silencers reduce a weapon's range by 10%. Homemade silencers work almost as well as bought ones (and cost only 1D4X10 dollars to make), but their use is limited to 1D10 shots, they reduce range by 15%, and the distance modifier to perception rolls is +1 for each 10 feet. **Cost:** (revolver) \$350, (automatic pistol) \$500, (bolt-action rifle) \$600, (automatic rifle) \$1,500, (sub-machinegun) \$2,000. These are black market prices, since silencers are unavailable on the commercial market. As with most illegal hardware, these prices can fluctuate between 50% and 200% of their listed price, depending on location, the buyer, the seller, and other circumstances.

Flash Suppressor: Another barrel shaped attachment that can fit over the barrel of a gun, but not over a silencer (unless made by a Weapons Expert). Typically used for nighttime operations, this instrument masks the muzzle flash when a gun fires. In the dark, a gun's muzzle flash can be seen easily, but with a flash suppressor, noticing it requires a Perception roll of 12 or higher. Flash suppressors reduce a weapon's range by 15%. **Cost:** (revolver) \$250, (automatic pistol) \$450, (bolt-action rifle) \$1,200, (sub-machinegun) \$1,600. Like silencers, flash suppressors are illegal and must be bought on the black market. **Note:** Combined silencers and flash suppressors are available, but they are rather expensive (combine the cost of a silencer and flash suppressor and add 1D4X10%, and THEN add whatever black market mark-ups might apply. Combination silencer/suppressors reduce a weapon's range by 25% and generally are only used for close-quarters fighting.

Laser Sights: These are small, coherent beam targeting systems that fit on all firearms, even pistols. They project a laser beam that produces a red dot on the target, showing approximately where the bullet will hit. Laser sights add +1 to all firearms rolls, including bursts, but their range is limited to 200 feet. **Cost:** \$200.

Recoil Diminishers: A small tube is mounted along the length of the firearm that is filled with a combination of mercury and ball bearings. The system is custom built for each class and type of firearm. When the weapon fires, the beads roll and the mercury shifts to help counter recoil. When burst firing, it adds a +1 to strike. **Cost:** \$1,000.

Weapon Descriptions

Abbreviations and Terms

Cartridge: Type of bullet; ammunition.

Magazine: Compartment which holds ammunition and is directly inserted into the weapon. In the weapons descriptions below, the abbreviation "mag." will be used.

Rounds: The number of cartridges/ bullets fired; i.e., 7 rounds equals 7 bullets fired, 13 rounds equals 13 bullets fired, etc.

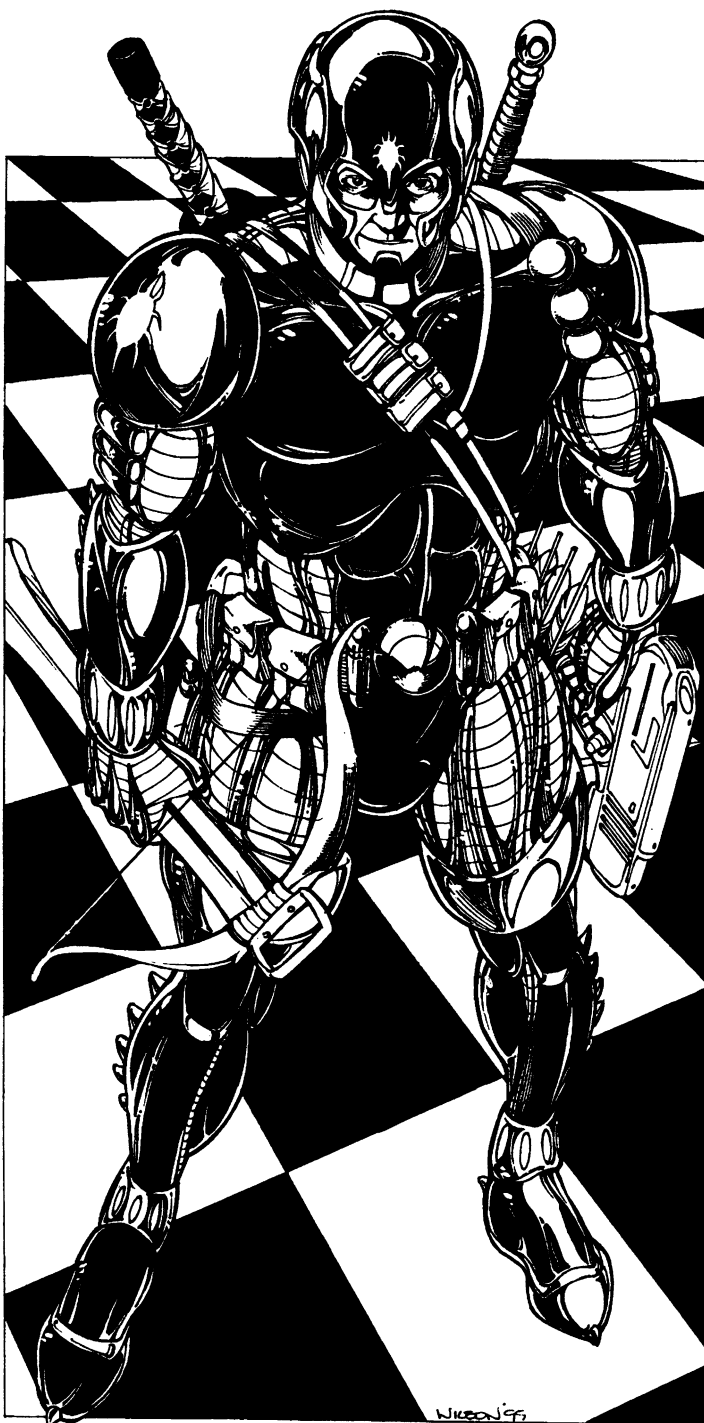

Feed: Method by which the cartridge enters the weapon.

Weight: gm = grams, kg = kilograms.

Length: mm = millimeters, m = meters.

Barrel Length: This is only the barrel's length. The overall length, when known, is listed in parentheses after the barrel length.

Muzzle Velocity: m/s = meters per second. This indicates the speed at which the cartridge is traveling when it leaves the muzzle of the weapon.

Approx. Effective Range: This is the longest distance that the weapon can be fired without losing accuracy or

damage. Guns can be fired beyond their effective range, but with no W.P. Skill Bonus and with a -4 to strike for every 25 feet beyond the effective range. Burst firing effectively reduces the weapon's range by half.

Bolt-Action: A feed method used mainly in older rifles. By pulling back the bolt, a spent shell is ejected from the breech. A spring-loaded mechanism then snaps the bolt forward, closing the breech, and a fresh shell is moved into firing position.

Breech: The opening where a shell is either inserted or ejected from a firearm.

Clips: Metal grips which hold the cartridge by the rim or base, which is then inserted into the magazine, forming part of the magazine mechanism.

Caliber: The internal diameter of a weapon's barrel. Calibers may be expressed in thousandths of an inch (as was the custom in the U.S. and Great Britain for many years), i.e. .357, .45, etc. More commonly, calibers are expressed in millimeters, i.e., 9 mm, 7.65 mm, etc.

Cost: The average cost for an average, good quality weapon. Superior quality, craftsmanship, ornamentation, silver, pearl and other plating will all increase the cost by 50% to 100%.

F.N.: A reference to the weapons manufacturer: Fabrique National d'Armes de Guerre of Belgium.

Expanded Firearms Listing

Handgun

Automatic pistols are not fully automatic. They are semi-automatic/self-loading firearms, which means a bullet is fired each time the trigger is pulled. Double-action revolvers work the same way (all the revolvers in this section, and most modern revolvers in general, are double-action). As noted in the Modern Weapons Combat section of **Heroes Unlimited**, revolvers are slightly more accurate than auto pistols due to a smoother firing mechanism, and often receive a bonus to strike. Both double-action revolvers and automatic pistols can fire rounds in rapid succession as detailed in the **Heroes Unlimited** Modern Combat Rules.

Errata: Remember that the * Note under **Firing a Burst (Heroes Unlimited, 2nd Edition, page 75)** is correct, but the examples are wrong. Semi-automatic weapons do require an extra action to fire bursts, but the example for the full melee burst should say "Counts as four attacks" instead of "Counts as three attacks."

Hardware Experts: Note that most Hardware: Weapon Experts can modify normal weapons and ammunition so they are more lethal. Common tricks include adding magazine capacity so bursts are more damaging, and increasing the propellant or structure of bullets for added stopping power.

Weapons with multiple calibers listed can be purchased in those different calibers. It doesn't mean the gun can fire different bullets just by changing clips, although a hardware character might make up a quick-change barrel sys-

tem that could accommodate different ammunition types during a firefight.

Automatic Pistols

Hardballer (AMT)

Country: U.S., **Cartridge:** .45 ACP, **Feed:** 7 round mag., **Weight:** 2.4 lbs (1 kg/1076 g), **Barrel Length:** 5 inches (127 mm), **Muzzle Velocity:** 1155 ft/s (350 m/s), **Approx. Effective Range:** 135 feet (41 m), **Damage:** 4D6, **Cost:** \$580.

On Duty (AMT)

Country: U.S., **Cartridge:** 9 mm and .40, **Feed:** 15 rounds (9 mm short) or 11 round (.40), **Weight:** 1.9 lbs (0.9 kg/840 g), **Barrel Length:** 46 inches (114 mm), **Muzzle Velocity:** 9 mm: 924 ft/s (280 m/s), .40: 973.5 ft/s (295 m/s), **Approx. Effective Range:** 165 feet (50 m), **Damage:** 3D6 (9 mm) or 4D6 (.40), **Cost:** \$550.

Automag (AMT)

Country: U.S., **Cartridge:** .22 Magnum to .50 AE, **Feed:** 9 round magazine (.22) and 7 round magazine (.44), **Weight:** 2 lbs (0.9 kg), **Barrel Length:** 4.6 inches (114 mm or 86 mm), **Muzzle Velocity:** 1188 ft/s (360 m/s), **Approx. Effective Range:** 165 feet (50 m), **Damage:** 2D4 (.22 magnum) up to 6D6 (.44 magnum and .50 AE), **Cost:** \$750-900.

A-80 (Astra)

Country: Spain, **Cartridge:** 9 mm, .38+, .45 ACP, or 7.65 mm, **Feed:** 15 round mag., **Weight:** 2.2 lbs (1 kg), **Barrel Length:** 4 inches (96.5 mm), **Muzzle Velocity:** 835 ft/s (253 m/s), **Approx. Effective Range:** 165 feet (50 m), **Damage:** 3D6 (9 mm, .38+, & 7.65 mm), 4D6 (.45 ACP), **Cost:** \$570-\$650.

P-018 (Bernadelli)

Country: Italy, **Cartridge:** 9 mm, **Feed:** 15 round mag., **Weight:** 2 lbs (0.9 kg), **Barrel Length:** 4.9 inches (122 mm), **Muzzle Velocity:** 990 ft/s (300 m/s), **Approx. Effective Range:** 135 feet (41 m), **Damage:** 3D6, **Cost:** \$525.

BDA 380 (Browning)

Country: Belgium, **Cartridge:** .380 Auto or 7.65 mm, **Feed:** 13 (.380 auto) or 12 (7.65 mm) round box mag., **Weight:** 1.4 lbs (0.6 kg), **Barrel Length:** 3.8 inches (96 mm), **Muzzle Velocity:** 924 ft/s (280 m/s), **Approx. Effective Range:** 135 feet (41 m), **Damage:** 3D6, **Cost:** \$550.

Delta Elite (Colt)

Country: U.S., **Cartridge:** 10 mm, **Feed:** 8 round detachable box mag., **Weight:** 2.4 lbs (1.08 kg), **Barrel Length:** 5 inches (127 mm), **Muzzle Velocity:** 957 ft/s (290 m/s), **Approx. Effective Range:** 135 feet (41 m), **Damage:** 4D6+2, **Cost:** \$725-875.

Mark IV Series 80 (Colt)

Country: U.S., **Cartridge:** .38+ or .45 ACP, **Feed:** 8 (.45 ACP) or 9 (.38+) round magazine, **Weight:** 2.4 lbs (1.08 kg), **Barrel Length:** 5 inches (127 mm), **Muzzle Velocity:** 1188 ft/s (360 m/s), **Approx. Effective Range:** 165 feet (50 m), **Damage:** 3D6 (.38+) or 4D6 (.45 ACP), **Cost:** \$500-700.

Combat Commander (Colt)

Country: U.S., **Cartridge:** .38+ or .45 ACP, **Feed:** 8 (.45 ACP) or 9 (.38+) round magazine, **Weight:** 2.3 lbs (1 kg), **Barrel Length:** 5.8 inches (146 mm), **Muzzle Velocity:** 924 ft/s (280 m/s), **Approx. Effective Range:** 135 feet (41 m), **Damage:** 3D6 (.38+) or 4D6 (.45 ACP), **Cost:** \$660-850.

Officer's ACP (Colt)

Country: U.S., **Cartridge:** .45 ACP, **Feed:** 6 round mag., **Weight:** 2 lbs (0.9 kg), **Barrel Length:** 35 inches (88.9 mm), **Muzzle Velocity:** 1155 ft/s (350 m/s), **Approx. Effective Range:** 165 feet (50 m), **Damage:** 4D6, **Cost:** \$750-900.

Double Eagle (Colt)

Country: U.S., **Cartridge:** 10 mm and .45 ACP, **Feed:** 8 round magazine, **Weight:** 4.9 lbs (2.2 kg), **Barrel Length:** 8.6 inches (216 mm), **Muzzle Velocity:** 1188 ft/s (360 m/s), **Approx. Effective Range:** 150 feet (46 m), **Damage:** 4D6+2 (10 mm) or 4D6 (.45 ACP), **Cost:** \$700-900.

Coonan

Country: U.S., **Cartridge:** .357 Magnum, **Feed:** 7 round magazine, **Weight:** 2.7 lbs (1.2 kg), **Barrel Length:** 5 inches (127 mm), **Muzzle Velocity:** 875 ft/s (265 m/s), **Approx. Effective Range:** 165 feet (50 m), **Damage:** 5D6, **Cost:** \$700-900.

CZ83

Country: Czechoslovakia, **Cartridge:** 7.65 mm, 9 mm, or .38+, **Feed:** 15 (7.65 mm) or 13 (9 mm and .38+) round box mag., **Weight:** 1.5 lbs (0.7 kg), **Barrel Length:** 4.5 inches (96 mm), **Muzzle Velocity:** 990 ft/s (300 m/s), **Approx. Effective Range:** 135 feet (41 m), **Damage:** 3D6 (9 mm, 7.65 mm, .38+), **Cost:** \$660.

Glock 17, 18, 20, 21, 22, & 23 (Glock)

Country: Austria, **Cartridge:** 9 mm Parabellum (Glock 17 & 18), 10 mm (Glock 20 & 21), .40 S&W (Glock 22 & 23), **Feed:** 17 round mag. (Glock 17), 19 or 33 round mag. (Glock 18), 15 round mag. (Glock 20, 21, 22, & 23), **Weight:** 1.4 to 1.5 lbs (0.6 to 0.7 kg), **Barrel Length:** 4.6 inches (114 mm; all), **Muzzle Velocity:** 1106 ft/s (335 m/s), **Approx. Effective Range:** 165 feet (50 m), **Damage:** 3D6 (9 mm), 4D6+2 (10 mm or .40 S&W), **Cost:** \$650-875. **Note:** While Glocks do contain a large number of non-metal parts, they also contain a significant number

of metal parts, including but not limited to the bullets, which means they *can* be detected by metal detectors, but careful placement of a disassembled Glock would have a much greater chance of getting by security undetected. Weapons Experts (Hardware) can build completely composite firearms that are undetectable to scanning equipment (except for advanced chemical scanners which would pick up the propellants in the rounds).

P226 (Sig Sauer)

Country: Switzerland, **Cartridge:** 9 mm, **Feed:** 15 round mag., **Weight:** 1.7 lbs (0.8 kg), **Barrel Length:** 4.5 inches (112 mm), **Muzzle Velocity:** 1006 ft/s (320 m/s), **Approx. Effective Range:** 165 feet (50 m) **Damage:** 3D6, **Cost:** \$800-900.

P7K3 (Heckler and Koch)

Country: Germany, **Cartridge:** .380 Auto, **Feed:** 8 round mag., **Weight:** 1.7 lbs (0.8 kg), **Barrel Length:** 3.9 inches (96.5 mm), **Muzzle Velocity:** 604 ft/s (183 m/s), **Approx. Effective Range:** 135 feet (41 m), **Damage:** 3D6, **Cost:** \$700-850.

1911A1 (Springfield Armory)

Country: U.S., **Cartridge:** .45 ACP, **Feed:** 7 round mag., **Weight:** 2.5 lbs (1.1 kg), **Barrel Lengths:** 35 inches (127 mm), **Muzzle Velocity:** 1188 ft/s (360 m/s), **Approx. Effective Range:** 165 feet (50 m), **Damage:** 4D6, **Cost:** \$500.

Desert Eagle (50AE) (Israel Military Industries)

Country: U.S., **Cartridge:** .50 AE, **Feed:** 7 round mag., **Weight:** 3.2 lbs (1.5 kg), **Barrel Length:** 10 inches (295 mm), **Muzzle Velocity:** 747 ft/s (245 m/s), **Approx. Effective Range:** 165 feet (50 m), **Damage:** 6D6, **Cost:** \$1200. **Note:** The listed damage is correct, because while the Desert Eagle does use .50 caliber rounds, they are not the full sized bullets used by .50 caliber machineguns and as a result do significantly less damage. A real .50 caliber round is 5.5 inches long and the bullet itself is 2.25 inches. It just won't fit in a handgun clip, though Aliens Unlimited does have a single shot handgun that uses full sized .50 caliber rounds (can be built by Weapons Experts). The Desert Eagle also comes in a variety of other calibers, including .44, .45, and .41 AE (each does 4D6 damage).

941 (Jericho)

Country: Israel, **Cartridge:** 9 mm Parabellum or .41 AE, **Feed:** 19 (9 mm) or 12 (.41) round magazine, **Weight:** 2.2 lbs (1000 g), **Barrel Length:** 4.8 (120 mm), **Muzzle Velocity:** 809 ft/s (245 m/s), **Approx. Effective Range:** 135 feet (41 m), **Damage:** 3D6 (9 mm) or 4D6 (.41), **Cost:** \$700-850.

P85 (Ruger)

Country: U.S., **Cartridge:** 9 mm Parabellum, **Feed:** 15 round detachable box mag., **Weight:** 3 lbs (1.4 kg), **Barrel**

Length: 4.5 inches (110 mm), **Muzzle Velocity:** 825 ft/s (250 m/s), **Approx. Effective Range:** 165 feet (50 m), **Damage:** 3D6, **Cost:** \$450-600.

Third Generation Pistols (Smith and Wesson)

Country: U.S., **Cartridge:** 9 mm, 10 mm, .40 S&W, .45 A.C.P., **Feed:** 11 round mag., **Weight:** 2.4 lbs (1.08 kg), **Barrel Length:** 4 inches (101.6 mm), **Muzzle Velocity:** 990 ft/s (300 m/s), **Approx. Effective Range:** 150 feet (45 m), **Damage:** 3D6 (9 mm), 4D6+2 (10 mm & .40), 4D6 (.45), **Cost:** \$650-800.

M-40 Firestar (Star)

Country: Spain, **Cartridge:** .40 S&W, **Feed:** 6 round magazine, **Weight:** 1.9 lbs (0.9 g), **Barrel Length:** 3.4 inches (86 mm), **Muzzle Velocity:** 1155 ft/s (350 m/s), **Approx. Effective Range:** 165 feet (50 m), **Damage:** 4D6, **Cost:** \$575-675.

PT 92/99 AF (Taurus)

Country: Brazil, **Cartridge:** 9 mm Parabellum, **Feed:** 15 round mag., **Weight:** lbs (949 g), **Barrel Length:** 5 inches (124 mm), **Muzzle Velocity:** 990 ft/s (300 m/s), **Approx. Effective Range:** 150 feet (45 m), **Damage:** 3D6, **Cost:** \$620.00.

P88 (Walther)

Country: Germany, **Cartridge:** 9 mm Parabellum, **Feed:** 15 round magazine, **Weight:** 2 lbs (0.9 kg), **Barrel Length:** 4 inches (102 mm), **Muzzle Velocity:** 1155 ft/s (350 m/s), **Approx. Effective Range:** 165 feet (50 m), **Damage:** 3D6+3, **Cost:** \$1,550.

Revolvers

King Cobra (Colt .357 Magnum)

Country: U.S., **Cartridge:** .357 magnum, **Feed:** 6 chamber side-loading cylinder, **Weight:** 2.9 lbs (1.3 kg), **Barrel Length:** 6 inches (153 mm), **Muzzle Velocity:** 1155 ft/s (350 m/s), **Approx. Effective Range:** 165 feet (50 m), **Damage:** 5D6, **Cost:** \$600-800.

Anaconda (Colt .44 Magnum)

Country: U.S., **Cartridge:** .44 magnum, **Feed:** 6 chamber side-loading cylinder, **Weight:** 3.7 lbs (91.7 kg), **Barrel Length:** 8 inches (203 mm), **Muzzle Velocity:** 990 ft/s (300 m/s), **Approx. Effective Range:** 150 feet (45 m), **Damage:** 6D6, **Cost:** \$600-850.

586/686 (Smith and Wesson .357 Magnum)

Country: U.S., **Cartridge:** .357 magnum, .38 Special, **Feed:** 6 chamber side-loading cylinder, **Weight:** lbs (1502 g), **Barrel Length:** inches (219 mm), **Muzzle Velocity:** 1155 ft/s (350 m/s), **Approx. Effective Range:** 165 feet (50 m), **Damage:** 5D6, **Cost:** \$650-800.

Machine-Pistols

These weapons fall somewhere between automatic pistols and true sub-machineguns. Some of them, like the Beretta Model 93R, are the size of auto-pistols, while others, like the Calico, are the same weapon as their sub-machinegun counterparts, but they lack a stock or other extension. The primary difference between machine-pistols and auto-pistols is their burst fire or fully automatic capabilities, while the difference between them and sub-machineguns is a lack of control extensions in favor of concealability. The result is a small, concealable automatic weapon but with small ammo capacities and no bonuses when burst firing due to their lack of stocks and the short barrels. Machine-pistols use the W.P. Sub-machinegun skill.

Model 93R Select Fire (Beretta)

Country: Italy, **Cartridge:** 9 mm Parabellum, **Feed:** 15 or 20 round detachable box mag., **Weight:** 2.5 lbs (1.1 kg), **Barrel Length:** 6 inches (156 mm), **Muzzle Velocity:** 1287 ft/s (390 m/s), **Approx. Effective Range:** 180 feet (55 m), **Damage:** 3D6, **Cost:** \$950. **Note:** The 93R fires in rapid, three round burst instead of fully automatic fire. Thus it can fire short bursts using one attack that do 3D6x2 damage, but it cannot spray.

7.65 mm Model 61 (Skorpion)

Country: Czechoslovakia, **Cartridge:** .32 A.C.P. (7.65 mm), **Feed:** 10 or 20 round box mag., **Weight:** 3.5 lbs (1.59 kg), **Barrel Length:** 4.5 inches (112 mm; 513 mm overall length with butt extended; 269 mm — butt retracted), **Muzzle Velocity:** 1085 ft/s (317 m/s — 274 m/s with silencer), **Approx. Effective Range:** 165 feet (50 m), **Damage:** 3D6, **Cost:** \$890-1000.

9 mm Mini Uzi (Uzi)

Country: Israel, **Cartridge:** 9 mm Parabellum, **Feed:** 20, 25 or 32 round box mag., **Weight:** 5.9 lbs (2.70 kg), **Barrel Length:** 7 inches (197 mm; 600 mm overall), **Muzzle Velocity:** 1155 (350 m/s), **Approx. Effective Range:** 500 feet (152 m), **Damage:** 3D6, **Cost:** \$800-900.

M950 (Calico)

Country: U.S., **Cartridge:** 9 mm Parabellum, **Feed:** 50 or 100 round helical box mag., **Weight:** 4 lbs (1.8 kg with 50 round clip), **Barrel Length:** 6 inches (152 mm), **Muzzle Velocity:** 1066 ft/s (323 m/s), **Approx. Effective Range:** 135 feet (41 m), **Damage:** 3D6, **Cost:** \$600+.

TEC-9

Country: U.S., **Cartridge:** 9 mm, **Feed:** 20 and 32 round magazine, **Weight:** 2.75 lbs (1.3 kg), **Barrel Length:** 5 inches (124 mm), **Muzzle Velocity:** 604 ft/s (183 m/s), **Approx. Effective Range:** 135 feet (41 m), **Damage:** 3D6, **Cost:** \$480.

Sub-Machineguns

Sub-machineguns (SMGs) are small automatic rifles, but their short barrels limit their overall range. Besides size, the major difference between SMGs and assault rifles is that SMGs use pistol ammunition. As stated previously, these weapons are available in semi-automatic/self-loading and will have to be converted to full automatic, unless the character buys them illegally or has a federal firearms license. Most sub-machineguns will have selector switches to adjust their rate of fire from single shot to three-round burst to fully automatic. The three-round burst works just like a short burst.

M-960A (Calico)

Country: U.S., **Cartridge:** 9 mm Parabellum, **Feed:** 50 or 100 round helical mag., **Weight:** 4.8 lbs (2.17 kg), **Barrel Length:** 13 inches (330 mm) **Muzzle Velocity:** 1320 ft/s (400 m/s), **Approx. Effective Range:** 615 feet (187 m), **Damage:** 3D6, **Cost:** \$950.

MP-6 (Heckler & Koch)

Country: Germany, **Cartridge:** 9 mm Parabellum or .40 S&W, **Feed:** 15 or 30 round box mag., **Weight:** 5.6 lbs (2.55 kg), **Barrel Length:** 9 inches (225 mm), **Muzzle Velocity:** 1320 ft/s (400 m/s), **Approx. Effective Range:** 660 feet (201 m), **Damage:** 3D6 (9 mm) or 4D6 (.40), **Cost:** \$1,260.

9 mm Uzi (Uzi)

Country: Israel, **Cartridge:** 9 mm, **Feed:** 25, 32, or 40 round box mag., **Weight:** 7.7 lbs (3.5 kg), **Barrel Length:** 10.4 inches (260 mm; 650 mm overall), **Muzzle Velocity:** 1320 ft/s (400 m/s), **Approx. Effective Range:** 660 feet (201 m), **Damage:** 3D6+1, **Cost:** \$1,000.

Ingram Model 10

Country: U.S., **Cartridge:** .45 A.C.P., **Feed:** 30 round box mag., **Weight:** 6.2 lbs (2.84 kg), **Barrel Length:** 1.5 inches (146 mm; 548 mm overall), **Muzzle Velocity:** 924 ft/s (280 m/s), **Approx. Effective Range:** 660 feet (201 m), **Damage:** 4D6, **Cost:** \$950-1100.

TMP (Steyr)

Country: Austria, **Cartridge:** 9 mm Parabellum, **Feed:** 15, 20, or 25 round box mag., **Weight:** 2.7 lbs (1.30 kg), **Barrel Length:** 1.5 inches (150 mm; 548 mm overall), **Muzzle Velocity:** 924 ft/s (280 m/s), **Approx. Effective Range:** 660 feet (201 m), **Damage:** 3D6, **Cost:** \$900.

Rifles

Rifles are long-barreled, high-powered, single-shot weapons with long ranges. All of these qualities also make them ideal for sniping and other long-range shooting. Rifles can not be converted to automatic fire (except possibly by a Weapons Expert).

McMillan M87R

Country: U.S., **Cartridge:** 12.7 x 99 mm (.50 Browning), **Feed:** 5 round box mag., **Weight:** 21 lbs (9.52 kg), **Barrel Length:** 30 inches (736 mm), **Muzzle Velocity:** 1257 ft/s (381 m/s), **Approx. Effective Range:** 660 feet (201 m), **Damage:** 1D4x10, **Cost:** \$4,000.

M82A1 & M82A2

Country: U.S., **Cartridge:** 12.7 x 99 mm (.50 Browning), **Feed:** 11 round box mag., **Weight:** (13.4 kg), **Barrel Length:** 30 and 32.4 inches (737 mm and 810 mm), **Muzzle Velocity:** 931 ft/s (282 m/s), **Approx. Effective Range:** 660 feet (201 m), **Damage:** 1D4x10, **Cost:** \$6,000. The M82A1 and M82A2 are both semi-automatic and can fire short or long burst, but their limited ammo restricts them to the pistol rules above.

Model 85 (Parker Hale)

Country: U.K., **Cartridge:** 7.62 mm NATO, **Feed:** 10 round box mag., **Weight:** 12.5 lbs (5.7 kg), **Barrel Length:** 27.6 inches (700 mm), **Muzzle Velocity:** 2805 ft/s (850 m/s), **Approx. Effective Range:** 2,133 feet (650 m), **Damage:** 4D6, **Cost:** \$2,200-3000.

7.62 mm Dragunov Sniper (SVD)

Country: Russia, **Cartridge:** 7.62 mm, **Feed:** 20 round box mag., **Weight:** 9.5 lbs (4.3 kg), **Barrel Length:** 21.6 inches (547 mm; 1225 mm overall), **Muzzle Velocity:** 2740 ft/s (830 m/s), **Approx. Effective Range:** 4,200 feet (1,200 m), **Damage:** 4D6, **Cost:** \$4,000. **Note:** The Dragunov is capable of short burst firing.

Model 86 (Mauser)

Country: Germany, **Cartridge:** 7.62 mm x 51 NATO, **Feed:** 9 round box mag., **Weight:** 11 lbs (4.90 kg), **Barrel Length:** 28.8 inches (730 mm), **Muzzle Velocity:** 2488 ft/s (754 m/s), **Approx. Effective Range:** 1,968 feet (600 m), **Damage:** 4D6, **Cost:** \$2400-3000.

SSG-3000 (Sig)

Country: Switzerland, **Cartridge:** 7.62 mm NATO, **Feed:** 5 round box mag., **Weight:** 12 lbs (5.40 kg), **Barrel Length:** 24 inches (610 mm), **Muzzle Velocity:** 2574 ft/s (780-800 m/s), **Approx. Effective Range:** 1,968 feet (600 m), **Damage:** 4D6, **Cost:** \$3,500.

Automatic or Assault Rifles

These are the weapons used by the world's military to arm their soldiers in the field. The military versions are fully automatic, with large ammunition capacities and very good range. Automatic rifles all have selector switches to adjust their rate of fire from single shot to three round burst, and full automatic. The three round burst works just like a short burst. Civilian models have often identical styling and will be semi-auto/self-loading, but can be converted to full automatic as previously discussed. Except for a specific model or two, these weapons are not com-

mon on the streets because of their size which limits concealability. The listed prices are for civilian self-loading versions.

FAMAS

Country: France, **Cartridge:** 5.56 mm, **Feed:** 25 round box mag., **Weight:** 8 lbs (3.61 kg), **Barrel Length:** 19 inches (488 mm; 1136 mm overall), **Muzzle Velocity:** 2772 ft/s (840 m/s), **Approx. Effective Range:** 2,000 feet (366 m), **Damage:** 5D6, **Cost:** \$3,500.

G11 (Heckler& Koch)

Country: Germany, **Cartridge:** 4.7 mm x 33 mm caseless, **Feed:** 50 round mag. (200% ammunition for bursts), **Weight:** 8 lbs (3.65 kg), **Barrel Length:** 20 inches (540 mm; 1025 mm overall), **Muzzle Velocity:** 2650 ft/s (780-800 m/s), **Approx. Effective Range:** 1,320 feet (400 m), **Rate of Fire:** Cyclic: 500-600 rounds/minute; Auto: 100 rounds per minute. **Damage:** 3D6, **Cost:** Not available in civilian markets. Prices would start at \$8,000-\$10,000 on the black market. **Note:** This advanced weapon was designed to fire a three round burst with no applicable recoil (the recoil takes affect after the rounds leave the gun). This weapon can fire short bursts with no penalty so the burst is +3 to strike, like an aimed shot! Ammunition for this weapon costs \$200 for 50 and special ammunition types cost ten times the normal costs. This ammunition leave no spent brass casing behind when it is fired.

MD2 (Imbel)

Country: Brazil, **Cartridge:** 5.56 mm NATO, **Feed:** 20 or 30 round mag., **Weight:** 8 lbs (4.40 kg), **Barrel Length:** 21.6 inches (453 mm), **Muzzle Velocity:** 2440 ft/s (800 m/s), **Approx. Effective Range:** 1,800 feet (550 m), **Damage:** 5D6, **Cost:** \$3,800.

AK-47 (Kalishnikov)

Country: Russia, **Cartridge:** 7.62 mm, **Feed:** 30 round box mag., **Weight:** 9.5 lbs (4.3 kg), **Barrel Length:** 17 inches (414 mm; 869 mm overall), **Muzzle Velocity:** 2343 ft/s (710 m/s), **Approx. Effective Range:** 985 feet (300 m), **Damage:** 4D6, **Cost:** \$2,200. **Note:** This is the most common assault rifle in the world. Numerous countries (including China, most notably) make their own knock-offs of this classic design. The cost of one might be 10-30% less in areas where many of these weapons have flooded the local market.

La France M16K

Country: U.S., **Cartridge:** 5.56 mm, **Feed:** 20, 30, or 90 round mag., **Weight:** 5.4 lbs (2.5 kg), **Barrel Length:** 9 inches (213 mm), **Muzzle Velocity:** 2460 ft/s (815 m/s), **Approx. Effective Range:** 1,650 feet (503 m), **Damage:** 5D6, **Cost:** \$3,200-4000.

SG 550/551 (SIG)

Country: Switzerland, **Cartridge:** 5.56 mm, **Feed:** 20 or 30 round box mag., **Weight:** 9 lbs (4.10 kg), **Barrel Length:** 21.6 inches (528 mm), **Muzzle Velocity:** 3280 ft/s (1,000 m/s), **Approx. Effective Range:** 1,510 feet (460 m), **Damage:** 5D6, **Cost:** \$3,000.

M16 & M16A1

Country: U.S., **Cartridge:** 5.56 mm, **Feed:** 20 or 30 round box mag., **Weight:** 6.8 lbs (3.1 kg), **Barrel Length:** 20.4 inches (508 mm), **Muzzle Velocity:** 3300 ft/s (1,000 m/s), **Approx. Effective Range:** 1,320 feet (402 m), **Damage:** 5D6, **Cost:** \$2,400.

Steyr AUG (Steyr-Mannlicher)

Country: U.S. **Cartridge:** 5.56 mm, **Feed:** 30 or 42 round mag., **Weight:** 8.5 lbs (3.85 kg), **Barrel Length:** 20.4 inches (508 mm), **Muzzle Velocity:** 990 ft/s (300 m/s), **Approx. Effective Range:** 1,200 feet (366 m), **Damage:** 5D6, **Cost:** \$3,000.

SR-25 (Stoner)

Country: U.S., **Cartridge:** 7.62 mm, **Feed:** 10 or 20 round mag., **Weight:** 10.8 lbs (4.88 kg), **Barrel Length:** 24 inches (600 mm), **Muzzle Velocity:** 990 ft/s (300 m/s), **Approx. Effective Range:** 1,200 feet (366 m), **Damage:** 5D6+1, **Cost:** \$3,800.

Shotguns

Shotguns are listed separately because they have a versatility unavailable to other weapons, a very large barrel and shell. Shotgun shells can be filled with a number of different shot, from rock salt to razor flechettes, and custom shaped solid slugs. Special rounds are listed in the Hardware section under *Special Bullets* (HU2, page 134).

Semi-automatic/self-loading shotguns can fire a three-round burst that acts as a short burst, but it is -1 to strike. Fully automatic shotguns are rare, because the recoil is almost impossible to control. When using such weapons, a short burst receives no bonuses, long bursts are -2 to strike, and full melee bursts are -4 to strike. Characters with exceptional P.S. ratings above 28 or those with Extraordinary, Superhuman, or Supernatural P.S. higher than 18, can fire them in bursts normally (-1 to strike and no knock down or damage). Anyone else firing these weapons in bursts suffer the penalties noted previously and are either knocked down or take 1D6 damage from the recoil (shooter's choice).

Semi-automatic or self-loading shotguns are limited in the effectiveness of their bursts by their ammunition capacity (see HU2, page 75).

Note: The effective range for virtually all shotguns is 100-150 feet (30.5 to 45.7 m). Buck shot and similar fragmentation rounds will spray a three foot (0.9 meter) area. A sawed-off shotgun has a dramatically reduced barrel size which increases the width of the buck shot "spray" (5 foot/1.5 m area), but reduces the effective range to about 50-60 feet (15 to 18 m).

The following stats apply to all shotguns unless specifically noted otherwise:

Approx. Effective Range: 100 feet (30.5 m)

Penetration Value (P.V.): 5 for slugs — 2 for shot.

Damage: 4D6 for Buckshot (Scatters to cover a 3 ft/0.9 m area at 30 feet and a 10 ft/3 m area at 60 feet); 5D6 for solid slug.

12 Gauge RS 200 Beretta Shotgun

Country: Italy, **Cartridge:** 12 Gauge, **Damage:** 4D6 buck or 5D6 slug, **Type:** Manual, repeating, pump action, **Feed:** 5 or 6 round pump-operated mag., **Weight:** approx. 6.6 lbs (3 kg), **Barrel Length:** 20.6 inches (520 mm), **Cost:** \$600.

Model 12 SPAS Franchi Shotgun

Country: Italy, **Cartridge:** 12 Bore, **Damage:** 4D6 buck or 5D6, **Type:** Gas, semi-auto or hand pump, **Feed:** 6 round magazine, **Weight:** 7 lbs (3.2 kg), **Barrel Length:** 20.4 inches (500 mm), **Cost:** \$850.

12 Gauge Franchi SPAS 15 Shotgun

Country: Italy, **Cartridge:** 12 Gauge, **Damage:** 4D6 buck or 5D6 slug, **Type:** Gas, semiautomatic, or manual pump action, **Feed:** 6 round box mag., **Weight:** 8.4 lbs (3.80 kg without magazine), **Barrel Length:** 15.6 inches (400 mm), **Cost:** \$1000.

12 Gauge Bernadelli B4 Shotgun

Country: Italy, **Cartridge:** 12 Gauge, **Damage:** 4D6 buck or 5D6, **P.V.:** 5, **Type:** Gas, semiautomatic or manual pump action, **Feed:** 3, 5 or 8 round mag., **Weight:** 7.6 lbs (3.45 kg), **Barrel Length:** 18 inches (460 mm), **Cost:** \$1200.

12 Gauge Striker Semiautomatic Shotgun

Country: South Africa, **Cartridge:** 12 Gauge, **Damage:** 4D6 buck or 5D6, **Type:** Repeating revolver, **Feed:** 12 shot cylinder, **Weight:** 9.3 lbs (4.2 kg), **Barrel Length:** 12 inches (300 mm), **Cost:** \$1100.

Model 37M Ithaca Shotgun

Country: U.S., **Cartridge:** 12 Gauge, **Damage:** 4D6 buck or 5D6 slug, **Type:** Slide action repeater, **Feed:** 5 or 8 shot tubular mag., **Weight:** 6.7 lbs (3.06 kg), **Barrel Length:** 19 inches (470 mm), **Cost:** \$650.

Stakeout Ithaca Shotgun

Country: U.S. **Cartridge:** 20 to 12 Gauge, **Damage:** 4D6 buck or 5D6 slug, **Type:** Slide action repeater, **Feed:** 5 round tubular mag., **Weight:** 20 gauge: 3.5 lbs (1.58 kg), 12 gauge: 5 lbs (2.26 kg), **Barrel Length:** 14 inches (336 mm), **Cost:** \$650-700.

Model 3000 Police Smith & Wesson

Country: U.S., **Cartridge:** 12 Gauge, **Damage:** 4D6

buck or 5D6, **Type:** Single shot, **Weight:** 7 lbs (3.06 kg), **Barrel Length:** 18 inches (458 mm), **Cost:** \$450-550.

12 Gauge Defender Winchester Shotgun

Country: U.S., **Cartridge:** 12 Gauge, **Damage:** 4D6 buck or 5D6 slug, **Type:** Slide action repeater, **Feed:** 7 shot tubular mag., **Weight:** 6.5 lbs (3.06 kg), **Barrel Length:** 18 inches (457 mm), **Cost:** \$650.00.

12 Gauge Stainless Marine Winchester Shotgun

Country: U.S., **Cartridge:** 12 Gauge, **Damage:** 4D6 buck or 5D6 slug, **Type:** Slide action repeater, **Feed:** 7 shot tubular mag., **Weight:** 6.7 lbs (3.17 kg), **Barrel Length:** 18 inches (457 mm), **Cost:** \$800.

Pancor Jackhammer Mark 3A2

Country: U.S., **Cartridge:** 12 Gauge, **Damage:** 4D6 buck, 5D6 most conventional slugs, 6D6 for rocket assisted and special rounds, **Feed:** 10 shot rotating cylinder, **Weight:** 10 lbs (4.57 kg), **Barrel Length:** 21.6 inches (525 mm; 787 mm overall), **Cyclic Rate of Fire:** 240 rounds/min., **Cost:** \$2,000. **Note:** The casing for this shotgun is made almost entirely of a high impact plastic and fiberglass! The internal workings are steel. It is designed to allow such payloads as armor piercing, flechettes, fragmentation loads, canister loadings, chemical rounds, and rocket-assisted projectiles, as well as conventional loads.

Remington M870 Mark 1 U.S. Marine Corps Shotgun

Country: U.S., **Cartridge:** 12 Gauge, **Damage:** 5D6, **Type:** Slide action, **Feed:** 7 shot tubular mag., **Weight:** 8 lbs (3.6 kg), **Barrel Length:** 21.6 inches (533 mm; 1060 mm overall), **Cost:** \$900.

USAS-12 Self Loading Shotgun (Daewoo Industries)

Country: South Korea, **Cartridge:** 12 Gauge, **Damage:** 5D6, **Type:** Gas operated, self loading, **Feed:** 10 round box mag. or 20 round drum, **Weight:** 12 lbs (5.4 kg), **Barrel Length:** 18.1 inches (460 mm), **Cost:** \$1,500.

M2000 "Dragonfire" Automatic Shotgun

Country: USA, **Cartridge:** 12 Gauge, **Damage:** 5D6 or 6D6 with armor piercing rounds, **P.V.:** 5 or 7, **Type:** Select fire, single shot, three-round burst, or fully automatic, **Feed:** 15 round box mag. or 30 round drum, **Weight:** 13.6 lbs. (6 kg), **Barrel Length:** 18.9 inches (480 mm), **Cost:** Generally unavailable, but if it would appear on the black market, prices would start at \$4,000. **Note:** All of the other shotguns in this section that are capable of burst fire, are semi-auto or self-loading weapons and use the rules for such. The Dragonfire is fully automatic and uses the normal burst fire rules; however, it is a monster to control at nearly 600 rounds per minute and requires superhuman strength to adequately fire long of full melee bursts. For details on handling fully automatic shotguns, refer to page 78 of HU2.

Machine Guns

Machine guns are illegal and all of them are fully automatic. They are distinguished from assault rifles by their high rates of fire. Some machine guns even use assault rifle ammunition, but they use the machine gun burst and damage rules. Machine guns do not have clips because of their high rates of fire, instead relying on large belts of ammo instead, though some robots will use hand held machineguns with clips instead of belts. The modern weapons rules give damages based on number of bullets fired in a burst. Each weapon lists its standard belt size which will provide one full melee burst or a proportionate breakdown of other bursts or single shots. If the weapon is vehicle mounted, it may have larger belts, providing more bursts without having to reload (which can sometimes be difficult if it is built into a vehicle).

Note: Despite their separate listings here as machine guns, these weapons and the Heavy Weapons below all fall under the W.P. Heavy skill. Also note that 20 mm and 30 mm machine guns are exclusively vehicle weapons and are presented elsewhere.

.30, 5.62 mm and 7.62 mm Caliber Light Machineguns

These are the most common kind of light machineguns found in military forces the world over. Includes the M-60, M-240 SAW, Heckler & Koch 21A1, Browning .30 Caliber, and similar weapons. **Cartridge:** .30, 5.62 mm and 7.62 mm in 100 round belts. **Weight:** 15-25 lbs. (6.8 to 11.2 kg) **Effective Range:** 3,000 feet (915 m) **Rate of Fire:** Aimed, burst or spray (see Modern Weapon Combat). **Cost:** \$4,000 and up (mostly illegal). **Damage:** 5D6 per round for 5.62 mm and 7.62 mm or 1D4x10 for .30 caliber machine guns.

.50 and 14.5 mm Heavy Machineguns

These are commonly found mounted on armored military vehicles. Accuracy is poor (-2 strike unless vehicle mounted) because they are meant for use against large vehicles or massed soldiers. On the other hand, they will punch right through armor or engine blocks. Carrying these weapons are difficult, and firing without support for a normal human is impossible unless the character has a P.S. of 30 or higher. Characters with superhuman P.S. can fire these large weapons as rifles if their strength is 20, but a 30 is needed to fire them from the hip on full automatic (long or full melee bursts). **Cartridge:** .50 and 14.5 mm in 200 round belts. **Weight:** 30 to 100 lbs (13.5 to 45 kg) **Effective Range:** 3,000 feet (915 m) **Cost:** \$6,000 and up (highly illegal). **Damage:** 1D4x10 per round.

Heavy Weapons

Remember, everything within the blast radius of an explosion takes half damage (which can be rolled with for 1/4 damage), while the target struck takes full damage (unless the explosion is rolled with). Also keep in mind that if a rocket or missile misses, it will continue on its course and detonate on impact unless it runs out of fuel. If there is something immediately behind a target, it may still be

caught in the blast radius of an otherwise “missed” attack. Also note that a missile can be dodged, but the explosion it creates can only be dodged if the character can get out of the blast radius (jumping, flying, teleporting).

Rocket Launcher

Called the “Super Bazooka”, it is designed as an anti-tank weapon, but was sometimes used against bunkers. **Weight:** 12 lbs (5.4 kg), front and rear tubes; 9 lbs (4 kg), rocket, **Length:** 61 inches (1549 mm), **Effective Range:** 3,600 feet (1,097 m), **Damage:** 1D4x100, **Cost:** \$4,500+ (highly illegal), **Blast Radius:** 50 feet (15 m).

66 mm Light Antitank Weapon (LAW)

Light and disposable, this is a favorite weapon for taking out “hardened” positions where the enemy has metal or concrete protection. **Weight:** 5.2 lbs. (2.3 kg), **Size:** 35 inches (889 mm), extended. **Rate of Fire:** Single shot and discard, **Effective Range:** 1,000 feet (305 m), **Blast Radius:** 50 feet (15 m), **Damage:** 1D6x100, **Cost:** \$6,000-8,000 (highly illegal).

90 mm Recoilless Rifle

This weapon looks like a bazooka or rocket launcher (see antitank weapons). Fires a single, antitank round. **Weight:** 35 lbs. (16 kg), unloaded. **Feed:** Breech. **Rate of Fire:** (rapid) 10 rounds per minute (max. of 5 rounds) - sustained rate of 1 round per minute. When firing at the rapid rate, a 15 minute cooling period must be observed after every 5 rounds. **Effective Range:** 1,200 feet (366 m). **Blast Radius:** 80 feet (24 m). **Damage:** 1D10x100 **Cost:** \$10,000-14,000 (highly illegal).

40 mm Grenade Launcher Mounted on Rifle

This was basically a M-79 installed under the barrel on a M-16 Assault Rifle. **Weight:** 10 lbs. (5 kg). **Length:** 15.6 inches (361 mm). **Feed:** Single shot. **Rate of Fire:** 3-5 rounds per minute. **Effective Range:** 1,150 feet (350 m). **Damage:** 2D4x10, **Blast Radius:** 20 feet (6.1 m), **Cost:** \$2,500 (highly illegal).

Special Guns

Tranquilizer Rifle

This is a bolt-action rifle designed to fire a tranquilizer dart. Its effective range is about half that of a normal rifle. **Range:** 800 feet (240 m). **Rate of Fire:** 2 per melee. **Bonus to Strike:** Must have W.P. Rifle. **Damage:** Tranquilizer will render its victim unconscious within 1D4 melees unless he saves vs. non-lethal poison. Even if the save is successful, victim will become woozy in 1D4 melees making him -2 to strike, parry, and dodge and -10% to skill rolls for 4D4 minutes. **Duration:** Effects last 4D4 minutes. **Cost (rifle):** \$1,500. **Cost (darts):** \$20 each.

Dart Gun

This is basically a pistol version of the rifle above. **Range:** 110 feet (33.5 m). **Rate of Fire:** 2 per melee. **Bo-**

nus to Strike: Must have a W.P. with Pistol or Revolver. **Damage:** Tranquilizer renders victim unconscious within 1D4 melees unless he saves vs non-lethal poison. Even if the save is successful, victim will become woozy in 1D4 melees making him -2 to strike, parry, and dodge and -10% to skill rolls for 4D4 minutes. **Duration:** 4D4 minutes. **Cost (pistol):** \$800. **Cost (darts):** \$15 each.

Gas Gun (pistol)

The gas gun is a long, wide, tubular barreled handgun that fires a gas canister. **Types of gases:** Tear Gas, Tranquilizer (knockout), Nerve Gas, and Smoke Gas/Screen. **Cost (gun):** \$700. **Cost of Tear Gas and Tranquilizer Gas Canisters:** \$120 each; **Nerve Gas:** \$400 each; **Smoke:** \$25 each. **Range:** 160 feet (48.8 m). **Rate of Fire:** 1 per melee. **Bonus to Strike:** Must have a W.P. with Pistol. **Damage:** Varies with the type of gas used (see *Gases: Grenades and Bombs* on page 341 of **HU2** for effects of different gases).

Pepper Gas/Spray

This extremely potent irritant temporarily impairs vision, causing eyes to burn and water profusely. It also swells the mucous membranes of the sinuses and throat, making it very difficult to breathe. Victims are -8 to strike, parry, dodge, and lose any chance for initiative. Effects are immediate, but a called shot to the face must be made. Spraying any other part of the body has *no effect* unless the sprayed area comes into contact with eyes or mouth. **Savings Throw:** Dodge for spay (comes in varying sizes and is often carried instead of mace), but gas dispersion has no save from a grenade or cloud (must dodge to escape the area). **Duration:** 4D4 minutes. **Cost:** \$10-\$20 for small spray bottles and \$75 for grenades/gas dispersers. **Note:** See page 341 & 342 of **HU2** for effects other types of gas and explosive grenades).

Hand-Held Stunner

This hand-held item is made of plastic, with a pair of contact posts on the business end. To stun an opponent it must touch him. **Damage:** When the trigger is depressed, it discharges a couple of thousand volts of electricity into the victim, stunning him. Victims are dazed, -8 to strike, parry and dodge, and reduce the number of attacks per round by half. **Duration:** 2D4 melees. A successful saving throw of 16 or higher means that the person has successfully fought off the effect and is unimpaired, but loses initiative. Roll to save against each successful strike. **Range:** Touch. **Rate of Fire:** Equal to the number of melee attacks. **Bonus to Strike:** H to H and P.P. bonuses only. **Energy Capacity:** 10 charges for both. **Cost:** \$500.

Stun Pistol/Blaster

This pistol fires an energy charge that short circuits the nervous system. **Damage:** Victims are dazed, -10 to strike, parry and dodge, and reduce attacks per melee round by half for 2D4 melees. A successful saving throw of 16 or higher means that the person has successfully

fought off the effect and is unimpaired except loses initiative and one melee action. Roll to save against each blast that strikes. Roll to save against each successful strike. **Range:** 100 feet (30.5 m). **Rate of Fire:** 5 per melee round. **Bonus to Strike:** Must have a W.P. with Energy Pistol. **Energy Capacity:** 10 charges. **Cost:** Gun: \$4000; Cost of energy clip: \$1000.

Energy Weapons

Energy Weapons are highly experimental, rare, and terribly expensive. The high cost largely is largely due to years of Research & Development costs, the lack of mass production, and rarity. Most designs are commissioned by the Military/Government use (or hand-made by superbeings/villains). At this point, each weapon is carefully hand built and most are considered prototypes each worth hundreds of thousands of dollars (if not millions). If they were mass-produced, the cost would drop to about 10% of their current expense with an additional 2D4 years needed before any additional or significant drops in price. Such weapons will not be made available to the public; Military use only!

Any organization with robotics or bionics development programs, including most governments, will have facilities for making and *recharging* energy weapons. If characters belong to the organization, they can get recharges for free, but if they are not, access will probably not be available. However, some *organizations* may allow use of the recharging system for a fee and access to the energy weapon for examination (which could take weeks, months, or years). Recharging fees can range from \$200 to \$2,000. Hardware characters can also recharge E-Clips (See *Hardware*).

Most energy weapons fire single shots, but some can unleash three rapid-fire shots, but the latter is considered a burst and use the *short burst* rules for semi-automatic weapons (See *Modern Weapons Combat*). Some alien races have true pulse weapons that fire energy bursts with little or no penalty, but such technology is beyond the current capabilities of Earth technology (See **Aliens Unlimited™** for such weapons and many other futuristic/energy weapons).

Energy weapons are generally only available to Robot and Bionic characters who have a high budget for their creations, specific power categories that receive them as equipment (*Secret Operative*) or to characters who can build weapons themselves (*Hardware*). High-tech villains may also have access to such rare weapons and gizmos.

Laser Pistol

Range: 500 feet (152 m), **Damage:** 3D6, **Rate of Fire:** Single shot or semi-auto burst (See *Modern Weapons Combat*), **E-Clip Capacity:** 10 blasts, **Weight:** 1.5 lbs (0.7 kg), **Cost:** Weapon: \$500,000+, E-Clip: \$25,000.

Laser Rifle

Range: 1,800 feet (548.6 m), **Damage:** 5D6, **Rate of Fire:** Single shot or semi-auto burst (See *Modern*

Weapons Combat), **E-Clip Capacity:** 20 blasts, **Weight:** 7 lbs (3.2 kg), **Cost:** Weapon: \$900,000+, E-Clip \$25,000.

Heavy Laser (with back-pack)

Range: 2,000 feet (609 m), **Damage:** 6D6+4, **Rate of Fire:** Single shot only, **Energy Back-Pack Capacity:** 100 shots; requires 12 hours to be recharged, **Weight:** 6 lbs (2.7 kg) for gun, 20 lbs (9 kg) for the pack, **Cost:** \$1.2+ million for the whole unit.

Mini-Laser (tool)

The mini-laser is a utility tool used by mechanics and communications engineers. It is double the diameter and slightly longer than the average ink pen. It fits easily in pockets, utility belts, mini-tool packs, or even in ones boot.

Range: 100 feet (30.5 m), **Damage:** Three settings: 1, 1D4, 1D6, **Rate of Fire:** Single shot, **E-Clip Capacity:** 20 charges, **Weight:** 6 ounces (170 grams), **Cost:** Weapon: \$400,000 E-Clip: \$15,000.

Simple Ion Blaster (Pistol)

Range: 200 feet (61 m), **Damage:** 4D6, **Rate of Fire:** Single shot only (each shot counts as one melee attack), **E-Clip Capacity:** 14 blasts, **Weight:** 2 lbs (0.9 kg), **Cost:** Weapon: \$550,000, E-Clip: \$25,000.

Heavy Ion Blaster (Rifle or Sub-Machinegun sized)

Range: 400 feet (122 m), **Damage:** 5D6, **Rate of Fire:** Single shot only, **E-Clip Capacity:** 10 blasts, **Weight:** 3 lbs (1.4 kg), **Cost:** Weapon: \$900,000, E-Clip: \$25,000.

Particle Beam Rifle

Range: 1200 feet (609 m), **Damage:** 1D6x10 or 1D6x10+40 (see below), **Rate of Fire:** Single shots only (no bursts), **Bonuses:** W.P. Energy Rifle. **E-Clip Capacity:** 10 blasts, **Weight:** 12 lbs (5.4 kg), **Cost:** Weapon: \$1.5 million+, E-Clip: \$35,000; super-rare.

The Following Restrictions Apply to All Particle Beam Weapons: When firing a P-beam weapon, ONLY a roll of 11-20 hits (includes applicable modifiers). Even then, a roll of 11-17 is only a nick, doing 1D6x10 damage. A strike roll of 18-20 is a direct hit, doing 1D6x10+40 damage! Objects destroyed or people killed by a p-beam blast are disintegrated!**Note:** Particle beams even damage Invulnerable characters, but does half damage.

Military Vehicles

Player characters are not likely to use these vehicles unless they are in the military and/or the G.M. is running a special kind of campaign. But they are much more likely to encounter them in the hands of villains, third world rebels or corrupt governments, and war-torn geopolitical hot spots. G.M.s should use these vehicles carefully, because all of them use very heavy firepower. We stated earlier that firearms are one of the great equalizers in **Heroes Unlimited**. Well that's even more the case here. The smallest guns on most military vehicles are machine guns,

some as large as 20 mm and 30 mm. Throw in some missiles and cannons, and you have a potentially lethal situation for any hero without invulnerability. So use these vehicles carefully. They are best saved as props or background elements to heighten stories, for dramatic effect, to make characters think and plan, and for character use in specialized or realistic/dramatic stories. They can also be used as inspiration for super vehicles.

Military armor is much more effective than other vehicle armors. Even though some of the vehicles in this section will have the same armor rating as the heavy armor in the Hardware section, they will have thicker armor, giving more S.D.C. and better protection. As a result, each entry will detail what kind of weapons simply will not damage the vehicle, no matter what the strike roll was. Weapons that can damage the vehicle use the normal vehicle A.R. rules to strike and for damage. In addition, all military vehicles are considered to have a ram prow. The mechanical genius and analytical genius can build super vehicles with this superior military armor, but it can not be concealed. Thus, a car can have armor like a tank, but it will look very much like a tank (as opposed to other super vehicles which look like normal vehicles but deflect bullets, etc.).

Note: Many of the heavier vehicles presented here are older models, because they are the ones likely to be in the hands of mercenaries, rebels, smaller governments, and other unofficial, criminal, or non-sanctioned entities.

Armored Vehicles

M-113 Personnel Carrier

Weight: 24,238 lbs. (10,900 kg)

Length: 16 feet (4.9 m)

Crew: 1

Max. Speed: 42 mph (67 kph)

Max. Range: 300 miles (482 km)

Armor: A.R.: 14. Stops pistols, rifles, light machine guns under .50 caliber grenades. The underside is vulnerable to mines and the side walls can be penetrated by antitank rockets or heavy machineguns with armor piercing rounds (penetration value of 9+).

S.D.C. By Location:

Main Body: 600

Treads: 75 each

Typical Armament:

.50 cal. machine gun: Damage: 1D4x10. Ammo: 900 rounds. Range: 3,000 feet (915 m)

Note: Could also be fitted with a rocket launcher or grenade launcher.

Attacks Per Melee: By Vehicle Combat (pilot) or Machinegun Rules (gunner).

Mercenary Price: \$150,000-300,000

Notes: Designed to carry 11 troops (one of whom would act as gunner). Often the soldiers would ride on top because of the high temperature inside. Although the M-113 was useful against small arms and fragmentation grenades, it would sometimes be deadly to the occupants when it contained the effect of mines and shape charges that did penetrate the armor. (Weapons with penetration values of 8+ generally will defeat the armor and have a 75% chance of inflicting full damage on the occupants.)

M-551 Sheridan Tank

Weight: 35,100 lbs. (15,795 kg)

Length: 21 feet (6.4 m)

Crew: 4

Max. Speed: 45 mph (72 km) on land, 3.5 mph (5.6 kph) in water

Max. Range: 470 miles (752 km).

Armor: A.R.:13. Stops pistol, rifle, machinegun and fragments. The underside is vulnerable to all forms of damage. The sides are vulnerable to rockets and weapons with penetration values of 8+.

S.D.C. By Location:

Main Body: 600

Main Gun: 200

Treads: 100 each

Typical Armament:

152 mm gun: Damage: 2D4x100. Blast Radius: 10 feet (3 m) Ammo: 40 rounds. Range: 4,500 feet (1,372 m)

7.62 mm machine gun: Damage: 5D6. Ammo: 1,000 rounds. Range: 3,000 feet (915 m)

.50 caliber heavy machine gun: Damage: 1D4x10. Ammo: 800 rounds. Range: 3,000 feet (915 m)

Grenade Launcher: Damage: Smoke grenades only. Ammo: 8. Range: 30 feet (9 m)

Attacks Per Melee: As Vehicle Combat (pilot) or Machinegun Rules (gunner). The main gun can fire a maximum of four times per round, but requires an action in between to reload.

Mercenary Price: \$6-9 million.

Notes: This tank was designed to be light enough to be air-portable. Because of the light armor, it wasn't particularly successful as a tank.

M-41A3 Walker Bulldog Tank

Weight: 52,200 lbs. (23,490 kg)

Length: 27 feet (8.2 m)

Crew: 4

Max. Speed: 45 mph (72 km) on land, 3.5 mph (5.6 km) in water

Max. Range: 470 miles (752 km)

Typical Armament:

76 mm gun: Damage: 4D6x10. Ammo: 65 rounds. Range: 3,000 feet (915 m)

Twin .50 caliber machine guns: Damage: 1D4x10. Ammo: 600 rounds. Range: 3,000 feet (915 m). These weapons fire separately and generally can not be fire linked.

Armor: A.R.: 14. Stops pistol, rifle, machinegun and fragments. Vulnerable to rockets and heavy machineguns with a penetration value of 9+.

S.D.C. By Location:

Main Body: 800

Main Cannon: 200

Treads: 175 each

Attacks Per Melee: As Vehicle Combat (pilot) and Machinegun Combat Rules (gunner). Main gun can fire a maximum of three times per melee, but requires an action to reload each time.

Mercenary Price: \$5-7 million.

Notes: Obsolete in the U.S. forces, but still used in many foreign countries including: Argentina, Brazil, Chile, Greece, Italy, Japan, Lebanon, New Zealand, Pakistan, South Africa, Taiwan, Thailand and Vietnam.

M-48A3 Patton II Tank

Weight: 104,820 lbs. (47,169 kg)

Length: 28 feet (8.6 m)

Crew: 4

Max. Speed: 30 mph (48 km)

Max. Range: 287 miles (459 km)

Armor: A.R.: 18. Stops pistol, rifle, machinegun and fragments. Vulnerable to mines and antitank rockets. Heavy machineguns with penetration values of 11+ can also damage the tank.

S.D.C. By Location:

Main Body: 1,000

Main Gun: 200

Treads: 200 each

Typical Armament:

90 mm gun: Damage: 1D4x100. Ammo: 50 rounds. Blast Radius: 20 feet (6 m) Range: 4,000 feet (1,220 m)

.50 cal. machine gun: Damage: 1D4x10. Ammo: 1,000 rounds. Range: 3,000 feet (914 m)

.30 caliber machinegun: Damage: 6D6. Ammo: 800 rounds. Range: 3,000 feet (914 m)

Attacks Per Melee: As Vehicle Combat (pilot) and Machinegun Combat Rules (gunner). The main gun can fire four times per melee with one action needed to reload after each shot.

Mercenary Price: \$5-7 million.

Notes: The main U.S. battle tank in the Vietnam war, it was reliable even under rough terrain conditions and despite climate related problems. It has outmatched its Soviet counterparts in every theater of conflict. Still used by the U.S., Bolivia, Chile, Iran, Israel, Pakistan, South Korea, Taiwan, Thailand, Turkey, West Germany and Vietnam (over 340 were abandoned there by U.S. forces).

High-Tech Tank (Average Prototype)

Weight: 43 tons

Length: 21 feet (6.4 m)

Max. Speed: 65 mph (104 km) on land, 10 mph (16 km) in water

Crew: 2, plus up to 3 passengers.

Max. Range: 580 miles (928 km)

Armor: A.R.: 15 Stops pistol, rifle, machinegun and fragments. The underside is vulnerable to mines and the side walls can be penetrated by antitank rockets or heavy machineguns with armor piercing rounds (penetration value of 9+).

S.D.C. by Location:

Main Body: 700

Turret: 280

Treads: 175 each side

Main Energy Cannon: 210

Laser Gun: 100

Typical Armament:

High-Speed Laser: Mounted on top of the turret in place of the traditional machinegun. Damage: 1D4x10 per blast. Range: 6,000 feet (1,829 m). Max. Rate of Fire: Full automatic fire, but not machine gun rates of fire (See Modern Weapons Combat). Ammo: 1000 shots per hour (equal to 10 "belts" of 100 blasts each).

90 mm Energy Beam Cannon: Damage: 1D6x100. Range: 6,000 feet (1,829 m). Max. Rate of Fire: 5 per melee. Ammo: 10 shots per hour.

Additional Weapons Systems: In addition two, or in lieu of, the 90 mm Energy Cannon, the G.M. may wish to use any of the heavy weapons found in the Robotics section of **HU2**.

Total Attacks Per Melee: As Vehicle Combat (pilot) or Modern Weapon Combat rules (gunners).

Bonuses: +4 to strike with all weapons in addition to the gunner's skill bonuses.

Special Systems: Full sensory capabilities, thermo-imager, infrared, night sights, 20 mile radar, targeting computer, combat computer, satellite navigation, terrain mapping sonar, atmosphere recycling, independent oxygen supply, and long range communications (laser, satellite, radio).

Notes: This tank is also chemical, radiation, and virus/biologically sealed/shielded.

Mercenary Price: \$16-20 million (triple if has energy weapons or tactical nukes).

Other Vehicles

High-Tech Armored Land Rover

Weight: 3.8 tons/8512 lbs (3830 kg).

Length: 24 feet (7.3 m)

Max. Speed: 120 mph (192 km)

Crew: One pilot and up to five passengers (3 comfortably). A.R.: 10

Range: 500 miles (800 km)

S.D.C by Location:

Main Body: 600

Wheels: 100 each

Bonuses: +2 to strike and dodge

Special Equipment:

Radio: Range: 50 miles (80 km).

High Intensity Headlights: 150 foot beam (46 m).

Loudspeaker: Amplifies voice by 90 decibels.

Mini-Radar: Range: 4 miles (6.4 km), but only 75% accurate and easily obscured by hills, mountains and forest.

Weapon Systems: (pick one of the following)

20 mm Machine Gun: Damage: 1D6x10. Ammo: 600 rounds. Range: 4,000 feet (1,220 m)

Missile Launcher: Same as the missile systems described on page 209 of **Heroes Unlimited, 2nd Edition (HU2)**.

Automatic Grenade Launcher: Same as the 40 mm grenade launcher described on page 208 of **HU2**, except that it has a payload of 200 and can fire in short and long bursts.

Notes: The Land Rover is a lightly armored reconnaissance vehicle suitable for rough terrain. It is a sturdy, open-air vehicle. **Mercenary Price:** \$4-6 million.

Light Utility Truck (“Jeep”)

Weight: 1.8 tons/4,032 lbs. (1,814 kg).

Length: 11 feet (3.35 m)

Max. Speed: 65 mph (104 km)

Crew: One driver and up to five passengers (3 comfortably)

Range: 300 miles (480 km)

Armor: A.R.: 6 Use normal vehicle A.R. rules, affected by all weapons.

S.D.C.: 300

Notes: The classic and reliable jeep served as a great way to move small cargo and personnel in safe areas. It has been replaced by the “humvee” in the U.S., but still receives wide usage throughout the rest of the world. A light or medium machine gun can be mounted in the rear on a 360° swivel mount.

Mercenary Price: \$40,000 to \$75,000.

2.5 Ton M-35 Cargo Truck

Weight: 6.7 tons/15,008 lbs (6,254 kg)

Length: 22 feet (6.7 m)

Max. Speed: 56 mph (89.6 km)

Cruising Range: 350 miles (560 km)

Armor: A.R.: 7. Affected by all weapons.

S.D.C.: 500

Notes: Although rated to carry 5,000 lbs. (2,250 kg), up to twice as much can be loaded onto this truck.

Mercenary Price: \$100,000-125,000.

5 Ton M-816 Wrecker

Weight: 18 tons/40,320 lbs (18,144 kg)

Length: 30 feet (9.1 m)

Crew: 2

Max. Speed: 52 mph (83.2 km)

Cruising Range: 350 miles (562 km)

Armor: A.R.: 8 Affected by all weapons.

S.D.C.: 650

Mercenary Price: \$150,000-180,000.

M-88 Truck, Recovery Vehicle

Weight: 55 tons/110,000 lbs (55,440 kg).

Length: 325.5 inches (27 ft/8.7 m).

Crew: 4

Max. Speed: 31 mph (50 km)

Cruising Range: 222 miles (355 km)

Armor: A.R.: 8. Affected by all weapons.

S.D.C.: 800

Mercenary Price: \$180,000-225,000.

Helicopter Rules (Optional)

How To Fly A Helicopter

First off, flying a helicopter takes two hands, two feet, as many fingers as you can spare, and an extra hand if you've got one. The foot pedals are the direction controls for right and left. Because a helicopter is constantly pulling to the right, you've got to be pushing these pedals constantly. With your right hand you control the Cyclic Control Stick (or “joy stick”), which also has buttons for micro-

phone, hoist, force trim, armament fire and cargo release. With your left hand you control the Collective Pitch Control Lever, which also has buttons for lights, engine idle, collective pitch control friction, power control throttle, power control friction adjuster, governor RPM increase/decrease, and the starter ignition. People with third arms can try using the other chopper controls. Of course, in **Heroes Unlimited**, people can have three arms (or a fully articulated tail) which would provide +1 attack and +1 to dodge while piloting a helicopter, while people with four arms actually get +2 attacks, +2 to strike, and +2 to dodge.

Why all the complicated controls? Think about what a chopper is. It's an engine with a large propeller attached to one end and nothing on the other end. Just naturally the whole thing wants to start turning. Then other forces, like torque, aerodynamic lift, and wind, buffet the craft in a dozen different ways.

Routine Helicopter Skills

The following moves require only simply helicopter piloting skills (no skill roll necessary):

Evaluating Landing Sites: You have to know within an inch whether the clearing is big enough for your chopper blades. That means you can tell/measure, by eyeball alone, the exact size of a landing zone. Most helicopters have rotors that measure 48 feet (14.6 m) from tip to tip. That means the Landing Zone has to be at least that large in diameter.

Huey Shuffle: This is a tail-wagging movement designed to distract enemy gunners. +2 to dodge.

Stationary Hover: It takes a few months of practice, but helicopter pilots can keep their choppers pretty much motionless. Not moving up/down, right/left, or forward/backward, is actually much harder than it looks. At full load, the chopper starts losing rpm and will eventually sink.

Helicopter Stunts

The following moves require helicopter piloting rolls, usually with a negative modifier for difficulty:

Formation Flying: Flying in formation with other helicopters with one helicopter's distance between each is a standard skill. Flying in formation with tips touching or overlapping takes a little more; roll under piloting skill. Night formation flying means you want to be close enough to see the instrument lights in the other guy's cockpit; roll under piloting skill at -15%. A failed roll during Formation Flying means that the aircraft actually touch. 75% of the time, this will cause one or both of the craft to crash. Since choppers are fairly fragile aircraft, crashes usually kill the crew and all passengers, so think twice before your characters go hot dogging!

Overloaded Take-Off: It takes a lot of experience, a bit of skill, and even some luck to take off with greater-than-maximum load. Basically, you've got to make some really tight circles and eventually speed your way up. For taking off at full or up to 50% over maximum cargo capacity, roll under piloting skill at -10%. Failure means the chopper simply lands back on the ground. Choppers

can not take off at all while carrying more than 50% over their maximum rated cargo capacity.

Emergency Landing: It's called auto-rotation and it means setting up the chopper so that the blades keep moving while the chopper sinks. It won't work if you do not have any forward motion (another good reason why you don't just sit and hover). If you fail, the chopper becomes an inert, falling object. Roll under piloting skill to pull out.

Making Your Own Landing Zone: Sometimes there's just not a big enough hole beneath you for a landing site, especially in the jungle or thick forest. Thankfully, a helicopter's rotor blades are 21 inches (about a half-meter) wide, weighted at the ends and moving at several hundred rpm. In other words, they make great lawn clippers, so long as you don't hit anything too big. If you do, then the rotors break off, and chances are the pilot either dies from having his head cut off by flaying rotor fragments, or when the rotorless bird crashes to the ground. This is one of those special moves where skill has nothing to do with it. The G.M. rolls D100; on a 15% or less, the rotors hit a branch that's too large, and bye-bye birdie.

Passing Between Obstacles: Remember the 48 feet (14.6 m) diameter/width of the chopper blades? Well, sometimes pilots can pass through a gap as small as 25 feet (7.6 m) by leaning the chopper to the side and angling through. This is a fairly risky move, though. Roll under piloting skill at -20%. A failed roll means a crashed chopper.

Helicopters vs Fighters

Use of helicopters where air superiority is not established is just plain stupid. Helicopters are terrific against ground troops; they are unbeatable as anti-tank weapons. They are dead meat against fighter aircraft. Why? First of all, they have a -6 to strike targets moving faster than 100 mph (160 kph), and they are also -6 to dodge incoming missiles or rockets. That, any they are hopelessly out-classed by jet armaments. The average air-to-air missile mounted on any jet fighter could pick off a helicopter from well outside the range of the chopper's own weapons. A few heavier choppers could theoretically be mounted with air-to-air missiles (like the AIM-9 Sidewinder), but even then, a helicopter's slow speed and lack of air defense measures (such as chaff and flares) would still make it a poor match against any jet fighter.

Hitting With Chopper Weapons

An armed helicopter (or "gunship") makes a great weapon platform against slower-moving ground targets. If you just hover and fire you can hit anything, with no penalties, no modifiers.

The problem is that if you just hover, you become the world's best aerial target. With next to no armor, this is not smart.

Firing from flying helicopters is also different for door gunners than for pilots. The pilot has to watch where he's going. The door gunner is concentrating on the ground targets.

Pilot Fire Modifiers:

-1 for each 20 mph (32 km) of speed ('cause he's going fast).

-1 for each 100 feet (30.5 m) of altitude ('cause he's far away).

Door Gunner Fire Modifiers:

-1 for each 30 mph (48 km) of speed.

-1 for each 300 feet (91.5 m) of altitude.

Helicopter Armament Systems

Helicopter armaments are meant for area effect, large-scale combat, and long-range troop suppression. At the G.M.'s discretion, these weapons systems can be mounted on larger ground-based vehicles, including characters' super vehicles. They can NOT be carried and fired by individuals (except possibly by giant robots) because they simply are too heavy and produce unmanageable recoil when fired.

When firing helicopter weapons, there is no bonus to strike unless the character has the Weapons System Skill (pilot related). Normal firearms W.P.s do not apply. When using these big weapons in combat, use machine gun combat rules.

As warfare creeps into the 21st century, gunships are taking on a new battlefield role: tank-killing. To this end, some modern gunships forego lighter rockets and fewer guns in favor of heavier anti-tank missiles. Also, these tank killers (like the Hughes AH-64 Apache, Apache Longbow and the Comanche) carry an impressive array of combat electronics, including targeting computers, thermal and infrared sensors, heat suppression systems (giving them +6 to dodge any incoming heat-seeking missile), and laser-guided weapons, to name just a few. In addition, in the **Heroes Unlimited** universe, any of the sensors or optics available to Robot or Bionic characters also can be found on cutting-edge gunships.

Helicopter hardware is military in nature and as such, it is highly illegal and difficult to obtain, even on the black market. One would have to be a big-league arms dealer or in tight with a rogue nation to be able to buy or sell this technology. In the U.S., getting caught with any one of these weapon systems typically means a 10-30 year prison term.

The availability of these weapons is exclusive to the world's military and should not be made easily available, even to wealthy villains. The use of such weapons is strictly prohibited by the government. Their use would be impossible to conceal and constitute deadly force on a major scale. Being caught with one or more of these weapon systems will get a person a long prison term (10-30 years).

A Note on Weapon Mounts: Most gunships mount their weapons on stubby armament wings (or "pylons") that come off the side of the vehicle. Smaller gunships, like the AH-1 Cobra of most Huey gunships, can only accommodate one weapons system per pylon. Heavier gunships, like the AH-64 apache or the infamous Russian Hind series can accommodate four weapons systems per pylon. In addition, all gunships can accommodate a machine gun, mini-gun, or grenade launcher on a chin turret.

XM-3 2.75" Rocket Launcher

Armament: 48 tubes of unguided 2.75" rockets.

Range: 11,250 feet (3,429 m)

Rate of Fire: Volleys of 2, 4, 8 or all 48.

Damage: 1D4x10 per rocket

Blast Radius: 20 feet (6.1 m)

Payload: 48 Rockets

Attacks Per Melee: Six

Notes: This resembles a large box mounted on the side of the helicopter. Smaller versions of this weapon (or "rocket pods") may contain 7, 12, 19, or 24 rockets each. The advantage to these smaller pods is that heavy gunships like the U.S. Apache or Russian Hind can carry up to four of them.)

Mercenary Price: \$400,000-750,000.

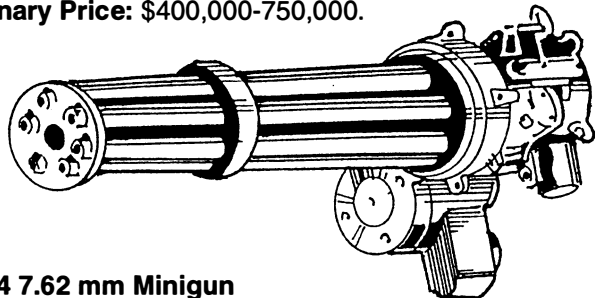

XM-134 7.62 mm Minigun

Armament: Six-barreled, 7.62 mm gatling gun, or "minigun." Miniguns have electric motors that rotate the gun barrels as they fire, allowing the weapon to achieve incredibly high rates of fire without overheating.

Range: 2,500 feet (762 m)

Rate of Fire: Long or full melee bursts only. This weapon fires so rapidly that a long burst uses only one attack and a full melee burst ties up the weapon for only two attacks. See Machine Gun Combat Rules for more info.

Damage: 5D6 per round

Rounds Carried: 4,000 rounds (enough for 4 melees of continuous fire)

Attacks Per Melee: Four as a vehicle weapon, equal to the gunner's attacks per melee as a manned weapon.

Notes: Miniguns usually are mounted on the sides of a gunship, either singly or one on each side. Gunships with two miniguns can either fire them separately (requiring a second gunner besides the pilot). Or, miniguns can be mounted as door gunner weapons. Usually, a special seat and cradle must be installed to accommodate this.

Special Note: Contrary to what movies like "Predator" and "Terminator 2: Judgement Day" would have you believe, a normal person CAN NOT carry and/or use a minigun as a personal weapon. They just aren't designed for it. That said, the G.M. may wish to make an exception for certain **Heroes Unlimited** characters, for three reasons.

First, it is possible that a Hardware: Weapons Expert character could modify a minigun for personal use by installing it with counterbalances, shock absorbers, etc. or buy building one out of super-light alloys, or by fitting one with a gyroscopic shooting rig like what the character Vasquez uses in the movie "Aliens." Or an Alien character might come to Earth with an advanced version of the minigun with the aforementioned gimmicks

already built in. Aside from that, the G.M. should also consider this: as heavy as a minigun may be, any super-strong character should be able to handle one.

Second, miniguns are popping up in movies, comic books and video games everywhere these days, so it's quite possible your players will really want their character to have one. G.M.s, if you let them do this, do keep in mind the firepower they will command. As long as game balance is maintained, everything should work out all right. The cost for one of these monsters shouldn't be cheap, though.

Mercenary Price: \$200,000-300,000.

Third, miniguns are damn cool! **Heroes Unlimited** is a rock 'em, sock 'em comic book role-playing game that isn't meant to mirror the real world. If your character can't have a minigun here, where can he?!? After all, there *is* a dude toting something awfully close to one on page 131 of the **HU2** rule book, right?

XM-32 .50 Cal. M2

Damage: 1D4x10 per round.

Payload: 500 rounds.

Range: 2,500 feet (762 m).

Rate of Fire: Fully automatic (See Machinegun Combat Rules).

Attacks Per Melee: Four as a vehicle weapon, equal to the gunner's attacks per melee as a manned weapon.

Notes: Used as door gunner weapon or mounted on the outside.

Mercenary Price: \$125,000-200,000.

M-23 7.62 mm M-60D

Range: 3,000 feet (914 m).

Rate of Fire: Fully automatic (See Machine Gun Combat Rules).

Damage: 5D6 per round.

Payload: 600

Attacks Per Melee: Five

Note: This weapon is virtually identical to the M-60 machine gun carried by infantrymen around the world. The big difference is that the M-60D has a modified firing mechanism designed specifically for door gunning. As such, this weapon can not be used as a personal weapon.

Mercenary Price: \$100,000-175,000.

M-2 Dual Machine Gun System

Damage: 5D6 per round, but both fire simultaneously at the same target, so damage is doubled (1D6x10 per round). A gunship can carry two of these weapon systems; when fire-linked, they do an whopping 2D6X10! However, gunships thus armed typically are too weighted down to carry any other guns, rocket pods, or missiles.

Payload: 1,000 per weapon.

Range: 3,750 feet (1,143 m)

Rate of Fire: Fully automatic (See machinegun combat rules).

Attacks Per Melee: Five
Mercenary Price: \$300,000-400,000.

M-21 Coordinated System

Armament: Combination of XM-134 Minigun and a seven-tube XM-158 2.75" rocket pod.

Damage, Blast Radius, Payload, Range, Rate of Fire, and Attacks per Melee: All are described above.

Note: This combined weapons system (or one like it) is very common on gunships from around the world. mounted onto the side of the gunship.

Mercenary Price: \$380,000-500,000.

Main Body: 150

Tail: 75

Rotor: 75

Bonuses: +2 to dodge and +5% to piloting rolls for stunts and maneuvers.

Mercenary Cost: \$120,000

Notes: Cheap, easy to find, and expendable, the Raven is a venerable design but remains popular as a light observation craft. This bird can be seen in numerous old television programs and is recognized by its distinctive, bubble-like canopy. Different versions are in use in the U.S., Canada, Colombia, Thailand, and the United Kingdom.

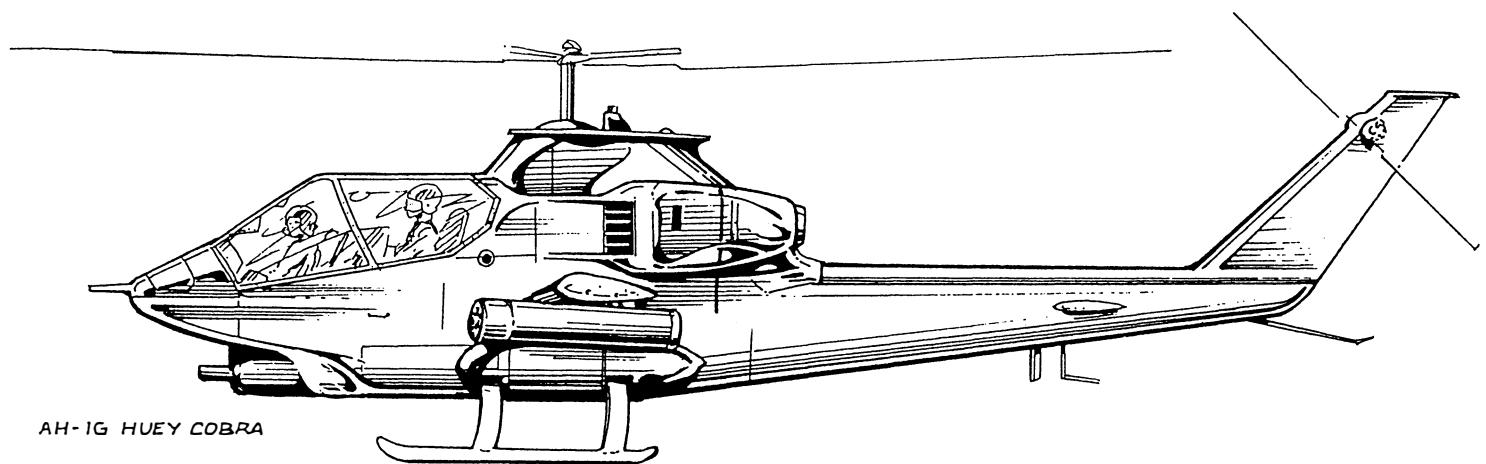
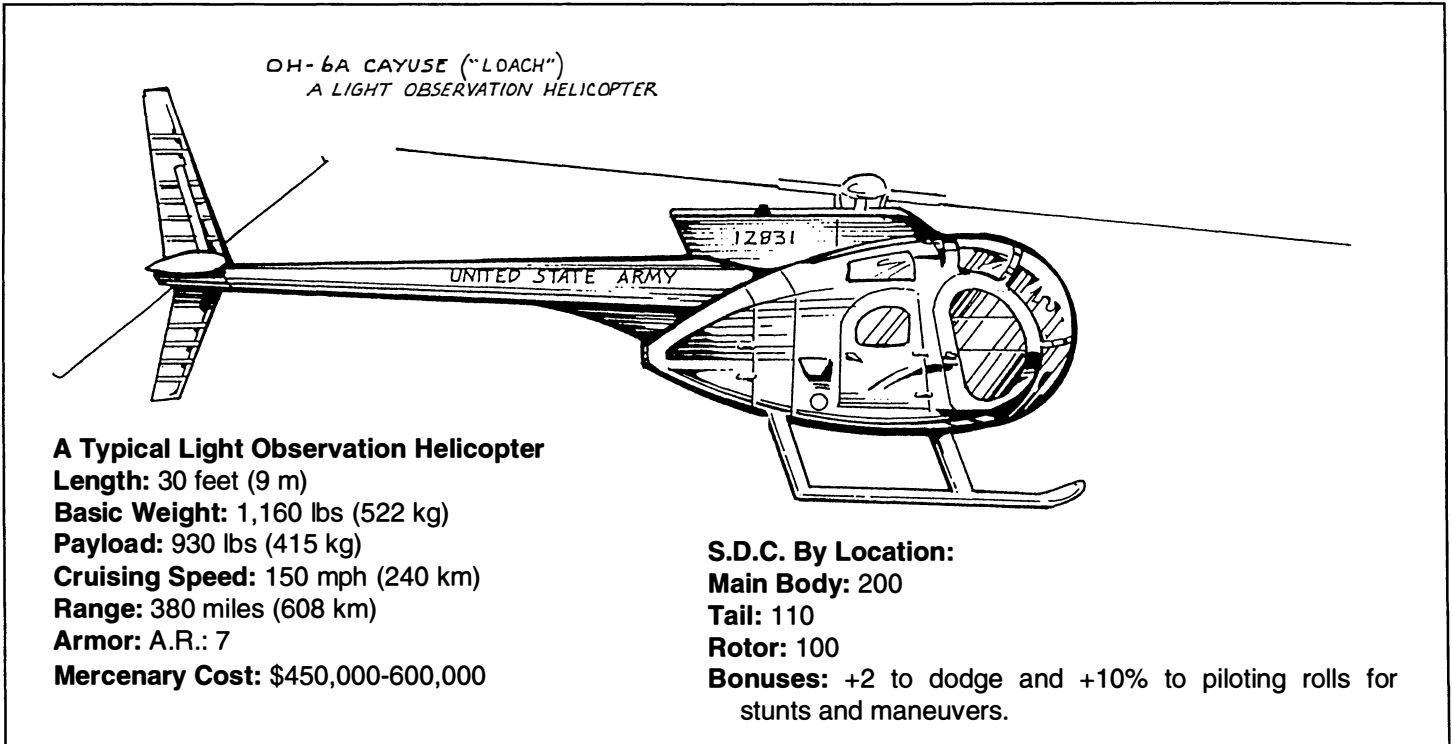

Tail: 300

Rotor: 250

Passenger Armor: A.R.: 14, S.D.C.: 350. Even if a Cobra is shot down, the passenger compartment is likely to remain intact.

Bonuses: +2 to strike

Mercenary Cost: \$10.5 million

Notes: By July 1969, there were 441 Cobras active in Vietnam. A typical "Snake" was armed with 40 mm grenade launcher, XM-3 48-tube 2.75" rocket pod system, and two M-60 machineguns. This helicopter remains in widespread use by the U.S. Army, Navy and Marine Corps, as well as numerous other nations. Updated versions of the Cobra are available to small nations and mercenaries for \$11 million each. These generally have Noroc armor for the crew seats and sides (Increase the A.R. of the passenger armor to 15), 2 M-X18 Miniguns, 2 M-157 Rocket Pods, special turret-mounted M-29 40 mm grenade launcher and a Vulcan six-barreled 20 mm cannon under the chin.

Special Note: The stats for this vehicle will serve as a good template for heavier modern gunships, such as the Apache, Comanche or Hind. As a rule of thumb, increase each S.D.C. location by 100 points, boost all A.R. ratings by two, and allow for two weapons systems to be mounted on each of the chopper's pylons, as well as one weapons system for the chin turret. In addition, really heavy birds like the Hind will have door gunners, too. For more information on gunships of the world, check out any one of a number of books on the subject. Your local library should have several. If not, try looking on-line for information. All branches of the U.S. military, for example, maintain web

pages with detailed weapons info on them that the enterprising G.M. can sue to whip up his own military vehicles. Good luck!

UH-1H Huey

Length: 57 feet (17 m)

Basic Weight: 4,900 lbs. (2,205 kg)

Payload: 3,116 lbs. (1,402 kg)

Cruising Speed: 127 mph (203 km)

Range: 314 miles (502 km)

Armor: A.R.: 9

S.D.C. by Location:

Main Body: 400

Tail: 200

Rotor: 150

Bonuses: None.

Mercenary Cost: \$4 million.

Notes: Perhaps one of the world's most ubiquitous helicopters, its military debut was during the Vietnam Conflict as the U.S. Army's bird of choice. Featuring a more powerful engine than earlier models, it was otherwise the same as the UH-1D. By April 1969, some 2,202 UH choppers were serving in Vietnam. This helicopter is used militarily in Argentina, Australia, Bolivia, Canada, Cambodia, Chile, El Salvador, Ethiopia, Greece, Japan, New Zealand, Spain, Taiwan, Thailand, and Venezuela. It also is used as a commercial passenger craft all over the world.

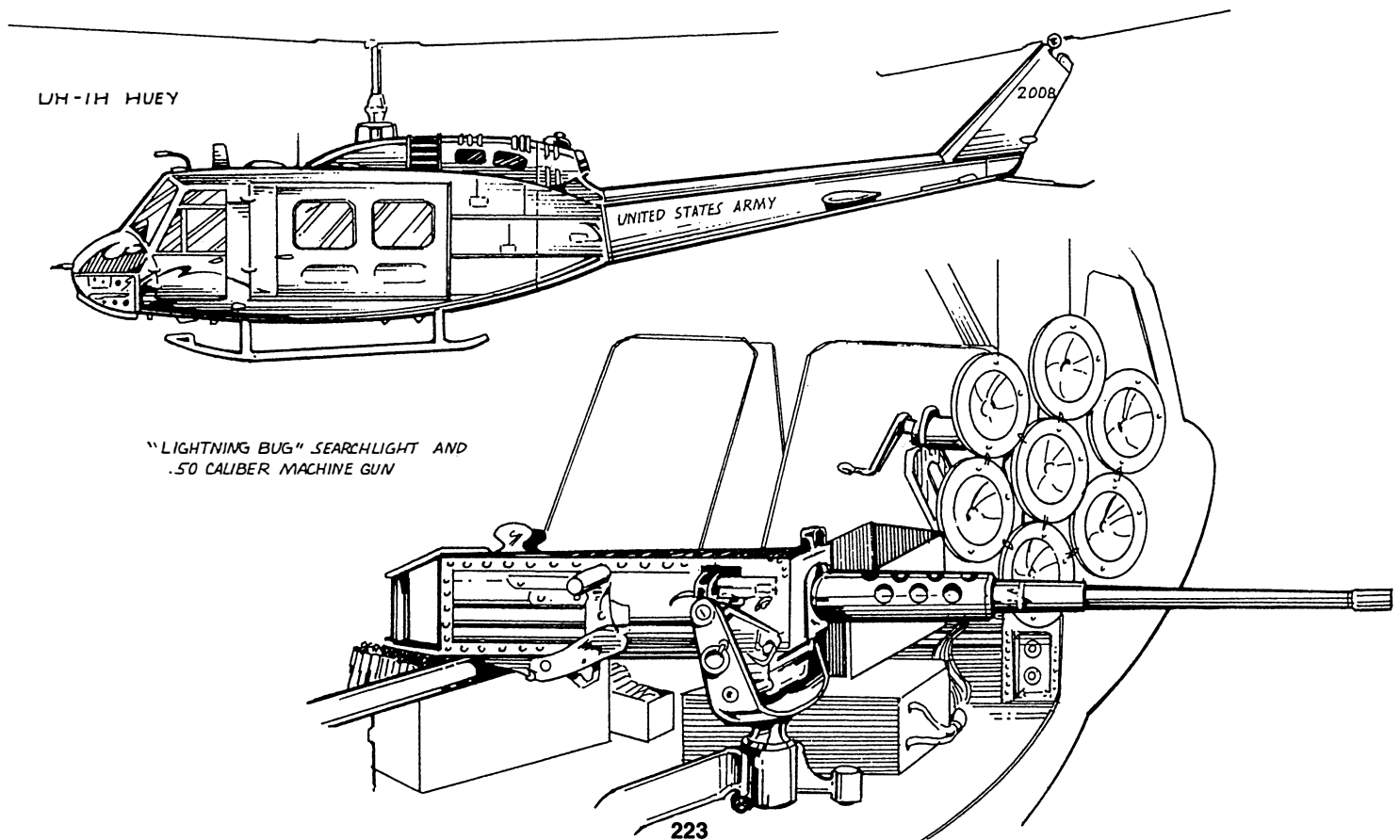

Explore the Palladium Megaverse®

The Palladium “Fantasy” Role-Playing Game®

A world of epic fantasy, incredible magic and amazing beings including the shape-changing Changeling, ferocious Wolfen, monstrous Melech, dragons, giants, trolls, dragons and creatures that defy description. Players can create scores of human and inhuman characters.

Combat is fast and fun.

Magic is different! There is spell casting wizardry, the wards of the Diabolist, the circles of the Summoner, and the powers of Druidism. Plus the mind-powers of the Mind Mage, elemental magic, the enchantments of the Alchemists, the blessings of the priest, the dark magic of the witch and magic items and creatures galore.

Sourcebooks define the world, offer new types of player characters, different player races and monsters, adventures and/or adventure ideas. This line is currently Palladium's second best seller (behind *Rifts*® and just edging out *Heroes Unlimited*™). • \$26.95 — 336 pages.

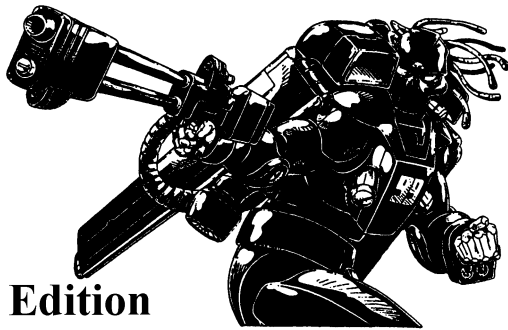

Rifts® Ultimate Edition

Dimensional *Rifts* are tears in the very fabric of space and time. Portals to other worlds. Doorways that allow the incredible, monstrous and magical to invade our world. Reshaping it into an alien landscape that is both frightening and wondrous, alien and yet strangely familiar.

Super-science, bionics, power armor and robots collide with the forces of magic, Techno-Wizardry, dragons and demons from the Rifts. Humankind struggles on the brink of extinction, and the possibilities are endless.

Discover a world where anything is possible and you are limited only by your imagination. • \$39.95 – 376 page hardcover RPG.



Heroes Unlimited™ RPG, 2nd Ed.

Create any type of superhuman hero you can imagine.

Aliens, mutants, robots, cyborgs, super-soldiers, psychics, super-sleuths, martial arts masters, gun-toting vigilantes, super-geniuses, masters of magic, demigods, Mega-Heroes and more!

Over 100 super abilities, plus scores of sub-powers and 40+ psionic powers. Over 100 magic spells, plus enchanted weapons and objects.

Everything one needs to play other than dice and friends are in this complete role-playing game. Cover by Jim Steranko. Written by Kevin Siembieda • \$26.95 — 352 pages.

After the Bomb® RPG

Discover the world of mutant animals. Play it as a stand-alone game environment or combine it with *Heroes Unlimited*™, but check it out.

Mutant animal creation rules that make building your mutant characters fast, fun and challenging. Over 100 mutant animals presented. More than 40 animal powers and psionics; many more if you include weird abilities exclusive to certain animal species. • \$24.95 — 224 pages.

Ninjas & Superspies™ RPG

Over 40 different types of martial arts, oriental mysticism, and superhuman abilities combined with spies, gizmos, super-vehicles, cybernetic implants and disguises, and more to create the ultimate spy and combat game. A complete role-playing game with everything you need to play. A complete game in itself as well as completely interchangeable with *Heroes Unlimited*™. Written by Erick Wujcik. • \$20.95 – 176 pages.

Nightbane® RPG

The world has never been the same since Dark Day. Some say the world governments have been supplanted, taken over by ... god only knows what. That doppelgangers can steal one's identity and life, and that demons and monsters lurk in the shadows. Creatures of evil who serve the Nightlords.

But the lords of shadow are not unopposed. There are creatures of light as well as creatures born from darkness but champion the light. These are the Nightbane. Ordinary people, many teenagers, able to shed their human facade and assume a supernatural alter ego. A monstrous, inhuman visage imbued with superhuman power and the stuff of magic. Written by C.J. Carella. • \$24.95 – 240 pages.

Beyond the Supernatural™ RPG

A game of horror, mystery, & dark secrets

BTS-2™ is a stark, plausible reality where ghosts, demons, psychics, and magic are real, yet remain unknown to the world at large. Player characters are part of the secrets, part of the problems, and humanity's only true hope of dealing with the unexplained. Truly unique characters that will challenge and excite those who play them. New P.C.C.s include the Psychic Medium (and Spirit Guide), the Diviner and Autistic Psychic Savant, all with new and unique abilities. Characters like the Psychic Sensitive, Nega-Psychic and other original P.C.C.s get a face lift, new powers, and more details. The secrets of the supernatural, ESP, and magic revealed. • \$24.95 – 256 pages. Written by Kevin Siembieda and Randy McCall.

Splicers® RPG

Splicers® is a new science fiction RPG set on a devastated world where machines rule, and human beings are vermin who are hunted and exterminated. The human struggle is complicated by a nano-virus that instantly turns metal objects touched by human flesh into killing machines. Consequently, humans have been forced to turn to organic technology to battle the world-dominating machines if they hope to reclaim any portion of their planet for themselves. Mega-Damage System – compatible with *Rifts*®, *Phase World*®, *Chaos Earth*™ and *Mechanoid Space*™. • \$23.95 – 224 pages. Written by Carmen Bellaire.

Palladium Books Inc.
39074 Webb Court
Westland, MI 48185

www.palladiumbooks.com

Copyright 2014 Palladium Books Inc. All rights reserved, worldwide. Palladium Books®, *Rifts*®, *Megaverse*®, *Nightbane*®, *The Mechanoids*®, and *After the Bomb*® are registered trademarks of Palladium Books Inc. *Heroes Unlimited*, *Ninjas & Superspies*, *Beyond the Supernatural*, *Splicers*, and *Rifts*® *Chaos Earth* are trademarks owned and licensed by Palladium Books Inc.



RIFTS®

- Imagine Earth transformed into an alien landscape.
- Humans exist – barely. And we are not alone.
- Aliens and monsters emerge from the Rifts – holes torn in the fabric of space and time, connected to countless worlds and realities.
- Ancient gods, demons and magic have returned.
- Magic and technology clash.
- Hundreds of character classes, many inhuman.
- *Rifts® Ultimate Edition* is the core RPG rule book.
- Expansive world setting with 90+ sourcebooks to draw upon.
- Rifts®, your portal to endless adventure.
- Limited only by your imagination.

www.palladiumbooks.com

© 2014 Palladium Books. Rifts®, Megaverse®, Nightbane® and other titles, slogans and likenesses are trademarks of Palladium Books, Inc. Palladium Books - 39074 Webb Court, Westland, MI 48185 USA - 734-271-2903 order line.

Other RPG Worlds from Palladium Books®:

- *Rifts®* – the ultimate role-playing experience.
- *Rifts® Chaos Earth®* – Play the apocalypse as it happens.
- *Splicers®* – Weird science. Bio-tech battles insane robot legions.
- *Robotech® RPG* – All eras of the TV show brought to life.
- *Dead Reign® RPG* – Can you survive the Zombie Apocalypse?
- *Palladium Fantasy RPG®* – Unique world, monsters as player characters, magic and more.
- *Heroes Unlimited™ RPG* – Play any hero; mutants, aliens, cyborgs, superhumans, mages, immortals and more.
- *Nightbane® RPG* – Conspiracy, magic, horror and monsters.
- *Beyond the Supernatural™ RPG* – Modern horror and suspense.
- *Ninjas and Superspies™*, and more.

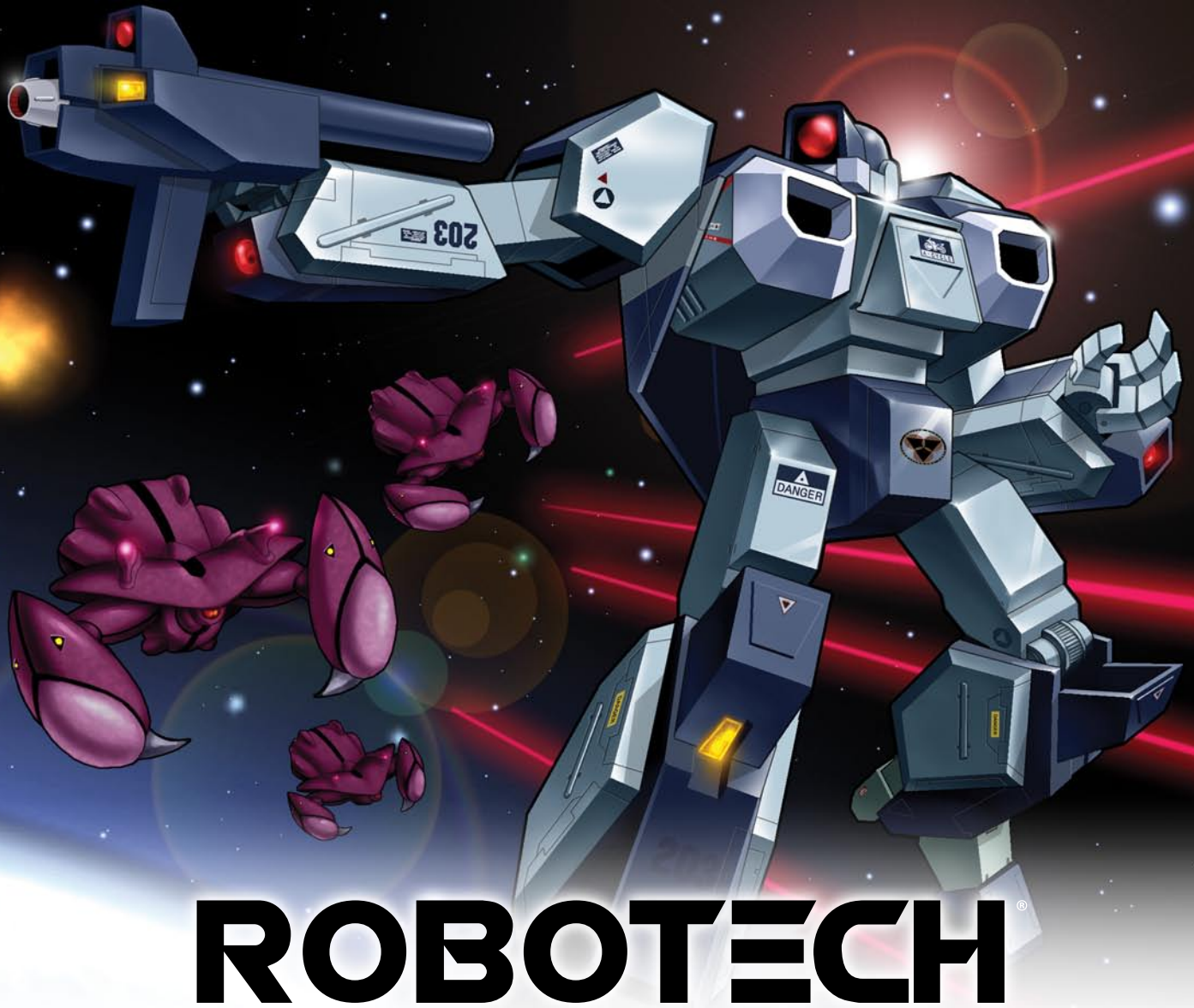

ROBOTECH®

Role-Playing Game and Sourcebooks

- **Four generations of heroes and mecha** • **Giant transformable robots** • **Alien invaders** • **Battle for control of the Earth** • **Combat takes to the stars** • **All presented in a core rule book and dynamic set of epic sourcebooks** • **Easy to learn** • **Fun to play** • **Quick character generation** • **Fast combat** • **Captures the action and adventure of the anime TV series** • **Isn't it time you joined the adventure?**

Robotech® "Core Rules" – Shadow Chronicles® RPG Hardcover

All the rules and information a player needs to start a Robotech® role-playing campaign with Admiral Rick Hunter and the United Earth Expeditionary Force trekking across the galaxy.

- Human mecha: Alphas, Betas, Cyclones & much more.
- Five character classes. 25 different Military Specialties.
- Invid mecha, Haydonites, and alien enemies.
- Quick roll character tables. Make a character in 15 minutes.
- A complete, stand-alone RPG.
- 224 pages. Cat. No. 550HC. 8½ x 11 size, hardcover.

Robotech®: The Macross® Saga Sourcebook – Cat. No. 551

A treasure chest packed with the iconic mecha, vehicles, weapons and characters that made Robotech® famous. Valkyries, Destroyoids, ground vehicles, aircraft, spacecraft, weapons, Zentraedi soldiers, Zentraedi mecha, alien invaders, heroes, villains, and more.

- All the iconic Macross mecha, vehicles, weapons & characters.

www.palladiumbooks.com

Robotech®: The Masters Saga™ Sourcebook – Cat. No. 552

Tons of never before seen stats and descriptions for the many weapons, armor, mecha and robots of the Army of the Southern Cross.

- The Army of the Southern Cross™ – all 15 branches and their mecha!

Robotech®: New Generation™ Sourcebook – Cat. No. 554

The battle for the liberation of Earth starts here.

- Kit-bashed mecha combining parts from different mecha.
- Invid Hives, world overview, key characters and adventure ideas.

Robotech®: Genesis Pits™ Sourcebook – Cat. No. 555

The Invid Genesis Pits, their purpose, function.

- Inorganics and other war machines of the Invid Regent.
- Genesis Pit mutations and monsters.

Robotech®: Expeditionary Marines Sourcebook – Cat. No. 553

Join the UEEF (United Earth Expeditionary Force) led by Admiral Rick Hunter as they travel across the galaxy liberating planets from the bondage of the Invid Regent, the Robotech Masters and other tyrants.

- New mecha, weapons, and character classes of the UEEF Marines.
- New alien species and allies. Planet hopping and more.



ROBOTECH

R P G T A C T I C S

Main Boxed Game – Cat. No. 55100 – Available Now!

A fast-paced, strategy battle game that captures the speed and action of Robotech®. Play Earth defenders or Zentraedi invaders.

- Scalable from small squad skirmishes to mass battles.
- Turn-based system of play and uses D6. Two or more players.
- 34 highly detailed game pieces. 6mm scale.
- 112 page color rule book with paint guide and index.
- 53 laminated, color game cards.
- 24 custom dice, two decal sheets and more.
- Assembly and painting required. Glue not included.
- \$99.95 retail – Cat. No. 55100 – shipping now!
- Available in North and South America, the EU, Australia & New Zealand.

Note: Each product contains plastic game pieces requiring assembly and painting. Glue not included. This is not a toy. Small parts, not suitable for children under the age of 13. Adult supervision advised. Images shown here are not to scale.



UEDF Valkyrie Wing™ – Cat. No. 55201

Build your fleet of Earth defenders with the Valkyrie Veritech Fighter; six game pieces total. **\$36.95 retail.**

- 2 Valkyries in Fighter mode.
- 2 Valkyries in Guardian mode.
- 2 Valkyries in Battloid mode.
- Multiple heads for making the VF-1A, VF-1J, VF-1R & VF-1S.



UEDF Tomahawk/Defender Destroids™ – Cat. No. 55202

Expand your Destroid squad with these formidable walking tanks; four game pieces total. **\$32.95 retail.**

- 2 Tomahawk Destroids – the main battle tank of Destroids, brimming with powerful particle beam cannons for arms, and wielding a battery of missiles and an array of other weapons.
- 2 Defender Destroids – a long-range, anti-aircraft juggernaut capable of shooting down incoming Zentraedi Battlepods and Gnerl Fighters.



UEDF Spartan/Phalanx Destroids™ – Cat. No. 55203

Add some long-range power and up-close punch to your army with these valuable Destroids; four game pieces total. **\$32.95 retail.**

- 2 Spartan Destroids – civil defense, riot control and deadly in hand combat.
- 2 Phalanx Destroids – a walking, long-range missile artillery unit.



Zentraedi Regult Battlepods™ – Cat. No. 55401

Expand your Zentraedi forces with their main infantry battle mecha; six game pieces total. **\$36.95 retail.**

- 6 Regult Tactical Battlepods – the lightning quick Regults, armed with a pair of particle cannons and auto-cannons, attack in wave after wave.



Zentraedi Artillery Battlepods™ – Cat. No. 55402

Give your Zentraedi legion greater firepower with these artillery and support Battlepods; four game pieces total. **\$36.95 retail.**

- 4 Zentraedi Support Battlepods, each of which can be made into:
 - Gluuhaug-Regult – Light Artillery Battlepod
 - Serauhaug-Regult – Heavy Artillery Battlepod
 - Telnesta-Regult – Experimental Particle Beam Battlepod
- Four game pieces total.**



Zentraedi Glaug Command™ – Cat. No. 55403

This diverse pack provides your Zentraedi forces with greater tactical capabilities; three game pieces total. **\$36.95 retail.**

- 1 Glaug Officer's Battlepod – the fast and deadly mecha of Zentraedi field leaders.
- 1 Quel-Regult Scout Battlepod – the stealthy eyes and ears of your Zentraedi battle force; electronic warfare capabilities.
- 1 Quel-Gulnau Recovery Pod – enhances the Glaug's ability to bring in Battlepod reinforcements. **Note:** This figure has NEVER before been offered by any company.

www.palladiumbooks.com

© Palladium Books Inc. Robotech® is a Registered Trademark of Harmony Gold USA, Inc. Palladium Books, 39074 Webb Court, Westland, MI 48185-7606. Order line: 734-721-2903.

Can YOU survive the Zombie Apocalypse?



The Dead Reign® RPG series

Dead Reign® RPG – “Core Rules.” It is the aftermath of the *zombie apocalypse*. The dead reign and the living fight against impossible odds. Can you survive? Find out with this fast-paced horror game. Easy to learn. Fast character creation and combat.

- **Zombie combat and survival rules, vehicles and equipment.**
- **6 iconic Character Classes plus Ordinary People (40+ occupations).**
- **7 types of zombies, plus the Half-Living.**
- **101 Random Scenarios, Encounters, Settings and other tables.**
- **\$22.95 retail – 224 pages – Cat. No. 230. Available now.**

Civilization Gone™ Sourcebook

Civilization has crumbled to nothing. There is no army. No government. No help coming. What now?

- **Madmen, Psychopaths, villains, heroes and protectors.**
- **House, home and survivor camp tables, resources & encounters.**
- **\$12.92 retail – 64 pages – Cat. No. 231. Available now.**

Dark Places™ Sourcebook

Travel the rails and urban underground to move about undetected by zombies.

- **Worm Meat, Bug Boy, Sewer Crawler & Impersonator Zombies.**
- **Traveling the rails, sewers and other dark places.**
- **Random encounter tables, boxcar content tables, and much more.**
- **\$12.92 retail – 64 pages – Cat. No. 232. Available now.**

Endless Dead™ Sourcebook

The zombies grow in number and strangeness. Can humankind survive?

- **Zombie amalgamations, tables and encounters.**
- **New player characters & timetables for your campaign.**
- **Weaponizing vehicles, vehicle combat rules, and military bases.**
- **Creating survivor caravans, hideouts, Safe Havens & more.**
- **\$16.95 retail – 96 pages – Cat. No. 233. Available now.**

Other horror titles from Palladium Books®

Beyond the Supernatural™ RPG **Nightbane® RPG**

© Copyright 2017 Palladium Books Inc. All rights reserved. Rifts®, Palladium Books®, Megaverse®, Nightbane®, Dead Reign®, Heroes Unlimited and other published book titles, names, slogans and likenesses are trademarks of Palladium Books Inc.

Fear the Reaper™ Sourcebook

Heroes who, like knights of old, travel the highways fighting zombies and helping survivors.

- **Comprehensive background on the Road Reapers.**
- **Their code, missions, weapons, strategies and tactics.**
- **The Terror Zombie and more.**
- **\$12.95 retail – 48 pages – Cat. No. 234. Available now.**

Graveyard Earth™ Sourcebook

The Zombie Apocalypse across the globe; provides a world overview and many adventure ideas.

- **Many tables for settings, encounters and adventure hooks.**
- **Random Safe Havens by region, and Survivor Leaders.**
- **How to get home from abroad, zombie threat levels & more.**
- **\$12.95 retail – 64 pages – Cat. No. 235. Available now.**

Hell Followed™ Sourcebook

This big, 160 page sourcebook begins to redefine the zombie genre. It broadens the field of possibilities and expands upon the modern zombie mythos. It is full of twists and surprises you will not expect.

- **11 new types of terrifying zombies.**
- **7 player characters, plus Masked Lunatics – heroes or madmen?**
- **21 disasters to complicate survival, and urban survival.**
- **Government enclaves, conspiracy theories and more.**
- **\$20.95 retail – 160 pages – Cat. No. 236. Available now.**



www.palladiumbooks.com

Palladium Books® Check List & Order Form

Dept. P-16, 39074 Webb Court, Westland, MI 48185

Name: _____ Address: _____

City: _____ State: _____ Zip/Postal Code: _____ Country: _____

Credit Card Number: _____ Expiration Date: _____ Visa MasterCard

Telephone Number: _____ Signature: _____ AMEX Other

The Rifter® Series

- ___ 175 The Rifter® #75 – \$13.95
- ___ 176 The Rifter® #76 – \$13.95
- ___ 177 The Rifter® #77 – \$13.95
- ___ 178 The Rifter® #78 – \$13.95 (Spring)
- ___ 179 The Rifter® #79 – \$13.95 (Summer)

Splicers® Note: Sourcebooks coming soon.

- ___ 200 Splicers® RPG – \$23.95

Dead Reign®

- ___ 230 Dead Reign® RPG – \$22.95
- ___ 231 SB 1: Civilization Gone™ – \$12.95
- ___ 232 SB 2: Dark Places™ – \$12.95
- ___ 233 SB 3: Endless Dead™ – \$16.95
- ___ 234 SB 4: Fear the Reaper™ – \$12.95
- ___ 235 SB 5: Graveyard Earth™ – \$12.95
- ___ 236 SB 6: Hell Followed™ – \$20.95
- ___ 237 SB 7: In the Face of Death™ (coming)

Rifts® Novels

- ___ 301 Sonic Boom™ – \$9.95
- ___ 302 Deception's Web™ – \$9.95
- ___ 303 Treacherous Awakenings™ – \$9.95
- ___ 304 Tales of the Chi-Town 'Burbs™ – \$12.95
- ___ 305 Rifts® Path of the Storm™ – \$12.95

Weapons Books

- ___ 401 Weapons and Armor™ – \$8.95
- ___ 402 Weapons and Castles™ – \$8.95
- ___ 403 Weapons and Assassins™ – \$9.95
- ___ 404 Weapons & Castles of the Orient™ – \$9.95
- ___ 409 Exotic Weapons™ – \$9.95
- ___ 410 European Castles™ – \$9.95

Palladium Fantasy RPG®

- ___ 450 The Palladium Fantasy RPG® – \$26.95
- ___ 4500HC Palladium Fantasy RPG® 30th Anniversary Hardcover – \$50.00
- ___ 451 Dragons & Gods™ – \$24.95
- ___ 453 Old Ones™ 2nd Ed. – \$24.95
- ___ 454 Monsters & Animals™ 2nd Ed. – \$24.95
- ___ 455 Adventures on the High Seas™ – \$24.95
- ___ 458 Island at the Edge of the World™ – \$20.95
- ___ 459 Yin-Sloth Jungles™ – \$20.95
- ___ 462 Western Empire™ – \$24.95
- ___ 463 Baalgor Wastelands™ – \$24.95
- ___ 464 Mount Nimro™ – \$20.95
- ___ 465 Eastern Territory™ – \$24.95
- ___ 466 Library of Bletherad™ – \$20.95
- ___ 467 Northern Hinterlands™ – \$24.95
- ___ 468 Land/Damned 1: Chaos Lands™ – \$24.95
- ___ 469 LoD 2: Eternal Torment™ – \$24.95
- ___ 470 LoD 3: The Citadel – \$24.95 (coming)
- ___ 471 Wolfen Empire™ – \$20.95
- ___ 472 Mysteries of Magic™ One: Heart of Magic – \$16.95
- ___ 474 Bizantium/Northern Islands™ – \$20.95
- ___ 475 Garden of the Gods™ – \$16.95 (coming)

Heroes Unlimited™ / After the Bomb®

- ___ 500-2 Heroes Unlimited™, 2nd Ed. – \$26.95
- ___ 5000HC Heroes Unlimited™ 30th Anniversary Hardcover – \$50.00
- ___ 501 Villains Unlimited™ Revised – \$24.95
- ___ 503 After the Bomb® RPG – \$24.95
- ___ 505 Road Hogs™ (After the Bomb® II) – \$9.95
- ___ 507 Mutants Down Under™ (AB III) – \$9.95
- ___ 511 Mutants of the Yucatan™ (AB IV) – \$9.95
- ___ 513 Mutants in Avalon™ (AB V) – \$16.95
- ___ 514 Mutants in Orbit™ (AB VI) – \$16.95
- ___ 515 Aliens Unlimited™ – \$24.95
- ___ 516 Heroes Unlimited™ G.M.'s Guide – \$24.95
- ___ 517 Century Station™ – \$24.95
- ___ 518 Gramercy Island™ – \$24.95
- ___ 519 Aliens Unlimited Galaxy Guide™ – \$24.95
- ___ 520 Mutant Underground™ – \$16.95
- ___ 521 Powers Unlimited® One – \$16.95
- ___ 522 Powers Unlimited® Two – \$16.95
- ___ 523 Powers Unlimited® Three – \$16.95
- ___ 525 Revised Ninjas & Superspies™ – \$20.95
- ___ 526 Mystic China™ – \$24.95
- ___ 527 Armageddon Unlimited™ – \$20.95

Robotech® RPG

- ___ 550 Robotech® The Shadow Chronicles® RPG (manga size) – \$16.95
- ___ 550HC Robotech® The Shadow Chronicles® Deluxe Hardcover RPG – \$30.95
- ___ 5500HC Robotech® The Shadow Chronicles® Gold Ed. Hardcover RPG – \$70.00
- ___ 551 Robotech® Macross® Saga Sourcebook – \$16.95
- ___ 552 Robotech® The Masters Saga™ Sourcebook (NEW in 8½ x 11) – \$20.95
- ___ 553 Robotech®: Expeditionary Force Marines Sourcebook – \$20.95
- ___ 554 Robotech® The New Generation™ Sourcebook – \$16.95
- ___ 555 Robotech® Genesis Pits Sourcebook – \$16.95

Robotech® RPG Tactics™ (New!)

- ___ 55100 Robotech® RPG Tactics™ – \$99.95
- ___ 55105 Robotech® RPG Tactics™ Rulebook – \$20.00
- ___ 55101 UEDF Dice Pack – \$12.00
- ___ 55102 Zentraedi Dice Pack – \$12.00
- ___ 55201 UEDF Valkyrie Wing – \$36.95
- ___ 55202 UEDF Destroid Pack – \$32.95
- ___ 55203 UEDF Spartan Pack – \$32.95
- ___ 55401 Zentraedi Regult Battlepods – \$36.95
- ___ 55402 Zentraedi Artillery Battlepods – \$36.95
- ___ 55403 Zentraedi Glaug Command – \$36.95

Rifts® Chaos Earth®

- ___ 660 Rifts® Chaos Earth® RPG – \$20.95
- ___ 661 Rifts® CE Creatures of Chaos™ – \$12.95
- ___ 662 Rifts® CE The Rise of Magic™ – \$12.95
- ___ 665 Rifts® Chaos Earth® First Responders™ – \$16.95 (coming)
- ___ 666 Rifts® Chaos Earth® Resurrection™ – \$20.95

Beyond the Supernatural™

- ___ 700 Beyond the Supernatural™, 2nd Ed. – \$24.95
- ___ 702 Tome Grotesque™ – \$20.95 (coming)
- ___ 703 Beyond Arcanum™ – \$24.95 (coming)

Nightbane®

- ___ 730 Nightbane® RPG – \$24.95
- ___ 731 Nightbane®: Between the Shadows™ – \$20.95
- ___ 732 Nightbane®: Nightlands™ – \$20.95
- ___ 733 Nightbane®: Through the Glass Darkly™ – \$20.95
- ___ 735 Nightbane® Survival Guide™ – \$20.95
- ___ 736 Nightbane® Dark Designs™ – \$20.95

Rifts®

- ___ 800HC Rifts® RPG Ultimate Edition – \$39.95
- ___ 801 Rifts® Sourcebook One Revised – \$20.95
- ___ 802-E Rifts® World Book 1: Vampire Kingdoms™, Revised – \$24.95
- ___ 803 Rifts® Conversion Book One™ – \$24.95
- ___ 804 Rifts® WB 2: Atlantis™ – \$20.95
- ___ 805 Rifts® Sourcebook 2: Mechanoids™ – \$16.95
- ___ 807 Rifts® WB 3: England™ – \$20.95
- ___ 808 Rifts® WB 4: Africa™ – \$20.95
- ___ 809 Rifts® Dimension Book 1: Wormwood™ – \$20.95
- ___ 810 Rifts® WB 5: Triax™ – \$24.95
- ___ 811 Rifts® Pantheons of the Megaverse® – \$24.95
- ___ 812 Rifts® Sourcebook 3: Mindwerks™ – \$16.95
- ___ 813 Rifts® Mercenaries™ – \$20.95
- ___ 814 Rifts® WB 6: South America – \$20.95
- ___ 815 Rifts® WB 7: Underseas™ – \$24.95
- ___ 816 Rifts® DB 2: Phase World® – \$24.95
- ___ 817 Rifts® DB 3: Phase World® Sourcebook – \$16.95
- ___ 818 Rifts® WB 8: Rifts® Japan™ – \$24.95
- ___ 819 Rifts® WB 9: South America Two™ – \$24.95
- ___ 820 Rifts® WB 10: Juicer Uprising™ – \$20.95
- ___ 821 Rifts® WB 11: Coalition War Campaign™ – \$24.95
- ___ 822 Rifts® WB 12: Pyscape™ – \$20.95
- ___ 825 Rifts® WB 13: Lone Star™ – \$20.95

- ___ 826 Rifts® WB 14: New West™ – \$24.95
 ___ 827 Rifts® WB 15: Spirit West™ – \$24.95
 ___ 828 Rifts® Sourcebook 4: Coalition Navy™ – \$16.95
 ___ 829 Rifts® WB 16: Federation of Magic™ – \$20.95
 ___ 830 Rifts® DB 4: Skraypers™ – \$20.95
 ___ 831 Rifts® Index Volume Two™ – \$16.95
 ___ 832 Rifts® WB 17: Warlords of Russia™ – \$24.95
 ___ 833 Rifts® WB 18: Mystic Russia™ – \$20.95
 ___ 834 Rifts® WB 19: Australia – \$24.95
 ___ 835 Rifts® WB 20: Canada™ – \$24.95
 ___ 836 Rifts® WB 21: Splynn Dimensional Market™ – \$24.95
 ___ 837 Rifts® WB 22: Free Quebec™ – \$24.95
 ___ 838 Rifts® WB 23: Xiticix Invasion™ – \$20.95
 ___ 839 Rifts® Coalition Wars®: Sedition™ – \$20.95
 ___ 840 Rifts® Coalition Wars®: Coalition Overkill™ – \$16.95
 ___ 841 Rifts® Coalition Wars®: Sorcerers' Revenge™ – \$16.95
 ___ 842 Rifts® Coalition Wars®: Cyber-Knights™ – \$16.95
 ___ 843 Rifts® Coalition Wars®: Shadows of Evil™ – \$16.95
 ___ 844 Rifts® Coalition Wars®: Final Siege™ – \$24.95
 ___ 845 Rifts® Game Master Guide™ – \$26.95
 ___ 846 Rifts® Aftermath™ – \$24.95
 ___ 847 Rifts® DB5: Anvil Galaxy™ – \$20.95
 ___ 848 Rifts® Book of Magic™ – \$26.95
 ___ 849 Rifts® Adventure Guide™ – \$24.95
 ___ 850 Rifts® Bionics Sourcebook™ – \$16.95
 ___ 851 Rifts® DB 6: Three Galaxies™ – \$20.95
 ___ 852 Rifts® Dark Conversions™ – \$24.95
 ___ 853 Rifts® Chi-Town 'Burbs™ – \$9.95
 ___ 854 Rifts® The Tolkeen Crisis™ – \$12.95
 ___ 855 Rifts® The Black Vault™ – \$9.95
 ___ 856 Rifts® The Vanguard™ – \$9.95
 ___ 857 Rifts® WB 24: China One™ – \$20.95
 ___ 858 Rifts® WB 25: China Two™ – \$20.95
 ___ 859 Rifts® DB 7: Megaverse Builder™ – \$16.95
 ___ 860 Rifts® DB 8: Naruni Wave 2™ – \$16.95
 ___ 862 Rifts® WB 26: Dinosaur Swamp™ – \$20.95
 ___ 863 Rifts® MercTown™ – \$20.95
 ___ 865 Rifts® Merc Ops™ – \$20.95
 ___ 866 Rifts® WB 27: Adventures in Dinosaur Swamp™ – \$20.95
 ___ 867 Rifts® Mercenary Adventure Sourcebook – \$12.95
 ___ 868 Rifts® WB 28: Arzno™ – \$20.95
 ___ 869 Rifts® WB 29: Madhaven™ – \$16.95
 ___ 870 Rifts® John Zeleznik Coloring Book – \$5.95
 ___ 871 Rifts® Machinations of Doom™ – \$18.95
 ___ 872 Rifts® DB 10: Hades™ – \$24.95
 ___ 873 Rifts® DB 11: Dyval™ – \$24.95
 ___ 874 Rifts® WB 30: D-Bees of North America™ – \$24.95
 ___ 875 Rifts® DB12: Dimensional Outbreak – \$24.95
 ___ 876 Rifts® Megaverse® in Flames™ – \$24.95
 ___ 876HC Rifts® Megaverse® in Flames™ Gold Hardcover Edition – \$50.00
 ___ 877 Rifts® Heroes of the Megaverse® – \$16.95
 ___ 878 Rifts® Sourcebook: Shemarrian Nation™ – \$16.95
 ___ 880 Phase World®: Fleets of the Three Galaxies™ – \$16.95
 ___ 881 Rifts® WB 31: Triax™ Two – \$24.95
 ___ 883 Rifts® DB 14: Thundercloud Galaxy™ – \$20.95
 ___ 884 Rifts® Vampires Sourcebook™ – \$20.95
 ___ 885 Rifts® WB 32: Lemuria™ – \$24.95
 ___ 886 Rifts® Black Market™ – \$24.95
 ___ 886HC Rifts® Black Market™ Hardcover Gold Edition – \$60.00
 ___ 887 Rifts® WB 33: Northern Gun™ One – \$24.95
 ___ 888 Rifts® WB 34: Northern Gun™ Two – \$26.95
 ___ 889 Rifts® Sourcebook: Coalition States, Heroes of Humanity™ – \$20.95
 ___ 890 Rifts® Dimension Book 15: Secrets of the Atlanteans™ – \$24.95
 ___ 890HC Rifts® DB 15: Secrets of the Atlanteans™ Gold Edition – \$50.00
 ___ 891 Rifts® World Book: Sovietski™ – \$24.95 (coming)
 ___ 892 Rifts® Sourcebook: The Disavowed™ – \$16.95 (coming)
 ___ 893 Rifts® CS: Heroes of Humanity™ Arsenal Sourcebook – \$16.95 (coming)
 ___ 894 Rifts® Haunted Tech™ – \$16.95 (coming)
 ___ 895 Rifts® Living Nowhere™ – \$16.95 (coming)
 ___ 2510 Rifts® & The Megaverse® Art Book – \$22.95
 ___ 2510-HC Rifts® & The Megaverse® Art Book, Hardcover – \$50.00
 ___ 2510-CML Rifts® & The Megaverse® Art Book, Collector's Masterwork – \$125.00
- Miscellaneous Products**
 ___ 600 Deluxe Revised RECON® RPG – \$22.95
 ___ 2537 Gamer Coffee Mug – \$10.00
 ___ 2539 Rifts® Dice Bag – Black – \$8.00
 ___ 2545 Dead Reign™ Coffee Mug – \$10.00
 ___ 2554 Palladium Bookmarks, Set One – \$5.00
 ___ 2555 Palladium Bookmarks, Set Two – \$5.00
 ___ 2561 Property of Chi-Town Library Pencil – \$0.50 each
 ___ 2562 Future Visions™ – The Artistry of Charles Walton II – \$13.95
 ___ 2566 Glitter Boy Mouse Pad – \$9.95
 ___ 2567 Old Ones Mouse Pad – \$9.95
 ___ 2568 Zombie Graveyard Mouse Pad – \$9.95
 ___ 2575 Rifts Poker Cards 1 (full color) – \$11.99
 ___ 2576 Rifts Poker Cards 2 (line art) – \$11.99
- Note:** T-shirts and other products can be found online: www.palladiumbooks.com
- Rifts® Miniatures**
 ___ MI8002 Xiticix Pack – \$18.00
 ___ MI8004 Coalition Dog Pack – \$18.00
 ___ MI8005 Men of Magic Pack #1 – \$18.00
 ___ MI8006 Cyborgs Pack #1 – \$18.00
 ___ MI8007 Simvan & Ostrosaurus Pack – \$18.00
 ___ MI8008 Coalition Skelebots Pack #1 – \$18.00
 ___ MI8009 Coalition SAMAS Pack #1 – \$22.00
 ___ MI8010 Coalition Sky Cycle Pack – \$22.00
 ___ MI8011 Coalition Dog Pack #2 – \$18.00
 ___ MI8015 Damaged Skelebots Pack #1 – \$12.00
 ___ MI8016 Cyber-Adventurers Pack – \$18.00
 ___ MI8017 Rogues & Scout Pack #1 – \$18.00
 ___ MI8018 Brodkil & Witchling Pack – \$18.00
 ___ MI8019 Damaged Skelebots Pack #2 – \$18.00
 ___ MI8020 Psi-Stalkers & Scouts Pack #1 – \$18.00
 ___ MI8021 Shadow Beast – \$12.00
 ___ MI8022 Mystic Knight – \$6.00
 ___ MI8023 Lord Magus – \$6.00
 ___ MI8024 High Magus – \$6.00
 ___ MI8025 Coalition Psi-Stalker – \$6.00
 ___ MI8026 Coalition Dog Boy in DPM-D1 Armor – \$6.00
 ___ MI8027 Coalition Dog Boy #2 – \$6.00
 ___ MI8028 Coalition Dog Boy #3 – \$6.00
 ___ MI8029 Coalition Dog Boy #4 – \$6.00
 ___ MI8030 Coalition Dog Boy #5 – \$6.00
 ___ MI8031 Glitter Boy – \$20.00
 ___ MI8032 Glitter Boy Pilot – \$6.00
 ___ MI8033 Kydian Overlord – \$20.00
 ___ MI8034 Dragonsaurus – \$10.00
 ___ MI8035 Slaver and Slave (Atlantis) Set – \$10.00
 ___ MI8036 Crazy – \$6.00
 ___ MI8037 Juicer #1 – \$6.00
 ___ MI8038 Juicer #2 – \$6.00
 ___ MI8039 Cyborg #1 – \$12.00
 ___ MI8040 Cyborg #2 – \$12.00
 ___ MI8041 Cyborg #3 – \$6.00
 ___ MI8042 Coalition Officer – \$6.00
 ___ MI8043 Coalition Grunt #1 – \$6.00
 ___ MI8044 Coalition Grunt #2 – \$6.00
 ___ MI8045 Coalition Grunt #3 – \$6.00
- When placing an order by mail, please add money for shipping and handling.** Add \$5.00 for orders totaling \$1-\$50, \$10.00 for orders totaling \$51-\$95, and for orders totaling \$96-\$200 please add \$15.00 US. Double the amount for Canada, and *quadruple* it for overseas orders. For more shipping options, order online at www.palladiumbooks.com.
 Allow 2-4 weeks for delivery.
 Make checks and money orders payable to: *Palladium Books*
- Check release dates for new products.** If the book you order has not been released yet, your order will be held as a backorder until the product is available. Please note that prices are subject to change without notice.
- Orders can also be placed by phone,** at (734) 721-2903 (order line only). Please have your credit card information when you call.

www.palladiumbooks.com



Also from Palladium Books®

Ninjas & Superspies™ RPG

- 41 different martial art styles. Dozens of mystic powers.
- Superspies and secret organizations.
- Gimmicks, cyborg agents and more
- 176 pages, Cat. No. 525. Written by Erick Wujcik.

Powers Unlimited™ One

- More than 120 new Minor Super Abilities.
- More than 45 new Major Super Abilities.
- New psionic powers and more.
- 96 pages, Cat. No. 551. Written by Carmen Bellaire.

Powers Unlimited™ Two

- 11 new power categories and subsets.
- Immortals, Empowered, Natural Genius, Gestalt & others.
- Supersoldiers, designer (genetic) heroes & symbiotes.
- Weaknesses, minor abilities, inventions and more.
- 96 pages, Cat. No. 522. By Carmen Bellaire & others.

Powers Unlimited™ Three

- More than 80 new Major Super Abilities.
- More than 40 new Minor Super Abilities.
- 112 pages, Cat. No. 523. Written by Carmen Bellaire.

Other Heroes Unlimited™ Titles:

- Mutant Underground™ – Mutant society & adventure.
- Century Station™ – 90+ heroes & villains in a detailed city.
- Gramercy Island™ – 90 villains & 101 adventure ideas.
- Aliens Unlimited™ – HU2-style galactic adventure.
- Aliens Unlimited™ Galaxy Guide™ – Spaceships & more.
- Armageddon Unlimited™ – *Minion War*™ Crossover.
- After the Bomb® – Compatible Mutant Animal RPG.



Heroes Unlimited™ Game Master's Guide

This "guide" to comic book style heroic adventure is full of tips, suggestions, and examples on how to create, run and play adventures. To start the G.M. and players off, we include 10 fully fleshed out adventures, plus all kinds of guidelines, random tables, lists, and background data.

- Game Master (and player) tips.
- Rampage combat rules — new!
- New magic spells (and lots of 'em).
- Quick roll Villains!
- Vigilantes and the law.
- Anti-Heroes and tips on playing in character.
- Superbeings as lawmen and alignment guidelines.
- Tips on how to build and run adventures.
- Ten full adventures and ideas for more.
- Written by Kevin Siembieda & Wayne Breaux Jr.
- Over 200 pages.

\$24.95

Cat. No. 516

ISBN-10: 1-57457-035-8

ISBN-13: 978-1-57457-035-9

**Palladium
Books Inc.**

www.palladiumbooks.com