

Palladium Books® Presents
A Sourcebook for Heroes Unlimited™

Aliens Unlimited™ Revised

By Wayne Breaux Jr.

Includes Rifts conversion notes.
Adaptable to Rifts® and Rifts Dimension Books™.



Breaux

Warning!

Violence and the Supernatural

This book may be inappropriate for young readers.

The fantastic Worlds of Heroes Unlimited™ are violent, deadly and filled with diabolical villains, aliens, madmen, magic and monsters. Other-dimensional beings, godlings, mutants, demons, psychic powers, super abilities, magic, insanity, combat, death, and heroic adventure are all elements of this book.

Some parents may find the violence and supernatural elements inappropriate for young readers/players. We suggest parental discretion.

Please note that **Aliens Unlimited™** is a work of fiction! NONE of the aliens, monsters, super powers or depictions are real. None of us at Palladium Books condone nor encourage the occult, the practice of magic, the use of drugs, or violence.

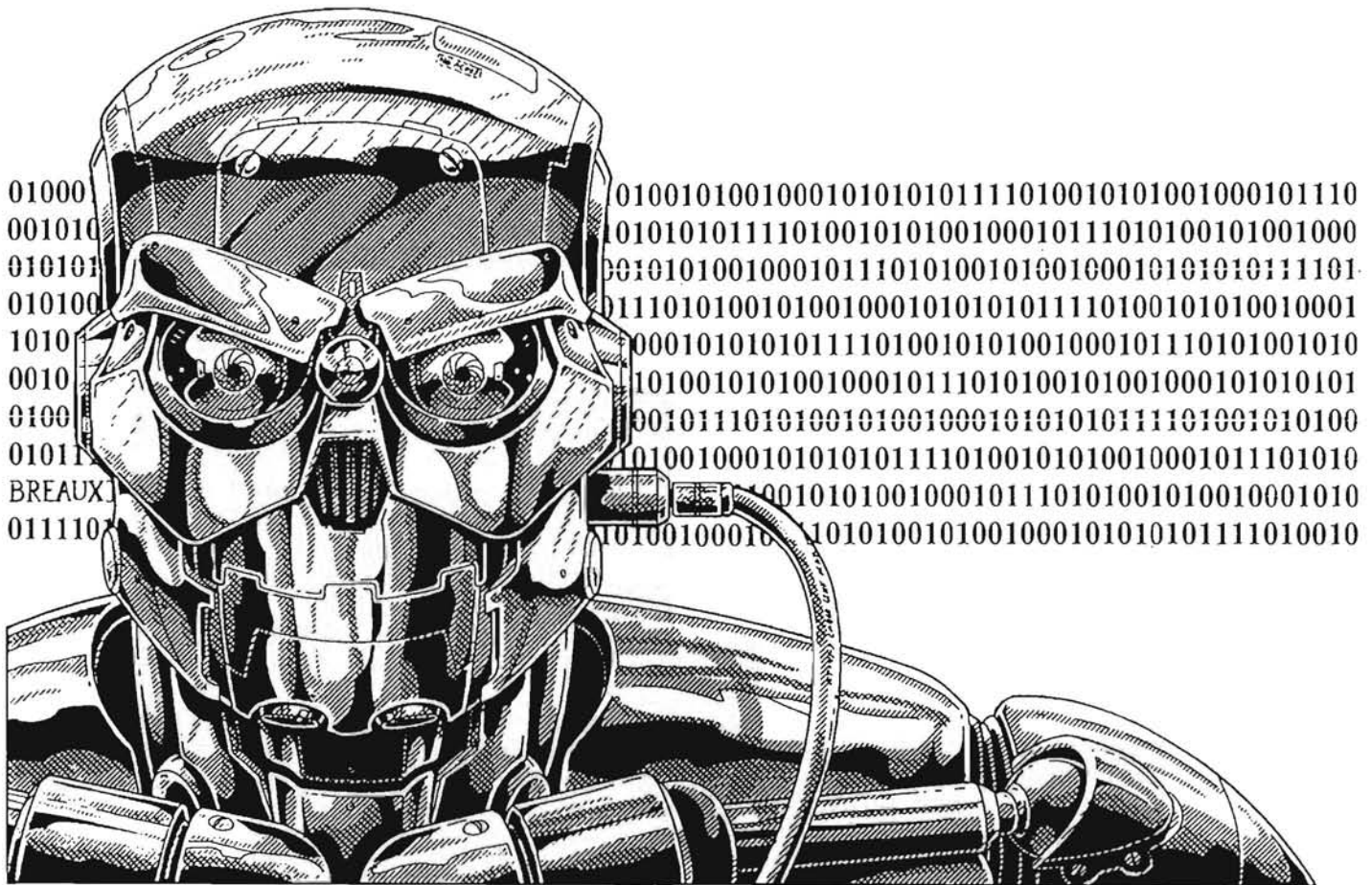

A supplement for the Heroes Unlimited™ RPG.

Compatible with Palladium's entire Megaverse® and includes notes for use in Rifts® and the Rifts® Dimension Books Phase World®!

Dedicated to my parents and my wife. Mom and Dad for never making me grow up, get a haircut, or get a real job. To Cathy for all the hours of role-playing.

— *Wayne Breaux Jr. 1994*

Other books for *Heroes Unlimited*[™]

Heroes Unlimited[™] Game Master's Guide (2nd Ed.)

Villains Unlimited[™]

Skraypers[™]

Century Station[™]

Mutants in Orbit[™]

Mutant Underground[™] (coming soon)

The Nursery[™] (coming soon)

Hardware Unlimited[™] (coming soon)

Excellent Companions

Ninjas & Superspies[™] RPG

Mystic China[™]

The Compendium of Contemporary Weapons[™]

The Compendium of (Ancient) Weapons, Armor & Castles[™]

Systems Failure[™] RPG

Phase World[®] & Phase World[®] Sourcebook (Rifts[®])

Third Printing — December 1999

Copyright 1994 Palladium Books Inc. and Kevin Siembieda
Revisions and new artwork Copyright 1999 Palladium Books Inc.

All rights reserved, worldwide, under the Universal Copyright Convention. No part of this book may be reproduced in part or whole, in any form or by any means, without permission from the publisher, except for brief quotes for use in reviews. All incidents, situations, institutions, governments and people are fictional and any similarity, without satiric intent, of characters or persons living or dead, is strictly coincidental.

Palladium Books[®], Rifts[®], The Mechanoids[®], Phase World[®], Megaverse[®] and After the Bomb[®] are registered trademarks owned and licensed by Kevin Siembieda and Palladium Books Inc.

Aliens Unlimited, Heroes Unlimited, Villains Unlimited, Beyond the Supernatural, The Rifter, Mega-Damage, S.C.R.E.T.S, Atorians, Riathenor, Dark Breeze, Morphus, and other names, titles, character names and character likenesses are trademarks owned by Kevin Siembieda and Palladium Books Inc.

Aliens Unlimited[™] is published by Palladium Books Inc., 12455 Universal Drive, Taylor, MI 48180. Printed in the USA.

Revised Aliens Unlimited™

Written By: **Wayne Breaux Jr.**

Additional Text, Rules & Development: **Kevin Siembieda**

Senior Editor: **Kevin Siembieda**

Editors: **Alex Marciniszyn**

James A. Osten

Wayne Smith

Julius Rosenstein

Best -



Cover Painting: **Wayne Breaux Jr.**
with **Siembieda & Long**

Interior Artist: **Wayne Breaux Jr.**

Additional Art: **Apollo Okamura**

Art Direction & Keylining: **Kevin Siembieda**

Typography: **Maryann Siembieda**

Based on the RPG rules, text, characters,
concepts and Megaverse® created by **Kevin Siembieda**.

Palladium Books On-Line: www.palladiumbooks.com



Special Thanks to Eric Breaux for his suggestions, Cathy Breaux for putting up with Wayne all these months, Kevin Long for reworking the background on the cover, and especially to Wayne for nine months of imaginative creation, writing and drawing of this exciting and detail packed sourcebook for *Heroes Unlimited*. I'd also like to thank C.J. for his understanding and company during production and to the usual gang of Palladium madmen for their work and dedication.

— *Kevin Siembieda, 1994*

Contents

Running a Galactic Campaign	6
Creating a (alien) Character	7
Step 1: The Eight Attributes	7
Physical Beauty & Alien Appearance	7
Step 2: Hit Points & S.D.C.	8
Step 3: Determining Super Abilities	9
Step 4: Determining Education & Skills	9
Step 5: Rounding Out One's Character	10
New Skills	10
Expanded Alien Character Generation Tables	10
Alien Appearance & Bonuses	10
Alien Physiological Modifications	13
Reasons for Coming to Earth	15
Familiarity with Earth	15
Money	16
Random Equipment	16
Special Alien Weapons	16
Special Ranged Weapons	16
Special Melee Weapons	17
Special Vehicles	17
Optional Alien Generation Tables	18
1. Determining Alien Race	18
Table A	19
Table B	19
2. Determining Super Abilities	19
3. Determining Education & Skills	19
4. Reasons for Coming to Earthy & Other Stuff	20
New Rules & Abilities by Super Power Category	20
Bionics	20
Experiments	21
Magic	21
Mutants	22
Physical Training	22
Psionics	22
Robotics	23
Alien Watch Groups	24
Earth Organizations & Individuals of Note	24
Government Agencies	24
Project Tyche	24
Special Agent Fores	25
Project Secure	26
Special Agent Sinder	27
Lock Down Teams	28
Lock Down Team Alpha	28
Ego	29
Komodo	30
Tinker	31
Washington	33
Civilian Organizations	34
Triton Industries	34
Standard TST Field Team	35
Arthur Harding	36
Shatter (super being)	36
Darclons (alien beings)	38
Triton Industries (stats)	39
TI Armor & Weapons of Note	39
Reach Up	41
S.H.O.C.K.	42
Ander Michaels	43
Special S.H.O.C.K. Equipment	44
Galactic Organizations	47
The Atorian Empire	47
Federation of Allied Races (FAR; alien)	47
Niamese Coalition (alien)	48
Tagoniglomerate (alien)	48
Thissera-Micean Cooperative (TMC)	48
Space Pirates	49
Dark Breeze	49
Diatome Pirates	49
Raiding Clans	50
A Catalog of Aliens	51
Amphibian Races	51
Axolotl	52
Caecil	53
Cameroon	54
Darkith	55
Deurycans	56
Mantella	57
Sorinam	58
Xenopus	59
Aquatic Aliens	60
Cherion	60
Errasa	61
Inennsi	62
Nattereri	63
Salar	65
Salvelinus	66
Tinalis	67
Ape Aliens	68
Anubios	68
Capucis	69
Cebus	70
Dyteens	72
Maeus	73
Thropo	74
Trogolo	75
Avian Races	76
Elecians	76
Gallopas	77
Gymoy	78
Struthios	80
Tagonicians	81
Threskians	82
Timneh	83
Canine Humanoid Aliens	84
Canis	84
Dergins	86
Latrans	88
Lupis	89
Toyoc	90
Vulpese	91
Wulf	93
Feline Alien Races	94
Altaicans	94
Concol	95
Felias	96
Giris	97
Linx	99

Pantherans	100
Pume	101



Humans & Humanoid Alien Races	103
Aluta	103
Arerri	105
Arismal	106
Atorian	108
Darakans	109
Hathas	110
Kassans	112
Klikita	113
Manarr	114
Naidens	116
Rotharrs	117
Shissans	118
Silisons	119
Swips	120
Titons	121
Insect Races	122
Superhuman Insect Abilities	122
Danaus	124
Lixilas	125
Manteze	126
Photins	127
Pyralis	128
Relogians	129
Xippus	130
Humanoid Mineral Races	132
Standard Natural Abilities	132
Basanite	132
Fredulians	134
Lassinikes	135
Liconians	136
Miceans	137
Raldemeans	139
Stoans	140

Reptile Races	140
Aurovax	141
Baccarus	142
Erittima	143
Jenjorans	144
Nithians	146
Qua-Trau	147
Thisseras	148
Humanoid Vegetation Races	149
Standard Plant Features & Abilities	149
Camleans	150
Chianas	151
Erythros	152
Kisent	153
Lachinelians	154
Sprekalians	155
Tedeschians	157
Galactic Monsters & Evil Beings	158
Brakkana	158
Cyklops-Serpentmen	159
Dark Breeze	161
Devourer Mound	162
Dop-elpoep: Doppelganger	162
Reipoc Doppelganger	164
Erishik Doppelganger	164
Dragonoids	165
Lotha	166
Mendoline	167
Morphos	168
Riathenors	170
Vacuum Ghouls	172
Vampyres	173
Lilliamok Vampires	173
Weapons and Equipment	175
Kisentite Weaponry	175
Energy Weapons	175
Notable Melee Weapons	176
Conventional Weapons	176
Gimmick Weapons	177
Special Large Caliber Firearms	178
Special Ammunition	180
Advanced Bows & Arrows	180
Advanced Weapon Features	181
Incendiary Weapons	182
Cold Weapons	184
Energy Weapons	185
Stun Weapons	186
Sonic Weapons	187
Body Armor	188
Power Armor	189
Special Features for Armor	191
Other Equipment	192
Humanoid Robots & Androids	194
Vehicles	198
Military Vehicles	200
Spacecraft	202
Alphabetical List of Aliens	205



Running a Galactic Campaign

It is likely that every **Heroes Unlimited** campaign has had at least one adventure that involved or revolved around an alien visitor or villain. However, aliens are comparatively uncommon in an Earth setting and in adventures in the outer reaches of space, even less so. **Aliens Unlimited** opens up new horizons for super hero and science fiction adventures. This book should spark countless ideas.

Space adventures are an exciting and refreshing change of pace from normal Earth-based routines. Getting super hero characters involved with alien beings and space adventures is easy too. Established characters can be kidnapped as prizes or slaves for some powerful otherworldly force, emperor, or madman. As unwilling champions ("Fight for our cause or we do not return you!" Or "We'll kill you." etc.), our heroes may find themselves caught in an interstellar war or scheme for conquest. They may be forced to play along (or innocents may suffer) until they can find a way out or a plan to defeat their captor/enslaver. This can lead to all kinds of subplots and political intrigue that could last years.

Perhaps they are approached by desperate aliens who have turned to them, Earth's greatest heroes, to help save them from, fill in the blank. How can any self-respecting hero turn down such an impassioned (and flattering) plea

for help? And there are a zillion other ways to get off-world and friendly with aliens: getting zapped by an enemy's transdimensional energy beam or caught in an experimental dimension spanning machine or alien device, magic, freak dimensional anomaly, a dimensional Rift, cosmic disturbance, or accidentally or deliberately stow away on an alien spacecraft they were investigating. Those who work for the government or a large corporation can volunteer or be ordered to participate in space missions. Established heroes may even have allies from outer space who ask them for help every now and then. And so on.

Meanwhile, back on Earth, alien characters can be fun and exciting heroes and villains who have come to Earth as explorers, refugees, interstellar police, bounty hunters (good or evil; pursuing alien criminals or refugees who are hiding on Earth or whom they believe are hiding on Earth), space pirates, childish pranksters, alien experimenters (good or evil; making mutants, monsters and/or super-powered heroes or villains), spies, criminals, predators, monsters, or world conquerors. They can be pitted against heroes as villains, misunderstood heroes against heroes, join the player characters as fellow heroes, appeal to them for help, fight the authorities (and our heroes because they are misunderstood or overreact or are pursued by a dark force), have been rocketed to Earth as infants, and ..., well, I think you get the picture.

The Future Earth Alternative: One easy way to handle a campaign set in space is to make advanced space travel accessible to humans. This can be done by advancing the campaign setting to a future date, like 2070. By such a date, the technology of a **Heroes Unlimited** type Earth is likely to have reached the level of the other races presented here. Such an achievement will probably allow humans to have access to the benefits of shared information and interaction with the galactic community. In this case, the equipment and weapons presented here will be readily available to most characters. Other than any social and technical adjustments for the time advancement that affects the setting, there will be few changes from the average **Heroes Unlimited** campaign. The only real changes in game mechanics will be the addition of new skills for the space environment.

The Alternate Earth Alternative: It is also possible for the characters to be from a parallel dimension of our own present or future Earth. In this reality, the people and heroes of Earth may be very similar or extremely different.

Exclusively Alien Worlds Alternative: The G.M. and players can forget about Earth entirely and play aliens in a far flung galaxy. In this option, Earth might exist, but our fledgling space program would restrict human space exploration and negate participation in the galactic community. Thus, the adventures would take place in space and on other worlds away from our solar system. Players would play any of 80+ alien player characters and have their hands full with the Atorian Empire, space pirates, monsters, exploration and more.

The possibilities are *unlimited!* Hence the name for this book, which explores just some of those possibilities and hopefully inspires thousands more. **Aliens Unlimited** is designed to give the Game Master and the players enough information to go in any direction they might want. Heck, with the data in this book, a Game Master could turn his entire **Heroes Unlimited** campaign into a cosmic adventure that takes place entirely in outer space and that could last decades! But the main idea is to have fun. So enjoy.

Kevin Siembieda and Wayne Breaux Jr.

Creating a Character

By Kevin Siembieda & Wayne Breaux

The alien character generation system from the basic **Heroes Unlimited, Second Edition** book was originally an expanded section on the character generation from the **Revised Heroes Unlimited** that was first printed in **Aliens Unlimited**. In order to make generating alien characters easier, they are again presented in this updated printing. **Optional Character Generation Tables** are also provided, allowing players to create a fully developed alien race with only a few dice rolls. Players can make their own alien through random creation, or pick or randomly roll for one of the 84 specific alien races presented in this book.

Step 1: The Eight Attributes

Some Notes About Attributes

None of the attributes are changed. They are I.Q., M.E., M.A., P.S., P.P., P.E., P.B., and Spd. Attribute generation is also unchanged, unless the Optional Character Generation System is used. See that section for details.

Physical Beauty & Alien Appearances

The majority of the aliens presented in the Catalog of Aliens section are of non-human origin and appearance. Over the years, several of my players have asked how animal-appearing aliens (and D-Bees in **Rifts**) can have high Physical Beauty (P.B.) ratings?

Well, first of all, the P.B. attribute rating is based on the *human* perception of what is beautiful, and what is ugly or alien. It is safe to assume that an alien with a high Physi-

cal Beauty is attractive to humans. Even if they look like a bird, feline, canine or other animal, the alien may have a high physical beauty and be attractive to humans. People often look at animals and comment on their beauty, cute appearance or power.

Second, finding an alien, animal or object "attractive," that is to say, pleasing to the eye, is not the same as sexual attraction. Somebody or something can be attractive, beautiful, charming or impressive without being sexy. The human psychology is such that a character's comfort level will be dramatically higher with beings that are perceived as familiar, normal or beautiful. Thus, it is safe to assume that the more human or beautiful, by human standards, the more comfortable Earth humans will be around aliens. Remember, beauty is in the eye of the beholder. Among aliens, humans may be seen as hideous monsters and the features humans see as ugly may be perceived as beautiful.

Third, remember beauty is only skin deep. Inhuman and even monstrous aliens may have a quality or aspect about them that makes them somehow appealing or sympathetic. That quality can be cuteness, lovability, kindness, courage, boldness/confidence, intelligence, nobility, regal stature, sincerity and other intangibles that make up the character/personality of all people. The character Vincent, from the television series **Beauty and the Beast**, is a good example of an inhuman/non-human looking character who had that romantic quality that women just adored. He may be a monster who looks half-man and half-lion, but he still makes women swoon.



Ugly, frightening and truly alien looking beings might have a heart of gold and be living saints, but humans are likely to judge them by their appearance. The less attractive, bestial or monstrous an alien may be by human standards, the more likely the player characters and people in general will view them with suspicion, fear and hatred. For this reason most aliens are given a *Horror Factor*. All supernatural monsters have a Horror Factor, as well as many non-human aliens and super villains. It represents the hideous appearance of the creature or its overwhelming aura of evil or power, or a combination of all three. The higher the Horror Factor, the more horrific the character.

To save vs Horror Factor (HF) the player must roll a 20-sided die. Just like a parry, the character's roll must be equal or higher than the Horror Factor. A failed roll means that the character is so overwhelmed by the horror that he or she is temporarily stunned. The horrified person loses initiative (don't even roll for it), loses one melee attack/action for that round, and is the last person to attack/take action. Furthermore, the character cannot even defend himself against the first melee attack from the source of the horror. Fortunately, the character quickly recovers his wits and can join the combat that same melee round. By the second and subsequent melee rounds, the character has completely regained his senses and functions as normal. Horror Factor is only applicable to the initial appearance of the fiend.

Highly intelligent aliens may be perceived as a threat, or as being superior to humans. This perception of *superi-*

ority may lead some humans to see the character as a potential enemy, enslaver or conqueror, whether the alien shares such sentiments or not. The same response is true of extraterrestrials who possess psionic abilities or super powers.

Step 2: Hit Points & S.D.C.

The determination of Hand to Hand is unchanged unless stated otherwise under the alien's description: P.E. plus per level. **The determination of S.D.C.** is also the standard 20 plus physiology, alien environment/features, super ability bonuses and skill bonuses unless stated otherwise. S.D.C. bonuses and modifications are much more common than hit point bonuses or adjustments. Each description of an alien race will indicate specific S.D.C. considerations and bonuses where applicable.

The Optional Character Generation System for random character creation predetermines the alien's base S.D.C. with the above factors all figured in. See the appropriate section for details.

Natural Armor Rating: Many aliens who have adapted to harsh environments or who are composed of inorganic material may have a natural armor from tough or scaly skin to natural plate armor like a rhinoceros or armadillo. This works the same as always; see *Heroes Unlimited, Second Edition*, page 18.

Rifts Mega-Damage Conversions: Ordinary humans or superheroes and aliens who are roughly equivalent to humans remain S.D.C. and hit point based life forms. This means in a Mega-Damage environment they will need to acquire M.D. weapons and M.D.C. body armor and/or vehicles for Mega-Damage protection and firepower. They can acquire these items through trade, purchases, theft, defeated opponents, as rewards and so on. Of course, until they can get them, they are terribly vulnerable to Mega-Damage attacks, even if they possess super abilities or psionic powers that set them apart from normal humans.

Aliens with high technology and space travel capabilities are likely to be able to create Mega-Damage armor and weapons. In the *Heroes Unlimited/Aliens Unlimited* universe, these things would remain S.D.C. items. However, if the characters are brought into the **Rifts Megaverse** (especially as a major force), one can assume that the weapons and armor are Mega-Damage items. Simply view the S.D.C. points listed here as M.D.C. points in the **Rifts** setting. This makes for quick, easy conversion and instant integration. Thus, if body armor has an A.R. 18 and 180 S.D.C., it would have an M.D.C. of 180 (A.R. is not applicable) in **Rifts**. Similarly, an energy weapon that inflicts 3D6 S.D.C. would now inflict 3D6 M.D. Of course, the Game Master can keep the alien's S.D.C. technology as such and make him acquire Mega-Damage items just as any human does. Ultimately, the decision is left up to the Game Master. Players should accept the G.M.'s views as to whichever direction he or she takes and work together to make a fun playing experience.

The **super abilities** of the character can also remain S.D.C., or be converted to Mega-Damage as the Game Master deems appropriate. Along these lines, alien characters with great mass, natural armor, or the power of invulnerability are likely candidates for becoming Mega-Damage creatures. Their normal S.D.C. number can be changed to the same number of M.D.C. or modified as the G.M. (Game Master) deems necessary.

Game Master's Note: The most important things to do are, 1) be consistent and fair in your conversions, and 2) be careful not to imbalance your **Rifts** campaign with superhuman characters that are too powerful. Most of the alien descriptions will suggest some possible integration consideration into **Rifts**. Also see **Rifts Conversion Book One** for specific super power conversions, the Supernatural P.S. into Mega-Damage, culture shock and other elements.

Also remember that most aliens, dimensional travelers and even human looking characters who exhibit unusual powers will be seen as dangerous mutants or D-Bees. They will be feared, hunted and destroyed by human supremacists like the Coalition States and the NGR.

Arriving on Rifts Earth can be the result of a dimensional anomaly/rift, plunging into a black hole, dimensional experimentation, magic, or as a slave or refugee. The Splugorth and other slavers are always on the lookout for superbeings and psionic characters as slaves. The alien's level of technology may also make them attractive to the Splugorth and other transdimensional or intergalactic traders, including the Cibolans and Naruni Enterprises. If set in the **Rifts: Phase World** environment, the scenario of slave, explorer, mercenary, or space adventurer works fine. Some are good guys and others may be villains.

Step 3: Determining Super Abilities

The specific alien races presented in this book will indicate what powers, range of powers, or available selections of powers are available. The player can select or randomly roll a power category, depending on what the Game Master allows.

Random Super Power Category Table

01-10 Alien Mutant: Design as usual, but keep in mind that the character is an alien. See **Heroes Unlimited**, page 158 and 162.

11-40 Super Abilities: Select one major and one minor super ability, or four minor powers, or roll on the Random Ability Table. These are likely to be abilities common to all members of that alien race.

41-50 Hardware or Physical Training: Create as usual, but keep in mind the alien's background, orientation and motives.

51-60 Psionics: See psionics section on page 189 of **Heroes Unlimited** for details and abilities.

61-70 Experiment: Select two minor super abilities and one major or four minor powers or roll on Table C in

Heroes Unlimited, page 116 (rolling on tables A, B, D, E, and F are optional).

71-80 Bionic: Design as usual, only made through alien technology and with unEarthly materials.

81-90 Alien Mystic: Wizard and spell magic only.

91-00 Robot: Design as usual, only made with alien technology.

Random Number (and type) of Super Abilities Table *

01-15 One major super ability and three minor.

16-32 Four minor super abilities (no major powers).

33-50 One major super ability and one minor ability.

51-69 One major super ability and two minor abilities.

70-86 Five minor super abilities (no major powers).

87-00 Two major super abilities (no minor powers).

***Note:** Many of the alien races detailed in this book already have super abilities assigned to them. In such cases, additional super abilities *may* be possessed by the character. Count up the number and type of super abilities and compare it to the chart. If none of the results are compatible or will not produce additional powers, then the character has no additional abilities. If additional abilities are possible, roll on the table (or select an appropriate result) until a compatible result occurs. Ignore incompatible rolls and roll again. If other abilities are available, the existing abilities replace the appropriate selections and additional powers are determined normally.

Step 4: Determining Education & Skills

The specific alien races presented in this book will indicate what skills or range of skills are available to them. The following table is provided for players and G.M.s creating new alien races. Randomly roll for skill range or pick one, depending on what the G.M. allows.

01-14 General Studies: Select three skills from science, three pilot and three communications, plus select 11 secondary skills. Skill Bonus: +5% to all skills, including secondary.

15-28 Pilot: Select five piloting skills (any), three pilot related skills and two skills from communications and two mechanical, as well as basic and advanced mathematics, computer operation, and four secondary skills. Skill Bonus is +15% on all piloting and pilot related skills, +10% on all others.

29-42 Military Specialist: Select five from espionage, five from military, 1D4 from physical, plus one hand to hand combat skill, four weapon proficiencies and select four secondary skills. Skill Bonus: +15%, except on secondary skills.

43-55 Science Specialist: Select five skills from science, two from medical, two from physical, two from communications, plus computer operation, basic math, and

read sensory instruments. Also select five secondary skills. Skill Bonus: +20%, except on secondary skills.

56-71 Combat Specialist: Select four physical skills plus one hand to hand of choice, six weapon proficiencies (any), one pilot, plus first aid and six secondary skills. Skill Bonus is +10% except on secondary skills.

72-85 Rogue/Smuggler: Select 1D4+3 rogue skills, 1D4 from espionage and two from communications, two weapon proficiencies, two from mechanical, two physical, plus computer operation, and four secondary skills. Skill bonus: 15% to all skills except secondary skills.

86-00 Engineer: Select six skills from the combined categories of electronics and mechanical, two from science, two from communications, plus computer operation, read sensory equipment and basic and advanced mathematics. Also select five secondary skills. Skill Bonus is +25% except on secondary skills.

Special Note: All aliens can learn three additional secondary Earth skills, but only if taught by a friendly human. Most aliens who have studied Earth can speak two languages or have a language translator.

Step 5: Rounding Out One's Character

Alignments: Most specific alien races presented in this book will indicate moral leanings and norms. Most random creations or new races created by the Game Master or players can be of any alignment. Of course, heroes and anti-heroes are usually of a good or selfish alignment.

Hand to Hand Combat: Combat skills are not automatic, and must be selected as a learned skill.

Attacks Per Melee (Hand to Hand): As with all heroes, the alien character automatically gets two attacks per melee. Additional attacks must be gained from hand to hand combat, and other physical skills.

Weapons and Armor: Except for the ones already determined by the Special Weapons Table that follows, only conventional weaponry, body armor, and equipment of Earth manufacture will be available. **If a special protective suit is needed**, the alien character automatically gets one suit and a single spare (see the Equipment Section under Environmental Suits for prices). Any additional suits will have to be specially built or acquired. Repairs will be possible only from high-tech scientists, high-tech armor manufacturers, hardware characters and fellow aliens. Note that protective suits of all kinds can be armored. Simply combine the costs of the armor and the suit, then add 10% to the total cost.

Spacecraft: It is best to assume that most alien player characters do not have a spacecraft at their disposal for Earth-based campaigns. Space campaigns are a different story (See the upcoming Galaxy Guide for rules on spacecraft, space travel, and spaceship construction rules).

The Expanded Alien Generation Table that follows provides tables and ideas regarding the alien's appearance, environment, familiarity with Earth, motives and oth-

ers. These are optional tables designed to allow G.M.'s and players to create their own alien races. They are guidelines that can be adjusted or modified as necessary. Just be careful to maintain playing balance and some reasonable level of plausibility.

New Skills

Several new skills for use in a galactic campaign can be added to the existing skill list. Game Masters can also add any appropriate skills from **Rifts** or **Robotech** that may not be found in **Heroes Unlimited**. There is a long list of specific space skills and descriptions for them in **Mutants in Orbit** and **Rifts Phase World**.

Mechanical

Spacecraft Mechanics, Base Skill: 35%+5% per level.

Pilot, advanced

Space Fighter (includes Combat Craft)

Base skill: 50%+5% per level.

Space Transport and Cargo Craft

Base skill: 45%+5% per level.

Medium Class Military Vessels

Base skill: 35%+5% per level.

Large Military Vessels

Base skill: 25%+5% per level.



Expanded Alien Character Generation

By Kevin Siembieda with additional text by Wayne Breau

Alien Appearance & Bonuses

Descriptions of new alien appearances are presented in the same format as in the **Heroes Unlimited** rule book. Other descriptions from the basic game are reprinted for the reader's convenience.

01-20 Human-like: Can easily pass for being human.

21-40 Humanoid: Resembles Earthlings closely, are bipedal, have two legs and arms, one head, eyes, nose

and ears, but have some distinguishing alien physical characteristic(s). Roll 1D4 times on the following Unusual Characteristics Table.

Unusual Characteristics Table:

01-16 Large or Pointy Ears

17-39 Odd Skin Color

01-10 Yellow

11-20 Green

21-30 Red

31-40 Grey

41-50 Light Blue

51-60 Stark White

61-70 Dark Blue

71-80 Coal Black

81-90 Purple

91-00 Orange

40-43 Ambidextrous: These characters can use the right and left hand with equal skill and dexterity. Bonuses: Adds one attack per melee, +1 to parry, +10% to climb, +5% to escape artist, pick locks, mechanical and electrical repair skills.

44-48 Odd Hair Color:

01-10 Green

11-20 Light Blue

21-30 White Streaked

31-40 Flame Red

41-50 Stark White

51-60 Bright Yellow

61-70 Metallic Silver

71-80 Dark Blue

81-90 Purple

91-00 Orange

49-53 Double-Jointed: See page 160 of **Heroes Unlimited** for full details. Can attempt to escape from bonds once per melee with the following chance for success: Hands and/or feet tied with rope, handcuffed or chained: 79% likelihood of escaping. Hands, arms, legs and body bound with rope, chains, straps, or straight jacket: 46% likelihood of escape. The double-jointed alien can contort his body to be half its normal width or thickness. Note: The average shoulder width of a muscular, 6 foot (1.8 m) male human is about 24 inches (0.6 m). Bonuses: +2 to roll with fall or impact.

54-58 Unusual Eyes:

01-17 Very small (half the size of a normal human)

18-34 Round

35-55 Very Large (twice the size of a normal human)

56-75 Odd Color (Roll on Odd Skin Table above to determine color).

76-89 Very Elliptical

90-00 Glowing Eyes

59-64 Extreme Amount of Body Hair:

01-20 Very bushy, full head of hair.

21-40 3x the normal amount of hair covers the body.

41-60 6x normal body hair. So thick, it resembles fur.

61-80 Short, half-inch (1.3 cm) fur covers the body except for the face, feet, and hands.

81-00 1D4 inches (1D10 cm) of fur covers the body except for the face, feet, and hands.

65-68 Prehensile Feet/Toes: See page 160 of

Heroes Unlimited for full details. -6 to strike when throwing objects with feet. +30% to climb rope when barefoot (Base of 30% if the character has no climbing skill). +1 to dodge.

69-72 Scaly Skin: A tough, smooth, reptilian skin with small scales covers the character's entire body. Adds 30 S.D.C.

73-76 No body hair at all!

77-79 Small Horns: 1D4 inches (1D10 cm) long, protrude from forehead.

80-84 Tough, Lumpy Skin: Adds 30 S.D.C.

85-89 Prehensile Tail: See page 160 of **Heroes Unlimited** for a full description. Bonus: +1 to strike and parry with the tail. +20% to climbing when tail is used. Can support character's weight when hanging and carry one-third of his weight. Length: 3D4 feet (0.9m to 3.7m).

90-94 Retractable Claws: Small, catlike claws. Damage 2D4 plus P.S. bonus per Swipe. Adds a bonus of +10% to climbing.

95-00 Stocky: Twice as broad as normal. Bonuses: Add 50 pounds (23 kg) to weight, +1D4 to P.S. and +4D4 to S.D.C.

41-45 Humanoid Insect Appearance: Large Round Eyes, antennae, claw-like hands and feet, no body hair, and a natural exoskeleton. The antennae are additional sensory organs for air vibrations, scent and sound, and provide the following bonuses: +1 to initiative, +1 to dodge, half normal penalties when blinded, and is difficult to surprise. Roll for the type of exoskeleton and its bonuses:

01-40% Soft Exoskeleton: +3D4x10 S.D.C. and a natural A.R. of 10; skin/chitin color of choice. Increase speed attribute by 10% and reduce P.B. by 10%.

41-00% Hard Exoskeleton: +3D6x10+40 S.D.C. and a natural A.R. of 14; skin/exoskeleton color of choice. Reduce speed by 10%, and the skills prowl, swim, acrobatics, and gymnastics are performed at -10% and disguise is at -60%. Reduce P.B. by 20%.

46-51 Stereotypical "Classic" Alien Appearance: The traditional alien with a bald, big head, dark almond-shaped eyes, and spindly arms and legs as reported by victims of alien abductions. Little or no facial features, a slit or two for a nose, long, smooth, featureless limbs, 1D4+1 fingers (plus an opposable thumb) and toes; generally a non-human appearance. These aliens also tend to have a pale complexion. Bonuses: +2 to P.P. and +1 to M.E.

52-56 Humanoid Skeletal: Sunken eyes and cheeks, very thin, long limbs, thin waist, and bony hands and body; skin may be soft and warm or rough and hard like bone. The shape of the body does not have to be human, and can be humanoid, animal-like, or any of the general shapes noted on this table. No body hair, but some may have hair on their heads. Bonuses: +1 to P.P., + to Speed, and has a Horror Factor of 9+1D6. P.B. can not be higher than 8.

57-59 Humanoid Amphibian: Soft, smooth skin, webbed hands and feet, semi-aquatic. Bonuses: Can hold

breath for 20 minutes, the swimming skill is automatic at 90% proficiency and swimming speed is six times greater than the alien's normal running speed. Maximum depth tolerance (unless a super ability alters this) is 500 feet (152 m).

60-64 Vegetation: Composed of the same essence as Earth plant life. Bonuses: +40 S.D.C. The plant being does not register on heat or infrared sensors. They also heal twice as fast as humans, possess extraordinary strength, and draw nourishment from sunlight, water and the minerals from the ground (generally do not need to eat).

65-66 Humanoid Pig: Husky build with a large, wide, pig nose and mouth, small eyes, and large ears. Can be smooth and pink with thin hair, or have coarse white, grey or brown hair and look boar-like, complete with a wild mane of hair on the head and running down the back of the neck. Bonuses: +1 to both P.E. and P.S. and +3D6+6 to S.D.C.

67-70 Humanoid Atroxian: Tall, serpent-like alien with flat, wide head, round eyes, large mouth, prominent fangs (1D6 or 2D4 bite damage), long, thin neck and limbs, and a slim, pliable body; 80% are double jointed. Able to slip out of handcuffs or bound ankles 65% , and 45% likelihood of escaping from bound limbs, straightjacket or prison cell with bars (can try to escape once per melee round/every 15 seconds). Bonuses: +1D6 to speed, +10 to S.D.C., +2 to save vs poison and drugs, natural thermal imaging sense (range 50 feet/15 m), and +5% to the escape artist skill.

71-73 Humanoid Reptilian: Lizard-like features, leathery or scaly skin, little or no body hair, long clawed fingers. Bonuses: +30 to S.D.C., +2 to P.P. and +1D6 damage from claws.

74-76 Humanoid Canine: Dog-like features, muzzle, ears, body fur or extreme body hair, round dark eyes. Bonuses: +1D4 to P.S., +2D6+4 to Spd and + 10 to S.D.C; has excellent sense of smell and hearing (top range of human capabilities, but not superhuman).

77-79 Humanoid Avian: Bird-like features with large, round eyes, clawed feet and hands, and feathers for hair. Only 10% have large wings capable of flying. Most bird humanoids have no wings or they are small/stunted and incapable of flight. Bonuses: +1D6 damage from claws, most (80%) are ambidextrous and have keen hearing and sight twice as good as a human's. Those with flight capable wings will have a flying Speed attribute of 1D6x10+20.

80-82 Humanoid Mineral: Rocky or crystalline appearance. Bonuses: Natural body armor: A.R. 14, +180 S.D.C. and +4D4+10 to P.S.

83-85 Humanoid Feline: Cat-like features; bright oval eyes, fur covered body, pointy ears, and small fangs (+1D6 damage from bite). Bonuses: +2 to P.P., +1D6 to Spd, +10% to climb, +10 S.D.C. and 01-50% will have retractable claws (+1D6 damage from claw attacks in addition to usual punch and P.S. bonus damage).

86-88 Humanoid Ape: Resembles an ape (no tail); long arms, fur covered or extreme body hair. Bonuses: +1 to I.Q. and M.A., +1D6 to P.S., and + 20 to S.D.C.

89-90 Humanoid Elephant (or similar beast, hippo, etc.): Large body, short limbs, thick, wrinkled skin (A.R. 7), wide head with long nose, large ears, small eyes, and may have tusks (45% chance; inflict 2D4 damage). Bonuses: +2D6 to P.S., +1D4 to P.E., + 30 to S.D.C. Add 4D6 inches (8D6 cm) to height. Weighs twice as much as a human of comparable size.

91-92 Humanoid Bison or Wildebeest: Wide, low forehead, wide nose, huge shoulders, may have horns (1D6 damage), and long hair or fur. Bonuses: +1D6 to P.S., +2 to P.E. and +24 to S.D.C.

93-94 Humanoid Rhinoceros: Large, powerful body, thick skin (A.R. 10), little or no hair, wide hands and feet, long, wide face with high ears, and a small mouth low on the face. May or may not have one or two horns (45% chance) above the nose. If so, it does either 2D4 (1-75%) or 2D6 (76-00%) damage. Bonuses: +2D6+12 to P.S., +1D4 to P.E., +2D6+6 to Spd, and +40 to S.D.C. Weighs nearly twice as much as a human of comparable size (about 80% more).

95-96 Demonic Appearance: Either fairly human in appearance, but devilishly attractive (+2D4 P.B.), with small horns, fangs, and red or bronze skin, or monstrous, with large horns or spines (especially on the head, forearm, elbows or shoulders), pointed teeth and/or large fangs, claws (+1D6 damage), and unusual skin color and texture (lumpy, scaly, slimy, etc.). A tail (only prehensile 01-33% of the time) or an extra pair of limbs (01-15% No extra limbs; 16-45% Wings with a flying attribute/Spd of 6D6+10; 46-80% two small arms with a P.S. of 2D6+6; 81-00% Two normal arms with the same P.S. as character. The extra arms add one melee attack but do not gain the other bonuses for Multiple Limbs unless that minor ability is also possessed). Either of the appearances can



have a tail and/or multiple limbs. Bonuses: +2 to P.S. (which is superhuman for those with the monstrous appearance), +1 on initiative, +2 to save vs Horror Factor, and a +20 to S.D.C.

97-98 Humanoid but Artificial Life Form/Robot:

These aliens are some sort of advanced robot or android. They will seem more human than machine-like, and possess an organic intelligence, or super sophisticated artificial intelligence on the level of the human brain. Bonuses: The character is immune to psionic powers that are not physical in nature, never tires, and rarely sleeps (only needs 3-4 hours of sleep or rest).

99-00 Humanoid Aquatic: Fish or aquatic mammal (dolphin, whale, seal, etc.), webbed feet and hands, smooth or scaly skin, blow-hole or gills, no body hair, dull grey to brightly colored. Bonuses: Swimming ability is equal to the swimming skill at 98%, swimming speed is 2D4x10; running speed is rarely higher than 10, can hold breath underwater for 3D6 minutes (indefinitely for gills), depth tolerance is 2D6x1000 feet, and +20 to S.D.C.

Alien Physiological Modifications Due To Unearthly Environments

All bonuses are applicable when on Earth or an Earth-like environment.

01-05 Normal Earth Environment: The homeworld of the alien is virtually identical to that of Earth; no bonuses or abilities.

06-14 High Gravity: The gravitational force of the alien's homeworld was considerably greater than Earth's. This gives the alien greater mass and physical endurance, and he is much faster and lighter on our planet than on his homeworld.

Height: 5 feet plus 1D6 inches (1.5 to 1.7 m).

S.D.C. Bonus: 3D4x10

P.S. Bonus: Add 2D4 to the P.S. attribute, increase normal speed by three times, and +1 to initiative.

15-21 Low Gravity: The alien's homeworld had a much lighter gravity than Earth's. This has made the alien much taller than a typical human. Although the increased gravitational pull of Earth slows the alien down, it also provides him with somewhat greater mass.

Height: 5 feet, 5 inches plus 1D6 additional feet (2.0 to 3.5 m)

Weight: Add 1D4x100 pounds (1D4x45 kg).

S.D.C. Bonus: 1D4x10

P.P. Bonus: Add 1D4 to the P.P. attribute and reduce normal speed by half.

22-30 High Radiation: Impervious to radiation that is normally deadly to humans. The character can also see ultraviolet light. The alien radiates low levels of radiation that will begin to harm humans exposed to him for more than a few weeks. If the alien does not wear a radiation shielded survival suit (see equipment section), those around him will contract radiation poisoning on a result of 1-30%; roll once per each week of exposure.

Note: The symptoms and effects of radiation poisoning are given under the Control Radiation major super ability.

Height: 6 feet plus 1D6 inches (1.8 to 2.0 m).

Weight: 190 plus 1D6 pounds (87 to 89 kg).

S.D.C. Bonus: 1D4x10

31-40 Frozen World*: Extremely low temperatures are the normal condition on this planet. Temperatures will range from freezing to hundreds of degrees below zero. The alien can come from areas that experience some warmth, up to +30 degrees Fahrenheit (0 C), or constant sub-zero temperatures as low as -200 degrees Fahrenheit (-130 C).

Height: 5 feet plus 3D6 inches (1.6 to 2.0 m).

Weight: 120 plus 2D6x10 pounds (63 to 109 kg).

The following table determines the exact temperature range a character comes from. All aliens from frozen worlds must wear refrigerated environmental suits to survive outside of their comfortable temperature ranges.

01-39 Tropical to temperate latitudes. Average temperatures are in the teens with highs near 25 degrees Fahrenheit (average -11 to -8 C, high near -4 C). Alien will become very uncomfortable at temperatures above 45-50 degrees Fahrenheit (7 to 10 C). Heat will begin to take its toll at 60 degrees Fahrenheit (16 C) or higher. Bonuses: +4 to save vs cold-based attacks or conditions, and suffers only half damage if the roll to save fails. Add 15 S.D.C.

40-64 Cold, upper latitudes. Temperatures stay at or near 20 degrees below zero (-29 C) most of the year. The alien begins to suffer heat effects at 30-40 degrees Fahrenheit (0 to 4 C). Aliens from these conditions must wear some form of light refrigeration suit to keep them comfortable in an Earth-like environment (see equipment section for survival suit information). Bonuses: Automatically takes half damage from any cold-based attack or conditions and is +6 to save from cold-based attacks. S.D.C. bonus is +25.

65-00 Arctic pole areas. Temperatures hover around 40 degrees below zero (-40 C) most of the year but can drop much lower. Heat damage begins to affect the alien at 20 degrees Fahrenheit (-7 C). These aliens are impervious to even deadly cold, no damage, but they must wear heavy refrigeration suits to survive in Earth-like environments. Bonuses: +40 to S.D.C. and takes no damage from cold or cold based attacks (even magical ones).

41-50 Toxic Atmosphere: The alien's has an atmosphere that is poisonous by Earth standards. It is either a chemical soup of pollution, or made up of gases different than those found in Earth's atmosphere. As a result, the alien cannot breathe the air on Earth. He will have to wear a breathing apparatus to survive here. The alien can also be from a planet with little or no atmosphere and doesn't need to breathe at all. However, the character will not have a sense of smell or taste. In either case, the alien is immune to the effects of gases, odors and many toxic airborne substances, but strong liquid poisons and acids will still harm him.

Height: 6 feet plus 1D6 inches (1.8 to 2.0 m).

Weight: 180 plus 2D6 pounds (82 to 87 kg).

S.D.C. Bonus: Add 2D4x10

51-60 Vegetation World: The alien's home planet is a fertile garden of greenery. The land masses are covered with immense growths of brush and huge plants. The trunks of giant vines are used as thoroughfares and massive trees are hollowed out for homes. The aliens spend much of their time climbing through the dense foliage and may develop body parts to help them get around; roll on the following table:

01-15 Prehensile feet and tail.

16-30 Prehensile tail only.

31-50 Prehensile, clawed feet only.

51-60 +10% on climb skill and +2 to roll with fall or impact.

61-00 No special developments.

Height: 5 feet plus 1D4 feet (1.8 to 2.7 m).

Weight: 150 lbs plus 2D10 lbs per extra foot (68 kg plus 0.9 to 9.1 kg per extra 0.3 m).

Special Bonus: Acrobatics: These aliens automatically have the acrobatics skill at +10%.

S.D.C. Bonus: Add 10 S.D.C.

61-70 Thermo World*: This planet is the exact opposite of the frozen world. Temperatures will range from 95 degrees Fahrenheit (35 C) to highs of nearly 300 degrees Fahrenheit (149 C). The alien can come from a variety of areas on the planet with varying temperatures. All aliens must wear environmental suits with a heating unit to survive in places other than the tropics or a desert.

01-39 Cold, upper latitudes. Temperatures stay at or near 110 Fahrenheit (43 C) most of the year. The alien begins to suffer cold exposure at 75 degrees Fahrenheit (24 C). Bonuses: +4 to save vs. heat attacks or environments. Subtract four points of damage from any heat-based attack. +15 S.D.C.

40-64 Temperate, middle latitudes. Average temperatures are 130 to 145 degrees Fahrenheit (54 to 63 C). The alien will become very uncomfortable at temperatures below 100 degrees F (38 C) and will suffer cold exposure at 85 degrees Fahrenheit (29 C). Aliens from these conditions must wear some form of survival suit to keep them alive and comfortable in an Earth-like environment. Bonuses: Half damage from any heat-based attack or conditions. +25 S.D.C.

65-00 Tropical, near the equator. Temperatures regularly reach 200 degrees Fahrenheit (93 C). The alien has a high tolerance to heat and will freeze in the cold environment of Earth — 99 degrees Fahrenheit (37 C) or colder. These aliens are impervious to even scathing heat. They take no damage, but must wear an environmental suit to survive in an Earth-like environment, with its wide range of temperatures. Bonuses: +40 to S.D.C.

An alien exposed to temperatures beyond his toleration level will be adversely affected by those temperatures. Use the same debilitating exposure penalties listed under the frozen planet.

Height: 5 feet plus 4D6 inches (1.6 to 2.1 m).

Weight: 100 plus 2D6x10 pounds (45 plus 2D6x4.5 kg).

71-80 Twilight World: An extremely dark, night-like world, which makes the alien highly sensitive to light.

While the alien can see well in near total darkness, light more than 60 watts is considered bright, and a 100 watts or more is blinding. The alien must wear a protective photo-sensitive visor, goggles, or similar eye shields to see in daylight, otherwise he is -8 to strike, parry, and dodge from being blind.



Height: 4 feet plus 1D4 feet (1.5 to 2.4 m).

Weight: 100 plus 2D4x10 pounds (45 plus 2D4x4.5 kg).

S.D.C. Bonus: Add 10 S.D.C.

Special Bonuses: Nightvision 600 feet (183 m). Sensitive hearing; about 20 decibels beyond the human range, +1 on initiative.

81-90 Aquatic world: The alien comes from a civilization that never left the ocean to walk on dry land, or has returned to the water where they have flourished. These aliens do not have to be fish-like in appearance. They swim with 85% proficiency with a speed equal to 2D4x10 (running speed is typically 70% slower). Aliens with Aquatic for their appearance are already assumed to come from an aquatic planet and may be allowed to re-roll their homeworld if this is the result.

Height: 6 feet plus 4D6 inches (1.8 to 2.4 m).

Weight: 190 plus 4D6 pounds (86 plus 2D6 kg).

P.S. Bonus: +1 above water; +1D6 below water. This is a one time bonus that remains constant each time they enter the water.

S.D.C. Bonus: +10 above water and an additional +20 below.

Other Bonuses: +2 to dodge underwater, can hold breath for 1D6x10 minutes (or may have gills, and can only breathe air for 1D6x10 minutes), and has a depth tolerance of 2 miles (3.2 km).

91-00 Abrasive Atmosphere: High, scathing winds or a corrosive atmosphere is this alien's natural environment. The being has developed a tough, thick skin or leathery plating like the Earth's rhinoceros.

Height: 4 feet plus 1D6 feet (1.5 to 3.0 m).

Weight: 200 plus 4D6x10 pounds (90 plus 4D6x4.5 kg).

A.R.: 12. This is a natural armor rating; results below 12 may hit, but they do no damage.

S.D.C. Bonus: Add 3D6x10 S.D.C.; physical strength is equal to the Minor Super Ability of Extraordinary Strength.

***Note:** Any alien exposed to temperatures beyond his toleration level will begin to suffer from exposure which will slowly kill the character. In game terms, it has the following effects:

A penalty of minus two (-2) on P.S. and P.P., minus eight (-8) on S.D.C., and a reduction of speed by one-third (1/3) is applied for every ten hours of exposure. These penalties are cumulative for each 10 hour period. After the S.D.C. is gone, damage continues to be done and Hand to Hand drop at the same rate. The alien is slowly dying and needs to be put into a refrigerated/heated suit, and/or into freezing/blistering environment to stabilize and recover. These same rules apply to humans and other aliens exposed to temperatures beyond their normal tolerance.

Reason for Coming to Earth

01-19 Last of a race of people. Has come to Earth because:

01-25 Earth reminds him of home.

26-50 It's a nice place; he/she just likes this planet.

51-75 To save mankind from itself.

76-00 Crash-landed, stuck here with no hope to salvage spaceship.

20-38 Crash-landed! Trapped on Earth, but will try to make the best of things; spaceship is destroyed. Feelings about Earth are:

01-20 It's an unpleasant world filled with barbarians.

21-40 It's a nice place; he/she likes it here.

41-60 Reminds him of home.

61-80 It's okay, but a bit primitive for his taste.

81-00 Undecided; has no place else to go.

39-55 Outcast! A fugitive from his own world for political, social, racial, religious or criminal reasons. There is a 01-50% chance that the alien is being hunted/pursued by his persecutors, bounty hunters or the law. He/she has selected Earth as a new home because:

01-20 It's more primitive and life should be easier.

21-40 To be free of his world's prejudice and/or persecution.

41-60 It's a nice place and he/she likes it here.

61-80 To hide from his people, who might seek him out for punishment or retribution.

81-00 Lost, this seemed as good a planet as any to settle on.

56-70 Intergalactic Champion of Justice. The alien has come to protect Earth because:

01-20 Earth needs guidance and direction if it is to blossom into a productive member of the intergalactic community.

21-40 It caught his eye and seemed like a worthy cause; likes Earth and its people.

41-60 Chose Earth because he/she likes the planet and its people, but tends to be very paternal and over-protective about this adopted world.

61-80 Assigned to Earth. Finds humans to be very interesting, but has not yet decided if he likes them or not. Tour of duty on Earth is at least 4D4 years.

81-00 Assigned to Earth. Finds its people primitive, aggressive, unfriendly, crude, and generally beneath him. The alien tends to be rude, arrogant, and condescending toward most "inferior" humans, but he does his job the best he can (whether the people want his help or not). Assigned for 4D4 years.

71-85 Glory hound who chose Earth to get fame and fortune. Since Earth is a bit more primitive than the alien's homeworld, it seemed like an ideal and easy opportunity. While the alien views Earth as "inferior," it does not mean he dislikes Earth. On the contrary, he likes it very much. It's just that he and his world are superior. This character is friendly, sincere, and gung-ho, but also a condescending, arrogant braggart and show-off.

86-00 Explorer or scientist who came to study Earth and couldn't help getting emotionally involved. The alien likes the people of Earth very much, and strives to become a champion, protector or mentor to its people.

Familiarity with Earth

01-20 No familiarity with Earth's culture, science, or laws. However, he can understand, speak, and write one Earth language quite well; 80% skill proficiency (a quick study). The G.M. can also allow a universal language translator at 88% proficiency.

21-60 Some Familiarity with Earth, its major nations, cultures, and laws. Can speak, read, and write three or four Earth languages at 90% skill proficiency.

61-00 Has studied Earth extensively and is as knowledgeable about the planet as a well-informed native human. The alien can speak, read, and write five or six different Earth languages fluently (98% skill proficiency).

Money

The alien visitors with NO familiarity with Earth are likely to have equivalent money in precious metals or stones. Those who have some familiarity with Earth may have half in real Earth currency (acquired from a previous visit). While those who have studied Earth extensively may actually have a variety of common Earth currency. Roll percentile dice to determine the amount of "money" available to the alien.

Aliens may also sell or trade a weapon, alien artifact, information, technology or service to acquire Earth currency. However, whether they get a fair price or exchange will depend on who they are dealing with and how desperate a situation they may be in. Such trades or sales can be with Earth corporations, individuals, scientists, a government, criminal organization, super hero(es) or super villain(s).

- 01-14 2D4x\$1,000
- 15-29 3D6x\$1,000
- 30-44 4D6x\$1,000
- 45-59 5D6x\$1,000
- 60-74 6D6x\$1,000
- 75-88 2D4x\$5,000
- 89-00 2D6x\$10,000

Random Equipment

Earth Clothes/Disguises

01-40 None

41-60 Several suits of acceptable fashion (from name brand tennis shoes to designer jeans).

61-74 Several suits of everyday apparel (generic labels).

75-00 Several suits of old or outdated clothes (work clothes or fad clothes from a past decade).

Special Alien Weapons

There are two tables for special weapons. One is for high-tech ranged weapons, and the other is for special melee weapons. The player should choose which table he/she wishes to roll on for his character's special weapon. Roll on only one of the tables.

Special Ranged Weapons

01-08 Laser Rifle: Range: 1400 feet (427 m), damage 6D6, 20 shot energy clip.

09-16 Laser Pistol: Range: 300 feet (91 m), damage 4D6, 15 shot energy clip.

17-24 Stun Pistol: Range: 135 feet (41 m). Damage to nervous system dazes victim: -8 to strike, parry, dodge, no

initiative, and reduce attacks per melee by half. Duration: 1D4 melees. 10 shot energy clip.

25-32 Ion Blaster (Pistol or Rod): Range: 200 feet (30.5 m), damage 5D6, 20 shot energy clip.

33-40 Alien Sub-machinegun: Range: 600 feet (183 m). Damage 4D6, 60 round magazine.

41-48 Mini-Laser: Small rod the size of a flashlight. Range: 100 feet (24.4 m). Damage 2D6. 10 shot energy clip.

49-56 Sonic Blaster: The sonic blaster generates shock blasts. The vibrations that cause the damage tend to jolt someone, even when they impact against body armor. On a roll below the armor rating, a sonic blaster does half damage to the armor. Half of any sonic damage carries through the armor and hits the person inside. Range: 80 feet (24 m), damage 3D6, 20 shot energy clip.

57-64 Sonic Disrupter: Similar to the stun gun, these weapons cause disorientation and loss of consciousness by using high frequency sound. Range: 150 feet (46 m). Physical damage is only one (1) point, but there is a chance that a person shot by the blast is rendered unconscious for 1D4 melee rounds (victims must roll a 14 or higher to save, P.E. bonus applicable; +4 to save if wearing protective armor), otherwise they lose one melee action and are -4 to strike, parry and dodge. 10 shot energy clip.

65-71 Microwave Gun: This can be either a pistol (1-60%) or rifle (61-00%). The energy from these weapons concentrates within a target as it passes through it and generates heat. The nature of the energy is such that it penetrates/bypasses all forms of natural body armor, Kevlar, ceramic, plastic, and other types of armor which are not made of metal. Microwaves are reflected by all types of metal, including material as frail as tin foil. Range: pistol: 120 feet (36 m), rifle: 1000 feet (305 m). Damage: pistol: 2D6, rifle: 3D6. 15 shot energy clip for pistols and 20 shot for rifles.

72-80 Energy Weapon of player's choice. This is an advanced projectile weapon that fires beams of energy instead of slugs or shafts. It can be anything from an energy bow to laser shurikens. Stats are identical to normal versions of the weapon, but add +1D6+3 to damages. Typically has 20 charges per clip/bundle.

81-85 Mini-Explosive Grenades: The size of a golf ball. Range: 90 feet (27 m). Damage: 1D4x10. Effective casualty radius is 12 feet (3.7 m). The character has 2D4+2 grenades.

Also has mini-smoke grenades the size of a golf ball. Throwing range: 90 feet (27 m). Damage: smoke covers a 20x20 foot area (6.1 m x 6.1 m). People inside the smoke cloud are -8 to strike, parry and dodge. The character has 2D6+2 smoke grenades.

86-90 Pair of Mini-Energy Wrist Blasters or Gauntlets: This weapon is typically a high intensity laser or ion blaster. Range: 200 feet (61 m). Damage: 3D6 per single blast, 6D6 per double blast (both arms are pointed at the same target and fired simultaneously; counts as one attack). Payload: 20 blasts each per hour; self-regenerating.

91-95 Mini-Missile Launcher: Can be a backpack unit (holds six, fires one at a time or in volleys of 2, 4, or 6), or a special armored gauntlet (only one for one arm, not a pair) or one shoulder unit that holds two missiles (takes four melee actions to reload; extra mini-missiles can be carried in a duffel bag, suitcase or backpack). Range of the missile is one mile (1.6 km), can be used as a point and shoot projectile or programmed to target one specific target (type of vehicle, uniform/costume, etc). The character has 2D4+6 mini-missiles.

96-00 Plasma Ejector or Particle Beam Rifle: An oversized rifle or bazooka-type weapon that fires devastating blasts of energy. Range: 1200 feet (366 m). Damage: 6D6+20. 10 shot energy clip.

Additional Ammunition

Energy clips and magazines: 1D6. Recharging on Earth costs \$5,000 a clip if a proper facility can be found (something can usually be jury-rigged). In a space campaign, recharging only costs 100 to 200 credits and facilities are readily available.

Grenades: 2D6. Special grenades like these cost 10 to 20 times their normal cost on Earth, and someone to make them must still be found (demolitions roll at 35% to make them). In space, they can be found as easily as normal grenades on Earth and cost the same, 10 to 30 credits each.

Special Melee Weapons

The term "melee" weapon refers to ancient styles of weapons such as knives, swords, axes, spears, clubs, staves, and similar. All *special* melee weapons are single-handed weapons. The use of two hands adds +2 to the damage plus any P.S. bonus.

Vibro weapons have their damaging edge surrounded by a high-frequency field that greatly increases their damage capacity (in **Rifts** they inflict equivalent Mega-Damage).

Energy weapons are hilts, shafts or rods with energy field generators that form their blades from concentrated light or other damaging energies (in **Rifts** they inflict equivalent Mega-Damage).

Kisentite weapons are forged from a dense meteorite metal that has an amazing hardness, and keeps a sharp edge when made into a blade. These blades are a deep blue/black color (in **Rifts** they inflict M.D. that is equal to one-third the S.D.C. damage listed here; i.e. 3D6 = 1D6 M.D., 2D6 = 1D4 M.D., and so on).

01-10 Vibro-Sword: A standard-looking long sword. The generator is in the handle. Average length: 3 feet (0.9 m). Average weight: 4.2 pounds (1.9 kg). Typical Damage: 4D6.

11-20 Energy Axe: This large, axe-shaped weapon has no blade until the power is turned on and the laser blade springs forth. Average length: 2.5 to 2.75 feet (.8 m). Average weight: 2.3 to 2.8 pounds (1.0 to 1.3 kg). Damage: 5D6.

21-30 Vibro-Axe: A standard axe with a handle generator like the sword. Average length: 2.25 feet (0.7 m). Average weight: 4.5 pounds (2.0 kg). Damage: 3D6.

31-39 Kisentite Sword: Typically a long, slim blade anchored in an elaborately etched hilt and cross guard. Average length: 3 feet (0.9 m). Average weight: 3.5 pounds (1.6 kg). Damage: 2D6+3.

40-46 Kisentite Axe: A finely crafted and decorated double-headed weapon. Average length: 2.75 feet (0.8 m). Average weight: 4.6 pounds (2.1 kg). Damage: 3D6.

47-55 Energy Knife: A glowing blade springs from the small handle generator of the knife. Average length: 0.75 feet (0.2 m). Average weight: 0.5 pounds (0.23 kg). Damage: 3D6.

56-66 Vibro-Knife: Same as the sword and axe. Average length: 12 inches (30 cm). Average weight: 1 pound (0.45 kg). Damage: 2D6+1.

67-75 Kisentite Knife: A broad, double-edged blade nestled in a wide, ornate cross guard and hilt. Average length: 1.5 feet (0.45 m). Average weight: 1 pound (0.45 kg). Damage: 2D4.

76-88 Energy or Vibro-Clubs: A clubbing weapon surrounded by either an energy or high-frequency field for increased damage. Average length: 2.25 feet (0.8 m). Average weight: 3 pounds (1.4 kg). Damage: 3D6.

89-94 Neuro or Stun Clubs: Special energy clubs that overload the nervous system to daze the victim. Average length: 2.5 feet (0.8 m). Average weight: 2.7 pounds (1.2 kg). Damage: 1D6 S.D.C. plus it stuns the victim who is then at -4 to strike, parry, and dodge, reduce speed by half and has no initiative for 2D4 melees.

95-00 Energy Sword: A long (12 inches/30 cm) hilt, with or without cross guard, holds the powerful energy generator for this weapon. The balance and length of the sword give it +1 to strike and parry. Average length: 3.5 feet (1.1 m). Average weight: 1.5 pounds (0.7 kg). Damage: 5D6.

Weapon Notes: Anyone who successfully parries one of these special weapons with a conventional one will have that normal weapon suffer minor damage. If a long sword is used to parry an energy sword, the laser beam will scorch and pit the metal of the sword. Only a Kisentite or magic weapon can parry a Vibro or energy weapon and not suffer some sort of damage. Physical Strength bonuses are added to the damage done by melee weapons.

See page 70 of **Heroes Unlimited** for the S.D.C. of conventional Earth weapons.

Special Vehicles

01-08 One-Man Fan Jet: A small aircraft with a single seat. A passenger may sit in the pilot's lap, but all pilot rolls are made at 10% and he suffers a penalty of -2 on initiative. Can fly as low as 20 feet (6.1 m) above the ground. Maximum speed: 300 mph (480 kmph) and VTOL capable. S.D.C.: 275. Range: 500 miles (800 km) before needing to refuel. The alien must have the piloting skill: airplane to fly this craft.

09-15 One-Man Hover Car: Maximum speed: 200 mph (321.8 kmph). S.D.C. 180. Hovers 3 to 12 feet (.9 to 3.65 m) above the ground. The piloting skill of automobile (-10%), or pilot hover vehicle must be known to the driver.

16-24 Two-Man Hover Car: Maximum speed: 200 mph (321 kmph). S.D.C.: 240. Hovers 3 to 12 feet (0.9 to 3.65 m) above the ground. The piloting skill of automobile (-10%), or pilot hover vehicle must be known to the driver.

25-33 Hover Cycle: Can be a two- or four-person model. Maximum speed: 160 mph (256 kmph). S.D.C.: 150. Hovers 3 to 20 feet (0.9 to 6.1 m) above the ground. The piloting skill of motorcycle (-15%), or pilot hover cycle must be known to the driver.

34-42 Micro-Jet Hover Boots: A pair of rigid boots similar to ski boots with several small thrusters. Maximum speed: 65 mph (105 kmph) and is +1 to dodge while airborne. S.D.C.: 50. Maximum altitude is 600 feet (183 m). The character must have the jet pack piloting skill.

43-50 Hover Platform: A round or square platform 4x4 feet (1.2x1.2 m), that comfortably supports two people (can hold up to four). Maximum speed: 90 mph (145 kmph). S.D.C.: 130. Hovers 3 to 300 feet (0.9 to 91 m) above the ground. The character must have the pilot hover vehicle skill.

51-60 Detachable Jet Pack: Straps onto the person's back. Maximum speed: 90 mph (145 kmph) and is +2 to dodge while airborne. S.D.C.: 80. Maximum altitude is 600 feet (183 m) above the ground. The character must have the jet pack piloting skill.

61-68 Antigravity Disk: Can attach to feet, back, or chest. Maneuvered by simple hand controls, or a voice-activated computer. They are about the size of a dinner plate. Maximum speed: 160 mph (256 kmph). S.D.C.: 40 per disk. Maximum altitude is unlimited and can carry the character into outer space. Maximum weight allowance: 1000 pounds (450 kg).

69-77 Antigravity Ring or Medallion: Creates an antigravity field around the wearer. Maximum speed: 100 mph (160 kmph). S.D.C.: 8. Maximum altitude is unlimited and can carry the character into outer space. Maximum weight allowance: 500 pounds (225 kgs).

78-87 A.T.V. Hover Vehicle: Large sedan-styled hover vehicle that can hold five passengers and the pilot comfortably. Maximum speed: 180 mph (288 kmph). S.D.C.: 440. Hovers 3 to 12 feet (0.9 to 3.65 m) above the ground. Space and underwater flight is also possible, but the vehicle cannot fly into space under its own power.

88-95 Antigravity Suit: A close-fitting body suit that creates an antigravity field around the wearer. Maximum speed: 300 mph (482 kmph). S.D.C.: 45 (provides no A.R. and minimal armor protection). Maximum altitude is unlimited and can carry the character into outer space. Maximum weight allowance: 500 pounds (225 kgs).

96-00 One-Man Gyro-copter (VTOL): A small, single seat rotorcraft. There is usually no canopy, just a seat, motor, landing gear, and tail. Maximum speed: 180 mph (290 kmph); cruising speed: 145 mph (133 kmph) and is +1 to dodge. S.D.C.: 300.



Optional Alien Generation Tables

There are over 80 specific alien races presented in this book for the Game Master's and player characters easy use. The following Alien Generation Tables provide randomly generated quick-roll villains, non-player characters or player characters. For random purposes, simply follow the steps given in this section. This generation system cuts out many of the steps and dice rolls of the original and expanded generation systems.

These tables are *optional* and are presented to help speed up the creation of characters and non-player characters. At the Game Master's discretion, players can simply pick the race they wish to play. Each specific race has a general description elsewhere in this sourcebook.

1. Determining Alien Race

This first step replaces nearly all of the eight steps of the original character generation system. The number of dice rolled for the eight attributes, S.D.C., appearance, physiological modifications, familiarity with Earth, special weapons, special vehicles, and alignment suggestions are all found under the specific alien descriptions in the Catalog of Aliens section. Roll on the tables below, then find the appropriate race by name.

Many of the specific alien races roll more than three dice to determine some of their attributes. This is a result of their physiology, special powers, appearance and homeworld environment. Any attribute roll with a result of 16, 17, or 18 gets the standard bonus die added to it, but results of 19 or higher do not get a bonus die roll added to them. Likewise, rolls of 2D6 that result in a 12 get a bonus die added to them.

01-70 **Roll on Table A**

71-00 **Roll on Table B**

TABLE A

01-02 Trogolo (Ape, frozen world)
 03-04 Timneh (Avian, thermal world)
 05-06 Vulpes (Canine, high radiation)
 07-08 Hatha (Human-like, thermal world)
 09-10 Altaica (Feline, thermal world)
 11-12 Kisent (Vegetation, thermal world)
 13-14 Xippus (Insect, twilight world)
 15-16 Daraka (Humanoid, high radiation)
 17-19 Aurovax (Reptile, high radiation)
 20-22 Chiana (Vegetation, twilight world)
 23-24 Baccarus (Reptile, thermal world)
 25-27 Felias (Feline, twilight world)
 28-30 Pyralis (Insect, frozen world)
 31-32 Silison (Human-like, high radiation)
 33-34 Thropo (Ape, high radiation)
 35-36 Thresk (Avian, twilight world)
 37-38 Wulf (Canine, twilight world)
 39-40 Lupis (Canine, frozen world)
 41-42 Caecil (Amphibian, high radiation)
 43-44 Cherion (Aquatic, thermal world)
 45-46 Arismal (Human-like, twilight world)
 47-48 Lachinelia (Vegetation, high radiation)
 49-51 Giris (Feline, frozen world)
 52-54 Kassa (Humanoid, twilight world)
 55-56 Panthera (Feline, high radiation)
 57-58 Toyoc (Canine, thermal world)
 59-61 Lixila (Insect, thermal world)
 62-64 Errasa (Aquatic, twilight world)
 65-66 Inenensi (Aquatic, high radiation)
 67-68 Deuryca (Amphibian, thermal world)
 69-70 Klikita (Human-like, frozen world)
 71-72 Sorinam (Amphibian, frozen world)
 73-74 Aluta (Humanoid, frozen world)
 75-76 Tagonica (Avian, frozen world)
 77-79 Photin (Insect, high radiation)
 80-82 Dytee (Ape, thermal world)
 83-85 Erritima (Reptile, frozen world)
 86-88 Mantella (Amphibian, twilight world)
 89-90 Erythro (Vegetation, frozen world)
 91-92 Thissera (Reptile, twilight world)
 93-94 Tinalis (Aquatic, frozen world)
 95-96 Gallopa (Avian, high radiation)
 97-98 Maeus (Ape, twilight world)
 99-00 Shissa (Humanoid, thermal world)

TABLE B

01-02 Arreri (Humanoid, abrasive atmosphere)
 03-04 Basanite (Mineral, high radiation)
 05-06 Concol (Feline, low gravity)
 07-08 Naterreri (Aquatic, abrasive atmosphere)
 09-10 Linx (Feline, high gravity)
 11-12 Capuci (Ape, high gravity)
 13-14 Dergin (Canine, abrasive atmosphere)
 15-16 Raldeme (Mineral, low gravity)
 17-18 Salvelinus (Aquatic, high gravity)
 19-20 Relogo (Insect, low gravity)
 21-22 Struthio (Avian, high gravity)
 23-25 Sprekalia (Vegetation, abrasive atmosphere)
 26-28 Xenopus (Amphibian, abrasive atmosphere)
 29-32 Naiden (Human-like, high gravity)
 33-35 Liconia (Mineral, thermal world)
 36-38 Tedeschia (Vegetation, low gravity)
 39-40 Jenjora (Reptile, high gravity)
 41-43 Stoan (Mineral, high gravity)
 44-47 Manarr (Human-like, low gravity)
 48-50 Cebus (Ape, low gravity)
 51-52 Elecian (Avian, low gravity)
 53-54 Salar (Aquatic, low gravity)
 55-56 Lassinike (Mineral, frozen world)
 57-59 Axolotl (Amphibian, low gravity)
 60-62 Canis (Canine, low gravity)
 63-65 Titon (Humanoid, low gravity)
 66-68 Camlea (Vegetation, high gravity)
 69-71 Nithia (Reptile, abrasive atmosphere)
 72-74 Pume (Feline, abrasive atmosphere)
 75-76 Danaus (Insect, high gravity)
 77-78 Rotharr (Human-like, abrasive atmosphere)
 79-81 Qua-Trau (Reptile, low gravity)
 82-84 Micean (Mineral, twilight world)
 85-86 Swip (Humanoid, high gravity)
 87-89 Cameroon (Amphibian, high gravity)
 90-92 Anubio (Ape, abrasive atmosphere)
 93-94 Mantis (Insect, abrasive atmosphere)
 95-96 Fredulians (Mineral, abrasive atmosphere)
 97-98 Gymoy (Avian, abrasive atmosphere)
 99-00 Latran (Canine, high gravity)

2. Determining Super Abilities

The alien descriptions mention the more prominent types of super abilities exhibited by that race. In general, most of the Super Power Categories as found in **Heroes Unlimited** are available to an alien race, unless specifically stated otherwise. Whether a character can possess powers not normally available to that race is up to the Game Master. The power category of a character may be picked from those stated in the alien description or the player can roll on the *Determining Super Abilities* table under *Step Three* of the Revised Character Generation Section.

3. Determining Education & Skills

Players and Game Masters can make a choice here based on the suggestions given in each alien entry, or

they can roll on the *Determining Education & Skills* table under *Step Four* in the Revised Character Generation section.

4. Reasons for Coming to Earth

These remain unchanged; roll as usual on the table above.

Other Stuff

Weapons and Armor: Specific alien races will indicate the general types of weapon, armor and equipment common to that race or type character. The equipment, weapons, and armor mentioned in each entry are the usual issue or preferred types common to that race or frequently used for field duty. The G.M. can give the character the full range of items, selections from typical equipment or

add conventional or common items to it. If a special protective suit is needed, the alien will have one suit and a single spare.

Structural Damage Capacity (S.D.C.): The base S.D.C. for each of the 80+ aliens described will include the typical S.D.C., appearance and physiological bonuses.

The typical alignment or alignment range are provided to help players and Game Masters better understand the motivations and outlooks of the featured aliens. Game Masters can use them as guidelines, but should always keep in mind that every society is composed of individuals and they will exhibit any and all of the alignments unless they are robots. There are rogues, traitors and villains among all people — hence the never ending battle of good versus evil.

New Rules and Abilities By Super Power Category

Bionics

Note: Available to humans unless stated otherwise.

Bio-Comp Self-Monitoring System: Nano-implants tied into a tiny computer system monitor, measure and transmit fundamental physiological information about the personal implanted in. The data is typically displayed on a wristwatch or bracelet-style monitor, but can also be displayed and recorded on a computer, portable bio-scan or portable laboratory via a fingerjack or headjack.

Data includes pulse rate, blood pressure, body temperature, blood sugar level, respiratory rate, breathing difficulties, and the presence of foreign elements in the bloodstream (indicating the presence of drugs or poison). **Cost:** \$15,000 for aliens. This technology is not currently available to humans. Any experimental prototypes will cost a human 3D4x100,000 dollars.

Energy Melee Weapons: Vibro-Blades and energy versions of melee weapons are available as retractable or concealed weapons. A single sword-like Vibro-Blade will do 2D6 damage, a pair of double claw blades do 4D6 damage and 6D6 for triple blades!

A single sword-like *energy* blade will do 3D6 damage, a pair of double claw blades 6D6 damage and 1D6x10 for triple blades, but an energy hip or backpack is required to power the weapon. The generator pack has 55 S.D.C. and attackers must make a called shot at -3 to strike to hit it. If the pack is destroyed, the claws do ordinary damage. Remember that energy melee weapons do not receive P.S. damage bonuses. **Cost:**

\$100,000 for aliens. This technology is not currently available to humans. Any experimental prototypes will cost a human 2D4x100,000 dollars.

Extendible Hydraulic Hands/Arm: Typically only one limb will have an extendible, hydraulic hand. The control mechanism can be designed to respond to mental or verbal commands with the speed and flexibility of a normal arm. The arm's reach is typically increased by three to six feet (0.9 to 1.8 m). The extendible hand/arm enables the character to reach into narrow places like storm drains, ventilator shafts, and so on, as well as places normally out of reach, like a high shelf or window ledge. A typical arm has a P.S. of 10 to 20. **Cost:** \$150,000.

Finger Camera: A tiny still camera fits inside the tip of one finger. The camera shoots 48 photos on microfilm, and is designed to automatically adjust for low or high light exposures. **Cost:** \$1200.

Gill-to-Lung Switching Mechanism: Aquatic aliens do not have to get rid of their gills to breathe air, they can get bionic lung implants. This implant allows a water-breathing alien to switch back and forth between the two types of respiration for unrestricted activity both above and below the water. **Cost:** \$125,000.

Gills: An alien with lungs can have gills implanted in order to breathe underwater without an air tank. This allows for extended activities underwater. Bionic gills will be implanted in the neck or between the ribs. Note that the latter position for gills will prohibit the use of chest armor or clothing when breathing underwater. The gills need an unrestricted passage of water to breathe. **Cost:** \$500,000 and includes a gill-to-lung switching mechanism.

Internal Comp-Calculator: A tiny computerized calculator connected to a head or ear implant or artificial eye. The computer responds to spoken, radio or computer transmitted mathematical equations. The answer is transmitted to the character in 1D4 seconds, depending on the complexity of the equation. **Cost:** Basic math (addition, subtraction, multiplication, division and fractions at 98%): \$10,000; advanced math (algebra, geometry, and calculus at 96%): \$15,000.

Language Translator: This built-in computer system can recognize and monitor up to three different voices and two different languages or dialects. Level of accuracy is 98.7% for known languages (i.e. aliens who have studied Earth), but only 30% for a completely unknown language. The translator can be programmed with a total of 16 different languages. There is a three second delay/pause between the time of the spoken word and the translation. **Cost:** \$15,000 for aliens. This technology is not currently available to humans. Any experimental prototypes will cost a human 3D4x100,000 dollars.

Palm Laser Torch: An "immediate" range laser torch built into the base of the palm and wrist of cyborgs (or robots). The device has the very short range of one foot (0.3 m), because it is intended as a high intensity laser torch tool to cut through armor, locks, and other tough materials. It can also be used for soldering metal and sealing bulkheads. It inflicts 3D6 damage per single blast or 6D6 per double blast (both hands combined). Range: One foot (0.3 m). Payload: Effectively unlimited; most tap into the cyborg's energy system. **Cost:** \$300,000.

Psionic Electro-Magnetic Dampers: Brain implants that distort and fog telepathic and other psionic probes. Psychic opponents find it difficult to read the thoughts and emotions of characters with the psionic dampers. **Bonuses:** +1 to save vs all psionic attacks, +2 to save vs possession, and +1 to save vs magic illusions and mind control. **Cost:** \$350,000 for aliens. This technology is not currently available to humans. Any experimental prototypes will cost a human 3D6 million dollars.

Third eye: This is a cybernetic eye that is implanted either above a real eye or in the center of the forehead. The mechanical eye can have any of the available bionic eye optics or weapons. **Cost:** \$150,000. **Penalty:** Reduce the character's beauty by 20%.

Other Options: See the equipment section in this book for other hand-held weapons, body armor and equipment that can also be used by bionic characters.

Experiments

Aliens who fall under the experiment power category roll for permanent side effects like humans, unless stated otherwise. Only a few races have taken their experimental programs beyond the hit and miss stage and can consistently induce the desired super abilities without side effects (or with only one or two consistent effects rather than a random plethora of them). It's up to the G.M. or the specific alien description as to whether or not there are side effects.

Magic

The magic system remains unchanged for aliens. The following new spells are available to aliens and humans alike.

Alphabetical List of New Spells

Breathable Air (5)
Cold Wall (15)
Create Gravity Well (45)
Energy Fist (15)
Ice Blast (10)
Magic Armor (5)
Resist Cold (3)
Resist Fire and Heat (3)

Breathable Air (Level 3)

Range: Self or others by touch.

Duration: One hour per level of experience.

Saving Throw: None

P.P.E.: Five

The magic of the spell does not cancel normal breathing systems, but magically turns the air into something breathable, allowing an alien from a toxic atmosphere or underwater to breathe in an atmosphere that is normally harmful or unbreathable. This would also allow a human to survive underwater or in a toxic atmosphere. Likewise, the spell will magically turn any atmosphere into breathable air, even those suddenly polluted by toxins or gases.

Cold Wall (Level 3)

Range: 90 feet (29 m)

Duration: 10 melees per level.

Saving Throw: None

P.P.E.: Fifteen

The spell will create a stationary wave or wall of deadly cold that is 10 feet high by 15 feet long by 5 feet deep (3.0x4.5x1.5 m) per each level of the caster. Anyone who touches or moves through the wall takes 4D6 points of damage for each five feet (1.5 m) of depth (Aliens from thermal worlds take 1D4x10 damage). Objects within the area of effect will also begin to freeze.

Create Gravity Well (Level 7)

Range: Half a mile (0.8 km) per level of experience

Duration: Lasts one melee per level of the caster, or until used.

Saving Throw: None

P.P.E.: Forty-Five

This powerful spell is used for advanced space travel. It can either create a temporary, artificial gravity well (that functions just like a real one for point-to-point travel), open an existing well, or activate a gateway structure. The upcoming Galaxy Guide will have full details on point-to-point and gateway systems. Using this spell has some limitations, though. An activated gateway or existing gravity well functions normally, but a magic-made well is only large enough to allow passage of a ship with a mass equal to 50 tons (45 metric tons) per level of the caster, or less. Secondly, the chance of emerging through the desired gravity well is based on the same chance of success as the

Teleport spell (See page 339 of **Heroes Unlimited** for the table).

Energy Fist (Level 6)

Range: Self

Duration: 4 melees/one minute per level of experience.

Saving Throw: Dodge or parry with weapon.

P.P.E.: Fifteen

The spell creates a glowing energy field around the hand/fist of the spell caster, turning his fist into a powerful energy weapon. Punches inflict 3D6 damage (3D6 M.D. if used in **Rifts**, costs 20 P.P.E. and is considered a 7th level spell). The energy fist can be used to grab or parry hand-held, energy weapons, objects that are on fire, live electrical cables, magic flaming swords and even energy blasts without suffering damage (-4 to parry energy blasts because they are extremely fast)! Characters who try to parry or hold the energy fist with their unprotected hands will suffer 1D6 damage, even if their parry is successful. The energy fist is considered a magical weapon for the purpose of determining who and what it can damage (ie. Invulnerable people).

The spell affects only one hand. To turn both hands (or more for some aliens) into an energy fist requires a second spell to be cast. Also note that while the energy sheathed hands may be invulnerable to energy, the rest of the character's body is not, so caution is wise. A laser blast or lightning bolt that hits the upper arm, leg, chest or head inflicts full damage.

Ice Blast (Level 5)

Range: 90 feet (27 m)

Duration: Instant

Saving Throw: Dodge

P.P.E.: Ten

A cone-shaped blast of intense cold beginning with the caster and covering a range out to 90 feet (27 m). It is 5 feet (1.5 m) at the base of the cone when it strikes the target, and it inflicts 1D6 points of damage per level of the caster (double damage against aliens from thermal worlds). A dodge roll must be made to avoid damage from the cone, but the victim must know it is coming and must roll an 18 or higher, just as with a fireball.

Magic Armor (Level 1)

Range: Self

Duration: 5 melees per level of the caster

Saving Throw: None

P.P.E.: Five

This spell is presented because players have asked for a "cheaper" magical armor spell. The spell is similar to the Armor of Ithan spell except it offers less protection: A.R. 13, S.D.C. 110.

Resist Cold (Level 3)

Range: Self or others by touch

Duration: 10 melees per level

Saving Throw: None

P.P.E.: Three

This spell provides protection from cold. Thus, it can be used by aliens from a thermal world to move about without an environmental suit in temperatures below their tolerance level. Furthermore, cold and cold-based magic does half damage.

Resist Fire and Heat (Level 3)

Range: Self or others by touch

Duration: 20 melees per level

Saving Throw: None

P.P.E.: Three

This spell is the same as resist fire except that it also includes protection from heat. Thus, it can be used by aliens from a frozen world to move about without an environmental suit in temperatures above their tolerance level. Furthermore, fire does half damage.

Mutants

Alien planets can have mutant life forms similar to those on Earth. Use the tables found in the Mutant section of **Heroes Unlimited** to create alien mutants.

Due to the animal appearance of many of the aliens in the Catalog of Aliens, intelligent mutant animals will fit in perfectly. The **Teenage Mutant Ninja Turtles** game and its supplements are amazingly compatible with the alien setting, especially for space campaigns. Mutant animals and other mutants can be the product of experiments in genetic engineering, environmental conditions, space anomalies or magic. They can be free citizens, second-class people or slaves. Just use the old imagination.

Physical Training

Aliens, like Earthlings, can elect to build their bodies through physical training. The only difference is the creature's physical attributes, and other physiological and environmental differences which may provide bonuses or penalties.

Psionics

Electrokinesis (Super)

Range: Special

Duration: Special

I.S.P.: Special

Saving Throw: As Dodge Only

Electrokinesis is the ability to mentally control and generate electricity.

Electrical Resistance: The psionic character can mentally make his body extremely resistant to electricity. The character takes no damage from electrical currents up to 60,000 volts. Currents of greater voltage, lightning, magical electricity, and electricity generated by super abilities inflict half damage. **Range:** Self. **Duration:** 3 minutes per level of experience. **I.S.P.:** 4.

Electrical Discharge: The psionic also has impressive electrical generating abilities. The character can create a strong static jolt (mostly to surprise someone) or generate a field of static. Both of these can either be a small annoy-

ance (hair standing on end) or they can be more powerful and damaging (2D6 damage per melee round). The field covers a 6 foot (1.8 m) area per level of experience. There is no save except to dodge the jolt or leave the field once it is created. **Range:** Touch or within field. **Duration:** Instant. **I.S.P.:** 2 per discharge or 2 per melee for the field.

Electric Bolt: The most powerful of the psionic's electrical discharge powers is the electric bolt. **Range:** 90 feet (27 m). **Duration:** Instant. **I.S.P.:** 6. **Damage:** 4D6. **Bonuses:** +2 to strike. **Saving Throw:** Dodge. **Attacks Per Melee:** Two (2).

Manipulate Electrical Devices: By generating and manipulating the electricity needed to run them, the psionic can exert limited control over small or minor electrical devices like light switches, computers, televisions, radios, blenders, microwave ovens, flashlights, toys (both battery and plug types), windshield wipers, and others that are electrically powered. It is also within this power to control the functions of a device, such as volume, channel selection, tuners, speakers, speed, light dimmers, and so on. The items do not have to be seen by the character. If they are within range, he can sense their presence and affect them. Up to a maximum of eight (8) functions can be manipulated per melee round. Turning a device on is one function and off is another (which leaves six other functions that round). Robots, turbines and other similar devices cannot be affected. Note that most new vehicles have extensive electrical systems and can be started, locked/unlocked, cruise control engaged, the radio turned on, and similar with this ability. **Range:** 20 feet (6.1 m) plus 5 feet (1.5 m) per level of experience. **Duration:** 2 minutes per level. **I.S.P.:** 6.

Sense Electricity: The psionic can sense the location of all electrical sources (outlets, batteries, wires, etc.). **Range:** 40 feet (12 m) plus 5 feet (1.5 m) per level of experience. **Duration:** 2 minutes. **I.S.P.:** 2 for every two minutes. **Base Skill:** 55% plus 5% per level of experience to pinpoint exact source. A failed roll means the sense is unclear, and only 1D6x10% of the devices/sources were detected.

Resist Heat (Physical)

Range: Self

Duration: 4 hours

I.S.P.: 2 or more

Saving Throw: None

This is a mind-over-matter discipline that allows the psionic to endure prolonged exposure to hot conditions with no ill effects. Two I.S.P. are required for every 12 degrees Fahrenheit (7 C) above 100 degrees Fahrenheit (38 C), except for frozen world aliens who must spend two I.S.P. for every 10 degrees (6 C) above their minimum exposure temperature.

Resist Cold (Physical)

Range: Self

Duration: 4 hours

I.S.P.: 2 or more

Saving Throw: None

This is a mind-over-matter discipline that allows the psionic to endure prolonged exposure to cold conditions

with no ill effects. Two I.S.P. are required for every 15 degrees Fahrenheit (7 C) below 32 degrees Fahrenheit (0 C), except for thermal aliens who must expend 2 I.S.P. for every 12 degrees F (7 C) below their maximum tolerable exposure temperatures.

Robotics

Create alien robots basically the same as those described in **Heroes Unlimited**, page 192. The only real differences will be alien designs and alien metal alloys, but most should be roughly equivalent to human robots.

Energy Melee Weapons: hand-held and energy versions of melee weapons are available as retractable or concealed weapons. Giant-sized weapons are typically twice as big and inflict an additional 1D6 or 2D6 damage. Otherwise, these items are fundamentally the same as the bionic ones.

Pressurized cabins are complete environmental systems that contain the alien's home atmosphere, sealed, cleaned and recirculated into the vehicle or suit. This is likely to be something other than normal Earth atmosphere and may include water/fluid, radiation, or air that is toxic to humans. Loss of 75% of an exoskeleton's body, or a vehicle's or robot *pilot's compartment* means cabin integrity is breached and loss of atmosphere will begin. Within 2D4+4 melees (1 1/2 to 3 minutes), the atmosphere will be gone and the pilot will start to suffocate unless other breathing apparatus are available. A spare tank with a mouthpiece-fitted hose is a good backup (cost of \$500).

Robotic armor ratings work the same way as vehicle armor and natural armor. Any rolls to strike that are below the armor rating simply bounce off the robot, while those that are above it do damage to the robot's S.D.C. (not the pilot). The pilot is not in danger until the robot's entire S.D.C. is depleted.

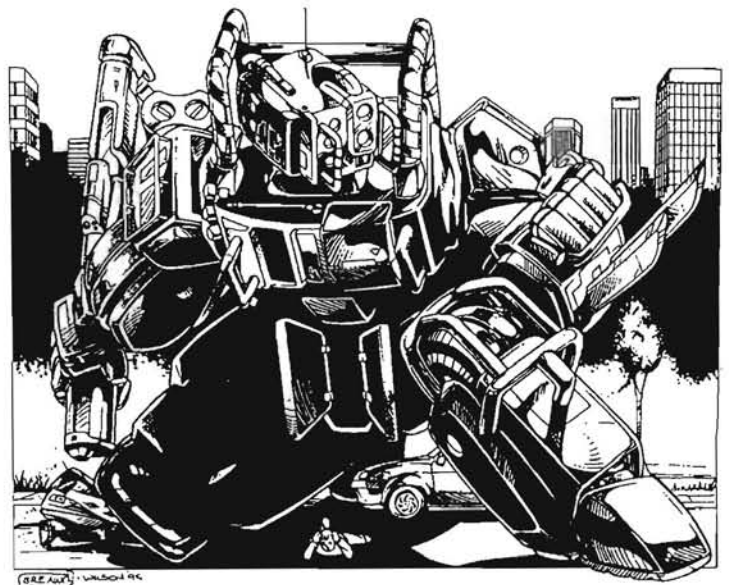

Alien Watch Groups

By Wayne Breaux & Kevin Siembieda

Earth Organizations and Individuals of Note

Since the nineteen-forties, there has been a significant increase of reports regarding UFO sightings and abductions around the world. Fearful and expectant, people have been watching the skies and looking for answers. From average civilians and professional astronomers to religious cultists and world governments, humans have been waiting for proof that intelligent alien beings have been visiting our planet. However, the answer to that question only creates new ones. Who are they? What do they want? Are they friends or foes? And so on. As a result, numerous organizations have been established to get the answers to these questions, and/or to protect Earth from the alien threat. Each of these groups has its own goals and agendas. Whether they are friend or foe to the alien visitor is often hard to determine. Many of them are operated by zealots and fanatics.

Note: In the comic book world of superheroes, strange humanoid mutants, super beings, robots, cyborgs, dimensional travelers, and time travelers, alien visitors are common. Many are maniacal villains, destroyers and world conquerors. Consequently, in the context of **Heroes Unlimited™**, **Aliens Unlimited™** and comic books in general, the question is not, "Is there intelligent life out there?" but "How many of them are out there? What do they want? And who will protect us from them?" The answers: Thousands! They want all kinds of things. And, of course, super heroes will protect us.

Remember, the organizations presented in this book are those of a fictional Earth where super beings are an everyday occurrence and aliens are real. They are not meant to reflect any true-to-life government agencies, organizations or sentiments.

Government Agencies

Project Tyche

Project Tyche is the current incarnation of the Air Force's UFO investigation operations. The name comes from an old goddess of good fortune who was supposedly beautiful, yet an outsider in her own pantheon. It was chosen because the government considers aliens to be potential godsend of good fortune, but most are definitely mysterious outsiders with unknown or questionable motives.

To the general public, Project Tyche is a high profile endeavor by the US military to keep the people safe from hostile aliens. This is partly true. It is the responsibility of

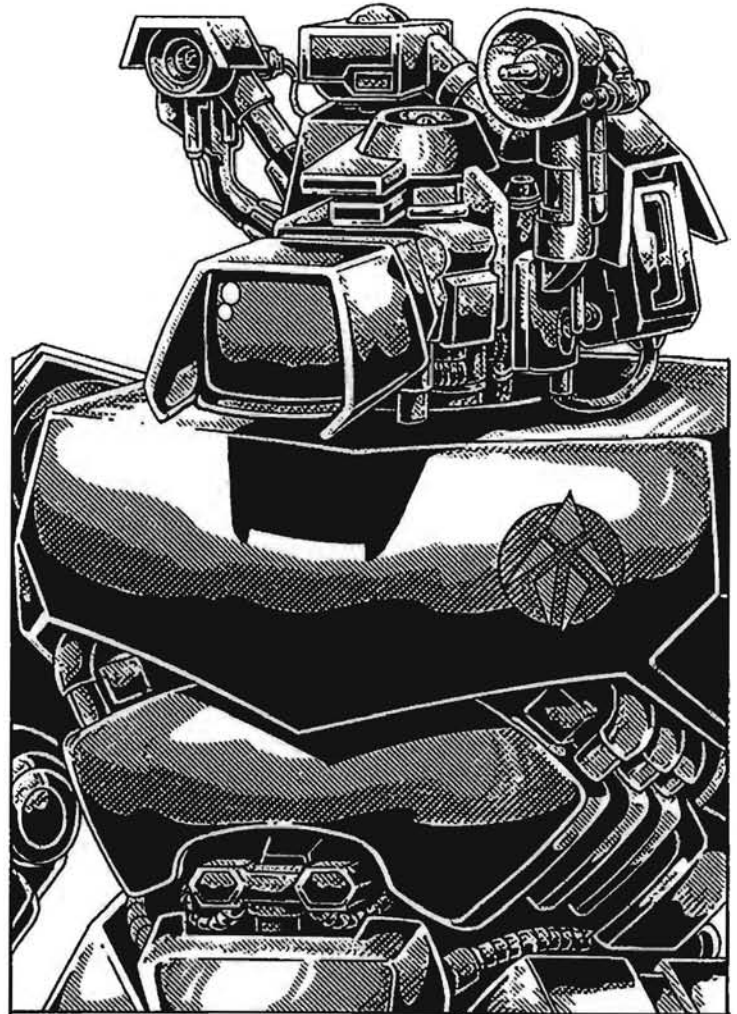

Project members to actively work at keeping aliens away from USA citizens, but they do so not only to protect them, but to acquire coveted UFO technology and to protect national security.

Whether the aliens are friendly or hostile, they are hunted down, captured, imprisoned, examined and interrogated. Agents from Project Tyche are frequently so eager to secure alien subjects that they have little regard for civilian laws, property or the people they are supposed to be protecting. Many of these operatives are superspies or superhumans who frequently step outside the boundaries of the law to get their job done. These extreme measures are usually allowed under the blanket of "national security." However, the public image of the project is one of protecting innocent humans from marauding alien monsters.

A great deal of the organization's time is spent on research and collating data. A low profile segment of Project Tyche quietly collects reports about UFO sightings, abductions, and strange phenomena (especially concerning

strange animals and so-called mutants and super beings) from newspapers, magazines, computer nets, wire services, and military and FBI reports. They also monitor rumors, allegations, and underground activities across the country, as well as comments and criticisms about Project Tyche and who said them (perhaps they are aliens or alien sympathizers trying to discredit or distract them).

The public relations office of Project Tyche is very visible and always prepared with a comforting or helpful commentary, evaluation, statement or cover story. It is largely a public relations front that is expert in cover-ups, misdirection and misinformation. They handle all press and public statements for Project Tyche, including press announcements, conferences, and details regarding current investigations, military involvement/actions, alleged sightings, the reliability of witnesses, and general security. The actual agents are highly skilled investigators and researchers, many of whom have a background in the military, FBI, CIA or law enforcement. They have gotten additional training in psychology, parapsychology, surveillance and sociology to help them deal with both people and aliens. **G.M. Note:** For *psychic investigators, parapsychologists* and different types of psychic characters, take a look at the characters, psi-powers, magic, skills and settings in **Beyond the Supernatural**. Some of the spies, gizmoteers and other characters in **Ninjas & Superspies** may also be useful.

Most investigators and personnel, especially those working with the public, will wear crisp uniforms and show courtesy, respect and cooperation when dealing with eyewitnesses, victims of alien attacks, the press, and other government agencies. However, out of the public eye they are extremely aggressive, forceful, secretive and work outside of the law.

Most "real" field agents are rarely seen in public and seldom make public statements. Some aren't even recognized by the agency as official investigators. This is especially true of those with "special" abilities, whether they are superspies, superhumans or aliens themselves. They tend to use force and strong-arm tactics to intimidate, persuade, and get results. Their uniforms reflect their assignments and needs. Thus, they can wear nondescript civilian attire, Air Force uniforms or high-tech body armor. They are the detectives and special investigators assigned to track down and "neutralize" alien invaders, predators and threats. Unfortunately, they exercise extreme prejudice, use deadly force and tend to jump to conclusions. Most, but not all, ascribe to the philosophy of containing or eliminating the potential danger (e.g. shoot first and ask questions later). These secret operatives also monitor and secure areas of alleged UFO landings, crashes, and alien activity, as well as securing (conceal from the public) physical evidence of alien life forms, their spacecraft, technology and their activities. They may work as independent Project Tyche investigators or in cooperation with the FBI, National Security Agency (NSA) or the military.

In addition, Project Tyche's secret operatives are charged with ferreting out any signs of aliens hiding in society. A task they execute with extreme diligence and near

fanaticism. This search, seize and "neutralization" procedure is the extent of Project Tyche's responsibilities. Once an alien or evidence of an alien is acquired, it is turned over to *Project Secure*, the NSA, the military or other top secret government agencies.



Special Agent Fores — Head of Project Tyche

Project Tyche is currently headed by Director Arnold Fores. Fores follows the old "us-and-them" approach to alien-human interaction. While he is intelligent and professional enough to acknowledge the benefits of aliens and their technologies, he still believes that they are not to be trusted. His reservations and prejudice make him callous in his dealings with aliens, and humans who protect or hide them. Although he rarely interferes directly with any investigation or handling of alien evidence, he does feel it is his duty to keep the Project moving ahead and producing results. If, for any reason, he feels a case is proceeding too slowly, he will apply pressure to speed things up. This often leads to mistakes, breaking the law, mistreatment of artifacts and specimens (living or dead).

Alignment: Diabolic

Attributes: I.Q. 14, M.E. 11, M.A. 13, P.S. 19, P.P. 10, P.E. 14, P.B. 8, Spd 12

Age: 54; **P.P.E.:** 9

Hand to Hand: 82, **S.D.C.:** 36

Equivalent Level of Experience: 10th level Military Specialist (espionage/Special Forces), 9th level administrator.

Educational Background: Military/combat, espionage, and administrative. Skills of note include hand to hand: assassin, sniper, intelligence, interrogation, surveillance systems, palming, pick locks, W.P. automatic pistol, W.P. automatic rifle, W.P. bolt-action rifle and W.P. knife.

Project Tyche

The following ratings and agency details are developed from the organizations section found in **Villains Unlimited**. It is a representation of the resources that have been allocated to Project Tyche and is in no way meant to encompass the statistics of the US Air Force as a whole. Resources and funding are divided into two categories. The statistics for the *public relations* section of Project Tyche is the first number and description. The second number and data given after the slash are for the covert, alien hunting operations. Both can be considered separate organizations under the same umbrella title and which work together.

Project Tyche is a military operation sponsored and operated by the United States government. Total Points: 251 for the public relations "front" agency and 480 for the covert arm of this organization.

- A. Outfits: #2 Utility Outfits (Uniforms): 2 points / #5 Gim-mick Clothing: 30 points
- B. Equipment: #4 Electronic Supplies: 10 points / #6 Un-limited Equipment: 50 points.
- C. Weapons: #3 Armed Agents: 5 points / #6 Unlimited Weapons: 50 points.
- D. Bionics & Robotics: #2 Basic Systems: 10 points / #3 Cyber Agents: 25 points; but considering building a ro-bot arsenal too.
- E. Vehicles: #5 Specialty Vehicles, including a fleet of ground vehicles and aircraft: 40 points / Same.
- F. Communications: #4 Computerized: 15 points / #5 Sat-ellite Network (military): 30 points.
- G. Offices, Hideouts, & Distribution: #3 National: 15 points / Same.
- H. Military Power: #3 Militia: 15 points / #5 Strike Force: 40 points; includes psychics, cyborgs and superspies.
- I. Super Powered Operatives: #2 Freelance: 10 points / #4 Super Strike Force: 40 points; eight super powered be-ings (may be divided into smaller teams of four).
- J. Sponsorship: #2 Military: 4 points / #4 Government: 10 points.
- K. Special Budget: #4 Large Loans: 25 points / #5 Big Bucks: 35 points.
- L. Administrative Control: #3 Free Hand: 15 points / #5 Li-censed to Kill: 35 points.
- M. Internal Security: #3 Tight: 10 points / #5 Paranoid: 25 points.
- N. External Infiltration: #2 Rare Minor Traitor: 5 points / #3 Information Source: 10 points
- O. Research and Information Gathering: #4 Excellent Connections: 20 points / Same.
- P. Agency Credentials: #5 Recognized: 30 points / #3 Faceless: 5 points
- Q. Agency Salary: #4 Good: 20 points / Same.

Project Secure

This is a special government agency loosely affiliated with the NSA and FBI, and closely affiliated with Project Tyche. The agency picks up where Project Tyche or other agencies leave off. When the Air Force or Project Tyche has identified, located and contained or "neutralized" per-sonnel or situations dealing with aliens or alien technol-ogy, Project Secure is brought in to take over. The sites of alien involvement are sealed using PS agents and armed government agents or soldiers. The only people allowed to examine and remove physical evidence or alien captives are Project Secure's own.

Under Project Secure's supervision, all physical evi-dence is meticulously cataloged, photographed, removed and transported to a "secured" (and secret) government research and quarantine facility; among them, Area 51. Aliens and artifacts are quarantined for decontamination and top medical and scientific personnel are brought in to investigate, analyze and interrogate. Again, these doctors, chemists, physicists, pathologists, engineers, interrogators and other operatives are government agents, or people working for the government and screened and authorized by Project Secure. Specimens are subjected to countless tests to determine as much as possible as quickly as pos-sible. Linguists, cryptographers, and scientists attempt to translate instructions and the function of alien mecha-nisms under controlled conditions and the ever watchful eye of PS agents. Functioning items are subjected to in-tense scrutiny with an eye toward copying the technology for integration into military weapons and defensive sys-tems. These items are sometimes given to Projects Tyche and Secure for field testing.

Live aliens are usually handled with care and kindness by Project Secure. Scientists usually try to determine whether or not the alien will be stable and strong enough to survive physical and psychological tests and examina-tions. They are treated humanely and given modest but nice living quarters. However, pressure from the top brass sometimes leads to rushed and botched research as well as occasional mistreatment, death or escape.

Getting live subjects is a rarity. Director Fores and the folks at Project Tyche have a nasty habit of "neutralizing" (e.g. terminating) aliens which are usually determined to be hostile, requiring deadly force. However, Project Se-cure has acquired over a dozen "live" alien subjects over the last two decades.

If the alien does not speak or understand a known Earth language, translators will use computers and psy-chics to establish communication. The next step is to es-tablish the alien's intentions on Earth and whether they threaten national (or global) security. Ideally, they want to build a relationship with friendly aliens in hopes of ex-changing technology, information and services.

Depending on the alienness of the character's appear-ance, his natural and superhuman abilities, personality and level of cooperation, the being may be allowed to work for the government for the rest of his life. A few may even be allowed into human society, but will always be un-

der government scrutiny. **The Alien Acclimation Program** (some would say indoctrination) and the surveillance of alien operatives is the responsibility of Project Secure. Project Tyche may also engage in *unauthorized* surveillance of the AAP and may intervene if an alien goes awol or "turns bad." This often turns into a race between the two agencies to see who can find the alien first. Project Secure will capture, question and try to "acclimate" the alien to the benefit of the nation and national security. Project Tyche typically perceives the alien as a dangerous monster or traitor that must be "neutralized" before "it" kills, or threatens national security. According to Director Fores, once an alien turns, it is no longer reliable and should be terminated.

The typical Alien Acclimation Program (AAP) lasts one to four years before it is determined whether the alien can be allowed to function in human society, even under strict military rules and observation. The period is governed by the friendliness and cooperation of the alien and how quick the being becomes acclimated to Earth society, civilization and the law. Those that successfully complete the AAP process are encouraged to join S.C.R.E.T. (Superbeing Control, Retrieval & Elimination Teams; see **Villains Unlimited** for details), Agec, Project Secure, Project Tyche, the FBI, NSA, CIA, military or other government agency. Many will accept the offers simply to live a reasonably free life. Those who refuse to cooperate, exhibit hostility or treachery, or simply cannot acclimate to human society are imprisoned at secret bases and periodically studied.

So far, no Earth governments have been approached by representatives from another world with a request to join an interstellar federation or to engage in any sort of trade. The aliens who have been captured are independent operatives, explorers, refugees, would-be heroes, criminals, madmen, monsters and would-be world conquerors. Sadly, dangerous aliens have far outweighed the number of friendly, peaceful alien visitors, which fuels the flames of paranoia and gives Project Tyche more political clout and credibility than Project Secure, under the administration of Director Sinder.

Game Master's Note: The vast variety of skilled personnel involved in the alien investigation and processing procedures under both Project Tyche and Project Secure provides a great environment to get a group of player characters together, human and alien, superspy and super powered. The conflicts between agencies Tyche and Secure are also excellent vehicles for sub-plots, espionage, intrigue, treachery and battle. Likewise, player groups who have an alien, or suspected alien may be placed under surveillance by one or both groups. At some point, Project Tyche or Project Secure may question the characters, arrest/capture the suspected alien(s), ask him or her to undergo AAP, make them work for them, or be "neutralized." Any heroes who try to protect or hide the alien threat, especially mutants, other aliens, and vigilantes, will be regarded as criminals, traitors, spies or a threat to national security. They may be hunted, attacked, placed under arrest, imprisoned, interrogated, indoctrinated and/or "neutralized!"

Heck, these two agencies can give a Game Master the basis for an entire campaign. Our heroes could be hounded by them, designated as dangerous criminals or subversives, work for them as project Operators or freelance superheroes or be secretly drawn into conflicts involving aliens. If nothing else, the agencies can be a reoccurring story element and subplot; friend, enemy, or both.

If the Game Master wishes the player characters to work for Project Secure or Tyche (the latter would agree in order to keep a close eye on supposedly "acclimated" alien agents), the corresponding agency and its director would be in control of their assignments, jurisdiction and activities. Director Sinder would be open, understanding and offer as much freedom as he reasonably could. Director Fores would be suspicious, restrictive and tend to play favorites. He will appreciate AAP aliens and other characters who enjoy hunting and killing aliens on the loose, which may be appealing to evil characters, and other aliens.



Special Agent Sinder **— Head of Project Secure**

Director Michael Sinder is the devoted head of Project Secure. He feels it is his duty to oversee the safe and humane handling of alien specimens and captives so the government, and country can benefit from them (or be protected from them). He is less aggressive, hostile and fanatical than Director Fores of Project Tyche. He believes that people from other worlds can become friends and allies and help bring Earth to a new age of cultural and technological advancement. To Director Sinder, this dream of a new prosperity is more important than playing on people's fears, eliminating potential alien threats, or engaging in agency politics. He and his agents are quietly dedicated

to their work and far less vocal or visible than Project Tyche. They avoid public scrutiny and even avoid the attention of the NSA and other government agencies. They have a job to do, and they do it. Consequently, it is the high profile, vocal and aggressive Director Fores at Project Tyche who has the ear of the military and highly placed officials who share his paranoia about national security and sanction his extreme conduct and use of deadly force. This actually gives Project Tyche and Agent Fores greater freedom, and sometimes greater authority over alien investigations, recovery and "neutralization" than Project Secure, which is supposed to be its superior parent agency.

These differing views, including Director Fores' unofficial policy of terminating aliens at the slightest provocation, often results in frequent clashes between the two agencies over methods, procedures and results. Director Sinder despises Fores and hates it when "alien threats" have been "neutralized" by PT agents. A corpse cannot provide information about alien technology or worlds and work with humankind to make Earth a better place. The two agencies and their directors represent the two extremes of power (good and evil).

Alignment: Scrupulous

Attributes: I.Q. 17, M.E. 14, M.A. 12, P.S. 15, P.P. 11, P.E. 12, P.B. 14, Spd. 9

Age: 41, **P.P.E.:** 8

Hand to Hand: 78, **S.D.C.:** 20

Equivalent Level of Experience: 6th level soldier, 10th level administrator.

Educational Background: Military/combat, research and administrative. Skills of note include hand to hand: expert, intelligence, interrogation, surveillance systems, land navigation, computer operations, computer programming, W.P. automatic pistol and W.P. automatic rifle.

Project Secure

Project Secure is a government agency. Total Points: 555, including 40 points for modifications.

- A. Outfits: #4 Specialty Clothing: 10 points
- B. Equipment: #6 Unlimited Equipment: 50 points
- C. Weapons: #5 The Arsenal: 30 points
- D. Bionics & Robotics: #5 Bionic Arsenal: 50 points
- E. Vehicles: #6 Unlimited Vehicles: 60 points
- F. Communications: #5 Satellite Network: 30 points
- G. Offices, Hideouts, & Distribution: #4 Regional: 25 points
- H. Military Power: #4 Private Army: 30 points
 - I. Super Powered Operatives: #5 Super Army: 50 points
- J. Sponsorship: #4 Government: 10 points
- K. Special Budget: #5 Big Bucks: 35 points
- L. Administrative Control: #4 Agency Protection: 25 points
- M. Internal Security: #5 Paranoid: 30 points
- N. External Infiltration: #4 General Infiltration: 25 points (this includes moles inside of Project Tyche, the FBI, NSA and Congress).
- O. Research and Information Gathering: #6 Unlimited Connections: 50 points

P. Agency Credentials: #3 Faceless (to the public, but authorities will treat them as #5 Recognized): 15 points

Q. Agency Salary: #5 Excellent: 30 points

Lock Down Teams

Project Secure Super Agents

Lock Down is the code name for Project Secure's Super Response Teams (SRT). These agents are specially recruited and trained for the capture, restraint, and if necessary, termination of alien fugitives, mutants and monsters. Lock Down is dispatched after any alien who exhibits extreme destructive, antisocial or psychopathic behavior. Likewise, they pursue escapees from Project Secure and subjects who represent a serious danger to innocent lives or national security. They may also face humans, foreign operatives, superhumans and super villains suspected of protecting, harboring, kidnapping or working with alien terrorists, criminals and other dangerous rogues. The primary goal of Lock Down is to capture the alien and secure the situation. Its secondary goal is to protect civilians, property, national security and the lives of Lock Down agents. Their third directive is to protect and preserve alien visitors and their technology. In most cases, Lock Down can use lethal force at their discretion, unless direct orders demand otherwise. Lock Down teams are seldom sent on seek and destroy missions, but they are authorized to kill an alien if it proves to be highly destructive or murderous.

There are currently four active Lock Down teams. As the number of qualified recruits grows, new teams may be added. Current teams are designated **Alpha**, **Beta**, **Delta**, and **Epsilon**. Abbreviated references are LDA, LDB, LDD and LDE on. **Alpha** team is stationed in New Jersey, just west of New York. **Beta** is located in California near Death Valley. **Delta** members are stationed in southern Arkansas close to Texarkana, and **Epilong** is found in Bismarck North Dakota. All of them are quartered in secret safe houses on or near an Air Force base or airfield where they wait for a call to action. They spend much of their active duty time investigating reports of UFO landings and abductions, tracking down and capturing suspected aliens, mutants and monsters, and assisting Project Secure in any way necessary. They are generally ready to go on a moment's notice.

Lock Down Alpha

Lock Down Alpha is the oldest of the teams. They have the most experience, highest clearance, and greatest skill and rank. The four NPCs presented below are the core members of Lock Down Alpha. One to four new agents may be temporarily rotated into Alpha for field experience and training. The four core agents have an excellent rapport with Director Sinder and share his views about alien life and how Project Secure should operate. Team Alpha has had many clashes with Director Fores and his operatives from Project Tyche. There is no love between them and Project Tyche.

Ego

Based on drawings by Eric Breaux.

Samantha Bolin is as confident, flamboyant and proud as her code-name, Ego, suggests. Born to a wealthy corporate family, the young Samantha had everything handed to her on a silver platter. In addition, she was a natural beauty with brains, agility and grace. She went to college, but had no real aspirations. Life was dull and her future seemed no brighter. One night, on her way back to her campus dormitory, she was attacked by a man with a knife. Her martial arts classes and gymnastics flashed into her mind. She responded with reflex-like motions that seemed natural and easy. First she slipped out of his grasp and used his own momentum to swing him in front of her. A series of swift kicks to the groin and head sent her assailant reeling. A simple arm hold kept him pinned until the police could be called.

The adrenaline rush gave her an unexpected thrill. Suddenly she knew what she wanted — excitement. Samantha began working out more extensively and took classes in criminology and law. After she acquired her degree, she applied to the FBI in hopes of becoming a field agent. During training, her superior reflexes, agility and uncanny luck were noticed by a recruiter for Project Secure. He convinced Samantha to try a few tests for an elite project called Lock Down. She breezed through one of the toughest training exercises ever devised and the project coordinator offered her a position with Lock Down Alpha. She's been with the team ever since.

Still accustomed to being rich, Samantha enjoys the high paying job and distinction of being one of the youngest and best in an "elite" secret government force. Furthermore, she thrives on the excitement, challenges and intrigue her profession brings. Samantha (or Ego, she hates being called "Sam") gets along well with the rest of the group and is a steadfast and loyal team player who doesn't hesitate to dive into the thick of things, but is rarely reckless or foolhardy. She likes Washington's seriousness and intelligence, although he is rather distant and sometimes weird. Tinker is a friendly genius who Samantha likes very much, even when he grumbles and curses. Komodo still intimidates her; he is a nine foot (2.7 m) tall powerhouse but his quiet, gentle nature has allowed her to accept him as a person instead of a monster. She considers her teammates to be her surrogate family and treats most of them better than she does her true relatives. Her real family cannot understand why she wants to risk her life doing such dangerous work with "freaks."

Code Name: Ego

Real Name: Samantha Bolin

Rank: Captain

Alignment: Scrupulous

Hit Points: 49

S.D.C.: 74

Weight: 127 pounds (57 kg)

Height: 5 feet, 6 inches (1.7 m)

Age: 29; **P.P.E.:** 18

Attributes: I.Q. 19, M.E. 14, M.A. 22, P.S. 16, P.P. 23, P.E. 15, P.B. 27, Spd. 19



Breaux

Disposition: Samantha is the proud daughter of parents who disapprove of her profession as an FBI agent (they don't know everything about her work, although they do know she works with super powered beings/freaks). She tends to think of herself as superior to others, but over the years this attitude has been tempered with experience. Ego knows the limits of her abilities and charm and uses them to their maximum effectiveness. Although she seems to flaunt her wealth, beauty, and unparalleled luck, she doesn't often do so deliberately and seldom underestimates her teammates or opponents. She is a good person who sincerely cares about her teammates, Project Secure and people in general (aliens included).

Experience Level: Eighth

Power Category: Mutant

Unusual Characteristics: None

Super Power Category: Super Abilities

Major Super Ability: Karmic Power; see *Heroes Unlimited*, page 278-279.

Minor Super Abilities: Extraordinary physical beauty, extraordinary physical prowess, and mental stun.

Combat Skills: Hand to Hand: Martial Arts.

Attacks Per Melee: Five

Bonuses: +4 on initiative, +7 strike, +12 parry, +14 dodge, +13 auto dodge, +2 damage, +10 roll with punch or impact, Critical on a natural 18, 19 or 20, karate style kick does 1D8 damage, jump kick (critical strike), leap attack (critical strike), entangle, and paired weapons.

Other Bonuses: +6 save vs poisons/toxins/gas, +6 vs psionics, +4 vs magic, +20% vs coma/death and +10% to all skills. Attacks from her enemies: Death blows do not kill her — only stun, critical damage attacks against her only do normal damage, she is knocked out only by a natural 20. **Note:** Opponents get no bonuses to strike, parry, or dodge the *karmic* character. Straight, unmodified dice rolls only.

Education Level: Bachelor's Degree in Criminal Science.

Skills of Note (includes all applicable bonuses): Cryptography 85%, laser communications 95%, optic systems 98%, radio: basic 98%, radio: scramblers 95%, radio: satellite relay 80%, T.V./video 95%, read sensory equipment 95%, computer operation 98%, intelligence 91%, photography 98%, writing (journalistic) 83%, language: Russian 98%, language: Spanish 98% and W.P. automatic pistol, W.P. chain and W.P. staff.

Secondary Skills: Dance 86%, basic electronics 70%, athletics, prowl 98%, swimming 98%, pilot: automobile 98%, pilot: motorcycle 84%, pilot boats: sail 84%, pilot boats: motor 72%, language: Japanese 85%, language: German 85%, first aid 65%, wilderness survival 45%, and art 44%.

Appearance: Samantha is a beautiful woman with long, red hair that falls in tight curls. She normally dresses in expensive and fashionable clothes. Often the attire is tight fitting, but her respectable background usually keeps her clothes from being too revealing. Her costume is a black and violet body suit with dark boots and loose sleeves.

Occupation: Government agent.

Weapons and Equipment: Typically she carries no weapons other than a pair of nunchaku concealed in her boots. However, she is trained in the use of the automatic pistol, staff and chain weapons. Ego prefers to rely on her physical abilities and ancient oriental weapons. Equipment is normally minimal and includes a small headset receiver/transmitter, her nunchaku (two pair) and two pairs of titanium handcuffs.

Vehicle: Her personal vehicle is a Shelby Cobra. On missions, the group is issued or assigned vehicles or transportation.

Body Armor: Her costume/body suit is a form of experimental *Flexi-Steel* armor (A.R. 14, S.D.C. 100). Ego refuses to use heavy suits of armor.



Komodo

Based on drawings by Eric Breaux.

Komodo is a successful recruit from Director Sinder's Alien Acclimation Program. He was found by Project Secure, quarantined, questioned, befriended and eventually became a member of Project Secure as a special operative. He feels a sense of debt to the program for allowing him to stay on Earth despite the atmosphere of distrust and fear regarding non-humans. He is devoted to "rescuing" (not capturing) and helping other aliens, mutants and so-called monsters to find a place in the world through Project Secure. He is a vocal opponent of Director Fores and those in Project Tyche who promote fear, prejudice and murder in the name of national security.

Komodo's real name is Tiloch Tark. He was a member of a failed coup to oust a military dictatorship on his homeworld and had to flee with a group of his comrades. Their spacecraft began to have trouble near Jupiter and was forced to land on Earth. The whole vessel broke up as it entered the atmosphere. Tiloch is the only known survivor. The four bodies of his companions were never recovered.

He feels very protective of the Alpha team members, Director Sinder and the Project. Tiloch was trained as an intelligence officer and spent a decade as a dutiful soldier, watching as the military took over his people. He sees disturbingly similar trends within the structure of Project

Tyche and other factions within the Earth's world governments. This time he plans to make a difference.

Code Name: Komodo

Real Name: Tark

Rank: Investigating Agent (roughly equal to a Lieutenant)

Alignment: Principled

Hit Points: 57

S.D.C.: 432, **A.R.:** 13

Weight: 375 pounds (169 kg)

Height: 9 feet, 2 inches (2.8 m)

Age: 195; **P.P.E.:** 12

Attributes: I.Q. 15, M.E. 19, M.A. 10, P.S. 30, P.P. 20, P.E. 20, P.B. 10, Spd. 23. P.S. is superhuman.

Disposition: Tiloch is a quiet, reserved powerhouse. He calmly observes all that he sees and remembers it. He has strong feelings for the other members of Alpha team and will do his best to protect them. Although he rarely allows himself to smile, Tiloch's favorite teammate is the good-natured Tinker.

Experience Level: Seventh

Natural Abilities: Natural armor rating.

Super Power Category: Alien experiment (Super Soldier).

Super Soldier Modifications: Invulnerability, increased agility, dexterity, and S.D.C.

Major Super Ability: None.

Minor Super Abilities: Energy expulsion: electricity 9D6 damage (or 1D6x10 for a quicker damage roll).

Combat Skills: Hand to Hand: Expert and Wrestling.

Attacks Per Melee: Five

Bonuses: +2 initiative, +5 strike, +7 with ancient W.P., +5 with aimed shots, +6 to parry, +8 to parry with ancient W.P., +6 dodge (+8 underwater), +6 auto dodge, +15 damage, +6 roll with punch and fall, critical strike on an unmodified 18, 19, or 20, paired weapons, and entangle.

Originating Alien Environment: Abrasive Atmosphere

Education Level: Military Specialist

Skills of Note (includes bonuses): Detect ambush 85%, detect concealment 75%, intelligence 81%, interrogation 85%, tracking 75%, swimming: advanced 95%, archery, W.P. knife, W.P. sword, W.P. energy pistol, W.P. energy rifle, language: English 90%, and language: Spanish 90%.

Secondary Skills: Navigation 90%, read sensory instruments 70%, first aid 80%, W.P. automatic pistol, W.P. semi and fully automatic rifle, W.P. sub-machinegun, climbing 74%, swim 98%, pilot motorcycle 64%, and pilot truck 64%.

Appearance: Tiloch could have modeled for an ancient samurai's battle mask. His face has a demonic, scowling expression, and his skin is a dark reddish grey. He often wears only pants. Komodo's costume is a stylized version of the ancient samurai armor, complete with helmet.

Occupation: Government agent

Weapons and Equipment: Komodo's personal treasure is his Vibro-Katana (5D6 plus P.S. damage). It is a family heirloom that is more than 400 years old, and is the only sentimental keepsake he has from his homeworld.

He also carries a pair of Earth knives and a high quality katana. His modern weapons usually include two 10 mm auto pistols (4D6 damage per bullet) and, when necessary, heavy assault rifles. Besides his headset receiver/transmitter, Komodo carries compact climbing gear.

Vehicle: A powerful hover cycle designed to carry Tiloch's mass. It is identical to a standard hover cycle, but it has 300 S.D.C. On missions, the group is issued or assigned vehicles or transportation.

Body Armor: Normally Komodo wears none, but he does have a full hard armor suit of his stylized armor (A.R. 16, S.D.C. 250) for the most dangerous heavy combat situations.

Tinker

Based on drawings by Eric Breaux

Michael Dax is the quintessential gizmoteer. Since he was old enough to sit up, he has had a knack for taking things apart and putting them back together again perfectly. As he reached his teens, he was able to make significant improvements on the original designs and fix just about anything. Michael had troubles in high school because his mind was always working on ideas and modifications for his "tinkerings." He dropped out of school halfway through his junior year and earned money as a mechanic on the racing circuit. A tour in Vietnam in 1968 turned his interest to weapons and combat vehicles. His work on helicopters during the war caught the attention of his superiors. When he returned Stateside, the government was waiting. He was recruited to build vehicles for various government agencies, including some work on the initial S.C.R.E.T. equipment. When Project Secure needed a highly skilled mechanic to examine and rebuild alien artifacts, Michael was the logical choice. He jumped at the chance and later joined Lock Down Alpha as code name Tinker.

Michael is a good-natured, old veteran whose humor is often of the adult variety. He likes to tell stories and jokes, often to no one in particular (he'll talk to humans and to his machines). He is meticulous, but only to the point of function. His creations do not have to look good, they just have to work. However, he doesn't mind when he is required to "pretty 'em up" and he has a good eye for aesthetic design. His skill as an artist with vehicles and weapons is unequalled.

Tinker likes the big alien, Komodo, and feels he needs to keep an eye out for Ego, but Washington is too secretive for his taste. He is loyal to his teammates and the cause.

Code Name: Tinker

Real Name: Michael Dax

Rank: Investigating Agent (roughly equal to a Captain)

Alignment: Scrupulous

Hit Points: 46

S.D.C.: 44

Weight: 110 pounds (50 kg)

Height: 4 feet, 10 inches (1.4 m)

Age: 45; **P.P.E.:** 9



Attributes: I.Q. 20, M.E. 12, M.A. 12, P.S. 17, P.P. 14, P.E. 11, P.B. 12, Spd. 15

Disposition: Michael often plays the gruff, old veteran to the hilt (dirty jokes and all). He is mostly dissatisfied with the state of the world, especially bureaucracy, but is surprisingly idealistic and hopeful. He keeps himself from becoming cynical or depressed through his humor and work with Project Secure.

Experience Level: Tenth

Super Power Category: Hardware

Hardware Category: Mechanical and Weapons.

Combat Skills: Hand-to-Hand: Expert and Boxing.

Attacks Per Melee: Four

Bonuses: +2 initiative, +2 to strike, +5 to strike with ancient W.P., +7 to strike with aimed shots, +5 to parry, +8 to parry with ancient W.P., +5 to dodge, +3 damage, +4 roll with punch or fall, critical strike on 18, 19, or 20, knockout (1D6 melee rounds) on a natural 20, paired weapons, entangle, and judo-styled body flip (1D6).

Education Level: Trade School

Skills of Note (includes all bonuses): Mechanical engineering 98%, automotive mechanics 98%, aircraft mechanics 98%, locksmith 98%, read sensory instruments 98%, weapon systems 98%, mathematics: advanced 98%, basic electronics 98%, demolition 98%, demolition disposal 98%, pilot tank and APC 98%, build super vehicles 98%, recognize vehicle quality 76/95%, W.P. blunt, W.P. chain, W.P. automatic pistol, W.P. rifle, W.P. semi and fully automatic rifle, W.P. heavy, sniper (+2 strike with rifle), make and modify weapons 98%, and recognize weapon quality 76/98%.

Secondary Skills: Computer operation 98%, running, pilot: automobile 98%, pilot: truck 98%, pilot: helicopter 98%, pilot: airplane 98%, pilot: race car 98%, pilot: motorcycle 95%, and pilot boats: motor 75%.

Appearance: Michael is physically small but he has gone through great pains to keep himself in shape. He is hardly ever seen out of his overalls, and even frequently wears them on missions. A red baseball cap stained with oil and grease rarely leaves his head. Stubble always covers his rugged face.

Occupation: Government Agent

Weapons and Equipment: Michael's personal weapon of choice is a Berreta 9 mm (he is +9 to strike with an aimed shot). He often carries a large .50 calibre handgun (identical to the Korimyr in the equipment section of this book) and always has his own version of the explosive strap gun (also in this book's equipment section). Michael (and all Hardware: Weapons characters) can make any of the special ammunition and build any of the advanced firearms presented in this book and *Heroes Unlimited*.

Vehicle: Miniature Jet Pack that is highly concealed and fits under his equipment backpack (stats identical to the jet pack on page 348 of *Heroes Unlimited*).

His personal transportation is a BMW 850i with concealed medium armor (A.R. 16, 700 S.D.C.), and twenty 2.75 inch (70 mm) rocket tubes in the trunk on a pop-up launcher, advanced radar targeting computer, smoke screen, vehicle caltrops, engine readout pack-

age, searchlight, winch and cable, theft alarm, and theft proof locks. Maximum speed is 270 mph (432 km)! He is always "tinkering" with his souped-up car and is considering giving it flight capabilities. This vehicle is often used on Team Alpha missions.

Personal Body Armor: A special ceramic and metal body suit of his own design: A.R. 16, S.D.C. 140, with detachable jet pack.

Washington

Based on drawings by Eric Breaux.

Brian Martin is the leader of Lock Down Alpha. He is a wizard whose code name is Washington. As a child, he was always athletic, but a sharp intelligence and curiosity lurked within the young man, so he excelled in both high school athletics and academics. When he graduated, Brian was a smart, strong and well rounded teen with a bright future. Wanting to learn all he could, he accepted an athletic scholarship to put him through college. While making his way through his master's degree, Brian met an interesting professor of history who would change his life. The wily old man was an arcanist who introduced Brian to the wonders of spell casting. By the time he graduated, Brian was well on his way to mastering the mystical arts.

He took a government grant sponsored by the military to research geomancy and ley lines. During this period, his forte in magic became known and he was contacted by the recruiter for the FBI's Super Agent Program (SAP). Brian declined his offer. A week later, the man returned with information dossiers on Project Secure and plans for the Lock Down teams. This caught his attention and inflamed his natural curiosity. Adventure, studying alien life forms and their technology, and unlocking the mysteries of the universe. It was an incredible opportunity. He wasted no time joining.

Brian/Washington, has been with Lock Down Alpha longer than anybody, 10 years, and currently functions as team leader. He doesn't have a military background, but training in basic military procedure, strategy and tactics, plus years of experience have turned him into an excellent leader. He feels responsible for each of the team members and considers himself lucky that only one agent under his direct command has ever died. The last two years he has been plagued by troubling nightmares that he fears may be visions of the future. They reveal a great magical catastrophe that will rock the planet. The visions offer no details, only impressions, so he can't tell when it will happen or how dramatically it will affect the world. He wonders if it is a natural disaster or if aliens are involved. He keeps his fears and nightmares to himself and takes special interest in other practitioners of magic, alien magic and psychics, hoping they may shed some light on his vision. These dreams have made him a bit moody and he has become increasingly quiet and secretive.

Washington is a competent and caring leader who is respected by his teammates. However, other members of Project Secure find the scholarly magic user to be aloof and a bit spooky, so they tend to avoid him after hours.

Code Name: Washington
Real Name: Brian Martin
Rank: Field Commander Agent (roughly equal to a Colonel)
Alignment: Scrupulous
Hit Points: 60
S.D.C.: 74
Weight: 210 pounds (95 kg)
Height: 6 feet, 2 inches (1.9 m)
Age: 36; **P.P.E.:** 205
Attributes: I.Q. 17, M.E. 19, M.A. 12, P.S. 18, P.P. 15, P.E. 23, P.B. 14, Spd. 13

Disposition: Brian is a calm, clear thinking man of obvious intelligence and education. He is very analytical and calculating, but not to the point of excluding emotions or compassion. He genuinely likes and cares for the people under his command, but he feels it is important to distance himself from them as their leader. His visions of doom have troubled and distracted him, but he will not allow those distractions to jeopardize any missions.

Experience Level: 9th

Super Power Category: Magic/Wizard

Spells: Knows all 1-4 level spells, plus the following: dispel magic barriers, negate magic, eyes of the wolf, fly as the eagle, globe of silence, ice blast (NEW), magic armor (NEW), Mystic shield, tongues, words of truth, calling, energy disruption, heal wounds, banishment, and wisps of confusion. **P.P.E.:** 205. **Spell Strength:** 15

Combat Skills: Hand to Hand: martial arts, boxing, and wrestling.

Attacks Per Melee: Seven

Bonuses: +3 on initiative, +2 to strike, +5 to strike with aimed shots, +5 to parry, +5 to dodge, +5 to damage, +10 to roll with punch or fall, jump kick (critical), entangle, critical on unmodified 18, 19, or 20, paired weapons, leap attack (critical), KO on natural 20 when punching, pin/incapacitate on unmodified 18, 19, or 20 (if declared), body block/tackle, +3 vs magic, +2 vs possession, and +3 vs Horror Factor.

Education Level: Doctorate/Ph.D.

Skills of Note (includes all bonuses): All science and medical skills at 98%, computer operation 98%, boxing, wrestling, fencing, gymnastics (all percentages at 98%). Lore: demons and monsters, lore: ghosts and faeries, lore: geomancy and lines of power, lore: religion, all at 98% proficiency. Chemistry, Holistic Medicine, and Archaeology, all at 98%.

Secondary Skills: Advanced mathematics 98%, hand to hand: martial arts, read sensory instruments 83%, basic mechanics 75%, basic electronics 83%, art 75%, writing 69%, photography 93%, W.P. revolver, W.P. automatic pistol, wilderness survival 53%, climbing 69%, pilot automobile 83%, and pilot airplane 70%.

Appearance: Brian is a tall, well-built and reasonably handsome man who looks more like he is entering his thirties than his forties. His hair is kept short. He prefers to wear comfortable clothes (often jeans and button-up shirts). His costume as Washington is a grey or navy blue jumpsuit with black gloves, boots and trim.

Occupation: Government agent under the jurisdiction of Project Secure, with a background in science, medicine, research and lore.

Weapons and Equipment: Carries both a revolver and an auto pistol and the issued headset receiver/transmitter when working. He always has a pair of optics in the form of nightvision (ambient light amplification) goggles.

Vehicle: Personal vehicle is a Lotus Elan.

Body Armor: Washington's costume has concealed armor (A.R. 10, S.D.C. 50) in it, but he relies heavily on his magic for protection.

Civilian Organizations

Triton Industries

By Kevin Siembieda & Wayne Breaux

Triton Industries is a developer and manufacturer of military, law enforcement and civilian weapons, ammunition, body armor and survival equipment. It is a growing corporation with its headquarters in Elko, Nevada. This is also the location of their main proving area and testing grounds. The corporation has a presence throughout the United States, Canada and Mexico.

Triton Industries has been a major innovator in the area of energy weapons and advanced body armor for the last seven years. Before that, it was the struggling child of its founder, *Arthur Harding*. The company was saved by an unexpected breakthrough in laser weapon technology.

Research and development has expanded into improvements and advancements of existing weapons, ammunition, and body armor. They have most recently developed an All-Weather, All-Environment exoskeleton Suit that has won them their second military contract. Their first contract is connected with Project Tyche (and to a lesser degree, Project Secure) and involves the identification and initial analysis of *alien* artifacts. Arthur Harding and his special research team have shown an amazing propensity for identifying and understanding alien technology. They have also shown the same kind of fanaticism about protecting US citizens from hostile aliens and dangerous weapons as Project Tyche has (or so it would seem). This has created a strong bond between Tyche's Director and Harding. Director Fores has become increasingly reliant on Harding and has arranged to make him and Triton Industries special advisors and agents connected with the Project; this includes Arthur Harding, Brittany Shale, and a team of Triton specialists (TST operatives) handpicked by Harding.

The Secret Behind Triton Industries

Many people have been puzzled about Triton Industries' amazing development of advanced laser technology which saved the struggling weapons manufacturer from the brink of bankruptcy. The truth behind Triton Industries' achievements does not rest with the genius of Arthur Harding or his research teams, but with the appearance of Brittany Shale, a visitor from another world.

Eight years ago, an alien spacecraft crashed in the backyard of Triton Industries. Harding and his people were the first on the site and helped the government, including Project Tyche agents, with securing the area and collecting the remnants. The crashed vessel was apparently a lifeboat jettisoned from a larger alien vessel in distress. The large vessel exploded high above the Earth and 98% of the debris is believed to have burned up in Earth's atmosphere. No remnants are known to have reached Earth. Unfortunately, the alien lifeboat didn't survive either and crashed in Nevada with a titanic explosion. The occupants were killed and burnt beyond recognition from the resulting crash, explosion and fire. The government seized what was left of the vessel and the corpses of an estimated 47 occupants.

Unknown to the government, there was one survivor. A woman was rescued and hidden by Arthur Harding. The owner of Triton Industries kept his "guest" a secret even from his closest associates. He was able to gain the alien's trust and, with time, her love and devotion. By studying her laser pistol sidearm, he was able to copy it and develop a working prototype to gain investors and attract the military. Once the necessary money was acquired, Triton Industries' skilled scientists, under Harding's supervision, were able to develop numerous advanced laser weapons and devices and win a government contract.

After his initial breakthroughs duplicating the alien technology, Harding realized what a beautiful system this was. If he could *acquire* additional alien technology, he could study and duplicate them (well, many of them) and make a fortune. To this end, he has encouraged ties with Project Tyche. Through this connection he has learned that for the last 60 years (perhaps for centuries), Earth has been visited by aliens from other worlds. By cementing his ties with Project Tyche, he could be among the first to rescue (steal and/or study) these items before they are taken by Project Secure or other agencies. By playing on the paranoia and animosity between Project Tyche and Project Secure, he has been able to convince Director Fores to let his people help in the "neutralization" of alien invaders, and prevent their dangerous weapons and technology from falling into the wrong hands; like super villains, foreign governments, Project Secure and other foolish liberals.

Harding and his trusted companion, Brittany Shale (the surviving alien), are careful to play the role of psychotic zealots, which has convinced Fores that they are kindred spirits. They never take foolish chances, and quickly turn alien artifacts over to Project Tyche or Secure operatives, but usually not before Harding has had a chance to examine them with his mutant powers and/or a detailed video documentation has been made. With the secret support and blessing of Director Fores, Harding has organized a half dozen squads of agents to investigate suspected aliens, UFO sightings and to "collect" equipment from alien visitors on Earth.

These squads are very similar in make-up and tactics to Project Secure's *Lock Down teams*. These Triton Strike Teams (TST) are always on call and ready to respond at a moment's notice. They are frequently deployed to investi-

gate situations that Project Tyche is unable to explore, either because the lead is too flimsy, or because the investigation has been turned over to another agency, like Project Secure. In this way, Director Fores has his fingers in the investigation (or so he thinks) through the TST (their true nature and ties to Triton Industries are concealed). These teams are also sent out to investigate leads of their own. Triton Industries employs several civilian wire services and UFO watch groups to keep them apprized of alleged sightings and strange occurrences. Once there is a solid lead, the Triton Strike Teams go into action and try to beat the government at finding aliens, and seizing their technology. Captured aliens are a rarity. TST operatives tend to kill these presumably hostile invaders and collect their weapons and equipment to be brought back to Triton Industries' secret fortress. The occasional alien captive may also be brought back to base where they are offered deals for information, cooperation and their equipment/technology. Deals are typically something like, "Give us what we want or we'll kill you," or, "we'll turn you over to the government (namely Project Tyche)." Those who refuse to cooperate are terminated and their bodies are either cremated or turned over to Project Tyche. Occasionally they are turned over to Project Tyche alive. But in most cases, the identity of the alien's interrogators and the location of its confinement are kept a secret to avoid incriminating Harding or Triton Industries.

A standard TST field team will be a six to eight man squad divided equally into two teams who engage in coordinated investigations and attacks. At least 75% of the team members will possess super abilities, and fall into the categories of alien, experiment, mutant, or psionic.

TST teams without super powered operatives will include agents from the Super Power Categories of bionics, physical training and hardware, or be non-superhuman ex-soldiers or espionage agents clad in experimental exoskeletons. Typical bionic operatives will have amplified hearing, some form of vision enhancement, radar, surveillance "bug" detectors, wide band radio receivers and transmitters, in addition to their bionic augmentation and 1D4 bionic weapon systems. Other operatives will be equipped with exoskeleton/body armor and laser weapons.

A fortress-like complex a few miles south of Triton Industries' headquarters is the Development Center and Testing Facility for secret military projects and experimental prototypes. It is protected by TI's weapon systems and elite guards (TST agents). Only Arthur Harding and hand-picked personnel have access to the facility. Ninety percent of the people at the main office never get past the front gate, let alone the front door.

This facility is the secret base and home for TST operations and agents, as well as for the studying, copying and storage of alien technology and artifacts. Within its inner sanctum are Darclon advisors, cells for alien captives and places for dark experiments. Other than Brittany Shale and Harding, there are only a tiny handful of people who are allowed into the inner sanctum or who know about the Darclon.



Arthur Harding

Head of Triton Industries

Arthur Harding is a brilliant designer due largely to his mutant super powers of holographic memory projection and mechano-link. These powers are especially useful in understanding, duplicating and improving new (alien) technology, as well as "knocking off" competitors' products. Unfortunately, many alien items are beyond Earth's manufacturing capabilities and require advancements that are beyond any Earth manufacturer. Although he has many high-tech weapons and designs in his head from studying Shatter's and Darclon equipment, he will have to wait until other areas of manufacturing catch-up to make their reproduction feasible.

Harding is the true brains and motivator behind the Triton success story. The majority of his technical staff and researchers are merely developers and aides who carry through on his designs. Publicly, he plays the role of the busy C.E.O. and tries to preserve his anonymity. His role as weapons developer and UFO investigator are closely guarded secrets. He has tasted the good life, and he wants more. His ambition has driven him to create the TST teams, to continue his secret campaign to pirate alien technology, and his dealings with the Darclon aliens for his own personal gain. He has become increasingly calculating, ruthless, and maniacal. Although he is self-serving and evil, he has his own twisted code. This includes not purposely harming innocent bystanders, protecting children, and not undermining the government, authorities or the law (it's one thing for "him" and his agents to circumvent the law for their gain, but not for other aliens, criminals, or super villains to do). In his own way, Harding is a patriot who will do what he can to defend and protect the

United States of America and the human race. He would be horrified to learn of the Darclons' schemes and would turn against them in a heartbeat. Shatter shares similar views.

Alignment: Aberrant

Hit Points: 33

S.D.C.: 65

Weight: 184 pounds (83 kg)

Height: 5 feet, 11 inches (1.8 m)

Age: 33; **P.P.E.:** 12

Attributes: I.Q. 20, M.E. 15, M.A. 17, P.S. 12, P.P. 14, P.E. 10, P.B. 15, Spd. 13

Experience Level: 6th level

Super Power Category: Mutant

Unusual Characteristic: Double-jointed

Super Powers: Mechano-link and holographic memory projection.

Combat Skills: Hand-to-hand: basic

Attacks Per Melee: Five

Bonuses: +1 to strike, +2 to parry and dodge, critical on unmodified 19 or 20.

Education Level: Four years of college.

Scholastic Skills (includes all bonuses): Electrical engineer 98%, surveillance systems 98%, computer repair 98%, robot electronics 55%, mechanical engineer 98%, locksmith 95%, aircraft repair 80%, robot mechanics 55%, navigation: space 98%, navigation (air, land, water) 98%, read sensory equipment 98%, weapon systems 98%, pilot: jet fighter 98%, and pilot: space shuttle 98%.

Secondary Skills: Computer operation 98%, hand to hand: basic, athletics (general), pilot: automobile 98%, pilot: airplane 98%, advanced mathematics 84%, languages: Spanish, French, Russian, and German, all at 80%; pilot: sailboats 98%, W.P. revolver, writing (journalistic) 38%, and pilot: motorboats 84%.

Occupation: Founder and C.E.O. of Triton Industries; a multi-millionaire and weapons developer.

Appearance: Harding is a suave, debonair and handsome man in his early 30's. He always wears expensive business suits and has an air of always being in control.

Shatter

Shatter (aka Brittany Shale) is the sole survivor from the space lifeboat that crashed in Nevada. Her vessel had been invaded by some sort of alien predators that appeared after their ship had gotten caught in a space and time anomaly. The dimensional anomaly warped them from their solar system into Earth's. They came to Earth because it was the nearest planet with intelligent, and as fate would have it, human life (Shatter and her people are human). However, the deadly invaders proved too dangerous and the ensuing battles caused the ship to explode in Earth orbit. She and 47 others were ordered into a life boat, but only she survived the crash.

The alien woman appears completely human although she possess some superhuman abilities. She has always viewed Arthur Harding as her rescuer and the two quickly

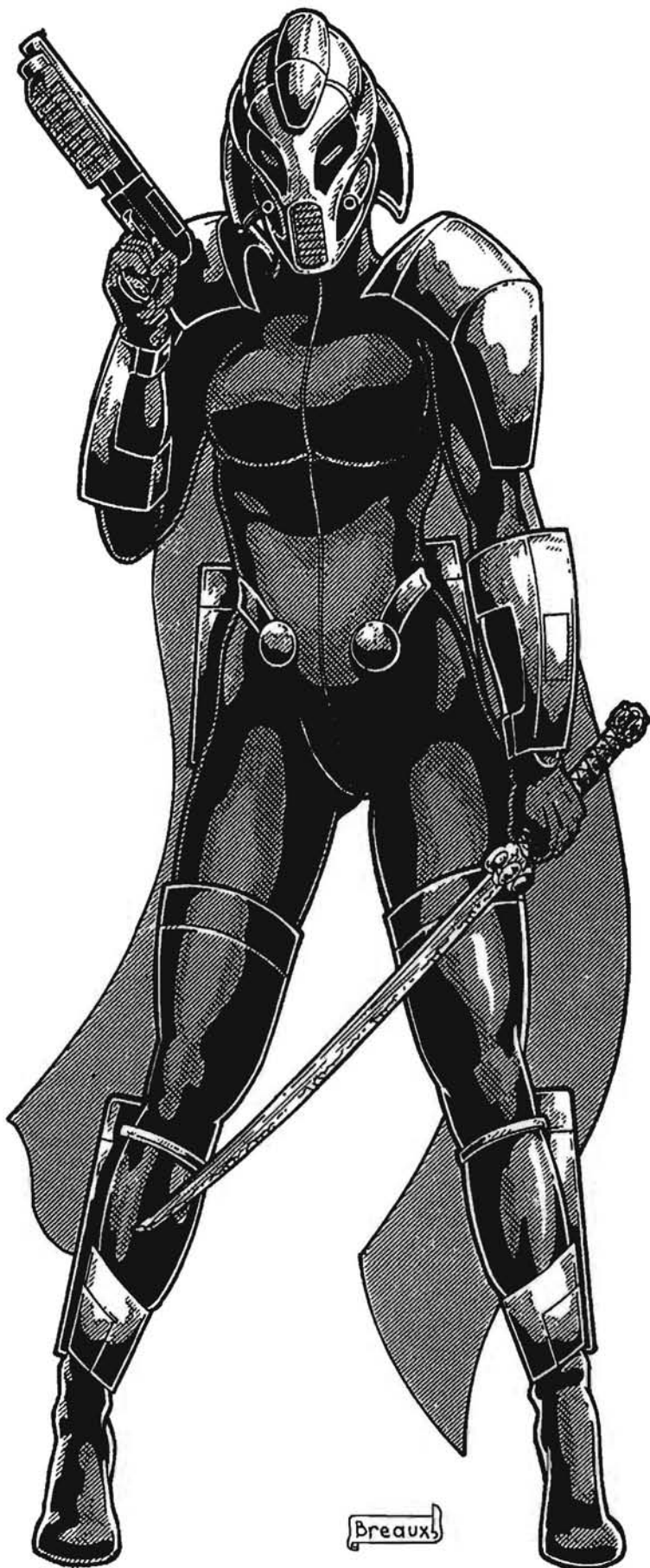

fell in love. The two have been inseparable for the last seven years. As *Brittany Shale*, she is Director of Security for Triton Industries. Under her *Shatter* persona, she is known as TI's top super powered operative. Only a few people know Shatter and Brittany are one and the same. Of course, this means she has access to all TI weapon systems, vehicles and facilities. She is also privy to Triton Industries' and Arthur Harding's secrets, including TST operations, their ties with Project Tyche and the presence of the Darclons.

Brittany does not trust the Darclons. They have no honor and she suspects them of having ulterior motives. She has expressed her concerns to Arthur, but he has assured her that they are his pawns and there is nothing to fear. Brittany isn't convinced of this, but keeps her suspicions to herself and an eye on the Darclons.

As Shatter, she is considered an unknown vigilante associated with an unknown group (TST) who hunts down and fights aliens, mutants and super villains. Authorities consider Shatter and her teammates to be low priority because the group keeps a low profile, does not engage in robbery or endanger civilians, and, in fact, have assisted or defended authorities against alien and/or super villains on several occasions. The "official" investigation of Shatter and cohorts has been *acquired* by Project Tyche (who know she is an agent of Arthur Harding, so they have killed the investigation. At least for the moment, Shatter and the TST can operate with minimal fear of government intervention).

Earth Identity: Brittany Shale; a.k.a. Shatter

Real Name: Britonshael

Alignment: Aberrant

Species: Humanoid, looks completely human.

Hit Points: 57

S.D.C.: 212, **P.P.E.:** 14

Weight: 154 pounds (69 kg)

Height: 5 feet, 6 inches (1.65 m)

Age: Unknown, looks to be in her late twenties.

Attributes: I.Q. 15, M.E. 11, M.A. 13, P.S. 27, P.P. 23, P.E. 20, P.B. 14, Spd. 66

Experience Level: 9th level

Super Power Category: Alien

Home Planet: High Gravity

Major Super Abilities: Vibration (Shock wave quick roll damage 1D6x10+12).

Minor Super Abilities: Healing factor and flight: wingless.

Combat Skills: Hand-to-hand: martial arts, wrestling, and boxing.

Attacks Per Melee: Seven

Bonuses: +1 on initiative, +6 strike, +8 strike with ancient W.P., +6 strike with aimed shot, +9 parry, +11 parry with ancient W.P.s, +9 dodge, +10 roll with punch or fall, jump kick (critical), entangle, critical on unmodified 18, 19, or 20, paired weapons, leap attack (critical).

Education Level: Alien Combat Specialist

Scholastic Skills (bonuses included): Martial arts, first aid 98%, boxing, S.C.U.B.A. 98%, wrestling, gymnastics 98%, languages: English, German, French, Russian, Spanish, and Italian, all at 98%; W.P. sword, W.P.

knife, W.P. paired, W.P. energy pistol, W.P. sub-machinegun, W.P. auto pistol, and archery

Secondary Skills: Prowl 98%, pilot: motorcycle 98%, pilot: automobile 92%, pilot: helicopter 60%, basic mechanics 52%, basic electronics 70%, read sensory equipment 95%, computer operation 98%, cook 98%, wilderness survival 95%, and W.P. blunt.

Equipment: As Head of Security at Triton Industries her usual complement of weapons includes a pair of throwing knives (1D6 damage), two automatic pistols (one loaded with armor piercing rounds), two stakeout style shotguns (one loaded with flechette rounds), one sub-machinegun firing needle rounds, or Triton Industries TKO rounds.

As Shatter: In addition to her powers and superhuman S.D.C., Shatter is always well armed with virtually any weapons and equipments she or her teammates (TST) need. Typical weapons include TI laser weapons, plasma ejectors or rocket launchers.

Brittany has a personal bank account with 1D4 million dollars.

Note: Only Harding and two of his most trusted scientists (both highly paid and 100% loyal), know that Brittany/Shatter is an alien.

Darclons

The Darclons are a race of evil aliens from another dimension. They have struck a deal with Harding to provide technological information and items in the areas of laser and energy weapons, body armor and exoskeletons/power armor in exchange for information about Earth, the solar system and alien visitors.

History: The Darclons were once powerful intergalactic arms dealers and slavers until the Splugorth and Naruni appeared in their dimension. Their new, ruthless transdimensional competitors literally destroyed the Darclons to eliminate the competition. Within 50 years, the Darclons had been extinguished as a force in their universe. Those who weren't slain, or put out of business, were captured and enslaved. Although tens of thousands survived as free people (there had been billions), they were forced into hiding and live a quiet existence. In an attempt to escape the Splugorth and Naruni Enterprises, the aliens turned their dwindling resources toward developing dimensional travel.

It took nearly a thousand years, but they have begun to master traversing the Megaverse. Their link to the Earth of **Heroes Unlimited** is one of their more promising doorways to another reality. One faction of Darclons is considering abandoning their native dimension to flee to another one not yet dominated by the Splugorth or other transdimensional menaces and conquerors. They are sizing up Earth and its universe as a possible candidate for such an exodus. The people of Earth, and even many of the more advanced "alien" races who inhabit the solar system, are comparatively primitive and could provide a rich environment for business, growth, and conquest.

The Darclons & Triton Industries: The Darclons are using Triton Industries as a pawn for their own schemes. It was Harding's Darclon "friends" and advisors who suggested the formation of the TST to study other aliens and to capture their technology (all the easier for them to learn about their potential opposition). The Darclons are also fascinated by the phenomenon of the "super hero/super being" in this dimension. They see such powers as a new marketing and military opportunity. This has led them to develop experiments with the intention of instilling super abilities in normal humans — so far none have been successful. Unknown to Harding, they are also experimenting with genetic engineering on animals, humans and aliens, for the purpose of creating an army (or slave force) of super beings to conquer this new universe and reclaim their own. Earth is just a potential stepping stone in this campaign.

Unknown to Harding and Shatter, it was the Darclons who attacked Brittany's spacecraft (she never actually saw the invaders). It was through this encounter that they discovered Earth and were able to track Brittany to Triton Industries. The Darclons were able to open a dimensional Rift near TI and send special agents to make a bargain with Arthur Harding. Thankfully, it is extremely difficult for the Darclons to create the dimensional opening to begin with (only 1D4 times an Earth year) and can seldom hold it open for more than a few minutes. There are five Darclon "advisors" at the TI Development Center and Testing Fa-

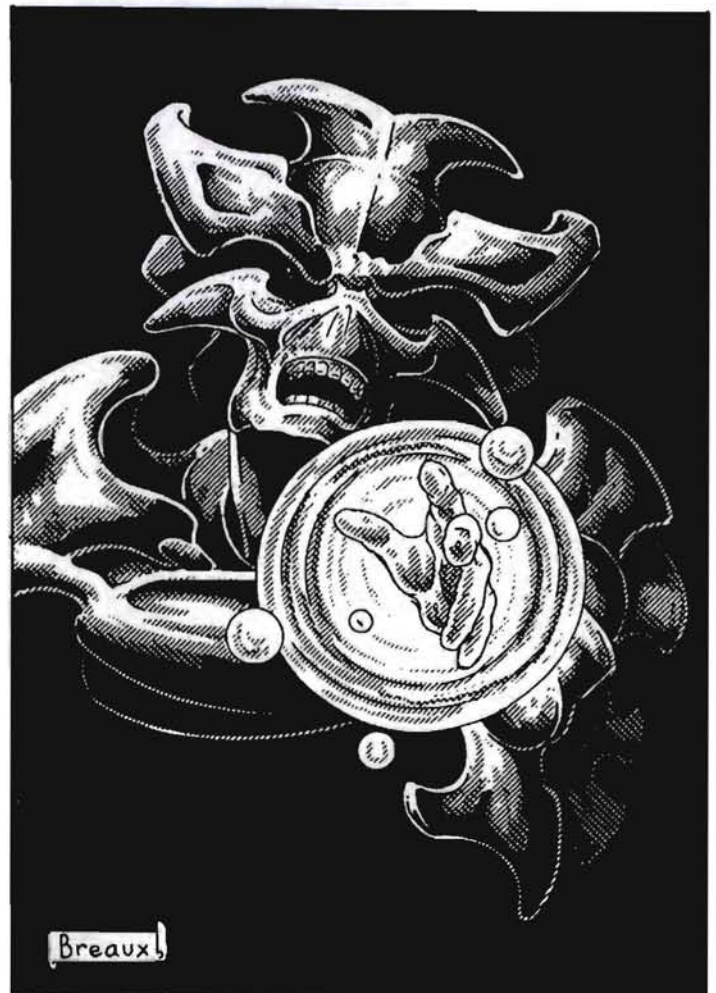

cility/Fortress. These five creatures help Harding develop new energy weapons, body armor and exoskeletons, help identify alien artifacts. One, a diabolic witch named Dreeja, is the leader of one of the Triton Strike Teams. Another pair of Darclons not affiliated with Triton Industries are conducting their own exploration of Earth and plan on recruiting a group of super villains (and perhaps conducting experiments on mutants and super humans to unlock the secrets of their powers and replicate them).

Alignment: Any, but usually selfish or evil.

Attributes: I.Q. 3D6, M.E. 4D6, M.A. 2D6+1, P.S. 4D6, P.P. 3D6, P.E. 4D6, P.B. 1D6, Spd 3D6

Hit Points: Standard; P.E.+1D6 per level of experience.

S.D.C.: 4D6x10; **P.P.E.:** 1D6x10

Natural Body Armor: A.R. 14

Height: 5 feet plus inches (1.6 to 2.0 m).

Weight: 100+ pounds (54 to 82 kgs).

Average Life Span: 240 years

Race: Humanoid

Super Abilities: All Darclons possess immense psionic powers. They are considered natural psionics, despite their alien origins, and are able to select five additional lesser powers and one additional super psionic power at first level. At additional levels, they get twice the usual number of powers. **I.S.P.** is a massive M.E.x10 plus 10 points per level of experience.

Natural Abilities: +5 to save vs Horror Factor, +2 to save vs disease, resistant to normal fire (half damage; but suffers full damage from magic, plasma or Mega-Damage flame) and +2 on initiative. They are also ambidextrous, which adds one attack/action per melee round, +1 to parry, +10% to climbing skill, +5% to escape artist, pick locks, mechanical repair, and electrical repair.

Special Weapons: Short- and long-range energy weapons are favorites.

Special Vehicles: Jet packs and hover vehicles.

Special Armor: They have half a dozen different types of power armor and giant combat robots back in their home dimension, but none have been brought to Earth.

Familiarity with Earth: Equal to "Has studied Earth" result on the Familiarity With Earth table.

Darclons in Rifts: As a Rifts character, a Darclon is a Mega-Damage Mind Melter with the following psychic powers: All physical powers, speed reading, total recall, telepathy, telemechanics, bio-regeneration (super), electrokinesis, pyrokinesis, telekinesis, group mind block, mind bolt, mind bond, psi-shield, and psi-sword. **I.S.P.:** M.E.x10 plus 10 per level of experience.

They are Mega-Damage creatures with 4D6x10 M.D.C. and technology level roughly equivalent to the Coalition States. In the Rifts World, their energy weapons inflict Mega-Damage and the armor of their bots, body armor and vehicles are also M.D.C. structures.

The Darclons are foul, merciless creatures who view humans and most other humanoid life forms as their inferiors; after all, they were used to being king-of-the-hill in their own dimension for eons before the Splugorth and Naruni Enterprises appeared and changed every-

thing. During their reign as intergalactic arms dealers and slavers, they were only slightly better than the Splugorth in regard to their treatment of other life forms. In many ways, it is befitting that they suffer at the hands of the Splugorth for what they did to countless others. To this day, there are thousands of Darclon slaves who serve willingly and by force as Minions of Splugorth, but not among the minions of Lord Splynncryth of Atlantis (remember, there are many Splugorth who dominate different parts of the Megaverse). The Naruni and a few others also have some Darclon slaves, although only one-tenth of the number owned by the Splugorth. The occasional Darclon slave, refugee or free man can find his/her way to Rifts Earth. All Darclons despise the Splugorth and dream of the day they can extract revenge (not likely). They also dislike Naruni Enterprises.

They have tackled the problem of dimensional travel from a scientific point of view and, although they draw on P.P.E. to create dimensional Rifts, they do not understand or practice magic.

Darclon player characters may be a rare alien of compassion and good alignment, but may be considered outcasts by others of the race; most are anarchist or evil.

Triton Industries

Triton Industries (TI) is a new mega-corporation in the area of advanced weapons, armor development and manufacturing. It has a total of 346 points. It is loosely associated with the US government and Project Tyche, as well as secretly associated with the Darclon aliens.

- A. Outfits: #4 Specialty Clothing: 10 points
- B. Equipment: #4 Electronic Supplies: 10 points
- C. Weapons: #5 The Arsenal: 30 points
- D. Bionics and Robotics: #3 Cyber agents: 25 points
- E. Vehicles: #4 Specialty Vehicles: 40 points
- F. Communications: #4 Computerized: 15 points
- G. Offices, Hideouts, Distribution: #4 National: 15 points
- H. Military Power: #4 Private Army: 30 points
- I. Super Powered Operatives: #3 A Few Regulars: 20 points
- J. Sponsorship: #3 Private Industry: 6 points
- K. Special Budget: #5 Big Bucks: 35 points
- L. Administrative Control: #2 Loose Laws: 5 points
- M. Internal Security: #4 Iron Clad: 25 points
- N. External Infiltration: #3 Information Source: 10 points
- O. Research and Information Gathering: #5 Superior Connections: 30 points
- P. Agency Credentials: #4 Known: 10 points
- Q. Agency Salary: #5 Excellent: 30 points

TI Armor & Weapons of Note

Triton Industries has developed a number of advanced energy weapons and high-tech ammunition, body armor and equipment. The items are "knock-offs" from alien sources. As a result, damage and data are often referred to as alien equivalents found in the equipment section of this book or items found in **Heroes Unlimited**.

Body Armor

TI Riot Body Armors: Triton produces armors identical to those in Heroes Unlimited, but because of alien technology, all have an armor rating one higher (+1) and an additional 10% S.D.C. than those listed. Cost is 25% higher too.

All Weather Armored Environmental Suit (A.W.A.E.S.): Identical to the H.E.A.S. except it has an A.R. of 13 and S.D.C. of 300. Cost: \$25,000.

Fanning Recoil Diminisher exoskeleton MK-III (FRDE a.k.a. Freddie): This power armor is a combination of a hydraulic leveling and recoil absorbing system built into a suit of protective body armor. The overall effect of the system is the near negation of recoil from automatic weapons. It also provides the wearer with +2 to P.S. and Spd. as well as basic body armor protection with A.R.: 14 and 160 S.D.C. points. **Other Bonuses:** +2 to strike when burst firing and +1 to strike when spraying/firing wild (See Modern Weapon Proficiency section). **Weight:** 100 pounds (45 kg) plus weapon and equipment weight. **Cost:** \$50,000 and up for a human-sized Freddie; double for giant characters.

The FRDE is currently a very hot commodity in the security and mercenary fields. Costs are high due to high demand and moderate production.

FRDE MK-IV-Super (a.k.a. Super Freddie): This is an advanced suit of power armor with the same systems as the MK-III, but has enhanced robotic augmentation, laser targeting (4000 foot/1200 m range), laser wrist blasters (3D6 damage, 2000 foot/610 m range). **A.R.:** 15, **S.D.C.:** 200. **Bonuses:** +4 to P.S. (Superhuman) and +10 to Spd., can leap 10 feet (3 m) lengthwise or up, +1 to dodge, +1 on initiative, +3 to strike with lasers, +2 to strike when firing bursts and +1 to strike when spraying/firing wild. **Penalties:** -15% to prowl. **Weight:** 200 pounds (90 kg) plus weapon and equipment weight. **Note:** This suit is not an EVA system. **Cost:** \$500,000 and up for a human-sized Super Freddie; double for giant characters. This is an experimental prototype.

BSEVA-1: An all-environment suit based on designs of the suit Shatter/Brittany wore when she was first discovered. This suit has NOT been made available on the open market or to the military. An alien suit of riot armor: **A.R.:** 15, **S.D.C.:** 230. **Features:** Built-in oxygen/S.C.U.B.A. apparatus, gas filters, air purge and circulation system (can breathe the same air for 2D4 days before it goes stale), long-range radio, laser targeting, radiation detector, and jet pack (90 mph/144 km). Brittany will wear one of these when involved in clandestine or defense operations. **Weight:** 30 lbs (13.6 kg). **Cost:** \$350,000.

Weapons & Ammunition

Armor Piercing Ammunition: \$275 per 100.

Flechette Ammunition: These rounds are composed of hundreds of small, razor-sharp blades. Their penetration value is low (add +2 to target's A.R.), but damage is high (6D6). They can only be used in shotguns. \$150 per 100.

Shotgun Sabot Ammunition: These are advanced slugs for shotguns. Their design doubles the normal range for shotgun slugs. Cost: \$80 per 100.

TKO .50 Calibre: Identical to the Korimyr.

TI Riproar: Identical to the Ridelly .560.

TI .50ACE: This handgun is basically a .45 calibre with ACE modification (6D6 damage per round).



TI Multi-Cal Rifle: Triton Industries' triumph in assault rifle technology is the Multi-Cal rifle. It is a dual purpose weapon designed for S.W.A.T. and other tactical uses. The rifle has an over-under dual barrel assembly. The top barrel can fire a variety of rifle cartridges, including the 7 mm, 7.5 mm, 7.62 and 7.65 mm. The bottom is a 12 gauge shotgun. Both barrels are fed by clips. The 7.62 mm is fully automatic, while the shotgun is semi-automatic (it can fire single aimed shots or rapid-fire short bursts). **Weight:** 12.8 pounds (5.8 kg), **Damage:** 4D6 or 5D6 per round depending on the cartridge; shotgun: 4D6 per round (5D6 slugs), **Rate of fire:** Aimed, burst, and wild; see Modern Weapon Proficiencies, **Effective Range:** Rifle: 1300 feet (396 m) or shotgun 100 feet (30.5 m). **Payload:** Rifle: 25 round clip; shotgun: 6 round clip, **Cost:** \$5,500.

TI Energy Weapons: Triton Industries makes a mini-laser tool, laser pistol, laser rifle, and heavy laser with backpack that are fundamentally the same as those found in the equipment section of this book.

TI Laser Wrist Band or Gauntlets: A pair of light-weight laser weapons worn on the arms or hands. **Weight:** 1 pound (0.45 kg) plus a 10 lb (4.5 kg) hip or backpack generator, **Damage:** 3D6, **Rate of fire:** Single or two-handed shot only, **Effective Range:** 300 feet (91.5 m), **Payload:** Two shots per each wrist band or gauntlet per melee round (15 seconds), self-regenerating energy pack. **Cost:** \$500,000.

TI Plasma Ejector: One of the only Earth companies capable of producing a plasma weapon is Triton Industries. **Weight:** 15 pounds (6.8 kg) plus a 20 lb (9 kg) backpack generator, **Damage:** 5D6+10, **Rate of fire:** Single shot only, **Effective Range:** 1000 feet (305 m), **Payload:** 10 shot energy clip, **Cost:** \$500,000. Plasma clips cost \$25,000.

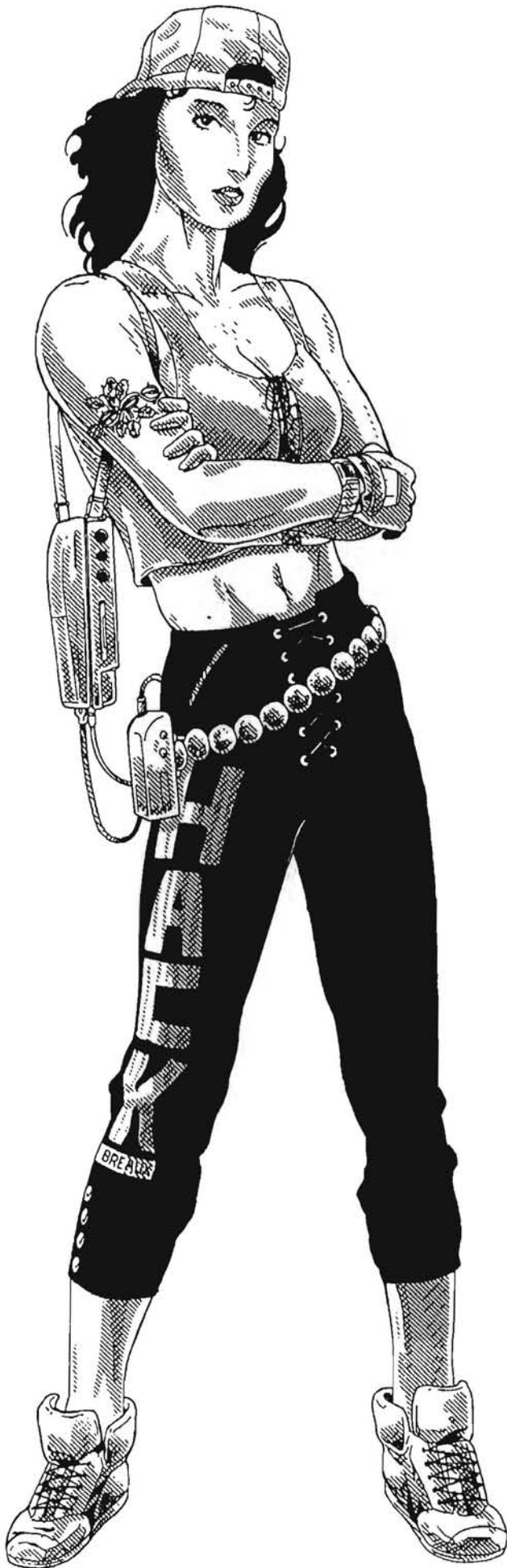

Reach Up

Reach Up is a civilian group of alien watchers. They come from all walks of life and have a common drive to see that aliens are given a fair chance on Earth. Most of them believe the government is a menacing organization that grabs up aliens and spirits them away to be dissected and studied. The members of Reach Up intend to do their best to keep alien visitors out of the hands of the FBI (not that they have ever had the opportunity to help any real alien visitors). They use the telephone, computer networks, delivery services, clipping services and firsthand reports collected by field agents to gather and distribute information to their members. Communication is mainly done via the telephone, computers and the occasional ham radio Operator. Important/secret information may be delivered by hand from one member to another.

Most participants of Reach Up have never met each other and only a dozen serve as field agents who go out to conduct physical investigations. Few can afford to jump on a plane to cross the country, so they call each other until someone in the area of the alien or UFO sighting can respond. If an alien is ever rescued, they have plans for a sort of alien underground composed of volunteers who will help hide, house, feed, care for and transport the extraterrestrial. These people have little access to equipment or resources, but they make up for it with determination and courage.

Reach Up

This is a civilian organization dedicated to unraveling the mystery of UFOs and reports of alien visitors. Total points: 96

- A. Outfits: None
- B. Equipment: #2 Cheap Gear: 2 points
- C. Weapons: None; operatives must purchase their own weapons.
- D. Bionics & Robotics: None
- E. Vehicles: None; only what each member has of his own.
- F. Communications: #2 Basic Service (including public computer networks): 2 points
- G. Offices, Hideouts, & Distribution: #4 Regional: 25 points (people's homes)
- H. Military Power: None
- I. Super Powered Operatives: None
- J. Sponsorship: #6 Agent Sponsored: 50 points
- K. Special Budget: Nickel and Dime: 5 points
- L. Administrative Control: Rigid Laws: No points
- M. Internal Security: None
- N. External Infiltration: #2 Rare Minor Traitor: 5 points (members that work for the government and news agencies).
- O. Research and Information Gathering: Cheap Resources: 2 points
- P. Agency Credentials: #3 Faceless: 5 points
- Q. Agency Salary: None; all are volunteers.

S.H.O.C.K.

Super Human Observation & Control Knights

By Wayne Breaux & Kevin Siembieda

The Super Human Observation and Control Knights (S.H.O.C.K.) are a fanatic army of human purists who operate as a political organization. They believe anyone who is not fully human, including mutants, cyborgs, people with psionics, and those with super abilities, are a potential threat to "natural man." Through the use of high technology, they have established an organization to monitor, categorize, and act upon any threat posed by "unnatural men" to natural men. To them, science (robotics), nature (physical and special training), and knowledge (spell and illusion magic) are meant to exist, for they in no way "remove the human from the man." Aliens are not human to start with, no matter what they look like. Other super powered people have to be altered or mutated in some way to possess "unnatural powers" and are thus not "natural." Androids who think and act as androids are accepted as non-human machines, but those who either think they are human, or pretend to be, are added to the enemies of S.H.O.C.K.

What S.H.O.C.K. calls its "Campaigns of Purity" are actually trails of terrorism and genocide. Their standard tactic is to locate and identify an "abnormal" person and make an appearance in their imposing armor. A warning shot is fired very close (within inches/centimeters) to the target. A camera in the armor records the shot to prove that it was not an attack. To the target, it will appear very much like an attack. If the target subject retaliates using *unnatural* powers, S.H.O.C.K. attacks with deadly force, claiming that the person was a violently dangerous, non-human villain. If the target of the assault does not attack, he is told he won't be killed if he comes with them peacefully. If the person agrees to go, he'll be brainwashed into forgetting he has unnatural powers (S.H.O.C.K. has mages with spells specifically designed for this task). An implanted suggestion will make the person call S.H.O.C.K. for help if he ever accidentally finds his powers again (great story idea, huh?).

The organization has had amazing success in eliciting public support. This is in part due to an excellent public relations campaign and impeccable timing. The organization immediately seizes every opportunity to preach hate and confuse the facts whenever superhumans or mutants are responsible for trouble and mayhem. During quieter moments, they preach subtle versions of their beliefs, publish propaganda, conduct charities and make political contacts (politicians looking to score points with constituents frightened by powerful villains and non-humans are especially attracted to S.H.O.C.K.). The S.H.O.C.K. organization has developed an almost "above the law" status as a people's militia ready to protect humanity against monsters and mutants while the government stands by idly. The illusion that its members are careful to make certain a suspect is not human before they take action, and that they only kill in self defense, only adds to their reputation as heroes and protectors.

Most S.H.O.C.K. agents appear to try to cooperate with the law. They never resist arrest, never endanger law enforcement officers or innocent (human) bystanders and, unlike many so-called super heroes and vigilantes, gladly remove any disguises, helmets, or masks to *proudly* reveal who they are. A definite improvement over those mysterious super vigilantes and lawless mutants. Of course, S.H.O.C.K. agents flagrantly disregard the law and civil rights to "get" super-freaks and unnaturals whenever the media's eyes are not focused upon them. Like most fanatics, the typical S.H.O.C.K. activist knows the law well and twists it to protect himself and further their cause.



Many people fall right into the "non-human" phobia S.H.O.C.K. propagates, and the organization benefits from that by way of financial, emotional and political support. It has supporters and agents who have many different educational backgrounds among its ranks: doctors, lawyers, government personnel, members of the military and police, media people, celebrities, the wealthy, teachers, clergy, farmers, factory workers, laborers, families and others. Nearly anyone can be an active or supporting member of S.H.O.C.K. The former are the militant and visible members involved in fighting "unnatural men," reforming laws, demonstrating and "making a stand for their children." Supporting members tend to be the silent majority, quietly sending in donations, information and words of

support. They are also the least informed about the extreme activities and measures the organization is willing to take to preserve the rights, liberty and life of natural men.

S.H.O.C.K. is by no means a widespread underground society, but it is gaining "grass root" support at an alarming rate. The organization claims to have the support of millions of Americans. To hear them talk, it seems that 80% of the nation is behind them. In reality, they have approximately 60,000 supporting members across the country and about 400 *active* core members. These active members are the most fanatical and violent. Their devotion to the cause fuels the fires of hate and motivates them to do the work of 4000. They can cover a surprising amount of ground. The founders and leaders have built a strong and stable organization that seems to be gathering support as more and more mutants, aliens and unnatural super beings seem to spring up every day. They are calculating, purposeful, driven and prepared. They do not usually make snap judgements, or take actions that will hurt the cause.

The surveillance of one target can, and usually does, take weeks. Before any move is made, as much information as possible is gathered on a subject(s) and its (their) abilities. Included in the observations are notes about the character's strengths, weaknesses, habits, public statements, friends, allies and associations. Many times a docile target will not be attacked but patiently monitored and held in reserve. This "unnatural man" will be put under regular surveillance to determine his/her/their threat level and capabilities until a point in time when more dangerous targets are scarce, or when the threat level of the surveillance subject(s) increases or they can be set-up to further the cause. S.H.O.C.K. has become quite masterful at framing "unnatural men" for crimes they do not commit, arranging threatening situations for super beings to look more dangerous than they really are, as well as provoking super beings into action and into the public spotlight to make S.H.O.C.K. look good or super beings, in general, look bad.

One of S.H.O.C.K.'s driving goals is to have legislation passed to monitor, control and imprison people with super abilities. If they can get this done, their status as licensed government operatives would be nearly assured (or so they believe). If it should ever happen, they will become advocates of legal genocide. **Game Master Notes:** The operatives and organizers at S.H.O.C.K. are veterans at capturing people with super abilities. Player characters, especially those in the public eye, or who are disfigured or obviously inhuman, will be high on their "hit" list. Alternately, secret operatives may manipulate the characters into situations that will discredit them or even get them to fight other super beings (good or evil). S.H.O.C.K. agents are becoming increasingly notorious for *arranging* super heroes to fight super villains and vice versa.

S.H.O.C.K. does not have robotics capabilities, but they do have several technical people and manufacturers associated with the organization. Non-combat members of S.H.O.C.K. field teams are typically researchers, observers (with still or video cameras in hand), surveillance or

communications personnel and general assistants. They frequently operate out of large vans or trucks filled with electronic scanners, surveillance devices, tracking systems, communications and recording equipment. Combat field operatives have military or other combat training, including the super categories of physical training, hardware and magic. Those sent to neutralize a super being may use disguises to look like an ordinary person or law enforcement officer or use a customized suit of Class Four Hard Armor with jet packs. The following section details some of that equipment.

The supporting and active members of S.H.O.C.K. are not necessarily evil people (although a good percentage are, or have become evil as a result of their fears and fanaticism). Most honestly believe in their cause and feel their efforts are making a better world — all the greater the tragedy.

S.H.O.C.K.

The Super Human Observation and Control Knights (S.H.O.C.K.) is an organization of militant human supremacists who have created a sort of terrorist anti-super being network: Total points: 270

- A. Outfits: #1 None: 0 points
- B. Equipment: #5 Gimmicked Equipment: 30 points (includes their armor).
- C. Weapons: #5 The Arsenal (except for energy weapons): 30 points
- D. Bionics & Robotics: #2 Basic Systems: 10 points
- E. Vehicles: #4 Spy Cars: 25 points
- F. Communications: #4 Computerized: 15 points
- G. Offices, Hideouts, & Distribution: # 3 National: 15 points
- H. Military Power: #3 Militia (Armed members): 15 points
- I. Super Powered Operatives: #1 None: 0 points
- J. Sponsorship: #6 Agent Sponsored: 50 points
- K. Special Budget: #2 Nickels and Dimes: 5 points
- L. Administrative Control: #3 Free Hand: 15 points
- M. Internal Security: #5 Paranoid: 30 points
- N. External Infiltration: #2 Rare Minor Traitor: 5 points
- O. Research and Information Gathering: #4 Excellent Connections: 20 points
- P. Agency Credentials: #3 Faceless: 5 points
- Q. Agency Salary: #1 None (These fanatics do it for the good of mankind.): 0 points

Ander Michaels

Founder & Leader of S.H.O.C.K.

Ander Michaels was the kind of kid that was scared of everything. He worried about monsters under his bed and big kids at school. Ander grew up to be a scared man. He was not bothered by people of other races, they were still human after all, but Ander came to believe that there were real monsters out there. Aliens, mutants, psychics, cyborgs, evil super beings, and even some who pretended to be super heroes.

One day as he left a shopping mall, he noticed a large crowd gathered in the parking lot. A sudden explosive crash sent the onlookers running. The disturbance was in

the area of his car, so Ander went to see what had happened. He found the remains of his Buick wrapped around a lamp post. The culprit was a very big, angry, alien or mutant. As the creature bore down on him, Ander wet his pants and fainted. When he awoke, a handsome young man in armor with a large rifle knelt over him. A super hero. The hero complimented Ander for his bravery and paraded him in front of television news cameras like a monkey on a string. Anders, in soiled clothes, was mortified, confused and angry. These super beings had seized control of his life and he wanted it back. He vowed to himself that he would take control of his life and free himself from these ... these ... things who weren't even human. That day the seeds of war were planted.

Over the next few years he began to speak out and gather supporters. A midwest industrialist and equally fervent human supremacist created S.H.O.C.K. armor and supplied two dozen units of these power armor suits and weapons to the organization. Since then, funds have been raised to create over 100 armored suits.

Ander is a paranoid xenophobe. He thinks aliens and super powered monsters lurk everywhere, mostly disguised, as humans. He feels safe and powerful now that he has become the master of his own fate and has surrounded himself with like-minded people. With each passing day, he becomes more of a megalomaniac, who believes his own hype and is honestly convinced of the dangers posed by non-humans and super beings. The sad thing is that he is convincing others of his beliefs and creating a dangerous world.



Real Name: Ander Michaels

Alignment: Effectively aberrant. His fears and righteousness blind him from the truth, fuel his hatred and destroy his capacity for compassion in regards to non-humans and mutants. However, he believes what he says and has his own twisted view of the law and reality. Unfortunately, he believes the ends justify the means.

Hit Points: 20

S.D.C.: 30

Weight: 185 pounds (83 kg)

Height: 5 feet, 10 inches (1.8 m)

Age: 29; **P.P.E.:** 6

Attributes: I.Q. 11, M.E. 9, M.A. 20, P.S. 8, P.P. 13, P.E. 10, P.B. 10, Spd. 18

Disposition: Ander thinks he is doing the right thing. He is dedicated to the organization and ultimately, the eradication of non-humans. He is no longer the frightened little man he once was, he is empowered by the truth and is willing to be a martyr to the cause.

Experience Level: Third

Super Power Category: None, completely human

Combat Skills: Hand to Hand: basic

Attacks Per Melee: Four

Bonuses: +2 to parry and dodge, +2 to roll with punch and fall.

Education Level: High School

Occupation: Office assistant/clerk.

Skills of Note: All skills are domestic or work related (unskilled labor); Ander has had a rather boring and simple life. Secondary skills of note include W.P. pistol and W.P. sub-machinegun.

Appearance: Ander is an average joe with thick, brown hair, glasses and an intense, almost pained expression.

Weapons and Equipment: Typically carries a .44 caliber auto mag pistol (5D6 damage) and a 9 mm mini-uzi (2D6 damage) on his person. A multi-optics helmet, shotgun, sap gloves, nightstick, 200 rounds of ammunition for both guns, two pairs of handcuffs and two smoke grenades are in the trunk of his car.

Vehicle: A new Jaguar sports car with cellular phone and anti-theft alarm and kill switch.

Body Armor: Concealed bullet-proof vest worn under his suit coat: A.R. 10, 50 S.D.C.

Special S.H.O.C.K. Equipment

S.H.O.C.K. Armor

Designed to be imposing yet functional, the S.H.O.C.K. armor is a suit of full environmental, Class 4 Hard Armor with a detachable jet pack, advanced targeting system and sensor array integrated into it. It has several built-in weapon systems and can fully link up with the Mobile Headquarters (MHQ) to share its more powerful systems. The armor must be within range of the HQ's signals for the information feed to be successful (See the MHQ for details).

Type: Heavily Modified Body Armor & exoskeleton

Model: S.H.O.C.K. A4

A.R.: 17

S.D.C.: 300

Speed: Running: Same as the wearer's natural speed.
Flying: 85 mph (136 km) for up to 45 minutes. Maximum altitude: 1000 feet (305 m).

Jet Pack S.D.C.: 100.

Weight: Entire suit: 100 pounds (45 kg)

Bonuses: +1 on initiative, +1 to strike (+2 with long-range weapons), +1 to parry and dodge (+2 in flight), +2 roll with impact or fall. Punch damage: 2D6 plus P.S. bonus.

Sensors: Infrared (1600 feet/488 m), thermo-imager (1600 feet/488 m), targeting sight, telescopic optics (up to 2 miles/3.2 km).

Cost: \$140,000

Weapons Systems:

1. Gas dispensers (left arm): Tear gas for crowd dispersement and disorientation. Targets are -6 to strike, parry, and dodge. No saving throw. See page 341 of **Heroes Unlimited** or riot control gases and grenades in the **Compendium of Contemporary Weapons**.

2. 40 mm grenade launcher (left arm): Used for anti-vehicle and anti-structure purposes, it is also used to knock invulnerable people off their feet (88% chance). Range: 1,100 feet (335 m), Damage: 1D4x100, Blast Radius: 20 feet (6.1 m), Feed: Single shot, Payload: 4 grenades (takes 2 actions to reload a single shell).

3. Automatic 9 mm SMG type mount (right arm): Damage 2D6 or by special bullet, Range: 550 feet (168 m), ammo: 30 round box magazine. Two extra clips are usually carried.

4. Dart Launcher (right arm): Range: 110 feet (34 m), Damage: Save vs non-lethal toxins or be rendered unconscious for 3D4 minutes. Payload: 4 darts (can fire up to two per round).

5. Stun Blast (left arm): Range 100 feet (30 m), Rate of fire: Up to five per melee, Damage: Save vs non-lethal toxins or -6 to strike, parry, dodge for 2D4 melees, Payload: 10 charges.

6. Optional Hand Held Weapons: The character can also have/use a conventional sidearm, pistol, rifle, hand grenades or energy weapon (the latter is a rarity for armored S.H.O.C.K. troopers).

S.H.O.C.K. Mobile Headquarters

Two-ton (1800 kg) moving vans are the usual choices for these mobile HQs. The S.H.O.C.K. Prime is their elite unit that uses an eighteen-wheel semi with box trailer for its Mobile Headquarters. The trucks are all armored. Each headquarters is manned by 2-4 technicians and equipped with surveillance, filming, recording and communications equipment.

A.R.: 10

S.D.C.: 400 for vans, 950 for semi-truck and trailer combined.

Speed: Maximum speed: 120 mph (192 km), cruising speed: 40 mph (64 km).

Weapon Systems: Typically none, but the occupants of the vehicle may be armed, and one is usually clad in S.H.O.C.K. armor to protect the vehicle and its agents.

Other Systems:

1. Advanced Audio Surveillance System: Range 600 to 800 feet (183 to 244 m). Includes shotgun and contact microphones (turns one wall of the van into an eight by ten foot (2.4 by 3.0 m) sounding board for recording and eavesdropping, and high and low frequency receivers.

2. Wide Band Radio Receivers and Transmitters: Range 60 miles (96 km). Can pick up and send out on nearly any wavelength, including citizen and police bands. Has a built-in scrambler system.

3. Multi-Media Recording Capabilities: Includes audio, video, laser disc, tape, and CD.

4. Sound Analyzing, Sorting, and Filing Programs: Part of the mainframe computer, this system is used to categorize voices, vehicle sounds, a specific individual's energy powers being used, and for hundreds of other purposes.

5. Advanced Optic System: Includes color and black and white filming, as well as low-light and starlight optics, infrared, ultraviolet, and thermo-imaging capabilities. Sensor extends above the van and has 360 degree rotation.

6. Motion Detectors: A last line of defense against those super powered entities who can slide past the other sensors. Range: 75 feet (23 m).

7. Other Sensors: All of the truck's sensory, optical data, communications and other audio-visual transmissions can be sent to any suit of S.H.O.C.K. armor within four miles (6.4 km). These are all real-time signals with no lag time.

8. Medical: Most Mobile Headquarters also have medical equipment equal to a paramedic.

9. Optional: 150 S.D.C. worth of armor can be added to vans and small trucks or 400 S.D.C. to a semi and trailer, but maximum speed is reduced by 10 mph (16 kmph) and handling is reduced (-10% on piloting skills).

The S.H.O.C.K. Prime - Mobile Headquarters

A rolling bunker with all necessary items for 2 months of field duty.

A.R.: 15

S.D.C.: 1,500 (truck and armor combined)

Speed: Maximum speed: 95 mph (152 km), cruising speed: 55 mph (88 km).

Mobile HQ Special Systems:

1-7: All are identical to numbers 1 to 7 above, but extend ranges by 10%.

8. S.H.O.C.K. Prime MHQ has full medical facilities and a medical doctor on board. He can perform surgery and any other necessary medicine in the field.

9. Holding Cell: S.H.O.C.K. Prime MHQ has a cell whose bars are specially designed ion/particle beams that separate the particles of anything that passes through them. Yes, the system is highly experimental and was stolen. Each time a beam is disrupted, the object that breaks the beam takes 2D4x10 damage, and the beam has a 40% chance of shutting down and taking the whole bar system with it. The beam will even separate the cells of an invulnerable character.

10. Two to four soldiers in S.H.O.C.K. Armor are always in the truck to protect it. Additionally, it has two concealed gun turrets, each has a 7.62 mm machinegun with enough ammo for two full minutes of continuous fire (10 full melee bursts).

Damage: 5D6 per round

Range: 2000 feet (610 m)

Rate of Fire: Aimed, burst, or wild. See Modern Weapon Proficiencies under machinegun.

Payload: Approximately 1500 rounds each.



Galactic Organizations

For Game Masters who wish to run a galactic campaign, there are endless Non-Player Characters (NPCs), player characters and villains that can be created. Large organizations and rival governments form a good basis for a coherent, believable campaign setting that offers a lot of versatility and plot options. The galaxy has thousands of races and each has unto itself hundreds of governments, organizations, movements, cults, clubs and factions. It would be impossible to document them all, so we have presented only a few major forces and brief mentions in **Aliens Unlimited**. The Game Master should feel free to build on these, or to develop his or her own intergalactic community. **Note:** A supplement is in the works that will expand on some of these alien forces.



The Atorian Empire

The Atorian Empire is the single most powerful and influential force in the Milky Way galaxy! More than 1,000 years ago, the humanoid Fehrans began to explore outer space and colonize other worlds. The most influential of the Fehran clans were the Atorians. They quickly forged

alliances and developed new technologies that made them a galactic powerhouse. This head start and aggressive adaptation to space exploration enabled them to monopolize the resources and space technology of their solar system. Thus, the Atorian Empire was born.

Atorian women quickly moved into positions of power, and as Atorian control solidified, the culture became a gynarchy. To this day, women hold the reins of power. As a planet is absorbed into the Empire, either by invasion or alliance, an Atorian Duchess or Lady is given it as a holding. She runs the planet and leads the native government. A large contingent of soldiers is also placed at her disposal, even on allied planets.

The Atorian Empire is currently ruled by the six Atorian Empresses. Each has control over one sector of the Empire, but they communicate frequently to determine imperial policies. Within their sectors, each Empress has a planet she has chosen as her throne world. These planets are all well within the Empire and protected by a vast amount of spacecraft and soldiers. The throneworlds have been this way for the past 600 years.

The Atorian Empire has access to the best technology in their galaxy. With the enormous amount of resources, planets, and personnel at its disposal, they make equipment, weapons, vehicles, and spacecraft of higher quality in less time, and at lower cost, than any other race. Most Atorian spacecraft, armor, and weapons will have 20% more S.D.C., 10% greater speed, and weapons inflict 10% more damage than their competitors'. Their robots have maximum S.D.C. and A.R. ratings for their type.

Fehrans look exactly like Earth humans, except their hair is always white, grey or silvery, and grows in a strange pattern. A line of hair grows down the middle of the head (like a mohawk) and on the base of the head in the back between the ears. Clan tattoos are also common and often fill in the bald spots above the ears.

Federation of Allied Races (FAR)

The members of the Federation are frightened people who have banded together to create an atmosphere of security. It is largely a political entity designed and constructed to oppose expansion by the Atorian Empire. It makes a big show of flexing its diplomatic muscles by sending envoys, criticism and threats to the Atorian Empire. However, its only line of defense is a barrier of warships stationed in space between them and the Empire.

Critics of the Federation are skeptical as to whether or not those defenses would do anything other than slow the Atorians down. Critics also contend that the Federation represents nothing more than empty threats and the Atorians know it. They cite the Federation's practice of re-

fusing membership to “high risk” planets close to the Atorian Imperial Borders, slow response to any threats from the Empire, and the fact that they have never taken a hard line against them other than vocal chastisement. The Federation is prepared to go to war, but they will do everything possible to avoid it, even selling out other planets if the compromise protects the majority.

Members of the Federation of Allied Races include the Maeus, Salvelinus, Silisons, Darakans, Kassans, Shissans, Caecils, Sorinams, Elicians, and a few others.

The Niamese Coalition

The Niamese Coalition is a more active opponent of the Atorian Empire. Founded and led by the Naterreri race (described in the Catalog of Aliens), this organization operates as a sort of expansive underground for guerrilla fighters and political powers who directly oppose the Empire. They are currently waging a political campaign against the Empire, not an all-out war. Not yet. They talk to representatives of planets not yet allied with the Empire to convince them not to join them. This is done by showing evidence of Atorian treachery, atrocities, and manipulation elsewhere, making alliances and trade agreements and offering limited military and moral support. The NC is also involved in smuggling Empire slaves to safety, sabotaging enemy operations, ferreting out spies, encouraging pirates to raid Atorian vessels and generally causing as much trouble for the Atorian Empire as possible.

The Niamese Coalition has done no serious damage to the Atorians, so they have not yet been targeted for eradication. The Empire is currently treating the rebellious attacks as minor occurrences, but they are becoming an annoyance. Standard imperial piracy countermeasures are being employed against the small, surgical strikes launched by NC guerrillas and pirates.

The nature of the multiracial Niamese Coalition means that all equipment has to be personally provided or salvaged. The sweet irony is that most of their salvage comes from the Empire. Tangible, but secret aid also comes from certain governments within the Federation of Allied Races and elsewhere (the TGE is not among them). Fully loaded supply craft will be totally lost or mysteriously reported as “crashed” within the operating areas of the NC. This silent support is quietly applauded by members of FAR, although it is publicly chastised for political reasons. The Federation plays “tippy-toe-around-the-Empire,” but they do not mind if someone else opposes them. As long as the NC doesn’t provoke the Atorian Empire to attack the Federation, FAR won’t do anything to stop the NC.

Over the last 20 years, the Niamese Coalition has managed to assemble a space fleet of nearly 500 spacecraft, including cargo and combat vessels, a pair of destroyers, a trio of assault craft, two deployers, a battleship, and over 275 fighting frigates. The NC has also established loose ties with the Raiding Clan pirates, Sorinams, Darakans, Xenopus and a few others.

Tagoniglomerate (TGE)

The galaxy’s single largest company is the Tagoniglomerate, or TGE. It produces nearly 9% of the galaxy’s mass market technical goods and is a political entity unto itself. It is owned and run by Tagonican aliens and employs almost 65% of that race, as well as millions of aliens from other worlds. TGE produces literally everything from laser pistols and exoskeletons to hover cars and computer chips.

TGE space stations are found in nearly every section of the galaxy where intelligent life or natural resources are found. Repair, medical and trade facilities are located in each. Their mining and production plants are equally abundant, employing aliens of the local races to turn out goods of all kinds. They dominate in the manufacturing of spacecraft, weapon systems for spaceships and the metals and shielding used in their construction by others. The TGE has factories, production facilities and mining operations on several worlds and even has its own moon purchased from the Tagonican government. The densely populated moon is the location of TGE’s Intergalactic Headquarters.

The company maintains a security force larger than the armed forces of most individual planets, including its own space fleet with thousands of cargo vessels, transports, passenger liners, various scout and assault craft, destroyers and a half dozen giant battleships. If war were to develop, the TGE space fleet would represent a powerful armed force with scores of allies. As of this time, however, the TGE maintains an unshakably neutral and completely non-aggressive military presence. The TGE security forces operate strictly as a defense force that helps to police the spaceways, escort TGE spaceships, and defend TGE property from pirates and other hostile forces. They occasionally get involved in the apprehension of pirates and criminals who have plundered their ships or properties. So far, they have NEVER provided military assistance to any nation, world or corporation. However, their economic power and the threat of a boycott is often sufficient to influence political entities.

Years ago, the Atorian Empire gave several key contracts to the Struthios race (including the matter/anti-matter research that ultimately destroyed them). The Tagonicans, who wanted those contracts badly, felt cheated and were very bitter when they went elsewhere. As a result, the TGE has boycotted the Atorian Empire for generations. This has served to escalate their rivalry and contempt for each other over the years. Consequently, there is no love between these two superpowers and some believe a deadly conflict is inevitable.

Thissera-Micean Cooperative (TMC)

The Thissera-Micean Cooperative, or TMC, is a galactic police force created by the reptile-like Thisseras and the rock-like Miceans (both are described in the Catalog of Aliens). They have permission from each planet in their ju-

isdiction to patrol and enforce that planet's laws and to protect the surrounding spaceways from pirates, criminals, and invaders. The laws they enforce govern a multitude of crimes, including murder, assault, theft, smuggling, confidence games/scams, kidnapping, extortion, sabotage, destructive or life-threatening vandalism, piracy, terrorism, conspiracy, mining claim infringements and other crimes.

Their training, organization, and operations are similar to the various specialized Earth government agencies such as the CIA, FBI, DEA, ATF, and so on. Their training, tactics and equipment include a variety of combat/military skills, weapons, explosives, espionage, stealth, and teamwork. Each branch or division is trained in a specialized field and agents from different divisions work cases together in an attempt to combine that expertise. Agents must also have a solid understanding of the laws and customs of the planets and people within their assigned sector of space.

Although the TMC was originally founded by the Thisseras and Miceans, who still head its operations, scores of other races are represented in its ranks, especially those not directly allied with the Atorian Empire (still, 17% of its agents are Thisseras and 20% are Miceans). Manpower, weapons, equipment and some financing are provided by each of the planets that contract work with the TMC. This means the organization has an incredible range of weapons, equipment and resources at its disposal. Some of their more common equipment includes body armor, pulse laser rifles, ion pulse pistols, and other energy weapons, fast spaceships, jet packs, two-man hover cars with light vehicle weapons, six-man A.T.V.s with heavy vehicle weapons, and one-man hover cycles for use in boarding spacecraft.

Space Pirates

Pirates are brigands who raid other spaceships and steal their cargo and sometimes the crew and ship. A group can turn to piracy for many different reasons. Some are simply criminals and villains who steal for a living. These evil brutes are also likely to kill indiscriminately, murder for pleasure, torture, rape, pillage and sell captives into slavery. Others may be discriminating pirates who only plunder the ships of rival or enemy races, corporations, competitors, and other pirates. This type of pirate can be a cutthroat, a crook with some scruples or code of honor, a loveable, swashbuckling Robin Hood, or a fighter for freedom, justice or revenge. Other pirates can also be Mercenaries hired by corporations or governments to attack/plunder their enemies. Still others may be refugees, nomadic tribes or castaways who have resorted to piracy to survive. Like many other pirates, these scavengers may be discriminating and take only what they need while trying to do as little harm as possible, or they can be cruel and murderous fiends.

Presented here are three major types (plunderers, murderers, and nice guys) of pirates that represent some of the largest and most infamous of the organized pirate conclaves in the Milky Way galaxy.

Dark Breeze

Dark Breeze is the chosen name for a pirate raiding fleet of *Riathenor* aliens (see the Lassinike aliens entry and Monster section for more details about the Riathenors). Dark Breeze is a 200 ship fleet that spreads across the galaxy, looking for victims and plunder. These murderous aliens kill their victims without hesitation or provocation. They find it much easier to rob the dead than to deal with the living. They enjoy murder and torture, sell captives into slavery and eat humanoids, which makes the dead victims part of the plunder.

Hauling off, manning and driving away, or stripping a full-size transport craft is difficult, and time consuming, opening oneself to capture and trouble. They'd rather strike, plunder and run, leaving the vessel behind. They prefer to hit small cargo ships, passenger liners, and private yachts. Such a vessel is usually easy to capture and plunder, even if it has a couple of fighters escorting it. In these cases, they may steal the vessel as well, provided it is in good condition and doesn't require more than a dozen men to pilot it.

The cruelty of the Dark Breeze pirates is such that they will often raid luxury transports for the sport of terrorizing or killing its hundreds of passengers. In such a case, about 50% will be killed and left on the drifting vessel. The other half will be taken prisoner to be sold as slaves, or to be eaten. The heartless Riathenors rarely waste their time with torture or questions. If you do not answer, they kill you, although they sometimes torture people just for fun.

Their favorite boarding strategy is to have all raiding members enchanted with the spells *breathe without air*, *fly as the eagle*, and *Armor of Ithan* in order to fly through the vacuum of space without need for a clumsy vacuum suit, power armor or grappling cables (and man-sized targets are difficult to strike, -5 from ship cannons). *Invulnerability*, *resist cold* and other spell magic can be added to the mix. The squad commander, who is typically 9th to 11th level and who commands six vessels, typically uses a *Mystic portal* on the hull of a ship, away from the airlocks, to penetrate the vessel without blasting. While the vessel's defenders hurry to secure and defend the airlocks from hostile boarders, the Dark Breeze pirates can gain access to virtually any area of the ship and attack. The bridge or communications is typically the first target. Killing the command crew and seizing control of the spacecraft usually results in a short fight. Few survive a riathenor attack of this nature. Magic can be a powerful weapon in space.

Diatome

Diatome is the name adopted by a Naterreri-led pirate group that is an unofficial part of the Niamese Coalition. The 95 member crew uses six combat craft to sweep the edges of Empire territories in search of appropriate victims. Plunder from these raids helps to fund the Coalition and help support needy communities of the pirate's choice.

Wealthy Empire transports and cargo craft are not the only targets of the Diatome. They have successfully raided Atorian fighters, spy ships, and other military vessels.



Their success seems to lie with the element of surprise — most military vehicles do not expect to be targeted by pirates. Much needed weapons and equipment, and in some instances, the vessel itself, are confiscated for use by both the Diatome and to the Niamese Coalition to continue their operations. All crew members of captured craft are placed on lifeboats and sent adrift toward the nearest space station. In some cases, the Diatome will send an anonymous message to authorities telling them where to find castaways and crippled spacecraft.

These Robin Hoods of outer space have earned the respect of the Raiding Clans through feats of daring, courage, kindness and acts of chivalry. The Clans have declared the Diatome to be their allies and unofficial members of the Raiding Clans (a full membership would be official if the crews were of one race). The Diatome have graciously accepted this great honor, but try not to involve the clans in their private war.

Raiding Clans

The infamous Raiding Clans are composed of close-knit family clans of several different races. Like spacefaring gypsies, they travel the spaceways plundering and enjoying total freedom. They are in constant trouble with the Atorian Empire and the TMC. Both forces are the frequent targets of the pirates, which has driven them to offer bounties with a large, outstanding reward for key

members. Most bounties are for dead or alive but positive identification is a must!

Although the clan members are bold and conniving thieves, smugglers and bandits who are a constant thorn in the side of the Atorian Empire and the TMC, they do not kill indiscriminately, attack vessels with women and children, or engage in torture or the slave trade. Their numbers are expanding through the birth of their own children and by recruiting new clans to join them. If a group of people prove themselves to be honorable, loyal raiders, and the majority of the band (90%) are all related, or at least the same race, they may be allowed to join the Raiding Clans as a new clan. Most clan members will be selfish in alignment. Wanton acts of cruelty and murder are not tolerated and the perpetrators are tried and executed or driven from the clan. Likewise, Raiders are never to steal from, betray, abandon or harm other members of the clan. There is some measure of honor and loyalty among this band of thieves that keeps the Raiding Clans strong.

It is rumored that there are other Raiding Clans scattered across the galaxy. The rumors also suggest that there is a homeworld that the original Raiders came from, possibly a huge moon outfitted like their planetoids, but no one can agree on what race the original Raiding Clans were. If the Clans know, they aren't saying.

All Clan spacecraft use microwave sails combined with antigravity engines and stealth coatings to make them

nearly invisible (75% equivalent prowling based on the pilot's skill. See prowling in spacecraft under the Space Combat section and stealth coating in the Equipment section for details).

Their main base of operation and residence is a 50 mile (80 km) long planetoid with two other nearby planetoids half that size, also used by some of the other clansmen. Each of these planetoids is outfitted with massive nuclear drives that can move them through space at 20% of the speed of light. Normally, they are accelerated to a certain speed, then the drives are shut down and the great rocks are allowed to drift in a particular direction. This gives them the appearance of being unmanned (the drive cones are concealed). Hidden amid the rocky surfaces of the planetoids are a variety of long range, heavy weapons, some of them battleship class.

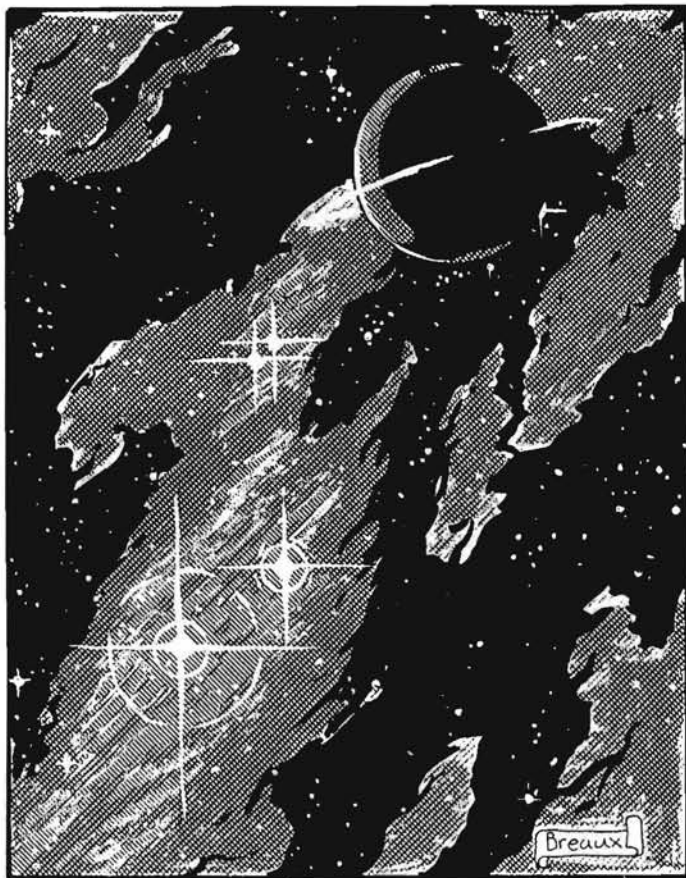

A Catalog of Aliens

This section can be used as a rogues' gallery of villains, non-player characters (NPCs), or player characters. They have been written to provide an idea of the types of alien characters that can be created and as an easily accessible trove of non-player or player characters for both the Game Master and player characters. It is by no means a definitive cataloging of all aliens available to the **Heroes Unlimited** universe.

The alien descriptions are brief, but should present

enough detail and possibilities to give the reader a fair idea of the character's homeworld, environmental conditions, life styles, social and political sentiments, tech-level, motives, ideals and alien character statistics. Of course, motivations and goals will vary from individual to individual and the player character or G.M. can digress from the general sentiments of that race. The information presented only represents a *general* portion of those people's beliefs.

Amphibian Races

Frogs, toads, newts and salamanders all belong to the amphibian family on Earth. Alien amphibians have an evolutionary cycle similar to their Earth animal cousins. Many of their physical traits and requirements are also similar.

Amphibians begin their life cycle as aquatic organisms. They reach maturity quickly, usually within a year's time. At physical maturity, the amphibian experiences great changes, like a tadpole changing into a frog. Consequently, in some cases the adult body is dramatically different (and more powerful and versatile) than the juvenile form. In other instances, like the newt, the change is minimal and the adult is mainly a larger version of the juvenile. In most cases, the young amphibian has gills and lives primarily, even exclusively, in the water. Upon reaching adulthood, their gills turn into lungs and the creature develops the ability to live both in water and on dry land. The limited skills and abilities they learned when young remain for life.

Alien amphibians are aquatic race who can live both on land and in water. Their soft, moist skins need moisture to keep them from becoming too dry and cracking or blistering. Their indigenous habitation is generally very humid with an abundance of fresh water. Even the toad-like aliens with comparatively tough, lumpy or textured skin have to keep themselves moist. When away from their homeland, most will need to take a long bath (30 minutes to an hour) once or twice a day. They are natural and instinctive swimmers who love the water and can spend all of their time in it without ill effects. The typical amphibian alien can automatically swim at 80% skill proficiency +1% per level of experience and can hold its breath for 10 to 20 minutes. Many have thin, transparent eyelids that can cover and shield their eyes underwater and enable them to see through murky water. **Note:** Despite their aquatic nature, adult amphibians have no gills and will drown if they remain submersed in water beyond their lungs capacity to hold air.

Amphibian skin can be as soft as a baby's or as lumpy as a toad's hide. The softer the flesh, the more often the creature will need to immerse itself in water. These more delicate beings will die within 1D4+1 days without water, while those with tougher skin like the toad can live on dry land and without water for 1D6+4 days. Most also heal twice as fast in the water.

Amphibian coloration can be as vibrant and brilliant as that of an exotic bird, or as drab as that of an elephant. Skin colors range from dull grays, black, browns and greens to bright greens, yellows, oranges, reds and blues.

The skin is usually covered with spots or stripes that help the creatures to camouflage themselves in nature and underwater.

The races detailed here represent a range of amphibians and include frog-like, toad-like, and salamander-like humanoids.

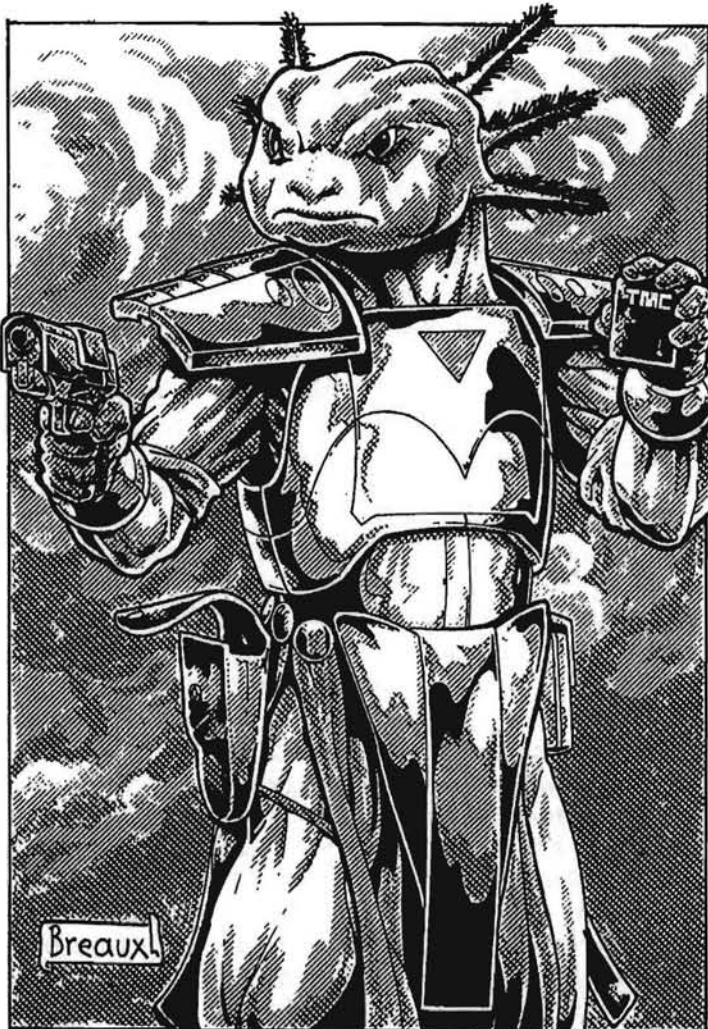

Axolotl

The planet Lolia is a calm, green world with plenty of water (80% of the surface is water). In the gentle pull of its low gravity, a race of amphibians known as the Axolotls have evolved. They are a tall people with a slight build and smooth, supple skin that varies in color from a creamy tan to pale pink. Axolotls have rounded heads and soft, smooth features. Their noses are barely detectable slits and the mouth is wide and flat. Their heads are framed by several stalk-like appendages that are normally a bright pink or red. These appendages once formed the gill structures of their ancestors and juvenile bodies.

They are an advanced civilization who have taken it upon themselves to help and protect other races in the galaxy. Their intervention as self-appointed galactic police and/or protectors can be welcomed by other beings or sternly rejected. Many people want to take care of their own affairs and don't appreciate the interference of the well meaning, but sometimes pushy and arrogant amphibians.

The Axolotl peacekeeper is expected to do everything in his power to help the native populace to which he or she has been assigned. This can range from providing knowledge of building, agriculture, medicine and science, or words of peace and advice or actively fighting and destroying monsters, invaders and enemies. Generally, the Axolotl peacekeeper restricts combat to "outside" threats and supernatural/superhuman forces such as other aliens, super-powered madmen and villains, and tyrants bent on destruction, genocide or widespread terrorism. Like interstellar knights, the Axolotl peacekeepers are sent throughout the universe righting wrongs and protecting the weak and innocent. Some Axolotl peacekeepers take back seats and quietly monitor a people's progress and subtly help and encourage the indigenous people. However, most are flamboyant and righteous heroes who fly into action with the subtlety of a nuclear bomb.

Typical peacekeeping operatives are issued a mini-laser, antigravity medallion, and survival gear for their assigned planet, and are educated to some extent on the society they will be dealing with. Standard field assignments last five years but can be renewed repeatedly and last decades. Both technical (science, advisory, medical, and similar) and military (defensive; the Axolotl are rarely the aggressors, they typically respond to acts of violence perpetrated by others) assignments are issued to qualified personnel for any given planet.

Not all Axolotl peacekeepers are kind-hearted knights. Some are evil or of anarchist alignment and willing to sell their services as Mercenaries or join forces with evil tyrants, enslavers, criminal kingpins, monsters and other dark forces for their own personal profit, power or amusement. The Axolotl Duty Council forbids such activities and will have rogue operatives removed from service, by force if necessary.

The Axolotls' sense of duty in helping and protecting the weaker and less fortunate entices many young Axolotls to join the Thissera-Micean Cooperative as galactic police officers in large numbers (see the TMC entry for more details). The TMC is more organized and respected than other inter-galactic peacekeeping forces.

Axolotl (pronounced ax-o-lotel)

Alignment: Any, but the majority of Axoloti are principled or scrupulous, with a high regard for life and high personal morality.

Attributes: I.Q. 3D6+2, M.E. 3D6, M.A. 3D6, P.S. 3D6, P.P. 4D6, P.E. 3D6, P.B. 3D6, Spd. land: 3D6x2; water/swimming speed is 3D6x6.

Hit Points: Standard, P.E. plus 1D6 per level of experience.

S.D.C.: 1D4x10 plus 20; thick, comparatively tough skin.

Height: 7 feet plus 3D6 inches (2.2 to 2.6 m).

Weight: 100 plus 4D10 pounds (47 to 63 kgs).

Average Life Span: 65 years. **P.P.E.:** 2D6

Super Abilities: Any power category is available, but bionics are the most common, followed by robotics, then super abilities via genetic engineering and mutation; less than 10% of all Axolotl have natural psionic or super powers. See the appropriate category in Heroes Unlimited for specific bionic features or powers.

Special Weapons: Other than weapons indigenous to their assigned planet, Axolotls are given mini-lasers (range: 100 feet/30.5 m, damage: 2D6 S.D.C., 10 shot energy clip).

Special Vehicles: Anti-gravity medallions are issued, but operatives are supposed to use them only when native transportation is inappropriate. Anti-gravity medallion: Maximum speed 40 mph (64 km). S.D.C. 8. Hovers 3 to 600 feet (.9 to 183 m) above the ground. Maximum weight allowance 500 pounds (225 kgs).

Preferred Armor: Bionic or robot power armor. Alternative types will have to be purchased from the natives. On primitive planets, armored vests (A.R. 13, S.D.C. 70) will be issued.

Familiarity With Earth: The Axolotls have no knowledge of Earth. Should they discover it and come to investigate or be assigned there, their language will be the equivalent of English.

Rifts Notes: If used in the **Rifts RPG** setting, the amphibians will be seen as D-Bees and shunned or destroyed by human supremacists like those in the Coalition States. Most are likely to be lone adventurer or a small group brought to Earth via a dimensional anomaly and not because they were assigned to keep the peace.

If set in the **Rifts: Phase World** environment, they are just one of many alien life forms, although they are likely to be viewed as meddling do-gooders or trouble-makers.

In both cases, the Axolotls are S.D.C. life-forms who need Mega-Damage weapons and armor or bionics or super abilities for Mega-Damage protection and fire-power. Quickie Conversion: Technology/weapons/armor can be simply switched from S.D.C. to M.D.C. for quick, easy conversion and integration. Thus, if the body armor had an A.R. 13 and 70 S.D.C., it would now have an M.D.C. of 70 (A.R. not applicable). Similarly, the mini-lasers would inflict 2D6 M.D. rather than S.D.C. Or the Game Master can keep the alien's S.D.C. technology and make the character acquire Mega-Damage items just as any human does.

Caecil

Caecils have long, rounded faces and thin limbs. Their eyes are small, black, and round. They have no body hair, and their skin is very soft and smooth. Skin colors range from dark blue to a pale bluish-grey. Their home planet has an abundance of radioactive minerals and all Caecils absorb and store the radiation. This has resulted in the appearance of people with super powers and psychic abilities. For thousands of years, people born with super abilities were believed to be of noble heritage and natural leaders. Thus, they were taken to palaces, educated and raised as the aristocrats and leaders of the nation. Unfortunately, the super-powered leaders felt superior to their subjects and treated the masses poorly. Many considered themselves to be gods and looked upon their people with cold indifference, or as worshipers, rather than offering them guidance and helping them to survive. The average person barely had enough to eat, while the super beings lived in luxury. Eleven years ago, a successful revolt top-

pled the Caecil nobles from their seats of power. The war was long and bloody, but in the end, all the super beings were slain or exiled to outer space.

The Caecil civilization has limited space capabilities that include faster-than-light drives, but most other levels of technology are considerably less advanced, roughly equal to 20th and early 21st Century Earth. They are particularly backward in the areas of genetic engineering, medicine, cybernetics, and space colonization/exploitation and development (the faster-than-light drive systems were created by a group of super Caecils who had a desire to visit the stars). These limited capabilities and the apathy of their past leaders have kept the Caecils as only minor participants in the galactic community.

The pendulum of public sentiment has swung to the other extreme regarding people with superhuman powers. Instead of being revered as gods, they are loathed. Those who exhibit insignificant powers are shunned or ridiculed and some are even beaten and killed. The authorities try to apprehend super-powered citizens for observation and "reconditioning." This involves the use of hypnotism/brainwashing, drugs and occasionally, surgery (lobotomy) to suppress the use of super abilities to allow the person to live a "normal life." Those who resist or reject reconditioning or who turn to a life of crime or vigilantism, are hunted, captured and exiled off-planet. Those who return are considered enemies of the people, and are hunted down and slain!



Many of the former nobles of Caecil society now survive as Mercenaries, bounty hunters, bodyguards and other professions off-world. Others have traveled to worlds where they are again worshiped as gods by primitive peoples. Others have become pirates, criminals and super villains. A larger majority seek revenge against their people and plot against them. Many are actively working to block Caecil efforts to acquire better technologies and join the galactic community. Meanwhile, one faction of super villains is gathering strength and allies for an invasion that will restore their place as godling rulers.

Caecil (pronounced kay-sill)

Alignment: Any, but most are selfish.

Attributes: I.Q. , M.E. 3D6, M.A. 3D6+2, P.S. 3D6, P.P. 3D6, P.E. 3D6, P.B. 3D6, Spd. 3D6

Hit Points: Standard; P.E. plus 1D6 per level of experience.

S.D.C.: 1D4x10

Height: 6 feet plus 1D6 inches (1.8 to 2.0 m).

Weight: 190 plus 1D6 pounds (87 to 89 kg).

Average Life Span: 60 years. **P.P.E.:** 1D6

Super Abilities: Any Super Power category is available to the Caecil race, including primitive bionics, hardware and physical training.

All exiled nobles and people considered to be "super" beings represent 10% of the overall population and make selections or random rolls on the Super Abilities Tables found under Step Three of the Character Creation section or from the Psionic power category.

Natural Abilities: The radioactive background of planet means all Caecils are immune to radiation that would be deadly to humans. However, their bodies give off low levels of radiation. If the character does not wear a protective suit, anyone exposed to him for more than two weeks will begin to suffer from radiation sickness (see the High Radiation homeworld description for details). Caecils can see into the infrared spectrum of light.

Special Weapons: Sub-machinegun: Range: 600 feet (183 m). Damage: 4D6. 50 shot clip. They are trying to develop energy weapons.

Special Vehicles: A.T.V. hover car: Maximum speed 140 mph (225 km). S.D.C. 440. Hover 3 to 12 feet (0.9 to 3.7 m) above the ground. Can carry a pilot and five passengers comfortably.

Preferred Armor: Nearly any form of armor will be worn. The type and protective value will vary with the character and occupation.

Familiarity With Earth: None.

Rifts Notes: Same as the . These creatures are likely to be S.D.C. beings with S.D.C. technology.

Cameroon

The Cameroons are unique, even among the multitudes of aliens in the galaxy. All members of this amphibian race are able to reduce their height to one inch (2.5 cm). They take full advantage of their size-reducing powers in the construction of their cities, roadways, and spacecraft. The first encounter with a 20 foot (6.1 m) long



Cameroon battleship with a 350 man crew is impossible to believe, let alone forget. The cities are even more amazing; almost 200,000 people can live in an area smaller than a half a mile. The amphibians can also reduce the size of objects. More memorable than their spacecraft is the sight of its crew as they leave it. The inch-tall (2.5 cm) people step out and, as soon as they are clear of the ship, return to their full five foot (1.5 m) height, equipment and all.

The reduced Cameroons all retain their mass as inch-tall (2.5 cm) people. Consequently, their cities and spaceships are constructed of very strong and dense materials. An Earth elephant could walk on top of one and only break windows and radio antennas. Furthermore, the fact that a one inch tall Cameroon may weigh a 100 or more pounds means that they are not blown away by strong winds or ground vibrations, nor can they be snatched up by a human-sized invader or animal. With the dense metals found on the planet Cameroa, the aliens have made an art out of the science of miniaturization. An amazing situation!

While the majority of spacecraft and cities are constructed on a small scale, much of the equipment inside them is manufactured at human-size and reduced. This is especially true of hand weapons, armor, clothing and other things. Items that are made human-sized and reduced can be used by the Cameroons in both their tiny

and enlarge sizes. Items created as miniatures to begin with cannot be enlarged later. Likewise, it is difficult to entertain other large life forms when one is the size of an insect. Consequently, the Cameroons have built a small fleet of full-sized spaceships and a few human-sized cities (with tiny ones nearby or underground). **Note:** Shrunken weapons have one-tenth the range and damage they possess when human-sized.

Most Cameroon space operatives are military personnel, but all have different educational backgrounds and skills in addition to their basic combat training. The powers of the Cameroons make them ideal for espionage, reconnaissance and spying. Soldiers are usually deployed in standard units that are broken down to groups as small as pairs. However, a typical team is four or five characters and a standard squad is eight or ten. Standard weapons are stun pistols, and each pair of soldiers is issued a shrunken two-man hover car. Two fourth level or one eighth level Cameroon can unshrink it (weighs about 1,200 pounds/544 kg).

Cameroon (pronounced cam-er-oon)

Alignment: Any, but the majority are principled, scrupulous or unprincipled.

Attributes: I.Q. 3D6, M.E. 3D6, M.A. 3D6, P.S. 4D6, P.P. 3D6, P.E. 3D6, P.B. 3D6, Spd. 3D6x3

Hit Points: Standard, P.E. plus 1D6 per level of experience.

S.D.C.: 3D4x10

Height: 5 feet plus 1D6 inches (1.5 to 1.6 m).

Weight: 120 plus 1D6x10 pounds (59 to 82 kg).

Average Life Span: 75 years. **P.P.E.:** 3D6

Appearance: The Cameroons are short by human standards, even when full size. Skin colors are rich reddish browns on the face and back with lighter tan or cream colored chests, bellies and undersides. The eyes are large with equally large, protective brows that form bony ridges.

Super Abilities: All Cameroons have the major abilities of shrink and item reduction (see new super abilities for the latter). None have or any other super powers.

Special Weapons: Cameroon Stun Pistol: Range: 135 feet (41 m). Damage: Dazes victim for melee rounds, during which time the victim has no initiative, is -8 to strike, parry, and dodge, and loses half of his speed and attacks per melee round. Effects may vary with different races and a saving throw of 16 or better means one's opponent has shaken the blast and only loses initiative and one melee action for that melee round. Payload: 8 shot energy clip.

Cameroon Particle Beam Pistol: Range: 200 feet (61 m). Damage: 1D4x10, rate of fire: equal to hand to hand attacks per melee, payload: 8 shot energy clip.

Cameroon Particle Beam Rifle: Range: 1600 feet (488 m). Damage: 1D6x10, rate of fire: equal to hand to hand attacks per melee, payload: 12 shot energy clip.

Cameroon Laser Pulse Rifle: Range: 2200 feet (670 m). Damage: 2D6 per single blast or 6D6 per triple pulse, rate of fire: equal to hand to hand attacks per melee, payload: 20 shot energy clip.

Weapon Note: Most Cameroon weapons will fire 20% farther than the common versions on the market. These people have a fondness for charged particle acceleration weapons like the P-beams listed above. Full-sized Cameroon agents may carry an arsenal of reduced weapons in their pockets, pouches or concealed anywhere on the body (the item reduction power reduces the object's weight).

Special Vehicles: Two-man hover car: Maximum speed 160 mph (260 km). S.D.C. 350. Hover 2 to 12 feet (0.6 to 3.7 m) above the ground. A spare hover cycle or two (same basic stats, only it weighs 800 to 1200 pounds/360 to 540 kg at full size) may be concealed in the glove compartment, trunk or carried in a pocket or pouch.

Preferred Armor: Low level soldiers will wear light armor (A.R. 10, S.D.C.: 60) while more experienced soldiers will wear heavier armor (typically A.R. 16, S.D.C.: 120 to 200).

Familiarity With Earth: The Cameroons have no knowledge of Earth.

Rifts Notes: If used in the **Rifts RPG** setting, the Cameroons will be regarded as suspicious D-Bees. The Splugorth, and military forces around the world, would love to get their hands on these creatures for use as spies and assassins. The Splugorth will find the Darkith especially attractive and may purchase their services and invite them into the fold as one of their minions or allies, like the Sunaj. If the Darkith refuses, they may be viewed as potential competitors and eliminated or enslaved. Other races, slavers, Mercenaries and adventurers should be glad to add a couple of Cameroons to their forces. The Coalition States will see them as a threat to national security and probably launch a campaign of death and terrorism against all amphibian and lizard man races in the States.

If set in the **Rifts: Phase World** environment, they are just one of many alien life forms who visit that world. The Darkith may have some connection and influence with the forces on Phase World (G.M.'s decision).

In **Rifts**, the Cameroons would definitely have Mega-Damage weapons, armor and technology at levels equal to Triax or the Kittani. Standard S.D.C. to M.D.C. conversions as suggested elsewhere in this book.

The Darkith

Although most Cameroons will not use their abilities for personal gain, others are not so restrained. The Darkith is one of the most notorious criminal organizations in the galaxy. It is led by a renegade space pilot, by the name of Captain Jordon Rithrop and a group of Cameroon criminals, assassins and ex-soldiers turned Mercenaries. At first they engaged only in piracy, but the prosperous organization quickly expanded to include assassination, murder, extortion, espionage, sabotage, bounty hunting, military assistance, and smuggling in addition to piracy, robbery and other criminal activities. One might consider them a fledgling cosmic Mafia that offers their services for hire as Mercenaries and spies.

Criminals and super villains of all races and temperaments have become part of the Darkith, but it is the thousand or so Cameroons who hold most of the power and dominate the organization. Those who wish to join must prove themselves clever enough, powerful and trustworthy, a process that can take years.

Nobody knows exactly how large the Darkith has become, but all agree that the organization is becoming a wealthy and dangerous power, with spies and connections on most major worlds and important outposts. Even the Atorian Empire has been known to hire Darkith spies and assassins. There are hundreds of warrants and bounties offered by dozens of planets, nations and corporations for members of the Darkith. The Cameroons have tried to capture Rithrop themselves and break up the organization but to no avail. They continue to offer rewards for information regarding the whereabouts of Captain Rithrop and Darkith activities in their sector of space.

The notoriety of the Darkith has given the Cameroon people a bad reputation that has led to distrust, fear and apprehension when dealing with some races, businesses and organizations.

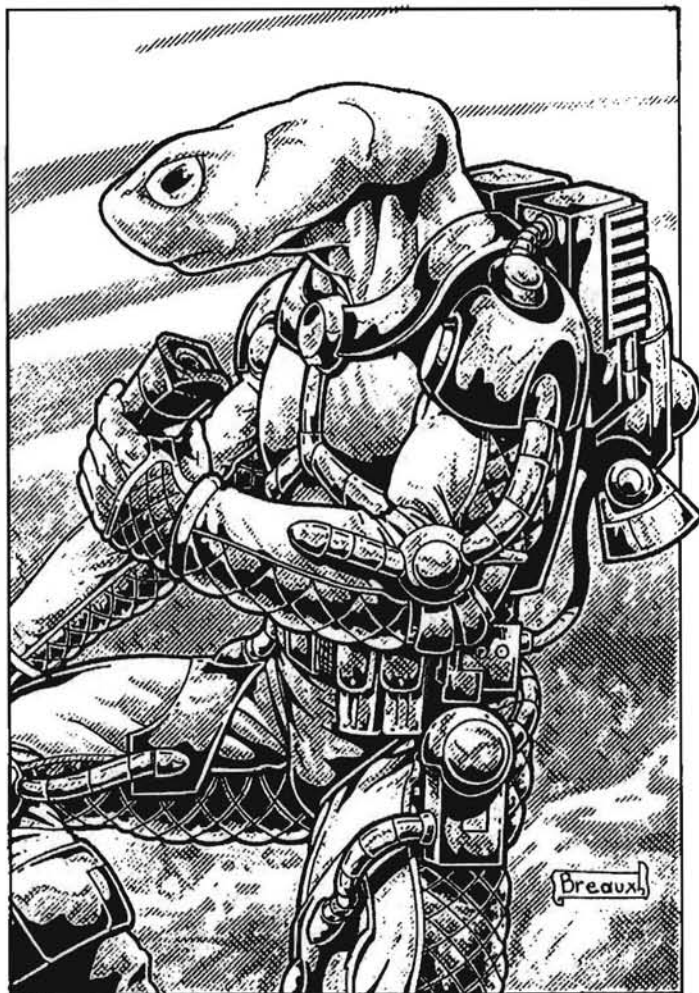

Deurycans

The Deurycans are a humanoid race from the thermal world Ry. They resemble Earth's newts in appearance, with long, flat heads and small mouths. The eyes are large

and round. Their lightly textured skin ranges from orange to a golden yellow. All members of this race have fire-projecting powers, nightvision, and amazing healing properties. Their ancestors crawled from the hot pools of boiling mud lakes thousands of years ago. They are born explorers who are intensely curious about everything and hungry for knowledge. Juveniles live in the hot pools, but as soon as they are mature, most leave Ry to explore the galaxy.

They are also natural engineers, which when combined with their curious nature, has resulted in amazing technological advancements. As soon as one development is perfected, another project or mission is begun. The amphibians are always searching for new challenges and adventure. It doesn't matter whether that endeavor is of paramount importance or trivial, philosophical or scientific, once it catches a deurycan's attention it becomes important. They have highly advanced space capabilities, hover vehicle technology, energy weapon systems and a host of other achievements.

Nearly all Deurycans feel an irresistible drive to experience as much as they can. To them, the universe is a vast and wonderful place filled with infinite mysteries waiting to be uncovered. Their government has organized study tours for its young, adventurous people. A typical deurycan spends 3D4 years exploring or developing one to several planets for colonization. Many go on to explore uncharted worlds or engage in other areas of space exploration or diplomacy (they love to study and interact with other races). This second tour can last 1D4x10 years before most Deurycans return to Ry to settle down, mate and bear offspring. Some never feel the need to return and spend their lives wandering the cosmos.

Deurycans are well liked and respected by many races. Their good nature, sharp minds and gentle dispositions have resulted in their being invited as ambassadors, diplomats and representatives for scores of people, businesses and governments.

Deurycan (pronounced due-rye-can)

Alignment: Deurycans are instinctively friendly, peaceful beings who seldom show (or feel) aggression or hostility toward others. Most don't generally suffer from feelings of anger, hate, envy, or revenge even under the most extreme situations. They may become confused or frustrated but are rarely violent. This trait makes them ideal explorers, diplomats and goodwill ambassadors. Most are principled, scrupulous or unprincipled in alignment. Anarchist and evil characters are a rarity.

Attributes: I.Q. 3D6+3, M.E. 3D6+3, M.A. 5D6, P.S. 3D6+3, P.P. 3D6, P.E. 4D6, P.B. 2D6, Spd. 3D6

Hit Points: Standard; P.E. plus 1D6 per level of experience.

S.D.C.: 2D4x10

Height: 5 feet plus 4D6 inches (1.6 to 2.1 m).

Weight: 100 plus 2D6x10 pounds (54 to 100 kg).

Average Life Span: 85 years. **P.P.E.:** 4D6

Super Abilities: All Deurycans have the following super abilities: Energy expulsion: fire, healing factor, and nightvision. They can also have an additional minor

ability (01-40%), two additional minor abilities (41-75%), a major ability (76-90%), or 1D4 minor psionic abilities.

Additional Bonuses: +20% to save vs coma/death, +3 to save vs magic, psionics, and toxins (this is in addition to P.E. bonuses); heat and fire do half damage (includes magic fire balls and plasma energy).

Penalties: Being accustomed to the heat of their homeworld means that the aliens begin to suffer from cold exposure at 75 degrees Fahrenheit (24 C). If they are in cold or chilly environments for an extended period, they will need a light survival suit with a temperature controlled heating system (see illustration). See the frozen world description for exposure rules.

Special Weapons: Deurycan laser pistols: Range: 500 feet (152 m). Damage: 4D6, 15 shot energy clip. Their laser rifle does the same damage but has a range of 3000 feet (914 m) and a 30 shot energy clip. The amphibians frequently use a medium stun pistol or rifle. Note, that while the Deurycans have a number of advanced energy weapons, they are not aggressive or hostile, and use them only in self defense.

Special Vehicles: A detachable jet pack is their favorite: Maximum speed: 140 mph (224 km), S.D.C.: 60, maximum altitude: 4000 feet (1200 m), +1 to dodge, and can be operate for six hours of continuous use without overheating.

Special Armor: Favorite is a light, thermal environmental suit: A.R. 15, 75 S.D.C. with excellent mobility (no prowl penalty).

Familiarity With Earth: Through their study programs, the Deurycans have information on Earth equal to the "Some Familiarity" result on the Familiarity With Earth table.

Rifts Notes: If used in the **Rifts RPG** setting, the amphibians will be seen as D-Bees. Most slavers and militaries will see little value in these peace-loving beings, except as mechanics, inventors, doctors and diplomats. Their description for use in **Aliens Unlimited** would be applicable to the **Phase World** environment.

In **Rifts**, the Deurycans would definitely have Mega-Damage weapons, armor and technology at levels equal to Triax or the Kittani. Standard S.D.C. to M.D.C. conversions as suggested elsewhere in this book.

Mantella

The Mantella are a warrior race who have become close allies with the Atorian Empire (some would say their lackeys or lap dogs). They thrive on war and enjoy the freedom and power their alliance with the Empire has given them. It was the decision of the Mantella to invade and eradicate the Xenopus (description follows); of course the Atorians supported and profited from the campaign. These predatory amphibians are not a particularly evil race, they are just incredibly aggressive, bloodthirsty and ruthless. They also tend to be arrogant and cruel, ignoring the rights of others and galactic laws to do as they please. One might think of these people as high-tech barbarian warriors (supplied and encouraged by the Atorian Empire). The Mantella believe that they deserve whatever they can

take. This means conquered people are their property to be slain, tortured, enslaved or sold; whatever the warriors desire. If a few lives are lost in a campaign for the advancement of their people, then so be it. Such is the way of war.

Mantella are ruled by a Council of the Learned. The Council is actually a political upper-class that comprises 10% of the population. Each clan elects representatives to the Council of the Learned, as does each branch of the military, many of whom are military engineers, strategists and tacticians.

As natives of a twilight world, they have large, prominent eyes and must wear dark goggles to protect them from bright light. As amphibians, they have wide, flat heads, large mouths and smooth, soft skin. Their eyes are a bright red and reflect light eerily. Skin colors are normally some shade of green, from pale and dull to bright and vibrant. Although most people don't think of amphibians as predators, even the common Earth frog stalks and feeds on insects, small rodents, fish and snakes. Like their animal kin, the Mantella are meat-eating predators with a hunter's nature and a taste for blood.

Mantella (pronounced man-tell-ah)

Alignment: Any, but most are selfish and evil.

Attributes: I.Q. 3D6, M.E. 3D6, M.A. 2D6, P.S. 4D6, P.P. 3D6, P.E. 5D6, P.B. 3D6, Spd. 6D6 (x2 swimming)

Hit Points: P.E. Plus 2D6 per level of experience.



S.D.C.: 1D4x10; **P.P.E.:** 2D6

Height: 6 feet plus 3D6 inches (1.9 to 2.3 m).

Weight: 100 plus 2D4x10 pounds (54 to 82 kg).

Average Life Span: 80 years.

Super Abilities: The Mantella population is divided between the following Super Power Categories: Hardware, physical training, bionics (typically partial conversions) and psionics. Less than 4% are mutants with random superpowers.

Natural Abilities: Nightvision 600 feet (183 m), see infrared and heat radiation (roughly equal to short-range thermo-imagers), sensitive hearing, 20 decibels beyond normal human ranges, and can hold their breath for 3D4 minutes.

Special Weapons & Vehicles of Note: Virtually any type of weapon or vehicles including Atorian and Kisentite items.

Preferred Armor: Typically heavy armor and plate half suits: A.R. 16, S.D.C. 260, with a detachable jet pack.

Familiarity With Earth: The Mantella have information equal to the "Some familiarity with Earth" result on the Familiarity With Earth table. It is very similar to their homeworld, but much too bright. Although they have researched the planet, no plans have been made to invade or tamper with it.

Rifts Notes: If used in the **Rifts** setting, the Mantella will be regarded as dangerous and aggressive D-Bees. Military forces around the world who accept D-Bees will find the violent and merciless Mantella to be excellent fighters. The Coalition States will see them as just another rampaging monster to be liquidated.

If set in the **Rifts: Phase World** environment, they are just one of many alien life forms who visit that world.

In **Rifts** the Mantella (and Atorians) definitely have Mega-Damage weapons, armor and technology at levels equal to the Coalition States or the Kittani. Standard S.D.C. to M.D.C. conversions as suggested elsewhere in this book.

Sorinam

Sorinams are short, frog-like amphibians with vibrant yellow skin accented by thick black stripes. They make their homes in the giant freshwater oceans of an arctic planet known as Namia. Surface temperatures on Namia are regularly below freezing. However, in the deep underwater caves and cities where the Sorinams live, there are rivers and seas of warm water from lava that seeps from geothermic fissures on the ocean floor. It is in these warm waters that the amphibians build their vast underwater cities and tend their vast algae and fish farms. Although their cities are underwater and the Sorinams are aquatic beings, the interiors of their cities are warm and dry with an Earth-like oxygen atmosphere.

Sorinam technology is slightly more advanced than that of Earth. Their bionics and robotics programs are still experimental, but as successful as Earth cybernetics and far more common. These aliens also study spell casting magic, and have a rudimentary understanding of ley lines.

The amphibians do not have an advanced space program or spaceships, but have sent numerous space probes and satellites deep into their galaxy. Through these devices, they have established communications with other races and have earned a place in the galactic community. They have joined the Federation of Allied Races (FAR) and constantly push for a stronger posture against the aggressive Atorian Empire. As active members of FAR, they are required to send operatives to designated member planets or to man a portion of the space fleet and assist in the advancement and defense of the FAR collective.

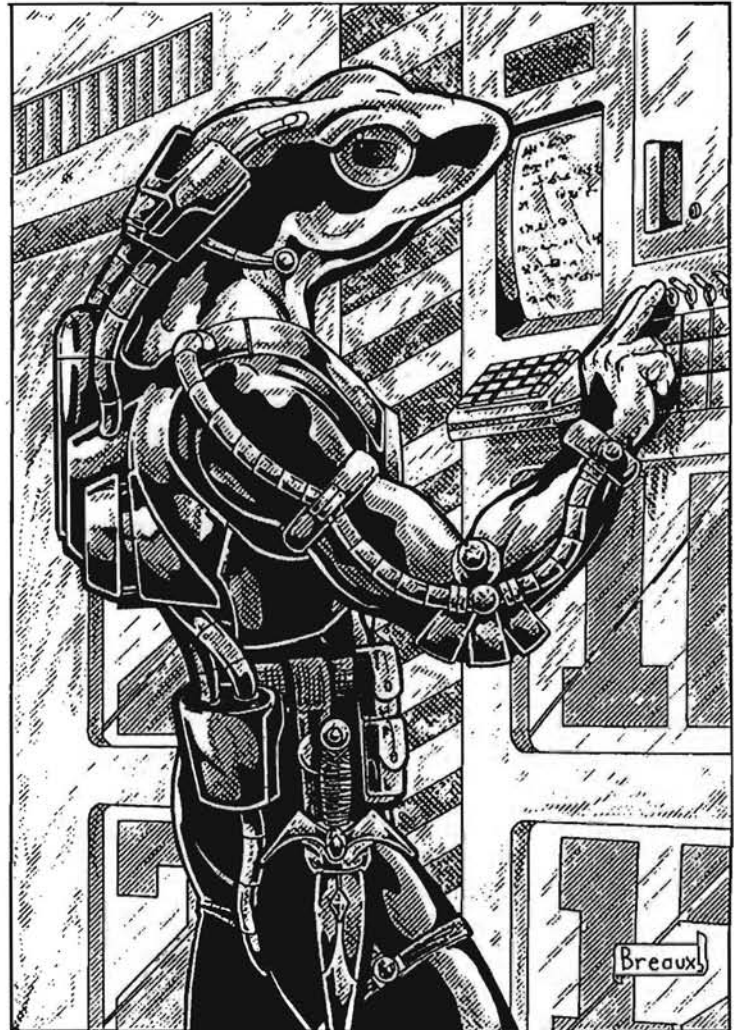

Sorinam space operatives are frequently military personnel, but include people from many other occupations. Half are volunteers who want to see the galaxy (they are picked up in spacecraft sent by FAR members). The typical volunteer is energetic, eager to learn, wants to see other worlds and help people. They are given only superficial knowledge about the cultures, laws, and customs of the people in their sector of space, but most Sorinams will take it upon themselves to learn much more. They are well-liked and respected in the FAR and among many non-allied races. Common tours of duty last 3D4 years.

Sorinam (pronounced sore-ih-nam)

Alignment: Any, but most tend to be good or unprincipled.

Attributes: I.Q. 3D6+2, M.E. 3D6, M.A. 3D6+2, P.S. 3D6, P.P. 3D6, P.E. 4D6, P.B. 3D6, Spd. 5D6 (x10 swimming)

Hit Points: Standard, P.E. plus 1D6 points per level of experience.

S.D.C.: 40+2D6

Height: 5 feet plus 2D6 inches (1.6 to 1.8 m).

Weight: 100 plus 2D4x10 pounds (54 to 82 kg).

Average Life Span: 95 years; **P.P.E.:** 2D6

Super Abilities: Limited to physical training, hardware, bionics and magic.

Natural Abilities: Keen, polarized vision, sensitive hearing, 10 decibels above the normal human ranges, swim at 10x normal running speed, and can hold their breath for 1D6x10 minutes.

Special Weapons and Vehicles: Virtually any weapons and equipment available to members of the FAR collective, as well as bionics, water vehicles (surface and underwater) and sonic weaponry of their own design.

Preferred Armor: Issued armor will be similar to that worn by the assigned planet's natives. In the case of Earth, a point-blank vest will be the likely choice (A.R. 10, S.D.C. 70).

Familiarity With Earth: Equal to the "Some familiarity with Earth" result on the Familiarity With Earth table.

Rifts Notes: If used in the **Rifts RPG** setting, the Sorinam will be regarded as D-Bees. The Coalition States will see them as dangerous beings because they are educated, promote learning and interracial cooperation and some even practice magic.

If set in the **Rifts: Phase World** environment, they are just one of the less advanced and curious aliens who visit that world.

In **Rifts** the Sorinams can be considered to have S.D.C. or primitive M.D.C. technology depending on the view of the G.M. These aliens will be fascinated by dimensional travel and other forms of magic.

Xenopus

Oria is a mid-sized planet on the edge of the quadrant (the same quadrant as our Earth). It was a dry but humid world with an abundance of minerals and ores. It was inhabited by a race of beings called Xenopus, who resembled giant humanoid horned toads. The future for these people seemed bright until the Mantella discovered the quality of Oria's ore. Without asking permission, a Mantella strike force landed in a remote area and began to build a mining complex. The Xenopus contested the Mantella's activities and demanded they leave their world immediately. The aliens responded by sending an invasion fleet of Mantella and Atorian vessels to obliterate them. The invasion quickly turned into genocide. Millions of Xenopus were slaughtered and millions more were taken prisoner and sold into slavery in the Atorian Empire and other parts of the galaxy. A comparatively minuscule percentage of the Xenopus race, forced from their homeworld, have accepted a life as slaves, pirates, Mercenaries, space explorers, vagabonds and refugees.

Many of the survivors were peaceful civilians with no combat skills, but their natural toughness makes them valuable slaves and laborers. Tragically, many of these once peaceful people have become embittered, vengeful and hate-filled. Many have learned to fight and have become ruthless pirates, privateers and Mercenaries who victimize the and Atorian Empire whenever they can. The tough-skinned amphibians have lumpy, tan hides with stripes of darker brown or grey as natural camouflage. They love Vibro-Blades, energy blades, and heavy weaponry.

Xenopus (pronounced zee-no-puss)

Alignment: Any

Attributes: I.Q. 3D6, M.E. 3D6+1, M.A. 3D6, P.S. 4D6, P.P. 3D6, P.E. 5D6, P.B. 2D6+2, Spd. 4D6 (x2 swimming).

Hit Points: P.E. plus 2D4 per level of experience

S.D.C.: 2D4x10 plus 2D6

Height: 7 feet plus 4D6 inches (2.2 to 2.7 m).

Weight: 300 plus 2D6x10 pounds (145 to 190 kg).

Average Life Span: 120 years.

Super Abilities: None, but all Xenopus have tough hides, high physical strength, endurance and special natural abilities. Of course, they can pursue the Super Power Categories of bionics (a rarity among Xenopus), hardware, physical training, and magic, plus 7% have psionic powers.

P.P.E.: 4D6



Natural Abilities: Keen vision and sense of smell, instinctive swimmers (+20%), climbers (+10%), can hold breath for 2D4 minutes, can leap 10 feet (3 m) from a standstill and are +2 to save vs poisons, drugs and disease. All Xenopus are natural and instinctive diggers/burrowers and have the following mutant animal powers: digging, tunneling and excavation (see *Heroes Unlimited*, page 169).

Special Weapons and Vehicles: Virtually any weapons and equipment available to members of the FAR collective, pirates and other intergalactic travellers.

Preferred Armor: Any, but tend to prefer heavy body armor and exoskeletons/power armor.

Familiarity With Earth: Equal to the "Some familiarity with Earth" result on the Familiarity With Earth table.

Rifts Notes: If used in the **Rifts RPG** setting, the Xenopus will be regarded as dangerous D-Bees. The Coalition States will see them as dangerous beings because they are big, monstrous-looking and aggressive, and some have psionic powers (typically major or master psionics). They can be considered to be S.D.C. or Mega-Damage creatures with natural armor/tough hides. Their technology can also be one or the other depending on the view of the G.M.

If set in the **Rifts: Phase World** environment, most Xenopus will be slaves or Mercenaries.

Aquatic Aliens

These humanoid aliens have evolved from aquatic life forms and live in a water environment. They can resemble fish, sharks, mammals (dolphin, whale, sea lion, etc.) or other aquatic animals. They all have webbed feet and hands for ease of movement underwater and may have fins, tentacles or tails. Depending on their origin, fish or mammal, their skin is either thick and smooth or scaly. Assuming all game attributes are based on human norms and perceptions, aliens of fish origin who have a high Physical Beauty score have scales so fine that they are unnoticeable. Aquatic aliens have no body hair. Bright body colors are common among the fish-like aliens, while the shark and mammal types are more subdued shades of grey, tan, brown and white.

Most fish-like aliens who have gills cannot breathe in an atmosphere for more than 20 minutes and even then their breathing will be labored (reduce speed by 1/3, -2 on initiative, -1 attack per melee, -2 to dodge or roll with impact and -6 to save vs gas attacks, even smoke will make them gag and choke). These aliens must have an atmospheric breathing apparatus to function in an atmosphere or remain constantly within the water. Such breathing apparatuses can be a helmet, environmental suit (filled with water), bionic lung implant, genetically engineered lung (as well as gills) or via magic; see the equipment section for data regarding environmental suits. Aquatic aliens will feel most at home in the water.

Characters who are aquatic mammals will have lungs, a nose or blow hole, and breathe air. These aliens will

have no problems breathing in an atmosphere, but they will not be able to breathe water like a fish; they hold their breath and must come up for air at regular intervals. Most aquatic mammals can hold their breath underwater for 20 minutes. If forced under for a longer period they will drown. Surgical removal of the webbing is unappealing to the aliens and will reduce swimming speed and underwater bonuses by half.

Note: Swimming abilities are often remarkable. Swimming speed for most aquatic races is their running speed multiplied by ten, and they have a natural swimming skill of 95%, unless stated otherwise.

Cherion

Chee is a planet with 90% water. Within its vast oceans, the people have evolved. They have an advanced technological society, and are masters of robotics, bionics, and space travel, with weapons, tools, and devices beyond Earth's current capabilities. Although they are an advanced society, their attempts to augment themselves through chemical experiments and genetic engineering have created generations of Cherions with unpredictable side effects and super-powered mutants.

All Cherions are required to enter into the Cherion Exploratory Militia (CEM), the space division of their armed forces. While this keeps the people active and working, it also creates some protest. Many Cherions feel they have no place among the stars, and should concentrate on the needs and defenses of their own homeworld. This is largely the result of threats and trouble with other races in the galactic community. Furthermore, the percentage rate for desertion is a whopping 16%! Many critics of the space program insist they are losing the resources of their youth and scientists to other worlds.

Any Cherion explorers assigned to a tour in a specific sector of the galaxy will be taught the names, languages, and general cultures of the major inhabited planets in that sector. A deserting explorer is likely to be able to read, speak, and write one or more languages of the planet he is deserting to. Only deserters responsible for serious crimes are pursued with vigor. Desertion is high because the vast majority of CEM career soldiers and officers are strict, mean and cold-hearted, and some are downright evil.

Cherion explorers without super abilities are nearly always outfitted with environmental body armor and/or battle robots or ATV exploration robot vehicles. As a result, they rarely need any type of hand-held weapons, but they are issued laser rifles or sonic weapons as a precaution.

Cherion (pronounced chare-eye-on)

Alignment: Any. The Cherion government and the CEM commanders are frequently anarchist, miscreant or aberrant.

Attributes: I.Q. 3D6, M.E. 3D6+2, M.A. 3D6, P.S. 4D6, P.P. 4D6, P.E. 3D6, P.B. 2D6, Spd. 2D6 (Swimming Speed is Spdx12).

Hit Points: P.E. plus 1D6 per level of experience.

S.D.C.: 2D4x10

Height: 5 feet, 6 inches plus inches (1.7 to 2.1 m).

Weight: 130 plus pounds (68 to 113 kg).

Average Life Span: 70 years. **P.P.E.:** 2D6

Appearance: They have large eyes, thick scales, and a prominent mouth. Spiny fins protrude from their forearms and along their spine. The hands are large, with prominent webbing. Their feet and legs resemble those of a frog.

Super Abilities: These aquatic aliens can select any of the Super Power Categories, but 45% have superhuman powers as a result of chemical mutation or genetic experimentation (roll under the mutant or experiment categories in **Heroes Unlimited**), and 15% are bionic (with artificial lungs). 33% of those who serve in the CEM pilot power armor suits or large one- to four-man robot All-Terrain Vehicles (ATV).

Natural Abilities: Swim 12x faster than running/land speed, swim at 95% skill, have gills, can sense electromagnetic energy and ley lines, and are +2 to strike, parry, and dodge underwater.

Special Weapons: Sonic, missiles/projectiles and laser weapons.

Special Vehicles: A variety of underwater vessels and advanced spaceships.

Special Armor: Full environmental suit for surface movement and space exploration; A.R. 16, S.D.C. 250.

Familiarity with Earth: Soldiers and explorers in the IIta quadrant where Earth is located have knowledge about Earth equal to "Some familiarity."

Rifts Notes: If used in the **Rifts** setting, the Cherions will be regarded as monstrous D-Bees. The Coalition States will see them as dangerous beings because of their inhuman appearance, super powers and tech-level. The CS is likely to exterminate them whenever they are encountered. These aquatic aliens will find the Great Lakes and Earth's oceans and seas inviting places to live. They can be considered to be S.D.C. or Mega-Damage creatures. Their technology can also be one or the other depending on the view of the G.M., but is probably Mega-Damage technology.

If set in the **Rifts: Phase World** environment, most Cherions will be adventurers, Mercenaries or slaves.

Errasa

Long ago, the planet Er was very much like Earth. Its waters were a deep, ultramarine blue, and full of life. The people known as the Errasa fled to the stars when the ecology of their homeworld collapsed and Er went through dramatic and deadly changes. Millions perished before the titanic space exodus could be launched. 80% of the planet's surviving population took to the stars. Of those who stayed behind, half have perished while the others struggle to adapt. An estimated 122 million space refugees have scattered to the four corners of the galaxy and have yet to find a place to call home. **Note:** They are not invaders and won't even consider conquering an inhabited world.

They have developed technology to a step just above that of Earth. They are able to create robots, have mas-

tered space travel, and dabble with robotics and bionics, both of which are still very new and experimental for them. Hover technology is a new skill they have learned, and many of them prefer it for above and below water travel. Errasa weapon technology is influenced by their underwater heritage, and many of their ranged weapons are based on condensed sonic discharges.

The Errasa vary widely in stature from less than five feet (1.5 m) to nearly nine feet (2.7 m) tall. They are thin, lightly-built aliens because of their high protein, low fat diet. Their scales are thick and close-fitting, with colors ranging from light grey with black accents to blue with yellow accents. Their eyes are small, round and dark.

Errasa (pronounced er-rass-ah)

Alignments: Any, but many tend to be good or selfish.

Attributes: I.Q. 3D6, M.E. 3D6, M.A. 3D6, P.S. 4D6, P.P. 3D6, P.E. 3D6, P.B. 2D6+2, Spd. 4D6 (Swimming Speed is Spdx6).

Hit Points: Standard, P.E. plus 1D6 per level of experience.

S.D.C.: 3D4x10

Height: 5 feet plus feet (1.5 to 2.4 m).

Weight: 100 plus pounds (54 to 82 kg).

Average Life Span: 85 years. **P.P.E.:** 3D6

Super Abilities: Super Power Categories are limited to bionics (rare and experimental), hardware, physical training, psionics and magic (none currently use magic but they *may* discover the Mystic arts from other aliens).



Natural Abilities: Like the lungfish on Earth, the Errasa have naturally developed both gills and lungs. They can stay underwater indefinitely, or on dry land for 24 hours before needing to immerse themselves in water (needs to be in water for at least three hours per every 48 hour period). They also have keen vision and hearing, and swim at 90% skill proficiency.

Special Weapons: Sonic Blaster Rifle: Range: 70 feet (21 m; 140 feet/43 m underwater). Damage: 5D6 per blast. 20 shot E-clip. Damage is 6D6 when used against targets with some form of heightened or advanced hearing, including other Errasas.

Vehicles: They use a variety of different vehicles but the hover platform is one of their favorites above water. It can hold up to four large people. Maximum speed: 120 mph (192 km), S.D.C. 120. Maximum altitude: up to 300 feet (91 m) above the ground.

Preferred Armor: In combat situations, special forces-style, full suit body armor of their own design: A.R. 15, S.D.C. 180.

Familiarity with Earth: None. If one of them should arrive here, his language will sound very much like Chinese.

Rifts Notes: If used in the **Rifts** setting, the Errasa will be regarded as D-Bees, but of no special interest to the Coalition. These aquatic aliens will find the Great Lakes, rivers and Earth's oceans to be comfortable places to live. However, they would never consider invading the Earth or any inhabited world where they were not welcomed.

They can be considered to be S.D.C. or Mega-Damage creatures. Their technology can also be one or the other depending on the view of the G.M., but is probably S.D.C. technology.

If set in the **Rifts: Phase World** environment, they will be explorers, adventurers, Mercenaries or refugees looking for a new homeworld.

Innensi

Many centuries ago, Nen was a beautiful planet, not unlike Earth. Then the Atorian Empire arrived (see the Atorian Empire entry in the Galactic Organization section). Nen was converted to an energy world for the Empire. Enormous, sprawling power plants and factories the size of cities covered the face of the planet to churn out nuclear energy and to manufacture weapons and equipment. The atmosphere is choked with fumes and chemicals and the water has been transformed into a toxic soup.

The Innensi and other inhabitants of Nen tried to fight the invaders when they first arrived but tens of thousands were slain. They have since tried to reclaim their world several times, but the Empire is too powerful. Of the four different races who once called Nen home, only the Innensi remain. Sadly, their race has been devastated, with millions killed, millions of others enslaved and taken off-world, and frightened survivors hiding in the ocean depths. Innensi slaves living in the Atorian Empire outnumber those living on Nen and as refugees spread across the galaxy combined.

The Innensi are of average size and weight by human standards. The toxic environment in which they are forced to live has destroyed the pigment in their skin (they are albinos), and causes their scales to fall out, as well as sickness and mutation. Exposure to radioactive materials and chemicals has made the Innensi who survived and adapted resistant to the effects of different radiation and toxic chemicals. Those who live on Nen are so saturated with radiation that they themselves give off constant low levels of radiation. Mutants with psionic or super abilities are increasingly common, as are brain damage, cancer and stillbirths.

The Innensi have little or no technology of their own, only simple weapons and tools. They rely on their special abilities to defend themselves. All the higher technology possessed by Innensi refugees has been stolen, salvaged, or purchased. Plenty of it will be Atorian Empire standard issue gear stolen from guards and soldiers.

Innensi (pronounced in-nen-sea)

Alignment: Any, many are good.

Attributes: I.Q. 2D6+3, M.E. 3D6, M.A. 2D6, P.S. 3D6 (+10 underwater), P.P. 3D6, P.E. 3D6, P.B. 2D6, Spd. 3D6 (Swimming Speed is Spdx10).

Hit Points: Standard; P.E. plus 1D6 per level of experience.

S.D.C.: 1D6x10

Height: 6 feet plus 1D6 inches (1.6 to 2.0 m).

Weight: 190+1D6 pounds (87 to 89 kg).



Average Life Span: Off-world slaves: 75 years; those born and raised on Nen (even for the first 18 years of their lives): 50 years. **P.P.E.:** 1D6

Appearance: White skin with smooth features and large, pale pink eyes. Their mouths are large and filled with two rows of tiny, sharp teeth. Their heads are crowned with 2D4+2 short spikes.

Super Abilities: Super Power Categories are limited to mutants and psionics. Most of those living on Nen have mutant super powers (01-56%) or psionics (57-72%). The rest have no special abilities (Hardware, physical training, etc.).

Off-world, only 35% of the slaves have super abilities and 12% have psionic powers. Slaves and freemen off-world without super abilities may learn magic, physical training, hardware or get bionics.

Natural Abilities: Swim 10x faster than running/land speed, swim at 95% skill, have gills (can breathe air for 2D6+20 minutes), can see the ultraviolet spectrum of light, and are +3 to save vs poison and drugs. Underwater they are +2 on initiative, +2 to strike, and +4 to parry and dodge (not applicable above water).

Special Weapons, Armor and Vehicles: Whatever they can acquire, from the Atorian Empire to FAR items. The luckiest will have an Atorian antigravity ring.

Familiarity with Earth: None for most Inenksi. Some refugees and Atorian slaves may have "Some Familiarity."

Note: The Inenksi are a desperate people in slavery, who would leap at the chance to be free. Those who do escape the clutches of the Atorian Empire often become explorers, freebooters or Mercenaries. Many Inenksi remember, through songs and stories, how green and blue Nen was long ago. Some hope they may find a world like that again and settle down there. Ironically, once they are free, most never settle down and wander the universe. A small group of Inenksi are members of the Raider Clans and another is part of a pirate band who plunder only Mantella and Atorian vessels.

Rifts Notes: If used in the **Rifts RPG** setting, the Inenksi will be regarded as monstrous D-Bees. The Coalition States will see them as dangerous beings because of their inhuman appearance and super powers. They are likely to exterminate them whenever they are found. These aquatic aliens will find the Earth's lakes, rivers, seas and oceans wonderful places to live. They are S.D.C. creatures who must acquire Mega-Damage weapons and equipment. The items they may have stolen can be S.D.C. or M.D.

If set in the **Rifts: Phase World** environment, most Inenksi will be adventurers, Mercenaries or slaves.

Nattereri

The Nattereris live and thrive within the violent oceans of Noth. They have developed thick, heavy scales and bony ridges to protect them from their hostile environment and monstrous predators. Their eyes are prominent, but sunken behind bony ridges. Their wide mouths are filled with rows of razor sharp teeth like Earth sharks. The color of their scales is silvery-grey on their backs and salmon

color to red on their fronts and sides. Instead of wide fins for maneuvering, the Nattereris have hard, keel-like bones on the head, back, forearms and lower legs.

They are a proud warrior race, but the wars that ravaged their planet are long over. The Nattereris continue to hold on to their ancestors' traditions and beliefs as a sacred creed of the warrior. They adhere to a tradition of martial combat, physical training and self-discipline of both the mind and body. Like the samurai of Earth, they view honor and skill as goals of personal perfection.

The Nattereris are the leaders of the Coalition. This secret galactic movement opposes many of the more oppressive ventures started by the Atorian Empire. The Nattereris are the only factor that holds many of the Coalition members together. The confidence, strength, and honor of these beings are the major force behind the Naimese movement. Noth has been untouched by war for a century, but that would change if the Atorian Empire discovers just how important they are to the Naimese Coalition.

Nattereri operatives are stationed on and around numerous planets across the galaxy to protect them from all kinds of dangers, as well as to collect information about the Atorian Empire. They also have diplomats (and spies) among the Federation of Allied Races. In fact, it was contact by members of FAR that brought the Nattereri into the space age and helped them to develop space technology.

The Nattereri warriors feel it is their duty to help others. They see the Atorian Empire as an evil force and a worthy opponent. Many of the warriors long for an opportunity to engage the Atorians and have won many skirmishes against the Mantella. However, these clever and disciplined warriors realize they must gain more knowledge, weapons and power before they face the evil Empire one on one. Until that day, they engage in subtle guerrilla warfare, sabotage, espionage and politics (see the Naimese Coalition described in the galaxy organizations section). They are a growing force in the galaxy, both technologically and spiritually.

Nattereri (pronounced nat-tare-er-ee)

Alignments: Any, but the great majority are principled, scrupulous or unprincipled. Many Nattereri rogues, pirates and villains will be aberrant or anarchist, but other evil alignments are possible, especially if the character has been unable to master his or her self-control and aggressive, predatory nature. These misanthropes are given to rages, self-indulgence and extreme acts of cruelty.

Attributes: I.Q. 3D6, M.E. 4D6, M.A. 4D6, P.S. 5D6 (+6 underwater), P.P. 3D6+2, P.E. 3D6+2, P.B. 2D6, Spd. 3D6 (Swimming Speed is Spdx10).

Hit Points: Standard, P.E. plus 1D6 per level of experience.

S.D.C.: 2D6x10 plus 6 per level of experience/age.

Natural A.R.: 15

Horror Factor/Awe: 14

Height: 6 feet plus 1D4 feet (2.1 to 3.0 m).

Weight: 200 plus 4D6x10 pounds (109 to 200 kg).

Average Life Span: 110 years. **P.P.E.:** 2D6



Super Abilities: All Nattereri warriors can make selections from the Super Power Categories of bionics (usually partial reconstruction or bionic lungs and minor implants), hardware, or physical training. Magic is unknown to these people but it could be learned from others.

In addition, all warriors get the following from their years of special martial arts training: +2 on initiative, +2 W.P. skills, the equivalent of healing factor and any one "extraordinary" power listed under minor super abilities.

Optional: The warrior can select the following abilities from **Ninjas & Superspies:** Three powers from *body hardening*, two powers from *zenjoriki*, two powers from the *arts of invisibility* and one *atemi* (see N&S, page 114). Plus he/she gets the "quickie" form of Tae Kwon Do karate (page 84).

Natural Abilities (evolved from a predator): Swim 10x faster than running/land speed, swim at 95% skill, have gills (can normally breathe air for 20 minute), excellent vision and hearing, a superior sense of smell (equal to advanced smell), can smell blood underwater up to three miles (4.8 km) away. On dry land and in the air they can track blood scent 65% skill proficiency, recognize the scent of a specific race 55%, of a specific person 40% +2% per level of experience (all are +10% underwater). The character's bite does 3D6 damage (+1D6 if 8 ft/2.4 or taller) and the bony fins on the arms and head can be used to parry melee weapons such as swords and clubs. Underwater the characters are +2 on initiative, and +2 to strike, parry and dodge (not applicable above water).

Special Weapons: Ion rifles: Range: 400 feet (122 m). Damage: 5D6 per blast. 20 shot E-clip. They are designed for use in turbulent underwater combat (double range when in an atmosphere). They also use sonic weapons and like heavy energy weapons and explosives. However, their favorite form of combat is hand to hand fisticuffs or with melee weapons.

Special Vehicles: Hover cycle (two-man): Maximum speed 200 mph (320 km). S.D.C. 120. Hover up to 45 feet (13.7 m) above the ground. +2 to dodge. They use a variety of items and are skilled in many weapons.

Preferred Armor: The resilience of the Nattereri's natural body armor means many warriors don't use artificial armor except environmental suits for space travel and planetary expeditions. Vast numbers of the Nattereri have gotten gills to lung bionic conversions and 1D6 minor implants.

Familiarity with Earth: They have detailed knowledge on many planets including Earth. An Earth operative will know information equal to the "Has studied Earth" result on the Familiarity with Earth table. Most others only have a passing knowledge.

Rifts Notes: If used in the **Rifts RPG** setting, the Nattereri will be regarded as monstrous D-Bees. The Coalition States will see them as dangerous beings because of their inhuman appearance, size and abilities, and because they promote peace and unity among other D-Bees. They are likely to exterminate them whenever they are found. These warriors will find the turmoil and villainy on Rifts Earth to be a challenge. They will travel the land like Cyber-Knights, righting wrongs and protecting the innocent.

They are definitely Mega-Damage creatures in the Rifts environment. Their weapons and equipment are also likely to be Mega-Damage items.

If set in the **Rifts: Phase World** environment, the basic setting described for **Heroes Unlimited** is applicable. Most will be good hearted adventurers, explorers, freedom fighters or Mercenaries.

Salar

Lyris is a planet that is approximately 60% water. Because of the great size of the planet, its oceans are vast and deep, but they exert less than normal Earth pressure at the great depths because of a lighter gravitational pull. Within these oceans, tall, elegant buildings cling to the faces of underwater cliffs. They are the homes of the Salars.

The Salars are tall and thin, and covered with gray scales on their backs that change to a bright pink on their sides, and white on their heads and palms. Fins are commonly located at the base of the head and upper back, as well as on the calves and forearms. They have large eyes set into squared heads above a wide mouth. Hands and feet are webbed. Lacking advanced technology, the Salars generally rely upon their natural abilities and magic.

The salar leaders are mysterious Mystics (these NPC characters get the major power common to all Salars in addition to spell casting ability). Most seldom leave their homeworld, but some do travel, and may occasionally be encountered on political or exploratory assignments in the field. They are very reserved and sometimes downright weird. They often speak in riddles or answer questions with questions, and wrap themselves in robes of secrecy. However, their advice and leadership is usually sound and they are revered by normal Salars. The Mystics operate a network of dimensional portals on their homeworld that are used to travel to and trade with other planets. Having little to offer more advanced peoples in the way of goods, they have done well by offering their services as soldiers/defenders, Mercenaries, advisors and Mystics.

The Mystic portals and presence of magic have made it so the Salars did not need to develop space technology or high-tech manufacturing. However, they are part of the galactic community and have traded for numerous materials and items, including energy weapons, hover vehicles, limited bionics and so on. Some Salars have also taken to the spaceways to make fortunes as Mercenaries, merchants or adventurers.

Salar (pronounced sah-lar)

Alignment: Any, but the typical outlook of the Salars would best be described as unprincipled.

Attributes: I.Q. 3D6, M.E. 3D6, M.A. 3D6, P.S. 3D6, P.P. 4D6, P.E. 3D6, P.B. 2D6, Spd. 6D6 (Swimming Speed is Spdx10).

Hit Points: Standard; P.E. plus 1D6 per level of experience.

S.D.C.: 1D4x10+20

Height: 8 feet, 2 inches plus 2D6 inches (2.5 to 2.8 m).

Weight: 1D4x100 pounds (54 to 181/108 to 362 kg). (Double in water form).

Horror Factor: 10, as a result of their extremely inhuman appearance.

Average Life Span: 75 years. **P.P.E.:** 3D6

Super Abilities: All Salars have the major super ability of *alter physical structure: liquid*. Salars in their water form are invisible to heat and infrared sensors. Other abilities are as listed in **Heroes Unlimited**: water bolt, water behemoth, water merge, manipulate shape, and limited invulnerability. 70% also have one minor ability selected from the category of *energy expulsion* (pick one). See Step Three of Character Creation in this book for determining additional super abilities. Only their NPC Mystic leaders study spell casting (and portal making) magic.

Natural Abilities: Swim 10x faster than running/land speed, swim at 95% skill, have gills (can breathe air for 20 minutes), have sharp vision and keen sense of smell. Underwater they are +2 on initiative, +1 to strike, and +2 to parry and dodge (not applicable above water).

Standard Weapons and Vehicles: A variety of items from around the galaxy and beyond (could include *Phase World* and other Palladium worlds). They like jet packs, speedboats, hover vehicles and vehicles that go fast.

Armor: Specially designed environmental armor keeps the characters moist and breathing on dry land for indefinite periods of time. A.R. 15, S.D.C. 180.



Familiarity with Earth: The Salars have had extensive dealings with many races in the megaverse. As they work with or for people who have studied or been to Earth, knowledge of the planet will spread to the rest of the Salars. Most of the field operatives, Mystics and explorers have "Some familiarity" with Earth as detailed in the Familiarity with Earth table.

Rifts Notes: If used in the **Rifts RPG** setting, the Salars will be regarded as monstrous D-Bees. The Coalition States will see them as dangerous beings because of their inhuman appearance and super powers. They are likely to exterminate them whenever they are encountered. These aquatic aliens will find the Earth's lakes, rivers, seas and oceans an acceptable places to live.

If set in the **Rifts: Phase World** environment, most will be adventurers or Mercenaries.

Salars are S.D.C. creatures who must acquire Mega-Damage weapons and equipment, however, their super powers may inflict Mega-Damage. The Salar Mystic can be played in **Rifts** as a dimension traveling practitioner of magic that is an equal to the Ley Line Walker O.C.C. or Temporal Wizard O.C.C. These characters may have links to *Phase World*, Naruni Enterprises, Cibola, the Splugorth (not likely), Techno-Wizards (they love magic of all kinds) and others.

Salvelinus

Salva is a planet of oceans with a high water density and a strong gravitational pull. The Salvelinus live in large cities built on the bottom of shallow oceans, two to three hundred feet below the waves. They are short, powerfully built humanoids covered with blue scales that are often decorated by bright red, pink, yellow, or orange spots on their backs. Fins are located at the base of the head, forearms and calves of the legs.

Although not light years ahead of Earth, the Salvelinus have slightly more advanced technology. They have developed their robotics and space travel beyond Earth levels and have begun extensive experimentation in the area of genetic augmentation and bionics. This includes gills-to-lungs cybernetics and power armor suitable for space exploration and surface dwelling. Their experiments have instilled a variety of super abilities in many test subjects with minimal dangerous side effects, but magic and are virtually unheard of on Salva.

The Salvelinus space program offers many types of study programs, from sociology to the sciences and survival. To protect the study groups, combat specialists with powerful spear guns are assigned as escorts and advisors. Most study group members receive light armor or environmental suits. The combat specialists have heavy armor.

Salvelinus (pronounced sal-veil-lih-nus)

Alignment: Any, but the majority seem to be selfish.

Attributes: I.Q. 3D6, M.E. 3D6, M.A. 3D6, P.S. 4D6, P.P. 3D6, P.E. 3D6, P.B. 2D6, Spd. 6D6 (Swimming Speed is Spdx10).



Hit Points: Standard; P.E. plus 1D6 per level of experience.

S.D.C.: 1D6x10+10

Height: 5 feet plus 2D6 inches (1.5 to 1.8 m).

Weight: 150 plus 1D4x10 pounds (72 to 86 kg).

Average Life Span: 70 years. **P.P.E.:** 1D6

Super Abilities: Super Power Categories are limited to mutants and experiments for super powered beings. Approximately 35% have undergone partial bionic reconstructions. Others can be normal, or select from the power categories of hardware or physical training. Psionics and magic are not available.

Natural Abilities: Swim 10x faster than running/land speed, swim at 95% skill, have gills (can breathe air for 20 minutes), have sharp vision and keen sense of smell. Underwater they are +1 on initiative, +1 to strike, and +2 to parry and dodge (not applicable above water).

Special Weapons: Salvelinus spear-gun (rifle): Damage: barb-tipped damage. Explosive 1D4x10. Range (underwater or in the air): 200 feet (61 m). Typical combination of spears is 10+4D6 barb-tipped and 2D6 explosive tipped.

Spear-gun (pistol): Damage: 2D6 barbed. 4D6 explosive. Range: 60 feet (18 m). Of course they can also use other types of weapons, although they seem to be particularly fond of explosives.

Special Vehicles: Vary with the need and the environment.

Preferred Armor: Combat specialists wear riot gear, full environmental armor: A.R. 14, S.D.C. 150. Light body armor: A.R. 11, S.D.C. 70.

Familiarity with Earth: The Salvelinus have visited many planets. They sympathize strongly with the plight of planets that are polluting their oceans. A typical aid and study program will last for six years, with only dire emergency contact with Salva permitted. The Salvelinus have only recently begun their study trips to Earth, and they have little familiarity with its cultures or laws, although they have learned one or two languages (at 50% proficiency).

Rifts Notes: If used in the **Rifts RPG** setting, they will be regarded as monstrous D-Bees. The Coalition States will see them as dangerous beings because of their inhuman appearance and super abilities. Slavers may find them attractive for underwater exploration and slave labor. Salvelinus are definitely S.D.C. creatures even in the Rifts environment, although their super powers, weapons and armor may be Mega-Damage items.

If set in the **Rifts: Phase World** environment, the basic setting described for **Heroes Unlimited** is applicable. Most will be adventurers, explorers, scientists or Mercenaries.

Tinalis

Tinal is an icy, dimly lit planet far from its sun. Below the ice are cold, still oceans where the Tinalis make their homes. The frigid liquid of Tinal is thicker than Earth water and can reach temperatures of one-hundred degrees below zero (-73C) without turning solid. The Tinalis have smooth, rounded features, tiny scales and are pale blue in color. An insulating layer of fat helps to keep them warm. On average, they are slightly shorter than humans and a bit heavier. Their head and eyes are smaller than other aquatic species.

The Tinalis have an advanced society and technology that exceeds that of Earth. Besides their starships and nuclear power, they have developed bionics and robot vehicles. New developments in robotics have the Tinalis developing life-like androids. Robots perform much of their difficult and dangerous labor.

The Tinalis have good relations with other alien societies in the galactic community and perform many services for their allies, including space exploration, hauling freight, transportation, making artificial intelligences, and manufacturing components for robots and cyborgs. Tinalis Exploratory Teams (TETs) are typically a combination of scientists, military specialists and robots/androids hired out to other governments for scientific exploration, rescue missions and reconnaissance. They may also agree to mercenary work to defend, or guard property, spaceships or outposts. It is rumored that certain *freelancers* will perform seek-and-destroy missions, sabotage and assassinations.

Tinalis (pronounced tin-al-iss)

Alignment: Any, but the majority of Tinalis are scrupulous or principled.

Attributes: I.Q. 3D6, M.E. 3D6, M.A. 3D6, P.S. 3D6+2 (+6 underwater), P.P. 3D6, P.E. 4D6, P.B. 2D6, Spd. 3D6 (Swimming Speed is Spdx10).

Hit Points: Standard.

S.D.C.: 80; **P.P.E.:** M.E.x2 or by Magic Power Category.

Height: 5 feet plus 3D6 inches (1.5 to 2.0 m).

Weight: 120 plus 2D6x10 pounds (54 to 100 kg).

Average Life Span: 75 years.

Super Abilities: Super Power Categories are limited to bionics, robotics, and hardware! Psionics, magic and super powers are not available.

Natural Abilities: Swim 10x faster than running/land speed, swim at 95% skill, have gills (can breathe air for 15 minutes), have sharp vision, can see in murky water and through smoke, keen sense of smell (equal to the mutant animal power of advanced smell) and are impervious to cold and cold-based magic (heat and fire does double damage). Underwater they are +1 on initiative, +1 to strike and parry, and +2 to dodge (not applicable above water).

Special Weapons: Sonic and laser weapons with 20 shot energy clips. Sonic blaster range is 70 feet (21.3 m), does 5D6 per blast, or 6D6 when used against targets with some form of heightened or advanced hearing. Laser rifle range is 2200 ft (488 m), and does 2D6 per shot.

Special Vehicles: Varies with needs. A favorite is an A.T.V. hover vehicle with a maximum speed of 140 mph (225 km), S.D.C. 440. Hover up to 12 feet (3.7 m)



above the ground. Space and underwater operations are possible.

Preferred Armor: Research personnel are issued concealed armor: A.R. 10, S.D.C.: 50. Military personnel are issued armored environmental suits: A.R. 12, S.D.C.: 120.

Familiarity with Earth: The Tinalis believe Earth has the potential to become a productive member of the space-faring community, and are considering giving Earthlings a guiding hand to that end. Thus, they have "Some Familiarity" with Earth and plan to visit soon.

Rifts Notes: The Tinalis will be regarded as monstrous D-Bees. The Coalition States will see them as dangerous beings because of their inhuman appearance and knowledge of science and weaponry. They are likely to exterminate them whenever they are encountered.

They are likely to possess Mega-Damage technology, but that decision is left to the Game Master.

If set in the **Rifts: Phase World** environment, the basic setting described for **Heroes Unlimited** is applicable. Most will be good hearted adventurers, explorers, scientists or Mercenaries.

Ape Aliens

The humanoid ape races have many things in common with their Earth counterparts. Many resemble gorillas, baboons, chimpanzees, orangutans, or any other species of apes. All are fully bipedal with human-like, upright posture. A layer of short hair or fur typically covers the head and back, and sometimes the entire body. Eyes are usually small and round, the nose is flat, and the mouth is large and can have large flat teeth or sharp canines. These aliens do not have tails (monkeys have tails, not apes) and may not climb trees. Of all the alien races with a non-human appearance, the ape races are most likely to have a human appearance. The ape races seem to be among some of the most violent and war-like. Some scientists have suggested that aggression and war developed during the evolution of the ape, perhaps it is even genetic.

Anubios

The abrasive, battering conditions of the planet Norima have pounded the Anubio mountain people into tough, hardy warriors. These beings resemble giant, lanky Earth baboons, with long snouts, sharp teeth, and close-set eyes. Their bodies are covered in a tough, hairless hide with hard plates covering parts of their head, neck, shoulders, and hips. They normally stand about eight feet (2.3 m) tall. These people love physical and mental challenges almost as much as the sense of accomplishment they get when they meet a challenge. Anubios express this need for challenge and adventure by physical contests that test their rugged bodies and combat skills.

For thousands of years the Anubios were divided into warring tribes that seemed to fight an endless series of

skirmishes. When they weren't fighting each other, they were fighting other natives or exploring their world (and conquering lands). If a war was too easy, the Anubios warriors would become bored and call it off, claiming victory and seizing booty or land. The losers were considered pathetic and weak, but allowed to live. If the "losers" persisted in fighting, rather than accept the declaration of their defeat, the Anubios would fight with renewed vigor, slaughtering man, woman and child until every last one was slain, or they begged for mercy and conceded defeat. People who can't or won't fight are considered cowards or weaklings. Those who put up a valiant fight, or can fight them to a stalemate will be deemed equals and heroic



warriors. In many cases, a stalemate will result in peacetime, because the Anubios respect their opponent and are willing to discuss matters and make concessions with an equal. Any race who can get the better of an anubio army (they seldom admit defeat) will be considered an honored opponent, a supernatural force, or their greatest enemy (of whom vengeance must be sought).

Individual Anubios are boisterous glory hounds quick to argue, wrestle, fight, or leap into action — the more challenging the situations, the better. Brawling is a favorite pastime; there is great pride for the Anubios who is the last one standing. In true combat situations, they are smart, relentless opponents capable of almost anything, from the daring to the sublime. They use whatever weapons are at hand or necessary for the job, whether it be en-

ergy weapons, Vibro-Blades, explosives or tooth and claw. Bionic augmentation may also be considered, although most Anubios prefer to rely on their god-given abilities, skill and cunning rather than on machines.

The Anubios joined the fraternity of space folk over 500 years ago when they were discovered by alien visitors who were impressed by their fighting skills and agility. They impressed the savage tribes with their powerful weapons and war machines, so when they offered the warriors the opportunity to fight their wars for them, the Anubios accepted (after all, it was a great new challenge). Even now, the Anubios are primarily warriors hired by other races as Mercenaries. They know how to operate computers, pilot spaceships and robot vehicles, and use energy weapons, but most know little about science or manufacturing. They are famous for being superior fighter pilots, robot pilots and special forces operatives (especially seek and destroy).

Anubios (An new boys)

Alignment: Any, but most are anarchist.

Attributes: I.Q. 3D6, M.E. 3D6, M.A. 2D6, P.S. 3D6+6, P.P. 4D6+1, P.E. 3D6+3, P.B. 2D6, Spd. 6D6

Hit Points: P.E. plus 2D6 per level of experience.

S.D.C.: 3D6x10+20

Natural A.R.: 12

Height: 7 feet, 6 inches+3D6 inches (2.4 to 2.7 m)

Weight: 300+3D6x10 pounds (150 to 217 kg)

Average Life Span: 75 years. **P.P.E.:** 3D6

Super Abilities: Available Super Power Categories are hardware, physical training, and robotics (giant robot combat vehicles and power armor/exoskeletons). Less than 6% have undergone bionic reconstruction and fewer than 2% have psionic powers or practice magic. Only the rare mutant or experiment has super abilities (about 1%).

Natural Abilities: +2 on initiative, +3 to save vs Horror Factor, +2 to roll with impact or fall, +5% to climb, gymnastics and swim skills, can leap 15 feet (4.6 m) high or lengthwise, excellent sense of smell and keen vision.

Favorite Weapons: Anubio warriors love plasma, energy and Vibro-Blades/melee weapons.

Favorite Vehicles: Giant combat robots, jet packs and hover vehicles.

Preferred Armor: None, if they can avoid it. Even robot vehicles which they are so good at piloting take away some of the excitement and challenge that is present in one on one hand to hand combat. However, the Anubios are far from foolish and will wear armor and use whatever is necessary to win a fight.

Familiarity with Earth: Their data systems hold information on Earth equal to the "Some Familiarity" result on the Familiarity With Earth table.

Rifts Notes: If used in the Rifts setting, they will be regarded as monstrous D-Bees. The Coalition States will see them as dangerous beings, but if the aliens show loyalty and respect for the CS, the powers that be may be able to convince themselves that the aliens are *mutant animals* and hire them as Mercenaries for missions outside of the Coalition States territories (like Tolkeen

and the Pecos Empire). The Anubios will be impressed by the CS troops, as well as Cyber-Knights, Crazies, juicers, dragons and other superior warriors. They don't think much of magic. The Splugorth will also be interested in these warriors for gladiatorial games, hirelings and slave stock. The Anubios Mercenaries will find plenty of jobs and opportunities in the tumultuous and war-racked world of Rifts Earth. Available Rifts O.C.C.s for Anubios characters include Robot Combat Pilot (equal to an NGR Power Armor Commando or Robot Combat Pilot, or CS RPA), Headhunter, 'Borg, Mercenary (any), military (any; CS, NGR and most others). Most will avoid Juicer or Crazy augmentation.

They are definitely Mega-Damage creatures in the Rifts environment. Their weapons and equipment are also likely to be Mega-Damage items.

If set in the **Rifts: Phase World** environment, the basic setting described for **Heroes Unlimited** is applicable. Most will be tough Mercenaries, pirates and adventurers.

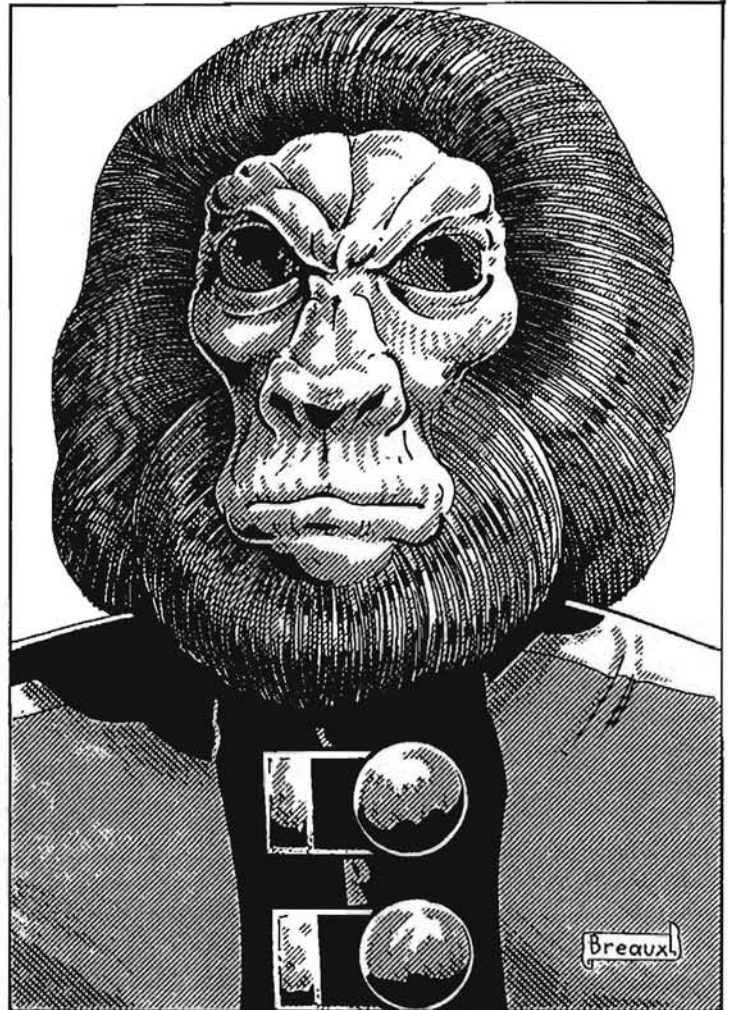

Capucis

The Capucis are a tall, thin race of apeish humanoids with a keen intellect and psionic powers. Their fur tends to be long like the Earth orangutan and grows in a long mane on the top and sides of their heads. Their arms and legs are long and delicate, ending in hands with six long slen-

der fingers. Their golden eyes are large with rippling streaks of black instead of the normal human pupil. The Capucis have evolved from a race of peaceful vegetarians and one of the least war-like of the ape races.

Most have well developed psionic abilities, while a small percentage exhibit select super abilities. Those with psionic abilities such as telemechanics, total recall, speed reading and mechano-link are part of the upper class, and work as scientists and engineers. Those with other abilities are also honored members of society and find work that best suits their abilities. The Capucis can be of any educational background, but they are strongly urged to enter fields where their special abilities would most benefit the Capuci people. This matching of superhuman abilities to the best area for their application and the apes natural high intelligence and inquisitive nature have enabled them to develop some of the most advanced technology, lethal weapons and finest products in the galaxy, especially in regards to robotics and bionics.

The Capucis have a small military presence in space. They spend most of their time in the areas of manufacturing and development. The search for other areas of knowledge, technology, and inspiration are prime motives for their space programs. However, when one looks at their superior tech-level and resources, it is obvious that the Capucis are not working to their full potential in the area of space exploration and colonization. They are timid and reserved, making few overtures to other life forms. They seldom step out in the forefront of intergalactic politics and tend to have an isolationist attitude, especially regarding visitors to their homeworld, which is highly restricted. Consequently, they are often overlooked among the galactic community and never considered a military power (which is how they want it). Some people have taken this conduct to mean that the Capucis think they are better than anybody else. This is not true. The Capucis, despite their great achievements, are timid and reclusive by nature. The level of their current involvement was a difficult and frightening step for them.

Capucis (pronounced Cah pew see)

Alignment: Any, but the vast majority are timid anarchist or unprincipled, about 25% are good and 15% are evil.

Attributes: I.Q. 3D6+6, M.E. 2D6, M.A. 2D6+2, P.S. 3D6, P.P. 4D6, P.E. 3D6, P.B. 2D6+2, Spd. 5D6

Hit Points: Standard, P.E. plus 1D6 per level of experience.

S.D.C.: 5D6 plus skill bonuses

Height: 8 feet+6D6 inches (2.6 to 3.4 m).

Weight: 1D6x100+500 pounds (272 to 498 kg).

Average Life Span: 100 years. **P.P.E.:** 1D6

Super Abilities: Capucis are limited to the Super Power Categories of psionics, robotics and bionics (cyborg and robot characters lose their psi-powers immediately after bionic/robot conversion). Only 4% of all Capucis exhibit "super abilities" and those are always limited to the minor powers of *heightened senses* (player's choice of two) and *radar sense*, and either the major power of *mechano-link* or *control others* (pick one).

The Game Master may allow the character to choose his education based on the power category and abilities generated, or he may assign an appropriate educational background and career.

Natural Abilities: None other than those already described.

Special Weapons, Vehicles & Equipment: Capuci weapons, robots and space technology are as advanced as the Atorians and better than most of the other races in their galaxy (and equal or slightly superior to the Kittani or Naruni from Rifts Earth). Typical energy weapons will inflict 1D6 more damage than average and have a 33% greater range and payload per clip. Most will be 1D4x10% lighter and of sleek design. Vehicles, including spaceships, will be 25% faster and more responsive to the pilot (+2 to dodge, +5% on piloting skill and the performance of special moves) and can have up to 10% more armor.

Preferred Armor: Capucis use body armors only when necessary. These can be anything from light vests to environmental armor and robot vehicles.

Familiarity with Earth: The Capucis have no familiarity or interest With Earth. However, they are experimenting with *warp drives* and dimensional travel.

Rifts Notes: If used in the **Rifts** setting, the aliens will be regarded as D-Bees. The Coalition States will see them as dangerous only if they exhibit their scientific knowledge (which is greater than the CS) or psionic powers. On Rifts Earth, most capucis will be a Mind Melter, or a master psionic with one of these O.C.C.s: Operator, Rogue Scientist, Cyber-Doc, body fixer, or robot pilot (equal to an NGR Power Armor Commando or Robot Combat Pilot or CS RPA). Given the opportunity, some may study magic.

If set in the **Rifts: Phase World** environment, the basic scenario in this book is appropriate. Most will tend to be scientists and the same types of characters as they are on Rifts Earth. They are likely to associate or trade with Naruni Enterprises, Phase World and other advanced civilizations, but not the Splugorth. They definitely would possess Mega-Damage technology.

Cebus

The Cebus are an example of the ultimate sadness of war and the final folly of a war-like race. The Cebus entered into a war with the Atorian Empire over planetoid mining and salvage rights in an asteroid field near their home planet. The Atorians allowed the war to go on just long enough to draw the attention of other worlds and nations, and used the Cebus as a show of their incredible power by shattering a world.

Anti-matter technology is rare, dangerous to manufacture and hideously expensive even for the Atorians, but they used one of their AM bombs on the Cebus while the galaxy watched. The planet ruptured and broke into massive pieces. Billions were killed in a matter of seconds. The Atorians and their Mantella lackeys scattered or destroyed the Cebus spacecraft and the war ended.



The Atorian Empire sold the mining rights to both the contested asteroid belt and the shattered debris of the Cebus homeworld. The display of unprecedented power and cruelty gained the Empire many new allies and quieted scores of other disputes that had been brewing — despite rumors that the Atorians have been unable to duplicate more than one additional anti-matter bomb since that terrifying day nearly 100 years ago.

Meanwhile, the Cebus survivors struggled with the nightmare that had befallen their people. Many survivors gave in to sorrow and despair and killed themselves on suicide runs against the forces of the Antorian Empire, or took their own lives. Those who managed to cope and endure went on to join other forces against the Antorians, or wandered off to build new lives elsewhere. Fewer than ten thousand Cebus are believed to exist scattered throughout the galaxy. More than a hundred are seldom found together at any one place.

These ape-men are powerfully built and courageous warriors. Their fur is normally short and covers most of their body, much like chimpanzees on Earth. The only exception is the fine black hair on their heads which they grow generally long and wear in a pony-tail. The educational backgrounds of the Cebus are varied, but the large majority are military specialists and all too many are bent on seeking retribution against the Antorian Empire — many have become Mercenaries, pirates and terrorists. Some have learned a powerful lesson from their experi-

ence and now roam the galaxy as protectors of the weak and preach of peace and cooperation. Their hatred of the has awakened a disdain for war and anyone who abuses power. They are roving paladins who hope to bring some light into the lives of others.

Cebus (pronounced seh bus)

Alignment: Any. Those who have become paladins tend to be of a good alignment. Pirates are typically selfish and evil. Terrorists will be anarchist or evil, depending on their targets, goals, and tactics.

Attributes: I.Q. 3D6, M.E. 3D6, M.A. 3D6, P.S. 5D6, P.P. 3D6, P.E. 3D6, P.B. 2D6+3, Spd. 6D6

Hit Points: P.E. x2 plus 1D6 per level of experience.

S.D.C.: 2D4x10

Height: 5 feet+1D6 inches (1.5 to 1.6 m).

Weight: 150+1D4x10 pounds (72 to 86 kg).

Average Life Span: 80 years. **P.P.E.:** 1D6

Super Abilities: Cebus are typically limited to the Super Power Categories of bionics, hardware, physical training, and robotics. Less than 1% have super powers as a result of mutation or genetic experiments, and even fewer have pursued the Mystic arts.

Special Weapons and Vehicles: Anything that will do the job, including Atorian, Capuci and other items. They also have a great fondness for Kisentite swords and axes; the weapons that survived the Great Holocaust have been passed down as family heirlooms for generations.

Preferred Armor: Cebus Paladin Class Environmental Battle Armor (CPCEBA): A.R. 17, S.D.C.: 200 with detachable jet pack, retractable twin Kisentite forearm blades (or Vibro-Blades: 3D6 damage) and laser forearm blaster (2D6+2 damage, 500 foot/153 m range, and unlimited payload — tied to the armor's nuclear power supply).

Familiarity with Earth: The Cebus have no familiarity with Earth. Our planet is very much like their destroyed homeworld, except for a lighter gravity. Survivors would be happy on Earth.

Rifts Notes: These aliens will be regarded as D-Bees and the Coalition States will see them as dangerous only if they exhibit their scientific knowledge, combat expertise or if it they challenge the CS tyranny against other D-Bees. On Rifts Earth, most Cebus Cyber-Knights, Headhunters, Wilderness Scouts, Mercenaries (any), military (any) Operators, Rogue Scientists or robot pilots (equal to an NGR Power Armor Commando or Robot Combat Pilot or CS RPA). Given the opportunity, some may study magic. Any weapons, armor, vehicles, and equipment they bring to Rifts Earth or Phase World will be Mega-Damage equivalents.

If set in the **Rifts: Phase World** environment, the basic scenario in this book is appropriate. Most will dislike outfits and monsters such as Naruni Enterprises, Cibolans, Sunaj, vampires and the Splugorh.



Dyteens

The north polar region of the planet Shia is the home of the Dyteens. Compared to the 210 degree Fahrenheit (99 C) temperatures found on the majority of the planet, the 110 degree (43 C) polar region is a cool respite. Furthermore, the dyteens live in the only, tiny region blessed with rain and a regular supply of water. There is no ice at the poles, but it rains regularly and a lush rainforest thrives there.

The Dyteens have built a prosperous civilization. They are technologically advanced, have a young space program and utilize robots and limited cybernetics. It was only after they launched their space program 79 years ago that they discovered the humanoid race known as the Shissans living on Shia! This was a surprise since the Shissans claim to be indigenous to the planet and yet, the Dyteens had never discovered them in their entire 4500 years of civilization! Scholars and scientists hypothesize that it "is" possible they never discovered the Shissans, but highly unlikely. 97% of the planet is a blazing desert with temperatures that are deadly to Dyteens, which has prevented exploration. However, the ape-men have mapped the planet reasonably well via satellite and have sent several dozen manned and unmanned robots to probe certain areas of the boiling wastelands of their giant homeworld. The odds that the Shissans could have been missed are one in 50 million, especially since they claim to have developed space technology independently. Most Dyteens believe the shissians are alien refugees who only

arrived on Shia 80 to 100 years ago. Since the Shissans are masters of the Mystic arts, some have suggested that they used magic to travel from their world, or perhaps a different dimension entirely, to Shia. Considering their reputation throughout the galaxy as intergalactic con-artists, smugglers and criminals, the Dyteens are probably right.

Since the appearance of the manipulative and treacherous Shissans, the Dyteens must be constantly on their toes to avoid getting drawn into one of their schemes or conflicts with people and governments they have cheated. In fact, the Shissans have made them wary and distrustful of other humanoids, especially practitioners of magic. Many Dyteens go into the galaxy as champions of justice, often defending people from or warning them about the Shissans and their profit generating ventures (profitable only for them).

The two races are not mortal enemies, but some Dyteens have taken it upon themselves to personally disrupt the underhanded games of the Shissans and villains like them. Most Shissans don't take this interference personally and find the whole situation amusing. Heck, some even genuinely like the Dyteens and would come to their aid if they needed it, or feel badly if one of their scams got them into trouble.

The hairy humanoids maintain a reasonable military force for their nation, but their entire population only numbers approximately 54 million, and their domain is only the size of the United States of America, representing less than 2% of the entire planet's surface. Combat training is pretty basic and primarily defensive, but Dyteens are capable fighters and don't take threats or misconduct lightly. They stand up for themselves and their beliefs, which are freedom, democracy and the pursuit of knowledge and happiness. Their space program is designed to learn more about their galaxy and the other life forms in it. They have heard of the Atorian Empire and have recently contacted the Federation of Allied Races. Their venture into space is a learning and growing experience that makes most Dyteens better people.

Dyteen (pronounced dye-teen)

Alignment: Any, but most are good, unprincipled or anarchist.

Attributes: I.Q. 3D6, M.E. 4D6, M.A. 4D6, P.S. 4D6, P.P. 3D6+2, P.E. 3D6, P.B. 2D6+2, Spd. 3D6

Hit Points: Standard, P.E. plus 1D6 per level of experience.

S.D.C.: 40

Height: 5 feet+4D6 inches (1.6 to 2.1 m)

Weight: 100+2D6x10 pounds (54 to 100 kg).

Average Life Span: 85 years. **P.P.E.:** 4D6

Appearance: The Dyteens are about the same size as humans and resemble Earth chimpanzees. Their bodies are covered in a light fur that ranges in color from white to silver to black.

Super Abilities: Most Dyteens are not super heroes nor possess super powers or psionics. Many are scientists, soldiers and ordinary people trying to explore the universe. Player characters and NPCs can be any one of the following Super Power Categories: bionics (very

limited), robotics, hardware or physical training. Until recently, Dyteens have never pursued magic, but thanks to their shissan co-inhabitants a few (about 2%) are beginning to practice the Mystic arts.

Special Weapons and Vehicles: Basically the full range of weapons and vehicles available.

Preferred Armor: Lightly armored environmental body armor: A.R. 14, S.D.C. 70.

Familiarity with Earth: No familiarity

Rifts Notes: If used in the **Rifts RPG** setting, the characters will be seen as mutants or D-Bees. These characters are S.D.C. Life forms but their weapons and equipment are likely to be Mega-Damage items in the Rift setting. Arrival on Rifts Earth is likely via a dimensional anomaly, magic or as a slave or refugee.

If set in the **Rifts: Phase World** environment, the scenario of slave, explorer, mercenary, or space adventurer works fine. Some are good guys and others may be villains.

Maeus

The Maeus once shared their dark homeworld of Ropora with the Mantella (see their entry in the amphibian section). The military-oriented Maeus clashed and battled with the Mantella for hundreds of years, until the amphibians formed an alliance with the Atorian Empire. Realizing they would be crushed by the evil Empire, the Maeus poured all of their resources into building a fleet of spacecraft to take their people off the planet and away from their enemies.

Their mission has been successful, at least in part. Approximately 30% of their people have been welcomed on other peaceful worlds. An additional 15% have found a small planet to share with the primitive, but friendly indigenous population. However, most continue to search for a new homeland. As strange as it may seem, many Maeus are content with their life of wandering (it's been nearly 150 years since they fled their homeworld). As they swept through the Atorian Empire as a great fleet of a million ships, they acted as a liberating army dealing out justice, and opposing the Atorians whenever they could. They quickly earned a reputation as an army of paladins and redeemers. It is reputation that the Maeus have enjoyed and continue to maintain, even though the great fleet has been reduced by people who have settled on other worlds and divided into several smaller units. Still, the legendary Maeus Paladins' numbers have remained surprisingly high by attracting and accepting other people with similar values and a desire to help others. Among their numbers are nearly a thousand Cebus (the largest gathering in the universe), thousands of Inenhsi, Nattereri, Axolotl, Deurycans, Sorinams, humans and many other champions of justice, goodness and freedom. In many regards, the Maeus fleet represents a mobile nation of free people from many worlds, and may eventually become an artificial world where those who believe in justice and freedom can escape the many injustices and horrors that plague the galaxy.

The smaller splinter groups share the main fleet's sentiments, goals and disciplines, but are able to focus on smaller troubles and the plights of people who might be otherwise missed. These groups can be as small as a dozen vessels or number into the hundreds, complete with battleships and destroyers.

Both the large and small fleets engage in humanitarian relief. Critics and allies of the Atorian Empire call them pirates, freebooters and mercenaries. In some ways they are mercenaries, because they are willing to work for those in need of a small (or large) military force for a good cause. Furthermore, some of the smaller groups have been known to pilot gunships or serve as escorts for pirates, smugglers and enemies of the Atorians who raid Mantella or Atorian vessels and outposts, or operate illegally in their territory. Having a battleship on your side can be a big benefit, especially in small skirmishes. If the cause is a good one, these champions will charge only enough to bolster their supplies and make repairs before they move on. In many instances, they don't charge anything at all.

A large collection of Maeus military spacecraft are found in the service of the Federation of Allied Races (FAR). These warships have joined the protective line that defines the demarcation zone between the Atorian Empire, FAR and other free peoples (see the Federation of Allied Races for additional information).



The Maeus have a wizened appearance very much like that of orangutans. They have small, twinkling eyes, flat noses, and prominent muzzles. Their fur is brightly colored in ranges from bright red to a vibrant mahogany brown. They always seem to look at the positive side of things and have a pleasant, comforting disposition.

Maeus (pronounced mowz)

Alignment: Any, but the vast majority are good.

Attributes: I.Q. 3D6+2, M.E. 3D6, M.A. 4D6+6, P.S. 4D6, P.P. 3D6, P.E. 3D6, P.B. 3D6, Spd. 4D6

Hit Points: Standard; P.E. plus 1D6 per level of experience.

S.D.C.: 50

Height: 5 feet plus 3D6 inches (1.5 to 2.0 m).

Weight: 100 plus 2D4x10 pounds (54 to 82 kg).

Average Life Span: 135 years. **P.P.E.:** 3D6

Super Abilities: They can be from any Super Power Category; 10% are psionic and 10% have super abilities via experimentation or mutation.

Natural Abilities: +2 on initiative, +2 to roll with fall or impact, +2 to save vs Horror Factor.

Special Weapons and Vehicles: A vast array of every kind of energy weapon, body armor, vehicle, and spacecraft. Roughly equal to the current standard of the universe but not as advanced as the Atorian Empire or Capucis.

Preferred Armor: Maeus environmental body armor: A.R. 16, S.D.C.: 180.

Familiarity with Earth: The wanderings of the Maeus have brought them into close proximity with Earth several times. As a result of recordings tapped from satellites and radio transmissions, their computers hold knowledge equal to the "Some familiarity" result on the Familiarity With Earth table.

Rifts Notes: If used in the **Rifts** setting, the Maeus will be regarded as D-Bees. The Coalition States will see them as dangerous beings because of their alien technology, abilities and because they promote peace and unity among other D-Bees. The Maeus, with their paladin-like ways will almost certainly clash with the CS and other despot rulers sooner or later. These warriors will find the injustice and villainy on Rifts Earth to be a sign that they are needed there. They will travel the land like Cyber-Knights, righting wrongs and protecting the innocent.

Maeus weapons and technology are likely to be Mega-Damage items equal to the Coalition.

If set in the **Rifts: Phase World** environment, the basic setting described for **Heroes Unlimited** is applicable. Most will be good-hearted heroes fighting villainy and injustice.



Thropo

Based on ideas by Cathy BreauX

The Thropos are a race of aberrant, combat-oriented apes that resemble gorillas. Their society is a tightly structured, almost feudal system with a twisted code of honor and system of birthrights. The homeworld of the Thropos is an irradiated nightmare of their own making. Their civilization was built without regard for the environment. That combined with war has made the planet a polluted industrial nightmare covered in toxic wastes, dead forests and bathed in acid rain. The Thropos have adapted as they gradually polluted their home and are immune to many of its dangers.

They are another strong and steadfast member of the Atorian Empire. As such, they maintain a large standing army, skilled in many forms of combat, strategies and tactics. Soldiers are trained in the use of energy weapons, battle suits and combat vehicles. Elite thropo troops and military specialists are used for important missions of destruction, assassination, smuggling and espionage.

There are those Thropos who do not agree with the policies of their people and their alliance with the Atorians. These are usually characters of a good alignment with a strong sense of honor and a high regard for life. Of course, those who display such sentiments or speak

against the Empire are outcasts. Some have joined the military just to get into space (and a position to desert to the Maeus or FAR). The term for warriors who abandon the Atorian Empire and their people is "Ronin." It is said that the first and most skilled of the apes to abandon his evil people took this title from some backwater planet at the edge of the galaxy (Earth).

Thropos, especially Ronnins, have an affinity for quality bladed weapons, especially Kisentite, Vibro and energy blades. Long, thin swords are favorites and many Ronins have adopted the katana (the first Ronin and his adoption of ancient Japanese Earth culture started the Thropo-Ronin movement and has been a great influence on the people). All Thropos use Kisentite weaponry. Despite their love for melee weapons, they do use a large variety of modern energy weapons and other high-tech weapons of destruction, including power armor and robot vehicles.

Their civilization is only slightly more advanced than that of Earth, but as Empire members, they have access to some of the most advanced equipment in the galaxy, especially weaponry.

Thropo (pronounced throw-po)

Alignment: Any, but most are anarchist or miscreant.

Attributes: I.Q. 3D6, M.E. 3D6, M.A. 2D6, P.S. 5D6+6, P.P. 3D6, P.E. 4D6, P.B. 2D6, Spd. 5D6

Hit Points: Standard.

S.D.C.: 1D4x10 plus 40

Height: 6 feet plus 1D6 inches (1.8 to 2.0 m).

Weight: 190 plus 1D6 pounds (87 to 89 kg) .

Average Life Span: 60 years. **P.P.E.:** 2D6

Super Abilities: Many Thropos (01-40%) possess the minor super abilities of *radar* and *heightened sense of hearing* (providing the following bonuses: +1 additional attack, +10 initiative, +3 strike, +3 parry, and +5 dodge). See Step Three of Character Generation in this book for determining additional super abilities. Others are mutants (41-65%) with other random powers, hardware (66-75%), bionics (76-86%) or physical training (87-00%). All have great physical strength, a lust for blood and are trained, high-tech soldiers.

Natural Abilities: Thropos are immune to the effects and damage of radiation, but they give off low levels of it themselves. This radiation will begin to harm those exposed to it for two weeks or more unless a protective suit is worn. They are also +2 to save vs poisons and drugs and a +6 to save vs Horror Factor.

Special Weapons and Vehicles: Anything at the disposal of the Atorian Empire.

Preferred Armor: Heavy environmental body armor: A.R. 17, S.D.C.: 280. Many Ronins prefer environmental armor styled like the old samurai armor of Earth: A.R. 16, S.D.C. 240.

Familiarity with Earth: Equal to the "Some familiarity" with Earth result on the Familiarity With Earth table.

Rift Notes: Basically the same as the Anubios.

Trogolo

These blonde chimpanzee-like aliens have the usual ape features along with a coat of four to six inch fur that helps protect them from the cold temperatures on Bornima, their homeworld. The Trogolo civilization, society and technology is advanced to a point about equal to Earth of the 1960's, but they haven't even considered space exploration or discovered nuclear energy. The average temperature around the equator is 40 degrees Fahrenheit. This is where the cities and population centers are found. The colder areas to the north and south can plummet to 40 degrees below zero. Social outcasts and criminals are banished there, rather than executed. If they can survive, they are allowed to eke out an existence in the wilderness. Hundreds of revolutionaries, political exiles, and criminals have been sent by the Trogolo to the northern wastes; fewer than 40% survive.

Totally unknown to the authorities and citizens, some of the exiles have found technological artifacts under the depths of the ice from an earlier civilization, or alien visitors. The initial discovery believed it to be a lost city beneath the ice, but their descendants and other outcasts who have continued the excavations realize that it is a large entombed spacecraft.

The vessel is designed for human/Trogolo-sized humanoids, but little else is known about it. The mystery of the craft is becoming deeper and deeper as the exiles ex-

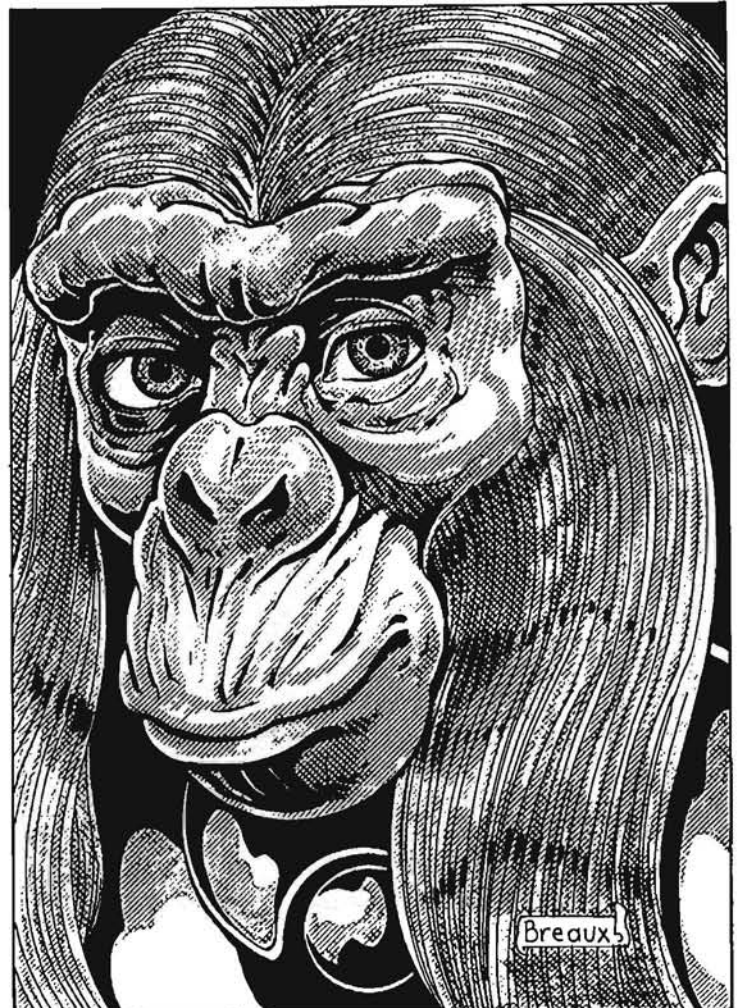

plore its interior. One mystery is that the food supply is fresh and appears to magically replenish its reserves, providing a potentially endless amount of food. Another is the unshakable feeling that the craft is eerily alive and may be studying them! Occasionally, visitors will disappear, never to be seen again! No bodies of the crew or written records have ever been found. The language used on labels is undecipherable and 90% of its computers and other systems remain inoperable (whether they are destroyed or simply shut off is not yet known).

Note: The authorities don't know anything about this vessel. The outcasts keep it a closely guarded secret. The question is, what exactly is this spaceship and what kind of power may fall into the hands of the criminals and radicals who have uncovered it?

Trogolo (pronounced trow go low)

Alignment: Any

Attributes: I.Q. 3D6, M.E. 3D6, M.A. 2D6, P.S. 3D6, P.P. 3D6, P.E. 4D6, P.B. 2D6, Spd. 3D6

Hit Points: P.E. plus 2D4 per level of experience.

S.D.C.: 1D6x10

Height: 5 feet plus 3D6 inches (1.6 to 2.0 m).

Weight: 120 plus 2D6x10 pounds (63 to 109 kg).

Average Life Span: 70 years. **P.P.E.:** 3D6

Super Abilities: Most (01-80%) of the population doesn't have any super powers (Hardware, etc.) but some are mutants (81-92%) and a few have psionic powers (93-00%). Approximately 65% of the criminals and exiles have super powers.

Natural Abilities: Resistant to cold (half damage), +4 to save vs any cold-based attack or condition.

Special Weapons or Vehicles: Nothing noteworthy.

Preferred Armor: Standard bulletproof vests. The alien spacecraft contains two dozen environmental armors: A.R. 17, S.D.C. 220. and some energy weapons.

Familiarity with Earth: None. In fact, they don't know about any other intelligent life forms.

Rifts Notes: Roughly the same as the Anubios.

selves galactic merchants, but provide advanced technology to the residents of a half dozen worlds, and they have become a rich people by selling their goods. Many of their production facilities are located on some of these planets to take advantage of cheaper labor or to avoid space transportation costs. All things considered, the Elecians have mastered the art of big business. Some of these worlds have become so dependent on them that they would suffer greatly if the Elecians should ever abandon them.

Private and government industry and scientific communities co-exist and often work together, but also work independent of each other. The military is strong but not oppressive or domineering.

The Elecians' achievements include advanced communications, medicine, manufacturing, space travel, weapons, bionics, robotics, and experimental programs in many different areas, including genetics, time travel and magic. The only things the Elecians do not sell to others are weapons and weapon manufacturing technology. However, while they may promote peace and refuse to sell weapons to others, they have developed a wide range of items for their own defense (they are one of the very few races to have microwave guns). This is a general practice observed by scrupulous businessmen and enforced by law. Some weapons do make it onto the black market and are sold to other planets, pirates and Mercenaries. Small merchant operations can leak a few at a time into the market and get away with it. However, large shipments are

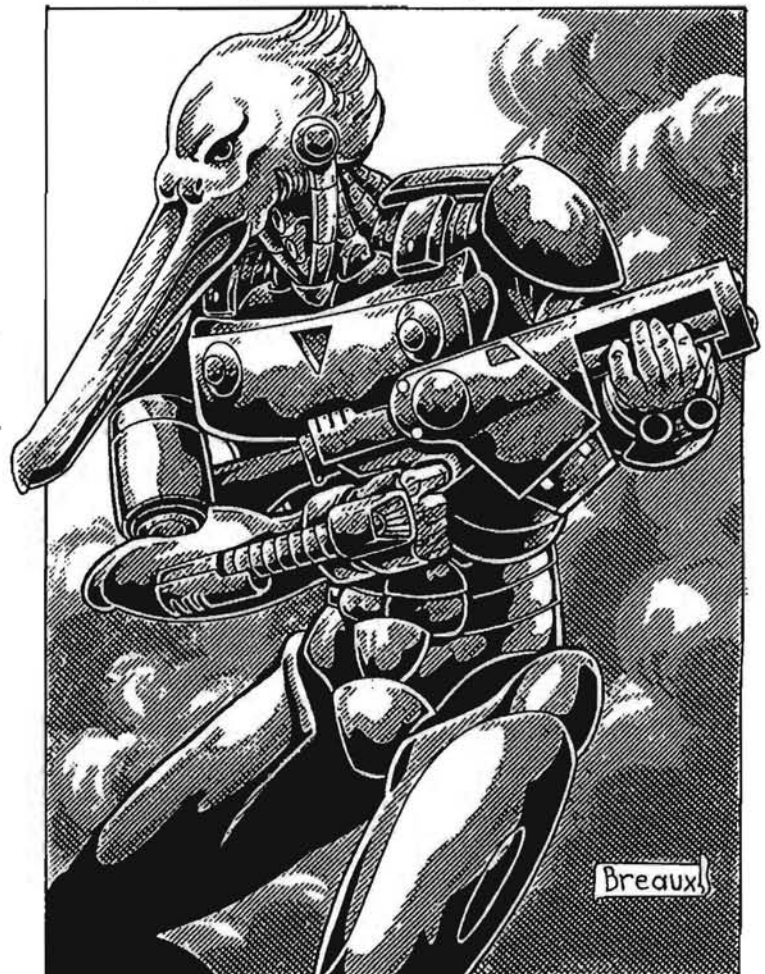

Avian Races

These aliens are from planets where birds have evolved into intelligent humanoids. In order to develop an advanced civilization, they would need hands. This is generally true of all avian humanoids, other than the rare exception where the evolutionary process included the growth of an additional pair of limbs. None of those listed here have wings. All of the avian races have feathers and most will have light bone structures. Their fingers tend to be long and delicate, or strong and thick, with sharp talons. Their feet are often large and clawed, but only 40% are prehensile. Feather coloration can range from blacks and grays to bright and iridescent colors of all kinds.

Elecians

The Elecians are a technologically advanced race, proud of their achievements. They do not consider them-

very difficult to pull off and illegal arms dealers face stiff criminal charges (treason for one), and can be imprisoned for life, or even executed!

Their society is similar to Earth's, with a democratic republic and relative freedom of speech and expression. There is the wealthy, the middle class, laborers and the poor. However, while there are those of lower income, there is little poverty and minimal crime. The society is pretty open-minded. As a result, even areas of study avoided or forbidden on other worlds, such as magic, flourish. The very stable civilization is dull and boring to many of the avians. Many join the military or space merchant marines in search of adventure and glory. They tend to be proud, arrogant, and condescending characters, but the majority of them will be of good alignment, spirit, and intentions.

As avian humanoids, their bodies are covered in feathers that can be pure white or lighter shades of brown. Because of low gravity homeworld, they are tall and thin, with long, delicate fingers and limbs. Their heads are short and rounded, but the beak is long and tapering.

Elecians (pronounced Eh-lee-see-uns)

Alignment: Any, but most are good or selfish.

Attributes: I.Q. 3D6+1, M.E. 2D6+4, M.A. 2D6+2, P.S. 3D6, P.P. 4D6, P.E. 3D6, P.B. 3D6, Spd. 5D6.

Hit Points: Standard; P.E.+1D6 per level of experience.

S.D.C.: 2D4x10. **P.P.E.:** 4D6 or by Magic Category.

Height: 6 feet plus 4D6 inches (1.9 to 2.3 m).

Weight: 120 plus 2D6x10 pounds (54 to 100 kg).

Average Life Span: 80 years.

Super Abilities: Any power category is available to Elecians. Roughly a quarter (01-25%) have undergone partial or full bionic reconstruction, 15% pilot combat-style robots or exoskeletons (26-40%; large and small), 15% are hardware (41-55%), 15% are the product of super power experiments (56-62%) or mutation (63-70%), 5% are practitioners of magic (71-75%) and the rest are others (76-00%).

Special Weapons: Microwave guns and laser pulse rifles (10% greater range than others). See weapons section for examples.

Special Vehicles: Antigravity disks that attach to the back or chest. Double the typical speed and weight allowance of others.

Preferred Armor: Elecian environmental suit: A.R. 17, S.D.C. 250, 25% lighter than most, with only a -5% prowl penalty. They also use a variety of others as well as robot and bionic systems.

Familiarity with Earth: The Elecians have studied Earth to decide if it would be worth selling technology to, but they decided that the humans are not ready to join the galactic community, and are dangerous to work with at their current level of civilization. Their knowledge of Earth is equal to the "Some familiarity" result on the Familiarity with Earth table.

Rifts Notes: If used in the **Rifts** setting, the Elecians will be regarded as inhuman D-Bees. They can be dimensional travelers accidentally brought to the Rifts Megaverse or they can be an active race within it. If the

latter, they trade with Naruni Enterprises and possibly others and are likely to reach Earth via a breakthrough in their own dimension travelling research or via Phase World. The Coalition States will see them as dangerous beings because they are educated, promote learning and interracial cooperation and possess advanced alien technology and Mystic or superhuman powers. The CS may even launch a campaign of extermination or post a bounty on their heads.

In the **Rifts** setting, the weapons, armor and technology of these avians will be Mega-Damage.



Gallopas

For eons the Gallopas had thrived under the slightly radioactive skies of their homeworld Gagine. Every hundred years, the people were witnesses to an incredible cosmic anomaly that lit up the midnight sky with a display of swirling lights, culminating six hours later with a fiery glow that made it seem as if the atmosphere were on fire. The centennial phenomenon was a sacred Gallopa holy day, a once-in-a-lifetime event that signaled a week of celebration. Gallopas everywhere gathered for the event. In addition, millions of other people arrived in spaceships from all corners of the galaxy to watch and record the legendary event and join in the celebration as they had for the last 300 years. One exception would be the crew of the battleship Babella, who went on a mission to aid a space station besieged by pirates.

On Gagine, the people prepared themselves for the coming spectacle. Celebrations and parties were in full swing as the hour approached. At midnight the sky exploded with dazzling lights and began to glow with a fiery brilliance, but then something went terribly wrong. When the Babella battleship arrived the next day, all the people of Gagine were gone! All magnetic records and computers were wiped clean as if the planet had been bombarded with powerful electromagnetic waves or solar flares. Other than some isolated fires, there was no sign of foul play or invasion. The 3.6 million visitors who had come to watch the spectacle from orbit around the planet were also gone, ships and all!

Sixty years later, nobody has any idea what happened. The crew of the Babella and approximately 80,000 other Gallopas off-world were the only survivors. About half have returned to Gagine to rebuild, but the place is a gigantic ghost town used by pirates, Mercenaries and refugees. However, most people avoid the planet, terrified that they will suffer the same bizarre fate as the Gallopas.

The crew of the Babella and their descendants have spent decades searching for some answers. They are convinced that their people are alive somewhere. The most popular theory is that they were somehow sucked through a dimensional vortex and exist in another dimension, or were flung backward or forward in time, but nobody really has any idea.

Gallopas have a rough, lumpy appearance to their skin, but it is actually soft and flexible, with colors ranging from white to bright reds and blues. Despite their avian origins, they have few or no feathers, and most are completely bald. Their heads are short and rounded, tapering to a pointed beak. Most tend to be thin, but their bone structure is not as delicate as in most avians.

Many of the survivors are bitter, cynical and disillusioned people. They have seen the worst side of the universe and it has crushed their spirits and driven some to the brink of madness. Many are loners, hermits, prospectors, Wilderness Scouts or vagabonds. Others are adventurers or who cling to life and are dedicated to rebuilding. Many have started religious cults, turning to Mysticism, the supernatural and the occult as means to cope or in search of answers.

The largest cult is the **Children of Anarchy**, who believe that the universe is a place of constant, violent change and that nothing is absolute. They insist that all intelligent life forms are just tiny, insignificant specks whose actions and accomplishments have no meaning in the greater scheme of the cosmos. 50% are Mystics, 30% psychics and the rest, a conglomeration of many beliefs and occupations. Most are of an anarchist or evil alignment who ignore the laws of all people, do as they please and engage in violent, decadent, murderous and self-serving activities. 20% are insane or teetering on the brink. The cult is growing and factions have cropped up throughout the galaxy, usually among evil and selfish groups.

Gallopas (pronounced gal-oh-paws)

Alignment: Any, although cultists tend to be anarchist or evil.

Attributes: I.Q. 3D6, M.E. 3D6, M.A. 3D6, P.S. 3D6, P.P. 3D6, P.E. 3D6, P.B. 2D6, Spd. 6D6

Hit Points: P.E. x2 plus 1D6 per level of experience.

S.D.C.: 1D4x10 **P.P.E.:** 5D6 or by Magic Category.

Height: 6 feet plus 1D6 inches (1.8 to 2.0 m).

Weight: 190 plus 1D6 pounds (87 to 89 kg).

Average Life Span: 75 years

Super Abilities: Of the survivors, 50% practice magic, 30% possess psionics and the rest can be any of the Super Power Categories found in **Heroes Unlimited**, or be normal folks.

Among the original Gallopas, students of magic represented only 25% of the population and 10% had super abilities.

Natural Abilities: Resistant to radiation: +6 to save, keen hawk-like vision equal to the minor super power of advanced sight, and +1 on initiative.

Special Weapons & Vehicles: The full range of advanced weaponry, vehicles, spaceships and equipment.

Preferred Armor: Gallopas environmental body armor: A.R. 15, S.D.C. 110; good mobility.

Familiarity with Earth: None.

Rifts Notes: Pretty much the same as the Elecians. The big question is, where did they vanish to? Was it to Phase World or another dimension? Did the Splugorth use the strange dimension warping phenomenon, brimming with Mystic energy, to zap the entire planet's population onto one of their slave worlds or to a location where they could be captured and enslaved (or perhaps it was some other alien intelligence, god or power)? Was the phenomenon completely natural? Were the people scattered randomly throughout the Megaverse where some perished, others thrived, and still others were enslaved? Did the people get pushed backward or forward in time? Are they safe but trapped in a dimensional or temporal limbo? Were other aliens involved? We leave the answer to these and other possibilities to the imagination of the Game Master.

In the **Phase World** setting, they may be alien visitors, explorers, adventurers, Mercenaries, slaves or victims of a dimensional anomaly. They may be enlisted by high-tech forces or become a new competitor for Naruni Enterprises and the Splugorth.

Gymoy

In the abrasive atmosphere of Mawon, only the strongest and toughest survive. All of the planet's native life forms have developed some form of protection against the toxic, scathing atmosphere. The Gymoys are the most prominent of the planet's intelligent natives. They have long, oval-shaped heads covered in a tough skin and bony casing. Their protective hides are covered with hard, bone-like plates as well as softer, leathery plating and thick patches of tough, water resistant feathers. Their prominent, white to pale grey, bony features, protective plates and scraggly black feathers give them a skeletal or demonic appearance.



From the beginning of their history, the Gymoys have been ruled and led by their "Gifted," people who developed super abilities, psionic powers or who wielded powerful magic. For thousands of years, these avians were primitive, predatory savages that survived by hunting and gathering food. The strong ruled over the weak and the hostile environment ruled over them. Then, one day, a gymoy wizard developed (discovered) elemental magic to control and block the pulverizing storms and toxic atmosphere. He taught the magic to pupils and formed alliances with other mages. Eventually, this small gathering of wizards was able to carve themselves a better life in a less hostile environment. They built lodgings outside of the caves that had sheltered their people for centuries. They were able to farm and raise animals. Eventually, the other Gymoys left their caves and went to live in wizard country. After a long period of conflict and antagonism between the different tribes, especially among the Gifted, the majority of people learned to live in a more organized and complex society. The wizards became social leaders and the developers of civilization, while the Gifted would control the military and defenses of their people. The gymoy military is run by officers with super abilities, and many of their troops have psionic powers, cast magic or possess super abilities. This combination of super abilities, psionics and magic, combined with their natural armor and abilities, makes them a very effective and powerful fighting force. It has been this way for more than a thousand years.

In the last century, they have begun to explore the Megaverse through Mystic portals and dimensional Rifts. They have begun to hire themselves out as Mercenaries and have discovered other races and high-tech weapons. They are especially fond of lasers and hover vehicles/platforms. They are descendants of birds of prey and are natural predators who enjoy combat and conquest. As they become more familiar with dimensional travel and other worlds, they may become conquerors or at least dimensional raiders.

Gymoy (pronounced jim-moy)

Alignment: Any, but most gravitate toward selfish and evil.

Attributes: I.Q. 3D6, M.E. 3D6, M.A. 2D6, P.S. 4D6, P.P. 3D6+1, P.E. 3D6+2, P.B. 1D6+1, Spd. 2D4x10

Hit Points: Standard, P.E. plus 1D6 per level of experience.

S.D.C.: 4D4x10 +20

Natural A.R.: 15 **P.P.E.:** M.E.x2 or by Magic Category.

Horror Factor: 12 for average Gymoys, 15 for those with magic or super abilities.

Height: 7 feet plus 3D6 inches (2.2 to 2.6 m).

Weight: 200 plus 2D6x10 pounds (100 to 145 kg).

Average Life Span: 95 years

Super Abilities: Gifted Gymoys are limited to three Super Power Categories: Magic (01-65%), psionic (66-80%) and mutant super beings (81-00%).

The typical is fast, strong and deadly. More and more Gymoys are learning magic to the extent that 29% of the overall population are spell casters of some kind and 8% are psionic or super empowered.

Natural Abilities: Vision and sense of smell equal to the minor super powers: advanced sight and heightened sense of smell. Furthermore, they are +2 on initiative, ambidextrous, +1 attack per melee round, +4 to save vs Horror Factor and have nightvision (can see 600 feet/183 m in the dark).

Special Weapons: Magic and laser weapons.

Special Vehicles: Magic and hover vehicles, the faster the better.

Preferred Armor: None; most rely on their own natural armor and magic for protection.

Familiarity with Earth: None.

Rifts Notes: If used in the **Rifts RPG** setting, they will be regarded as nightmarish D-bee monsters. The Coalition States will see them as a serious danger because of their inhuman appearance, natural Mega-Damage armor, magic and super powers. They may even put a bounty on their heads, or launch a campaign of extermination.

In the **Rifts** setting, the are Mega-Damage creatures (4D4x10+20 M.D.C.) with Mega-Damage powers. Available O.C.C.s will include the Mind Melter, Mystic, Shifter, and any practitioner of magic. They can also become Wilderness Scouts and Mercenaries.

The Splugorth, Naruni and other dimensional merchants and raiders will look at the Gymoys with great interest as far as adding them to their legions of slavers and fighting forces. In the **Rifts: Phase World** environment, most will be adventurers, Mercenaries, mages or slaves.

0110101000101010001010110101010011010100010101
0101011010101001101010001010100010101101010100
0101000101010001010110101001101010001010100
101101010100110101000101010001010110101010
1000101010001010110101001101010001010100010
1010101001101010001010100010101101010100010
010101000101011010101001101010001010100010
0101001101010001010100010101000101010001010
101000101011010101000110101000101010001010
10011010100010101000101010001010100010101000
00010101101010100110101000101010001010100010
1101010001010100010101000101010001010100010
10101101010100110101000101010001010100010
1010001010100010101101010001010100010101000
01101010100110101000101010001010100010101000
000101010001010101000101010001010100010101000
0101010011010100010101000101010001010100010
101010001010100010101000101010001010100010
1010011010100010101000101010001010100010101000
01000101011010100010101000101010001010100010
001101010001010101000101010001010100010101000
00101011010100010101000101010001010100010101000
101010001010100010101000101010001010100010101000
0101101010100010101000101010001010100010101000
010001010100010101000101010001010100010101000
1101010100010101000101010001010100010101000

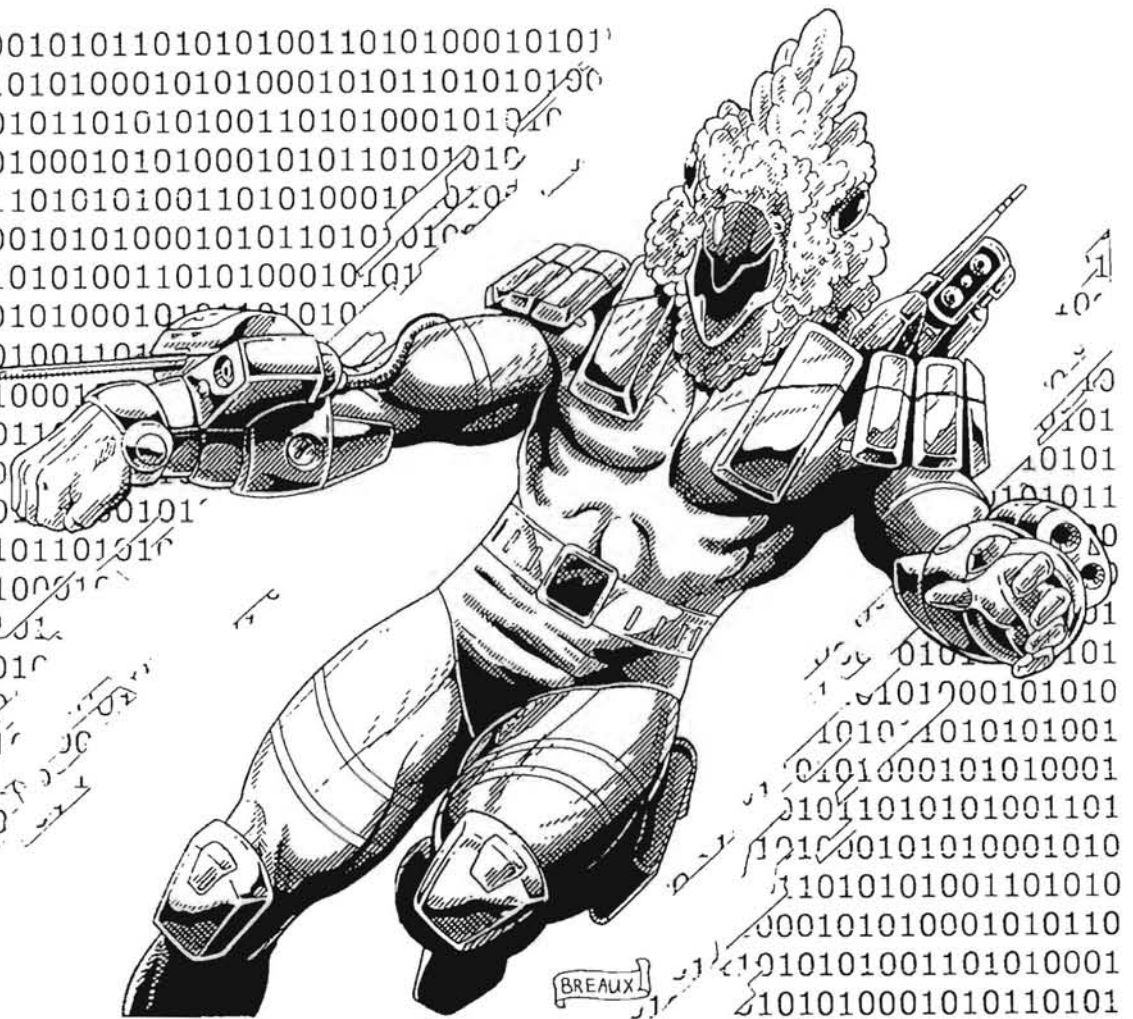

Struthios

The Strythios are short beings with a completely bird-like head and bodies covered in soft white or pink feathers. The eyes are large and inquisitive, the beaks are hooked and their voices are gravelly and high pitched like that of a parrot.

These avians are natural engineers. Their dexterity and mechanical aptitude are apparent even while they are in their infancy. Few races can equal their mechanical aptitude and love for research and development. Even their personal equipment is customized and built to their individual specifications. They enjoy having unique equipment and will tinker with everything, including brand new items. A favorite weapon customization for Struthios is to take some form of archaic weapon, like a bow or crossbow, and modify it to use modern energy or explosives. Their reputation as technical geniuses has spread across the galaxy, making Struthio scientists, engineers and technicians valuable and coveted resources (and garners them outrageous salaries).

The Struthios are even respected by the Atorian Empire, which is where disaster befell them. The Atorians gave the mechanical wizards an important contract to research and develop matter/anti-matter systems that would be smaller and more versatile than the clunky giant engines that were a half mile (0.8 km) wide and could stretch for a mile or more in length. The avian technicians wel-

comed the challenge and went to work. No one knows exactly what went wrong, but one day the Struthios homeworld faltered in its orbit and the planet began to slow in its rotation. The atmosphere was torn away and the surface was shattered by earthquakes and terrible storms. That day the planet died.

Presumably the disaster was the result of an anti-matter or anti-gravity experiment gone terribly wrong. The galactic community was horrified. Even the Atorian Empire mourned the death of the Struthio people and did everything it could for the millions of survivors off-world. To this day, about half the Struthio population, an estimated 18 million, are counted among the elite scientists and engineers of the Empire. The rest are scattered throughout the galaxy. Their genius is so coveted that some groups of Struthios can be found among the ranks of the most advanced worlds and space traveling corporations and organizations, including the Niamese Coalition.

Struthios (pronounced strooth-eye-ohs)

Alignment: Any

Attributes: I.Q. 4D6, M.E. 3D6, M.A. 4D6, P.S. 3D6, P.P. 4D6, P.E. 3D6, P.B. 3D6, Spd. 3D6x3

Hit Points: Standard.

S.D.C.: 3D4x10+20. **P.P.E.:** 4D6

Height: 5 feet plus 1D6 inches (1.5 to 1.6 m).

Weight: 160 plus 1D4x10 pounds (77 to 91 kg).

Average Life Span: 120 years

Super Abilities: All Struthios have the major super ability: Mechano-link, with the following bonuses: +20% to all piloting skills, +20% to all pilot related skills, +20% to computer, electrical and mechanical skills, +2 to strike with modern and energy weapons (but not ancient melee types), and a 60% base skill to understand and operate unknown or alien machines. See the super ability description in **Heroes Unlimited**, page 282, for full details and Step Three of Character Creation in this book for determining additional super abilities.

Natural Abilities: Excellent vision and hearing; ambidextrous and double jointed; add one attack per melee round, but these avians tend to avoid combat and war.

Special Weapons: Customized energy weapons, including bows and crossbows that fire energy beams, energy , and just about anything else. The typical Struthio weapon will inflict 1D6 additional damage and have an increased range of 25%. Typical energy clips may also hold five additional charges.

Special Vehicles: Lightweight jet packs (50% faster and lighter with double the altitude and flight time) and microjet hover boots are favorites. Jet boots: Speed: 160 mph (256 km), maximum altitude: 1000 feet (305 m), +2 to dodge and maneuver,

S.D.C.: 80.

Preferred Armor: Struthios environmental armor: A.R. 11, S.D.C. 70, but with a detachable force field generator: A.R. 19, S.D.C. 100. When the S.D.C. of the field is depleted, it takes two hours to recharge. Jet boots and packs cannot be used while the force field is engaged.

Familiarity with Earth: The Struthios have captured at least one Earth satellite or space probe for study purposes and have information on Earth equal to "Some Familiarity."

Rifts Note: If used in the **Rifts** setting, they will be regarded as inhuman D-Bees and the CS will fear and hunt them because of their inhuman appearance and superior technology (equal to Triax). They can appear on Rifts Earth as the result of a dimensional experiment, strange anomaly or magic. They can be the equivalent of the Operator, Cyber-Doc or Rogue Scientist O.C.C. with the special power of mechano-link. Their abilities will be especially appreciated among high-tech manufacturers such as Northern Gun, Naruni Enterprises, etc., as well as by struggling kingdoms and Mercenaries operating outside of CS territory. In the **Rifts** setting, Struthio weapons, armor and technology will be Mega-Damage.

In the **Phase World** setting, they may be alien visitors, explorers, adventurers or Mercenaries. Or they may be a new competitor for Naruni Enterprises and the Splugorth.

Tagonicans

The Tagonicans are a squat people from the tropical latitudes of an otherwise cold planet called Agika. Their bodies are covered in tiny feathers that cling closely to the body. From a distance they cannot even be recognized as feathers. The colors of the plumage range from light blue to blue-grey, with white on the alien's front/underside. Their heads are rounded with thin, tapering beaks. Their bodies are muscular, and their hands and fingers are thick and stubby.

The Tagonicans are an advanced civilization with a limited space program. The only galactic travels these avians undertake are for trade, diplomacy, and research. Of the three, research is the primary factor for their space programs. The majority of the avians are scientists and engineers. Their interest in these fields has brought the Tagonicans to a high level of technical achievement that includes advanced space travel and robotics. They provide many planets in their quadrant with processed metals, microchips, mechanical and scientific goods. To this end, they have one of the galaxy's largest orbital space stations. Its size is mostly attributed to its vast factory and manufacturing facilities.

Tagonicans are an inquisitive people who find other beings, especially more primitive people, very interesting. They sometimes consider these other, primitive life forms to be lesser beings and conduct gruesome or inhumane experiments on them, mainly in the area of bionic aug-

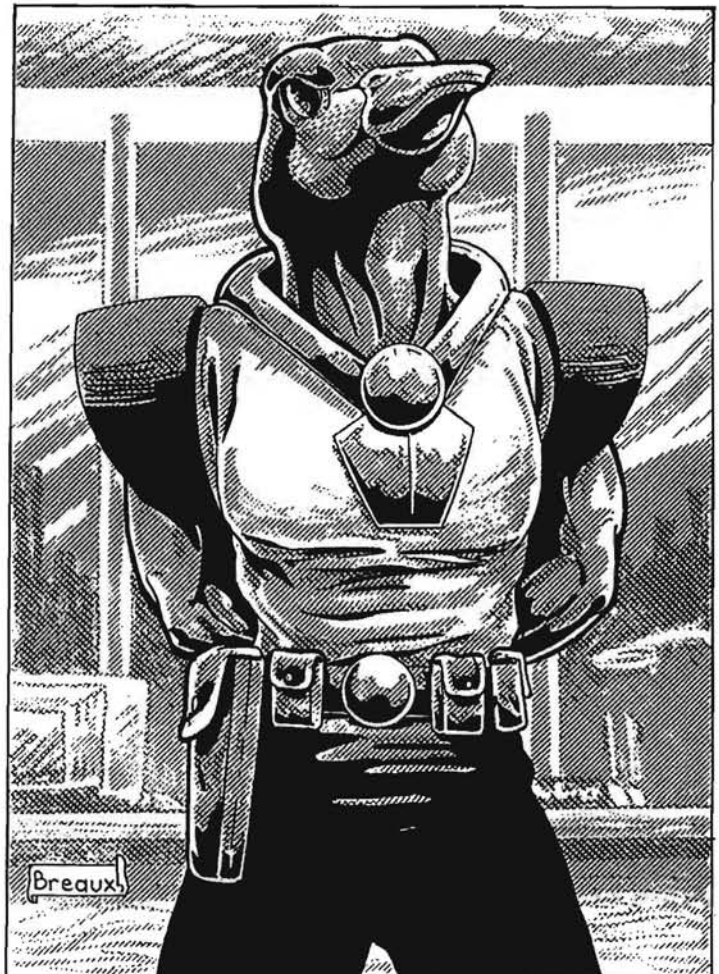

mentation and genetic engineering. These cruel or villainous Tagonican experimenters/tormentors will be of an anarchist or evil alignment. They conduct such experiments for their own personal gain, or in the name of science, without regard to others. One particular villain, Octanlio, had made incredible advancements and was able to mutate humanoid and select animals into more powerful creatures. In humans and apes, he was able to instill major super abilities and at one point, created a small army of super villains to engage in criminal activity under his control. His secret base was discovered and destroyed. He is presumed dead, but the body of Octanlio and some of his super-powered henchmen were never found.

Tagonicans (pronounced tag-on-ih-cans)

Alignment: Any, but frequently selfish or evil.

Attributes: I.Q. 3D6+6, M.E. 3D6, M.A. 2D6, P.S. 3D6, P.P. 3D6, P.E. 3D6, P.B. 2D6, Spd. 3D6

Hit Points: Standard, P.E. plus 1D6 per level of experience.

S.D.C.: 30

Height: 5 feet plus 3D6 inches (1.6 to 2.0 m).

Weight: 120 plus 2D6x10 pounds (63 to 109 kg).

Average Life Span: 75 years. **P.P.E.:** 3D6

Super Abilities: The average Tagonican does not have super abilities. However, player characters and NPC villains can be created from any of the Super Power Categories found in **Heroes Unlimited**. As noted in the description, some unscrupulous or evil Tagonican scientists experiment on other intelligent life forms and turn them into super-powered slaves and henchmen.

Natural Abilities: None of note.

Special Weapons, Armor and Vehicles: Virtually any of the items in the equipment and weapon section, except antigravity devices.

Familiarity with Earth: The Tagonicans have sent at least one study expedition to Earth and have "Some Familiarity" with the planet.

Rifts Notes: Basically the same as the Elecians.

Threskians

The Threskians are a race of avian humanoids from the planet Ther. It is a dark planet under perpetual cloud cover and frequent fog. They average six feet in height and have small, round heads with large, curved, golden beaks. Feathers are normally white or light yellow, or a mix of the two, and located on the shoulders and back. The head and the rest of the body are featherless. Technologically, they are on a par with most of the civilizations in the Federation of Allied Races and have a reasonably large space program.

The Threskians strive for peace but have been caught in one conflict or another for decades. Up to a decade ago, the Threskians were at war with the Linx (see feline aliens). The conflict had lasted for 50 years before an uneasy peace was attained. During the decade of the war the Threskians decided to find and train those with psionics and super abilities and add them to the military.

They even had some success creating super beings through experimentation. These elite soldiers were then used as special forces operatives, for sabotage and spearheading surgical strikes. In the end, the Linx finally accepted defeat and retreated to lick their wounds and concentrate on less steadfast opponents. Unfortunately, the turmoil of the Linx War did not end there.

The normal Threskian population was now deathly afraid of the super powerful soldiers who walked among them. To make matters worse, there were several incidents involving superhuman veterans that put all of them in a bad light. Lobbies began to form against them and incidents of violence increased to the point that most super soldiers were eventually stationed off-world. Unhappy with this situation, the soldiers launched their own protests. Frustrated and angry, some of the less stable warriors began to fight amongst themselves or went on rampages. Others went AWOL to become Mercenaries, pirates or super villains. This prompted the government to declare all super soldiers a threat, discharge them from military service and exile them permanently off-world. The public was torn and the debate on this issue was fierce, but in the end, the anti-super soldier movement won and the patriots who had fought to keep Ther free were forever exiled. Special arrangements were made to unite those loved ones who wanted to join the exiles, which displaced thousands of normal Threskians as well.

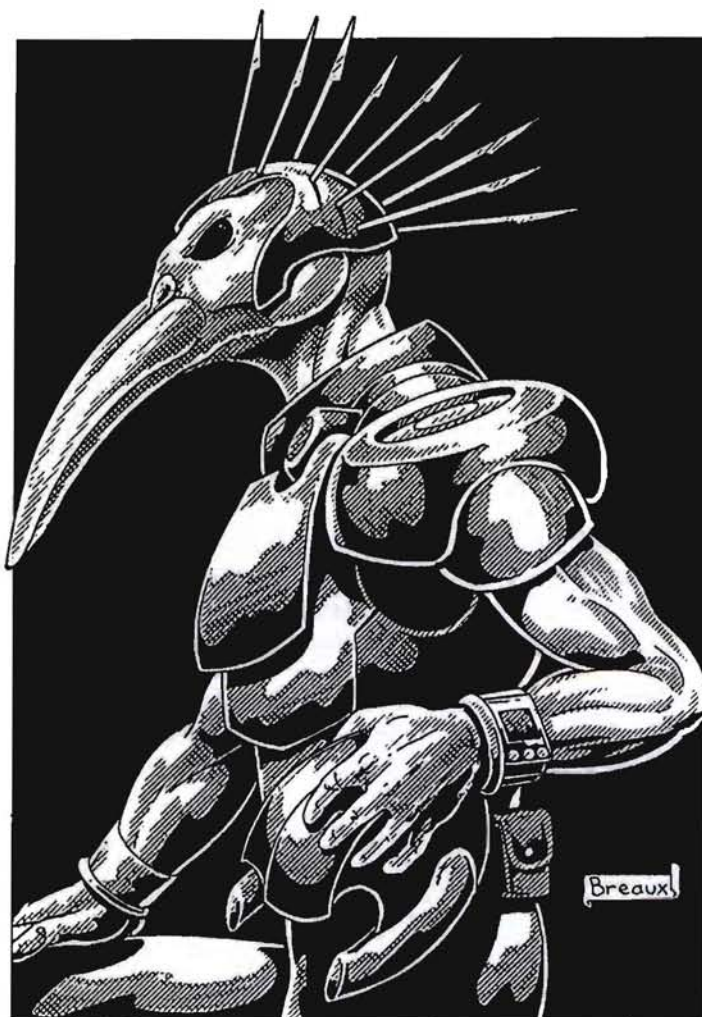

All of the exiled warriors are combat veterans. Many were trained as spies, saboteurs, terrorists and assassins. This training, combined with the rejection of their own people, has made many very bitter, vengeful and cruel. Very few of them are of good alignment. Among the exiles, the incidence of evil alignments and insanities is much higher than normal.

They now have a rigidly conditioned civil defense army that is made up of Threskians. Those with super abilities or psionics are constantly monitored and literally brainwashed into obedient fighting machines that never disobey an order (or think for themselves). Meanwhile, the exiles make their living as mercenaries, bounty hunters, pirates and assassins.

Threskians (pronounced thres-keye-ans)

Alignment: Any

Attributes: I.Q. 3D6, M.E. 3D6, M.A. 3D6, P.S. 3D6, P.P. 3D6, P.E. 3D6, P.B. 2D6, Spd. 4D6

Hit Points: Standard, P.E. plus 1D6 per level of experience.

S.D.C.: 30

Height: 6 feet plus 3D6 inches (2.0 to 2.3 m).

Weight: 100 plus 3D4x10 pounds (59 to 100 kg).

Average Life Span: 75 years. **P.P.E.:** 2D6

Super Abilities: All exiled threskian veterans have either super abilities or psionics, and all have had extensive combat, espionage and military training. Half are the products of government experiments. Magic is not known by these people. Only a small percentage of all Threskians are born with super abilities (01-11%) and even less with psionic powers (12-20%).

Natural Abilities: Nightvision is an impressive 1000 feet (305 m), they can also see infrared light, and have natural thermo-imaging abilities (range: 500 feet/46 m) and their hearing is twice as acute as normal humans (equal to the minor super ability of heightened hearing).

Special Weapons & Vehicles: Both the normal and super-powered Threskians have access to most standard high-tech weapons and vehicles. The super soldiers will tend to have the best and more lethal items.

Preferred Armor: Threskian environmental battle armor: Light: A.R. 13, S.D.C.: 55 or heavy: A.R. 18, S.D.C. 200. Both types have a helmet with detachable spikes that can be used as throwing spikes or parrying weapons.

Familiarity with Earth: "Some Familiarity."

Rifts Notes: Basically the same as the gymoy.

Timneh

Timnehs are nomadic glory hounds who travel the galaxy looking for excitement and attention. The more on-lookers and praise they can receive from their actions the better. Their continual search for situations in which they can show off makes them annoying. Most people tire of timneh quickly and the swaggering braggarts move on when they are no longer the heroes of the day.

Despite this, they can be friendly, social people. They are very smart, resourceful, and daring and can make

steadfast and loyal companions. Timnehs will not speak about their homeworld. They insist that they were born among the stars and are destined to roam among them. This cocky statement probably covers the fact that these people don't know the planet of their origin — they've been intergalactic nomads for at least 1000 years.

Timnehs can be from any educational background and will show off their skills and expertise whenever an opportunity presents itself. Likewise, they are quick to point out the failings of others, commenting on how they would have done such and such differently (and correctly or better). Those with a background in combat will seem especially arrogant and cocky. The general alignment of the timneh will determine the seriousness, recklessness and brutality of the warrior's actions.

All Timnehs have light grey feathers with darker grey edges and accents. Their heads are large and resemble giant parrots. Their arms, legs and fingers are thin and delicate, and their eyes always have an intelligent, evaluating look to them. They are creatures of magic and many (60%) are spell casters. Perhaps the magical nature of

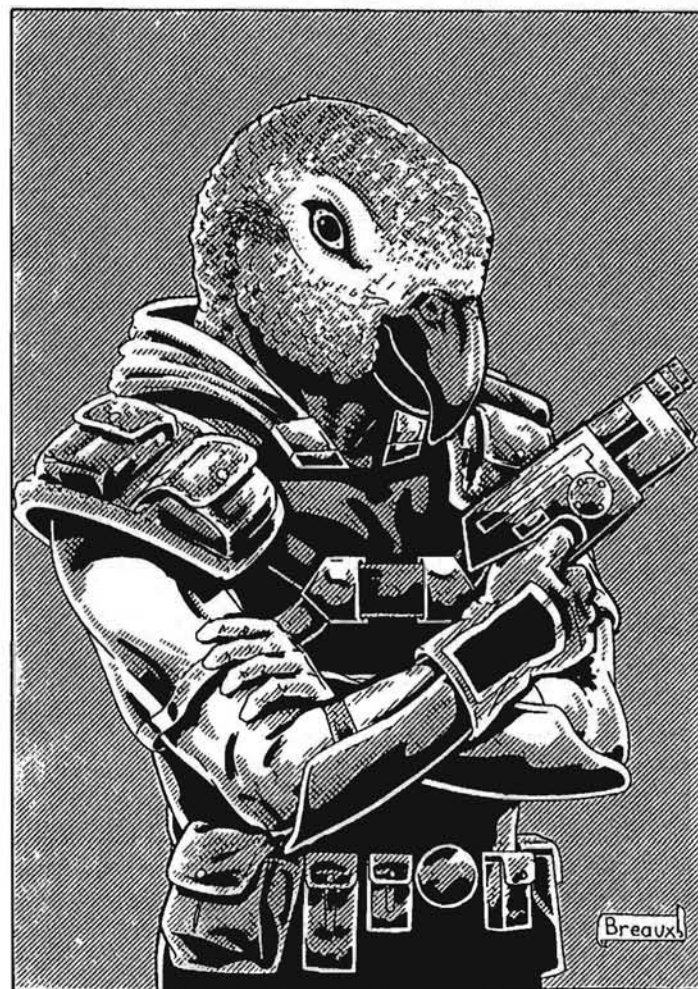

these avians is why they shroud their origins in secrecy and draw attention to their actions instead of their Mystic powers. Magic is the one thing they don't brag about or flamboyantly display.

Timnehs (pronounced tim-neigh)

Alignment: Any

Attributes: I.Q. 3D6+1, M.E. 3D6, M.A. 3D6, P.S. 3D6, P.P. 3D6+3, P.E. 3D6+3, P.B. 3D6, Spd. 4D6

Hit Points: Standard; P.E. plus 1D6 per level of experience.

S.D.C.: 45. **P.P.E.:** M.E.x3+1D6 per level.

Height: 5 feet plus 4D6 inches (1.6 to 2.1 m).

Weight: 100 plus 2D6x10 pounds (54 to 100 kg).

Average Life Span: 125 years

Super Abilities: All Timnehs, regardless of education, can naturally cast the following magic spells: Magic armor, chameleon, fly as the eagle, tongues, globe of daylight and Mystic portal. They cast these spells just as any wizard would using the magic rules. Spell strength is always equal to a first level wizard: 12. P.P.E. is P.E. x3 plus 1D6 per level of experience. Timnehs who do not pursue the Mystic arts can select any educational background or power category, but partial or full bionic conversion will destroy their innate magics (**Rifts:** Any O.C.C. except 'Borg or 'Bot). Yes, they can have super abilities in addition to these natural spell abilities.

Those who go on to study and practice magic as a wizard under Mystic study (magic), can select two additional spells for each level 1-4 (for a total of six spells from each level) and four additional spells from levels 5-10 (total of 12 spells from those combined levels) as

their starting spells. They also receive 2D4x10 additional P.P.E. points added to their base P.P.E.

Special Weapons & Vehicles: They have access to most high-tech weapons and items.

Armor: Most Timnehs rely on magical armor like the Armor of Ithan spell (A.R. 18, S.D.C. 200) and the Mystic armor spell (A.R. 14, S.D.C. 120). Many also wear light armor and vests: A.R. 10, S.D.C. 40.

Familiarity with Earth: The Timnehs have access to information on Earth equal to the "Has studied Earth" result on the Familiarity with Earth table.

Rifts Notes: If used in the **Rifts RPG** setting, the Timnehs will be regarded as D-Bee Mystics and can be any of the magic O.C.C.s found in the **Rifts RPG** line. However, most will be Ley Line Walkers and Mystics, and their magical nature grants them a bonus of 2D4x10 additional P.P.E. and allows them to select 1D6+6 additional spells. The Coalition States will seek to destroy them, while the Federation of Magic and Tolkeen may try to recruit them.

If set in the **Rifts: Phase World** environment, they can be practitioners of magic, Mercenaries, pirates or bounty hunters.

They are S.D.C. creatures who use Mega-Damage weapons, armor, vehicles and magic. These aliens will be fascinated by dimension spanning magic — an area of magic they are not familiar with.

Canine Humanoid Aliens

The canine races vary in build from thin with tight musculature like a greyhound, to bulky, wide bodies similar to pit bulls. Their height also varies, as does the shape of the head, tail, and the length, thickness and color of fur. On the Earth of **Heroes Unlimited** they may be mistaken for mutant animals. On **Rifts Earth** they may be mistaken for Dog Boys or Wolfen.

Canis

The Canis are tall, thin humanoid canines that resemble Earth's greyhounds. Their homeworld is Rath, a planet very similar to Earth, but with a lighter gravitational pull. The native animals and plants grow tall and elegant in its comfortable, clean atmosphere. For some reason, the color of their fur will indicate their innate abilities. **White Canis** are born with magical abilities. They are the Mystic leaders of the canine society. **Black Canis** will develop super abilities and are typically urged into military or police duties. **Brown Canis** are psionic. **Grey** are normal, non-powered citizens. Each of the four types were divided almost evenly, approximately 25% each.

For thousands of years, the brown Canis, known as *Psianines* (pronounced sigh-aye-nines), were disliked because of their fur color and mental powers. The grey Canis, because they didn't possess any powers were considered inferior. Both the brown and grey Canis were treated as second-class citizens, bullied and mistreated by

the white and black Canis. They could not hold positions of power, political office, or business. The greys, in particular, served as the beleaguered working class to a level bordering on slavery. Feeling overpowered and inferior, they accepted their fate.

In early Canis history, brown babies were killed at birth. Later, they were allowed to live and served as manual laborers and slaves. The brown Psianines frequently rebelled and used their abilities to fight back. These constant battles were often bloody and seemed only to make things worse. Up to 200 years ago, they were slowly gaining rights and freedoms, but a brown Canis named *Rithorn* instigated a revolution that rocked Canis civilization. In the end, the revolution was crushed, 61% of the brown Canis population was eradicated, Rithorn was executed, and the other conspirators banished along with ALL Psianines! At first, they were relegated to their own slum-like cities away from the other Canis, but the fires of hate still burned and trouble continued.

The **Canis Tribunal of Mystics** decided to banish all Psianines from Rath once and for all. A massive space ark was constructed in orbit, and the entire brown Canis population was placed on it and rocketed into outer space. Those who refused were executed as dangerous rebels. Some of the psionic Canis went on the ark willingly. They were able to boost the morale of their fellows with talk of freedom and a new life. However, the people of Rath had one last, foul scheme to play upon their psionic cousins.

The ark was secretly programmed to plunge into a black hole. Before the ark could reach its destination, it accidentally slipped into a dimensional syphon (see space travel section for details). The craft survived and the exiles found a wonderful world to colonize. Luckily, the Psianines landed on the first habitable planet they found (which also reminded them of Rath). If they had travelled much farther, the Atorian Empire would surely have detected the craft and they would have been slaves again. A large psianine colony now exists on the planet, Noth.

Approximately 200 years have passed since the psianine refugees were launched into space and established the Noth colony. The Canis on their homeworld have since perfected their space program and are beginning to use gravity wells to travel deeper into the galaxy. This means, one day, the brown Canis of Noth may be visited by bionic grey Canis soldiers and super powered Canis explorers. The Psianines are willing to forget the past but there will be great animosity between the brown Canis and their Rath brothers. If the Canis of Rath try to subjugate them in any way, there will be a bloody battle, only this time the psionic Canis have technological equality and larger numbers than before. **Note:** The brown Canis have not ventured deep into the stars. They have been too busy building a world for themselves. There are about 64 million psianine Canis (there are eight times as many Rath Canis).



Canis (pronounced cane-iss)

Alignment: Any. The brown Canis tend to lean toward good, while the others tend to lean toward selfish and evil.

Attributes: I.Q. 3D6, M.E. 3D6, M.A. 3D6, P.S. 3D6+3, P.P. 4D6, P.E. 3D6+3, P.B. 3D6, Spd. 6D6+10

Hit Points: Standard; P.E. plus 1D6 per level of experience.

S.D.C.: 1D4x10+20

Height: 9 feet, 5 inches plus 4D6 inches (3.0 to 3.5 m).

Weight: 300 plus 3D6x10 pounds (149 to 217 kg).

Average Life Span: 65 years; 75 years for the Brown Psianines. **P.P.E.:** M.E.x2 or by Magic Category

Super Abilities:

White Canis are limited to the Super Power Category of magic (typically a spell casting wizard; in **Rifts**, the character would be a Mystic).

Black Canis have two minor super abilities and one major, or two major abilities.

Brown Canis are natural psionics.

Grey Canis have no super powers, but can include characters from the categories of bionics, hardware or physical training. Grey Canis are typically lower class citizens, military grunts, indentured servants and slaves.

Natural Abilities (all Canis): In addition to their attributes, they are alert, have keen color vision (can see about 30% farther than humans) and have excellent hearing; +1 on initiative, +1 to dodge, +1 to roll with impact or fall. They can also leap 10 feet (3 m) high or lengthwise from a standing still position (double if running near full speed).

Special Weapons and Vehicles: The equivalent to most energy type weapons, hover vehicles and spacecraft. They like fast vehicles! Consequently, most Rath vehicles can travel at speeds 1D4x10% faster than normal (-10% on piloting skills at high speeds).

Preferred Armor: Light riot armor, A.R. 13, S.D.C. 60 (no prowl penalties) or heavy, full environmental armor, A.R. 16, S.D.C. 220 (-10% on prowl, swim, gymnastics and acrobatics skills).

Familiarity with Earth: None for both the Psianines of Noth and Canis of Rath.

Rifts Notes: If used in the **Rifts** setting, the Canis will be regarded as D-Bees or mistaken for CS Dog Boys. The Coalition States may mistake them for renegade Dog Boys or see them as potential D-bee recruits for Dog Pack squads in wilderness and hostile territories. This is especially true of the grey and brown Canis. The CS will destroy white and black Canis as dangerous *Mystics* or super-powered mutants.

If set in the **Rifts: Phase World** environment, they are just one of the less advanced and curious aliens who visit that world. It is also possible that some Canis, particularly grey and brown, are slaves. Others may be bounty hunters, mercs or adventurers.

In **Rifts**, the Canis are S.D.C. creatures who *may* possess S.D.C. or primitive M.D.C. technology depending on the view of the G.M. These aliens will be fascinated by dimensional travel and magic.



Dergins

The Dergins are natives of a planet they call Reginia. Early Dergin society evolved from canine packs or tribes of nomadic hunters. These were family clan communities that were led by the strongest warriors. Consequently, those with superhuman powers were usually the leaders and warlords. With time they developed an advanced civilization.

Those who served in the military were warriors known as *Wardions*. They were highly respected even in times of peace, and their super-powered leaders held great influence over the people. All Wardions were considered just and noble defenders and became a subculture in Dergin society that symbolized strength, spirit, freedom, justice and nobility. The generals and warlords were considered almost saintly champions of the people. In fact, the benevolent military was so popular and accepted that virtually one third of the population was counted among its ranks.

As the nomadic and warrior ways of the people changed, the warriors became part of an organized and powerful military. Political factions began to fear that the influence of the Wardions would undermine their power, even though the canine warriors had never spoken or acted against the government. Dergin society was very communal — like a giant dog pack. Although there were minor squabbles and jockeying for positions of power and leadership within the society, the warriors/military had always worked toward the good of the whole rather than the

individual. Still, the power moguls looked upon the power and respect held by the military and coveted it for themselves. To usurp that power, it was they who began to subtly undermine the people's faith and respect for the military.

Over the years, the warrior Dergins grew to dislike and distrust the policies and decisions of the government. Verbal confrontations between the two factions increased dramatically and often became very public. Meanwhile, the political machine discredited the military at every opportunity. The politicians and power brokers posed questions, asking, why did the military cling so fiercely to their power if they had only the welfare of the people in mind? If they served the people, and the people wanted them to downsize, even disband, why did the military resist? What were their motives? These and similar questions cast a pall over the heroes and evoked feelings of confusion and distrust. The people questioned the need for such a large military considering peace had reigned for over 300 years. They had been manipulated to believe that the military represented archaic ideals, dogma and unnecessary expenditures. They demanded reductions of troops, arms and military authority.

The Wardions considered taking military action against the government which they now viewed as a dangerous and self-destructive enemy, but a coup would only seem to prove their accusations and cause bloodshed. The mighty Wardions recognized that they had lost a political war because they had failed to respond to it until it was too late. Against their better judgement, the Wardions agreed to compromises, arms and troop reductions and alliances they felt were unsound. In the face of the government's now overt propaganda campaigns they felt they had little recourse but to comply.

A few years later, while the were making advances in their space program, they were contacted by the Atorian Empire. The Empire had extended its borders by 20 light years and Reginia was well within that radius. The Empire sent diplomats and made exciting offers to the people of Reginia. The government saw much opportunity and began to cater to the Atorians. The military was suspicious of the Atorian Empire and insisted on extreme caution, but their warnings were ignored. Frustrated by the bureaucrats, the Wardions launched an extensive, secret, intelligence campaign against the Empire. Their spies gathered convincing data that suggested the Atorian Empire was manipulating the government to become willing pawns in the exploitation of their planet's people and resources. Dergins would see little benefit and with time, the people would become little more than slaves to the dark Empire — at best, second-class citizens in an intergalactic web of tyranny.

The Wardions' intelligence and conclusions were presented in private to government officials who were outraged by their audacity at spying on their new allies. The information was buried. In a last ditch attempt to prevent disaster, the military went public with their findings and formally protested any alliance with the Atorian Empire. They called upon the people to rise up and reject the alliance. Sadly, the situation was turned against the Wardions to

make them look like rebellious extremists and the alliance was overwhelmingly approved.

Things went from bad to worse. The Wardions had lost much of their credibility. Many old leaders resigned (several had mysterious accidents) and were replaced by young warriors who shared the government's view of the future and who regarded the Atorian Empire as a valuable ally. Those Wardions who refused to retire and continued to express suspicions about the Atorians were isolated and sent to distant command posts. The alliance required military support and defense of the Atorian Empire. Consequently, millions of Wardions were sent offworld to defend distant outposts and alien borders. The Wardions realized their position was a no win situation and decided to obey. To do otherwise meant certain retaliation by the evil Empire, not against them, but at their people. The Dergins fell to the Atorian Empire, not through military invasion and conquest, but instead sold out by their own people.

One particularly defiant branch of the military was assigned to an operation in a dangerous part of the Atorian Empire. The troops had no delusion that this assignment was meant to *eliminate* them. Two nights before their scheduled departure, the Wardion armies boarded and captured the Atorian Defense Station orbiting Reginia with only 1,200 losses. The warriors threatened to use the space station's formidable weapons against their homeworld unless they were allowed to have their families and loved ones join them on the giant space station. Wanting to avoid bloodshed, and figuring they'd get all the rebels at one time, the government allowed the families to join the rebels. Meanwhile, four Atorian battleships were rushing to the scene to blow them out of the heavens.

However, the Wardions had their own plans. When the battleships emerged from the space gateway, the Wardions, utilizing intelligence data and secret codes they had acquired through covert means, quickly slipped past the emerging ships and plunged into the gateway themselves, and disappeared. The Wardions had stolen the Atorian Defense Station (the first and only time such a feat has ever been accomplished; the Atorians still can't explain exactly how it was done). The Atorian Empire was furious, but could do little about it. Their only recourse was to put a massive bounty out for information on the station's whereabouts (one million cr) or for its safe return (50 million cr). They have avoided capture for nearly ten years now.

The Wardions have done extensive modification work on the space station to the point that it is nearly unrecognizable as an Atorian construct. Only the design of the main weapon systems and some of the interior deck plans gives it away. The space station is currently disguised as a planetoid with a blow-away rock cover. The canine warriors have formed an alliance with a small pirate enclave and count a large number of Thropo Ronins among their soldiers. They live the old ways as hunters and warriors, preying on evil beings, such as cutthroat pirates, smugglers, mercenaries, slavers and members of the Atorian Empire. There are approximately 90,000 Wardions/war-

riors and roughly 280,000 Dergin civilians, mostly family members, living on the space station. An additional 10,000 or so heroes/warriors from other worlds are also counted among their ranks. A small fleet of about 30 medium-sized space cruisers and 120 one- to four-man fighters are part of the group.

Back on their homeworld, the Dergins are quickly falling in line under their Atorian masters. The military has been taken over and sent offworld by the Atorians to defend its possessions and borders. This situation has left Reginia virtually defenseless. Many of the older Wardions are unhappy and see themselves as a conquered people. They long for the old days and would support rebellion/liberation if it ever came. However, many of the young warriors are finding fulfillment and opportunity as soldiers for the Atorian Empire. In fact, the Wardions have distinguished themselves so many times in combat that they are quickly becoming the Atorians' favorite troops. An elite corp of young, loyal Wardions is being established to serve the Empire as military specialists, espionage agents and shock troops.

The lavish favoritism is causing bad blood between the Dergins and the Mantella. The latter have been the Atorians' favorite minions for generations and they don't like losing even a little of their "favored status."

Ironically, it will be the Dergin military who reaps any real benefits from the alliance. Under the aggressive military of the Atorian Empire, the warriors have regained their place as respected warlords. Sadly, the Atorians are evil tyrants who conquer worlds they cannot win through political maneuvering, subterfuge or threats. Thus, within a few generations, the once noble Wardion heroes will become the elite strike force of a conquering army devoid of compassion, honor or nobility. The other people of Reginia will never become more than second-class citizens of a backwater world in the Atorian Empire's outer edges. For the moment, the ruling body still enjoys a certain amount of autonomy, but they are clearly a tiny cog in a much larger machine.

Dergins (pronounced der-gins)

Wardions is the warrior class (pronounced war-die-ons)

Alignment: Any. Most rebel Wardions are of a good or selfish alignment and continue to be warrior champions. Many of those under the Atorian regime are becoming selfish or evil and ambitious.

Attributes: I.Q. 3D6, M.E. 3D6+2, M.A. 3D6, P.S. 5D6, P.P. 3D6+4, P.E. 4D6, P.B. 3D6, Spd. 4D6

Hit Points: P.E. x2 plus 1D6 per level of experience.

S.D.C.: 4D4x10+30

Natural A.R.: 13

Height: 8 feet plus 4D6 inches (2.5 to 3.0 m).

Weight: 340 plus 4D6x10 pounds (172 to 263 kg).

Average Life Span: 80 years. **P.P.E.:** 3D6

Super Abilities: The typical Dergin does not have super abilities, although 10% have psionics, and 20% can select abilities and/or training from the categories of bionics, robotics, hardware or physical training. They do not know the Mystic arts but that is a new possibility with exposure to other races.

All Wardions have the following **Super Abilities:** Energy expulsion: light or energy (choose one) and heightened sense of hearing (+1 to parry, +2 to dodge, +6 on initiative). Wardions can be any power category, including physical training, hardware, and bionics or robotics, but bionic implants will have the usual effects on these super abilities. Wardions can also have two additional minor abilities or one major super ability (make a random roll or selection), making them mutants (as per the power category), but such super powered people are rare (less than 10% of the population).

Natural Abilities: Reflected in their attributes and natural armor.

Special Weapons and Vehicles: The equivalent to most types of weapons, hover vehicles and spacecraft. Favorites include energy swords, heavy energy weapons/rifles and explosives.

Preferred Armor: Most Dergins, including the Wardions, rely on their natural armored hides for protection. Of course in outer space, additional protection is required. Light environmental suit, A.R. 10, S.D.C. 40. Full environmental armor, A.R. 17, S.D.C. 180 (-10% on prowl, swim, gymnastics and acrobatics skill).

Familiarity with Earth: Neither the Dergins or the exiled Wardions have any familiarity with Earth.

Rifts Notes: If used in the **Rifts** setting, the Dergins will be regarded as D-Bees or mutant CS Dog Boys. The Coalition States may mistake them for renegade Dog Boys or see them as potential D-bee recruits for Dog Pack squads in wilderness and hostile territories (never in the cities or at military installations).

If set in the **Rifts: Phase World** environment, they are just one of the less advanced and curious aliens who visit that world. It is also possible that some are slaves, bounty hunters, mercenaries, pirates or adventurers.

In **Rifts**, the natural body armor of the Dergins makes them Mega-Damage creatures (4D4x10+30). They are also likely to have super abilities that inflict Mega-Damage. In this setting they possess M.D.C. technology equal to the Coalition States. These aliens will be fascinated by dimensional travel and magic.

Latrans

The Latrans are a race that seems to have literally walked out of the pages of human myth. They are shapeshifting humanoids who can turn into giant, four-legged wolves! In their natural forms, they are short, powerfully built humanoids with the head of a wolf. Long fur covers their head, shoulders, and back.

While in wolf form, their senses are acute and they possess a savage instinct to survive. As a wolf, their intelligence is reduced by half, but their instincts take over and they become cunning and deadly warriors on a more bestial and predatory level. A Latran will not shift for the fun of it, to frighten others or to show off. They believe the power comes from the spirits of their ancestors that dwell within them and make the transformation possible in times of need. They are insulted by suggestions that the power may be an innate racial ability without any supernatural connection to the dead.



Most believe their ancestors will leave them if they abuse their "gift," so the power is used with discretion. It is also warned that Latrans who shapeshift frequently or who enjoy the savage power of their animal spirit will turn "feral." Feral Latrans are usually selfish or evil villains who prefer their animal form and change into humanoids only when necessary (usually to disguise themselves). These feral monsters typically disregard the law and prey on others, including other Latrans. Many of them enjoy murder and torture for the sheer *sport* and pleasure of it.

Most of these canine humanoids are honorable, gentle and spiritual people with an air of nobility around them. They are friendly toward outsiders and have a genuine curiosity about other races, dimensional travel and magic. They elect their leaders from among the most capable of their eldest females. Most warriors prefer melee weapons and close combat. By following the "old ways" of combat, they believe they honor their ancestors. All duels are fought using melee weapons or tooth and claw (in humanoid or wolf form). Most soldiers are accomplished at prowling and intelligence skills, but not all Latrans are combat trained. However, even the most feeble character becomes dangerous when transformed into a wolf. Military personnel and fighters frequently have their claws capped with Kisentite fingernails or even small blades which adds 1D6 damage to claw attacks.

Their home planet is a lush, green world named Goreal. It has a higher gravitational pull that produces heavy metals similar to Kisentite. The Latrans honor the spirits of the

land and live in relative peace with the other races and animals that inhabit their world. Latrans feel sorry for other races who are not in touch with their own spirits, let alone their ancestors'. They have developed space and computer technology roughly equal to most members of the Federation of Allied Races (FAR) and are new members in the galactic community. Many travel the galaxy working as gurus, Mystics, bodyguards and bounty hunters, but despite their chosen profession, most try to help people, especially those that need direction in their lives. Many have joined forces like FAR, the Wardions and others that oppose the Atorian Empire (the Empire does not know anything about these canines).

Latran (pronounced lah-tran)

Alignment: Any. Most are good or unprincipled, with the occasional selfish or evil character. Aberrant Latrans are extremely honorable and protective, but those they find unworthy can face a cruel and merciless opponent. Only "feral" Latrans are completely anarchist, diabolic or miscreant. They are extremely dangerous, have no honor, and are often employed by shady forces as assassins.

Attributes: I.Q. 3D6, M.E. 3D6, M.A. 3D6, P.S. 4D6, P.P. 3D6, P.E. 4D6, P.B. 3D6, Spd. 4D6x3

Hit Points: Standard, P.E. plus 1D6 per level of experience.

S.D.C.: 2D4x10; also see the transformation.

Height: 5 feet plus 1D6 inches (1.5 to 1.7 m).

Weight: 160 plus 4D10 pounds (74 to 91 kg).

Average Life Span: 90 years. **P.P.E.:** M.E.x2

Super Abilities: Special! Their bonuses when humanoid are listed separately from their stats as a wolf.

Bonuses (Humanoid): All are in addition to attribute bonuses. Minor super abilities of healing factor and heightened sense of hearing: +1 to parry, +2 to dodge, +6 on initiative, +20% to save vs coma/death, +3 to save vs magic, psionics, and toxins; other details are found under the description of the two powers on page 233-234 of **Heroes Unlimited**.

Bonuses from the Wolf Transformation: Shape-change into a giant, monstrous wolf, six feet (1.8) long and four feet (1.2 m) tall at the shoulders. This ability is similar to *animal metamorphosis: canine (wolf)*, but even more incredible. All bonuses and abilities are in addition to attribute bonuses and the humanoid powers and bonuses above.

Double speed, can leap 20 feet (6 m) high or lengthwise from a standing position (add 10 feet/3.0 m for a running start), add one additional attack per melee round, add 200 to S.D.C., increase P.S. by 6 points, +2 to save vs poison and disease, +2 to save vs magic, +8 to save vs Horror Factor, bite attack does damage, claws do 2D4 damage plus P.S. bonus, extraordinary sense of smell (track by smell: 50%+4% per level and recognize a specific scent: 56%). **Note:** Other changes while in wolf form are not so positive: reduce I.Q. and M.A. by half (returns when humanoid) and the wolf is very aggressive, likes the taste of blood and raw meat, and is easily provoked to fight. They often lose themselves in battle, fighting until their foe is slain or unconscious.

Occupational Note: Latrans can pursue any occupation.

Special Weapons and Vehicles: The equivalent of most types of weapons, hover vehicles and spacecraft. Favorites include energy swords, Kisentite weapons and Vibro-Blades.

Preferred Armor: Light ceremonial or decorative armor is normally all that is worn. Heavier types of armor or restrictive suits prevent the transformation (must be removed first). Ceremonial armor will be A.R. 10 with 30 S.D.C. and is specially designed not to hinder or damage a shapechanging Latran (Cost: 375 dollars). Otherwise, any type of humanoid body armor or environmental suit can be worn when in humanoid form.

Familiarity with Earth: None.

Rifts Notes: If used in the **Rifts** setting, Latrans will be regarded as dangerous D-Bees or mistaken for CS Dog Boys. The Coalition States may mistake them for renegade Dog Boys when in humanoid form but will never knowingly recruit these shapechanging monsters. The CS will destroy every Latran they can identify. However, the Splugorth, Werebeasts, Wolfen, demons and other monsters races will find them intriguing and invite them into the fold (demons and evil folk may enslave them). Rifts Latrans can be any O.C.C., but avoid bionics, M.O.M. implants, Juicer enhancements and similar physical augmentation because they prevent shapechanging.

If set in the **Rifts: Phase World** environment, the basic **Aliens Unlimited** setting is applicable. Technology is likely to be primitive M.D.C., but Latrans are S.D.C. creatures when in humanoid form. However, in wolf form they become Mega-Damage creatures (2D6x10+100 M.D.C.) and their bites and claws do 2D6 and 1D6 M.D. respectively. They can be considered creatures of magic (4D6x10 P.P.E.) although Latrans rarely pursue the Mystic arts. These aliens will be fascinated by dimensional travel and magic, and love to use magic weapons, rune weapons, Bio-Wizardry and Techno-Wizard items.

Lupis

The Lupis are another species of humanoid canines. They have a heavy build with a thick layer of fur that insulates them from the frigid temperatures of their native world, Nystum. The color of their fur is white or a light grey.

Although the Lupis are capable of advanced space travel, they rarely travel far from Nystum. They prefer to maintain a policy of isolationism and mind their own business. They have refused membership with FAR and the Atorian Empire and, so far, have successfully kept themselves out of galactic politics. They are especially concerned about interplanetary war and want to avoid involvement in the squabbles of others at all costs. Thus, they reserve deep space travel as a tool for commerce and research. A large portion of the space program focuses on space stations. There are over three dozen space stations that function as research and development



centers, trade centers, manufacturing facilities and defense stations around Nystum.

The Lupis have perfected many robot systems and regularly use exoskeletons, robot vehicles and drones for heavy labor, manufacturing, exploration, and combat. The bulk of their military might is in the form of robot technology. Security officers outfitted in exoskeletons/power armor are normally sent on space missions and are found on space stations. They are typically supported by a squad of Lupis with super abilities. The canines have successful super ability experimentation programs used specifically to create super-soldiers.

Lupis (pronounced lew-piss)

Alignment: Any, but many lean toward selfish.

Attributes: I.Q. 3D6, M.E. 3D6, M.A. 3D6, P.S. 4D6, P.P. 3D6, P.E. 3D6, P.B. 3D6, Spd. 4D6

Hit Points: Standard, P.E. plus 1D6 per level of experience.

S.D.C.: 70

Height: 5 feet plus 3D6 inches (1.6 to 2.4 m).

Weight: 120 plus 2D6x10 pounds (63 to 109 kg).

Average Life Span: 85 years. **P.P.E.:** 3D6

Super Abilities: Lupis characters can make selections from the following Super Power Categories: bionic (01-10%), robots (11-70%), hardware (71-80%), physical training (81-90%), and experiment (91-00%).

Natural Abilities: Resistant to cold (half damage), keen vision and are instinctive swimmers (80%).

Special Weapons and Vehicles: The equivalent of most types of weapons, hover vehicles and spacecraft. Favorites include lasers and robot exoskeletons.

Preferred Armor: Standard Security Team power armor (SST-12): A.R.: 18, S.D.C.: 300, with full environmental capabilities, long-range radio, radar, sonar, multi-optics system, jet pack (maximum speed in an atmosphere is 100 mph/160 km with a maximum altitude of 600 feet/183 m). **Armor weapon systems:** Right arm: concealed laser (4D6 damage and a range of 1600 feet/488 meters, effectively unlimited payload). Laser Finger Blaster (2D6 damage, 100 foot/30.5 m range). Left arm: retractable Vibro-Blade (3D6 damage). Electromagnetic boots for clamping onto the hull and floors of metal ships. All other types of armor and spacesuits can also be used.

Familiarity with Earth: Equal to the "Has studied Earth" result from the Familiarity With Earth table, but has no plans to make contact.

Rifts Notes: Basically the same as the Canis.

Toyoc

Toyocs are the survivors of a nuclear war that has turned their once warm planet into an icy wasteland.

One fateful night, as the canines sat enjoying their evening, the emergency broadcast systems interrupted their routines with grave news. Nuclear missiles had been launched and a full-scale thermo-nuclear war was underway! Time seemed to tick by slowly until massive fireballs filled the sky, incinerating cities and sending fiery winds lashing through the countryside. Billions died, but the worst was yet to come for the survivors. Their planet was much hotter and drier than Earth. When the missiles detonated, thousands upon thousands of tons of dust, debris and pulverized cities were thrown into the air. The result was a nuclear winter effect. The planet's inhabitants began to freeze in the unprecedented cold.

Millions died from the dramatic shift in the climate and radiation poisoning. Plagues swept the land and the Toyocs were plunged into dark age. Only 11% of the population survived.

A hundred years has passed since the terrible war. The skeletons of ancient cities still mar the landscape and claw at the sky. The Toyoc survivors have not yet recaptured the technology of their ancestors. Their society is modest by comparison and after their experiences, most Toyocs try to avoid war and do not tolerate people who use great destructive power. The typical tech level is roughly equal to that of 18th to 19th century Earth with a few pockets of development that are equal to the 1930's. No Toyoc possesses space technology, or knows anything about life on other planets.

The most primitive people live in small villages or tribes and reject all modern technology. Some wilderness communities are reportedly practicing magic. Many of those who consciously reject technology are people who possess superhuman, psionic or Mystic powers. Some of these groups are so fanatical that they destroy machines whenever they are found and punish, even slay, any who

use them. These people will regard alien visitors who are robots, androids or cyborgs (even partial), or use power armor/exoskeletons, or energy weapons as *demons* to be feared and destroyed. A society known as **Technocrats** are the most advanced, roughly equal to 1930's Earth, and live in a cluster of towns and small cities. The anti-machine tribes view them as heretics who will bring disaster to their world. It is only a matter of time before these two factions clash.

One of the side effects of the war and subsequent radiation has been the manifestation of mutant super abilities and psionic powers among the Toyocs. The traditional Toyocs were roughly human-sized, with long snouts, thick manes of hair and light rust colored fur, but there are many new and unusual traits among the mutants.

A few hundred Toyocs managed to leave the planet on spacecraft that survived the holocaust, but nobody knows what may have become of them.

Toyoc (pronounced toy-ahk)

Alignment: Any

Attributes: I.Q. 3D6, M.E. 3D6, M.A. 2D6+2, P.S. 4D6, P.P. 3D6, P.E. 3D6, P.B. 3D6, Spd. 5D6

Hit Points: Standard, P.E. plus 1D6 per level of experience.

S.D.C.: 45. **P.P.E.:** 5D6 or by Magic Category

Height: 5 feet plus 4D6 inches (1.6 to 2.7 m).

Weight: 100 plus 2D6x10 pounds (54 to 100 kg).

Average Life Span: 75 years.



Super Abilities: Limited to magic (01-10%), physical training (11-20%), psionics (21-40%) and mutants (41-75%; definitely roll once or twice on the unusual characteristics table). The remaining 25% are normal and do not possess any special abilities other than the natural abilities listed below (They will be bionics (76-80%), robotics (81-90%), or hardware (91-00%)).

Natural Abilities: Heightened sense of smell equal to the minor super power and nightvision (600 foot/183 m range).

Special Weapons: The level of technology varies from clubs and swords to automatic weapons salvaged from the ruins of ancient cities. The TC-7 Sub-machinegun is the most advanced weapon among surviving technocrats: Range: 600 feet (183 m), Damage: 4D6, with a 15, 30 or 60 round clip.

Special Vehicles: Land rovers and motorcycles to riding animals. Aircraft and military vehicles are a rarity.

Preferred Armor: Mainly primitive types of body armor, including padded, leather, chain mail and plate armor. The Technocrats manufacture and use several different types of pre-holocaust combat armor. The most advanced is a metal plate and ceramic suit of hard armor: A.R. 14, S.D.C. 75.

Familiarity with Earth: None

Rifts Notes: Fundamentally the same as the Latran. A more advanced, evil civilization such as the Splugorth (or Atorian Empire) might enslave these people or conquer this world.

Vulpese

The Vulpese civilization on Ter is technologically advanced and very peaceful. Through the use of psionic and Mystical means, they have virtually eliminated violence in their society. There have been no wars in hundreds of years, and what crime exists is rarely violent. By mechanical, mental, and Mystical means, the Vulpese governing council keeps a watchful eye on the people. There is literally no privacy for these canines due to constant government sweeps searching for troublemakers, contraband and illicit activity. Psychics and mages working with technological support teams are on constant alert for any signs of anarchist behavior.

Virtual reality duels are allowed as a way to settle arguments. Duels between public officials and celebrities have become spectator sports sanctioned by the government to satisfy the more base desires of its people. Duels are a way of venting violent feelings among the populace without actually inflicting physical injury or destruction. However, despite the popularity of dueling, the participants are by no means skilled combatants. Fighting skills of any kind are outlawed on Ter, as well as the use of weapons.

Any citizen caught studying or practicing fighting skills or in possession of weapons (ancient, automatic or energy) must undergo extensive psychological therapy and is placed under strict police surveillance. The canines believe that anyone who would be inclined to practice the arts of war is naturally inclined to violence and rehabilitation is a must. Repeat offenders may find themselves sub-



jected to psionic mind wipes or *behavioral modification* through chemicals. Despite the laws against it, there is a sizeable underground society that practices martial arts for physical and mental discipline. The meditation techniques and mental disciplines they develop have allowed them to go undetected by the government's anarchy sweeps. The movement is non-violent and seeks only to remain undetected, but if the government were to discover them, it would begin a campaign of extreme measures to eradicate these dissidents.

The most violent or those considered to be incapable of rehabilitation are placed in *cryostasis*, put on a small spacecraft and flown through a nearby space gateway. The passenger is awakened when it approaches a space station or inhabited planet. The craft's computers are programmed with basic information about the planets in the area closest to the exit gateway. If the Vulpese inside the spacecraft survive (80% likelihood), they must make a new life away from their homeworld. Many become mercenaries and adventurers, and others join the space programs or armies of other worlds. Sadly, about 40% of these exiles are intercepted by brigands who engage in the slave trade.

The Vulpese have no standing military in a conventional sense. The defense of Ter is handled by a network of weapon platforms orbiting the planet. Each is controlled by an artificial intelligence. The sheer number and firepower of these platforms is believed to be more than a

match for any invader. If an alien invader should penetrate the orbital defense network, the Vulpese are confident that their large civil police corps of psionics and mages would be able to fend off landing parties. Since Ter has never been invaded, the viability of this system has not been tested.

Vulpese (pronounced vul-peas)

Alignment: Any

Attributes: I.Q. 3D6, M.E. 4D6, M.A. 3D6, P.S. 3D6, P.P. 3D6, P.E. 3D6, P.B. 3D6, Spd. 4D6

Hit Points: Standard, P.E. plus 1D6 per level of experience.

S.D.C.: 1D4x10. **P.P.E.:** 6D6 or by Magic Category.

Height: 6 feet plus 1D6 inches (1.9 to 2.0 m).

Weight: 190 plus 1D6 pounds (87 to 89 kg).

Average Life Span: 65 years

Appearance: Humanoids with a canine head that resembles an Earth German shepherd, fox or wolf. Their fur is thin and grows close to the body, but is thick and shaggy on the head and neck. Fur colors can range from strawberry blonde and light orange to copper and red.

Super Abilities: Most are psionics (01-35%; latent psionics as normal. 36-65%; *natural psionics*), some wizards (66-90%) and the rest are mutants with super powers (91-00%). Hand to hand combat, physical and espionage skills are not known to most of these people. Unless the character is a rebel, hand to hand skills are not available, though psionic attacks can be made three per round and spells can be cast two per round (additional psionic or magical attacks are gained at levels 3, 6, and 10).

Rebels can be any of the above, but also study and practice hand to hand combat (select one of choice) and other physical skills like boxing, wrestling, general athletics, gymnastics, etc. (select four), and espionage (select two).

Natural Abilities: Keen senses of vision, smell and hearing, +2 on initiative, +2 to dodge, +1 to roll with impact, +2 to save vs Horror Factor, and +3 to save vs radiation poisoning.

Special Weapons and Vehicles: The equivalent of most types of hover vehicles and spacecraft. Weapons and armor are illegal. Only the law enforcement agencies use weapons and those are restricted to stun weapons and billy clubs.

Preferred Armor: Police only: A.R. 11, S.D.C. 30.

Familiarity with Earth: None.

Rifts Notes: If used in the **Rifts RPG** setting, the Vulpese will be regarded as D-Bees or mistaken for CS Dog Boys. The Coalition States may mistake them as renegade Dog Boys or see them as potential D-bee recruits for Dog Pack squads in wilderness and hostile territories. This is especially true of those with fighting abilities and minor psionic abilities. The CS will destroy those with major psionic or super powers and those who wield magic.

If set in the **Rifts: Phase World** environment, they are another race of alien beings who trade on that world. It is

also possible that some are slaves, bounty hunters, mercenaries or adventurers.

In **Rifts**, the Vulpese are S.D.C. creatures who *may* possess S.D.C. or basic M.D.C. technology depending on the view of the G.M. Rifts O.C.C.'s can include any of the psionic, magic and non-violent ones.



Wulf

The Wulfs are a race of psionic canines that come from the twilight homeworld of Ornilla. Their society is structured in a modern feudal system of Lords, Dukes, and Kings. They are of average humanoid height and build, with dull grey or black fur that grows thickly on the head and shoulders. Their heads are wide, with powerful jaws and eerie green eyes. All Wulfs have the major psionic power of pyrokinesis and rely on it in combat. Their natural fiery abilities and temper have earned them the nickname of "Hellhounds."

Despite a high level of technology that includes self aware computers and advanced space programs, the Wulfs have not developed, and most will not use, long-range weaponry — at least not on their homeworld. These psychic warriors live by an unusual code of combat that insists that opponents must face each other in close combat. They feel if one is to kill, it should be done close and personal, and that such a code actually reduces callous and casual murder. As a result, firearms and energy weapons are uncommon on Ornilla and used mainly

off-world against aliens who have no "code." A wulf in combat will carry one to four different melee weapons, as well as rely on his natural psionic powers. The sword becomes an object of pride and can only be taken from the fighter when he is dead. Wulf melee weapons are of superior quality.

Planetary defenses and spacecraft weaponry may also rely on psionic abilities as well as missiles or lasers. The canines have developed a wide range of psionic amplifiers that extend the range and damage of their abilities so that they are on the same scale as artificial weapons. All of these amplifiers are very large and can only be mounted in buildings or on spacecraft. A psionic amplifier weapon is roughly the same size as the heavy weapon it replaces and has effectively the same range and damage. Most are plasma/fire, laser and force (telekinesis). These amplifier weapons make the Wulfs' spacecraft particularly feared because the weapons do not fire in the traditional sense and utilize psychic energy instead of conventional power systems.

The Wulfs have a strong military presence in space, but have remained neutral in the power struggles between various factions. All Wulfs serve mandatory tours in the military for a minimum of three years. Many former and retired military personnel work as military advisors, mercenaries and bounty hunters.

Wulf (pronounced woolf)

Alignment: Any, but tend to be principled, anarchist and aberrant.

Attributes: I.Q. 3D6, M.E. 4D6, M.A. 3D6, P.S. 4D6, P.P. 3D6, P.E. 3D6, P.B. 2D6+3, Spd. 5D6.

Hit Points: P.E. plus 2D6 per level of experience

S.D.C.: 50

Height: 7 feet plus 2D6 inches (2.2 to 2.4 m).

Weight: 200 plus 2D4x10 pounds (100 to 127 kg).

Average Life Span: 80 years. **P.P.E.:** 3D6+4

Super Abilities: All Wulfs are *natural psionics* with the power of pyrokinesis in addition to the usual abilities available to such characters.

Natural Abilities: Nightvision 600 feet (183 m) and sensitive hearing 20 decibels beyond human range; +2 on initiative, +1 to pull punch, +1 to roll with impact and +3 to save vs Horror Factor.

Preferred Armor: Most Wulfs will wear full suits of environmental plate armor: A.R. 17, S.D.C. 200.

Familiarity with Earth: The Wulfs have access to information on Earth equal to the "Has studied Earth" result on the Familiarity with Earth table.

Special Weapons and Vehicles: The equivalent to most types of weapons, hover vehicles and spacecraft. Favorites include energy melee weapons, Vibro-Blades and other types of powerful melee weapons.

Rifts Notes: Basically the same as the Vulpese.

Feline Alien Races

All feline aliens have cat-like features that include oval eyes and wide noses. Some look extremely human, while others look more feline. Fur usually covers their entire body and varies considerably in both length and color. Many have retractable claws, fangs and superior physical dexterity and balance.

Altaicans

The Altaicans are natives of the thermal world, Thissia. Their numbers are mostly located in the tropical latitudes where temperatures hover just below 200 degrees Fahrenheit (93 C). They are a tall, powerfully built race with features similar to the lions of Earth, although their manes are not quite as prominent and are shaped differently. The fur is long and thick on their head and upper back but barely an inch long over the remainder of their bodies. Colors range from tan to grey.

Each Altaican city is governed by a shaman-like Mystic called a *Wisam*. Each Wisam keeps a council of Mystic advisors. Of this council, one member is elected to represent their city at the nation's capital. The capital and many major cities are located on ancient sites with magical significance. They are called *The Gathering Places*. At The Gathering Places, the Mystics are able to commune with their ancestors and the spirits of the planet for help and guidance. The spirits do not condemn or forbid the development of science because it is seen as part of the natural evolution of the race. However, the misuse of technology or magic will be judged against the offender.

With the blessings of the spirits, the Altaicans have made advances in space travel and other high-tech areas. They have developed bionic programs that are highly successful, and their space related achievements include moon colonies and deep space exploration. One area forbidden by the spirits is experimentation to develop super abilities or psionic powers.

Most Altaicans have a strong sense of justice, and feel a responsibility to help the weak and less fortunate. Many of those who leave Thissia to travel to the stars, bring their personal sense of justice and honor with them. They are effectively knights-errant who correct injustice and defend the innocent wherever they go. As the felines roam the galaxy, they may choose one planet or people to protect or avenge. Many will remain on that world or with those people for decades, sometimes till the day they die. Some, especially the young, will swear an oath to right or avenge a particular wrong or engage in a specific noble quest. The Altaicans' term for a noble quest is a "Soul Find." Altaicans on a Soul Find are often of selfish alignments because they do not yet know what they want from life or from themselves. Eventually, most become scrupulous as they engage in a lifetime of helping others. However, there are evil and selfish Altaicans. Some become engrossed in war and cruelty, others seek glory and power at the cost of other people.

The Altaicans would be prime candidates for opposition to the Atorian Empire, but their homeworld is light years away from the Empire's nearest border on the outer edge of the Milky Way. Thus, they know little about the Atorian Empire and have never faced them in any conflict. However, as the felines make inroads into the outer reaches of the galaxy, they are beginning to meet other intelligent life forms and have begun to hear stories about the Empire, FAR (Federation of Allied Races) and other worlds.



Altaicans (pronounced al-tay-cans)

Alignment: Any, but young adventurers are often unprincipled or anarchist, while older characters will generally be good or evil.

Attributes: I.Q. 3D6, M.E. 3D6, M.A. 4D6, P.S. 4D6, P.P. 3D6+2, P.E. 3D6+2, P.B. 3D6, Spd. 4D6

Hit Points: Standard, P.E. plus 1D6 per level of experience.

S.D.C.: 1D6x10+10

Height: 5 feet plus 4D6 inches (1.6 to 2.1 m).

Weight: 100 plus 2D6x10 pounds (54 to 100 kg).

Average Life Span: 70 years. **P.P.E.:** 3D6

Super Abilities: The following Super Power Categories are available to Altaican characters: bionics, hardware,

magic, mutants with super powers, and physical training. No Altaicans have psionic powers.

Natural Abilities: As a native of a thermal world, the character is immune to the effects of heat and resistant to fire (half damage). However, any temperatures below 98 degrees Fahrenheit (37 C) are freezing to them and the aliens will suffer exposure as detailed under the Frozen World description unless they are in a heated survival suit. Also +1 on initiative, +2 to roll with impact.

Special Weapons and Vehicles: The full range of weapons and vehicles is available, except for antigravity devices. Sonic disruptors are a favorite weapon and two-man hover cycles and jet packs are favorite vehicles.

Preferred Armor: Will depend on the occupation of the Altaican. Most will use the armors of their adopted planet because they are repairable and replaceable. Depending on the alien's personal tastes, this can be anything from a vest (A.R. 10, S.D.C. 50) to Class Four Hard Armor (A.R. 17, S.D.C. 280).

Familiarity with Earth: Equal to the "Some familiarity" result on the Familiarity with Earth table.

Rifts Notes: If used in the **Rifts** setting, the felines will be regarded as D-Bees. The Coalition States and other human supremacists will see them as dangerous beings because they are inhuman, educated, and they promote learning and interracial cooperation, as well as practice magic.

If set in the **Rifts: Phase World** environment, the basic setting presented above for this book is satisfactory. The character will be an S.D.C. creature, like humans, who possesses Mega-Damage weapons and technology.

Concol

Col is a planet of low gravity surrounded by perpetual cloud cover. As a result, the planet is a dark and gloomy twilight world. The native life forms, including the Concols, have developed nightvision to allow them to function within this dark environment. The Concols are a race of tall feline aliens with rather drab grey or dark brown fur. Their eyes are a vibrant yellow and the ears are tall and pointed.

As they evolved over the ages, other natural abilities began to manifest that would change the outlook of the people and give them new direction. About 400 years ago, the people suddenly exhibited the ability to fly without wings or devices, and to project light from their bodies. Presumably, these abilities had always existed, but had remained latent. What triggered them to suddenly appear when they did remains a mystery. The Concols took it as a sign that they should venture beyond their darkness and into a new golden age of technological, philosophical and sociological advancement. Within 200 years, their scientists and engineers had created vehicles to carry them above the clouds and to the stars. They want to see it all.

New vistas have been opened to the Concols. They explore and adventure just to see what will present itself next. Although many of them leave their homeworld never

to return, most do not stay away for more than a few decades, and frequently visit their world to regenerate their spirits. The felines who do not have the driving need to explore the universe stay on their homeworld to explore other horizons in regard to literature, music, painting, all the arts and the mind. Most accept all people and cultures at their face value. Although they love to share and exchange ideas, the Concols never try to force their views on others. They revel in the experience of life and seek to unravel its mysteries. The felines are sometimes called the "philosopher's cat" and are regarded as gentle, curious beings. However, while most Concols would like to think this is true, they do not allow themselves to be mistreated or caged. Now that they have been set free from the darkness that once caged them, they will never be imprisoned by the dark again, whether it is the darkness of their world, the darkness of the mind or the darkness of the soul.



Concol (pronounced con-coal)

Alignment: Any, but most tend to be good or unprincipled.

Attributes: I.Q. 3D6, M.E. 3D6, M.A. 4D6, P.S. 4D6, P.P. 4D6, P.E. 3D6, P.B. 4D6, Spd. 6D6+10 (x3 when flying)

Hit Points: P.E. x3 plus 1D6 per level of experience.

S.D.C.: 2D4x10

Height: 9 feet, 6 inches plus 3D6 inches (3.0 to 3.8 m).

Weight: 300 plus 3D4x10 pounds (149 to 190 kg).

Average Life Span: 95 years. **P.P.E.:** 3D6

Super Abilities: All Concols have the following super abilities: Flight: wingless, super-vision: nightvision, energy expulsion: light and one other minor super ability of choice!

Bonuses (In Flight): One additional attack per melee, +2 to strike, +2 to parry, +4 to dodge when hovering, +6 to dodge at 90 mph (144 km) and faster, and +4 damage for every 20 mph (32 km) of flight speed.

Natural abilities: Keen senses of hearing, smell and vision (+2 on initiative and +1 to roll with impact or fall). Their powerful bodies also give them great speed and they can leap 12 feet (3.6 m) high or lengthwise from a standing still position; double from a running start! They are also +10% to climb, prowl and maintain balance.

Special Weapons & Vehicles: The Concols have an affinity for laser weapons and technology, but can use all types of weapons, vehicles and equipment. Their tech-level is high, but they don't have antigravity systems.

Preferred Armor: Most Concols will not wear armor except for combat or when an environmental suit is necessary for exploration and space travel (A.R. 17, S.D.C. 150). Other types of armor can be used as well.

Familiarity with Earth: The Concols study other planets that are less advanced than themselves to decide if they should help them along. Their data on Earth is equal to the "Some familiarity." For the moment, they, like many others, have decided to leave Earth alone.

Rifts Notes: The Concol try to stay out of the affairs of others, but they find it difficult to tolerate beings who imprison and enslave others. Still they will try to stay uninvolved unless they are imprisoned or attacked themselves. If they feel threatened they can be deadly foes who will carry on the battle until the enslaving darkness is destroyed. This means they are natural enemies to the likes of the Splugorth, vampires, demons and tyrants. Even the Coalition States will be seen as an enslaver of the mind and spirit that will entice the felines to free those enslaved through lack of knowledge and self-esteem. The CS will try to destroy them.

In the **Phase World** setting, they will be regarded as heroes or meddlers depending on the person and their outlook on life.

For **Rifts** settings, the Concols can be S.D.C. creatures as described above or Mega-Damage creatures with 2D4x10 M.D.C. plus 1D6 per level of experience. They possess Mega-Damage weapons, armor and technology equal to the Coalition States.

Optional Rifts Subplot: Unknown to the Concols, they are an aborted experiment of the infamous *gene-splicers*. It was through genetic reconstruction at the hands of these insane geniuses that the felines developed not only super abilities, but human form and intelligence!



Felias

The Felias are indigenous to the planet Leine. They are a race of tall, black furred, feline humanoids that specialize in collecting, collating and distributing information. For hundreds of years these aliens have used their natural psionic and super abilities to sweep the galaxy in search of usable information. They collect volumes of knowledge that includes names, places, dates, people, politics, governments, planets, military bases, weapons, spacecraft, stars, weather, production facilities, technologies, wars, assassinations, bounties, and scores of other subjects both mundane and impressive. This information is stored and sold to clients across the galaxy. For the Felias, knowledge is their most valuable commodity.

All the Felias are knowledge brokers. Many operate as spies/espionage agents, extortionists, negotiators, researchers, historians, smugglers and Mercenaries. They make masterful use of their speed reading and total recall abilities to remember and disseminate information. They can also make predictions on probable outcomes based on hundreds of factors. Prized as advisors and historians, Felias agents are a presence in many places of power throughout the galaxy, including the Atorian Empire and the Federation of Allied Races (FAR). The Felias are also one of the wealthiest races in the galaxy.

Felias who respect the laws, mores and secrets of other worlds are respected and welcomed everywhere. However, this is seldom the case and many worlds have

come to fear the presence of a Felias, terrified that embarrassing secrets or damaging information may fall into their hands and be used against them. Some worlds and space stations have banned the felines from their territories.

The entire **Felias Information Network (FIN)** is regulated and directed by their governing body, known simply as the Board of Direction, which runs the entire society like a monstrous mega-corporation. Both collection and dispensing agents operate under their government's jurisdiction. Only freelancers and rogues don't have to answer to the Board, but they cannot gain legal access to FIN. Payments for information collected by active agents are given to the Board. The money is used for normal government maintenance and activities, plus each operative is paid a handsome salary. Freelance collectors and brokers are not sanctioned or tolerated by the Board or other operatives, and bounties for these rogue agents are frequently issued to have them returned to the homeworld for a prison sentence or execution — the Felias are extremely competitive.

All information brokers are psionics. They collect information from the FIN (which controls a galaxy-wide information network) and several sanctioned collectors that work for them in regional space. Collectors will almost always have super abilities, especially those involving heightened senses and stealth, such as invisibility and nightstalking. The Felias' military, police, and enforcers are heavily armed and intolerant of alien lawbreakers. Many are robots, androids or bionic soldiers, others possess super abilities and psionics. Most collectors will have military educations with plenty of espionage and surveillance training, while brokers commonly have espionage and communications skills or a background in engineering or science.

Felias (pronounced fee-lee-ahs)

Alignment: Any, but most are anarchist or aberrant.

Attributes: I.Q. 3D6 (3D6+2 for brokers), M.E. 3D6, M.A. 3D6, P.S. 4D6, P.P. 3D6+3, P.E. 3D6, P.B. 3D6, Spd. 4D6

Hit Points: Standard, P.E. plus 1D6 per level of experience.

S.D.C.: 2D4x10

Height: 6 feet plus 3D6 inches (1.9 to 2.7 m).

Weight: 120 plus 2D4x10 pounds (63 to 91 kg).

Average Life Span: 80 years. **P.P.E.:** 2D6

Super Abilities: All Felias, regardless of power category, have a minimum I.S.P. equal to their M.E. x2 plus 1D6 points per level of experience and have the psi-abilities of speed reading, total recall and mind block. The average, non-super-powered character (hardware, physical training, robotics, and bionics, but implants affect psi powers normally) can select one additional minor psi-ability and can pursue any occupation.

All information brokers, gatherers and spies are **natural** psionics and can select the normal number of psionic powers in addition to those given above (see the psionics description in **Heroes Unlimited**, page 190).

Felias collectors can be from the Super Power Categories of bionic, robot, hardware or super-powered mutant (the vast majority are the latter). Super Felias select two minor powers and one major ability or two major powers from the following selection: **Minor Abilities:** Super vision: x-ray or advanced sight, heightened sense of hearing, nightstalking, adhesion, or flight: glide or wingless. **Major Super Abilities:** Chameleon, invisibility, shape change, darkness control, intangibility, holographic memory projection, multiple beings/selves, mechano-link, or shrink.

Soldiers will either be bionic, robot, hardware, mutants or experiments with super abilities. Although they have collected data on magic, no Felias practice the Mystic arts.

Natural Abilities: Keen senses, reflexes and powerful muscles.

Special Weapons & Vehicles: The Felias have access to all types of weapons, armor, vehicles and technology, including Atorian Empire equipment.

Preferred Armor: Most operatives will have plain clothes armor (A.R.: 14, S.D.C.: 50) and a suit of environmental body armor (A.R.: 18, S.D.C.: 200).

Familiarity with Earth: Recently, the Felias' Board of Direction has found the time to send secret FIN operatives to Earth. They have no knowledge of Earth as of yet, but that will change quickly.

Rifts Notes: In the **Rifts** setting, the Felias will be considered D-Bees, spies and criminals. The character can select any of the mercenary, scholar and adventurer O.C.C.s., as well as 'Borg, Headhunter, Military Specialist, RPA Elite/Power Armor Pilot and Techno-Wizard. Many will deal with the most unsavory characters and may establish ties with the Coalition States, Naruni Enterprises, the Splugorth, Cibolans, New Dragcona, the Black Market, crime lords, gangs and others. They may also engage in the capture and sale of slaves. The CS will try to use those they can manipulate and control and destroy those they cannot.

The setting presented in the description for **Aliens Unlimited** as spies and information brokers is applicable for **Phase World**. The Felias are not trusted and are likely to have loose ties as operatives for Naruni Enterprises.

For **Rifts** settings, the Felias are S.D.C. creatures who use Mega-Damage weapons, armor and technology.

Those with psionic powers are either master psionics or Mind Melters!

Giris

The Giris are a race of feline humanoids native to the frozen planet Alora. Large sections of the upper layers of its crust are composed of crystal and other precious stones. Immense veins of gemstones and crystals fill the glaciers and frozen rock. The sheer volume of precious stones is unimaginable. These formations are very important to the Giris as a means of making money. The crystal and gems are sold off-world for industrial use in lasers and as gems for jewelry and art. However, the stones have

even greater value as a focus for power and a means of defense, because all Giris have the ability to draw amazing powers from the gems. These powers and wealth have made the Giris arrogant and cold-hearted.

After the Giris discovered the first few spacefaring people, they became incredibly curious about other worlds with intelligent life and kept a watchful eye on many planets, both advanced and primitive. Many Giris happily volunteer to be members of study expeditions for extended periods of time. They do so not with thoughts of conquest, but with thoughts of finding new markets and new resources for gems.

The study teams are usually government sanctioned, but are typically sponsored by private industry. This means there is a certain amount of autonomy and self-interest among each group. The structure and motivation of these study groups vary greatly. Some are serious scientific expeditions, others are in search of new geological resources or people to exploit. Many are more like a bunch of rich people going on vacation to see how other people live. Many of these expeditions exploit the people and planetary resources of other worlds, because the Giris tend to have little regard for other people.

Giris (pronounced gir-iss)

Alignment: Any, but tend to be selfish, arrogant and self-serving.

Attributes: I.Q. 3D6, M.E. 3D6, M.A. 2D6, P.S. 3D6, P.P. 3D6+3, P.E. 3D6, P.B. 2D6+1, Spd. 3D6+2



Hit Points: Standard, P.E. plus 1D6 per level of experience.

S.D.C.: 45

Height: 5 feet plus 3D6 inches (1.6 to 2.4 m).

Weight: 100 plus 2D6x10 pounds (54 to 100 kg).

Average Life Span: 75 years. **P.P.E.:** 4D6

Super Abilities: All Giris have the natural super ability known as *gem powers* (major super ability), which enables the character to release energy, bend light, bio-regenerate and unleash many other powers. Furthermore, all Giris have one additional major power of the player's choice.

Natural Abilities: As natives of a frozen planet, the Giris are extremely resistant to the effects and damage of cold. They get a bonus of +4 to save vs cold based magic and suffer half damage from cold. They will suffer from exposure as detailed under the Frozen World description when temperatures rise above 55 degrees Fahrenheit (13 C), unless they are wearing a protective suit to keep them cool.

Special Weapons & Vehicles: The Giris are reasonably advanced, but their real knowledge and manufacturing abilities are limited to low-end items of fair quality. However, they buy whatever they need from others, which means they can acquire virtually any type of superior weapon, armor, vehicle or equipment they want. Many Giris rely on their natural super abilities more than technology.

Preferred Armor: Specific armor designs will vary depending on the individual's occupation, wealth and personal taste, but stylish armor and environmental suits with family crests, gold trim, and gems are common. A typical environmental suit offering maximum comfort, movement and style will have an A.R. 14, S.D.C. 60. A heavy combat suit will have an A.R. 18, S.D.C. 120+2D4x10.

Familiarity with Earth: Several Giris study teams have been to Earth and have collected information equal to the "Has studied" result on the Familiarity With Earth table.

Rifts Notes: The Giris will be considered dangerous, super-powered D-Bees by the Coalition States, and dangerous, self-serving rogues by most others. It is the rare Giris who assumes the role of a hero, protector or mentor. Most are self-serving opportunists who will work as thieves, smugglers, assassins, spies, or criminals. Others will become advisors to those in power or try to rule over those less capable as a king or even a god. A Giris character can be ANY of the mercenary O.C.C.s (see **Rifts Mercenaries**). Many will have ties with the Black Market, criminals, evil forces and other unsavory characters.

In **Phase World**, they will act as cosmic opportunists like the Naruni, except they are more laid back and hate to really work hard at anything. They will associate with the Naruni, Splugorth and anybody who can help them get what they want. They are not highly respected in the space community.

Although super-powered, the Giris are S.D.C. creatures and must use Mega-Damage technology for

Mega-Damage protection and firepower. However, some of their super abilities may be Mega-Damage equivalents (see **Rifts Conversion Book One** for M.D. super power conversions and adjustments).



Linx

The Linx are an advanced, militaristic people from the planet Hista, who have engaged in galactic conquest, slave trade and strong-arm tactics to build their power base. The avians known as Threskians did not take kindly to the feline's encroachment on their space and a war erupted. The Linx gladly accepted the challenge and leapt into a war that would rage for half a century. The battle was hard fought, with devastating casualties on both sides. The threskians held a slim advantage in the area of super-powered operatives which successfully countered the Linx's more traditional armored military, especially in regards to espionage.

During the later course of the war, operatives of each race began to appear on their enemy's homeworld to destroy key targets and assassinate leaders. These seek-and-destroy teams became increasingly important to winning the war. Again, it was the Threskians who were able to seize the greatest opportunities through their super-agents. Super soldiers worked their way into positions to strike crippling blows to the Linx's military and political infrastructure. They successfully removed several key leaders and replaced them with shape-changed im-

postors! These impostors infiltrated military operations, causing sabotage and sending their people information about the Linx's strategies and battle plans. This enabled the avians to launch several preemptive attacks that devastated their feline enemy. The greatest blow to the Linx was the impostors' ability to instigate civil war that tore their people apart. This civil war on the Linx homeworld led off-world colonies to also erupt into violence as many tried to win their freedom while the Linx were weak. Others became the targets of pirates and other enemies.

Ultimately the Linx were forced to withdraw troops to address crises on their homeworld, and dangers threatening their galactic possessions. An uneasy peace agreement was signed by both parties and has been in force for about a decade. The Linx never did uncover the full scope of the Threskians' treachery or involvement in the civil crisis. The avians have covered their tracks well and it is likely the Linx will never know how close to destruction they had come. If the Threskians were more aggressive or evil, the Linx would now be a Threskian possession.

The Linx are still in the process of rebuilding. Some civil unrest continues both on their homeworld and on off-world possessions. The military is omnipresent and martial law is in place at many locations. There have also been disturbing incidents with Linx soldiers who have undergone experimental treatments to turn them into superbeings (an attempt to counter the Threskian agents). Many have gone AWOL to become Mercenaries, criminals and super villains. In the long run, the Linx should survive the turmoil and remain a power to be reckoned with.

There is great resentment toward the Threskians and a prolonged peace is not likely. Currently, the two galactic powers won't have anything to do with each other. The Linx encourage pirates, freebooters and other troublemakers to plunder Threskian ships and outposts by offering them limited (usually unofficial) protection in space under their jurisdiction, to fence stolen goods (including spacecraft), sell them supplies, and even provide them with helpful strategic information.

Ironically, the Threskians have had their own civil war concerning super-powered soldiers and are not the power they were during the 50 Year War. A second war would almost certainly be short and end with the Linx as the victors (the felines don't realize this yet).

Hista is a planet with a high gravity which has made the Linx a short, powerful race. Their fur is long and shaggy, their eyes are a dark emerald green. Many have undergone bionic reconstruction, or are empowered by exoskeletons/power armor, and most, male and female, have extensive combat training.

Linx (pronounced links)

Alignment: Any. NPCs will tend to be rough, gruff and aggressive characters of selfish or evil alignment.

Attributes: I.Q. 3D6, M.E. 3D6, M.A. 3D6, P.S. 4D6, P.P. 3D6+6, P.E. 3D6, P.B. 3D6, Spd. 3D6x3

Hit Points: P.E. x2, plus 1D6 per level of experience.

S.D.C.: 4D4x10

Height: 5 feet plus 1D6 inches (1.5 to 1.8 m).

Weight: 100 plus 2D6x10 pounds (54 to 100 kg).

Average Life Span: 90 years. **P.P.E.:** 2D6

Super Abilities: Linx characters can select the following Super Power Categories: Bionics (01-30%), robots (31-45%), hardware (46-65%), physical training (66-85%), psionics (86-90%), or super soldier as a result of experimentation (91-00%). None practice magic.

Natural Abilities: Keen hearing and sight equal to the minor super abilities of *heightened sense of hearing* and *advanced sight*; +1 on initiative, +1 to roll with impact, +2 to save vs Horror Factor.

Special Weapons & Vehicles: Their tech-level is high. They prefer bionics, heavy weapons and explosives, but can use all types of weapons, vehicles and equipment, except antigravity systems.

Armor: Riot armor: A.R. 14, S.D.C. 110. Hard armor environmental suit: A.R. 18, S.D.C. 260. Standard Linx Combat Power Armor: A.R. 18, S.D.C. 400, +6 to P.S., double running speed, can leap 20 feet (6 m) up or lengthwise, fly up to 200 mph (320 km), maximum altitude 10,000 feet (3048 m). Weapon systems include ion wrist blasters (one on each arm, does 4D6 damage per single blast or 1D6x10 per double blast, range 600 feet/183 m), plus 2D4 hand grenades, energy rifle (typically plasma or particle beam) and sidearm.

Familiarity with Earth: None.

Rifts Notes: Linx are aggressive warriors so they spell trouble for the Coalition and most others. Most will be Mercenaries (any), 'Borgs, Headhunters, soldiers (any) or power armor/robot pilots (any). The Coalition States will destroy them because they are monstrous humanoid animals who possess bionics, robots, and high-technology — besides, they are most likely to be recruited as Mercenaries by enemies of the CS.

The setting described for **Aliens Unlimited** is also applicable for **Phase World**.

The Linx possess Mega-Damage weapons and technology. It is up to the G.M. whether they are Mega-Damage creatures because they come from a planet with a strong gravity. If so, they will have 4D4x10 M.D.C.

Pantherans

The Pantherans are menacing looking creatures because of their sleek, jet black fur and blank, white eyes (actually the pupil and iris are such a pale blue and green that the eyes appear to be completely white).

Always in search of knowledge and adventure, they were thrilled when they were contacted by beings from other worlds. Consequently, after a display of impressive generosity and kindness by the Atorian Empire, the Pantherans made an alliance with them. The deal was to turn their planet Seriv into an Energy Core for the Empire in exchange for knowledge regarding advanced technology, particularly in the areas of manufacturing, micronization, computers and space travel. This meant turning the planet into an enormous industrial facility with sprawling power plants and factories the size of cities. Luckily for the Pantherans, their world was radioactive to begin with and they had adapted to the harsh environment

eons ago, thus the levels of radiation and additional air pollution had no effect on them. In addition, a battalion of Thropo warriors (see the ape entry) would be stationed at key facilities to defend them and to help teach the people in their operation. A space station would be built to give the felines their first step into the cosmos. The people of Seriv were delighted.

Forty-five years have passed and the Pantherans are becoming dissatisfied with their dealings with the Atorian Empire. The energy facilities have become larger and more extensive than originally described; to the point that they claim one-third of the planet's surface (with no signs of stopping there). Entire cities have been leveled and the people are forced to live at the gargantuan power plant or industrial city that replaced it. The number of Thropo forces has grown at an alarming rate. In many cases, the apish soldiers have placed cities under martial law and have become the ruling force. The space station is nearing completion but it will serve as a military base for the small Mantella and Thropo fleet that "protects" the planet. When it is completely operational it will be manned by 10,000 troops and accommodate a fleet of a hundred fighters and six battleships.

As one might suspect, the Atorian Empire has been slow on its promise to provide the Pantherans with useful information and the means for technological advancement. The government protests and petitions the Empire about the situation and breach of their agreement, but



they are ignored. The only response they get is to cooperate and relax. Atorian diplomats insist the problem is only a matter of "adjustment" through a period of transition. With time, everything will work out fine.

Without the promised technology, the Pantherans are in no position to make *demands* or to force the Atorian Empire off their world. However, they are fast learners and are quietly watching, learning and upgrading their knowledge, weapons and equipment. Talk of revolution is in the air, but even the most militant Pantherans must admit that they are no match for the combat troops and resources of the Atorian Empire. They would be hard-pressed to repel even the current occupation force which is small compared to many Atorian Empire operations.

The Pantherans have always been a people geared toward learning and developing knowledge. Before the Empire expanded to include Seriv among its interstellar territories, the felines were advancing quickly in the technological arena and were at a level roughly equivalent to Earth of the 1950's. There was also a large number of Mystics among them. Their pursuit of knowledge was not prejudiced or divided between science and the supernatural. Many of these Mystics have been lured into the service of the Atorian Empire as explorers, specialists and bodyguards off-world. As a result, there are very few Mystics on Seriv, although a large number of young adepts (currently, most are first level or fledgling students) are turning to magic as a means to expel the Empire from their world.

Despite the Empire's insistence that everything will work out fine, revolution and war are on the horizon. If the opportunity should arise, the Pantherans will join forces with enemies of the Empire. In fact, several thousand are in the service of the Atorian Empire's military and labor force, as well as a handful of adventurers and free agents who are in space gathering information about the Atorians, the galaxy, technology, weapons, space travel and the enemies (potential allies) of the evil Empire.

Pantherans (pronounced pan-th-air-ans)

Alignment: Any, but most lean toward good.

Attributes: I.Q. 3D6+3, M.E. 4D6, M.A. 3D6, P.S. 4D6, P.P. 3D6+2, P.E. 4D6, P.B. 3D6, Spd. 3D6x2

Hit Points: Standard, P.E. plus 1D6 per level of experience.

S.D.C.: 1D4x10+20

Height: 6 feet plus 1D6 inches (1.8 to 2.0 m).

Weight: 190 plus 1D6 pounds (87 to 89 kg).

Average Life Span: 70 years. **P.P.E.:** 4D6

Super Abilities: A character can be built from any of the Super Power Categories described in **Heroes Unlimited**, but the majority will be magic, physical training and hardware.

Natural Abilities: +6 to save vs radiation poisoning and suffers half damage, +2 to save vs toxins, pollution and disease, +1 on initiative, can leap 15 feet (4.6 m) high or lengthwise, are natural climbers (80%/70%) and swimmers (65%), and can see into the ultraviolet spectrum of light. The Pantherans themselves are slightly radioactive. Anyone exposed to them for a period of

two weeks or more will run the risk of suffering radiation poisoning (see High Radiation world description for details).

Special Weapons and Vehicles: Limited availability, especially on their homeworld, but those in space can acquire just about anything if they can afford it. Vibro-blade weapons and detachable jet packs have become favorites among rebels.

Preferred Armor: Again, availability is limited, especially to those trapped on their homeworld — their Atorian masters don't want a disgruntled people to have too many military resources. In space and under Atorian Empire military service, the Pantherans are equipped with Atorian weapons and armor. PAE-2 environmental suits provide an A.R. of 10, and 45 S.D.C.; they also contain the radiation. PAE-6 environmental power armor has an A.R.: 17, S.D.C.: 200, and a detachable jet pack.

Familiarity with Earth: None.

Rifts Notes: The Pantherans will be considered feline D-Bees on Rifts Earth. They can be escaped slaves, explorers, adventurers or freedom fighters who have come to Earth via magic. Freedom fighters will be looking for weapons, technology and allies to use against the Atorian Empire. If they stay out of the way of the Coalition States they will not be singled out for destruction.

On **Phase World**, the setting presented in their description here will be applicable. Some may be Mercenaries, adventurers, or slaves.

These characters are S.D.C. beings, like humans, who must acquire Mega-Damage weapons and equipment.

Pume

The planet Gorthia is surrounded by a toxic atmosphere, but there are life forms that have managed to thrive in its inhospitable environment. The most prominent of these life forms is a race of intelligent, humanoid felines called the Pume (pronounced "poo-may"). These tall, feline humanoids resemble Earth tigers. They are physically powerful and possess psionic powers. Most live in an almost Mystical culture of meditation and soul searching for inner peace. They are self-disciplined, alert and sensitive.

The Pume believe that as creatures of free will and thought, they are chaotic by nature. The multitude of choices a person has to make is a constant storm inside each individual. It is each person's responsibility to keep that storm as calm and restrained as possible. To help themselves understand and control the chaos within themselves, the Pume regularly study other people. Most of the felines use observations as a way to insight about others and themselves.

About one third of the population practice an ancient philosophy known as *Subjugation*. The idea is that one cannot truly understand himself or the world around him, unless he has first hand experience. Thus, those who practice Subjugation perform actions, good and evil, in order to gain first hand experience of them. In this way, the



person will be better prepared to suppress that action or emotion in the future. Pume who follow this path may even commit murder, torture, arson and other crime, but the idea is to do so only once or twice as a learning experience and never again. Furthermore, most do not inflict their heinous crimes on innocent people. Thus, it is not uncommon to hear a Pume to say something like, "I tried murder once. I didn't like it (or it was too chaotic) and I try to avoid it now. So please do not tempt me to do otherwise." Surprisingly, this approach does give the Pume an inner peace and understanding of life and enables the to control their emotions!

There are, however, a number of people who choose Subjugation and are not able to control the storm inside themselves once they let it loose. Sometimes they like the horrible things they do and the emotions they feel, and continue to do them out of self-gratification. These villainous rogues are called "Chaos Riders" or the "Children of Chaos." Pume given over to chaos are almost always anarchist, miscreant or diabolic in alignment and are likely to develop insanities (particularly obsessions) as a result of their life-style and beliefs.

Most young Pume (teen to 50) are on the quest to discover themselves and find inner peace. These characters can be amazingly chaotic and may even seem schizophrenic as they change emotions from quiet, soft-spoken reserve to boisterous outbursts and sudden acts of aggression. They tend to take wild chances and try to experience everything they can. Elder Pume, by comparison,

are usually demure, soft-spoken and friendly. However, even they can perform sudden acts of strength and aggression.

The Pume are technologically advanced and have integrated the sciences, technology, art and philosophy of many alien cultures into their own. They love to explore the universe and to observe and interact with others as much as possible. They make a temporary alliance or associate with a particular group or race for decades, but are just as likely to disappear one day. To experience life they will join other people's causes and fight their wars, but it is likely that there will be just as many Pume on the opposing side!

Pume (pronounced poo-may)

Alignment: Any, but most young are anarchist, while older more experienced characters will be good or evil.

Attributes: I.Q. 3D6, M.E. 3D6, M.A. 3D6+2, P.S. 5D6, P.P. 4D6, P.E. 3D6, P.B. 4D6, Spd. 6D6

Hit Points: P.E. x3, plus 1D6 per level of experience.

S.D.C.: 2D4x10

Height: 9 feet plus 2D6 inches (2.8 to 3.0 m).

Weight: 400 plus 1D6x10 pounds (186 to 208 kg).

Average Life Span: 100 years. **P.P.E.:** 2D6

Super Abilities: All Pume are master psionics. They are generated as natural, instead of latent psionics, and gain two extra lesser psionic powers. They also receive a super psionic ability every level (instead of every other level) and a one time bonus of +20 to their I.S.P. All Pume also get the martial arts and gymnastics skills automatically.

Special Option (see Ninjas & Superspies): Those who study the ways of Subjugation are similar to the Chinese Mystics of Earth. They know martial arts combat equal to Commando (agent; quickie Jujitsu, page 83 of N&S), plus the following martial arts powers: Select two *atemi abilities* or *body hardening exercises*, select two *chi mastery* or *zenjoriki abilities*, and select two *martial arts techniques* or *special katas*. HOWEVER, the character loses all but one minor psionic ability (powers manifest themselves as the special martial arts abilities listed here).

Special Weapons and Vehicles: Any, including antigravity items. Many Pume, especially those who practice Subjugation, prefer ancient types of melee weapons, although they may be high-tech versions like Vibro-Blades and energy shurikens. A Pume energy shuriken: Range: Thrown, about 200 feet (61 m). Damage: 4D6 each.

Preferred Armor: Lightweight, fiber suit that looks like silk but is as tough as steel: A.R. 15, S.D.C. 42; no prowl or movement penalties. Full environmental Hard Armor: A.R. 17, S.D.C. 280, -15% to prowl, climb or perform acrobatics and gymnastics. Other common suits and armor may be available.

Familiarity with Earth: Some knowledge.

Rifts Notes: In a **Rifts** setting, the can be a Mystic, mind bleeder, Mind Melter, wilderness scout (with master psionics) or rogue scholar (with martial arts training or master psionics). They will be considered feline D-Bees

on Rifts Earth. They can be escaped Splugorth or Naruni slaves, or explorers, adventurers or Mercenaries and freedom fighters who have come to Earth via magic or a dimensional anomaly in space. If they stay out of the way of the Coalition States they will not be singled out for destruction.

The setting described for **Aliens Unlimited** is also applicable for **Phase World**.

The Pume possess advanced Mega-Damage weapons and technology, but are S.D.C. beings, although some of their powers may inflict Mega-Damage.

Humans & Humanoid Alien Races

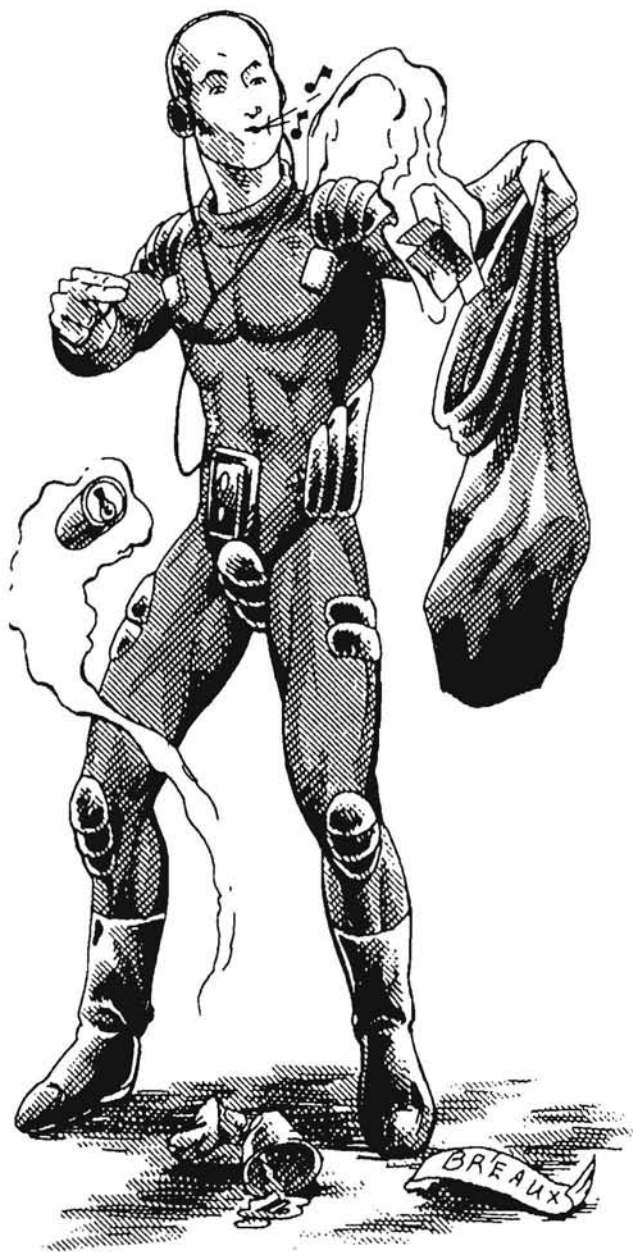

Humans are ... well, human. Strangely enough, human beings just like those on Earth are found scattered throughout the universe. Some have minor physical differences (and attributes) but if they are true humans, they can mate and bear offspring with Earthlings.

The human-like alien races resemble Earth humans so closely that they can walk among them unnoticed. A variance in their physical stature, build or density may identify them as different, but not necessarily alien. Many of them are identical to humans, right down to their cellular structure. Since the Earth people of **Heroes Unlimited** have not developed planet spanning space technology, they are not, typically, major participants in galactic travel, exploration or colonization without extraordinary means (super powers, magic, dimensional Rifts, etc.) or alien intervention. Whether or not the humans from other worlds are related to those on Earth in any way (which is likely) will probably remain a mystery. Except for some modifications resulting from adaptation to other environments, treat these aliens as advanced human beings.

Humanoid aliens in the context of **Heroes Unlimited**, are ones that closely resemble humans, but have one or more physical traits that set them dramatically apart. These beings are a different species and cannot bear offspring with humans, no matter how similar they may appear. The sub-table given under step two of the **Expanded Character Generation** section gives quite a few options, but it does not begin to explore all the possibilities. Minor characteristics can range from six fingers on a hand to fangs or an unusual growth pattern for hair. Major characteristics could be oddly-shaped heads, longer proportions, two hearts and so on. The following are just a few examples.

Aluta

The planet Rizza is the home of two distinct human-like races. In the upper latitudes of the southern pole, half a world away from the Klikita, the Aluta make their homes on the glacial ice of the frozen planet. They are a race of humanoids very similar to Earth humans. Their most striking physical difference is a pair of large, pointed ears which give them an "elf-like" appearance. Most have long,



black or brown flowing hair, fair skin and grey eyes. All Aluta are gifted with psionic abilities that manifest around the time of puberty.

The Aluta carve and shape cave cities out of the glacial ice using psionic abilities such as hydrokinesis, pyrokinesis, and telekinesis to cut, melt, and move large sections of ice. They also have an advanced civilization with sciences, engineering and space capabilities. They've even perfected antigravity vehicles. As one might expect, they rely heavily on their natural abilities and often prefer to use them instead of machines or equipment. In fact, there is a small, radical movement among the Aluta to abandon their dependence on machines and rely entirely (or mostly) on their psionic powers. These radicals also suggest that Aluta are superior to most other races and should conquer them, starting with the Klikita.

Generally speaking, the vast majority of Aluta are sympathetic towards other races, and are famous for helping and advising civilizations that are less developed or successful than they. Except for the occasional radical, they are never condescending and are genuinely concerned and helpful. This is a general point of argument between the haughty Klikita. The Aluta will sell the services of their military to people or planets in need of aid, but it must be a worthy, humanitarian cause. Those who use their gifts for mercenary purposes or to cause dissension and unrest are considered psionic leeches. The most extreme are cast out from Aluta society.

Aluta space programs are designed to explore space, make contact with other life forms and establish an amicable relationship for their mutual growth, development, trade and defense. They never push themselves on others, and leave if the indigenous people don't want them there, or are frightened by their presence.

Aluta (pronounced al-oo-ta)

Alignments: Any, but most Aluta are generally good. Radicals of the small militant supremacist movement are typically selfish or evil.

Attributes: I.Q. 3D6, M.E. 3D6+6, M.A. 4D6, P.S. 3D6, P.P. 3D6, P.E. 3D6, P.B. 3D6+2, Spd. 3D6

Hit Points: Standard, P.E. plus 1D6 per level of experience.

S.D.C.: 45

Height: 5 feet, 8 inches plus 1D10 inches (1.7 to 2.0 m).

Weight: 150 plus 1D6x10 pounds (72 to 95 kgs).

Average Life Span: 170 years. **P.P.E.:** 3D6

Race: Aluta humanoids

Super Abilities: All belong to the power category of Psionics only. Unlike the usual limitations for alien characters, Alutas are natural psionics (unlike other aliens that must be latent psionics). Select psionic abilities normally and generate I.S.P. as usual. The M.E. and M.A. bonuses for psionics are already figured into the above attribute dice rolls.

An Aluta can be a full or partial cyborg, usually the result of grievous physical damage to his body, but loses all psionic abilities to full conversion and most of his or her psionic powers to partial conversion. In the latter case, all that remains are 1D4 minor abilities.

Natural Abilities: Resistant to cold, suffers half damage from any cold-based attack or environment. In heat above 60 degrees Fahrenheit (15 C), they suffer from heat exhaustion and exposure (see the exposure rules under the Frozen World description). Their environmental spacesuits protect them from the heat (and radiation) of other worlds.

Special Weapons: Most Aluta rely upon psionics for attack and defense purposes. Those that have no offensive powers depend on energy weapons and TK force field generators.

Special Vehicles: Antigravity Disk: A.R. 18, S.D.C. 45, maximum speed is 100 mph (160 km), or can hover stationary, maximum altitude is unlimited. Maximum weight allowance is 1,000 pounds (450 kgs). They also have antigravity flying disks (look like flying saucers) that come in sizes that can accommodate five people, 20, 50 or 150!

Special Armor: Mostly light, padded environmental suits/spacesuits: A.R. 10, S.D.C. 55 (weighs 14 pounds/6.4 kg) and/or telekinetic force field generator. The latter is generated via a special psionic boosting helmet, headband or brain implant.

The TK force field is artificially induced, and is in addition to natural psionic powers. To activate, it costs 10 I.S.P. and has an A.R. of 20 and 50 S.D.C.; duration is 20 minutes. When the duration time elapses or the S.D.C. is destroyed, the psionic can raise a new force field 1D4 seconds after the previous one vanishes.

Characters who have natural telekinesis (either normal or super) get a bonus 25 S.D.C. and double duration of their force field for the same I.S.P. cost, while those with telekinetic force field add 5 S.D.C. per level and double duration for the same cost.

Familiarity with Earth: They have collected a wealth of information on a multitude of planets from their numerous dealings with other races. Included in this data is information about Earth equal to the "Some Familiarity" result on the Familiarity With Earth table.

Rifts Notes: If used in the **Rifts** setting, the character will be seen as a mutant human, elf or treacherous D-Bee who is feared or hunted (and destroyed) by human supremacists like those of the Coalition States. Arrival on Rifts Earth is likely via a dimensional anomaly, black hole, dimensional experiment, magic or as a slave or refugee. The Splugorth and other slavers are always on the lookout for superbeings and psionic characters as slaves. Their level of technology will also make them appealing.

If set in the **Rifts: Phase World** environment, the scenario of slave, explorer, mercenary, or space adventurer works fine. Most are good guys, but others may be villains.

These characters are S.D.C. life-forms who need Mega-Damage weapons and armor for Mega-Damage protection and firepower. Quickie Conversion: Technology/weapons/armor can be simply switched from S.D.C. to M.D.C. for quick conversion and integration. Thus, if the body armor had an A.R. 13 and 70 S.D.C., it would now have an M.D.C. of 70 (A.R. not applicable). Similarly, an energy weapon that inflicts 3D6 S.D.C. would now inflict M.D. instead. Or the Game Master can keep the alien's S.D.C. technology and make the character acquire Mega-Damage items just as any human does. The super abilities of the character would inflict the equivalent in Mega-Damage (see **Rifts Conversion Book One** for specific super power conversions).

Arerri

The Arerri are a race of tall humanoids from a turbulent planet named Arora. The atmosphere of Arora is filled with debris and particles that lash about in perpetual wind storms. To survive in this environment, the Arerri have evolved a tough, lumpy, armored hide. Skin colors range from a peachy flesh to a multitude of browns and grays. Despite their large, coarse appearance, the Arerri are an intelligent race who have achieved many technical advancements.

Their scientists have perfected superpower inducing experimentation, bionic augmentation, and robotics technology. Their technological achievements include full sensory holograms, teleportation devices, light speed travel, particle beam weaponry, fully automated robots suitable for virtually every task, and they are currently experimenting with warping space, and dimensional travel. The Arerri pursue all facets of knowledge, including magic, and have developed a nearly utopian society, but they have to guard

it carefully. If other races were to learn of their achievements, half of the galaxy would be banging on their door and the Arerri do not want that. Despite their successes and advancements, the Arerri have none of the arrogance of the Kassans, Kliikita and other races. There has not been a war on Arora for 300 years and the people want to keep it that way.

The planet is dotted with huge domed structure that stretch for miles in diameter and are hundreds of feet high. Inside these armored shells are the cities. It is necessary to shield their homes from the constant storms which wreak havoc outside of the domes. The Arerri also use the domes to help hide their cities from prying eyes. They rarely permit other races to land on their planet, and most people avoid it because the atmosphere is so uninviting.

Arerri spacecraft are intentionally outfitted with technology roughly equal to any other advanced race, so that if a ship should happen to be captured, teleporters and other highly advanced items will not be found on it. Such items are few and rigged to self-destruct in the event of capture by hostile forces. These tactics have worked for over 250 years.

Arerri

Alignments: Any, but the majority are good.

Attributes: I.Q. 4D6, M.E. 3D6, M.A. 2D6+2, P.S. 3D6, P.P. 3D6, P.E. 3D6+2, P.B. 2D6, Spd. 3D6. P.S. is equal to the minor super ability of extraordinary strength.

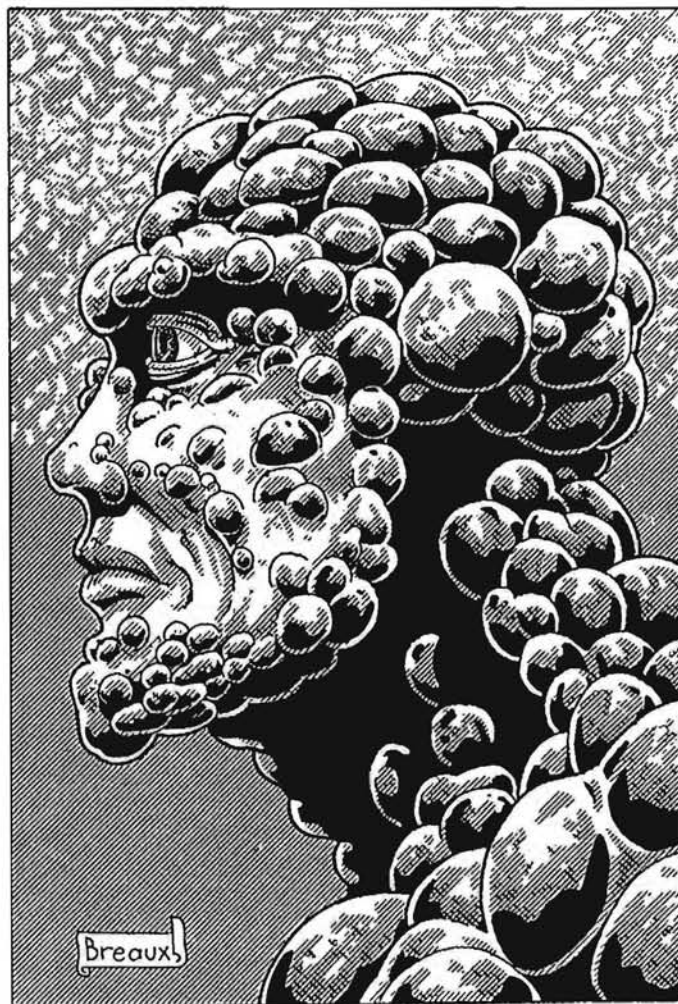

Hit Points: P.E. plus 2D6 per level of experience.

Natural A.R.: 14

S.D.C.: 4D6x10 plus 25

Height: 6 feet plus 4D6 inches (2.0 to 2.4 m).

Weight: 200 plus 4D6x10 pounds (109 to 200 kgs).

Average Life Span: 95 years. **P.P.E.:** 1D6

Super abilities: Arerri can be any of the super power categories found in *Heroes Unlimited*. Most are Hardware, Physical Training, or Robots. Only a handful are Experiments, Magic, Mutants, or Psionics; they tend to avoid bionics and really don't need armor because of their natural S.D.C. armor.

Robot characters can be a transferred intelligence, an Arerri wearing an exoskeleton/power armor suit or piloting a robot vehicle. However, the robot character is just as likely to be a sophisticated artificial intelligence — a true robot created by the arerri for exploration, research or defense/protection (typical budget falls into the 11 to 13 million categories).

Natural Abilities: Can breathe toxic fumes and pollution without ill effect, +5 to save vs disease, drugs and poisons, resistant to fire, heat, and cold (does half damage).

Special Weapons: 1. Sonic Blaster (pistol or small rod): Range: 65 feet (20 m), damage 3D6 S.D.C. and half of that damage will go right through body armor to affect the person inside (does not penetrate armored vehicles). Payload: 12 shot energy clip.

2. Sonic Bazooka: Range: 500 feet (152 m), damage 1D6x10 S.D.C. and half goes through the armor, bionic shielding or vehicle and affects the person or people inside (same rules as the sonic cannon in the equipment section)! Payload: 12 shot energy clip.

3. Particle Beam Pistol: Range: 100 feet (30.5 m), damage 6D6 S.D.C., payload: 10 shot energy clip.

4. Particle Beam Rifle: Range: 1600 feet (488 m), damage 6D6+12 S.D.C., payload: 20 shot energy clip.

They also have access to all common energy weapons, computers, armor and vehicles.

Special Vehicles: Micro-jet hover boots: Maximum speed 60 mph (96 km), can hover 3 to 100 feet (0.9 to 30.5 m) above the ground, maximum altitude is 1000 feet (305 m), S.D.C. 40 per boot. A jet pack that goes twice as fast and high (100 S.D.C., A.R. 14) is also available.

Special Armor: They tend to rely on their own protective hides, but also use robot exoskeletons and protective spacesuits.

Familiarity with Earth: Equal to the "Some Familiarity" result on the Familiarity With Earth table.

Rifts Notes: Characters who arrive on Rifts Earth will be seen as dangerous D-Bees to be feared, hunted and destroyed by human supremacists. Arrival on Rifts Earth is likely via a dimensional anomaly, dimensional experiment, magic or as a slave. The Splugorh, Cibolans, Naruni and other slavers will find the Arerri to be very attractive for gladiatorial games and slave labor. They will also covet their scientific knowledge and weapons for military exploitation.

If set in the **Rifts: Phase World** environment, the scenario of slave, explorer, mercenary, or space adventurer

works fine. Some are good guys and others are villains.

The Arerri are Mega-Damage creatures in Rifts environments. If the character has 190 S.D.C., it becomes 190 M.D.C.; the same is true of their robots, spaceships and equipment. The super abilities of the character are also likely to inflict the equivalent in Mega-Damage (see **Rifts Conversion Book One** for specific super power conversions).



Arismal

The Arismal are a race of human-like aliens originally from a planet of the same name. The planet Arismal orbited a dark sun which emitted more heat radiation than it did light, making it a dark but warm planet. The society and civilization of its natives advanced to rival those of other galactic races. Their military spacecraft patrolled local space and merchant craft from other races came to trade with them. Then, one fateful day, a convoy of military craft, using "point-to-point" travel, mistakenly locked onto Arismal's gravity field (see the upcoming *Galaxy Guide* for full details), sending 10 massive spaceships colliding into the planet at the speed of light. The collision literally cracked the planet in half, killing billions. Only a few thousand Arismal on military duty off-planet survived the destruction.

The Arismal survivors were all part of the military space program. Just like any military organization, they represent many educational backgrounds, including scientists, doc-

tors, engineers, pilots, and combat personnel. Under strong military leadership, the Arismal have stayed together as a militaristic organization, living on their battleships while searching for a new home. The officers do not want their people to be divided or lured away, so it is very difficult for personnel to get permission to leave a vessel, or have direct contact with other life forms, especially when orbiting a planet or docking at a space station to acquire supplies, or make repairs. It is not impossible, however, and several hundred soldiers have deserted/escaped to begin new lives.

All soldiers have mini-lasers and antigravity suits. Special forces units include robot personnel, bionic soldiers, and those with super abilities or psionic powers. These special operatives are usually combat specialists, and are issued Kisentite knives instead of mini-lasers, and hover cycles for transportation.

Alignment: Most Arismal are scrupulous and principled. Aberrant is the most common of the evil alignments. Other alignments are possible, especially among rogues and deserters. Arismal of high rank are typically ruthless and determined to hold onto their power at any cost.

Attributes: I.Q. 3D6, M.E. 3D6, M.A. 3D6, P.S. 3D6, P.P. 3D6, P.E. 3D6, P.B. 3D6, Spd. 3D6

Hit Points: Standard; P.E. plus 1D6 per level of experience.

S.D.C.: 30

Height: 5 feet plus 4D6 inches (1.6 to 1.8 m).

Weight: 100 plus 2D4x10 pounds (54 to 82 kgs).

Average Life Span: 90 years. **P.P.E.:** 2D6

Race: Human

Super Abilities: On Earth, the majority of humans are average people and only a small minority have super abilities. Among the Arismal the situation is reversed. Nearly everyone has some super ability and only a few do not (01-10%). The average (11-54%) Arismal has one (01-60%) or two (61-00%) minor super abilities, frequently an extraordinary attribute. A smaller percentage (55-79%) will have highly developed and varied super abilities (three minor and one major, or two major powers with no minor powers) and some (80-00%) manifest incredible powers (have two major and 1D4+1 minor powers, or three major super abilities, or eight super psionic powers).

Those without super abilities can receive bionic implants or training in piloting robot power armor and/or vehicles. Arismal with psionic abilities will have a base I.S.P. of 1D6x10+10+M.E. attribute and will gain 1D4+3 additional I.S.P. points per level.

Natural Abilities: The Arismal are at home without light. Sixty watts of light is considered extremely bright. To move about in the equivalent of Earth sunlight, they must either wear dark, photosensitive goggles, or other protective covering, or are blinded (-4 on initiative, -8 to strike, parry, and dodge). On the up side, they have nightvision to a range of 600 feet (183 m) and sensitive hearing (20 decibels beyond normal human range).

Special Weapons: All soldiers are issued mini-lasers (range: 80 feet/24.4 m, damage: S.D.C., 10 shot en-

ergy clip), except for special forces members who receive Kisentite knives (length 15 inches/38 cm, weight 1.2 pounds (0.5 kg), damage 2D6+3 S.D.C.).

Special Vehicles: Antigravity suits are standard issue (maximum speed 90 mph/145 km, S.D.C. 30, can hover from one to 1,200 feet/0.3 to 366 m). Maximum weight allowance is 500 pounds (225 kgs), but the special forces tend to prefer hover cycles (maximum speed 120 mph/190 km, S.D.C. 130, and can hover from 3 to 20 feet/0.9 to 6.1 m above the ground).

Preferred Armor: Arismal are issued normal half suits of armor (A.R. 11, S.D.C. 50 to 75). For combat missions, appropriate heavy or full body armor will be issued. This will probably be hard armor, A.R. 15 to 17 with an S.D.C. of 150 to 300.

Familiarity With Earth: Although the planet Arismal was across the galaxy from Earth, its people have nearly identical cultures, beliefs, languages, and value systems. The Arismal would surely be interested in Earth if they learn about it, but as of yet, they have not. They have the equivalent of the "Has studied Earth" result on the Familiarity With Earth table.

Rifts Notes: If used in the **Rifts RPG** setting, the characters will be seen as human mutants or treacherous D-Bees and feared or hunted (and destroyed) by human supremacists like the Coalition States. Most are likely to be lone adventurers or part of a small group. Arrival on Rifts Earth is likely via a dimensional anomaly, black hole, dimensional experiment, magic or as a slave or refugee. The Splugorth and other slavers are always on the lookout for superbeings.

If set in the **Rifts: Phase World** environment, the scenario of slave, explorer, mercenary, or space adventurer works fine. Some are good guys and others are villains.

These characters are S.D.C. life forms who need Mega-Damage weapons and armor for Mega-Damage protection and firepower. **Quickie Conversion:** Technology/weapons/armor can be simply switched from S.D.C. to M.D.C. for quick conversion and integration. Thus, if the body armor had an A.R. 13 and 70 S.D.C., it would now have an M.D.C. of 70 (A.R. not applicable). Similarly, an energy weapon that inflicts 3D6 S.D.C. would now inflict M.D. instead. Or the Game Master can keep the alien's S.D.C. technology and make the character acquire Mega-Damage items just as any human does. The super abilities of the character would inflict the equivalent in Mega-Damage (see **Rifts Conversion Book One** for specific super power conversions).





Atorians

The Atorians appear to be humans. The only obvious physical difference is the growth patterns of their hair which only grows in certain patterns, not over their entire head like Earthlings. The predominant growth pattern has a single path down the middle of the head (called a mohawk on Earth) and matching strip patterns on each side of the head. The bald areas between them are often filled with clan tattoos. They are originally from a high gravity world, but their physiology differs only slightly from other humans. Males are short and the females are tall. Males develop large builds with powerful muscles, while the females are tall and shapely, with well chiseled muscles but not what one might call muscle-bound.

The Atorian civilization prospered, they developed space travel, and eventually went on to explore their solar system. That was a long time ago.

As they spread out into the galaxy on exploratory missions, the Atorians began to encounter other races. At first, they devoted themselves to helping the less advanced people they encountered with information and guidance. A few looked to them for leadership and they suddenly found themselves with people and entire worlds as their possessions. This chain of events would ultimately change their view of life and they began to colonize and claim many worlds as part of their *empire!*

As the Atorian Empire grew, the Atorians become more arrogant and ruthless. They began to see themselves as an unstoppable super power that was superior to most other life forms, at least in the area of technology, robot-

ics, weapons and space travel. They have since conquered scores of worlds, often with force and the employment of warrior races as their storm troopers and minions. For the last 1000 years they have been regarded as an evil Empire that gobbles up worlds to increase its holdings, power and for other diabolical purposes. The evil empire rarely has the welfare of any people in mind and does whatever it takes to win a battle, make a profit and to expand in power. Profits and power are all that seems to matter anymore.

The Atorians' society is gynarchal—woman ruled. The males have been relegated to servants and slaves used for manual labor, entertainment, and reproduction. Full details on the Atorian Empire, its allies, equipment, and other aspects will be given in a future supplement.

Atorians (a.k.a. Fehrans)

Attributes: I.Q. 3D6, M.E. 3D6, M.A. 3D6, P.S. 4D6, P.P. 3D6, P.E. 3D6, P.B. 3D6, Spd. 3D6x3

Hit Points: Standard, P.E. plus 1D6 per level of experience. S.D.C.: 2D4x10 plus physical training.

Height: 5 feet+1D6 inches for males. 5 feet, 6 inches +2D4 inches for females.

Weight: 150+2D10 lbs. **P.P.E.:** 4D6 or by Magic Category.

Average Life Span: 140 years

Super Abilities: Atorians are almost never born with super abilities. Any female who does have exceptional powers will be given status and training from birth to

best utilize her abilities for the Empire. A male who exhibits super abilities will command a very high price at auction because of his genetic structure and breeding potential. This lack of naturally occur. ring super abilities does not mean that they do not exist in the Empire. Their advanced technological capabilities include genetic and other experimental programs that instill psionics and super abilities.

The following Super Power Categories are available to Atorians: Bionic (20%), Robot (20%), Hardware (20%), Physical Training (9%), Psionics (10%), Experiments (10%), Mutants (9%) and Magic (2%).

Special Weapons, Vehicles and Equipment: They possess some of the most advanced weapons and technology in the galaxy, including all the weapon systems and armor listed in the weapon section. Most weapons and vehicles will have 20% greater range and payload. They also master (and guard the secrets of) anti-gravity systems.

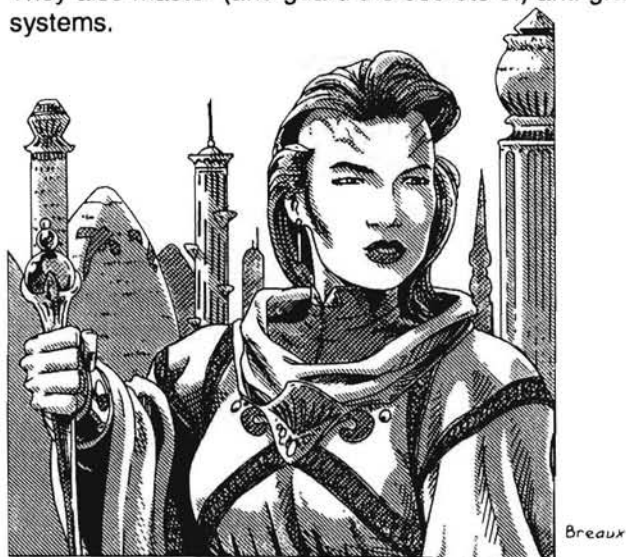

Familiarity With Earth: None. They are not currently aware of the Earth. If it should ever come to their attention, it is unlikely they would have any immediate interest, given its distance from the Empire and the Earthlings' comparatively low technology.

Rifts Notes: The Atorian people would be accepted as Earth humans unless they revealed that they came from another planet. They can be any of the **Rifts** O.C.C.s available to humans, al., though most avoid magic in favor of technology. Many, especially Atorian females, will relate to the Coalition States and; Triax and are likely to try to become a power within these advanced societies.

In the **Rifts** setting, they are S.D.C. beings like Earth humans who have advanced technology and possess and manufacture mega-damage weapons, vehicles, armor and technology superior to Triax!

In the **Phase World** setting, the basic setting presented in this book as being aggressive competitors both in business, trade and conquests of worlds is applicable and could lead to conflicts between them (as new rivals) and other powers like the Splugorth and Naruni Enterprises. However, the Atorian Empire does not know about dimensional travel and cannot compete on that level.

Darakans

The galaxy contains many planets like Earth, vital green and blue orbs full of life. The planet Daraka is such a thriving Earth-like planet. Even its sun is similar although the brightness and levels of radiation are stronger than on Earth. This is why the Darakans have charcoal black skin, white hair and small, dark eyes. Their bodies can also tolerate levels of radiation that would kill normal humans and they have natural polarized vision which means they can see in light that would normally blind a human. **Note:** Earth humans would need to wear a radiation suit and sunglasses to survive on the planet for any length of time beyond a day or two.

The Darakans have many forms of government, religions, cultures, and levels of society, but their technology is more advanced than Earth and includes space travel and exploration. The darakan race is one of the most ac-

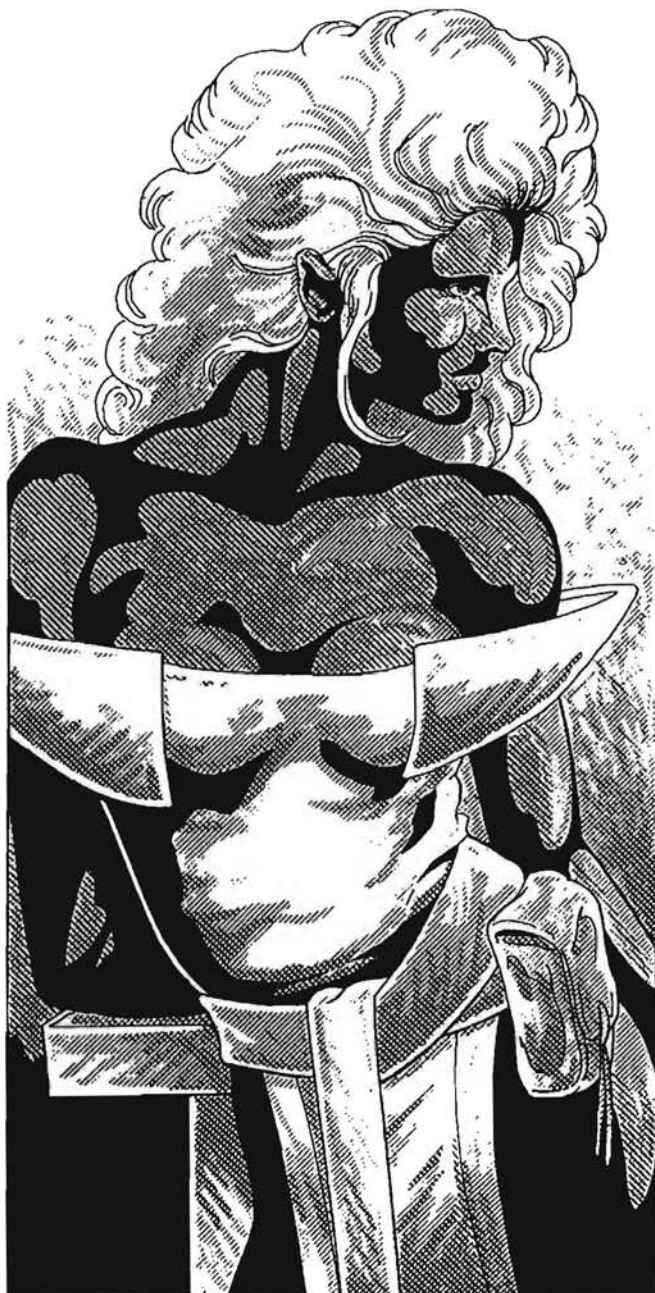

tive within the space community, making their spaceships and people a common sight in their part of the universe. All aspects of space travel are taken advantage of, including military, mining, manufacturing, science, research, exploration and colonization.

Darakans (pronounced: dar-ro-cans)

Alignment: Any

Attributes: I.Q. 3D6+3, M.E. 3D6+3, M.A. 3D6+3, P.S. 3D6, P.P. 3D6, P.E. 3D6, P.B. 3D6+3, Spd. 4D6

Hit Points: Standard, P.E. plus 1D6 per level of experience

S.D.C.: 1D4x10 plus 20

Height: 6 feet plus 1D6 inches (1.8 to 2.0 m).

Weight: 190 +1D6 pounds (87 to 89 kgs).

Average Life Span: 130 years. **P.P.E.:** 3D6

Race: Humanoid

Super abilities: Forty percent (01-40%) of the Darakans are *natural psionics* (yes, natural instead of latent). Others (41-60%) are from the super categories of Bionics, Robots, Hardware, Mutants, or Physical Training, and the rest possess super powers (61-00%; select four minor powers or two minor and one major power).

Natural Abilities: Because of their sun's radiation, the Darakans are immune to radiation, and give off low levels of it themselves. Unless they wear a protective suit, humans and other animals will suffer from radiation poisoning after a few weeks of exposure to them (see the High Radiation world description). They can also see into the ultraviolet and infrared ranges of light, see a large spectrum of color and have polarized vision.

Special Weapons: soldiers are issued sonic stunners, and many civilians carry them for protection. It does one point of damage and imposes the following penalties: Victims lose initiative, reduce speed by 25%, and are -4 to strike, parry, and dodge for 2D4 melees. Range: 150 feet (46 m), payload: 15 shot energy clip.

Special Vehicles: Detachable jet packs: A.R. 12, S.D.C. 50, maximum speed is 90 mph (145 km), or it can hover stationary or reach an altitude of 600 feet (183 m) above the ground.

Special Armor: Light, radiation proof, environmental suit: A.R. 10, S.D.C. 50. Military armored suit: A.R. 15, S.D.C. 140. Both have an air purification and temperature control system.

Familiarity with Earth: None.

Rifts Notes: Same as the Arerri, above.

Hathas

The parched surface of Hatha has no oceans and receives very little rainfall. Even at the poles, ice is minimal. All surface water is trapped within the cool depths of its rocky surface. For this reason, the only source of water is found in caves where the natural aquifers seep from the rocks. As a result, the majority of animal and plant life on Hatha lives underground. Temperatures within the caves remain at 100 degrees Fahrenheit (37 C) nearly the entire year. Compared to the 200 degree Fahrenheit (93 C) surface temperatures, the caves are cool. Still, the presence

of water is minimal and, by itself, could not support much life.

During the evolution of the Hathas, the people developed the *power* to bring water to the surface. Through evolution, all Hathas have the ability to control water. On their native planet, this power is generally limited to drawing water to the surface in the form of a small trickle. On other worlds, where water is in abundance, their power is much more impressive.

There are some Hathas who live on the scorched surface, despite the cool shelter of the caves. The shamans have control over elements of the atmosphere, and it is even said that they can call forth rain. They live upon the surface to "keep their touch with the sky and the moons." However, most who struggle upon the surface do not do so by choice. They are the criminals and political exiles banished there for crimes and dangerous beliefs. The surface-dwelling Hathas are a mix of new exiles and the descendants of long-time surface inhabitants. They flourish in the baking heat due mostly to contact with space travelers who have visited the planet. Many of the exiled surface Hatha sign on with the visiting aliens and leave their homeworld for adventure and freedom.

Hatha civilization is still primitive, especially in the cave cities, which are about equal in technology to Earth of the 1930s. However, the exiles on the surface have received some technology and knowledge from space travelers. They possess Vibro-weapons and others equal to approximately the Earth of the late 1990s. Their main choice for



transportation is a small, single or double seat gyro-copter. It has a special rotor design that cools the air as it flies, a rare luxury for many new exiles.

Those Hathas who leave the planet with alien visitors usually do so as workers, or indentured operatives. Their value dramatically increases when they are exposed to a water-rich environment, and the full extent of their water-calling powers becomes apparent. It is an amazing "awakening," and the Hatha usually becomes a treasured operative, or a preferred slave. Those who are unable to buy or earn their freedom escape and are very often chased by bounty hunters. Free Hathas may stay with their current position/occupation, or move on to become intergalactic explorers, merchants, soldiers, Mercenaries, or bandits.

Most surface Hathas are the descendants of exiles. This means either their ancestors' hatreds and beliefs will be forgotten (or at least, significantly less extreme), and they hold little hard feelings for the cave dwellers, or they will be angry, aggressive, hostile people who despise their cave dwelling brothers and sisters above all others. All surface dwellers are a hardened people accustomed to adversity, struggle and pain.

Hathas (pronounced: hath-ahs)

Alignments: Any. Cave dwellers tend to be more peaceful and of a good or selfish alignment. Many surface dwellers are bitter, and have a selfish or evil alignment. More than a few of the criminals and fanatics exiled to the surface are psychopathic or suffer from some other insanity (may be a crazy hero/villain or have some of these character elements).

Cave Dweller Attributes: I.Q. 3D6, M.E. 3D6+2, M.A. 3D6, P.S. 3D6, P.P. 3D6, P.E. 4D6, P.B. 3D6, Spd. 3D6

Surface Dweller Attributes: I.Q. 3D6, M.E. 3D6+1, M.A. 2D6+2, P.S. 3D6+3, P.P. 3D6, P.E. 5D6, P.B. 3D6, Spd. 3D6

Hit Points: Standard; P.E. plus 1D6 per level of experience.

Cave Dweller S.D.C.: 45, resistant to fire and heat (half damage)

Surface Dweller S.D.C.: 60, impervious to fire and heat!

Height: 5 feet plus 5D6 inches (1.6 to 2.3 m).

Weight: 100 plus pounds (54 to 100 kg).

Average Life Span: 70 years (90 to 100 if they leave).

Race: Human. **P.P.E.:** 2D6

Super Abilities: Surface Hatha are immune to the effects of heat and fire; no damage. Cave Hathas take half damage. In temperatures colder than 90 degrees Fahrenheit (32 C), the surface dwellers must wear a heavy, thermal survival suit; cave Hatha can use light suits. Without them, they suffer from prolonged exposure to the cold. See the Frozen World description for the effects of exposure on an alien.

Cave Hathas possess the major super ability of Control Elemental Force: Water. This is how they bring the deeply hidden waters to the surface. The overall lack of water is the reason that only a trickle of it is created at one time, but on other planets, like Earth, where water is abundant, they wield great power.

Surface Hathas possess the major super ability of Control Elemental Force: Air or Fire (pick one).

The Hatha shamans have the ability to Control Elemental Force: Water and either Control Elemental Forces: Air, Earth or Fire (pick one).

In addition to the above major super abilities, Hathas may have additional super abilities. Roll on the Number and Category of Super Abilities table (p. 226 of Heroes Unlimited) and ignore results that have no major super abilities. Replace the appropriate number of major ability choices with the given powers and determine other abilities normally.

Special Weapons: The surface Hathas have traded services, and sometimes their very lives, to alien visitors to escape the rigors of life on the surface. By comparison, few cave dwellers have left their homeworld, but these masters of water have also joined the intergalactic community. They are especially coveted for finding underground water reserves on planets where water is scarce. Those who have taken to space can possess a number of high-tech weapons, armor and devices — limited by their wealth, or what is provided by their master if a slave or indentured servant. Many surface dwellers have Vibro-Knives and swords passed on from generation to generation, but a smattering of Kisentite weaponry can also be found. Vibro-Swords: Length 3 feet (0.9 m). Weight 3.5 pounds (1.6 kgs). Damage 2D8+2 (or 3D6 S.D.C.).

Special Vehicles: Off-world Hathas can acquire nearly anything that suits their fancy. Most like gyro-copters, jet packs and hover cycles.

Preferred Armor: Hathas use armor based on occupation and the situation at hand. No general preference has been noted.

Familiarity With Earth: Hathas who wander the galaxy have a fondness for tropical planets with lush vegetation and/or an abundance of water. They find such planets fantastic visions as if from a dream. As such, they tend to learn all they can about each. In the case of Earth, this can be as in-depth as the "Has studied Earth" result on the "Familiarity With Earth" table or no knowledge at all, depending on the character's background and alliances. Though they may remind them of home, most Hatha hate deserts.

Rifts Notes: If used in the **Rifts RPG** setting, the characters will be seen as human mutants or treacherous D-Bees and feared or hunted (and destroyed) by human supremacists like those of the Coalition States. Most are likely to be lone adventurers or a small group brought to Earth via a dimensional anomaly, black hole, dimensional experiment, magic or as a slave. The Splugorth, Cibolans and the Naruni are likely to find Hathas a wonderful slave stock. In fact, the Splugorth and Cibolans may even consider finding their homeworld and conquering it to make its people one of their regular slave commodities.

If set in the **Rifts: Phase World** environment, the scenario of slave, explorer, mercenary or space adventurer as presented above works fine. Some are good guys and others are villains.

In any case, the Hathas are S.D.C. life forms who need Mega-Damage weapons and armor for Mega-Damage protection and firepower. **Quickie Conversion:** Technology/weapons/armor can be easily switched from S.D.C. to M.D.C. for quick conversion and integration. Thus, if the body armor had an A.R. 13 and 70 S.D.C., it would now have an M.D.C. of 70 (A.R. not applicable). Similarly, a Vibro-Blade that inflicts 3D6 S.D.C. would now inflict M.D. instead. Or the Game Master can keep the alien's S.D.C. technology and make the character acquire Mega-Damage items just as any human does. The alien's superpowers would inflict the equivalent in Mega-Damage (see **Rifts Conversion Book One** for specific super power conversions).



Kassans

The Kassans are a fortunate people. Their homeworld of Kissia, though perpetually in twilight, is fertile and abounds with life. Its air is clean and relatively free of pollutants. Their society has not had a major war in over 125 years, and relations between their nations are amicable. All Kassans develop super abilities or psionics, and their exploration of space is at its peak.

This is all less than enjoyable for other races that come in contact with them. The prosperity on Kissia over the last century has gone to the inhabitants' heads, making the

once friendly Kassans obnoxious, arrogant braggarts with a blatantly condescending attitude toward most others. The average Kassan believes he is blessed and somehow better than less advanced or "ungifted" races. They will not hesitate to tell someone that a piece of equipment, a weapon, or the way they are doing something is inferior in quality or execution. They are constantly criticizing others and pointing out their faults ("took too long, sloppy, poor craftsmanship, seen better, mistake, etc."). This haughty attitude also tends to make them underestimate their opponents and to take foolish chances. Worst, they are difficult to tolerate in social situations and incite arguments, brawls and hard feelings. As a result, many races avoid contact with arrogant and competitive Kassans. The Shissans are one of the few who deal with them regularly and enjoy exploiting their arrogance in their favor.

Science and engineering are the primary fields of education for many Kassans. Secondary fields include the military, history, art and other technical areas. This emphasis on the sciences and technology is another element in their feeling of superiority because they are so skilled in the higher forms of science. Their level of technology is so advanced that they consider it the highest quality in the galaxy. Their achievements include advanced space travel, space colonization, energy weapons, and micro-hover technology. Their spacecraft, homes, clothes, and personal items are showy, but not necessarily gaudy.

Kassans (pronounced: cass-sans)

Alignment: Any, but many are selfish.

Attributes: I.Q. 3D6+4, M.E. 3D6, M.A. 2D6+2, P.S. 3D6, P.P. 3D6, P.E. 3D6, P.B. 3D6+2, Spd. 3D6

Hit Points: Standard, P.E. plus 1D6 per level of experience

S.D.C.: 30

Height: 5 feet plus 3D6 inches (1.6 to 2.0 m).

Weight: 100+2D4x10 pounds (54 to 82 kgs).

Average Life Span: 140 years. **P.P.E.:** 3D6

Race: Humanoid

Super Abilities: All Kassans possess either psionics or limited super powers.

Psionics: Create latent psionics as usual, but add +20 to the base I.S.P. of 1D4x10+M.E. times two.

Super Powers: The powers of the Kassans are limited to two minor abilities selected from energy expulsion or heightened senses and one major ability selected from the following: Darkness control, gravity manipulation, magnetism, mechano-link, or teleport.

Natural Abilities: Living in the darkened environment of a twilight world has made the Kassans' eyes extremely sensitive to light. It also gives them nightvision with a range of 600 feet (183 m), but daylight will blind them (-8 to strike, parry, dodge) unless special photosensitive goggles or glasses are worn. They are also ambidextrous which adds one attack/action per melee round, +1 to parry, +10% to climbing skill, +5% to escape artist, pick locks, mechanical repair, and electrical repair.

Special Weapons: Energy swords are favorites among many Kassans: Length: 4 feet (1.2 m), weight: 1.5 pounds (.7 kg), damage: 3D6+3.

Special Vehicles: Jet packs and hover cycles.

Special Armor: A lightweight environmental suit with an A.R. 12. and S.D.C. 50. (weight 14 pounds/6.3 kgs), plus a light force field generator. The force field has an A.R. of 18 and 60 S.D.C. Once it is depleted it recharges at a rate of 10 S.D.C. points every hour.

Familiarity with Earth: Equal to "Has Studied Earth" result on the "Familiarity With Earth" table. The Kassans have studied Earth, but they believe its people are big, dumb apes who are progressing at an arduously slow pace.

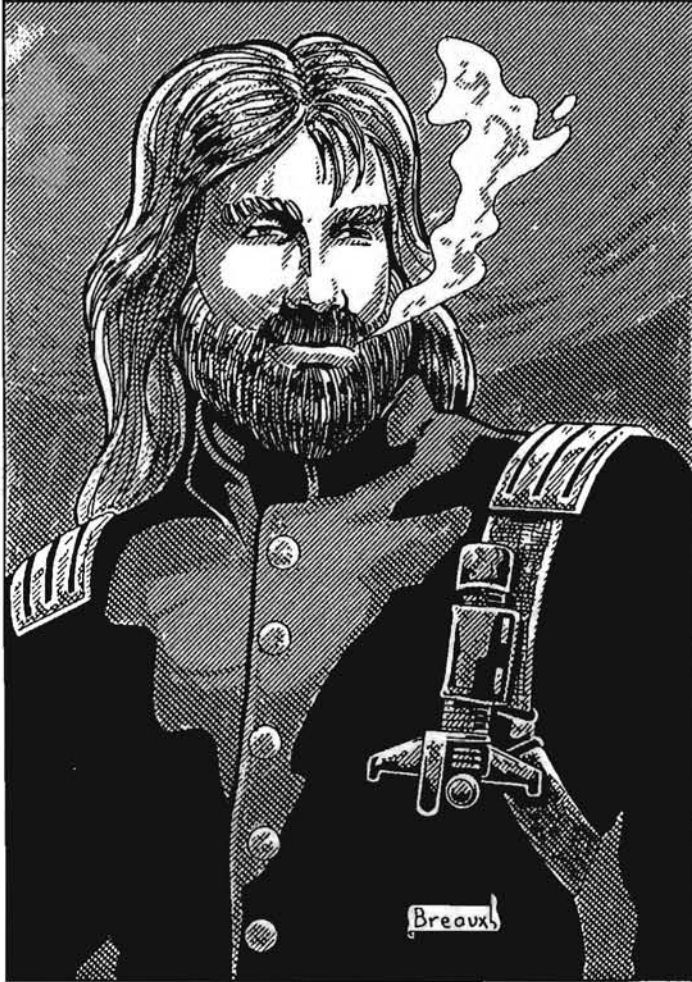

Klikita

The Klikita are a race of human-like aliens who inhabit the upper latitudes of a frozen world named Rizza (located on the edge of the Iltia quadrant). The wind-swept ice fields of Rizza may seem rather bleak and harsh to other races, but the Klikita are at home there. Freezing temperatures by Earth standards, is a heat wave for these aliens. The temperatures at Rizza's equator might reach 40 degrees Fahrenheit (4 C), but in the northern latitudes where the Klikita live, temperatures average a frigid ten degrees below zero (-23 C).

The Klikita look very much like Earth humans. They have thick blonde hair that is usually shoulder length or longer. Their arms, legs and bodies are quite hairy. Facial hair and the hair on their head grows three times faster than Earth humans. Generally speaking, they are a jovial,

noble, and peaceful people, but exhibit a certain degree of arrogance and intolerance toward other, so-called "softer" races, which includes just about everybody. The Klikita are very outgoing and adventurous. They take opportunities to brag and show off whenever possible and spend hours exchanging survival or adventure stories with anyone who has had similar experiences or is willing to listen.

A Klikita's prized possession is the energy knife each is given at maturity. Males and females are considered equal and they share a maturity rite and celebration at age 16. Each knife is unique and is as much symbolic as it is practical. The laser blades are ideal for carving the dense Rizzan ice and for opening the heavily insulated hides of its native animals.

They have highly developed technology that includes robotics and space travel. This technology is used mostly in industrial or construction roles like the excavation of the tunnel cities in Rizza's glacier surface, and food processing. Most space operatives also have robots and advanced equipment, much of which is military grade and used for defense and security. A small unit of combat specialists is also found on most merchant spacecraft. The Klikita have a reasonably large fleet of warships, cargo and merchant space vessels and are actively engaged in space exploration, mining, scientific experimentation, and limited trade with other worlds.

They are aggressive and mildly paranoid of other races. As a result, they have strong defenses and firepower on Rizza. This attitude has led them into the area of human augmentation and they have created the means to instill super abilities into their people. This is a recent area of intense research and development.

Note: The Klikita share Rizza with another race of humanoids known as the Aluta. Although they engage in limited trade and resources, they view the Aluta as rivals and with a certain amount of contempt and suspicion. However, there have never been any bloody wars between the two.

Klikita (pronounced: kleh-key-tah)

Alignment: Any

Attributes: I.Q. 3D6, M.E. 3D6, M.A. 3D6, P.S. 3D6, P.P. 3D6, P.E. 3D6, P.B. 3D6, Spd. 3D6

Hit Points: Standard, P.E. plus 1D6 per level of experience.

S.D.C.: 45

Height: 5 feet, 6 inches plus 2D6 inches (1.7 to 2.0 m).

Weight: 120 plus 2D6x10 pounds (63 to 109).

Average Life Span: 65 years. **P.P.E.:** 3D6

Race: Human

Natural Abilities: Klikita are resistant to cold and take half damage from any cold-based attack, but in heat above 60 degrees Fahrenheit (15 C), they suffer from heat exhaustion and exposure (see the exposure rules under the Frozen World description).

Super Abilities: A Klikita character can be created from almost any of the super ability categories found in **Heroes Unlimited**, including Hardware, Mutant, Physical Training, Robots and Bionics. Less than 5% have psionic powers, and magic is not practiced by them.

However, a full 25% are the product of augmentation experiments that instill *super abilities* (but don't roll for side effects usually associated with experiments). These super powers frequently focus on cold abilities, physical endurance (including healing factor), alter physical structure, light and energy based abilities. Powers can be selected from these general categories; however, there is always a random element and the best Klikita scientists can hope for in duplicating a specific power is 44% (character can select specific abilities on a roll of 01-44%, otherwise they are random).

Special Weapons: Laser knife: length: 22 inches (56 cm) from the butt of the handle to the blade tip. Weight: one pound (0.45 kg) and inflicts 2D8+3 S.D.C. damage.

Special Vehicles: 4x4 foot (1.2x1.2 m) hover platform (holds two to four people). Maximum speed 90 mph (145 km), S.D.C. 120, hovers 3 to 300 feet (0.9 to 91 m) above the ground.

Preferred Armor: Klikita generally prefer soft, half suits (A.R. 12, with an S.D.C. 50 to 90) of armor.

Familiarity With Earth: Rizza is rather close to Earth, 30 light years away, and many Klikita have heard of the blue and green orb. Their computer networks contain information about Earth and other neighboring planets that is equal to the "Some Familiarity" result on the Familiarity With Earth table.

Rifts Notes: Same as the Arismal aliens.

Manarr

The Manarr are a dying race. Less than a thousand are believed to exist.

It all began over one hundred years ago when a mysterious plague ravaged the population. Their doctors and scientists toiled for twenty years before finding a cure, but by then, the plague had killed more than 70% of the people. The exhaustive efforts of the researchers and their exposure to the afflicted eventually cost many of them their lives. The survivors rejoiced and began to rebuild their lives, but, unknown to them, the deadly killer was not gone. A decade later, a strain of the plague resurfaced and devastated the planet. The complex malady had mutated and become a part of the Manarr's genetic structure, so that all Manarr were born with the dormant killer gene waiting to awaken and bring death.

For fifty years, scientists searched for the invisible disease. Its symptoms confused them and eventually they perished in its grip. All Manarr will die within five years of the awakening of the killer chromosomes. The average Manarr is stricken during the early teen years and most are dead by the age of eighteen. The last few thousand Manarr fled their planet in spaceships with the hope that they could escape the plague. They were wrong, and now only an estimated 300 to 900 of them remain, but these survivors are free of the plague!

Unknown to the Manarr, a tiny percentage of their race is immune to the plague. In addition, those who possess super abilities have either radically different gene structures which aren't affected, or have superhuman

metabolisms that are impervious to, or repair/cure the plague chromosomes. Manarr who have major bionic reconstruction are also resistant to the illness. Ironically, most Manarr don't know this, and they believe their deaths are imminent. Furthermore, most have decided there is no cure and have stopped looking, so they may never learn that the small numbers of survivors are forever free of the plague and can rebuild their race.

Instead, death has become a constant companion making them insanely bold, daring and foolhardy. They live for adventure, thrills and excitement before they die. They fear little and respect and value life above all else. This has made many wandering Manarr space knights, heroes and vigilantes determined to help others and preserve life. Most wear skeletal armor to remind themselves of their mortality and to welcome death. The helmets are sculpted into a skull motif and the armored plates resemble bones. Some may carry energy sickles and scythes as weapons and use hidden antigravity disks to further enhance their Grim Reaper appearance. Their death-image armor and tall, thin physical stature help give the Manarr, an aura of menace and foreboding. The sight of a Manarr in full battle armor, floating forward with sickle in hand, is unnerving to nearly anyone. **Note:** Each Manarr has a slightly different stylization to his or her armor, making each personal and unique.

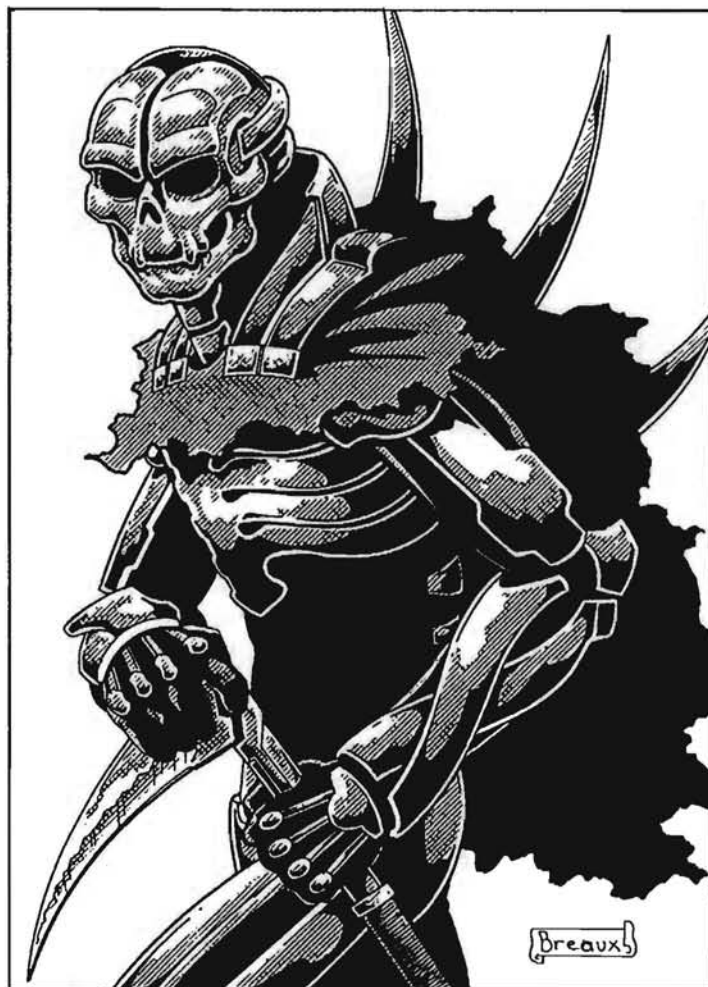

Manarr (pronounced: man air)

Alignment: Any, but most are principled, scrupulous or unprincipled. Evil and/or murderous are seen as traitors to both the Manarr race and life itself.

Attributes: I.Q. 3D6, M.E. 3D6, M.A. 3D6, P.S. 3D6, P.P. 4D6, P.E. 3D6, P.B. 3D6, Spd. 5D6

Hit Points: Standard; P.E. plus 1D6 per level of experience.

S.D.C.: 1D4x10 plus 20

Height: 6 feet, 5 inches plus 4D6 additional inches (2.0 to 2.5 m).

Weight: 1D4x100 pounds (45 to 181 kgs).

Average Life Span: Their natural life span is 90 years, but many die violent deaths at a much earlier age.

Race: Human. **P.P.E.:** 5D6

Super Abilities: About 35% (01-35%) have four minor super abilities, 20% (36-55%) have two major super powers, 15% (56-70%) have two minor and one major power, 15% (71-85%) are bionic and the remainder are immune to the plague and fall into the categories of Physical Training, Special Training, or Hardware.

Natural Abilities: Although basically human, their experiences and resolve about life and death have made the Manarrs fearless: +1 on initiative, +8 to save vs Horror Factor and +2 to save vs mind altering drugs and mind control; they are even unimpressed with the super ability of divine aura. These heroes do not hesitate in their decisions, which can also get them into trouble and make them reckless. All the Manarr survivors are free of the plague.

Special Weapons: Manarr adventurers commonly have stun pistols or stun grenades, tear gas capsules, and a variety of energy weapons at their disposal.

1. Their famous energy sickles can cut through metal like a hot knife through butter, inflicting 6D6 S.D.C. per strike. However, the Manarrs usually use this weapon to cut through hulls and hatchways, and to disable cyborgs and destroy robots. The sickle or scythe can also fire a short-range blast that inflicts 6D6 S.D.C. at a range of 100 feet (30.5 m). Its payload is limited to 8 blasts before requiring automatic recharging (recharges one blast per hour).

Built into the end of the scythe is a stun blaster that temporarily short circuits the nervous system of an opponent. Victims get to make a saving throw (14 or higher means they save; no penalties) and characters who are invulnerable, bionic or robotic are not affected. Stunned characters are dazed: reduce speed and the number of attacks per melee by half, plus the victim is -8 to strike, parry, and dodge for 1D4+1 melee rounds; multiple stun blasts may extend the duration of the stun effect but not the penalties. Range is limited to 135 feet (41 m) and the payload is 12 shots (it regenerates one blast every 30 minutes).

2. Energy shurikens/throwing discs: Throwing range: 120 feet (36.5 m). They don't actually cut but cause an impact when they strike that inflicts 2D6 S.D.C. and have a 1-80% likelihood of knocking their victim off his feet! Not applicable to beings who weigh 500 lbs or more (225 kg). The knockdown impact causes the vic-

tim to lose initiative and one melee action/attack each time he is knocked off his feet.

The average Manarr has 3D4 energy shurikens and one sickle or scythe, grim reaper body armor and a portable jet pack, as well as other weapons and equipment.

Special Vehicles: Hover disks on the back, hidden under cloaks: Maximum speed 90 mph (145 km). S.D.C. 40. Hover 1 to 1,200 feet (.3 to 366 m) above the ground. Maximum weight allowance: 1,000 pounds (450 kgs).

Special Armor: The grim reaper armor is a light exoskeleton with the following features: A.R. 19, S.D.C. 160, P.S. 24, doubles the wearer's natural speed, leaps up to 12 feet (3.6 m) high or 18 feet (5.5 m) lengthwise, and limited flight via detachable jet backpack (50 mph/80 km or hover stationary; maximum altitude is 1000 feet/305 m), long-range radio (150 miles/240 km), enhanced optics: see into the infrared and ultraviolet spectrums (600 foot/183 m range), built-in language translator, full environmental body armor with independent oxygen supply, air purification and circulation system, an internal cooling system and most of the features common to environmental body armor.

Laser beams can be fired from the eyes: 1D6 S.D.C. from one eye beam, 2D6 from both; range: 200 feet (61 m).

Familiarity With Earth: The Manarrs have extensive information on many less-advanced planets. They have access to information about Earth that is the equivalent of the "Some Familiarity" result on the Familiarity With Earth table. The Manarrs carry microcomputers in reinforced backpacks to store their collected information.

Rifts Notes: The Manarrs will be seen as human mutants or treacherous D-Bees, feared and hunted by human supremacists. Most are likely to be lone adventurers or part of a small group. Arrival to Rifts Earth is possible via a dimensional anomaly, black hole, dimensional experiment, magic, as a slave or refugee, or by spaceship. In the latter case, the ship is likely to have been damaged or destroyed by the orbital defense web still in operation around the planet, thus trapping the Manarr on Earth. The Manarr and such beings as the Splugorth, vampires and other supernatural monsters are natural enemies, because of their diametrically opposing views toward life and slavery.

If set in the **Rifts: Phase World** environment, the scenario of explorer, mercenary, hero, or space adventurer works fine. Most are good guys.

Most of these characters are S.D.C. life forms who need Mega-Damage weapons and armor for Mega-Damage protection and firepower. **Quickie Conversion:** Technology/weapons/armor can be easily switched from S.D.C. to M.D.C. for quick conversion and integration. Their energy weapons are roughly equivalent to the Kittani plasma blades. If any race has Mega-Damage weapons it's the Manarrs. See **Rifts Conversion Book One** for specific super power conversions and other details.

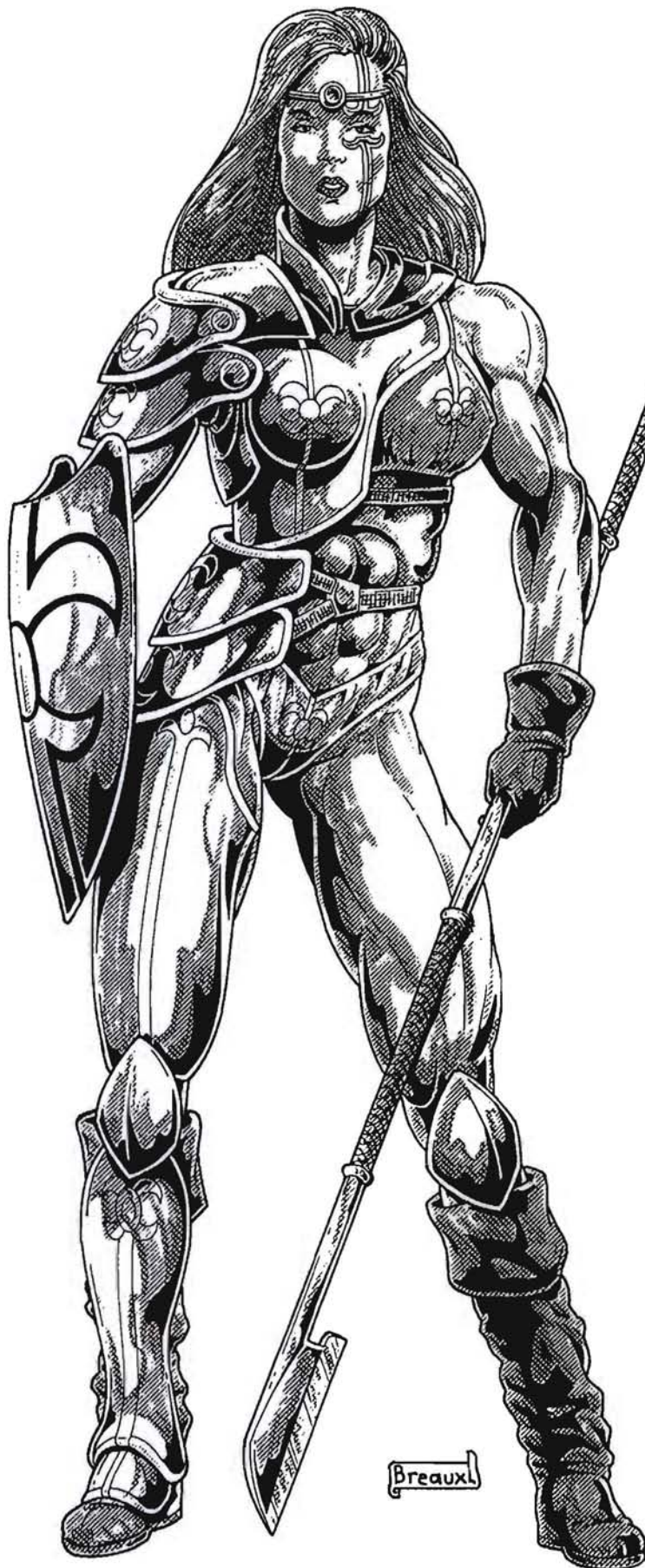

Naidens

Based on Ideas and Drawings by Eric Breaux.

The planet Nadine is a green and blue globe that supports a vast variety of life. The most advanced of its indigenous species is a race of humans called the Naidens. Evolution in Naiden's powerful gravity has shaped the Naidens into a short, strong people. They weigh more than an average human due to their dense muscle tissue and mass. Otherwise they look like Earth humans, with fiery red hair (occasionally orange or reddish brown).

The main area of strife is overpopulation. Nadine's gravity is so heavy that it is difficult to build upwards, so most of the planet is covered by low, sprawling cities and vast underground cities. The inability to build up into the skies reduces the number of people per square mile (2.59 square km) and has caused overcrowding, war and unrest. War over real estate frequently also serves to keep the swelling population under control.

The **Aborea** are an elite class of Naiden operatives trained as warriors and tacticians to command the regular troops. They can come from any social or economic background. The thing that sets them apart from other Naidens is their superhuman abilities and a tattoo placed over the left eye as a sign of rank. All Aborea are left-handed (though not all left-handed Naiden are Aborea) and possess superhuman powers used for war and law enforcement.

The mere presence of an Aborea makes other Naidens nervous and afraid. The Aborea are practically pariahs among their own people because of their reputation as ruthless and deadly warriors who slaughter thousands during civil unrest and war. This fear and distrust among their own people causes some Aborea to become frustrated and angry, sometimes going berserk and lashing out with murderous rage or in devastating temper tantrums. Most are intolerant of the contemptuous, weaker and inferior Naidens. This only adds to the strain between these two related races. These sentiments often entice members of the Aborea to leave their homeworld to explore the cosmos or to find a place where they can make a difference and be respected. Others become villains or madmen, but most remain loyal defenders of their people.

Despite their advanced technology, the Naidens, and especially the Aborea, have a love of archaic-styled weapons. The Naidens are considered some of the best melee combatants in the galaxy. Their weapons are made of a very rugged metal known as *anira steel*, which is nearly indestructible and can even parry energy blades without being damaged.

Naidens

Alignment: Any

Attributes: I.Q. 3D6, M.E. 3D6, M.A. 2D6, P.S. 4D6 (+1D6 for Aborea), P.P. 3D6 (+2 for Aborea), P.E. 3D6+2, P.B. 3D6, Spd. 3D6x3

Hit Points: Standard, P.E. plus 1D6 per level of experience.

S.D.C.: 3D6x10 plus 60 for the Aborea.

Natural A.R.: 10; tough, hard skin.

Height: 5 feet plus 1D6 inches (1.5 to 1.6 m).

Weight: 200 plus 4D6 pounds (90 to 100 kgs).

Average Life Span: 85 years. **P.P.E.:** 2D6

Race: Humanoid

Super Abilities: The average Naidens are partial or full conversion cyborgs. Magic-using Naidens are unheard of and those with psionic powers or who possess super abilities are all Aborea.

Psionic Aborea: As with most aliens, the Aborea are latent psionics, but their selections are limited by their combat nature. The initial eight lesser psi abilities must come from physical and the super psionic ability must be an offensive ability such as pyrokinesis, mind bolt, bio-manipulation, etc. Additional abilities will always come from the physical or super psionic lists. Also add +20 to the base I.S.P.

Aborea with super abilities: Have one major super ability of choice (must be an offensive power) and two minor abilities from the categories of energy expulsion, extraordinary attributes or super vision.

In addition, all Aborea have one additional attack per melee round and a +5 to save vs Horror Factor.

Special Weapons: Most Naidens prefer archaic melee weapons such as swords (this includes retractable forearm blades for bionic characters). Aborea receive a bonus of +1 to strike and parry with any melee weapon. Many Naidens, and all Aborea use weapons of anir steel (which is the equivalent of Kisentite weaponry). The character gets a Kisentite equivalent weapon of his choice.

Special Vehicles: Most soldiers are issued two-man hover jeeps (maximum speed 160 mph/260 km, S.D.C. 280, hovers 3 to 12 feet/0.9 to 3.65 m above the ground), but the Aborea prefer one-man hover cycles (maximum speed 200 mph/321 km, S.D.C. 200, hovers 3 to 30 feet/.9 to 9.1 m above the ground).

Preferred Armor: Naidens wear half suits of armor: A.R. 12, S.D.C. 100. Aborea warriors wear full or half suits of plastic and ceramic plate with an A.R. 14 and S.D.C. 90 or hard armor A.R. 17, S.D.C. 250.

Familiarity With Earth: None. If they should find themselves there, their language would be very much like the English of Earth.

Rifts Notes: Characters who arrive on Rifts Earth will be seen as dangerous D-Bees to be feared, hunted and destroyed by human supremacists. Arrival to Rifts Earth is likely via a dimensional anomaly, black hole, dimensional experiment, magic or as a slave. The Splugorth and other slavers are always on the lookout for superbeings.

If set in the **Rifts: Phase World** environment, the scenario of slave, explorer, mercenary, or space adventurer works fine. Some are good guys and others are villains.

The Naidens and Aboreas are Mega-Damage creatures on Rifts Earth and Phase World. If the character has 160 S.D.C. it becomes 160 M.D.C.; the same is true of Naiden cyborgs. The super abilities of the character would also inflict the equivalent in Mega-Damage (see **Rifts Conversion Book One** for specific super power conversions).

Rotharr

The Rotharrs are a powerfully built race of giants native to a planet called Carr. It spins quickly upon its axis, churning the atmosphere into a wind-battered, inhospitable environment. Dust and sandstorms are continuous, and the surface of Carr is ground smooth from exposure. The native life forms have developed hard exoskeleton plates to protect them from this abrasive atmosphere. The Rotharrs would appear human if not for their natural heavy plating and large size.

The Rotharrs are an advanced, space-capable civilization and have been dabbling with robotics and bionics, but these are still relegated to experimentation (their natural body armor also makes bionic augmentation less necessary or appealing). Weapon technology is approximately equal to 21st Century Earth, including Vibro-weapons, rail guns, lasers and ion blasters.

Much of the Rotharr culture is built around a strict militaristic society. All Rotharrs, males and females, are required to spend at least one six-year tour in the armed forces. Those that do not enlist by their twenty-first birthday are forced into service, and deserters are arrested. The strict codes of the Rotharr military have also sent many soldiers to prison, although punishment is generally just and fair.

Rotharr (pronounced: roth-ares)

Alignment: Most Rotharrs will be principled, scrupulous, unprincipled, or aberrant. Anarchist, miscreant and diabolic characters will probably spend time in and out of prison for various offenses and may become stellar pirates or intergalactic criminals.

Attributes: I.Q. 3D6, M.E. 3D6, M.A. 3D6, P.S. 4D6+4, P.P. 3D6, P.E. 3D6, P.B. 3D6, Spd. 6D6

Hit Points: Standard; P.E. plus 1D6 points per level of experience.

Natural A.R.: 14 and may wear additional armor or pilot power armor.

S.D.C. (natural body armor): 5D6x10 plus 40

Height: 9 feet plus 4D6 inches (2.8 to 3.4 m).

Weight: 350 plus 2D6x10 pounds (168 to 213 kgs).

Average Life Span: 80 years. **P.P.E.:** 3D6

Race: Humanoid

Super Abilities: Rotharrs can be of any Super Power Category, but most fall into the Hardware or Physical Training categories. Less than 20% have super abilities (01-20%) and only another 20% have psionics (81-00%). Bionics is a rarity; usually found in military experiments.

Natural Racial Abilities: Giant size, super strength, and natural body armor; +1 on initiative, +1 to save vs magic, +2 to save vs poison/disease and drugs, and +2 to save vs Horror Factor.

Special Weapons: Vibro-axes: Length 2.5 feet (.8 m), weigh five pounds (2.3 kgs), and inflict 4D6 S.D.C. damage plus P.S. attribute bonus.

Special Vehicles: A.T.V. hover vehicle (can comfortably hold the pilot and five passengers), S.D.C. 440, maximum speed 140 mph (225 km), can hover from 3 to 12



feet (0.9 to 3.65 m) above the ground. It also has space and underwater capabilities. They also use jet packs.

Preferred Armor: Rotharrs do not normally wear armor of any kind. They rely on their natural armor plating for protection, although they may add metal and ceramic shoulder, arm and leg plates for additional protection (typically adds about 50 S.D.C. and one point to the A.R.).

Familiarity With Earth: The Rotharr military computers have information in them that is equal to a "Some familiarity" result on the Familiarity With Earth table.

Rifts Notes: Characters who arrive on Rifts Earth will be seen as dangerous D-Bees to be feared, hunted and destroyed by human supremacists. Arrival on Rifts Earth is likely via a dimensional anomaly, black hole, dimensional experiment, magic or as a slave. The Splugorth and other slavers will find Rotharrs to be very attractive for gladiatorial games and slave labor.

If set in the **Rifts: Phase World** environment, the scenario of slave, explorer, mercenary, or space adventurer works fine. Some are good guys and others are villains.

The Rotharrs are Mega-Damage creatures on Rifts Earth and Phase World. If the character has 190 S.D.C. it becomes 190 M.D.C.; the same is true of Rotharr spaceships and equipment. The super abilities of the character would also inflict the equivalent in Mega-Damage (see **Rifts Conversion Book One** for specific super power conversions).

Shissans

Shia is a planet of dust and heat. The 210 degree Fahrenheit (99 C) surface temperature at the equator limits the amount of water, precipitation, and life on the hot planet.

Despite the inhospitable conditions, there is life on Shia and at least one form is intelligent. The Shissans have managed to adapt to the torturous conditions and they thrive there. Their population is low, but that is because the available amounts of food and water to sustain them are minimal and they must rely on foods grown from hydroponic gardens on space stations orbiting the planet. They are active in the galactic community and are avid explorers. Shissan settlements are found on many thermal (and other) planets. This has led many to speculate that the Shissans are not indigenous to Shia and are actually the descendants of ancient space refugees.

Shissans look quite human, except for their light red or rust complexion, flaming red hair and a pair of small horns (1D4+2 inches long) on their foreheads.

The planet, Shia, is a magic-rich environment very much like that of Rifts Earth. In this Mystic environment, they have developed an attunement to magic and practice a variety of Mystic arts. Many use their magic to operate as con-men, smugglers, forgers, Mercenaries and spies/espionage agents. Many are self-serving and are always in search of easy opportunities, or get rich quick schemes. As such, they are infamous for tricking primitive people into believing they are gods, demigods, demons or supernatural beings, to get them to worship and obey them, shower them with riches, or help them achieve some other goal. There are more scrupulous members of the race who earn their money by performing legitimate services, but they are a small percentage of the whole. Most Shissans operate as lone freelancers or in small groups.

Shissans

Alignment: Any, but the vast majority are anarchist or miscreant.

Attributes: I.Q. 3D6+1, M.E. 4D6, M.A. 4D6, P.S. 3D6, P.P. 3D6, P.E. 3D6, P.B. 3D6, Spd. 3D6

Hit Points: Standard, P.E. plus 1D6 per level of experience.

S.D.C.: 60

Height: 5 feet plus 4D6 inches (1.6 to 2.1 m).

Weight: 100 plus 2D6x10 pounds (54 to 100 kgs).

Average Life Span: 160 years

Super Abilities: All Shissans are alien Mystics who fall under the **Heroes Unlimited** power category of Mystic Study (Magic), making them full wizards. They are trained from a very young age to hone their natural skills and start with one additional spell from each level 1-4 (total of 5 from each level instead of the normal 4 in addition to the other starting spells of the wizard) and a bonus of +30 to the base P.P.E.

Natural Abilities: Shissans are totally immune to the effects of heat and fire (no damage), but if exposed to temperatures less than 98 degrees Fahrenheit (37 C), the characters will begin to suffer from exposure (see exposure effects under the Frozen World entry for details on exposure). Most wear body suits while adventuring that regulates temperature at a nice, comfortable 140 to 180 degrees Fahrenheit.

Special Weapons: Shissan weapons are identical to Kisentite weapons.

Special Vehicles: Antigravity rings or medallions: Maximum speed 60 mph (96 km); S.D.C. 8. Maximum alti-

tude is unlimited. Maximum weight allowance is 500 pounds (225 kgs).

Preferred Armor: Shissans prefer magical protection over conventional, but will use whatever is necessary to get the job done, or that strikes their fancy. Traditional explorer garments are a heated body suit concealed under a loose fitting shirt, pants and a hooded cloak, A.R. 13, S.D.C. 80.

Familiarity with Earth: Equal to "Has Studied Earth"; most of their data is from their kassan allies.

Note: The Shissans like the kassan and frequently work, associate and trade with them.

Rifts Notes: If used in the **Rifts** setting, the character will be seen as a mutant human or D-bee sorcerer who is feared and hunted by human supremacists like those of the Coalition States. They can be any of the magic O.C.C.s found in the **Rifts** series, including Techno-Wizards, Temporal Wizards, Necromancers and Biomancers. They love rune magic and the use of parasites and symbiotic organisms.

Arrival on Rifts Earth is likely via a dimensional anomaly, magic or as a slave or refugee. They know about the Splugorth, but prefer to trade and work with their rivals, the Cibolans and Naruni Enterprises.

If set in the **Rifts: Phase World** environment, the scenario of slave, explorer, mercenary, or space adventurer works fine. Some are good guys and others may be villains.

These characters are S.D.C. life-forms who need to acquire Mega-Damage weapons and armor for Mega-Damage protection and firepower. Magic spells and abilities will be equal to others found on Rifts Earth and will have Mega-Damage effects.



Silisons

Feradine is a verdant world populated by human-like aliens known as the Silisons. The sun that warms this world also sends out powerful radiation that accelerates the production of rigid calcium deposits, disease and mutation. For the Silisons to survive, mutated organs, bones and limbs must be replaced with artificial ones. To this end, they have perfected the science of bionic reconstruction and cybernetic implants. The radiation also prevents their bodies from growing hair. In fact, any facial or head hair are artificial implants. Social status and rank are often shown by the addition of hair and beards. They also learned how to make native plant life radiation resistant.

The majority of Silisons prefer to have realistic artificial skin placed over their artificial limbs and appendages, especially on the head. Many look completely human although they are 90% machine. The older a Silison gets, the more body parts that have to be replaced. The elder Silisons become cold and mechanical as their flesh and bones are exchanged for machinery. Many begin to show evil alignments, and some forsake covering their mechanical body with skin or clothes. Elders, many ranking military officers and the insane, may replace their face/head with a demonic or otherwise frightening visage.

Those Silisons who qualify for space duty usually do so. Ten years away from their sun often stops the growth of painful calcium deposits and physical deterioration. However, the radiation damage that results from living on their homeworld will affect and impair the Silisons for their entire lives.



Silisons

Alignment: Any, but as frustration and bitterness fester, many older, bionic Silisons become cruel, selfish and evil. Insanities are also common with age because the brain may begin to calcify or deteriorate due to the radiation.

Attributes: I.Q. 3D6+2, M.E. 3D6, M.A. 3D6, P.S. 3D6, P.P. 3D6, P.E. 3D6, P.B. 3D6, Spd. 3D6 or by bionics.

Hit Points: Standard; P.E. number plus 1D6 per level of experience.

S.D.C.: 1D4x10 plus 20 or by bionic reconstruction/conversion. Those who are full cyborgs will typically have an S.D.C. of 250 to 300 with an A.R. of 10 or 12 without bionic armor.

Height: 6 feet plus 1D6 inches (1.8 to 2 m).

Weight: 190 plus 1D6 pounds (86 to 89 kgs); additional weight will be added from bionics.

Average Life Span: Roughly 55 years for those who stay on the planet. Those who leave but are primarily bionic can live for 200 years.

Race: Human. **P.P.E.:** 1D6

Super Abilities: None, other than bionics. All Silisons will receive some form of bionics unless they leave

Feradine before they are ten years old (even then they may require corrective surgery and/or minor cybernetic reconstruction). The typical Silison will have one or two bionic arms and hands, reinforced spine and shoulders, artificial lungs and various other internal organs and possibly bionic legs. By age 30, most have undergone complete bionic reconstruction, with only the brain and a handful of living body parts. Silison bionic characters have 10% more S.D.C. than normal (including exoskeleton and armor S.D.C.) and add 500,000 to their budgets.

Natural Abilities: Resistant to radiation poisons (half damage and penalties, +3 to save) and they can see into the ultraviolet spectrum of light. Many Silisons also radiate low levels of radiation. Full conversion Silisons are immune to radiation and do not radiate any damaging radiation.

Education: Most Silisons are skilled in the areas of medicine, science, mechanical engineering/bionics/robotics, research/ investigation, space exploration and combat. Many will fall into the Science Specialist Education Category.

Special Weapons: In addition to bionic weapons, many Silison explorers and military personnel are issued plasma ejector rifles (range: 1200 feet/366 m, 6D6+20 damage, 10 to 20 shots per energy clip).

Special Vehicles: One-man fan jets, jet packs and spacecraft.

Preferred Armor: Bionic body armor: A.R. 11 to 18, S.D.C. 250 to 900.

Familiarity With Earth: The Silisons have no knowledge of Earth. If they arrived there it would be by accident.

Note: Silisons raised from infancy away from their homeworld are free of most of the physiological problems associated with the homeworld and look quite human. A few small colonies have been established on other worlds, but finding habitable worlds is a more difficult task than one might think.

Rifts Notes: Same as the Rotharrs.

Swips

The Swips are inhabitants of a lush, Earth-like planet called Tith. The gravity of Tith is many times stronger than that of Earth, so its native life forms are stout, powerfully built creatures. The Swips are human in appearance, except for their short stature and elliptical eyes. All have an insatiable curiosity, a desire for tinkering and a natural inclination for building, as well as the mechanical and electrical sciences. They have to figure out how something works and enjoy making improvements on the creations of others. All types of machines attract their interest. Due to their energetic nature, their work tends to be more function than form. Few feel the need to waste time nor do most have the patience to make something look good. If it works, it works.

Not all Swips are as absorbed in technology. Nor are they all single-minded. Some are more inclined to figure out how people work and become politicians, speakers

and leaders. However, all are adrenaline junkies who look for adventure and fun. Many will participate in combat and physical activities regardless of personal gain. They enjoy games of chance, racing, running, wrestling, fighting, exploring, risk taking and challenges. Their many tales of adventure may sound like fish stories, but most are true and not overly embellished. Swips are too reckless and proud to exaggerate.

Personal skill and daring play a large part in the Swip's feeling of excitement and accomplishment. Many prefer to use manual controls to pilot vehicles and robots and enjoy tests of their minds or physical bodies as much as anything else. Their weapons, gimmicks and armor are usually concealed beneath long, duster-styled coats. Wide-brimmed hats, boots, and leather chaps are also common choices for traveling.

Swips

Alignment: Any

Attributes: I.Q. 3D6+4, M.E. 3D6, M.A. 3D6, P.S. 5D6, P.P. 3D6, P.E. 3D6, P.B. 3D6, Spd. 3D6x3.

Hit Points: P.E. x2 plus 1D6 per level of experience.

S.D.C.: 3D4x10

Height: 5 feet plus 1D6 inches (1.5 to 1.6 m).

Weight: 200 plus 2D6x10 pounds (90 to 144 kg).

Average Life Span: 80 years. **P.P.E.:** 1D6

Super Abilities: Available categories are limited to Hardware, Physical Training, Robotics or Bionics; though the latter is rarely used on themselves.



Special Weapons: Neural-bolas that discharge and overload the nervous system. This dazes the victim, who will lose initiative and be at -4 to strike, parry, and dodge for 1D6 melee rounds. On a "to hit" roll of 18, 19, or 20, the bolas will entangle the victim.

Otherwise, they use all kinds of weapons and equipment and easily adapt to all types of technology (+10% to identify and use alien technology).

Special Vehicles: Swips like to ride robot animals with all-terrain capabilities: walk, run, leap, hover, fly, etc.; usually mechanical hover horses, canines and felines. If the character is skilled in the robotics power category, he may wish to spend some of his budget on modifying his "mount" to include concealed weapons, extra armor, and so on.

The basic standard robot animal: A.R. 14, S.D.C. 220, maximum running speed 80 mph (128 km), maximum flying speed 240 mph (390 km) and can hover stationary; maximum altitude is typically 600 feet (183 m) above the ground. Maximum additional weight is limited to 500 pounds (225 kgs). It is +2 to dodge. Special pilot skill needed for hover animals. Those without it can default to hover cycle or ride horse at 10% or motorcycle at -20%.

Preferred Armor: All kinds, especially power armor and exoskeletons.

Familiarity with Earth: None.

Titons

The Titons are a race of giant warriors who roam the galaxy helping others and working with those in need. Their homeworld is a glorious planet of soaring golden buildings and glittering crystal. Other races could easily mistake its shimmering towers and green gardens for the home of the gods, or some equally heavenly place. The Titons are a noble people who have visited many planets in their quest to improve the galaxy. Earth was visited by them several hundred years ago. After helping the natives and pointing them in the right direction, the Titons left. They have in-depth knowledge of many planets from such visits. The legends of "Titans" on many planets are likely a recounting of the Titons' visit and interaction with their world.

The Titons are powerfully built giants with broad shoulders and muscular bodies. They use antigravity devices built into their body armor and vehicles, which gives them the power of flight and enhances the illusion that they are godlings in the eyes of primitive peoples. The giants believe this misconception is easier for primitive people to understand and accept, rather than try to explain higher technology to them. It also enhances their acceptability among the people.

Titons travel the spaceways in gleaming, laser-resistant spacecraft that are truly works of art, but the spires, pinnacles, and vanes that give the crafts their beauty also serve to conceal their defenses. Many of the small to mid-sized craft have transatmospheric capabilities, so they can enter atmospheres and land on planets. Many also have

antigravity systems. As these sculpted craft slowly land upon a planet, they appear very much like a castle or city descending from the clouds. This sight also lends credence to the image of gods descending from the heavens.



Titons

Alignment: Any, but most Titons are of good alignments, with a high standard of morality and sense of justice.

Attributes: I.Q. 3D6+1, M.E. 3D6+2, M.A. 3D6+3, P.S. 3D6+20, P.P. 4D6, P.E. 3D6+4, P.B. 3D6, Spd. 3D6x4

Hit Points: P.E.x 2 plus 2D6 per level of experience.

S.D.C.: 1D6x10 plus 40

Height: 8 feet plus 1D4 additional feet (2.4 to 3.6 m).

Weight: 1D4x100 plus 80 pounds (68 to 216 kgs).

Average Life Span: 250 years. **P.P.E.:** 3D6

Super Powers/Abilities: All Titons are of the Super Ability power category. Select one minor super ability from the *Extraordinary Attribute* category and one from the *heightened senses* or *super vision* category. In addition, the Titon can select or randomly roll to determine one major super ability.

Special Weapons: Titons will use all types of weapons but have a fondness for energy blade weapons and magic weapons.

Special Vehicles: Antigravity system for armor and small vehicles: Maximum speed 90 mph (145 km); S.D.C. 50, maximum altitude is unlimited. Maximum weight allowance is 1,000 pounds (450 kgs). The speed and weight allowance for larger vehicles is dramatically higher.

Preferred Armor: Most wear specially made suits of giant chain or plate armor. Each is styled to its owner's taste and constructed of reinforced ceramic composites (even the chain links). Titon Chain Mail Armor: A.R. 13, S.D.C. 120. Titon Plate Armor: A.R. 17, S.D.C. 250. Both are designed to enclose or incorporate an environmental suit.

Familiarity with Earth: Very familiar with Earth culture, languages, religions, and customs equal to the "Has Studied Earth" result on the Familiarity With Earth table.

Insect Humanoid Races

Insectoid aliens have a humanoid shape but resemble giant insects, complete with a chitin type of exoskeleton/body armor, compound eyes, antennae and superhuman strength. The exoskeleton colorations can vary from a flat or glossy black, brown, green or red to a shimmering, iridescent rainbow of colors. Some will also have multiple limbs, legs, horns, spikes, enhanced healing and regenerative powers.

Superhuman Insect Abilities

By Kevin Siembieda

The following are abilities and features common to most insectoid races.

S.D.C. damage from typical insect aliens & mutants

Punch: 2D4 plus P.S. bonus.

Power Punch: 4D6 S.D.C. (counts as two melee attacks/actions)

Body Slam: 3D6 S.D.C.

Kick: 2D6 plus P.S. bonus.

Bite from small mandibles or mouth like that of a fly or bee: 2D4

Bite from medium mandibles: 3D6 S.D.C.

Bite from large mandibles like those of a beetle: 4D6 S.D.C.

Rifts M.D.C. —

Damage by insect supernatural P.S.

P.S. 15 or less: 4D6 S.D.C. for full strength punch or kick.
1D6 M.D. for a power punch.

P.S. 16 to 20: 1D6 M.D. for a full strength punch or kick.
2D6 M.D. for a power punch.

P.S. 21 to 25: 2D6 M.D. for a full strength punch or kick.
4D6 M.D. for a power punch.

P.S. 26 to 30: 3D6 M.D. for a full strength punch or kick.
6D6 M.D. for a power punch.

P.S. 31 to 35: 4D6 M.D. for a full strength punch or kick.
1D4x10 M.D. for a power punch.

P.S. 36 to 40: 5D6 M.D. for a full strength punch or kick.
1D6x10 M.D. for a power punch.

P.S. 41 to 50: 6D6 M.D. for a full strength punch or kick.
2D4x10 M.D. for a power punch.

P.S. 51 to 60: 1D6x10 M.D. for a full strength punch/kick.
2D6x10 M.D. for a power punch.

Note: Bites: Small mandibles inflict M.D. while large inflict 3D6 Mega-Damage. Body blocks/rams inflict 2D6 M.D. and have a 55% chance of knocking down the victim of the hit. Victim loses one melee attack and initiative.

Insect Exoskeleton Body Armor

Light Armor: Cockroaches, earwigs, crickets, and butterflies. Main body: 100 S.D.C. and A.R. 13 (or 130 M.D.C.).

Medium Armor: Flies, bees, wasps, ants, grasshoppers. Main body: 200 S.D.C. and A.R. 16 (or 240 M.D.C.).

Heavy Armor: Beetles, praying mantis, and some ants. Main body: 300+3D6x10 S.D.C., A.R. 18 (or 400 M.D.C.).

Rifts Note: All insectoids will be Mega-Damage creatures with natural M.D. body armor.

Compound Eye

Insect vision is crude, offering shapes, shadows, and limited color range. Insects cannot read or see details. Limited color vision, like a human looking through a tightly woven screen window. The following features are available:

Typical Insect Eye & Special Features:

- 1. 180 degree area of sight** and +1 to dodge.
- 2. Ultraviolet vision:** Can see that spectrum of light.
- 3. Polarized sight:** Can tell direction (95%) by the position of the sun and by the direction of sunlight. Not adversely affected by bright light and glare.
- 4. Hard eye:** 50 S.D.C. (or 30 M.D.C.).
- 5. Optics bonus:** +2 on initiative and +1 to strike and dodge.

Antennae

Antennae function like arms and hands that can hear and smell. The sensitive antennae can feel motion, wind, changes in temperature, and touch objects. In this capacity, antennae can be used to feel around in darkness and to identify food, friends and enemies. The typical antenna is covered in thousands of tiny tubercles and scent-sensitive hairs, making it super-sensitive to odors. The insect can smell and identify a range of smells twice as great as the best hunting dog, at twice the range!

Note: Sonic and vibration weapons and super powers inflict an additional 1D6 damage and temporarily knock out all of the alien's special antenna abilities for 3D4 melee rounds per blast.

Antenna: Smelling Powers:

1. Track and maneuver by smell alone: 75%.; roll once for every 1000 feet (305 m). Double range to follow the chemical secretions of that species, and four miles (6.4 km) for smelling the chemical alarm of that species (automatically recognizes alarm chemicals). A failed roll means the scent trail is temporarily lost; two successful rolls out of three means the trail has been rediscovered.

2. Identify common, known smells, and insect chemical smells: 90%. Range: 1200 feet (365 m).

3. Remember and identify a specific unusual scent: 50%. Range: 1200 feet (365 m).

4. Smell the coming of rain and large fires: 60%; two miles (3.2 km) range.

Antenna: Touch Powers:

1. Accurately identify common, known objects/substances: 30% +5% per level of experience (30% if uncommon).

2. Identify temperature (within 1D6 degrees): 50% +5% per level of experience; includes air temperature.

3. Accurately identify wind direction: 30% +5% per level of experience.

Antenna: Hearing/vibration/motion sensing abilities:

1. Track by sound alone: 30% +3% per level of experience. The characters can locate human prey by following the vibration of a running car or a robot engine, voices, noise from movement, or the audio transmissions of a radio. Range: 1000 feet (305 m).

2. Motion detection and track by motion detection alone: 50%. Can follow and locate prey by following the air vibrations caused by movement (not sound per se, but air movement). Range: 500 feet (152 m).

3. Feel the vibrations of an approaching ground vehicle(s), giant bot, herd of mammals, and giant animals, up to six miles (9.6 km) away. Running or walking humans, 2000 feet (365 m) away. Flying vehicle or animal, 4000 feet (122 m) away.

4. Hear ultrasonic sounds; super keen hearing: Average range 2000 feet (610 m).

5. Communicate with ultrasonic sound: Average range 2000 feet (610 m). Can also produce and communicate using sounds audible to humans.

Insect Chemicals

The insect can secrete a variety of chemicals that send a warning scent to other members of its species or as a means of natural defense. Many, but not all, insects can have one or two of the following chemical spray abilities. Those with a chemical system will have the **chemical alarm** and one additional (player or G.M.'s choice). Assume the specific alien characters that follow do **not** have a chemical ability unless it is specifically stated.

Chemical Alarm: The warning scents include danger, attack, and death (of the sender). The scent can be smelled a distance of about four miles (6.4 km). The scent can only be smelled by other insectoids of that same species, and characters with advanced/superior sense of smell (including Dog Boys).

Chemical Trail: The alien secretes a chemical that is left on the ground and on foliage that the insect travels, allowing others of its species to follow his trail. Not available to flying insects.

Chemical Attack: A corrosive acid spray can be squirted from the insectoid's mouth, hands or special glands (usually located on the head, neck or shoulders) and occasionally, the abdomen. The range is limited and the chemical is typically used to inflict more damage to

wounded prey. Common among ants. Range: 20 feet (6 m). Damage: 4D6 S.D.C. (or 2D6 M.D.C.), Bonuses: Counts as one additional attack per melee, +2 to strike with spray attack.

Chemical Death: When the alien is killed or loses 80% of its main body S.D.C. or M.D.C., it releases a strong chemical that reeks of death. This warns others of its kind that one of their members has just been violently slain; signalling danger.

Chemical Love: A chemical aroma is released that can be smelled by adult males of the same species for up to four miles (6.4 km). Males are irresistibly drawn to the area and are bewitched by the females' aroma of love: must roll an 18 or higher to save vs the insect love chemical — no bonuses to save are applicable.

The intoxicated male is distracted and docile, thinking only of mating and ignoring all else except self defense. Penalties: Reduce the character's number of melee attacks by half, -6 on initiative, -3 to strike, parry and dodge. Plus the love-sick bug will not leave the side of the female, even if under attack, until he has mated. Note that only females can secrete this chemical and the love scent affects only members of that specific species of insect. Automatic for all beetles, moths, and butterflies.

Danaus (Atorian Empire)

The planet Danude is the learning and knowledge center of the Atorian Empire. It is a high gravity planet covered in green grass, vegetation, sparkling oceans, and blue skies located deep within the Empire, about 23 light years from the *Imperial Core System*. The Atorian Empress, Philia, has her palace and seat of power for the Fourth Imperial Sector on Danude. Scholars of prominence from across the Empire reside or frequent its libraries and places of learning, while many from outside pay handsome prices for the privilege of using limited facilities. Some of the greatest minds of the galaxy gather here, but the Scholars that originally founded this mecca of learning do not share in its glory. The Danaus no longer call Danude home.

The planet was caught in the second wave of the Atorian expansion campaigns some 600 years ago. At that time, the Atorian Empire was not the overwhelming force it is today, so their presence in that sector of space did not call for immediate alarm. When the Atorian fleet surrounded the planet and demanded its peoples surrender, the Danaus refused. The majority of the population were Scholars, scientists and people of peace. They were not prepared for the savagery of the Atorians' onslaught. They valiantly defended their libraries, colleges, and data bases to the best of their abilities, but in the end they fell to a superior power. The battle lasted longer than it would have because the invaders sought to preserve the wealth of knowledge and intergalactic history. This also made the people suffer more at the hands of the cruel Atorian invaders. Though hundreds of millions were conquered and enslaved, the noble and honorable Danaus refused to cooperate and proclaimed that they'd rather die than help

the vile Atorian Empire conquer other people. Their angry conquerors gave them their wish and slaughtered millions. When the Empress finally put an end to the massacre, not more than six million Danaus remained. Only a few thousand refugees had managed to escape into space, the remaining survivors were enslaved and scattered throughout the Atorian Empire.

The majority of the refugees found a dimensional syphon and escaped to another planetary system. There they found the planet Nors, which was reminiscent of their homeworld, and have settled there to build new lives. Their desire to reestablish themselves as a source of learning sent the insects back into space and drove them to intense research in an accumulation of knowledge. As a result of their diligent efforts, the danaus remain perpetual students and keepers of history, science, the arts, magic and knowledge of all kinds. An ancient danaus saying is, "The key to the Megaverse is through knowledge. With knowledge, all of its secrets can be unlocked." Their numbers have grown over the centuries to approximately 3.7 million. Many of them travel the galaxy in their never-ending search for higher knowledge and collect ancient or alien items, artifacts, and magic for the already extensive libraries on Nors. Explorers/researchers are often loners and live and work with people from other worlds.

An estimated 48 million Danaus, most of whom (99%) have been born in captivity, serve the Atorian Empire as

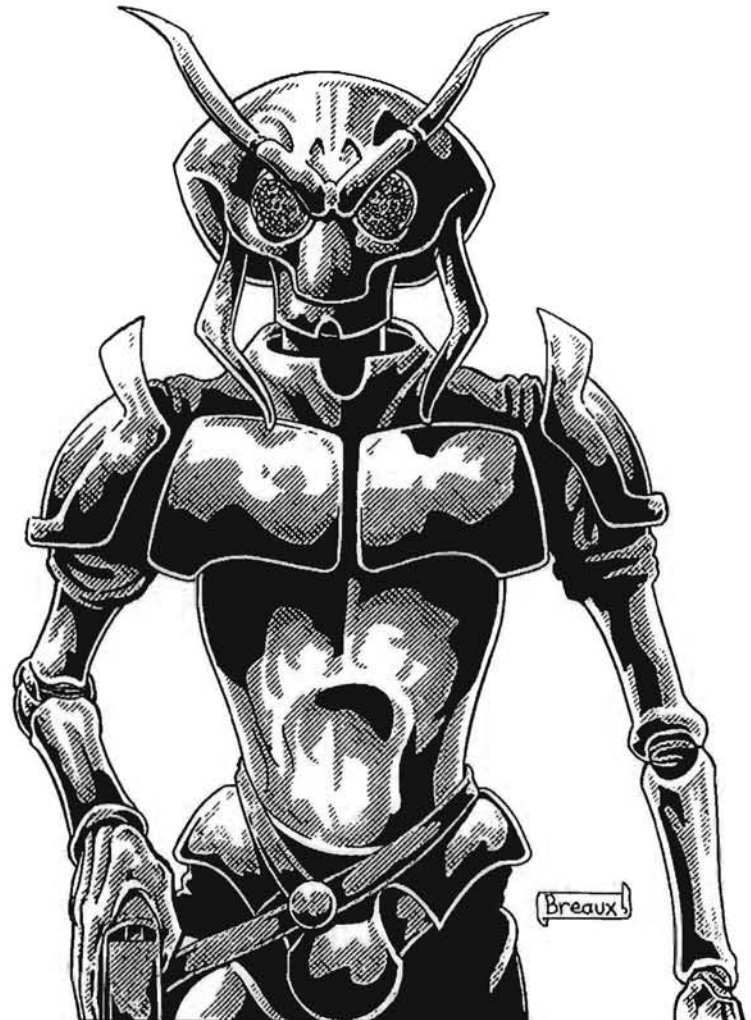

slaves. Yet even though these people have been slaves for nearly 600 years, they have great spirit and do little to help their enslavers to hurt or enslave others. They are taught Danaus history and exhibit the same driving curiosity and craving for knowledge that they always have. In the last 50 years, a secret information underground has been developed, linking about 64% of the Danaus slaves to share observations and information. If the opportunity arises, they will help the enemies of the Empire to free other slaves, but they will stay to help their people and to observe.

Danaus (pronounced dan-ouse)

Alignment: Any, but most are scrupulous, unprincipled or anarchist. A truly evil Danaus is a rarity.

Attributes: I.Q. 3D6+4, M.E. 4D6, M.A. 4D6, P.S. 4D6, P.P. 3D6, P.E. 3D6, P.B. 1D6, Spd. 3D6x3

Hit Points: Standard, P.E. plus 1D6 per level of experience.

Medium Armor Exoskeleton: A.R. 16, 200 S.D.C.

Horror Factor: 11

Height: 5 feet plus 1D6 inches (1.5 to 1.7 m).

Weight: 100 plus 2D4x10 pounds (54 to 82 kg).

Average Life Span: 80 years. **P.P.E.:** 1D6

Super Abilities: In addition to their natural insectoid powers, 33% of them are psionic, with the following abilities (in addition to other selections as a latent psionic): Death trance, total recall and speed reading. I.S.P. bonus of 4D6. The scholarly insectoids can be any occupation but most are researchers, Scholars, artists and historians. 12% are practitioners of magic.

Natural Abilities: All the features of the compound eye and antennae; no chemical secretion.

Special Weapons and Vehicles: The equivalent of most types of weapons, hover vehicles and spacecraft are available. Most will try to use non-lethal weapons whenever possible.

Preferred Armor: Due to the highly protective nature of their exoskeletons, most Danaus do not wear armor. To breathe in inhospitable atmospheres, they will wear a helmet or face mask with an air purification system and/or air supply.

Familiarity with Earth: Through their extensive collection of knowledge and information, the Danaus have information on Earth equal to the "Some familiarity" result on the Familiarity with Earth table. Their libraries contain many volumes on a number of different planets (and those on Nors include data about other dimensions).

Rifts Note: The Danaus of Nors have discovered that there are many dimensions layered one on top of the other to create a myriad of realities. They have mastered some of the secrets of magic and dimensional travel via Rifts and magic. They are aware of the Splugorth, Temporal Raiders, and supernatural monsters, but have maintained a quiet presence in the Megaverse to avoid another incident like that with the Atorian Empire. Thus, they tend to be quiet, unobtrusive people. Even so, Danaus are counted among the slaves of the Splugorth and other powerful forces in the

Megaverse. In the Rifts setting, most Danaus will be Temporal Wizards, Shifters, Ley Line Walkers, Mystics, Scholars, Body Fixers and Operators.

The Coalition States and other human supremacists will consider the gentle Danaus to be horrible monsters and destroy them whenever they are encountered. Most humans and D-Bees may shun them as monsters. The Danaus' inhuman appearance may cause humans and D-Bees to mistake them for demons and other frightening monsters.

In the **Phase World** setting, these insectoids will fit the same basic setting as described for **Aliens Unlimited**.

They will avoid the Splugorth and are careful in their dealings with the Naruni and other unsavory people and forces.

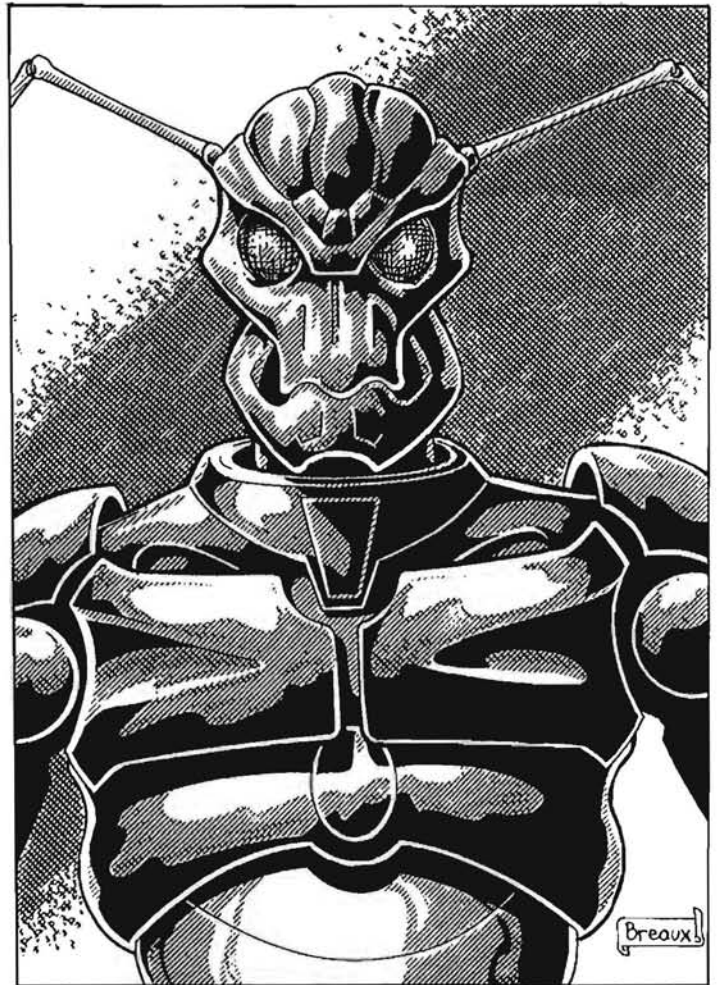

Lixilas

The Lixilas are a race new to long-range space travel. Their society's technological level is highly advanced, but they have developed spacecraft with a propulsion system that would exceed the speed of light only within the last decade. Now that they have achieved this, other races are welcoming them into the galactic community. This has given them the opportunity to experience other people and cultures and to trade for technology even more advanced than their own. The Lixilas are thrilled by these developments and are currently very devoted to diplomatic relations with the numerous other races. They are also very

interested in exploring the far reaches of space and seeing all the wonders of the universe.

Their home planet is a thermal world, known as Xil. Most Lixilas inhabit the scorching tropical latitudes where temperatures can reach 200 degrees Fahrenheit (93 C), but these areas are covered by rain forests and trees that tower as high as 800 feet (244 m). The heat of the planet causes pressures to build in its surface, and the ores there are greatly compressed, increasing their density. The Lixilas' main bartering chip for advanced tech is this dense, Kisentite-like ore. Many of the insectoids' traditional weapons are swords, spears and polearms made from this metal. These same tough metals are used in their robots and body armor, although their level of advancement (equal or superior to most) is a closely guarded secret. Their robots are never exported or sold. They are held in reserve as a means of defense ("an ace in the hole," so to speak).

The Lixilas have a higher than normal incidence for the manifestation of super abilities, with about 28% of the population exhibiting them to some degree. Those with special powers will be recruited and coaxed into an occupation where they can be put to best use. Most individuals that do gain super abilities cannot resist the offers of their military, space program and expeditions to other worlds.

All positions of authority in the Lixilas' society are held by the females. All lawmakers, government officials, and military officers are females. Although this does mimic an insect social structure to some extent, the Lixilas are by no means a hive society. The individual is important and they enjoy many forms of art and personal expression. A male can achieve a social status or rank as high as any female, but they must work twice as hard and tolerate sexual prejudice.

Lixilas (pronounced licks-il-las)

Alignment: Any

Attributes: I.Q. 3D6, M.E. 3D6, M.A. 3D6, P.S. 4D6, P.P. 4D6, P.E. 4D6, P.B. 1D6, Spd. 4D6

Hit Points: P.E. x2 plus 1D6 per level of experience.

Medium Armor Exoskeleton: A.R. 16, 200 S.D.C.

Horror Factor: 12

Height: 5 feet plus 4D6 inches (1.6 to 2.1 m).

Weight: 100 plus 2D6x10 pounds (54 to 100 kg).

Average Life Span: 75 years. **P.P.E.:** 1D6

Super Abilities: Lixilas characters can be created from any of the Super Power Categories found in **Heroes Unlimited**, except magic and physical training.

Natural Abilities: All the features of the compound eye and antennae; no chemical secretion. They are also instinctive climbers 90%/80%, swimmers 80% and are resistant to heat and fire (half damage).

Special Weapons and Vehicles: The equivalent of most types of weapons, hover vehicles and spacecraft are available.

Preferred Armor: Due to the highly protective nature of their exoskeletons, most do not wear armor. To breathe in inhospitable atmospheres they will wear a helmet or face mask with an air purification system and/or air sup-

ply. A full environmental exoskeleton that looks just like the Lixilas is used by the military and some explorers: A.R. 18, S.D.C.: 250, adds 6 points to the wearer's P.S. and 12 to his speed. It comes with a detachable jet pack, retractable forearm blades (2D6 damage each) and a second pair of robot arms (add one attack per melee).

Familiarity with Earth: The Lixilas are eager to help other races that are on the brink of reaching the stars, and they collect information on such planets, including Earth. Their current knowledge of Earth is equal to the "Has studied" result on the Familiarity with Earth table.

Rifts Notes: In the **Rifts RPG** setting, the Lixilas will be regarded as monstrous D-Bees. The Coalition States and other human supremacists will see them as dangerous beings because of their inhuman appearance, technology and powers. They may also be mistaken for monsters and demons.

If set in the **Rifts: Phase World** environment, they are just one of the less advanced and curious aliens who visit that world. These insectoids will fit the same basic setting as described for **Aliens Unlimited**. They can be explorers, adventurers or Mercenaries.

Manteze

The Manteze are an imposing race of insectoid warrior Mystics. They are a very hardy people with exoskeletons strengthened and polished by the abrasive atmosphere of their homeworld Fiktia. Their resilient exoskeletons are a smooth, glossy black and their eyes a sparkling green. The plates of their natural armor are as strong as some tanks! Combined with their magical abilities and combat training, this makes them extremely formidable opponents. Young Manteze are raised on Fiktia and trained by the elders in the arts of combat, self-awareness and magic. Warriors, both male and female, are taught to rely mostly on their wits, natural abilities and magical powers. They may use other, so-called "technologically advanced" weapons, but are taught never to become completely reliant on them like humans and so many others. Also as part of their combat training, each is schooled in tactics and the combat applications of their spells.

Upon reaching physical maturity at the ripe old age of ten, the newly recognized adults are sent into space as part of their rite of passage into adulthood. They must wander the galaxy for at least 20 years to build character, to learn about life and to find a direction for themselves. Most (72%) eventually return to Fiktia to mate, have children, become elders, and teach the young.

The elders on Fiktia are not necessarily the oldest of the race. They are adults who have found themselves and returned to the homeworld to help the young continue the cycle. The planet is home to millions of elders and millions more young. The **Queen Mother** is the supreme ruler of the race. She is very old and powerful in the ways of magic (10+2D4 level of experience). She uses her unparalleled Mystical abilities to guide and rule her people. Although the Queen Mother is the ultimate leader, males



and females can attain equal positions and status within the Manteze society.

Manteze (pronounced man-teeze)

Alignment: Any, with leanings toward good and selfish.

Attributes: I.Q. 3D6, M.E. 3D6, M.A. 3D6, P.S. 5D6, P.P. 3D6, P.E. 3D6+3, P.B. 2D4, Spd. 4D6

Hit Points: Standard, P.E. plus 1D6 per level of experience.

Heavy Armor Exoskeleton: A.R. 18, 300+3D6x10 S.D.C.

Horror Factor: 10

Height: 5 feet plus 1D4 feet (1.8 to 2.7 m).

Weight: 200 plus 4D6x10 pounds (109 to 199 kg).

Average Life Span: 90 years.

Super Abilities: All Manteze have natural magic abilities; see Mystic study in the Magic section of *Heroes Unlimited*, 2nd ed. P.P.E. Bonus of +15.

Natural Abilities: All the features of the compound eye and antenna, and chemical secretions: warning, chemical trail, and chemical attack. They also have the ability to climb walls and ceilings equal to the minor super ability *adhesion*, and are instinctive swimmers (75%). Special combat training bonuses give them +2 on initiative, +2 to pull punch, +2 to roll with impact or fall, +3 to save vs Horror Factor and +1 to save vs magic.

Preferred Armor: Due to the amazing strength of their exoskeletons, they never wear additional armor. To breathe in inhospitable atmospheres they will wear a

helmet or face mask with an air purification system and/or air supply or use magic. They can also use magic to communicate.

Familiarity with Earth: Through travels and Mystical means, the Manteze have collected information on Earth that is equal to the "Has studied" result on the Familiarity With Earth table.

Rifts Notes: Basically the same as the Lixilas. In **Rifts** they can be any of the magic O.C.C.s, including Temporal Wizard, Temporal Warrior, biomancer and necromancer!

Photins

The Photins were once the elite shock troops of the Atorian Empire. They were impressive, menacing soldiers with natural, black chitin exoskeletons, four arms, and large, insect-like wings. They were tough, cunning, resourceful and merciless soldiers who were hard to kill and could fly under their own power. Their homeworld has long been forgotten, but it was a high radiation planet. The Photins' natural resistance to radiation allowed them to be sent in for cleanup operations right after a nuclear strike, and they were not used exclusively as shock troops. Able to use the darkness to hide themselves, the Photins also made fearsome assassins, saboteurs and spies. Like horrible animated shadows, they appeared seemingly from nowhere (a tree, the ceiling, the sky) to slaughter their enemies.

For 400 years the Photins were the favored warriors of the Atorians. It was through their efforts that the young Empire made incredible inroads during their legendary second wave of expansion. The aggressive military conquest of entire worlds, one after another by the Atorian Empire, meant centuries of combat. As the Atorians gathered allies in their expansion, they quickened their efforts to expand. Some Photins of great skill or reputation were given positions as premier operatives, but the majority of the insects remained on the front-line. The instinctively predatory Photins loved war, but their numbers dwindled with each new conquest. The battle for Yakin, 200 years ago, would end the Photins' reign as the elite shock troops of the Atorian Empire. Intelligence had been faulty and sent 250 million photin warriors to their doom. Although outnumbered twenty to one, the incredible insectoids held all but two strategic positions until reinforcements arrived. Yakin fell to the Empire but the price was too high. Of the 250 million troops sent to Yakin, only 37 million survived and 40% of them would perish in other battles across the galaxy.

Today an estimated 164 million Photins are scattered throughout the Atorian Empire. Surprisingly, the warriors did not blame the Atorian Empire for the near destruction of their race. Violent death is the end of any warrior. They were simply proud that they held their posts when the planet fell, and that the Atorian Empire wrote songs and stories, and made films about their courageous last stand, and praise them to this day as heroes of the Imperial Realm. Only a few rogues oppose the Empire and hate the Atorians for killing their people.



For the last two centuries, the Atorian Empire Photins have been used as special elite operatives, mainly for espionage, seek and destroy missions and assassination. From time to time, an entire field army will be dropped into trouble zones to eradicate especially difficult or stubborn problems. An estimated 6 to 10 million non-allied Photins (many are Mercenaries and pirates) are believed to live and work in other parts of the galaxy.

Photins (pronounced foe-tins)

Alignment: Any, but most tend to be anarchist or evil. The Photins are murderous predators who love to hunt and kill more than anything in the universe. They also engage in torture and acts of brutality.

Attributes: I.Q. 3D6, M.E. 3D6, M.A. 3D6, P.S. 4D6, P.P. 3D6, P.E. 3D6, P.B. 1D4, Spd. 6D6+10 running.

Hit Points: Standard, P.E. plus 1D6 per level of experience.

Medium Armor Exoskeleton: A.R. 16, 200 S.D.C.

Horror Factor: 15

Height: 6 feet plus 1D6 inches (1.8 to 2.0 m).

Weight: 195 plus 1D6 pounds (89 to 91 kg).

Average Life Span: 75 years. **P.P.E.:** 1D6

Super Abilities: All Photins have the following super abilities: Control radiation, multiple limbs (new; four arms and hands, adds one additional attack per melee round), flight: winged (insect; actually a natural ability), adhesion (natural), nightvision (natural), and nightstalking. Photins do not roll for additional super abilities.

Natural Abilities: All the features of the antenna and chemical trail. They are also ambidextrous (one additional attack per melee round). Photins are natives of a high radiation planet which also makes them immune to the effects and damage from radiation. They also give off low levels of radiation that can be harmful to those exposed to them for two weeks or more. See the High Radiation homeworld description for details.

Special combat training bonuses: +3 on initiative, +2 to pull punch, +2 to roll with impact or fall, paired weapons, +6 to save vs Horror Factor and +1 to save vs poison and disease.

Flight Bonuses: When in flight, these warriors get an additional attack per melee round, are +2 to strike, +2 to parry, and +4 to dodge at speeds below 80 mph (128 km), +6 when flying faster than 90 mph (144 km). See the appropriate super ability descriptions for full details.

Special: Advanced Eye: This insect eye is smaller, about twice the size of a human eye, has mammal-like vision capable of seeing color and small details and is considered equal to the minor super ability *advanced sight*.

Special: Horns: A pair of bony horns protrude from the sides of the head. They inflict 2D4 damage from head butts and can be used to parry attacks.

Special Weapons: Any, usually a variety of Atorian design.

Special Vehicles: Antigravity Medallion: maximum speed: 100 mph (160 km), S.D.C. 8, altitude is unlimited. Maximum weight allowance: 1000 pounds (450 kg).

Preferred Armor: Due to the protection of their exoskeletons, they seldom wear armor. To breathe in inhospitable atmospheres they will wear a helmet or face mask with an air purification system and/or air supply.

Familiarity with Earth: None.

Rifts Notes: Basically the same as the Lixilas. They make fabulous thieves, spies and assassins (can be any mercenary O.C.C.). They will be coveted as agents and minions of the Splugorth, Soul Worms, Sunaj, Naruni, the Gargoyle Empire, Black Marketeers, warlords and other criminal or evil forces. Most of these black-hearted predators will associate with anybody, including demons, Gene-Splicers and vampires, if the work is good and they are treated well.

Pyralis

Pyralis are various shades of pale green or blue with yellow eyes. Their bodies are covered in protective plates that give them one of the strongest exoskeletons in the universe.

Approximately one hundred years ago, their planet, Litha, became a target of the Atorian Empire. The Pyralis knew they couldn't fight the Atorian invasion fleet so they mustered all of their spacecraft into a rag-tag armada, collected all the people they could and blasted into outer space. The Empire allowed them to leave and took the planet without contest. The remaining Pyralis population

surrendered and took their chances under the dictatorship of the Atorian Empire.

As the moving fleet of refugees searched for another planet to call home, they found many people in the galaxy that suffered from injustices similar to theirs. This included cities ruled by petty tyrants, nations controlled by cruel dictators, and other races that had been obliterated or enslaved by the Atorian Empire. The Pyralis decided to do what they could for those less fortunate than themselves, especially the more primitive societies where their intervention could have a profound impact. Operatives are sent to help as soon as a trouble spot is found. They commonly have little or no knowledge of the planet or people they help, but they really don't care. The only problem is that these insectoids are so determined to help others that they can often be tricked or manipulated into helping crime lords, tyrants, smugglers, pirates and others. However, they generally do more good than bad.



Pyralis (pronounced pie-ral-is)

Alignment: Any, but tend to be good.

Attributes: I.Q. 2D6+3, M.E. 2D6+2, M.A. 4D6, P.S. 6D6, P.P. 3D6, P.E. 4D6, P.B. 2D6, Spd. 4D6

Hit Points: P.E. x3 plus 2D6 per level of experience.

Heavy Armor Exoskeleton: A.R. 18, 300+4D6x10 S.D.C.

Horror Factor: 12

Height: 5 feet plus 3D6 inches (1.6 to 2.0 m).

Weight: 120 plus 2D6x10 pounds (63 to 109 kg).

Average Life Span: 85 years

P.P.E.: 4D6 or by Magic Power Category.

Super Abilities: Pyralis warriors/champions are typically one of the following Super Power Categories: Magic (01-35%), super-powered mutant (36-70%), experiment (71-75%), physical training (76-85%) or hardware (86-00%).

The cold conditions of Litha have made the Pyralis extremely tolerant to freezing conditions. They begin to suffer heat exposure at 50 degrees F (10 C). See the frozen world description for effects and damage from exposure. Refrigerated survival suits found in the equipment section are necessary to avoid exposure.

Natural Abilities: All the features of the compound eye and antenna (no chemical secretion), impervious to cold (even cold-based magic does half damage, and they receive a +4 to save), and are +2 on initiative, +2 to pull punch, +1 to roll with impact or fall, +2 to save vs Horror Factor and +1 to save vs magic.

Special Weapons: They can use any, but seem to prefer hand-held melee weapons, especially energy swords and clubs.

Special Vehicles: Any except antigravity.

Preferred Armor: Their exoskeletons are so powerful that they seldom wear additional armor. To breathe in inhospitable atmospheres they will wear a helmet or face mask with an air purification system and/or air supply or use magic. They can also use magic to communicate.

Familiarity with Earth: The Pyralis have no familiarity with Earth. **Rifts Notes:** Basically the same as the Lixilas. In **Rifts** they can be any of the magic O.C.C.s, including Mystic, Ley Line Walker, Shifter, Techno-Wizard, Necromancer and Priest.

Relogians

Relogian society is somewhat hive-like. It is governed by the eldest, most competent females. Younger females can occupy other positions of power and authority below the heads of state, but the higher offices are reserved for the eldest. Most females are Scholars, scientists, healers, engineers/builders, and leaders in every branch of society, including the male-dominated military. Males are considered beneath females and compose the labor force and military. It is difficult for males to achieve any respectable status or level of power and it is nearly impossible for a male to succeed in the political arena.

The homeland of the Relogians is called Relo. It is a beautiful, Earth-like planet covered with forests and jungles. Its low gravity does little to impede the skyward growth of trees and plants, so most native life forms are tall, elegant, and graceful. The majority of Relogian cities are built in the trees or giant, skyscraper-like pillars reminiscent of termite mounds.

The Relogians believe the planet is nurtured by the goddess Arsta. The insects have great faith in their deity and believe they are Arsta's chosen people, and are destined for greatness. This belief stems from the fact that Relogians may seem to "die" many times, but are miraculously restored or resurrected before finally ceasing to exist. The many lives of the Relogians make them devoted to Arsta. No one knows if these multiple lives are the re-

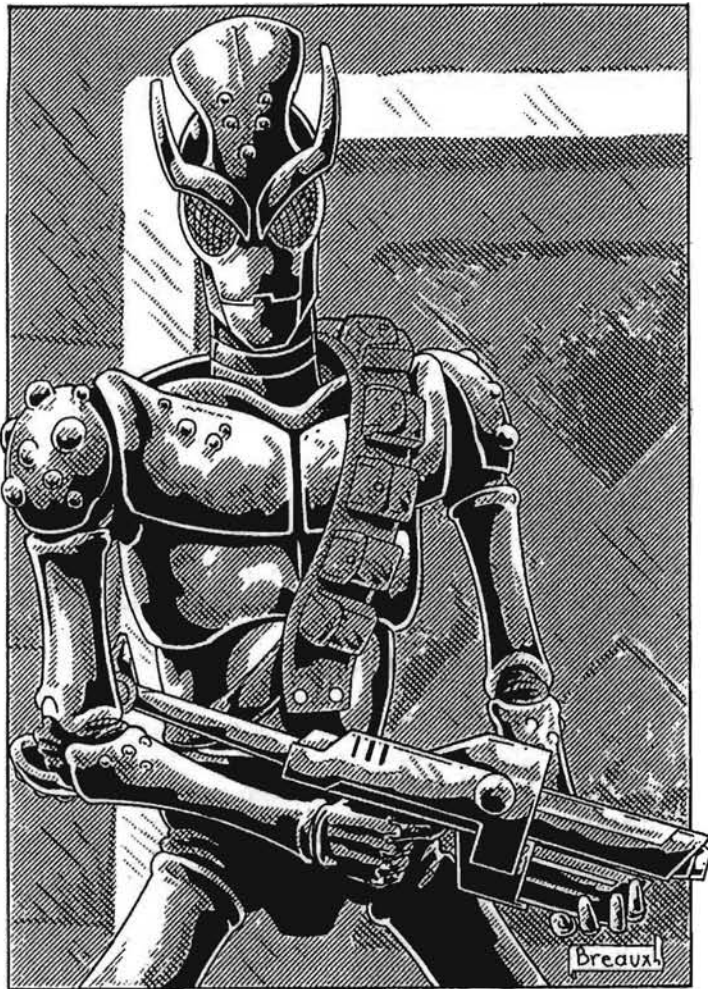

sult of divine intervention, or something entirely different, but changing the mind of a regolian will be impossible.

The insectoids consider it their duty to aid and defend less advanced cultures. They try to help people to avoid the dangers and pitfalls they may be creating for themselves. Regolians who choose to champion these causes can act on their own or accept a government assignment on a planet in need of assistance. Many wander the universe like knights-errant or sagely advisors. When on assignment, the insectoids normally employ easily hidden antigravity suits and carry stun-type energy clubs and pistols. Although many try to avoid violence and hurting others, they can use any type of weapon and are capable fighters.

Regolians who reject Arsta and turn toward evil, can seem to be evil incarnate. These are frequently males who have died several times, only to return to life without any great revelation or insight as to their fate. They engage in brutal acts of murder, rape, torture and destruction. They can be pirates, Mercenaries, assassins, crime lords, super villains or despot rulers of weaker people who will resort to anything to get what they want. Many are quite mad.

Regolians (pronounced reh-low-guy-ans)

Alignment: The great majority of Regolians will be of good or selfish alignments. Evil alignments are rare in the young and are more common among those who have died and returned several times. These individuals begin to lose their grip on reality and become angry and bitter.

Many become heretics who believe that the goddess is a chaotic entity who keeps bringing them back to life to do She-only-knows-what.

Attributes: I.Q. 3D6, M.E. 3D6, M.A. 3D6, P.S. 5D6, P.P. 4D6, P.E. 3D6, P.B. 1D4, Spd. 6D6

Hit Points: P.E. x3 plus 1D6 per level of experience.

Medium Armor Exoskeleton: A.R. 16, 200 S.D.C.

Horror Factor: 14

Height: 8 feet, 8 inches plus 3D6 inches (2.7 to 3.1 m).

Weight: 250 plus 3D4x10 pounds (127 to 168 kg).

Average Life Span: 125 years. **P.P.E.:** 3D6

Super Abilities: All regolians have the following super abilities: Multiple lives, adhesion, healing factor, and radar. Regolians do not roll for additional super abilities.

Natural Abilities: All the features of the compound eye and antennae (the two large, horn-like protrusions are its antennae), and chemical secretion: warning and death. They are also instinctive climbers (85/75%), acrobats (70%) and swimmers (65%). Special bonuses: +1 on initiative, +1 to pull punch, +2 to roll with impact or fall.

Special Weapon: Can use any, but the energy stun-club is a favorite: Length: 2.5 feet (0.8 m). Weight: 2.7 pounds (1.2 kg). Damage: 1D6 plus the victim must save vs non-lethal poison or be stunned to the effect of losing initiative and is -4 to strike, parry, and dodge for 1D6 melee rounds.

Special Vehicles: Can use any, but a favorite is the antigravity suit: Maximum Speed: 120 mph (192 km), S.D.C. 60, maximum altitude: unlimited, maximum weight allowance: 800 pounds (360 kg).

Preferred Armor: Due to the protection of their exoskeletons, they seldom wear armor. To breathe in inhospitable atmospheres they will wear a helmet or face mask with an air purification system and/or air supply.

Familiarity with Earth: The Regolians have sent champions to Earth before. As a result, they possess information on Earth equal to the "Some familiarity" result on the Familiarity With Earth table.

Rifts Notes: Basically the same as the Lixilas. They can be any of the scholar or adventure O.C.C.s, druids or priests. None possess psionic abilities or practice magic. In the latter case, it would seem wrong to rely on (magic) powers not provided by their goddess.

Xippus

The Xippus are from a dark, twilight planet called Minticka. They are a tall race of insect humanoids with dark brown, glistening exoskeletons and large compound eyes. Their society is very hive-like in several respects. A queen presides over each city. All other positions of power are held by females, and the males function as the workers and warriors. The females in a city are limited to certain numbers. Males normally share communal living quarters, while females own houses or large estates. Perhaps the most dramatic hive characteristic found in the Xippus culture is the expulsion of members who are detrimental to society. This normally includes the old, weak,

crippled, sick, and dying, but the Xippus tend to carry it to extremes. They exile anyone who is different, or not "pure." This includes those with deformities, mutant features, psionic powers or super abilities. Even those with different colorings are sent away. Only the queens are allowed to have psionic or super abilities, and only females are taken care of when they get old or sickly. Any insectoid who resists expulsion or who attacks or harms a "pure" Xippus is slain on the spot.

This revulsion means they are also fairly intolerant of other races. They consider most mammals and amphibians to be inferior and dangerous. Other are considered potential rivals and enemies. Most other life forms are viewed with suspicion. Consequently, the average Xippus avoids contact with other life forms and lives happily on their homeworld. Interstellar trade is extremely limited and preferably conducted with inorganic or plant life. Alien visitors are usually kept at special outposts. Any who threaten, harm or kill a Xippus are captured and slain. Any who threaten a queen are executed and their companions told to immediately leave their planet, never to return, or they'll suffer the same fate.

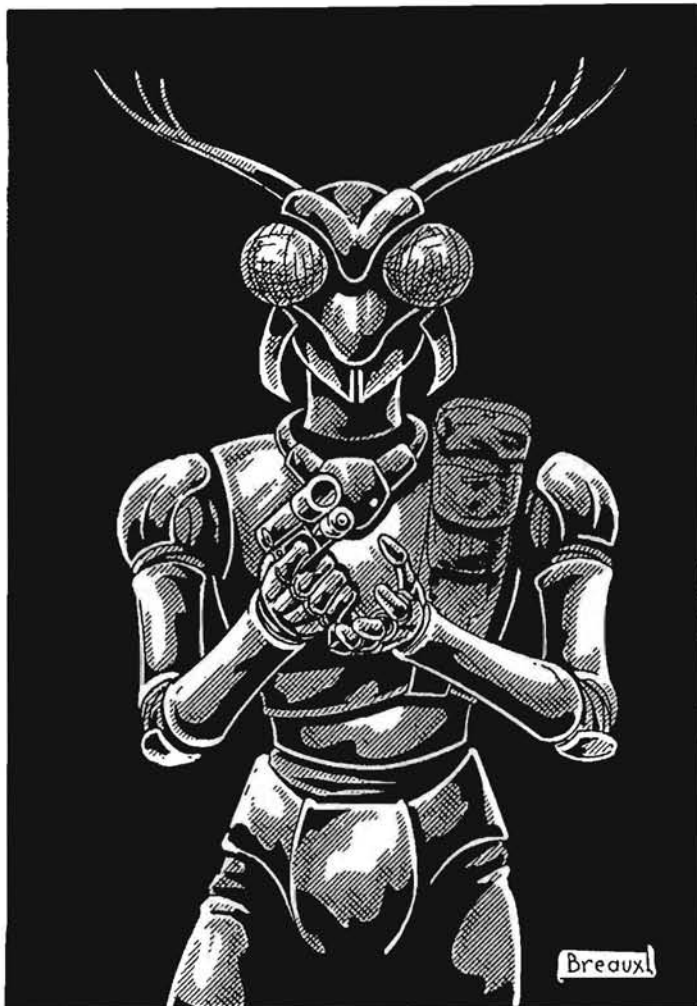

The Xippus have a technologically advanced civilization with fair space capabilities. Many exiles are placed on small spacecraft in groups of 30 to 90, with minimal supplies and no weapons and rocketed to a nearby planet that can support life. In a strange way this is their idea of

space colonization. A surprising number have survived the bleak trip and have started several dozen tiny colonies. Others have stumbled upon far-off space stations where they are introduced to the strange life of non-insectoids. Others drift aimlessly until they die or are intercepted by pirates, slavers or explorers. Many of these rescued insectoids have managed to integrate themselves into galactic life. Other exiles may hitch a ride with alien traders or live in small hive communities away from the rest of Xippus society. If their community gets too large and is perceived as a threat, the dominant Xippus will either break the community up into smaller fragments or attack, killing 4D6 percent and capturing an additional 3D6 percent and launching them into space.

They adapt best when separated as individuals or small groups of two to eight. Individuals and small groups tend to be submissive, helpful and loyal. They can be incredibly savage and aggressive and make excellent soldiers, Mercenaries, bodyguards and pirates. *Larger groups* keep the hive mentality and consider most non-insectoids to be inferior monsters and often plot against them and/or try to establish a new hive. Exiles may be bitter toward their race for exiling them, but the hive instinct tells them to forget about it and to start their own hive. Mammals, other insectoids and alien life forms are instinctively perceived as inferiors and/or enemies of the Xippus. While individuals will be submissive, large groups are instinctively predatory, territorial and aggressive. Xippus space pirates and criminals are among the most ruthless, merciless and bloodthirsty in the universe.

Note: Remember, the exiles were driven away because they were different from the average Xippus. This means the majority possess super abilities or psionics.

Xippus (pronounced zeye-pus)

Alignment: Any, but mostly selfish and aberrant evil. From a human/mammal point of view, Xippus are predatory insects and evil enemies.

Attributes: I.Q. 3D6, M.E. 3D6, M.A. 2D6, P.S. 5D6, P.P. 3D6, P.E. 3D6, P.B. 1D6, Spd. 6D6+12

Hit Points: Standard, P.E. plus 1D6 per level of experience.

Light Armor Exoskeleton: A.R. 13, S.D.C. 130

Horror Factor: 13 for exiles and typical Xippus; 16 for queens.

Height: 6 feet plus 2D6 inches (1.8 to 2.1 m).

Weight: 100 plus 2D4x10 pounds (54 to 82 kg).

Average Life Span: 60 years; queens 170. **P.P.E.:** 1D6

Super Abilities: The average Xippus has no special abilities other than those described under *natural abilities*, *exoskeleton* and *attributes*.

Exiles are super-powered mutants (01-60%) or latent psionics (61-00%). Roll under one of those two categories in **Heroes Unlimited** to determine their abilities.

Queens: Have all the standard abilities plus the super powers of *control insects (not arachnids)*, *alter metabolism*, and *negate super powers!* This is in addition to *psionic powers*: M.E.x10+100 I.S.P.; powers include: bio-manipulation, empathic transfer, ectoplasmic

arm, telekinesis, mind block, object read, see aura and sixth sense!! The typical alignment of a queen is aberrant. Queens never leave their hive/palace and are not recommended as player characters.

Natural Abilities: All the features of the compound eye and antennae, have medium mandibles (3D6 damage), and chemical secretion: warning, trail and death. They are also instinctive climbers (95/85%), acrobats (75%) and swimmers (50%), as well as possess the minor super abilities of *adhesion* and *nightvision*.

Special: 360 degree area of sight and cannot be surprised by attacks from behind — gets an automatic parry or dodge and a bonus of +1 to parry and dodge, +2 on initiative, and +3 to roll with impact or fall.

Special Weapons and Vehicles: The equivalent of most types of weapons, hover vehicles and spacecraft are available. They do not possess antigravity, bionics, or robot sciences.

Preferred Armor: Due to the highly protective nature of their exoskeletons, most do not wear armor. To breathe in inhospitable atmospheres they will wear a helmet or face mask with an air purification system and/or air supply. However, light to medium body armor can be worn.

Familiarity with Earth: None.

Rifts Notes: Basically the same as the Photins.

Humanoid Mineral Races

These aliens are humanoids composed of some form of mineral or inorganic material, whether it is crystal, rock, or even soil. Crystal aliens can be smooth and glass-like or squared and polished like a cut stone. They can also resemble the rough, lumpy forms of natural quartz. These aliens can come in any color. The most common are pink, ruby, emerald green, blue, amethyst, yellow, brown, grey, black and crystal clear.

Aliens made of rock can also be smooth, like a stream pebble, or they can be rough as concrete, as coarse as pumice or volcanic rock, and have jagged spikes or lumpy nodules.

They all have a **natural armor rating (A.R.)** and their **Structural Damage Capacity (S.D.C.)** will reflect their strong, dense and heavy physical mass and armor.

All mineral aliens have no need for food, water, or respiration, at least not in the human sense. Most typically feed on some form of ambient energy. The energy can be something as simple as sunlight (the vast majority) or something else, like radiation, nuclear energy, electricity, microwaves and even magic energy or the life force of living animals (thankfully these last two are comparatively rare). If one of these aliens is deprived of energy for more than a week, it begins to starve. Use the same effects, damage, and penalties as for exposure (see the frozen homeworld description), but apply them every 48 hours, instead of every ten. Once allowed to soak up energy, the

alien will recover twice as quickly as most organic life forms.

These beings are so different from organic life forms that it may be impossible for some to understand or relate to organic life forms. Things like robotics, bionics, agriculture and medicine hold no meaning or purpose for them.

Standard Natural Abilities & Features

By Kevin Siembieda

Resistance to Damage: Kinetic energy and impact weapons such as bullets, rail guns, punches, kicks, falls, thrown weapons, and explosives do half damage. Electricity, ion beams and lasers also do half damage. Extreme fire, heat, cold and powerful microwaves only do 10% their normal damage. Normal fire, heat and cold don't usually hurt the character at all. Radiation usually does no damage.

Plasma energy, particle beams, sonic blasts, vibration powers, magnetism, magic, psionics and nuclear explosions do full damage.

Impervious to airborne or ingested poisons, toxins, drugs, gases, pollution and magic potions. If it needs to be ingested or otherwise put in a character's bloodstream, it will have no effect on the mineral being.

Healing: Physical damage is restored at a rate of 2D6 S.D.C./hit points per 24 hour period. Aliens who sustain massive damage may go into a hibernative sleep or trance that can last one to a dozen days. During this trance the character's healing doubles every day; i.e. the first day 4D6 points are restored, day two 8D6, day three 16D6, day four 32D6 and so on until completely restored. The healing trance even enables the character to regenerate lost limbs, but an extra day of healing is needed for each limb (24 hour days). However, for the trance to work the character must be exposed to the source of energy that he feeds upon. Also, during the healing period the character cannot take any action whatsoever and is oblivious to the things transpiring around him. It is also impossible to rouse the character from the trance. He wakes when he is healed (in part or completely, character's choice).

Don't Breathe: Most mineral beings also don't need to breathe or eat (absorb and feed on ambient energy) and can function at maximum efficiency with only four hours rest/sleep.

Rifts Note: All mineral beings are Mega-Damage creatures in the Rifts setting. Their P.S. and P.E. are considered to be supernatural, so their punches and kicks inflict Mega-Damage. Likewise, special powers are likely to do Mega-Damage.

Basanite

The planet Issini is a small, rocky globe with no vegetation and no atmosphere. It is an inhospitable ball for most organic life forms, but beneath its surface live the crystalline, Basanites.

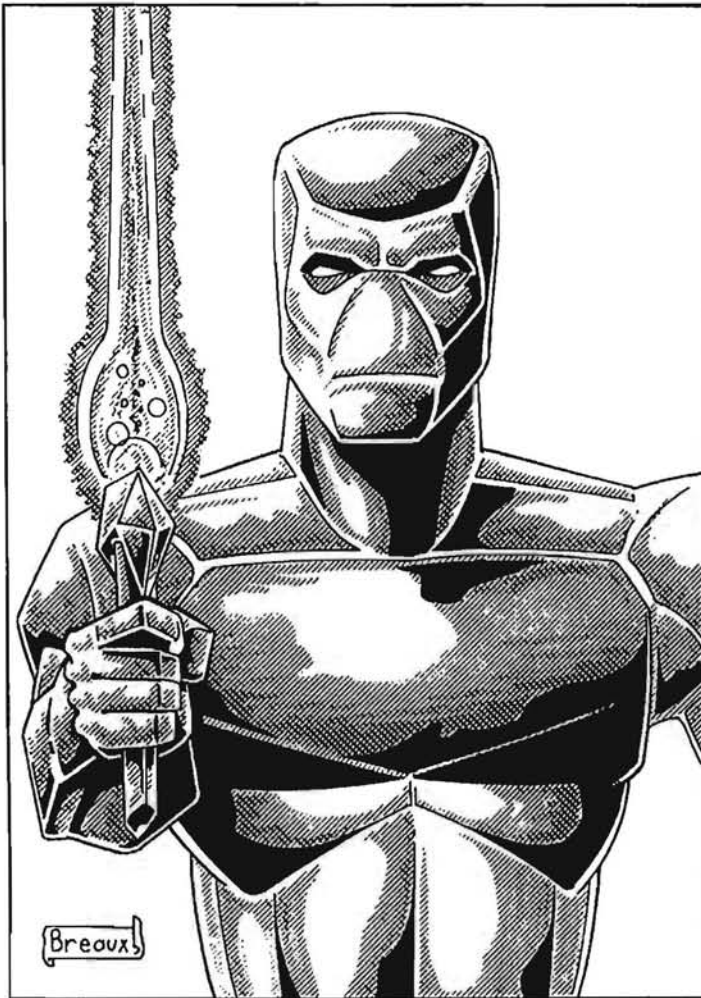

In the last few centuries, several satellite probes and spacecraft have crashed on their small planet; most are the casualties of war. Intrigued by the fabricated metal objects and the "soft" things inside them, the aliens began to study them. Aided through psionics and super abilities, the Basanites have been able to figure out what many of these objects are and how they worked. In an attempt to duplicate the effects or functions of some of these devices, they have made advancements in their own culture and have created a sort of crystal science.

The Basanites are able to communicate through crystals by simply touching them and thinking. Veins and lines of crystals that are miles long form an extensive communications network across the planet. In their search to duplicate the computers on the downed spacecraft, the Basanites discovered certain stones that act as storage cells. When these specific rocks are formed and linked to communication crystals, information can be stored and retrieved. Eventually, they were able to create their own unique computers.

Basanite research eventually led to the development of mind boggling spaceships constructed completely from pure crystal of varying colors. Along with their beautiful appearance, the materials are laser reflective (lasers do half damage) and sturdier than conventional metal composites used for the hulls of most spacecraft. The weapons on these vessels are also crystal and mineral based. Energy concentrating crystals produce laser weapons with 50%

more firepower (damage) and range than most available systems. Special explosive crystals can be charged and launched, and explode on impact, functioning much like floating mines or slow-moving missiles (have no guidance system and are -1 to strike).

Approximately 33% of the Basanite population has psionic abilities, while the remaining 67% have super abilities of some kind. All are trained in the full use of their powers, including attack, defense, and self discipline. Through their limited research and a couple of encounters with organic life forms (dead and alive), they have acquired a basic understanding about their physiology. Mainly they have come to realize that these "soft" beings are very fragile and break easily, but they admire their will and courage to explore the universe despite their own incredible weaknesses. This has inspired the Basanites to do likewise. They want to learn more about all the different "soft" beings and discover the wonders of the universe. Their perception of "soft" beings as noble, curious creatures has instilled a sort of reverence and awe toward *all* humanoid mammals and living things in general. Organic life seems miraculous to them, especially intelligent life. Thus, while the Basanites explore other worlds, they make an effort not to hurt or destroy the living. This reverence for life means they try to protect "soft" beings, especially intelligent ones, whenever they perceive them to be in danger.

On one hand, this can make the Basanites friendly and helpful. On the other, they can be easily misled and used as a force for selfishness, evil and destruction. For one thing, they have no understanding of laws, morals or right and wrong. They view death as sad and the wanton taking of life frightens, angers and confuses them. Remember, they see all life, good or evil, animal or intelligent, as wondrous and are horrified by its destruction. Thus, they may protect a criminal or murderer without realizing it and fight, perhaps even kill good guys they mistake as evil "destroyers of life." Those who imprison/enslave life are almost as bad. They have much to learn and may be incapable of understanding many human emotions, laws and customs. Similarly, while these aliens are not stupid, certain things are simply too alien for them, and are beyond their comprehension.

The Basanites are newcomers to the galactic community and are only just beginning to contact other life forms. Undoubtedly, some will be destroyed, enslaved and corrupted, but most will get along reasonably well with others. They are eager to work and live with others, and will want members of their people to study under as many different people as possible. However, there is only a total population of one million Basanites. What impact they may have on others remains uncertain.

Basanites (pronounced bass-ah-nites)

Alignments: Any, but most are effectively good, innocent, gentle beings, typically with a high regard for life.

Attributes: I.Q. 3D6, M.E. 3D6, M.A. 3D6, P.S. 3D6, P.P. 3D6, P.E. 4D6, P.B. 4D6, Spd. 5D6

Hit Points: P.E. x3 plus 1D6 per level of experience.

Natural A.R.: 15

S.D.C.: 2D6x10+200

Horror Factor: 9

Height: 6 feet plus 1D6 inches (1.8 to 2.0 m).

Weight: 380 plus 2D6 pounds (173 to 178 kg).

Average Life Span: 275 years. **P.P.E.:** 2D6

Super Abilities: 33% of all Basanites are natural psionics with the following psi-powers: Mind bond, object read, telepathy, mind block and see aura (in addition to the normal selections of a natural psionic). They also receive an additional super psionic power of choice at level one.

67% have the following super abilities: Select two minor super abilities of choice from heightened senses or energy expulsion powers, plus choose two of the following — gem powers, holographic memory projection, control radiation, or bend light. They also have the natural ability to telepathically communicate through pure crystal simply by touching it and concentrating.

Natural Abilities: All the standard abilities and features. Plus Basanites can see into the ultraviolet spectrum of light, are +4 to save vs Horror Factor, and are composed of elements and minerals that absorb radiation. Thus they themselves are slightly radioactive. Anyone exposed to them for more than two weeks will suffer from exposure to radiation. See the high radiation homeworld description for details on radiation sickness/poisoning.

Special Weapons: Can use any conventional weapons they find, gem powers or the Basanite crystal energy sword. It appears as a plain, unadorned, foot-long (0.3 m) piece of crystal, but when the character channels some of his personal energy into it, a blade of concentrated energy appears. Only the Basanites are able to use the crystals in this way, but it costs the character 1D6 S.D.C. points each time it is activated. The lost points are restored through the normal healing process and rest. Once activated, the sword remains "on" until its owner deactivates it. *Basanite Energy Sword:* Average length is 4.5 feet (1.4 m) activated. Damage: 4D6 (add 1D6 at experience levels six, ten and 14; does Mega-Damage in **Rifts**). Weight: One pound (0.5 kg) and is +1 to strike and parry.

Special Vehicles: Uses a variety of different vehicles of basanite and other designs.

Preferred Armor: Don't need any. Some may wear armor from time to time to look more frightening, or as a disguise.

Familiarity with Earth: None.

Rifts Note: The beautiful crystalline creature will be considered a strange D-bee. Warlocks and primitive people may consider them to be (or even worship them as) earth Elementals. The Coalition States will see them as dangerous monsters and destroy them whenever the opportunity avails itself.

If set in the **Rifts: Phase World** environment, the background presented for **Aliens Unlimited** is appropriate. Most will be explorers, but some can be slaves, pirates, Mercenaries or pawns of selfish and evil men.

In **Rifts**, the Basanites are Mega-Damage creatures (2D6x10+200 M.D.C.) but their technology can be

S.D.C. or M.D.C. technology depending on the view of the G.M. These aliens will be fascinated by dimensional travel and other forms of magic.



Fredulians

The Fredulians are a mysterious race of people from the planet Fre-Ad. There are no cities and only a few thousand fredulian elders. The elders serve as teachers for the young. They wait patiently as the wind and sand of Fre-Ad's abrasive atmosphere wears the soft rock away from the Mother Mountains. Beneath the surface of those mountains are unborn generations of Fredulians! As the soft rock is slowly eroded away, the full-sized young, curled into a ball, are released from the stone. How they got there is unknown. How many are encased in the mountains, waiting to be born is also a mystery, but one suspects there are hundreds of millions, perhaps billions, but it will take millions of years for them all to be released! Only 2D6x10,000 are born from the mountains every year. The actual beings have no sex, or sexual organs, and do not mate or give birth (the gender term "he" is used as a matter of human reference).

The elders meet the newborns to lead them to the less windy lowlands to begin their teaching. The newborns are taught philosophy, the basics of mathematics and physics, as well as told about the life that abounds in the universe.

They are also taught self-control, inner peace, balance and control, both internal (themselves) and external (the galaxy and those around them). This training instills the aliens with a strong sense of justice. They are taught to work with others and try to understand the ways of organic life, but to never compromise on one's inner spirit, light and virtue. These teachings usually last two to five years.

Once their training is complete, the elder tells the young alien that he is ready to go his own way. The young one is placed on one of the few ancient Fredulian spacecraft (of alien design?) and taken to a nearby space station at the edge of the Federation of Allied Races (FAR) territory. Here he is left to begin his life among other life forms. The young creatures are left to fend for themselves and to learn from others. Unlike the Basanites, these elemental beings adapt well to human society and understand and use their laws, weapons and technology. The majority of them have a high regard for life and become wandering champions of justice. As such, they often act as judge, jury, and enforcer of just retribution or recompense, but not executioner. They kill only when they are left with no other option. In some instances they find a planet or people they really like and spend the rest of their lives among them. About 70% of the Fredulians never return to their homeworld.

Fredulians (pronounced free-dull-eye-ans)

Alignment: Any, but most are good and possess a strong sense of justice and fair play.

Attributes: I.Q. 3D6, M.E. 4D6, M.A. 4D6, P.S. 6D6, P.P. 3D6, P.E. 3D6, P.B. 3D6, Spd. 4D6

Hit Points: P.E. x2, plus 1D6 per level of experience.

A.R.: 16 (natural)

S.D.C.: 6D6x10+200

Horror Factor: 13

Height: 6 feet plus 1D4 feet (2.1 to 3.0 m).

Weight: 600 plus 8D6x10 pounds (290 to 1080 kg).

Average Life Span: 6000 years. **P.P.E.:** 2D6

Super Abilities: All Fredulians have the following super powers: Mental stun, energy expulsion: energy, energy absorption, control elemental force: earth, and one additional minor power of choice. Fredulians do not roll for additional super abilities.

Natural Abilities: Standard powers and features, plus +1 on initiative, +2 to pull punch, +2 to roll with impact or fall.

Special Weapons and Vehicles: They can use whatever items they can acquire through their friendship and employment with other races. Most have an attraction to energy weapons, especially plasma and lasers.

Preferred Armor: Don't need any. Some may wear armor from time to time to look more frightening, or as a disguise.

Familiarity with Earth: None, although a few may have heard of Earth.

Rifts Note: The Fredulians will be seen as superhuman monsters. Warlocks and primitive people may consider them (or even worship them) as Earth Elementals. The Coalition States will see them as dangerous monsters and destroy them whenever they are encountered. The

Fredulians will see the CS as an evil dictatorship and will work with their enemies to topple them. They will also see the Splugorth, Cibolans/Soul Worms, Naruni Enterprises, and the Federation of Magic as evil forces.

In **Rifts** the Fredulians are Mega-Damage creatures (6D6x10+200 M.D.C.) but their technology can be S.D.C. or M.D.C., depending on the view of the G.M. These aliens will be fascinated by dimensional travel and magic. They will like using magic weapons.

If set in the **Rifts: Phase World** environment, the background presented for **Aliens Unlimited** is appropriate. Most will be explorers, adventurers, fighters, knights and heroes. Any of the scholar and adventurer O.C.C.s can be selected. They never study magic and don't possess psionics.

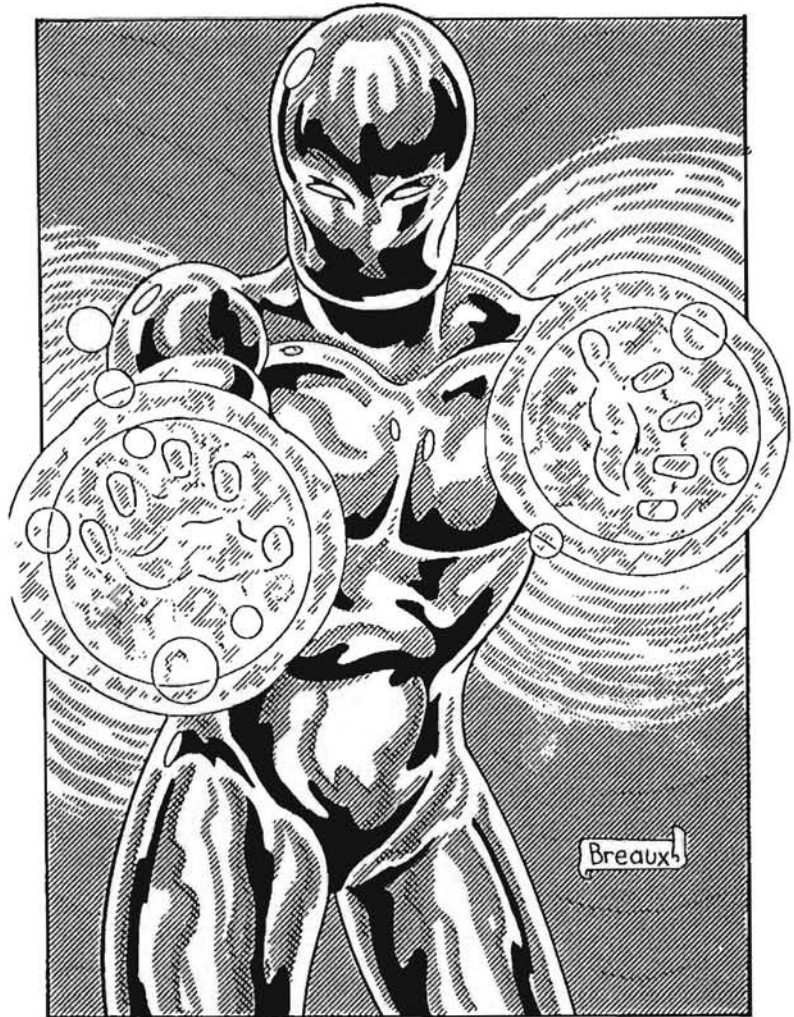

Lassinikes

The Lassinikes are a race of humanoids composed of a smooth, very dense material that resembles solid, clear glass. They once called a frozen world named Assin their home, but it no longer exists. Assin was a planet strong in magical energies, much like Shia and Rifts' Earth. The Lassinikes lived in the magic rich environment for millennia and their bodies became attuned to the magic energy. The aliens eventually learned to channel and control the Mystic energies in the form of spells and rituals. Centuries went by and the Lassinikes grew in their magic knowledge and power. They began to establish trade with other plan-

ets by using Mystic portals. This method of commerce did not require expensive cargo spacecraft and the Lassinikes prospered greatly from it. Like the Atlanteans of Earth, they became a great power in the galaxy and a hub of magical knowledge and power. Their efforts even halted Atorian expansion into their sector four hundred years ago, but they would ultimately make a tragic mistake.

In an effort to expand and improve their trade routes by reducing the numerous small portals they maintained, the Lassinikes sought to create massive Mystic portals that would allow the passage of immense cargo craft. Their experiments led to the development of the *Create Gravity Well* spell, but it was not quite what they wanted, since only a very powerful mage could make a well large enough for cargo craft. While searching for short cuts in Mystic travel, an experiment opened a dimensional portal to the homeworld of the *Riathenors* (see the monster sections for details).

The Riathenors were experienced dimensional raiders that were always looking for new opportunities. When the Lassinikes' Rift opened on their homeworld, they were instantly aware of it and knew what to do to keep it open. The foul demons had an experiment of their own in mind and decided to use the Lassinikes' homeworld as a test. Their experiment caused the lines of Mystic energy on Assin to erupt, killing thousands. The surge of magic on an already magical planet was devastating. As more people perished, their life forces brimming with Mystic energy themselves, fed the surging energy, creating new dimensional Rifts and magical storms. Even the Riathenors didn't intend to destroy the planet, but within 48 hours, Assin ripped itself apart and the Lassinikes were no more.

Very few Lassinikes survived. Less than 60,000 managed to escape through dimensional gateways to some of the worlds they traded with. An estimated 20,000 escaped by fleeing into the dimensional portal to the Riathenors' world, where they were enslaved and sold to other monstrous beings across the Megaverse. Thousands of others were saved by fleeing into (or falling into) the hundreds of random Rifts that blinked in and out around the world during the 48 hours of destruction, but they have been scattered as tiny clusters all across the Megaverse. Over a billion of them perished.

The survivors travel the universe in search of other survivors or live among other races. Some of those refugees have taken it upon themselves to make sure other civilizations do not make the mistake they did. These crusaders confront those who abuse magic or use it to raid other dimensions. Many of them oppose the awesome power of the Atorian Empire because they see them as a dangerously reckless power and fear it may one day threaten to destroy the galaxy.

There are rumors that several of the Assin dimensional portals remain open, hidden among the debris of the shattered planet. Space rifts are still only theory in most parts of the galaxy and none are known to exist. The regular appearance of Riathenors in that sector of space would seem to suggest that the rumors may be true.

Lassinikes (pronounced lass-sin-nikes)

Alignment: Any

Attributes: I.Q. 3D6+2, M.E. 3D6, M.A. 3D6, P.S. 4D6, P.P. 4D6, P.E. 4D6, P.B. 3D6, Spd. 3D6

Hit Points: P.E. x3 plus 1D6 per level of experience.

Natural A.R.: 14

S.D.C.: 2D6x10+125

Height: 5 feet plus 3D6 inches (1.6 to 2.0 m).

Weight: 240 plus 4D6x10 pounds (127 to 217 kg).

Average Life Span: 350 years

Super Abilities: All Lassinikes are wizards as described in **Heroes Unlimited**. All know the following magic spells in addition to their starting spell selections: Fly as the eagle, globe of daylight, tongues and armor of Ithan. Additional spells are gained normally.

Rifts/BTS Note: The bodies of these characters are so attuned to magic energy that they not only absorb and feed on ambient P.P.E., they can also absorb and store 15 P.P.E. points per level of experience! P.P.E. can be absorbed from ley line nexuses, magic talismans, and energy released from magic ceremonies, blood sacrifices and the moment of another's death.

Natural Abilities: Standard powers and features plus they are laser reflective (suffer only 1/3 damage from lasers) and are virtually invisible underwater (equal to a 90% prow). +2 to save vs Horror Factor. They feed on Mystic energy which is present in some form or another on most worlds and in outer space.

Special Weapons and Vehicles: They can use whatever items they can acquire through their friendship and employment with other races. Most have an attraction to magic weapons and items.

Preferred Armor: Don't need any. Some may wear armor from time to time to look more frightening, or as a disguise. They also use magic as a means of additional protection.

Familiarity with Earth: None, although some may have heard of Earth and it is possible that one or more were dimensionally Rifted to Earth (or just about any other planet or time).

Rifts Notes: Lassinikes in a **Rifts** setting will be the enemy of dimensional raiders, the Sunaj, Splugorth, Soul Worms, the evil denizens of Wormwood and any dragon, demon or being who uses magic to abuse, enslave or raid other dimensions.

In **Rifts**, the Lassinikes can be any of the magic O.C.C.s, including Temporal Wizard, Temporal Warrior, Techno-Wizard, Line Walker and Shifter, but will never practice Bio-Wizardry, necromancy or other destructive or enslaving types of magic. As usual, they are Mega-Damage creatures (2D6x10+125 M.D.C.) who possess Mega-Damage technology and magic.

Liconians

In the scorching 200 degree Fahrenheit (93 C) heat of the desert planet Licon live the Liconians. They are a race of humanoid mineral aliens that resemble the rough, pitted pumice rocks found on Earth. Their society is a very ordered and rigid one, like the people themselves. They sel-



dom express emotion and act as cold as their stone-like appearance. They have reached their current level of technology, including robotics, bionics and experimental programs, by being a calm, calculating people. Their society reflects this. Any other race visiting Licon would be totally bored by the lack of anything out of the ordinary. Everything is perfectly arranged and scheduled to avoid confusion and chaos.

There are a significant number of Liconians that leave Licon to study and travel the galaxy. They normally undertake these travels to be observers, but many quickly flee back to the calm of Licon. Many cannot cope with the constant chaos that exists outside their orderly and quiet society. Others are so amazed by the excitement outside of their world that they never return to their dull life. Once they experience thrills, they become hooked on a life of adventure. Only a Swip could enjoy life more.

All Liconians are trained to be Scholars, scientists, engineers or technicians. Those who find they like the vibrancy of the galaxy apply those skills by learning all they can about the universe. These Liconians are constantly studying and experiencing all they can about everything. Liconians are not giddy children, just eager to learn and experience. Their taste in weapons and vehicles tends to be flashy and dynamic.

Liconians (pronounced lie-cone-eye-ans)

Alignment: Any, tend to be good or anarchist.

Attributes: I.Q. 3D6, M.E. 2D6, M.A. 3D6, P.S. 5D6, P.P. 3D6, P.E. 4D6, P.B. 1D6, Spd. 3D6

Hit Points: P.E. x3, plus 1D6 per level of experience.

Natural A.R.: 14

S.D.C.: 4D6x10+160

Height: 5 feet plus 4D6 inches (1.6 to 2.1 m).

Weight: 200 plus 4D6x10 pounds (109 to 199 kg).

Average Life Span: 300 years

Super Abilities: All Liconians have the following super abilities: Holographic memory projection and control elemental force: fire. One in a thousand will possess 1D4 additional minor abilities or one additional major power (consult with G.M.).

Natural Abilities: Standard powers and features, plus +1 on initiative, +2 to pull punch, +2 to roll with impact or fall.

Special Weapons and Vehicles: They can use whatever items they can acquire through their friendship and employment with other races. Most like explosives and plasma weapons.

Preferred Armor: Don't need any. Some may wear armor from time to time to look more frightening, or as a disguise.

Familiarity with Earth: None, although a few may have heard of Earth.

Rifts Note: These humanoid rock creatures will be considered monstrous D-Bees. Warlocks and primitive people may consider them to be (and even worship them) as Earth Elementals. The Coalition States will see them as dangerous monsters and destroy them whenever they get the opportunity. They are Mega-Damage creatures (4D6x10+160 M.D.C.) who also possess Mega-Damage technology.

If set in the **Rifts: Phase World** environment, the background presented for **Aliens Unlimited** is appropriate. Most will be explorers, adventurers, fighters, and technicians. Any of the scholar and adventurer O.C.C.s can be selected. They never study magic and don't possess psionics.

Miceans

The planet Minas is a large, dark globe covered in thick, perpetual cloud cover, and is the twilight home of the Miceans. They have a multi-faceted, chiseled stone appearance with a grey or brushed silver color. Their eye is one oblong plate of polished black stone. Their sharp edges belie their warm, gregarious, and outgoing personalities. They are generally friendly, often brash and always competitive. Their education and training normally focuses on history, politics and combat/military. Most are skilled with energy weapons and ancient melee style weapons.

These tall, mineral aliens have a natural competitive streak and a need for attention that is a mile long. They do not necessarily have to win, they just want to be able to compete and be recognized for it (but winning is best). The more recognized their achievements, the better. They spent centuries trying to outdo each other in both sports and technology. Eventually, they broke through the cloud cover and into the reaches of space. There they would discover many different life forms and adventures. Their greatest competitors, the Thisseras (see reptilian entry), also ventured into space in search of glory and the two peoples would spend many decades in good natured competition before agreeing on an idea that would change the galaxy.

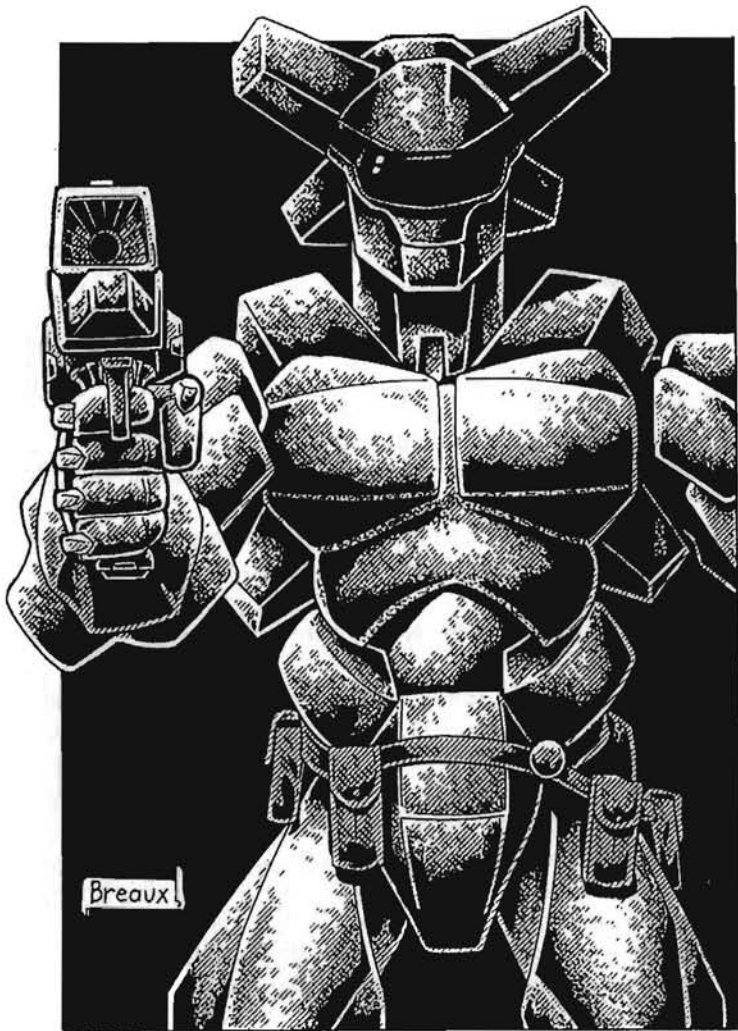

Miceans (pronounced my-see-ans)

Alignment: Any, but the vast majority are good or selfish.
Attributes: I.Q. 3D6, M.E. 3D6, M.A. 4D6, P.S. 6D6, P.P. 3D6, P.E. 3D6, P.B. 3D6, Spd. 3D6
Hit Points: P.E. x3 plus 2D6 per level of experience.
Natural A.R.: 16
S.D.C.: 3D6x10+240
Horror/Awe Factor: 12
Height: 8 feet plus 1D6 inches (2.4 to 2.6 m).
Weight: 400 plus 2D4x10 pounds (190 to 217 kg).
Average Life Span: 465 years. **P.P.E.:** 2D6
Super Abilities: Micean abilities are either from the psionic (01-25%; latent psionics) or super powered (26-00%; select two minor abilities and one major ability).

Natural Abilities: Standard powers and features, plus the equivalent minor super abilities of super vision: ultraviolet and infrared and nightvision. They are also ambidextrous (+1 attack per melee round and paired weapons) and are +1 on initiative, +3 to pull punch, +2 to roll with impact or fall and +4 to save vs Horror Factor.

Natural Limitations: Sensitive to bright light. Daylight vision is 300 feet (91 m).

Special Weapons and Vehicles: They can use whatever items they can acquire through their friendship and employment with other races. Most like explosives and plasma weapons.

Preferred Armor: Don't need any. Some may wear armor from time to time to look more frightening or as a disguise.

Familiarity with Earth: Earth's solar system is located in the patrol and jurisdiction ranges of the TMC. As a result, information on Earth is equal to the "Has studied Earth" result on the Familiarity With Earth table (Earth is not a member planet of the TMC protection agreement).

Rifts Note: These humanoid rock creatures will be considered strange, giant D-Bees. Warlocks and primitive people may consider them to be (or even worship them as) Earth Elementals. The Coalition States will see them as dangerous monsters and destroy them whenever they get the opportunity. The Micean lawmen will get along well with Cyber-Knights and other heroes and will almost certainly clash with the CS. They will also see the Splugorth, Cibolans/Soul Worms, Naruni Enterprises, and the Federation of Magic as evil forces. They are Mega-Damage creatures (3D6x10+240 M.D.C.) who also possess Mega-Damage technology.

If set in the **Rifts: Phase World** environment, the background presented for **Aliens Unlimited** is appropriate. Most will be lawmen, bounty hunters, adventurers and the occasional mercenary. Any of the mercenary, scholar and adventurer O.C.C.s can be selected. They never study magic.

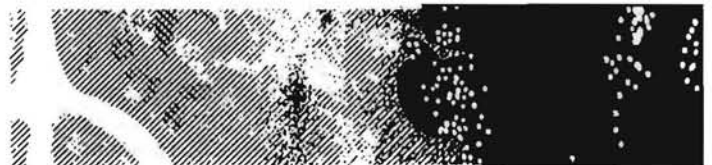

The Miceans came to realize that their eternal quest for challenge and glory could be fulfilled on a daily basis by becoming heroes. To implement this, they decided to form a galactic police force to defend the weak and protect the helpless. They would fend off pirates, repel invaders, dethrone tyrants and enforce the law. To better facilitate the salvation of the galaxy, they invited their long-time rivals, the Thisseras, to join them in this bold venture. The two races mulled over the idea and decided it had merit. They would become intergalactic heroes and win galaxy-wide recognition. The two races proposed the idea to their people who voted in favor of the plan. After a period of intense training and diplomatic work, they established funding and permission to launch a galactic protection agency called the **Thissera-Micean Cooperative** or **TMC** (also see the TMC entry in the Galactic Organizations section).

Together, the Miceans and Thisseras have made the TMC a force to be reckoned with. They have lived up to every expectation and have won intergalactic recognition. On several occasions they have even stood up to the Atorian Empire and recently beat the stuffing out of a Throppo strike force posing as pirate raiders to test the borders of FAR space. If there is a problem with these high-spirited, well-intentioned peace officers, it is that they enjoy the thrill of combat too much, take foolish chances, tend to underestimate their opponents and grandstand. They may remind Earthlings of the stereotypical movie cowboy or swashbuckler.



Raldemeans

The appear to be composed of a limestone-like substance that gives them a powdery white complexion and grainy texture. However, they are as durable as any of the other mineral aliens. The low gravity of their homeworld, Dimian, has formed them into a tall, thin race. They are an aggressive people and often work as Mercenaries, spies and assassins. They have also been known to hire out entire field armies under government contracts to help fight private wars. They are a non-allied race of Mercenaries who will hire their services to whomever makes them the best offer. Their clients include the Atorian Empire, the Federation of Allied Races, and many other races, corporations, organizations and individuals.

The elite of Raldemean society, both civilian and military, are those that possess super abilities different from the majority of their race. Those who display such special gifts are given the best schooling and training so they can one day assume positions of power within the military and government.

Non-gifted Raldemeans also possess some special powers, but revere those who are chosen by nature to have extraordinary abilities

Raldemeans technology levels are high because of extensive interaction with other races. Mercenary contracts are often settled in goods or an exchange of technology or services rather than money. Microwave and particle beam

weapons are favorites of the Raldemeans. They also love antigravity suits (acquired from the Atorian Empire) as the ultimate means of transportation. Although they have the technology, robotics and bionics are almost never used except in industry. The Raldemeans rely on their natural abilities, super powers and skills.

Raldemeans (pronounced rawl-dee-me-ans)

Alignment: Any, but most are selfish or evil.

Attributes: I.Q. 3D6, M.E. 3D6, M.A. 2D6, P.S. 4D6, P.P. 4D6, P.E. 3D6, P.B. 2D6, Spd. 4D6x2

Hit Points: P.E. x2, plus 1D6 per level of experience.

Natural A.R.: 14

S.D.C.: 2D4x10+200

Horror Factor: 13

Height: 9 feet, 6 inches plus 3D6 inches (3.0 to 3.4 m).

Weight: 2D4x100 pounds (91 to 362 kg).

Average Life Span: 300 years. **P.P.E.:** 3D6

Super Abilities: All Raldemeans have the following super abilities: Radar and magnetism. Super powerful mutants (01-30%) have the powers of radar and magnetism plus a random number of additional powers (roll on the *Random Super Ability Selection Table* and then for specific powers or the GM can assign a number of additional powers, but never less than an additional minor and one additional major ability).

Natural Abilities: Standard powers and features.

Special Weapons: Any, but microwave, particle beam weapons and Vibro-Blades are favorites.

Special Vehicles: Can use all types of vehicles but their favorite is the Atorian antigravity suit: Maximum speed: 150 mph (240 km). S.D.C. 50. Maximum altitude: Unlimited, capable of reaching outer space. Maximum weight allowance: 1000 pounds (450 kg).

Preferred Armor: Raldemeans seldom wear armor, especially during covert operations, but in heavy combat situations they may wear Class Four Hard Armor: A.R. 17, S.D.C. 280.

Familiarity with Earth: No familiarity with Earth.

Rifts Note: These humanoid rock creatures will be considered monstrous D-bees or demons. The Coalition States will see them as dangerous monsters and destroy them whenever they get the opportunity. Raldemeans will get along famously with the Splugorth and their minions, Cibolans, Naruni, demons, mercenaries, crime lords, tyrants and other war-like or power hungry misanthropes. They are Mega-Damage creatures (2D4x10+200 M.D.C.) who also possess Mega-Damage technology.

If set in the **Rifts: Phase World** environment, the background presented for **Aliens Unlimited** is appropriate. Most will be villains, bounty hunters, adventurers and the occasional mercenary. Any of the mercenary, scholar and adventurer O.C.C.s can be selected. They never study magic.



Stoans

The Stoans spend their long lives collecting and applying vast amounts of knowledge. They pursue the arts, sciences and technology with a slow, methodical perfection that few other races could employ. Their achievements in biology, chemistry, and technology are perhaps some of the finest in the galaxy. Their computer libraries on Oana are second only to those on Danude and Nors (see the previous Danaus Insectoid entry), but the stoans do not share their knowledge.

This hoarding of knowledge is not a totally selfish practice. The Stoans are aware of the fate of the Danaus and do not wish to follow in their footsteps. Another barrier against sharing with others is the slow, personal nature of Stoan research. The long-lived Stoans have incredible patience and proceed with excruciatingly slow thoroughness as they work. Swarms of anxious, eager pilgrims would surely distract the normally intense study of these aliens. A select few are sometimes allowed to share information with the scholars on Oana. These visitors are usually important or renowned historians, scholars and scientists. However, sometimes those allowed into the fabled libraries are common adventurers who have unearthed an ancient relic or uncovered a piece of a puzzle to any number of mysteries.

A large number of Stoan scholars, researchers and explorers scour the galaxy in search of data and knowledge. These expeditions can include trips to the Nors library for

additional research or extended visits to other planets for the collection or exchange of information. Primitive and less advanced planets are a favorite environment for Stoan researchers to observe and study sociological elements and technical evolutions in progress. The average Stoan investigator/researcher tries to stay out of the affairs of others and avoids violence. To that end, many carry a stun weapon or two for defense, but most are surprisingly excellent fighters. They fear the Atorian Empire and avoid all contact with them or their minions.

Stoans have jagged, quartz-like clusters that cover their entire bodies. Their colors range from white to bright reds and purples with translucent or opaque qualities. The texture of their bodies is either polished smooth or lightly textured. Their voices have a faint tinkling sound reminiscent of chimes.

Stoans (pronounced stones)

Alignment: Any, but most are selfish and self serving.

Attributes: I.Q. 3D6+1, M.E. 3D6+2, M.A. 3D6, P.S. 4D6, P.P. 4D6, P.E. 3D6, P.B. 3D6, Spd. 3D6x3.

Hit Points: P.E. x3, plus 2D4 per level of experience.

Natural A.R.: 15

S.D.C.: 3D4x10+220

Horror Factor: 14

Height: 5 feet plus 1D6 inches (1.5 to 1.7 m).

Weight: 240 plus 2D8x10 pounds (118 to 181 kg).

Average Life Span: 800 years. **P.P.E.:** 1D6

Super Abilities: All Stoans have the following super powers: Bend light, energy expulsion: light, and intangibility. Some rare Stoans (01-15%) will be slightly more powerful and have an additional minor super ability.

Natural Abilities: Standard powers and features, plus +2 to roll with impact or fall.

Special Weapons and Vehicles: They use a variety of different weapons and hover vehicles, and antigravity devices. Many use stun weapons to defend themselves, or rely on their own super abilities.

Preferred Armor: Don't need any. Some may wear armor from time to time as a disguise.

Familiarity with Earth: Earth is among the many planets that have been studied by the Stoans. Their libraries contain knowledge equal to the "Has studied Earth" result on the Familiarity With Earth table.

Rifts Note: Basically the same as the Liconians.

Reptile Races

These races share many of the physical characteristics of either Earth's lizards or warm-blooded dinosaurs/birds. They typically have tough, leathery or scaly skin that covers their entire body and provides increased S.D.C. protection. Skin color includes the entire spectrum of colors, from yellows and greens to browns and grays. They have no body hair but may have distinguishing and colorful markings, ribbing, horns and spines. Their physical builds can range from thick and squat to thin and tall.



Aurovax

Manida is a deceptively beautiful world of clear blue waters, green forests, and flowering plants. Gleaming skyscrapers fill sprawling cities inhabited by the reptilian Aurovax. On the surface, the planet appears to be a balance of technology and nature. The advanced civilization of the Aurovax has nearly eliminated pollution, disease, and crime. Most of their mining and processing is done in space. They have mastered the sciences of medicine (for reptiles anyway), robotics, bionics, cloning and space engineering. If not for their unreasoning fears and prejudices, the Aurovax might well have the closest thing in the galaxy to a perfect society.

Manida and its beautiful cities can be deadly for humans and other life forms. The planet has a thin atmosphere that allows much of its sun's radiation to strike the planet, while the Aurovax society has its own hidden darkness. Despite all of their achievements, the Aurovax are a closed-minded people filled with prejudice and fear. The reptilians distrust all mammals and are quick to jump to conclusions and harsh judgements based on the flimsiest of accusations or evidence. The Aurovax don't trust strangers to begin with and those with unusual powers and abilities are viewed as evil, potential enemies. Deadly force is often used in the name of self-defense. Consequently, the Aurovax tend to deal primarily with other reptilians, amphibians, aquatics, mineral and vegetation types of life forms.

The Aurovax also deal harshly with the unusual among their own people. They have their share of citizens gifted with super powers or psionic abilities, but in the Aurovax society, such people are feared and ostracized. This is an ancient practice. No one remembers why it was started, but it has remained in place for thousands of years. In ancient times, anyone discovered to have *unnatural* abilities was sent away or killed before they could harm anybody. Today, they are exiled without trial. No one is given the benefit of the doubt and in a society with advanced space capabilities, exile means a one-way trip into the void.

The have a large, highly skilled military, with robot and bionic troops. However, much of their society is composed of scientists and engineers, many of whom are engaged in the study of other planets, people, and societies (including Earth). Many of these studies involve the crime, chaos and influence of super beings in both advanced and primitive civilizations. By knowing what mistakes and catalysts to avoid, the Aurovax hope to keep their crime and civil problems at a minimum. Members of investigative expeditions usually carry easily concealed mini-lasers and other high-tech weapons for defense purposes.

Aurovax are rather tall and thinly built. Their bodies are smooth and sleek, and are covered in small, iridescent scales. Fingers and toes are long, thin and delicate, with long, sharp nails. The head is large, flat and thick, with a huge mouth and small, dark eyes. The only forms of augmentation that do not carry any stigmas are those based in technology. Even genetic manipulation is taboo, although experiments in cloning for medical purposes is allowed.

Aurovax (pronounced Are-oh-vacs)

Alignment: Any, but most lean toward selfish and aberrant evil (work toward the preservation of Aurovax society and prosperity regardless of the cost to others).

Attributes: I.Q. 3D6+2, M.E. 3D6, M.A. 2D6, P.S. 3D6+2, P.P. 3D6+2, P.E. 3D6, P.B. 2D6, Spd. 3D6

Hit Points: P.E. $\times 2$ plus 1D6 per level of experience.

S.D.C.: 1D4 \times 10+60

Horror Factor: 10

Height: 6 feet plus 1D6 inches (1.8 to 2.0 m).

Weight: 190 plus 1D6 pounds (87 to 89 kg).

Average Life Span: 180 years. **P.P.E.:** 2D6

Super Abilities: The average Aurovax has no super powers or psionic abilities but can be bionic, robot, hardware, or physical training. They avoid magic like the plague (it's unnatural).

Exiles are typically super-powered mutants (01-45%) or mutant psionics (46-95%; latent psionics), and a handful are practitioners of magic (96-00%).

Natural Abilities: Keen senses equal to the minor super abilities of heightened sense of smell and taste. Instinctively know how to swim (80%) and climb (55%/45%). Aurovax can also see into the ultraviolet spectrum of light and are impervious to radiation poisoning. Living in the radiated atmosphere of Manida has made the Aurovax radioactive themselves. Anyone exposed to them for more than two weeks will suffer from exposure to radiation. See the high radiation homeworld description for details on radiation sickness/poisoning.

Special Weapons and Vehicles: The equivalent of most types of weapons, hover vehicles and spacecraft are manufactured or purchased by these reptilians. Favorites include laser weapons.

Preferred Armor: Seldom wear armor, except for off-world expeditions. Light environmental body armor: A.R. 11, S.D.C. 40, heavy environmental armor: A.R. 16, S.D.C. 140. For heavy combat situations they may wear Class Four Hard Armor: A.R. 17, S.D.C. 280 and have their fair share of bionic and robot warriors and armor. Exiles are not given armor and must acquire equipment on their own.

Familiarity with Earth: The Aurovax study groups have come to Earth and have collected information equal to the "Has studied Earth" result on the Familiarity with Earth table.

Rifts Notes: If used in the **Rifts RPG** setting, the reptilians will be regarded as monstrous D-Bees. Their fears and prejudices make the Aurovax as bad as the Coalition States! They will avoid associating with humans and mammals, but will be attracted to other reptilians, including gargoyles. They may also try to establish their own kingdom of non-mammalian life and will crush any who get in their way. The CS will see them as dangerous beings and will attack any community that is established. Individual characters may be good guys or villains. Unless an exile, they can be any O.C.C. except magic (all), crazy, or juicer. In **Rifts**, the Aurovax are S.D.C. creatures who possess Mega-Damage bionics, weapons and technology.

If set in the **Rifts: Phase World** environment, the background presented for **Aliens Unlimited** is appropriate. Exiles can be most anything, from Mercenaries to adventurers.

Baccarus

Accara was once a planet of intense temperatures. Near the equator, they could soar to 250 degrees Fahrenheit (121 C). In this sweltering environment, evolved the Baccarus. Their civilization and technology grew over the years as the race evolved and advanced. The reptilians were well on their way to achieving manned space flight when fate intervened on a cosmic scale. They had managed to get several satellites into orbit and they were able to detect the gigantic asteroid as it raced toward Accara. Their limited space capabilities meant little could be done to stop it. Several attempts were made to fragment it with nuclear warheads, but again, their technology was lacking.

The huge space rock hit the planet squarely. The impact threw billions of pounds of dust into the air and killed millions of Baccarus. With the sun obscured by a veil of debris, the weather patterns changed dramatically. Accara began to cool. Temperatures dropped to deadly levels (well below 70 degrees Fahrenheit/21 C; freezing cold to creatures use to the boiling temperatures of the past). Those Baccarus who did not die from exposure would eventually die from starvation or disease. Several years later, a Tagonican survey craft looking for mineral deposits rescued the last survivors.

The survivors were the lucky and those with special facilities or powers, including military personnel hidden away inside bunkers and underground complexes, Baccarus and those with special abilities, such as psionics, magic, and super abilities. After a full year of rescue efforts, approximately 2.5 million people were saved. Unable to live on Accara, the Baccarus sold their homeworld for salvage and mining to the Tagonicans. This meant each survivor was wealthy (roughly 125 million credits per person) and are able to go wherever they wanted. Many of those rescued were subsequently employed by *Tagoniglomerate*, the massive Tagonican owned mega-corporation. Others



settled on one thermal world or the other and some went on to wander the galaxy, exploring the wonders that are forever denied to the rest of their people.

Baccarus (pronounce back-care-us)

Alignment: Any, but most are good or selfish.

Attributes: I.Q. 3D6, M.E. 3D6, M.A. 3D6, P.S. 4D6, P.P. 3D6+2, P.E. 3D6, P.B. 2D6, Spd. 4D6

Hit Points: Standard, P.E. plus 1D6 per level of experience.

S.D.C.: 100 **P.P.E.:** 3D6 or by Magic Category

Horror Factor: 8

Height: 5 feet plus 4D6 inches (1.6 to 2.1 m).

Weight: 100 plus 2D6x10 pounds (54 to 100 kg).

Average Life Span: 135 years

Super Abilities: Most of the surviving Baccarus had special powers and/or training. Thus, characters can be any of the following Super Power Categories: Bionic (01-10%), hardware (11-25%), physical training (26-35%), magic (36-45%), psionic (46-65%) or super-powered mutants or products of super experiments (66-00%)

Natural Abilities: See ultraviolet and infrared light radiation equal to the minor super ability. Keen hearing. As natives of a thermal world, the Baccarus are immune to extreme heat and resistant to fire and radiation (does half damage; +6 to save). However, they cannot tolerate cold. Even temperatures as warm as 95 degrees Fahrenheit (35 C) are considered freezing and will cause them to suffer from exposure as detailed under the frozen world description.

Special Weapons and Vehicles: Most can afford to buy whatever they need, although in many cases, money is tied up or controlled by family clans, so the character may have limited resources. Favorite weapons include Vibro-Blades, lasers, and particle beam guns. Their favorite means of transportation is antigravity devices.

Preferred Armor: Any type of armor can be worn depending on the situation and personal tastes (see the Equipment section).

Familiarity with Earth: None.

Rifts Notes: If used in the **Rifts RPG** setting, the Baccarus will be regarded as a D-bee. The Coalition States will become alarmed when they realize that these beings possess magic, psychic or super powers and will destroy any they subsequently encounter. Individual characters may be heroes or villains of any O.C.C. In **Rifts**, the characters are S.D.C. creatures who possess Mega-Damage bionics, weapons, magic and technology.

If set in the **Rifts: Phase World** environment, the background presented for **Aliens Unlimited** is appropriate. Most will be wealthy businessmen, explorers, adventurers, practitioners of magic or Mercenaries.



Erittima

Erittimas are the product of genetic engineering by a mysterious race known only as the Vymras. According to legend, the god-like Vymras took the Erittima from the forest, shaped them in their image, gave them intelligence and taught them how to fight. Their creators spoke of a great war and explained that they gave the reptilians strong bodies and self-awareness to fight a terrible enemy. One day, thousands of spacecraft landed on their world to take them to the field of battle. The obedient Erittimas boarded the ships and blasted into space. The giant fleet came to orbit around a large planet, but the battle they expected never came. The planet was uninhabited, although it was habitable, with a variety of environments from forests to deserts, but there was no enemy. As for their creators, the Vymras were never seen or heard from again! The Erittimas have since claimed this world as their own and have named it Vymra.

There are now nearly one billion Erittimas. Tens of thousands have gone to explore other parts of the galaxy in search for their creators, but to no avail. All Erittimas

are taught that their destiny is not their own. That one day their creators will return and beckon them to join them in a great battle. On that day, every man, woman and child will follow their gods into battle and glory, for that is their purpose — their destiny. Until that day, they hone their combat skills so that they will be ready. They have waited for nearly 400 years!

The Erittimas are intelligent, nimble creatures with lightning quick reflexes and natural (genetically instilled) super abilities. Because they wait for the return of the gods and the call to battle, they have not engaged in space colonization or conquest, although they have made contact with numerous alien life forms. Whatever their creators may have in store for them, the Erittimas are good natured and loving people with sharp minds and a strong respect for life. Over the centuries, they have decided that the Vymras are Gods of Light and that it is their destiny to fight and vanquish a great evil. A large faction has decided that evil force is the Atorian Empire. This has led some to venture into Atorian territory as advanced scouts and spies to gather information about the enemy. Some have joined the TMC or travel the galaxy as champions of justice, righting wrongs and seeking out potential allies to fight at their side when the great battle comes.

These warm-blooded lizard-looking warriors are roughly human in size. They have flat, yellow-green scales covering their bodies, with cream colored highlights and accents. Their heads are large and reptilian in appearance, yet the creatures are gentle and graceful, giving them an attractive appearance even to fickle humans.

They have a reasonably advanced society and middle level technology. They also have access to incredibly advanced technology, including antigravity spaceships and devices given to them by the Vymras, but they don't completely understand how they work and don't know how to duplicate them. Thus, the original giant space fleet and antigravity devices have been maintained for hundreds of years. What they don't understand or can't build themselves, they acquire from others.

Erittimas (pronounced Ee-rit-tih-mas)

Alignment: Any, but most are good or selfish.

Attributes: I.Q. 3D6, M.E. 3D6, M.A. 3D6, P.S. 3D6+7, P.P. 3D6+7, P.E. 3D6+2, P.B. 3D6, Spd. 5D6+16

Hit Points: P.E. $\times 2$ plus 1D6 per level of experience.

Horror/Awe Factor: 10

S.D.C.: 1D4 \times 10+65 (does not include super power bonuses or skills)

Height: 5 feet plus 3D6 inches (1.6 to 2.0 m).

Weight: 100 plus 2D6 \times 10 pounds (54 to 100 kg).

Average Life Span: 90 years. **P.P.E.:** 2D6

Super Abilities: All have the following super abilities: Alter metabolism, healing factor, energy resistance, and flight: wingless. Do not roll for additional super abilities. Combat training (in addition to the skills from education) includes acrobatics or gymnastics, boxing (add one additional attack per melee round), wrestling, climbing, swimming and hand to hand martial arts.

Natural Abilities: Ambidextrous (add one additional attack per melee round), double jointed, keen color vi-

sion, hearing and sense of taste; +2 on initiative, +2 to pull punch, +2 to roll with punch, +3 to save vs Horror Factor.

Special Weapons: Can use a variety of weapons. Energy knives and swords are their favorites: **Energy Knife:** Length: 20 inches (0.5 m), damage: 2D6+3, weight: 1 pound (0.5 kg). **Energy Sword:** Double the length and weight, inflicts 5D6 damage.

Special Vehicles: Use a variety of items, but fast hover vehicles and antigravity vehicles are their favorites.

Preferred Armor: Uses all kinds, but their favorite is the Vymras environmental body suit (skintight): A.R. 17, S.D.C. 200 — no prowl or movement penalties.

Familiarity with Earth: The Erittimas have access to information equal to the "Some familiarity" result on the Familiarity With Earth table.

Rifts Note: These reptilians will be considered D-bee champions of good. The Coalition States will see them as dangerous monsters and destroy them whenever they get the opportunity. The Erittimas champions will get along well with Cyber-Knights and other heroes and will almost certainly clash with the CS. They will also see the Splugorth, Cibolans/Soul Worms, Naruni Enterprises, and the Federation of Magic as evil forces. They are S.D.C. creatures with Mega-Damage weapons, powers and technology.

If set in the **Rifts: Phase World** environment, the background presented for **Aliens Unlimited** is appropriate. Most will be law men, bounty hunters, adventurers and the occasional mercenary. Any of the **Rifts** O.C.C.s can be selected. They rarely study magic.

Jenjorans

The Jenjorans are natives of the planet Lorila, a high gravity world of dense jungles and shallow oceans. These aliens are short, with thick limbs and wide heads, with oval-shaped fins. Their eyes are prominent, and skin color ranges through the spectrum of greens and browns, but change constantly because of a natural chameleon-like ability.

Most Jenjorans are educated as engineers, scientists and Scholars, but the most respected are the anti-magic warriors who live by centuries of tradition. This tradition is linked with the outlawing of magical practices and ancient stories of a time when magic and technology clashed and almost destroyed their world. According to legend, wizards unleashed dangerous demons and magic energy in a bid to conquer the world. However, specific facts and details have been lost and nobody seems to know exactly what transpired. The only thing that is known for certain is that the wizards were defeated and magic is forever banned. The anti-magic warriors hunt down practitioners of magic on Lorila and destroy them. Some have carried their crusade to the stars, fighting evil sorcerers and supernatural monsters. Off-world they tolerate the existence of magic users and creatures of magic provided they use their powers for good and do not enslave or torment others. How-



ever, they *never* trust any men of magic or supernatural beings.

Near the center of every major old city on Lorila is a 30 foot (9.1 m) wide, three foot (0.9 m) tall, octagon shaped device. They are all nearly identical and strongly resemble sliding blast doors, hence their name, "The Doors." These Doors are obviously mechanical and represent a technology beyond that possessed by the Jenjorans when they were built 1,200 years ago. None of the doors appear to have any kind of opening mechanism. The Jenjorans no longer remember what is on the other side of The Doors, but they fanatically maintain them out of fear and tradition. It is rumored that some of their elders know what The Doors keep in check, but they do not talk about it, and faerie tales about The Doors abound. Among them are prophecies of doom and tales of doorways to other worlds and dimensions created by magic. The last reference to The Doors warns, "The portals must ever be sealed, lest we lose all that we know."

The Jenjorans study other planets, people, and civilizations for clues to the origins and purpose of The Doors. Some argue that the levels of technology currently available would make the risk of opening a Door very small and there is growing support for this movement, which comes from overconfidence, pride, and ignorance. However, they are not yet ready to risk opening even one to see what it contains (or holds back). Scholars and researcher have been sent to other worlds in hope of finding similar structures and clues to their purpose, but thus far they have not.

Jenjorans (pronounced jen-jor-ans)

Alignment: Any; most are good or anarchist.

Attributes: I.Q. 3D6, M.E. 3D6, M.A. 3D6, P.S. 4D6, P.P.

3D6+2, P.E. 4D6, P.B. 1D6, Spd. 6D6

Hit Points: P.E. plus 2D4 per level of experience.

Natural A.R.: 9

S.D.C.: 3D4x10 (does not include super power or attribute bonuses).

Horror Factor: Typically 14 — 15 for anti-magic warriors.

Height: 5 feet 1d6 plus inches (1.5 to 1.7 m).

Weight: 100 plus 2D4x10 pounds (54 to 82 kg).

Average Life Span: 75 years

Super Abilities: All Jenjorans have the following super abilities: chameleon and animal abilities: reptile. Do not roll for additional super abilities.

Natural Abilities: Superior senses equal to the minor super abilities heightened sense of hearing (+6 on initiative, +1 to parry, +2 to dodge), advanced sight and nightvision. Plus can leap 10 feet (3.0 m; add five feet/1.5 m from a running start), natural climbers (75%/65%) and swimmers (65%).

The anti-magic warrior gets the following bonuses from training and special abilities: impervious to possession (and the bite of the vampire), +4 to save vs magic (all types), +2 to save vs mind control of all kind, +5 to save vs Horror Factor, and 40%+5% per level of experience to recognize enchantment or magic items. Bonuses are in addition to attribute or super power bonuses. **Rifts Notes:** The character has the natural abilities of P.P.E. shield and mind block auto-defense. These powers automatically engage and don't require I.S.P. The anti-magic warrior has a natural P.P.E. base equal to his P.E.x10! The P.P.E. of the average jenjoran is P.E.x3).

Special Weapons and Vehicles: They use most types of weapons, hover vehicles and spacecraft. Energy clubs and jet packs are favorites.

Preferred Armor: Jenjorans environmental battle armor: A.R. 13, S.D.C. 210; complete with mini-computer and bio-scan (left arm), wrist lasers (one on each hand, two damage settings: 2D6 or 4D6 damage per single blast, 800 foot/244 m range, effectively unlimited payload), short-range radar, short-range radio, basic life support systems.

Familiarity with Earth: They have collected extensive information on various planets across the galaxy. Their information on Earth is equal to the "Has studied Earth" result on the Familiarity With Earth table.

Rifts Notes: They are considered monstrous D-Bees and are likely to be shunned by most humans and human-like creatures. The anti-magic warrior and most other Jenjorans will be horrified at what magic has unleashed on the planet Earth. Both distrust, fear or hate supernatural monsters and all beings who use magic and will destroy any they perceive as evil. Some extremist may go on a killing spree to destroy ALL Mystic creatures. They will get along best with psi-stalkers, dog boys and simvan monster riders. The Coalition States will exterminate them whenever they are encountered in CS territory, even though they hunt practitioners of magic and demons. In **Rifts**, the characters are Mega-Damage creatures who possess Mega-Damage weapons, armor, and technology.

If set in the **Rifts: Phase World** environment, the background presented for **Aliens Unlimited** is appropriate. They can be any of the O.C.C.s except psychics and practitioners of magic.

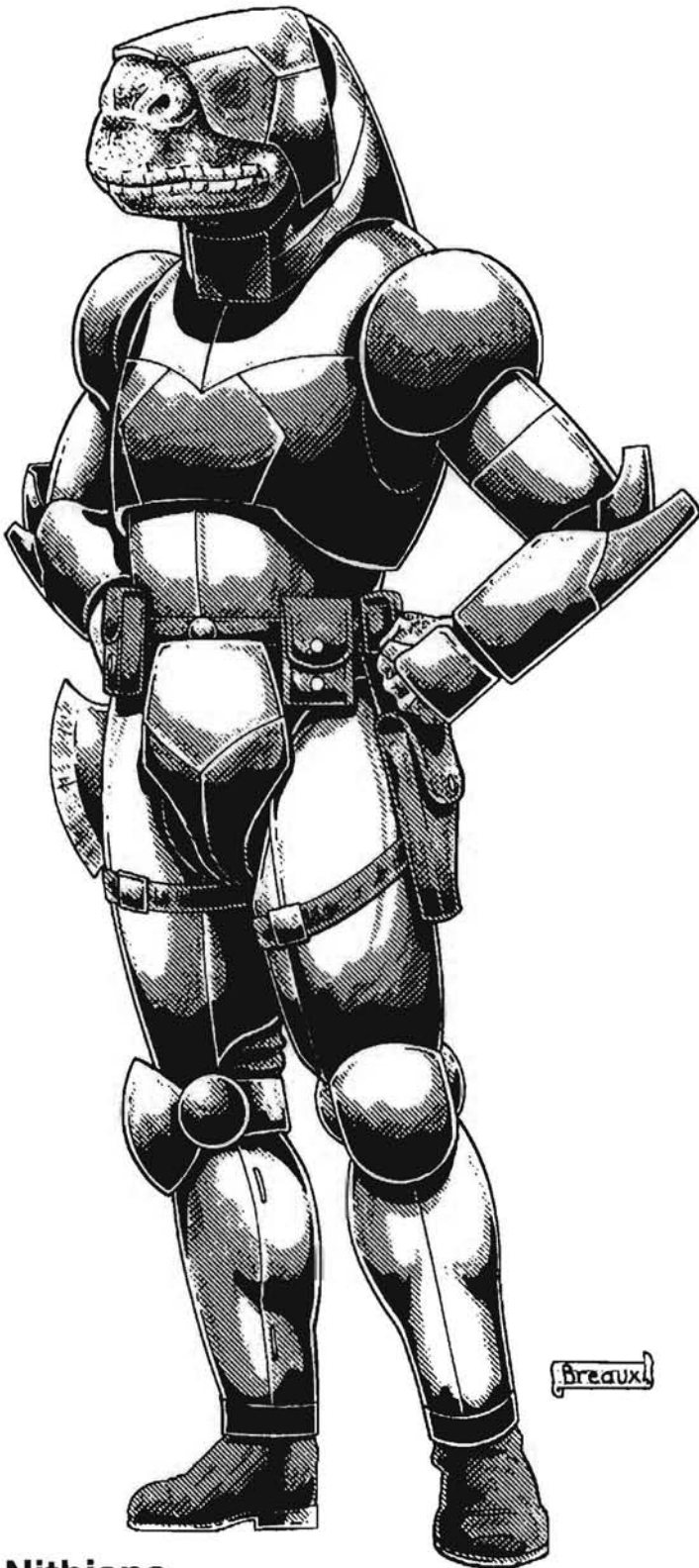

Nithians

Nithia is a beautiful, Earth-like planet that is the homeworld of the dinosaur-like Nithians. Although the planet resembles Earth, its air is toxic to Earthlings and most humanoids. The acid rains and mists are also dangerous to most life forms and will damage rubber and

many compounds of plastic. The Nithians have evolved within the harsh atmosphere, so they can breathe the foul air and their skin is thick, scaly and toughened to protect them. The scales are tight and close fitting, with additional large scales on the neck, shoulders and back. Skin colors are various shades of yellow, tan and orange. Their heads are wide, with a large mouth filled with large, pointed teeth.

The Nithians have developed Faster Than Light (FTL) drives and have just begun deep-space exploration. They have already made limited contact with several other galactic communities, including the Naidens and Sorinams and the Federation of Allied Races (FAR). In their search for new knowledge and cultures, the Nithians have recently begun organizing study expeditions to a variety of moons, planetoids and planets. These expeditions can last as long as ten years or as short as a few months. They are typically composed of scientists accompanied by a military escort. The escorts are soldiers with either bionic or robot augmentation or super abilities. All expedition members will have vibro-weapons for utility and defense purposes, and the team uses hover platforms for transportation. The armed forces have a variety of special forces units. The robot and cyborg teams function as flexible heavy support and light battlefield units. The super teams often pull similar details, but their most prominent area of expertise is in seek and destroy, infiltration, and other more sensitive operations.

Nithians (pronounced nith-eye-ans)

Alignment: Any

Attributes: I.Q. 3D6, M.E. 3D6, M.A. 3D6, P.S. 5D6, P.P. 3D6+2, P.E. 3D6+2, P.B. 2D6, Spd. 5D6

Hit Points: Standard, P.E. plus 1D6 per level of experience.

Natural A.R.: 12

S.D.C.: 3D6×10+20 (does not include super power or attribute bonuses).

Horror Factor: 12

Height: 9 feet plus 3D6 inches (2.8 to 3.2 m).

Weight: 380 plus 1D6×10 pounds (177 to 199 kg).

Average Life Span: 95 years. **P.P.E.:** 2D6

Super Abilities: Available Super Power Categories: Bionics (01-25%), robots (26-43%), hardware (44-58%), magic (59-60%), mutants (61-65%) and super-powered experiments (66-00%). Nithians do not possess psionics.

Special Weapons and Vehicles: They use most types of weapons, hover vehicles and spacecraft. The Vibro-axe is a favorite.

Preferred Armor: Besides various robot and cyborg armors, the Nithians do not rely on any type of armor unless they are engaged in battlefield combat or exploration off-world. In such a case, they may wear an environmental Class Four Hard Armor: A.R. 17, S.D.C. 280, or a lightly armored environmental suit: A.R. 14, 70 S.D.C.

Familiarity with Earth: None.

Rifts Notes: Basically the same as the Baccarus.



Qua-Trau

The Qua-Trau are natives of the low gravity planet Kwera. These reptiles are tall and strong with aggressive tendencies. A century ago the Atorian Empire landed on Kwera. The barbaric Qua-Trau fell to superior numbers and vastly superior technology. The dinosaur-like humanoids initially believed the invaders to be gods (antigravity devices and energy weapons can have that effect) and many still do.

Hostile at first, the Qua-Trau were quickly shown by example that they had much to gain from cooperating with their new masters. Through the use of language translators and psionics, the Atorian Empire easily recruited them as allies. Now, 90 years later, they are some of the Empire's most effective shock troops. Outfitted with modern weaponry and armor to complement their natural savagery, the Qua-Trau enjoy their new found power and the opportunity to wage war. The most loyal have even been trained in the operation of tanks, hover vehicles, robot vehicles and power armor/exoskeletons. However, most of these dim-witted troopers have only a minimal knowledge of communications, computer operation and the basics of life and combat. None of them are taught the sciences or the arts.

The still primitive inclinations of these beings makes them savage fighters, easily impressed and controlled by the Atorians. Many Qua-Trau still consider themselves servants of the Gods and believe themselves to be in their

service as Angels of Death. They revel in the wonders of their new gods and exalt their power (weapons) and superhuman abilities (via hover vehicles, antigravity devices, space travel, etc.). While most of the Qua-Trau enjoy being shock troopers and harbingers of doom, others have realized that they are being exploited by mortals and have mixed feelings about the Atorian Empire. Some long for the freedom to wander the open galaxy and to escape the war and barbarism encouraged by the Empire and the ancient ways of their people.

Qua-Trau (pronounced Kuwah-trah)

Alignment: Any, but most are selfish or evil.

Attributes: I.Q. 2D6+1, M.E. 2D6+2, M.A. 2D6, P.S. 6D6, P.P. 4D6, P.E. 5D6, P.B. 1D6, Spd. 6D6

Hit Points: P.E. $\times 3$ plus 1D6 per level of experience.

S.D.C.: 3D6 $\times 10$ +20 (does not include super power or attribute bonuses).

Horror Factor: 14

Height: 10 feet, 6 inches plus 1D10 inches (3.2 to 3.5 m).

Weight: 400 plus 1D4 $\times 10$ pounds (186 to 199 kg).

Average Life Span: 85 years. **P.P.E.:** 2D6

Super Abilities: Qua-Trau will be one of the following: bionic (01-25%), robot/power armor (26-45%), hardware (46-65%) or super-powered mutant (66-00%). Mutants can select one major power and one minor ability (do not roll for additional powers).

Combat training includes gymnastics, boxing (add one additional attack per melee round), climbing, and hand to hand: expert, W.P. axe, W.P. sword, W.P. energy pistol, and W.P. energy rifle.

Natural Abilities: Heightened sense of smell equal to the minor super power, double jointed, color vision, bite attack 3D6 damage, +2 on initiative, +1 to roll with punch, +5 to save vs Horror Factor. They often eat the flesh of their victims.

Special Weapons: They use whatever is appropriate for the job, but they love energy melee weapons, Vibro-Blades and Kisentite axes. Giant-sized Kisentite axe: Length: 5.75 feet (1.7 m). Weight: 12 pounds (5.4 kg), Damage: 4D6+2.

Special Vehicles: Atorian antigravity medallion.

Preferred Armor: Besides cyborg and robot power armors, the Qua-Trau prefer lighter full and half suits of heavy plate armor and environmental suits: A.R. 12, S.D.C. 120 for half suits, A.R. 17, S.D.C. 280 for full suits.

Familiarity with Earth: None; they go wherever their Atorian masters tell them to go and don't really care about who they fight.

Rifts Notes: The Qua-Trau are carnivorous predators who instinctively fight and prey on creatures weaker than they are. This means they will be given to conquering and ruling over small towns and villages, engaging in terrorism, torture, wholesale slaughter, and other acts of savagery and brutality. They will be feared and shunned by humans and most peace-loving beings. The CS will terminate any they encounter. However, the Pecos Empire, Mercenaries, and demonic monsters may add them to their forces. The Splugorth,

gargoyles and most evil supernatural creatures will welcome them as kindred spirits and delightful minions. In **Rifts**, the characters are Mega-Damage creatures with supernatural P.S. and P.E., and who possess Mega-Damage weapons, armor, and technology.

If set in the **Rifts: Phase World** environment, the background presented for **Aliens Unlimited** is appropriate if the Atorian Empire is also part of the scenario. Otherwise, they will be new minions of Splugorh, vile bounty hunters or savage Mercenaries.

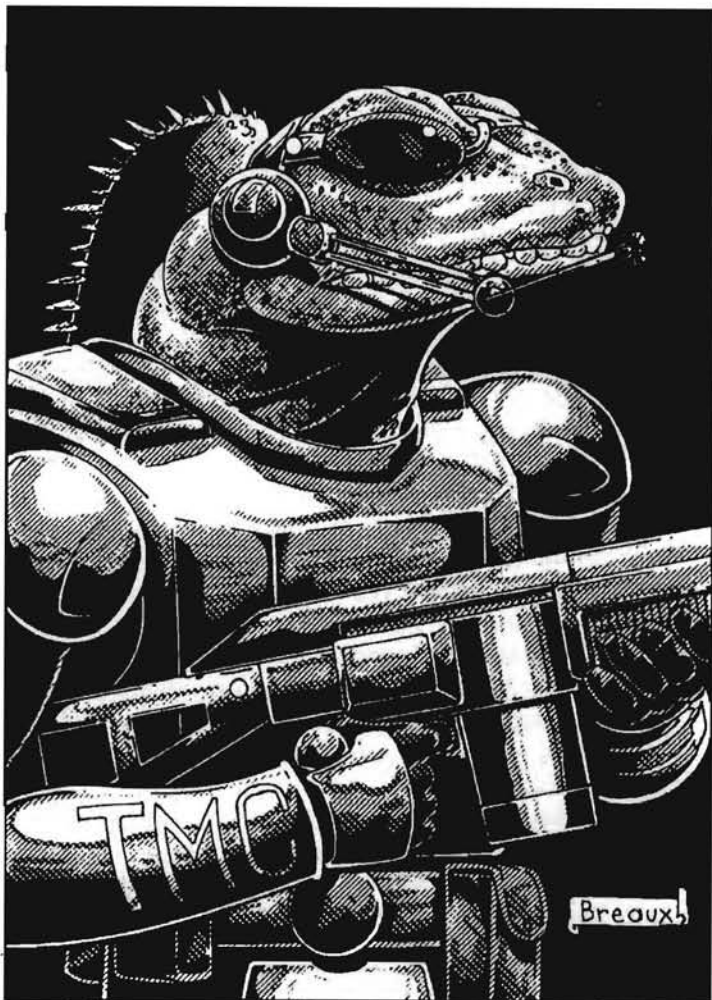

Thisseras

The Thisseras are a tall reptilian race with wide, flat heads, large, dark eyes and a prominent mouth. They tend to be thin, and are covered by fine scales. A fin-like appendage runs along the back of the neck and is crowned with small, sharp spines. The colors of their skin is typically pale blue, with brown patterns. They are nocturnal creatures who live in the tropical forest of the world known as Ansim. As a result, they have little tolerance for bright light, but have excellent nightvision.

Long ago, these aliens were a fiercely warlike people who knew little about peace. As their technology and civilization developed, it became obvious that one day their achievements would reach a point where a weapon would be developed that could kill all Thisseras in one fiery blast. The reptiles tried peace negotiations for decades, but

climbing above one's racial past is difficult. Eventually, mutually agreeable pacts were signed and all Thisseras learned to live in peace. They turned their warrior spirits to sports and friendly competition on every level of society, business and pleasure. The reptilians organized extensive competitions of all kinds to challenge themselves. These events were satisfactory for a long time.

Space exploration became their next great conquest. Thisseras were at last able to travel the galaxy freely. The prospect of competing with a multitude of other races united them like never before. Shortly after entering the spaceways, they encountered the equally competitive **Miceans** (see mineral aliens). Like the Miceans, the Thisseras are glory-hounds who feed on fame, prestige and notoriety. These two races engaged in fierce but friendly competition for decades. Both came to respect and like each other very much.

Then one fateful day, the Micean Council proposed a partnership in which the two races would form an intergalactic police organization and become heroes of the universe. It would provide them with thrills, adventure, and an audience for their incredible exploits, daring-do and achievements on a grand scale. At first the competitive Thisseras debated and hesitated. A partnership suggested that they might not get their fair share of the limelight. The debate came to an end and the reptilians cheerfully agreed when the Miceans suggested the name of their organization as the Thissera-Micean Cooperative (a.k.a. TMC). Getting top billing satisfied their ego and the long-time friendly rivals joined forces. Both the Thisseras and Miceans now compete against each other to see who can defeat and bring to justice more criminals and super villains. This has actually made them an aggressive and effective police force, with each act of courage or daring inspiring the other to equal or surpass it. The only down side is that these champions of justice don't know when to retreat, take foolish risks, and sometimes underestimate their opponents. They can also be insufferable braggarts and swaggering egomaniacs.

Thisseras (pronounces thiss-ser-rass)

Alignment: Any, but most lean toward good or unprincipled.

Attributes: I.Q. 3D6, M.E. 3D6, M.A. 3D6, P.S. 3D6, P.P. 3D6+4, P.E. 4D6, P.B. 2D6, Spd. 5D6

Hit Points: Standard, P.E. plus 1D6 per level of experience.

S.D.C.: 2D4×10+40

Horror Factor: 10

Height: 6 feet plus 3D6 inches (1.6 to 2.3 m).

Weight: 100 plus 2D4×10 pounds (54 to 82 kg).

Average Life Span: 175 years. **P.P.E.:** 1D6

Super Abilities: The typical Thisseras have the following super abilities: Chameleon, healing factor and super vision: nightvision. A rare few (01-15%) can select two additional minor powers or one major, while others (01-10%) have psionic powers instead (create latent psionic normally) or no powers (create hardware character as normal). All have extensive combat, espionage/military and crime-busting training.

Natural Abilities: Can leap 12 feet (3.7 m) high or length-wise (double with a running start), instinctive climbers (85%/80%), swimmers (80%), and acrobats (80%), +2 on initiative, +2 to pull punch, +3 to roll with impact or fall. They also has keen vision and hearing; 20 decibels beyond the human range. Poor day vision (200 feet/61 m) and must wear some sort of protective eye-shade or risk being blinded by bright lights and sunshine.

Special Weapons & Vehicles: Any, but most Thisseras are fond of personal, melee-type weapons, and Kisentite swords are especially popular. Fast vehicles with high maneuverability and high speeds, like one-man hover vehicles, are preferred for transportation.

One-Man Hover Car: Maximum Speed: 260 mph (416 km), S.D.C. 200, hovers 3 to 12 feet (0.9 to 3.7 m) above the ground and has excellent maneuverability.

Preferred Armor: Thisseras combat environmental body armor: Light suit: A.R. 14, S.D.C. 80 (no prowl or movement penalties). Heavy suit: A.R. 17, S.D.C. 225, but -15% to prowl, climb, acrobatics and gymnastics skills.

Familiarity with Earth: The extensive operations of the TMC includes some of the space around or near Earth.

Their files contain information on Earth equal to the "Some familiarity" result on the Familiarity With Earth table.

Rifts Note: These reptilian humanoids will be considered D-Bees. The Coalition States will see them as dangerous monsters because they possess super powers and the spirits of heroes. They will try to destroy them whenever they get the opportunity. Thisseras lawmen will get along well with Cyber-Knights and other heroes. They will almost certainly clash with the CS and other villains, including the Minions of Splugorth, Cibolans/Soul Worms, Naruni Enterprises, and the Federation of Magic. They are S.D.C. creatures who also possess Mega-Damage body armor, weapons and technology.

If set in the **Rifts: Phase World** environment, the background presented for **Aliens Unlimited** is appropriate. Most will be lawmen, bounty hunters, adventurers and the occasional mercenary. Any of the mercenary, men at arms, scholar and adventurer O.C.C.s can be selected, although they rarely get bionic, juicer or M.O.M. conversions. They rarely study magic.

Humanoid Vegetation Races

Alien life forms come in all shapes, sizes and structures. Those referred to as *vegetation* are intelligent plant-life. Leaves, vines, bark, algae, and any other matter resembling plants or leaves form the alien's body. Those described in the following pages have the shape of bipedal humanoids, with two arms, two legs, and a head, but others may have multiple vine-like or tentacle-like limbs, or be sedentary like trees. Some may have only large lumps for heads, or fully developed heads with eyes, nose, mouth, and ears (or appendages resembling them). Such features may be the result of evolution in which the plants needed to resemble humans or animals to survive.

Standard Plant Features & Abilities

By Kevin Siembieda

Common Features

Resistance to Pain: Weapons inflict normal damage but the plant being is only about half as sensitive to pain as mammals.

Healing Factor: The plant-like resilience of these aliens means they heal twice as fast as flesh and blood aliens, and can regenerate lost limbs and body parts within 3D4x10 days.

Invisible to Sensors: Even advanced sensor systems cannot differentiate between *sentient* plant life forms and ordinary plants, making sentient forms invisible to sensors. Furthermore, They are cold life forms and will not register as warm-blooded animals on heat sensors or infrared de-

tectors. They are also invisible to mechanical detection when hiding among other plants and may be difficult to see with the naked eye, as they are likely to blend in with surrounding vegetation.

Breathe: Vegetation aliens can breathe through every inch of their bodies. They can wear clothes and armor that restricts most of the body and still breathe normally. While all of this makes them nearly impossible to smother, they are extremely susceptible to *defoliating chemicals*: -5 to save vs gases, sprays and other chemical attacks designed to kill vegetation. However, they are impervious to most drugs and toxins designed to hurt or affect animal life.

Aliens composed of green vegetation do not need to eat in the animal sense. Most feed primarily on sunlight/solar energy and water (some need minimal water to survive, while others need more). Some may feed on radiation rather than light. Most plants turn radiant energy (from the sun or artificial sources) into food. Use the same feeding and hunger rules given under the Humanoid Mineral section for these aliens.

Plant Body Armor

Most plant beings have a tough outer skin that provides some level of natural protection.

Light/Soft Armor: Resembles the stems and leaves of plants or skins of fruit. Main body: 2D4x10+20 S.D.C. and A.R. 10 (or 65 M.D.C.).

Medium Armor: Tough vines, fibers and resilient branches. Main body: 2D4x10+60 S.D.C. and A.R. 13 (or 110 M.D.C.).

Heavy Armor: Bark, nutshells or strong fibers. Main body: 2D4x10+200 S.D.C., A.R. 16 (or 200 M.D.C.).

Rifts Note: Most plant creatures will be mega-damage creatures with natural M.D. body armor/hit points.

Heightened Senses of Plants

1. Track and maneuver by smell alone: 72% +2% per level of experience. Roll once for every 2000 feet (1200 m). A failed roll means the scent trail is temporarily lost; two successful rolls out of three means the trail has been rediscovered.

2. Identify common, known smells, and airborne aromas: 90%. Range: 2000 feet (1200 m).

3. Remember and identify a specific unusual scent: 80% +1% per level of experience. Range: 1200 feet (365 m).

4. Smell/Sense the coming of rain, smoke and large fires: 50% +2% per level of experience; two mile (3.2 km) range.

5. Accurately sense the wind direction: 68% +2% per level of experience.

6. Accurately sense the time of day and direction (north, south, east, west, etc.): 80% +1% per level of experience but needs sunlight. Without sunlight, reduce the success ratio by 40%.

7. Accurately identify temperature (within 1D4 degrees): 70% +2% per level of experience; includes air temperature.

8. Sense the location of underground water reserves: 40% +2% per level of experience.

9. Feel the vibrations of an approaching ground vehicle(s), giant bot, herd of mammals, giant animals, explosion or earthquake up to six miles (9.6 km) away. Running or walking humans 1000 feet (350 m) away. Flying vehicles or animals 500 feet (152 m) away. +2 on initiative and a +1 to dodge.

10. Hear ultrasonic sounds; super keen hearing: Average range 2000 feet (365 m).

11. Communicate via natural telepathy: Average range is 400 feet (122 m) when communicating with animal life, but extends to 1200 feet (366 m) when communicating with sentient plant life. Typically this is an automatic ability that does not require the expenditure of I.S.P.

Camleans

Camleans are short, corded bundles of thick, green plant fibers on a humanoid frame. They are compact, with burly features that were formed by the powerful gravity of their homeworld, Imle. Their coloration normally ranges from drab browns to bright tans, reds and oranges. They have humanoid heads with slots that resemble eyes. They even have a tiny bird-like mouth at the end of the chin, and like birds, their voices are musical and wonderful to listen to. The lyrical range of their voices has given the Camleans a reputation as singers (and musicians). They are recognized by many in the galaxy as masters of composition and the performers of music and song. All

Camleans are taught to sing by their parents at a young age. Many pursue the arts to their fullest and become musical entertainers. Camlean singers have a powerful reputation to help start their careers, but they also have the greater responsibility in upholding that reputation. Many singers and musical groups are openly welcomed on any planet or space station as special guests, especially worlds that respect the arts, or are governed by nobility — to have music performed by these bards in one's court is a prestigious event. Music has become a big business for some Camleans.

In addition, these beings are attracted to music and they send teams of researchers, explorers and musicians to observe, study and record the musical sounds, songs, lyrics, instruments, events and other cultures on many other worlds. The information gathered from these trips is used for inspiration and variety in lyrical compositions. Many of the finest musical instruments in the galaxy are created and collected by the Camleans.

Despite their reputation for exquisite music, some Camleans have darker personalities. The evil aligned members of the race have sinister uses for their music which match their dark souls. They use music (and their psionic powers) to evoke dark emotions or confusion among their listeners, and spread violence and discord by working crowds into riotous mobs. These villains are usually members of a revolutionary movement within the

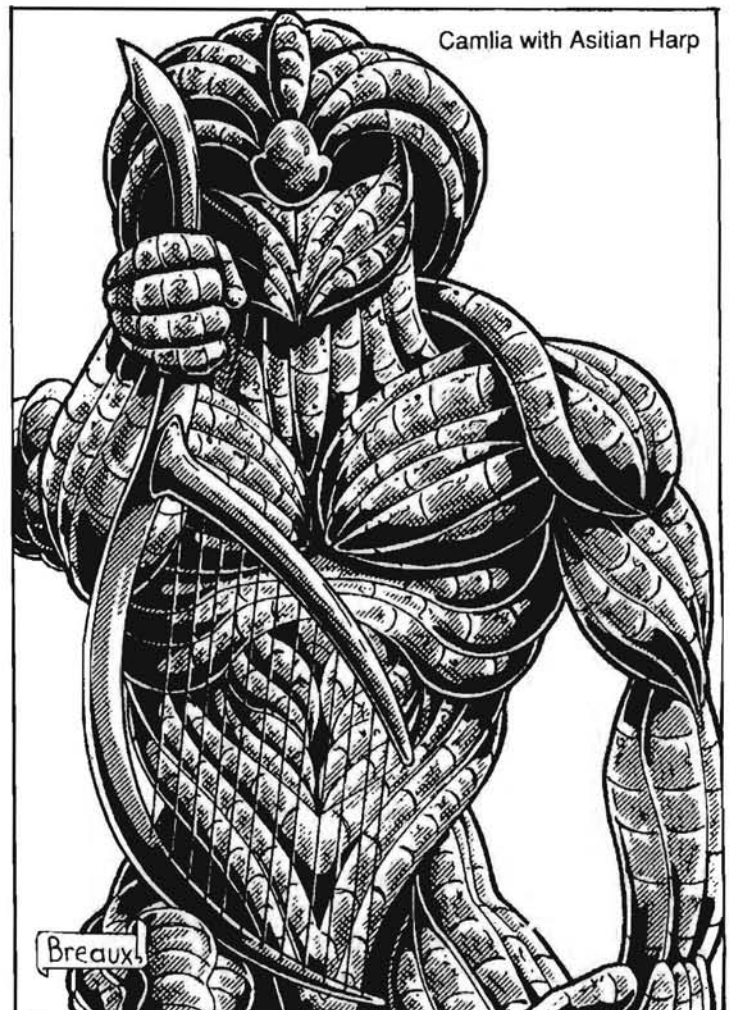

Camlean race. It is clear that they believe themselves superior to animal life, but what their goals are, and the extent of their influence, is not yet clear. Some are just mercenaries or adventurers with little or no interest in music.

Camlean society is much like that of Earth, with cities, states, and nations ruled by a variety of government types. They have soldiers, scientists, engineers, and all of the other members of a diverse modern society. Their technology includes advanced space travel, robots, bionics, and sonic weapons, but much of it has been acquired from other races. Fine quality melee weapons are a favorite of many Camleans. Even those who are not in combat related professions will carry ornamental, but functional, Kisentite weapons. Their love of ornamentation is often present in other aspects of their lives, such as the decorative antigravity suits commonly employed for transportation.

Camleans (pronounced cam-lee-ans)

Alignment: Any, but most tend toward selfish.

Attributes: I.Q. 3D6, M.E. 3D6, M.A. 4D6, P.S. 4D6, P.P. 3D6+2, P.E. 3D6, P.B. 2D6, Spd. 3D6x3

Hit Points: P.E. x2, plus 2D6 per level of experience.

Natural Heavy Body Armor: 2D4x10+200 S.D.C., A.R. 16

Height: 5 feet plus 1D6 inches (1.5 to 1.7 m).

Weight: 100 plus 2D4x10 pounds (54 to 82 kg).

Average Life Span: 400 years. **P.P.E.:** 2D6

Super Abilities: All Camleans, regardless of power category, have the psionic abilities of telepathy, emphatic transfer and mind block (I.S.P. is M.E. x3). Those with full blown psionics (01-33%) are considered natural psionics (get the I.S.P. normally attributed to those characters in addition to the I.S.P. previously noted; In **Rifts**, they are Mind Melters), while others can be hardware (34-66%), robotics/exoskeletons (67-76%), bionics (77-86%; have the usual impact on psionics), super abilities (87-96%) as a result of mutation or experimentation or they can study magic (97-00%).

All have some talent in music or singing and have the following skills automatically: sing (+10%), play musical instruments (+5%, choose one), or writing (music compositions); all are of professional caliber.

Natural Abilities: All common features and heightened senses.

Special Weapons: Can use all kinds of items, but are attracted to laser, sonic and Kisentite weapons and other types of melee weapons.

Special Vehicles: Any, but prefer antigravity devices.

Preferred Armor: Robotic or bionic characters will have armor from their respective category. Other Camleans tend to avoid wearing armor except for environmental suits necessary for space exploration: A.R. 12, S.D.C. 60. However, any armor can be used.

Familiarity with Earth: The diversity of music and cultures on Earth has attracted many camlean investigators to it. Those researchers have collected information equal to the "Has studied Earth" result on the Familiarity with Earth table.

Rifts Notes: In the **Rifts** setting, the Camleans are considered monstrous D-Bees. Most humans and many other mammalian life forms will find the creatures unnerving, despite their beautiful music. The Coalition States will destroy them whenever they are encountered. Slavers will find them attractive as both slave labor and entertainers.

If set in the **Rifts: Phase World** environment, the background presented for **Aliens Unlimited** is appropriate. Most will be vagabonds, entertainers, thieves, bounty hunters, adventurers and the occasional mercenary.



Chianas

These vegetation beings are powerful psionics from a dark world known as Khina. The Chianas are the planet's dominant life form. More than two hundred years ago, the aliens' population was at a critical level. There were so many Chianas that their society and the planet's resources were strained. Raw materials were becoming harder to find, which made prices rise, along with stress and despair. The people were at each other's throats. As their planet reached its limits of population support, the Chianas applied their skills to the development of advanced space drives to colonize other worlds and find new mineral resources.

Many spacecraft would leave Khina in the next few decades as expeditions desperately searched for other suitable planets for mining and colonization.

Meanwhile, riots and mayhem increased on their homeworld. Martial law was declared and the military took over. This military government was still headed by the po-

litical leaders, but they were mostly figureheads who received orders from military commanders. For hundreds of years, the people were ruled and guided by the military. Violence was met with violence. Rebels and criminals were slaughtered to make space for law abiding citizens. After a generation of military control, it became the social structure, and all Chianas learned to live by military law and discipline.

The Chianas' military is the government and protector of its people and possessions. Every citizen is expected to serve 10 years in the armed forces, and is a permanent part of the militia. The military government teaches its people order, self-discipline, self-confidence, obedience, respect for authority and the law, fighting skills and mastery of their psionic abilities. Surprisingly, this military rule is benevolent and also instills self-reliance, compassion, an acceptance of other life forms, and a need for the individual to make sacrifices for the greater good of the majority. It has become a combination spiritual, political, and military force that has brought comparative peace and structure to the people.

Those who left Khina to go to the stars eventually found planets where their people could live, and places to mine and build factories. This has done a great deal to relieve the crisis on their homeworld, and to loosen the extreme control of the military. However, the Chianas still retain their unique military-based government, structure and beliefs. Criminals and rebels are still treated harshly and are either expelled from the community or executed. The Chianas get along well with other races. They respect the laws and customs of other people and are among the most polite and law abiding people in the universe. Many have joined interstellar police forces (including the TMC), while others have become bounty hunters, lawmen, explorers and mercenaries. They are especially hard on Chianas who have turned to crime or evil ways.

Chianas (pronounced cheye-anas)

Alignment: Any, but most will be principled, scrupulous or aberrant.

Attributes: I.Q. 3D6, M.E. 3D6, M.A. 3D6+3, P.S. 4D6, P.P. 4D6, P.E. 3D6, P.B. 3D6, Spd. 4D6

Hit Points: P.E. x2 plus 1D6 per level of experience.

Natural Light Body Armor: 2D4x10+20 S.D.C., A.R. 10

Height: 7 feet plus 2D6 inches (2.2 to 2.4 m).

Weight: 195 plus 1D4x10 pounds (93 to 235 kg).

Appearance: Luminous green humanoids, with large, attractive leaves and yellow-green eyes.

Average Life Span: 300 years. **P.P.E.:** 3D6

Super Abilities: All Chianas are natural psionics (instead of latents) and are combat trained (espionage and physical training).

Natural Abilities: All common features and heightened senses. Khina is a twilight world and all Chianas have nightvision out to 1000 feet (305 m), and feed on various types of radiation but not light per se (they do not give off radiation).

Special Weapons and Vehicles: They can use the equivalent of most types of weapons, hover vehicles and spacecraft. Favorite weapons include lasers and

vibro-blades, with antigravity devices as their favorite mode of transportation.

Preferred Armor: Being fully combat trained, the Chianas will often wear additional body armor and environmental suits. Everyday light riot armor will likely be a combat vest (A.R. 10, S.D.C. 50), while more dangerous situations will warrant full environmental body armor (A.R. 15, S.D.C. 180).

Familiarity with Earth: None

Rifts Notes: In the **Rifts** setting, the Chianas are considered D-bees, but most humans and other life forms will find the creatures attractive and friendly. The Coalition States will destroy them whenever they are encountered. Slavers will find them attractive as slave labor, fighters and mercenaries. They are mega-damage creatures with mega-damage technology.

If set in the **Rifts: Phase World** environment, the background presented for **Aliens Unlimited** is appropriate. Most will be lawmen, bounty hunters, adventurers and mercenaries.

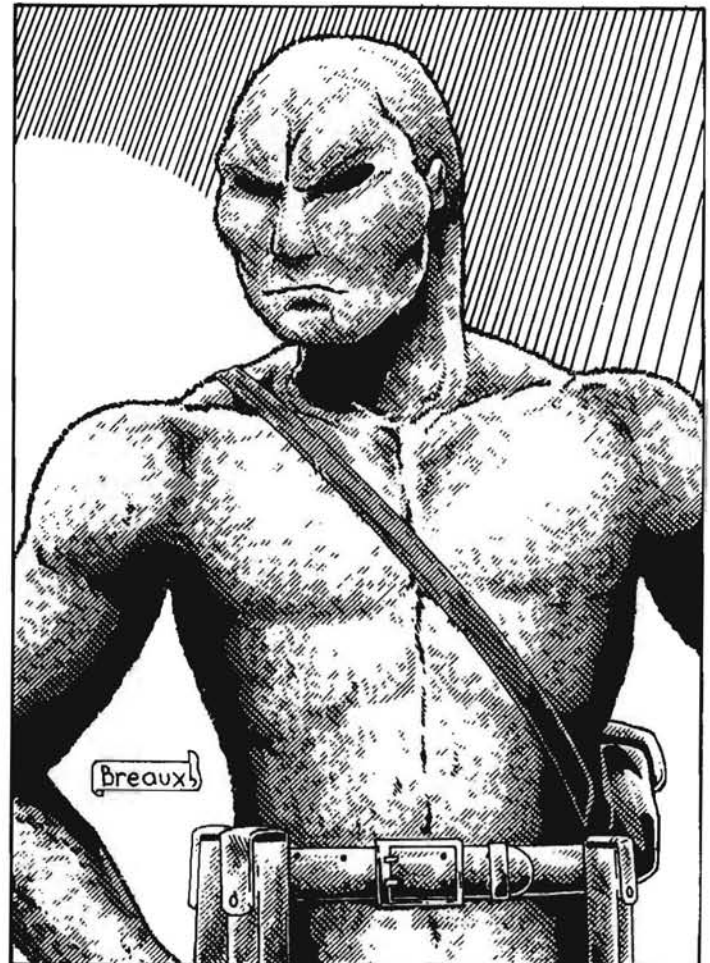

Erythros

The Erythros are a mysterious race of humanoids composed of brown and dull green vegetation. They are of average humanoid height, and their bodies are covered with tiny leaves and lichen-like fuzz. Their heads are very human-like, with obvious eyes, a nose and a mouth, but this all changes when they are angered or forced to defend themselves. The fine lichen grows to amazing bulk and

thickness and each fine leaf blossoms into a weave of protective armor. The Erythros increase in size and S.D.C., and towers 60 feet (18.3m) tall! As giants, they are unaffected by heat or cold (including plasma and magic) and their normal S.D.C. is increased dramatically!

There are very few of these plant aliens in the galaxy, which sparks many speculations on their origin. Many people believe the Erythros are either a new race in the galaxy, or are members of a dying one, because there are so few known to exist and they are scattered throughout outer space. In truth, they are the survivors of a war in another galaxy. The Erythros were engaged in a war with the insane cyborgs known as the Mechanoids (See **Rifts Sourcebook Two: The Mechanoids**). Like all races who oppose the Mechanoids, the Erythros were losing. They had hidden their last large military base near a black hole to help conceal it from their enemies, but the unrelenting cyborgs found them. One of their large military space stations was thrown out of orbit by a Mechanoid attack and drifted off as the battle continued. The drifting station was pulled into the black hole and was subjected to a space (and time?) warping anomaly that flung them in to the Milky Way galaxy. Other Erythros may have escaped the Mechanoids' onslaught, but are scattered across the universe.

The few thousand in the Milky Way have decided to rebuild their race. While some search for a new world to inhabit, most have found a place living with other beings. However, such alliances are tentative. No one is sure about the Erythros' goals or motives, but the fact that most oppose the Atorian Empire helps to quiet many doubts. These Erythros oppose the Empire because it reminds them of the Mechanoids, and they are angered by any race that seems bent on intergalactic conquests, slavery and war. They will not let another maniacal race destroy their last chance for survival.

They know how to use advanced weapons, vehicles and computers, which seems to confirm that they were a technologically advanced race. The quality of their space station (what survived) is also an indication that their tech-level was high. By selling the remains of their space station as scrap and through work as mercenaries and bodyguards, many have purchased spaceships and equipment to explore their new galaxy. There are several small fleets of spacecraft and mercenary troops under the command of Erythros forces.

Erythros (pronounced ear-ee-throws)

Alignment: Any, but most seem to be selfish.

Attributes: I.Q. 3D6, M.E. 3D6, M.A. 2D6, P.S. 5D6, P.P. 3D6, P.E. 3D6, P.B. 2D6, Spd. 3D6

Hit Points: P.E. x3, plus 1D6 per level of experience.

Natural Light Body Armor: 2D4x10+20 S.D.C., A.R. 10; increase when giant (see the super ability *growth*).

Height: 5 feet plus 3D6 inches (1.6 to 2.0 m).

Weight: 150 plus 2D6x10 pounds (77 to 122 kg).

Average Life Span: 700 years. **P.P.E.:** 2D6

Super Abilities: Erythros are all from the power category of Super Abilities. They all have the major super ability *growth* and the minor super ability *impervious to fire*

and heat. There is a 01-30% chance that the character can have one other minor ability.

Natural Abilities: All common features and heightened senses, numbers 1-8.

Special Weapons and Vehicles: They can use the equivalent of most types of weapons, hover vehicles and spacecraft. Favorites weapons include lasers and Vibro-Blades, with antigravity devices as their favorite mode of transportation.

Preferred Armor: Rarely use any, except environmental suits for hostile environments, or as a disguise.

Familiarity with Earth: Only what they have heard from others, which is not much; equal to the "some familiarity" result on the Familiarity With Earth table.

Rifts Notes: Basically the same as the Camleans. They are Mega-Damage creatures with Mega-Damage technology.



Kisent

Phorila is a scorching, thermal planet currently on the edge of the Atorian Empire. What isn't desert or volcanic wastelands is covered in lush tropical forests. Deep within its crust, flows molten rock at temperatures beyond those of other planets. This heat causes pockets of intense pressure to build which eventually explode as violent volcanoes. Within those high pressure areas, are incredible thermal forces that compress the normal metal densities and create incredibly strong substances. Nearly a century

ago, the Kisent aliens discovered and perfected the process for forging these metals using high technology (laser forge). As a result, the metal known as *Kisentite* was named after them.

The Kisent are vegetation aliens of average humanoid height and build with a leaf-like crown on their heads. Their body colorations are a variety of browns with green, and green highlights. Their humanoid frames are covered in a hard skin reminiscent of bark. Kisent are otherwise very humanoid in appearance with five fingered hands, full featured faces (eyes, nose, mouth, ears), and loose, leafy hair.

Their technological level is highly advanced and includes robotics, microwave weaponry, and advanced space travel. Their laser forges are considered the best in the galaxy, and they have also developed specialized particle beam forges that help to create Kisentite weapons of unsurpassed quality. Kisent-forged weapons are perfectly balanced (+1 to strike and +2 to parry) and expensive (triple the cost of normal steel weapons). Although the aliens are best known for their melee weapons, they produce nearly every type and class of weapon from Vibro-Knives to plasma cannons. The Kisent logo on any weapon insures its quality, durability, and high price.

All educational backgrounds are found in Kisent society. Despite their massive manufacture of weaponry, their armed forces are no larger than average for a humanoid race. They make up for size, however, by using top quality equipment. They are ruled by a powerful Council of Direction that runs the planet like a giant corporation. After the forging of Kisentite was perfected and space travel assured, the Council began what could only be called a marketing campaign. Their efforts have firmly established the Kisent as top quality galactic weapons manufacturers, and that reputation has endured for centuries.

Kisent (pronounced kiss-sents)

Alignment: Any, but most are selfish and aberrant evil.

Attributes: I.Q. 4D6, M.E. 3D6, M.A. 2D6, P.S. 3D6+2, P.P. 3D6+4, P.E. 3D6, P.B. 1D6, Spd. 3D6

Hit Points: P.E.x3

Natural Heavy Body Armor: 2D4x10+200 S.D.C., A.R. 16

Horror Factor: 10

Height: 5 feet plus 4D6 inches (1.6 to 2.1 m).

Weight: 130 plus 2D6x10 pounds (68 to 113 kg).

Average Life Span: 400 years. **P.P.E.:** 1D6

Super Abilities: The Kisent aliens can be from a number of Super Power Categories: Bionics, robots, hardware, experiments, and magic.

Natural Abilities: All common features and heightened senses. Being aliens from a thermal world, they resistant to fire and heat (half damage), but they will suffer from exposure at temperatures of 90 degrees Fahrenheit (32 C) or less as detailed under the frozen world description. A survival suit must be worn to offset those effects (See the Equipment section).

Special Weapons and Vehicles: They use and manufacture the equivalent of most types of weapons, vehicles and spacecraft. Favorites weapons include Kisentite melee weapons and microwave blasters.

Preferred Armor: Types of armor worn will vary with the character's occupation and needs.

Familiarity with Earth: The Kisent have information on Earth equal to the "some familiarity" result on the Familiarity With Earth table.

Rifts Notes: In the **Rifts** setting, the Kisent are considered monstrous D-bees. Most humans and many other mammalian life forms will find the creatures unnerving, and many of these plant beings will engage in mercenary or criminal activities. The Coalition States will destroy them whenever they are encountered. The Splugorth will find them attractive allies as assassins, warriors, gladiators and weapon designers. They can be any O.C.C. except psionic.

If set in the **Rifts: Phase World** environment, the background presented for **Aliens Unlimited** is appropriate. Most will be weapons merchants, bounty hunters, mercenaries and adventurers. They represent competition to Naruni Enterprises, the Splugorth and others, except that they have not yet mastered dimensional travel. They are Mega-Damage creatures with Mega-Damage technology.



Lachinelians

The Lachinelians are a race of vegetation aliens from the planet Arachin, which is composed entirely of radioactive elements. The environment is deadly to most animal life, but the Lachinelians have evolved, and thrive in their irradiated habitat. Despite the radiation, there are only two

common mutations. One is the growth of bulbous matter on their bodies. The bulbs are perfectly harmless and do not interfere with normal movement or health in any way. They have become an accepted trait among the aliens. The second mutation is a mental change that results in a high amount of psionic abilities.

Magic is common on Arachin and a large portion of the people study and use it, especially in everyday applications like farming and construction. The majority of the Lachinelian military is composed of mystics and psionics. Although their technological level is only equal to that of 19th Century Earth, their special abilities make them extremely formidable.

Despite their psionic and magic powers, the Lachinelians have fallen victim to raids by alien invaders who capture their people and enslave them. Such raids came to an end when the reptilian toogarth invaded (see **Villains Unlimited** for details on the Toogarth Empire and people). The invaders' advanced technology, natural abilities, and relentless drive overwhelmed them. They have since been forced to become part of the Toogarth Empire. The reptilians wanted the abundant radioactive elements in Arachin's crust to fuel their armada's nuclear drives. The conquered Lachinelians work for the toogarth, mining and refining ores and other mineral resources, and some continue to be sold into slavery by their new masters.

Escaped and liberated Lachinelians can be found roaming the galaxy. Most are vagabonds, mercenaries or adventurers. Some have a price on their heads and are pursued by Toogarthian bounty hunters. Others can be found across the galaxy performing services and conducting business as slaves.

Lachinelians (pronounced: la-chin-nel-eye-ans)

Alignment: Any

Attributes: I.Q. 2D6+1, M.E. 3D6, M.A. 2D6, P.S. 5D6, P.P. 3D6, P.E. 3D6, P.B. 1D6, Spd. 4D6

Hit Points: P.E. x2, plus 2D4 per level of experience.

Natural Heavy Body Armor: 2D4x10+60 S.D.C., A.R. 13

Horror Factor: 12

Height: 6 feet plus 1D6 inches (1.8 to 2.0 m).

Weight: 150 plus 1D6 pounds (68 to 71 kg).

Average Life Span: 375 years. **P.P.E.:** 3D6

Super Abilities: All Lachinelians have the psionic powers of empathy, mind block and resist fatigue, with an I.S.P. base of M.E. x3. These characters can also study magic and learn various occupations (normally quite primitive, but as slaves many have learned a variety of modern skills).

Most (01-35%) have natural psionics (mind melters in **Rifts**) and have all the I.S.P. and abilities available to that power category, plus those already detailed. Some (36-50%) have two of the following super abilities as well as the psionics common to all: Chameleon and plant control or control radiation (pick one). A significant number do practice magic (51-80%), and the remaining plant people have no special powers (81-00%; bionics and hardware).

Natural Abilities: All common features and heightened senses, numbers 1-7. Their high radiation homeworld

has made them immune to the effects of radiation, but their bodies give off low levels of it to the environment around them. Anyone exposed to them for more than two weeks is likely to suffer from radiation exposure (see the high radiation world description for details on radiation poisoning). These aliens can also see into the ultraviolet spectrum of light.

Special Weapons and Vehicles: They can learn to use most types of weapons and vehicles, but only the most intelligent can pilot aircraft, spaceships or operate complicated devices.

Preferred Armor: Types of armor worn will vary with the character's occupation. Mystics often have protective spells, and some psionics can summon S.D.C., so they often do not need to wear armor.

Familiarity with Earth: None.

Rifts Note: They are mega-damage creatures.

Sprekalians

The Sprekalians are natives of the planet Rikal. The abrasive atmosphere of the planet has made them into physically hardy specimens with a tough, bark-like skin and resilient bodies. They are a tall, imposing people, traits which tend to belie their highly technical advancements. The Sprekalians have mastered space travel, robotics, and many other sciences.

Thilik-3 is a drug developed by sprekalian scientists from the beneficial Thilik and Thilik-1 series. The medicinal use of these drugs is as a kind of steroid to boost a patient's resilience and increase healing. Thilik-3 builds on that, and adds heightened reflexes and powers to the results. The negative aspect of it is that recipients of the customized drug develop insanity, psychotic tendencies and anti-social behavior. It became very popular with gangs and illegal enforcers, and became so widespread that the police could not handle the great numbers of criminals juiced on Thilik-3.

A government committee decided it was necessary to form an Anti-Thilik branch of their Illegal Substance Enforcement Agency. The Ikta were created as a special Anti-Thilik assault division. Sprekalian volunteers were subjected to special government experimentation procedures that gave them super abilities to combat the users of Thilik-3.

The hundreds of Ikta went to war with the illegal Thilik-3 makers, dealers and users. Twenty years later, they were so successful that most Thilik dealers left the planet or stopped dealing. The government has declared the Thilik threat over and has reassigned many Ikta to positions off-world. Their super abilities made them better candidates for the demands of space travel and for dealing with hostile aliens. Some pursue Thilik dealers and criminal users off-world. Some are liaisons with other police forces (including the TMC) or military forces. Others have become mercenaries, criminals or freebooters themselves. Only a small Ikta force remains on Rikal.

Thilik-3

Duration: 2D4 hours



Cost: Varies greatly depending on availability, but never less than 500 credits.

Effects: The drug has the following effects on Sprekalians and vegetation aliens with similar physiology:

1. Insanity: Unsettles the psyche, resulting in temporary insanity. Use the crazy hero *Random Crazy Elements Table* and rules for villains using Thilik-3 (see page 19 of *Heroes Unlimited*). At first, the craziness wears off when the drug does, but frequent and long-time users of more than six months, will be driven permanently insane. In addition to the crazy hero tables, long-time users and addicts should roll once on the affective disorder table and once on the phobia or obsession table. All of them tend to be suspicious of others and prone to acts of violence and cruelty (anti-social).

2. Heightened Awareness & Reflexes: +2 attacks/actions per melee round, +3 on initiative, +2 to strike, +3 to parry and dodge, +3 to roll with impact, +4 to P.S., and +6 to speed. All bonuses and increases are temporary and disappear when the drug's duration lapses.

3. Super Abilities: There is a 01-42% chance of a random major power manifesting itself (pick one when applicable, abilities may change with each use of the drug). Abilities are limited to: Alter physical structure (any), disruptive touch, gravity manipulation, control radiation, magnetism, and divine aura.

Powerball

Thilik-3 has recently appeared as a drug for animal humanoid life forms. It is called *Powerball*. When they use it, the following effects occur:

Duration: 2D4 hours

Cost: Varies greatly depending on availability, but never less than 500 credits.

1. Insanity: Same as above, but is permanent after two months of use.

2. Heightened Awareness & Reflexes: +1 attack/action per melee round, +4 on initiative, +3 to strike, +4 to parry and dodge, +6 to save vs Horror Factor (fearless unless insanity dictates otherwise), +6 to P.S., +10 to Spd, and can leap 10+1D4 feet (3.0 to 4.3 m), fatigues at 20% the normal rate and has an additional +1D4x10 S.D.C.! All bonuses and increases are temporary and disappear when the drug's duration lapses.

3. Hyper: The character becomes a ball of energy with superhuman endurance (see S.D.C. bonus above), and no need to sleep or eat (this effect lasts 3x the normal duration). Unfortunately, the need to release that energy usually results in physical violence. Daredevil stunts are also a way these crazies vent energy; leaping from rooftops and speeding in vehicles are common.

4. Addiction, Side-Effect & Penalties: Powerball is instantly addictive to humans and most other animals, requiring daily fixes. Permanent insanity occurs after two months of use. The character also has trouble sleeping and must eat more frequently to compensate for the energy that is burned up. **Penalties:** Reduce P.B., P.E. and M.A. by 20%. Most addicts will die within 2D4 years. Many aren't aware of this yet, but if they find out, it will only add to their reckless and violent life style. Super powers are not instilled in non-plant beings.

Sprekalians (pronounced sprek-ah-lanes)

Attributes: I.Q. 3D6+2, M.E. 3D6, M.A. 3D6, P.S. 3D6, P.P. 3D6, P.E. 3D6, P.B. 3D6, Spd. 3D6.

Hit Points: P.E. x3 plus 2D6 per level of experience.

Natural Heavy Body Armor: 2D4x10+200 S.D.C., A.R.

16. **Alignment:** Any

Horror Factor: 13. **P.P.E.:** 3D6 or by Magic Category.

Height: 8 feet, 6 inches plus 3D6 inches (2.7 to 3.0 m).

Weight: 360 plus 2D4x10 pounds (172 to 199 kg).

Average Life Span: 500 years

Super Abilities: Sprekalians can be any of the following power categories: Bionic, robot (typically exoskeleton or vehicle), hardware, physical training or magic. Only the Ikta, created through super power inducing experiments and those who use Thilik-3 possess super abilities.

Ikta characters can select two major abilities or one major and two minor super powers. They also have the following bonuses: +2 on initiative, +2 to save vs Horror Factor, +2 to pull punch, +2 to roll with impact, +5 to save vs any chemical/drug/toxin (includes helpful drugs), recognize and identify plants at 88%, and add 1D4x10 to S.D.C.

Natural Abilities: All common features and heightened senses, numbers 5-11.

Special Weapons and Vehicles: They use and manufacture the equivalent of most types of weapons, vehicles and spacecraft.

Preferred Armor: Types of armor worn will vary with the character's occupation and needs.

Familiarity with Earth: The Sprekalians have information on Earth equal to the "some familiarity" result on the Familiarity With Earth table.

Rifts Notes: Similar to the Chianas.



Tedeschians

The Tedeschians are a race of tall plant beings from the low gravity planet Odach. Their limbs are long and tapering, and their bodies are covered by a light green, smooth, bark-like skin that resembles insect chitin. Their heads are large and oblong, and their hands and feet have only four digits. They were once a very scientific people. Their homeworld's close proximity to a black hole made them one of the premier researchers on this phenomenon. Scientific minds from many worlds came to Odach to study the anomaly. Yet black holes were not the only area of study that interested the Tedeschians. All sciences, including magic, were explored by these inquisitive beings. With time, magic became quite prominent, especially in exploration and the military.

They were at a high point in their evolution and development, then they began to die. Slowly and inexplicably, something crept through the populace, until a wide-scale epidemic began to devastate tens of thousands. The Tedeschians and hundreds of scientists from around the galaxy worked furiously to discover the cause and a cure. They quickly came to realize that the cause was a microscopic parasite. This began a futile war of medicine against the deadly microbes. Even magical spells and rituals had no effect. Other races were unaffected, except for

those composed of plant-like matter. In an uncharacteristic gesture of compassion, the Atorian Empire sent representatives to assess the situation and offer help. They were worried the epidemic might spread, until they realized that the parasite only attacked vegetation aliens. Many suspect the Atorian scientists only offered help to get some samples for their bio-weapons division.

The number of fatalities escalated and the scientists grew frustrated. They had identified the culprit, but they still could not figure out a way to counteract it. Then, as the native population of Odach dwindled to a few thousand, the dying suddenly stopped. The survivors were not infected and none of them had physically suffered from the epidemic. Follow-up research discovered that the microscopic killer was the product of genetic experimentation that had gotten out of control. The survivors, swore to forsake genetic research and have reduced their pursuit of all sciences in favor of magic.

The survivors have rebuilt, but even 148 years later, much of the planet is a ghost-town, still littered with abandoned cities and towns. They can relate to the plight of the homeless and have invited different groups of refugees to share their world with them. Many have accepted their kind offer. **Note:** Only about 1.7 million Tedeschians exist in the galaxy.

Tedeschians (pronounced the-desh-eye-ans)

Alignment: Any, but most lean toward good.

Attributes: I.Q. 3D6, M.E. 3D6, M.A. 4D6, P.S. 5D6, P.P. 4D6, P.E. 2D6, P.B. 3D6, Spd. 5D6

Hit Points: Standard, P.E. plus 1D6 per level of experience.

Natural Light Body Armor: 2D4x10+20 S.D.C., A.R. 10

Height: 5 feet, 5 inches plus 1D6 feet (1.7 to 3.5 m).

Weight: 1D4x100 pounds (45 to 181 kg).

Age: live to be 600 to 1000 years old.

Super Abilities: Most surviving Tedeschians (90%) are practitioners of magic. Others are possible, but they are a rarity. **P.P.E.:** As per Magic Category; +10 bonus.

Natural Abilities: All common features and heightened senses.

Special Weapons and Vehicles: They use and manufacture the equivalent of most types of weapons, vehicles and spacecraft.

Preferred Armor: Types of armor worn will vary with the character's occupation and needs.

Familiarity with Earth: As a result of the extensive search for a cure, Odach now contains the most extensive library of information on the galaxy's various planets and their inhabitants. Their database on Earth has information equal to the "Has studied" result on the Familiarity With Earth table.

Rifts Notes: Similar to the Chianas. Many are humanitarians and explorers.

Galactic Monsters & Evil Beings

The variety of evil and predatory creatures in space is greater than the number of the intelligent humanoid races. Some of the more notable, powerful, or legendary of them are presented in this section. Many of them will combine the aspects or abilities of several super power categories. As a result, they are not available as player characters unless specifically stated and defy the norm.

Note: Additional supernatural beings, entities and monsters can be found in **Beyond the Supernatural** and **Mystic China**, as well as **Rifts** titles (particularly *Rifts Conversion Book One* and *Rifts Dimension Books*), but the latter will require conversions to the S.D.C. damage rules.

Rifts Note: In a **Rifts** setting, these beings will be Mega-Damage creatures with Mega-Damage powers, magic, weapons and technology unless noted otherwise.



Brakkana

The Brakkana are supernatural beings of an unknown origin. They are giant, muscular, demonic humanoids with arms that end in slashing scythe-like blades. Their eyebrows and foreheads are protected by bony ridges, and the head is crowned by two large, downward turned horns. The maw is disproportionately large and filled with sharp teeth. The eyes are white slits. The horrible creatures are truly befitting the identification of "monsters." They are no-

toriously aggressive, savage warriors who kill for pleasure and torture captives. They eat humanoid flesh and seem to prefer humans and other mammals. The Brakkana have settled on several planets and do not appear to have a homeworld in this galaxy, but many also wander the spaceways as Mercenaries, pirates, assassins and murderers.

They show little interest in the arts and sciences, relying almost entirely on their magic and supernatural powers. Likewise, while they sometimes congregate in armies and large groups, they are not social creatures and bicker and fight amongst each other constantly. The most powerful rule, making intimidation and brute force (occasionally cunning) the way to success. Many scientists have noted that the Brakkana are feral predators who use their instincts and natural abilities to survive. As such, they are natural hunters who often eat what they kill, even humanoids.

Brakkana are prized by some for their size, strength, and magic. They can be trained for guard work, gladiatorial combat, and other roles that require magic, brute strength or ruthlessness. However, they are difficult to control, because they really only respect power and cruelty. They are best as the savage minions of other supernatural powers (especially alien intelligences, godlings and demon lords). There are rumors that the Atorian Empire has an elite force of Brakkana warriors working for them and one of the Empresses is said to have one as her personal bodyguard.

Brakkana (pronounced Brah-con-na)

Alignment: Evil or selfish, but usually Miscreant or Diabolic.

Attributes: I.Q. 2D6*, M.E. 3D6, M.A. 2D6, P.S. 5D6+6, P.P. 4D6+3, P.E. 4D6, P.B. 1D6, Spd. 6D6; supernatural P.S. and P.E.

* Roll another 1D6 when an 11 or 12 is rolled. These more intelligent Brakkana are often the leaders, advisors and spies of the race.

Size: 8 to 10 feet tall (2.4 to 3.0 m)

Weight: 400 to 600 pounds (181 to 272 kg).

Hit Points: 1D6x10

S.D.C.: 4D6x10

Natural A.R.: 15

Horror Factor: 15

Average Life Span: 1000 years. **P.P.E.:** 2D4x10.

Disposition: Most are mean, vindictive, and barbaric.

They will eat nearly anything, and weaker humanoids are always in danger of becoming dinner. The more intelligent members of the species are still gruff, but more cunning and civilized. Leaders often have some twisted, demonic honor code, but not always.

Experience Level: Not appropriate. Spells are cast at 4+1D6 levels of experience.

Natural Abilities: See the invisible (a sort of thermal optic, infrared sight), impervious to heat and fire, track by smell 66%, can smell blood a mile (1.6 km) away (and follow the blood scent at 78% efficiency), bio-regenerate 3D6 hit points/S.D.C. per minute, poisons and drugs only do half damage, can leap 25 feet (7.6 m) and seem to magically understand all languages.

Power Category: Alien Mystic equal to 4+1D6 level experience (leaders get an extra 1D4).

Spells: Limited to breathe without air, call lightning, fire ball, dispel magic barrier, Mystic shield, paralysis: lesser, speed of the snail, eyes of the wolf, fly as the eagle, teleport (self), chameleon, tongues, and wall of flame, plus two spells of choice. Leaders will have an additional 2D4 spells. **P.P.E.:** 4D4x10.

Combat Skills of Note: Paired weapons and W.P. sword.

Attacks Per Melee Round: Six (6)

Bonuses: These are in addition to possible attribute bonuses. +3 on initiative, +2 to strike, +4 to parry, +1 to roll with punch, fall, or impact and +6 to save vs Horror Factor.

Originating Alien Environment: Abrasive Atmosphere

Education Level: Not really applicable, but the more intelligent ones can have the equivalent of a General Studies or Combat Specialist education, while the average Brakkana will know 2D4 skills from the categories of communication, domestic, espionage, and physical (in **Rifts**, rogue and wilderness are also available).

O.C.C. Bonus: None

Weapons: The Brakkana's arms naturally end in long, sickle-like blades; they have no hands. The natural weapons do 3D6+P.S. bonus each for damage. Some have enhanced them with bionic metal blade versions such as Kisentite. Vibro-Blades add +1D6 damage and energy blade replacements add 2D6 damage.

Vehicles: Do not use them (no hands) but can be chauffeured places.

Armor: None. They rely on their natural armor rating.

Cyklops-Serpentmen

Optional player character race.

Based on drawings and ideas by Eric Breaux.

The Cyklops-Serpentmen are a race of giant, multi-limbed humanoids with huge, bat-like wings, twin snaking tails, four arms and one great eye in the center of their ugly heads. The mouth is filled with fangs and sharp teeth, and a thick mane of hair frames the head. Skin color is light blue with violet striping. The tails give them exceptional balance and stability in combat, both on the ground and in the air. Despite the name "Serpentmen," a Cyklops warrior can be a male or female

The Cyklops are a race of skilled warriors that enjoy testing their abilities against all who dare to challenge them. They are very intelligent, and many work as Mercenaries, soldiers, pirates, hit men, bodyguards, bounty hunters, heroes and adventurers. They usually choose a profession that gives them numerous opportunities to

show their prowess in battle. Despite their monstrous appearance, the Cyklops-Serpentmen have a natural enmity with most so-called demons, alien intelligences, Brakkana, and other supernatural monsters.

Many Cyklops will live by some sort of strict personal code of honor. These codes vary from individual to individual and the Game Master and players are left with free rein to detail them to suit their characters. Characters who live by a code of honor will be Aberrant, Principled or Scrupulous in alignment. Most regard other warriors of comparable skill as equals and respect them for acts of courage, honor and skill. If someone defeats them in combat, the Cyklops will forever after respect that individual unless he does something terrible to discredit himself. Those who win the respect of a Cyklops may also earn his or her undying allegiance or friendship.

Some Cyklops-Serpentmen that oppose discord and chaos have joined the Atorian Empire because it represents strict order, unity (forced and otherwise) and strength, but others who cannot tolerate oppression have sided with, or secretly help the Niamese Coalition, FAR, and others who oppose the Empire.

Cyklops-Serpentmen

(pronounced sigh-clops-sir-pent-men)

Optional Player Character: G.M.'s discretion.

Alignment: Any, but tend toward aberrant evil or principled good.

Attributes: I.Q. 3D6+3, M.E. 4D6, M.A. 3D6, P.S. 4D6+20, P.E. 4D6, P.B. 3D6, Spd. 6D6 running or 160 mph flying! P.S. and P.E. are considered to be supernatural.

Size: 18 to 20 feet tall (5.5 to 6.1 m)

Weight: 1,800 to 2,000 pounds (815 to 907 kg).

Hit Points: 2D4x10

S.D.C.: 2D4x100 (Mega-Damage in **Rifts**)

Natural A.R.: 13

Horror Factor: 16

Average Life Span: 300 years. **P.P.E.:** 5D6

Disposition: Cyklops-Serpentmen tend to be quiet mountains of power with deep, regal voices. They are aggressive and react quickly to violence, returning it in kind, but most are not vicious or murderous. Challenges, duels, and physical contests are enjoyed by the giants, especially in favor of settling disputes. Wrestling and fencing are favorite sports, followed closely by target skills.

Experience Level: Average: 4th level (roll 2D4). In **Heroes Unlimited** use the bionic experience table, in **Rifts** use the dragon's experience table.

Natural Abilities: Swimming 80% and does not need to breathe. Immune to gases and inhaled substances, regenerates a lost eye within 10+2D6 days and limbs in 20+4D6 days! The giants are ambidextrous with both pairs of arms, and their tails are prehensile and can be used to strike, entangle or hold.

Power Category: Super Abilities

Major Super Abilities: None

Minor Super Abilities: Multiple limbs: arms, multiple limbs: tail, flight: winged (leather), extraordinary physi-



cal strength, advanced sight and healing factor (in addition to the regenerative powers mentioned previously). Cyclops-Serpentmen do not roll for additional super abilities.

Combat Skills: Hand to hand: expert, boxing, wrestling, and paired weapons.

Attacks Per Melee Round: Eight! And 9 in flight!!

Bonuses: These are in addition to possible attribute and hand to hand bonuses, but they do include super ability bonuses. +5 on initiative, +3 to strike (+6 in flight), +4 to parry (+7 in flight), +4 dodge (+9 in flight or hover, +11

when faster than 90 mph/144 km), +6 to roll with punch, fall, or impact, pin/incapacitate on natural 18, 19, or 20 (if declared), +4 to save vs Horror Factor, +3 to save vs magic, psionics and toxins.

Originating Alien Environment: Toxic Atmosphere.

Education Level: Combat Specialist

Scholastic Bonus: +15%

Common Skills: Physical: Those listed above, plus fencing and acrobatics (used in aerial combat); Weapon Proficiencies: W.P. knife, W.P. targeting, W.P. sword, blunt, or chain, W.P. energy rifle and/or pistol, W.P. heavy (this is a common selection). First aid, and six secondary skills. Secondary skills are normally those that are necessary, plus vehicle and language skills.

Weapons: The Cyklops love weapons, especially archaic and melee types. Because of their immense physical size, the giant weapons they employ do an extra 2D6 damage. Again, because of their size, they are able to wield large weapons, including large machineguns, vehicle mounted weapons and occasionally even artillery cannons (must have a supernatural P.S. of 30 or greater).

Vehicles: Rarely used, but some Cyklops do have an affinity for technology and like to hitch rides on large vessels, and like antigravity items when they can get them.

Armor: None; they rely on their natural armor rating and massive S.D.C.

Dark Breeze

These are the horrible creatures the Riathenor pirates have named themselves after. They are ancient creatures of evil that have haunted and tormented the humanoids of many worlds since the beginning of time. They are predatory spirits that drain the very energy and life essence from their victims. The monsters are intangible and move through solid doors and walls to hunt down their prey. Their intangible nature also means they cannot lift and carry physical objects. They are tangible on the astral plane, and their specter-like touch drains the life essence of living beings — they need the equivalent of 50 hit points/S.D.C. per 24 hour period to survive, but many like to gorge themselves on ten times that amount. Without a tangible essence, they are very difficult to kill; psionics, magic and sonic weapons (the latter does double damage) are one's best defense against these monsters.

They appear as monstrous, living, black shadow with glowing white slits for eyes and gaping white openings for mouths. A grey aura of energy radiates around them. When this aura fades, opponents know the Dark Breeze is hurt or starving.

These nightmarish monsters seem most at home in the dark void of space, and worlds brimming with magic energy. The Dark Breeze require no edible food, water, or air to survive, but are energy vampires who feed on the vital life essences of living things. Thankfully, there seem to be few in the universe and most live solitary lives with little interaction with others of their kind. One rarely encounters more than one or two at any given time.

Dark Breeze

Alignment: Miscreant or evil.

Attributes: I.Q. 2D6, M.E. 3D6, M.A. 1D6, P.S. 2D6, P.P. 3D6, P.E. not applicable, Spd. 4D6 — most physical abilities are applicable only when in a tangible state or on the astral plane.

Size: 6 to 8 feet tall (1.8 to 2.4 m)

Weight: None

Hit Points: 1D4x10

S.D.C.: 1D6x10 (represented by the grey aura; double on the astral plane). **P.P.E.:** 2D4x10+22

Natural Armor: Intangible natural state.

Average Life Span: Unknown; may be immortal.

Disposition: Predatory hunter of supernatural origin.

Natural Abilities: Prowl 80%

Power Category: Super abilities.

Major Super Abilities: Intangibility (natural state) and bio-ghost. The Dark Breeze can become tangible only through a great deal of effort and only for a maximum of 10 minutes. During this time the creature can use physical weapons and inflict physical damage with them. It can become intangible at any time.

Minor Super Abilities: None

Psionic Abilities: 4D4 I.S.P.; abilities are limited to empathy, mind block, detect psionics, and astral projection (it is a creature from the astral plane).

Attacks Per Melee: Three (3)

Bonuses: +2 to strike, +4 dodge and +8 to save vs Horror Factor.



Originating Alien Environment: Astral plane

Weapons, Vehicles, and Armor: None

Note: The super abilities and psionics are natural abilities and are not affected by the Negate Super Abilities ability.

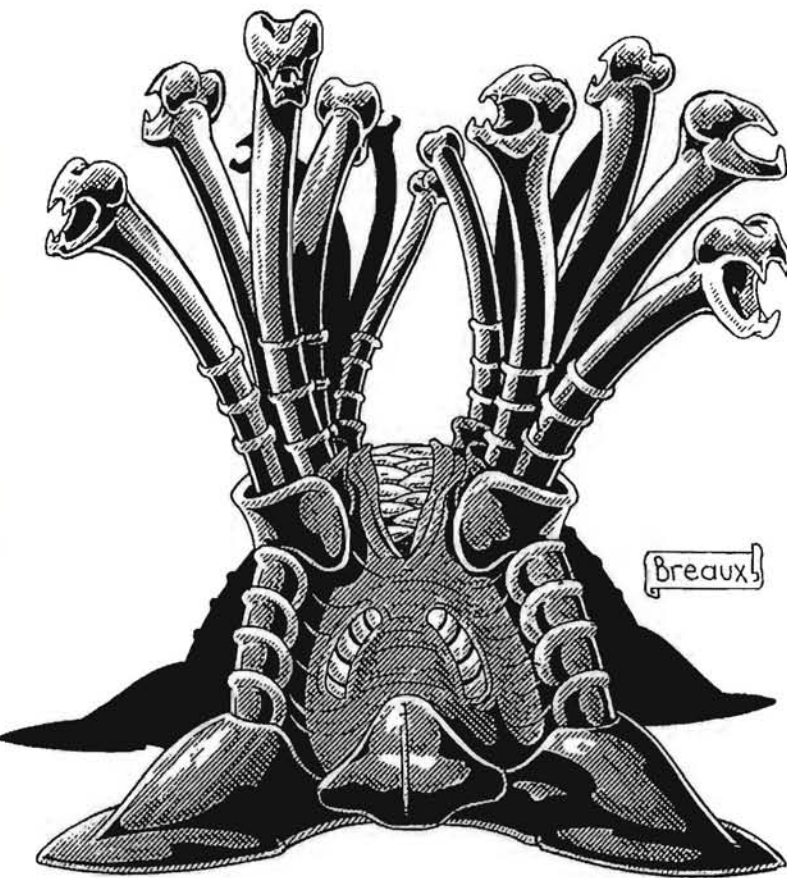

Devourer Mound

These huge creatures are monstrous, carnivorous, plant-like beings nearly five feet (1.5 m) in height. Sixteen long tentacles, each ending in a fanged mouth, surround an oversized maw at its top, and it has moveable plates that cover the base of its body. The mound can move at a slow pace, but on its homeworld, it typically stands stationary, waiting for an animal to get within striking range, and then strikes with 2D4 tentacles and rips its prey apart! The Devourer Mound can extend its tentacles 20 feet (6.1 m). The monster detects its prey through scent and radar.

The mound is little more than an animal predator, but it can be trained to recognize sounds and scents, and actually learn to obey simple commands, passwords and whistles similar to a trained dog. Consequently, they are often taken from their homeworld and used as guards and living defense systems, (after conditioning).

Devourer Mound

Alignment: Considered a miscreant predator.

Attributes: Cunning animal predator I.Q. 2D4, M.E. 4D6, M.A. 1D6, P.S. 4D6+10, P.E. 4D6, P.B. 1D6, Spd. 2D4 (it waddles)

Size: 4 foot (1.2 m) tall body, but tentacles normally extend sixteen more feet (4.9 m).

Weight: 800 to 1,200 pounds (362 to 544 kg).

Hit Points: 1D6x10

A.R.: 11 (natural)

S.D.C.: 2D6x10 main body; 30 per each tentacle.

Average Life Span: 100 years, **P.P.E.:** 2D6x10

Disposition: Predatory hunter

Power Category: Super Abilities

Major Super Abilities: Stretching (tentacles only)

Minor Super Abilities: Radar, heightened sense of smell and healing factor (severed tentacles grow back within 2D4 weeks).

Natural Abilities: Resistant to cold and heat.

Attacks Per Melee: Nine tentacle attacks or one large maw. The tentacles typically skewer and tear apart its prey, shoving pieces into its large maw, but they can also be used to entangle and pull prey into the giant, tooth filled mouth.

Fanged tentacles do 2D6 damage per strike/bite or 1D6 for a whipping strike. The large maw does 5D6. Tentacles release their hold after receiving 15 S.D.C. of damage (they have no A.R.) and are destroyed with 30 S.D.C. of damage.

Bonuses: +1 on initiative, +4 to strike, +8 to parry, impervious to Horror Factor, +6 to save vs poison, toxin or disease.

Originating Alien Environment: High gravity; jungle and forest.

Weapons, Vehicles, Armor: Not applicable

Doppelgangers

Doppelgangers are legendary monsters and demons that can duplicate the form of a person. The reasons for which this is done are varied, but they range from pure survival (easier to hunt) to the accumulation of power (by replacing leaders or those close to them). There are several races across the galaxy that can be classified as Doppelgangers. Each has its own motives and abilities to copy, duplicate, or imitate humanoid life forms. Some are able to simply assume the guise of the person or animal, while others must kill or even eat the victim before they can take its shape. Some are alien beings while others are supernatural horrors. The three races presented here are the most common of the Doppelganger races in the **Aliens Unlimited** galaxy.

Dop-elpeep

These intelligent, evil Doppelgangers were once widespread and powerful within the Toogarth Empire. They slowly infiltrated and subverted the reptile conquerors, but the Zylik, intent on overthrowing the Toogarth themselves, discovered and exposed the Dop-elpeeps' many guises. With the help of the Zylik, the Toogarth were able to exterminate a large portion of these aliens, including their entire homeworld population. Unknown to either the Zylik or Toogarth, hundreds of thousands of the Dop-elpeeps were already spread across the galaxy, building their personal power.

These Doppelgangers are a race of vegetation humanoids. On their homeworld, their ability to copy other life forms is used to help them hunt and hide. When visitors

from the stars landed, they were quickly infiltrated by the Dop-elpoeps. The fiends are amazingly adaptable and intelligent and quickly learned how to use modern weapons and equipment. Some even learned how to pilot spaceships! The advantage of imitating other life forms and specific people meant it took years before anybody realized that the damned monsters were even among them, and by then it was too late. With the cosmos opened to them, the shapechangers had a hundred worlds as their hunting grounds. The curious beings have found space travel, exploration, and hunting to be fun and challenging.

A Dop-elpoep will create a special duplicating chamber, about the size of a closet, in a place he feels is a safe haven/lair. If possible, the lair will be a secret or hidden place.

To create a Doppelganger, the creature secretes a resin that is formed into a roughly humanoid shape. The chamber is then sealed. Once the Dop-elpoep chooses the person or life form it wishes to copy, it will observe that person or race and learn all it can about them. Everything it sees, hears, smells, or touches about the person or form it hopes to imitate is transmitted to the resin in the hidden chamber. The resin form begins to pulse silently and slowly takes on the size, shape, and features of the person observed. The Dop-elpoep is psionic and can even send thoughts and emotions from the target to the resin. Each hour the creature spends studying the target gives the resin a 3% copy percentage. A 99% copy ratio takes two to three weeks. The duplicate does not begin to resemble a specific individual until at least 50% of the copying is done.

When the Dop-elpoep is ready to activate the copy and replace a person, it goes to the chamber and, after an hour of meditation, moves its life essence into the new body. Its old body will live for 2D4 days, and then dies and deteriorates (or can be destroyed sooner). Some enterprising Dop-elpoeps have large chambers with a half-dozen or so bodies in storage just in case. The person it is imitating must be captured, imprisoned or killed in order to take his or her place. Or the creatures can create a body with the general traits of that race but not any one specific person (it can mix and match); this general process also takes half the time it does to make an exact duplicate.

These Doppelgangers are hard to detect, unless a copy was rushed and has a low copy percentage. In such a case, the ineptitude and possible looks of the person will raise suspicion. Otherwise, the two major ways to detect them are through the use of psionics, physical examination and thermal optics. Although the resin body looks and feels normal, it is still a vegetable-based organism and a cold life form. This will show up on thermo-optics and other heat sensors, but nearly all Dop-elpoeps know this, and have developed heat suits or other means of disguise and avoid physical examinations. Psychic characters are also able to detect these creatures with alien thought patterns, and an aura that will seem more plant-like than animal. As creatures of mutable form, they are immune to psionic bio-manipulation, but their delicately balanced copy is dev-

astated by mind wipe. Even the normal application of temporary memory erasure will throw the copy into violent convulsions as its copied form is forcibly erased. Within 1D4 melee rounds, the Dop-elpoep will be returned to its true resin form.

Dop-elpoeps (pronounced dop-el-popes)

Alignment: Any, but most will be evil or anarchist.

Attributes: I.Q. 3D6+1, M.E. 3D6+3, M.A. 3D6, P.S. 4D6, P.P. 3D6, P.E. 3D6, P.B. one less than the copied creature, Spd 5D6.

Size: Can assume sizes from three to 12 feet (0.9 to 3.6 m).

Weight: 160 to 500 pounds (72 to 225 kg).

Hit Points: P.E. plus 2D4 per level of experience.

S.D.C.: 3D4x10



Average Life Span: 2000+ years; potentially immortal, because it can keep transferring its life essence into a new body whenever the old one becomes too worn out or damaged.

Gender: None, these beings can assume any gender. Both males and females can create seed pods that grow into new Dop-elpoeps, but only one can be created every 50 years and they must return to their homeworld to do so.

Disposition: Most Dop-elpoeps are callous and cold from a lifetime of using people. Many are cruel and ruthless cutthroats, but not all. For example, the person copied does not have to be killed. He or she can be captured or even left alone entirely if the Doppelganger is going to travel away from the area (even off-world).

Experience Level: The Doppelganger itself will have its level determined by a roll of 1D6. All skills of the copied person are also copied, but they are used at two (2) levels lower than the original's. The Dop-elpoep only has access to the skills of the copy it is currently in. This is another reason abandoned copies may be kept, to have necessary skills on hand if their use is required.

Natural Abilities: All are natural actors and are able to conceal their emotions, impersonation/acting 90%, disguise 70%, escape artist 70%, create Doppelganger and transfer life essence.

Power Category: Special Doppelganger ability as described. **P.P.E.:** 3D6x10

Super Abilities: Healing factor and energy resistant.

Psonic Abilities: Empathy, telepathy, mind block, alter aura, and see aura.

Attacks Per Melee: Two plus hand to hand combat training of choice.

Bonuses: +2 on initiative, +2 to strike, +3 to parry, +3 to dodge, +1 to pull punch, +2 to roll with punch, fall, or impact.

Originating Alien Environment: Vegetation World

Education Level: General Studies

Scholastic Bonus: +5%

Common Skills: Areas of study can be any, although many choose espionage/military skills, but limited to six main skills and five secondary.

Weapons, Vehicles, Armor: Varies with skills and needs.

Note: When a Dop-elpoep is killed, its body reverts to a sort of plant fiber and resin 3D4 minutes after the moment of death.

Reipoc Doppelganger

Optional player character race

In their natural form, the Reipoc are tall, featureless humanoid with a pale grey skin color. Their copying abilities are less precise than those of the Dop-elpoeps', but they can transform instantly, on the spot. They can only duplicate other bipedal humanoids. Wings, extra arms and tails can be duplicated but the Reipoc cannot fly nor can he get additional attacks or bonuses from additional limbs. They can maintain a particular form indefinitely, can assume any gender, and can change from one shape to another in 1D4 melee rounds (15 to 60 seconds). They find imitating a specific person difficult and hard to maintain (specific traits slip) and only have a 50% +2% per level of experience chance of creating a passable imitation.

These creatures are very intelligent, quick thinking and resourceful. They are also curious about other life forms, magic and the supernatural. Their abilities are normally used to get closer to prey, spy or hide among humanoids and not to copy any one specific person. In the vast arena of space, with the unlimited opportunities of a myriad of races, many Reipoc are using their skills to forge a living as spies, bounty hunters, confidence artists, crooks and Mercenaries.

As a predator, the ancient Reipoc hunted and fed on other humanoids. Over the centuries they have learned to

eat animal meats and synthetic foods, however, about 25%, especially among villains, prefer to hunt and eat the flesh of other humanoids. The majority of them do retain their racial preferences and will feed on humanoids, but most avoid it because of the complications in their more elaborate deceptions.

The Reipoc can be allowed as player characters if the Game Master approves.

Reipoc (pronounced rye-pock)

Alignment: Any, but tend to be selfish and miscreant.

Attributes: I.Q. 4D6, M.E. 3D6, M.A. 3D6, P.S. 3D6, P.P. 4D6, P.E. 3D6, P.B. 1D6 (naturally, and nearly any when changed), Spd. 3D6.

Size: 5 to 12 feet (1.5 to 3.7 m) tall.

Weight: 350 to 400 pounds (159 to 181 kg).

Hit Points: Standard, P.E. plus 1D6 per level of experience.

S.D.C.: 50 (1D4x10 plus 20 for player characters)

Horror Factor: 9 when people realize what they are, or when they witness a transformation.

Average Life Span: 190 years. **P.P.E.:** 3D6x10

Disposition: Generally, Reipoc are self-serving creatures with little or no concern for those around them. Their species evolved through hunting and survival, and many still rely on the skills of their ancestors.

Experience Level: The average Reipoc Doppelganger will have 2D6 levels of experience. Player characters should use the alien experience table.

Natural Abilities: In addition to the shapechanging powers, the creatures have perfect vision and a keen sense of hearing.

Power Category: Super Abilities

Super Abilities: Natural shapechanging ability, plus alter facial features & physical stature and chameleon. Do not roll for additional super abilities.

Attacks Per Melee: Two plus hand to hand skills.

Originating Alien Environment: Low Gravity

Education Level and Skills: Can be any that a human and other humanoids can pursue.

Scholastic Bonus: +10%

Weapons, Vehicles, Armor: Varies with skills and needs.

Erishik Doppelganger

These are the deadliest of the Doppelgangers because they must eat the person or animal they wish to duplicate! As the Erishik ingests the victim's flesh and blood, every aspect of the victim is copied. This allows duplication down to matching DNA! All aspects of the dead victim are reproduced flawlessly by the Erishik, including strong memories, the memories of the last 48 hours, attributes, and natural and super abilities. They are totally indistinguishable from the original, except their teeth tend to be sharper and more pointed than humans/many humanoids and they retain their natural psionic powers.

The Erishiks are the most cunning and dangerous of the Doppelgangers described here. All of them are totally evil and possess powerful psionics. These powers are used to control and influence others (they often use these

abilities to make the observant not notice or forget about their teeth). These foul beings are cruel, aggressive and power hungry. Once they adopt a body, they rarely change it unless an unequalled opportunity arises. Consequently, they choose their candidates for duplication very carefully. Such targets are often important individuals in positions of influence and power, or beings who wield great power or have high attributes.

There are those Erishiks that do not choose their victims so carefully, nor do they stay with one copy for any length of time. Each time a victim is eaten and copied, the Erishik grows in physical power, and these exceptions thrive on that kind of power. Any deceptions or schemes they instigate will generally be short-term operations with quick results. These barbarians are often hunted by their fellow Erishiks to prevent them from drawing attention to their kind. Thankfully, these brutes are often less cunning or more reckless than their brethren.

Erishiks (pronounced eh-rish-iks)

Alignment: All are evil. Most will be miscreant, and aberrant Erishiks are rare.

Attributes: Same as their victim, but add +2 to I.Q., and +1D4 to M.E. and P.E.; can be any humanoid except mineral and energy beings, creatures of magic or supernatural beings.

Size: Equal to the victim. Can copy any creature exactly. The only restriction is the length of time needed to ingest the victim. This is approximately 1D6 hours per 150 pounds (68 kg) of the victim.

Weight: Same as victim.

Hit Points: Same as victim, plus P.E.

S.D.C.: Same as victim, plus 2D4x10. **P.P.E.:** 2D6x10

Horror Factor: 14 when people realize what they are dealing with or when they witness a transformation.

Average Life Span: 1000+ years; potentially immortal because the monster can keep changing bodies.

Disposition: Cold, calculating, cruel, power hungry and evil.

Experience Level: Equal to the victim.

Natural Abilities: Shapechanging and psionics.

Power Category: Psionics. The Erishik Doppelganger will also possess any super abilities, natural abilities and attributes possessed by the creature it has duplicated.

Super Psionic Abilities: Mind control and mind wipe.

Minor Psionic Abilities: Detect psionics, hypnotic suggestion, mind block, see aura, sixth sense, and total recall (With this ability, the Erishik has a 25% chance of recalling memories from previous victims). **I.S.P.:** 2D4x10+M.E. attribute plus 1D6+1 per level.

Attacks Per Melee: Same as the copied creature plus one.

Appearance: Natural form is unknown.

Originating Alien Environment: Unknown.

Education Level: Same as creature copied, plus 3D4 secondary skills at 9th level proficiency.

Scholastic Bonus: Same as creature copied.

Skills: Same as creature copied. With Total Recall, the Erishik has a 25% chance to recall how to use a skill that a previous victim possessed. If successful, the per-

centage to use it will be low, at about 45%, and is forgotten after a week.

Weapons, Vehicles, Armor: Varies with skills, needs and availability.

Note: Erishiks have bounties on their heads in all sections of the galaxy. Some areas may also have bounties on other Doppelgangers, depending on local history and prejudices. Common bounties are 20,000 to 50,000 credits.

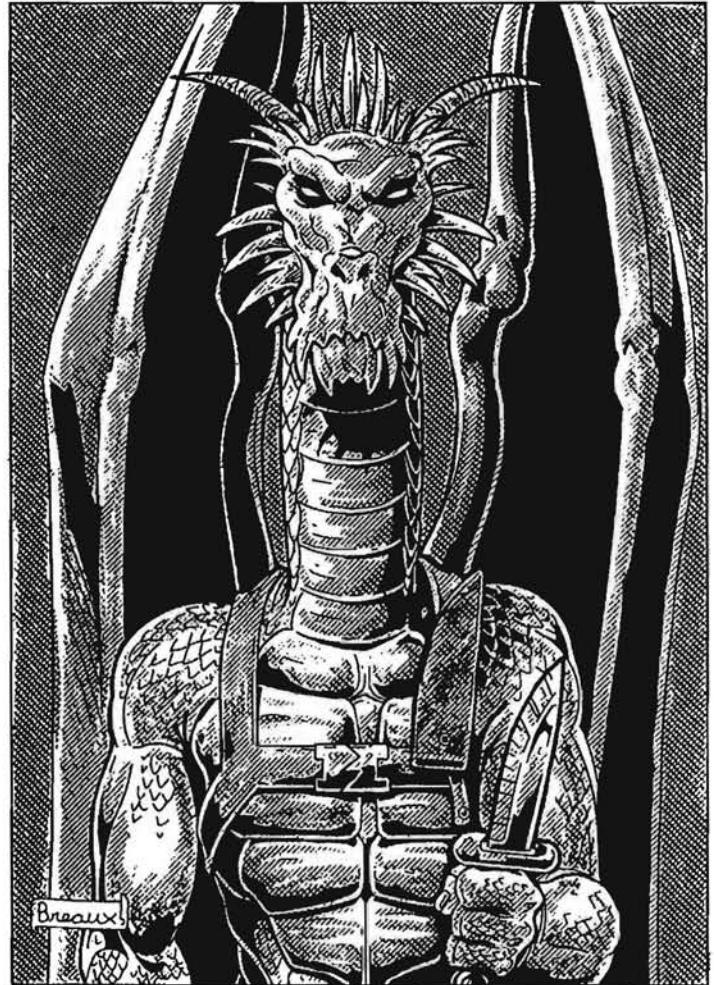

Dragonoids

Optional player character race

The aliens known as Dragonoids are also called dragons and dragonmen. They are a race of bipedal humanoids with larger leathery wings, long necks and serpentine tails. Their features are very much like those of mythical dragons, including thick scales, horns, and the ability to breathe fire. Like true dragons, the Dragonoids are solitary creatures. If they have a homeworld with a society as we know it, it is still a secret.

Dragonoid non-player characters (especially villains) may be alien mystics in addition to their natural abilities, but as player characters, they are limited to the abilities given here. The following statistics are for young or young adult Dragonoids. Older ones leave the company of other races and go into seclusion in well-hidden locations. Their activities and abilities are much grander and far reaching than their younger relatives, but much more secretive.

They are intelligent creatures with an interest in new and exotic things. They prefer ornate or rare equipment, weapons, and magic items. It is rumored that older Dragonoids have hidden caches of alien artifacts from throughout the universe. The younger members of the race have a much stronger curiosity than their elders and spend their first 200 years or so exploring and experiencing life in the galaxy. The alignments of these young dragons will reflect the company they keep and the ways they are treated. Adult Dragonoids are 250 years or older. Player characters should start at 20+2D6 years of age and use the juvenile dragon stats.

Dragonoid (pronounced drag-on-oid)

Alignment: Any, but nearly all are anarchist.

Attributes: I.Q. 3D6, M.E. 4D6, M.A. 3D6, P.S. 20+2D6, P.P. 4D6, P.E. 4D6, P.B. 1D6, Spd. 5D6 running, flying speed is 160 mph plus 10 mph per level (256 km plus 16 km per level).

Size: Young: 8 to 12 feet (2.4 to 3.7 m), adult: 14 to 25 feet (4.3 to 7.6 m).

Weight: 400 to 900 pounds (181 to 408 kg) or adults 800 to 1,200 pounds (362 to 541 kg).

Hit Points: P.E. x4, plus 1D6 per level of experience.

Natural A.R.: 10 (adult special)

S.D.C.: 2D4x10 plus 80 (for adult add another 1D6x10; mega-damage creature in **Rifts**)

Horror Factor: Young: 11, adult: 14

Average Life Span: 500 years; **P.P.E.:** M.E. x3

Disposition: Varies from one individual to the next, but all tend to be quiet loners, even when they are among friends. Like true dragons, many of them are vain and proud creatures vulnerable to both greed and flattery. Most feel superior to other beings and can act with arrogance and callousness. Many become police officers, bounty hunters, and slave traders.

Experience Level: Average fifth (5) (Roll 1D6+3, but player characters should start at first level of experience). Adults are typically 6+1D6 levels.

Natural Abilities: Resistant to heat and fire (half damage), see the invisible, and impervious to disease. Also see super abilities. Add the following for each 100 years of age: +1 to save vs horror factor, +1 to all attributes, +1 to A.R., +30 to S.D.C., +1 on initiative and +1 attack per melee round.

Power Category: Super Abilities (natural abilities)

Major Abilities: None

Minor Abilities: Energy expulsion: fire (breath), flight: winged (leathery), heightened sense of smell, extraordinary physical strength, and healing factor.

Attacks Per Melee: Five to start (+1 in flight).

Bonuses: All bonuses are in addition to attribute bonuses, but include super ability bonuses. +1 on initiative, +2 strike (+4 in flight), +5 parry (+7 in flight), +5 dodge (+9 in flight or hover, +11 when going faster than 90 mph/144 km), +3 roll with punch or fall, +20% save vs coma/death; +2 save vs magic, psionics, and toxins, resistant to fire and cold (1/2 damage); 1/3 damage and effect from drugs, toxins, and poison.

Appearance: Humanoid Reptile. They look like fully bipedal dragons.

Originating Alien Environment: Low Gravity

Education Level: Any; player character's education level is determined normally. Many adults and villains pursue magic (in **Rifts** they can be any magic O.C.C.).

Skills: Vary

Weapons and equipment: Natural claws do 2D6+P.S. damage bonus. Fiery breath does 2D6+1D6 per level (average damage of 6D6). The Dragonoids have no aversion to technology, except for bionic implants. They refuse to have them implanted. Other equipment like translators, detectors, optics, scanners, computers, and tools are also used by these aliens if they have the proper skills.

Vehicles: Dragonoids have no aversion to modern travel, especially spacecraft.

Armor: Normally none. They rely upon their armored scales for most situations, but some are not averse to using heavy armors if they think it will be necessary. Armor needs to be custom made for dragonoid anatomy and size, and costs four times as much as listed prices.



Lotha

The Lotha is a controlling entity that attaches itself to an animal or humanoid on their neck. One of its gelatinous tendrils attaches to the spinal cord to seize control of the motor operations of the body. The host creature is still alive and fully alert, only unable to control his own body. Once the Lotha has control of the body, it sends another

tendrils into the head to start eating select parts of the brain. A natural anesthetic numbs the pain, and the host feels itself slowly slipping away until the memory and personality parts of the brain are gone; only the portion that controls the motor parts are kept — the process is like a monstrous lobotomy. The Lotha then squeezes its boneless, jellylike body into the small opening at the base of the skull and replaces the brain as the control center for the body.

For 5D6 hours after it attaches to the victim, the fist-sized, fleshy Lotha must conceal itself somewhere on the victim to avoid discovery until it can slip inside the skull. Once it squeezes into the head, it is undetectable except for the small neck wound where it entered, but that will heal in 1D4 weeks, leaving a small scar. Once it controls the body, a Lotha can speak through natural use of the vocal cords. The body will continue to function through its normal life expectancy, barring unnatural death from disease, accidents, or murder. The whole process is actually a kind of brain transplant or replacement. There is no aspect of the original person left — only the Lotha. **G.M. Note:** Use this terrible NPC creature judiciously and primarily against other NPCs. It is no fun for players to have the brain of their favorite character eaten and their body permanently taken over. Thankfully, these terrible monsters are rare and usually destroyed whenever encountered. In the **Rift Megaverse** the creature can only affect S.D.C. beings. They cannot penetrate mega-damage flesh.

Lotha (pronounced low-tha)

Alignment: Miscreant or diabolic evil only.

Attributes of the Lotha: I.Q. 2D6+6, M.E. 3D6, M.A. 1D6, P.S. 1D4, P.P. 2D6, P.E. 3D6, Spd. 1D6. Of course, when it inhabits a host body it has all the physical attributes of that body.

Size: 4 to 8 (0.1 to .2 m) inches naturally, but a host body can be of any size.

Weight: 1 pound (.45 kg) for the Lotha itself. The host bodies can be of any size.

Hit Points: 4D6

S.D.C.: The Lotha has 1D6 itself, the host body may be pretty tough depending on race and powers (an S.D.C. creature in **Rifts**).

Horror Factor: 8

Average Life Span: 100 years; **P.P.E.:** 3D6x10

Disposition: All are intelligent and evil. Most use their host bodies for evil purposes and often seek positions of power where they can dominate, enslave and manipulate others. Most enjoy inflicting torture (mental and physical), humiliation and other acts of cruelty on others.

Experience Level: Average Sixth (6) (Roll 1D6+3).

Natural Abilities: In addition to its terrible powers to seize control of a host body, it has many other powers. When in its natural fleshy form, the Lotha has radar senses and an advanced sense of touch and smell. All three are identical to the minor super abilities. A strong flesh eating secretion is used to instantly burn a hole in the back of the neck and give the Lotha access to the

spine and brain. This method of attack involves surprise (prowl 75%) and attack from behind.

They are natural climbers (90%/80%), prowl (70%), and swim (50%). The creature takes half damage from impact damage, punches and projectiles (they pass through or temporarily displace the soft body). The creature can also regenerate 1D6 hit points per hour, so it is important to make certain it is dead or it will heal and attack some helpless victim and start its cycle of horror again.

Power Category: Super Abilities

Major Abilities: Special, see the above descriptions.

Minor Abilities: See natural abilities.

Attacks Per Melee: Three (3) in its natural form. Five when it occupies a host body.

Bonuses: All bonuses are in addition to attribute bonuses. +1 strike, +2 parry, +2 dodge, +3 roll with punch or fall.

Appearance: Amorphous bulb of flesh with pseudopods.

Originating Alien Environment: High Gravity

Education Level: General Studies

Scholastic Bonus: +5%

Skills: Vary from one Lotha to another.

Weapons: None in natural form other than acid secretion (1D6 damage). In host bodies, they will use any weapons they have proficiencies in or are at their disposal. However, they usually try to avoid violence and have other foul characters do their dirty work for them.

Vehicles & Armor: Applicable only for their host body.

Mendoline

The Mendoline are a race of frightening looking beings. The head is rounded and crowned by several short tentacles. The mouth is large and full of sharp teeth. The eyes glow a fiery orange and their long bodies are basically humanoid, with powerful builds. Long, sharp claws tip each digit and a pair of long tentacles are anchored at the shoulders and rib cage.

Despite their appearance, Mendoline are not true demons. They are an alien race that evolved on the twilight planet of Thear. Their society is a nightmarish place of evil. The buildings are old, looming, and frightful. The streets are filled with constant antagonism and chaos. Brawls often flare into open warfare or riots. The only other races on Thear are those acquired as slaves. The only comfort to other races in the galaxy is that the Mendoline do not yet possess space technology, don't have a tech level high enough to even try, and show no interest in acquiring it. However, they have been contacted by a few other worlds (usually evil or selfish beings and organizations) who occasionally trade with them and sometimes take them off-world as employees for unwholesome purposes. Mendoline are another of the many creatures favored as guards and powerful muscle by shady organizations, the underworld, pirates and demons. Their psionic abilities make them ideal guards, assassins, enforcers, and terrorists. They can detect other psionics and potential danger in addition to being able to start fires and move objects with mental strength alone. Not to mention their natural attributes and abilities.



Mendoline (pronounced men-doe-line)

Alignment: Selfish or evil only.

Attributes: I.Q. 2D6+3, M.E. 5D6, M.A. 1D6, P.S. 4D6+3, P.E. 3D6, P.B. 1D6, Spd. 4D6.

Size: 6 to 8 feet (1.8 to 2.3 m).

Weight: 190 to 380 pounds (86 to 172 kg).

Hit Points: 2D4x10; **Average Life Span:** 200+ years

S.D.C.: 50 plus 2D4x10 for the main body, 25 points per each tentacle (4).

Horror Factor: 15

Average Life Span: 80 years; **P.P.E.:** 1D6x10

Disposition: Arrogant, belligerent, aggressive, bullying power-mongers. Most enjoy work as mercenaries and assassins regardless of the employer, job, or money; they just like to fight and cause mayhem. The more intelligent and self-controlled mendoline can acquire positions of authority and leadership (usually second in command) among pirates, criminals, monsters and cut-throats.

Experience Level: Effectively sixth or higher (Roll 1D6+5). Use the alien experience table.

Natural Abilities: Nightvision 600 feet, keen hearing 20 decibels beyond normal human ranges, climb (85%/75%), prehensile tentacles, and severed tentacles will grow back to full length after 2D6x10 days.

Power Category: Psionics

Major Psionic Abilities: Pyrokinesis and telekinesis.

Minor Psionic Abilities: Detect psionics, sixth sense, summon inner strength and mind block.

I.S.P.: M.E. x2+2D4 and an additional 10 I.S.P. per level of experience.

Attacks Per Melee: Seven physical or four psionic at sixth level and higher (four and two at 1st or 2nd level). Tentacles can reach 12 feet (3.6 m).

Bonuses: All bonuses are in addition to attribute bonuses. +4 on initiative, +2 strike, +5 parry, +3 dodge, +2 to pull punch, +4 roll with punch or fall, kick attack, leap kick, jump kick, paired weapons, critical damage on a natural 19 or 20, +4 to save vs disease, and +5 to save vs horror factor.

Originating Alien Environment: Twilight World

Education Level: Nearly any, but most are General Studies

Scholastic Bonus: +5% usually.

Skills: Can study any area (select 10 primary skills and six secondary), but most focus on combat/physical (excluding hand to hand), espionage, military, piloting and domestic.

Weapons: Any, but most rely primarily on their psionics and physical abilities. Bite does 2D6 damage, their claws do 3D6+P.S. damage bonus, kick 4D6 damage +P.S. bonus and tentacles do 2D6+P.S. bonus or entangles on a natural 19 or 20 and squeezes each round for 3D6 damage.

Vehicles: Any, varies with piloting skills and personal taste.

Armor: Mendoline rarely ever wear armor because it restricts their tentacles and movement, but those who can afford it may have a suit of custom light body armor or hard suit made at three times list cost.

Morphos

These horrific creatures are boneless globs of gelatinous flesh. Most are about the equivalent of 55 gallons (208 liters) in size, but size does nothing to change their deadliness. Morphos can grow to enormous proportions, although most do not get bigger than a 20 foot blob (roughly cube shaped, 20x20x20 feet/6.1x6.1x6.1m), un-

less they live on a planet. These jelly-like creatures normally float through space in a semi-dormant state. To help them resist decompression and easily snag passing spacecraft, they flatten themselves and drift as large sheets or ribbons. They are most commonly found near gateway structures, dimensional syphons, or gravity wells. Craft emerging from these types of travel rarely detect the drifting Morphos and often strike them with their speeding craft. The impact normally rips the creature into several smaller pieces that stick to the vessel. Each of those pieces becomes a new creature! They never reform with each other, they just turn into new ones. Many will slide along the vessel in search of a way in. They are able to eat through rubber and soft plastics (like gaskets and seals) at a rate of 1D4 S.D.C. per melee round. But most just wait until a vessel docks with a space station or lands in a suitable environment (most burn up when a ship enters an atmosphere unless they can find a safe place to hide). Those Morphos that somehow make it to the surface of a planet are not broken into pieces as regularly as those in space, and they can grow to enormous sizes; as big as a house, with 2,000 S.D.C.

Once a Morphos gets inside a ship, it begins hunting and feeding. Its entire outer body adheres to the things it touches, particularly flesh and cloth. The flesh of its victims stuck to it is eaten by an acid-like enzyme and is instantly absorbed into the monster's body. A 10 foot (3 m) Morphos can kill its prey in four melee rounds (60 seconds), inflicting 2D4x10 S.D.C. of acid damage per melee to any organic substance that touches/is adhered to it. The corpse is digested within another minute and will in-

stantly instill the monster with 6D6 S.D.C. points. Thus, the more it eats the more powerful it becomes! This is also how it increase its size. Each human-sized body increases its size by 10%.

Parrying or striking at the creature with a bare limb means automatic adhesion/attachment and digestion of the limb. The more that is dissolved the more of the limb is pulled in. Space travelers have been known to amputate their own limbs in order to escape this monster. Touching it even with a hand, adheres the person to it, requiring a combined P.S. of 40 to pull free and even then the character suffers 1D4x10 damage (the hand will be half eaten away and may require a bionic or clone replacement). Creatures with a natural armor rating above seven have some measure of protection, suffering one-quarter of the acid's damage, can be pulled off with a P.S. of 30 and takes 10 times longer to digest. Characters clad in metal or ceramic body armor and mineral beings have the most protection. They can be pulled off of the fiend with a P.S. of 20 and the armor suffers only 10% the normal acid damage. However, if the armor is breached and the monster can find and reach bare flesh, the fighter is in serious danger. Mineral beings cannot be devoured, but can be slowly damaged by the acid.

The creature moves in a slow, undulating kind of way. Although it is a huge glob, it can ooze under doors, through vents and small openings as narrow as an inch tall (must be several inches long/wide). It can also form part of its body into a wide, flat appendage that resembles a tongue or short tentacle; only one such tentacle can be made. This appendage is used to feel around for prey. Otherwise, the morphos must trap its prey in a corner to capture, touch and devour it.

Morphos (pronounced more-foes)

Alignment: Miscreant evil predator.

Attributes: I.Q. 1D4+3, equal to a predatory animal. M.E. and M.A. not applicable, P.S. 4D6+4 per every 10 feet (3 m) in size, P.E. 3D6+10, P.B. 1D4, Spd. 3D6

Size: Averages 10 to 20 feet across (3 to 6 m).

Weight: Varies

Hit Points: 2D4x10. **Average Life Span:** Unknown

S.D.C.: 1D4x10 plus an additional 6D6 per human-sized victim it devours. It can eat humanoids, animals and any organic substance, including plant aliens. These additional points are permanent as long as a steady food supply is available, otherwise it loses 6D6 S.D.C. and 10% of its size and mass for every week of starvation. However, at 10 feet it will go into suspended animation until it senses food within 1000 feet (305 m). This creature is strictly an S.D.C. monster even in the **Rifts** setting. Its acid has no effect on M.D.C. armor or living beings.

Horror Factor: 15. **P.P.E.:** 3D4x10

Disposition: Continuously hungry predator.

Natural Abilities: A cold life form, it does not register on heat sensors or as alive in the human or animal sense. Its soft body diffuses impact attacks, including punches, clubbing, stabbing, shootings and so on — they do only 25% their normal damage. Sonic, vibration and electri-



cal attacks also only inflict 25% damage. Cold attacks do no damage! Most forms of magic and psionics also inflict no or little damage unless fire based.

Explosions will severely hurt it but not kill it. Instead the explosion will blast it into 1D6 additional small pieces, with 1D6 S.D.C. and 1D4 hit points, that will instantly begin to hunt, feed and grow!

Fire, plasma, microwave and particle beam attacks do full damage!

Other abilities: Prowl 50%, swim 50%, climb 50%, it does not breathe, impervious to mind control, empathy and horror factor, is immune to gases, acids, disease, poisons and drugs, and bio-regenerates by eating. The only way to be certain it is destroyed is to burn it until nothing is left but vapor.

Natural Psionics: Presence sense (1000 feet/305 m), empathy (only to sense the presence of prey via fear, horror and other emotions 1000 feet/305 m), see aura (see its prey as glowing energy) and death trance. All are automatic powers that can be used without restriction or a counting of I.S.P. The creature is so alien that it cannot communicate or be controlled in any way. A telepathic or empathic probe will only show hunger.

Power Category: Special, see previous description and details.

Attacks Per Melee: Three

Bonuses: +2 strike and +6 roll with impact or fall.

Appearance: Amorphous. A large, clear, gelatinous mound.

Originating Alien Environment: Unknown

Note: Does not use weapons or technology.

Riathenors

Very little is known about these other-dimensional beings. Thousands of them poured in from the Rifts that destroyed Assin (see the lassinike entry in the *Mineral Alien Section*), and now they wander the galaxy as ruthless and murderous assassins, terrorists, pirates, crime lords, enforcers, bounty hunters and mercenaries. Killing and destroying is what they do best. In appearance, they seem to be humanoids clad in advanced armor or possibly full bionic conversions, but their use of magic would seem to discount both possibilities. Full cybernetic conversion and the use of power armor normally negates magic.

The styling of various armors seems to indicate both male and female members of the species. Either sex is as deadly as the other in both ranged and melee combat. Their strength and reflexes are superhuman, and spell casting abilities are as formidable as any mystic. All Riathenors have the same spells and may indicate innate natural abilities or a supernatural origin. As they progress in levels, additional spells are just known to them/manifest themselves.

The Riathenors are a race of natural mystics from another dimension. They are humanoids, but their exact features are unknown, concealed as they are under their alien armor. The armor itself is actually a living symbiotic organism with a super strong exoskeleton. All Riathenors have these symbiotic suits of organic armor bonded to

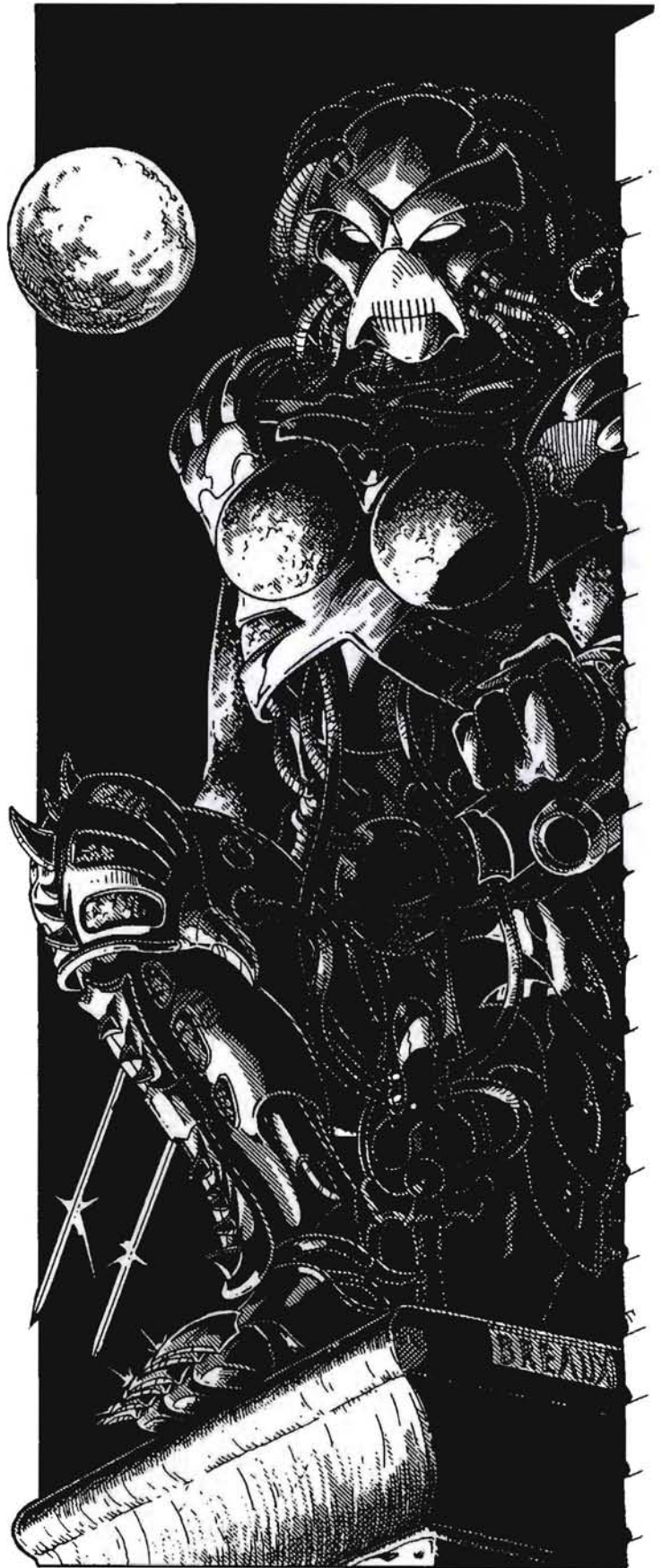

them. To surgically remove the armor is to kill the riathenor. Speculation has suggested that it is highly likely that only warriors came through the Rifts on Assin and other Riathenors back on their homeworld are not armored, but nobody knows. In fact, very little is known about these

vicious marauders. They tend to keep to themselves and those who associate with other races refuse to speak about themselves, their people or their homeworld. Even the information presented in this paragraph is not known to most people.

All of the weaponry built into their armor is either a vibro-blade or heat/plasma based, except for the short-range particle beam gun on the left forearm (6D6 damage, 500 ft/153 m range). A multitude of razor sharp blades and spikes cover the armor, making it difficult to hold on to the creature without getting stabbed or cut. They are also used for cutting and slashing opponents and parrying weapons. The material is comparable to Kisentite metal and is nearly indestructible.

The Riathenors' plasma and blade weapons cannot be removed from the dead alien. They are a part of the armor, not simply attached or integrated into it. The plasma weapons draw on mystic (P.P.E) and organic energy within the host body and cannot be attached to an alternate source of power. When the living armor and its host are slain, the weapons "die" with it. **Note:** A spark of the symbiote's life essence lingers from 48 hours after the apparent death of the body. Any character with magic abilities (or large amounts of P.P.E.; 40 points or greater) who wants the armor will be sensed by the symbiote and it will magically ooze onto that person. However, once the armor is attached it can never be removed without killing the host body. Its revealed, original host body is a mass of rotting flesh, goo and protoplasm that smells terrible (nothing can be learned by examining it). The new wearer of the suit has all of the same powers and abilities as the riathenors, including the same spell casting abilities.

Riathenors (pronounced rye-ath-en-nors)

Alignment: All Riathenors are evil or anarchist.

Attributes: I.Q. 3D6, M.E. 3D6, M.A. 2D6, P.S. 35, P.P. 24, P.E. 30, P.B. 7, Spd. 58; ALL Riathenors have identical physical attributes due to augmentation by the armor. Physical attributes are considered to be supernatural.

Size: 7 feet plus 1D6 inches (2.1 to 2.3 m).

Weight: 300 pounds (136 kg); includes the armor.

Hit Points: P.E. x3, plus 2D6 per level of experience.

Natural Armor Rating: 15

S.D.C.: 200+2D6x10 (includes armor; M.D.C. in Rifts).

Horror Factor: 12. **Average Life Span:** 250 years.

Disposition: Riathenors are usually arrogant, cocky, cold, cruel, and as heartless as humanoids get. They have no respect for anyone or anything that is not riathenorean. These beings (some believe they are demons) feed on the flesh and blood of those they kill, including other Riathenors! Thus, they frequently view and treat all other races as food. They do not bluff, will not waste their time with torture or questioning, and show no mercy.

Experience Level: 4+1D4 for the average warrior. The high level is because the troops sent through the Rifts were skilled warriors, not run of the mill foot soldiers. Those with the highest rank are called Dagotte (pronounced D-got) and are usually 10th level or higher.

Natural Abilities: Ultraviolet and infrared vision and

heightened sense of hearing equal to the minor super abilities. The armor can bio-regenerate 1D4x10 points of damage every 30 minutes and makes its wearer impervious to disease, poison, drugs, gases and other toxins, as well as impervious to fire and heat (even mega-damage). Can leap 20 feet (6 m) and breathe any atmosphere, as well as breathe without air.

Power Category: Special: Empowered by symbiotic organism.

Spells: All spells function normally as regards to range, duration, damage, and area of effect. Riathenors begin with seven spells to start, but at higher levels they gain other, more powerful spells. Initial spells include: Tongues, see the invisible, teleport (self), mystic shield, breathe without air, eyes of the wolf, and fireball.

Riathenors gain spells automatically as they grow in experience, but they are limited as follows: 2nd level: chameleon, 3rd level: fly as the eagle, 4th: wall of flame, 5th: dispel magic barrier (2), 7th: invisibility (self), 9th: magic net, 11th: mystic portal (3), 13th: negate magic, and at 15th: dimensional teleport (a 15th level Dagotte will be able to travel to his own dimension and take or return with 13 fellow riathenors at a time).

Combat Skills: Equal to Hand to hand: expert

Attacks Per Melee: 7 plus one additional attack for 8th level Riathenors.

Bonuses: +4 on initiative, +2 to strike, +3 to strike with swords, +3 to parry, +2 to dodge, +2 to roll with punch, fall, or impact, +3 to pull punch, +6 to save vs horror factor.

P.P.E.: 3D6x10+10 per level of experience.

Originating Alien Environment: Unknown.

Education Level: These are all military specialists.

Typical Skills: Concealment, detect ambush, detect concealment, tracking, wilderness survival, acrobatics, climbing, prowl, W.P. sword, W.P. heavy, W.P. energy pistol, and W.P. energy rifle. Secondary Skills: Computer operation, navigation, read sensory instruments, basic and advanced math.

Weapons: All of the following are part of the symbiotic armor. If one is torn off or destroyed it will grow back in 30 days.

1. The right arm: A pair of retractable blades (symbiote bone equal to magic blades): 3D6 damage from one blade, 1D4x10 for two blades plus P.S. bonus.

The wrist, forearm and elbow also have hooks and blades for parrying and hooking an opponent's melee weapon and can be used to rake, slash or stab a foe, adding 1D6 to the normal punch damage.

2. Right Shoulder: Fires small plasma bolts: 5D6 damage per single blast or 1D6x10 per simultaneous blast, 3000 ft (910 m) range, payload: 24 (12 per each shoulder gun), regenerates after 12 hours.

3. Left Shoulder: A heat blast: 4D6 damage, 1200 ft (366 m) range, and effectively unlimited payload. Can be fired at a rate equal to the warrior's hand to hand attacks/actions per melee.

Shoulder System Note: Each shoulder has a separate weapon system, but both are linked to the helmet/vision of

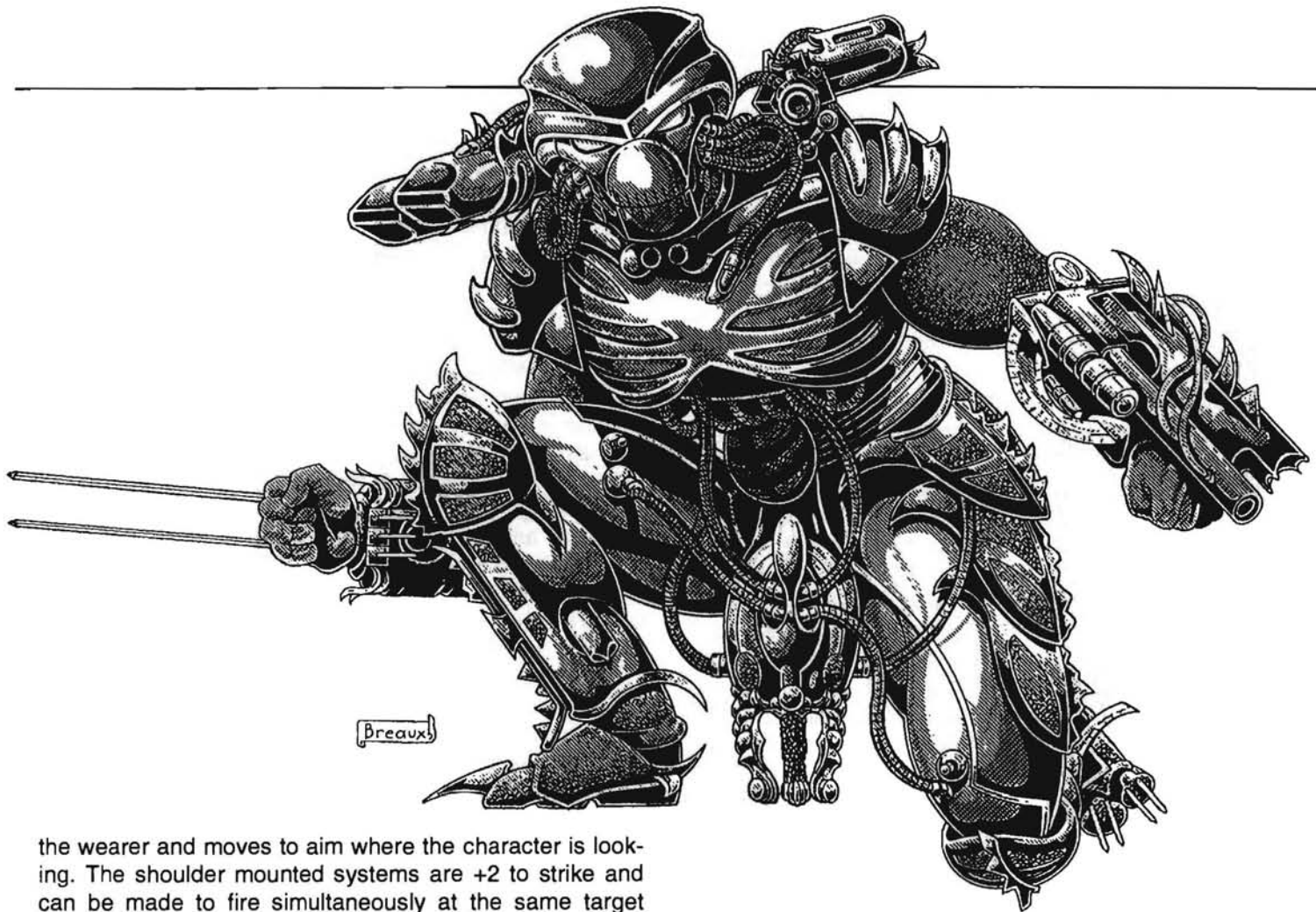

the wearer and moves to aim where the character is looking. The shoulder mounted systems are +2 to strike and can be made to fire simultaneously at the same target (combine damage from both shoulder weapons, but counts as one melee attack).

4. The left forearm weapon package: Pop-out crescent blades on the sides for slashing foes: 2D4+2 damage plus P.S. bonus.

Short-range particle beam gun on the forearm (the narrow barrel): 6D6 damage, 500 ft (153 m) range, payload: 4 blasts per melee round, each counts as a melee action.

Plasma ejector (the wide, square opening): 1D4x10 damage, 1200 ft (366 m) range, payload: 2 blasts per melee round, but effectively unlimited. Each blast counts as a melee action.

5. Toe and knee blades: Add 1D6 damage to kick attacks.

6. Body blades: All the other smaller blades and spikes cause 1D6 damage to foes who try to grab, hold, flip or tackle the warrior. Backhand slaps, tackles and body flips/Judo throws by the riathenors add 1D6 damage.

7. Optional: Additional weapons: The warriors can also use other swords, clubs, rifles and weapons. These additional weapons are usually long-range rifles and/or exotic weapons like lasers, cold or sonic blasters.

Special Vehicles: Whatever they can acquire through employment, purchase or theft.

Armor: None, other than their natural symbiotic armor.

Vacuum Ghouls

Vacuum ghouls are so named because most are apparently from space related deaths. Behind the ghoul's existence is an evil entity/energy being that thrives on strong emotions. These creatures inhabit the bodies of the dead and forge a connection with the body's former essence. Their usual choices are people who were murdered, because the dead essence and strong emotions related to violent death (fear, hate, sorrow, etc.) will draw them like a magnet. After inhabiting the corpse, the entity will feed on remnant emotions of rage and despair. Using a variation of empathic transfer, the energy being fuels and amplifies these emotions until it has a murderous creature that is a deadly shadow of its former self.

The tortured ghoul now goes out and performs acts of violence in anger, hatred and revenge. Acts that also cause plenty of turmoil and emotions for it to feed on. Every creature the vacuum ghoul injures, maims, or kills spills emotion to nourish the monster. The ghoul is not an insane resurrection of the dead person. Instead, it is a tortured, maddened wraith that only resembles its former self, even though it may hold a few of the memories and desires of the deceased. With these fragments of memory it may recognize old friends and enemies and even seek them out, but the monster is not the deceased and its ulti-

mate goal is to feed. The only way to put it to rest is by leading it to its killer. Once avenged, the vacuum ghoul's ties to the memories of the deceased is gone and it flies away to find a new body. Destroying the animated corpse will also release the entity and send it away. Mages and psychics with the power of exorcism may have some success at dispelling the thing as well.

Vacuum Ghoul

Alignment: Diabolic and chaotic; nothing matters to the suffering soul.

Size: Varies with the race of the deceased. The energy being is about the size of a basketball.

Weight: By race of deceased. The energy being has no weight.

Hit Points: The energy being has 4D6.

S.D.C.: The animated corpse of the vacuum ghoul has 200 S.D.C. The energy being has none.

Attributes: Mental attributes do not apply in the ghoul's crazed state, and the energy being is little more than a predator. The corpse is a zombie bent on causing destruction and chaos. P.S. 5D6, P.P. 1D6, P.E. does not apply, P.B. 1D6, Spd. 2D6

Average Life Span: An animated body can be kept alive indefinitely, but the energy being itself lives approximately 300 years. P.P.E.: 2D4x10

Disposition: Totally chaotic. The energy being only wants emotions and the ghoul lashes out at anything in range in a vain attempt to end its pain and to feed on the emotions of others.



Natural Abilities: Immune to mind control and psionics, poisons and toxins, and heat and cold because it is undead. Does not show up on thermal sensors.

Power Category: The energy being is psionic.

Major Psionic Abilities: Empathy and empathic transfer

Minor Psionic Abilities: None

Attacks Per Melee: Four by the corpse, or three via psionics.

Bonuses: None

Weapons, Vehicles, and Equipment: None, but it can open doors and operate simple things like light switches and can try to imitate others like by picking up a gun and shooting, but it doesn't know how it works and cannot reload, operate computers, drive, etc.

Vampyres

There are a number of races in the galaxy that fall into the broad definition of "vampire," creatures who feed on the blood of other living creatures. Their appearances vary and most are not supernatural demons. Thus, while they often hunt in the dark, they are not necessarily harmed or repulsed by the light of day.

Lilliamok Vampires

These are horrible creatures that resemble the traditional supernatural vampires and are often referred to as nosferata. They have most of the weaknesses traditionally attributed to vampires, including sunlight and water as well as many of their powers, like supernatural strength, speed and mind control. They appear as giants, eight to ten feet (3.0 m) tall, with a monstrous head, terrible fangs, blank eyes and powerful, clawed hands. A pair of spines protrude from their backs like the armatures for wings, but no feathers or membrane hang from them. Perhaps the most frightening aspect of the Lilliamok are a pair of serpent-like tentacles with fanged mouths, that emerge from each palm. With these, the vampire can attach itself to his victims and drink their blood. In fact, using its mouth and hands it can drain three victims dry at the same time. The Lilliamok have voracious appetites and tend to be gluttonous, gorging themselves whenever possible.

Lilliamok may be supernatural beings formed of or connected with the element of earth. They are highly susceptible to the effects of water and can be hurt by *grounding* them back to the earth. The latter is done by holding the monster on the ground/dirt and pounding a large wooden or metal stake into its heart. The stake must penetrate the body all the way through and into the ground. When this happens the Lilliamok lapses into unconsciousness and its life essence slowly drifts away (into the ground?). After being staked to the ground for more than 48 hours, the creature is dead. The stake can be removed and the body buried or cremated. However, if the stake is removed before the 48 hour period, the hellish creature will instantly awaken and attack.



The Lilliamok are nocturnal hunters and may originate from a twilight world. Consequently, their eyes are sensitive to all light, but especially sunlight (blinding, -8 to strike, parry and dodge).

Ordinary water (H₂O) is like acid to these beings. An eight ounce glass will inflict 3D6 damage. Turning a hose on one will do 2D6x10 damage per melee round (15 second) and literally melts them away. Disgusting but true.

These vampires also possess the strength of the earth and are powerful, formidable opponents. They heal as quickly as the parted soil, and are as strong as the rocks, but their speed rivals the wind. For every 100 years the Lilliamok has existed, add +1 to all attributes and +10 to both hit points and S.D.C. They also gain one point of A.R. for each 200 years.

There are bounties on them across the galaxy. Most start at 5,000 credits and go up from there. An old or powerful Lilliamok can be worth as much as 50,000 credits.

Lilliamok (pronounced lil-lie-mok)

Alignment: Any evil, but most will be diabolic.

Attributes: I.Q. 3D6, M.E. 4D6, M.A. 2D6, P.S. 4D6+12, P.P. 3D6, P.E. 2D6x12, P.B. 1D4, Spd. 6D6+20 (supernatural being in Rifts).

Size: 8 to 10 feet (2.4 to 3.0 m).

Weight: 200 to 400 pounds (91 to 181 kg).

Hit Points: 1D6x10

S.D.C.: 120+2D6x10. Each hand tentacle has a 15 foot (4.6 m) reach and 30 S.D.C. each (this is an M.D.C. creature in Rifts).

Natural A.R.: 14

Horror Factor: 16 P.P.E.: 1D6x10

Average Life Span: 5,000 years or more.

Disposition: All are cold, calculating hunters with no regard for the lives of others. They only respect other powerful, long-lived races like demons and dragons. Many of them have the greedy, solitary, egomaniac

personalities of mythical dragons and others like to be worshiped as gods or dominate others.

Experience Level: Not applicable.

Natural Abilities: Nightvision 1000 feet (305 m), fly (90 mph 144 km), bio-regeneration 1D4x10 per melee round, impervious to fire and heat (while alive), impervious to cold, cold weapons, drugs, poisons, disease, mind control, and radiation, and energy weapons do half damage! Bullets, explosions and magic do full damage. The thing doesn't breathe air, can leap 30 feet (9 m), can use wing armatures to strike like clubbing arms, and has tentacles that emerge out of its hands!

Psionic Powers: Presence sense, hypnotic suggestion, hypnosis/mesmerism, death trance, and mind block. I.S.P.: M.E.x 5.

Power Category: Supernatural

Attacks Per Melee: Seven (8 in flight).

Bonuses: All bonuses are in addition to attribute bonuses. +3 initiative, +6 to strike (+8 in flight), +7 to parry (+9 in flight), +4 to dodge (+2 in flight), +1 roll with punch or fall, +3 to pull punch, +8 to save vs horror factor. Claws do 3D6 damage plus P.S. bonuses, a wing armature inflicts 2D6 damage, mouth bite 4D6, and tentacles do 3D6 damage. The lilliamok feeds exclusively on the blood of humanoids.

Appearance: Demonic, skeletal humanoid that is white or pale grey in color.

Originating Alien Environment: Unknown

Education Level: Knows six secondary skills suitable for the modern world, like driving a vehicle, plus automatically knows tracking 65%, land navigation 70%, prowl 50%, and climb 80/70%).

Weapons and Vehicles: Can use them but rarely does, usually relying on its natural powers and abilities.

Armor: None

Weapons and Equipment

Weapons are listed by "general type" rather than presenting a specific version of the same weapon or item for each of the 100+ alien races presented in this book. Game Masters may slightly adjust damage, range, design and other features for the various races or aliens of his/her own design. Likewise, some of the specific races will make note of such things as enhanced range or damage and may even list a specific item in an alien's description.

Ancient and Melee Weapons

The ancient and oriental weapon descriptions found in **Heroes Unlimited** are unchanged. For a selection of over 700 different melee weapons and ancient styles of armor, see Palladium's **Compendium of Weapons, Armor, and Castles**. Below are some additional ancient/melee weapons that have been upgraded with advanced technology, as well as those made of advanced alloys.

Kisentite Weaponry

Kisentite metal was first discovered and successfully forged by the Kisent aliens. It is a very hard, dense metal usually found on asteroids, planetoids, and high gravity and thermal planets. The metal is close to indestructible and can withstand incredible amounts of damage and heat without any ill effect. When forged into a blade, it maintains amazing sharpness. However, they are nearly impossible to create without special laser or particle beam forges.

A Kisentite weapon can stop bullets and energy beams, but trying to parry such projectiles is nearly impossible; use a straight, unmodified dice roll at minus six (-6). Only single bullets or blasts can be parried, not bursts, rapid-fire pulses or multiple attacks.

A Kisentite weapon generally adds a damage bonus of 1D6 to conventional weapons of that same type. If a normal weapon is used to parry one made of Kisentite, the conventional weapon will suffer some damage (25% of the normal damage inflicted by such a weapon). If there is a disadvantage to Kisentite weapons it is their weight (due to their dense molecular structure). Giant-sized weapons weigh five times more than those listed but also inflict 1D6+3 additional points of damage.

General

Weapon Type	Avg Length	Avg Weight	Damage	Average Cost
Kisentite Battle Axe	2.75 ft	5.5 lbs	3D6	2,500 CR
Kisentite Polearms	7.5 ft	10 lbs	4D6	4,000 CR
Kisentite Spear	6.0 ft	6.0 lbs	2D6	2,500 CR
Kisentite Knives	1.5 ft	1.6 lbs	2D6	1,500 CR
Kisentite Sword	3.0 ft	5.0 lbs	2D6+3	4,000 CR
2-H Sword	5.0 ft	9.0 lbs	3D6+3	5,500 CR
Kisentite Clubs	2.5 ft	5.0 lbs	2D6+2	2,000 CR
Kisentite Arrows	3.0 ft	0.1 lbs	2D6	2,000 CR/dz
Kisentite Katana	3.0 ft	4.2 lbs	4D6+3	8,000 CR
Kisentite Kusari-Gama	1.5 ft	6.0 lbs	2D6+3	2,500 CR

Vibro-Blade Weapons

These melee weapons have their damaging surface covered by a high frequency vibrating field. This field acts to both strengthen the weapon and increase its damage. They generally weigh slightly more than normal weapons of their type because of the vibration field generating motors.

A Vibro-weapon can stop bullets and energy beams, but parrying them is just as difficult as with a Kisentite weapon; use an unmodified dice roll at minus six (-6). Only single bullets or blasts can be parried, not bursts, rapid-fire pulses or multiple attacks. A vibro-weapon generally adds a damage bonus of 1D6+3 to the conventional weapon of the same general type. If a normal weapon is used to parry a vibro-blade, the conventional weapon will suffer some damage (30% of the normal damage inflicted by such a weapon).

Weapon Type	Avg			
	Length	Avg Weight	Damage	Avg Cost
Vibro-Battle Axe	2.25 ft	4.6 lbs	3D6+3	4,000 CR
Vibro -Polearms	7.0 ft	5.8 lb	5D6+3	9,000 CR
Vibro-Spear	6.0 ft	4.75 lbs	2D8+1	4,000 CR
Vibro-Knives	1.0 ft	1.0 lbs	2D6+3	2,800 CR
Vibro-Sword	3.0 ft	4.2 lbs	3D6+3	6,500 CR
Vibro-2-H Sword	4.8 ft	7.75 lbs	4D6+3	9,000 CR
Vibro-Clubs	2.3 ft	3.0 lbs	2D8+2	4,000 CR
Vibro-Katana	3.0 ft	2.8 lbs	5D6	12,000 CR
Vibro-Kusari-Gama	1.5 ft	2.6 lbs	3D6	5,000 CR

Energy Melee Weapons

These weapons have no blades or heads in the standard sense. When they are activated, a magnetically shaped energy blade will appear in place of the blade or around the blade (depending on the style of the weapon). The pure energy these weapons use to inflict damage makes them the most powerful melee weapons in the known galaxy in the **Heroes Unlimited** setting, but P.S. bonuses do not apply to damage.

An energy weapon can stop bullets and energy beams, but parrying them is just as difficult as with a Kisentite weapon; same conditions and restrictions. An energy weapon generally adds a damage bonus of 2D6+3 to conventional weapon, of that general type.

If a normal weapon is used to parry a energy-blade, the conventional weapon will suffer serious damage (50% of the normal damage inflicted by such a weapon). They have been known to slice conventional swords in half.

Weapon Type	*Avg Length	Avg Weight	Damage	Avg Cost
Energy Axe	2.5 ft	2.3 lbs	4D6+1	8,500 CR
Energy Polearms	6.5 ft	3.0 lbs	6D6	18,000 CR
Energy Spear	5.2 ft	2.2 lbs	3D6+3	10,000 CR
Energy Knives	0.75 ft	0.5 lbs	4D4+3	6,000 CR
Energy Sword	1.1 ft	1.5 lbs	4D6+3	12,000 CR
Energy 2-H Sword	1.5 ft	3.0 lbs	5D6+1	18,000 CR
Energy Stun Clubs	2.5 ft	3.0 lbs	**	8,500 CR
Energy Arrows	2.75 ft	0.2 lbs	3D6+3	6,000 CR/dz
Energy Katana	1.0 ft	1.1 lbs	5D6+3	20,000 CR
Energy Kusari-Gama	1.3 ft	0.8 lbs	3D6+2	10,000 CR
Energy Shuriken	0.3ft	0.1 lbs	2D6+3	3,000 CR

* This is the inactivated haft or hilt only. When activated, energy weapons are the same length as their normal counterparts.

** Energy clubs either do 3D6+3 damage or stun damage, not both. Stun damage is 1D4 plus the victim must save vs non-lethal poison. A failed roll means the character is stunned, loses initiative and is -5 to strike, parry, and dodge and skill performance is -10% for 1D6 melee rounds.

Other Notable Melee Weapons

Particle Whip: This weapon appears to be the hilt of an energy sword, but when activated, a long, thin, flowing stream of energy trails out. The whip is an energy weapon that uses a modified particle beam in a magnetic shaping field. It is quite difficult to use, but does impressive damage due to its tendency to coil about a target. To strike with a particle whip, the character must make a called shot and does NOT get any bonuses to strike, not even attribute bonuses. A 12 or higher is needed to make a successful hit. If the roll is a natural 18 or 19, the whip does double damage, and on a natural 20 it does triple damage. **Length:** Varies with setting, from 6 to 14 feet (1.8 to 4.3 m). **Damage:** 4D6+3 (no strength bonuses are applied), **Cost:** 15,000 credits.

Clippers: Clippers are laser bolas. Many bounty hunters of evil alignment use them to "hamstring" fleeing targets. The actual result is frequently dismemberment. Good aligned characters can use clippers as weapons, but rarely do and do not intentionally remove limbs, which is evil and prohibited. **Length:** 4.5 foot (1.4 m) diameter. **Damage:** 5D6, **Cost:** 6,000 credits. **Note:** Bonuses from P.P. and throwing skills are applicable.

Cestus: The Cestus is a weapon nearly identical to those from the gladiatorial arenas of Earth, but in space they are often elements of street life and survival. They are made by lining a heavy glove or gauntlet with various blades and spikes. It can be made at home easily and inflicts the same damage as a professionally crafted cestus. The only difference is professionals use higher quality materials. **Length:** Overall length depends on the glove, but blades are rarely longer than three inches (8 cm) each. **Damage:** 1D6 standard or homemade versions, 2D6 for vibro, crystal, or Kisentite models, which may be built into armored gauntlets. 3D6 damage for energy models. **Cost:**

60 to 100 credits for conventional, 1000 for Kisentite or Vibro-Blade and 4000 for energy blades.

Razars: Another variety of glove weapon with long claw-like blades that are fitted on each finger and reinforced along the length of the hand. **Length:** Blades are normally 4 to 6 inches (10 to 15 cm) long. **Damage:** 1D6 normal, 2D6 Vibro, Crystal, or Kisentite, and 2D6+3 for energy. **Cost:** Same as the Cestus.

Conventional Firearms

In many of the most advanced areas of the galaxy, firearms are considered primitive, and even barbaric. These aliens would use energy weapons exclusively, but a bullet, especially armor piercing, explosive and other *special rounds*, may inflict the same damage and even puncture armor designed to reflect energy beams. So despite the higher tech weapons presented here, do not underestimate the effectiveness of old-fashioned pistols, rifles and machineguns, especially at close range or in close quarters on board spacecraft. They may also be used for hunting, duels, target practice and sport.

Despite the high-tech weapons given on the special weapons table and the variety of equipment available in a galactic campaign, it should be understood that many aliens still use projectile type weapons. Although considered "antiquated" or viewed as low-tech, projectile weapons can often match energy weapons in damage, especially with advancements in ammunition. The improved damage of some alien weapons over their Earth equivalents is not necessarily due to bigger bullets. More likely they are due to advancements in propellants, velocity, explosives, high-tech materials and better bullet design. Most projectile weapons are also incredibly less expensive to make and maintain.

The down side to projectile weapons compared to most energy weapons is their weight, noise, comparatively shorter range and the mess they make. Firearms produce large amounts of noise and smoke (compared to lasers), and the bullets do not cauterize wounds the way many energy blasts do. Consequently, blood and gore is everywhere and a wounded individual may bleed to death, which many races consider inhumane (as if war can be humane). Projectile weapons will work fine with or without an atmosphere. There is a danger, however, in puncturing a protective environmental suit or structure by accident. The recoil from a projectile weapon discharge can send the shooter spinning wildly if he is not anchored in place.

Note: See Palladium's **Compendium of Contemporary Weapons** for over 400 Twentieth Century weapons from around the world, plus special types of ammunition, riot control items, hand grenades, mortars, EOD equipment, body armor, tanks, and more!

Prices reflect the galactic market, not Earth.

Average Galactic Revolver

Feed: 6 round cylinder, **Weight:** 2.1 pounds (1 kg), **Length:** 8.5 inches (22 cm), **Range:** 200 feet (61 m), **Damage:** 5D6, **Rate of Fire:** single shot, **Cost:** 800 credits (CR).



.38 Luger Franchi Revolver

Earth-Type Revolver

Feed: 6 round cylinder, **Weight:** 2.5 pounds (1.1 kg), **Length:** 8.5 inches (22 cm), **Range:** 165 feet (50 m), **Damage:** 3D6, **Rate of Fire:** single shot, **Cost:** 200 CR.

Average Galactic Automatic Pistol

Feed: 15 round magazine, **Weight:** 2.8 pounds (1.3 kg), **Length:** 8 inches (20 cm), **Range:** 20 feet (61 m), **Damage:** 5D6, **Rate of Fire:** Aimed or short burst, **Cost:** 1,000 to 1,500 CR.

Earth-Type Automatic Pistol

Feed: 8 to 12 round magazine, **Weight:** 3.5 pounds (1.6 kg), **Length:** 8 inches (20 cm), **Range:** 170 feet (52 m), **Damage:** 4D6, **Rate of Fire:** Aimed or short burst, **Cost:** 300 CR.

Average Galactic Sub-Machinegun

Feed: 50 round box magazine or 100 round drum, **Weight:** 5 pounds (2.3 kg), **Length:** 20 inches (0.5 m), **Range:** 700 feet (210 m), **Damage:** 5D6 per round, **Rate of Fire:** Aimed, burst, or spray, **Cost:** 1,800 CR.

Earth-Type Submachine Gun

Feed: 40 round box magazine, **Weight:** 5.5 pounds (2.5 kg), **Length:** 22 inches (0.6 m), **Range:** 600 feet (183 m), **Damage:** 3D6 pre round, **Rate of Fire:** Aimed, burst, or spray, **Cost:** 600 CR.

Average Galactic Assault Rifle

Feed: 60 round box magazine or 120 round drum, **Weight:** 7.5 pounds (3.4 kg), **Length:** 30 inches (0.8 m), **Range:** 2000 feet (610 m), **Damage:** 6D6, **Rate of Fire:** Aimed, burst, or spray, **Cost:** 2,000 CR.

Earth-Type Assault Rifle

Feed: 20 to 40 round box magazine, **Weight:** 10 pounds (4.5 kg), **Length:** 34 inches (0.9 m), **Range:** 1,600 feet (490 m), **Damage:** 4D6, **Rate of Fire:** Aimed, burst, or spray, **Cost:** 800 CR.

Average Galactic Shotgun

Feed: 32 round box magazine (Can fire 8 short bursts, each uses four rounds). **Weight:** 6 pounds (2.7 kg), **Length:** 38 inches (1.0 m), **Range:** 130 feet (36 m) for shot and 300 feet (91.5 m) for slugs, **Damage:** 5D6 for shot and 6D6+6 for slugs, **Rate of Fire:** Aimed or short burst, **Cost:** 750 CR.

Earth-Type Shotgun

Feed: 6 round tubular magazine, **Weight:** 5 pounds (2.2 kg), **Length:** 42 inches (1.1 m), **Range:** 100 feet (30 m) for shot or 200 feet (61 m) for slugs, **Damage:** 4D6 for shot and 5D6+4 for slugs, **Rate of Fire:** Single shot or two barrels (double damage), **Cost:** 200 CR.

Average Galactic Light Machinegun

Feed: 120 round box magazine or 300 round belt, **Weight:** 30 pounds (13.6 kg), **Length:** 50 inches (1.25 m), **Range:** 4000 feet (1200 m), **Damage:** 1D6x10, **Rate of Fire:** Aimed, burst, or spray, **Cost:** 5,000 CR.

Gimmick Weapons

These are unique or special application weapons that did not quite fall into any of the previous categories.

Bracelet Gun: This is a wide, ornamental armband made of decorative metal or fine ceramics, but bounty hunters and Mercenaries prefer more functional matte gray versions. With the touch of a recessed button, a hidden barrel assembly pops up, and another touch of the button fires it. Due to the unconventional design, this weapon is -2 to strike, even with an aimed shot. It comes in three models: bullet firing, laser, and ion. It is typically used as a backup or concealed weapon and is a favorite of spies and thieves. **Range:** 60 feet (18 m). **Length:** 6 to 8 inches (15 to 20 cm). **Weight:** 1 pound (.45 kg). **Damage:** 4D6 with armor piercing bullets, 4D6 for laser ver-

sions, and 5D6 for ion models. **Payload:** Two bullets or four laser or ion blasts. **Rate of Fire:** Single shot; each blast counts as one melee action. **Cost:** 1000 credits for bullet model, 200 for either energy models.

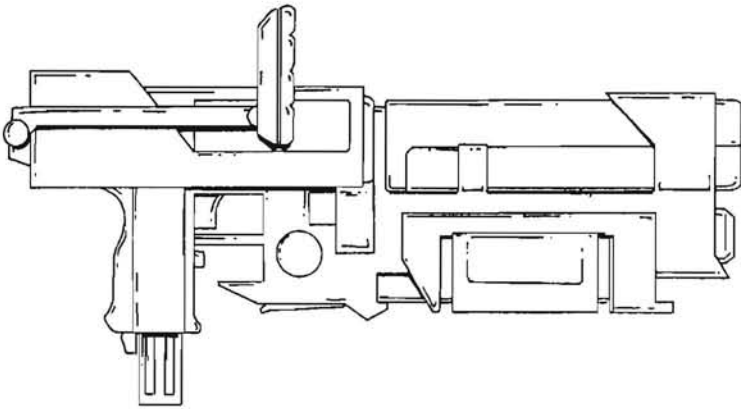

Multi-Comp Annihilator: This weapon offers the versatility of a firearm and energy weapon in a single package. Built in an over/under configuration, the Annihilator resembles a large *sub-machinegun* with an under-barrel grenade launcher. However, the lower barrel is an ion blaster. The two cannot be separated, but they can fire simultaneously for incredible damage. The only drawback is that the ion beam tends to overheat and detonate the microjet or other explosive rounds if it is used constantly for more than four melee rounds. There is only a 15% chance per twin firing of this happening (45% after 8 melee rounds). **Range:** 1,200 feet (366 m) for both. **Length:** 26 inches (0.7 m), **Weight:** 12 pounds (5.4 kg), **Damage:** 6D6 per microjet round or 1D4x10 per ion blast, or 2D4x10 for simultaneous shots from both. **Payload:** 30 microjets and 20 shot energy clip. **Rate of Fire:** Single or double barrel shots (counts as one melee action), but the microjets can be fired in bursts. **Cost:** 16,500 credits

Turbulence Generator: This is an eight inch (20 cm) diameter, vented cylinder with handles. When activated, it spins at great speeds, creating concentrated blasts of wind at nearly 60 mph (96 km). It is used as a non-lethal anti-personnel/riot control weapon, designed to incapacitate rather than kill. **Range:** 40 feet (12.2 m), **Length:** 25 inches (0.6 m), **Weight:** 10 pounds (4.5 kg), **Damage:** 1D4 from impact, and knocks the character off his feet and sends him 1D4x10 feet backwards. The character loses initiative and two melee attacks. Characters weighing more than 300 pounds (136 kg) may not be knocked down (only 01-45% chance); no effect if someone weighs over 600 pounds (172 kg).

Aiming the blast at a person's hand will inflict 1D4 damage and knock whatever he is holding out of his grasp and send it flying 2D6x10 feet away. If the character has a P.S. 24 to 30, the chance of losing the object is only 01-50%, 31 or higher 01-25% chance, 46 or higher: no way.

Rate of Fire: Single shot; each blast counts as one melee attack/action. **Payload:** Effectively unlimited. **Cost:** 7500 credits.

Special Large Caliber Firearms

There are three ways to increase the damage and/or effectiveness of firearms: make bigger guns, make better guns, and/or make better ammunition. The following sections provide examples of each, from large caliber weapons to high-tech weapons and special ammunition. All of the firearms presented in this section can be used as special weapons for the *Hardware* weapons character in a standard **Heroes Unlimited** campaign.

The bigger something is, and the faster you can make it move, the more damage it will do to whatever it runs into. Like many sporting enthusiasts on Earth, the galactic community has had its share of inventors that have come up with the biggest guns that are reasonably manageable, especially for those with greater strength and/or size than humans. They use alternate sources of propellants, explosives, electromagnetism and other high-tech modifications. Bounty hunters and Mercenaries are especially fond of the knockdown power of the large bore weapons.

Ridelly .560: The Ridelly is actually a short shotgun. A special mercury bead recoil system had to be developed to offset the recoil of its 12 inch (0.3 m) barrels. The weapon is arranged in an over/under barrel assembly, with each barrel fed by a separate tubular magazine mounted beside it. A selector switch allows both barrels to be fired simultaneously, or one at a time. The magazines must be pumped manually and both cycle in tandem. Because of this, when a single barrel is fired, the selector automatically switches to the other barrel. **Feed:** 6 round tubular magazine, **Range:** 40 feet (12 m) with stunballs, 100 feet (30.5 m) normal cartridges or explosive, 130 feet (36 m) with microjets. **Weight:** 4 pounds (1.8 kg), **Length:** 15 inches (0.4 m), **Damage:** 6D6 conventional, 1D6x10 microjets or explosives, **Rate of Fire:** Single shot or both barrels (double damage), **Cost:** 1000 credits.



Korimyr: This is a single shot handgun that makes extensive use of gas venting to offset recoil. Instead of a bolt action, it ejects spent shells at the touch of a button and closes the same way. **Feed:** One round and requires an action to eject and load another round, **Range:** 610 feet (186 m), **Weight:** 5 pounds (2.2 kg), **Length:** 11 inches (0.3 m), **Damage:** 1D4x10 normal, 1D6x10 microjets or explosive, **Rate of Fire:** Single shot, **Cost:** 900 credits.

Stomper: This is a large handgun that resembles the auto pistols or sub-machineguns of Earth. It has a pair of ammo-clips that feed alternately from each side of the gun. **Feed:** Two clip system for a total of 12 rounds, **Range:** 610 feet (186 m). **Weight:** 6 pounds (2.7 kg), **Length:** 10 inches (0.25 m), **Damage:** 5D6 normal,

1D6x10 microjets or explosive rounds, **Rate of Fire:** Single shot/semi-automatic, **Cost:** 2500 credits.

Simpyr Takedown: Possibly the most powerful firearm a normal human can carry and use, the Takedown is a single shot, large bore rifle that is often used for big game hunting and sniping. Although it can be fired like a normal rifle with no additional support, the recoil will cause characters with Physical Strength scores of 20 or lower to lose their next melee attack. Proper bracing of the weapon with its "gravity boot" anchors it in place and will allow any character to fire it normally without a loss of attacks. The anchors will hold the Takedown steady when resting on any solid surface. **Feed:** Six rounds per clip, **Range:** 4,000 feet (1200 m), **Weight:** 16 pounds (7.6 kg), **Length:** 54 inches (1.4 m), **Damage:** 1D6x10 standard rounds, 2D4x10 from large bore microjets or explosive rounds, **Rate of Fire:** Single shot, **Cost:** 16,500 credits.

Rapid Fire/Small Caliber (RFSC)

Rapid Fire/Small Caliber weapons are small or compact weapons that resemble automatic pistols or sub-machineguns but often have multiple barrels (typically 2 to 5) that fire a *simultaneous* burst (2 to 5 rounds at the same time; one from each barrel), enabling the shooter to fire a more accurate and larger burst than conventional weapons. The individual rounds are often so small that they have to be coated with teflon or made of Kisentite to assure penetration and damage. A single round does little damage, but the idea is to fire a short or medium burst, typically five to ten rounds/bullets at a single target (10 is often the entire magazine of a conventional pistol but may be less than that for 10% for these weapons). The combined number of rounds and impact of a burst from these weapons makes the damage from small ammunition comparable to larger caliber weapons. The small size of these rounds prohibits the use of conventional and special types of ammunition. Typically the entire clip cannot be emptied in one long spray, so only single shots, short and long bursts are possible and must be aimed at a *single* target.

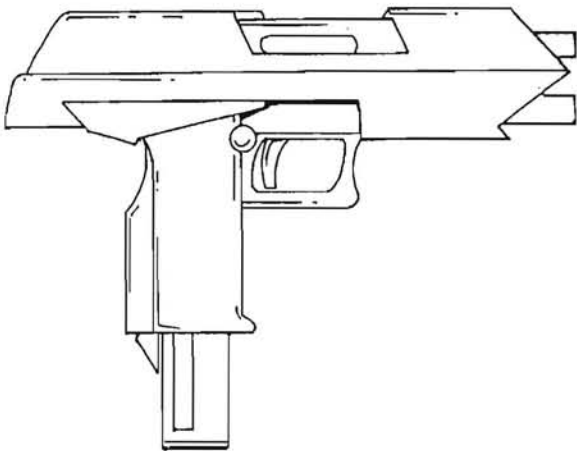

Spitfire: A small, automatic weapon about the size of most large Earth automatic pistols. Its small size limits ammunition capacity, and the rapid rate-of-fire depletes it quickly. **Feed:** 14 rounds, which is enough for one long or 2 short bursts (the long burst empties the magazine), **Range:** 135 feet (41 m), **Weight:** 3.8 pounds (1.7 kg),

Length: 8.75 inches (0.2 m), **Damage:** 1D4 points per round/bullet, or short burst of seven rounds which does one round x4 damage or a long burst (14 rounds) which does one round x8 damage. **Rate of Fire:** Aimed, burst, or spray, **Cost:** 1,200 credits.

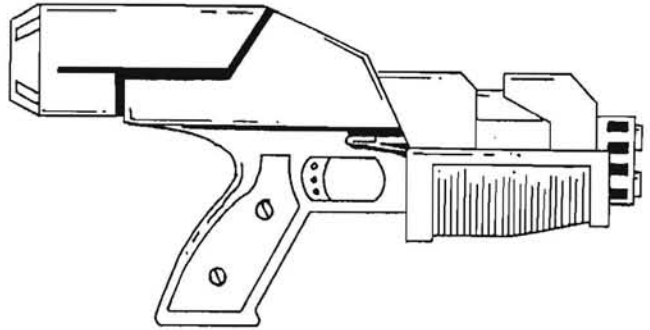

Stinger Brae: This weapon is named after the assassin who designed it. It is a fully automatic pistol with a top mounted, rear sliding clip. The clip uses a unique "U" spring feed system that doubles the pistol's ammunition capacity. **Feed:** 120 rounds, **Range:** 160 feet (49 m), **Weight:** 4 pounds (1.8 kg), **Length:** 9 inches (0.2 m), **Damage:** 1D4 points per round/bullet, or short burst of ten rounds which inflicts one round x6 damage or a long burst (20 rounds) which does one round x12 damage. **Rate of Fire:** Aimed, burst, or spray, **Cost:** 5,000 credits.

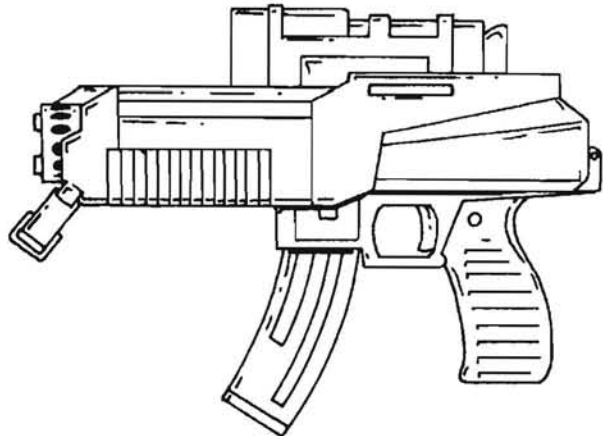

Cerator SMG: This is a small but deadly member of the sub-machinegun family. Its damage and easy concealment makes it a favorite among terrorists. **Feed:** 120 rounds, **Range:** 250 feet (76 m), **Weight:** 5 pounds (2.3 kg), **Length:** 12 inches (0.3 m), **Damage:** 1D6 points per round, or short burst of ten rounds which inflicts one round x6 damage or a long burst (20 rounds) which does one round x12 damage, **Rate of Fire:** Aimed, burst, or spray, which gives it the standard number and types of bursts per clip of ammunition. **Cost:** 7,500 credits.

TGC Riproar: As the only production line rapid-fire assault rifle, the Riproar is popular with many combat personnel across the galaxy. It is especially coveted in dense jungle or foliage environments because of the amount of saturation it can spray. **Feed:** 210 rounds, **Range:** 600 feet (183 m), **Weight:** 5.5 pounds (2.5 kg), **Length:** 18 inches (0.5 m), **Damage:** 1D6 points per round, or short burst of 12 rounds which inflicts one round x8 damage or

a long burst (30 rounds) which does one round/bullet x14 damage, or spray (long burst) one round x6, **Rate of Fire:** Aimed, burst, or spray. **Cost:** 11,000 credits.

TGC Riproar Mini-gun (TGC-RMG): This is an eight barrel version of the three barreled Riproar. The RMG has an unbelievable rate of fire that is only successful because of the small size and design of its ammunition. It is nearly identical to the Riproar, except for design and stylistic changes. Because of its amazing rate of fire, the TGC-RMG uses the machinegun rules for all aspects of combat, including damage. **Feed:** 1,000 round belt, **Range:** 1000 feet (305 m), **Weight:** 15 pounds (6.8 kg), must be tripod or vehicle mounted, **Length:** 18 inches (0.5 m), **Damage:** 2D6 points per round, or short burst of 16 rounds will inflict one round x10 damage or a long burst (32 rounds) which does one round x20 damage, **Rate of Fire:** Aimed, burst, or spray, **Cost:** 25,000 credits.

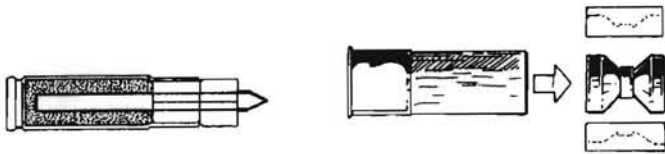

Special Ammunition

Another way to increase the effectiveness (damage) of a firearm is by using specialized ammunition. Below is a list of damages, comments, and prices for some special ammunition by weapon type. All prices are for 100 rounds. Arrows for bows and crossbows can be outfitted with heads to duplicate any of these special ammunitions. Use the pistol damage listed but double the cost for arrows.

Exploding/Mercury Tipped Ammunition: Exploding/mercury tipped rounds have a channel drilled in them that is filled with mercury, then capped. When the bullet hits a target, the round literally explodes as the mercury is compressed and ruptures the lead.

Pistols & Sub-Machineguns: add 1D6 damage per round, Cost: 500 credits.

Shotguns (slugs): add 3D6 damage per round, Cost: 800 credits.

Semi- and Fully Automatic Rifles: add 2D6 per round, 30% chance of jamming when burst firing, Cost: 700 credits.

Exploding/Plastique Tipped Ammunition: Exploding/plastique rounds are like miniature rockets that explode on contact.

Pistols & Sub-Machineguns: add 2D6 per round, 1 foot (0.3 m) blast radius, Cost: 750 credits.

Shotguns (slugs): add 4D6 per round, Cost: 1000 credits.

Semi- and Fully Automatic Rifles: add 3D6 per round; 35% chance of detonating when burst firing, Cost: 900 credits.

Hollow Point Ammunition: Hollow points have a hollow cavity in their nose that allows the round to expand on impact for greater damage.

Pistols, Sub-Machineguns and Rifles: add 1D6 per round, Cost: 350 credits.

Shotguns (slugs): add 2D6 per round, Cost: 600 credits.

Glaser Ammunition: Glaser rounds have a thin outer shell filled with small beads of shot. It ruptures on impact, and the shot is driven into the wound, but the small beads have little penetration value and tend to bounce off solid, non-fleshy objects. They cannot be used in weapons other than pistols and revolvers.

Pistol: add 2D6 damage per bullet; only does 1D6 damage to body armor and other hard targets, Cost: 450 credits.

Armor Piercing Ammunition: Armor piercing rounds are constructed of teflon, Kisentite or some other materials that are strong enough to penetrate hard substances easily.

Adds 1D6 to the damage capacity of the average round and is +2 to penetrate armor (this means an A.R. of 15 is an A.R. of 13 in regard to this bullet); usually reserved for larger calibers. Bullets made of Kisentite are considered AP rounds and are +3 to penetrate armor. Half the bullet's damage is expended on the armor and half strikes the person inside the armor.

Microjet Ammunition: Unlike the exploding bullets, these are true rockets with microjet engines that dramatically increase range and damage. These rounds cannot be silenced and they cannot be safely fired in bursts. There is a 75% chance that burst shooting will cook the entire clip, explode the gun and inflict 2D4x10 damage to the shooter.

Pistols & Sub-Machineguns: 6D6 per round, blast radius of 18 inches (0.5 m), doubles the normal range of the weapon, Cost: 3,000 credits.

Shotguns (slugs): 2D4x10 per round, blast radius of 18 inches (0.5 m), doubles the normal range of the weapon, Cost: 5,500 credits.

Semi- and Fully Automatic Rifles: 1D6x10 per round, blast radius of 18 inches (0.5 m), doubles the normal range of the weapon, Cost: 8,000 credits.

Advanced Bows & Arrows

Advanced technology has not only improved firearms, but many of its predecessors. Bow weapons have had their share of improvements from the advance of technology. Snap Cord is a type of stretchable cord that returns to its original unstretched state many times faster than conventional elastic materials. Instead of the bow flexing to provide motion, the "string" is now solely responsible for propulsion, and velocity increases, which in turn extends range and raises damage. Other innovations include spring loaded or pneumatic launchers that either increase range and damage or rate of fire.

SC Penetrator: This is a standard short bow outfitted with the snap cord string. The bow itself is made of light metal alloys and can be used as a clubbing weapon (1D6 damage). **Range:** 550 feet (168 m), **Weight:** 1 pound (.45 kg), **Length:** 3 feet (0.9 m), **Damage:** 2D6, **Rate of Fire:** Standard, see the archery skill. **Cost:** 500 credits.

SC Penetrator II: This is a long bow version of the Penetrator. It does 1D8 damage as a clubbing weapon. **Range:** 900 feet (274 m), **Weight:** 2 pounds (0.9 kg), **Length:** 4.5 feet (1.4 m), **Damage:** 3D6, **Rate of Fire:** Standard, see the archery skill. **Cost:** 750 credits.

SC Penetrator III: A large compound bow. It also does 1D8 damage as a clubbing weapon. **Range:** 1,000 feet (305 m), **Weight:** 3.75 pounds (1.7 kg), **Length:** 3.5 feet (1.1 m), **Damage:** 4D6, **Rate of Fire:** Standard, see the archery skill. **Cost:** 975 credits.

SC Mark II Penetrator: This is a crossbow version of the Penetrator. It does 2D6 damage as a clubbing weapon. **Range:** 900 feet (274 m). **Weight:** 5 pounds (2.3 kg), **Length:** 30 inches (0.8 m), **Damage:** 5D6, **Rate of Fire:** Standard, see the archery skill. **Cost:** 975 credits.

Compound Snap-Bow: The "snap-arms" on this weapon are arranged in a double pivot structure to give easier pull but more snapping power. It can also be loaded and locked into firing position and carried until needed. **Range:** 800 feet (244 m). **Weight:** 6 pounds (2.7 kg), **Length:** 34 inches (0.9 m), **Damage:** 2D8, **Rate of Fire:** Standard, see the archery skill. **Cost:** 875 credits.

Livian Crossbow: This weapon is mounted on a rifle stock and is capable of loading and locking two bolts. The bolts can be fired individually or at the same time. It can also be loaded and locked into firing position and carried until needed. **Range:** 700 feet (213 m). **Weight:** 6.6 pounds (3 kg), **Length:** 30 inches (0.8 m), **Damage:** 3D6 or 6D6 with two arrows, **Rate of Fire:** Standard, see the archery skill. **Cost:** 1,000 credits.

SAR Crossbow: Nearly identical to the Livian above, this version has a large, box-type, forward section that is actually an oversized clip of bolts. The SAR can rapid fire two bolts, one after the other. **Range:** 850 feet (260 m). **Weight:** 8 pounds (3.6 kg), **Length:** 30 inches (0.8 m), **Damage:** 3D6 per bolt or 6D6 for a rapid twin shot, **Rate of Fire:** Standard, see the archery skill, **Payload:** 14 bolts, **Cost:** 1,000 credits.

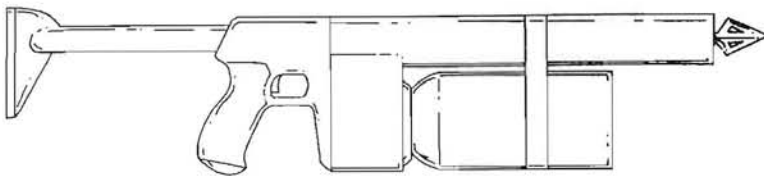

CAL Bow: This weapon resembles a crossbow without the bow arms. Arrows are placed into a round launch tube and fired by highly compressed air. **Range:** 500 feet (152 m). **Weight:** 4.75 pounds (2.15 kg), **Length:** 26 inches (0.6 m), **Damage:** 3D6, **Rate of Fire:** Standard, see the archery skill. **Cost:** 850 credits.

CAL Repeating Bow: This is another air compression launch system, but it has an oversized clip of bolts and an automatic reloading mechanism for rapid fires. **Range:** 600 feet (183 m). **Weight:** 6 pounds (2.7 kg), **Length:** 30 inches (0.8 m), **Damage:** 3D6 per bolt, or 6D6 for a rapid twin shot, 1D6x10 for a burst of six. **Rate of Fire:** Same as an automatic weapon, **Payload:** 20 bolts, **Cost:** 1,200 credits.

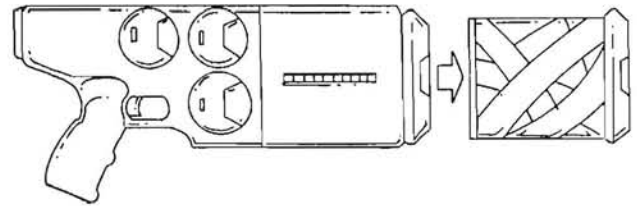

Explosive Strap Gun: This is a unique projectile weapon that fires a large projectile with compressed straps/cords. When the bundle impacts on a target, a charge inside of it goes off and the straps extend. Weights on the ends of the cords force them around the target, where they impact and adhere to each other with a molecular resin. The final result is the effective cocooning of the target. It will even restrain someone with a P.S. of 30! **Range:** 60 feet (18.3 m). **Weight:** 6 pounds (2.7 kg), **Length:** 20 inches (0.5 m), **Damage:** 1D6 from impact plus immobilization of the target. A successful dodge means the target is not struck. If the dodge fails, the victim is coiled and must be cut loose. Each of the 20 cords has two S.D.C. points when cut. The straps are very hard to break, requiring a P.S. of 31 or higher, but burn very easily because of the molecular resin. The straps burn up in one round, but the character inside takes fire damage. **Note:** One explosive strap arrow is twice the size of a normal arrow. **Cost:** 600 credits for the gun, 300 credits per bundle of 12 arrows. It takes two melee attacks/actions to reload the strap gun. Each bundle does come with an aerosol agent to counteract the resin.

Advanced Weapon Features

Advanced design firearms are created using computers, laser tools, and some alien sciences to improve the general capabilities of a weapon. These modifications, unless specifically noted, cannot be applied to shotguns, machineguns, mini-guns, rail guns or plasma ejectors.

Weapon Balancing: Adds +1 to strike with aimed shots. Can be combined with other modifications and added to the above high-tech weapons, but can only be applied once per weapon. **Cost:** 350 credits.

Mercury Bead Recoil Diminishers: Work to counter both recoil and effects of recoil. Can be combined with other modifications but can only be applied once per weapon. Adds +1 to strike with any burst. **Cost:** 600 credits.

Ammunition Caliber Expansion (ACE): The weapon is bored out so that it fires larger bullets. The weapon will, however, be off balance, and -2 to strike. If the Weapon Balancing modification from above is taken, the penalties are negated, but no extra bonuses are gained. The other problem with ACE modification is that there is a 20% chance of jamming if firing a burst. Not applicable to energy weapons. **Cost:** 1,000 credits.

Additional Ammunition Capacity: By customizing the design of a weapon's ammo clip, lengthening the clip, or adding additional clip ports, a weapon's ammunition capacity can be expanded. An additional short burst (or 20%

of capacity) can be squeezed into an existing clip size by replacing the feed mechanism with a more compact variety at a cost of 500 credits. Adding a long burst (or 50% capacity) requires the lengthening of the clip (which will make it harder to hide) and costs 475 credits. An entire extra magazine can be added by creating a side port to feed it into the weapon. Once one clip is empty, the flick of a switch allows ammunition from the second clip to feed into the firearm without costing an attack. This extensive procedure adds 25% to the weight of the weapon and costs 1,500 credits. Another alternative for sub-machine guns or larger weapons is a conversion to belt-fed ammo (typically 300 to 500 rounds). Any length of ammo belt can be employed. The cost of belt feed conversion is 2,000 credits. This modification can be applied to energy weapons for 5000 credits.

Heat and Motion Targeting Microcomputers (H&M Microcomps): These sensors and basic tracking programs lock onto warm or moving targets and notify the shooter when he is on target with a soft chime, beep or other sound. +2 to strike for aimed shots or +1 for short bursts. **Maximum effective range:** 500 feet (153 m), **Cost:** 7,500 credits. This system takes up so much of the weapon's surface that no other modifications except for ACE can be used with it. This modification can be applied to energy weapons.

HUD Feed: Gyroscopic, laser and sonar targeting sensor systems measure the firearm's exact angle of elevation and distance to target and send the information to a Heads-Up Display on a helmet or pair of goggles in the form of a targeting box or cross hairs that indicate the exact spot where the weapon is pointing, target distance, target speed (if moving), and the success percentage to get off a clean shot. Wherever the target icon is, that is where the bullets will hit; give or take a few inches or sudden movement. With this system, the shooter can look around corners, over a wall or other obstacles/cover and get a reading as to his target's position and whether or not he has a clean shot. By moving his gun hand or wrist he can adjust his aim to strike with deadly accuracy without actually seeing his target! Of course, the chance of shooting the *wrong* person is increased dramatically as this system cannot identify specific targets. No other modifications other than ACE can be placed on the weapon with this system and the shooter must wear a HUD helmet, goggles or glasses. It confers a +3 bonus to strike for aimed shots, +2 for short burst and +1 for long bursts and sprays. **Maximum effective range:** 1600 feet (488 m) **Cost:** 16,000 credits.

Incendiary Weapons

Fire has always been used in combat with varying effectiveness. With high technology it is more devastating than ever. Fire and heat do more damage to aliens from frozen worlds, so they are prized, powerful weapons to aliens in those environments.

Advanced incendiary weapons have considerably better range and precision than their ancient predecessors.

The following examples of incendiary weaponry are general representations from each class and type. The classes include pistols, rifles, and field weapons. The three types are flame emitting, exploding gel-pellets, and plasma ejectors. Flame emitting weapons fire a concentrated jet of flame similar to that of common Earth flamethrowers. Rupturing gel-pellets are fired by a low powder charge or compressed air. They are made of a durable but impact-breakable pellet containing a flammable gel like napalm. When the pellet impacts, it ruptures and ignites upon exposure to atmosphere. Plasma ejectors and rifles fire a bolt of intense liquid heat that burns ten times hotter than normal napalm.

High-Tech Flamethrower: This is an advanced version of the flamethrower. It is a rifle-like weapon, with a long barrel. Feed tubes connect it to a large backpack with twin fuel Canisters. The application of advanced technology has increased the range and upgraded the burning temperature of the fuel for better damage. The stream of flame can be adjusted and thickened. The thinner flame has reduced range and greater accuracy, striking the intended target only. The thick fire stream will hit the target and 1D4 others. The flamethrower can fire a continuous stream with effects similar to the bursts and sprays of automatic weapons. Use the machinegun rules for determination of how many targets are hit by a spray, but the damage multiples are not used. Furthermore, any flammable material will catch fire and burn until the flames are smothered (against people, the continuing damage is equal to a single blast damage every melee round until the flames are smothered). The fire is likely to spread to other combustibles. It is not wise to use such weapons inside a building unless the shooter is trying to burn it down.

Range: Thin stream: 85 feet (26 m), thick stream: 200 feet (61 m), **Weight:** 40 pounds (18 kg), **Length:** 36 inches (0.9 m), **Damage:** Thin stream 1D6x10 (1D6x10+15 to most frozen world aliens) or 2D4x10 thick stream. A full melee burst (equal to six thick blasts or 12 thin) does double damage (x2) and will set the entire area ablaze! **Payload:** 40 shots (each thick blasts counts as two). **Cost:** 1900 credits.

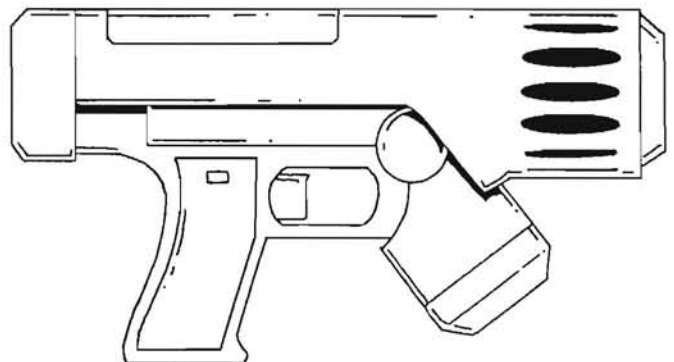

Dragon Pistol: This is a large handgun with four nozzle-like barrels. It fires a jet of flame, much like a mini-flamethrower. Reloading the weapon with a new gel Canister takes three melee actions/attacks. Changing the fuel can of the larger backpack Canisters takes six melee actions. **Range:** 60 feet (18 m), **Weight:** 5 pounds (2.3

kg), **Length:** 10 inches (0.3 m), **Damage:** 5D6 (7D6 to most frozen world aliens), **Rate of Fire:** Single shot, **Payload:** 6 shots. **Cost:** 750 credits (120 credits to refill the payload). An optional backpack unit offers a payload of 20 shots and costs an additional 800 credits (400 to refill).

Dragon Rifle: The dragon rifle is a larger version of the pistol, but it is not a full-size flamethrower. The compact rifle design limits the amount of propellant and fuel, and the optional backpack only adds to payload, not range. Furthermore, the dragon rifle only fires a single blast of flame, unlike the continuous stream possible with a true flamethrower. Changing fuel Canisters requires the same amount of time as the dragon pistol. **Range:** 120 feet (36 m). **Weight:** 10 pounds (4.5 kg), **Length:** 28 inches (0.7 m), **Damage:** 6D6 (8D6 to most frozen world aliens), **Rate of Fire:** Single shot, **Payload:** 10 shots. **Cost:** 1,200 credits. An optional backpack unit adds 14 shots to the payload and an additional 500 credits to the cost.

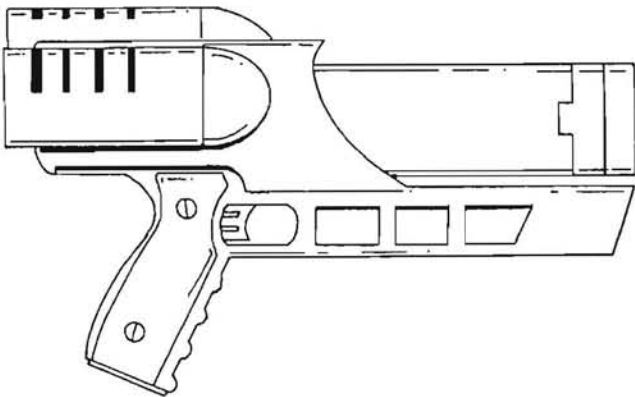

Incendiary Pistol: This pistol has an oversized barrel that makes it look like a large bore weapon. It fires gel-pellets that explode and ignite on impact. The pellets are loaded into a mini-clip that holds nine pellets. It takes one action to replace a clip. **Range:** 100 feet (30.5 m). **Weight:** 4 pounds (1.8 kg), **Length:** 12 inches (0.3 m), **Damage:** 4D6 (6D6 to frozen world aliens), **Rate of Fire:** Single shot, **Payload:** 9 shots. **Cost:** 1100 credits.

Incendiary Rifle: The incendiary rifle looks very much like a shotgun with an integrated under-barrel mount. The under-barrel assembly is actually a large pellet clip. It only takes one melee action (about 3 seconds) to change the clip. **Range:** 400 feet (122 m). **Weight:** 8.8 pounds (4 kg), **Length:** 32 inches (0.8 m), **Damage:** 6D6 (8D6 to most frozen world aliens), **Rate of Fire:** Single shot, each blast counts as one melee action. **Payload:** 18 shots. **Cost:** 3,400 credits.

Atorian Incendiary Gun: Look very much like a grenade launcher, this weapon fires flaming, grenade-sized gel pellets! On impact, they rupture to spread a flaming gel that covers over a 10 foot (3.0 m) area. It sticks to most surfaces and burns at incredibly hot temperatures for 2D4 melees. **Range:** 200 feet (61 m). **Weight:** 8 pounds (3.6 kg), **Length:** 24 inches (0.6 m), **Damage:** 6D6 for impact and initial rupture (8D6 to most frozen world aliens) plus 1D6x10 damage per each round thereafter until it burns out! **Rate of Fire:** Single shot, **Payload:** 12 pellets. **Cost:** 9,500 credits.

Incendiary Field Gun: This is a three-man, tripod mounted unit used as a battlefield weapon or mounted on a vehicle. It is a large gun that resembles a repeating grenade launcher with a longer barrel. On impact, the round ruptures to spread a flaming gel covering over a 10 foot (3.0 m) area. It sticks to most surfaces and burns at incredibly hot temperatures for 2D4 melees, same as the previous Atorian weapon. **Note:** Any weapon classed as a "field" weapon requires a two or three man crew to be fully utilized, but a character with a 24 P.S. and a 20 P.E. (or bionics) could carry and use them as over-sized rifles. **Range:** 600 feet (183 m). **Weight:** 80 pounds (36 kg), **Length:** 6 feet (1.8 m). **Damage:** 1D6x10 (1D6x10+12 to frozen world aliens), **Payload:** 50 shot drum. **Cost:** 9,000 credits.

Atorian Field Artillery Plasma Ejection Cannon: This large plasma ejector is normally vehicle mounted. On impact, the round ruptures to spread a flaming gel covering over a 20 foot (6.0 m) area. It sticks to most surfaces and burns at incredibly hot temperatures for 2D4 melees, same as the previous Atorian weapon. **Range:** 3000 feet (914 m). **Weight:** 100 pounds (45 kg), **Length:** 4 feet (1.2 m). **Damage:** 2D6x10 (3D6x10 to most frozen world aliens), **Payload:** 25 shot fuel drum. **Cost:** 55,000 credits.

Plasma Pistol: The smallest of the plasma ejectors, this weapon has heavy hitting power, but a limited payload. The range, however, is impressive for such a small weapon. **Range:** 350 feet (107 m). **Weight:** 4 pounds (1.8 kg), **Length:** 9 inches (0.2 m), **Damage:** 6D6 (8D6 to frozen world aliens), **Rate of Fire:** Single shot, **Payload:** 5 shots. **Cost:** 4,000 credits.

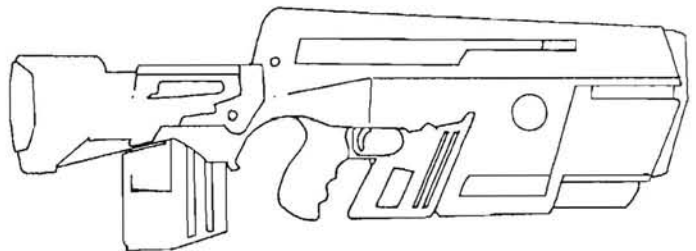

Plasma Ejector: The full-sized, rifle version of the devastating plasma pistol. **Range:** 1,200 feet (366 m). **Weight:** 12.5 pounds (5.7 kg), **Length:** 24 inches (0.6 m), **Damage:** 6D6+20 (8D6+30 to frozen world aliens), **Rate of Fire:** Single shot, **Payload:** 10 shots. **Cost:** 15,000 credits.

Gel Pellet Ammunition and Fuel Packs for Flame Emitters: This is the ammunition used by flame producing weapons. It is the same cost for fuel or gel pellets. The cost is for a full payload for the weapon it is purchased for. Backpack reloads cost double the listed price unless stated otherwise in the previous weapon descriptions..

Pistol: 175 credits.

Rifles: 250 credits.

Plasma Ejector Fuel Canisters: The specialized heat generated by plasma ejectors is different and more expensive than for normal heat-based weapons.

Pistol: 425 credits.

Rifles: 750 credits.

Incendiary Shells for Use in Shotguns: These special shells reproduce the effects of incendiary weapons using the large bore of the shotgun barrel. All costs are for 25 rounds. Flame rounds produce a burst of fire like the dragon weapons above, and gel-pellets work identical to their namesakes.

Flame rounds: Damage: 4D6 for standard mix, 6D6 for thickened gel, Range: 100 feet (30.5 m). **Cost:** 200 credits.

Cold Weapons

In the high-tech world of aliens and interstellar travel, there are a variety of unusual and innovative weapons. The Atorian Empire and others have their own collection of specialty weapons, including cold inducing weapons.

There are two types of cold weaponry, those that fire Dense Ice Projectiles (a.k.a. DIPs) and freeze damage weapons. DIPs use air or powder charges to propel a super-dense fragment of ice or frozen metal. When the projectile enters its target, its frozen temperature does additional damage. In game terms, each bullet lodged in a character's body will do one point of cold damage per melee round (2 points for each bullet for thermal aliens). After 2D4 rounds, the DIP will warm to a point where it does no further damage. They will melt totally in 6+4D6 hours so surgical removal may not be necessary unless internal organs are damaged or bleeding cannot be stopped (it also hurts like the dickens to have anything stuck in one's body for hours, and healing can't really begin until it is gone). Recently, DIP weapon designers have been experimenting with freezing toxic/poisonous liquids into frozen projectiles. As they melt, the poison seeps into the body or blood of the injured person, inflicting additional damage. Some DIPs are designed to fragment, making a larger impact wound. Do not underestimate the strength of ice. DIPs are almost as strong as conventional bullets.

Note: A heat patch has been marketed to melt DIPs quickly in the wound. They cost 250 credits each and do 1D4 points of damage when applied, but they melt the average DIP round in five minutes.

Freezing damage weapons work much like the dragon incendiary weapons, but use super cold liquids instead of fire, heat and gels. Liquid gases are commonly used as freezing ammunition. These weapons are larger than most because of the refrigeration units needed to keep their ammunition frozen. Even DIP rounds need special cryo-clips to keep the bullets from melting, as well as special gloves when handling the round. Even touching a DIP or freezing chemical gel will cause 2D4 damage!

Freezing damage weapons require the use of pack units to give them adequate payloads. Hip-pack units weigh 8 pounds and triple the listed payload of most freeze clips. A backpack unit weighs 20 pounds and increases the payload by ten times.

Freezing Damage Note: Each time a character takes damage from a freeze blast, he must save vs non-lethal

poison. A failed save means one of his limbs temporarily goes numb from the cold (compassionate G.M.s can make it the character's leg or the arm that isn't the character's normal shooting arm). Of course, combat bonuses and/or speed may be reduced 10% to 60% depending on the amount of impairment. A character that loses all S.D.C. from freezing weapon damage or has all limbs, including head and chest, frozen, lapses into a frozen state, even if he has plenty of hit points left. He can often be revived in a cryo-stasis facility or with even heat within 3D4 minutes and with little or no side effects. Those who lose S.D.C. and hit points are +25% to save vs coma and get 3D4 hit points back when revived.

Dense Ice Pistol: The large DIP cryo-clip is mounted under the front of the pistol. This makes the weapon nose-heavy and -1 to strike unless two hands are used to fire it. **Range:** 175 feet (53 m), **Weight:** 6 pounds (2.7 kg), **Length:** 10 inches (0.3 m), **Damage:** 3D6 (5D6 to thermal world aliens), **Rate of Fire:** single shot, **Payload:** 10 shots. **Cost:** 3,000 credits.

Dense Ice Rifle: The rifle version of the DIP pistol has none of the balance problems of the pistol, despite its own large cryo-clip. **Range:** 550 feet (168 m), **Weight:** 11.5 pounds (5.2 kg), **Length:** 32 inches (0.8 m), **Damage:** 5D6 (7D6 to thermal world aliens), **Rate of Fire:** Aimed or Short Burst, **Payload:** 20 shot cryo-clip. **Cost:** 8,500 credits.

Freezing Pistol: This weapon fires a projectile that erupts on impact to release either a quick freezing gas or gel. See the general description for complete damage and side effects. **Range:** 100 feet (30.5 m). **Weight:** 6 pounds (2.7 kg), **Length:** 12 inches (0.3 m), **Damage:** 4D6 plus numbing (6D6 plus numbing to thermal world aliens), **Rate of Fire:** Single shot, **Clip Payload:** Five shots. **Cost:** 6,200 credits.

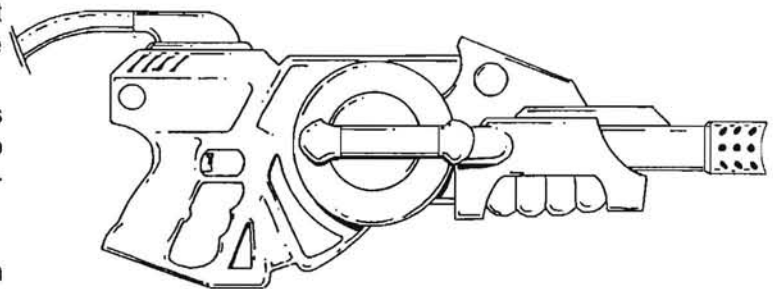

Freezing Rifle: The rifle is a large weapon similar to the pistol, with greater range and increased damage. Most of them use the hip or backpack for increased payload. **Range:** 600 feet (183 m). **Weight:** 15.5 pounds (7 kg), **Length:** 34 inches (0.9 m), **Damage:** 6D6 plus numbing (8D6 plus numbing to thermal world aliens), **Rate of Fire:** Single shot, **Clip Payload:** 7 shots. **Cost:** 13,500 credits.

DIP Fragmenting Grenade: This is a cryo-case about the size of a baseball filled with explosives and fragments of dense ice. The concussive force of the blast does damage and sends deadly fragments flying like bullets in a sphere of destruction. **Range:** Thrown to about 90 feet (27 m). **Weight:** One pound (.45 kg), **Blast Radius:** 20 feet (6.1 m). **Damage:** 1D4x10 (double to thermal aliens),

Rate of Fire: Equal to hand to hand attacks per melee; each toss counts as one melee action. **Cost:** 175 credits each.

Energy Weapons

In the standard **Heroes Unlimited** campaign, energy weapons are rare and expensive experimental items, but to the alien races who have mastered space travel and high technology, such weapons are as common as handguns and rifles on Earth. There are five categories of energy weapons: laser, microwave, particle beam, ion, and stun.

Laser weapons fire a coherent, damaging beam of light. **Particle beams** and **ion blasters** use accelerated, charged particles in a tight, destructive beam. These are the two most powerful kinds of energy weapons. **Stun weapons** include tasers and other electrical-based devices, as well as specialty weapons that disrupt or override the nervous or muscular system to stun, incapacitate or disorient a victim.

Microwave weapons fire streams of radiated particles that travel at amazing speeds, passing through anything not metallic! These particles generate great amounts of heat as they pass through and cause damage. These streams of particles will pass through walls, wood, glass, plastic, ceramics, Kevlar and other materials. Metal of any kind, including aluminum and tin foil, will stop them.

Backpack power units are available for each type of energy weapon. They typically provide 10 times the payload of a standard energy clip and weigh 15 pounds (6.8 kg). Typical cost for a backpack is 28,000 credits.

Ion Weapons

Because of their great damage, good payloads, and moderate costs, ion weapons are commonly the heavy weapons of choice for sidearms and personal weapons. All Atorian ion blasters are +1 to strike and +2 on damage per blast.

Mini-Ion Blaster: A small pistol about the size of an Earth auto-pistol. **Range:** 200 feet (61 m), **Length:** 8 inches (0.2 m), **Weight:** 2 pounds (0.9 kg), **Damage:** 3D6, **Payload:** 6 shot energy clip, **Rate of Fire:** Single shot; each blast counts as one melee attack. **Cost:** 2000 credits.

Ion Blaster: This is a full-size pistol, slightly larger than the mini-blaster. **Range:** 400 feet (122 m), **Length:** 8.75 inches (22 cm), **Weight:** 2.2 pounds (1 kg), **Damage:** 5D6, **Payload:** 10 shot energy clip, **Rate of Fire:** Single shot, **Cost:** 5000 credits.

Heavy Ion Blaster: A large, slightly oversized pistol. **Range:** 300 feet (91 m), **Length:** 10 inches (25 cm), **Weight:** 3.5 pounds (1.6 kg), **Damage:** 6D6, **Payload:** 8 shot energy clip, **Rate of Fire:** Single shot, **Cost:** 6,750 credits.

Ion Blaster Rifle: The standard energy rifle version of the ion weapon. **Range:** 3,000 feet (914 m), **Length:** 24 inches (.6 m), **Weight:** 7 pounds (3.2 kg), **Damage:** 5D6, **Payload:** 18 shot energy clip, **Rate of Fire:** Single shot, **Cost:** 16,000 credits.

Heavy Ion Rifle: A heavy, oversized rifle. **Range:** 2,000 feet (610 m). **Length:** 30 inches (.8 m), **Weight:** 10 pounds (4.5 kg), **Damage:** 1D4x10, **Payload:** 12 shot energy clip, **Rate of Fire:** Single shot, **Cost:** 18,000 credits.

Ion Field Cannon: A heavy infantry weapon normally used for anti-vehicle purposes. **Range:** 4,000 feet (1200 m). **Length:** 45 inches (1.2 m). **Weight:** 78 pounds (35 kg). **Damage:** 2D8x10. **Payload:** 30 shot energy battery (weighs 18 pounds/8.2 kg.). **Rate of Fire:** Single shot, **Cost:** 62,000 credits.

Laser Weapons

Lasers are the most common energy weapons. They have good damage, large payloads, and a superior range. They can be considered the preferred sidearms of space travelers. Lasers are the only weapons that are currently produced with pulse capabilities.

Mini-Laser: Either a small pistol or a flashlight-like rod. These are common emergency weapons or tools. Most of the rod types have a low setting that allows them to be used as a cutting or soldering tool. **Range:** 50 feet (15.2 m), **Length:** 4 to 6 inches (0.1 to 0.15 m), **Weight:** 0.5 to one pound (0.2 to 0.45 kg). **Damage (3 settings):** 1D4, 1D6 and 2D6. **Payload:** 8 shot energy clip. **Rate of Fire:** Single shot, **Cost:** 1800 credits.

Laser Pistol: The standard, pistol-size sidearm. **Range:** 800 feet (244 m). **Length:** 9 inches (.23 cm). **Weight:** 2 pounds (.9 kg). **Damage:** 4D6. **Payload:** 20 shot energy clip. **Rate of Fire:** Single shot, **Cost:** 3,800 credits.

Laser Pulse Pistol: A large pistol about the size of an Earth machine pistol. **Range:** 1000 feet (305 m), **Length:** 9 inches (23 cm), **Weight:** 2.5 pounds (1.1 kg), **Damage:** 2D6 single shot or 6D6 for a triple pulse, **Payload:** 24 shot energy clip (a triple pulse uses 3 shots). **Rate of Fire:** Single shot or a three beam pulse (counts as one melee action). **Cost:** 5,500 credits.

Heavy Laser Pistol: A large, slightly oversized pistol. **Range:** 1000 feet (305 m), **Length:** 10 inches (25 cm), **Weight:** 3 pounds (1.4 kg), **Damage:** 5D6, **Payload:** 10 shot energy clip, **Rate of Fire:** Single shot, **Cost:** 7,500 credits.

Laser Rifle: The standard energy rifle version of the laser pistol. **Range:** 4,000 feet (1219 m), **Length:** 26 inches (0.6 m), **Weight:** 6 pounds (2.7 kg), **Damage:** 5D6, **Payload:** 24 shot energy clip, **Rate of Fire:** Single shot, **Cost:** 15,000 credits.

Laser Pulse Rifle: The rifle version of the pulse pistol. **Range:** 4,000 feet (1200 m), **Length:** 19 inches (0.5 m), **Weight:** 5 pounds (2.3 kg), **Damage:** 3D6 single shot or 1D4x10+10 per triple pulse, **Payload:** 24 shot energy clip (a triple pulse uses 3 shots). **Rate of Fire:** Single shot or a three beam pulse, **Cost:** 21,500 credits.

Heavy Laser Rifle: A heavy assault rifle-styled laser weapon. **Range:** 6,000 feet (1829 m), **Length:** 28 inches (0.7 m), **Weight:** 8 pounds (3.6 kg), **Damage:** 1D4x10, **Payload:** 15 shot energy clip, **Rate of Fire:** Single shot, **Cost:** 24,000 credits.

Laser Field Cannon: A heavy, infantry weapon normally used for anti-vehicle purposes. **Range:** 8,000 feet (2438 m), **Length:** 60 inches (1.5 m), **Weight:** 65 pounds (29 kg), **Damage:** 2D4x10, **Payload:** 40 shot energy battery (weighs 16 pounds/7.2 kg), **Rate of Fire:** Single shot, **Cost:** 75,000 credits.

Microwave Weapons

Their high cost and low damage make microwave weapons less popular than the other kinds of energy weapons, but their ability to bypass body armor makes them very attractive to certain types of warriors. The overall lack of huge markets limits the production of these weapons and only standard pistol and rifle versions are available, but the Atorian Empire does have experimental field models of microwave weapons. **Remember**, microwave weapons fire streams of radiated particles that travel at amazing speeds, passing through most anything not metallic! These particles generate great amounts of heat as they pass through living things and cause damage. These streams of particles will pass through walls, wood, glass, plastic, ceramics, Kevlar and other materials. Metal of any kind, including aluminum and tin foil will stop them.

Microwave Pistol: The standard pistol-size sidearm. **Range:** 800 feet (244 m), **Length:** 10 inches (0.25 m), **Weight:** 3 pounds (1.4 kg), **Damage:** 2D6, **Payload:** 15 shot energy clip, **Rate of Fire:** Single shot, **Cost:** 6,000 credits.

Microwave Rifle: The standard energy rifle version of the microwave pistol. **Range:** 1,100 feet (335 m), **Length:** 20 inches (0.5 m), **Weight:** 6 pounds (2.7 kg), **Damage:** 3D6, **Payload:** 20 shot energy clip, **Rate of Fire:** Single shot, **Cost:** 26,000 credits.

Particle Beam Weapons

These are the most devastating of the energy weapons. These have a low payloads due to the incredible energy needed to power them, and high costs, limiting their popularity, but their damage cannot be equaled in hand-held weaponry.

Particle Beam Pistol: This is a large, oversized sidearm. **Range:** 900 feet (274 m), **Length:** 10 inches (0.3 m), **Weight:** 5 pounds (2.3 kg), **Damage:** 6D6, **Payload:** 6 shot energy clip, **Rate of Fire:** Single shot, **Cost:** 7,000 credits.

Light Particle Beam Rifle: The standard energy rifle version of the P-beam weapon. **Range:** 2,000 feet (610 m), **Length:** 25 inches (0.6 m), **Weight:** 9 pounds (4 kg), **Damage:** 1D4x10, **Payload:** 10 shot energy clip, **Rate of Fire:** Single shot, **Cost:** 20,000 credits.

Heavy Particle Beam Rifle: This is a heavier version of the energy rifle. **Range:** 3,000 feet (914 m), **Length:**

36 inches (0.9 m), **Weight:** 12 pounds (5.4 kg), **Damage:** 1D6x10, **Payload:** 10 shot energy clip, **Rate of Fire:** Single shot, **Cost:** 24,000 credits.

Particle Beam Cannon: A heavy infantry field weapon normally used for anti-vehicle purposes. **Range:** 4,000 feet (1219 m), **Length:** 75 inches (1.9 m), **Weight:** 105 pounds (48 kg), **Damage:** 1D6x20, **Payload:** 20 shot energy battery (weighs 20 pounds/9.1 kg), **Rate of Fire:** Single shot, **Cost:** 120,000 credits.

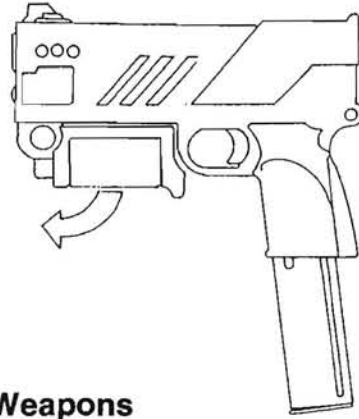

Stun Weapons

In the context of **Heroes Unlimited**, stun weapons do little or no physical damage, but they do inflict penalties that daze and incapacitate. Particularly tiny or frail creatures and children may suffer 2D6 damage and the duration for penalties may be doubled. Psionic characters will have a headache that lasts 4D6 minutes per each stun blast.

A typical saving throw is 16 or better; P.E. bonuses to save vs poison are applicable. A successful save means the character has shaken the effects of the blast and only loses initiative for that one melee round (initiative and one melee action from heavy stun blasts).

Light Stunner: A weapon commonly used in riot, crowd and animal control situations. It has a short range and delivers a light jolt that stuns the nervous system and incapacitates one's opponent. **Range:** 40 feet (12 m). **Length:** 7 inches (18 cm). **Weight:** 2 pounds (0.9 kg). **Damage:** Victims must save vs non-lethal poison or suffer -4 on initiative, and -3 to strike, parry, and dodge. **Duration:** 1D6 melee rounds. **Payload:** 12 shot energy clip. **Rate of Fire:** Single shot. Each blast counts as one melee attack/action. **Cost:** 3000 credits. **Note:** Light stunner rifles are identical, except they are 15 inches long (0.4 m), weigh 4 pounds (1.8 kg), have double the pistol range, 20 shot clips, and cost 2,500 credits.

Normal or Medium Stunners: **Range:** 85 feet (26 m). **Length:** 8 inches (20 cm). **Weight:** 3 pounds (1.4 kg). **Damage:** Victims must save vs non-lethal poison or suffer -6 to strike, parry, and dodge, lose initiative and one melee action. **Duration:** 1D6 melee rounds. **Payload:** 8 shot energy clip. **Rate of Fire:** Single shot, **Cost:** 5500 credits. **Note:** Stunner rifles are identical, except they are 16 inches (0.4 m) long, weigh 4 pounds (1.8 kg), have double the pistol range, 16 shot clips, and cost 1850 credits.

Heavy Stunners: **Range:** 135 feet (41 m). **Length:** 9 inches (23 cm). **Weight:** 4 pounds (1.8 kg). **Damage:** Vic-

tims must save vs non-lethal poison or suffer -8 to strike, parry, and dodge, reduce speed by half, and attacks per melee round by two. **Duration:** 2D4 melee rounds. **Payload:** 8 shot energy clip. **Rate of Fire:** Single shot, **Cost:** 7000 credits. **Note:** Heavy stunner rifles are identical, except they are 24 inches long (0.6 m), weigh 5 pounds (2.3 kg), have double the pistol range, 16 shot energy clips, and cost 10,000 credits.

Sonic Weapons

Sonic weapons use high-pitched sound waves to produce damaging or disorienting effects. There are three types of sonic weapons: sonic blasters, sonic stunners, and sonic disrupters. **Sonic blasters** use powerful, compressed sound waves that impact on a target and cause damage. These attacks will partially pass through armor, causing *half* damage to the target. **Rifts Note:** In the **Rifts** setting, sonic weapons will have no effect against Mega-Damage armor or structures. They are S.D.C. weapons. However, half the S.D.C. damage will penetrate M.D.C. body armor and M.D.C. vehicles, and hit and hurt the person inside. One-third of the S.D.C. damage will penetrate and hit Operators of power armor and one-quarter of the S.D.C. damage will penetrate and hit pilots of small robots and M.D.C. vehicles. They have no effect against the pilots of giant robots larger than 18 feet (5.4 m).

Sonic stunners use sound frequencies to upset the inner ear and cause dizziness and loss of balance. **Sonic disrupters** work much the same way as sonic stunners, but their effects reach to the brain and cause sensory overload that can result in unconsciousness.

Sonic stunners and disrupters require a save vs non-lethal poison. A successful save means no effect. A failed save means penalties and side effects. Roll for each attack that successfully strikes. Helmets add +4 to saving throws. Helmets with sonic insulation (costs 200 credits) and full environmental body armor (with the helmet on), make the wearer immune to the effects of sonic stunners and disrupters until the helmet is destroyed or removed.

Notes: 1. All sonic weapons do +10 damage when used underwater. 2. Multiple blasts increase the duration that penalties last, but the penalties themselves are not cumulative.

Sonic Blaster Pistol: **Range:** 65 feet (23 m). **Length:** 9 inches (20 cm), **Weight:** 3.2 pounds (1.4 kg), **Damage:** 2D6; half will carry through the armor and inflict S.D.C./hit point damage, **Payload:** 10 shot energy clip. **Rate of Fire:** Single shot, **Cost:** 3500 credits.

Sonic Blaster Rifle: **Range:** 100 feet (30 m), **Length:** 24 inches (.6 m), **Weight:** 7.6 pounds (3.4 kg), **Damage:** 3D6+2; half will carry through armor. **Payload:** 20 shot energy clip, **Rate of Fire:** Single shot, **Cost:** 6,500 credits.

Sonic Stunner Pistol: **Range:** 150 feet (46 m), **Length:** 9 inches (23 cm), **Weight:** 3.5 pounds (1.6 kg), **Damage:** 1 point plus save or suffer -5 on initiative, -4 to strike, parry, and dodge for 1D4 melee rounds, **Payload:** 15 shot energy clip, **Rate of Fire:** Single shot, **Cost:** 4,000 credits.

Sonic Stunner Rifle: **Range:** 175 feet (53 m), **Length:** 20 inches (.5 m), **Weight:** 7 pounds (3.2 kg), **Damage:** 1 point plus save or suffer -7 on initiative and -6 to strike, parry, and dodge for 1D6 melee rounds. Also reduce Spd. by 20%, **Payload:** 18 shot energy clip, **Rate of Fire:** Single shot, **Cost:** 14,900 credits.

Sonic Disrupter Pistol: **Range:** 85 feet (26 m), **Length:** 8 inches (20 cm), **Weight:** 4.5 pounds (2 kg), **Damage:** 2 points plus save or be rendered unconscious for 1D4 melee rounds. If the character makes a successful saving throw, he remains conscious but is -2 on initiative, and to strike, parry, and dodge for 1D6 melee rounds. Multiple blasts increase the duration that penalties last, but the penalties themselves are not cumulative. **Payload:** 10 shot energy clip, **Rate of Fire:** Single shot, **Cost:** 1800 credits.

Sonic Disrupter Rifle: **Range:** 200 feet (61 m), **Length:** 21 inches (.5 m), **Weight:** 6.8 pounds (3.1 kg), **Damage:** 3 points plus save or be rendered unconscious for 1D4 melee rounds. If the character makes a successful saving throw, he remains conscious but is -2 on initiative and to strike, parry, and dodge for 1D6 melee rounds. **Payload:** 12 shot energy clip, **Rate of Fire:** Single shot, **Cost:** 5,500 credits.

Sonic Blaster: **Range:** 100 feet (30 m), **Damage:** 3D6, half will carry through armor. **Sonic Stunner:** **Range:** 175 feet (53 m). **Damage:** 1 point plus save or suffer -6 to strike, parry, and dodge for 1D6 melees. **Sonic Disrupter:** **Range:** 150 feet (46 m). **Damage:** 1 point plus save or be rendered unconscious for 1D4 melee attacks and -2 to strike, parry, and dodge for 1D4 additional attacks while shaking the effects off (the -2 penalty here is cumulative with the -6 above if it was not saved against, for a total penalty of -8). **Rate of Fire:** for all settings: single shot, **Length:** 30 inches (.8 m). **Weight:** 13 pounds (5.8 kg). **Payload:** 30 shot energy clip. **Cost:** 12,000 credits. Rarely available.

Atorian Variable Sonic Rifle: This is a large sonic rifle with various generators in it, and a selector switch. It can be set to function as any of the three kinds of sonic weapons. With the flip of a switch a soldier can disorient opponents with a sonic stunner effect, then switch to a disrupter attack on his next action and render them unconscious. The damage and range statistics vary with the weapon's setting, but are all equivalent to rifle range and damage. **Cost:** 25,000 credits.

Atorian Sonic Cannon: This field weapon takes all three aspects of sonic weapons and combines them into one devastating attack. When the sonic cannon hits a target without sonic insulation, the victim must save vs non-lethal poison twice; once to resist disorientation penalties (as per stunners) and again to fight off unconsciousness (as per disrupter). In addition, the hapless target suffers damage from the impact of the blast. Half of the damage done is to the structure of the body armor, vehicle or protective cover, and the other half hits ALL the occupants of a vehicle's cockpit/pilot's compartment inside, or everybody in a ten foot (3.0 m) radius. This makes it an incredibly effective field weapon against power armor and

vehicles, because not only does it damage the vehicle but there is an excellent chance that one to three blasts will incapacitate or knockout the pilot and his crew!

Range: 800 feet (244 m; double underwater). **Blast Area:** 10 foot radius (3.0 m; roughly a 20 foot/6.1 m diameter of effect — double underwater). **Length:** 48 inches (1.2 m). **Weight:** 98 pounds (44 kg). **Damage:** 2D4x10, half of which carries through armor and may inflict unconsciousness and disorientation. **Penalties From Stun Effect:** No initiative, reduce number of attacks per melee by half, speed by half, skill proficiency by half, -7 to strike, parry, and dodge for 2D4 melee rounds. Halve penalties on a successful save. **Payload:** 30 shot energy battery (weighs 25 pounds/7.6 kg) or 100 shot field generator. **Rate of Fire:** Two times per melee round (15 seconds). **Note:** Not effective against robots larger than 35 feet (10.7 m) and aircraft, spacecraft or vehicles larger than 60 feet (18.3 m). **Cost:** None have ever been available, even on the black market. The Empire protects these weapons well and no other major weapon manufacturer has yet perfected a production line model. **Estimated cost:** 3D4 million credits.

Body Armor

Note: All armors on page 342-343 of **Heroes Unlimited** are available at the prices listed. Also see **Palladium's Compendium of Contemporary Weapons** for additional conventional body armor, riot gear and other weapons and equipment.

Kisentite Armor: Any of the ancient styles of armor from chain mail to full plate armor can be fashioned out of Kisentite, but the metal is not plentiful, is too heavy for most beings and the cost is high. Thus, this armor is really only suitable for cyborgs and beings with incredible P.S. and P.E. This is the main reason only weapons are forged from the substance. Here are some common types of Kisentite Armor:

K-Mail & Ceramics: A.R. 15, 100 S.D.C., weight: 60 lbs (27 kg), Cost: 4,000 CR, penalties: -10% prowl, acrobatics and gymnastics.

K-Chain Mail (light): A.R. 14, 85 S.D.C., weight: 70 lbs (31 kg), Cost: 2,600 CR, penalties: -15% prowl, acrobatics and gymnastics.

K-Double Mail: A.R. 16, 120 S.D.C., weight: 90 lbs (40.8 kg), Cost: 4,000 CR, penalties: -20% prowl, acrobatics and gymnastics.

K-Scale Mail: A.R. 17, 160 S.D.C., weight: 100 lbs (45 kg), Cost: 6,500 CR, penalties: -25% prowl, acrobatics and gymnastics.

K-Plate Mail: A.R. 18, 300 S.D.C., weight: 140 lbs (63 kg), Cost: 10,000 CR, penalties: -40% prowl, acrobatics and gymnastics, reduce speed by 20% and increase the fatigue factor by 50%.

Crystal Armor: Coming in either a transparent or translucent form of any color, this armor is grown in molds

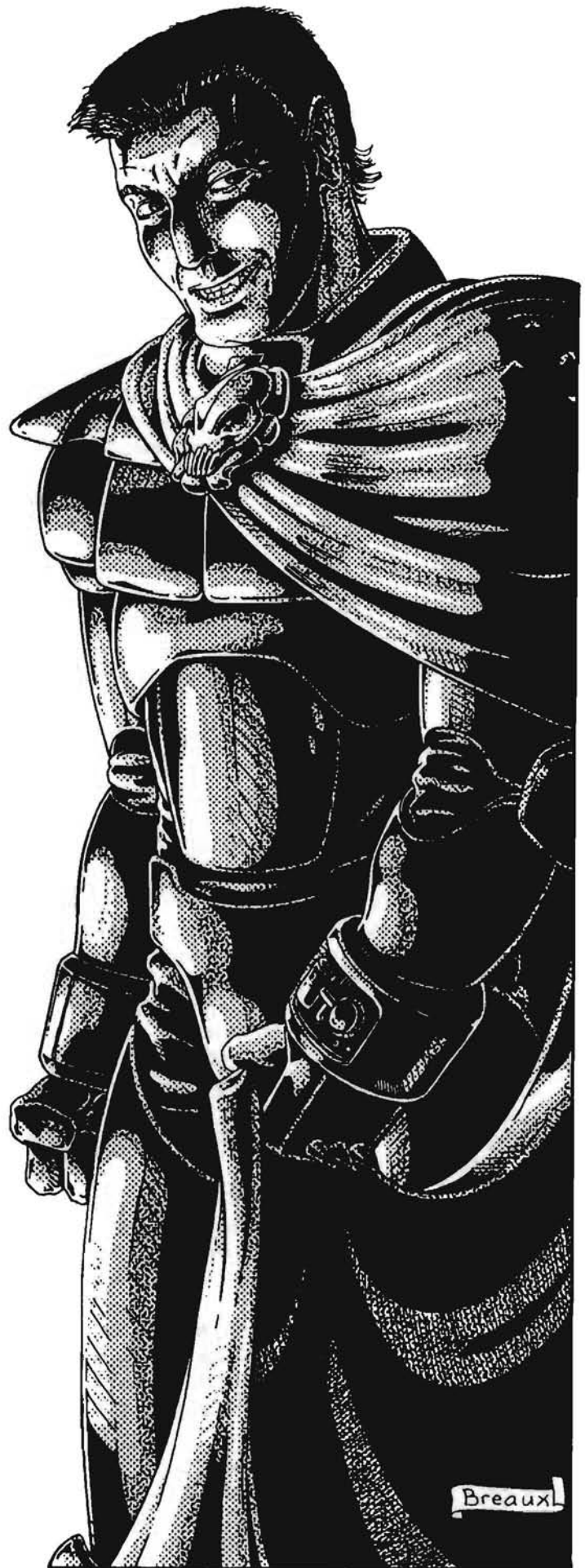

and reaches a resistance level equal to that of Hard Armor. However, it is much lighter. As can be expected, cost is high, but availability is good. Many Imperial Lords, Dukes, and Duchesses outfit their guards and bodyguards with this attractive but functional armor. Movement penalties are also slight: -5% to prowl, -10% on acrobatics, gymnastics and similar skills.

Armor	A.R.	S.D.C.	Weight	Cost
Crystal Vest (1/2 suit)	12	120	10 lbs/4.5 kg	2,800 CR
Crystal Armor (3/4 suit)	16	260	12 lbs/5.4 kg	4,000 CR
Crystal Armor (Full suit)	17	280	13 lbs/6 kg	4,500 CR

Atorian Diamond Armor: The Atorian Empire has developed a process that chemically strengthens crystal armor. Combining this technology with advanced designs, they have developed a hardened body armor which functions like robotic armor in terms of armor rating rules. If a roll to strike is less than the armor's A.R., the attack simply bounces off! Attack rolls equal to or greater than the A.R. do full damage to the armor. The Empresses keep heavy security over the secret process, and only the most loyal Atorian commanders and personal guards have the armor. Many governments have rewards out for information on this process, but no one has managed to get a copy of it yet. Rewards can total as much as a million credits.

Armor	A.R.	S.D.C.	Weight	Cost*
Diamond Vest (1/2 suit)	9	110	13 lbs/6 kg	N/A
Diamond Armor (Full)	12	220	17 lbs/7.7kg	N/A

* If any suit were to find its way to the market, prices would begin at 70,000 credits. If the process was ever copied and the suits were to be mass produced, they would be limited to military personnel for quite a while, and the price would remain high, about 50,000 credits.

Flexible Armored Suits (FAS): Very similar to the Flexi-Steel armor developed by Fabricators Inc. on Earth (see **Villains Unlimited**), FAS armor fits like an athlete's body suit. It is made of an advanced alloy that shifts to accommodate movement, yet provides unrivaled protection for the amount of flexibility it allows. FAS armor is practically undetectable under clothes and is perfect for bodyguards, undercover police, spies and anyone in a low profile but dangerous profession. They can also be worn under other armor, for additional S.D.C. protection. FAS armor is the only *non-rigid* armor that can have special armor options added to it or be worn with other types of armor. No movement penalties!

Armor	A.R.	S.D.C.	Weight	Cost
FAS Torso Armor (1/2 suit)	10	80	10 lbs	2,000 CR
FAS Body Armor (3/4 suit)	14	175	14 lbs	4,500 CR
FAS Full Body Armor	16	200	16 lbs	5,000 CR

Kinetic Suits: These suits are not *protective* S.D.C. armor in themselves, but serve to augment the capabilities of armor. They appear to be lightly padded, wire-mesh suits that are worn beneath standard armors, even FAS armor. Kinetic suits use a unique compound that distributes the force applied to it across its entire surface. In game terms, this means that the impact of projectiles, arrows, explosives, punches, falls and sonic blasts that hit and pass through the top armor will do only half damage! This does not include energy beams (they have no impact).

Kinetic suits have no A.R. rating or protective S.D.C. This technology is still new and prices are high. Cost: 20,000 credits. Repairs cost 100 credits per square foot.

Thermolate: Another armor augmenting and survival item, thermolate is also new technology and expensive. It resembles FAS armor in that it is a close fitting body suit of dull grey color. Enhanced material properties allows the suit to counteract the environmental temperature when it greatly differs from the body inside it. A character can function in temperatures as much as 40 degrees Fahrenheit above or below (+/-22 C) his normal level of tolerance before suffering from exposure. Human exposure temperatures are roughly 35 degrees Fahrenheit (2 C) from the cold and 100 degrees Fahrenheit (38 C) from heat. Cost: 10,000 credits.

Power Armor

Exoskeletons are basically wire frame constructs or simple, lightly armored shells or braces designed to augment a character's physical attributes by increasing speed, strength, agility or endurance. Many provide little or no armored protection. *Power armors* are full suits of robotic armor that use the robot A.R. rules and are designed to both protect and enhance the wearer. All robotics sold to the general public are powered by a micro-generator and recharger that have a five year life. Any color or style is available.

Unlike Earth with its new and experimental robotics programs, the galaxy is filled with races that have achieved much higher levels of success in that area. Some are even marketing their successes. In the interest of preserving their technical superiority, these races will only sell inexpensive, low capability *exoskeletons* and robots. Few offer upgrades, and most mass market power armors come with no built-in weapon systems.

Characters who feel they need to have upgrades or weapons installed have little recourse other than to turn to the black market, organized crime or hardware/robot specialists. In such arenas they will be able to find what they want, but it will be expensive (25% to 75% higher than book prices). Furthermore, availability of particular weapons, gimmicks, features and improvements may not be available (G.M.'s discretion).

Even a character with the robot electronics and mechanics skills will find it expensive to do the work himself. Before he can even make a roll (-40%), he will have to buy

parts and may need to rent expensive equipment. Rare, uncommon parts will cost him 50% to 150% above book price. **G.M. Note:** If the Game Master feels uncomfortable with exoskeletons or upgrades outside of the Robotics class, he or she can rule that such equipment is not available. For a vast variety of different types of power armor, take a look at **Rifts**, **Rifts Sourcebook One**, and **Rifts Triax**; of course, the Mega-Damage stats will have to be converted and modified (reduced) for use in **Heroes or Aliens Unlimited**.

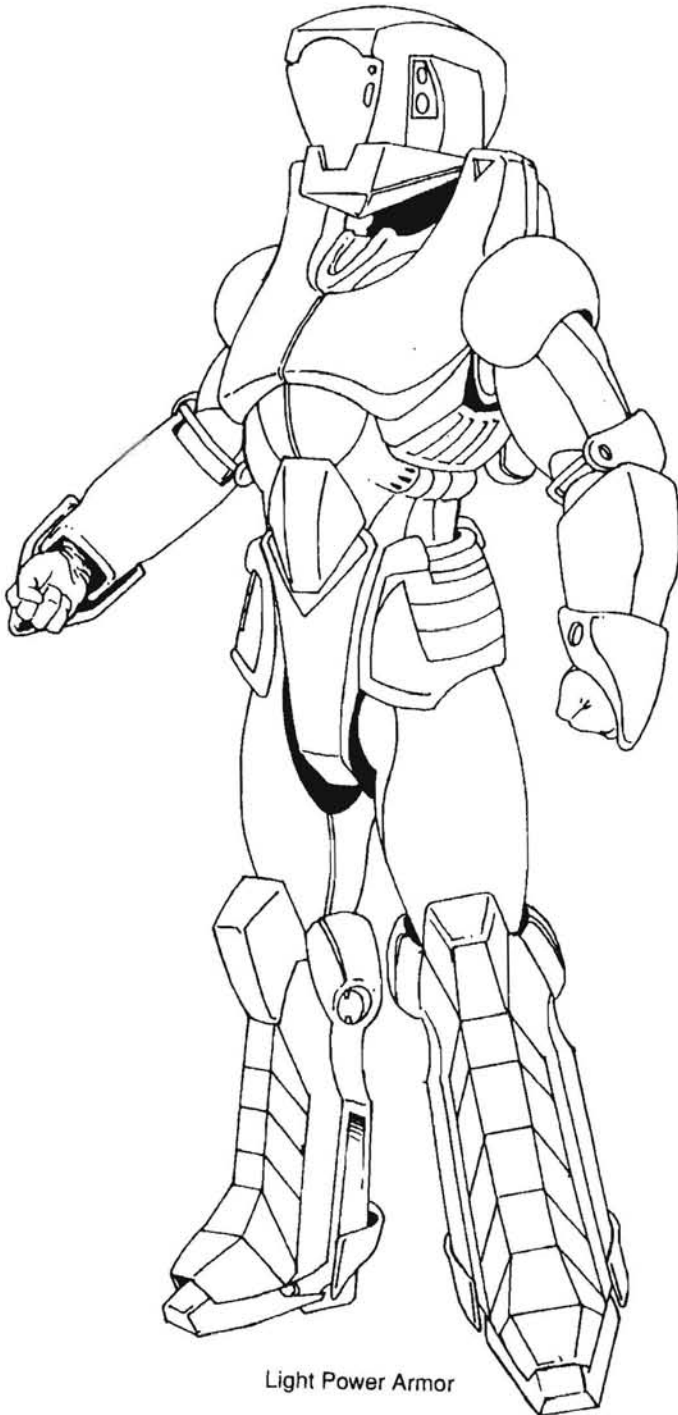

Light Power Armor

The following are some quickie stats for various basic types of mass market exoskeletons and powered suits.

Light Exoskeleton: Provides the following bonuses and systems: +4 to P.S., reduce fatigue by 50%, increase speed by 10%, leap six feet (1.8 m), advanced optic sys-

tem (typically multi-optics), and basic communications system. The light exoskeleton has no armor rating and only 15 S.D.C. protection for the wearer. If built into a suit of **Hard Armor** it will have A.R. 16, S.D.C. 200. Normal A.R. rules are used for this suit, not the vehicle/robotics/natural A.R. rules. **Cost:** 170,000 credits.

Utility Exoskeleton: A wire frame, strength augmenting system that is designed for heavy work (not combat). +6 to P.S. (equivalent to the extraordinary P.S. minor power, without the bonuses), can lift and carry weight 10 times normal, reduce fatigue by 60%, increase speed by 10%, and has a basic communications system. The exoskeleton offers an A.R. of 8 and 25 S.D.C. protection for the wearer. **Cost:** 200,000 credits.

Combat Exoskeleton: A wire frame, strength augmenting system that is designed for combat. +6 to P.S. (equivalent to the extraordinary P.S. minor power, without the bonuses), +2 to P.P., increase speed by 20%, add one attack per melee round, and +1 on initiative, plus reduce fatigue by 50%, and it has an advanced optic system (typically multi-optics), and basic communications system. The exoskeleton has an A.R. 10 and 50 S.D.C. **Cost:** 270,000 credits.

Light Power Armor: Provides the following stats and systems: A.R. 12, S.D.C. 200, P.S.: 22 (superhuman), Spd.: 45 (30 mph/48 km), advanced robotics optic system, advanced audio and communications system, targeting sight (+1 to strike), and can leap 12 feet (3.6 m). **Cost:** 450,000 credits. A jet pack can be added for flight capabilities. **Jet Pack: Speed:** 250 mph (400 km). **Range:** Fuel for 350 miles (560 km). **Bonuses:** +2 to dodge while in flight. **Cost:** adds 100,000 to the cost of armor.

Heavy Power Armor: Provides the following stats and systems: A.R. 15, S.D.C. 400, P.S.: 27 (superhuman), Spd.: 88 (60 mph/96 km), advanced robotics optic system, advanced audio and communications system, targeting sight (+1 to strike), short-range radar (8 miles or 13km, 24 target tracking), and can leap 20 feet (6 m). **Cost:** 650,000 credits. A jet pack can be added for flight capabilities.

Jet Pack: Speed: 200 mph (320 km). **Range:** Fuel for 275 miles (440 km). **Bonuses:** +1 to dodge while in flight. **Cost:** adds 100,000 to the cost of armor.

Environmental Suits

To make it easier on players buying equipment, a few specific environmental survival suits are presented here. Some of the specific alien descriptions *may* also offer additional types of spacesuits and Environmental Battle Armor (EBA). The temperature control systems and insulation protects from heat and cold (reduce damage by 1/2 from heat and cold attacks and environments).

Hostile Environment Survival Suits (H.E.S.S.): An unarmored survival suit that protects the character from hostile environments. These can be used as standard space suits. Light suits have A.R. 6, 15 to 20 S.D.C. and light insulation. They have no movement penalties. Heavy

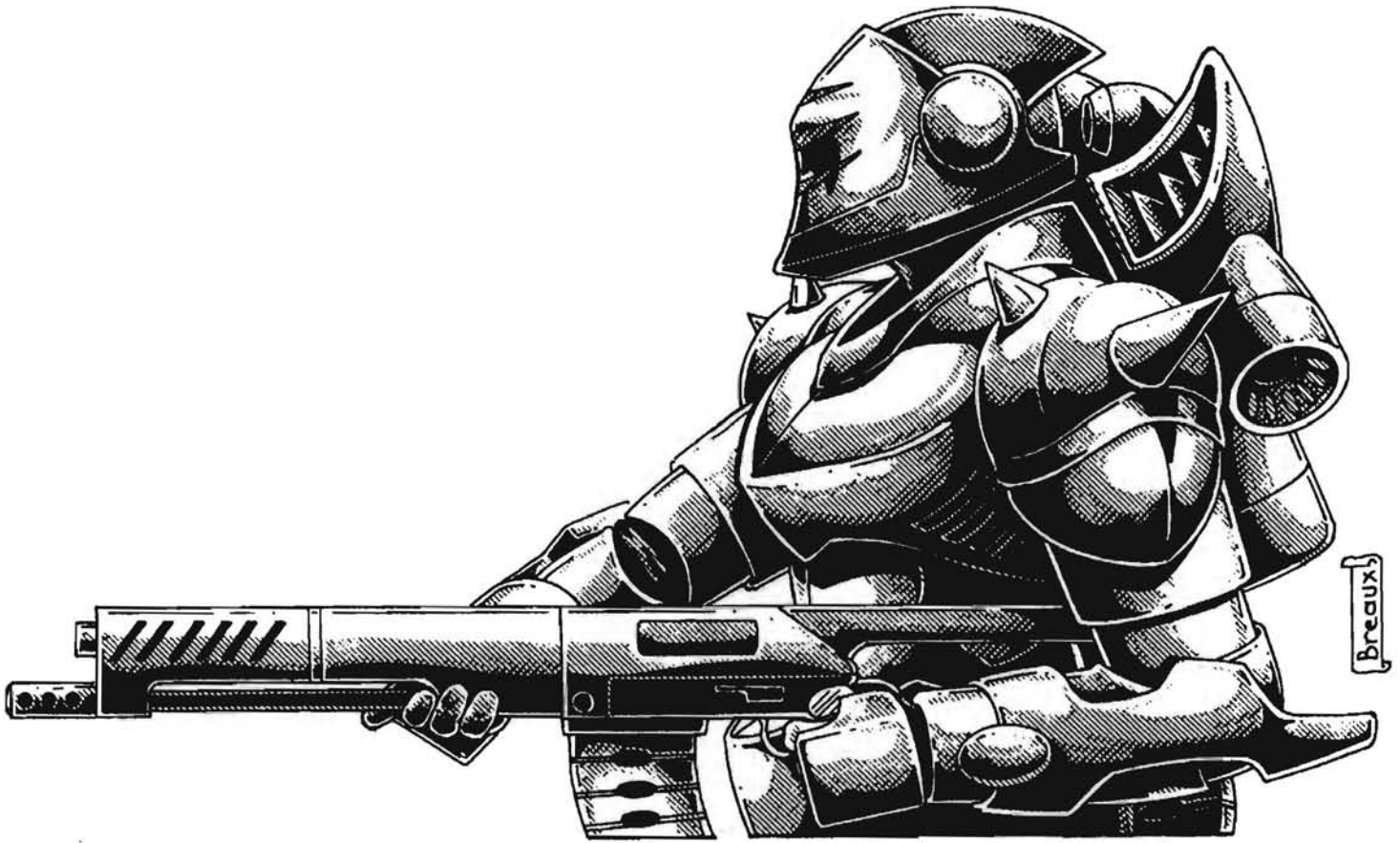

models protect against extreme temperature ranges and have an A.R. 8, S.D.C. 25 to 30, but are -10% to prowl, perform gymnastics, acrobatics, climb or swim. **Cost:** 11,000 credits for light models and 16,000 credits for heavy models.

Hostile Environment Survival Armor (H.E.S.A.): This full environmental suit is combined with plastic, ceramic and metal armor for additional protection. Includes full insulation, environmental air purification system, radiation shielding, and built-in 5 mile (8 km) radio. Light: A.R. 10 or 11, S.D.C. 55 to 85, but prowl and similar skills are -5% and reduce speed by 10%.

Heavy: A.R. 12 or 13 and 90 to 150 S.D.C., but is -15% to prowl, perform gymnastics, acrobatics, climb or swim. Also reduce speed by 20%. **Cost:** 18,000 credits for light insulation, 25,000 credits for heavy.

Full Environmental Battle Armor: This is a heavily insulated hard suit with full environmental systems like the H.E.S.A. Typically, they have an A.R. of 15 to 17, S.D.C. 180 to 250. **Cost:** 38,000 credits.

Shields

All shields are small and light. Shields have no A.R. rating because they are used to directly counter an attack. They either block it or they don't. Shields give their user +2 to parry in melee combat. Projectiles and energy blasts can also be parried, but at -6 due to their high speeds of travel. Laser resistant coatings can be applied to shields to reflect them without damage to the shield. Kisentite shields are very expensive. A Kisentite shield only suffers damage when parrying energy weapons or other Kisentite

weapons. A shield suffers damage only on a "called" shot that is directed at the shield itself.

Costs: Typical metal and ceramic shields cost about 5 credits per S.D.C. to a maximum of 80 S.D.C. (400 credits). Kisentite shields cost 20 credits per S.D.C. point to a maximum of 100 (2000 credits).

Special Features for Armor

The following special options can be applied to any rigid armor, be it metal, ceramic, plastic, crystal, diamond, or a survival suit (the latter could be rigid or not). Robot and bionic characters are also welcome to add these options to their armors. Up to five features can be added to a suit of armor.

Cold or Heat Insulation: Special insulation is added to reduce the effects of cold or heat on the armor wearer. Characters wearing insulated armor only suffer half damage from cold or heat attacks and environments which it is insulated against. Thermal and frozen world aliens would only suffer normal damages instead of increased ratings. **Cost:** 5,500 credits for each kind of insulation, or 8,500 for both.

Environmental System: The armor must include a helmet. The helmet is sealed to the torso armor by a neck addition, and an independent air supply with an air purification and circulation system is incorporated in a portable backpack (A.R. 10, 50 S.D.C.). All this provides is an airtight environment with a breathable atmosphere that can be cleaned and breathed without getting stale for 1D4 days. **Cost:** 5,000 credits.

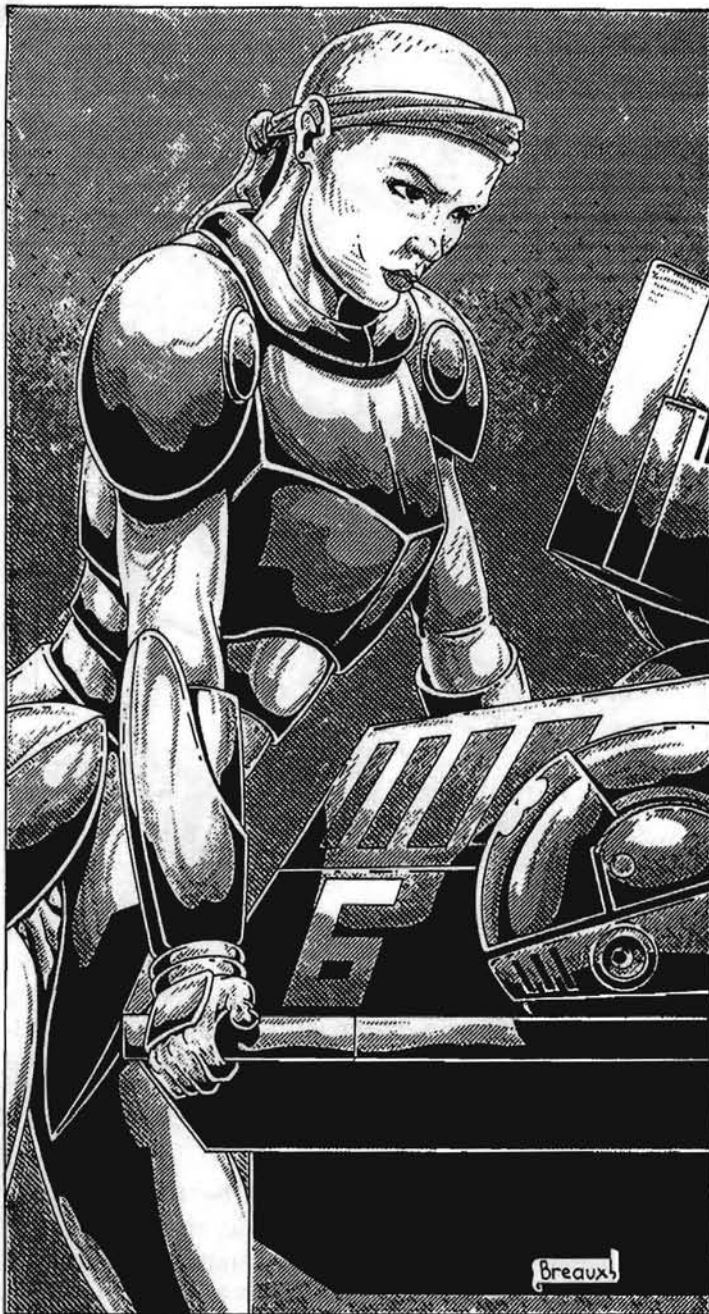

Force Field Generators: Still a new technology, portable force field generators are very expensive. They cover the body with a close fitting force field for protection. Pistols and other small weapons cannot be used while the field is engaged, but rifles and large melee weapons are not contained within the field and can be used. The small rechargeable batteries that power a compact field generator have a life of about 24 hours before needing to be recharged. Recharging costs 500 credits. The S.D.C. of the force field is 100 but it regenerates 10 points per hour. **Cost:** The force field generator and system costs: 60,000 credits.

Laser Resistant Coating: This reflective ceramic coating partially deflects the damage of lasers. As a result, lasers and Energy Expulsion: Light powers only do half damage to the character and the armor. Can be applied to ancient and modern styles of armor. This cannot be combined with any other type of exterior coating. **Cost:** 50 credits per A.R. point of the armor.

Magnetic Particle Coating: A layer of ceramics formed of magnetic particles coats the armor and breaks up the coherent beams of charged particles from ion and particle beam weapons. The armor and wearer of this coating only suffer half damage from such weapons. This cannot be combined with any other type of exterior coating. **Cost:** 500 credits per A.R. point of the armor.

Stealth Coating: A chemically treated, non-reflective coating is applied to the armor. The character is invisible to radar and sends confusing signals to thermal sensors and infrared systems. The dark coating also helps the character to prowl (+10%) at night and in dark settings. This cannot be combined with any other type of exterior coating. **Cost:** 30,000 credits.

Radiation Shielding: The armor is treated and designed to prevent the penetration of harmful radiation. A radiation detecting gauge is also installed with this option. **Cost:** 2,000 credits.

Magnetic Boots: These boots have powerful magnets to anchor them to solid metal surfaces. They add +15% to a climbing skill if the structure being climbed is metal. They are especially useful in space to hold a space walker to the hull of a spacecraft. **Cost:** 2,000 credits.

Other Equipment

Any of the following items can be portable, hand-held equipment or built into body and power armor. Game Masters can also use other features and equipment found in any of Palladium's other RPGs (check our **Rifts** titles and the other game books).

Micro-Translator: A small computer pack, about the size of most Earth laptops, with a headset or transmitter/receiver that slips into the ear and a miniature microphone to speak into. Alien languages (if known by the computer) will be translated and sent to the ear speaker. The computer must first hear a language to determine if it knows it. This technology is still relatively new and is often used by diplomats, political dignitaries, space merchants, wealthy mercenaries and explorers. It knows approximately 322 languages, including all known members of FAR, The Atorian Empire, Earth and others. **Weight:** 3 pounds (1.4 kg). **Size:** About 12 inches (0.3 m) long, eight inches wide (20 cm), and two inches (5 cm). **Cost:** 45,000 credits.

Atmosphere Analyzer: A hand-held mini-computer about the size of a large pocket calculator. It has two sensory antennas, each about 3 inches long (8 cm), which analyze air/gas composition, temperature, corrosive or toxic elements, and light and radiation levels. It is used to determine the general compatibility of an atmosphere for a specified race. A different program will be needed for each race. **Cost:** 8000 credits.

Chemical Analyzer: This device looks like a 4.5 inch (11.4 cm) metal cylinder with a small readout screen on its top face, along with several buttons. A small portion (about 1/2 teaspoon) of any solid or liquid is placed into the analyzer. About two minutes after being activated, a readout of the substance's chemical composition is scrolled slowly over the screen. **Cost:** 50,000 credits.

Portable Medical Computer: This computer unit is about the size of a large three-ring binder. It has a full keypad and a flip-up screen. Characters unskilled in medical emergencies can ask the computer for help. They type in the injuries or symptoms, and the medical programs ask further questions to clarify the problem, using graphics and text to effect greater precision in diagnosis. It then suggests treatment with step by step instructions, diagrams and photographic references. More expensive models are given vocal capabilities. **Skill level:** 55% diagnose/65% treatment. This reflects the computer's base level of expertise in the hands of a completely inexperienced character. Add 20% when in the hands of a paramedic or nurse and 30% in the hands of a doctor. **Cost:** 20,000 for text models; add 2,000 for voice system.

Radiation Detector: A wristwatch size and styled sensor that comes in many different models. It gauges the type and danger level of radiation that is dangerous to a particular race. A simple audio alarm beeps or buzzes and a warning flashes on the face of the watch. It activates automatically. **Cost:** 600 credits.

Navigation Mini-Computer: This is a hand-held unit about the size of a paperback novel, with a small screen and keypad. It will give compass directions, always indicating north, as well as show wind direction and speed. If there is a satellite or orbiting spacecraft to feed it information, the NMC will show a general aerial map of the area within a three mile (4.8 km) radius. Adds +20% to navigation rolls with full satellite support, or +5% for just the unit. **Cost:** 750 credits.

Aberrant Bio-Signature Detector (a.k.a. ABS detector): This device is still experimental and, as a result, does not have a great percentage for success: 71% for the full-size models and 55% for the portable compact models. In basic game terms, it is a super ability detector! The machine does not identify what the specific super or psionic abilities are, only that the bio-signature indicates the potential for (active or latent) super abilities. Note that the ABS detector has a tendency (80%) to register attributes above 20 as non-standard energies (be it mental or physical). The machine will give the following results after a 15 second (one melee round) scan:

1. Genetic class (mutant, genetic manipulation/reconstruction, chemically altered, radiation or alien).
2. The presence of non-standard energies (super abilities).
3. The presence of non-standard mental energies (psionics).

The scanner works by having a sensor pad touched to or laid on the head or chest of the test subject. Full-sized models are the size of a briefcase and have a computer keyboard and monitor. Compact models are the size of a small portable computer. **Cost:** Full sized: 700,000 credits. Compact: 780,000 credits.

Aberrant Biological Energy Dampers (ABE Dampers): Normally used by law enforcement personnel, these items are also popular in slave markets and arenas. They are over-sized boots and gauntlets that generate a field to

suppress aberrant energies, i.e. super abilities and psionics! In game terms, they function exactly like the major super ability Negate Super Powers, but it will also impair bionics (all sensors and bio-systems are slow to respond: no-combat bonuses, speed is reduced by 75%, and weapons are deactivated). In addition, it interferes with magic (half the normal duration and damage). **Cost:** One million credits per ABE system.

Artificial Augmentation

Cloned Parts & Augmentation

The high level of medical advancement in the galaxy makes cloned replacements for lost limbs or organs (except the brain and spinal cord) possible. The character has tissue samples taken, and the parts will be grown for him (takes 6 months). If he should ever need that replacement, it is taken out of stasis and attached. The new limb or internal organ will match the character's unique bio-signature exactly. Advancements in the creation of synthetic skin and internal organs allow easy operations and replacement of internal organs, skin and limbs without benefit of cloning. Also see bionics.

Cost of artificial bio-systems:

Vital Organs: 15,000 credits each.

Other Organs (Eyes, Ears, Throat, etc.): 5,000 credits each.

Arms: 8,000 credits each.

Legs: 12,000 credits each.

Skin: 1,000 credits per square foot (10,760 credits per square meter).

Alien Bionics

Most advanced races have developed the science of cybernetic augmentation. This means they can create partial or full cyborgs, as well as replace damaged organs and limbs with mechanical ones. They can also implant small devices to boost the senses or provide mechanical assistance like monitoring radio transmissions, etc. A partial or full *alien* cyborg should be created with the rules in **Heroes Unlimited, Second Edition**, pages 103-113. Also see **Ninjas & Superspies** for additional gimmicks and bionic implants, and the **Rifts RPG** and **Rifts Triax** for additional ideas for cybernetic implants and bio-systems. Of course, weapons and armor from the latter must be changed from Mega-Damage to S.D.C. for the *Heroes Unlimited* setting.

The cost of bionic replacements in a galactic campaign will be one-quarter the prices listed for Earthlings in **Heroes Unlimited** (The prices in **Rifts** are doubled). During character generation, alien bionic characters use the same budgets and the full prices given in the bionic section of *Heroes Unlimited*. It is only during gameplay when someone wants new or additional implants that the reduced costs apply. This is not only to reflect the market availability of bionics in such an advanced setting, but it also serves to keep things simple and prevent us from recalculating and reprinting the bionic system prices.

Bionic implants and cybernetics used as prosthetics to replace missing limbs and organs can be used on

super-powered beings as well, but even partial reconstruction will eliminate all or most of a character's super powers, magic or psionic abilities.

A good rule is that three small implants or replacement organs and one limb will not adversely affect a character's ability. Each and every implant or limb/large cybernetic addition beyond the first four will have drastic effects. **Mystics** will have their spell effects, damage, duration and range cut in half for each new bionic item. **Psionics** will lose half of their I.S.P. and the range, duration and damage of psionic abilities will be reduced by half per each additional implant. **Superbeings** lose one melee attack and the duration, damage, and range of their abilities are reduced by half for each additional bionic item. The penalty is cumulative for each implant beyond the 3 small and one large limit. In ALL cases, the character loses all special abilities if half of his body is bionic (partial reconstruction), but effectively switches his original character class from superbeing, magic user or psionic to cyborg/bionic.

Humanoid Robots & Androids

Another entire book could be written on robots and androids, so this section will only present a few specific, specialized robots and androids. Some are surprisingly affordable. This is because there is a great demand for that type of robot, so they can be produced in large quantities and their prices are reduced.

Androids are designed to appear as human (humanoid) as possible. This means most will have natural sounding voices and response patterns, and artificial skin covering at least their face, neck and hands. The rest of its body may be mechanical or armor covered but can be concealed with clothing. **Robots** are often humanoid or bipedal in construction, but are obviously machines. These robots have no personalities, voices are digitized (except for some translators) and they may be larger or smaller than the beings who make them. They methodically go about their jobs until told to do otherwise, or until a pause is required, in which case they simply stop moving and rest. They are machines and equipment, not interactive NPCs, unless the Game Master wishes to animate them (their logic, programming and structured perceptions can make for great comic relief).

All robots and androids have both the basic listening system and the basic optic systems. All combat robots will have targeting sights and combat computers; additionally, battlefield and assault robots will also have micro-radar and maxi-radar respectively. The special coatings listed under the armor section can be applied to robots. Remember, availability and prices are not equal to Earth prices but reflect advanced alien technology and markets.

Communication & Translator Android: They are a common sight at the sides of political ambassadors, dignitaries and important people of state. They are a full-sized version of the portable language translator with arms, legs and a humanoid appearance. CT androids are programmed with over 600 languages from across the gal-

axy. Their vocal capabilities are top of the line and their hearing is commonly amplified to pick up each and every inflection and variation in dialects.

Typical CT Android statistics: A.R. 6, S.D.C. 150. All attributes are 10, except for I.Q. 13 and M.E. 13. P.S. is normal (not superhuman). Height: 6 feet (1.8 m). They have

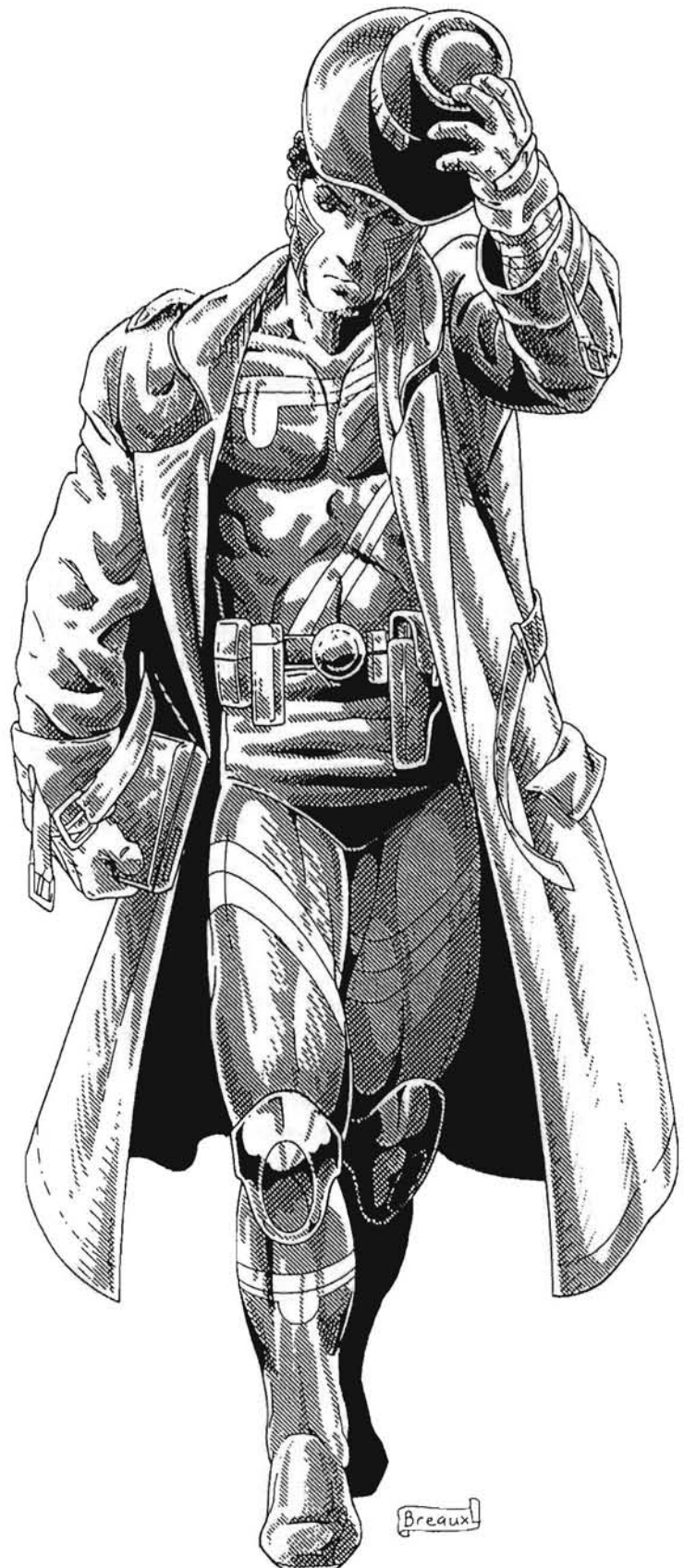

no weapons and are not programmed to use any type, not even a knife or club. Furthermore, their programming prevents them from taking any hostile action even in self-defense, other than dodge and parry (both +4) and to run away to get help. This has been done to assure the safety of the political and business leaders they assist. Their programming includes the following skills, each at 92%: Computer operation, radio: basic, radio: scrambler, radio: satellite, cryptography, laser communications, read sensory instruments, T.V./video, navigation, pilot hover car, languages: 600 of them. Cost: 1.2 million credits.

Navigation & Pilot Android: Commonly employed as chauffeurs and co-pilots, these robots are highly skilled pilots, but they lack imagination and initiative, and follow orders to the letter. Maneuvers and procedures will be textbook perfect, but special maneuvers or illegal activity will tend to confuse them. They are not trained in weapon combat, except for vehicle mounted defense systems.

Common NP Android statistics: A.R. 10, S.D.C. 160. All attributes are the equivalent of 11. P.S. is normal (not superhuman). Height: Varies; generally compatible with the purchaser's racial characteristics or preferences. Programming includes the following skills at 90%: Basic and advanced mathematics, navigation, navigation: space, land navigation, read sensory instruments, weapon systems, radio: basic, 48 different languages, and select 9 piloting skills (any). Cost: 1.5 million credits.

Medical Robots: These can be androids or mechanical looking robots. Their common uses are as paramedics, nurses, chemists and assistants to flesh and blood doctors. Mobile units can have either legs or wheels, and

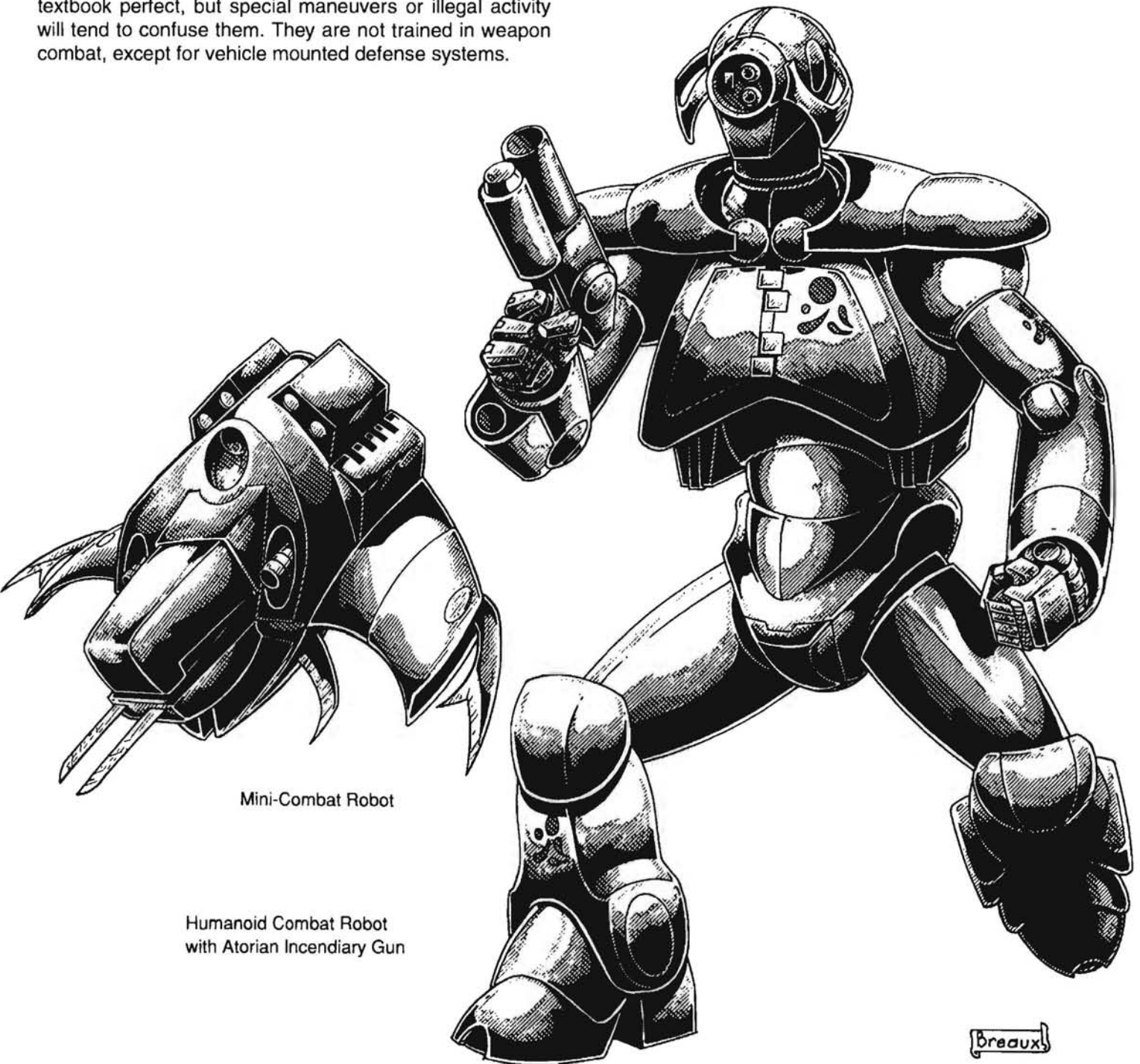

Mini-Combat Robot

Humanoid Combat Robot
with Atorian Incendiary Gun

Breaux

many resemble robotic spiders with four to six spider-like legs for greater speed and balance. Many of the robots will have a second pair of smaller arms and hands designed for delicate surgical uses and complex tasks.

Common Medical Robot statistics: A.R. 10, S.D.C. 160 to 200. All attributes are 10, except I.Q. 16, P.P. 16, and Spd. 33. P.S. is normal (not superhuman). Height: varies. Programming includes the following skills at 94%: Biology, pathology, paramedics, read sensory instruments, computer operation, radio: basic, chemistry, chemistry: analytical, 48 different languages, basic and advanced mathematics and W.P. knife. Cost: 2.7 million credits for robots, 3 million credits for androids.

Mini-Reconnaissance Robot: At less than four feet (1.2 m) tall, these machines are used for stealth and light support purposes. They hardly ever have humanoid appearances. More than likely, they will be bulbous or cylindrical in shape, with retractable blades and/or protruding weapon barrels. They may move via a hover system, antigravity (add 5 million to cost) or legs, and may or may not have arms. Common weapons include large retractable blades (used for raking fly-bys, damage is 6D6), a pair of small rifle-class weapons (projectile or energy; 4D6 damage per single blast or shot) or a small missile rack (1D4x10 damage each; payload of 4).

Common Mini-Reconnaissance Robot Statistics: A.R. 13, S.D.C. 200. All attributes are 10. P.S. is normal (not superhuman). Height: Varies, but rarely larger than 3 or 4 feet (0.9 to 1.2 m). Programming includes the following skills at 90%: W.P. knife, W.P. energy rifle, W.P. semi and fully automatic rifles, land navigation, intelligence (recognizes 1200 different enemies, including insignias, uniforms, weapons, and vehicles) and knows 72 different languages. It can also prowl, detect ambush, and detect concealment at 60%. Combat Statistics: Five attacks per melee round: +2 to initiative; +8 to strike with modern weapons (+6 with bursts and +7 to strike with blades); +7 to dodge; +4 to parry (+6 to parry with knives); +3 to roll with punch, fall, or impact. Cost: 6 million credits.

Standard Humanoid Combat Robot: These are powerful, 6 to 8 foot (1.8 to 2.4 m) tall humanoid robots used for security, general combat duties, support, and front-line combat. They can carry and fire any of the oversized field weapons described previously, except for cannons and other artillery. Some pirates and mercenary forces use them as initial assault units to soften up enemy defenses. The robot's lack of ingenuity and adaptability limits its abilities compared to flesh and blood troops. A small missile pod is normally built into the center of the chest (1D6x10 damage each; payload of 4), and a light energy weapon is integrated into the right or left forearm (typically ion or laser).

Common Combat Robot Statistics: A.R. 15, S.D.C. 400. All attributes are 10 except P.P. 20, P.S. of 25 (superhuman), Spd. 44. Height: Varies from 6 to 8 feet (1.8 to 2.4 m). Programming includes the following skills at 90%: W.P. knife, W.P. energy rifle, W.P. semi and fully automatic rifles, W.P. heavy, weapon systems, radio: basic, and robotics combat program. Combat Statistics: 6 attacks

per melee round, +2 on initiative, +7 to strike with built-in weapons, +7 to strike with hand-held modern weapons (aimed), +6 to strike with blades; +5 to parry and dodge, +3 to pull punch, +3 to roll with punch, fall, or impact. Cost: 8 million credits.

Standard Battlefield Robot: A larger version of the combat robot, these war machines are 12 to 15 feet (3.6 to 4.6 m) tall. They are main support units for foot soldiers, or heavy security for highly restricted areas. Weapons commonly include heavy energy rifles and large machineguns. Typical built-in weapons include a .50 caliber machinegun, rail gun or microjet rifle in one arm and a heavy or long-range energy weapon in the other.

Common Battlefield Robot Statistics: A.R. 17, S.D.C. 700. All attributes are 15 except P.P. 22, P.S. 28+2D4 (superhuman), and Spd. 40+4D6. Height: Varies from 12 to 15 feet (3.7 to 4.6 m). Programming includes the following skills at 90%: W.P. sword, W.P. energy rifle, W.P. heavy, weapon systems, demolitions, demolitions disposal, radio: basic, land navigation, and robotics combat program. Combat Statistics: Six attacks per melee round, +2 to initiative, +9 to strike with all built-in weapons, +7 to strike with hand-held modern weapons (aimed), +6 to strike with blades, +5 to dodge, +5 to parry, +7 to parry with swords (large blades), +3 to pull punch, +3 to roll with punch, fall, or impact. Cost: 10 million credits.

Standard Assault Robot: These are the equivalents of walking tanks. They are heavily armored as well as armed. The rarest among the combat model robots, they are more often piloted by a humanoid operator, but a significant number are truly automated. Common integrated weapons include a full missile system (2D6x10 damage fragmentation missiles, payload 8), twin microjet .50 calibers (2D6x10 damage from twin shot), and a heavy particle beam rifle (1D6x10 or 2D8x10 damage). Atorian assault robots carry sonic cannons, most of the time as gun pods.

Typical Assault Robot Statistics: A.R. 17, S.D.C. 1,300. All attributes are 15, except P.P. 22, P.S. 38+2D6 (superhuman), and Spd 40+4D6. Height: Varies from 22 to 28 feet (6.7 to 8.5 m). Programming includes the following skills at 90%: W.P. blunt, W.P. energy pistol, W.P. energy rifle, W.P. heavy, W.P. automatic rifle, weapon systems, radio: basic, and robotics combat program. Combat Statistics: 7 attacks per melee round, +3 to initiative, +10 to strike with all built-in weapons; +7 to strike with hand-held modern weapons (aimed); +5 to dodge; +5 to parry; +3 to roll with punch, fall, or impact. If a human pilot is operating an assault robot, the programming and combat bonuses are replaced by his own skills and bonuses. Cost: 12 million credits.

Robot Vehicles: See **Heroes Unlimited** and/or **Rifts Sourcebook One** (with modifications) for other types of robots and robot vehicles.

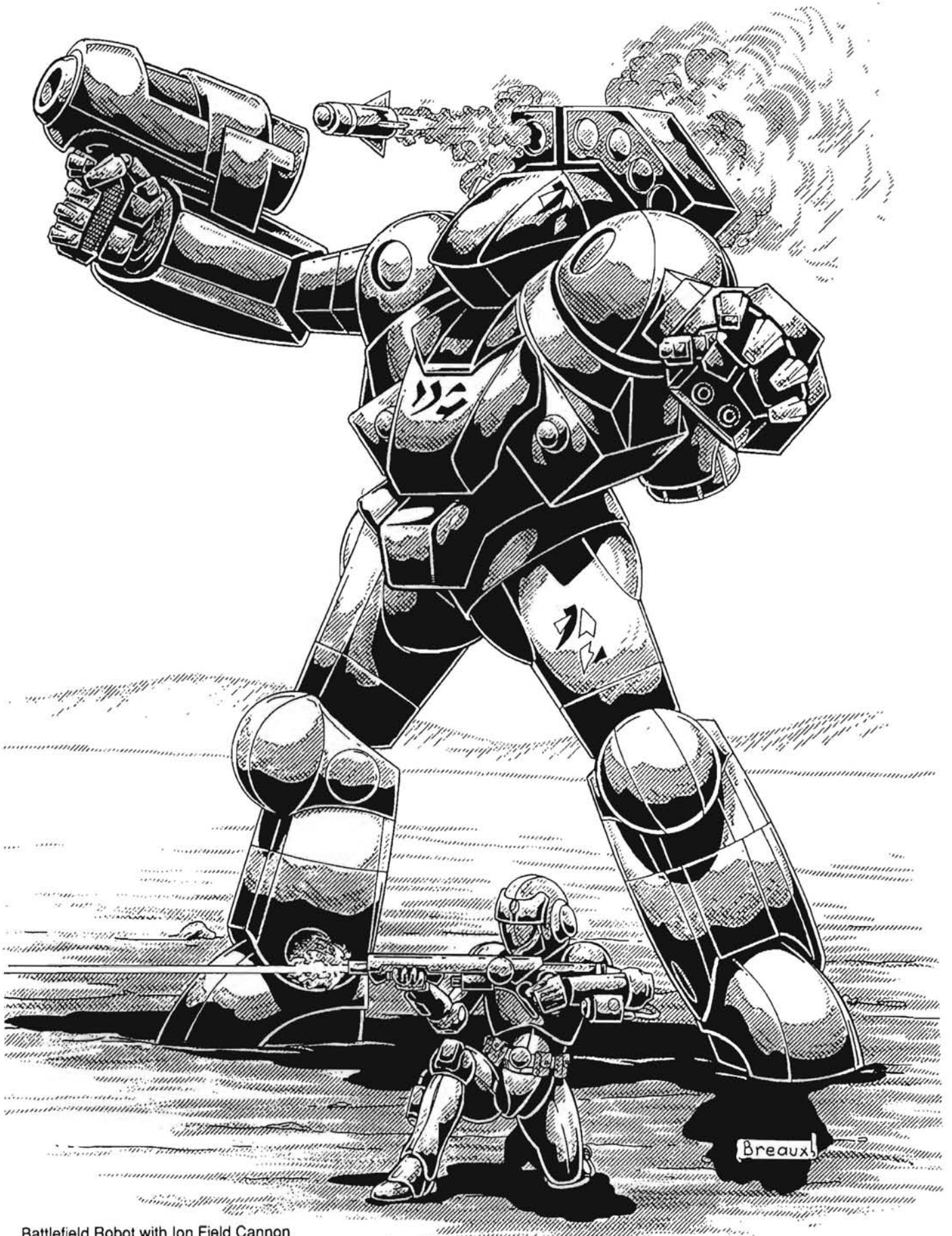

Battlefield Robot with Ion Field Cannon

Vehicles

A list of conventional vehicles can be found on page 349 of **Heroes Unlimited**. The advanced technologies of other worlds make hover cars more common and often more practical than wheeled vehicles, but the lower tech vehicles do have their uses and advantages and are generally less expensive to produce and maintain. Hover vehicles either use small jets or cushions of air to support them. It is up to the Game Master whether they can traverse water or not (if so, maximum speed will be one-quarter normal). Antigravity travel uses a shaped field of energy to warp gravity around the item and hold it aloft, as well as move it along. Such devices can be used to travel through the air, over water, underwater and in space, but they are incredibly expensive (cost millions) and are comparatively rare — the majority of people do not possess antigravity technology.

All hover vehicles and aircraft that have enclosed cabins can be made space-worthy. This involves sealing the cabin, installing an oxygen/atmosphere supply, purification and circulation system, radiation shielding, adding small maneuvering rockets and other features necessary for use in space. The main jets are also adjusted to provide thrust instead of lift at the flip of a switch. This makes the vehicle capable of short trips through space, most likely to travel from one spacecraft to the other.

Note: Remember, availability and prices are not equal to Earth prices but reflect advanced alien technology and markets.

Terrain Rover 4x4: This is a full-sized truck with a closed-in bed and large, oversized, all-terrain tires. Popular in swampy, rough, rocky or dry conditions. Covered bed can hold two to four bunks or 6x8x6 feet (1.8x2.4x1.8 m) of cargo, up to 2.5 tons (2300 kg). **A.R.:** 8, **S.D.C.:** 450, **Speed:** 120 mph (192 km), **Range:** 400 miles (640 km) before needing to refuel, **Cost:** 24,000 credits and up.

Survivor 4x4: This is a full-sized van version of the terrain rover. It can comfortably sleep six people in three sets of over/under bunks, plus stow all of their survival gear for extended outings. The survivor is popular for use in all terrains. **A.R.:** 10, **S.D.C.:** 475, **Speed:** 100 mph (160 km), **Range:** 300 miles (480 km), **Cost:** 28,000 credits and up.

One-Man Hover Cycle: The hover version of an Earth motorcycle. **A.R.:** 7, **S.D.C.:** 130, **Speed:** 200 mph (320 km), Hovers 3 to 20 feet (0.9 to 6.1 m) above the ground, **Bonuses:** +2 to dodge, +5% to handle stunt moves, **Range:** 600 miles (960 km), **Cost:** 10,000 credits and up.

Two-Man Hover Cycle: The hover version of Earth's street bikes. **A.R.:** 8, **S.D.C.:** 150, **Speed:** 180 mph (288 km), Hovers 3 to 20 feet (0.9 to 6.1 m) above the ground, **Bonuses:** +2 to dodge, **Range:** 600 miles (960 km), **Cost:** 15,000 credits and up.

Four-Man Hover Cycle: These are larger bikes, similar to the "Hogs" of Earth. They are two seaters with a sidecar that can hold another two people. **A.R.:** 9, **S.D.C.:** 190, **Speed:** 130 mph (208 km), Hovers 3 to 20 feet (0.9 to 6.1

m) above the ground, **Cost:** 26,000 credits and up, **Bonuses:** +1 to dodge, **Range:** 550 miles (880 km).

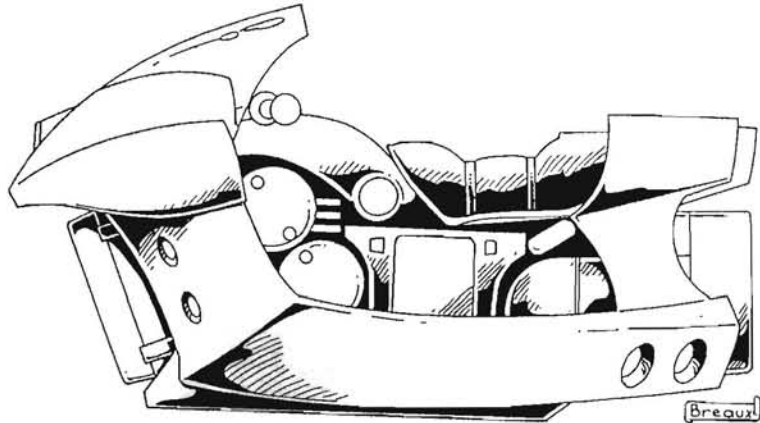

Two-Man Hover-Jet Cycle: This is a very fast, jet assisted hover cycle. They are often used for racing, but find a lot of popularity with characters who like to cut loose. These are a favorite of the Swip who often style them to look like mechanical animals. **A.R.:** 10, **S.D.C.:** 150, **Speed:** 500 mph (800 km), cruising speed is around 150 mph (240 km). Hovers 3 to 600 feet (0.9 to 183 m) above the ground, **Bonus:** +3 to dodge, **Range:** 1000 miles (1600 km), **Cost:** 90,000 credits and up.

One-Man Hover Car: A small, economical vehicle popular for travel at space stations, large spacecraft, and other enclosed structures. Their decent range and high speeds also make them popular for commuters. **A.R.:** 9, **S.D.C.:** 180, **Speed:** 160 mph (256 km). Hovers 3 to 12 feet (0.9 to 3.7 m) above the ground, **Bonus:** +2 to dodge, **Range:** 500 miles (800 km), **Cost:** 15,000 credits and up.

Two-Man Hover Car: A slightly larger version of the single occupant model above, these vehicles enjoy some of the same popularity as their smaller cousins. **A.R.:** 8, **S.D.C.:** 240, **Speed:** 160 mph (256 km), Hovers 3 to 12 feet (0.9 to 3.7 m) above the ground, **Bonus:** +2 to dodge, **Range:** 450 miles (720 km), **Cost:** 25,000 credits and up.

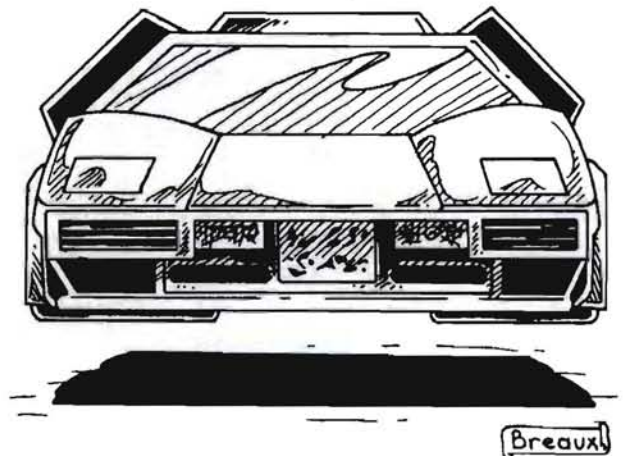

Full-Sized Hover Car: This is the average, full-sized hover car. It seats a driver and four passengers, with lots of elbow room, or up to six passengers with no loss of

comfort. Comes in either sedan or wagon styles. **A.R.:** 10, **S.D.C.:** 450, **Speed:** 140 mph (224 km), Hovers 3 to 12 feet (0.9 to 3.7 m) above the ground, **Range:** 600 miles (960 km), **Cost:** 30,000 credits and up.

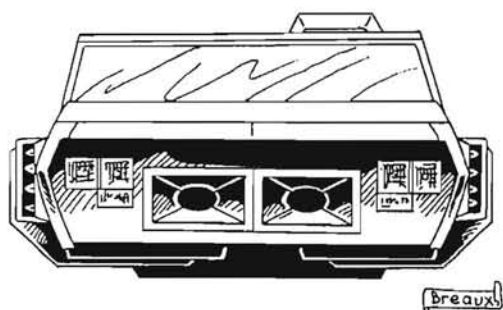
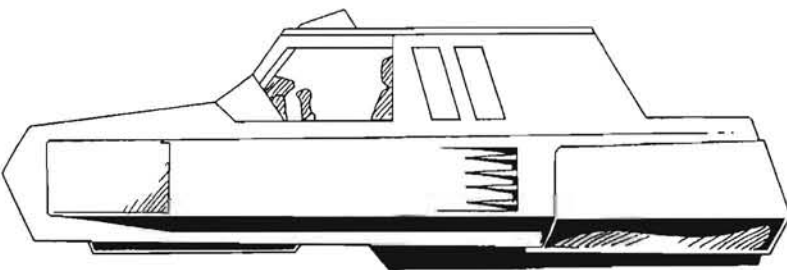

A.T.V. Hover Vehicle: This is a rugged vehicle with a small truck bed taking up its rear section. It can only hold three passengers comfortably in the cabin, but up to six more could easily fit in the back. It has a higher hover range to aid in negotiating rough terrain. An optional hard cover for the bed is also available. Bed holds 6x8x4 feet (1.8x2.4x1.2 m) of cargo. **A.R.:** 12, **S.D.C.:** 550, **Speed:** 120 mph (192 km), Hovers 3 to 20 feet (0.9 to 3.7 m) above the ground, **Range:** 850 miles (1360 km), **Cost:** 50,000 credits and up.

Sporty Hover Car (One-Man Model): Features sports car styling in a hover vehicle. **A.R.:** 7, **S.D.C.:** 150, **Speed:** 220 mph (352 km), Hovers 3 to 12 feet (0.9 to 3.7 m) above the ground, **Bonus:** +3 to dodge, **Range:** 500 miles (800 km), **Cost:** 40,000 credits and up.

Sporty Hover Car (Two-Man Model): The standard sports car for those who can afford the truly exotic automobile. **A.R.:** 10, **S.D.C.:** 300, **Speed:** 200 mph (320 km), Hovers 3 to 12 feet (0.9 to 3.7 m) above the ground, **Bonus:** +1 to dodge, **Range:** 400 miles (640 km), **Cost:** 55,000 credits and up.

Exotic Two-Man Hover Car: These are the high-class, high-performance, luxury speed machines of the hover type. They are the Ferrari, Lamborghini, or Porsche of hover vehicles. **A.R.:** 7, **S.D.C.:** 300, **Speed:** 360 mph (576 km), Hovers 3 to 12 feet (0.9 to 3.7 m) above the ground, **Bonus:** +4 to dodge and +5% to handle special maneuvers, sharp turns and jumps, **Range:** 350 miles (560 km), **Cost:** 120,000 credits and up.

Two-Man Hover-Jet Car: This is a jet assisted hover car used in racing or for law enforcement. **A.R.:** 8, **S.D.C.:** 400, **Speed:** 575 mph (920 km), Hovers 3 to 1,000 feet (0.9 to 305 m) above the ground, +3 to dodge, **Range:** 1,200 miles (1920 km), **Cost:** 200,000 credits and up.

The armored police version is **A.R.:** 14, **S.D.C.:** 750, **Speed:** 475 mph (760 km), and **Costs:** 350,000 credits, but also includes short-range radar, laser targeting/tracking, long and short-range radio communication system, crash bar, spotlight, siren, and towline and winch.

Hover Platforms: Hover platforms are open-air hover vehicles that come in nearly any shape, including round, square, pentagonal and rectangular. They can reach reasonably high speeds but passengers must be careful not to be thrown from them during high speed pursuits. Most have a railing and/or lifeline for passengers to steady themselves with. The most common are 2 to 4 person models, but larger versions are available.

Hover platforms have many uses. Some cultures use them for mass transit (similar to monorail systems) or freight hauling over short distances. They are also used by traffic police to monitor and direct traffic patterns, rescue teams to reach rooftops and to fly over traffic, and by construction people and explorers to survey an area or monitor work in progress. Hover platforms come in ten sizes, each one holding ten more than its smaller cousin, up to 100 people (roughly the size of a train car). Repair facilities can be built onto the larger ones so they can be used to repair robots, power armor, and vehicles.

General Stats: **A.R.:** 7, **S.D.C.:** 120 for 2 to 4 man types, while larger models have an additional 100 S.D.C. per every ten passengers it can hold. **Speed:** 90 mph (144 km), Hovers 3 to 300 feet (0.9 to 91 m) above the ground, **Bonus:** +1 to dodge for smaller, 2-4 passenger models, **Range:** 500 miles (800 km), **Cost:** 12,000 credits for the two to four passenger models, 20,000 for six to 10 passengers, 40,000 for 11 to 40 passengers and 80,000 and up for larger models.

Detachable Jet Pack: This is a small, strap-on jet pack that gives the user limited flight capabilities. For 1000 credits it can be built into a suit of armor. **Typically A.R.:** 10, **S.D.C.:** 50, **Speed:** Standard: 90 mph (144 km), medium fast: 100 to 140 mph (160 to 224 km), or fast: 150 to 220 mph (240 to 352 km). Hovers 3 to 600 feet (0.9 to 183 m) above the ground, +2 to dodge, **Range:** 800 miles (1280 km), **Cost:** 28,000, 40,000 and 60,000 respectively.

Micro-Jet Boots: Several small propulsion jets are incorporated at exact angles into a set of hard armor boots. The result is a very compact, inexpensive form of hover transportation. The only drawback is full exposure to the elements. Most come with an EBA suit. **Boots alone:** **A.R.:** 6, **S.D.C.:** 40, **Speed:** 65 mph (104 km), Hovers 3 to 500 feet (0.9 to 153 m) above the ground, +3 to dodge, **Range:** 200 miles (320 km), **Cost:** 45,000 credits and up.

Antigravity Disks: The units themselves can be of any geometric shape, but are typically the same size, 10 inches (0.27 m) across. They can be worn on the chest, back or on the feet. Most use simple hand controls, but voice-activated models are available (cost an extra 1000 credits). Maximum weight allowance is about 1,000 pounds. **A.R.:** 5, **S.D.C.:** 40, **Typical Speed:** 90 to 160 mph (144 to 256 km), **Altitude/hover:** Unlimited, can even break the bonds of gravity around planets and fly in outer space, **Bonus:** +3 to dodge, **Range:** Unlimited, **Cost:** 50 million credits and up.

Antigravity Jewelry: This is an antigravity disk worked into some form of jewelry, usually a bracelet, belt buckle or necklace. Same stats as the disk. Cost is also the same, plus the cost of the jewelry which can range from a few thousand to millions of credits depending on the precious materials and gems used to make it.

Antigravity Suit: Similar in appearance to the FAS armor, this body suit is interwoven with antigravity circuits that generate the field that propels and holds the character aloft. It can be worn under armor comfortably and affords some basic protection itself. **A.R.:** 8, **S.D.C.:** 30, **Speed/Altitude:** Same as the disk. **Cost:** 55 million credits and up.

One-Man Fan Jet (VTOL): This small aircraft uses a large, rear mounted, fan type propeller and small jet thrusters to fly. The cockpit is designed for the pilot only, but a passenger can ride in his lap. This will, however, interfere with his piloting rolls (-10%). **A.R.:** 9, **S.D.C.:** 275, **Speed:** 300 mph (480 km), can fly as low as 20 feet (6.1 m) above the ground, **Bonuses:** +2 to dodge at speeds less than 200 mph (320 km) and +3 when going faster. **Range:** 900 miles (1440 km), **Cost:** 150,000 credits and up. A two-man model is available with identical stats for 200,000 credits.

One-Man Gyrocopter (VTOL): Resembling little more than a seat with a motor and stabilizing tail, this small helicopter is used for patrol, observation, and transportation. Its full flight capabilities combined with the ability to hover make it a favorite in dense foliage or swampy settings where solid or open ground is limited. **A.R.:** 6, **S.D.C.:** 140, **Speed:** 180 mph (288 km), **Bonus:** +1 to dodge, **Range:** 750 miles (1200 km), **Cost:** 90,000 credits and up.

Military Vehicles

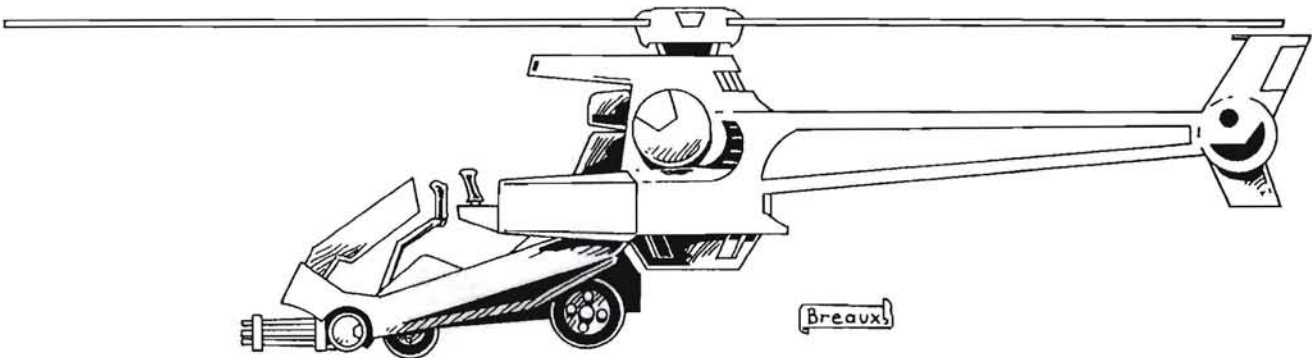

Military Hover APC: These armored personnel carriers are common in many armed forces and militaries across the galaxy. They are normally armed with a field version of the pulse laser (damage 1D4x10 per blast or 2D8x10 for a pulse). Short-range fragmentation missiles

are also commonly mounted on the wings (2D6x10 damage). **A.R.:** 16, **S.D.C.:** 900, **Speed:** 120 mph (192 km), Hovers 3 to 12 feet (0.9 to 3.7 m) above the ground, Can hold 12-18 troops, **Range:** 850 miles (1360 km). **Cost:** 450,000 credits.

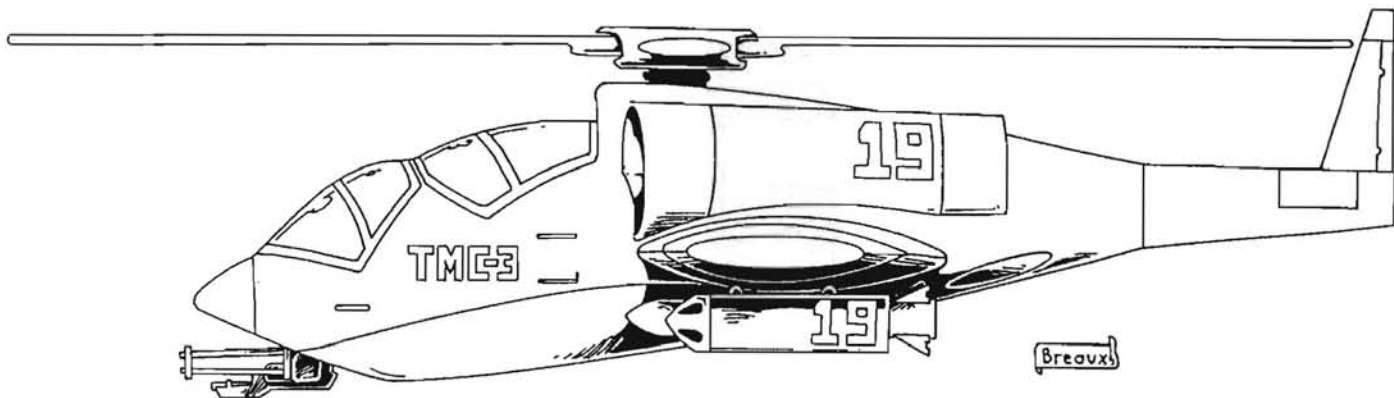

Assault Rotor-Jet: This full-sized combat aircraft combines the aspects of both fighter jet and assault helicopter. With the rotors extended, it has full hover and vertical take-off and landing (VTOL) capabilities, and can fly at low speeds. **A.R.:** 14, **S.D.C.:** 700, **Speed:** When the chopper accelerates to 200 mph (320 km), the jets can be engaged and the vehicle can accelerate up to a maximum speed of Mach 2 (1,340 mph/2144 km). While in jet configuration, the rotors fold backwards and retract against the body of the vehicle. **Weapons:** Common weapons include mini-missiles (up to 10) and/or conventional missiles (4). The nose is also fitted with an energy blaster, usually laser, ion or plasma. **Bonuses:** +2 to dodge in chopper mode and +3 in jet, **Range:** 2,500 miles (4000 km). **Cost:** 750,000 credits and up.

Typical Energy Weapon Tanks: These are battlefield tanks that fire energy cannons and 6 to 12 mini-missiles. **Weapons (one cannon and mini-missiles):** Laser cannon damage is 2D6x10, ion cannon damage is 1D4x100, particle beam cannon damage is 1D6x100, and mini-missiles typically do 1D4x10 each. **A.R.:** 17, **S.D.C.:** 1,700, **Speed:** 60 mph (96 km; increase by 50% if a hover tank), **Bonuses:** +1 to dodge and +1 to strike, **Cannon Range:** One mile (1.6 km), **Tank Travel Range:** 300 miles (480 km), **Average Cost:** 20 million, but not usually available on the open market.

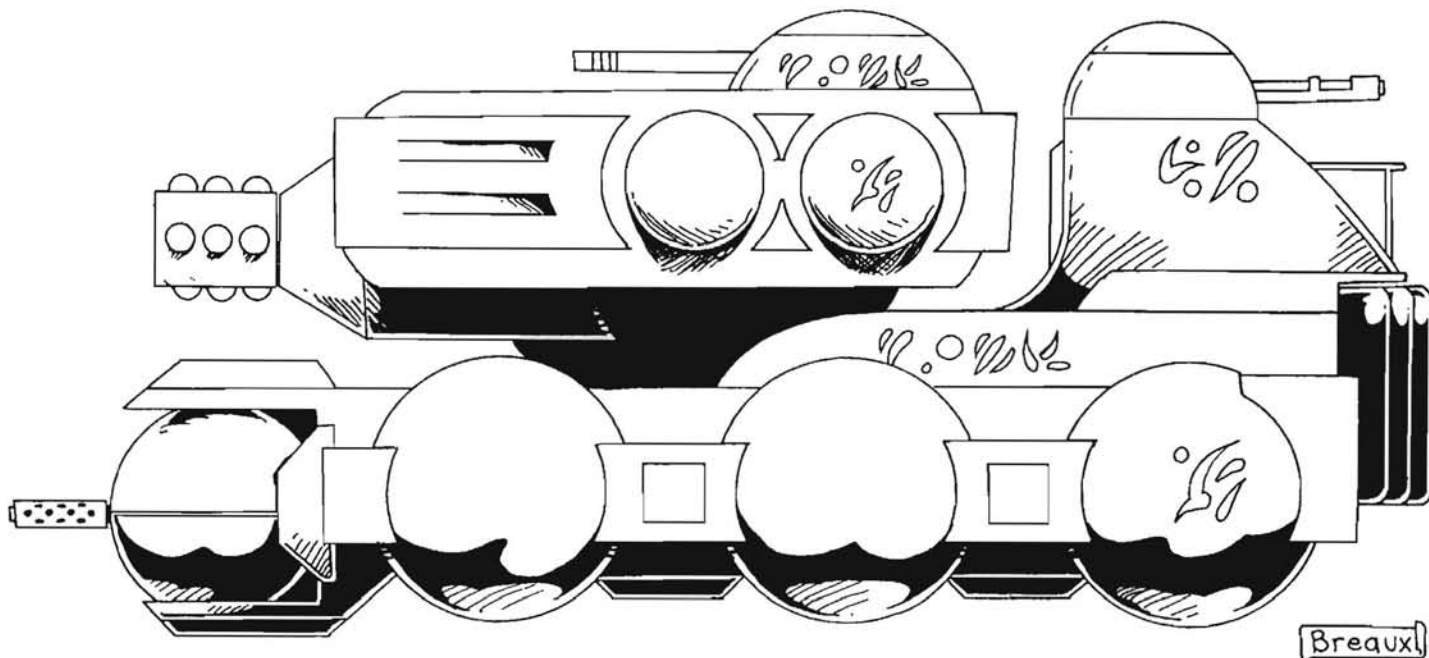

Atorian Sonic Hover Tank: Perhaps one of the most feared vehicles on the battlefield, this heavily armored hover tank carries a vehicle-sized version of the Atorian sonic cannon. **Weapon:** The sonic cannon has its normal effects (see weapon description), but it does 2D6x10 damage. Anyone within 45 feet (13.7 m) of the sonic impact

takes 4D6 damage from shock waves. **A.R.:** 18, **S.D.C.:** 2,000, **Speed:** 100 mph (160 km), Hovers 3 to 12 feet (0.9 to 3.7 m) above the ground, **Bonuses:** +1 to dodge and +2 to strike, **Cannon Range:** One mile (1.6 km), **Tank Travel Range:** 400 miles (640 km), **Cost:** 50 million, but has NEVER been available on the open market.

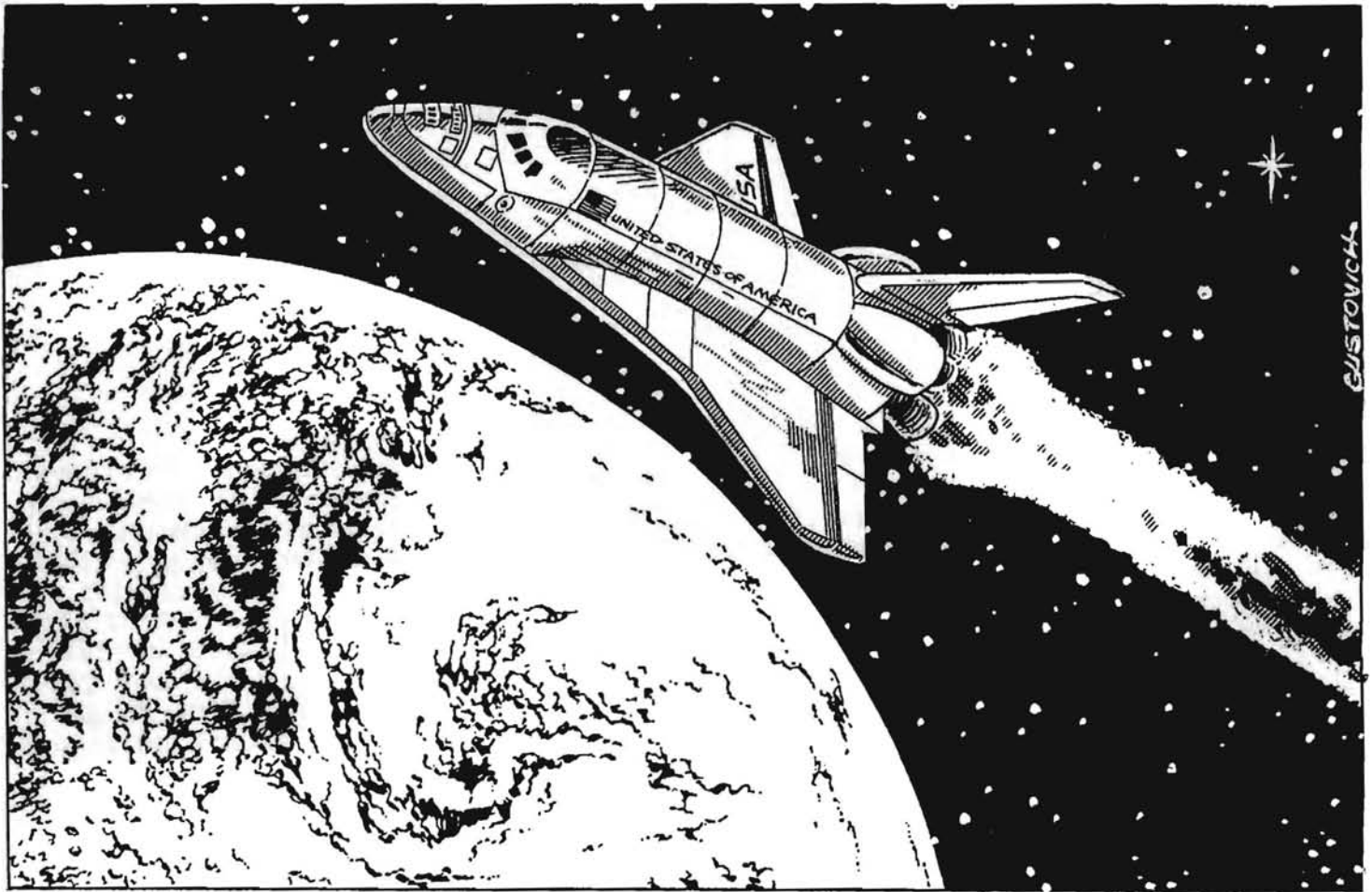

Spacecraft

Due to space limitations, the rules for spacecraft construction will be omitted, but look for them in the upcoming Galaxy Guide. Here are some general rules and sample spacecraft.

The packages for military craft, those with weapons and armor, are for reference for Game Master use. In a campaign, they would only be sold to government authorized clients and military allies. They can, however, be purchased on the black market for 25% to 50% more than the prices listed.

Combat: Craft larger than 500 tons (450 metric tons) cannot dodge in the normal sense. They maneuver to minimize damage and will take half damage on a successful dodge.

Speed FTL: Factor ratings are multipliers of the speed of light. Factor 2 is equal to twice the speed of light.

Weapons: These are some really general damage ratings for spacecraft weapons.

- Light Weapons: 1D4x10, Range: 5,000 feet (1.5 km).
- Medium Weapons: 2D6x10, Range: 12,000 feet (3.7 km).
- Heavy Weapons: 6D6x10, Range: 25,000 feet (7.6 km).
- Anti-Ship Weapons: 1D6x100, Range: 10 miles (16 km).
- Battleship Weapons: 2D6x100, Range: 20 miles (32 km).
- Nuclear Missiles: 1D4x300, Range: 1,000 miles (1600 km).
- Great Cannons: 1D6x1000, Range: 75 miles (120 km), can only fire once per melee round.

Shuttle — Production Line Package

Length: 120 feet (37 m)

Mass: 110 tons (99 metric tons)

Crew: Two; plus up to 8 reserve crew members, support personnel or passengers.

Drive Type: Photon/Fission

Maximum Speed: Factor 0.5 (half the speed of light)

Transatmospheric Capabilities: Yes; speed in atmosphere is Mach 1.

Advanced Travel Systems: Two sleep modules

S.D.C.: 1,650

A.R.: 10

Weapons: None

Cargo Space: 6,000 cubic feet (170 cubic meters) or 10x10x60 foot (3x3x18 m) area.

Cost: One million CR

Cargo Shuttle — Production Line Package

Length: 700 feet (213 m)

Mass: 650 tons (585 metric tons)

Crew: Four; plus a support crew of eight is common.

Drive Type: Metallic Hydrogen

Maximum Speed: Factor 1 (speed of light)

Transatmospheric Capabilities: None

Advanced Travel Systems: Four sleep modules, point-to-point generators, and gateway codes and beacons.

A.R.: 10

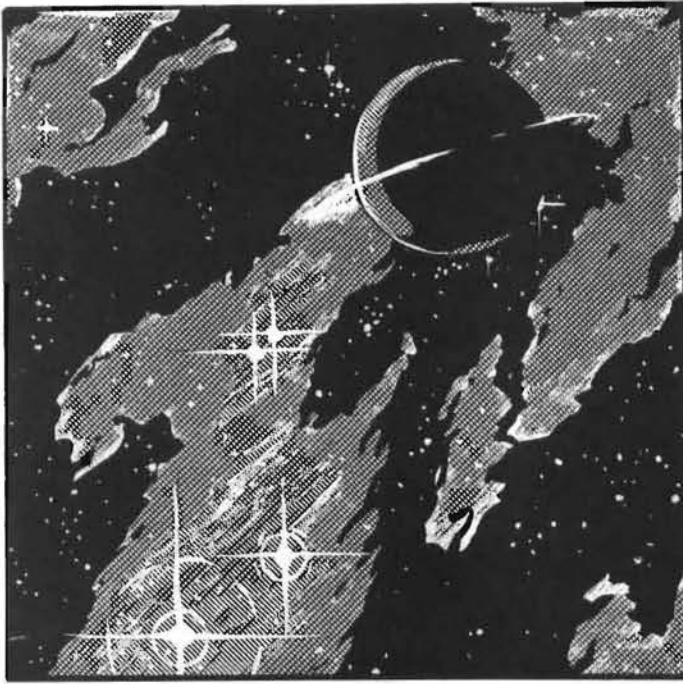

S.D.C.: 5000
Armor: None
Weapons: None
Cargo Space: 100,000 tons (90,000 metric tons); 25,000 (22,500) per bay.
Cost: 27 million CR

Space Fighter Craft — Production Line Package

Length: 20 feet (6 m)
Mass: 16 tons (14,400 kg)
Crew: One
Drive Type: Ion/Fission
Maximum FTL Speed: Factor 2
Transatmospheric Capabilities: None
Advanced Travel Systems: None
S.D.C.: 480
A.R.: 15
Weapons: 2 light laser weapons. Each in a light armored turret (A.R. 12, S.D.C. 100).
Cargo Space: 24 cubic feet (0.68 cubic meters); 4x2x3 foot (1.2x0.6x0.9 meter) area.
Cost: One million CR

Medium Assault Craft — Military

Length: 360 feet (110 m)
Mass: 380 tons (171 metric tons)
Crew: Five command personnel and 10 gunners, plus 72 additional troops or personnel can be accommodated.
Drive Type: Nuclear Fusion
Maximum FTL Speed Factor: 4
Transatmospheric Capabilities: None
Advanced Travel Systems: Stasis for 24, gateway codes and beacons, point-to-point generators.
S.D.C.: 10,440
A.R.: 17
Weapons: All are in light armored turrets (A.R. 12, S.D.C. 100). 4 nuclear missile racks (24 missiles), 4 anti-ship

weapons, 2 long-range missile launchers (20 missiles), 3 battleship weapons, 12 heavy weapons, 4 short-range missile racks (40 missiles), 6 mini-missile racks (72 missiles).

Cost: 65 million CR

Heavy Assault Craft — Military

Length: 625 feet (191 m)
Mass: 700 tons (630 metric tons)
Crew: 17 command personnel, 80 combat personnel, and 128 others.
Drive Type: Nuclear Fusion
Maximum FTL Speed: Factor 6
Transatmospheric Capabilities: None
Advanced Travel Systems: Bio-Chem stasis for 200, gateway codes and beacon, point-to-point generators.
S.D.C.: 18,500
A.R.: 15

Weapons: All are in medium armored turrets (A.R. 13, S.D.C. 200). 4 battleship weapons, 2 nuclear missile racks (16 missiles), 2 long-range missile racks (20 missiles), 3 anti-ship weapons, 12 heavy weapons, 4 medium-range missile racks, 12 medium weapons, 4 short-range missile racks (40 missiles), 12 light weapons, 4 mini-missile racks (56 missiles). Plus 10 fighters (use production line package) and 4 satellites (unmanned fighters with 4 light weapons and an anti-ship weapon).

Cost: 90 million CR

Battleship — Production Line Package

Length: 1,000 feet (305 m)
Mass: 1,200 tons (1,080 metric tons)
Crew: 30 command personnel, 275 combat personnel, and 100 others.
Drive Type: Nuclear Fusion
Maximum Speed: Factor 12
Transatmospheric Capabilities: None.
Advanced Travel Systems: Stasis for 300, gateway codes and beacon, point-to-point generators.
S.D.C.: 42,000
A.R.: 17

Weapons: All are in heavy armored turrets (A.R. 15, S.D.C. 300). One fixed forward great cannon (can shoot once per melee round), 5 nuclear missile racks (50 missiles), 9 battleship weapons, 6 long-range missile racks (60 missiles), 12 anti-ship weapons, 12 heavy weapons, 4 medium-range missile racks (48 missiles), plus 50 fighters (use production line package) and 6 satellites (unmanned fighters but add one anti-ship weapon and a rack of 12 short-range missiles).

Cargo Space: Personal belongings of the crew, ammo, supplies, and parts, plus 20,000 cubic feet (566 cubic meters) of space in hangars that can accommodate two small shuttles, 3D4 fighters, and up to 72 human-sized power armor units, or 24 giant robots.

Cost: 200 million CR



Breaux
77

Ego

Komodo

Index of Aliens

Alphabetical List of Aliens

Altaicans (feline)	94
Aluta (human-like)	103
Anubios (ape)	68
Arerri (human-like)	105
Arismal (human-like)	106
Atorians (human)	108
Atorian Empire	47
Aurovax (reptile)	141
Axolotl (amphibian)	52
Baccarus (reptile)	142
Basanite (mineral)	132
Brakkana (monster)	158
Caecil (amphibian)	53
Cameroon (amphibian)	54
Camleans (Plant)	150
Canis (canine)	84
Cebus (ape)	69
Cebus (ape)	70
Cherion (aquatic)	60
Chianas (plant)	151
Concol (feline)	95
Cyklops-Serpentmen (monster)	159
Danaus (insect)	124
Darakans (human-like)	109
Darclons (amphibian)	38
Dark Breeze (monster)	49 & 161
Darkith, The (amphibian)	55
Dergins (canine)	86
Deurycans (amphibian)	56
Devourer Mound	162
Diatome Pirates	49
Doppleganger: Dop-elpoep (monster)	162
Doppleganger: Erishik (monster)	164
Doppleganger: Reipoc (monster)	164
Dragonoid	165
Dyteens (ape)	72
Elecians (bird)	76
Erittima (reptile)	143
Errasa (aquatic)	61
ERythros (plant)	152
Fehrans (aka Atorians)	108
Felias (feline)	96
Fredulians (mineral)	134
Gallopas (bird)	77
Giants (see Titons)	121
Giris (feline)	97
Gymoy (bird)	78
Hathas (human-like)	110
Inennsi (aquatic)	62
Jenjorans (reptile)	144
Kassans (human)	112
Kisent (plant)	153
Weapons (see Kisent)	153
Kisentite Weaponry (stats)	175
Klikita (human-like)	113
Lachinelians (plant)	154

Latrans (canine)	88
Lassinikes (mineral)	135
Liconians (mineral)	136
Lilliamok Vampires (monster)	173
Linx (feline)	99
Lixilas (insect)	125
Lotha (monster)	166
Lupis (canine)	89
Maeus (ape)	73
Manarr (human-like)	114
Mantella (amphibian)	57
Manteze (insect)	126
Mendoline (monster)	167
Miceans (mineral)	137
Morphos (monster)	168
Naidens (human)	116
Nattereri (aquatic)	63
Nithians (reptile)	146
Pantherans (feline)	100
Photins (insect)	127
Pume (feline)	101
Pyralis (insect)	128
Qua-Trau (reptile)	147
Raldemeans (mineral)	139
Relogians (insect)	129
Riathenors (monster)	170
Rotharr (human-like)	117
Salar (aquatic)	65
Salvelinus (aquatic)	66
Shissans (human-like)	118
Silisons (human-like)	119
Sorinam (amphibian)	58
Sprekalian (plant)	155
Stoans (mineral)	140
Struthios (bird)	80
Swips (human-like)	120
Tagonicans (bird)	81
Tedeschians (plant)	157
Thisseras (reptile)	148
Threskians (bird)	82
Thropo (ape)	74
Timneh (bird)	83
Tinalis (aquatic)	67
Titons (human-like)	121
Toyoc (canine)	90
Trogolo (ape)	75
Vacuum Ghouls (monster)	172
Vampire: Lilliamok (monster)	173
Vulpese (canine)	91
Wulf (canine)	93
Xenopus (amphibian)	59
Xippus (insect)	130

Organizations

Atorian Empire (alien)	47
Diatome Pirates (alien)	49
Federation of Allied Races (FAR; alien)	47
Niamese Coalition (alien)	48
Project Tyche (government)	24

Project Secure (government)	26
Reach Up	41
S.H.O.C.K.	42
Tagoniglomerate (alien)	48
Thissera-Micean Cooperative (TMC)	48
Triton Industries	34

PALLADIUM BOOKS® PRESENTS:

SYSTEMS FAILURE™

A COMPLETE ROLE-PLAYING GAME



When the cities fell, and the world went “off-line,” all seemed lost. Anarchy reigned.

All that is left are the Survivalists, Nature-Lovers, Farmers, Gun Bunnies, Eggheads and backwoods wackos living on the fringe. Most are people found in remote regions — many because they were prepared for the Y2K Bug and the collapse of civilization.

Oh, there are “bugs” all right. Alien bug-like things that feed on energy and turn humans into zombie-like slaves.

Things are even worse than those “prepared” could have imagined, but these survivors aren’t ready to give up. America (and then the world) will be free! And they mean business.

That’s right, play one of the “wackos” fighting to save the world in a post-holocaust envi-

ronment that makes worries about the Y2K Bug seem like a picnic.

- A complete, new role-playing game.
- Everything you need to play in one dynamic package (dice and players not included).
- Quick, easy-to-learn rules.
- Fast paced and dynamic fun.
- The Villains: Inhuman invaders from another dimension.
- The Heroes: Society’s castaways, nutcases & survivalists.
- The adventure: Reclaiming the world for god-fearing humans.
- Don’t miss the adventure.
- 128 page role-playing game.
- Only \$12.95 — in stores everywhere.

PALLADIUM BOOKS® PRESENTS:

SYSTEMS FAILURE™

Palladium Books® Inc.
12455 Universal Drive
Taylor MI, 48180

RIFTS®

There is so much to tell about **Rifts®** that we don't know where to begin.

Earth has been torn apart and reshaped. It is as alien as some distant planet, yet strangely familiar. Humankind has risen from the ashes of armageddon to reclaim their planet, only this time there are other creatures who claim it as well.



Rifts® is science fiction

It is high-tech science fiction with Mega-Damage rules, cybernetics, bionics, robotics, energy weapons, rail guns, power armor, giant robot vehicles, and fantastic cities. Cities where character classes like the *City Rat*, *Cyber-Doc*, *Operators*, *Body Fixers*, and other rogues call home. Cities controlled by the empire known as the Coalition States; a nazi-like government who controls the minds and hearts of its people and where books are forbidden. Places where men of magic, psychics, and scholars are hunted by the *Coalition Dog Packs* and *Psi-Stalkers*.



Rifts® is fantasy

The "science of magic" is as developed and powerful as robotics. *Ley lines* and their mystic energies are tapped to open doorways to other worlds and used to create technological marvels like *TK-Guns* (fire telekinetic bolts instead of bullets) and *Wing Boards* (surfboard like platforms that sail along ley lines). A world where creatures of legend walk among men. A world where character classes like the *Line Walker*, *Techno-Wizard*, *Shifter*, and *Mystic* are just beginning to master the power that ancient man called magic.

Copyright 1998 Palladium Books Inc.
Palladium Books®, Rifts®, Megaverse®, The Mechanoids® are registered trademarks owned by Palladium Books Inc. Other titles and names are also trademarks of Palladium Books Inc. Robotech® is a registered trademark of Harmony Gold USA, Inc.

Rifts® is horror

Where ley lines meet, they are called junctions or "nexus" points. These are the places where portals or "Rifts" tear open the fabric of space and time. Sometimes the Rifts can be controlled, but all too often they tear open like an erupting volcano of mystic and psychic energy. From the eruption, hordes of creatures emerge. Some are monstrous flesh and blood creatures, others are alien intelligences, but the worst are supernatural beings that even future man calls *demons*.

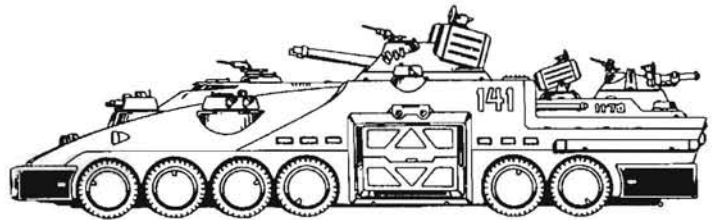

Rifts® is post-holocaust adventure

The world is a vast wilderness, a new frontier with many wonders waiting to be explored, and just as many horrors barring the path. Player characters are the brave, idealistic, adventurous explorers of this new world. The men and women who dare to carve their place in a world gone mad. Occupational Character Classes include the *Cyber-Knight*, *Bursters*, *Juicers*, *Borgs*, *Crazies*, *Mind Melters*, *Coalition Elite*, and many, many others.

Rifts® is great artwork

The cover by *Keith Parkinson* is only a hint at what awaits you inside. Incredible new robots, bionics, weapons, vehicles, characters and more are breathtakingly illustrated by *Kevin Long* and others. Plus a 12 page center spread of paintings by Long and Parkinson that brings the world of **Rifts®** to life. Written by *Kevin Siembieda*. \$24.95 plus \$3.00 postage and handling. 256 pages — Complete role-playing game.



Rifts®, your source to the Megaverse®

The original game took three years to design, write and illustrate. It has been a smash hit since the day of its release.

The sourcebooks that have followed continue the tradition of great art, dynamic characters, strong story, and high-concept. But we go beyond the boundaries of Earth. Dimension Books carry the reader to alien galaxies and strange, new worlds. Better yet, **Rifts®** is compatible with Palladium's entire Megaverse® of games, from *Heroes Unlimited™* and *Robotech®* to *Palladium Fantasy®* and *Nightbane®*. Available at stores everywhere.

Visit Palladium's Web Site to see our complete catalog, the latest news, talk to fans in our chat rooms, access special sourcebooks and data, and join in all the fun and excitement! Moderated by V.P. Maryann Siembieda.
www.palladiumbooks.com

Palladium Books Inc.
Dept. D

12455 Universal Drive
Taylor, MI 48180

Your doorway to the Megaverse®



Copyright 1997 Kevin Siembida

RifterTM Subscription

Don't become a slobbering beast driven mad because you're afraid you'll miss an issue of **The RifterTM**. Subscribe and get every issue delivered to your doorstep in a protective cardboard envelope.

One Year (four issues) — Only \$25.00

That's right, only 25 bucks! Postage and handling included. That's over 500 pages of source material, fun and inspiration for an incredible bargain. Of course, every issue should be available from fine stores everywhere — and stores need your support.

Each issue will be 96 to 128 pages (typically the latter).

Published quarterly with a cover price of \$7.95 (a bargain at that price).

Contributing authors will include *Kevin Siembida, Eric Wujcik, Wayne Breaux Jr., Jolly Blackburn* and other Palladium notables.

What Exactly is The RifterTM ?

Well, flipping through this issue should give you a fairly good idea, but every issue will be different.

Really, there has never been anything like it.

The Rifter is a synthesis of a sourcebook, Game Master's guide, a magazine and talent show — a fan forum.

The RifterTM is like a sourcebook because it will include a ton of role-playing source material (optional and official). This will include New O.C.C.s, NPC heroes, NPC villains, new powers and abilities, weapons, adventure settings, adventures and adventure ideas, and Hook, Line and SinkersTM.

The RifterTM is like a G.M.'s guide because it will include special articles and tips on role-playing, how to handle common problems, how to build an adventure and so on.

The RifterTM is like a magazine because it will come out four or five times a year (we're shooting for a regular quarterly release schedule), and because it will feature Palladium news, advertisements, serial articles and continuing features.

Most importantly, The RifterTM is a forum for Palladium's Fans. At least half of each issue will be text and material taken (with permission) from the Web, as well as fan contributions made especially for **The RifterTM**. We get tons of fan submissions that are pretty good, but not good enough for publication as an entire sourcebook. In other cases, the submission is something clever and cool, but only a few pages long. There's lots of cool stuff on the Internet, but you must have a computer and Internet access, something a lot of fans just don't have.

The RifterTM will reprint some of those "Web-WorksTM" allowing fans (and the world at large) to get a glimpse of their genius. It is one more avenue in which fans and professionals alike can share their visions of role-playing and the Palladium Megaverse with other fans. It's a chance to get published, get a little cash, get your name in lights (well, in print) and have fun.

This also means, more than any RPG publication ever produced, **The RifterTM is yours.** Yours to present and share ideas. Yours to help shape and mold. Yours to share.

Why call it The RifterTM? Because each issue will span the Palladium Megaverse of games, adventures and ideas. Each issue will publish features from people across the Web and beyond! But mainly because each and every one of us, from game designer and publisher, to Joe Gamer, traverses the **MegaverseTM** every time they read an RPG or play in a role-playing game. We travel the infinite realm of the imagination, hopping from one world to the next — building one world to the next. Time and space are meaningless in our imaginations as we *Rift* from one place and time to another.

**Palladium Books Inc.
Rifter Dept.**

**12455 Universal Drive
Taylor, MI 48180**



Also from Palladium Books Villains Unlimited™

A giant sourcebook packed with over 80 unique and original villains, including the Masters of Speed, Freak Maker, Hellhound, Triple Threat, the Aggressor, Mr. Plague, and many others. New super powers, gimmicks, weapons and rules. Plus enough adventure ideas and settings to keep a Game Master busy for years!

Compatible with *Aliens Unlimited*, *Ninjas & Super-spies*, *TMNT*, *Beyond the Supernatural*, *Rifts* and the entire Palladium Megaverse.

Highlights Include:

- Over 80 original super villains with complete stats.
- 18 new super abilities including nightstalking, bio-ghost, divine aura, negate super powers and many others.
- S.C.R.E.T.s: Superbeing Control Retrieval and Elimination Teams — an elite government strike force.
- Rules for creating secret organizations plus groups like the Fabricators, Brotherhood of Armageddon, The Dark Tribunal, and Sentinels of Justice.
- The Sentinels of Justice and other heroes.
- Dark secrets, deadly villains, and countless adventure ideas.
- Art by Long, Siembieda and Gustovich.
- Written by Long and Siembieda.
- 224 pages of adventure

Palladium Books® Presents:

Aliens Unlimited™ Revised

Includes Rifts® conversion notes.

Adaptable to Rifts®, Mechanoids® and Rifts® Dimension Books™.

- Over 100 specific alien races and monsters!
- Random alien creation tables and rules.
- New super powers, bionic and skills.
- High-tech weapon and equipment.
- Spaceships and creation rules.
- U.F.O. watch groups.
- Secret Organizations and spies.
- Rifts conversion notes. Adaptable to Rifts®, Mechanoids®, Rifts Dimension Book Two: Phase World™ and the entire Palladium Megaverse®.
- Enough ideas and information to create dozens of campaigns.
- Written by Wayne Breaux and Kevin Siembieda.

\$24.95

Cat. No. 515

I.S.B.N. 0916211-76-2

ISBN 0-916211-76-2

