

CAMPAIGN CLASSICS™

#1030



Avalon

VIKINGS™



For
Rolemaster

&
Fantasy
HERO™

Adaptable to most
major FRP systems.

Angus McBride '89



VIKINGSTM

BACKGROUND AND ADVENTURES IN THE ERA OF THE NORSEMEN FOR *ROLEMASTER* AND *FANTASY HERO*

by Lee Gold

Special thanks to Barry Gold and Niall Shapero

CREDITS

Author/ Designer: Lee Gold

Editor/Developer: John Ruemmler & Kevin Barrett

Cover Art: Angus McBride

Interior Art: Gerald Forton

Layouts: Steve Sullivan

Additional Art & Graphics: Gerald Forton

Project Specific Contributions: *Series Editor:* Kevin Barrett; *Content Editor:* John Ruemmler; *Pagemaking:* Kevin Williams; *Layout:* Eileen Smith, Cheryl Kief, Ted Dinwiddie, Andrew Christensen; *Cover Graphics:* Haines Sprunt; *Editorial Contributions:* Coleman Charlton

Special Contributions: Barry Gold & Niall Shapero

ICE MANAGEMENT — *Production Manager:* Terry Amthor; *Sales & Customer Service Manager:* Deane Begiebing; *Art Director:* Richard Britton; *Editing & Development Manager:* Coleman Charlton; *President:* Peter Fenlon; *CEO:* Bruce Neidlinger; *Controller:* Kurt Rasmussen.

ICE STAFF — *Marketing Consultant:* John Morgan; *Licensing:* Kurt Fischer; *Print Buyer:* Bill Downs; *Production Supervisor:* Suzanne Young; *Art & Graphics Staff:* Haynes Sprunt, Lydia Conder; *Editing & Development Staff:* Terry Amthor, Kevin Barrett, Rob Bell, Pete Fenlon, Leo Ladell, Jessica Ney, John Ruemmler; *Production Staff:* Larry Brook, Andrew Christensen, Ted Dinwiddie, Will Hyde, Cheryl Kief, Jennifer Kleine, Leo LaDell, Eileen Smith, Kevin Williams; *Sales & Customer Service Staff:* John Brunkhart, Heidi Heffner; *Shipping Staff:* John Breckenridge, Robert Crenshaw, David Johnson, Corey Wicks.

Copyright 1989 © by Iron Crown Enterprises Inc. . . . All rights reserved. . . . No reproduction without author's permission.

Produced and distributed by IRON CROWN ENTERPRISES, Inc., P.O. Box 1605, Charlottesville, VA 22902.

First U.S. Edition 1989.

Stock # 1030

ISBN 1-55806-047-2

TABLE OF CONTENTS

INTRODUCTION

PLAYERS SECTION

1.0 CHARACTER CREATION

1.1 Appearance	9
1.2 Social Classes	10
1.3 Viking Cultural Skills	11
1.4 The Viking and His Family	14
1.5 Viking Names	16
1.6 Buying and Selling	18
1.7 Package Deals for Goods	25

2.0 VIKING HOME LIFE

2.1 The Viking Calendar	25
2.2 Viking Farmlife	26
2.3 Social Life on the Farm	27
2.4 Viking Courtlife	28
2.5 Viking Social Codes	28
2.6 Family Occasions	29
2.7 Religion	30
2.8 Laws and Government	31

3.0 VIKINGS AWAY FROM HOME: TRADING AND RAIDING

3.1 Viking Navigation	33
3.2 Travel Speed	34
3.3 Travel Hazards	34
3.4 Raiding and Danegeld	35
3.5 Trading	39
3.6 Joining the Royal Housecarls	39

4.0 COMBAT, INJURY AND CURING

4.1 Mass Combat	40
4.2 Individual Combat	42
4.3 Other Dangers	44
4.4 Tending Injuries	45

5.0 FOLKLORE AND SUPERSTITION

5.1 Fate and Luck	45
5.2 Trolls and Giants	46
5.3 Dwarves and Elves	46
5.4 Nis	47
5.5 Valkyries	47
5.6 Water Spirits	47
5.7 Treasure Fires	47
5.8 Mages and Other Strange People	47
5.9 Herbalism	48
5.10 Tales of the Skalds	48

6.0 MAGIC AND UNUSUAL CHARACTERS

6.1 Magic Artifacts	49
6.2 Leeches	51
6.3 Berserks	52
6.4 Trollblooms	53
6.5 Rune Carvers and Skalds	53
6.6 Second Sighted and Shamans	54
6.7 Wizards	55

THE SETTING

7.0 VIKING HISTORY

7.1 Scandinavian Geography	56
7.2 The Early Viking Era (768-874)	56
7.3 The Middle Viking Era (875-986)	58
7.4 The Late Viking Era (987-1066)	60
7.5 Viking Timeline	64

8.0 THE WIDE WORLD

8.1 Norwegian and Danish Trade Marts	65
8.2 Other Norse Trade Centers	67
8.3 The Lapps	67
8.4 Swedish Trade Marts	70
8.5 The Baltic Coast and the Slavs	72
8.6 Greater Sweden	73
8.7 Byzantium	75
8.8 The Baghdad Caliphate	75
8.9 The Carolingian Empire	76
8.10 Britain	77
8.11 Spain	78
8.12 Imaginary Lands	78
8.13 Languages	79
8.14 Vikings vs Foreigners	79

GAME STATISTICS

9.0 ANIMALS

9.1 Domesticated Animals	80
9.2 Wild Animals	80
9.3 Animal Detect Skills	81
9.4 Shapechanging	81
9.5 The Sea Serpent	81
9.6 The Nicor	81
9.7 The Dragon	81

10.0 MONSTERS AND SPIRITS

10.1 Trolls	82
10.2 Giants	82
10.3 Dwarves and Elves	82
10.4 Nis	82
10.5 Water Spirits	82
10.6 The Dead	82
10.7 Monster Tables	84

11.0 GODS AND GIANTS

11.1 Thor	85
11.2 Tyr	85
11.3 Odin	86
11.4 Valkyries and Norns	86
11.5 Loki	86
11.6 Baldur	86
11.7 Frey	87
11.8 Njord	87
11.9 Freyja	87
11.10 Other Goddesses	87
11.11 Other Gods	87
11.12 Aegir the Sea Giant	87
11.13 Frost Giants	88
11.14 Surt the Fire Giant	88

12.0 CHARTS AND GAME NOTES

12.1 Calendars	88
12.2 Weather	89
12.3 Good Years and Bad	90
12.4 Random Encounters	90
12.5 Reading and Writing	91
12.6 Treasure	91

13.0 ADVENTURE SCENARIOS

13.1 Scenario 1: Yule at Ormhall	92
13.2 Scenario 2: The Vulture Sets Sail	95
13.3 Scenario 3: Winter at Court	97
13.4 Viking NPCs	101

INDEX	102-104
-------------	---------

RECOMMENDED READING	104
---------------------------	-----

APPENDIX	105-110
----------------	---------

INTRODUCTION

The Viking Age is a wonderful setting for role playing adventures. Your player characters can roam the whale's track (ocean) in their wave traveler (ship), seeking Frodi's flour (gold). They can harry the towns of coastal Europe as far up-river as their shallow-bottomed sailing ships can be rowed. Or they can trade their goods in the marts of Frisia, Ireland, Normandy or inland Russia. Or they can stay at home and look after their farmstead — and perhaps fight a blood feud. They'll see berserks and shield maidens, troll-wise wizards and rune carvers and shamans, exiled kings and runaway thralls and outlawed warriors. If their deeds are heroic enough, perhaps they'll be written into a skald's song and remembered forever.

This book will allow you as GM to create the atmosphere of the Viking Age. It contains the background you need to set up a role playing campaign and outlines adventures usable in several campaigns. You can find out all about life in the Viking homelands and gather enough information about nearby lands to run a Viking trading or raiding voyage. You'll learn about all aspects of the Viking world, including historical events, superstitions and folklore, magic and religion.

HOW TO USE THIS BOOK

This book is divided into four sections. The Players Section is intended for both players and the GM to read. It shows you how to create characters and describes the Viking culture in which they live. A section on magic allows the GM to set the campaign's magic level anywhere from legendary but nonexistent to highly visible.

Second is the Historical Section, which describes the larger territory the Vikings can explore and raid. This was a time when Arab and Jewish traders linked the trading marts of Russia to the Silk Road, when outlawed Icelanders might travel through Russia all the way to Byzantium, then ruled by the Greek-speaking descendants of the Roman Empire. In this era, a Viking fleet of sixty ships could take a four year voyage, raiding Aquitaine, Moorish Spain, and North Africa before sailing back to the northland by way of Italy. This section contains maps showing the world of the Viking Age, a timeline, and descriptions of major historical figures.

The Gamemaster Section is third. It describes characters the GM might role play — animals, spirits, trolls and giants, and maybe even pagan gods. Treasures which the Vikings may encounter in their adventures are fully described here. Finally, this part of the book presents encounter charts plus three detailed adventure scenarios to help the GM's campaign get off to a good start.

Finally, there's an index to help you find information quickly. With it is a Bibliography, a list of books to read if you want to explore the Viking Age in further detail.

To use this book, players should read the Players Section, while the GM would be wise to read the whole book. First, the GM should decide the type of campaign he wants to run: its magic level, scope and approximate historical date. Then players can create Viking characters, with the GM helping to integrate these characters into the campaign world so that they can adventure with (or against) each other in an exciting and realistic manner.

This book can be used as a complete campaign in its own right or as part of your current fantasy campaign. You will find material useful in any role playing game: new monsters, character types, treasures, and magic spells. Of course, your players are not restricted to only playing Vikings. They can be from any of the

other many countries which the Vikings raided and traded with: the Carolingian Empire, Moorish Spain, Greek Byzantium, or even Slavic Russia. Or PCs might come from other times (and other campaigns), brought to the northland by a shaman's mighty spells.

ROLE PLAYING IN THE VIKING AGE

Vikings reckoned that a boy came legally of age at twelve years. A youngster of twelve might take up a blood feud or sail off on a year-long voyage. A fifteen-year-old might marry and leave home to run his own farmstead.

Here is some good advice a young Viking might get from his kinsmen. The poetry is from the Havamal, Odin's advice to a King. (The lesson of each poem appears first, in parentheses.)

*(Be on your guard among strangers)
Before a man goes inside the gate
He should watch warily, look well around.
Often he may find a foe
Sitting on a seat inside.*

*(Be generous to your friends)
If there's a friend that you fully trust
And want to get good from,
Mingle your thoughts, and give him fair gifts,
And visit him often.
If there's a man you never will trust
But want to get good from,
Give him fair words but false smiles.
Pay fraud back with falsehood.*

*(Value your honor)
Cattle die and kinsmen die
And someday each man will die.
There's only one thing that never dies:
The fame of the deeds you've done.*

As the last verse shows, the Viking realized that wealth depended on the whims of fate. A year of drought or poor fishing could reduce a prosperous farmer to near-poverty. A valiant but unlucky fighter might end up maimed or killed. Prudent young Vikings were the most apt to end up becoming old Vikings. If characters meet every problem by pulling out their swords, they're apt to wind up either dead or outlawed — with no support from anyone but their closest relatives and friends, and their victims' revengeful kinsmen after their blood.

Some Vikings returned from raiding with bags of treasure from looted monasteries or their share of the "danegeld" paid by terrified foreigners in return for a promise not to raid there any more. Other Vikings came back rich after a season of trading, taking fur and wool cloth from the northland down to the south and returning with silk and glassware, silver and gold. Other Vikings became housecarls at the royal court of Denmark or Norway, or at the courts of Viking kings in Ireland or Scotland or York or the Danelaw, and received great presents: weapons and jewelry, ships and land. There are more ways to become rich than just fighting.

You can GM as many players as you can handle in a Viking Age scenario. An inexperienced GM might want to start with only a few players, each role playing only one character. An experienced GM might well want to have more players, or permit each player to run several characters, to give the campaign more scope and depth.

BACKGROUND OF THIS BOOK

Our knowledge of the Viking Age comes from the sagas and the historians. The sagas weren't written down until centuries after the events they retell. Some are firmly based on historical traditions based in fact. Others are fiction but preserve the authentic background of the times they portray. Still other sagas are set in a land of romance and fairy tale. Historians have cross-checked the saga material with archeological research and the chronicles of other lands touched by the Viking expansion. Sometimes the sagas and the historians disagree. When this happens, I've taken the historians' account of dates and technological development, but the sagas' account of such matters as magic, trolls, spirits, and gods.

RUNNING A CAMPAIGN

As GM, you will notice that each of the players has only one or two characters to role play while you may have dozens. You get to role play all the other people in the world, each with his or her own ambitions and fears, likes and dislikes. The more alive and real you can make your characters, the more real the world will seem to your players. Here are some helpful hints to bear in mind:

1. Keep a calendar: Know the season and the phase of the moon (from one full moon to the next is about 29.5 nights) and the month. Decide what the weather will be: clear or stormy or cloudy or windy, warm or cool. Keep track of the day of the week and the holidays, pagan and Christian. (These factors are discussed in Section 2.1.) Keep track of your campaign's history too. That way you can tell characters how long it will take them to heal their wounds, how many days it will take their ship to reach its next destination, and so on.

2. Know the characters' home base: It may be a farmstead or a valley in the mountain wilderness or a ship or a royal court or a trading mart. But you should know its layout, how near a trip it is to the nearest settlements — and the nearest trading mart.

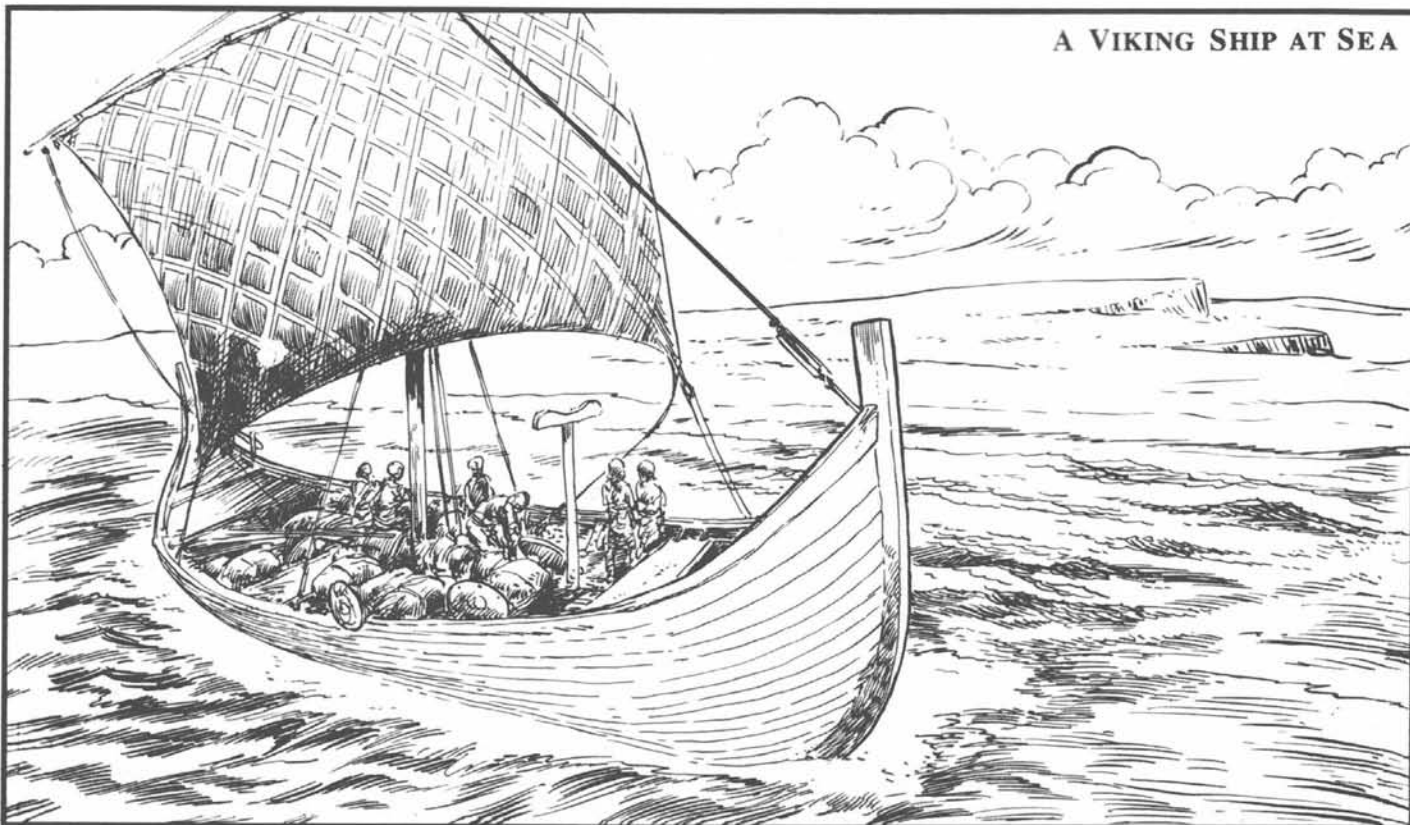
3. Let the adventures grow from the characters: Know your characters' skills and weaknesses, their friends and enemies, their fears and ambitions. Then weave your adventures accordingly.

Vikings did not fight monsters for fun. They fought them to protect their friends and family, or to avoid being taunted as cowards. If they wanted money, they got it by trading or raiding or by selling what they made or grew. Only a crisis could drive a Viking to dig up a grave-mound and to carry off the treasure buried there. Everyone knew that doing that invited an attack by the walking corpse of the dead man who once owned that treasure.

If your campaign has too many major crises, you will probably find that its power level is escalating beyond your ability to control it. Keep your adventures small at first.

4. Describe what the characters sense and notice: Start an adventure by reminding the players how their characters feel and what they see. Did their last adventure leave them weary and wounded? Are they in the wilderness or on the seas or among civilized people, at a farmstead or a trading mart or within a royal court? What is the weather like? What time is it? Are they indoors or outdoors? Are there other people around? What does the terrain or hall look like? If they don't start doing something by then, tell them what they hear and see and smell.

If at any point the player characters seem to be behaving out of character for Vikings, remember they probably haven't read this book as carefully as you have. Feel free to stop the action and remind them of what they seem to have forgotten. "You are Vikings now! Behave like Norsemen!"



PLAYERS SECTION

1.0

CHARACTER CREATION

Vikings were part-time adventurers. The rest of the time, most of them kept busy with the day to day work of running a farmstead: farming and herding, fishing and hunting. Many Vikings had a yearly schedule of going on brief trading or raiding voyages during the spring or summer or fall, but spent the winter quietly at home with the family. Other Vikings alternately passed years at home and away on longer voyages, leaving their wives and sons to manage their farmsteads in their absence.

Only outlaws had no home. They had to somehow eke out a living hunting in the mountains or on pirate ships that preyed upon passing merchant ships. It was illegal to shelter an outlaw, but some still managed to find farmers who'd take them in awhile as hirelings, to work on the farm or to fight for their master.

The Players Section of this book will tell you about the Viking culture. Regardless of the game system you use, you will want to learn more about the Viking lifestyle. This section will help you design characters (both PCs and NPCs) and introduce the sort of people they might meet on the isolated farmsteads of northern Norway and Iceland or in the villages of southern Norway and Denmark, in the wilderness and on the high seas, in trading marts and royal courts.

Skim the next few chapters and begin to visualize your character. Is your character male or female? A youngster of twelve, a fully grown youth of eighteen, or a seasoned adult of 25 or so? What's your character's personality like? Valiant or cowardly, quiet or a braggart, extravagant or greedy, honorable or unscrupulous? Is your character a major mage? There's Rune magic and Shaman magic and Wizard magic, each with its own powers. Does your character have one of the lesser magic talents — Berserk or Leech or Second Sighted or Trollblooded?

What kind of a family does your character come from? What about his friends and enemies, business allies and rivals? Is your character caught up in a blood feud? Is he outlawed or sheltering an outlawed relative or friend? Is there some sort of curse or prophecy about his future? Check with your GM to see what sort of subplots might work well in the campaign.

CAMPAIGN POWER LEVEL AND TIMING

The GM should decide before the campaign starts how high the power level should be. Will the gods take a hand in the action now and again, or remain offstage? What sorts of magic will be common? What kind of magic is not allowed?

Will any of the characters start with a magic item, as a parting gift from their mother or father? How many magicians will act in the campaign? You may want to limit players to one magic talent for every non-mage (or for every five non-mages with magic items); one major mage for every three with magic talents. Your adventures will be more like the sagas if there are proportionately more non-mages.

Read the history in Section 7 and determine when the campaign will be set. Will it be in the early Viking era, when neighboring landholders might get together to send out a few ships to raid or

trade with foreigners? Will it be in the middle Viking era when a regional chieftain might send a fleet of several dozen ships to sail the seas for a year or more, raiding in one place to trade the looted goods in another? Or will it be in the late Viking era, when royal fleets set sail to the British Isles, aiming at conquest? You can use the timeline in Section 7 as your campaign background, or perhaps you'll find an interesting point to begin an alternate world. The adventure scenarios and major NPCs (with complete stats) detailed in Section 13 may also prove useful.

Your choice of historical era will also influence the characters' religion. In the 9th and 10th centuries, most Vikings were pagans who believed less in their gods than in the power of their weapons. In the 11th century, many Vikings were nominal Christians.

Once the campaign era is chosen, you as GM can help the players choose their characters as you roll up the characters that you will roleplay, the major NPCs: chieftains and priests, berserks and outlaws, hirelings and gossiping beggars, wandering skalds and peddlers.

YOUR CHARACTER'S PROFESSION AND SKILLS

If your character is going to be a historically authentic Viking, then you'll have to make a number of changes in the standard professions, whether your game system is *Rolemaster*, *Fantasy Hero*, or another. Of course, you can opt to play a Viking who behaves more like a standard fantasy role playing character than a hero of the Norse sagas. Or you can choose to play a character from one of the many other cultures the Vikings raided and traded with (see Section 8). Note the *Fantasy Hero* Package Deals in Section 6 for Shaman, Berserk, Skald and Leech.

THIEVES

There were Viking thieves, but they didn't use lockpicks to open strongboxes; they just smashed them with axes. They didn't hide in shadows to rob houses. The houses were so badly lit, especially at night, that it took skill not to walk in shadows. There were no pickpockets because the clothing people wore then did not have pockets. (Instead, they cut purses, slitting the bottom seam of the pouch that hung from a man's belt or a woman's neck-brooch, and caught the contents as they fell.) They didn't learn to disarm traps, because the Vikings didn't guard treasure by setting traps. (Some treasures were guarded by warriors; others were buried with their dead owner, who was supposed to wake and fight anyone who tried to rob him.) Stalking and Hiding and Climbing were general skills, used in hunting game.

However, a character in a Viking campaign can still be a normal rogue with the standard thieving skills, perhaps as a citizen of the Carolingian Empire or a native of Byzantium. Of course, the Vikings will distrust him, not just as an outlander but also because of his strange abilities. They will probably consider him a mage.

PAGAN PRIESTS

Viking pagan priests were men rich enough to host the neighborhood's celebrations of the major festivals, aided by contributions from poorer neighbors. Later, Christian missionaries came to the northland, usually from Ireland, England, and Germany. Neither pagan nor Christian priests were famed for their spells.

A few stories recount how devout Christians defended themselves against magicians, berserks and trolls by invoking the name of God or, after the year 1000, the name of St. Olaf. Consult the GM if you'd like to run a character whose prayers can bring about miracles. The GM might tell you that there won't be any miracles in the campaign, or he might want to judge each prayer by how well you role play, or he might let you create a priest with the usual skills. The Vikings will treat any character with such skills as a magician.

LEECHES AND MAGIC HEALING

The sagas contain very little mention of magic healing. Most fights ended in the death of one or more combatant. Survivors knew how to treat wounds. If the wounds were serious, a Viking went to a leech, often a woman, to be nursed back to health — eventually. Leeches might take hours to heal light wounds, days to heal medium wounds, and weeks or even months to heal major wounds.

No one was sure if leeches knew magic; clearly, they knew a lot about herbalism (which they learned as a standard skill, not by means of magic spells). See Section 6.2 for a description of the leech. The Vikings will treat any character with healing spells as a leech.

A few non-historical sagas tell of dwarves and trolls (and trollwise wizards) who had "herbs of life" which let them preserve and rejoin a severed hand or foot or eye. The GM might want to allow one such mighty healer in the campaign. If the player characters ever manage to find their way to his wilderness home, such a healer should demand a high price for his services.

A few stories tell of people healed from wounds and illness and poisoning by the prayers of devout Christians. Consult the GM if you'd like to have a character whose prayers have this sort of effect. Remember: any character who lets his neighbors know that his prayers have this sort of power will be always busy healing. He will no doubt be visited by every farmhand who breaks a leg herding cattle, every sailor who's strained his back rowing, every neighbor or relative who's ill ... There is no surer recipe for disaster in the Viking culture than refusing to help your dependents and neighbors and relatives.

BERSERKS

Berserks drank blood and ate meat raw; to give themselves courage, berserks ate the hearts of large animals and monsters they had slain. They went into a frenzy at the prospect of a fight; a berserk's wolflike howling terrified most people. Once a berserk entered the frenzy, he would attack his enemies despite any wounds he received, until he was killed or had killed his enemies. Berserks did not attack people who had not threatened or insulted them. Of course, a berserk might interpret mild criticism as a deadly insult. Vikings treat anyone who seems to fight in a frenzy as a berserk.

Berserks were never afraid of anything they could fight: not of other berserks or wild animals or even of aftergangers (the walking dead). As long as their frenzy lasted, berserks were immune to fire and edged weapons; their strength was as great as that of a bear, and they ignored any injuries or pain. Afterwards, if they survived, they were at minimum strength for a full day.

A berserk's power came from a divine patron, Odin or Freyja, in return for his promise to fight in his patron's army at the final battle of Ragnarok. Once the berserk had attained his greatest power and began to bore his patron god, the divine favor was withdrawn, and the valkyries sped down to watch the berserk's last fight and to bring his soul away with them after his death.

RUNES AND THEIR CARVERS

Norse legend said that Odin learned the Runes during his self-initiation, hanging nine nights on the world-tree Yggdrasil, with a spear wound in his side. Rune carvers had to be fully literate, able to read and write both the modern 16 rune alphabet and the ancient 24 rune alphabet. They were also skilled at poetry, another one of Odin's divine gifts. Rune Carvers also colored the runes with their own freshly shed blood (which they first had to enchant, by improvising a poem).

Rune Carvers were able to affect people's morale, emotions, and health. Miscarved runes could injure the wearer of the enruned item or whoever came in contact with them, causing psychological or physical problems. Rune Carvers who offended Odin lost their poetic ability and with it, their Rune magic. Vikings treat any one who writes things down or carves letters into stone or wood as a Rune Carver.

SKALDS

Skalds were poets who recited or sang their poems. Only some could read, but all were familiar with pagan myths, which they used in the kennings of their verse. (A kenning is a metaphorical reference to something. For instance, the first paragraph of the introduction to this book gives kennings for ocean, ship and gold: whale's track, wave traveler, and Frodi's flour.)

A skald's poetry was not magic but was important. Praising a hero's bravery or a woman's beauty or a trader's cunning added to their reputation. A song about an inhospitable host or an unfaithful wife or a cowardly warrior was a major insult. Icelandic law ruled that a love song to an unmarried maiden called for a fine if it implied that she had been too free with her favors, because it hampered her chances of making a good marriage.

A few skalds were Rune Carvers. But even a skald who wasn't a spell user could identify and undo miscarved magic Runes, as long as he could read the ancient 24 rune alphabet. The Vikings will treat any character who is a poet or singer as a skald.

SHAMANS

Like Berserks, Shamans also got their powers from Freyja or Odin. In order to use their magic powers, they had to enter a trance, by listening to singers chant songs of enchantment. The trance state lasted several hours and could not be broken without risking injury to the soul of the shaman. The Vikings will assume that any character who falls into a trance is a shaman.

Shamans usually entered a trance state while standing on a platform raised on pillars, just like a gallows. Most shamans were women; a few were men. A shaman's clothes were usually lined or edged with cat-fur, wolf-fur or bear-fur.

While in a trance, a shaman could send her soul out in animal form to see faraway places or to travel to the otherworld to ask for insight into the future or glimpses of the past. She could also animate the unburied battle-dead and send them out again to fight the next day. A few shamans were able to transform other people into wild animal form as a curse.

WIZARDS

Wizards learned their magic from trolls, Lapps, or other beings who weren't quite human. People sometimes called them "trollwise." (See Section 6.7 for a description of Viking Wizards or use standard Essence Magicians. Vikings will assume that any character who can control the elements or human pain is a Wizard.)

Wizards could raise or still the waves, calm or loose the winds, and slake fire until it seemed no hotter than warm water. They could also weave spells that kept people from noticing that they were tired or hungry or injured. A few wizards could even weave spells that changed men's forms to those of animals. Wizard spells affecting the elements used rope magic, tying the wind or waves or flames into a knot that would hold them until it was untied again. Wizard spells affecting people used herbs.

The GM may want to require that PC Wizards enchant their ropes or herbs, or that they make them out of special ingredients: rope from the skin of a white seal or walrus, herbs picked at the dark of the moon or the morning of the spring equinox or at noon of the summer solstice. This sort of approach seems particularly appropriate for the "herbs of life," which would allow a Wizard to preserve and rejoin a severed hand or foot or eye.

Some Wizards embedded their spells into magic artifacts. This action required not only the use of magic but also the skills of a weaponsmith or embroiderer and might take the wizard a year and a day of difficult work. The GM will probably want to rule that player characters cannot be Wizard Artificers. Vikings will assume that any character who can create magic artifacts is a Wizard Artificer.

Each wizard artifact was unique, had its own name and special abilities shaped by the personality of its maker, and the strengths and weaknesses of its intended recipient. Wizard artifacts were extremely powerful. A magic cloak or magic shield did not just slightly raise your chance against enemy attack; it protected you totally against all edged weapons (and did not protect you a bit against clubs or rocks or having your foe bite your throat out). A magic sword didn't just slightly raise your chance of hitting your enemy; it killed anyone it wounded. A magic shirt could keep you from being cold or tired, even if you had to jump overboard and swim miles to the nearest port.

SPELL USE NOTES

Viking spell users did not have many magic spells at their command and were not able to store spells for future use in staves or wands; nor could they focus their magic power through artifacts. A mage might win favor at the court of a pagan king or even lead his own band of raiders. Even so, mages were distrusted by most Viking commoners, especially Christians. If the community's mistrust turned to fear, a mage's neighbors might kill him. A warrior who killed a mage would usually win community approval, unless the mage had been very helpful to the neighborhood.

Consult your GM if you would like to play a foreign mage with spell-storing powers or to employ other non-Viking magic abilities. You could role play a Byzantine magician or a time-traveling Celtic Druid from before the Romans conquered Gaul and England, or even a mage from one of your other campaigns, brought into the northland by the powerful spells of a Shaman.

Some Vikings had what we might think of as magic spells but were not considered to be spell users. Most people could see omens of blood or fire that warned them when they were about to die. Many could see "fylgja," apparitions of kinsmen or friends who had just died in battle, asking the viewer for revenge. A few could interpret dreams or read a person's aura to determine whether he was lucky or unlucky.

A few Vikings had Second Sight and could see future dangers or future choice-points. These Vikings were neither mages nor priests, just ordinary farmers or warriors. For instance, one farmer warned a neighbor that he would have a long life only if he never killed twice in the same family. The Vikings believed that fate could be glimpsed but not outwitted. A common saying noted that "Good luck and great ability are two different things."

Note that all player characters must be human, though some may be rumored to have some trollblood. Such people are usually tall and ugly, with hair that turns gray by the time that they reach their late twenties or early thirties. (The Vikings thought of grey as the color of wolf-fur.) Vikings suspect that any tall, ugly men are trollblooded, especially if they have gray hair and unlined faces.

Trollbloods are often either Berserks or Wizards and are rumored to grow stronger at night and to see as well at night as in the daytime. The GM can decide whether all this is true in his campaign, or partially true, or just superstition. (See Section 6.4 for a description of Trollblood abilities.)

VIKING CHARACTERS FOR ROLEMASTER

Choose your character's profession from the following list. If you are playing in a historically authentic campaign, all the Viking spell users will have some unusual magic abilities but very restricted spell lists, compared to standard mages.

Warrior: Use the standard Fighter in *ChL/Cal* or the variation provided in *RMIII*.

Trader/Fighter: Use the Trader in *RMII* with greater fighting skills.

Farmer/Hunter/Fisher: Use the Farmer in *RMIII* but add hunting skills, including Climbing, Stalking, Hiding, Detect Hidden, etc.

Skald: Use the Profession from *RMIII*, with higher stats for remembering old lays, improvising poetry, detecting and undoing runes, etc.

Berserk: Use a standard *RM* Fighter plus Frenzy or adapt the Paladin detailed in *RMCI*. (Remember that the Berserk is a fighter dedicated to Odin. Just modify the Paladin's moral code to accent Norse honor: it is honorable to die fighting and dishonorable to let anyone insult you, no matter how trivially.)

Note: *Prime requisites are Strength and Constitution. Working into a Frenzy depends on Self Discipline. Reasoning and Memory are at half normal during frenzy. As your character's level increases, he is stronger and enters a frenzy quicker; in addition, the frenzy lasts longer, and he has a greater chance of hitting a target. His howling is more frightening as well. Immunity to fire and iron-edged weapons is not affected by level. See Section 6.3 for a description of Berserk Frenzy for Rolemaster.*

GM Note: *Viking characters are not Barbarians. If you want a Barbarian, you can role play a Lapp or a Slav tribesman. These warriors had weaker weapons and practically no armor and were less technologically advanced than the Vikings.*

Leech: See Section 6.2 for more about Leeches or use a standard *RM* Lay Healer. As your character advances in levels, his chance of finding herbs, healing wounds, etc. should increase. However, wounds do not heal faster with advances in level.

Wizard: See Section 6.7 or use a standard *RM* Essence Magician. As your Wizard character advances in level, his powers increase in area, range, and duration. Also, more people are affected by herbs and more weapons are affected by gaze; the chance of finding herbs increases. Start with Enchant Rope and Enchant Herbs and add spells per level.

Wizard Artificer: See Section 6.1 or adapt the *RM* Crafter or the *RM* Alchemist.

Shaman: See Section 6.6 or use a *RM* Shaman who does not have an animal totem or familiar, but merely projects his spirit in animal form while in a trance. You may want to use a standard *RM* Channeling Cleric. As your character rises in levels, he enters a trance faster, the trance lasts longer, his spirit can travel farther, and the number of questions that can be asked of the dead increases. However, these basic spells should be there at the start. You might later add Detect and Animate Dead spells.

Rune Carvers: See Section 6.5 or use the standard Channeling Cleric or a *RM* Runemaster, but let him carve runes into wood or stone rather than writing them on enchanted paper. (If carrying a piece of wood is too difficult, you may allow the rune to write on vellum, with a goose quill pen.) The Rune Carvers' power came from a god, Odin, so they should be classed as Channeling mages rather than Essence mages, as in *RM*. Enchant Blood, Undo Runes and other spells should be added per level. Miscalved Rune effects should probably be limited to spells; otherwise, Carvers might miscalve deliberately to achieve a wider and more powerful range of effects.



VIKING CHARACTERS FOR FANTASY HERO

A Viking grew up on a farm, part of a family held together by ties not just of affection but by economics and reputation. A Viking saying went, "Bare is the back without brother behind it." If a young man wanted to go abroad, he asked members of his family to see what his relatives' plans were. If he wanted to set up his own farmstead, he asked for a loan from his relatives.

All landholders met at least once a year at the local Thing, the gathering which agreed upon the laws and settled differences between families. Most Vikings knew one another fairly well, if not personally, then by gossip carried by traders and hirelings, by wandering skalds and beggars. If a man or a woman behaved dishonorably, the entire family's reputation suffered. Another Viking saying asserted that "One man is outcast in every family."

Thus, each Viking should have at least a minimal Disadvantage of Friends (& Family) and Reputation.

Psych. Lim: loyalty/protection of Family (Common, Strong) 15 points

Reputation: Dishonorable quality (Sometimes, Bad rep) 5 points

The Viking culture also seems to call for two new *Fantasy Hero* Disadvantages:

TOUCHY HONOR

Viking custom held that any apparent insult, deliberate or accidental, had to be paid for, either with money or in blood. The legal system (See Section 2.8) left the choice to the victim. If compensation was denied, the Viking felt socially pressured to demand blood vengeance. His honor had to be defended, or other people would feel they could insult him, and his family, with impunity. All Berserks and Trollbloodes should have this disadvantage, as do many other Vikings, particularly chieftains.

Touchy Honor = Psych Lim: Protective of Honor (Common, Strong) 15 points

TROLLBLOODED

Vikings were suspicious of tall, ugly people, whom they suspected of being trollblooded. (Norse folk tales mention men and women who spent a term of years in a troll mound.) A few sagas do have "troll" characters, who actually seem to be outlanders, probably Lapps or Slavs. The GM may choose to treat stories about trollblooded people as just superstition, or to give them certain special abilities. For example, trollblooded folk could be farmers, warriors, skalds, berserks, wizards, etc. Being a trollblooded individual is not a Skills Package Deal but a Disadvantage Package because other people are nervous about you, but you may have some special abilities, like Distinctive Looks, Ugly (Comeliness of 5 or less), Cold and Heat Resistance, Nightvision, Strength only at night (-1/2), Resistance to Edged Weapons (by Aid).

THE ORDEAL: BECOMING A BERSERK, RUNE CARVER OR SHAMAN

The GM may want to require that Berserks, Rune carvers and Shamans pass an Ordeal to get their powers. You may roleplay the Ordeal in detail or just have the player make a roll based on the character's stats. (In *RM*, base the roll on Self Discipline and Intuition; in *FH*, base it on Ego.) The GM may use the sample Ordeals below or make up his own.

Berserks were dedicated to Odin or Freyja, then led into a cave to fight a hibernating bear with their bare hands. Afterwards, if they survived, they would eat the bear's heart and drink its blood. To leave the cave, they had to run through a blazing fire, to show that it could not harm them.

Rune Carvers were dedicated to Odin, then spent nine nights tied to an ash tree, alone in the wilderness, using Runes to keep themselves alive. (The GM might want to shorten this to nine hours, with one attack from animals or spirits coming each hour.)

Shamans were dedicated to Freyja or Odin, then spent the night atop a gallows platform, chanting to the spirits who might try to attack them at midnight.

SECOND SIGHT

Second Sight occurs on two sorts of occasions. Sometimes, the GM will tell a player to make a roll, with success meaning that the character has a vision. Other times, a character with Second Sight may decide that he wants his character to have a vision. He should ask the GM a question like "How will my friend's lawsuit do at the Thing?" or "What will happen if our merchant ship fights the pirates instead of paying them for safe passage?"

Sometimes the GM will know the answer to the question or be willing to decide what will happen right then and there. The friend has a 75% chance of winning the lawsuit peacefully, a 5% chance of losing, and a 20% chance of being challenged to a duel; the pirates have a 50% chance of capturing the ship with the traders surrendering and losing their cargo, a 25% chance of capturing the ship and killing 80% of the traders, and a 25% chance of being defeated.

At other times, the GM will want to let the outcome of an event depend on how the situation is roleplayed in detail. In these cases, he should feel free to give the Second Sighted character an enigmatic answer. "The ravens will feed," but will it be on our hero or his enemies? "Grass will grow," but will it be on the meadow where the herds graze, or on a new grave? "Flames will devour wood," but will it be a house burning down as its inhabitants die, or a Yule log blazing at a neighborhood festival? Sometimes, there will be no vision at all, only gray clouds blowing to hide the future.

The easiest visions for the GM to handle are those which reveal something that has already happened. PCs may see fylgja, apparitions of recently killed relatives or friends or even enemies who will soon attack them. (Perhaps too soon for them to avoid a battle.) They may see blood on their weapons, indicating that a fight will soon take place. Or perhaps they'll see blood in a house or on a field, indicating where the fight will take place... someday.

The GM may also use a vision to give the characters a vague warning of some approaching danger. If they understand the warning, they may be able to escape the danger. Such visions are often symbolic. Enemies lurking in ambush may appear as wolves or ravens or vipers. An avalanche may appear as a white cloaked she-troll. A storm may appear as a boiling cauldron. Second Sighted characters will also be able to see the aura of Luck (or Unluck) around people, and also the aura of a Curse or of a miscarved Rune.

A few GMs may have players mature enough to run characters who are fey and aware that they are doomed to die. In such campaigns, people with Second Sight will be able to foretell characters' deaths. Again, such visions are usually symbolic. Death may appear as a herdsman calling his sheep to the barn or as a woman welcoming guests to a banquet. Fey characters will take up their weapons, aiming not to survive but to make their last minutes as heroic as possible.

Doom may not quite be certain after all. One Viking dreamed of a fight in which he and some friends were killed. He awoke and told his friends about it, then went back to sleep and had another dream in which a strange old woman came along, saw his dead body, and told him to get up and go home. In the fight that occurred the next day, he was left for dead by the attackers and later recovered from his wounds — but all of his friends died.

Second Sight Character Notes for *Fantasy Hero*:

- Elemental Control:** Second Sight (15 active) 13 points
A. Clairvoyance (See past or future) (60 active) 45 points
B. Detect Luck, Sense, Analyze (29 active) 14 points
Total = 72 points



1.1 APPEARANCE

Some Vikings were fair-skinned, blond or red-headed and blue-eyed, with an average height of 6'. Others were olive-skinned, dark-haired, and brown-eyed, with an average height of 5'6", much the same as the average European. Vikings were much taller than the Lapps and Slavs to their north, who were olive-skinned and dark-haired with an average height of 5'2".

Vikings counted long hair as one of a woman's beauties, particularly if it was golden. Men were admired for their strength and their height. Tall, ugly men or women were distrusted because they appeared to be trollblooded.

CHARACTER AGE

Viking children were counted as adults at the age of twelve. They could go overseas on an expedition or get married and manage a farmstead. However, a youngster of twelve had not reached his or her full height or strength yet.

GM Note: refer to *RM* teenage STR and Height/Weight. *Fantasy Hero* Base Stats follow:

Age	12-14	15-16	17-18
Str	8	9	10
Dex	8	10	10
Con	10	10	10
Int	8	9	10
Ego	7	9	10
Pre	8	9	10
Com	10	10	10

Figured Stats as normal.

Old men were valued for their wisdom and experience — and often for their wealth. A man's lands and most of his wealth went to his eldest legitimate son, but he might give some of it away to younger legitimate sons or even — with the permission of his legitimate sons — to an illegitimate son. The estate of a man without sons went to his daughter, but her lands were under the control of her father's nearest male relative. The estate of a man without children went to his widow, but her lands were legally under the control of her late husband's nearest male relative.

FEMALE CHARACTERS

Some sagas mention shield maidens at royal courts. (They seem to have been a little less common than berserks or mages.) There's even one non-historical saga about a king who had only one child, a daughter. She was more skilled with weapons than most men and refused to marry any man who could not defeat her in battle. Her father assigned her a region of his kingdom, where she was acclaimed as king by the local Thing, the assembly of landholders. She was also very beautiful and skilled at all womanly pursuits.

The common Viking woman, however, was not a shield maiden but a housewife. She managed the household, making sure there was enough food and drink to last through the winter, including offering generous hospitality to any guests who dropped in. She also oversaw the other women in making cloth, both for the household's own clothes and for trading. She carried the keys to all the strongboxes and locked sheds.

The housewife ran the farm in her husband's absence. She could hire men and assign them their duties, including ordering a hireling to kill an enemy. Many blood feuds would have died out but for a kinswoman of the victim taunting her menfolk to seek revenge. Vikings reminded one another, "Women's counsels are cold."

1.2 SOCIAL CLASSES

Viking myths claimed that they had three social classes: chieftains, landholders, and thralls. In reality, their society was slightly more complicated.

CHIEFTAINS

Chieftains were the major landholders. They were rich enough to host neighborhood celebrations of pagan festivals at the spring and fall equinoxes and the summer and winter solstices. They could also afford to coordinate a region's defenses against invasion — or to lead a warband to raid another region.

The chieftain's housecarls were his private guards who fought at his side in battles. During peacetime, they collected harvest taxes from the farmers and shipping taxes from foreign traders (who sometimes built ships with special compartments for smuggling goods). Some housecarls were berserks, mages, or shield maidens. A visiting warrior or trader might be accepted as one of the chieftain's housecarls for the length of his stay in the region.

The chieftain also maintained musicians and jugglers as part of his household. The royal court had skilled hirelings, like brewers and cooks. In addition, there were thralls to do the drudgework.

In the early Viking age, a chieftain was the "king" of a group of villages that traded with one another. Later, the size of the "kingdom" grew to a larger region, perhaps a day's ride across. By the late 10th century, the Vikings had begun to think of themselves as Danes or Norwegians rather than just men of Jutland or Trondheim. The old regional kings had become "jarls," who now owed at least nominal allegiance to the national king. But the king still had to be acclaimed by each of the regional Things before the landholders of that area would regard him as their true ruler.

The chieftain's heir was his eldest son. If he were under twelve at his father's death, his mother or uncle might serve as his regent. Often there were other claimants to the title: a younger son or the chieftain's brother or, later on, one or more of the regional jarls. The claimants' housecarls and supporters fought one another, usually on the sea.

The winner would host a lavish wake for the dead king, then drink a horn of mead and make a public oath in front of his housecarls, outlining what he would try to achieve in his reign. Then he would have himself acclaimed as king by the regional Things. Any surviving but losing claimant (and his men) would seek refuge at the court of a neighboring chieftain with whom they had ties of kinship, marriage or friendship.

THE LANDHOLDER

The base of the Viking economy and social structure was the landholder, the free man who owned enough land to support himself, his family and servants through farming, hunting, and fishing, supplemented by occasional trading and raiding. Another name for the landholder was "Thingman," meaning that he attended and voted at the local Thing, the seasonal or annual gathering at which debts were paid, lawsuit settled, and criminals outlawed. The Thing and the religious festivals were the major social events in the Viking calendar.

Many landholders were rich enough to build their own ships, stock them with their own trade goods, and crew them with their own men, drawn from their families plus tenants, hirelings, and neighbors. The key to the Viking defense system was that each coastal landholder was held responsible for defending his strip of shoreline against the attack of one or two warships.

Later, as the size of raiding fleets (and of kingdoms) grew, a beacon system was set up which could rouse an entire region in only a few days. (There were penalties for lighting a beacon without due cause.) The landholders could also be called up by a "war arrow" being sent round from Thing to Thing. The war arrow might summon the Thingmen to mount an invasion of a foreign country, promising them riches and perhaps land. Or it might ask them to back a jarl's decision to rebel against a tyrannical king.

Since a landholder's estate went to his eldest son, younger sons had to make their own way in the world. Some became housecarls at the royal court. Others acted as crewmen on Viking ships and returned with enough foreign silver to set up their own farms. Denmark and Norway had relatively little fertile land; it was hard for even a rich man to buy an old farm or set up a new one. In the mid-ninth century, Vikings began to settle abroad, first in the Atlantic Islands, then in Iceland. At about the same time, Vikings began to settle in northern England and France, in the areas that would later become known as the Danelaw and Normandy.

Some Viking farmers owned their own land but were too poor to defend it against raiders or to meet the social obligations of being a Thingman. They gave their allegiance to one of the neighboring Thingmen in exchange for protection. The Vikings called them "smallholders."

Other farmers were too poor to even own their own land. They were tenants of a chieftain or landholder and paid their rents with a share of their harvest crops and slaughtered livestock.

Many smallholders and tenant farmers were also craftsmen, who peddled their goods around the region during the spring or fall. Other craftsmen lived in small homes at a trading mart. During the summer, their women tended the herd animals in rented mountain fields. During the winter, the family lived together in the nearly deserted trading mart.

HIRELINGS

Even lower on the social scale were the hirelings. These men were typically younger sons of smallholders or tenant farmers or craftsmen, without the social connections necessary to become a housecarl or crewman. They had nothing of value but their skills as farmers or herdsman or hunters. Landholders and chieftains hired them for a year's service in exchange for little more than their clothing, bed, and board. They felled trees for firewood, made charcoal, cut peat, and herded horses and cattle.

Some hirelings were hotheaded men skilled with axe or sword who would seek out a landholder involved in a blood feud. The Viking culture had enough such wanderers that often they asked only that their new master maintain their reputation by demanding blood vengeance for them if they died fighting for him, rather than accepting compensation.

THRALLS

Lowest of the land-based classes were the thralls, servants owned by the master of the farm on which they worked. Many were Anglo-Saxon or Celtic, captured as youths during a Viking raid on coastal Britain. Some of them were Christian, but during the early Viking era they had no priests to conduct religious services, and their children were brought up as pagans.

Like hirelings, thralls received little more than their clothing, bed and board — plus a small plot of land they could farm themselves, perhaps a quarter acre. They worked ten hours a day for their master. Afterwards, they could work their own land. In three years of work for a generous master or ten years work for an average one, a thrall could earn enough to buy his freedom.

A freedman was always a lower social class than a man born free. Law and custom demanded that a freedman continue to live on his former master's estate and pay him allegiance, but his children were born free. (The son of an English or Celtic freedman was often called Freedmansson, so that people wouldn't have to pronounce his father's long and complicated name.)

Male thralls built walls and dinged fields, herded pigs and goats, and did the other work of hirelings. Female thralls ground meal in querns, washed clothes, kneaded bread, milked cows, made butter, and did most of the other tiresome household chores, including spinning. Thralls wore simple garments of white, undyed wool; their hair was kept close-cropped.

For all their social inferiority, thralls were a part of the landholder's family in a way that tenants and hirelings were not. Thralls were often chosen as nurses and foster parents for the children of their master, bringing them even closer into the family circle. It was a common saying that "One-fourth (of a man's might) comes from the foster father."

OUTSIDERS

Finally, there were some people outside the land-based social system.

Beggars wandered from farm to farm. By custom it was rude to stay more than three days as a guest except with a relative or business partner, but beggars didn't worry much about their reputation. By law, a man was considered a vagabond if he took to the roads and accepted alms for more than two weeks. An able-bodied vagabond could be outlawed, placed outside the protection of the law. But a beggar only had to worry about being outlawed if he offended a landholder. Some beggars were cripples, wounded in a blood feud, with no relatives left to take care of them. Others were women with no home of their own, their family estate lost due to drought or perhaps won by a berserk.

Beggars were willing to help out around the farm for a few days or weeks in exchange for hospitality; their gossip enlivened the dull hours. It was considered disgraceful to refuse a beggar hospitality.

Of course, there were outlaws. It was against the law to feed or house any outlaw, but some people did so anyway, particularly for a kinsman or friend. One saga tells of a woman who often sheltered outlaws. She had her house built so there was a storeroom hidden beneath it. A trapdoor led from her kitchen to the underground room, and a tunnel led from the storeroom to a nearby riverbank. That way, even if pursuers tracked him to her home with bloodhounds, the outlaw could flee to safety.

Notice that none of these people is a city dweller. That's because the Vikings didn't have cities. The closest approximation to a city in the northland was a trading mart, which was fully inhabited only during the summer, when traders came north up the coast of Europe or westward across the rivers from the Viking-ruled lands of the Russian interior where they traded with Byzantium and the Caliphate. During the rest of the year, trading marts were inhabited only by craftsmen, many of whom returned to their families' farms during the winter.

A few trading marts had nearby royal courts, which were sometimes occupied by the king and his housecarls. Frequently, the court would be elsewhere, staying with one of the regional jarls or at the home of some other major chieftain. Such royal travels not only allowed the king to keep in touch with his people, but also let him make the lesser chieftains pay their share of the royal upkeep.

1.3 VIKING CULTURAL SKILLS

The Viking lifestyle called for jacks of all trade, not for the specialized professionalism so typical of modern life. Vikings grew up on the farm and were familiar with the various skills demanded of a farmer. They didn't spend their childhood going to school, but learned the skills they would use as adults by observing and helping the adults around them. Typical Viking skills include raising crops and livestock, fishing and hunting, egg hunting, salt making, and managing household supplies for people and animals during the long winter. Everyone could ride a horse or drive a cart during the summer, or ski, skate or drive a sledge during the winter. All Vikings had some acquaintance with the lays and legends of the Norse gods and heroes, the local laws, and the regional history.

Viking men could row and sail boats, fell trees or cut peat to keep their homes warm in winter. They knew how to use Viking weapons as well as farming and hunting and fishing implements. They also could compete at games, including a ball game something like field hockey, horse fighting, and "tables" (a boardgame like Fox and Geese).

Viking households did their own handcrafting. The women made cloth and dyes. Men did their own woodworking, soapstone carving, and ivory, horn and bone carving. They butchered herd animals and hunted fur animals and seal and walrus, later tanning the skins, making calfskin into vellum. Vikings also made their own charcoal for blacksmithing, and many smelted their own iron from iron-rich bog mud.

Vikings did have a few part-time specialists. These included lawyers (who had to memorize the laws, which were never written down, only recited at the start of the Thing), skalds, leeches, ship and house builders, weapon smiths, and jewelers (who worked with precious metals and ivory).

VIKINGS AND LANGUAGE

A few Vikings spoke foreign languages, but most understood only their own language. The Norse tongue was spoken throughout Scandinavia, although each region had its own dialect. Vikings who settled in the Atlantic Islands, Iceland, Greenland, and the British Isles took their families with them and continued to speak Norse. Those who settled in Normandy and Russia married native women and, in a few generations, lost their ability to speak Norse.

Vikings found it easy to communicate with their southern neighbors who spoke the closely related Teutonic languages. These included German, Anglo-Saxon (spoken in England), and Frisian and Franconian (spoken in the Netherlands and Belgium). They found it difficult to communicate with their northern neighbors who spoke the totally unrelated Uralic languages, including Lapp, Finnish, Hungarian, and Estonian.

Viking voyagers dealt with a large number of different cultures. Most of these peoples spoke distantly related languages, like Armenian, Celtic (Welsh, Irish, Gaelic, Manx, Breton, Cornish), Greek (spoken in Greece and Byzantium), the Romance languages (Latin, Italian, French, Spanish), and Slavic (Prussian, Lithuanian, Bulgarian, Russian, Polish). They also encountered some people who spoke totally unrelated languages: Greenland Eskimos, Vinland Indians, and Arab and Jewish traders, whom they contacted at Spain and at the inland Russian trading marts.

LITERACY

Most Vikings were illiterate. Christianized Vikings who could read and write did not use paper but vellum, made from calfskin, and ink made from barberries. Most pagan Vikings wrote using runes carved on bone, horn, ivory, wood, or stone. The ancient runic alphabet had 24 characters, but by the Viking Age the runes had been simplified to only 16 characters. Most Europeans used the Latin alphabet of 24 characters (no distinction between I and J, no distinction between U and V). The Byzantines and Greeks used the Greek alphabet.

GM OPTIONS

The GM might decide, for simplicity's sake, to play a nominally Viking culture in which characters began with the standard skills for the gaming system being used. Or the GM might allow players to role play non-Viking characters, from many different technological levels: a Lapp wizard whose people had barely mastered working iron, a Byzantine thief or missionary or warrior used to the comforts of the Imperial city, an Arab or Jewish trader, or a Carolingian warrior. (Don't forget that one of Charlemagne's paladins was Ogier the Dane.) The GM might even let players bring in "time travelers," characters from other fantasy roleplaying games.

STANDARD VIKING SKILLS FOR ROLEMASTER

Some skills are rare (and should cost more than common ones)

• marks skills common for men but rare for women

¥ marks skills common for women but rare for men

Common Skills: •Adrenal Defense, •Ambush, Animal Handling (can be used on a whole a herd), Animal Healing, Animal Training, Appraisal, •Armor Evaluation, •Armorer/Weaponsmith, Astronomy, •Athletic Games, Beast Mastery, Begging, •Body Development, •Brawling, Climbing, Contortions, ¥Cooking, •Cooper, •Counselor, Crafting (Candle Maker), Critic, ¥Dyeing, Embroidering, Furrier, •Law, Messenger/Runner, •Miller, Net Maker, Ropemaker, Sail Maker, ¥Seneschal (=housewife), ¥Spinner, Stewardship, Tailoring, Weaver), •Detect Ambush (but not traps), Direction Sense, Distance Running, Diving, Driving (cart, sledge), Drug Tolerance (alcohol), Duping, •Engineering, •Falconry, Fauna Lore, Fishing, •Fletching, Flora Lore, Foraging, General Perception, Gimmickry, Gossip, Herbalism, Herding, Hide Item, Horticulture, •Hostile Environments (arctic), Interrogation, •Ironmaster, Jumping, Lays and Lore (Norse gods and heroes, Leadership, Leather Working (includes making vellum), Lie Perception, Loading, Locate Secret Opening, •Metal Evaluation, Metal Lore, ¥Midwifery, Mimicry, Mnemonics, •Navigation, Perception, Play Instruments, •Public Speaking, Rappelling, •Read Tracks, Region Lore, •Reverse Stroke, Riding, Rope Mastery, •Rowing, •Sailing, Scrounge, Seduction, •Sense Ambush, Skating, Skiing, Skinning, •Smithing, Spacial Location Awareness, Sprinting, Stalk, Star-Gazing, Stone Evaluation, Stone Lore, •Stonecrafts (Masonry, Stone Carving, Stone Cutting), Surveillance, Swimming, Tactical Games (Table games), Tale Telling, Tracking, Trading, Trading Lore, Tumbling, •Tumbling Evasion, Weather Watching, •Weapon Evaluation, Woodcrafts.

Rare Skills: Acrobatics, Acting, Boat Pilot, Bribery, Camouflage, Caving, Command, Dance, Diplomacy, Disguise, Dragon Lore, Juggling, Lipreading, Mapping, Mechanition, Military Organization, Mimery, Mining, Missile Artillery, Numeracy, Painting, Poetic Improvisation, Poison Lore, Propaganda, Racial History, Scripture (Christian only), Sculpting (from soapstone, bone/ivory, wood), Siege Engineer, Signaling (with battlehorn), Silent Kill, Singing, Subduing, Tactics (battlefield, naval, small unit), Trickery, Tumbling Attack, Two Weapon combo, Use/Remove Poisons.

Unavailable Skills: Administration, Advanced Math, Advertising, Alchemy (except for Wizard Artificers), Anthropology, Architecture, Attunement, Basic Mathematics, Biochemistry, Body Damage Stabilization, Crafts — Ceramics & Calligraphy, Channeling (except for Rune Carvers and Shamans), Circle Lore, Control Lycanthropy, Demon/Devil Lore, Diagnostics, Directed Spells, Disarm Foe (Unarmed), Disarm Trap, Dowsing, Drafting, Faery Lore, Falsification, Flying/Gliding, Heraldry, Hypnosis, Iai, Lancing, Locklore, Martial Arts, Music, Philosophy/Religious Doctrine, Physics, Picking Locks, Pick Pockets, Planetology, Pole Vaulting, Power Perception, Power Point Development, Power Projection, Psionic Perception, Runes (except for Rune Carvers and skalds), Sanity, Healing Lore, Sense Reality Warp, Set Traps, Spell Mastery, Staves and Wands, Stilt Walking, Surfing, Surgery, Symbol Lore, Targeting, Tightrope Walking, Transcend Armor, Trap Building, Ventriloquism, Warding Lore, Xeno-Lore, Yado.

Variant Skills: The following must be adapted or made unavailable.

•**Adrenal Move:** Either unavailable or use as pattern of Berserk instead of Frenzy. But instead of a pre-penalty, have a post-penalty that lasts several hours and goes into effect a random number of rounds later.

Crafting: There are two new sub-skills for Crafting. They are Ship Builder and House Builder. Ship Building skill allows a person to design and craft clinker-style ocean going vessels, as well as dug-out canoes for river travel. House Building skill allows a person to design and erect simple domicile structures.

•**Disarm Foe, Armed:** The usual ways the Viking did this were 1) Twisting an impaled shield, 2) Severing weapon haft, 3) Severing weapon arm, 4) Bashing weapon hand/arm.

Divination: Use only if Second Sight is not used.

First Aid: Treat Wounds.

Frenzy: Use only if Berserk is not used.

Linguistic Skills: points for literacy. Learning closely related languages is quite easy (start higher up). Learning distantly related languages is normal. Learning unrelated languages is even harder.

Magical Language: Available only to Rune Carvers.

Magical Ritual: Available only to Shamans.

•**Maneuvering in Armor** (chieftain class only): soft leather or chain only.

Meditation: Available only to Shamans (as a trance).

¥**Second Aid:** Unavailable except for Leech. Leechcraft.

•**Spear Return:** Dodge out of spear path, catch it, whirl around to absorb momentum, and throw — all in one motion.

Spell List Acquisition: If you use the truncated spells, you may wish to omit this skill — or at least make it optional.

Sports: Ball.

•**Stonecrafts:** The Vikings didn't use brick. Gems during this period were not cut into facets but polished.

Streetwise: Unavailable. No cities. The "underworld" consisted of outlaws, either in the wilderness (solitary or in gangs) or as ship crews. Substitute Outlaw Lore instead.

Taunt: to drive someone into a murderous rage (directed at someone else, ideally) with a poem or a joke.

Time Sense: thrown off as you go significantly north or south.

Two-handed Attack with One-handed weapon: for added damage.

•**Weapon Skills:** 1-handed edged (seax, sword), 1 handed concussion (club), 2 handed (broad axe, bearded axe), polearm (spear, handaxe), thrown (dagger, javelin), missile thrown (stone, composite bow).

STANDARD VIKING SKILLS FOR FANTASY HERO

VIKING FARMER

See all those standard skills used in farming, hunting, fishing, and homecrafts. All Viking Normals ought to have these skills as a package deal.

Farmer:	2	P/S Farming	11-
	3	Hunting	11-
	2	P/S Fishing	11-
	2	P/S: One form of Home Craft	11-

VIKING HERO

Choose between the Lesser Hero and the Greater Hero. The Lesser Hero is capable but has no special powers granted by the gods. The Greater Hero begins with a lesser special power (i.e., he may take a "spell Power" to the 5th level or take 15 skill ranks to be applied to skills in 1 category) and has a godly enemy as well as a godly patron, both of whom may intervene in the hero's affairs.

VIKING ROGUE PACKAGE DEAL

Outlaws, vagabonds, beggars, etc.

Unlike the standard *FH* Rogue, the Viking Rogue used an axe (socially less prestigious than a sword). Viking culture was ocean- and farm-based, not urban, so the Viking Rogue is unfamiliar with the City Guard or a Home City. The only significant thing about the Rogue's past crimes is whether he's gotten a reputation for them — and is being hunted by his victim (or his victim's friends and relatives).

Rogues liked to spread gossip about people who seemed to be respectable. Vikings were always interested in rumors that someone had insulted them. Rogues also tried to ingratiate themselves with chieftains — and then sometimes duped them or seduced their female relatives.

Rogue:	1	Fam w Axes	
	2	K/S: Region	11-
	3	Persuasion	
	3	Seduction	
	1	Fam w/respectable people	
	-5	reputation as a Criminal	
		Hunted: Bloodfeud/Enemies, Friends and Family	11-

VIKING HOUSECARL PACKAGE DEAL

Despite the "Viking package Deal" in standard *FH*, most Vikings were not involved in a blood feud. Omit the "Hunted" Disadvantage and substitute "Psychological Limitation: Touchy Honor, easily provoked by apparent insult, Common" for a more accurate depiction of Viking psychology.

SKALD

Knowledge: Modern Runes, Mythlore.

Other: Poetic Inspiration

Optional Skills: Ancient Runes, Undo Runes; Odin as Watcher (rare); may take away Poetic Inspiration, Rune Knowledge.

SECOND SIGHTED

Visions are not under conscious control and may not have choice-points, just warnings of unavoidable doom a few days off (Foretelling) or a warning of danger immediately ahead (Sixth Sense). Both skills may "fail" the character or just puzzle him. Should be combinable with standard farming/fighting/trading package. You might add Friends who are Unlucky or in a Blood Feud for extra drama.

LEECH

Knowledge: Herbalism.

Magic Herbalism: Limited by locating herbs in the Norse world.

BERSERK

Note Optional Ordeal to pass before qualifying for Package Deal. If he fails the Ordeal, he may settle for Trollblooded.

Odin or Freyja act as Watchers. When the watcher-god determines the berserk's drama has reached a fitting climax, or the berserk is in danger of death, the berserk loses his powers during a fight, and the valkyries wing down to take his soul.

Berserk:	1	Fam. w Axes	
	6	+15 Strength (1 phase activation, -5 Strength after Frenzy is over, only for Combat)	- 1 1/2 lim.
	3	Immunity to intense heat (based on Str)	
	8	+8 p.d. Armor (only vs. Edges/iron weapons, based on Str)	-1
	9	+15 Presence (only causes fear, must howl)	-3/4

RUNE CARVER

Note Optional Ordeal to pass before qualifying for Package Deal. If the ordeal is failed, the character may settle for Skald.

Knowledge: Ancient Runes, Modern Runes, Mythlore

Dexterity: Rune Carving

Magic Skills: Limited, take 5 rounds to cast, require shedding own blood, chance of backfire if miscarved. (See Section 6.5 for effects: Dispel, Restore, Shadow, Destroy)

Odin as Watcher may take away Rune knowledge, Poetic Inspiration.

WIZARD

Knowledge: Herbalism, Knotting

Magic Skills: Restricted — use herbs picked at special times. Cloak, Dominate, Heal, Images, Obscure, Shadow, Transform-Self, Transform-Other

Magic Skill: restricted, use knotting from special ropes: Weather Control, Fire Control (via Protect or Shield)

Magic Skill: Blunt Edged/Iron Weapons (via Protect or Shield)

1.4 THE VIKING AND HIS FAMILY

Every Viking grew up in a family, with kinfolk he could call on in case of trouble and who might make similar demands upon him, often at inconvenient times. A Viking family wasn't just your parents, brothers and sisters, but your cousins and uncles and aunts — and all their relatives by marriage, their friends and their trading partners. Even outlaws looked to their kinfolk and friends for aid. Only hirelings had no network of family and friends to support them. A Viking's reputation depended not only on his own skills and behavior but also on the skills and behavior of his relatives.

The player may wish to build his character's family or to have the GM build it for him. Some relatives may become significant campaign characters, role-played either by the original player, some other player, or the GM. Some characters will have families that are roughly balanced, offering protection and inviting danger. Other families will be chiefly assets or liabilities to their members. Check with the GM if you decide to have unusually powerful or troublesome relatives.

The GM will find the character's family useful in creating plotlines. A relative may be involved in a lawsuit or blood feud, or he may be threatened by a berserk or an afterganger. Or perhaps a relative is planning a voyage abroad, to raid or trade with foreigners. Either way, there's a good chance of adventure opening up for the character and any friends he is willing to vouch for.

THE CHARACTER'S SOCIAL CLASS

As a player you'll start by deciding the social class of your character's parents. Maybe they were thralls or freedmen. If so, where did they come from? England, Ireland, and Scotland are likely choices, but they could be from anywhere in Europe. What was their original social class? One saga tells of a hero whose mother was a thrall, but her father was a regional Irish king who gave great gifts to his Viking grandson when he sailed to Ireland as a trader.

Is your character illegitimate? Your father could be a hireling or vagabond, an outlaw or berserk who had a casual liaison with a woman, then wandered away. Does her family want vengeance? Maybe your father is the local landholder or chieftain, with your mother being the daughter of one of his smallholders or tenant farmers. Or perhaps your character is the child of a tenant farmer or smallholder or the child of a craftsman who lives at a trading mart.

You will probably choose a character who is at least the equal of most of the Vikings he'll meet. Give him a father who's a landholder or a housecarl or even a chieftain. Such a man had one legal wife and perhaps a concubine or two. Which one of the women is your character's mother? Some players might find it interesting to roleplay a character whose father was an exiled chieftain, claiming a throne held by a more powerful warrior.

THE EXTENDED FAMILY

The typical Viking family included three or four children, but some families had as many as twelve children. The heir to the family estate was the oldest son or, if there were no sons, the oldest daughter. Unwanted children were killed by leaving them outside. Children accepted into the family were sprinkled with water and given a name by a distinguished friend or relative. None of the Viking sagas mentions twins, but the Norse myths do: one killed the other. It's likely that if twins were born, at least one of them was left exposed to die.

All children of well-to-do parents were tended by a nurse, one of the women on the father's farmstead or a servant whom the mother brought with her from her parents' home. Once weaned, most children of well-to-do parents were given into the care of a foster father, usually a man who owed allegiance to the father: a landholder's freedman or tenant or smallholder, or a jarl's landholder, or a king's jarl. It was a common saying that fostering a child showed you were less important than the child's father. Still, sometimes grandparents fostered a child, when the young parents lived aboard a ship.

Both boys and girls might be fostered off. Usually all the boys in a family had the same foster father. It was commonly said that a man got a quarter of his strength from his foster father. The children of one's foster father were one's foster brothers and sisters and became part of the Viking's extended family, able to call on each other for aid in time of need.

Children usually returned to their own family at adulthood (twelve years old) unless they married and went to live with their in-laws. The typical age for a first marriage was 15-25 for a woman, 20-30 for a man. You'll have to decide if your character is married, courting someone, getting over a sweetheart's death or marriage to someone else, or still looking over the field of eligible prospects. If your PC is married, note any prominent in-laws, particularly ones that live nearby or often come visiting. (This may include the spouse's foster parents.)

If a character's father or mother died when he was young, the surviving parent often remarried. A woman's remarriage could create bad blood between the families of her first and second husbands because of the property that was transferred from one family's control to the other's. If either of your character's parents has died, you should decide whether the death was due to an accident or illness (including childbirth for a woman) or due to being killed by enemies (abroad, in a raid — or at home, in a blood feud). A Viking who has reached the age of fifteen but not yet taken blood vengeance for a parent will be reproached by his kinfolk.

Or maybe your character's parents were divorced. Divorce was fairly common in Viking times. Either husband or wife could divorce the other. You'll have to decide whether the divorce was by mutual agreement or not. Is there still bad blood between the two families? How does the family of the divorced person get along with the family of the new spouse?

A TYPICAL VIKING FAMILY

Let's make up a Viking family, the sort you might make up for your character. Thorhall Sigurdsson is the eldest surviving son of Sigurd the Bold, son of Leif, and Helga Borksdaghter. His older brother, Thormod Sigurdsson, was killed on a trading voyage to Frisia by pirates. Thorhall's nurse was a thrall named Bera. His foster father was Harald Ivarsson, who rents a small farm from Sigurd and does most of the area's weaponsmithing.

Thorhall is now 17. Both his mother Helga and his foster father Harald are alive and well. His nurse Bera is now a freedwoman; she is very old and almost blind. Thorhall makes sure she receives enough food and clothing and peat for her fire. Last year Thorhall's father Sigurd Leifsson died fighting gloriously on a Viking raid. His men brought his ship back home and gave their leader's share of the loot to his family. The newly widowed Helga wants Thorhall to marry soon to give her grandchildren. He'll be looking for a bride on his next trip to the regional Thing. He still remembers last year's Thing, when he was struck by the beauty of Gunnhild the Fair, then 14. He might consider talking to her father and arranging a match once he's proved his bravery on a raid.

Thorhall has a younger brother, Ulf Sigurdsson. Ulf is brave and good at hunting, but brags a lot about the bear he killed last summer. Some people have started to call him Ulf the Big Mouth. Thorhall has decided he'd better take Ulf along when he goes off raiding, to keep an eye on him.

Thorhall is planning to take his first Viking trip this fall, along with his uncles, the Leifssons, Einar and Hakon. His uncles' sons, Thorhall's first cousins Olaf and Grim, will be coming along too. His mother will manage the family estate while he's away. He hasn't thought of what he'll do if he returns home to find out she'd like to remarry.

So far, so good. A common Viking saying noted that every family had its flaw. Who's the black sheep in Thorhall's family? Thorhall's grandfather Leif the Generous had a concubine, Groa the Outlander. Their son was Thorhall's father's half-brother. Groa and her son have a herd of goats in their home up in the mountains. They seldom mix with other people. (Some of the farmstead folk claim Groa is trollblooded but no one is quite sure. Luckily, she rarely shows up at family gatherings.)

Your family tree may be used to link your character to some of the other players' characters. Family ties won't mean that all the PCs are good friends, but kinsmen will usually unite against outsiders.

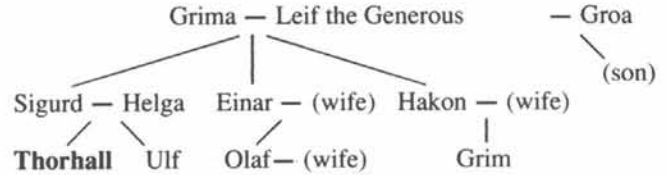
If you as GM are running a multi-generational campaign, make sure that at least one member of each generation is powerful enough that players won't mind switching PCs when their original characters die of old age or in battle.

OTHER NOTES FOR PLAYERS

Players, perhaps your GM will permit you to run several characters in the campaign. You might want to have one character abroad, while another remains at home, letting you take a hand in any action that comes up. This will also give the GM a chance to advance several ongoing plotlines, set in different places, all taking place at more or less the same time.

Or your GM might let you run several characters simultaneously: relatives or blood brothers or trading partners. Or you might decide it would be fun to roleplay a character and one of his enemies. You should also consider offering your character's relatives and allies and enemies to other players. The more people you can get involved in helping you to individualize your character's extended family, the richer and more interesting the relationships between family members will turn out to be.

Thorhall's Family Tree looks like this:



Of course, in addition to his relatives and in-laws, your character may also have trading partners, battle comrades, sworn friends, or even blood brothers. And he probably also has a patron: the nearest landholder or the local or regional chieftain. The patron and his men are bound by mutual ties of loyalty and respect. The patron's prestige would suffer if the men who owed him loyalty became impoverished. A landholder was expected to help his smallholders and tenants manage their resources, making sure they kept only as many cattle as their hay could keep alive during the long dark winter months.

You should decide if your character has enemies, based on his family background and personality. Enemies may be personal, familial, political, or mercantile. (You may wish to add a dead brother to your family tree, in order to give your characters a blood feud with the people who killed them.) Each enemy will involve you in bad feelings not just with one man but with that man's extended family.



Let's look at Thorhall again. His uncle Einar, the father of his first cousin and friend, Olaf Einarsson, helped his wife's brother settle a blood feud some years back. The two of them killed two of the Ketilssons and wounded a third, putting out his right eye and scarring his face. Now Eirik Ketilsson and his two sons are Einar's enemies. They seek a chance to humiliate him and his family, and it wouldn't take much to get them angry with the rest of Einar's kinsmen.

Eirik Ketilsson's farmstead is a five days' ride away from Thorhall's home. Thorhall sees Eirik and his family only a couple of times a year. So far he's managed to steer clear of a fight with them, without giving anyone the impression that he's a coward. What will he do at the next Thing when he sees Eirik Ketilsson talking to Gudrun the Fair?

THE MULTI-GENERATIONAL CAMPAIGN (OPTIONAL)

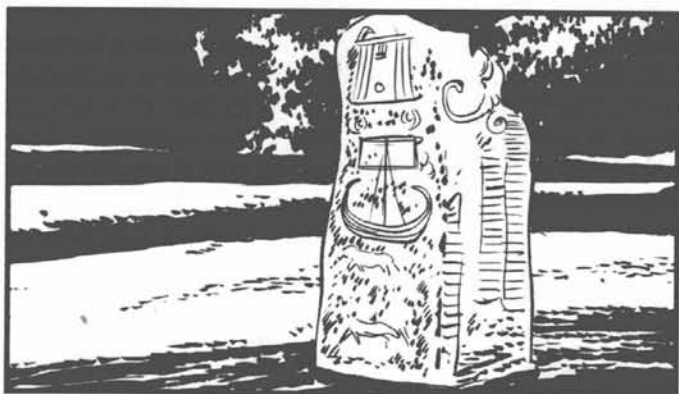
Norse sagas often tell stories that span decades. Tensions slowly build up between two families, eventually erupting into a killing which the law can not keep from turning into a blood feud. Such a feud might seem to go on forever. For month after month, the enemies will treat one another with stiff courtesy when they meet at the Thing or at a neighborhood gathering. But as tensions rise, the least insult can precipitate a deadly fight, leaving the victim's relatives with a new cause for vengeance.

A GM may wish to try to set up such a multi-generational campaign, allowing characters to age and bringing in the next generation as new characters.

The usual pacing of a Viking saga was episodic. Heroes grow from youth to manhood and sometimes survive into ripe old age, leaving their wealth and friends (and sometimes their blood feuds) to their children. Your playing group might be interested in having a multi-generational campaign along these lines. If so, the GM may end each session by announcing when the next session will take place. Characters can use this time to improve their skills and financial position. A roll of the dice adds the element of chance to what can be a simple group decision.

Next Session: roll 2D6

2	in the spring
3-6	at the Thing
7	during the summer or autumn
8-9	abroad, on a voyage
10	in winter
11-12	roll again for month next year



1.5 VIKING NAMES

Vikings had only given names. Their "last name" was usually their father's name plus "-sson" for a man or "-daughter" for a woman. If the Viking's mother was a prominent widow, her children might be known by her name instead plus "-rson" for a man or "-daughter" for a woman. Often, families alternated the name of the eldest, so that Arn Gunnarsson might be the father and son of Gunnar Arnsson and the grandfather and grandson of Arn Gunnarsson.

VIKING MEN'S NAMES

Aevar	Bjorn	Geir	Hallgrim
Alf	Bjornolf	Geirfinn	Hallkel
Aki	Blann	Geirleif	Hallmund
Amundi	Bodalf	Geirmund	Hallstein
An	Bodvar	Geirolf	Hallvard
Anakol	Bolli	Geirstein	Hamund
Ari	Bolverk	Geirhjof	Hanef
Arinbjorn	Borgar	GeitirGest	Harald
Armod	Bork	Gellir	Hardbein
Arn	Botolf	Gilli	Harek
Arnbjorn	Brand	Gisli	Hauk
Arnfinn	Brodur	Glam	Havard
Arngeir	Brondolf	Glum	Hedin
Arngrim	Bruni	Gizur	Hegg
Arnljot	Brusi	Grani	Helgi
Arnkel	Brynjolf	Grettir	Heming
Arnlaug	Dag	Grim	Herjolf
Arnor	Dagfinn	Grimar	Herlaug
Arnvid	Dunfjall	Grimkel	Hermund
Aron	Dyri	Grimolf	Herstein
Asbjorn	Egil	Gris	Hildiglum
Asbrand	Eid	Grjotgard	Hildir
Asgaut	Eilif	Gudbrand	Hjalti
Asgeir	Einar	Gudlaug	Hjalkar
Asgrim	Eindridi	Gudleif	Hjarrandi
Askel	Eirik	Gudmund	Hjor
Aslak	Eldgrim	Gudrod	Hjorleif
Asmund	Erlend	Gunnar	Hjort
Asolf	Erling	Gunnbjorn	Hlenni
Asvald	Eydis	Gunni	Hlodvir
Asvard	Eyjolf	Gunnlaug	Hogni
Atli	Eystein	Gunnstein	Holmstein
Audbjorn	Eyvald	Guthorm	Hord
Audgisli	Eyvind	Hadd	Hoskuld
Audolf	Finn	Haeng	Hosvir
Audun	Finnleik	Haf	Hraerek
Balki	Flosi	Hafgrim	Hrafn
Bard	Fridgeir	Hafliði	Hrafnkel
Baug	Fridmund	Hafr	Hrapp
Beinir	Frodi	Hagi	Hreidar
Berg	Galti	Hakon	Hrein
Bergfinn	Gamal	Halfdan	Hrifla
Bersir	Gamli	Hall	Hroald
Birning	Gardar	Hallad	Hroar
Bjalfi	Gardi	Hallbjorn	Hrodgeir
Bjartmar	Gauk	Halldor	Hrolf
Bjorgolf	Gaut	Hallfred	Hrollaug

Hromund	Odd	Skuli	Thorhall
Hrossbjorn	Oddleif	Skuti	Thorlak
Hrosskel	Ofeig	Snaebjorn	Thorir
Hrut	Ogmund	Snaekol	Thorkel
Hunbogi	Olaf	Snae-Ulf	Thorketil
Illugi	Oleif	Snorri	Thorleif
Ingi	Olvir	Solmund	Thorleik
Ingimund	Ondott	Solvi	Thormod
Ingjald	Ongul	Sorli	Thorodd
Ingolf	Onund	Soti	Thorolf
Iri	Orgumleidi	Starkad	Thororm
Isi	Orlyg	Starri	Thorstein
Isleif	Orm	Stein	Thorvald
Ivar	Orn	Steinar	Thorvard
Jokul	Ornolf	Steinbjorn	Thorvid
Jomar	Ospak	Steingrim	Thrain
Jon	Osvif	Steinkel	Thrand
Jorund	Oswald	Steinmod	Throst
Kadal	Otkel	Steinolf	Tjorvi
Kalf	Otrygg	Steinthor	Tofi
Kari	Ottar	Storolf	Torfi
Karl	Ozur	Sturla	Torrad
Ketil	Radbard	Styr	Trandil
Ketilbjorn	Ragi	Styrkar	Trygg
Kjartan	Ragnar	Styrmir	Tyrfing
Kjotvi	Randver	Stigandi	Tyrkir
Knut	Raud	Sumarlidi	Ufi
Kodran	Ref	Surt	Ulf
Kol	Regin	Svafar	Ulfjot
Kolbein	Rognval	Svan	Uni
Kolskegg	Runolf	Svart	Valbrand
Kormak	Saemund	Svein	Valgard
Konal	Serk	Sveinbjorn	Vali
Kori	Sigfast	Sverting	Valhjof
Kotkel	Sigfus	Teit	Vandil
Lambi	Sighvat	Thidrandi	Var
Leidolf	Sigmund	Thkodolf	Vebjorn
Leif	Sirghadd	Thostar	Vebrand
Lifolf	Sigtrygg	Thjostolf	Vegeir
Ljot	Sigurd	Thorarin	Veleif
Lodin	Sigvaldi	Thorberg	Vermund
Lodmund	Skamkel	Thorbjorn	Vestar
Lopt	Skapti	Thorbrand	Vestein
Lyting	Skarf	Thord	Vestgeir
Mak	Skegg	Thorfinn	Veturlidi
Mar	Skidi	Thorgaut	Vidkunn
Modolf	Skjold	Thorgeir	Vifil
Mord	Skopti	Thorgest	Vigbjord
Nefstein	Skorri	Thorgils	Vikar
Njal	Skuf	Thorgrim	Yngvar

MEN'S NICKNAMES

Giving a nickname was like naming a newborn baby; it created a special tie between the name-giver and the name-taker. The newly-named person could demand a gift from the name-giver, either a present or a favor, even if the nickname is derogatory.

Your character's nickname should reflect his personality (and help the other players and the GM keep him straight from all the other Vikings with the same name). Nicknames sometimes went by contraries: a man with swarthy skin might be nicknamed "the Fair"; an unusually tall man might be nicknamed "the Short."

Some Viking nicknames appear below, grouped by category:

(wisdom) Wise, Fox, Sage, Fool, Foolish.

(clothes) Grey Cloak, Hairy Britches, Peacock, Showy.

(body) Flat Nose, Hog-Head, Broad-Paunch, Halt, Short, Feeble, Stout, Lean, Handsome, Fair, Dark, Halftroll.

(hair, beard) Fork-Beard, Hairy-Cheek, Bald, Beardless, Bristle-Beard, Cropped Beard, Red, White, Grey, Black, Tangle-Hair.

(swimming ability) Trout, Seal.

(fighting) Blood Axe, Dragon Slayer, War Tooth, Long Reach, Killer, the Warrior, Skull-Splitter, Warrior, Berserk, Iron-Sword, Hot-Head.

(strength, bravery) Strong, Mighty, Trunk-Back, Backbone, Iron-side, Hell-hide, Broad, Anvil-Head, Fearless.

(wealth) Gold Bearer, Ring Scatterer, Powerful, Generous.

(speech habits) Grim, Silent, Word Master, Learned, Poet, Smooth-Tongued, Adder-Tongue, Unruly, Noisy, Gossip, Braggart.

(eyesight) Crow, Eagle.

(magic ability) the Healer, Sorcerer, Trollwise.

VIKING WOMEN'S NAMES

Aesa	Gerd	Hrodny	Solvor
Aldis	Gjaflaug	Hungerd	Steinunn
Alfdis	Gorm	Ingibjorg	Steinvor
Alfeid	Grelod	Ingigerd	Svanlaug
Alof	Grima	Ingirid	Thjodhild
Arngunn	Grimhild	Ingunn	Thora
Arnkatla	Groa	Isgerd	Thorbjorg
Arnora	Gudbjorg	Jaddvor	Thordis
Asa	Gudfinna	Jodis	Thorelf
Asdis	Gudrid	Jofrid	Thorgerd
Asgard	Gudrun	Joreid	Thorfinna
Aslaug	Gunnhild	Jorunn	Thorgerd
Asleif	Gyda	Ljufa	Thorgunna
Asny	Gyrd	Luta	Thorhalla
Asta	Halla	Kadlin	Thorhild
Astrid	Hallbera	Moeid	Thorkatla
Asvor	Hallberta	Nidbjorg	Thorlaug
Aud	Halldis	Oddbjorg	Thorljot
Audbjorg	Halldora	Oddny	Thorunn
Audhild	Hallfrid	Olof	Thorve
Bera	Hallgerd	Ormhild	Thorvor
Bergljot	Hallgrim	Osk	Thraslaug
Bergthora	Hallkatla	Ottkatla	Thurid
Bjartney	Hallveig	Rafarta	Ulfheid
Bjorg	Helga	Ragna	Una
Bothild	Herbjorg	Ragneid	Unn
Dalla	Herdis	Ragnhild	Valborg
Dotta	Hervor	Rannveig	Vandrad
Ermingard	Hild	Reginleif	Valgerd
Freydis	Hildigunn	Saeunn	Vigdis
Freygerd	Hildirid	Salbjorg	Yngvild
Frida	Hlif	Signy	Yri
Fridgerd	Hrafnhild	Sigrid	Yrsa
Geirlaug	Hrefna	Solveig	

VIKING WOMEN'S NICKNAMES

Few Viking women had nicknames; most described the woman's wisdom, beauty, wealth, or speech habits. One woman was nicknamed "Lace Cuff" to describe her elegant clothes. An Icelandic woman was known as the Strong-minded because she refused to marry a man who was not a godi, a regional priest-chieftain. A third was known as the Deep-minded because of her ability to plan things on a grand scale. She was the most noteworthy of the original settlers of Iceland.

1.6 BUYING AND SELLING

Most Vikings lived in farming villages or on isolated farmsteads. Even Vikings who lived at a trading mart or near a royal court did not have access to the sorts of businesses that we have nowadays, though some fantasy role playing games take them for granted. There were no restaurants or inns; travelers either stayed as guests with local families or set up tents on grounds reserved for visiting traders and cooked the provisions they'd brought with them. They might be able to buy more provisions from local farmers on market day. Sailors couldn't cook aboard their ships, but a ship sailing in coastal waters might beach itself at night so the men could cook and sleep ashore in greater comfort.

There were no general stores. Each craftsman produced his own wares, either part-time on his farm or in a trading mart, often on a street lined with the homes of similar craftsmen. Traders sold imported goods in a meadow that was like an open air market. Some set up stalls; others laid their goods on the ground. Each trading mart had its own Thing, presided over by a representative of the jarl or king, to settle legal disputes.

Most of the items Vikings used were made locally. Some were routinely available (food, cloth, items carved from soapstone, livestock, timber, bone and ivory, fur), though their price might vary greatly depending on the season. (Food and hay cost at least twice as much during winter and in early spring.)

Other items were not immediately available but had to be made to order. A woman might take days to make new clothing, particularly if it was to be dyed or to be trimmed with lace or gold thread. A weaponsmith might take days to make a shield, weeks to make iron weapons, and months to make a ring-mail byrnie. A team of craftsmen under the direction of a master builder would likely take several weeks to build a house or a ship.

If the GM is generous, characters may be able to acquire some of these items by inheriting them, receiving them as presents from relatives or friends or generous patrons, borrowing them, stealing them or by acquiring them as part of the estate of a conquered opponent after a duel or fight.

Raw goods (like iron ingots and bolts of undyed cloth) looked alike, but each handcrafted item was unique. A man could be identified by the knife he had dropped; a woman's cheeses by the molds she used. A weaponsmith could be identified by the blades he forged; a woman by her embroidering style.

THE AVAILABILITY OF GOODS

Import goods were never routinely available, even at the trading marts and royal courts. These included not only such luxuries as wines, fine woolen or silk cloth, glass and pottery, but also items used routinely on the farm, such as lava querns and basalt millstones. In Iceland, all timber had to be imported, in order to make fine houses or ships. Everywhere but Denmark and southern Norway, mead and wax candles, salt pork and wheat flour were imports.

GM Note: we suggest making import goods available 10xD6 (10-60%) of the time during the summer and half that during the rest of the year; cut the figure in half again if you are not located in a trading mart or near a royal court. Trade good prices should fluctuate dramatically, depending on whether the shipper is the first with such a cargo that year, or perhaps in several years — or whether there are several other merchants already in town with much the same goods for sale.

MONEY, WEIGHTS, AND MEASURES

Most Viking business was done by buying things with weighed out silver. The Vikings did not mint their own coins until the 11th century, when royal mints were established at all major trading marts. Counterfeiters made aur bars or coins of iron coated with a thin layer of silver. Most brooches and armbands were made to weigh exactly half a mark or a full mark, to make it convenient to value them.

1 mark of silver weighed about eight ounces. 8 silver marks equaled one mark of gold. 1 silver mark equaled 8 aur. (An aur weighed about an ounce). An aur equalled 3 ertog or 30 silver pennies. A mark equalled 24 ertog or 240 pennies.

There were also heavier weights. A fjorthung (quarter) was 20 marks (about 10 pounds). A vaett (vat) was 8 fjorthungs or 160 marks, about 80 pounds.

Christians used a different system of weights. They sold goods by the (12 ounce) pound, which was divided into 20 shillings, each worth 12 pennies, so the pound weighed 240 pennies. Three Viking pennyweights of silver were worth two Arab silver dirhams or two Anglo-Saxon silver pennies (or Carolingian silver deniers). These coins were heavier but more impure than refined Viking silver.

Vikings treated coins like any other silver and frequently cut them up to make just the right weight. Gold and silver jewelry received the same treatment. Impure, alloyed hacksilver and coins were accepted as half the value of refined silver ("burned silver"). If a man's purse was too full of hacksilver, he'd have the silver recast as one aur bars of refined silver.

One aur would buy a milk cow of 4-10 years old. Other animals were valued in terms of a standard cow, which was worth one ox or stallion, a sow with her piglets, four mares, or six shorn sheep or goats.

One ertog would buy a length of homespun (undyed, coarse wool cloth) 2 ells by 16 ells long, or one yard wide by eight yards in length. Two pennies would buy enough homespun for a woman's gown; one penny enough for a man's tunic and pants. Linen or imported fine wool cost more.

All of these — silver, cows, and homespun — were used as units of value in trading transactions. Each Viking merchant carried a folding bronze scale and set of weights. Usually it was buried with him.

Volumes were measured by the pot (about 1.5 quarts), the skeppe (basket) which was 12 pots (about 4.5 gallons or half a bushel), and the tun (barrel) which was 8 skeppes (about 36 gallons or 4 bushels).

WEAPONS

All men except thralls had the right to carry weapons. The landholders at the Thing showed their approval of new laws or a new chieftain by clashing their weapons against their shields, to show they would fight to support it. Each Viking, man or woman, adult or child, free or thrall, carried a knife to eat with, which could be used as a weapon in an emergency.

Vikings took pride in their weapons, and no two were identical. Many had names. Most weapons had decorated hilts or scabbards, inlaid with gold, silver, ivory, copper or niello (a black metallic mixture of silver, copper, lead and sulphur). A blade might also have inlaid silver patterns. Some weapons were made not for use but for show; they were hung in the hall as a sign of the wealth and generosity of a man's patron.

GM Note: we suggest double the normal cost for niello or copper decoration, five times for silver or ivory, ten times for gold.

The weaponsmith sold just the blade; the buyer had to have this fitted with a hilt of wood or carved bone or ivory — and with a wooden scabbard, which would hang from a man's belt or from a baldric slung from his shoulder. Similarly an axe blade or spear-point had to be fitted with a shaft by a woodworker. Arrowheads had to be fitted with shafts by a fletcher.

THE SWORD

The most prestigious of the Viking weapons was the sword. Snorri Sturluson, writing about poetic language, remarked that axes were given the names of she-trolls but swords were called the "fires of Odin" (the god of battle and death and poetry itself).

The Viking sword was pattern-welded out of iron and steel. It took months to blend the metals properly, so that the edge could be made razor-sharp, while the tougher iron lay at the heart of the weapon. A sword might be one-edged or double-edged; it was usually used to slash, not to thrust. It was usually used one-handed, but might be used two-handed to give the blows greater force.

Imported swordblades from Germany or France were also highly valued. Charlemagne made it illegal to sell such blades to the Norse but some traders did so anyway. Archeologists think that some "Frankish" swordblades were actually forgeries, made in the northland.

THE AXE

The seax (or sax) was the weapon after which the Saxons had named themselves. It was a short sword, usually used as a slashing weapon, and was sold without hilt or scabbard.

The Viking "hand-axe" was a common farming tool, with a small axe on one side of the haft and a hammer on the other side. It was set on a long shaft, sometimes iron-bound and spiked at the bottom, so it could be used as a walking stick or even as a spear. A farmer never knew when he might have to defend himself against the attack of a wild animal — or an enemy. The Vikings did not have a small axe balanced to throw as a missile.

The bearded axe had two horns: an axe blade and a spike below it. In sea battles, the spike was used to grapple the enemy's boat. It was difficult to dodge or parry a bearded axe. Even if one horn missed or was parried by a shield, the other might still hit a victim.

The broad axe or poleax blade was often a foot across. A warrior needed two hands to wield it.

THE SPEAR AND OTHER WEAPONS

The thrusting spear was a cheaper but less prestigious weapon, since only its tip was iron. Its shaft might be bound with iron to keep its target from simply chopping off the spearhead. It was usually made of ash and was about as long as its wielder was tall.

Missile weapons included thrown stones, throwing spears, and arrows. The best bows were made of yew, but many were made of ash or elm. Bowstrings were made of linen. In an emergency, a broken string might be replaced by a length of woman's hair. Using a bow when it was raining was likely to make the bowstring stretch or break, often snapping the bow in two. Arrows were made of pine or birch with iron heads, sometimes with iron barbs and were carried in a wood quiver.

Some hunting weapons might be used in a fight, such as the barbed fishing spear and the bear spear. Farming tools also might be used in a fight, though they weren't considered weapons. This included not only the hand axe, but the flail, scythe, pitchfork, and rake. Another often improvised weapon was the wood club, usually hastily cut to attack a berserk or magician who could not be affected by edged weapons.

ARMOR

THE BYRNIE

The most prestigious kind of armor worn by the Vikings was the knee-length ring-mail byrnie. Some byrnies were hooded; others were worn with steel helmets. (These helmets were not horned. The "Viking horned helmet" seems to have been only used in religious rituals.) Like swords, many byrnies were named. One Viking king named his armor after his mother, Emma. A leather tunic was worn under the byrnie, to prevent the mail from chafing the skin.

The byrnie was rare and expensive and took a skilled craftsman almost a year to make. (Only chieftains could afford one.) Most Vikings wore padded leather jerkins, sometimes reinforced with plaques of bone. Some wore metal helmets or conical leather helmets, but many left their heads bare. The byrnie was also heavy and uncomfortable to wear. No one wore a byrnie in a sea battle, when it would not only slow you down but might drown you if you fell overboard. Even on land, few chieftains wore byrnies, particularly during hot weather. The Heimskringla records that many chieftains only wore byrnies at the start of a battle, to protect themselves from missiles, but took them off when the melee began.

At the battle of Stamford Bridge, in Yorkshire, King Harald led his men to receive the surrender of the town they had conquered the day before. The weather was so warm that he and his housecarls left their byrnies on the ship and carried only their shields, helmets, and weapons. They were surprised to find that the English army had managed to reach the town, by a series of forced marches. Seeing their enemies charging towards them, one Viking made up a verse that they had left their shrouds on the ships along with their byrnies.

King Harald sent a messenger to the men still on the ships, summoning them to his aid. They didn't have horses, but they put on their armor, took up their weapons and ran to their king's side. By the time they got to the battlefield, many of them were so overheated that they threw off their byrnies to fight and were easily overcome.

VIKING SHIELDS

Most Vikings carried circular wooden shields, with a central iron boss. Defense depended on the shield's being light and easy to maneuver, so the shield was not weighed down with metal. Most shields had a wooden hand-grip and a strap, so they could be slung around one's neck, leaving one's hands free. A shield could also be jammed downwards into the dirt to protect the legs, if one stood braced to deliver a blow. The shield was often slung on the neck to shield one's back, especially against thrown stones.

Shields often broke after receiving a massive blow. Sometimes an enemy's weapon impaled the shield and stuck in it, allowing the defender to try to twist the weapon out of his attacker's hand or to immobilize the weapon with his shield arm and to attack, unparried.

FH Note: if a weapon does body to a shield but does not break it, assume that it is stuck.

Some shields had rims reinforced with leather or small bronze plates. These were less apt to break — or be impaled. They were also heavier and less maneuverable, so they reduced the user's parrying abilities. And they were more expensive.

HORSES

The typical Viking or Anglo Saxon army was mounted infantry. Warriors rode horses to the battlefield, then dismounted to fight on foot. This was partly because the horses they used were what we'd now call Shetland ponies. They were usually less than 56" high at the shoulder and weighed at the most a thousand pounds. A stallion cost 1 cow (1 aur) and was valued at four mares.

Given such mounts, it is not surprising that the sagas tell of a few men who were so strong and massively built that they could not find a horse to carry them. Viking horse-gear included bridle and saddle, stirrups and spurs. Viking carvings show tall men riding short horses, with the men's legs sticking forward up to the horse's chest. No wonder they dismounted to fight; such stirrups would not provide much support for giving or receiving blows.

In addition to being used as riding horses, horses were also used to pull plows, carts, or sledges — or as pack animals, with pack saddles or panniers for carrying peat or other materials. Horses could be transported on Viking ships, but usually warriors preferred to steal horses from the local farmers after they landed, if they decided to raid inland.

In summer, horses ran loose in the meadows. A guest would dismount in front of a farmstead and remove his horse's bridle, then turn it loose. A member of the household who wanted a horse would catch the nearest one. He would know a guest's horse by its distinctive saddle but might borrow it in an emergency. (Of course, a visitor might be offended if one of his host's household borrowed his mount and misused it.)

In winter, horses were kept in stables and fitted with spiked horse sandals to prevent their slipping on ice. One Viking superstition was that a horse stumbling at the start of a journey was an omen of bad luck for its rider.

Some horses were specially trained for racing, and more than a few stallions were trained to fight other stallions. Horse milk and meat were part of the staples of the Viking diet. Some sagas say that horsemeat was a special part of the Yule feast, perhaps in honor of the god Frey.

CLOTHING

Viking men wore a long-sleeved, knee-length jerkin of wool or linen, tapered at the waist. The cuffs might be trimmed with lace or embroidered with gold thread. Underbreeches were also made of wool or linen. There were two styles of trousers: untapered and ankle-length — or wide and knee-length, with gartered leggings worn on the lower legs.

A cloak of wool or imported silk was worn indoors or in good weather. A winter cloak was made of pile wool and looked like a shaggy fur. The cloak was pinned with a brooch at the right shoulder, so that it hung to ankle-length in the front and back, but left the wearer's weapon-arm free. It could be thrown back, leaving both arms free.

The belt was made of leather, with a metal clasp. It might be decorated with precious metals or plaques of bone or ivory, or it might be embroidered. A man's knife and purse were tied onto his belt. (A sneak thief was not a pickpocket but a cutpurse, who would slit the bottom of a purse and catch its contents as they fell.) The sword scabbard hung from the belt or from a baldric, a sash tied across one of the shoulders.

Hands were protected by mittens or gloves, made of fur or wool. Mittens kept the fingers warmer; gloves allowed a better grip.

Socks were made of fine wool and might be sewn onto leggings. Soft leather shoes were worn indoors and in good weather. Winter shoes were made of furred leather. Boots were made of the untanned skin of a cow's hind leg, with the hairy side out and the dewclaws on the heel for traction on icy ground.

Most men wore their hair long enough to cover the neck. It was held back from the face by a headband, often brightly dyed or embroidered. Some Danes had a shaggy bowl-cut. One Englishman complained that his countrymen were imitating the Danish hairstyle "with bared neck and blinded eye." (He also complained that the Danes not only bathed weekly but also washed their hair and changed their undergarments regularly, and so were able to seduce Englishwomen. An Arab trader who encountered Viking traders in inland Russia agreed that they washed regularly but called them filthy, because a group of men would wash their hands and faces every morning, all using the same bowl of water.)

Viking women wore a sleeveless chemise of linen or wool under a lined robe of wool, perhaps made of linen or imported silk. The robe's shoulder straps hung from a pair of brooches pinned to the chemise at the collar bone. These brooches were linked by silver chains or by a necklace of bone, ivory or imported glass beads. From the right-hand brooch hung other chains from which dangled keys, a knife, scissors, perhaps a purse, and a sewing case that held needles and thread. Like men, women wore gartered leggings and soft leather shoes. A woman might wear a cloak of wool or silk. For warmth, she might wear a wool shawl pinned across her chest with a third brooch.

Two pennies would buy 32 marks weight of unspun wool or enough homespun to make a woman's gown; one penny was enough for a man's tunic and pants. Fine woolen cloth from England or Frisia cost three times as much as homespun. Norse linen cost five times as much as homespun; imported linen eight times as much. Cloth was dyed red (with madder), brown or violet (with lichens), black (with iron-laden bog mud), or green (with powdered stone). The cost of clothing depended on the fineness of the cloth, the intricacy of the dyeing or embroidery, and the quality of the decoration.

GM Note: *we suggest you charge one-third the usual game amount for homespun clothing, 5-8 times the usual for linen or embroidered clothing, 20 times the usual for lace decoration or silk, and 30 times the usual for brocade.*

Unmarried girls wore their hair loose, with a headband across the forehead. Married women pinned their long hair back at the neck, then let it fall loose down their backs. Women often wore cap-like head-dresses, some of them elaborately worked with silver or gold thread.

Men and women also wore jewelry. There were silver or gold finger-rings, arm-rings, necklaces (often with talismans as pendants: the hammer of Thor or an image of Tyr as a horned warrior in pagan days, a cross in Christian times), and collars. Sometimes jewelry was also carved from reindeer horns or from seal or walrus ivory.

Of course, all this elaborate clothing was worn only by the prosperous. A poor man or a thrall usually wore trousers of undyed wool, covered by a wool blanket with a hole cut in it for the head; this served him as both jerkin and cloak. A poor woman or female thrall usually wore a robe of undyed wool. Both had wool leggings, socks, and shoes. They wore their hair cropped short.

PROVISIONS

Vikings usually ate two meals a day: a mid-morning meal about three hours before noon and an evening meal about halfway between noon and midnight. (Sunrise and sunset vary so greatly in the northland, depending on the season, that they were not used to indicate the time of day.)

A traveler often carried a food bag full of provisions and a leather flask of sour whey. Icelanders who rode to the two week-long Althing, which might lie a day's ride or a week's ride away, tied a food bag to their saddles with all the provisions they would need when away from home. At the Althing, they could buy locally brewed ale, made by neighborhood farmers.

The staple of journey food was hard-baked bread, often unleavened, made of rye, oats or barley. Heavily salted butter and cheese were also favorites. Fish that had been smoked raw was eaten smeared with butter. Meats included chicken, goose, and gamebird; goat, beef, mutton, pork or horse. These might be smoked, made into sausage, or pickled in brine or whey. Seasonings included sea salt and imported honey.

One mark would buy six tuns (24 bushels) of grain, reckoned enough to feed a family for a year. Five pennies would buy one skeppe (1/2 bushel) of grain, reckoned enough to feed a family for a little more than a week. One penny would buy four dried fish, weighing about 10 pounds.

Ships carried crates and kegs of provisions, including wooden pots of whey, cheesy curds, and ale, all of which were fitted with a locking lid so the spout could only be used if the lid was twisted. Ships also carried cooking gear like iron cauldrons and gridirons. These were used ashore where a fire could be safely kindled. Aboard ship, the sailors ate their food cold.

TRANSPORT

People rode horses or walked in the summer. In the winter they rode or skied or skated (on skates made of pigs' shin-bones). Viking skis were only attached to their shoes with a toe-strap, so they could not ski as fast or turn as quickly as modern skiers.

Trade marts often had cobblestone roads, used by ox-drawn or horse-drawn carts in the summer, as well as by the trains of pack horses that peddlers used to carry their goods to the inland farmsteads and villages. In the winter, horse-drawn sledges were driven across snow and ice, drawn by horses fitted with spiked sandals. Some archeologists believe that a Viking cart's body could be detached from its wheels and attached to convert it into a sledge — or even lifted onto a ship, so goods could be transported without having to unpack and repack them.

There were no paved roads outside the trade marts, but the major routes were well marked, at least in summer. Many had been improved by laying gravel topped by wooden planks across swampy ground. A few rivers were also bridged with planks laid upon pilings, but these tended to break up when the river froze in winter, and then to wash away in the spring floods. Most rivers had to be crossed by fording them. This could be risky when they were swollen by the spring thaw or the autumn rains.

SHIPS AND BOATS

Ships were built of oak, felled in the summer and stored in marshy pools to keep the timber supple until wintertime. A mark would buy 480 lengths of timber, enough to make a ship or house. The shipyard was by the harbor, where a team of craftsmen worked under the direction of a master ship builder. It might take a couple of weeks to make a dugout canoe or a rowboat, a couple of months to make a ship fit to sail the coastal ocean, and the whole winter to make a craft fit for the open seas of the North Atlantic.

Dugout canoes were used on rivers by traders who went to the great Russian marts, which required several miles of portaging a day to avoid rapids or to cross from one river to another. Canoes were also often used as ferries across lakes or fjords. They were usually rowed by one man, or at the most, two.

Rowboats were used to cross the narrow fjords or to travel to nearby offshore islands. They ranged from the "two-oared boat" rowed by one man up to the "twelve-oared boat" which was rowed by a maximum of six men. (One man could row a six-oared boat and have more room for cargo.) One or more rowboats were carried aboard every sailing ship. They might be left on deck or towed behind the ship or could be used to tow a vessel free that had gone around on a shoal, or to escape a ship overturned in a storm or set ablaze. More likely, rowboats were used to store extra cargo. Borrowing a rowboat or canoe was like borrowing a horse. No one objected as long as you didn't damage it.

SAILING SHIPS

All Viking sailing ships, whether intended for coastal waters or for the high seas, had certain things in common. They had pine masts that could be unmounted and laid on the deck to prevent their being broken by the winds of a storm. Sail could also be taken in by unshipping the yardarm. The sails were often dyed blue or red, or checkered or striped with one or both of those colors on white. The sides of the ship were often brightly painted above the water line. There was a weather vane at the prow, to help the steersman judge the prevailing wind.

Under sail, a Viking ship usually sped along at 10-12 knots (11.5 - 14 miles an hour) and could be steered at cross angles to the wind by pulling ropes attached to the sails. The steering rudder was on the starboard (steering board) side of the ship and could be handled by one man, even in the worst storms (according to the report of a modern captain who sailed a reconstruction of a Viking ship across the North Atlantic).

Viking ships also had oars, to be used when the vessel was becalmed or facing a head wind — or for maneuvering in a fjord, river or harbor. Oars were inserted through slotted holes in the side of the ship. The oarholes were closed by swiveling wooden covers when the ship was under sail, to lower the amount of bilgewater shipped.

A Viking ship had low sides and a high prow and stern and was relatively easy to load with cargo. Livestock could be led up a gangplank onto the side bulwark and then down another plank onto the deck of the ship. The ship was quite shallow-bottomed, drawing only 3 - 3.5 feet, fully loaded. Viking ships could sail up-river to attack inland towns. They could sail up the Seine as far as Paris and up the Loire as far as Tours.

The ship anchor was iron, attached with a rope made of seal or walrus hide. Grappling hooks were used to secure vessels to one another, prow to prow, during a naval battle, permitting warriors to jump from the front of one ship across to the front of the other.

The decking was not nailed down but made of planks laid loosely on top of knees built into the sides. These planks could be easily removed to get at the cargo space — or to bail out bilgewater with a scoop or a bucket.

Decks were tented at night during long sea voyages, so the men could sleep protected from the weather. The ends of the tent-frames were carved with fierce animal heads, often painted or gilded. Some men slept on beds framed with similarly carved heads. Others used sleeping bags made of furred animal hide, sometimes sharing their bags for warmth.

The scuta (scooter) was built for speed, a light ship, probably used only in coastal waters. It had twenty to thirty oarsmen and a clearance of only a couple of feet, permitting it to go across shoals on which a heavier craft would run aground.

The karfi was also used only in coastal waters, by short-haul traders. It had 6-16 benches (12-32 oarsmen) and would take a cargo of about eight tons, with a crew of 10-32 men. Both were about 70 feet long and 17 feet wide.

The trader's cargo ship was the knorr. It had high-boarded bulwarks and could hold 15-20 tons of cargo in a space of about 270-320 cubic feet. A knorr might have a crew of 15-25 men and was about 75 feet long and 18 feet amidships.

The longship or dragon was the Viking warship, half as wide as the knorr but usually about as long, with a crew of 20-35 men. A few giant longships were built, usually as show pieces in a royal fleet, with up to 70 oarsmen. These were called admiral ships.

The longship's prow was reinforced with iron, to help withstand the shock of being grappled to another ship, head to head. Some longships also had spikes set at the prow, which might sink a ship that wasn't iron-reinforced. The prow also usually had an elaborately carved and painted figurehead of a fierce monster, often a dragon. (Icelandic law called for the figurehead to be removed before the longship sailed into an Icelandic harbor, lest the sight of the monster anger or terrify the "spirits of the land" — and presumably local residents.)

The sides of a longship had wooden bars on which the crewmen's shields were hung when the vessel lay in harbor or rowed to the attack. These shields were taken aboard once the longship set sail. They were only lightly attached to the side of the ship and would be easily carried off by a high wave.

A VIKING DRAGON: SEVERAL PERSPECTIVES

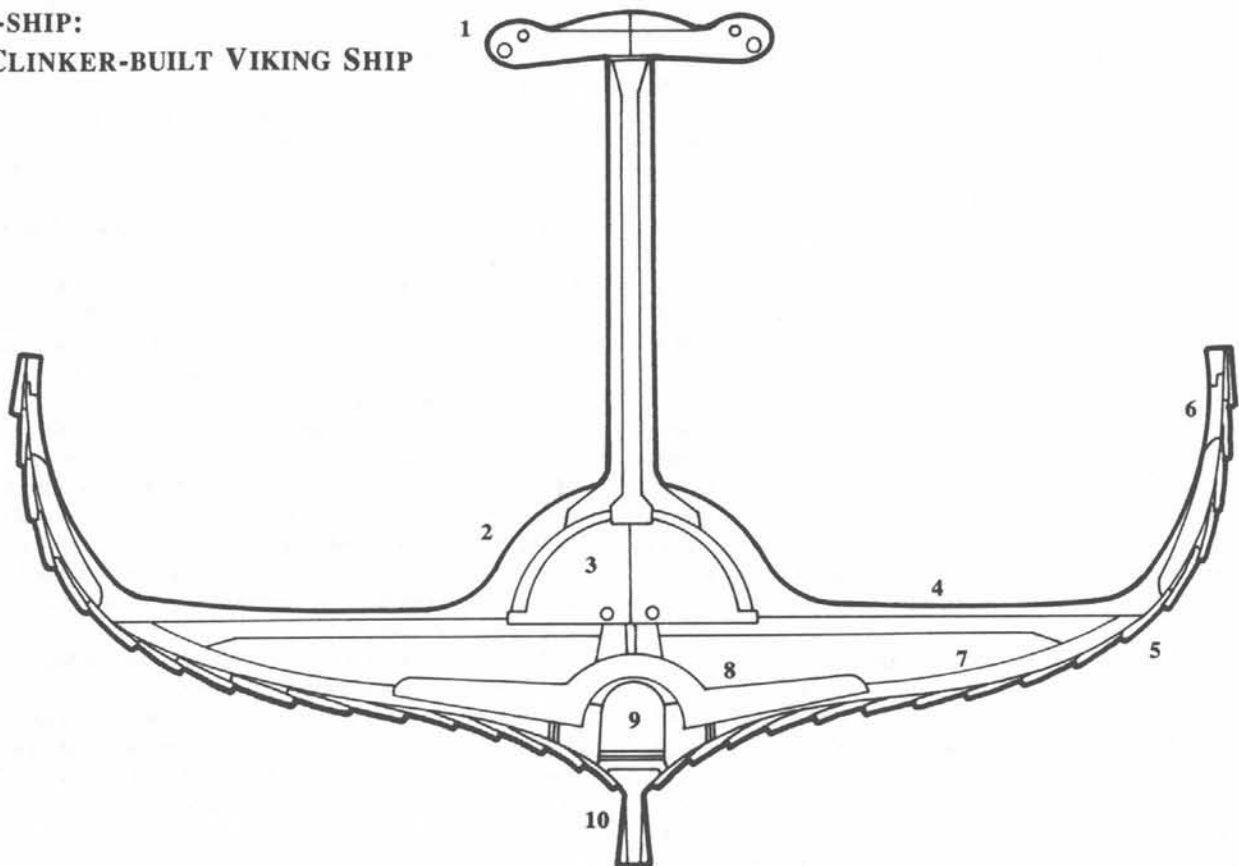
This large ship (rendered in several perspectives) was built of oak, although pine decking was not uncommon. The keel was cut from a single timber and resembles a "T." Planking overlapped and was tied to the supporting ribs with spruce roots. The top edge of the ship's side, or gunwale, was usually fastened by trenails through the ribs and cross beams. Oar holes could be closed off from inside the ship by hinged wooden plates, a nifty trick. Warriors' shields were tied by rope through grips inside the rail.

A VIKING DRAGON'S MIDSHIP

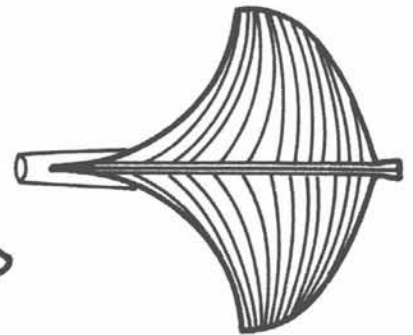
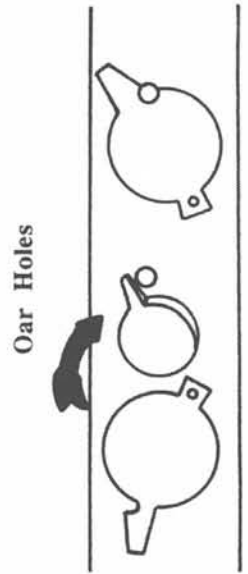
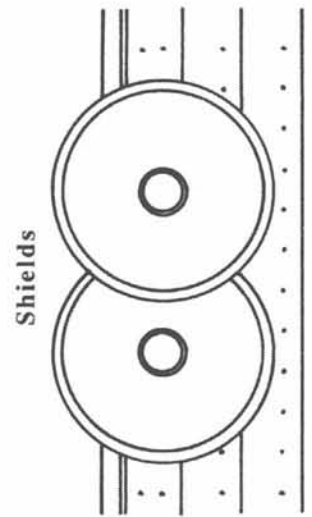
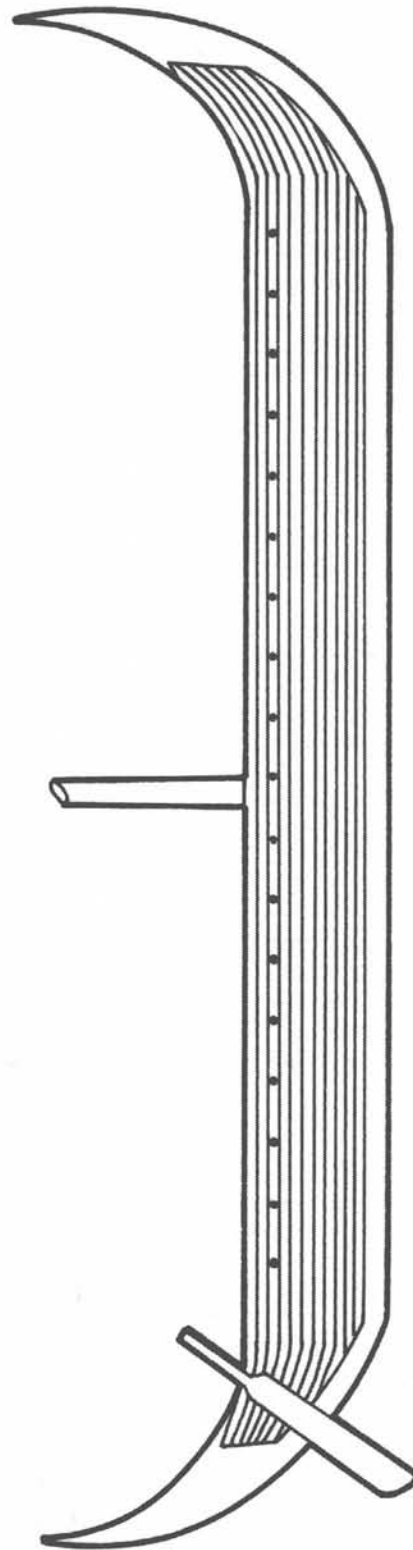
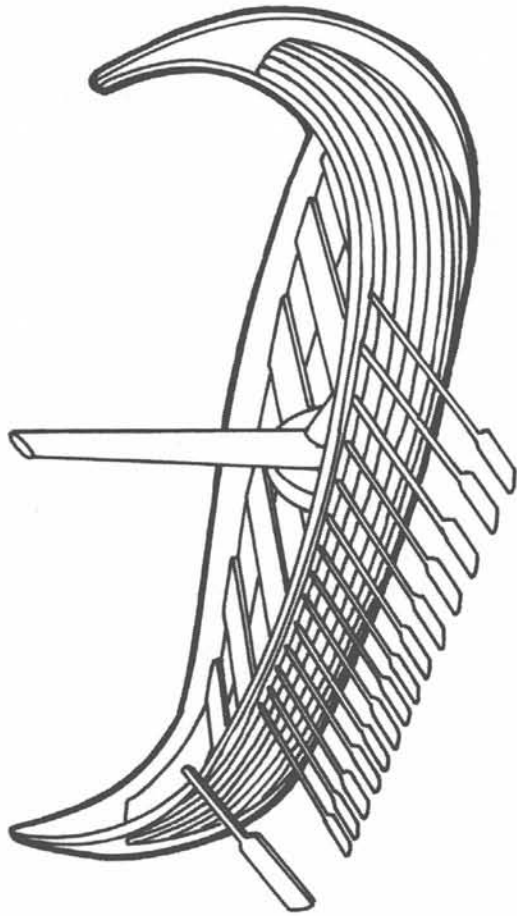
Typical of a 9th century ship, this beauty has a deep keel for sailing the seas. Instead of decking, the ship has wooden floors fitted over frames and mast partners (#3) to hold the mast steady. The supporting gallows (#1) held tent poles and other equipment.

1. **Gallows.**
2. **Riders.** These pieces held the mast partners firm.
3. **Mast partners.**
4. **Flooring.**
5. **Clinker-built** (overlapping boards and wooden plates)
6. **Toptimber.**
7. **Futtocks**, the upright curved timber ribs of the ship.
8. **Floors.**
9. **Keelson**, or timbers fastened inside the hull and along the keel to add structural integrity to the ship.
10. **Keel**, the central supporting piece of the ship. The keel ran along the length of the bottom and supported the frame.

**MID-SHIP:
A CLINKER-BUILT VIKING SHIP**



A VIKING SHIP: A PERSPECTIVE



HOUSEHOLD AND OTHER EQUIPMENT

THE PRICE OF THRALLS

A male thrall usually sold in Scandinavia for 12 aur (1.5 marks); a female thrall for 1 mark. Vikings might sell the young men and women they had captured on their raid to Arab traders in Spain for 3-5 marks apiece.

LIVESTOCK

Livestock included horses, cattle, sheep, goats and (in the south) pigs. A cow was worth 1 aur. A full-grown stallion or draft-ox was valued at a cow. So were four mares, six shorn sheep or goats, and a sow with a litter. A yearling calf was worth only 1 ertog. A sheep fleece was worth 5 pennies.

Horses and cows would be considerably cheaper in the late autumn, when many good animals had to be killed because there wasn't enough hay to keep them alive through the winter. It took 70 vaetts (5600 pounds) of hay to keep just one cow or horse alive over the winter. Sheep and goats were able to find enough grazing to survive the winter on their own.

Chickens and geese abounded, as did hunting falcons and hunting dogs (including bloodhounds and elkounds). Cats were kept as mousers and in some areas as a source of fur. Two cat skins or three kitten skins were worth one aur.

Leather was made from farm animals. One cow's hide was worth 5 pennies. Leather was also made from game animals: aurochs, reindeer, elk, red deer, wild boar, and seal, walrus, and stranded whales. Down and feathers came from farm chicken and geese and from game birds like puffins, guillemots, eider duck, and ptarmigan. Winter hunting and trading with the Lapps and Slavs brought in furs, including martin, sable, squirrel, hare, red fox, arctic fox, wolf, bear, ermine, beaver, badger, and lynx. Six arctic fox skins were worth 1 aur.

FARM TOOLS

Farm tools included plow, spade, pick, hoe, shovel, flail, pitchfork, rake, scythe, sickle, and leaf-knife. One scythe cost 2 ertog. Grain was ground in stone querns or more finely in imported lava querns — or milled with imported basalt millstones. Metal bells were attached to the cow, sheet or goat which was the leader of the herd, to make it easier to find them.

OTHER TOOLS

Fishing tools included a net, baited line and pole, and the barbed spear used for hunting seal and walrus. The hunting spear had a crosspiece to prevent a bear or boar from running up it to attack the hunter.

Traders weighed payments with bronze scales, which could be folded and stored away.

Some ropes were made of linen. Ship ropes which had to be very sturdy were made of seal or walrus hide, cut in a spiral so one skin made one length of rope.

Few things were written down though ink was available, made from the barberry plant. There was no paper. People wrote on vellum (made from calfskin). It took several weeks to make a sheet of vellum, and it might take over a hundred calfskins to make enough vellum sheets to record one saga.

Smiths usually bought their raw materials. A vaett (80 pounds) of bog iron was worth 5 aur; a vaett of smelted iron was worth 6 aur. Bog iron was smelted during the winter, then often peddled in the form of crude axes, which the trader kept threaded on a leather strip. Each axe-like chunk of iron weighed about a mark and cost about a penny.

Smithing tools included charcoal for the forge fire, hammer, anvil (though a smooth boulder would do in a pinch), bellows, metal shears and tongs, soapstone casting molds and ladle, hacksaw, and wire drawplates for making wire. Some smiths made bronze using bog iron plus imported copper and tin.

Woodworking tools including a wood hammer, chisel, wedges, woodcutter's saw, adze, rasp, plane, auger and bits.

Cloth tools include distaff, loom, needle and tweezers (for drawing silver or gold thread through the cloth).

HOUSEHOLD ITEMS

Fire was kindled with a flint and steel tinderbox. Rooms were lit by a longfire, a hearthfire or torches. Ships and well-to-do homes were lit by soapstone oil lamps (filled with whale or seal oil) or by imported wax candles set in candlesticks. One thick wax candle weighing a mark (8 ounces) cost 15 pennies and burned long enough to last a day and night. Heating was provided by wood or peat.

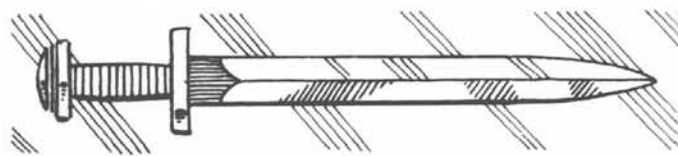
Cooking and eating items included iron cauldrons and gridirons; wooden buckets and vats; pots and bowls made of soapstone or imported pottery; wooden platters or plates of looted silver or gold; wooden or horn spoons, as well as eating knives; drinking horns made of animal horn or of imported silver or gold or imported glasses. An iron kettle that held one tun cost 15 aur.

Furniture included wooden tables, benches (with carved, removable front panels). A chieftain (and his guest of honor) sat on a raised seat, flanked by pillars which rose to the ceiling. The well-to-do might decorate the walls of their home with painted or carved wooden panels, tapestries, embroidered or dyed bench cloths, wall shields which had been painted or even inlaid in gold, and wall weapons with precious metal inlays. Beds were soft with down-filled mattresses, comforters, and pillows. Household items not in use were hung on the wall or kept in chests. Valuable items were kept in iron-bound strongboxes, with metal locks, the keys usually held by the housewife.

Musical instruments included the harp, fiddle, pipes, and drum. People also amused themselves by playing tables, a boardgame.

SOME GEOGRAPHICAL DIFFERENCES

Denmark and southern Norway were significantly warmer than the rest of the northland. Farmers there could raise wheat and pigs and had beehives with wax for candles and honey to sweeten food or for mead. These products had to be imported to the rest of the northland. Iceland and Greenland were too far north for pine to grow, so they had to import all their timber for churches, expensive homes, and ships. Most homes on these islands were made from sod. Greenland was too far north for any grain to grow and had to import it.



1.7 PACKAGE DEALS FOR GOODS

Road Kit #1: The Adventurer in Summer: Pony, Food-bag (two weeks supply of dried fish, smoked or pickled meat, bread, cheese), Leather Flask (one day's supply of sour whey), Flint & Steel. Cost = 4 silver marks.

Road Kit #2: The Adventurer in Winter: as above but add: Skis & Poles, Leather Sleeping Bag, Boots. Cost = 6 silver marks.

Trade Goods #1: Danish/southern Norway Exports to the rest of Scandinavia: pork, mead, wax, timber, wheat. These imports could be sold in the northland for about their weight in silver. A pack pony could carry about 2 vaett or 4 skeppes, worth about 320 marks.

A knorr's cargo was worth about 32,000 marks of silver. It was common to sell half-shares in a vessel's cargo, which would bring the investor a third of the cargo's sale price. (One-third of a ship's income always went to its owner.)

Trade Goods #2: European Exports: as #1 plus glass, pottery, wine, swords and other fine metalwork, jewelry, fine querns and millstones, fine woolens and linens, spices, tin, salt, and thralls. These imports could be sold in the northland for about their weight in silver (except for the thralls who were worth only a mark or two each).

Trade Goods #3: Byzantine and Caliphate Exports: brocades, silk, spices. These imports could be sold in the northland for about three times their weight in silver. A pony's pack could carry about 1000 marks worth of such goods. A Russian dugout canoe could carry about 5000 marks worth of such goods.

Trade Goods #4: Scandinavia Exports to Europe: furs, dried fish, vellum, walrus and narwhale ivory, walrus and seal hides, soapstone, reindeer antlers, falcons, down and feathers, non-Christian thralls. This cargo was worth about half its weight in silver.

A knorr's cargo was worth about 16,000 marks of silver. It was common to sell half-shares in a vessel's cargo, which would bring the investor a third of the cargo's sale price. (One-third of a ship's income always went to its owner.)

Trade Goods #5: Scandinavian Exports to Caliphate: Like #4 plus Christian thralls which were worth about 3-5 marks each.

Leech Bag: Styptics, vulneraries, alexipharmics, burnwash (see Section 6.2). The money cost should be minimal since none of these things is bought.

Wizard Bag: Special enchanted rope, herbs (see Section 6.7).

GM Note: *feel free to change any prices in your campaign for valid reasons. Use Chl/CaL or FH as a guide.*

2.0

VIKING HOME LIFE

In Denmark and southern Norway, crops were more important to the Viking economy than herd animals. Farmers tilled small, terraced fields of one quarter to three-quarters of an acre. Farms were clustered together in villages, for mutual defense.

In northern Norway and Iceland, the "farmer" was primarily a herder. A few fields were used to raise grain, but most were valuable chiefly for their hay, which had to be harvested so the cattle could be fed during the winter. Each farmstead had to have extensive lands for its animals and was usually several hours ride from the nearest neighbor.

2.1 THE VIKING CALENDAR

In the Viking era, the Norse used a seven day week, similar to the Roman one that the Christians had adopted. The Norse days were Sun Day, Moon Day, Tyr's Day, Odin's Day, Thor's Day, Freyja's Day, and Washing Day. (The Anglo Saxons named the fifth day Frigga's Day instead, in honor of Odin's wife, which is why our English name for it is Friday.)

Christianized Vikings observed Friday each week as a meatless fast day, on which they would not bake bread or perform work involving swinging or rotating motions. They also kept Sunday as a day of rest. Later Norwegian folk tales have the Wild Hunt targeting homes with Friday-baked bread and Sunday-raked hay.

The Vikings used a different calendar than the Christians of Europe (see Section 12.1). It began at Yule, the Winter Solstice (the modern December 21st, then December 17th, since the Christians used the Julian calendar which had drifted several days early since it had leap years in centuries not divisible by four). The year was divided into two seasons: summer and winter. The Icelandic names for the six summer months are useful to know, because they indicate the typical activities for each month.

The last month of winter was called Spring. Its highlight was the festival of Summers Eve, which was celebrated the first Thor's Day after the Spring Equinox. Neighbors gathered at the local landholder's or chieftain's to offer sacrifices to the gods. (Some Vikings who had visited Christian lands held the festival but didn't offer sacrifices.) Christians transferred this festival to the celebration of Easter, on the first Sunday after the first full moon of Spring.

The first month of summer began in mid-April and was called Cuckoo Month or Sowing Month. The fields were plowed for barley and oats (and rye and wheat in Denmark and southern Norway). Plows were usually drawn by oxen, with one man guiding the plow and another encouraging the oxen with a long stick. Afterwards, the seed was harrowed in. With most fuel exhausted during the long winter months, men also went out to gather peat and fell trees. The earthbanks and stone walls between the meadows were repaired from the snow. And the home field was manured with the animal dung saved during the winter.

The second month of summer began in mid-May and was named either Egg Month or Lamb's Fold Month. People gathered the eggs of seabirds that nested on the coasts and on islands. Some men stayed on the islands and fished. Lambs were weaned, and the flocks sheared. The local Thing met to settle local lawsuits and debts.

The third month of summer began in mid-June and was named either Shieling Month or Sun Month. Herds were driven into the upland pastures of the mountains, with only a few beasts kept on the main farm to give the household its milk. Each farm had its own mountain shieling, a small house where the herdsmen lived during the summer. Women milked the animals and made whey, butter-milk, fresh and salted butter, soft cheese, and curds.

Midsummer or May Day was marked by a festival on honor of Baldur (see Section 12.6). People danced around the May Pole (from the Norse word *maya*, meaning "to decorate," because the pole was hung with ribbons). They drank ale, lit bonfires called "Baldur's balefires," and searched for mistletoe. Later this festival was transferred to St. John's Eve (June 23rd), dedicated to John the Baptist.

Merchant ships were now arriving from abroad, and men brought trains of pack animals to the coast to trade with them. This was often the month for the regional Thing, which was held on a Thor's Day. (In Iceland, it was the time for the national Thing, the Althing.)

The fourth month of summer began in mid-July and was named Haymaking Month. All the walled meadows were mown with scythes, as was the open countryside. Some of the hay was stored in barns; the rest was built into haystacks, topped by sod or straw thatching. After 1030, July 29th was kept as the feast day of St. Olaf, the late king of Norway.

The fifth month of summer began in mid-August and was named Grain Cutting Month. During this period, haymaking continued, and grain fields were harvested.

Finally, in mid-September came the last month of summer, Autumn. Herd animals were rounded up in mountain pastures, sorted by their earmarks and brought down to the valley farmsteads. Each farmer would reckon how many beasts he could feed during the winter, according to how much hay he had put away. These animals were driven into the reaped grainfields and hayfields to eat whatever the reapers had left—and manure the ground with their dung. The other animals would be slaughtered, and their meat dried or salted.

The Autumn Month was the last month the Vikings bothered to count. The 65 days until Yule, they just called Winter. The festival of Winter's Eve was celebrated the first Freyja's Day after the Fall Equinox. Again, this was a major pagan festival, celebrated at the local landholder's or chieftain's. People offered goats (the animal of Thor) and horses and boars (the animals of Frey and Freyja); then they feasted on the flesh of the sacrifices. Christians transferred this festival to All Saints' Eve, October 31st.

Winter was a time for indoor work. Tools were repaired. Hides and sheepskins from the autumn slaughter were worked into clothing, shoes, bed-coverings, harness and other ropes. Boats were tarred and repainted, built and repaired. Craftsmen carved wood, bone, and horn. Men smelted bog mud for its iron. Meanwhile the cattle had to be kept indoors and fed. Sheep and goats were kept inside at night but driven out in the few daylight hours to feed on whatever they could find.

The Twelve Days of Yule began the new year. They were celebrated at the winter solstice, when the sun seemed to be bobbing, unwilling to come higher in the sky. During this period, men and women did no chores, particularly nothing that involved a swinging or rotating motion like kneading and rolling out bread. Later this gathering was transferred to Christmas, with Christmas Eve becoming a fast day on which no swinging or rotating motion was permitted. The Christianized Vikings also celebrated the holiday of Candlemas on February 2nd when the daylight hours had visibly begun to grow once more.

Yule was followed by the month of Thorri, which began in mid-January, and then by the month of Goi, which began in mid-February. The Orkneying Saga explained these names as those of an early chieftain and his daughter, but they are plainly those of the god Thor and some unknown goddess. Christians observed the Lenten Fast during Goi. They didn't eat meat, butter or dairy products; only fish, whale, bread, vegetables, nuts and fruit.

2.2 VIKING FARMLIFE

The Viking farmstead was virtually a one-room longhouse. A small one was 25 feet across and 60 feet long. It sheltered as many as twelve people: the farmer's family plus two or three thralls. Behind a partition were the farm animals: perhaps a dozen cows plus two or three horses for plowing.

A good-sized farmstead was 40 or 50 feet across and 80 or 100 feet long. It sheltered an extended family of perhaps thirty or forty people: the landholder's family (including his parents and married children) and his hirelings. Thralls were housed in a number of small huts, 10-15' in diameter. Byres held the farmer's six dozen cows, and a stable held his dozen horses.

There were usually no windows to the structure. The floor was trampled earth, which might be strewn with rushes at festival time. The smoky hall was lit by a longfire, in a stone-lined trench that ran the length of the room. A well-to-do home might supplement this light with oil lamps or candles. If you stood at one end of the room, you might not be able to see the far end.

At one end of the hall was the kitchen area with a cooking hearth, perhaps behind a wooden partition. At the other end another partition set off a small room where the women wove. A front porch allowed visitors to talk to members of the household, sheltered from the summer sun or winter snow or rain.

There might be a loft where the master of the house slept. Or he and his family might each have a sleeping closet, with a down-filled mattress, blanket, a comforter, and pillows. These closets had doors which could be latched for privacy. Most people slept on benches which ran down the hall's sides, with pillows of straw.

The farmstead was surrounded by a number of smaller buildings. (In Iceland and northern Norway, these small buildings were often annexed to the farmstead, so people didn't have to go outside as often during the long cold nights of winter.)

There were small huts, byres for the cattle, and stables for the horses. There was a privy and, in a separate building, a sauna, with an oven or hearth where stones could be heated, then covered with water, to fill the room with steam. Some Icelanders were lucky enough to have a hot pool on their estate.

Near the farmstead was a storehouse which held dairy goods, bread and fresh meat. Other storehouses held dried and salted foods and other goods like tools, ropes, and bales of cloth. One building had open, slatted walls and held fish, allowing it to be dried by the wind. There were barns with nearby sheds for hay. The smithy was set some distance away from the other buildings, since it was the most likely to catch on fire. There was also an open-ended shed by the harbor in which the farmer's boat or boats were stored in winter, dragged inside on rollers.

Sometimes a trench brought water from a nearby stream to the farmstead door. Underground rooms stored food (and sheltered visiting outlaws). The whole complex of buildings was enclosed inside a palisaded earthbank, for protection against wolves and enemies.

There were no cupboards. Some possessions were hung on the walls; others were stored in chests. The housewife carried the keys to the store sheds and iron-bound strongboxes.

There were no temples. Most pagan festivals were held out in the open in good weather, indoors in bad weather. A king's or jarl's court might have a building which sheltered the statues of the gods. It was only to be entered by people who had washed their hands and faces, and taken off their weapons.

In front of the farmstead lay the homefield, carefully tended to produce the farm's richest hay. It was fenced by walls of sod or stone to keep stray animals out. Often there was a homefield boar

or stallion, who was allowed to fatten on its grass. The farm also other meadows of grass, walled in but not manured, and plowed fields where grain was grown. There might also be an apple orchard and a vegetable plot where onions and turnips were grown.

In Denmark and southern Norway, where winters were milder and timber was plentiful, fine buildings were made out of wood. The roof rested on rows of free-standing inner posts, and could be pulled off by enemies, using ropes.

Cheaper buildings had walls made of earth, stones and sod, and a sod roof, with wood for roof supports and internal partitions. Most buildings in northern Norway were of this type.

In Iceland, the stone was all volcanic — too soft and porous for building. Timber for fine houses or churches had to be imported. Most buildings there were built of sod and turf, with walls 3-6 feet thick. Such sod-walled buildings were cheaper and warmer than wooden ones. Grass grew on the sod roof, and sometimes men had to climb up and chase away goats or cattle grazing up there.

At the Thing, men lived in booths. These were roofless huts, about 10-20' in diameter. During the Thing, they were covered with coarsely woven cloth, which could then be taken down and brought home again.

2.3 SOCIAL LIFE ON THE FARM

A visitor who walked or rode up to a Viking farmstead would find his arrival announced to the residents by the barking of dogs. A rider would remove his horse's bridle, then turn the beast loose to graze in a nearby meadow, and go to the farmstead's front porch.

VIKING HOSPITALITY

Vikings prided themselves on their hospitality. Friends and relatives of the householder felt free to drop by at any time for a few days — or for months, if the landholder invited them to stay. One saga tells about a woman whose foster father murdered her first husband (because the foster father saw her crying after her husband had slapped her). Her second marriage covenant included the stipulation that her foster father not be allowed to come as a guest to her new household for more than three days without her husband's permission.

Other visitors included peddlers and beggars, who wandered from village to village, farmstead to farmstead, particularly during the summer months. A trading ship might beach itself near the farmstead and ask for hospitality. The owner would be invited to stay as a guest, while the crew would take their tents from the ship and pitch them in the homefield. A wandering skald might come by, or a belligerent berserk or an outlaw. Sometimes isolated farmsteads were threatened by gangs of outlaws or pirates.

GAMES

Most Viking leisure activities were competitive. Men passed the evenings trying to see who could drink the most or by telling tales, singing songs, and reciting poetry. People also played "tables," a sort of boardgame rather like the modern "fox and geese." (Some books translate this as "chess," but that game didn't come up to the northland until after the Viking Age.) The pieces used in these games had "tails" that stuck into holes on the board, so they could be played aboard ship safely.

Outdoors, men raced one another or their horses or rowboats, wrestled in the field or pulled one another underwater to see who could breathe longest. They set their stallions to fighting one another, kicking and biting. (The handlers used horse-goats to make sure that the stallions kept fighting.)

Vikings also played ball games. No one's quite sure of the rules, but we know that they were played in the winter time, with each side trying to bat the ball past the other side's boundary line. Often these ball games turned into shoving matches; sometimes men hit one another. One saga tells of how a hot-tempered youth got so upset at how an opponent had pushed him around that he ran off the field, got his axe, ran back and killed the fellow.

MEALS, FOOD AND DRINK

People ate at long tables, sitting on benches. The center seat on one bench was reserved for the master of the house and his family; the center seat on the bench facing it for his most honored guests. If the master was a chieftain (a king or jarl or an Icelandic godi), he sat upon a cushion, on a seat flanked with pillars that reached all the way to the (low) ceiling. The bench opposite also had a high seat at its center. Some of these benches were ornamented with carved boards showing scenes from the myths or the family history. (Eirik the Red was banished from Iceland because of killing a man in a blood feud that started when he lent a neighbor some bench boards and did not get them back.)

Some food did not need cooking: cheese and curds, bread and crackers, salted or smoked meat, dried raw fish smeared with butter. But people preferred a hot meal: meat or fish roasted on a spit or baked in an earth oven filled with embers or, best of all, stewed in a cauldron. Food was served on wooden platters or carved soapstone bowls, and eaten with soapstone spoons and knives.

Red meats included veal and beef, lamb and mutton, pork and bacon, goat, and horse. (Christians refused to eat horsemeat, but it was standard pagan fare.) Fowl eaten included chicken, goose, and wild birds such as grouse, ducks, plover, woodcock, ptarmigans and puffins. Fish included salmon, trout, perch, pike, halibut, cod, herring, mackerel, walrus, seal and whale, when stranded.

Viking bread was made from wheat (grown in Denmark and southern Norway and imported). Most people ate dark bread made from rye, oats or barley and mixed with inner birch bark (rich in Vitamin C), which made the bread so bitter that few ate it unless they had grown up with the taste. Grain was also made into unleavened bread, porridge and gruel.

Vikings served and ate peas, cabbage, beans, wild leeks and seaweed. Apples, cherries, plums, berries and nuts were favorite "desserts." Salt, wild garlic and honey seasoned bland food.

People drank milk or water in the day, but adults drank ale in the afternoon. Mead (made from fermented southern honey) was a favorite drink. Wines were imported from Byzantium and were costly and rare. Often, two or more Vikings shared a drinking horn.

One saga relates the tale of Vikings who walked in uninvited to an isolated royal farmhouse on an island and asked the attending steward for hospitality. The steward ordered fires built in a shed so that wet journeymen could dry their clothes and themselves. Then dinner was brought in: bread, butter, and bowls of curds. The steward apologized for the lack of ale. The visitors drank all the curds and bowls of whey, which the steward also offered. Then the steward offered them beds of hay in the shed.

Late that night, the king and queen arrived at the island. They were ushered into the great hall and served hot meats and ale by the horn. The king heard of the unexpected guests and invited them to join him. One of the guests, a skald, was offended by the steward's lies and drank horn after horn of ale. Deciding that he was mocking her and her husband, the queen ordered the skald's drink to be poisoned, but the wise skald suspected treachery and carved runes into the drinking horn with his blood. He improvised a poem of suspicion, and the horn split apart.

The skald fled, pursued by the steward; they argued, and the skald stabbed the steward and fled. In the darkness of the hallway, the king ordered light to be brought, and upon spying his dead steward, ordered the skald caught and killed. To find out what happened next, read Egil's Saga.

Viking hospitality was customarily kinder. Another saga relates the tale of a landholder's thrall who took in a shipwrecked family for the winter, "telling them there was nothing to pay for their keep." Later, the thrall told his master what he had done (without asking the landholder's leave!), and the master freed his servant — and gave him the farm as well!

In famine years, when crops failed, people ate brood mares and milk cows to survive. Men hunted ravens and foxes. Some stole from their neighbors; others starved. Outlaws increased. During one great famine, the Althing passed a law that any outlaw who killed three others of that class would be accepted as an honest man again, and many did so.

2.4 VIKING COURTLIFE

The king appointed men as stewards of his many estates, to preside at the trade mart Thing, to collect taxes from importers and farmers, to receive furs as tribute from the Lapps, and to tend to his lands and minions. A Viking royal court was a center of intrigue where ambitious courtiers tried to outwit and replace royal favorites. A saying had it that "a king has many ears." Many a saga records how an honest man is driven from court by lies — and what revenge he took.

In winter, the king and his court remained at home in a lavish and large hall not unlike a typical farmstead in design and function. The Danish royal court sat in Jelling, in Jutland. The Norwegian royal court was held in Konungahela (in the south) and at Hladir in the far north. Sweden's royal court sat in Uppsala, Russia's in Kiev, Northumbria's in York, Scotland's at Kirkwall in the Orkneys and Normandy's at Rouen. Iceland had no court but was ruled by the Althing which met once a year in Thing Valley.

The king and his court travelled by ship in the summer, visiting stewards and chieftains, who entertained and amused their liege with gifts, song, verse and food.

Traders paid taxes and brought gifts for the king and queen, often a coarse wool sail 40' square and more rarely, a scuta (a fast coastal craft). One saga recalls a poor traveller who brought a polar bear to the king and was rewarded with a fully laden knorr (cargo boat), a chest of silver and a gold armband!

COURTLIFE

Ceremony abounded in the Viking court. Trumpets summoned housecarls and visitors to hear royal proclamations. Infractions of etiquette were corrected by forcing the offender to drink a punishment horn of mead while seated on the floor. Skalds and harpists entertained the court with poetry and song. Men toasted one another and swapped poems and tall tales; those who passed out early in the evening were viewed as weak.

The king served his housecarls the best food and drink in the kingdom and dressed them well. On holidays or after a victorious battle, he rewarded them with gifts, usually weapons, jewelry, scarlet cloth, furs, land or ships. The king also loaned ships to his men to be used for trading or raiding, expecting to be repaid with a third of the profit on either enterprise.

The king was bound to revenge the death of a housecarl. He might order the murderer slain, or if evidence and testimony supported the violence, the king might allow the murderer to assume the housecarl's position in court.

2.5 VIKING SOCIAL CODES

Vikings expected a man to be faithful to his patron: a thrall or freedman to his master, a tenant or smallholder to his landholder, a warrior to his leader, a landholder to his regional chieftain, a jarl or steward to his king. A man was also expected to defend his family's honor at whatever cost and to take vengeance when wronged. A death in bed was considered disgraceful, "like a cow on straw." Myths told that a man who died in bed went to Hel (see Section 10.6).

Vikings also expected a woman to be faithful to her husband (at least outwardly) and to her family. Some women were said to have parted with their children easily and to have sent them far away to be raised, often when the mother despised the father of the child. More often, newborn sons were raised by nearby foster parents. One queen ordered her newborn daughter to be raised as a thrall, to show her hatred for the girl's father.

A man might slap a woman but would never attack her. One saga tells how a woman felt free to take the pouch heavy with silver she'd been offered to betray a kinsman — and hit the man trying to bribe her, making him bleed profusely. He yelled at her, but didn't even lay a hand on his weapons. Another saga speaks of how a pregnant woman was visited by the men who had just killed her husband to notify her of the death. (A hidden slaying was murder; an announced one was merely manslaughter and could be atoned for by paying compensation.) One of the men wiped her husband's blood off his sword onto her belly, challenging her unborn son to revenge.

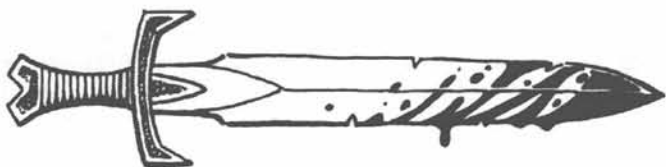
News about dishonorable behavior spread rapidly from village to village, from farmstead to farmstead. The roads were full of travelers, and people were always interested in the latest gossip. Wandering skalds and peddlers, beggars and beggarwomen would praise you or blame you according to how you treated them.

People were quick to improvise games based on interesting gossip. One saga relates the tale of a recently divorced man who saw a group of boys playing out all the details of his divorce case. Another saga tells how a pair of Icelanders agreed to duel one another but then sailed abroad instead, to separate destinations. Some months later, in the Hebrides, one of the Icelanders saw two men mock-fencing, pretending to be him and his enemy. The bystanders around the dueling pair jeered that Icelanders dealt small blows and were slow to act upon their boasts.

Vikings wanted to be thought wealthy but hospitable, polite but fearless, good friends but fierce enemies. They despised misers, truce breakers, liars and cowards. A man might sneak into his enemy's house at night to kill him, but he would first awaken his victim.

Vikings prided themselves on keeping their word. Of course, they might occasionally mislead people. One man, left alone with the women when his host went to church and faced with a dozen berserks, told them: "If I thought that I had any grudge to repay, this is exactly how I would have wished to come, for here is everything you need, both ale and other pleasures... I shall give you such assistance as I can." He got them drunk, then he killed them.

Vikings fought fiercely even in the face of being burned to death or pierced by a spear to the heart. Many sagas record the flippant last words of a man who had just received his death blow. One man, speared through the waist, said: "Broad spears are becoming fashionable nowadays."



It was a deadly insult to accuse a man of crying. Brave men and women tried not to show their grief even at hearing of the death of a dear friend or relative. The worst word of disgrace a Viking could use was *niddering*, a backstabber who was not brave enough to challenge an enemy face to face, but instead killed by poison, treachery or magic.

One saga reveals how a hero killed a berserk who had tricked the crew of a Viking ship into swearing allegiance to him. The crew's leader thanked the hero for freeing them and offered to accept him as their new captain, provided he agreed to their code: "I and my men refuse to eat raw meat... In my opinion, it's a habit more fit for wolves than men. I never rob merchants or peasants beyond the occasional raid to satisfy my immediate needs. I never rob women, even when we meet them on the road with plenty of money, and no woman is ever to be brought to my ship against her own free will. And if she can show that she's been taken to the ship against her will, the one who took her, whether he's rich or poor, shall be put to death."

Vikings were keenly competitive for social honor. One saga reports that a newly married woman went with her husband to a neighbor's home for the Winter's Eve feast. They were asked to move down on the bench when the host's married son and his wife arrived a bit later. The indignant woman announced, "I'm not moving down like an outcast hag." Her husband hastily took her home, but she and the neighbor's wife began a blood feud. Similarly, housecarls fought one another (not always bloodlessly) for the right to sit nearest the king.

Many sagas weave tales of chieftains who were deeply insulted because they were sued for compensation at the Thing. The proper way to treat a man of high standing was to offer him self-judgment (allowing him to assess how much compensation he owed his victims).

Vikings expected men to seek either an apology (with compensation) or blood vengeance for any insult, however minor. Many sagas mention elderly relatives who taunted young men with betraying the family honor. One father told his son, "I'd much rather lose you than have a coward for a son."

Njal's Saga tells of a chieftain's widow who offered her hospitality to his kinsman, who was riding to the Thing to accept compensation for her husband's death. She gave him a high-seat though he was not a chieftain. Then she brought out a gift he had given her husband, a silk cloak that the man had been wearing when he was killed.

"She threw the cloak around his shoulders, and the clotted blood rained down all over him.... I call upon God and all good men to witness that I charge you in the name of all the powers of your Christ and in the name of your courage and your manhood, to avenge every one of the wounds that marked (my husband's) body — or be an object of contempt to all men."

He threw off the cloak and stalked out of the house and rode on to the Thing. There he was offered three times the usual wergild for his relative's death — and a silken cloak. But when he saw the cloak, he started an exchange of insults that ended with his refusing compensation and seeking blood vengeance.

Similarly, the Laxdaela Saga speaks of a woman who took her sons riding till they came within sight of the farm of the man who had killed their elder brother. She asked them if they knew who lived there. Then she told them, "You are remarkably unlike your noble kinsmen if you don't want to avenge the death of such a brother as Kjartan was. Your grandfather...would never have behaved like this. It is cruel to have such craven sons; and I for one believe it would have suited you better to have been your father's daughters and been married off."

2.6 FAMILY OCCASIONS

A Viking's extended family was his closest source of friends, battle companions, and business partners. Marriages and funerals were celebrated by feasts, usually with the entire neighborhood invited. These feasts were usually held in the autumn or winter, when there was plenty of ale and meat, and little farmwork to do.

MARRIAGE SETTLEMENTS

Marriage was a family business arrangement more than a matter of romance. A man who had seen or heard of a woman he wished to marry (or that his father suggested would be a good wife) would approach her father (or other male legal guardian) and offer him a bride-price, in money or land or other property. This had to be at least one silver mark for the woman to be considered a legal wife, not a concubine. The woman's family then offered a dowry of similar value. The woman's consent was usually sought, but was not necessary for her first marriage. Once the arrangements had been settled, the betrothal was announced, usually at the local Thing, either by the woman's guardian or — if the woman was a widow or divorced — by the woman herself.

The wedding was usually held at the bride's family's home, but might be held at the husband's home or that of one of his prominent relatives. The couple would drink the "bridal ale" before witnesses; then the man would be led to the woman's bed, in which a hammer had been hidden (originally a pagan ceremony, showing that Thor hallowed the marriage). The next day, the man would make the woman another gift of money or property, called the bridal-veil fee. The feast would go on another week or two, depending on the wealth and hospitality of the host. Departing guests were given small presents.

The bride-price, dowry, and bridal-veil fee were administered by the husband, but were the wife's property. They went to her children after her death. If she died childless, they had to be returned to her family. If the couple got divorced, there might be legal bickering over whose fault the divorce was and whether the wife should get back all her money or half of it or none of it. Such disagreement naturally involved both the husband's and wife's extended families as well.



DIVORCE

Christians and Arabs were shocked at pagan Viking divorce customs, which let either husband or wife dissolve the marriage, for any reason or no reason at all. One woman whose husband asked her to welcome her brother's killer grabbed the man's sword and wounded him. He didn't attack her (only a coward would attack a woman), but did ask the husband for compensation. The woman then named witnesses, declared herself divorced, and moved to another area.

It was common for a divorced woman to exchange any land that neighbored her ex-husband's property with someone else who wasn't involved in the disagreement. During Christian times, priests permitted childless marriages to be annulled. Couples who'd had children were permitted to separate but neither could legally remarry until the other had died.

FUNERALS

Some Vikings buried their dead in a community graveyard, others in an isolated grave mound; still others cremated their dead. Most were laid to rest in a boat, either a real wooden craft or a symbolic outline of stones, with a heavy stone anchor to keep the corpse from straying. (One saga refers to "Hel shoes" tied on a man's corpse, presumably to keep it from walking after death. See Section 10.6 for grave mounds and aftergangers, the walking dead.)

Often, valuable items were buried (or cremated) along with the dead man or woman: horses and dogs, jewelry and clothing, weapons and armor. One Viking was buried with a peacock; another with a length of Chinese silk. After the burial or cremation, the heir would hold a funeral feast and formally claim the estate by drinking a toast and presenting small presents to the guests.

Dead outlaws or criminals were buried with equal care but less honor. Their weapons were often buried with them, but their graves were dug below the high tide mark or on a desolate mountain ridge or islet where no man farmed, herded cattle or had a home. Even then, there were stories that sometimes their bodies walked after death and had to be subdued once more. After the introduction of Christianity, suicides' graves were treated similarly.

BLOOD BROTHERHOOD

Blood brothers vowed to treat one another as brothers: that is, to share their wealth with one another and seek blood vengeance for each other. One description of the ceremony says that the men stood under an arch of turf which was still attached to the ground at both sides and was held up in the center by a spear. They walked around the spear, cut their arms, and sprinkled their footprints with the blood or pressed their cut arms together to mix their blood. Such a ceremony did not unite the extended families, only the two men who took oaths.



2.7 RELIGION

Few Vikings were devout believers in any religion. Many warriors claimed that they believed neither in the old gods nor in Christ, but only in the might of their weapons. Some invoked both religions. One prominent Viking considered himself a Christian and even named his farm "Kristnes" (Christ's headland), but "made vows to Thor for sea voyages and in tight corners, and for everything that struck him as of real importance."

NORSE RELIGION

Thor was honored through the northland and invoked at marriages, child-naming, funerals, and at the opening and closing of the Thing. Myths related how Thor protected the gods against the frost giants, with his mighty hammer, which represented lightning. Carvings in stone and wood showed him wrestling the Midgard Serpent, which lay in the ocean that encircled the earth.

Tyr was most honored in Denmark. Myths told how he had given up his hand so that Fenris Wolf could be chained. Many swordsmiths carved the rune that bore his name on sword-hilts.

Ull was most honored in southern Norway and Sweden. We know little about this god except that he was skilled in the use of the yew-bow and skiing.

Frey was honored in Sweden as the god of harvest and horses. He had given up his sword to win the love of a beautiful frost giantess; his weapon was a stag's antler. His sister, the beautiful Freyja, was the goddess of romance, shamanic magic, and berserk battle frenzy. She wore the brisingamen, a rich and beautiful necklace crafted by dwarves. Their father Njord lived in the hall of Noatun (ship-town) and was the patron of sea voyages.

Odin was chief of the gods, master of poetry and the runes, lord of battle-victory and of panic and death. Kings paid him honor, but no one ever claimed that Odin was trustworthy. He might favor a man in battle after battle and then betray him and allow him to be killed. Few commoners prayed to him, except skalds, rune carvers, shamans, and berserks. Odin's wife was Frigga, goddess of marriage and the family.

Pagan festivals were not held in temples consecrated to the gods but in the open fields or inside the home of a landholder or chieftain wealthy enough to host the neighborhood. There were no full-time priests to attend on the gods. In the Havamal, Odin advised, "Better no prayer than too big a portion. Measure your gift by what you want to get."

GM Note: For more about religion, see Section 11.

CHRISTIAN CUSTOMS

The Carolingian Empire founded by Charlemagne sent missionaries to the Vikings in the hope that they would stop raiding once they became Christianized. Irish and English monasteries did the same. Some of these missionaries were priests; most were black-robed Benedictine monks. Viking chieftains permitted missionaries to set up schools, but most students were more interested in learning to read and write and use numbers than in the foreign religion. Some Vikings did accept Christ as another god, as beautiful as Odin's dead son Baldur, but certainly not as powerful a figure as Thor or Odin.

Many Viking traders underwent *primesigning*, in which the sign of the cross was made on their forehead. This gesture permitted them to continue to observe pagan holidays but to count themselves as Christian enough to be allowed to trade in the Carolingian marts of Germany, Frisia, and France.

Non-Christian merchants were not allowed to trade in Christian Europe. Arab traders had to sell their goods to Vikings who were *primesigned* or baptized. Jewish traders were allowed to sell their goods if they went first to the royal court to hear a sermon and to present gifts to the king.

Carolingian and British kings usually insisted that one of the terms of a peace settlement with a Viking chieftain was that the chieftain and his housecarls be baptized. Afterwards, the newly baptized men wore white clothes for the next week. Usually these clothes were the gift of the Christian monarch, including shirts of fine Frisian wool. At one peace settlement, the king did not have enough shirts to give all the newly baptized Vikings, so he gave them token pieces of white cloth instead. One Viking indignantly refused to let himself be baptized if that was all he'd get. He said he'd had it done many times before and knew what he was entitled to.

Some Vikings became devout Christians, usually out of admiration for the god of a brave missionary. King Harald Bluetooth of Denmark became a Christian when a German priest held a bar of red-hot iron and then showed his hand was uninjured as proof of the power of his god. Iceland's first missionary was a German priest named Thangbrand, who fought and killed a berserk using a crucifix as a weapon. He was outlawed for refusing to pay compensation for this and other killings.

Several Christian kings tried to spread their new faith, but were forced off the throne by pagan resistance. One king was forced first to rename his baptized son with a pagan name and then to abdicate in favor of the boy. Another's refusal to take part in the seasonal pagan festivals resulted in his jarls rebelling against him and eventually to their killing him in battle.

Pagan kings were willing to tolerate Christian subjects, but the reverse was not true. The Orkneys became Christian when King Olaf Haraldsson of Norway arrived there with a fleet of five ships and told the local jarl: "I want you and all your subjects to be baptized....If you refuse, I'll have you killed on the spot, and I swear that I'll ravage every island with fire and steel." The jarl surrendered and was baptized and gave up his son as a hostage, who was also baptized. After his death, Olaf Haraldsson was made a saint for his work in spreading Christianity.

Vikings who were devout Christians gave up the customs of eating horsemeat and exposing unwanted children, but still took part in battles and blood feuds. Christian chieftains continued to host the neighbors, now at Christian festivals. Many chieftains built churches on their property. A common belief noted that a man who built a church would be allowed to bring as many people into heaven with him as his church could hold.

Some landholders forced their illegitimate sons (who could not inherit more than 12 marks without the permission of the legitimate sons) to become priests in their churches. Others paid for thralls to become priests. Such a priest was still socially classed as a thrall, owned by his landholder. Vikings who became Christian priests did not remain celibate but married and had children, passing on their priestly duties to their sons. Priests were clean-shaven and tonsured but did not wear special clothes. They carried weapons, herded, farmed and sometimes went on raids just like ordinary men.



2.8 LAWS AND GOVERNMENT

As mentioned before, Viking law was not written down but memorized. Most people were familiar with their legal rights, but only a skilled lawyer knew all the obscure provisions of the law. The Icelandic Althing was headed by a Law-Speaker who recited one-third of the laws each year, so that anyone who attended three years in a row would hear all of the laws.

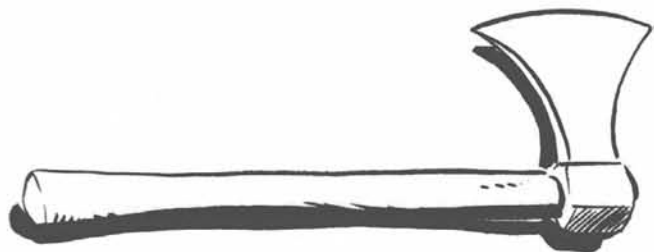
Property claims included not only land and animals and other possessions but also use-rights to land. The owner of a field could sell or rent or share farming rights and grazing rights. The owner of a wood could sell or rent or share woodcutting rights or hunting rights. The owner of shoreland could sell or rent or share harbor rights or driftage rights (which included the right not just to driftwood but to the meat and skin of a stranded whale). One Viking settler lost a mare soon after landing. He sold the right of owning her (if she ever turned up again) to another settler, who found her the next spring.

In modern legal terms, the Vikings had no criminal law. All law was civil, an offense against a certain person or people (and their family) which could be settled by appropriate compensation. Even premeditated murder could be settled if enough *wergild* (literally "man money") was paid to the victim's children and other relatives. (His widow didn't count as a relative any more.)

If someone planned to initiate a lawsuit or knew there was a case against him, he would ride to the Thing accompanied by as many relatives and friends as he could muster. Then at the Thing, he would hold open house at his booth and tell people his side of the case. Crowd opinion might sway the judges' opinion, or he might need supporters in case the legal system broke down and a battle broke out.

A hidden killing or deliberately setting a wood on fire or other major crime was punished by full outlawry. The exile was supposedly permanent, though there was a tradition that one's banishment expired if the man managed to stay alive for twenty years. Anyone who sheltered or traded with an outlaw risked being fined or outlawed himself. Anyone could legally kill an outlaw without having to pay compensation. Once a man had been fully outlawed, all his possessions were forfeit, half to his victim(s) and half to his neighbors.

A few full outlaws had a reward of 1-3 marks of silver set on their heads, but there were no Viking "bounty hunters." Most outlaws were pursued only by the friends or relatives of their victims. A few men were such formidable warriors — and so popular in the neighborhood — that they continued to live at home and socialize with their neighbors despite being fully outlawed. Most full outlaws fled to the wilderness, where they lived by robbing travelers and farmers, until they were killed.



A TYPICAL VIKING TOWN: A PERSPECTIVE

This large port town stretches from the water north to gently rolling hills and nearby harbors. Within the protection of the town wall, dusty streets, some of them paved in wood, were crowded with women hurrying to market, traders, carts, beasts of burden and Viking men on foot and horseback, some of them serving in the garrison which guarded the town. Buildings were made of wood and functional in design. A broad graveyard stretches just beyond the town wall, which sports many openings and high gates, allowing easy access to traders and (one would surmise) gravediggers. Viking ships easily rested where they pleased; deep-draught ships from Frisia and elsewhere had to sail to one of the more distant harbors, where Vikings excavated a basin to suit the needs of the trading ships.

1. **Watchtower.** Manned at all times by a member of the town garrison.
2. **Gate.** Defensive and built of oak, the gate could be sloed in a matter of seconds.
3. **Town Wall.** The wall was well-maintained and paid for by the citizens of the town.
4. **Streets.** Some were paved with oak.
5. **Piers.**
6. **Great Hall.**

3.0

VIKINGS AWAY FROM HOME: TRADING AND RAIDING

The inland reaches of Scandinavia were difficult to travel even in the best of times. There were dense pine forests and steep mountains, many snow-capped the year round, some covered by glaciers. In addition, swamps and peat bogs and rivers had to be forded (and might be swollen with melting ice in spring or rains in fall). Only a few traders with trains of pack horses made their way each summer and fall from the great trading marts into the back country to sell goods to the farmers in exchange for furs and other valuables.

The fast road from one Viking settlement to another was not by land but by sea. Small ships could easily sail along the coast or row up shallow rivers; canoes darted across a narrow fjord or lake. Larger ships sailed down coastal Europe or across the Atlantic to Britain, the Atlantic Islands, Iceland, Greenland, or even to Vinland and Markland in North America.

Climatologists report that the Viking Age was (perhaps not by coincidence) a time of warmer and less stormy weather than the eras before and after. Viking ships took routes even our modern ships can no longer take, because they are blocked by icebergs. Even now, the fjords and lakes of Norway and Denmark seldom freeze thanks to warm ocean currents.

Ships were usually captained by the landholder or chieftain who owned them or his heir. The crew was composed of his relatives, hirelings and other dependents. The captain's share was a third of the loot or trading profit. Sometimes a neighbor or friend would buy a half share in the voyage.

A trading ship's captain sometimes sold passage to one or two young men, off to see the world and make their fortune. First, the captain checked out the neighborhood gossip about his would-be passengers. For instance, few captains objected to carrying a man outlawed for three years for an honorable killing in a blood feud, but no sensible captain would carry two men who had been outlawed for feuding with each other.

3.1 VIKING NAVIGATION

Most Viking men knew how to navigate down the coast of Europe, steering from one landmark to the next. For example, one trader named Ottar told Britain's King Alfred how he steered from Skiringssal (also known as Kaupang), a mart on the western shore of Norway's Oslofjord, to Hedeby, the great Danish trading port on the neck of Jutland.

"From Skiringssal...he sailed in five days to the port which is called Hedeby...He had [Danish-ruled Sweden] to port and the open sea to starboard for three days, and then for two days before he reached Hedeby he had Jutland and South Jutland and many islands to starboard. And those two days he had to port the islands which belong to Denmark."

The key to Viking navigation of the deep oceans was latitude sailing. A captain would take his ship north or south along the coast, checking the sun's height at noon and (during the dark nights of spring and fall) the North Star's height, until he came to the approximate latitude of his destination. Then he would set sail due west (or due east).

Even in fog, a captain could tell he was nearing land when he saw or heard birds and sea creatures that lived only in coastal waters. An experienced navigator knew how to tell one part of the ocean from another by the color of the ocean, the gleam of distant icebergs, currents, seaweed and driftwood, cloud formations, and the feel of the wind. The Icelandic Book of Settlements gives the following course from Norway direct to Greenland.

"From Hearnar in Norway one must sail a direct course west to Hvarf in Greenland, in which case one sails north of Shetland so that one sights land in clear weather only, then south of the Faroes so that the sea looks halfway up the mountainsides, then south of Iceland so that one gets sight of birds and whales from there."

Iceland was about the same latitude as northern Norway, Greenland, and Canada's Baffin Island, after which a Viking craft could go south along the coast of North America to Newfoundland and Nova Scotia, which some people identify with Leif Eiriksson's Markland and Vinland.

Southern Norway was about the same latitude as northern Scotland and the Atlantic Islands (Shetland Island, the Faroes, the Orkneys, and the Hebrides).

Denmark was about the same latitude as southern Scotland, northern England, and Ireland.

Both coastal and latitude sailing required the navigator to count off days of sailing — and to assume that his ship's speed was constant. A storm could catch up a ship and blow it cross-course or many times faster than the navigator expected. Prudent captains lowered their sails and unmounted their masts for a storm. Some reckless voyagers, however, took the storm winds and sailed by chance. Such voyages were responsible for the discovery of Iceland, Greenland, and Vinland and Markland in North America.

One saga tells of a trading ship that sailed from Iceland to England but ran first into galewinds which blew them north of their course, then into dense fog. Eventually the men found themselves in shallow waters and were sure they must be near land but had no idea where. It might be the Orkneys or Scotland or Ireland, since they were all at about the same latitude.

For more information about major Viking trade routes (and trade marts), see Section 8.

3.2 TRAVEL SPEED

LAND TRAVEL

On foot: Reduce speed for rain/snow/ darkness (particularly important in the winter). Usual longterm walk is 3 mph for both human and horse, reduced that to 1 mile an hour after dark, 1/2 a mile per hour on ice or snow.

Horse (pony)-drawn wagon: speed of 2 miles an hour, reduced to 1 mile an hour on ice or snow; unsafe after dark.

Ice skating: (Olympic speed for a 6 mile course is 18 mph; a 500m course is 40 mph): Cross country skating speed of 6 mph; sprints at 15 mph. Unsafe after dark.

Skiing: (Olympic speed at a 31 mile course is 6.4 mph): Cross country skiing speed is 2 mph. Downhill skiing is at 6 mph with significant chance of falling. Unsafe after dark.

GM Note: *The Norse ski was not tied to the boot like the modern ski but held on by a toe-strap, making it considerably less maneuverable. The Lapps used one long ski and one short, or pusher ski. One ski pole could be strung as a bow; the other had a metal tip and could be used as a spear. Both had baskets on their bases.*

Horse(Pony)-drawn sledge speed in winter: 2 mph with ice-shoes, 1 mile an hour without; unsafe after dark.

WATER TRAVEL SPEEDS

Canoe and rowboat: sprint 500 feet in 1 minute, row 9 mph.

Scuta: sail 14-17 mph, row 7 mph.

Karfi/knorr: sail 5-18 mph; row 4 mph.

Longship: sail 12-13 mph; row 6 mph.

3.3 TRAVEL HAZARDS

FOOT TRAVEL HAZARDS

Winter and Spring Snows: chance of an avalanche in mountain passes is 2D6%.

Fall and Winter Rains: chance of being swept away fording a river is 3D6%.

Wild Animal Attack: by wolf, bear, lynx, or boar: 2D6% by day; 5D6% by night.

Horse Stumbling: The Vikings regarded it as an omen of bad luck for a journey to begin with a horse stumbling, particularly if the rider was thrown or had to jump free (see Section 5.1). Chance is 2D6% on dry ground, 5D6% on wet or snowy ground.

At any time of year, there was a chance of encountering outlaws or robbers when traveling between one settled area and another.

GM Note: *for more about hazards, see Section 12.4. Note that a 2D6% indicates that you should roll 2D6 (two six-sided dice), then roll 1-100; if the second result is less than or equal to the first, the "chance" (of a hazard occurring) has indeed happened.*

SEA TRAVEL HAZARDS

There was always a risk of pirates when traveling by sea. A pirate ship or a fleet of raiders might be hidden in a fjord or in an island cove, ready to ambush one or two merchant knorrs sailing by. But pirates could be fought if your crew were valiant, or if you'd managed to get a longship to escort you.

What could not be fought so readily was a sudden gust of wind or, worse yet, an unseasonal storm, which could overturn a shallow-bottomed Viking ship. Use the following table, rolling once per D6 days of voyage. Add 30 if it's raining (see Section 12.2).

Roll (D100)	Ship's Fate
01-80	Usual winds.
81-85	BeCALMED D6 days; crew must row.
86-90	Headwinds D6 days; crew must lower sail, row.
91-93	Gusts; captain must make steering roll every hour.
94-96	Strong winds: captain must make navigation roll or risk overshooting target.
97+	Stormwinds: Shipwreck. (GM may permit the crew to throw all cargo overboard and to reroll their fate at 90+D10.)

A shipwreck in deep ocean means that the ship overturns, the cargo is lost, and most of the passengers drown. (The GM may allow characters to jump into the ship's rowboat and to row for shore. See Section 8.12 for information on Utrost, the land of the sea spirits.)

A shipwreck in coastal waters indicates that a rowboat or canoe overturns: all cargo is lost, and the passengers must swim for their lives. To see what happens to a sailing ship which wrecks in coastal waters, roll D6:

Roll	Outcome
1-2	Ship runs aground on an island or shoal. 5D6% of cargo is lost.
3-4	Ship runs aground on offshore reef. 5D6% of cargo may be rescued within 2D6 hours by rowboat; otherwise, all cargo is lost.
5-6	Ship overturns within a mile of shore. All cargo is lost. Passengers must swim for their lives.

THE MAELSTROM

The Maelstrom lay off the coast of Norway, between two of the Lofoten Islands, far to the north of Trondheim. A huge whirlpool, it could be crossed safely by a cautious captain but was often deadly, depending upon wind and tide. Legends speak of other, larger maelstroms that suddenly appeared in coastal waters or even in mid-ocean, far to the north near the realm of the frost-giants.

GM Note: for more about hazards, see Section 12.4.

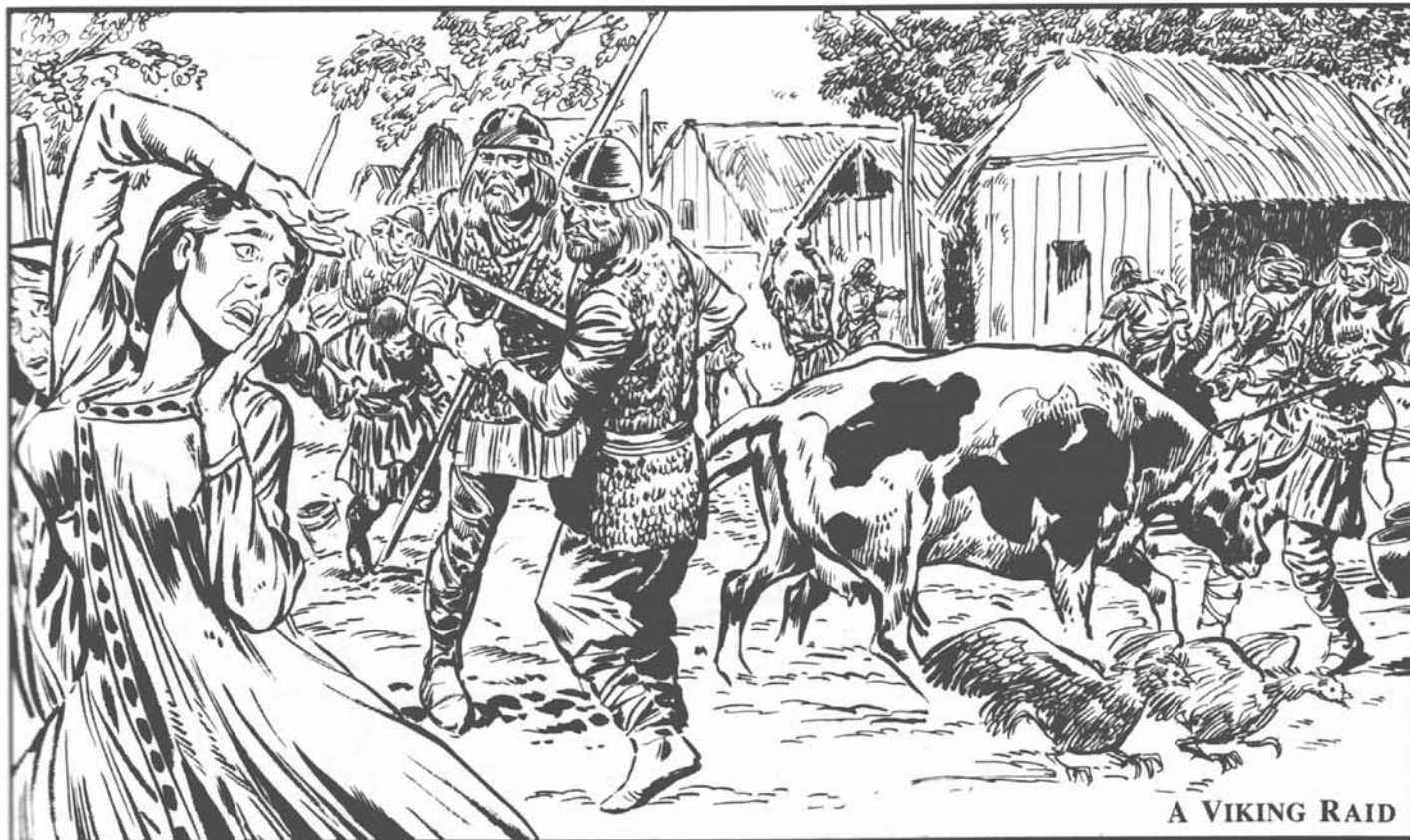
3.4 RAIDING AND DANEGELD

The first known Viking raid on Ireland was on the defenseless island monastery of Lindisfarne on June 13, 793. A century later, the Anglo-Saxon Chronicles described it thus: "The harrying of the heathen miserably destroyed God's church on Lindisfarne by rapine and slaughter." Three centuries later, another English chronicler embroidered upon the earlier account:

"The pagans from the northern regions came...to the Church of Lindisfarne, laid everything waste with grievous plundering, trampled the holy places with polluted steps, dug up the altars and seized all the treasures of the holy church. They killed some of the brothers, took some away with them in fetters; many they drove out, naked and loaded with insults; some they drowned in the sea."

The Irish monks seem to have been less upset. They stayed in their monastery until 875 before evacuating it, fearing attack from Danish forces overrunning England. When they left, they took the Lindisfarne Gospels, the coffin of St. Cuthbert and as many church treasures as they could carry, much of the loot left behind by the earlier Viking raid rather than accumulated anew in the previous 82 years.

Vikings probably called what happened on Lindisfarne a shore-raid. In this era, most Norse villages or trade marts expected to fight off an occasional shore-raid from a longship of some other region. The raiders took livestock, ale and thralls. One honorable (in his own eyes) Viking claimed that he never robbed "merchants or peasants beyond the occasional raid to cover my immediate needs."



A VIKING RAID

A COASTAL MONASTERY: A LAYOUT

Nearly surrounded by steep cliffs and reached (from the sea) only by a narrow winding path, this monastery is typical of many raided by Vikings in the 9th and 10th centuries.

MONASTERY

1. **Path** to/from the bluffs along the sea coast.
2. **Paths** to/from the steps down to the sea.
3. **Stone walls.**
4. **Bluffs** above the pounding surf.
5. **Church.** The center and focus of the monks' life, this stone structure was the grandest of any monastery. Within it lay items of gold and silver which held great appeal to the Vikings.
6. **Monk's Quarters.** Simple stone houses, they held little of value.
7. **Barn.** Cows, goats, horses and sheep were fed and cared for here; these beasts were often sought out and taken by Vikings.
8. **Fields.** Common crops included barley, malts, wheat and rye.

RAIDS UPON VILLAGES

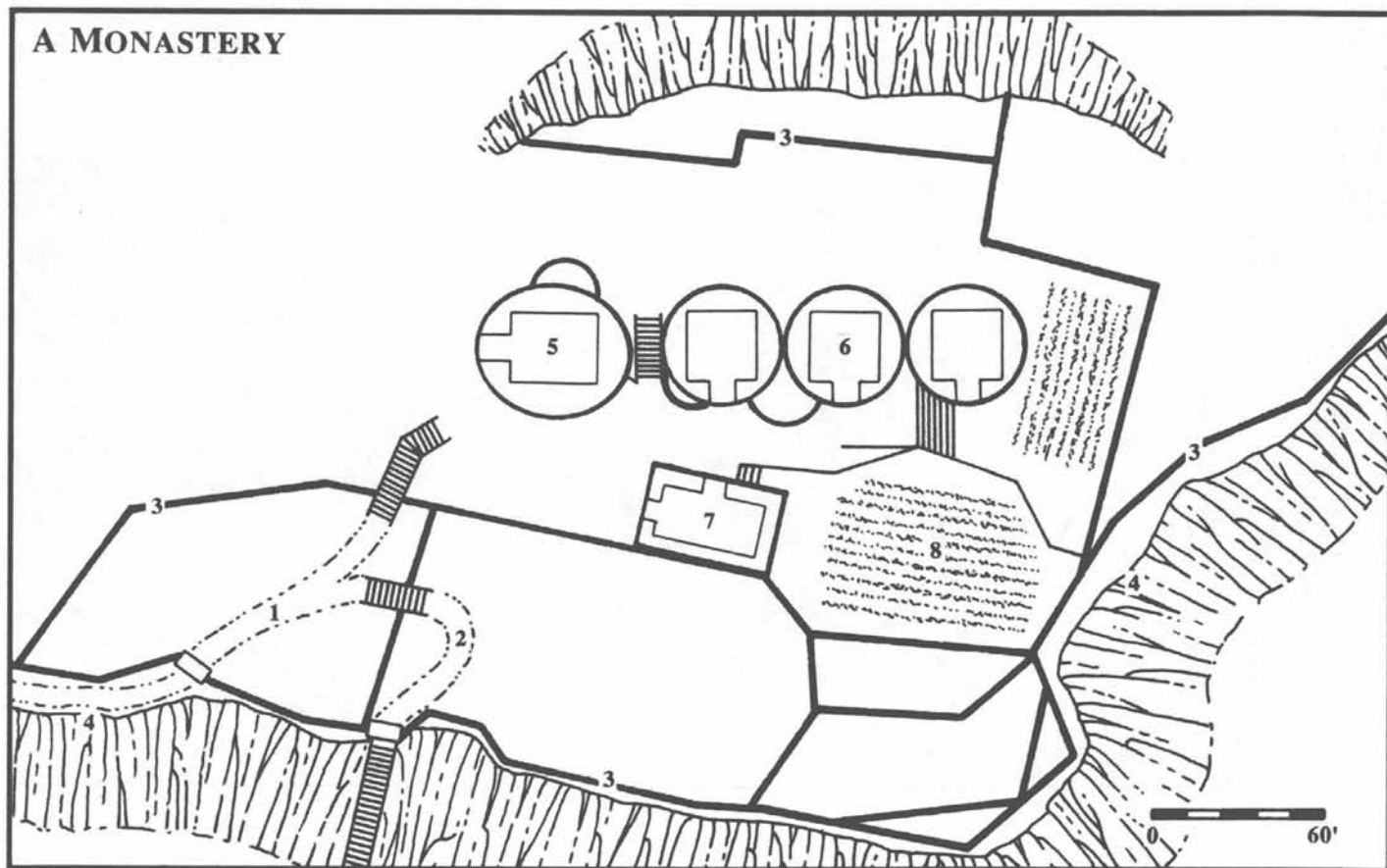
At this time, Irish and English villages were accustomed to being the targets of cattle raids. But non-Viking raiders left island monasteries alone; their monks were not fighters but hermits, neutrals. Vikings played the game by different rules and horrified the Christian world.

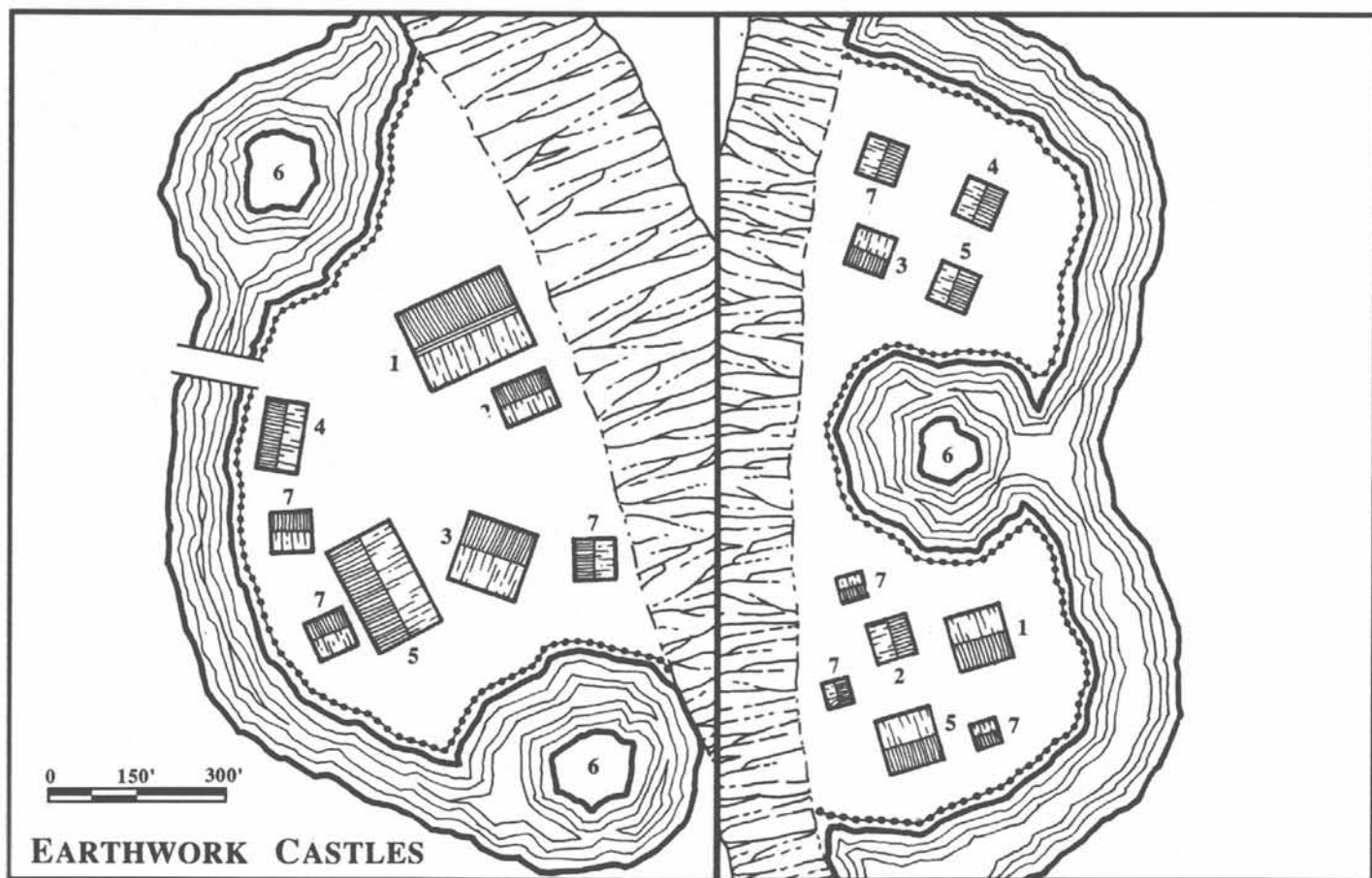
Monasteries were perfect targets for a raid: they sheltered no warriors, had no defenses, and held lots of loot. Vikings returned and told friends about the easy pickings they had found in Britain's coastal waters. For decades, Viking longboats had made shore-raids in the northland. Now they turned their attention southward. Viking settlements enjoyed greater security, and Christians added a new prayer to their litany: "A furore Normannorum libera nos, Domine." (Save us from the fury of the Northmen, O Lord.)

The Viking warrior Ivar the Boneless boasted in 866: "Is there any living man, king or prince, on land or water as bold as we? No one dares to meet us sword with sword. Be we right or wrong, all yield before us, plowman and merchant, horseman and ship."

In the middle Viking era, the Viking raiders pushed far inland. Ships would appear unexpectedly in a British or European harbor, whereupon its warriors would rush ashore and loot the town, stealing its horses. Then the raiders would ride inland, pillaging but steering clear of castles and other fortified areas. (There was little need to attack such places, when plunder was so easily available elsewhere.)

However, a few adventurous Vikings relished the challenge of storming a motte and bailey castle, which bore little resemblance to the grand stone edifices which would tower above the fields and towns of Europe centuries later. Two typical earthwork castles of the 11th century are detailed herein. A Viking raider of that period might well have admired the timbering of the towers (or mottes) more than the banks of earth which formed the heart of the structure's defense. Note that all of the castle's structures were located within the protected courtyard (or bailey) protected by a ditch and ramparts.





Local nobles were helpless against such tactics. By the time they had been notified of a Viking raid by terrified peasants or monks, the raiders had usually gone elsewhere. If they called on the king for help, their plea for help would only strengthen the power of the royal bureaucracy, which they spent most of their time fighting.

Sometimes, Viking raiders chose to spend the winter abroad, rather than sail home during bad weather. They usually reside on a small island at the mouth of a major river like Thanet and Sheppey by the Thames or Noirmoutier at the Seine. There, they were safe, because European ships were too slow and clumsy to fight a sea battle against Viking longboats. Noirmoutier had been the home of a monastery whose monks had controlled Europe's salt and wine trade. When the Vikings arrived, the monks left and never returned.

TWO MOTTE AND BAILEY CASTLES

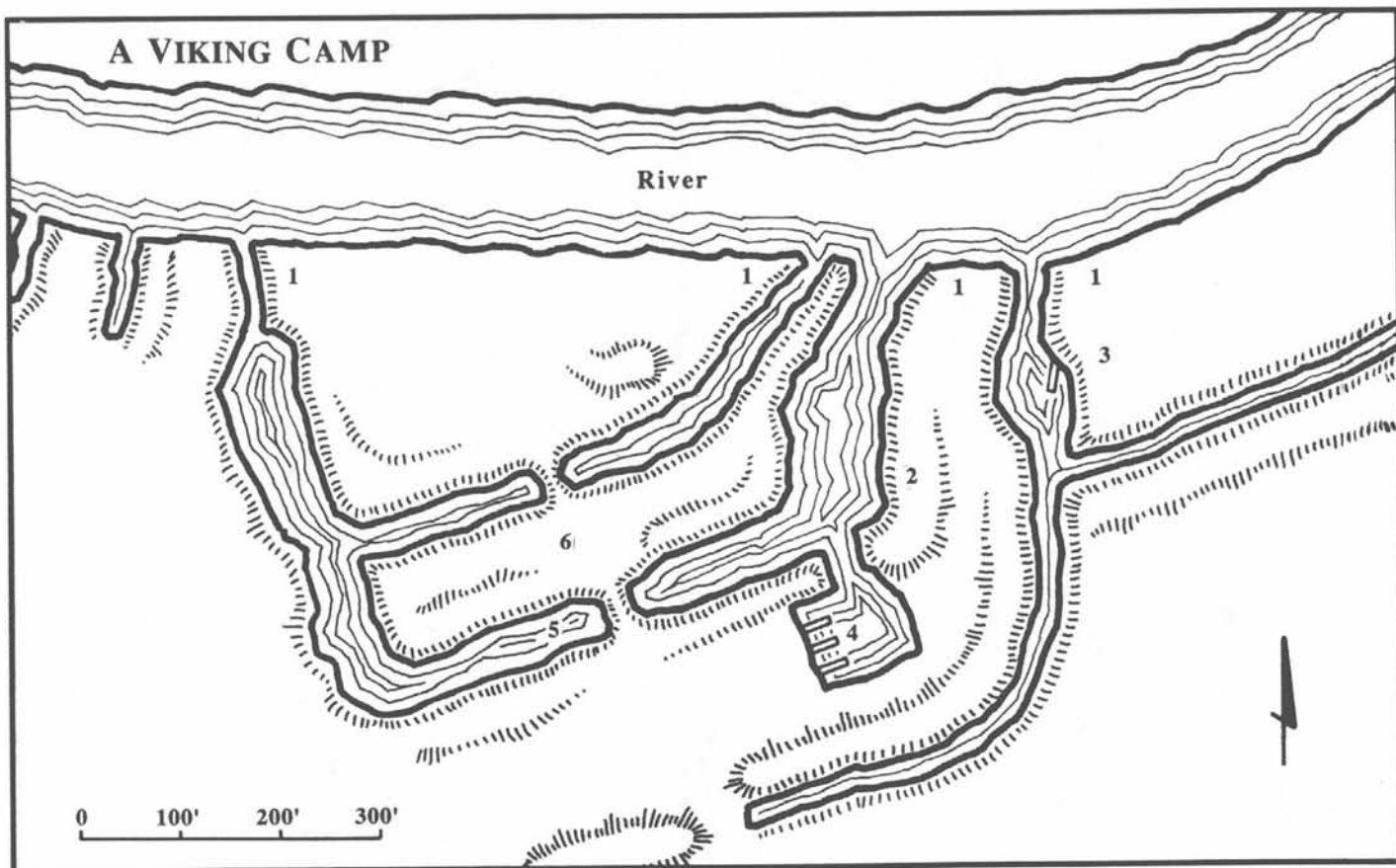
1. **Hall.** The central building where valuables were kept and the landowners lived.
2. **Kitchen.** Hungry Viking raiders might stop here for a quick bite to eat before pillaging further.
3. **Chapel.** Religious icons and other items of value stand openly displayed here.
4. **Stables.** Here, small horses were sheltered from cruel winds and cold weather.
5. **Barn.** Cows, geese, ducks and goats lived here, tended by watchful thralls.
6. **Motte.** A large earthen pile is topped by a timber watchtower.
7. **Shed.** Implements and tools were sometimes stored here. Some landowners dug pits under the earthen floor of the shed and buried gold and coins therein, hidden from all eyes.

DANEGELD

Eventually, Carolingian and British rulers evolved a strategy to cope with the Viking raids: Danegeld. In a nutshell, Danegeld was payment made to the raiders for their promise to go away and not to return. Vikings sometimes called it a "fire tax," because they were being paid not to set the town on fire. Sometimes the Christians would stipulate that the pagan raiders must be baptized in order to receive the Danegeld. The Vikings did not mind the ceremony, for baptism was an impressive and interesting ritual, and usually one received new clothes of fine wool as well.

The amount of silver the Christian nations paid as Danegeld is staggering. In 850, the legendary Ragnar Hairy-Britches got 7000 pounds of silver from King Charles the Bald (Charlemagne's grandson, ruler of France) to leave Paris and go home. Six years later, Bjorn Ironside seized an island base and was besieged by the forces of Charles the Bald and his brother, King Louis the German, but they were unable to conquer the Vikings, or to force them to retreat. Instead, they contacted another Viking chieftain, Welund, and offered him 5000 pounds of silver plus grain and cattle to get rid of Bjorn. Bjorn then paid Welund 6000 pounds of silver to allow him and his men to leave the island with their loot.

Apparently European nobles felt they could easily spare Danegeld rather than see their lands laid waste. After all, more silver could be gotten easily enough by taxing the peasants. (And a bit of the taxes collected to pay the Vikings to go away somehow remained in the coffers of the noble who paid the fierce Norsemen.) Eventually, the Vikings came to think of Danegeld as a kind of annual tribute which vassal lands must be reminded to pay by the sight of a fleet of warships sailing into their harbors.



Most of the Danegeld silver went to the fleet's royal master, not to the crewmen. The standard Danegeld was 5 marks for a crewman, 10 marks for a pilot or exceptional fighter, and 15 marks for the captain. Men aboard a ship captained by a landholder or jarl could expect similar amounts from a prosperous trade mart, but only half as much from a small trade mart or prosperous village.

In the late Viking era, royal fleets swept across the seas, bent upon conquest. Rollo the Walker (said to be too large to ride a horse) and his Danish troops conquered the Seine valley in the early 10th century. In 911, he was recognized as Duke of Normandy by the Frankish king, Charles the Simple, on the condition that he swear allegiance to and protect Normandy against further Viking attack. The oaths seem not to have bound Rollo and his descendants very much. Viking raiders could always be certain of a welcome and a market for their plunder in Normandy.

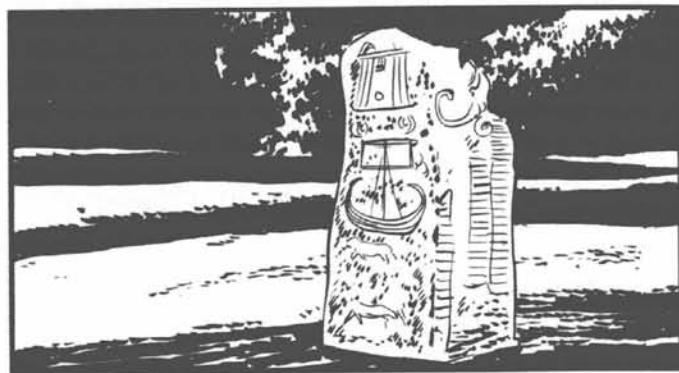
At about the same time, Danish forces conquered Northumbria and Mercia in England. They did not displace the English peasants living there but instead settled areas with land like that back home: streamside land, easily flooded and heavy in gravel and sand. Norwegian forces seized power in Scotland and also settled there, not displacing the local farmers but bringing in herds of cattle, sheep and goats, pasturing them in the mountains during the summer and feeding them hay cut from lowland meadows during the winter, a style of herding hitherto unknown to the English.

Meanwhile, the royal forces gathered greater amounts of Danegeld. By 994, Olaf Trygvasson received 16,000 pounds of British silver to distribute among his men in exchange for his consent to be baptized and his promise not to raid England again. He took the money and went home to Norway, where he claimed the kingship. Only eight years later, the English king, Ethelred the Ill-advised, paid 24,000 pounds of silver to King Svein Forkbeard of Denmark and his men. Such episodes of payment and repayment were not rare.

A VIKING CAMP (HOME AWAY FROM HOME)

Located along a the southern bank of a swift-flowing river (for easy transport of booty), this Viking camp is typical of those built in England and France in the 9th century. From the camp, Viking raiders moved inland via the river, taking horses and booty from upriver towns.

- 1. Earthen ramparts.** Defensive in nature, they presented a formidable barrier to revenge-seeking Europeans.
- 2. Harbor area.** Shallow-bottomed Viking ships could easily lodge here.
- 3. Small dock.** For the loading and unloading of food and small items of note.
- 4. Large dock.** For the unloading of larger booty and animals, etc.
- 5. Moat.** Another defensive measure typical of the Vikings, who never underestimated the capacity of their enemies to wreak havoc.
- 6. Fort.** Here the Vikings camped, sang, ate and slept.



3.5 TRADING

Wherever an honest (or even a not so honest) trader went, he had to pay taxes, based on the value of his cargo. Harbor taxes had to be paid when you docked at a trading mart. If you sailed a river, you had to pay taxes to the chieftain who controlled river traffic. One saga tells of a man who had specially built vats which seemed full of sour whey for the crew to drink, but had a hidden interior compartment in which he kept valuables.

When the chieftain's representative at the trade mart inspected cargo, he was doing more than just figuring how much to tax the carrier. For the first three days you were at a mart, the only person you could sell to was the king's man. This restriction insured that the royal court always had as many goods of value as the king was willing to pay for. If you offended the king's man, you risked a royal pronouncement forbidding people to buy your goods. If you had a new product to sell, and you managed to sell some to the king's man, the rest would probably go quickly at a good price. If a foreign trader or visitor died without naming an heir, all his goods went to the king.

The sagas usually present the payment of harbor tax as the ship captain generously making a present to the king. Undoubtedly that was how many proud Vikings thought of it. Paying taxes is (on the whole) undignified. Similarly a Viking trader who passed the winter as a guest of a landholder would make his host a generous present from the cargo, then give him first rights of buying all or part of the rest of it. Probably neither the host nor the guest thought of this as a business transaction, but only as an exchange of gifts.

One 13th century trader wrote a book of advice called *King's Mirror*, which would have served well in the Viking Age:

"Whenever you are in a market town,...be polite and agreeable; then you will secure the friendship of all good men. If you are unacquainted with the traffic of the town, observe carefully how those who are reputed to be the best and most prominent merchants conduct their business. You must also be careful to examine the wares that you buy before the purchase is finally made to make sure that they are sound and flawless. And whenever you make a purchase, call in a few trusty men to serve as witnesses as to how the bargain was made.

"You should keep occupied with your business till breakfast or, if necessity demands it, till midday. After the meal, you may either take a nap or stroll around a little while to pass the time and to see what other good merchants are employed with, or whether any new wares that you ought to buy have come to the borough.

"On returning to your lodgings [with your purchases], examine your wares lest they suffer damage after coming into your hands. If they are found to be injured, and you are about to dispose of them, do not conceal the flaws from the purchaser; show him what the defects are and make such a bargain that you cannot be called a deceiver. Also put a good price on your wares, though not too high, and yet very near what you can see be obtained; then you cannot be called a cheat."

GM Note: see Sections 8.1 and 8.2 for more information about Viking trade marts and customs.

3.6 JOINING THE ROYAL HOUSECARLS

It was easy to be accepted as one of the king's housecarls. All you had to do was ask. Some sagas tell of famous warriors who came to the royal court, gave a false name, and claimed they were totally useless, unskilled at anything, clumsy and cowardly. Then, as the days went by, it turned out that they just happened to be better at the many contests of skill than anyone else.

Housecarls were keenly competitive. In peacetime, they spent the day engaged in sporting contests: swimming, wrestling, running and nightly drinking contests. Any man who couldn't keep up with the others would be despised, the butt of all the jokes. This "weakness" was more than just embarrassing; it was dangerous. If the other housecarls felt a man wasn't up to their standards, they would throw the bones of their meal at him after eating. Some sagas tell of heavy ox bones thrown with such force that they put out a housecarl's eye or even killed him.

Every night, as the housecarls sat at the table, the bravest and most admired sat closest to the king. A fight might break out when one housecarl told another to move down for him. Most men quickly got up for a berserk who had come late to dinner and wanted his seat. (See Section 2.4 for more details on life at a Viking court.)

Some Vikings left Scandinavia far behind and went down to Byzantium, a voyage of several thousand miles. There, they took up service at the court of the Emperor. In the late 10th or early 11th century, the Varangian Guard was founded. The Guard was the Emperor's personal men, his housecarls, and all of them Vikings. Later, after the Norman Conquest, so many Anglo-Saxon exiles went to Byzantium that the Varangian Guard became largely English. (See Section 8.7 for more information on Byzantium.)



COMBAT, INJURY, AND CURING

4.1 MASS COMBAT

Most Viking armies were small by modern standards. A typical warship carried 20-35 men. A prosperous landholder might lead 50 or 60 men into battle, drawn from the ranks of his relatives, hirelings, smallholders, and tenant farmers, and be able to crew one warship. A regional chieftain might lead a land army of 150-1000 men — or crew 3D6 (3-18) warships. In the later Viking Age, a king of Norway or Denmark could field an army of 500-5000 men and lead a fleet ten times as large as a chieftain's, or 30-180 warships. Of course, victims of a Viking attack frequently exaggerated the size of the forces they were fighting in their chronicles, in order to make more palatable their loss.

NAVAL BATTLES

Most Viking battles were naval and occurred between ships in coastal waters, often in front of the harbor of a trade mart or in straits traversed by a major trade route. They began with a hail of thrown stones, spears, and arrows. Grappling hooks and anchors might also be thrown as weapons. The men on the ships might put up wooden shields on the sides, to screen themselves against missiles.

During this exchange, crews would lower the ship mast and maneuver their vessel's prow up to the prow of the enemy vessel. Grappling hooks were cast, linking the two ships. Sometimes one ship managed to outmaneuver the other and would ram it amidships, usually sinking it. A few warships were built with spiked prows that would damage another ship grappling them. Many warships were built with iron-reinforced prows.

Melee fighting at the prows would follow, until a ship's warriors broke through and began to run onto the other's deck and attack its men. The front benches were the position of honor for a warship's crew.

Most naval battles were fought on a small scale. Pirate ships would dart out of a fjord or a river mouth or an island cove to attack passing traders. Trading vessels tended to sail in groups for safety's sake, often hiring a warship crewed by friends to convoy them when they passed shores where pirates were rumored to lurk.

Pitched naval battles between rival claimants for the crown were not unusual, or between a home defense fleet and invading ships. Viking strategy for such battles was to see that defensive ships took down their masts and maneuvered into a line blocking the enemy's assault, then roped the prows of the vessels together, to keep them in line.

Once it was plain to see which side was winning a naval battle, some ships might cut themselves free and try to escape. Some crew members might take to the rowboats each warship carried. Some men might even jump overboard to escape, but only a few managed to swim to safety.

ARMY BATTLES

Viking armies (like most armies of their day) were a mounted infantry. They would ride to the battlefield, then dismount and form battle lines. (The first Europeans to develop a cavalry seem to have been the Normans.)

In Scandinavia, if an invading force was too strong for the local defense force to handle, the men would light beacons to summon the royal army. Depending on how near the royal court was, it



might take only half a day or up to three days for the king and his housecarls and half the fighting men of the kingdom to arrive to beat back the invaders. (Penalties for lighting a beacon when there wasn't an enemy attack were severe.)

Warriors could also be called up by sending the "war arrow" round from Thing to Thing, calling on the landholders to summon their men to fight for the jarl or king. The war arrow might summon men to mount an invasion of a foreign country, promising them riches and land as well. Or it might ask them to 'back a jarl's decision to rebel against a tyrannical king.

The heart of the Viking army was its leader. As long as he was visibly in the forefront of the battle, with his battle standard flying beside him, carried by one of his most distinguished housecarls, his men would have confidence that they would win. If the leader were wounded or the battle standard went down and did not arise again, then morale would plummet, and many would take to their heels.

The importance of the battle standard is shown by the fact that many had names, and a few were said to be magic. Battle standard names tend to be grim. One was called "Land Waster"; another "Raven," in honor of the birds who would flock to eat the dead.

Like naval battles, Viking land battles began with a hail of missiles: stones, arrows, and spears. Sometimes the leader or one of his berserks might cast a ritual spear, dedicating the enemy forces to Odin the Spear-god, promising him a sacrifice of all captives. (The GM will have to decide whether this action had any effect. Certainly the Vikings believed that Odin inspired berserks to enter a battle frenzy and felt that Odin could catch the souls of an army's warriors in his "war fetter," panicking them and rendering all their weapon skills useless.)

After the missiles, the men formed themselves into a line, their shields overlapping. This maneuver was known as the shield wall. A "shield fortress" formed around the leader to defend him against enemy attack. Another set of fighters formed around the standard bearer as he led the army's advance. The rest of the leader's housecarls took the brunt of the battle, with berserks and shield maidens expected to be especially prominent. Their leader had supported and honored them; now they would show whether his judgment had been sound. A Viking saying had it: "Mead is sweet; bitter when paid for."

A shield wall might move forward until it encountered the enemy's shield wall. Warriors would strike from behind their shields until one side gained the upper hand. The loser's shield wall would fall apart as men broke and ran, and the battle would disintegrate into individual fights. Then again, a shield wall might be broken when the enemy's housecarls formed a wedge, sometimes called a "swine array." This battle technique was so effective that the Vikings claimed it had been devised by Odin himself.

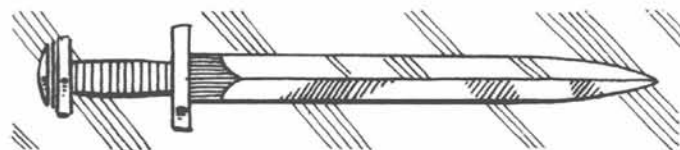
After the battle, the victors might find themselves with a number of captives. Most would be slain out of hand, but a few — who looked important, judging by their clothing — would be kept as prisoners, with a ransom demanded for their freedom. Some might be given their freedom in respect for their bravery. A proud Viking might refuse to accept any favor at the hands of a man he didn't consider his equal, so if you wanted to let a brave enemy go, you'd ask, "Will you accept your life from me?"

Prisoners served to amuse the troops. Shackled with iron chains, they would sit in the victor's mead hall. Warriors who dined there would take the bones from their meals and throw them at the prisoners for amusement. If the ransom were not paid, prisoners were killed, often as a sacrifice to Odin, speared in the side, then hung from a tree. The English chronicles tell of an Archbishop of York who was captured by Vikings, refused to permit himself to be ransomed, and died in the mead hall, slain by the axe of an angry warrior.

VIKING TACTICS AGAINST FORTIFICATIONS

Viking armies never fully overcame the defensive problems created by primitive motte and bailey castles (palisaded earthworks surrounding a central stone keep). Their favorite targets were monasteries and towns, whose main protection was their walls. Sometimes they improvised crude catapults and battering rams to break into such strongholds.

One legend tells of a Viking chieftain who got his men into the walled Italian city of Luna (which he thought was Rome) by a curious strategy. His men told the Italians that their chieftain had died, and they wanted a Christian funeral for him. When the Viking party got to the local church, they opened the coffin. The corpse leapt out and led his "mourners" in an attack upon the horrified congregation. Soon they had opened the gates from the inside so the rest of their men could join them.



CHARACTER PARTICIPATION IN MASS BATTLES

Several sagas recount tales of Viking heroes who participated in major historical battles. The customary technique is to summarize the course of the battle, supplemented by a detailed account of how the hero fought. The GM may want to provide similar opportunities for the player characters.

First, the GM should determine which side will win the battle. The major factor will probably be which side has more men. Of course, the men's confidence in their leader and his housecarls is also important. A force's chance of winning will be affected by which side has more notable warriors, particularly berserks and mages.

The GM should decide whether one side's chance of winning is:

- overwhelming** — give them the victory
- great** — they win if a D6 comes up 1-5
- good** — they win if a D6 comes up 1-4
- unclear** — they win if a D6 comes up 1-3

Next, the GM should determine each side's casualties. The winner's casualties are 4xD6% (4%-24%); the loser's casualties are 5x3D6% (15%-90%).

Now, without revealing any of this information to the players, the GM should ask each player whose characters are involved in the battle to designate a few characters (including NPCs) as "significant." The GM should then make a percentage roll against that side's casualty percentage to check if any of the significant characters are "endangered."

The GM may treat an endangered Significant Character in one of two ways. He can confront him with a suitable number of appropriate enemies and map out the fight in detail. Or he can roll on the following table to see his fate.

Roll	Fate
1	escaped, uninjured
2	escaped, only lightly injured
3	escaped, badly injured
4	captured
5	land battle: badly injured and left for dead naval battle: jumped overboard and tried to swim for land
6	dead

4.2 INDIVIDUAL COMBAT

Vikings admired men who planned their vengeance carefully. One hero said that only a thrall avenged himself at once — and a coward never did so. A challenge to a duel usually meant three days notice, even from a berserk. Men who had decided to ambush an enemy or to burn down his home usually started their attack by shouting a war cry. It was considered cowardly and dishonorable to attack a sleeping man.

However, many fights began with unpredictable bursts of violence. A ballgame or horsefight might start peacefully; suddenly there would be shouts of rage, and men would start to attack one another with whatever weapons were at hand. Sometimes, fights broke out at the Thing. In one saga, a piece of tricky legal maneuvering so infuriated one man (who was seeking compensation for an entire family of his relatives burned to death in their house) that he started by killing the defense lawyer, then led his men to attack the defendants.

Vikings did not fight on horseback. Their horse gear included stirrups, but their legs were angled sharply forward, not down. (This was probably to keep the rider's legs from dragging on the ground, given the relative height of the Vikings and their ponies.) A mounted man would be unable to give or receive a blow without great risk of falling off the horse.

MISSILES

A few men trained themselves to throw two spears at once. Some could return a spear thrown at them, by dodging it, catching it in mid-air, and turning around to absorb its momentum before throwing it back again — all in one smooth movement.

Hero Skill Note: *Missile Catching: Missile Deflection vs. Thrown Weapons with Reflection (25 points)*

In the sagas, the man in the path of a Spear Return usually fell dead. The GM may wish to allow this maneuver an increased chance of instant kill, unless the target is a PC or major NPC. The same might be done for the hero who manages to pull out a spear that has wounded him significantly, and throw it back at the enemy.

Bows were only used in dry weather, since the wet air was likely to make the bowstring stretch or break, often snapping the bow in two.

MELEE: PARRYING

Swords and other metal weapons were not used to parry metal weapons or iron-bound wood-shafted weapons, because the brittle, razor-sharp iron of the blade was apt to crack. The primary parrying defense was the small circular shield. A blow that squarely hit the shield's iron-reinforced center would bounce off, harmlessly parried. A blow that hit its edge had a good chance of impaling it and of splitting the shield. The sagas tell of many a spear and even a few arrows that went through shields — and through the victim too, killing him.

A duelist was allowed up to three shields, because one strong blow not received on the central boss would probably break the shield. One common fighting technique was to move your shield to the side just after parrying, so that you could push any weapon that impaled it away from your body.

A blow that broke a parrying shield might leave the weapon stuck in the shield. Thus, the shield-carrier could twist the weapon out of his enemy's hand. Or it could be used to immobilize the weapon and pull the enemy off-balance, allowing an attack with an increased chance of hitting. Twisting the shield might even snap a weapon, breaking the wooden shaft of an axe or spear or snapping a sword or axe blade off at the hilt.

Hero System Note: *If a weapon hits a shield and does body to it but does not break the shield, then the weapon is caught. Caught weapons may be resolved by a Str vs. Str roll using the active points in Def of the shield as a Str value. Heavier shields have more Def and body.*

A bearded axe had an axe blade plus a spike set somewhat below it. Sagas recall many a fight in which a defender's shield parried the "lower horn" (the spike), but the "upper horn" (the axe) killed the victim.

Hero System Note: *Bearded Axe: Multishot (limited to 2 shots); advantage on Kill.*

Some shields had rims reinforced with leather or small bronze plates. These were less apt to break — or be impaled. They were also heavier and less maneuverable, so they reduced the user's parrying chance. They were also more expensive.

Several sagas describe fights in which a warrior used his sword or axe to "parry" a wood-hafted weapon — by cutting off the haft. A concussion blow against the haft could knock the weapon from the enemy's hand and send it flying through the air.

Hero System Note: *Attacks on Weapons: Roll as attack on the weapon itself and check def and body.*

A weapon could also be "parried" by cutting off the wielder's weapon arm. A heavy enough blow against the arm from a concussion weapon (or from a "blunted" edged weapon) could break the armbone, causing the victim to drop his weapon. One saga tells how a man parried an axe-blow barehanded, knocking the haft aside with his left hand, and causing his enemy to drop the axe.

Hero System Note: *Attacks on Limbs: Divide twice the Target's body by 4. Assume this is the number of body needed to amputate a limb.*

MELEE: DODGING

The Viking had little protection from an enemy's blows. His shield was small and flimsy. Even his ringmail byrnie did not cover his legs. Little wonder that his defensive fighting style depended on being light on his feet, frequently jumping backwards, to the side, or into the air to dodge blows directed at his feet.

The Eyrbyggja Saga tells how one warrior saved a friend who had slipped and fallen on ice by running up and sheltering him under his own shield. He cut off the leg of the man who was attacking his friend as he leaped up into the air so that another enemy's sword passed harmlessly between his legs.

Hero System Note: *This move is not really a dodge but the use of DCV or pb.*

MELEE: ATTACK

Many Vikings trained themselves to use two melee weapons, one in each hand. (This feat is easiest if the two weapons have similar attack modes and weight.) Vikings were able to switch their weapon to their other hand, if their weapon arm was wounded.

In addition, a warrior might drop his shield or hang it around his neck, in order to grip his weapon two-handed, so his blows would cause more damage.

Danish historian Saxo wrote, "Of old, in the ordering of combats, men did not try to exchange their blows thick and fast, but there was a pause and, at the same time, a definite succession in the striking, the contest being carried on with few strokes, but those terrible, so that honor was paid more to the mightiness than to the number of the blows." (As GM, you might decide that all blows must be aimed at the head or at a limb.) Here's one saga account of a fight, which illustrates Saxo's point.



A LAND BATTLE

"Skarp-Hedin waited while Sigmund put on his helmet and shield, then hung his sword at his belt and picked up his spear. He thrust his spear at Skarp-Hedin, who took it on his shield, then severed the spear-shaft with his axe. Then he swung his axe at Sigmund, splitting his shield.

"Sigmund drew his sword with his right hand and hacked at Skarp-Hedin, piercing his shield and sticking there. Skarp-Hedin twisted the shield so sharply that Sigmund let go of the sword. Then Skarp-Hedin swung his axe again. It caught Sigmund on the shoulder, sheared through his jerkin and severed his shoulder-blade. Skarp-Hedin jerked the axe toward him, pulling Sigmund forward onto his knees. Sigmund jumped back up to his feet again. Skarp-Hedin hacked once at his helmet, then cut off his head with the next blow."

A Viking warrior who wished to insult an enemy but not injure him did not "pull" his weapon blow. Instead he struck with the flat of the sword or the back of the axe handle or with his shield.

MELEE: DUELS

Dueling was an accepted alternative to lawsuit in the Viking culture. Either the plaintiff or the defendant could decide at any point in the legal process to stop bothering with the law and to challenge the other side to a duel instead. Usually this meant that the challenged individual had three days to refuse or accept, possibly naming a champion to fight for him.

Refusing a challenge to a duel was an acknowledgement that a man was old, feeble or a coward. (The GM would be wise not to push this idea to extremes. A man could refuse the challenge of a botheaded youth without losing his reputation. A woman or an elderly man could ask for a champion to fight in their place.)

A common tactic of the berserk bully was to challenge a smallholder or tenant farmer or craftsman to a duel, with the stakes being his estate and often one of his unmarried daughters, or even his wife. Or a berserk might kidnap a lovely woman, keep her with him a few days, then ride off again. One saga tells of a Swedish

berserk who came to Norway as a wandering duelist in order to get rich. He had gotten a lot of land and goods from the farmers he'd killed — until a hero killed him, at last.

Another saga records how one divorced Viking announced he intended to keep all the property his ex-wife had brought to the marriage and challenged her father to fight him if he objected. Her old father was unable to find any champion willing to face him and had to accept. Years later, the woman persuaded a great warrior to help her. He managed to revive her divorce suit and then made her ex-husband the same challenge: fight me or give your wife's money back to her, all of it. The ex-husband did so, but cursed him.

A duel was held in a level field, often on an island, perhaps because these were often unowned by any landholder. It was unlucky to kill a man where his afterganger could haunt a household or farmland.

In a formal duel, the dueling area was marked off somehow, sometimes with stone markers or hazel posts, sometimes by pegging down a piece of cloth two yards on a side. Each duelist was allowed up to three shields, one after the other, since they were so easily broken. In some cases the duelist was allowed a second who protected him with a shield. The challenged had the right to strike the first blow.

If one of the fighters was wounded enough to bleed significantly, the fight could be counted as won by the other. Putting one foot outside the limits was called a "retreat"; putting both feet outside was called "running away." Either action could be counted as ending the fight, with the loser obligated to pay a fine (customarily three marks of silver) to the winner. Or the duel might go on and on until one of the fighters was dead.

If the challenger won, he got everything at stake. If he lost, he had to pay a sum that had been previously agreed on. If he was killed, he forfeited all of his property, which was inherited by the man who killed him. The king got a tenth of the estate of any man killed in a duel.

SURRENDERING

Sometimes Vikings surrendered, when faced with overwhelming numbers of opponents. A prisoner might be tied up with bowstrings, then later bound with iron shackles and chains and displayed at the victor's mead hall, to give sport to his warriors. Or he might just be thrown into a pit or imprisoned inside a barn.

Robbers usually demanded jewelry or money, then left with the loot, leaving their victims still alive. Similarly, at sea, men might capture a ship but would not kill any of the crewmen who surrendered. Instead such men were put ashore. They were usually allowed to keep their clothing and weapons.

QUICK COMBAT RESOLUTION

If you want to get a fight over fast so you can get on with the adventure, use the table below (based on the sagas). First determine for each player character (or significant non-player character) involved which character-type best describes him. (If none seems to, then don't use this table.) Next, roll D100 for Fight Outcome.

Character

- 1) Hero:** a man in his mid-20s who has quite a reputation for bravery and honor.
- 2) Novice:** a younger man who hasn't got a reputation yet but also hasn't done anything cowardly or ignoble.
- 3) Braggart:** a man whom other Vikings laugh at because he boasts a lot but doesn't accomplish much.
- 4) Niddering:** like the hero but actually a treacherous backstabber (see Section 2.5).
- 5) Normal:** an ordinary Viking.

Fight Outcome	Character				
	1	2	3	4	5
enemy loses	01-50	01-30	01-10	01-35	01-20
enemy escapes	51-80	31-60	11-25	36-60	21-40
no clear winner	81-95	61-90	26-60	61-80	41-60
chased by enemy	96-98	91-95	61-95	81-90	61-80
enemy wins	99-00	96-00	96-00	91-00	81-00

4.3 OTHER DANGERS

SWIMMING

Viking sporting contests included swimming races and ducking contests (in which men pulled one another under water to see who could go the longest without breathing). Beowulf tells of a swimming endurance contest in which two heroes spent three days swimming in the ocean, to see which of them would outlast the other. Occasionally they had to draw their swords and fight off nicors (sea monsters).

A Viking might also have to swim for his life to cross a rain-swollen river to escape his enemies, or to reach land from a sinking boat. A man fording a river in winter or early spring might have to fend off large chunks of ice floating downstream.

Obviously, the more a swimmer was encumbered by clothes, armor, weapons, treasure, and other possessions, the harder it was to swim. A wounded man often found that plunging into the cold water sent him into shock. A skilled swimmer could swim for several hours in the relatively warm water of the summer ocean, but would probably last only 30-60 minutes in the colder waters of the spring or fall, and just 15-30 minutes in the winter.

WINTER AND STORMY WEATHER

Climatologists say that the weather was milder during the Viking period than it is nowadays. Many of the trade routes used by Vikings were abandoned a few centuries later because they were so frequently blocked by icebergs. There were fewer storms during the rainy season. Yet any voyage was somewhat dangerous. Even a boat crossing a fjord might be caught by a sudden gust of wind and capsized, often drowning its passengers. (See Section 3.3 for shipwreck notes.)

Winter brought rain, wind, freezing cold and darkness. A walk to the privy became a test of will. Mountain snowbanks might come tumbling down as a deadly avalanche, burying travelers where no one would find them until the spring thaw (see Section 3.3). In one saga, a shamaness's song caused an avalanche that toppled an entire farmstead, killing the family. Neighbors gathered and captured the evil magic user, took her down to the ocean shore, and stoned her to death.

A fight under winter weather had special hazards. A fighter might well slip and fall on the icy ground. Heavy clothing (which had to be worn to keep warm) increased the fighters' encumbrance and decreased their chance of dodging.

Winter cold was dangerous all by itself. Frostbite could cause anything from mild discomfort to loss of a limb due to gangrene to the victim's death from shock. Chance of frostbite depends not just on the cold and wind velocity, but whether or not the victim is sick, drunk, or wounded.

POISON

Of course, venomous serpents slithered upon the mainland; Iceland and Greenland were too cold. Poison herbs included baneberry, mistletoe and yew. Poison was rarely used, but one saga does tell of a treacherous queen who slipped it into a drinking cup she offered an enemy, who detected it and insulted her.

FIRE

Wooden buildings were easily set afire during the dry season, since the wood was tarred like that of a ship to keep it from rotting. Sometimes, the people inside were able to put out the fire by using buckets of whey or ale. But if a building would burst into flames, everyone who remained inside was doomed.

Even when the enemies had surrounded a house and set it fire, it was considered honorable to let the women, children and thralls to leave the building. One saga tells of a man who put on a dress and tried to leave with the women. He was spotted and killed.

DRUNKENNESS (OPTION)

Drinking Contests were a common way to pass the evening at a Viking court. Here's how to figure out who wins. A character has 1 ounce of blood for each pound he weighs, when fit. (Pounds of overweight don't count. Pounds of underweight are subtracted.)

One drinking horn of ale has half an ounce of alcohol. One drinking horn of mead or wine has a full ounce of alcohol.

Starting when the character hits 1% of blood (1.5 ounces for a 150 pound man), after each horn he drinks he must roll Con or lower or suffer the effects of that drunkenness level. If he makes the roll, he will suffer the effects of the next lower drunkenness level — unless he makes another roll. Thus, someone at 3% must make three rolls to avoid being affected. (10% of the alcohol drunk goes to the bloodstream, so the Blood Alcohol %age is 10% of that given below.) A character can metabolize 1% of blood in two hours.

Trollbloods and berserks can handle twice as much alcohol as normal. Trolls, dwarves, and giants can handle five times as much alcohol as normal.

Alcohol Percentage	Effects
1%	Lower Dex, skills, saves. Reduce Ag by 5 in <i>RM</i>
2%	Even lower.
3%	Even lower.
4%	Affects as Mild Poison; fall asleep. Even lower stats if awake.
5%	Affects as Medium Poison; may die, otherwise asleep.



4.4 TENDING INJURIES

STAUNCHING BLEEDING

All Vikings knew how to bandage a wound so as to keep the victim from bleeding to death. They could even treat a man who had an arm or a leg lopped off. Several Viking heroes had wooden legs. One of them was nicknamed Onund Tree-Foot. After the fight in which he'd been maimed, he got married but continued to go on raiding expeditions. In one fight aboard ship, he took off his wooden leg and rested his knee on a log so he could move about a bit without losing his footing. He killed his enemy and boasted, "On a single leg, I dodged the blows you dealt me."

LEECHES AND HERBALISM

Leeches not only knew more about herbs than the average man but had special recipes (and perhaps even magic talents) to make the herbs they used more efficient. Leeches could not, however, tell the difference between natural illnesses and those caused by miscarved runes. The GM may wish to require that a leech's most powerful recipes be made of herbs picked at certain special times or enchanted by various spells. See Section 6.2 for more information about leeches.

5.0

FOLKLORE AND SUPERSTITION

The GM must decide whether the following beliefs are mere superstitions or actually the way things work in the campaign. All the player characters will believe the superstitions, of course, and will heed their warnings.

5.1 FATE AND LUCK

Each person's fate was determined by the Norns who had come to his birth. A man could be lucky regardless of how stupid and clumsy he was. (A lot of Norse folk tales have as their hero a lazy third son who's finally kicked out from home. He'd spent his time sitting at the hearth, doing nothing brave or heroic, and so he was called Ash-boy: the male equivalent of Cinderella, with no jealous stepbrothers to blame for his misfortunes.)

Or a man might be unlucky, despite being intelligent and brave and strong. One Viking king told a hero: "I realize that few men alive now equal you in strength and valor....But your ill luck is so great that you cannot stay with us. You are free to spend the winter wherever you please, but next summer you must go back to Iceland, for that is where you are fated to die."

A number of people had Second Sight and could see the aura of Luck surrounding someone. They could also sometimes see visions of the future and know what would happen long before it did.

A man whose luck had run out was *fey*, doomed to die. Often he saw omens of his end: phantasmal blood on a field or fire in his house or the *fyrgja* of his enemies who would soon attack him. He might be warned by a prophetic dream, or by the words of a friend who had Second Sight. A dying man's curse could bring his killer bad luck. The safest way to guard yourself against a death curse was to not let your victim know your name or, failing that, not let him look at you with his death gaze.

Most players will probably not want to send their characters into a fight they have no hope of surviving. Instead, their characters will pay keen attention to the omens before going into a battle. (As GM, you should remember that some "bad omens" are coincidences.)

Here's the advice given Sigurd Dragonslayer by Odin using the name of Nikar Fjolvir (Much-Knowing Spear-Thruster):

*It is well if a warrior meets a black raven.
It is well to see two famous men fighting each other.
It is well to hear a howling wolf under an ash.
It is well to see your foe before he sees you.
It is ill to fight facing the afternoon sun in summer.
It is ill if you stumble as you go forth to fight.
It is well to comb and wash yourself and eat breakfast, for who knows where you will be by evening?*

Njal's Saga tells how Gunnar Hamundarson was outlawed for three years because of his killings. He planned to go raiding to pass the time; his Second Sighted neighbor Njal had assured him that the trip would be successful. "You will come back a man of great renown; you will live to be an old man, and no one here will be your equal. But if you break this settlement, if you don't leave the country, you will be killed here in Iceland."

But as Gunnar was riding to his ship, his horse stumbled, and he had to leap from the saddle to avoid falling. He got back into the saddle and turned his horse back homeward again. He told his brother that his land looked too beautiful to leave, but probably he was also thinking that nothing but ill luck would come from a trip that began with a stumble and fall.

Eirik the Red also left home because he was outlawed, first burying a chest of gold and silver. As he rode off, he was thrown from his horse, breaking some ribs and injuring his shoulder. He didn't stay home, but he did send a message to his wife, telling her where he'd hidden the treasure and to dig it up again. "He said that he had been punished for hiding it."

Many Vikings wore amulets to bring them luck. Thor's hammer was popular among the pagans, often with two eyes engraved on its hilt so the god could see what was happening to the wearer. So was the image of Frey as a warrior wearing a horned helmet. Christians wore crosses as amulets. Some silversmiths had molds that could be used to cast both forms, to satisfy all their customers.

Luck for Rolemaster

See *RMCI*, Section 5.4 for Luck. See *RMCI*, section 3.6, spell #36, "Imprecation" for Dying Curse.

Luck for Fantasy Hero

Amulets: 3d6 Luck (Independent = Amulet) = 5 points.

Death Curse: 3d6 Unluck, usable on others, AT Range, based on ECV; Only at death, only on killer = 22 points.

5.2 TROLLS AND GIANTS

The GM must decide if trolls were nonhumans who lived underground and turned to stone by daylight (see Section 10.1) or just Lapps with strange, seemingly magic powers (see Section 8.3). Either way, Vikings distrusted and feared them. Troll-mounds rose on red pillars on the great pagan festivals (and later at Christmas, Easter, St. John's Eve, and All Hallows Eve), so that anyone could enter and with luck, exit.

Later folk tales claimed that associating with trolls could leave you feeble-minded. Vikings told one another that trolls were afraid of steel and fire, the marks of civilized man's high technology. You could scare off a troll with your tinderbox of flint and steel.

Trolls feared fire and steel, but they knew a lot about special herbs of life which could be used to preserve a severed eye or hand or foot so it could be reattached to the body, by a troll, a trollwise leech or a wizard. Trolls used "sleep-thorns," which could be thrust into someone's arm or leg; the victim would go to sleep at once and continue to sleep until the thorn was removed.

WATER-TROLLS

Water-trolls breathed both air and water; they lived behind waterfalls or at the bottom of deep pools. Beowulf mentions how its hero fought first a water-troll Grendel and then its mother. Grettir's Saga tells how its hero fought a she-troll who carried a trough in one hand and a big cleaver in the other. He cut off her right arm, and she ran away to a river gorge and vanished under the waterfall. Grettir followed her there the next day and found a giant, whom he fought and killed.

Another saga speaks of a mighty shaman named Grim Aegir who must have been the son of a sea ogress; he breathed both sea and fresh water. Like a berserk, he ate raw meat and drank blood. He could also shapechange into a dragon which breathed venom and fire. Of course, a cave behind a waterfall was also a good hiding place for an outlaw, who might perhaps be a berserk. The GM must decide whether water-trolls are legendary or real.

FROST GIANTS

Norse myths told of Frost Giants who towered as high as the mountains and were stronger than most gods. Norse sagas spoke of giants who lived in Greater Sweden, in Permia and in the lands further north (see Section 8.12). The GM can decide whether there really are giants, and if so, how tall and strong they are (see Section 10.2).

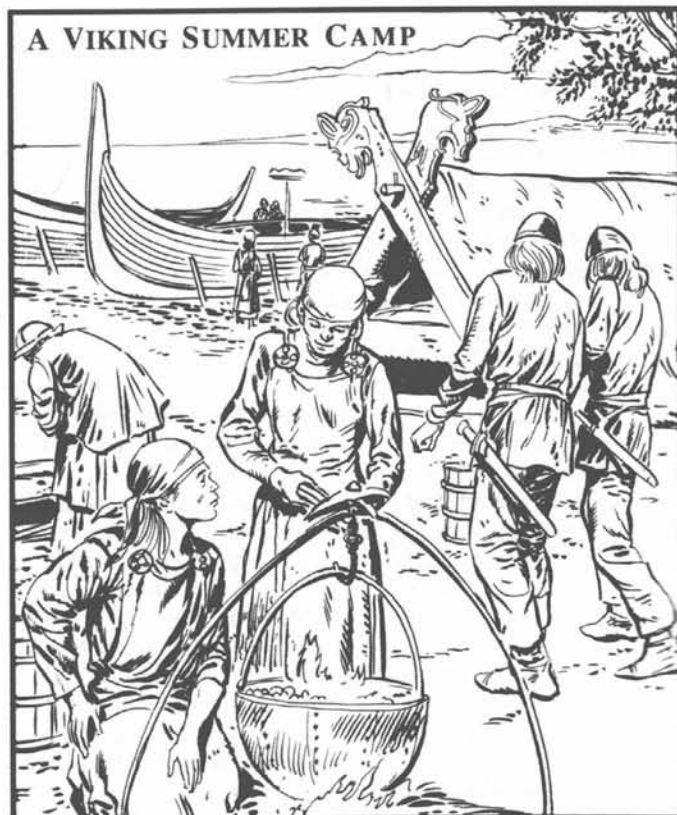
5.3 DWARVES AND ELVES

Norse myths speak of Dwarves who were as small as children but knew more smith-magic than the gods. Some Dwarves were master smiths; others were wizards who knew the secrets of magic herbalism. Dwarves made Freyja's beautiful necklace and Thor's mighty hammer, which flew back to him after he threw it. By nature, Dwarves were always greedy for gold. The Norse sagas also mention Dwarves. Some said Dwarves wore mist-caps which made them invisible, but added that they turned visible again if the cap were knocked off. Others insisted that Dwarves were superb at skulking and hiding. The GM must decide whether there really are Dwarves, and what they are like (see Section 10.3).

Norse myths also spoke of White Elves, who served Frey and Freyja. Norse folk tales mentioned elves who lived in hill-mounds, like dwarves and trolls. In fact, the Norse called all of them the hill-folk, and described some as tall and ugly, some short and ugly, and others mid-sized and beautiful. Elves were invisible most of the time, because they wore the same mist-caps as Dwarves.

Elves had their own chieftains, each with his own band of housecarls. Sometimes people claimed to have seen an Elf army standing by the shoreline, waiting to defend the land against human raiders who would arrive the next day. At night, Elves pastured their blue-skinned cattle on the dew of the meadows or danced beneath elder or linden trees. People who cut down such trees or swept dirt under them or who stood under them after sunset would annoy the Elves and suffer bad luck.

People who listened for Elf music at midnight sometimes heard "The Elf King's Tune," which made anything that heard it start to dance, even furniture. If a human musician tried playing the tune, he couldn't stop playing — unless he managed to play the tune backwards or someone came up behind him and cut the strings of his harp or fiddle.



5.4 NIS

Each farmstead supposedly had a Nis who brought it good luck, as long as people paid him proper respect. Norse folk tales about Nis are like English folk tales about brownies. A Nis was the size of a two-year-old child, but had the face of an old man. He dressed in gray with a pointed red cap. If given nice new clothes, he would stop working.

Nis didn't like noise and dirt and punished careless or lazy workers. They would clean the stable if left a bowl of porridge with a pat of butter atop. In Christian homes, it was the Nis who brought the children presents on the Twelfth Night of Christmas (January 5th). Nis were shy and if anyone spied on them, they would pack up and leave the farm, taking all its luck with them. The GM can decide whether there really are Nis, and if so, what they are like.

5.5 VALKYRIES

Norse myths spoke openly of Valkyries, Odin's daughters who flew through the air to seize the souls of heroes who died in battle. Some sagas told of beautiful valkyries in swan-cloaks; others told of giant valkyries ugly as trolls (see Section 11.4).

Some said that the Valkyrie flew at Yule to rouse the souls of those that had died and to see which ones were brave enough to enter Valhalla. Any living man foolish enough to go outside when the Valkyries flew by in their Wild Hunt might also be taken. Or perhaps people cowering from the Wild Hunt really heard the howling of the winter winds, and what they saw were the lights of the aurora borealis. The GM must decide whether there really are Valkyries, and if so, what they are like.

5.6 WATER SPIRITS

Vikings heard legends of mermen, who looked like handsome men with green hair. One merman appeared to an Iceland settler and prophesied a great future for his son, but said nothing of the man's own future. The man died the next year. Another merman appeared to a boat of fishermen and complained of the cold. One of the men threw him a mitten. That night, when the fisherman was ashore in bed, he heard a voice warning him of a storm. He dragged his boat up into its shed to protect it. Fishermen who had left their boats beached on the strand saw them wrecked by the great waves.

A few tales of beautiful mermaids, with long golden hair who pastured their snow-white sheep at the seaside, existed as well. Seeing a mermaid was unlucky, for they only came up just before storms. People lost or drowned at sea were sometimes said to have been taken into the dwelling of a lonely mermaid.

A *stromkarl* (stream freeholder) is a river spirit that looked like a handsome boy or man, with golden hair and a red cap. He loved playing the harp, particularly by a waterfall. His music was so beautiful that the trees danced to it, and the waterfall stopped running to hear it.

Draugs were the unrecovered bodies of drowned sailors who did not have enough money to be made welcome in the halls of Ran (see Section 11.12). They could sometimes be seen, rowing half a boat or screaming as the storm winds howled. They could not find rest until they had brought Ran a guest who could pay for both their welcomes. (See Section 10.6 for further details.)

5.7 TREASURE FIRES

Corpsefires were said to burn over the grave mounds of mighty warriors who had been buried with silver and gold. Sometimes, like the troll mounds, these grave mounds opened up. After Gunnar Hamundarson's death, his eldest son and his neighbor Njal's eldest son saw him one night by moonlight.

"Suddenly it seemed to them that the mound was open. Gunnar had turned round to face the moon. There seemed to be four lights burning inside the mound, illuminating the whole chamber. They could see that Gunnar was happy....He chanted a verse [saying that he would rather die than yield]."

Corpsefires were also said to burn over buried treasure; many chests of silver were buried in Scandinavia. The Vikings buried their treasure hoards in time of danger, lest robbers steal them. Whenever there was a major battle between claimants for the crown, warriors on each side would hide their wealth. Some of them survived to dig it up again; others didn't. Some men, perhaps fearing that their grave-mounds would be robbed, arranged shortly before their death to have strongboxes full of silver thrown into swamps and bogs where it would be impossible for a mortal to dig it up again.

Sometimes dead people, especially great warriors and wizards, walked again after death and could only be stopped by killing them once again — and then cremating them. (See Section 10.6 for further details.)

5.8 MAGES AND OTHER STRANGE PEOPLE

Most shamans were women who were possessed by Freyja, goddess of love and death. Many sagas tell how shamans went from farm to farm from Winter's Eve in the fall to Yule at midwinter, forecasting the weather and luck of the coming year.

A shaman would mount the gallows-like platform, listen to the chanting and enter a trance, possessed by the spirits of the dead. A male shaman was considered effeminate. People gossiped that he turned into a woman once every eight days, because Freyja would not give her gifts to someone who was always a man. Even Odin had had to take on women's form in order to learn shaman magic. (See Section 11.3.)

Most Vikings were illiterate. Some could read the modern runic alphabet of 16 characters; only a few could read the old runic alphabet of 24 characters. People said that just writing these characters could cause magic effects, and added that if they were miswritten, they would curse anyone who touched them. Runes were carved over a grave to protect the dead person from being bothered and his grave goods from being stolen.

Vikings feared tall ugly men as trollblooded, possibly shapechangers. They believed such men could see at night as well other men did by day, and that their strength increased by night to far greater than usual. Many such troll-like men were berserks, who ate meat raw and drank blood as if they were animals. They had other animal ways, howling like wolves when they entered their frenzy. Most fought with the strength of a bear.

Berserks were thought to be immune to fire and steel and could only be wounded by wood or being bitten. Some Christians claimed that a berserk could be wounded by a fire lit in God's name or by a wood crucifix. Most people thought that mages were also immune to fire and steel and could only be killed by being strangled, drowned or bludgeoned to death with a wood or stone implement.

One Viking saga tells of a man whose father and elder brother were both killed by a great bear. He hunted the bear and killed it, and then ate it raw, taking its meat as his wergild. When his neighbors heard about this, they grew nervous about him. His sister must have behaved strangely, because her neighbors seized her and announced they were going to stone her to death as a witch. The bear-killer heard the news and rescued her, traveling — so gossip went — 220 miles by foot that night, across the mountains. Men told one another that he was a shapeshifter and ceased to bother him.

5.9 HERBALISM

Vikings believed that many herbs held the secrets to staunching bleeding and making wounds heal faster. In the hands of a born leech, these herbs might even heal wounds that would otherwise prove to be fatal. Other herbs might save someone who'd been poisoned or stung by a venomous viper. Rare "herbs of life" would preserve a severed limb and allow it to be rejoined, as good as new, to the body it had come from.

5.10 TALES OF THE SKALDS

Norse skalds sang songs of the great heroes of ancient times, not of Vikings but of Germans whose tales had become popular (and were changed) in Scandinavia. Scenes from these tales were carved in wood and ivory, embroidered on tapestries, and enameled on display shields.

VOLUND ALL-WISE

Volund All-wise was known to the Germans as Weyland Smith. He was, said the Norse skalds, one of three Lapp brothers, who married three princesses who wore swan-cloaks so that they could fly through the air in swan-form. After seven winters, the girls flew away once more. Two of the brothers went in search of their wives, but the third, Volund, remained home and counted his wealth. Then he woke one morning and found himself fettered, captured by King Nithuth of Sweden, who addressed him as "the greatest of Elves."

The Swedish king took his captive back home. He wore Volund's sword and gave his daughter a gold ring he had stolen from Volund's treasure. When he saw Volund's gnashing teeth and glowing eyes, he had them cut the smith's knee tendons so that he couldn't fight or run away. Volund was taken to an island where he made precious things for his captor and brooded about revenge.

One day, Nithuth's two sons came to look at the smith. Volund cut off their heads. He then sent Nithuth their skulls set in silver, with jeweled eyes. From the boys' teeth he made a brooch which he sent to Nithuth's daughter Bothvild. Then he forged himself wings and flew away.

SIGURD DRAGONSLAYER

Sigurd Dragonslayer was known to the Germans as Sigfried, the descendant of Volsung, who was descended from Odin. He had a magic sword given him by a Dwarf named Regin. He used the sword to slay Fafnir, a Dwarf who had taken on dragon-form to guard his treasure, wergild for his brother's slaying paid by Odin long ago. The wergild gold was cursed, because it had been stolen by Loki from another Dwarf, Andvari. It would always bring bad luck and betrayal.

Fafnir got the treasure by killing one of his brothers for it. He guarded it for centuries, but was then killed by Sigurd. He spent his dying minutes trying to learn Sigurd's name. Once he had found out his killer's name, he warned him that the treasure would be his bane if he took it.

Sigurd took Fafnir's heart and roasted it. Its blood let him hear the nearby birds warning him that Regin was Fafnir's brother and that he was plotting to kill him to revenge his brother's death. Sigurd killed Regin, then drank his blood. Afterwards, Sigurd followed the birds to where a swan-cloaked princess lay sleeping, surrounded by a ring of fire. Her name was Brynhild, but she was nicknamed Sigrdrifa (Victory Bringer).

Later, Sigurd married another woman, Gudrun, daughter of Djuki, king of the Burgundians. Her mother gave him a magic potion which caused him to forget all about Brynhild. Later, Sigurd arranged for his brother-in-law Gunnar to marry Brynhild. Eventually Gunnar learned that Sigurd had seduced Brynhild. He plotted revenge with his brother Hogni, killed the hero and took his treasure.

Sigurd's wife Gudrun married again, this time a king, Atli (Atilla the Hun). Atli invited his wife's brothers to visit him. Once they were in his power, he asked them where Sigurd's treasure was. Gunnar told him to have Hogni's heart cut out. Then he told him that no one knew where the treasure was but he himself, and he would never tell. Atli had him imprisoned in a pit full of snakes, which he supposedly kept calm by playing the harp — with his toes, because he was bound hand and foot! Gudrun learned of her brothers' deaths and prepared a banquet for Atli — made from the flesh of their two sons. Then she set his hall on fire and burned him and his men alive.

Later, Gudrun married a third time to a king called Jonak and bore two more sons. Svanhild, Gudrun's daughter by Sigurd Dragonslayer, was married to King Jormunrekk, who grew jealous that his wife was betraying him with his son. He ordered his son hanged and saw that his horses trampled Svanhild to death. Gudrun sent her two young sons to avenge their half-sister; Jormunrekk's men stoned them to death.

FRODI AND HIS MILL

King Frodi was the grandson of Odin's son Friddleif, who ruled Denmark and Gotland. Under his reign, the whole world was at peace. Men did not kill the slayers of their relatives. A gold ring could lie on the ground and no one would steal it.

One day King Frodi visited the royal court at Sweden. There he bought two strong female thralls named Fenja and Menja. He brought them home and put them to work at the hand-mill Grotti, whose two millstones were too huge for anyone else to use. The millstones were magic and would grind out whatever you sang you wanted. He told them to grind out gold, peace and prosperity for his people. They couldn't stop longer than a cuckoo stops its singing.

The thralls ground at the hand-mill and wrote a song which they called "Grotti's Song" after the hand-mill. Once it was done, they sang the song as they ground, and the hand-mill ground out an army. The army went to Frodi's court, killed him and looted his palace. The peace of Frodi came to an end.

The Viking at the head of the party took the hand-mill Grotti and the two thralls away with him on his ship. He ordered the women to grind out salt, which was valuable in those days because the sea was as fresh as the rivers. At midnight, they asked him if they could go to sleep, but he said they had to go on grinding. Soon the ship sank. The sea poured into the hand-mill and became the Maelstrom. The thralls kept on grinding, and that's why the sea is now salty.

MAGIC AND UNUSUAL CHARACTERS

Many Viking kings kept berserks as specially valued housecarls who sat on the front benches of the hall each night and entertained the royal court but were expected to fight in the front line of the army during battle. Some kings also had shamans and trollwise wizards among their housecarls, to find their enemies in hiding and to cast spells against them.

Some spell users were outlaw chiefs, who led bands of robbers or pirates. Gangs of berserks lived in the wilderness but made forays into an isolated farmstead or a village, much like bandit gangs in the Wild West who terrorized frontier farms and towns.

There were also some spell users who lived peacefully on farms. These mages carefully concealed their abilities from their neighbors, for fear that they would be blamed for everything that went wrong. Rune Carvers passed as Skalds, Shamans as ordinary people with Second Sight, Wizards as Leeches.

There are saga stories about an apparently normal farmer or farmwife who cast a spell too obviously and woke up to find themselves bound and hooded (so they wouldn't be able to curse people with their gaze). Their neighbors killed them by strangling, drowning, or stoning; then buried the bodies below the high tide line or on a desolate mountain ridge where no man plowed or herded or hunted. Even so, sometimes their bodies walked again as aftergangers.

It's not surprising that most wizards and shamans chose to live in the wilderness, like outlaws. Wizards, particularly wizard artificers, had huts high in the mountains (to be near their friends, the trolls, the Vikings would tell you). Shamans lived in the deep forests, among the animals, but came down to the lowlands at Yule. They spent the winter going from village to village, from farmstead to farmstead, telling people's fortunes for the coming year.

If your party of adventurers has spell users, they should not mention it to the average Viking farmers or traders they meet. Only mention it to a chieftain if you want to receive an invitation to become a member of his housecarls. If you refuse the invitation, the king will probably decide that you are his enemy and he may send his housecarls after you.

6.1 MAGIC ARTIFACTS

Despite the Viking distrust of spell users, many a Viking hero had a magic artifact. It might have been inherited from a famous ancestor or given during a trip through the wilderness by a chance-met stranger, or won in a fight from a great warrior. (Sometimes the warrior would be dead, an afterganger fighting to keep the weapons he'd had buried with him.)

Each magic artifact was unique, with its own name. Many could not be used except under special conditions. One sword could not be drawn in sunlight or in the presence of a woman. Another could only be drawn three times in a man's life. A third had to slay some human being once it had been drawn, even if that meant slaying the wielder's best friend. One linen shirt, magically embroidered, protected the wearer against all wounds as long as he never retreated from combat, no matter how overwhelming the odds.

There were magic swords, spears, axes and arrows, magic shirts and cloaks of reindeer hide that protected the wearer better than a byrnie, magic rings and necklaces and other pieces of jewelry. Each had its own special powers of attack or protection.

None of these magic artifacts stored spells. Vikings had no wizard staffs or wands, no scrolls of spells, and no potions of spell casting. However, you as GM may want to include some of these magic items in your game. Perhaps they arrived from faraway lands where the Vikings traded, like Byzantium, China and Egypt.

Wizard artifacts mentioned in the sagas typically take a year and a day to make. A wizard artificer needs standard weaponsmith skills to make a magic weapon or armor or shield, standard weaving and embroidery skills to make a magic shirt, etc. Some of these artifacts will be preserved as family heirlooms; others will be presents from patrons or won in battle. Some of them may be broken, like Sigurd Dragonslayer's sword, which had to be reformed by a man who knew no fear before it was used. Mending a broken artifact requires the same magic knowledge and standard skills as making it in the first place.

For sample magic items, a GM may refer to *RM's C&T* or to *FH's Magic Items*. You may wish to keep a list of all magic artifacts in the campaign, to be sure that no two are exactly the same. Ideally you should know what wizard made each artifact and why. Of course, the players won't know the details of each artifact, even the ones currently used by player characters.



MAGIC ARTIFACTS

Here is a list of several magic artifacts mentioned in the sagas:

- A weapon enchanted so that it is the only way to kill someone or something. This weapon may be wielded by the person who's vulnerable to it.
- A shield or armor enchanted so its wearer is the only person who can kill someone or something.
- A sword that must slay once drawn — and can only be drawn three times in a man's life.
- Three arrows, each of which returns to the quiver once shot, unless shot at a mage.
- A shirt whose wearer is never cold, tired, hungry, burned, or injured — as long as he does not retreat from an enemy. (Leaving a ship to search for someone to save a friend's life counted as retreating.)
- A sword that could cut through iron or rock.
- A poleaxe that could kill anyone whose full name the wielder knew.
- A sword which inflicted wounds that would not heal but couldn't be unsheathed in sunlight or in the presence of a woman.
- A cloak that protected the wearer against iron or edged weapons or venom.
- A ring whose wearer would not lose his way.
- A necklace that protected the wearer against iron or edged weapons.
- A cloak made of reindeer hide from Lappland that protects like a byrnie.
- A battle standard which assured victory, but cost the bearer his life.
- A keg of Ale of Healing.

You, as GM, may want to use the following table to create wizard artifacts. Feel free to make up artifacts not on the table. If characters want to have a magic artifact made, you might want to explain that it takes a year and a day to make — and has to be begun on a particular day. See Section 12.2 for day of the week, moon phase, month, etc. The day on which a specific artifact's construction must begin is shown on the following chart:

Artifact Type	Day to Begin
Fire-based.....	Sun Day
Boats and ships	Moon Day
Most weapons, armor, and hide-based items	Tyr's Day
Bane and rune weapons	Odin's Day
Weather or law-based	Thor's Day
Woven or jewelry items	Freyja's Day
Black magic	Washing Day

When the construction of an artifact began, the phase of the moon at that time had an affect on the chance of successfully creating the item. Consult the following listing to determine these modifiers.

MOON PHASE IN WHICH CONSTRUCTION BEGAN

Full moon: +20% chance of success in constructing a defensive item.

New moon: +20% chance of success in constructing an offensive item.

As with the phase of the moon, if an artifact's construction began on a certain holiday, the chance that the project would be successfully completed increased. Consult the following listing to determine what these modifiers are.

HOLIDAY DURING WHICH CONSTRUCTION BEGAN

Yule (Dec 17th): +10% chance of success in constructing an item associated with ice, darkness or weather.

Summer's Eve (Mar 17th): +10% chance of success in constructing an item associated with healing or fertility.

Midsummer (June 17th): +10% chance of success in constructing an item associated with heat or light.

Winter's Eve (Oct 17th): +10% chance of success in constructing an item associated with death.

When a GM finds it necessary to generate a random Wizard Artifact, he may use the following charts. First make a roll on the Artifact Type chart. Next roll for the Attack or Defense Item Type, then roll once (or more) for the Artifact's power(s), and once (or more) for the Artifact's Limitations.

ARTIFACT TYPE CHART

Roll	Artifact Type
1-7	Attack Item
8-0	Defense Item

ATTACK ITEM TYPE CHART

Roll	Attack Item
01-33	Sword
34-45	Seax
46-47	Hand Axe
48-60	Beardedaxe
61-70	Broadaxe
71-80	Spear
81-85	Arrow
86-98	Throwing Spear
99-100	Battlestandard

DEFENSE ITEM TYPE CHART

Roll	Defense Item
01-25	Byrnie
26-27	Shield
28-29	Helmet
30-35	Wovencloak
36-50	Hidecloak
51-75	Shirt
76-80	Ring
81-85	Necklace
86-100.....	Amulet

ATTACK ARTIFACT'S POWERS

Roll	Power
01-20	+10 Magic Offensive Bonus.
21-30	+15 Magic Offensive Bonus.
31-40	+20 Magic Offensive Bonus.
41-50	Item returns if thrown or lost.
51-60	Weapon delivers an extra critical.
61-70	Item improves the morale of friends.
71-80	Item strikes foes with fear.
81-90	Item brings exceptional luck to bearer.
91-95	Weapon delivers a Slaying critical.
96-100	Weapon will kill foe if it hits.

ATTACK ARTIFACT'S LIMITATIONS

Roll	Limitation
01-20	No effect if used during daylight hours.
21-30	No effect if used when woman present.
31-40	No effect if used when drunk.
41-50	Only usable 3 times in one lifetime.
51-60	User must have drunk blood that day.
61-70	Item must draw blood, or user will die.
71-80	Item loses power under New Moon.
81-90	Item will only strike Christians.
91-95	Item only usable against relatives.
96-100	Wielder must know foe's name to hit.

DEFENSE ARTIFACT'S POWERS

Roll	Power
01-20	+10 Magic Defensive Bonus.
21-30	+15 Magic Defensive Bonus.
31-40	+20 Magic Defensive Bonus.
41-50	Bearer given Heat Resistance.
51-60	Bearer given Cold Resistance.
61-70	Bearer may not be struck by missiles.
71-80	Bearer will not succumb to hunger.
81-90	Bearer will never become exhausted.
91-95	Bearer immune to venom.
96-100	Item will heal non-fatal all wounds.

DEFENSE ARTIFACT'S LIMITATIONS

Roll	Limitation
01-20	Ineffective if user retreats from a fight.
21-30	Ineffective if user is rude to someone.
31-40	User must know the attacker's name.
41-50	Ineffective if used when drunk.
51-60	User must have drunk blood that day.
61-70	Ineffective if user is a known coward.
71-80	Works once for each foe user kills.
81-90	Ineffective against Christian foes.
91-95	Ineffective against Berserk foes.
96-100	Ineffective against attack by relative.

WIZARD ARTIFACTS FOR ROLEMASTER

GMs are free to use the above tables for random item generation, or the item-making capabilities of the *RM* Crafter or the standard *RM* Alchemist may be used.

Wizard Artifacts for *Fantasy Hero*

Sample Artifact: Returning Arrows	
6 points	2d6 RKA (OAF = Bow & Arrows, Independent, 3 recoverable uses) (-4)
3 points	5 Strength T.K. only to return arrows, not vs. Mages, 0 End. Persistent; always on.
9 points	Independent. OAF (-5)

6.2 LEECHES

Leeches were usually women who understood herbalism. They washed wounds with herbs steeped in hot water, anointed them with herbal salves, then bound them in white linen. They knew how to set bones and assist women in childbirth but could not tell the difference between a natural illness and one caused by miscarved runes. A Leech got 1 silver mark for each month she nursed a patient plus enough money to cover what the patient ate and drank.

The GM will probably want to declare that a Leech must learn herbalism as a standard skill and not acquire it through magic. The GM may decide that a Leech's herbs must be picked at a special time to gain their magic effect. Perhaps herbs of healing minor wounds must be picked at midnight during a waxing moon and in the spring, while herbs of healing medium wounds must be picked at sunrise on the night of the full moon during the summer, and herbs of healing major wounds must be picked at noon on Midsummer's Day.

"Herbs of Life" allow the Leech to preserve and rejoin a severed hand or foot or eye in three days time. Such herbs are rare indeed. The GM may decide that they only blossom in the depths of the mountain wilderness, at Yule. That way a mage who wants them

will have to brave the threat of avalanches, wolves, bears and freezing to death. Or perhaps that's only the legend, and the Leech will have to find out by trial and error under what conditions herbs must be picked to have truly magic effects. Among the herbs prized by the Vikings are the following:

- **Styptics (staunch bleeding):** Amaranthus, Clown's Woundwort, and Yarrow.
- **Vulneraries (promote healing of an injury):** Bugle, and Ribwort.
- **Alexipharmics (anti-poison):** Blessed Thistle, Snakeweed, St. John's Wort, and Stinging Nettle.
- **Burnwash (promote healing of a burn):** Barberry, and Hound's Tongue.

HERB CHART

Herb	Effect
Styptics:	
Amaranthus	Heals 2 hits/rnd of bleeding.
Clown's Woundwort	Heals all bleeding from one wound.
Yarrow	Instantly heals all bleeding.
Vulneraries:	
Bugle	Heals 2-20 hits.
Ribwort	Heals any broken bone.
Alexipharmics:	
Blessed Thistle	Cures the effects of any poison.
Snakeweed	Cures any snake bite.
St. John's Wort	Cures any enchanted poison.
Stinging Nettle	Cures any plant-based poison.
Burnwash:	
Barberry	Heals one burn area.
Hound's Tongue	Heals all burns and frostbite.
Special:	
Herb of Life	Heals any one non-fatal wound.

LEECHES FOR ROLEMASTER

The Leech should take knowledge of herbs as a standard skill, rather than as a magic spell. Spells available include Flowstop I, Clotting I, Healing 1-10, Frost/Burn Relief I, Sprain Repair, and Herb Enhancement. Players may use a standard Lay Healer, but obviously the Viking Leech is far less powerful than the *RM* Lay Healer. The Vikings would probably take the standard *RM* Lay Healer to be a Wizard and would treat him accordingly.

LEECHES FOR FANTASY HERO

13 Pts. "Healing": 4d6 Aid, affects all reduced Characteristics, only to starting value, 1 turn preparation, Full concentration, 11F = Herbs, Hard and Dangerous to Locate, 12 uses. Based on Medical Roll.

Leech Package Deal

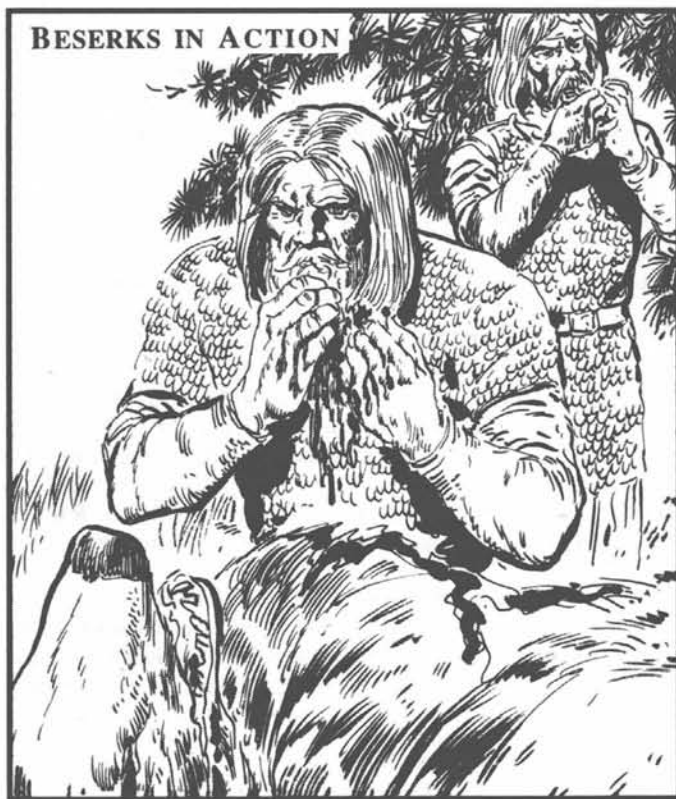
Pts	Leech Package
5	Paramedic w/+1 Roll
2	K/S: Herbs
2	P/S: Leech
1	Fam. with knives
2	AK: Nearby Wilderness
3	Survival
-3	Package Bonus
-5	Reputation: Leech

6.3 BERSERKS

Berserks were men who went into a frenzy at the approach of combat. They chewed their shields (but also used them to defend themselves) and uttered terrifying wolflike howls. Some Berserks were honored housecarls at the royal court. Others were greedy bullies who went around the countryside challenging one farmer after the other to a formal duel for their property and womenfolk. Still other Berserks were outlaws who lived in the wilderness. Here's one saga's description of a Berserk:

"[Ljot] was a very big man, strong-looking and carried a shield and a sword. As he approached the combat area, his Berserk fit came on, and he began howling horribly and biting his shield. [Our hero Egil attacked him, but] Ljot warded off Egil's blow with his shield."

During his frenzy, a Berserk seemed as strong as a bear. Iron did not bite on him, the Vikings told one another. Fire would not burn him (though one saga does say that a Berserk was afraid of fire kindled in the name of God by a Christian missionary). A strong enough blow on his weapon hilt or arm might make him drop his weapon, but he could only be hurt by non-iron weapons: hurled stones or wooden clubs. One Viking fighting a Berserk dropped his sword, grappled the Berserk and killed him by biting his throat.



Berserks had touchy tempers, but they did not attack bystanders who had not insulted or threatened them. Of course, they might feel insulted by a mild reproach like, "I wish you hadn't gotten blood all over my good clothes." But the GM should not create Berserks who fight until all spectators are killed.

Once the Berserk's frenzy was over, he was very weak for the next full day. And of course, the Berserk was always at the mercy of his patron god, who might take away his powers at any time and summon him to Valhalla in his full strength rather than risk his dying of sickness or old age.

Players who wish to play Berserk characters may have to have them go through an Ordeal, based on Self Discipline and Intuition, as described in Section 1.0.

BERSERK FRENZY FOR ROLEMASTER

"Berserk Frenzy" is a special ability only available to Berserk characters. The effect of a Berserk Frenzy is based upon the Berserk's level. Consult the following chart to determine the exact effects of Berserk Frenzy. It takes a short period of time to bring on a Berserk Frenzy. GMs should only allow a character to bring on a Berserk Frenzy if in combat, or if a fight is imminent. The Fear Effect is induced by howling and shield biting. If neither of these options present themselves, then the GM should disallow this capability. The (normal) fire and (normal) iron weapon immunity should be rolled for at the onset of the the Berserk Frenzy. The immunity will be total for the duration of the Berserk Frenzy. Once a fight in which Berserk Frenzy is used is over, weakness will come on, and last for a day after the battle. The maximum weakened strength for Berserks is listed in the last column of the chart.

As a GM, you can use a standard *RM* Fighter to represent a Berserk character — just add the Berserk Frenzy capability. Alternately, you may develop Berserks as *RMC* /Paladins without spell casting abilities. Remember that the Berserk is a fighter dedicated to Odin. Just modify the Paladin's moral code to accent Norse honor: it is honorable to die fighting; it is dishonorable to let anyone insult you, no matter how trivial the matter may be.

BERSERK FRENZY FOR FANTASY HERO

Berserk Package Deal

Pts	Berserk Package
2	Familiarity with Common Melee
10	Increased STR Maximum (30)
6	+10 STR, 1 Phase Activation, only in Combat, Normal Strength reduced by 5 for 1 full day after combat.
2	Immune to Intense Heat (Based on Increased STR)
6	8 r.p.d. Armor (Based on STR, only vs. Edged/Iron weapons)
4	+6 PRE, Fear only
-3	Package Bonus
-25	Berserk: In Combat 14, 11-

BERSERK FRENZY EFFECTS CHART

Level	# Rounds for Frenzy to Come On	# Rounds Frenzy Lasts	Radius of Fear Effect	Minimum Frenzied Strength	Chance of Immunity to Fire/Iron Weapons	Maximum Weakened Strength
1—3	6	6	10'	95	10%	5
4—6	4	18	50'	97	25%	10
7—10	2	60	100'	99	50%	25
11—20	1	180	250'	100	75%	50
21+	0	360	500'	101	100%	90

6.4 TROLLBLOODS

Trollbloods were tall, ugly men, with hair that turned wolf-grey while they were still young. They could see as well by night as by day, just like a wolf. And when they fought, their strength increased after sunset. In the northland, the winter sun sets only an hour or so after noon, and rises only an hour or so before noon, while the summer sun sets an hour before and after midnight. Nightstrength and Nightvision (see below) are much more significant in the winter than in the summer.

It wasn't an insult to call a man "trollblood." Some of these men even had nicknames like Half troll or Wolf. Trollbloods didn't quite go into a Berserk Frenzy when fighting, but they had fierce tempers and were keen competitors. One man named Evening Wolf was playing ball with his two sons and after sunset got so caught up in the game that he killed one of the boys as well as the nurse who tried to protect the other boy. No one took any legal action against him because the killings had all been in his family. The son who survived wouldn't talk to him for the rest of the winter and left home the next spring.

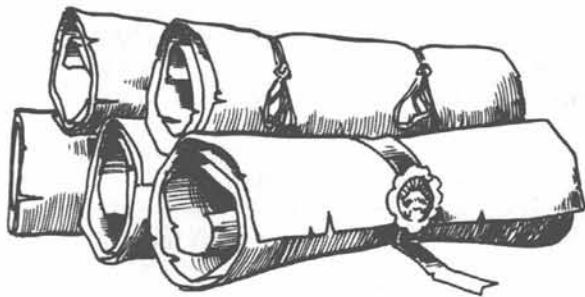
TROLLBLOODS FOR ROLEMASTER

Trollblood characters, which may be of just about any profession, have two unique abilities: Nightvision, and Nightstrength. Nightvision may be treated as a standard infravision capability for Trollblood characters. Nightstrength will cause an increase in the character's Temporary Strength of 1D5 whenever the sun goes down, through the St stat may not exceed 100, and it will always return to normal when the sun rises again. The Nightstrength stat bonus may cause the character's Potential Strength stat to be exceeded temporarily. Along with the Strength increase comes a decrease of the Temporary Self Discipline stat by 1D10.

TROLLBLOODS FOR FANTASY HERO

Trollblood Package Deal

Pts	Trollblood Package
7	+10 Strength (only at night)
7	Strength Min up to 30 (only at night)
3	Immune to intense cold & heat
5	Night Vision
8	+8 r.p.d. Armor (vs. Edged weapons only)
-10	Phy. Lim.: Limited Effectiveness in Sunlight
-15	Distinctive features: Tall, Grey Hair & Ugly: Causes Fear
-3	Package Deal
Total = 2 points	



6.5 RUNE CARVERS AND SKALDS

Skalds were poets who might recite or sing their songs. Some wandered the road from village to village, farmstead to farmstead, telling people the old lays of the gods and heroes — and reciting new poems about the heroes and villains of the day. Other Skalds were honored members of a chieftain's court, expected to chronicle his great deeds to insure that he would be remembered by coming generations. A Skald's praise or insult was highly valued because it significantly affected people's reputations. King Eirik Blood Axe spared the life of a Skald who was an old and hated enemy because of the great poem the Skald recited in his praise. The poem is known as "The Head-Ransom."

Few things were written down in the Viking days. Even the Christian lands of the south had no paper, only vellum: calfskin which had been laboriously shaved and scraped clean, then tanned, and finally written on with a quill pen. The pagan Vikings didn't even use vellum, but rather carved their runes in wood and stone. Most chieftains and some landholders knew how to read the 16 modern runes. Rune Carver mages and some Skalds knew not only the modern runes but also the 24 ancient Runes. The rest of the Vikings were illiterate. (See Section 12.5 for the Rune alphabet.)

A Rune Carver engraved runes into wood or stone, then cut himself and dyed the runes with his own blood, which he enchanted by improvising a poem. Enchanted Runes affected people's morale, emotions and health. Miscarved runes would injure anyone who came in contact with them, causing psychological or physical problems. Both Rune Carvers and Skalds could spot miscarved Runes and undo them, but only Rune Carvers could carve magic Runes. Rune Carvers and Skalds who offended Odin lost their poetic ability and, with it, their Rune magic.

GMs may require characters who wish to be Skalds or Rune Carvers endure an Ordeal as described in Section 1.0.

RUNE CARVERS AND SKALDS FOR ROLEMASTER

In terms of *RM*, Skalds may be treated as Bards, while Rune Carvers might be developed as Clerics who automatically receive the Symbols spell list. Rune Carver runes should be engraved with the Symbols spells. Such Symbol-Runes carved in portable wood plaques should be limited to the 5th level of effect. Whenever a Rune Carver engraves an enchanted Rune, he should make a roll against his Rune skill to determine if the Rune was carved correctly. If there was a mistake made, then the Rune will have an undesirable effect as determined by the GM.

Carving a Rune should be a much longer process than just the casting of a Symbol spell; a length of time determined by the GM, being dependant upon the complexity of the spell effect being cast.

Both Skalds and Rune Carvers should possess Linguistic Writing, and Poetry skills.

Some common Runes which may be drawn from the various *RM* spell lists include: Heal, Sleep, Stun, Charm, Command, Pain, Discord, Insanity, Strength, Heal, Fear, Binding, Calm, Confusion, Suggestion, Forgetting, Chill, Grey Vision, Wasting, Impair, Ache, and Fire Nerves.

If a Rune is miscarved, any of the following spell effects might be substituted for the desired result: Stun, Pain, Discord, Insanity, Forgetting, Chill, Grey Vision, Wasting, Impair, Ache, or Fire Nerves.

A Skald may undo an enchanted Rune by rolling against his Rune skill.

RUNE CARVING AND SKALDS FOR FANTASY HERO

Skald Package Deal

Pts	Skald Package
3	Conversation or Persuasion
3	Courtier or Seduction
3	Oratory
2	P/S: Poetic Improv. (Based on PRE)
2	P/S: Singing (Based on PRE)
2	P/S: Tale-telling (Based on PRE)
2	P/S: Rune Carving
1	K/S: Ancient Runes
2	K/S: Modern Runes
-3	Package Bonus
-5	Professional Rival
-5	Reputation as Poet/Skald

Fantasy Hero Spell

Pts	Rune Carving
19	75 point Multiplier (Gestures, Incantations, Uses own blood, OAF = Rune Board, Skill Roll, 37 point side effect)
1	U10d6 Mind Control (0 END, Emotions only) = Morale/Emotion
2	U6d6 Aid (0 END, Variable Characteristic) = Health
2	U2d6 Characteristic Point Drain (0 END, Variable Characteristic, 1 recovery every 6 hours) = Sickness.

Total = 24 points

6.6 SECOND SIGHTED AND SHAMANS

Second Sighted people were usually ordinary Viking farmers or warriors who sometimes had visions (see Section 1.0). Shamans had far greater powers because they were able to enter a trance by invoking the favor of Freyja, goddess of passion, magic and battle frenzy. Most Shamans were women. Male Shamans were often despised as unmanly, because they fought with magic rather than risking death in battle.

Shamanism was usually practiced high atop a gallows-like platform and was often called "platform magic." One saga tells of how a Rune Carver interfered with the spells of an enemy Shaman by carving runes on the legs of the platform which interfered with the spells being cast above.

A Shaman needed a singer who knew special songs which would help her enter the trance and protect her during it. During the trance, the Shaman sent forth her soul in the likeness of a bird, fish, land beast, or a dragon to see faraway places or to travel to the realm of the dead to see the past and future. This beast-like form was not the Shaman's familiar, just a projection. It had no actual body; it could neither fight nor be injured, only observe.

The Shaman was not a medium. She could not contact a specific dead person's spirit and question it. Instead, she went to the realm of the dead and looked back at the world of the living. Her visions were detailed and symbolic or fuzzy and literal. The farther away she was, in time and space, from what she was investigating, the more she could learn.

The Heimskringla describes how every Iceland landholder had an insulting poem written about King Harald Bluetooth of Denmark. King Harald considered attacking Iceland and had a Shaman look the situation over. The great men of Iceland back then were Brodd Helgi in Vapnafjord, Eyolf Valgerdson in Eyjafjord, Todi Gelli in Breidafjord, and Torod the Good by the Olfus river.

"[The Shaman] went in the shape of a whale. At Vapnafjord, he tried to go ashore. But a great dragon came down from the valley, followed by many serpents, toads and adders, and they blew poison at him. Then he went to Eyjafjord, but a bird came so big that its wings neared the hills on each side of the fjord; with it were a number of other birds, both great and small. He went to Breidafjord, but a great ox waded out in the sea and began to bellow horribly; a great many spirits followed it. Then he went to the Mouth of the Olfus. But against him there came a great hill giant with a iron staff in his hand, and many other giants followed him."

The Shaman's visions could be affected by other mages by using a Rune of Confusion, another Shaman's counter-detection spell or by the Luck of the person being sought. An enemy's fylgja might make it impossible for a Shaman to see the person she was searching for by covering the area with mist and fog. Or it might make her yawn so deeply that she woke herself up.

Shamans could also animate the battle-dead to fight again, possessed by spirits the Shaman had summoned from the other-world. If the Shaman were killed, all the animated dead fell lifeless once more. One saga tells of a mage who walked widdershins (clockwise) around the piled up corpses on a battlefield, whistling and mumbling ancient chants, so that the dead warriors would do no further harm. Another hero merely had the corpses thrown into the river.

A Shaman's gaze could blunt iron and edged weapons so they would do her no damage. The dying gaze or last speech of a Shaman could curse her killers.

A GM may stipulate that a character must go through an Ordeal, as described in Section 1.0, before becoming a Shaman.

SHAMANS AND SECOND SIGHT FOR ROLEMASTER

Shamans may be developed as *RMC II* Shamans who don't use drugs or require animal totems. Alternatively, Shamans may be created along the guidelines of *RM* Clerics with the special Shaman capabilities described in this section.

A Shaman's Platform Magic spells are cast as trance-like dreams and require that an assistant be present to dance while the trance is underway. Spells that may be cast while in a dream trance include the various Dream spells, Visions, Detections, Locations, and Control spells (including Control Undead).

Additional Shaman abilities include Edged Weapon Blunting. Either through a curse, gaze, or while on a trance journey, a Shaman may blunt the edge on one foe's weapon every week (subject to an RR). A weapon blunted in this way incurs a weapon quality penalty of -25. Weapons which incorporate silver into their construction are immune to this effect.

Second Sightedness may be an ability assigned by the GM to any character. Second Sighted characters may use some or all (GM's discretion) of the following spell-like effects: Dream I, Detect Curse, Detect Undead, Control Undead I, Life Typing, Perceive Power, Detect Scrying, Location and Mislocation spells.

SHAMAN PACKAGE FOR FANTASY HERO

Pts	Shaman Package
3	Oratory or Persuasion
3	Conversation
3	Scholar
1	K/S: Theology
2	K/S: Holy Rituals & Trances
1	K/S: Omens
2	Choose two other Knowledge Skills
-3	Package Bonus
-5	Reputation: Tribal Shaman
-5	Distinctive Features: Shaman (furs, Paints, Equipment, etc.)

Total = 2 points

PLATFORM MAGIC FOR FANTASY HERO

Pts	Platform Magic
30	60 Point Multiplier (Full concentration, 14-)
2	U "Soul Projection": Clair sentience (Past/Present/Future). Projection: leaves body behind.
2	U "Obscurement": 12d6 Detection Suppression. Projection: leaves body behind.
1	U "Animate Dead": 2d6 Transformation, Cumulative,) End, Gestures, Incantations, 1 turn preparation.
2	U "Blunt Weapon": 2d6 Killing Attack drain, 1 recovery per minute, Based on Ecy, At Range, only vs. Edged Weapons.
2	U "Death Curse": 3d6 Unluck Against Others, At Range, Based on Ecy, Persistent.

Total = 39 points

6.7 WIZARDS

Wizards were trollwise. If the campaign has real trolls who live in troll mounds, then wizards are trollfriends. Otherwise, they probably learned their secrets from Lapp wizards. Like the Shaman, a Wizard's gaze could blunt edged weapons, but Wizards may use this power 1x/day and such weapons could do no harm to the Wizard who blunted them. Again, weapons which have some silver component are immune to this effect.

Wizard spells come from nature rather than from the gods. They needed special ingredients to cast their spells, unlike the Shaman who needed only to enter a trance, or the Rune Carver who needed only his eating knife and a piece of ordinary wood to carve. A Wizard's magic knots could control the elements: raise or calm the winds and waves, slake fire till it was no hotter than a warm bath, shield someone from heat or cold. A Wizard's herbal brews could control the feelings of men, making them unable to feel fatigue or pain or hunger.

A few Wizards could also transform a man or woman into an animal by steeping the fur of a wild animal in a mixture of enchanted herbs. Usually the transformed person became a bear or a wolf. One saga does tell of two wizards who duelled one another by taking on the shapes of monsters.

TROLLWISE MAGIC FOR ROLEMASTER

Trollwise Wizards are developed as *RM* Magicians, except that they have access to additional spells. These include all Open Channeling spell lists and the Creations Closed Channeling list. These extra spell lists are treated as Closed Essence lists by Trollwise Wizards.

TROLLWISE MAGIC FOR FANTASY HERO

Pts	Wizard Magic
18	45 Point Multiplier (OAF = Rope, Requires 1/2 Concentration, Full Phase action) = knot tying.
2	U 30 Strength Animate Object, Elemental Forces only = Element Manipulation. END 4.
2	U 2d6 RKA, No Range Modifier = Lightning. END 4.
2	U 2" r Darkness to all visions, 14-. 0 Endurance = Fog. END 0.
2	U20 Strength T.K. Explosion = Wind. END 4.
2	U Change Environment = 8 hex radius = Waether Manipulation. END 4.

Total = 28 points



INTRODUCTION

7.0

VIKING HISTORY

If the geography and history that follows seems too complex and confusing, feel free to skip to Section 7.5, where you'll find a timeline of major events.

7.1 SCANDINAVIAN GEOGRAPHY

Denmark's Jutland is well named. It juts up north into the ocean, dividing the North Sea from the Baltic Ocean. A little below its western edge is the mouth of the Elbe, which in the Viking Age divided the Carolingian Empire ruled by Charlemagne and his descendants from the lands of the Slavs. The neck of Jutland was cut off from the rest of Europe by swamps and forests.

Denmark controls a number of nearby islands to its east, three of them good-sized: Odense, Zealand, and Fyn. In the Viking Age, its domain also reached north to the Oresund Islands and Skane on the Scandinavian peninsula, now part of Sweden, but then virtually an island, isolated by the impenetrable forests of Smaland from the rest of the peninsula. All of these lands, including the islands, have fertile plains, easily farmed.

The Scandinavia peninsula dangles like two fingers south from the Barents Sea, pointing toward Jutland. Norway lies on the west, its shores warmed by ocean currents, so that its fjords rarely freeze. Norway's lands are mountainous and rocky except for stretches along the coast, where most of the population lives. One Norwegian term for Dane is "flatlander." Norway has three main regions:

1. **the Westlands**, with their steep cliffs and rocky beaches, bogs full of iron-rich mud, fjords rich with fish, and tiny plots of farmland;
2. **the Eastlands**, where the best farms lie;
3. **Trondelag** in the north, where herds are pastured on grassy meadows.

A mountain ridge called the Keel splits Norway off from Sweden, most of whose farmable land lies on its east coast, the Gulf of Bothnia. Land routes between Sweden and Norway had to go south of the Keel, by Lake Mjosa, or through the Trondheim Gap in the north.

Across the Gulf of Bothnia from Sweden lies Finland, which is bordered on the east by Russia.

The Atlantic Islands (the Faroes, Shetland Island, Orkneys, and Hebrides) lie across the North Sea, just north of Scotland, about the same latitude as southern Norway. Scotland lies about the same latitude as Denmark.

Iceland lies just south of the Arctic Circle, west across the Atlantic, at the same latitude as the Trondelag, the northernmost region of Norway. It has two hundred volcanoes, with an average of one eruption every five years. Only the shore regions are farmable; the inland is a barren wilderness of glaciers and volcanic rock.

Greenland lies farther west yet, its southern tip at the same latitude as Iceland and at the same latitude as the Hudson Straits of Canada, which divide Baffin Island from Labrador.

At the beginning of the Viking Age, the Norse were organized in loose groupings of villages for trade and for mutual defense against raiders. National consciousness came late to the northland. Norway's very name points to the fact that it was long thought of not as a country but as a trade route: the North Way. Denmark and Sweden were unified earlier, but none of these countries had stable borders during the Viking Age. Power and territory went to the man whose followers could hold it for him, and the alliances a chieftain forged usually fell apart after his death.

The Vikings were unified not politically but socially; they had a common language, culture, and religion. They were keenly aware of how they differed from the Slavic Wends to the east, the Lapps to the north, and the Teutonic Franks and Anglo-Saxons to the south and west.

7.2 THE EARLY VIKING ERA (768-874)

Charlemagne (Charles the Great) was one of the two heirs of Pepin, "King of all Franks." Pepin partitioned his realm between his two sons in 768. Three years later, after his brother's convenient death, Charlemagne became king of the territory that now includes Germany, Holland, Belgium and France. His capital was Aachen in the Rhineland, on what is now the border of West Germany and Belgium. The next year he began a campaign against the pagan Saxons, which was to last until 804. During this period, he also sent troops south to conquer Lombardy in Upper Italy in 773-74 and became "protector" of the Papal States. In 778 came Charlemagne's first great defeat; his army under the command of his nephew, the paladin Roland, was defeated by Arab forces in the valley of Roncesvalles.

In 787-8, Charlemagne experienced his first major political crisis, a rebellion by the Duke of Bavaria. He soon conquered the duke and banished him to a monastery, but the empire was still not at peace. Both 792 and 793 were years of bad harvests, with widespread famine throughout Europe. A conspiracy to unseat Charlemagne was led by his favorite bastard (Pepin the Hunchback), backed by many French nobles. Charlemagne eventually reasserted his control of his empire and required fresh oaths of his supporters.

During the 780s, Norwegians (mainly Westlanders) sailed west to settle the Atlantic Islands: the Faroes, Orkneys, Hebrides, Man, and Shetland Islands, conquering the local Picts and expelling Irish monks who had gone there to set up summer hermitages. Most of these settlers were younger sons, looking for land to farm.

The first Viking raid was chronicled in 787, when Norwegians harried Dorchester. Six years later in 793, Vikings raided Lindisfarne, off the coast of Northumbria. The next year the Vikings hit another Northumbrian monastery. The year after, they raided a monastery on Iona, off of Scotland, and an Irish island monastery. In 799, they harried the islands off Aquitaine.

In 800, Charlemagne was firmly in control of his empire again. He began to fortify his coasts and to rebuild his navies. He was crowned Imperial Emperor of the Romans that year, just before Christmas. Viking raids in Europe stopped and did not resume for another generation. However, Viking raids in Ireland continued. Norwegians conquered many areas of the country, not just looting the monasteries and fleeing, but settling in as herders.

Charlemagne continued to rule until his death in 814. He was followed by his son, Louis the Pious, who kept up the coastal defenses, stationing fleets in river mouths not only in Frisia but all along the northeast coast of France, including the Seine. He also occasionally raided north just to remind the Vikings of his power. He also persuaded the Pope to send missionaries north: Ebo, Archbishop of Rheims to the Danes in 823, and Anskar, Archbishop of Hamburg, to Sweden in 829.

Beginning in 830, Louis the Pious faced a series of rebellions by his sons; Viking raids resumed at once. Targets included Cornwall and Kent in Britain. In 834 the Frisian trade mart of Dorestad was captured and looted. In 836, Vikings raided another key trade mart, the monastery on the island of Noirmoutier at the mouth of the Loire in France. The next year they raided the city of Rouen, an inland town, up-river on the Seine.

In 839, a chieftain named Torgils invaded Ireland and declared himself "King of all foreigners in Erin." He established fortified harbors and trade towns at Dublin, Wexford, Waterford, Cork and Limerick. He also took over Armagh, the ecclesiastical center founded in Ulster by St. Patrick and set up a temple there to his own gods. Five years later, the Irish captured and drowned him.

In 840, Louis the Pious died, and his sons went to war. Eventually, they divided the Carolingian Empire into Germany, France, and the Middle Kingdom, which was in turn to be divided into Lorraine, Burgundy, Provence, and Italy.

In 842, Viking raids grew more extensive. A fleet raided back and forth across the English channel, robbing London, Quentovic, Rochester, Aquitaine, and then passing the winter at Noirmoutier. Two years later, a fleet of 150 ships plundered the Garonne river area almost as far up-river as Toulouse, then sailed south to Moorish Spain to conquer Seville. Viking fleets wintered on Thames islands in 850 and 855. Another raid in 855 looted Hamburg. Archbishop Anskar escaped, but his church, school and library were burned.

As the years went by, groups of Norse Irishmen arose. They followed the Norse religion, but had their own armies with their own leaders. In 845, they killed the king of Meath (in Leinster) and conquered his kingdom.

Also in the 850s, Danes and Norwegians fought one another for control of Ireland. Olaf, a Norwegian prince, took over Dublin in 853 and ruled there until 871, when he was succeeded by his brother Ivar, Lord of Limerick.

In 865, the three Ragnarssons led a fleet of over five hundred men to invade East Anglia in England, ruled by King Edmund. They stole horses and rode inland to capture York, then fanned out to subdue the rest of Northumbria. They also invaded Mercia but retreated to York after being given Danegeld.

Next year, the Ragnarssons overran East Anglia, defeating the royal army and killing King Edmund. Legend reports that the king was captured but refused to share his Christian kingdom with the heathen invaders. They tied him to a tree and shot him with arrows, then struck off his head. Edmund was thereafter revered as a martyred saint. His body was enshrined at Bury St. Edmunds in Suffolk, where a great abbey was founded in 1020. His emblem is — what else? — an arrow.

After conquering East Anglia, the Ragnarssons focused their attacks on Wessex, ruled by King Ethelred and his brother Alfred, who became king in 871. That year, the Danes wintered in London.

The pattern of the 9th Century seems to be that the Vikings raided Europe and Britain whenever the local kings were weak or turned their armies towards fighting one another instead of defending their coastlines and keeping the Vikings in check. Meanwhile, Viking settlers became farmers in East Anglia and herders in Northumbria and Scotland. After a generation or two of Viking administration, native Anglo-Saxons and Celts became accustomed to Norse laws, customs and language. The free farmers of a region met at a Thing where they made their own laws and acclaimed the king they chose to rule them.

One interesting fantasy scenario might revolve around Charlemagne's legendary paladin, Ogier (Holger) the Dane, supposedly the hostage son of Geoffroy, the first Christian king of Denmark. Ogier was also the protege of Morgan le Fay, who gave him the magic sword, Cortana. Charlemagne's other paladins (imperial nobles) included Rinaldo of Montalban (another of Charlemagne's nephews); Oliver of Vienna and Florismart of the Sylvan Tower; Namo, Duke of Bavaria; Salomon, King of Brittany; Archbishop Turpin; Astolph of England, Malagigi the Enchanter; Carahue the Saracen, King of Mauritania; and the treacherous Ganelon of Mayence.

During the reign of Charlemagne, the major Danish king was Godfred, who established the trade mart of Hedeby, at the neck of Jutland. Charlemagne waged a campaign against him beginning in 804 until Godfred was killed by one of his own followers in 810, during a raid on Frisia. This left two chieftains who claimed power in Denmark: Horik Godfredsson and Harald Klak. Harald was converted by Archbishop Ebo to Christianity, but expelled from Denmark by Horik Godfredsson in 827. Horik was killed in 854. For a while, Denmark was ruled by his son, Horik the Younger.

By 840, Harald Klak ruled the island of Walcheren at the mouth of the Scheldt in Frisia. Some historians claim he got the land from Louis the Pious, who hoped that Harald would prevent the Vikings from raiding the Empire. Others claim that Harald seized it from Louis's son, Lothar, ruler of the Middle Kingdom. After Horik Godfredsson's death, Harald Klak managed to seize the neck of Jutland, a major trade route. He was eventually succeeded as ruler by his brother Rorik.

The Heimskringla tells us that in 821 King Gudrod of Westfold (in Norway's Westlands) was killed at the orders of his wife, Asa, a princess (of Agdir, another small Westland kingdom) whom he had kidnapped. She ruled as regent for her newborn son, Halfdan the Black, until he became 18 in 839.

During this period, Swedes began to settle among the Slavs who called them Rus. They set up trade marts, with royal courts at Novgorod and Kiev (see Section 8.6). Eventually they reached first the Black Sea and then Byzantium. They attacked Byzantium in 853 but were beaten off and learned it was more profitable to trade there than to try to fight the imperial army. The Byzantines called them Varangs, and eventually the Emperor was to use them as his own private bodyguard, the Varangian Guard (see Section 8.7).

7.3 THE MIDDLE VIKING ERA (875-986)

At the beginning of this period, Denmark was ruled by a number of kings. There were also a number of "sea kings" whose income came from their raiding fleets, not their lands. Shortly before 900, King Olaf of Sweden seized southern Jutland and ruled it as part of his kingdom. By 934 he had died, and Denmark was ruled by his son Gnupe, while other chieftains fought over who would rule Sweden.

Henry the Fowler became the first Saxon Emperor of Germany in 913. He eventually subdued the territories of Bavaria, Lorraine, and Swabia. In 934, he invaded Denmark and forced Gnupe to pay him tribute and to submit to baptism.

Years later, Archbishop Unni came north from Germany as a missionary and found Denmark was now ruled again by a Dane, a heathen king named Gorm the Old, whose royal court lay at Jelling in northern Jutland.

HARALD FAIRHAIR

In Norway, Halfdan the Black drowned in 875 and was succeeded by his son Harald, whose regent was his foster-father and uncle Guttorm. When he came of age, Harald vowed that he would not cut or comb his hair until he had conquered all of Norway. Thus he was called Harald the Shaggy. He defeated the last of his enemies in 887 at the battle of Hafræfjord. Once he had combed his hair, men were surprised at how much better he looked, and he got the nickname of Harald Fairhair. He was overlord of two regional jarls:

- Hakon Grjotgardsson, Jarl of Trondelag, Harald's father-in-law whose regional capital was at Hladir.
- Guttorm, Harald's foster-father, was Jarl of Vestfold until his death. He was succeeded by Rognvald the Shrewd, Jarl of Moer, whose youngest son was supposedly the Hrolf (Rollo) the Walker who was the first Duke of Normandy. Rognvald's brother was the first Jarl of the Orkneys and led his men to conquer large areas of Scotland, including Caithness and parts of Argyll, Moray, Sutherland, and Ross.

After Rognvald's brother's death, the jarl's son Hallad became Jarl of the Orkneys, but he could not defend his lands from Viking raiders. "When the farmers complained of their losses to Jarl Hallad, it seemed to him beyond his power to right matters for them, so tiring of his rule, he gave up the earldom and went back to Norway as a common landholder. This excursion of his made him a laughing stock." Rognvald then sent his youngest and least favorite son Einar to the Orkneys, and he became Jarl of the islands and of Viking Scotland.

Harald Fairhair's victory angered many of the Norwegian regional chieftains. One saga quotes a chieftain as saying he "had no inclination to become the slave of a king and to beg for his own property." There's even a tale of one chieftain who, when he heard Harald was marching against him, went into a grave mound along with eleven of his men, and had it sealed up over them and their goods, in order to "die with honor like the King he was."

Icelanders claimed that Harald promptly imposed the full weight of royal law across all of Norway. "Every farmer and every forester had to become his tenant, every salt-maker and every hunter on land or sea had to pay taxes to him." The Icelandic sagas note that their newly discovered country was settled largely by exiled chieftains fleeing Harald's tyranny. "Many great men... fled from their estates in Norway because King Harald had made all those who fought against him outlaws and had confiscated their property...."

Historians, however, have decided that the Norwegian settlement of Iceland didn't begin after Harald's great victory in 887 but in 874, the year before Harald's father died. The GM must decide whether to believe the Icelandic sagas or the historical evidence for his campaign timeline.

ALFRED THE GREAT AND THE DANELAW

By 876, the Danish army had nearly succeeded in conquering Wessex in England. Legend says that Alfred and his few followers were fugitives, who had to hide in forests and swamps. Eventually, Alfred managed to raise fresh troops and to defeat the Danes at Edington, in Wiltshire, in the spring of 878. The Vikings withdrew to their lands in East Anglia, where they were ruled by King Guthrum, who had allowed himself to be baptized.

That year, a huge Viking fleet sailed for England but, hearing of Alfred's victory, decided to head across the channel to Europe, where chroniclers called it "the Great Army." In April, it reached Ghent. It continued to harry Germany, Flanders, Belgium, and France for the next thirteen years. Meanwhile, in 886 Alfred (now called Alfred the Great) recovered London from the Danes.

Finally, in 892, Europe was stricken by a great famine and pestilence. The Great Army gathered their families and sailed across the Channel to Kent, a force of 250 ships, where they were fought by Alfred's forces. By 896, the Viking forces had gone home or north to Northumbria and East Anglia.

Alfred now signed a treaty with Guthrum, recognizing a boundary between their dominions. Southern England, including London and Wessex, would be ruled by Anglo-Saxons. Northern England was recognized as now culturally Danish and would remain under Guthrum's rule. This area was called the Danelaw. It had two centers:

- The Five Boroughs: Lincoln, Stamford, Leicester, Nottingham, and Derby. From the Humber and Wash in the east to Wales and western Mercia in the west, this area was largely settled by Danes.
- York and its surroundings, settled by both Norwegians and Danes.

THE DUKES OF NORMANDY

Meanwhile in France, Charles III (also known as Charles the Fat) lost his throne in 887. His heirs were still called kings, but could not control regional nobles, including the Count of Paris and the dukes who ruled Champagne, Aquitaine, Gascony, Toulouse, Gothia, Catalan, Brittany, Normandy, Flanders, Navarre and the Asturias. Similarly in Germany, the royal court of Louis the Child (900-911) could not control the tribal duchies of Saxony, Thuringia, Bavaria, Swabia, Lorraine, Franconia, and upper Italy. And the nobles' lands were also being attacked from the east by Magyar raiders from Hungary (see Section 8.6).

During this period, the Vikings raided as they chose, sometimes sailing their fleets up-river far inland. Around 896, the Danish Vikings stopped raiding the Seine valley and instead began to settle there. By 911, Rollo (Hrolf, known to the Norse as the Walker because he was too big to ride a horse) became Duke of Normandy, after making feudal submission to King Charles the Simple. His duchy included the modern French departments of Seine Inferieure, Eure, Calvados, Manche, and most of Orne, with its capital at Rouen.

One legend says that when Rollo was told that this ceremony involved kissing the king's foot, he ordered one of his followers to kneel down and do so for him. Another claims that he kissed Charles' foot himself, by seizing the king's leg and raising it to his lips, toppling the monarch backwards.

As Duke, Rollo strengthened Normandy's defenses and gave its lands to his soldiers. These Vikings followed the pattern of French nobles; they did not become farmers but knights, feudal overlords of the serfs whose harvests they taxed. Likewise, they did not send home for women but married in France. Rollo's son William Longbeard could speak Norse, but William's son, Richard, who became Duke of Normandy in 942, needed a tutor to learn the Norse tongue. His son, also named Richard, was followed by Robert the Devil (Duke 1027-1035), followed by William the Bastard (Duke 1035-1087,) who conquered England.

Normans spoke French but with their own regional accent. They also continued to sympathize with their Norse cousins. The dukes of Normandy made treaty after treaty vowing to give no assistance to the Vikings, but Viking ships were always welcome to winter over in Normandy, as long as they didn't attempt to raid there.



ERIK THE BLOOD-AXE AND HAKON THE GOOD

Harald Fairhair had several wives and at least nine sons (some sources say twenty). They grew up to be arrogant men, who bullied the regional chieftains. Two of them killed Jarl Rognvald of More. One surrendered to Harald and was pardoned. The other fled to the Orkneys, ruled by Rognvald's son, who killed him, then paid Harald 60 gold marks as compensation.

The eldest surviving Haraldsson was Eirik Blood-Axe, whose mother was Ragnhild, daughter of King Eirik of Jutland. Eirik was married to Gunnhild, daughter of Gorm the Old, King of Denmark. Egil's Saga, however, says that Gunnhild was a wizardess, the daughter of a Lapp chieftain named Ozur Toti.

When Harald Fairhair died in 944, his youngest son Hakon was only 15; his mother was Thora, Harald's "maidservant." He had been living with his foster-father, King Athelstan of England. At first Eirik Blood-Axe seized the throne. But soon Hakon arrived from England and presented himself at the Trondelag Thing where he was acclaimed as king. In a few years, Hakon defeated Eirik's forces and drove him out of Norway and into England, where he became king of the Danelaw. The Orkeyinga says of Eirik that "as he had little land and a large following, he ran short of money, which is why he spent the summers plundering, while staying in his kingdom over winter."

As king, Hakon was nicknamed Hakon the Good. He built up Norway's coastal defenses against Danish Vikings. He was famed as a lawgiver and used the national Thing as a council. Brought up in England as a Christian, Hakon tried to introduce Christianity to Norway, but "found the new religion obnoxious to most of his subjects, [and] promptly embraced the old one." Like his father, Hakon had regional jarls. Sigurd Hakonsson was Jarl of the Trondelag. His nephew Tryggvi Olafsson ruled much of Eastland, and another nephew, Gudrod Bjarnarson, ruled Westland.

HARALD BLUETOOTH

Harald Bluetooth became king of Denmark in 950, after the death of his father, Gorm the Old. He let Christians worship publicly, due to pressure from Otto the Great, the strong King of Germany, whose forces also defended his land from the invading Magyars of Hungary. Otto was crowned Holy Roman Emperor at Rome in 962, then conquered Lombardy in Upper Italy.

Harald's sister Gunnhild had married Eirik Blood-Axe, eldest son of Harald Fairhair of Norway and king for awhile of the British Danelaw. After Eirik's death in 954, Gunnhild fled to the Danish court, along with her five sons, asking her brother to back their claim to the Norwegian crown, against Hakon. The Eirikssons, led by their eldest brother, Harald Greycloak, made repeated raids on Norway. For a while Hakon not only drove them back, but seized the Danish island of Zealand and keep it for a year or two. But in 961, the Eirikssons killed Hakon in a naval battle at the mouth of the Hardangerfjord. The eldest Eirikson, Harald Greycloak, became king of Norway.

That same year also saw Harald Bluetooth's conversion to Christianity, in order to make peace with Otto the Great after an unsuccessful border raid. Credit for his conversion was given to the priest Poppo, who gripped a red-hot bar of iron to show the power of Christianity. Four years later, Harald married his second wife, daughter of King Mistivoy of Wendland, who controlled a major Slavic trading mart and who promised to be his ally against the Germans.

After his success at backing the Eirikssons, Harald married his daughter to Styrbjorn Starki, who was trying to seize the Swedish crown from his uncle, King Eirik Sigrsaell. Styrbjorn died and his troops were defeated at a battle near the Swedish capital of Uppsala.

In 973, Otto the Great died. The next year, Harald and his Wendish allies, and Jarl Hakon of Trondelag allied to raid Holstein. Otto II's troops fought them off and invaded far north into Jutland. Eventually terms of peace were signed, under which Harald Bluetooth began the Christianization of Denmark, with some success in the south (near Germany), but none in the north and west.

In 983, Harald's son, Svein Forkbeard, attacked Germany, along with his grandfather, King Mistivoy. They raided Slesvig, Brandenburg, Holstein, and Hamburg. In 986, Svein Forkbeard drove his father from the throne and became King of Denmark. Harald Bluetooth went into exile in Wendland, at his father-in-law's court, where legend said he founded Jomsberg (see Section 8.5). He soon died and was buried eventually in his church of the Holy Trinity, in Roskilde, on the island of Zealand.

THE DANELAW UNDER ENGLISH RULE

In the early 10th century, the Danelaw was gradually reconquered by Alfred's son and grandson, Edward and Athelstan. After a generation, the Danelaw was Christian and English speaking again, but its people still kept many Norse customs. English kings recognized that imposing the Anglo-Saxon feudal system on the free farmers of the Danelaw would only lead to rebellion. King Athelstan took in Harald Fairhair's youngest son Hakon as his foster son, to cement his ties with the Vikings. Athelstan also kept Norsemen among his housecarls, insisting only that they undergo primesigning.

After Athelstan's death in 939, the Viking king of Dublin led his men south and claimed the rule in York. Athelstan's brother Edmund ceded him the Five Boroughs as well. In a few years, Olaf had died, but two more Viking kings followed, both of whom acknowledged Edmund as their king and accepted baptism.

7.4 THE LATE VIKING ERA (987-1066)

By the latter part of the 10th Century, Viking ships no longer sailed in pairs but only as part of royal fleets, making war and demanding tribute from other lands. Kings did not tolerate private raiding expeditions, locally or abroad. In addition to Norse settlements in Normandy and the British Isles, Vikings continued to raid Europe. There were raids on Spain and Portugal in the 960s; the pilgrim shrine of Santiago de Compostela was attacked in the Asturias.

ETHELRED THE UNRAEDY

During Ethelred's reign, said the English chroniclers, "the Vikings were never offered tribute nor fought against in time; only after they had done us the greatest injury was truce and peace made with them." Viking tactics were simple: to sail from region to region, promising each local ruler peace in exchange for silver, but only sailing home after receiving Danegeld from the king himself.

In 991, for example, the Vikings landed in Kent and soon defeated the local force, then plundered the region. "Then the king and his council decided that they should be opposed by a fleet as well as an army. But when the ships were ready, there was one delay after another....Always the English retreated inland and the Vikings pursued them. In the end, neither the fleet nor the army came to anything." The Vikings finally left after Ethelred paid them 16,000 pounds of silver.

Norse writers thought better of Ethelred than the English chroniclers. One saga calls him "a good leader of his people" and describes how he generously rewarded a skald for praising him. This was the poem's refrain:

*All folk fear as much as God
Great England's ring-giver
Kin of the keen in battle
The world bows to our warlord*

In 1002, Ethelred gave the forces of King Svein Forkbeard of Denmark 24,000 pounds of silver as Danegeld. Shortly afterwards, Ethelred married Emma, daughter of the Duke of Normandy. Feeling secure against invasion, he ordered that "all the Vikings who had sprung up in this island should be destroyed by a most just extermination" in the Massacre of St. Brice's Day (November 13th). Thousands of "Vikings" (many peaceful farmers who had been in England for generations) were killed, including Gunnhild, Svein Forkbeard's sister.

GREENLAND AND VINLAND

The large Arctic island of Greenland was discovered in the early 980s. In 986, there was famine in Iceland, and an expedition of 25 ships of settlers sailed for Greenland; 14 ships arrived safely. The expedition was led by Eirik the Red, who'd been born in Westland in Norway, then settled in Iceland, but been outlawed for three years due to killings committed in a blood feud.

Next year, Bjarni Herjolfsson sailed for Greenland but missed it and found Vinland in North America, though he did not land there. He was followed some years later by an expedition led by Leif Eiriksson which wintered over but was driven away by the Indians, whom they called Skraelings (the same name they gave the Greenland Eskimos). Greenlanders continued to make voyages to Vinland more or less routinely until 1020, to get timber and furs.

Two years after Edmund's death in 946, his brother Eadred became king of England. The Danelaw was promptly seized by Harald Fairhair's eldest son, Eirik Blood-Axe who had been expelled from Norway by his younger brother, Hakon the Good. He fought both King Eadred of England and Olaf Sigtryggson of Dublin and was finally killed in 954, at the battle of Stainmore, when he was defeated along with five other Norse kings by Eadred's forces.

Eadred was recognized as king of all England. He was followed by Eadwig the All-Fair, who was followed by Edgar the Peaceable, who decreed: "It is my will that there should be in force among the Danes [in the Danelaw] such good law as they can decide on. I have ever allowed them this and will allow it as long as my life lasts, because of the loyalty which you have always shown me."

Edgar was followed by his young son Edward, who was killed in 978, at the age of 15. He had been on his way to visit his 12-year-old half-brother Ethelred, but was set upon by Ethelred's retainers and stabbed before he could dismount from his horse. A century later, people said Ethelred's mother Elfrida had schemed to put her son on the throne. Edward's body was moved to the nunnery church at Shaftesbury where he was venerated as a martyred saint. Ethelred became king of England. Soon he would become known as Ethelred the Unraedy (the Ill-Advised). The Viking raids against England promptly began again.



HARALD GREYCLOAK AND JARL HAKON

Harald Greycloak became king of Norway in 961, with Sigurd Hakonsson still jarl of Trondelag, Tryggvi Olafsson still Jarl of Eastland, and Gudrod Bjararson still Jarl of Vestfold. Harald was a Christian and sent his men to break up gatherings at pagan festivals and to cut down groves sacred to the old gods.

Njal's Saga was set at the court of Harald Greycloak at Konungahela in the Eastland. His mother Gunnhild appears as a beautiful and crafty wizardess, who has her own hall and her own housecarls. She takes a fancy to one Icelander and makes her son give him a seat of honor among his housecarls, then lends him two longships for a summer's raiding. She also sends her housecarls to find the man who has stolen the Icelander's inheritance, kill him, and recover the money.

Even with troll magic on his side, Harald Greycloak was not a lucky king. His reign brought Norway years of bad harvests, bad fishing, and poor weather. The Eirikssons began to suspect that the regional jarls were harboring rebels and killed them. Svein Forkbeard of Denmark, himself a pagan, promptly allied with the banished Hakon Sigurdsson, son of Jarl Sigurd of Trondelag. Together their forces killed Harald Greycloak in 970, in a battle off Limfjord in Jutland.

Jarl Hakon Sigurdsson now ruled Trondelag and Westland as vassal of the King of Denmark, with Harald Bluetooth ruling Eastland himself. Under their rule, sacrifices to the old gods were reinstated and the sacred places restored. The two remaining Eirikssons and their mother fled to the Orkneys, from which their raiding ships sailed against Norway until they died near the end of the century. For a while, Jarl Hakon remained allied with Harald Bluetooth. But after the disastrous raid on Germany in 974 and Harald's baptism, the two became enemies.

JARL HAKON SIGURDSSON

After the death of Harald Bluetooth, Jarl Hakon Sigurdsson of Trondelag was effectively king of Norway. Sixteen jarls served him, one for each region of Norway. Harald's son Svein sent a fleet against him, but it was defeated. Men told one another that Hakon had sacrificed his son Erling to Odin and was granted in return a hailstorm that destroyed many enemy ships.

Hakon had always enjoyed the company of women. Now there was gossip that the jarl was indulging his lusts not just with thralls and the daughters of his housecarls, but with the daughters of his regional chieftains. The *Heimskringla* says that he "had the daughters of mighty men taken and brought home to him; he lay with them a week or two and then sent them home." The women's kinsmen and landholders began to grumble at his rule.

ICELAND

Iceland's landholders came from the Norwegian Westland, the Atlantic Islands, and the Norse kingdoms of Ireland and Northumbria. There, the thirteen regional assemblies of Iceland met each spring and fall. Each regional assembly covered the territory of three *godir*, the local chieftains.

All landholders of Iceland met once a year at the national assembly, the Althing. There laws were made by the 39 *godir*, chaired by the Lawspeaker who recited a third of the laws to the landholders each year. The laws of Iceland were modeled on the lawcode of the Gula-Thing of Western Norway, which was brought to Iceland by Ulfjot, the first Lawspeaker. After him, the Lawspeakers up till 1066 were:

930-949	Hrafn Hengsson
950-969	Thorarin the brother of Ragi
970-984	Thorkel Mani
985-1001	Thorgeir Thorkelsson
1002-03	Grim Svertingsson
1004-30	Skapti Thoroddson, Grim's nephew
1031-33	Stein Thorgestsson
1034-53	Thorkel Tjorvason
1054-62	Gellir Bolverksson
1063-65	Gunnar the Wise
1066-71	Kolbeing Flosason

King Olaf Trygvasson of Norway sent an Icelander named Stefnir Thorgilsson along with several priests to Iceland to preach Christianity, hoping to convert it before the millennial year 1000, which some people thought might see the Second Coming of Christ. The Icelandic response was to outlaw Stefnir and the priests and to pass a law that Christianity was to be regarded as a disgrace for the family; thus, people with Christian relatives should sue them if they insulted the heathen gods.

King Olaf sent more missionaries, who returned with tales of Icelandic witches and berserks. Olaf took hostage all the Iceland traders at his court, refusing to permit them to sail because Iceland was so stubbornly pagan.

Meanwhile, some prominent Icelanders became Christian, and Icelandic law seemed about to break down. Pagans and Christians could not swear oaths that were acceptable to one another. That year the Althing decided that all Icelanders would become nominal Christians. People were no longer to offer sacrifices to the old gods, eat horsemeat or expose unwanted children. On hearing this news, Olaf set the hostages free to sail once more.

The priests wanted to baptize all the freeholders at the Althing. Most refused. Rather than be dipped in the cold river that ran through the Thing Valley, they preferred to be baptized in hot springs on their way home.

OLAF TRYGVASSON

Olaf Trygvasson was the son of Tryggvi Olafsson, Jarl of Eastland, who was killed by King Harald Greycloak. Olaf was raised in exile by his mother's brother Sigurd, a noble at the Viking court of Vladimir of Russia. He raided Britain in the early 990s in alliance with Svein Forkbeard. He was baptized in London in 994, and given his share of a Danegeld of 16,000 pounds of silver in return for promising not to raid England again.

He took the money home to Norway, where he was acclaimed as king by the Trondelag Thing. Jarl Hakon Sigurdsson fled and hid in a pit with his thrall Kark. The *Heimskringla* reports that the jarl fell asleep and "shrieked loudly and horribly. Kark became afraid and horror-struck, and he grabbed a great knife from his belt, stuck it in the jarl's throat and cut it out." The next day, he took the jarl's head to Olaf, who ordered him executed.

Soon the Eastland and Westland Things recognized Olaf as king. He established his court (and a new trade mart) in the Trondelag, naming it Nidaros because it was near the mouth of the river Nid. Olaf married Svein Forkbeard's sister Thyri and married his own sister to Rognvald, Jarl of the Westland. He attempted to Christianize Norway but met with little success. He did succeed in bringing about the conversion of Iceland and (more forcibly) of the Orkneys.

The *Laxdaela Saga* describes how an Icelander met Olaf swimming in the Nid River and competed against him to see who could pull the other underwater the longest. Later he went at Christmas to hear Olaf preach and decided to be baptized as soon as possible.

A later, non-historical saga tells how one of Olaf's retainers journeyed into Giantland and called on King Olaf for good luck when threatened. He later returned to court with his bride, a tall woman, the daughter of Jarl Agni whose (mythical) land of Grundir lay between Giantland and Jotunheim. King Olaf had her baptized and instructed her in Christianity.

Olaf died in a sea battle in 1000, defeated by the forces of Svein Forkbeard of Denmark allied with King Eirik the Victorious of Sweden and the Hakonssons of Trondelag.



SVEIN FORKBEARD

Svein Haraldsson became King of Denmark (and overlord of Norway) in 978. His daughter Gyda was married to the exiled Jarl Eirik Hakonsson. He also arranged a marriage between Eirik's brother, Svein Hakonsson, and the sister of the king of Sweden, Olaf Skotkonung, son of King Eric the Victorious. Svein himself married Skotkonung's mother, Eric's widow. After they had defeated Olaf the Stout, Svein appointed the Hakonssons as his jarls, Svein Hakonsson as Jarl of Westland, Eirik Hakonsson as Jarl of Trondelag.

Svein raided England repeatedly, receiving ever increasing sums of Danegeld. After the death of his sister Gunnhild in the Massacre of 1002, his fleets sailed year after year to take wergild for her death — and to conquer Ethelred, the king who had ordered it. His forces established an English base on the Isle of Wight.

In 1009, the Danish fleet was led by Thorkel the Tall, allied with Olaf the Stout, who was later to be king of Norway. Olaf's ships sailed up the Thames but found their way barred by London Bridge, on which stood men hurling stones and spears on them. Eventually Olaf ordered ropes tied around the bridge's pilings; then his ships rowed downstream again. The pilings broke and the bridge fell down, the origin of the well-known nursery rhyme.

In 1013, Svein led his fleet in person against England. He sailed to the heart of the Danelaw, which acclaimed him as king. He conquered Mercia, then attacked London. Ethelred fled to the court of his father-in-law, Richard II, Duke of Normandy.

Svein Forkbeard entered London at the head of his army and was acknowledged as King of England. A few months later, in February, Svein suddenly died, leaving his forces under the command of Knut, his 18-year-old son.

OLAF THE STOUT (ST. OLAF)

Olaf the Stout was the stepson of Sigurd Sow, an Eastland chieftain. He accompanied Thorkel the Tall on his raids to England, then sailed with Richard of Normandy. After Svein's death, he briefly helped the forces of Edmund, Ethelred's son. He returned to Norway in 1015 and was acclaimed king, defeating the Hakonssons the next year in a naval battle. He then allied with King Anund of Sweden, marrying his daughter Astrid.

Olaf was a zealous Christian who used all the force at his disposal to convert the country. He announced that pagans should either "hold battle with him and suffer burning of their farms or take up Christianity and bring him their sons as hostages."

After his defeat by Knut's forces at Holy River in 1027, Olaf led his fleet north, then landed and took his men into Russia. His brother Harald Hardrada (the Ruthless) journeyed still farther and became a soldier in Byzantium.

After Jarl Hakon's death in 1035, Olaf left his son Magnus behind in Russia and returned to Norway at the head of an army, some of them foreigners, some of them pagan Vikings. He was killed on July 29th of 1035 at the battle of Stiklestad, on the Trondheim fjord, the first land battle in Norse history.

Soon a cult grew, and he was acclaimed the national saint of Norway. His body was enshrined in a cathedral at Nidaros and was a place of pilgrimage. In England, churches were dedicated in his honor in London, York, Exeter, and elsewhere. (Some historians remark that it was financially useful to Norway to have its own saint; thus, pilgrims no longer were forced to journey south all the way to Rome, and Norway could receive pilgrims from Denmark and Iceland.)

KNUT SVEINSSON (KING CANUTE)

After Svein's death in 1013, the English nobles sent messengers to Ethelred in Normandy, inviting him to return. Knut mutilated the hostages his father had taken, put them ashore, then returned to Denmark where his elder brother Harald Sveinsson was king. He returned to England two years later, allied with Jarl Eirik of Trondelag and Thorkel the Tall.

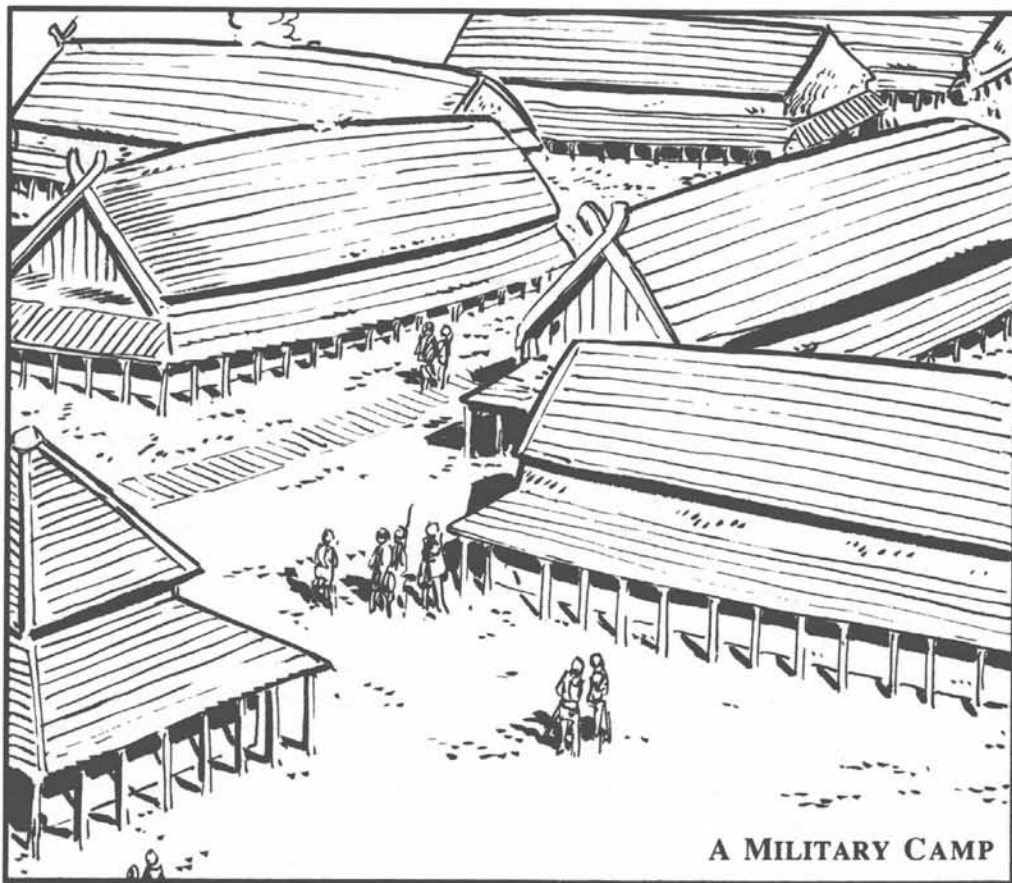
It took Knut a year to conquer the English forces, by luck. Ethelred died while camped in London in April of 1016. His son, Edmund Ironside, was chosen to succeed him, but he died suddenly in November of the same year.

Knut now divided England into regions. He ruled Wessex himself, gave Northumbria to Jarl Eirik, East Anglia to Thorkel the Tall, and Mercia to Eadric Streona, a powerful English noble who had helped give him victory by betraying Edmund. A few months later, Eadric Streona was executed, and Knut divided Wessex and Mercia into smaller earldoms.

In 1018, Knut received a Danegeld from England of 172,000 pounds of silver plus another 10,000 pounds of silver from the city of London. Thereafter, he settled for an annual tax on his English subjects. He summoned a national assembly at Oxford which agreed to accept the laws of King Edgar the Peaceable.

Knut was famed through England as a peace bringer, a legislator, an administrator and a patron of the Church. One legend about him reports his response to courtiers who told him that the very winds and tides would obey him. He dealt with this flattery (or perhaps he thought of it as an accusation of being a wizard) by having a throne set up on the shore and letting them watch the waves come in and soak him.

By now Knut already had an English wife, Algiva of Northampton. He also married Emma, King Ethelred's widow and daughter of Richard Duke of Normandy. Emma was acknowledged as Queen of England; Algiva became merely a lesser consort. Harald Harefoot was the son of Algiva. His younger half-brother Hardaknut was the son of



A MILITARY CAMP

Queen Emma.

In 1018, Knut's elder brother Harald died without children, and Knut became King of Denmark, but remained in England. Denmark was ruled by a jarl: first Thorkel the Tall (who died in 1024), then Ulf, who had married Knut's sister Estrid. In 1025, Knut arranged a marriage between his daughter Gunnhild and Emperor Conrad of Germany and received as a present from Conrad the territory of Schlesvig.

In 1027, Knut took a fleet to Norway where he conquered the forces of Olaf the Stout and his father-in-law, King Anund of Sweden, on the Holy River. Knut ordered his brother-in-law Ulf killed, but gave generous estates to his widowed sister. She arranged for her son Svein to be fostered at the Swedish court, for his protection. Knut summoned the Trondelag Thing and proclaimed Hakon Eiriksson Jarl of Norway and his son Hardaknut as King of Denmark, after which he returned home to England. Hakon Eiriksson drowned in 1029 while visiting England, and Knut sent his consort Algiva to rule Norway as regent for her young son Swein Knutsson.

Knut died in 1035, on November 12th, less than four months after his final battle with Olaf the Stout at Stiklestad.

IRISH VIKING RULERS

During the tenth century, large parts of Ireland were ruled by Viking dynasties, which had now become Christianized. One Irish chronicler wrote that "There was a Norwegian king in every province, a chief in every clan, an abbot in every church, a sheriff in every village, a warrior in every house." The king of Dublin was the most powerful of these Viking chieftains. Sigurd the Stout, Jarl of the Orkneys, controlled all the Scottish and Irish islands, including the Isle of Man.

Good Friday, in the April of 1014, was the date of a great battle on the plain of Clontarf, near Dublin Bay. Sigurd the Stout, Brodir of Man, and the Dublin Vikings were allied with King Maelmordha of Leinster. They were opposed by the forces of Brian Boru, High King of Ireland, who seems to have triggered the battle by raising taxes on cattle so high that the Irish herdsmen of Leinster joined the Norse herdsmen of the Orkneys in their rebellion.

Brian Boru was killed as he prayed for victory. On the other side, Jarl Sigurd soon found no man willing to carry his raven banner, which guaranteed victory but which often cost the standard bearer's life. Finally he rolled it up under his arm, saying that a beggar should bear his own burden. He was killed a few minutes later.

Njal's Saga tells of one Icelander at the battle who stopped running to tie a shoe-thong. An Irish noble stopped near him and asked why he wasn't running like the other Vikings. He replied that unlike them he could not reach home that night, since he lived in Iceland. The Irish noble spared his life.

Afterwards, the Norse chieftains acknowledged the new Irish High King. But they remained great lords in their various towns.

NORWAY AFTER KNUT'S DEATH

After Knut's death in 1035, eleven regional chieftains of Norway went to the court of Yaroslav at Novgorod in Russia to ask Magnus Olafsson (son of St. Olaf) to return to Norway. They explained they hated Algiva and her son Swein Knutsson and wanted no more Danish jarls. They took oaths that they were acting in good faith. Magnus consented to return, and they swore allegiance to him.

Under Knut's rule, regional chieftains were not permitted to maintain their own troops. Only the royal army was tolerated in Norway. Magnus returned with his own men from Russia and was

acclaimed by the regional Things as king of Norway.

The Heimskringla describes Magnus as "of average height, with regular features and a fair complexion and fair hair. He was well-spoken and quick-thinking; he was noble-minded and exceptionally generous with his wealth, a great warrior and very courageous in battle. He was the most popular of kings, and was praised by friend and foe alike."

Soon after becoming king, Magnus allied with Svein Estrildsson and helped him conquer Denmark from Hardaknut Knutsson. For awhile Svein ruled Denmark as Magnus's jarl. The two fought together against invading Wends, then became enemies. In 1047, Svein was journeying back to Sweden once again when he heard that Magnus had died, due to a fall from horseback. Svein promptly returned to Denmark and reclaimed the kingship.

HARALD HARDRADA AND SVEIN ESTRIDSSON

Harald Hardrada was the son of Sigurd Sow, stepbrother to Olaf the Stout, Magnus's father. In Byzantium, he had risen to lead the Varangian Guard. He returned to the northland in 1038 with chests of gold, some of it won on the battlefield, some gotten by looting the Imperial Palace on the death of an Emperor (a Byzantine custom the Varangian Guard was quite fond of).

At first, Harald allied with Svein Estridsson; eventually he reached an agreement with his nephew Magnus. Magnus accepted Harald as his heir and fellow king of Norway as long as Harald paid him proper honor. The Heimskringla says that Harald swore to give Magnus precedence in greetings, in attendance and in rank; to let him take the best berth in the harbor for his ship and the middle seat when three kings sat together. Harald also opened up his chests of gold and gave half of his wealth to his nephew.

Once Magnus died, Harald was acclaimed king by the regional Things. He then killed the jarls of Trondelag and Eastland and ruled the regions directly, sending his fleet to harry Denmark's trade marts for the next 17 years. Eventually he and Svein Estridsson of Denmark signed a peace treaty acknowledging that Denmark and Norway were separate states.

Harald now allied with Tostig, the exiled jarl of Northumbria. Their combined fleets attacked York in 1066. They received the city's submission but were defeated and killed by the army of Harald Godwinson, hastily marched north from London in only three days.

ENGLAND AFTER KNUT'S DEATH

Hardaknut fled to England, where his elder half-brother, Harald Harefoot ruled as king, assisted by his mother Algiva. After Harald Harefoot's death in 1036, Hardaknut became king. He died in 1042, poisoned (according to legend).

The English chose as their new king Hardaknut's half-brother Edward, son of Emma and Ethelred the Unraedy, nephew of the Duke of Normandy. Edward died in January of 1066 and was succeeded by his sub-king Harold Godwinsson, brother of Tostig, the deposed Jarl of Northumbria. Tostig fled to the Orkneys and allied with Harald Hardrada of Norway, promising him England. Their combined invasion fleet totaled 300 ships and 9000 men. They were defeated by Harold Godwinsson's troops who'd been force-marched north at the battle of Stamford Bridge, near York.

Then Harald heard that William, Duke of Normandy, had landed in southern England, with another great army. Again he hurried his troops southward, but they were defeated at the battle of Hastings. Legend says that they broke their shield wall to attack the Norman mounted knights who seemed to be fleeing. It was a trick, however, and Harald's forces were defeated. William the Conqueror gained control of England, and the Viking Age of conquest was over.

7.5 VIKING TIMELINE

Europe	Great Britain		Denmark	Norway
787-93 — Viking raids	Raids on monasteries Vikings settle Atlantic Islands, Ireland	780	King Godfred (dies 810) King Horik (dies 854)	King Gudrod (dies 821) Queen Asa as regent for son Halfdan
		800		
830s — Viking raids on trade marts, inland towns	Raids on islands, coastal towns Torgils rules Irish Vikings, founds trade marts	820	Harald Klak expelled, rules Walcheren, part of Frisia	King Halfdan the Black (dies 875)
840s — Viking raids on upriver towns 850s — Raids continue	Raiding ships winter over 853 — Olaf rules Dublin. Ragnarssons overrun East Anglia, Northumbria, settle Danelaw.	840	King Horik the Younger	
860s — Raids continue 877 — The Great Army	Alfred in Southern England, peace in 892 with Danelaw under Guthrum	860		875—Guttorm as regent for Harald Halfdansson Settling of Iceland
		880	Olaf of Sweden conquers Denmark - late 890s succeeded by son Gnupa	Harald unifies Norway
890s — Rollo conquers Normandy		900		
913 — Henry I unifies Germany. Raids on France continue.	Northward English push, under Athelstan (died 939) and Edmund (died 946).	900		
		920	934 — Gnupa submits to Henry I of Germany King Gorm the Old (dies 950)	
Magyars raid Germany, France		940	King Harald Bluetooth Eirikssons in Denmark	944 — King Eirik Blood-axe 945 — King Hakon the Good dies 961 (killed by the Eirikssons)
961 — Otto I of Germany raids Denmark Hugh Capet crowned king of France in Reims	Kings respect Danelaw customs. Eirik Blood-Axe and allies defeated in 954 by Eadred (died 955), Eadwig (died 959), Edgar the Peaceable (died 975), Edward (died 978)	960	978 — King Svein Forkbeard	961 — King Harald Greycloak (killed 970 by Jarl Hakon, King Harald Blue-Tooth) Harald Blue-tooth
Otto II defeats Magyars, Harald Blue-Tooth Otto III defends Italy vs Arabs, Byzantines	Ethelred the Unraedy frequent Viking raids	980		986 — Greenland settled Jarl Hakon rules land 995 — King Olaf Trygvasson
French "kings" couldn't control vassals. Conrad II cedes land to Knut, Magyars, loses Lombardy	1002 — Ethelred orders Massacre of Danes 1014 — Battle of Clontarf Brian Boru's forces win 1016 — Knut Sveinsson becomes English King (dies 1035) 1017 — King Harald Harefoot Knutsson	1000	1013 — Svein conquers England, dies 1014 1014 — King Harald Sveinsson, followed in 1018 by Hardaknut Knutsson	1000 — Iceland Christianized Olaf killed by Svein, Hakonssons 1015 — King Olaf the Stout 1027 — defeated by Knut, Jarl Hakon. 1029 — King Svein Knutsson
	1036 — King Hardaknut Knutsson 1042 — King Edward, son of Ethelred (died 1066)	1030	1035 — King Svein Estrids-son (Knut's nephew)	1035 — Olaf the Stout returns, killed in battle. 1035 — King Magnus Olafsson 1047 — King Harald Hardrada killed 1066 by York, three days before Hastings
	1066 — King Harold Godwinsson, defeated at Hastings	1066		

THE WIDE WORLD

This section briefly covers the cultures and major trade marts visited by Viking ships. The maps in this section of the book show (among other things) the major Viking trade routes. Viking ships traveled all the known world, from eastern Canada to Baghdad, from the frozen reaches of the Arctic Circle down to the warm and gentle shores of the Mediterranean Sea.

Most European traders in this age confined themselves to coastal sailing; only the Vikings had the courage to sail into the unknown, trusting the fates to land safely somewhere interesting and profitable. One reason they dared do this was that they did not believe that sailing the Atlantic put them in any danger of falling off the edge of the world. Instead, Vikings believed that the Atlantic was a very large lake! They believed that northern Sweden, Greenland, and northern Canada were all connected by a land bridge somewhere in the Arctic Circle.

Viking ships sailed coastal routes after the fields had been sown in April and ending in the month of Autumn, in mid-October. The waters of the Atlantic were more dangerous. Ships usually didn't set out across the deep ocean until mid-May and either returned by mid-September or wintered over.

8.1 NORWEGIAN AND DANISH TRADE MARTS

Viking trade marts were not easily accessible from the open sea. Some were located inside bays protected by chains of islands or sandbanks, so a ship had to row its way through, carefully piloted by someone who knew the waters. Some were located on lake islands or on rivers leading from lakes, while other marts were hidden inside fjords, narrow but navigable arms of the sea. Most trade marts were protected by a palisaded earthwork, usually overlooked by a nearby fortified height.

Each Viking mart had its own Thing to settle disputes, presided over by a representative of the king. This royal steward inspected each ship that came in to see how much harbor tax it should pay. He also had the right to make first bids on all cargo, and no other trader could bid until three days had passed.

During the summer, the harbor bustled with trading ships. Traders unloaded their cargos onto ox-carts which were drawn over cobblestone roads to the fairground, usually a meadow where traders set up stalls or laid their goods on lengths of homespun cloth on the ground. Most traders set up tents on the fairground and slept there, to protect their goods. They ate the food and drank the ale brought to the fairground for sale by local farmers. Some men were left behind aboard the ship, to protect it, but even they cooked their food ashore.

Usually the craftsmen had their own section of the trade mart. Their shops, barns, stables, storage sheds, and houses stood side by side, their homes enclosed by palisades of plaited hurdles. There was usually a ship-repairing yard by the harbor. By the early 11th century, most of these marts also had royal mints. Before that, merchants used foreign coins or hacksilver.

During the six winter months, most Viking trade marts were either deserted or half-empty. If there were a royal court nearby, it usually kept to itself in the winter except at Yule. Only craftsmen remained behind as permanent inhabitants. Some craftsmen had small herds or tended small plots of land, which gave them food to put up for the winter. Others had to buy provisions from the local farmers.

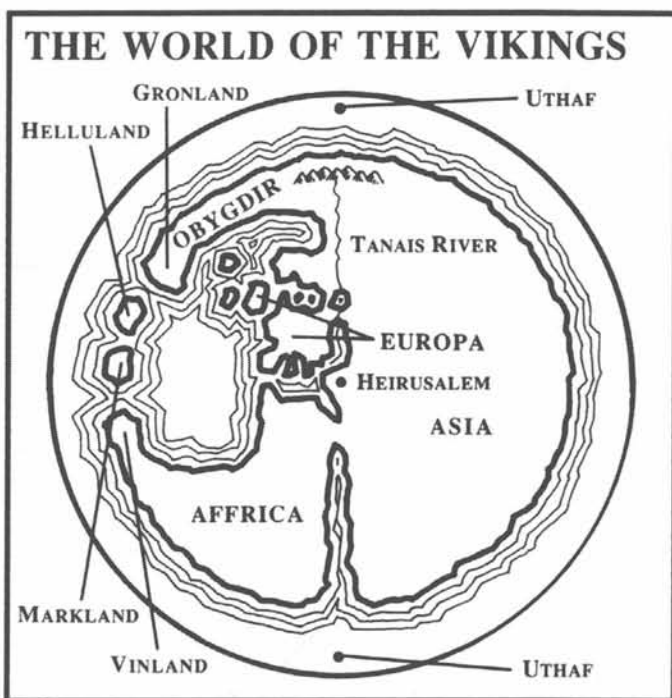
HEDEBY ON JUTLAND, DENMARK

Sailing around the Jutland of Denmark was a hazardous trip. Any cove might hold a pirate vessel. It was safer to head for the Danish trade mart of Hedeby, on the eastern side of the neck of Jutland. This meant sailing from the North Sea up the Treene River, then offloading the cargo onto ox-carts to be carted eight miles overland to the Sliefjord, and then loading the goods you had bought or had not sold onto other ships and sailing down to the Baltic.

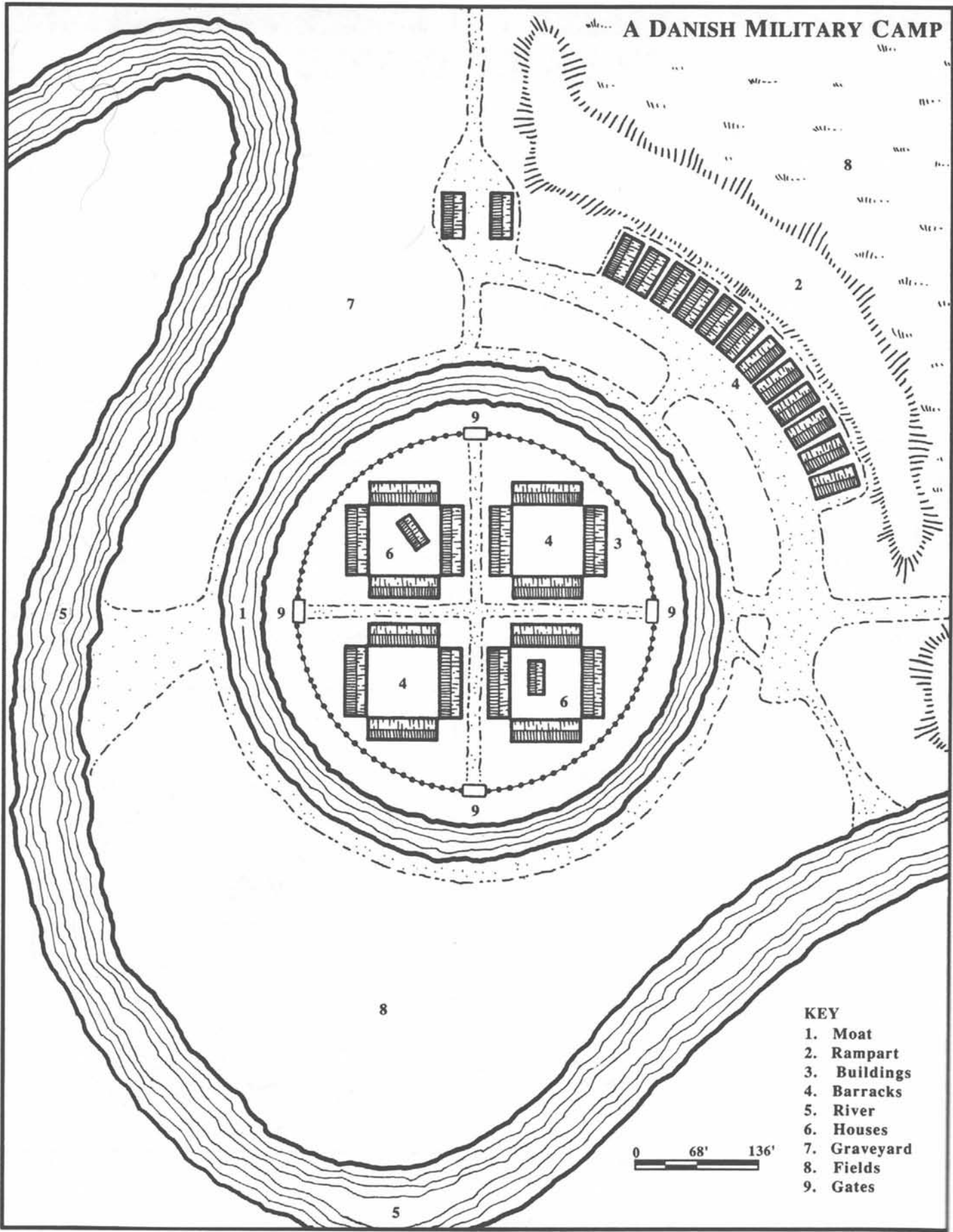
Hedeby means "heath town." The sixty acre mart was surrounded by an earthwork on the north, west, and south. To its east lay Haddeby Noor, a large inlet of the fjord. A river ran through the town and into the cove. Brooks flowed north and south of the mart. Two main roads met each other at right angles. The center of the town held large buildings of twenty feet by fifty feet; in the west, there were mainly small huts of ten foot diameter. There were also several graveyards.

Many European merchants came by land and sea to trade at Hedeby, which they called Slei Town. So did a few Arab traders from Baghdad, one of whom wrote: "Slesvig is a large town at the farthest end of the world ocean."

European traders brought in ceramics, glassware and basalt millstones (and smuggled Frankish swords). Viking traders travelled west from the Slavic lands with thralls and furs and goods imported from Russia, Byzantium, and Baghdad (see Sections 8.6, 8.7, and 8.8). There were also many goods made at Hedeby itself. Some craftsmen carved soapstone or bone and horn; others were weavers and jewelers and glass makers and potters and smiths who worked bronze and iron. There was even a mint.



A DANISH MILITARY CAMP



- KEY**
- 1. Moat
 - 2. Rampart
 - 3. Buildings
 - 4. Barracks
 - 5. River
 - 6. Houses
 - 7. Graveyard
 - 8. Fields
 - 9. Gates



Hedeby held the first Christian mission to Denmark, led by Anskar in 826-9, who built a small school there. In 850, he built a church as well, which four years later was given a bell. By 948, a colony of German traders and craftsmen lived at Hedeby, sent there by German Emperor Otto the Great, and the church had a bishop named Hored.

Hedeby was burned to the ground by Harald Hardrada in 1050 during his war with Danish king Harald Estridsson. It was rebuilt, only to face a raid by the Slavs in 1066. But what truly killed it was that a new town, also called Slesvig by the Germans, grew on the north side of the Sliefjord.

OTHER DANISH TRADE MARTS

Ribe lay on the west side of Jutland, on the Ribea river. During storms, ocean waves often threatened to overwhelm the town. The sea bottom was so shallow you could wade at low tide to the isle of Mando, six miles away.

Viborg lay north of Ribe, at the end of a deep fjord on the west coast. It was the site of the main Danish Thing, the one that chose the king. On the northern tip of Jutland lay Lindholm Hoje (a little north of the modern Aalborg), on the Limfjord which then linked the North Sea with the Kattegat. (Now it's largely silted up.) Halfway down the east coast of Jutland lay Aarhus. The royal court of Jelling lay inland in the center of the country, south of Lindholm Hoje and Aarhus and Viborg, north of Ribe and Hedeby.

There were also island trade marts. Across the Little Belt from Jutland lay the island of Fyn, with its trade mart of Odense (a center of Odin worship). Across the Great Belt from Fyn, lay Brovold on the island of Als, and Roskilde and Ringsted on the island of Zealand. (The current Danish capital city of Copenhagen was only a minor harbor on Zealand.) North across the Sound from Jutland lay Skane, a virtual island at the southern tip of what is now Sweden; its trade mart of Lund was founded in 1020. A number of other Danish islands lay in the Sound and the Baltic.

Regional trade marts allowed local villages to trade with one another as well as to import and export goods to a worldwide market. Many of these marts were probably only inhabited in the summer, with the craftsmen going home to family villages during the long, dark winter months.

SKIRINGSSAL IN VESTFOLD, NORWAY

Skiringssal is now called Kaupang, which means "market place." It had no man-made defenses, but lay on a bay behind a screen of islands and shoals. It was visited by many merchants sailing from England and Ireland, with goods from there such as metalware and finely woven cloth. Local craftsmen worked in soapstone and metal. It was also a local market town.

Skiringssal would have been a good place for merchant ships to assemble before sailing south to Hedeby (a five day trip) or east through the Oresund to the Baltic, in order to protect one another against pirates.

OTHER NORWEGIAN TRADE MARTS

The jarls of Trondelag had their court at Hladir ("Lade," in English), on the southern shore of the Trondheimfjord. Later, Olaf Trygvasson founded the trade mart of Nidaros (modern Trondheim) nearby at the mouth of the river Nid, in the hope it would be a Christian rather than a pagan community.

Eastland trade marts included Tunsberg and Avaldsnes, home of the court of Harald Fairhair. Oslo wasn't founded by Harald Hardrada until 1050. It lies at the head of Oslofjord, where the Akers river flows into the sea.

8.2 OTHER NORSE TRADE CENTERS

Latitude sailing (see Section 3.1) west across the Atlantic brought the Viking trader to the other Norse lands: the Atlantic Islands (the Faroes, Orkneys, Hebrides, Man, and Shetland), Iceland, and Greenland. It was a seven days' sail from Norway to Iceland, a five days' sail from Iceland to Ireland, and a four days' sail from Iceland to Greenland.

In these lands, each harbor region was dominated by its local chieftain. One saga tells how an Icelandic chieftain "with no great reputation for fair dealing" handled a visiting trader who was "a popular man and a sound trader."

"Odd heard tell of the ship's arrival. It was his practice to get down to the market among the very first and set a price on the merchants' goods, for he held rule over the district, and no one presumed to buy or sell till they were clear as to his intentions. So now he met the merchants and asked them their business, and how soon they wanted to get their goods on sale, explaining that it was the practice there for him to fix the price of men's merchandise.

"[The merchants refused to let him run things, so Odd proclaimed:] I forbid all men to buy or sell with you, and I am likewise banning all movement of goods. By the same token, I shall levy fines upon any who give you the slightest help. And finally, I know that you cannot get out of the harbor here till the next spring-tide [in another two weeks]."

The Vikings didn't have regular trade relations with the Skraelings (North American Indians) of Vinland and Markland, though the Vinland Sagas report one occasion on which the men traded red cloth or milk for fur pelts. On other occasions, Vikings and Skraelings fought. The Skraelings had no armor or metal weapons, but they did have deadly arrows and a pole-catapult that launched heavy rocks. Some Skraeling children the Vikings captured told them that their people had no houses but lived in caves or holes in the ground.

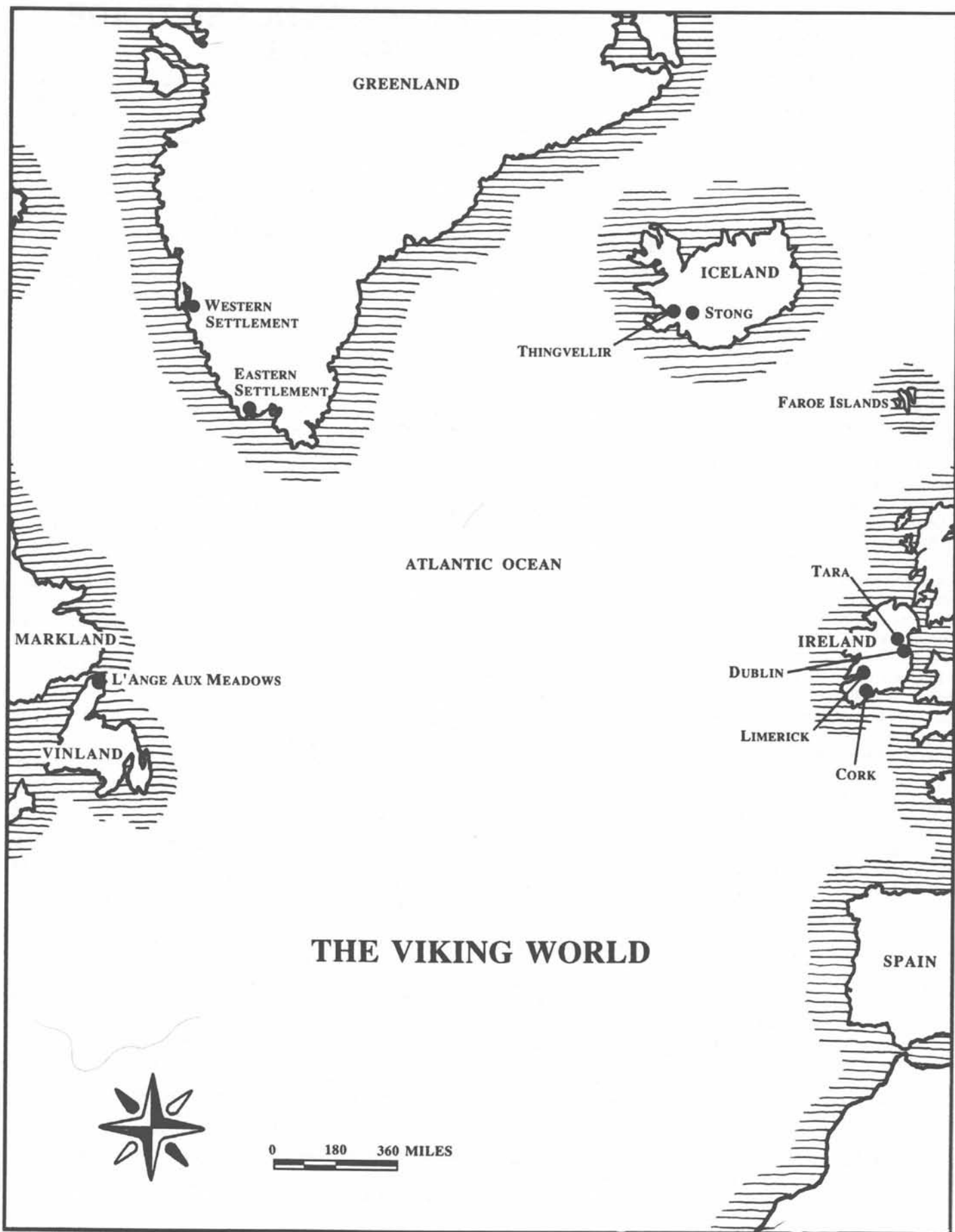
8.3 THE LAPPS

The Lapps lived where the Scandinavian peninsula touched the mainland of Europe. They called themselves "Sameh"; the Norse called them Finns. They were olive-skinned, dark-haired, and short. The men averaged 5' tall, the women 4'8".

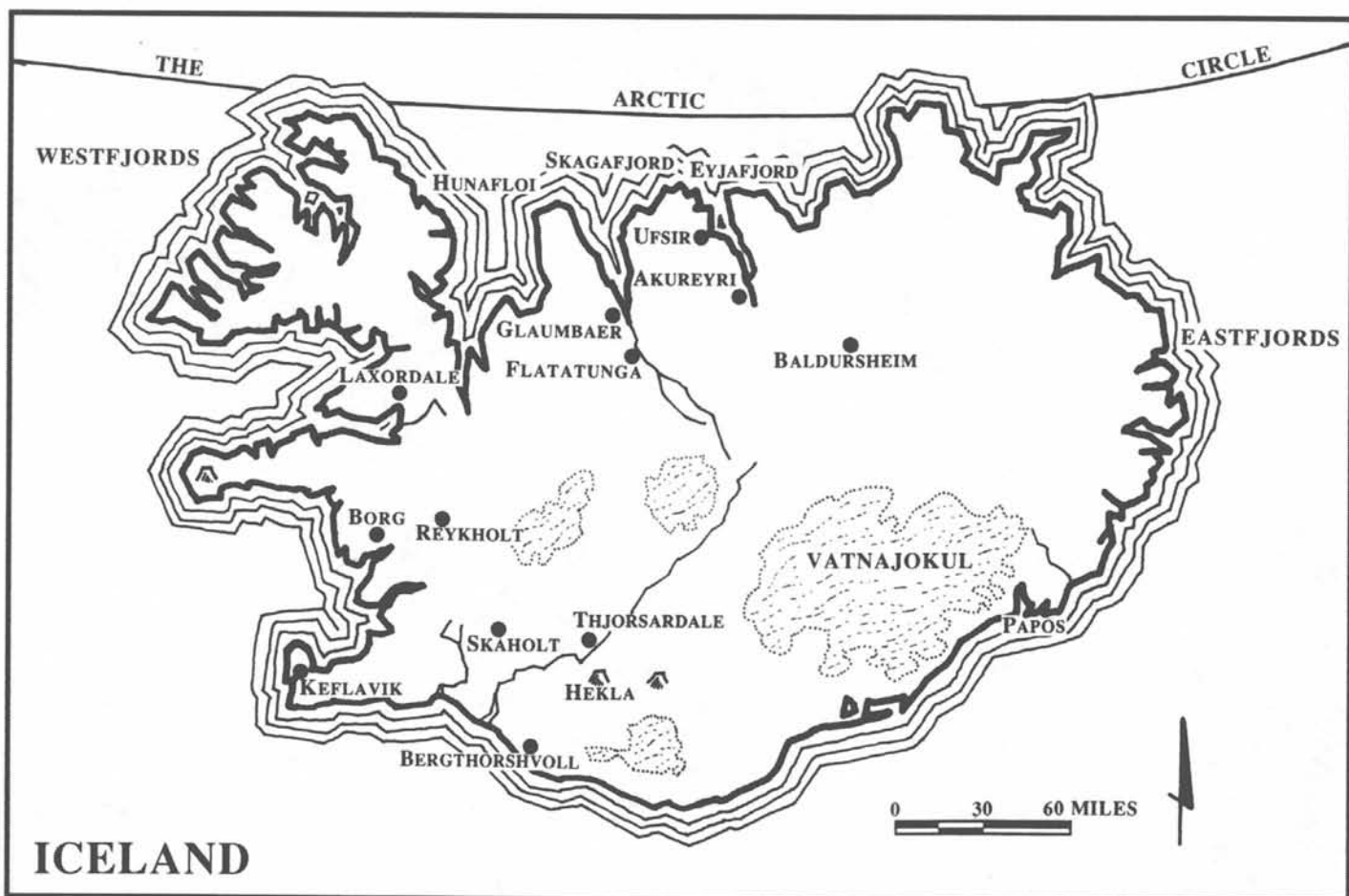
Lapland was covered with snow except for high summer (June through September); the mountains were always snow-covered. Summer brought swarms of hungry mosquitoes and temperatures in the mid-60s. Winter brought inland temperatures as low as 44 degrees below zero — and rich furs, many of them white.

The Lapps were fishers and nomadic hunters. Their small tribes of 30-90 people were led by a headman and followed the herds of wild reindeer (that they would tame centuries later). Each tribe spoke its own dialect of their language, with Lapps themselves often unable to understand people from far-off tribes. They lived in skin tents and moved their belongings on human- or dog-pulled sledges. If they could hide from the Norse warriors, they did so; if not, they paid tribute in fur pelts, walrus hides and walrus ivory.

Lapps hunted with dead falls, snares, stockade drives, and bone-tipped spears and arrows. One of their "ski poles" was a spear with a basket tip; the other, a longbow of laminated birch or pine, also with a basket tip. They had no armor, and their shields were just wood with no iron boss. Brass was a sacred metal; their priests offered it to the gods.







The Lapps' gods were Jumale (the day sky), Perive (the sun), Aske (the moon), Biegg (the wind) and Tiernes (thunder). Next came the Radien family of fertility gods: Atje (the father and creator), Akka (the mother), Kiedde (the son who gave souls to the newborn), and Neida (the daughter who made plants green in the spring). An idol of stone or wood was placed on a standing stone, sometimes surrounded by a semicircle of reindeer antlers or birch branches decorated with silver. Worshippers removed their hats and knelt, hands raised, palms up. Offerings might be babies or reindeer on important occasions; fish, dogs, cats or blood on less important ones.

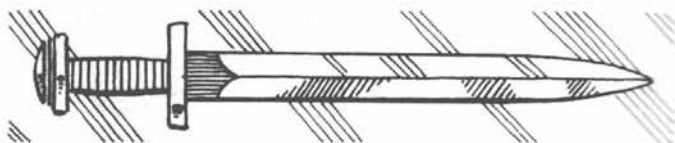
Priests used magic drums, which were stored at the back of the tent (along with weapons) by the exit that could only be used by adult male hunters. They wore magic belts, decorated with brass rings and amulets: miniature knives, bear teeth, etc. Priests also had a magic cap made of skin, with fur inside and animal horns on top. They decorated their drum skins with symbols drawn in red, with birch juice, and beat them with bone hammers. Lapp priests claimed to foretell the future by which symbols vibrated when the drum was beaten.

Lapps worshipped the bear as a demigod, since it could walk like a man, climb trees, and slept through winter. Finding a hibernating bear in the winter called for a tribal killing, followed by three days of abstinence and prayer for the dead bear's soul, followed by three days of orgies and feasting, after which the bear bones were put back in order and buried.

8.4 SWEDISH TRADE MARTS

Sweden lay just across the Skagerrak from the southern tip of Norway and the northern tip of Denmark, and the Swedes were part of the same culture as the Norwegian and Danish Vikings. The center of trading activity in Sweden lay in Lake Malar, in eastern Sweden. To get there, ships had to sail past the narrow strait where modern Stockholm lies, then thirty miles inland to the great lake. The Swedish capital of Uppsala lay slightly inland from the north edge of Lake Malar. In the winter, Lake Malar froze, but land traders could get there by sledge.

North of Uppsala, Sweden was mountainous and cold. Its fertile lands lay in the south. Settled areas were separated by dense forests, which could be cleared only with difficulty. Swedish younger sons did not have to band together to conquer foreign lands; instead, they cleared and farmed the forested plains, less rocky and steep than those of Norway. Swedish traders looked not west but east, across the Baltic to the ports and inland marts of Russia, and beyond to Byzantium and Baghdad.



BIRKA

During the Viking Age, the principal trade mart in Sweden was the 32 acre community of Birka (Birch Island), in the heart of Lake Malar. A huge bonfire was kept burning on the fortified height above the trade mart so ships could easily identify which island to head for.

During the summer, traders came to Birka from all over the world: Vikings and Swedes with fish, timber, cloth, vellum, furs, and thralls; Germans and Frisians and French and Anglo-Saxons with metalware, fine cloth, pottery and glassware; Slavs with furs, and Byzantine Greeks with wine and brocades. Arab and Jewish traders came from the Baghdad Caliphate, to buy goods with silver from the Choristan mines and perhaps to sell silks, imported to Baghdad from China on the Silk Route.

A wide port, Birka had a jetty on the sea-front, two natural harbors a little north of town, and an artificial harbor east of town. Local craftsmen included metal workers, silversmiths, and carvers of reindeer horn and bone and walrus ivory. Archbishop Anskar visited Birka in 829 and converted its royal steward, who built a church on his own land.

Unlike the usual Viking trade mart, Birka was also busy during the winter when fur traders came down from the north, across the frozen lake. Many of those buried at Birka had spike-soled boots or ice skates on their feet.

One chronicler told of a Christian woman who lived in Birka along with her daughter. When she was dying, she ordered her daughter to take all her goods and sell them and give the money to

the poor. "Since there are so few poor folk here,...take the money and journey to Dorestad [in Frisia] at the first opportunity. There you will find many churches, priests and holy men; there you will find many needy people."

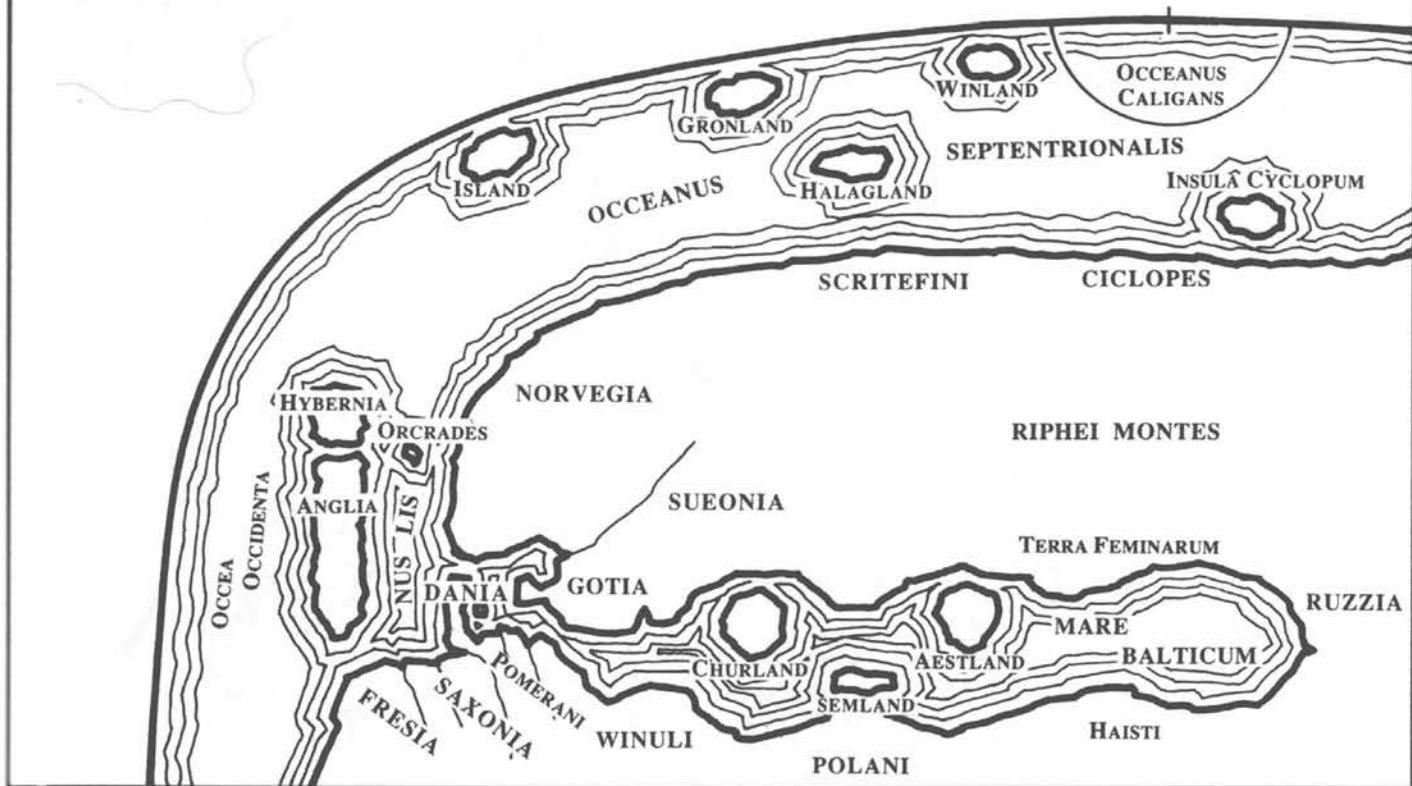
The code of Birka lived on even after the trade mart died in the mid-10th century. A 13th century Norse trader advised that "if a man wishes to be a merchant there is no law which he should study more carefully than the Birka Law, the Law of Trade." Swedish law provided lesser penalties for killing or injuring a non-Swede than a Swede, but Birka Law treated all men as equals. Among other provisions, there was a 10 mark fine for starting a fistfight and a 3 mark fine for theft.

OTHER SWEDISH TRADE MARTS

In the mid-10th century, the Arab Caliphate lost the silver mines of Choristan; the water level in Lake Malar began to fall, making it less convenient to dock at Birka. The trade mart of Sigtuna was founded on another island of Lake Malar but never became more than a regional center. Most Baltic trade went to the town of Vastergarn, on the island of Gotland, near the modern town of Visby. A stone maze lies nearby, probably used in some religious ritual.

Talje lay south of the straits that led to Lake Malar, near present-day Stockholm. Konungahela lay on the Gota River. Skara lay west of Lake Vatter.

ISLANDS OF THE NORTH: THE VIKINGS' VIEW



8.5 THE BALTIC COAST AND THE SLAVS

The eastern coast of the Baltic is now Poland, Lithuania, Latvia, and Estonia, and Russia. In the Viking Age, the Vistula River was the dividing point between two Slavic cultures, as it emptied into the Bay of Danzig (Gdansk). The Wends lived to the south of the Vistula; the Kurs to the north. Both tribes supplied rich furs and amber, highly valued by the people of Christian Europe.

Slavic tribes were never at peace with the Germans to the south, who raided their borders and sold them as thralls, making of the word "Slav" a degrading "slave". The Swedes accepted them as vassal tribes and got along peacefully with them as long as the Slavs paid a fair tribute.

Slavs lived in villages of fifty to a hundred people, governed by a village council in which each man had a voice. They were herders, hunters and fishermen, and many farmed by felling trees and burning them for fertilizer. After a few years when the soil was exhausted, they moved away to repeat the process. They made mead of honey and smelted bog mud, but their iron wasn't quite as good as the Vikings'; their weapons were lighter and, even so, more apt to break. They didn't wear metal armor, just jerkins, cloaks of reindeer hide and shields of wood. Their homes were dug into the ground for insulation during the winter, with roofs only a few feet above the ground.

Slavs worshipped Perun the Thunderer as their chief god and said that the other gods were his children: Dazbog the sun, Chores and Veles the gods of cattle, and Vesna the spring. They also placated Stribog (god of storms) and Morana (goddess of death). They also believed in forest nymphs, vampires, and werewolves. They had no temples or idols, and no full-time priests.

JUMNE, WENDLAND

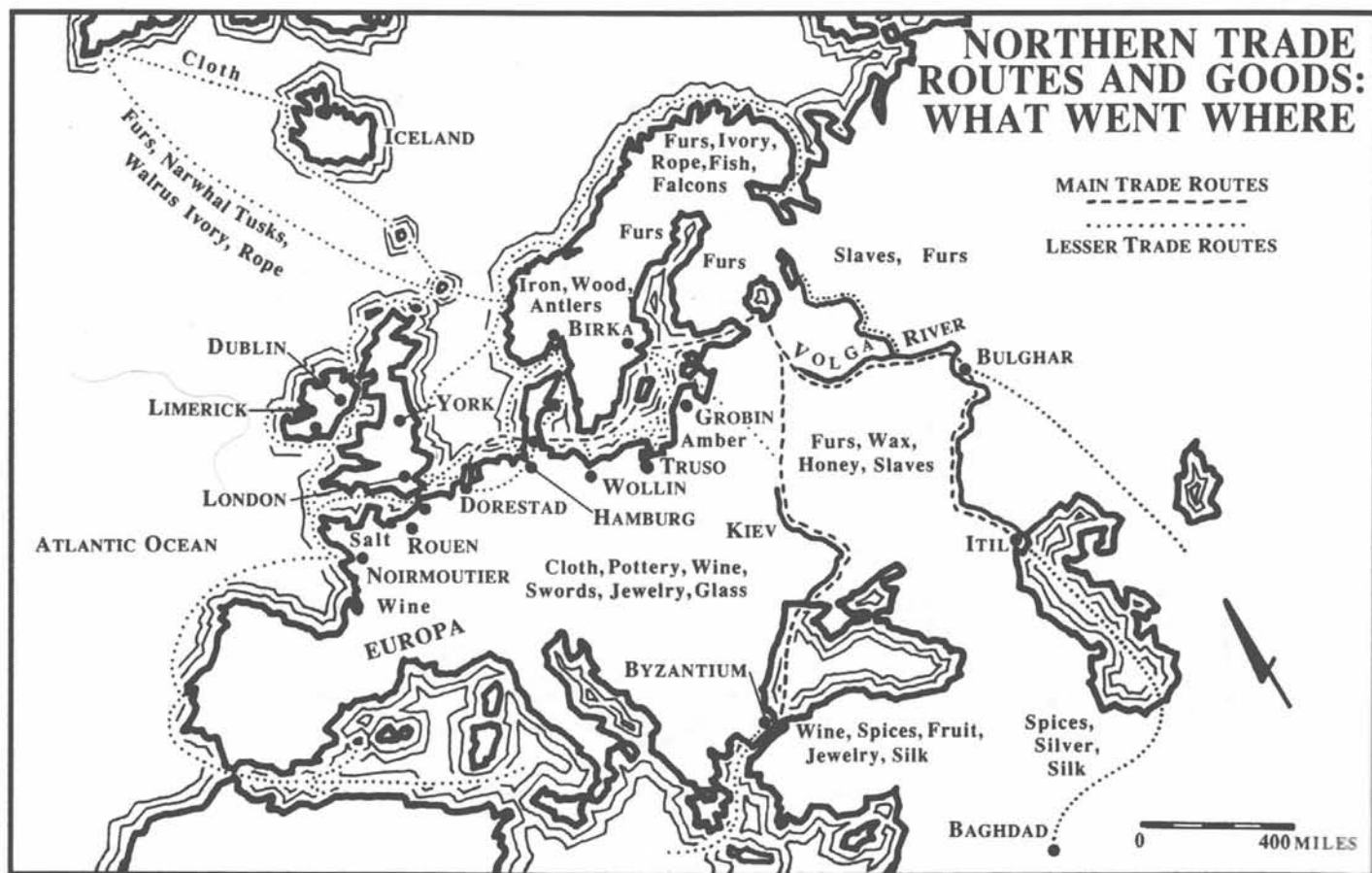
Jumne was established at the mouth of the Oder (near modern Stettin), at the start of the 11th century. It controlled the trade along the Oder into central Europe. Adam of Bremen in the 11th century wrote it was "inhabited by Slavs and such other people as Greeks and barbarians. Even visiting Saxons are permitted to live there...as long as they do not disclose they are Christians....There is an abundance of merchandise from the Nordic countries, and the town is well provided with all good and precious things."

Some historians identify Jumne with the legendary Jomsborg, home of the famous Jomsborg Vikings supposedly founded by Harald Bluetooth after he had been overthrown by his son Svein Forkbeard. The Joms Vikings, so the tale went, lived on a fortified height that overlooked a harbor. No woman could enter their fortress; it was only for heroes, like Odin's Valhalla in Asgard.

Joms Vikings were aged 18 to 50, bound by oath as blood brothers: never to fight one another, always to share their loot equally with one another, always to revenge each other's deaths. In the summer, their services were on sale to the highest bidder; in winter they lived at Jomsborg. An individual Joms Viking was only allowed three days leave for independent adventuring.

OTHER BALTIC TRADE MARTS

Kurland marts included Apulia on the river Barte (modern Apuole in northwest Lithuania) and, 25 miles north, Seeburg on the river Alanda (modern Grobin in western Latvia). These were apparently towns under Swedish military control but largely populated by native Slavs. They collapsed in the mid-9th century, when trade shifted eastward to inland Russia.



Viskiauven lay a hundred miles south of the Kurland marts in the shallow, sand-barred bay of the Kurisches Haff. Eighty miles farther south, inside the huge bay of the Frisches Haff was Truso, on the Vistula delta, the frontier between Wendland and Kurland. These marts were used during the entire Viking Era; they were convenient not only for the Baltic coastal traders but also for traders who went up the Vistula into Russia and then down-river to Byzantium. Truso was seven days sail from Hedeby.

8.6 GREATER SWEDEN

The forests and swamps that lay east of the Baltic were ruled by various Slavic and Finnish tribes, who traded with the Swedes, whom they called "Varangi." The Norse called the land either "Greater Sweden" or "Gardariki" (Kingdom of Towns), because of its numerous small towns, each a tribal capitol. Russian chronicles say that by 859 "the Varangians from beyond the sea imposed tribute" upon the tribes, which soon rebelled against them, but then warred with one another. They also lived in fear of the horse nomads who roamed the grassy steppes to the south: the Pechenegs, the Khazars, and the Bulgars.

"So they went overseas to the Varangian Russes...[and said]: 'Our land is great and fruitful, but lacks order. Come over and rule us.' They chose three brothers, who brought with them their kinsfolk and the Rus people. The oldest, Rurik, came to Ladoga and built the town of Aldeigjuborg....Two years later [after the deaths of his brothers], he went south and built on the shore of Lake Volkhov the town of Novgorod....[His son] Oleg set himself up as prince in Kiev and declared that it should be the mother of Russian cities."

A 10th century Arab geographer who visited Novgorod in the 10th century noted that the Swedish Rus "do not cultivate the land themselves but live on what they get from the Slavs. When a baby boy is born, his father walks up to him and throws down his sword, saying: 'I won't have anything to leave to you when I die, so you will have to get what you can for yourself with this sword.' They have no estates or villages or fields, and their only business is trading; they sell the pelts of sables, squirrels and other animals. They are paid for their goods in coins which they keep hidden in their belts. Their clothes are clean and the men decorate themselves with gold armbands. They treat their slaves well and wear splendid clothes....They have many towns.

"The Rus honor their guests, and are kind to all strangers who ask them for shelter, and to anyone who is in trouble. They do not allow anyone to annoy their guests or do them any harm. If anyone dares to insult them or do them an injustice, they help and defend them.

"The Rus are full of courage in battle....They are well built, good looking and daring, although they do not appear so on land. They always go on raids and expeditions by water, never by land."

KIEV

The greatest Russian town was Kiev, which the Norse called "Konugard" (Boat City). It stood high above Dnieper, so that it was unaffected by the spring floods, which made it unsafe for ships in April and May. Kiev was connected by land trade routes with the other great cities of inland Europe: Cracow, Breslau, Prague, Pilsen, Regensburg and Mainz.

In 988, the ruler of Kiev, Vladimir, allowed himself to be baptized and so acquired the sister of the Byzantine emperor as his wife (in addition, so the Byzantines said, to his eight hundred concubines and slavegirls). The language of the Russian branch of the Greek Orthodox Church was established as Slavonic, not Greek or Norse; by that time, Norse was a second language for the Swedish-descended ruling class.

Vladimir's son Yaroslav married Ingigerd, the daughter of Olaf Skotkonung, King of Sweden. He also took in Olaf the Stout, and his son and stepbrother, Magnus Olafsson and Harald Hardrada (to whom he married his daughter Elizabeth). His two other daughters also married well: to King Andrew I of Hungary and King Henry I of France. Four of his sons married into the courts of Byzantium and Germany. He conquered the Slavic Chuds and the Pechenegs and in the 1030s imported artists to build the first Russian cathedral.

OTHER RUS TRADE MARTS

Lake Ladoga lies slightly north of modern Leningrad. It was the door to the vast inland. Norse ships reached it by sailing to the northern tip of the Gulf of Finland, then up the river Neva to Lake Ladoga.

A ship that went south (up-river) on the Volkhov about six miles would reach the town the Norse called Aldeigjuborg (Staraja Ladoga, Old Ladoga) on the north bank of the river. Farther south on the Volkhov was Lake Ilmen, on whose shores lay Novgorod, which the Norse called "Holmgard" (Island City). The town was built on a low-lying area, with a kremlin (citadel) on the opposite side of the river to guard it, like the typical Viking trade mart.

Continuing south across Lake Ilmen and the Lovat river brought the ship to the area east of Polotsk (another trade mart), where three great rivers had their source. The Dnieper ran south past the towns of Smolensk, Lyubech, and Chernigov to Kiev and then down to the Black Sea. The Dvina ran south to the Baltic Bay of Riga. The Volga ran east to the lands of the Bulgars and from there, to the Black Sea and Byzantium.

A ship could go up the river Svir from Lake Ladoga to Lake Onega and then up-river to the White Sea, on whose southern shore lay the town of Beloozero, then continue up-river on the Syeksna to the Volga. Or a ship could take the river Syas out of Lake Ladoga, then portage to the river Mologa and also eventually reach the Volga.

THE NOMAD TRIBES OF RUSSIA

Thousands of miles southeast of Russia on the Black Sea lay the Byzantine Empire, the successor to the old Eastern Roman Empire. South and east of Byzantium lay the Baghdad Caliphate, which had subdued Persia. Between the forests of the Slavs and these great civilizations were the steppes, which held many fierce nomadic tribes. The Rus traders found river routes that would take them past the steppes to the rich trading marts of Byzantium and Baghdad.

Both Byzantium and Rome sent many missionaries to Russia and eventually succeeded in converting most of the Slavic and nomadic tribes. The Caliphate also sent missionaries, who eventually converted the Bulgars. Meanwhile, the Khazars, always independent, chose to convert to Judaism, probably to avoid falling under the domination of either Byzantium or Baghdad.

The Baghdad Caliphate also sent traders: Arabs, Jews and a perhaps even a few Orientals, since Baghdad lay on the 5000 mile Silk Route that linked Istanbul to China. Traders brought silver from the Choristan mines with which to buy thralls, weapons, honey, wax and furs and to sell, Persian glass, Chinese silk, bronze bottles from east of the Caspian, embroidered purses from India, spices and wines.

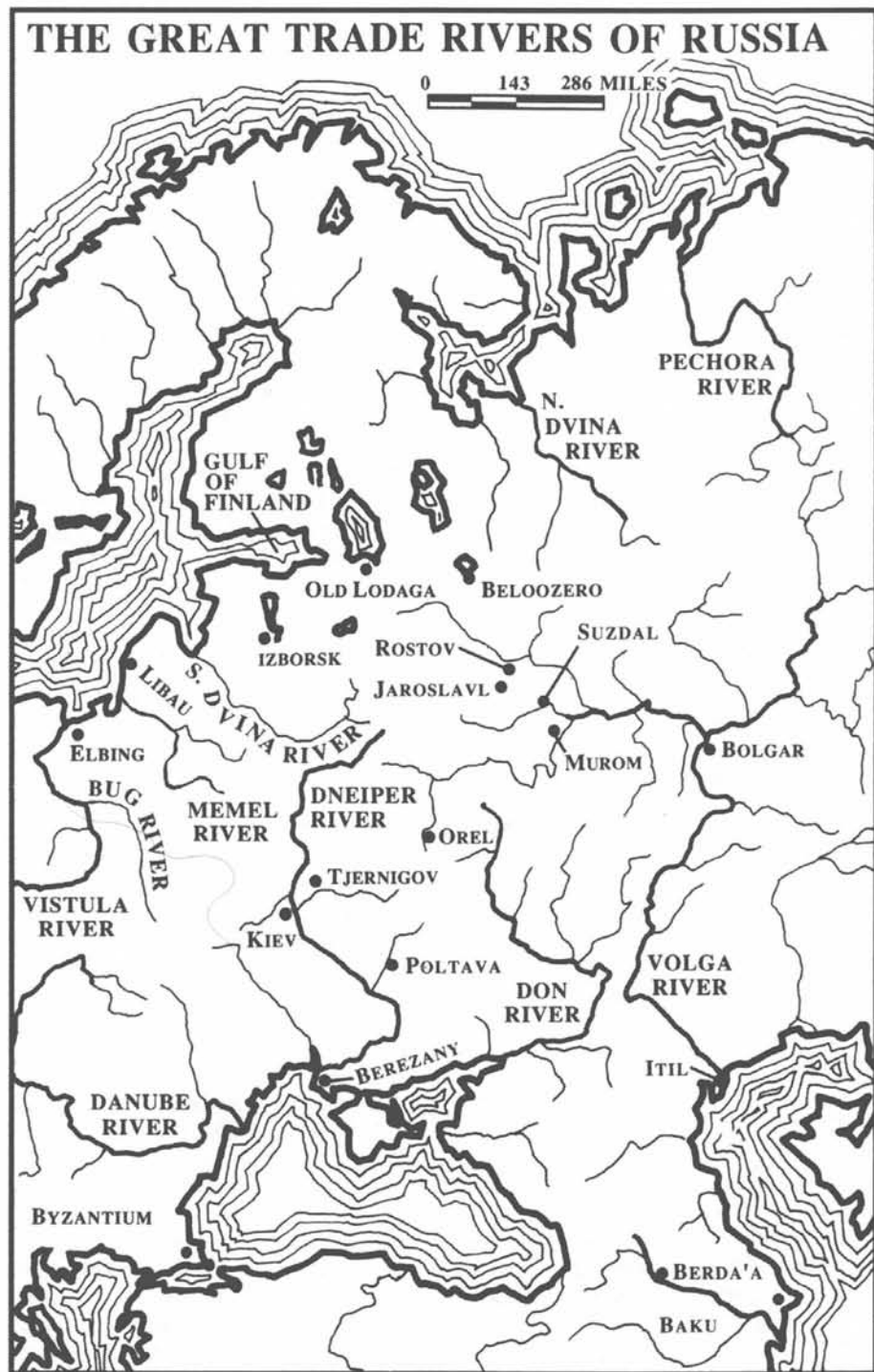
Between Byzantium and the Slavs was the khaganate of the Khazars. Many Jews fled north for refuge after they were expelled from Byzantium. Eventually the Khazar khagan decided to make Judaism his people's official religion. The Khazar capital was at Itil in the Volga delta, near the modern Astrakhan. One half of it housed the Khagan and other Jews. The other half of the city was for Christians, Moslems, and pagans, including Rus traders.

The Khazars controlled the lower Volga and Don rivers and charged traders 10% of their cargo to pass. They were horsemen, their nobles armored in byrnies, armed with shortbow, spear, and sword. During the summer they lived in tents, followed their herds and tilled their land; in the winter, they returned to their cities of brick.

Northeast of the Khazars were the Bulgars, a nomadic tribe who lived in skin tents. They paid tribute to the Khazars: one sable fur per tent, fifty thousand sables a year. They were named for their great encampment at Bulgar in the bend of the Volga river near Kazan. Here fur traders from the northern forests came westwards along the Kama river to meet Norse, Byzantine, and Baghdad traders.

North of the Khazars but south of the Slavs lived the Pechenegs, another nomadic tribe which also tribute to the Khazars. The Pechenegs and Bulgars also had light cavalry troops but not as well-trained as those of the Khazars.

Northeast of the Khazars lived the Magyars, who paid tribute to the Khazars until they were defeated by the Pechenegs. They fled west with their families and herds and ended up conquering Hungary by the mid-9th century.



THE ROUTE TO BYZANTIUM

The Rus traders spent the winter among the Slavic tribes, collecting tribute. In April they gathered in Kiev, where they bought freshly built dugout canoes from the local Slavs (but thriftily used their old oars and other gear). In early June they set out together, downstream on the Dnieper, paying river taxes along the way to the Bulgars, Pechenegs, and Khazars — always on guard in case the tribesmen decided they wanted blood as well as tribute. By mid-July, it was too late to take the Dnieper south; the summer heat had lowered the river's water level, exposing too many rocks.

The 1400 mile long journey down the Dnieper to the Black Sea took two to six weeks. The worst part of the trip were the twenty-five miles of rapids. The crew would row the ships up-river against the current for hour after hour, then — warned by their pilot that they were nearing rapids — they would get out and push the boats along the shore until they had passed the danger. There were seven stretches of white water, each with its own ominous name:

1. Essupi (Don't Sleep)
2. Ulvorski (Island Rapid)
3. Gelandi (Loud Rapid)
4. Aifor (Narrow Rapid): the Pecheneg region, so guards were posted.
5. Baruforos (Rocky Rapid)
6. Leanti (Bubbling Rapid)
7. Strukun (Swift Rapid)

After the rapids, the Norse stopped at St. Gregor's Island to offer thanks to the gods. They caught live birds (with birdlime made from mistletoe) and cast lots to see which ones were to be set free and which would be speared and hung on a giant oak. They also put bread and meat at the foot of the oak.

Ships then continued south along the Dnieper to the island of Berezany and the Black Sea, to the west of the Crimean Peninsula. From there it was a short journey along the northern coast of the Black Sea to Constantinople at the Straits of the Bosphorus.

8.7 BYZANTIUM

Byzantium with its capitol at Constantinople (the modern Istanbul) lay at the eastern end of the Mediterranean Sea and the western end of the Black Sea, on the land bridge where Europe touches Asia. It was bordered on the south by the Arab Caliphate, with its capital at Baghdad; and on the north by the Khazars and Slavs. Byzantium dominated the northern coast of the Mediterranean, including not only Greece and Albania but also lower Italy. The Vikings called Constantinople "Mickle-Gard" (Great City). The inner city had a population of about a million people, and more lived in the suburbs. A ninth century Arab described Constantinople as it would be shown to a foreign ambassador.

"The sea flanks Byzantium on the east, and a plain that leads to [Constantinople] on the west. The Roman Gate is made of gold and has five statues on it in the form of elephants and a man holding their reins. The Imperial palace is near the church [St. Sophia] in the middle of the city. Beside it is the Hippodrome or race track.... All the people of Constantinople attend these [chariot] races...."

"The Imperial palace is surrounded by a wall that reaches the sea in the west. Through the entrance chamber, there is a courtyard with a curtained door to the palace. If you raise the curtain, you will see another huge courtyard inlaid with green marbles, its walls adorned with mosaics and paintings."

"Before the Emperor's seat stood a tree made of gilded bronze whose branches were filled with birds of like metal who each sang the song of its own kind. The throne was so marvelously constructed that at one moment it would be close to the ground and at another it would rise into the air. It was of immense size and was guarded by bronze or wooden lions covered in gold, who beat the ground with their tails and roared dreadfully with great open mouths and quivering tongues."

An ambassador was received ceremoniously and instructed in Imperial etiquette. He was expected to prostrate himself before the Emperor on his first visit. If he behaved rudely, he would be thrown into prison. If he was found acceptable, he would be invited to an imperial banquet where he could talk less formally to the Emperor and various bureaucrats.

The Byzantine army was noted for its heavy cavalymen, armored with steel helmets and mail shirts. They carried swords, lances, and bows. Some foot soldiers carried shortbows or javelins. Others wore mail and carried axes, spears, swords and shields. An army unit was accompanied by servants and slaves to dig trenches, pitch the soldiers tents, and do other heavy work.

The Byzantine navy was made up of galleys and biremes. In an emergency, the city could also commandeer merchant ships to defend it. Some naval ships had battering rams at the prow; all of them carried Greek fire which could either be thrown in small pots or hurled by catapults, a barrel at a time.

According to the Byzantine Chronicles, in the 860s, a Norse fleet sailed from Kiev under the command of the city's rulers, Askold and Dir. They harried the shores of the Black Sea until they came to Constantinople, without its Emperor who was elsewhere, leading his troops. The Christians prayed to the Virgin for storms. The weather remained calm, but the fleet halted its approach and negotiated a peace treaty.

In 907, the Rus returned, their fleet led by Oleg of Kiev. The chronicles say that the Byzantines attempted to blockade this fleet by chaining the Straits of the Bosphorus, but the wily Norse put their ships on wheels (!) and sailed them overland to attack Constantinople. Eventually, the Byzantine diplomats managed to conclude a new trade agreement, promising the Rus free baths, provisions, and ships' gear in exchange for guaranteeing them trading rights. Further Rus dealings with Byzantium followed this pattern of threat followed by new treaty concessions.

In 945, the Rus were guaranteed summer quarters in the suburbs of Constantinople, with a month's free lodging and food. In exchange, they promised not to enter the city except unarmed, and in groups of fifty men or less. They were allowed to purchase fifty gold pieces worth of silk, which had to be stamped by customs before it left the city and were entitled to travel provisions when they returned to Kiev in the autumn. They also promised to defend Byzantium against the Bulgars, in cooperation with the Khazars. Like all traders, they had to pay duties of a flat 10% on all imports and exports.

8.8 THE BAGHDAD CALIPHATE

The Rus did more trading with the Caliphate than with Byzantium. To get there, they first sailed up the Lovat River to the Polotsk region, where they dragged their ships across the land to the headwaters of the Volga. Then they rowed downstream 2400 miles past the trade mart of Bulgar to the Caspian Sea.

Some Norse fleets raided the coastal villages of Persia (modern Iran) on the banks of the Caspian. Others landed peacefully and proceeded by camel-train south to Baghdad (in modern Iraq). Here they found goods not only from the Arab Caliphate but also from India to the south and China to the East, linked by the Silk Route. The Norse called the area Serkland (Silk Land).

The Baghdad Caliphate had been established in 762 and soon dominated not only the Arabic Peninsula but also the southern shore of the Mediterranean and much of northern India. One famous Caliph was Haroun al-Rashid (who became legendary thanks to the Thousand And One Arabian Nights; he ruled 786-809, at the start of the Viking Age. As Caliph, he had a yearly income of 1200 tons of silver, of which 120 tons came from newly developed silver mines of Choristan. Much of this money was spent trading with the Vikings in inland Russia for luxury goods including Christian slaves.

By the middle Viking Era, the Caliphate was being run by Seljuks, a Turkish tribe, originally the Caliph's bodyguards, with the Caliph's duties being strictly religious. Many Arabic areas had become independent nations, including Egypt, Morocco, and Choristan.

Arabs tolerated Jewish and Christian residents as long as they paid a special tax. Some held prominent social positions; others were traders. The Carolingian Empire did not allow non-Christian traders in their domains, but did make an exception for Jewish traders from the Caliphate as long as they appeared at the royal court once every two years (presumably to give the king generous presents).

One Arab wrote that the Jewish traders "speak Arabic, Persian, Roman, Frankish, Spanish, and Slavonic.... They disembark in the land of the Franks and travel overland to [the Red Sea], and from there, again by ship and land, to the holy cities of Medina and Mecca, to Sind [Pakistan], Hind [India], and China. On their

return, some of them go to Byzantium to sell their merchandise to the Romans. Others go to the homelands of the Frankish kings to dispose of their wares there. Sometimes the Jewish merchants sail from the land of the Franks across the Mediterranean to Antioch, and take the route over Baghdad, to Oman, Sind, Hind and China...."

Arabs eagerly bought the European thralls the Vikings had for sale. Once they had bought slaves directly from Europeans — criminals, prisoners, and debtors. But after Europe became Christianized, the Church forbade selling Christians to Moslem owners, and now Arabs had to deal with Viking traders who could trade in Europe because they had been primesigned (their foreheads marked with a cross of holy water, but not formally baptized). One Arab listed typical Scandinavian goods as "eunuchs, male slaves, female slaves, beaver and martin skins and other furs."

In 1040, Yngvar the Far-Traveled led a Viking expedition to Baghdad. Archeologists have found 25 runic stones in eastern Sweden which were erected to the memory of men who died on the trip. One reads: "Tola had this stone raised for his son Harald, Yngvar's brother. They journeyed boldly, far afield after gold. In the east they gave food to eagles. They died in the south, in Serkland."

8.9 THE CAROLINGIAN EMPIRE

In the late 8th century, Charlemagne (Carolus Magnus) united the lands of Christian Europe into what historians call the Carolingian Empire. In 800, Charlemagne confirmed the (forged) Donation of Constantine which recognized the Pope as independent from the Eastern Patriarchate of Byzantium, spiritual head of Europe, with political power over the city of Rome. In exchange, the Pope crowned Charlemagne as Holy Roman Emperor. After Charlemagne's death, his empire was split into two major divisions.

In 962, the Pope crowned Otto II, King of Germany, as Holy Roman Emperor, recognizing him as Charlemagne's descendant. Otto's authority was limited to Germany. He was overlord of a number of German-speaking duchies including Saxony, Friesland, Lorraine, Swabia, Franconia, Thuringia, and Bavaria. Italy lies due south of Germany, jutting into the Mediterranean, and Otto was also overlord of a number of Italian-speaking provinces including Lombardy, Verona, Tuscany, Spoleto, and the Roman area ruled by the Pope.

Similarly, in France, the king was only the overlord of a number of French-speaking counties which included (from north to south, along the coast): Flanders, Normandy, Brittany, Poitou, Aquitaine, Gascony, Barcelona, and Gothia. There were also the inland counties of Champagne, Maine, Anjou, Blois, Burgundy, Bourbon, Auvergne, Rodez, and Toulouse. France also ruled what is now the northern part of Spain: the Navarre and Asturias.

Italy lies due south of Germany but juts into the Mediterranean Sea. East of it lies another peninsula with Albania and Greece, and beyond that stands Byzantium. In this period Italy was a buffer state. Lombardy in the north was ruled by Germany, which also claimed some rights over the Papal region of Rome. Lower Italy (Sicily, Venice, Naples) was ruled by Byzantium, but often attacked by the Caliphate which lay to the south. In the 11th century, Lower Italy was conquered by the Normans. In 1042, Harald Hardrada (later King of Norway) led the Byzantine forces against the Normans but lost the battle to them.

Remember that this is the Europe of Charlemagne, not that of Malory's King Arthur or Scott's Ivanhoe. It wasn't until the Crusades began in the late 11th century that European minstrels began to sing songs of chivalry and gallantry. It was also then that European nobles first felt the need to devise and wear heraldic arms so they could identify one another during a battle. The language of scholarship was still Latin, but many nobles and most men-at-arms could only speak their regional dialect and could not read at all. Charlemagne himself never learned how to read. He said it might have been simpler for him if the letters had looked more like weapons, which he was familiar with.

Vikings visited the European towns often. Sometimes they came to trade, bringing furs, amber, wool, dried fish and Slavic thralls. Sometimes, when they had observed the marts were poorly defended, they came instead to fight, pillage, and burn.



GERMAN AND FRISIAN TOWNS

Hamburg lies on the banks of the Elbe river. It became a cathedral town in 831, under Archbishop Anskar and was sacked and burned by a Viking assault in 845 by a fleet of six hundred ships. Nearly a century later, it was burned again by the Wends and Danes, yet it remained a major German trade mart due to its strategic commercial location.

Other major German trade marts were Aachen, Bremen, Worms, Frankfurt, Wurzburg, and Regensburg. These towns typically had one street, lined by buildings which were craftsman's homes on the front and barns at the back. There was a church at the far end of the street.

Dorestad lay in what is now the center of the Dutch coast; it controlled the Rhine delta, and its ramparts protected it as much against the flooding of the river as against enemy attack. Nowadays its site is covered with sand. From 780 to 834, it was a major European trade mart, which linked the North Sea's coastal trade route to the Rhineland valley and the town of Cologne.

Dorestad covered 33 acres, with a High Street that ran down its center. The native Frisians lived to the west of this street; the east side was reserved for traveling merchants, who had paid their harbor dues and been permitted by the royal steward to trade there. It was a royal mint, and its silver coins were eagerly sought by the Vikings.

In 834, Dorestad was stormed and looted by a fleet of Danish Vikings. After that it was repeatedly plundered by Viking raiders — but always rebuilt in a year or two, since the location was still commercially significant.

In 864, the Frisian coast was struck by a series of tidal waves which left sand dunes behind where towns had once stood. The Rhine changed its course north toward Utrecht. Dorestad died, its river silted up. Its place was taken by Utrecht, Deventer, and Domburg (on the island of Walcheren, ruled by Vikings; see Section 7.2).

Egil's Saga, set in the early 10th century, describes Friesland as having few harbors but many swamps. "The land was very flat with great marshes. Ditches had been dug everywhere and were full of water. The people used the ditches to mark off their fields and meadows, and in some places big logs had been laid over them so that people could cross. These bridges were floored with planks. The local people fled into the forest and gathered together there as the Vikings penetrated deep into the settlements."

FRENCH TOWNS

Quentovic was the other major Carolingian mart (and mint) on the North Sea. It lay on the Straits of Dover, near modern Calais, and had close trade ties to England.

Up-river on the Seine lay Rouen (first looted by the Vikings in 841) and, farther yet, Paris. The lower Seine Valley would eventually be conquered by the Norse and renamed for them, as Normandy (see Section 7.3).

Noirmoutier was a small island at the mouth of the Loire, home to a monastery, which controlled the coastal wine and salt trade of Europe. It was captured by the Vikings in 835. Farther up the Loire was Nantes, which was looted by a fleet of 67 Viking ships in 843, at the invitation of rebel Count Lambert, who wished to make Aquitaine independent. He did subdue Nantes once the Vikings had withdrawn for the winter back to Noirmoutier.

The Vikings also raided other coastal and river towns, sometimes rowing as far inland as Paris or Toulouse, if they had heard that a city had lots of loot available. Major French towns raided by the Vikings included Bordeaux, Limoges, Angouleme, Tours, Orleans, and the pilgrim town of Santiago (St. James) de Compostela in the Asturias.

8.10 BRITAIN

Britain was divided into a number of small kingdoms. Ireland had a high king at Tara who nominally ruled over the feuding Celtic kingdoms of Connaught, Munster, Leinster, and Ulster. Scotland held the Pictish kingdom of Alba, the Celtic kingdom of Dalriada, and the Saxon kingdom of Strathclyde. England held Northumbria in the north, East Anglia (East Midlands), Mercia (West Midlands plus the Celtic areas of Wales and Cornwall), and Wessex (south).

IRELAND

All of Ireland lay easily accessible, none of it more than sixty miles from the coast. Its warrior defenders had (said one Irish chronicler) "nothing to protect their bodies and necks and gentle heads save only elegant tunics with smooth fringes and shields and beautiful, finely wrought collars." Ireland's ecclesiastical center was Armagh, founded by St. Patrick in the south of Ulster, near the ruined site of Emain Macha, the home of Cuchulain.

The Vikings soon subdued the Irish harbors and fortified them, both against the Irish and to protect them from later Norse raiders. All the major Irish towns sprung up: Dublin, Cork, Limerick, Waterford, and Wexford. In 820, an Irish chronicler wrote that "not a harbor or landing, fort or stronghold was without fleets of Scandinavians and pirates."

Dublin became an internationally known market town, mentioned in Irish, Norse, English and Arabic chronicles. Its streets were paved with stone flags or timber boardwalk. A mint was set up by the late 10th century. Some historians think Dublin was also a Viking trade center for shipping thralls to the Emirate of Cordoba.

SCOTLAND

The jarl of the Orkneys ruled not only the island chain but also the Caithness, the northeast tip of Scotland and at times dominated large parts of Argyll, Moray, Sutherland, and Ross. However, these Vikings made no attempt to establish Scottish trade marts or to fortify their Scottish harbors. They seem to have had enough trouble keeping Viking raiders off of the Orkneys.

Each of the other Atlantic Island groups had its own Thing and jarl, including the Hebrides, Shetlands, Faroes, and Man.

The Pictish kingdom of Alba covered the northern Highlands, with its capital at Scone Palace on the Tay River, near the modern Perth. Each new king was crowned on the Stone of Destiny (also called the Stone of Scone). The ecclesiastical center of Alba was the town of Dunkeld.

The Celtic kingdom of Dalriada lay south of Alba (and merged with it in 1034). Its capital was Dunadd Fort, near the modern town of Oban on the western coast, at one end of the Firth of Lorne. After Alba and Dalriada had merged, their capital was Inverness, on the east coast. One of the first rulers was King Duncan, who was killed in 1040 by Macbeth, Thane of Fife.

The Saxon kingdom of Strathclyde lay south of Dalriada, bordering Northumbria. Its capital was Dumbarton Palace near Glasgow, a harbor port.

ENGLAND

In England, the Vikings took over existing towns rather than build new ones. Njal's Saga described England as "the most productive country in Western Europe, because all sorts of metals are worked there, and vines and wheat grow, and a number of different cereals besides. More varieties of cloth and textiles are woven there than in other lands. London is the principal town, and then Canterbury. Besides these are Scarborough, Hastings, Winchester, and many towns and cities not mentioned here."

BRITAIN



Egil's Saga says that "Northumbria is reckoned one-fifth of England, being the northernmost part of it down the east side, south of Scotland. It used to be ruled by the kings of Denmark in the old days, and its main town is York...[It had to be defended against] the Scots, Danes, and Norwegians who kept raiding and making claim to it. The reason given for this was that all the important people in Northumbria were of Danish descent, either on their father's side or their mother's, and in many cases on both." The other major cities of the Danelaw were the Five Boroughs. Nottingham (originally called Snotingham) was the largest of these; the others were Lincoln, Derby, Leicester, and Stamford.

The chief town of Anglo-Saxon England was London on the river Thames. The next largest Anglo-Saxon port was Winchester, capital of Wessex.

8.11 SPAIN

The Emirate of Cordoba ruled the Iberian peninsula (modern Portugal and Spain). As with the Baghdad Caliphate, Jews were tolerated. Few Vikings ever managed to successfully raid the Emirate. One of the first attempts came in the 840s, when a Viking fleet of 150 ships sailed down to Spain after first plundering the Garonne region of France. They harried Lisbon and looted Seville, then retreated with their loot to an island at the mouth of the Guadalquivir, from which for awhile they raided the neighboring countryside.

Soon the Moorish navy arrived and penned the Vikings in on their island. Their raiding parties were cut off and captured, and several ships were destroyed by Greek fire. Vikings lost thirty ships in a naval battle. The Moors took so many prisoners that there weren't enough gallows in Seville, and many Norsemen were hanged from palm trees. The Emir of Cordoba sent two hundred severed heads of Vikings to his allies in Tangier as proof of his victory. Finally, the Vikings exchanged their Moorish captives not for more loot but for food and clothes and the right to sail away safely.

8.12 IMAGINARY LANDS

Some of the lands the Vikings visited are strictly imaginary. The GM must decide how to handle these lands in his game. The characters will think of them as romantic, far-away places whose location is not definitely known.

UTROST

Rost is the outermost island of the Lofotens, beyond the Maelstrom from the coast of Norway. The Norse, however, told and heard tales of Utrost: an island that lay even farther out in the cold sea. Sailors sometimes called it "the Blessed Land," out of respect for the spirits who lived there.

The legend goes that Utrost can only be seen when no other land is visible — and then only by people in danger of shipwreck. The spirits of Utrost live much like normal people: farming and herding, fishing and sailing. But their pastures are greener than anywhere else in the northland. They give lavish hospitality to their guests: plates always heaped with good food and a drinking horn full of mead that can never be emptied. These spirits aren't Christian, and Utrost will vanish at once if anyone invokes the name of Christ.

There's a folk tale about one fisherman who returned from Utrost with a brand-new fishing boat that would withstand any storm because "there was someone on board that no one could see who supported the mast with his back when things looked bad." The fisherman always remembered to leave something good on his boat at Yule as thanks, and afterwards could hear the sound of the Utrost folk celebrating their own version of the holiday.

The GM may want to use Utrost to rescue a gallant crew whose ship is doomed by a bad storm.

GIANTLAND

In the Norse myths, Jotunheim was the home of the Frost Giants, the enemies of the gods whose home was Asgard (see Section 11). One myth tells how the god Thor made a journey to one of the towns of Jotunheim: Geirrod's Town, whose ruler was the giant Geirrod, "as cunning as a fox and a dangerous enemy." Geirrod challenged Thor to a competition at catch and threw him a red-hot bolt of iron. Thor caught it and threw it back. Geirrod dodged behind an iron pillar for safety, but the bolt "went through the pillar and through Geirrod and through the wall and so outside and into the earth."

Some sagas tell of heroes who went on equally strange journeys. Thorstein Mansion-Might, the biggest man in Norway, was shipwrecked on an unknown fjord and went inland, looking for people. He met some giants, whose leader was Godmund, "the ruler of Glasir [Shining] Plains, a dependency of Giantland" who takes him along on his journey to the court of King Geirrod of Jotunheim.

Geirrod watches his visitors play a game of catch with a "gold ball" which turns out to be a red-hot seal's head weighing over two hundred pounds, "with sparks flashing from it like a forge fire and fat dripping from it like burning tar." Eventually Godmund throws it at Geirrod, who gets out of the way. The ball hits two of Geirrod's men, kills them both, travels on through a glass window, and splashes down in the moat surrounding the town.

In the sagas, the giants react to the humans' small size by calling them "children." One tells a hero, "I've never met a child as small as you who was so arrogant, and crafty as well." Another tells his liegeward that the hero with him is a "servant-boy that Odin sent." One giant woman is amazed that a Viking is even smaller than her newborn baby brother. At first she puts him in the cradle with the baby, then in her own bed where she learns he is no child.

Permia was the name for the northmost forests of Russia (about the same area as present-day Moscow). Several sagas mention Permia as neighboring on Geirrod's Town and Giantland. One saga describes Permia as "a region of eternal cold, covered with very deep snows, and not sensible to the force even of the summer heats: full of pathless forests, not fertile in grain and haunted by beasts uncommon elsewhere." Its people can cast spells that make it rain and storm. They worship a god called Jomali. Permia is ruled by King Harek, who can turn into a venom-breathing flying dragon.

The GM must decide whether his Permia will be history or fantasy, whether the Russian forests will border Siberia or the Glasir Plains and Giantland.

8.13 LANGUAGES

Norse and the Teutonic Languages dominate the realm of the Vikings. However, many other languages were spoken in the countries the vikings sailed to and raided.

Norse: generally spoken in Scandinavia, Iceland, Greenland, the Atlantic Islands, and the Danelaw. Spoken as a second language by many people of Norse descent in Viking areas of Russia, Ireland, Normandy, and non-Danelaw Britain.

Languages Closely Related to Norse, the Teutonic languages: German, Anglo-Saxon (spoken in England), and Frisian and Franconian (spoken in Frisia).

Languages Distantly Related to Norse: Armenian; Celtic (Welsh, Irish), Gaelic (spoken in Dalriada), Manx (spoken on the Isle of Man), Breton (spoken in Brittany), Cornish (spoken in Cornwall); Greek (spoken in Greece and Byzantium); the Romance languages (Latin, Italian, French, Spanish); and Slavic (Prussian, Lithuanian, Bulgarian, Russian, Polish).

Languages Unrelated to Norse: Greenland Skraeling (Eskimos); Vinland Skraeling (Indians); Pictish (spoken in Alba); Uralic (Lapp, Finnish, Hungarian, Estonian); Arabic (spoken by Arab traders in Russia and in Spain); Hebrew (spoken by Jewish traders in Russia)

If you want to give your players an idea of how a Teutonic language speaker sounds to a Viking, try adopting the following speech pattern:

1. Say "he" for "he," "she" and "they".
2. Say "sh" instead of "sk" at the start of a word: "Shool" instead of "school," "shipper" instead of "skipper".

8.14 VIKINGS VS FOREIGNERS

Working with the data in this section, you might want to specify typical arms and armor for: Lapps, Slavs, Nomads, Byzantines, Caliphate Arabs, Carolingians, Anglo-Saxons, Celts, and Emirate Arabs. In addition to the standard stuff, you'd also need mechanics for:

- Greek Fire
- Inferior Weapons/Shields (for Lapps, Slavs)
- Superior Weapons/Shields (for Damascus steel from the Emirate)

The GM should remember that the type and quantity of loot gotten in a Viking raid will depend on the target raided. Here are some sample figures you can adopt for your campaign.

Standard Danegeld: 2D6 marks of silver
 5 times standard for a notable fighter
 10 times standard for a captain
 Lapps, Vinland Skraelings, or Russian
 Nomad Camp: half standard
 Major Trade Mart (including Itil, Bulgar):
 5 times standard

VICTORY CHANCE TABLE

Victory Chance in a battle depends on the relative strengths of the opposing forces (see Section 4.1). The table below gives Victory Chance for Vikings fighting an enemy force of twice their own number or less.

Vikings vs	Victory Chance	Trade Goods (Loot)
Lapps	99%	amber, fur
Slavs	80%	amber, fur, wax, honey
Europeans	80%	fine cloth, wax, honey, metalware, glass, pottery, lava querns, basalt, millstones
Celts	80%	fine cloth, pottery, (thralls)
Vinland Skraelings	67%	timber, (thralls)
Anglo-Saxons	67%	fine cloth, pottery, (thralls)
Vikings	50%	dried fish, vellum, rough cloth, tallow, furs, soapstone, bone, horn, sea ivory (to Iceland/Greenland: timber, pork, wheat)
Nomads	33%	nothing
Byzantines	17%	wine, brocades, pottery, glass
Caliphate	17%	silk, porcelain, glass
Emirate	17%	fine metalware, wines

GAME STATISTICS

9.0 ANIMALS

9.1 DOMESTICATED ANIMALS

Viking herd animals included cattle, horses, sheep, goats and — in southern Norway and Denmark — pigs. Most animals were pastured in mountain meadows in the summer. A few were left in the lowlands to supply the farmstead with milk and cheese.

Often, one boar or stallion was allowed to roam the green, well-dunged pasture of the fenced-off homefield that lay in front of the farmhouse. Originally, this animal was sacred to the god Frey. One saga tells of a chieftain who had a large herd of horses, led by a stallion named Freyfaxi, whom he forbade his hirelings to ride, even in an emergency. Injuring or killing the homefield beast was an insult to the farmstead folk and to their god as well.

The Viking Yule (and later Christmas) ceremony prominently included the Yule buck, who was fetched into the home. This he-goat was associated with Thor, whose thunder chariot was drawn by goats. Some festivals also featured a horse or boar, in honor of Frey.

The small Viking horse was about the size of the modern Shetland pony. Most Vikings could ride, but some sagas describe heroes who were too big for any horse to carry them. Horses were also used to carry peddler's goods or loads of timber or peat. They drew wagons on the trading mart's cobblestoned streets during the summer, and sledges across the icy snow in the winter. Plows were drawn either by horses or by cattle.

Some stallions were fighters but not warhorses. (Vikings fought on foot.) One Viking amusement was to encourage stallions to fight one another. If the horses grew tired of the sport, men would use a horse-goad to push them forward and into action.

Vikings hunted on horseback or afoot, sometimes using falcons which hunted small animals or birds, sometimes hunting with hounds. The Norwegian elkhound is one of the earliest known breeds of dogs. Some sagas also refer to the use of bloodhounds to track fugitives. Most Viking homes seem to have kept dogs. A visitor's arrival was announced by a chorus of barks.

GM Note: game statistics for all animals, domestic and wild, can be found in *Creatures & Treasures* (for *Rolemaster*) and *The Hero System Bestiary* (for *Fantasy Hero*).

9.2 WILD ANIMALS

Vikings snared various birds and small animals. They also hunted a number of good-sized animals (with bow or spear) for their hides and fur. Herbivores hunted included the aurochs (wild cattle), elk, deer, and reindeer. Ocean game included the walrus and seal, which were hunted with harpoons.

Other game animals also had fur and meat that were prized, but they were better able to defend themselves: the fox, the wolf, the lynx, the wild boar, and the bear. Polar bears roamed Greenland; their white fur was highly prized. One Greenlander brought a live polar bear to the mainland as a present for a king. Some bears, including polar bears, were trained to perform tricks.

HUNTING BEAR



Carion-eating birds entered the action at the end of a hunt or a battle: the raven, buzzard, and eagle were especially prominent. The raven particularly was associated with Odin, lord of the dead, whose birds brought him news of all that went in the world of men.

Lappland in the summertime was notorious for its swarms of mosquitoes which viciously attacked travelers from May through October (whenever the night temperature was above 50°F).

9.3 ANIMAL DETECT SKILLS

In addition to their attack abilities, animals both natural and fantastic are skilled at noticing strangers and hidden people. Predators are obviously very good at tracking prey, and this is facilitated if the quarry is wounded and/or bleeding.

9.4 SHAPECHANGING

Shamans were able to project their spirits forth in beast-form to see faraway lands, but only a few trollwise wizards mastered the secrets of shapechanging. These few wizards were able to change their enemies into the form of animals of about the same size, usually a bear, sometimes an elk or wolf. One saga tells of a man who was forced by a magic spell to be a bear by daytime but who reverted to his human form at night. When killed by hunters one day, he remained a dead bear.

Stories abound about women who wore cloaks of swan feathers which allowed them to shapechange into swan-form. Sometimes these were valkyries, the servants of Odin, god of the dead. In other tales, the swan-maiden was a princess who might marry a man for a few years, then fly off, to never be seen again.

Some legends reported that wizards could transform themselves into the form of giant animals, becoming a bear twice as tall as a man on horseback or turning into a wolf the size of a bull or an eagle able to pick up an armored man and fly off with him. One non-historical romance tells of a Lapp wizard who transformed himself into a whale on the battlefield — and then dove in the ground as if he were diving underwater. Such transformations are not affected by the presence of daylight or the phase of the moon.

The GM should think seriously about just what sort of shapechanges to permit. He will probably want to restrict shapechanging to animals which range from half to twice the character's weight.

GM Note: game statistics for shapechangers and monsters can be found in section 10.7 of this book.

9.5 THE SEA SERPENT

Norse myths spoke of Jormungand, the Midgard Serpent, who was so long that he encircled the world, and so strong that not even the mighty Thor could overpower him. Viking sailors told one another about encounters with the sea serpent, who was large enough to block a fjord. The serpent was said to breed inside inland lakes and, at a certain age, to swim away to the open sea. The beast was greedy for human blood and tried to overturn ships to eat the men inside. Usually only one sea serpent was seen, but some tales describe many such awesome beasts.

One tale says that the sea serpent's deadly foe was the sea horse, a horse that could run on the top of the waves. It attacked the serpent by biting and kicking. The hoof of a sea horse (bitten off in a fight with a sea serpent) was later used as a corn bin and held 48 bushels of corn.

Sea serpents could be killed by men. Their hide was too tough to be injured by weapons, but their eyes were vulnerable to attack. Serpent's blood was bright green. The meat was poison, and after the creature's death, it stank incredibly. The only way to deal with the carcass was to burn it. Serpent bones were as strong as iron; no tool could carve them.

9.6 THE NICOR

The nicor is a river-horse which can breathe water as well as air, and which likes the taste of human blood. Sometimes the wicked beast haunts a river ford, drowning people who try to cross the wide waters. Or it may come up on the land, looking like a beautiful grey horse. (Some legends say that you can tell it because its hooves are turned backwards.) Anyone mounting a nicor will find themselves "glued" to its back, unable to get down, as it runs to the nearest river or lake and plunges in, drowning its rider.

Other tales note that a nicor could be tamed if a man managed to get a bridle into its mouth. (The beast's power was overcome by the steel in the bit.) If the bridle fell off, the nicor would bolt to the nearest water, dragging the plow or wagon it was pulling with it.

9.7 THE DRAGON

Vikings were familiar with the story of Sigurd Dragonslayer (see Section 5.10). Sigurd used a magic sword to slay Fafnir, who had transformed himself into a dragon. As a dragon, Fafnir breathed deadly venom. He also wore a "fear-helm," which terrified most creatures who saw him. He fiercely guarded his treasure hoard of gold and jewelry.

The wily Sigurd dug a trench on the path that Fafnir used to crawl to and from the river and stabbed the great dragon upwards, into the heart. Afterwards, Sigurd cooked the dragon's heart on a spit, then tried it with his finger to see if it was done. The monster's heart's blood on his tongue let him briefly understand the speech of the birds, which warned him that the man who had forged his sword now planned to kill him.

Anglo-Saxons also heard and told stories of dragons. Their hero, Beowulf, had killed nicors and trolls in England, then returned home to the northland and become a king. Later, he died fighting a dragon which had come to his kingdom to recover a jeweled cup stolen from its treasure hoard. This dragon was no transformed mortal but a true beast. It flew through the air and breathed fire, so that Beowulf had to use an iron shield to defend himself.

A few non-historical sagas tell of a Russian or a Lapp wizard who could shapechange into dragon-form and fly over battlefields, breathing fire and venom on his foes. In similar stories, wizards also changed into other legendary animals, like the Skergip (an enormous bird with an ugly horned head, strong enough to kill a dragon) and the Hjasi (an animal the size of an ox that looks like a dog, except that its ears are so large they touch the ground).

No Viking stories speak of dragons in Scandinavia, but there are the carved dragonheads on Viking warships. Viking graves sometimes also had carvings of dragons. Perhaps the fearsome monster was supposed to protect the dead man and his buried treasure. Or perhaps the Vikings believed that the dead man would appear in dragon-form to attack enemies who tried to rob him.

The GM may want to rule that dragons are totally mythical. Or he might allow a wizard (or someone with a wizard artifact) to shapechange into a dragon. Or he might allow aftergangers (see Section 10.6) to appear in dragon-form. An old dragon, deep in the northern wastes of Lappland or Russia, might rest warily guarding his hoard of treasure. Dragons should never be so common that the characters think of them as a run-of-the-mill menace.

MONSTERS AND SPIRITS

10.1 TROLLS

Mound trolls were like humans but taller, uglier and stronger. Their homes were earth mounds like those the dead were buried in (see Section 10.6) or like the pit homes of the Slavs. They could dive into the earth like a whale into the sea and “swim” as fast under the earth as a man could run on top of it.

In Iceland, trolls were thought to cause volcanic eruptions. One saga tells how a troll rowed up a river in an iron boat, then walked ashore to a farm and began digging at the entrance to the milking shed. “During the night, fire erupted out of the earth.” The whole region was consumed by fire and quakes.

Trolls were afraid of daylight, which turned them to stone. They also were afraid of thunder and lightning, because it meant Thor was nearby. A man could scare off a troll by lighting a fire with flint and steel. (*GM Note:* Later folk tales had the fire and steel of a rifle shot scare off a troll. This might come up if your campaign has time traveling characters with modern firearms.)

Water trolls were like normal trolls but could breathe both air and water. They lived behind waterfalls or at the bottom of deep pools. The old children’s tale of the Three Billy Goat Gruffs is about a water troll who lived under a bridge. One saga tells of a sea troll’s son who had to be killed by one blow to the chest. “Everything that’s cut off him turns into poisonous snakes. And no one must look him in the face when he’s dying — that would mean death for sure.”

GM Note: game statistics for all monsters detailed herein appear in section 10.7 of this book.

10.2 GIANTS

Giants lived in Greater Russia, north of Permian (see Section 8.12). A tall man barely came up to a giant’s knees, and they were strong enough to wrestle and kill a polar bear.

10.3 DWARVES AND ELVES

Dwarves and Elves lived under the ground like mound-trolls but were shorter than humans, about the size of Lapps or Slavs. Dwarves were considered to be ugly; Elves were beautiful. Both Dwarves and Elves wore mist-caps that made them invisible and could only be seen if they removed them — or if you accidentally knocked off the mist-cap.

Dwarves were master miners and smiths, who knew about all the silver and gold veins of the earth. Some of them stole hidden treasure whose owner had died. They also knew how to find special herbs. The sleep-thorn would keep someone asleep, without needing to eat or drink, until it was removed. He wouldn’t even wake up if you cut off his feet. “Herbs of life” could reattach a severed limb in three days time.

Elves herded their blue-skinned cattle on the hills by night or spent the hours dancing and singing, often in the shade of an elder or linden tree. Bad luck came to anyone who annoyed them.

Some elves could send their spirits out in a trance in the form of horses. Such a night-mare could sit on a sleeper’s chest and disturb his dreams. A man who’d been ridden by a mara would get up in the morning more tired than when he’d gone to bed, afraid of the horrible things he’d seen in his sleep.

10.4 NIS

Nis were small and shy dwarf-like beings who lived in a house or barn and brought good luck to the farmstead.

10.5 WATER SPIRITS

Mermen and mermaids were handsome or beautiful beings who lived in the sea or on Utroost (see 8.12). They could breathe water as well as air.

A stromkarl (stream freeholder) appeared as a handsome young harpist who lived in a river, often near a waterfall. He too could breathe water as well as air. A stromkarl might teach his skill to someone who brought him a black lamb on a Thor’s Day evening. If the lamb were lean and poor, he only taught the pupil how to string his instrument. If the lamb were fat, the stromkarl seized his pupil by the right hand and swung him around till the blood ran out at the tips of his fingers. Afterwards, the man could play wonderfully (but never as well as a stromkarl, for humans have only ten fingers and a stromkarl has eleven).

10.6 THE DEAD

Norse myths said that after death, people’s spirits went to the homes of the gods or goddesses or to the home of Hel. Half of the heroes who died fighting went to Valhalla (Slain Hall), the home of Odin, brought there by the Valkyries. Odin was called Valfather (Slain Father) because all the battle-dead were his adopted children. The other half of the heroes who died fighting went to Folkvanga (Field of Warriors), the home of Freyja. They were chosen by Freyja herself, who rode into battle to choose them.

VALHALLA

Valhalla was roofed with golden shields. It had more than 640 doors, each large enough to let 960 men walk through it at one time. Heroes who lived there got up every morning and fought in armor with weapons. Then they raised the slain, were reconciled, and ate breakfast. Afterwards they might fight again or amuse themselves by drinking or playing table games. Twice a day, they ate pork stew made from a great boar who was boiled every day and came alive in the evening. Their mead was milked from a goat that pastured on the tree called Laerad which stood outside the door of Valhalla.

Each Yule, Odin mounted his horse Sleipnir and led the Valkyrie through the skies. Behind them flew the souls of the heroes who lived in Valhalla. Grave mounds gaped open so the dead heroes’ bodies could watch their souls fly by. Any living man foolish enough to go outside when the Wild Hunt flew by might also be taken.

Gefion’s hall held the souls of women who die unmarried. She may be an aspect of Freyja, one of whose names was Gefn (Giver).

The spirits of good men and women went to Gimle (Lee of the Fire), the hall of the white trolls (elves), the home of Frey.

Hel was one of the three monstrous children of Odin’s foster brother, Loki. Her right side was living woman, her left side a black corpse. She reigned in Niflheim where she had a number of halls. People who died in bed of sickness or old age went to Eljudnir (Sleep Damp). Perjurers and murderers went to Nistrandir (Corpse Strand) which was made of woven serpents and had streams of poison running underfoot or to Hvergelmir, where they were eaten by the great serpent Nidhogg.

MOUND DEAD

Some saga heroes promised to meet again in Valhalla if they were killed in an upcoming battle. Usually Vikings did not expect to live on in another world after they died. Instead, they expected to go on living in this world, in their grave mounds. That's why instead of bequeathing their treasure to their families, they tried to take it with them.

Viking grave mounds were not just heaps of earth but instead resembled underground buildings with wooden frames and rafters, sometimes roofed with tiles. It took one strong hero almost a full day to dig his way into a grave mound. Inside, the dead man was laid to rest on a ship or seated on a chair, with his treasures piled around him.

One saga tells how two heroes, Asmund and Aran, became blood brothers. Then Aran died, and Asmund had him put in a mound seated on a chair in full armor, along with many treasures — and his horse, his hawk and his hound. Then Asmund had another chair brought for himself and sat down inside the mound holding onto a rope that led outside, and had the mound closed up over them.

The first night, the dead man got up, killed the hawk and hound and ate them. The second night, he killed the horse and tore it to bits and ate them, "the blood streaming down from his mouth all the while he was eating. He offered to let Asmund share the meal, but Asmund said nothing. The third night, Asmund became very drowsy, and the first thing he knew Aran had got him by the ears and torn them off. Asmund drew his short-sword and sliced off Aran's head, then he got some fire and burnt Aran to ashes." Asmund then pulled the rope and was hauled out of the mound, taking all of Aran's treasures back with him. After that, the mound was covered up again.

Another saga tells how a hero made his way to the grave mound of a dead king in spite of "magic weather." It took him a day to reach the mound because as soon as he neared it, a blizzard sprang up in the forest around the grave. The wind was so strong that oak trees were uprooted and flew through the air.

AFTERGANGERS

Some dead men didn't stay in the grave mound but instead got up and walked around. These were called aftergangers because they walked after death, and they did not like living people on their domain.

One saga tells of a man who only left his son a small farm on a medium-sized island. Once he had died, however, his afterganger soon chased all the other farmers off the island. Only his relatives and their people were safe, so his son ended up owning the entire island.

Most aftergangers didn't make this sort of exception for their relatives; they attacked anyone on their territory. Mighty warriors, berserks, trollbloods, and mages were most apt to become aftergangers. People tried to bury them where they were unlikely to be disturbed: say, on a desolate headland where no ships landed or up on a mountain ridge where no one farmed or herded or felled trees.

One saga speaks of a huge thrall with prematurely gray hair who worked on a Christian farm but had to be buried under a cairn of rocks, because no one could find his body when a priest came along with the party. But he didn't lie quiet under the rocks. First people

saw him walking about the farmhouse. Then he started to climb up on the roof at night; it sounded as if the roofbeam was about to break. Then he began walking about day and night. He killed horses and attacked men. Finally a hero wrestled him down and killed him — again. With his last breath, the afterganger cursed the hero with bad luck and fear of the dark.

Another saga tells of an afterganger who first murdered most of his hirelings, then went on to attack his neighbors' men. People dug up his body and moved it far away from any paths or pastures. His son farmed the land, but went mad and died. Everybody moved away from the area.

Finally another hero took over the land but found it hard to keep servants. One hireling saw the afterganger standing in the door of the byre, trying to catch hold of him. They dug up the body again, and found it still undecayed. They burned the body and carried the ashes out to sea. So ended the hauntings.



DRAUGS

Men who drowned at sea could not be given a proper burial. Their bodies walked after their death, trying to drown other men. Some fishermen heard draugs shrieking in the wind or saw them sailing in half a boat, a sure sign a bad storm was coming. At Yule, draugs came back to their old farms. You might see a draug looking over the seats in a fishing boat to see which member of the crew would drown on the next trip, or just sitting in front of the boathouse, covered with seaweed.

10.7 MONSTER TABLES

ROLEMASTER MONSTERS										
Monster	Lvl	Base Rate	Max Pace/ MN Bonus	Speed MS/AQ	Size/ Crit	Hits	AT (DB)	Attacks	# Enc.	Outlook IQ
Afterganger	8D	30	Spt/10	SL/MF	M/LA	90E	1(50)	90We/70LBa	1	Protect
Dragon	13G	210	Dash/30	VF/VF	H/LA	350G	12(60)	70HBi/120HCl	1	Varies
Draug	3C	30	Spt/10	SL/MF	M/I	50A	1(20)	40We/50LBa	1	Varies
Dwarf	3C	50	Spt/0	SL/MD	M/—	50E	16(35)	60Melee/30Missile	1-20	Varies
Elf	5E	75	Dash/15	MD/MD	M/—	50D	1(50)	80Melee/100Missile	1-10	Varies
Frost Giant	11F	80	FSpt/10	FA/MF	H/LA	350G	11(40)	100We(3D)/60ro(250')	1-2	Greedy
Giant Bear	10G	90	Spt/10	MF/MF	L/II	230G	8(30)	85LGr/65LCI	1-5	Aggres.
Giant Eagle	8F	150	Dash/20	VF/VF	M/I	90F	3(60)	80LCI/60MBa	1-10	Aggres.
Giant Wolf	6C	110	Dash/20	FA/FA	L/I	150E	3(30)	65LBI	2-20	Aggres.
Mound Dead	12D	40	Spt/10	SL/VF	M/LA	115E	1(70)	110We/90LBa	1	Protect
Merfolk	3C	60	Dash/10	MD/MD	M/—	50D	1(35)	60Melee/30Missile	1-6	Varies
Nicor	3B	70	Dash/30	MD/MF	M/—	125E	4(30)	60SCr/40SBi	1	Aggres.
Nis	2B	30	Dash/30	MD/MD	T/—	25D	1(40)	5Melee/20Missile	1-5	Carefree
Sea Serpent	15G	100	FSpt/20	MF/FA	H/SL	400G	16(30)	90HGr/80HBi	1	Aggres.
Stone Giant	9E	70	FSpt/10	MD/MD	L/II	275F	12(30)	90We(2D)/50ro(150')	1-2	Normal
Stromkarl	5E	80	Dash/10	MF/MD	M/—	80D	1(20)	50Melee/50Missile	1-4	Altru.
Troll	7D	65	FSpt/0	SL/MD	L/II	150F	11(15)	80LBa/65LCI	1-10	Hostile
Wild Hunter	1A	160	Dash/40	BF/BF	M/I	50A	1(40)	Special	2-10	Hostile

FANTASY HERO MONSTERS												
Monster	STR	DEX	CON	BODY	PRE	PD	rPD	ED	rED	SPD	Damage	Move
Afterganger	13	14	11	10	11	10	—	3	—	2	1D6+1K	6"
Dragon	70	18	30	30	25	14	—	10	—	4	+4D6	15"
Draug	10	11	8	9	8	6	—	2	—	2	1D6	5"
Dwarf	12	14	15	14	12	5	—	2	—	2	1D6+1K	6"
Elf	10	15	13	10	18	6	—	4	—	4	1D6	8"
Frost Giant	50	12	40	20	20	12	—	9	—	2	2D6	12"
Giant Bear	30	18	19	18	28	10	2	7	1	3	2x1D6	4"
Giant Eagle	-8	18	6	4	13	3	—	2	—	4	2x1D6-1	18"
Giant Wolf	10	17	15	10	15	5	—	3	—	4	2x1/2D6	7"
Merfolk	5	14	8	7	8	4	—	2	—	2	1D6	8"
Mound Dead	15	16	13	12	13	14	—	4	—	4	2D6	8"
Nicor	15	12	14	12	12	3	—	2	—	2	+1D6	12"
Nis	4	10	2	5	4	2	—	3	—	7	0	4"
Sea Serpent	60	15	40	30	50	20	—	18	—	3	2 1/2D6K	15"
Stone Giant	55	13	45	22	21	13	—	10	—	2	2D6	12"
Stromkarl	6	13	7	6	7	3	—	2	—	2	1D6	7"
Troll	30	23	25	15	12	10	—	8	—	5	+2D6	10"
Wild Hunt	8	15	10	8	6	16	—	2	—	3	1/2D6K	7"

GODS AND GIANTS

Norse gods were divided into two categories: the Aesir and the Vanir. At first, say the myths, these two sets of gods were enemies and fought two great battles. Afterwards, they exchanged hostages and became friends. The only Vanir we know much about are the three hostages they sent to the Aesir: Njord and his two children, Frey and Freyja.

The Aesir were also related. Snorri Sturluson traces their origin back to Troy (and says that their name means "Asians"). He says that the first of the Aesir was Thor son of Priam whose wife was "a prophetess called Sibyl whom we call Sif" and whose descendant in the 18th generation was Odin, whose wife was called Frigg, and whose children ruled various countries, among them: Baldur (Westphalia), Sigi the ancestor of Sigurd Dragonslayer (France), and Yngvi (Sweden). Most myths say that Odin was the father of Thor and Sif, not their descendant, and that Odin's children were not the founders of royal dynasties but gods. They also explain Yngvi as merely another title of Frey the Vanir.

The Aesir and the Vanir lived in Asgard (Aesir Town). They were often on bad terms with the frost giants who lived in Jotunheim (Giant Home). On the other hand, the myths also speak of how Njord and Frey took beautiful giant maidens as their brides. The warrior god Tyr was the son of Hymir the sea giant, and the sentinel god Heimdal was the son of Hymir's daughters, the nine sea giantesses. The vast wall of Asgard had been built by a frost giant, because the gods were not strong enough to do it.

This section describes a few of the most well-known gods and giants and some of their deeds. As GM, you should feel free to rework the myths to suit your campaign. Perhaps in your campaign, the Aesir and Vanir are still fighting. Perhaps the giants have managed to win some of the goddesses as their wives. Perhaps Loki remained faithful to his first wife, Sigyn the goddess, and never took up with Angrboda the giantess, so Hel, Fenris and the Midgard Serpent were never born. Maybe Odin had children by the lovely giantess Guddloth, who guarded the mead of poetry. Their children might be even more evil than those of Loki and Angrboda, or they might be able to solve the problems posed by the Trickster's children. Perhaps Frey and Freyja married according to Vanir custom and had children.

11.1 THOR

Vikings loved Thor most of all their gods. When the Norse argued with Christian missionaries, it was Thor they defended. One lady asked a missionary if he'd heard how "Thor challenged Christ to a duel, and Christ did not dare to accept the challenge?" And many supposedly Christian Vikings were like Helgi the Lean who still prayed to Thor in regard to anything important.

Thor was the strongest of all gods, and they looked to him for protection against the Giants. Much too big to ride a horse, Thor either walked (like a peasant) or drove a cart pulled by goats. He had glowing red eyes and a great red beard as well as a belt of giant strength and gloves of iron. In addition, Thor carried a magic hammer (Mjollnir) which returned to his hand after he threw it. His worshippers sometimes wore hammer-shaped amulets to bring them luck. At pagan festivals, the feasters made the sign of the hammer over their food and drink to show their devotion to Thor.

Thor had pieces of whetstone in his forehead, which he'd gotten in a duel with the giant Hrungrnir, whose whetstone weapon was shattered by the iron Mjollnir. (The whetstone in Thor's forehead

suggested that if he hit his forehead with his hammer, he could make sparks, just as a Viking used his tinderbox's flint and steel to kindle a fire.)

Thor was the god of thunder and lightning; sailors sacrificed a goat to him before making a voyage. Thor was also the god of safety from evil. Men tucked newlyweds into bed along with a hammer, to make sure their marriage bed would not be cursed by jealousy or infertility. Thor was the god of law. The Icelandic Althing began on a Thor's Day because it was an assembly for settling disputes by law rather than by fighting. Many statues of Thor had a golden arm ring which worshippers would touch when they wished to swear a binding oath.

Thor's wife, Sif, had beautiful golden hair, which had been forged by dwarves out of real gold to replace her own hair which was cut off by the Trickster Loki. (Most scholars say that Sif is the golden grain. Another theory is that she's the golden fire, kindled by a lightning strike.)

11.2 TYR

Tyr was the god of battle, whom the Saxons had called Seax and after whom they named their short-swords. Renowned for bravery, Tyr deliberately put his right hand into the mouth of Fenris the giant wolf, Loki's monstrous son, to fool Fenris into letting himself be chained. Men prayed to Tyr for victory in battle. Some myths said he was the son of the sea giant Hymir; others claimed that he was the son of Odin. Perhaps Odin was his foster father, as he was of all brave heroes who were willing to risk death in battle.



11.3 ODIN

The God of Poetry, Battle Frenzy and Death, Odin gave up one of his eyes in exchange for the ability to see the future. Then he sacrificed himself to the only power he respected, himself. He hung on the world-tree Yggdrasil for nine nights, a spear in his side, without food or drink. This ordeal allowed him to bring back the magic Runes.

Odin was served by carrion-eating ravens and wolves. His eight-legged horse Sleipnir was the coffin, which four men bore to the grave. He taught men to burn their dead inside ships so they could sail to the afterlife, and so he was called the "God of Cargoes." He had many other names as well, among them: Svipall (Changeable), Sanngetall (Riddle Guesser), Bal-Eyg (Flame-Eyed), Bolverk (Worker of Evil), and Fjolsvid (Wise One).

Odin risked his life by going to Jotunheim to get back the mead of poetry, which the dwarves had made by mixing honey with the blood of Kvasir the Wise. (The Aesir and Vanir had made Kvasir by spitting into a jug to celebrate their peace treaty. The wicked dwarves killed him and drained his blood for their mead. Suttung the giant then took the mead from the dwarves.) Odin used the name of Bolverk and tricked Suttung's beautiful daughter Gud-dloth into letting him take three swallows of the mead. He swallowed it all in three huge gulps, then flew home to Asgard in the shape of a great eagle.

Viking kings and poets worshipped Odin as the chief of the gods, father of all the Aesir. They prayed to him for victory in battle and for inspiration in poetry. Berserks also worshipped him as the source of the frenzy which allowed them to put aside all fear of pain, wounds, and death. Ordinary people thought of Odin as a powerful but treacherous patron, who gave his worshippers power and riches and strength and talent — and then betrayed them to death. He also knew shaman magic which made them doubt his masculinity. Loki accused him of having spent a time in the form of a woman to learn Freyja's magic.

Many myths and several sagas mention Odin mingling with mortals, disguised as an old man. Sometimes he appeared to be a farmer in an isolated mountain region; other times, he seemed to be a beggar. He wore a blue cloak and a broad-brimmed hat that shaded his face, so people didn't immediately notice that he had only one eye. Odin rewarded people who treated him well with battle luck and magic weapons, but punished people who treated him rudely.

11.4 VALKYRIES AND NORNS

Odin was brought the souls of dead heroes by the Valkyries ("Choosers of the Slain"). Sometimes the Valkyries were described as beautiful maidens who rode through the air on horseback or flew in swan-form. Usually Valkyries were also the daughters of a nearby king and priestesses of Odin as long as they remained maidens. At other times a Valkyrie appeared as a giant woman, riding a wolf, using a viper for reins. Njal's Saga shows a Valkyrie weaving. "Men's heads were used in place of weights, and men's intestines for the weft and warp; a sword served as the beater, and the shuttle was an arrow."

The three Norns were Urd (Fate), Skuld (Being) and Verdandi (Necessity). They lived by the spring of Urd in Asgard, at one of the roots of the Yggdrasil. They watered the tree with the spring water and wove the fates of both mortals and immortals. The weaving Valkyrie who chose who would be slain were another version of the Norns.

11.5 LOKI

Odin's blood brother was Loki the Trickster, a shapechanger who could turn himself into a falcon or a fish, a mare or a giantess. Loki once competed with the Giant Logi (Fire) to see who could eat faster, so some people also think of Loki as the god of fire. Others view Loki as Satanic, a powerful spirit who betrayed all that was good and beautiful and sided with the forces of evil.

However, most myths portray Loki as a prankster, not as a god of fire or the devil. He played tricks on the gods and goddesses and engaged in insult contests with them, but when they needed someone with crafty intelligence, he was the one they went to — and he was always willing to help.

After the gods hired a giant to build a wall around Asgard, they asked Loki to find a way to break the contract with the giant, to whom they swore to give the beautiful goddess Freyja as a reward. Loki then turned himself into a mare and distracted the giant's mighty horse. Some months later, he bore the eight-legged horse Sleipnir and gave him to his blood brother Odin.

One convenient way to think of Loki is as a reflection of Odin. Odin is Poetry and Death; Loki is Deceit and Dreams.

11.6 BALDUR

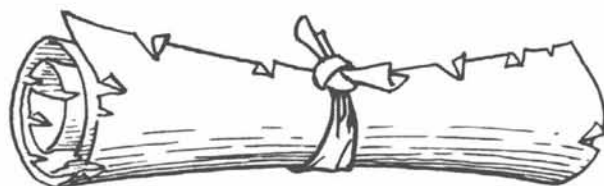
Baldur was the most fair and beautiful of the gods; his twin brother Hoder was dark-skinned and blind. (They were sons of Odin and his wife Frigga.) One myth reports that their mother Frigga heard that Baldur might be killed and so made every thing promise not to hurt him. Every thing in the world listened and heeded but the mistletoe, which was neither a plant with its roots in the ground nor a beast, but grew on an oak tree in the air. (Mistletoe was boiled to make sticky birdlime to catch birds.)

Now that Baldur was invulnerable, the gods began a game of throwing things at him. Some sagas describe the Vikings playing "games" like this, with the target being a prisoner or the weakest man among a king's housecarls. The object of the game was to scare the victim away — or accidentally to kill him.

Finally, blind Hoder came along and wanted to play too. Loki the Evil (and in this myth he is indeed evil, not merely a prankster) gave Hoder a piece of mistletoe to throw. The mistletoe struck Baldur, who died, and his father Odin had him cremated on a ship along with his wife Nanna and a hoard of treasure. The Norse called their Midsummer bonfires, "Baldur's bale fires." Odin's final, unanswerable riddle was to ask what the last words were that he had whispered to Baldur just before the fire was lit.

Another version of Baldur's death reports that Baldur was invulnerable thanks to the aid of the Valkyries, who fed him on food mixed with serpents' venom. He and Hoder both loved the beautiful Nanna. Hoder learned that to win Nanna, he would need a sword named "Mistletoe." He went on a long journey to get it, through a land of cold and darkness, perhaps the land of the dead. Finally he returned and married Nanna. Baldur challenged him to a fight, and Hoder won. The slain Baldur was given a royal funeral.

As GM you can decide what version of the story your characters might believe.



11.7 FREY

Frey (the Norse word for “Lord”) was the god of fertility. The Norse prayed to him, especially at Summer’s Eve in the spring for good crops and healthy herds. Women prayed to him for babies. People sometimes dedicated a horse or boar to Frey, and would honor it at Winter’s Eve or Yule. In Sweden, whose royal dynasty supposedly descended from Frey, the fall festival of Winter’s Eve was marked when a priestess toured the countryside driving a cart in which stood an image of Frey.

Frey’s wife was the lovely frost giantess Gerd, who married him for fear of the threats of his servant Skirmir. In exchange, Skirmir took Frey’s sword, which was so powerful that it fought by itself against giants. This left Frey armed with a deer’s horn. (Lapp priests wore horned helmets; Lapp gods sometimes had horns placed in front of their altars. The horned Viking helmets found were never worn in battle but were probably worn by priests or priestesses of Frey.)

11.8 NJORD

Frey’s father, Njord lived at Noatun (Ship Town) and was unhappy if he spent even a few days inland. People prayed to him for good luck at sea. He left his first wife behind among the Vanir; we don’t know her name, only that she was his sister. Given the names of his son and daughter, it’s likely that her name was Njorda.

Njord’s second wife was the giantess Skadi, a skier who hunted wild animals with her bow and arrow. She married Njord as compensation from the Aesir for the death of her father, the frost giant Thjazi, killed through the craft of Loki. But she was unhappy when she tried to spend a few days at Njord’s home by the coast. They eventually agreed to live apart.

11.9 FREYJA

Freyja (the Norse word for “Lady”) was Njord’s daughter and Frey’s sister. She was incredibly beautiful, and every man desired her. The wall around Asgard was built by a giant who’d been promised Freyja as a bride. Several other giants also tried to marry the beautiful goddess, but each was outwitted by the crafty Loki. Hnoss (“Treasure”) was Freyja’s beautiful daughter, but her mother was so much more beautiful that no one ever married her.

Like her brother, Freyja also sometimes rode on a wild boar or transformed herself into a horse. Her chariot was pulled by cats. She had a falcon cloak which allowed the wearer to shapechange into a falcon at will and knew all the secrets of shaman magic, teaching them to women (and a few men) who worshipped her. She and Odin had an agreement to each take half of the heroes who died in battle, and both of them could initiate berserks into the battle frenzy.

Some myths say that Freyja was married to the god Od, one of the Vanir, a long-lost wanderer. She wept tears of gold in mourning for her husband. Other myths report that she was willing to take anyone as a lover if he offered her great gifts. One saga says she spent one night with each of four dwarves to win her beautiful necklace, the Brisingamen. Loki accused her of having an affair with her brother (who would have been her husband if they’d stayed with the Vanir).

Notice how similar the names of Freyja and her husband Od are to that of Frigga and her husband Odin. Some scholars think that originally there was just one couple: Odin, god of death and poetry, and Freyja his wife, goddess of death and romance.

11.10 OTHER GODDESSES

Frigga was Odin’s wife. Women prayed to her and Freyja during childbirth. She had a number of goddesses as servants, among them: Fulla who knew all her secrets; Hlin who protected men whom she wanted to save from danger; and Gna, who carried her messages mounted on a horse that could ride over the sea and in the air.

Eir was the best of physicians. Var (Vow) listened to oaths and took vengeance on those who break them. Syn (Denial) defended people who were unjustly accused. Idunn kept the apples of youth in a box. Without them, the Aesir would grow old and decrepit. She was the wife of Bragi, the god of eloquence and poetry (whose name is the source of the word “brag”).

11.11 OTHER GODS

Ull was a handsome warrior and Sif’s son (as well as Thor’s stepson). Like Skadi, he was a good archer and skier. Forseti was the son of Baldur. At his great hall, he held court and reconciled everyone who came there with legal disputes.

Heimdall was the gold-toothed son of the sea giant Hymir’s nine giant daughters (the great wave which follows nine lesser waves). He kept watch by the rainbow bridge which linked Asgard to the other worlds. He could hear the grass grow on land and the wool grow on sheep. The blast of Heimdall’s trumpet was so loud it could be heard all over the world. He kept it ready to blow to summon the gods when the giants at last attacked Asgard.

11.12 AEGIR THE SEA GIANT

Aegir ruled the sea. The skalds said that the “jaws of Aegir” devoured ships that were lost at sea. He had a huge ale cauldron a mile deep that brewed the waves and the ocean storms — and held enough ale to feast all the gods. His home was on the island of Hlesey (nowadays called Laeso) in the Kattegat (the strait between Jutland and Sweden). Aegir’s other names included Hymir and Gymir. He was the father of the warrior god Tyr and of the giantess Gerd, who married the god Frey.

Aegir’s wife was the giantess Ran, whose great net entrapped ships and whose claws brought their passengers down to her hall. It was only polite to reward her for her hospitality. One saga tells how a hero gave his men small pieces of gold when they were caught in a storm at sea, so that no one would have to appear at Ran’s hall empty-handed. If a man’s fylgja appeared at his funeral feast, it was a sign Ran had welcomed him. Otherwise, he would be a draug, haunting the waters until he had brought Ran a guest with better manners.

Ran and Aegir had nine daughters, mothers of the sentinel god Heimdall: Gjöl (Yelper), Greip (Gripper), Eistla (Foamer), Eyrgjafa (Sand-Strewn), Ulfrun (She-Wolf), Angeyja (Anguish Whelmer), Imth (Dusk), Atla (Fury), and Jarnseaxa (Iron Sword).

One myth tells how Tyr brought his friend Thor to his father Hymir’s house on a visit. Hymir took Thor out fishing. Thor rowed out to the deeps of the ocean, threw in his line, and hooked one of Loki’s monstrous children, the Midgard Serpent, a creature so huge that it lay coiled around the earth. When it grew angry and lashed its tail, tidal waves covered the land. Thor’s great strength pulled its head to the surface, and the two glared at one another, whereupon Hymir grew frightened and cut the fishing line, freeing the snake. Thor boxed Hymir’s ears, then jumped out of the boat and waded ashore.

11.13 FROST GIANTS

Frost Giants lived in Jotunheim (Giant Land). There are a number of myths about Thor's visits to Jotunheim. One tells how he visited Geirrod's Town (see 8.12). Another reveals how the giant Thrym stole Mjollnir, Thor's hammer, and refused to return it except in exchange for the beautiful Freyja. Loki disguised Thor as Freyja and escorted him to Thrym's hall, where the mighty god ate an ox and eight salmon at the wedding feast. Finally the giants brought out the hammer to hallow the wedding. Thor seized it and killed Thrym and all his men.

Then there's the story of how Loki and Thor visited Utgard, the capital of Jotunheim, and found it ruled by a giant named Utgard-Loki, a master of illusion. He ordered Loki to share a trencher with a giant named Logi (Wildfire), who really was a fire, and easily ate faster than the god. Next he gave Thor a drinking horn and mocked him for not being able to drain it, but its other end rested in the sea

and Thor's drinking made the ebb-tide. Finally he forced Thor first to wrestle a cat (the Midgard Serpent: Thor barely managed to lift one of the paws) and then an old woman (Old Age: she brought Thor to his knees).

11.14 SURT THE FIRE GIANT

Surt guarded the land of Muspel, the region of flames which was too hot for any mortal. He carried a flaming sword. It was prophesied that there would one day be a final battle of the gods and the giants. The battle would come after a winter that lasted for three long years. After most of the giants and gods had killed each other off, Surt would ride across the rainbow bridge to Asgard, and it would shatter beneath him. Then he would draw his sword and burn up all that remained in the world, except for sea and the world-tree Yggdrasil. Afterwards, some said, Baldur and Hoder would return from Hel, at peace once again.

12.0

CHARTS AND GAME NOTES

12.1 CALENDARS

The pagan year began at the Winter Solstice with ten months of 30 days each, followed by "Winter." Christian Europe at this time used the Julian Calendar, which had drifted about four days earlier, so that the Winter Solstice came on December 17th.

SUNRISE AND SUNSET

The chart below shows the times of sunrise and sunset for the first day of each month at latitudes 40, 50, and 60 degrees. Twilight lasts for an hour after sunset and begins an hour before sunrise. Iceland and northern Norway are about latitude 65, so far north that twilight never quite fades to night around midsummer or turns to day around midwinter. Denmark and Scotland lie at about latitude 60 degrees; Ireland, England, Germany, the Netherlands, and Normandy stand at about latitude 50; France, Spain, Italy and Byzantium are near latitude 40. Thus, on April 17th, a month after the Spring Equinox, at latitude 60, the sun would rise at 4:27 AM and set at 7:32 PM.

MOON PHASES, MOONRISE AND MOONSET

The period from one full moon to the next takes 29-30 days. (The exact period is 29.503585 days.) The new moon rises and sets with the sun; the full moon rises at sunset and sets at sunrise. The first quarter moon rises halfway between sunrise and sunset and sets halfway between sunset and sunrise; the last quarter moon does the reverse. So on April 17th, the first quarter moon would rise at about noon and set at about midnight, while the last quarter moon would rise at about midnight and set at about noon.

Full Moons repeat themselves in an eight year cycle. The first full moon of the year came on the following dates in January for the period 830-837. Determine the first full moon for your campaign year. For instance, 853 is 23 years after 830. 23 divided by 8 has a remainder of 7, so 853 corresponds to the 7th year: 837, whose first full moon was on January 4th.

1st (830) Jan 22nd	5th (834) Jan 7th
2nd (831) Jan 11th	6th (835) Jan 26th
3rd (832) Jan 29th	7th (836) Jan 16th
4th (833) Jan 18th	8th (837) Jan 4th

Note: the first full moon of the year appears on the top line. Read the rest of that column for other full moons in the year.

SUNRISE AND SUNSET CHART

Pagan Month	began	latitude 40		latitude 50		latitude 60	
		Sunrise	Sunset	Sunrise	Sunset	Sunrise	Sunset
Yule	Dec 17	7:18 AM	4:37 PM	7:56 AM	4:00 PM	9:02 AM	2:54 PM
Thorri	Jan 16	7:16 AM	5:04 PM	7:49 AM	4:34 PM	8:40 AM	3:28 PM
Goi	Feb 15	6:48 AM	5:40 PM	7:04 AM	5:25 PM	7:26 AM	5:01 PM
Spring	Mar 17	6:02 AM	6:30 PM	6:02 AM	6:14 PM	6:00 AM	6:16 PM
Sowing	Apr 16	5:15 AM	6:43 PM	4:48 AM	7:01 PM	4:30 AM	7:30 PM
Egg Time	May 16	4:40 AM	7:12 PM	4:08 AM	7:46 PM	3:12 AM	8:42 PM
Shieling	June 15	4:31 AM	7:32 PM	3:50 AM	8:12 PM	2:35 AM	9:27 PM
Haymaking	July 15	4:46 AM	7:26 PM	4:11 AM	8:00 PM	3:11 AM	9:00 PM
Grain	Aug 14	5:14 AM	6:53 PM	4:53 AM	7:13 PM	4:20 AM	7:46 PM
Autumn	Sep 13	5:42 AM	6:06 PM	5:38 AM	6:10 PM	5:32 AM	6:16 PM
Winter	Oct 13	6:12 AM	5:18 PM	6:24 AM	5:06 PM	6:43 AM	4:46 PM
Winter	Nov 14	6:48 AM	4:42 PM	7:17 AM	4:13 PM	8:05 AM	3:25 PM

DAY OF THE WEEK CHART

01	02	03	04	05	06	07	08	09	10	11	12	13	14	15	16	17	18	19	20	21	22	23	24	25	26	27		
28	29	30	31	32	33	34	35	36	37	38	39	40	41	42	43	44	45	46	47	48	49	50	51	52	53	54	55	
56	57	58	59	60	61	62	63	64	65	66	67	68	69	70	71	72	73	74	75	76	77	78	79	80	81	82	83	
84	85	86	87	88	89	90	91	92	93	94	95	96	97	98	99											00		
700s																												
Th	Sa	Su	M	Tu	Th	F	Sa	Su	Tu	W	Th	F	Su	M	Tu	W	F	Sa	Su	M	W	Th	F	Sa	M	Tu	W	Th
800s																												
W	F	Sa	Su	M	W	Th	F	Sa	M	Tu	W	Th	Sa	Su	M	Tu	Th	F	Sa	Tu	W	Th	F	F	Su	M	Tu	W
900s																												
M	W	Th	F	Sa	M	Tu	W	Th	Sa	Su	M	Tu	Th	F	Sa	Su	Tu	W	Th	F	Su	M	Tu	W	F	Sa	Su	Tu
1000s																												
Su	Tu	W	Th	F	Su	M	Tu	W	F	Sa	Su	M	W	Th	F	Sa	M	Tu	W	Th	Sa	Su	M	Tu	Th	F	Sa	M

Day of the week for January 1st appears on the top line. Read rest of that column for days of the week of the other months.

	normal year							leap year (divisible by four)																				
Jan 1	Su	M	Tu	W	Th	F	Sa	Su	M	Tu	W	Th	F	Sa	Su	M	Tu	W	Th	F	Sa	Su	M	Tu	W	Th	F	Sa
Feb 1	W	Th	F	Sa	Su	M	Tu	W	Th	F	Sa	Su	M	Tu	W	Th	F	Sa	Su	M	Tu	W	Th	F	Sa	Su	M	Tu
Mar 1	W	Th	F	Sa	Su	M	Tu	W	Th	F	Sa	Su	M	Tu	W	Th	F	Sa	Su	M	Tu	W	Th	F	Sa	Su	M	Tu
Apr 1	Sa	Su	M	Tu	W	Th	F	Sa	Su	M	Tu	W	Th	F	Sa	Su	M	Tu	W	Th	F	Sa	Su	M	Tu	W	Th	F
May 1	M	Tu	W	Th	F	Sa	Su	Tu	W	Th	F	Sa	Su	M	Tu	W	Th	F	Sa	Su	M	Tu	W	Th	F	Sa	Su	M
June 1	Th	F	Sa	Su	M	Tu	W	F	Sa	Su	M	Tu	W	Th	F	Sa	Su	M	Tu	W	Th	F	Sa	Su	M	Tu	W	Th
July 1	Sa	Su	M	Tu	W	Th	F	Su	M	Tu	W	Th	F	Sa	Su	M	Tu	W	Th	F	Sa	Su	M	Tu	W	Th	F	Sa
Aug 1	Tu	W	Th	F	Sa	Su	M	W	Th	F	Sa	Su	M	Tu	W	Th	F	Sa	Su	M	Tu	W	Th	F	Sa	Su	M	Tu
Sep 1	F	Sa	Su	M	Tu	W	Th	Sa	Su	M	Tu	W	Th	F	Sa	Su	M	Tu	W	Th	F	Sa	Su	M	Tu	W	Th	F
Oct 1	Su	M	Tu	W	Th	F	Sa	M	Tu	W	Th	F	Sa	Su	M	Tu	W	Th	F	Sa	Su	M	Tu	W	Th	F	Sa	Su
Nov 1	W	Th	F	Sa	Su	M	Tu	Th	F	Sa	Su	M	Tu	W	Th	F	Sa	Su	M	Tu	W	Th	F	Sa	Su	M	Tu	W
Dec 1	F	Sa	Su	M	Tu	W	Th	Sa	Su	M	Tu	W	Th	F	Sa	Su	M	Tu	W	Th	F	Sa	Su	M	Tu	W	Th	F

12.2 WEATHER

This chart shows the average temperature for the northern region (Iceland, northern Norway, Scotland) and the southern region (Denmark, southern Norway, and England). The daytime high will probably be 5-10 degrees hotter and the night low 5-10 degrees colder. The southern region is snow-covered from December through March; the northern region, October through April. Rainstorms and snowstorms are frequently accompanied by high winds which significantly increase the chance of frostbite or freezing to death if the temperature is 40 degrees or lower.

A long dry period during the summer will leave the trees tinder-dry, ready to burn if set afire by lightning or by a careless cookfire. Such a wildfire might take several days to burn itself out, endangering not just valuable timberland but also herds and farmsteads. A man could be fined heavily or condemned to lesser outlawry for starting a wildfire accidentally; he could be condemned to full outlawry for starting a wildfire on purpose.

Fog lowers general visibility and make it impossible for a navigator to be sure of a ship's exact position. It may also result in D6 days of rain (or if under 32 degrees, snow), if the GM likes.

Pagan Month	began	North temp	South temp	chance of fog/rain/snow
Yule	Dec 17	25	45	40%
Thorri	Jan 16	30	45	25%
Goi	Feb 15	35	50	20%
Spring	Mar 17	45	55	20%
Sowing	Apr 16	55	58	20%
Egg Time	May 16	58	60	15%
Shieling	June 15	63	65	15%
Haymaking	July 15	60	65	20%
Grain	Aug 14	50	60	25%
Autumn	Sep 13	40	55	60%
Winter	Oct 13	35	50	55%
Winter	Nov 14	30	45	50%

Thus, as the year 837 has its first full moon on January 4th, its first full moon of Spring (which began March 17th, due to the Julian calendar's drift) is April 3rd. The first Sunday after January 3rd is Easter Sunday.

FINDING THE DAY OF THE WEEK

To find out what day of the week January 1st fell on, use the following chart. Note that every year divisible by four (including century years) was a leap year.

The year 837 started on a Monday, so April 1st was a Sunday. The first Sunday after the full moon of April 3rd is April 10th, which is Easter Sunday. On the other hand, the year 1005 began on a Sunday, so July 1st was a Saturday, and July 29th (St. Olaf's Day) was also a Saturday. Another example: 977 began on a Friday, so December began on a Wednesday, and December 25th was a Saturday.



12.3 GOOD YEARS AND BAD

THE ECONOMY

The GM may want to roll each Yule for the upcoming year to see how the Viking economy will fare: Crops, Herds, Fishing, Fur Hunting, Trading and Raiding. The results may merely affect prices of trade goods or perhaps set up a major plotline. A Viking king who was attempting to Christianize his people would find the farmers reasonably tolerant if times were good, but liable to rebel if crops failed repeatedly.

Roll (3D6)	Economic Indication
3	Dismal Failure: 50% less than usual
4-5	Hard Times: 25% less than usual
6-8	Worse Than Average: 10% less than usual
9-12	Average
13-14	Better Than Average: 20% more than usual
15-17	Good Times: 50% more than usual
18	Unbelievable Success: 100% more than usual

MINOR TROUBLES ON THE FARMSTEAD

None of these minor troubles will necessarily result in major troubles like a blood feud, unless that's how the players involved react. Such problems will pep up a campaign in which things are going along too smoothly. As GM, pick whatever suits you or roll D20.

1. A fight breaks out between thralls or hirelings (same farm or neighboring farms) while felling trees, making charcoal, herding animals;
2. A fight occurs between hirelings or relatives while cutting up a stranded whale;
3. A fight breaks out over just where boundary lies between neighbors in regard to herding cattle, a freed thrall, etc.;
4. A fistfight breaks out over sports (ball game, horse fight, etc.);
5. A berserk duelist challenges someone;
6. An afterganger is rumored to be prowling the area;
7. A theft of jewelry, food, cattle, etc. alarms the region;
8. A lawsuit is unjustly filed against someone in your family;
9. A woodland fire breaks out nearby your land;
10. A volcano, earthquake, tidal wave, avalanche, or unseasonal storm wreaks havoc in the area;
11. Someone seduces an unmarried women on the farmstead;
12. An insulting poem or gossip about someone on the farmstead enrages your family;
13. A hibernating bear wakes in winter or polar bear drifts ashore on ice-floe;
14. An outlawed relative or inlaw comes by for a visit;
15. You have a nightmare about people dying, a bad marriage, etc.;
16. A local shaman prophesies unlucky future for someone in your family;
17. There is a shipwreck nearby;
18. A gang of outlaws or Viking ship raids the neighborhood;
19. A loan is not returned (money, hay, furniture, weapon, jewelry, ship, etc.) to your family;
20. You are stuck with counterfeit silver. Revenge?

SHAMAN PROPHECIES

It was customary for a shaman to go from farmstead to farmstead at Winter's Eve and Yule and prophesy the future (see Section 6.6). As GM, you may want to use the shaman's travels to warn characters of future economic or personal problems or to forecast upcoming plotlines. (See Section 1.0 for a discussion on handling Second Sight.) First, the shaman should predict the weather and the health of herds and people. Then, she ought to turn her gift to the people: who will receive what gifts, warnings, injuries, etc.? If you use Luck, see Section 5.1.

Here are some sample prophecies from the sagas.

- You will make a most distinguished marriage.
- You will live in honor and respect till your old age.
- Your reputation will spread throughout the world.
- You won't have to wrestle with old age, but people will say you are as brave as a bear.
- No matter how far you go, you'll die at home, killed by your horse.
- You will always be regarded as a good farmer.
- By next year, you will have a new set of friends.
- You shall be avenged by someone you think is a weakling.
- You will never lack for gold.
- You will receive three great wounds, but no weapon will kill you.

12.4 RANDOM ENCOUNTERS

Sometimes player characters have nothing planned, just a dull day of traveling or doing farmwork. You may want to spice it up with random encounters. Many possible encounters do not appear below because they should not be random, including: an afterganger, ambush, corpsefire, dragon, draug, dwarves, elves, fylgja, giants, maelstrom, merpeople, nicor, nis, Odin, royal visit, sea serpent, stromkarl, trolls, valkyries, and Wild Hunt.

RANDOM ENCOUNTER TABLE (Roll Encounter; check twice a day on the road, once a day on the farm)

Roll	Encounter
01-15	visiting relatives
16-35	visiting neighbors
36-40	visiting friends
41	meet skald (or rune mage)
42	meet leech (or wizard)
43-50	meet hunter(s)
51-53	come upon a man making charcoal
54-55	meet a trader from abroad
56	blood feuder(s)
57	meet a shaman (or Second Sighted)
58	meet a Christian priest
59-60	meet berserk or trollblood
61-65	meet a peddler
66-75	meet child(ren) or thrall(s) with herd animals
76-85	come upon people doing farmwork
86-90	meet a beggar or beggarwomen
91	come upon outlaw(s)
92	come upon a cattle raiding party
93-97	find a stray horse
98-99	attack by a pack of wolves
00	attack by a bear (or polar bear or shapechanger)

RANDOM ENCOUNTER TABLE	
On the High Seas (check once per voyage)	
Roll	Encounter
01-30	merchant ship(s)
31-50	raiding ship(s)
51-85	pirate ship(s)
86	ship sailing without or against the wind (wizard aboard)
87-90	flotsam of wrecked ship
91-00	whale or sharks
IN THE MOUNTAINS (check once a day)	
Roll	Encounter
01-25	outlaw(s)
26-30	blood feuder(s) looking for specific outlaw
31-40	hunter(s)
41	wizard
42-45	leech
46-50	corpse (D10 days old)
51-55	stray goat(s)
56-70	wolves
71-73	bear (or shapechanger)
74-80	elk, deer or aurochs
81-00	nothing unusual

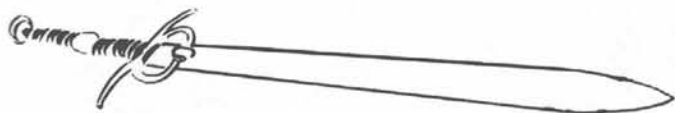
12.5 READING AND WRITING

Most Vikings were illiterate. Chieftains were taught to read and write the 16 modern runes. Vikings traded with people who used not only many different languages (see Section 8.1), but also many different alphabets as well. For example:

Europeans used the Latin alphabet, which during this period had only 24 letters: "I" was used as both a vowel and a consonant (instead of "J"); "U" was used as both a vowel and a consonant (instead of "V"). Greeks and Byzantines used the Greek alphabet. Arab traders used the Arab alphabet. Jewish traders from the Caliphate and Emirate used the Hebrew alphabet.

Viking Skalds and Rune Carvers knew the 24 ancient runes, which had been given to men by Odin and which could work magic (see Section 6.5). One Norse poem tells how Sigurd Dragonslayer learned from Brynhild how to write runes on his sword-hilt for victory, on his drinking horn for luck, on his palms to attend a woman in childbirth, on his ship's prow and oars for safety at sea, and on the bark of a tree to take away the sickness of a wounded man.

GM Note: *Rolemaster gamers will find the Runes noted in RMCI among the Qabbals in Section 10.3. (Actually, the Qaballah was an ancient Hebrew magic system based on the Hebrew alphabet.) The runes below are cross-referenced to RMCI, section 10.3.*



RUNE TABLE		
Sound	Rune (Qabbal #)	Word
f	#5	fe (property)
u,w	#23	urr (aurochs)
th	#31	thurs (giant)
ae,o	#4	as (god)
r	#24	reid (journey, raid)
k,g	#12	kaun (torch, boiling)
g	#3	gyfu (gift)
w	#1	wyn (joy)
h	#32	hagl (hail)
n,ng	#30	naud (need)
i,y	#29	iss (ice)
a	#6	aar (year, harvest)
y	#13	yr (bow, yew)
th	#26	theorth (unknown)
s	#2	sol (sun)
t,d	#25	tyr (god, star, honor)
b	#7	biarkan (birch)
eo	#10	eorl (horse)
m	#22	madr (human being)
l	#9	legr liquid
e	#14	elg (elk)
ng	#8	yng (Frey)
ae	#28	aethel (home)
d	#11	daeg (day)

12.6 TREASURE

As GM, you are responsible for how rich the player characters get. You must decide how much loot they bring back from their voyages, how well their home herds, crops, and fishing are doing. If they get too much money to be interested in farming or short voyages, you will have to come up with ever greater prospects to tempt them into action: perhaps raids on Byzantium or a Giant Land. If PCs get too little money to go on farming or to outfit a ship, they may become outlaws, wandering the wilderness, robbing travelers and farmers who are too weak to defend themselves. You have to strike a balance.

If the characters seem to be getting too rich, they may soon be asked to host the neighborhood holiday feast. It's also likely that they will come to the king's attention; the regent may pay them a visit — with all his court! Neighbors and relatives will turn to wealthy PCs for loans of money and food. If word gets out that a wealthy PC is away from home, his farmstead may well be the target of a nearby robber gang.

If PCs are relatively poor but lucky, a distant relative might ask them to crew a ship. They might find buried treasure — or a long-lost grave mound. Perhaps a trader whose ship stranded nearby might cut them in for a share of his profits in return for their Viking hospitality.

When you hand out treasure, describe it so it sounds interesting; don't just say how many ounces of silver it is. Some treasure may be coins, some jewelry, and some hacksilver (cut-up coins or jewelry). Cows and sheep, silk and brocade, dyed clothing or cloth (linen or fine wool or homespun), sea ivory or furs, weapons or armor (see Section 1.6 for ideas) were all valuables in the Viking Era. Some of the loot may be magic (see Section 6.1). Remember that the amount and kind of treasure should depend on where and who the characters are (see Section 8.14).

ADVENTURE SCENARIOS

If you want to send your characters off on a quest to far-off lands, you have a lot of places to pick from (see Section 8). They could sail with Leif Eiriksson to Vinland, or go with Yngvar the Far-Traveller to raid the Baghdad Caliphate. They might journey to Byzantium and join the Varangian Guard. Christians could make a pilgrimage to Rome to ask to be forgiven of their sins. If they dare, PCs could raid Giantland.

But probably you will want to start them closer to home. In this section, you'll find three detailed adventure scenarios. You can use any or all of them to start your Viking campaign, whether the player characters are Vikings or foreigners, or you can insert one of them into your current campaign to give it a new plotline. The scenarios are designed such that a group of strangers is faced with a common problem, giving you the chance to introduce the player characters to one another and to become friends.

13.1 SCENARIO 1: YULE AT ORMHALL

This adventure is set at a pagan feast, with lots of opportunity for colorful descriptions of the culture. It's also a murder mystery, with several suspects, and a horror story with an afterganger who kills guests. If the player characters aren't up to handling the afterganger by themselves, NPCs will help them, but the PCs must do the brainwork.

Remember that when you're running this adventure, the sun will rise about 9AM and set about 3PM. There will be about an hour of twilight before sunrise and after sunset, but after that it will be pitch dark. (If you feel generous, you can say there's a full moon. You can also mention the aurora borealis flickering in the skies, to make the outside scenes eerier.) You may choose to have clear weather or fog or rain or snow, or roll using Section 12.2. If there's a storm, some of the characters may think that the Wild Hunt is riding by.

ORMHALL AND ORM VIPER-TONGUED

Ormhall is the home of Thormod the Strong, his wife Gerd, and his 15-year-old son Gizur. His feasting hall can hold fifty people and was built by Thormod's father, Orm Viper-tongued, who is alive but retired. Many guests are present, including members of Thormod's family, Thormod's neighbor Eyjolf the Lawyer, Gerd's family and the player characters.

Gerd welcomes each of the guests to the farmstead. She's in her late thirties and beautiful, with long golden hair. She's also very richly dressed, with a silk gown, gold brooches, and a string of glass and silver beads. Her sleeves and headdress are patterned with amber and gold beads.

Old Orm Viper-Tongued insults each person there. He tells Thormod that he's a coward, Gerd that she's promiscuous, young Gizur that he's a charcoal chewing lazybones, Ulf the Berserk (Gerd's brother) that he's stupid, and neighbor Eyjolf the Lawyer that he's so greedy that he uses false weights.



Everybody agrees that Orm's too old and feeble to kill, and his son is too rich and strong to offend. Besides, Thormod always gives a lavish feast, and he had a good year raiding, so he's apt to distribute generous presents as well.

Base Orm's insults to each character on what you know about that character or use the following table. Don't worry if Orm uses the same insult on several guests; it'll give them something in common to complain about.

INSULTS (ROLL 1-10)

1. You're so greedy, you give your guests water, not ale.
2. You haven't yet taken revenge for your father's death, you coward!
3. You look like a troll, only uglier!
4. You kiss your horse when nobody's looking. I have seen you with my own eyes!
5. You hid from your enemies by hiding in a thrall's hut.
6. Your sister is living with a berserk — and enjoying it!
7. You threatened to kill your own father.
8. You're still covered with dung from your farmwork.
9. When arrows are flying, you cower behind your shield.
10. You're having an affair with your (relative's) (wife/husband).

THE SHAMAN PROPHECIES

At dinnertime, one of Thormod's smallholders arrives with a shaman, Sif. She's an old lady, who leans on her staff, which has a brass knob. The shaman wears a blue cloak with a hood lined with white cat's fur. Under it, she has a black dress and a necklace of glass beads. Sif also has catskin gloves with the white fur inside. Her granddaughter, Little Sif, is a teenager who's dressed the same.

Thormod ushers Sif to the high seat on the bench opposite his; her granddaughter sits at her right. He asks her to cast her eyes over his home and household and herds. She tells him that she'll climb the platform after dinner.

Gerd and her maidservants offer everyone water and white napkins to wash their hands. Afterwards, dinner is served. There's boiled pork, roast beef and lamb, and all sorts of other good things (see Section 2.3). Sif eats a special meal: gruel made from goat's milk and a platter of hearts. She uses a brass spoon and an ivory-handled eating knife.

Once dinner is over, the table is cleared. Sif climbs up onto a platform at the far end of the hall and sits crosslegged. Her granddaughter sits underneath and sings. Her voice is beautiful, but no one understands the words.

After awhile, Sif says that she can see many spirits, and they can tell her many things. She foresees good weather for the next year, with few shipwrecks and large harvests. She tells Thormod that he will bring home much silver and gold but find fewer people to welcome him. She turns to Orm and tells him that he will have even fewer friends tomorrow than today. She stuns Eyjolf by saying that a shadow lies across his future. Sif goes on to make other prophecies for other guests, including the player characters (see Section 12.3). Several NPCs are told that they will have warm beds tonight but cold beds tomorrow. She does not respond to questions. Eventually, the shaman yawns and suddenly comes back to her senses.

A short while later, the women withdraw, first to the weaving room at the end of the hall, then to their beds. (Later, it turns out that Sif and her granddaughter left Ormhall at midnight, but didn't say where they were going; the pair is impossible to locate for the rest of the scenario.)

THE DRINKING CONTEST

Now the somewhat worried men turn to serious drinking. Gizur soon gets drunk and boasts that last week, he fought off a wolf while alone in the woods. Orm tells him not to boast of being too weak to kill the beast. Eyjolf brags that he's paying 1 ounce of silver for a lynx fur, but only 5 pennyweights for a wolf fur. Ulf says he'll bring him some lynx furs next spring; then he mentions how five years ago he killed a troll with just his eating knife. Most of the people there have already heard the story a few times.

The player characters should be encouraged to boast of their own past deeds, real or fictitious, thus giving them a chance to get to know one another better, and to develop characterization.

The drinking goes on awhile, but eventually all the men go to sleep.

ORM'S FUNERAL FEAST

The next morning, old Orm is found dead in his bed closet, with Ulf the Berserk's knife stuck in his ribs. Ulf solemnly swears that he did not kill Orm and offers to hold a red-hot iron to prove his vow, but Thormod says a berserk could probably do that anyway. Thormod challenges Ulf to a duel then and there, and kills him, using a wooden club. Then he announces the feast will go on, as a funeral feast for his father. He orders his thralls to bury Orm in a grave mound, along with his sword. For safety's sake, Ulf is to be buried on an offshore island. A few hours later the thralls return and announce that his orders have been carried out.

Thormod now gives presents to his guests: one ertog (equivalent to 10 pennyweights) of hacksilver to each person present. Some people get 15 English pennies, others small brooches or half-brooches.

At this point, a few (unlucky) guests make polite excuses and leave for home. There are screams from outside. Gizur opens the door and announces, "They're dead! And grandfather's back!" Orm's afterganger is stalking the house, holding the sword he was buried with. He climbs onto the house roof and starts pounding on it. Eyjolf claims this is all strictly illegal, and demands that Thormod escort him home. Gerd begs him to stay and not endanger himself.

MAJOR CHARACTERS

ORM VIPER-TONGUED

As an afterganger, the shrewd and wicked warrior appears old but is much stronger.

AFTERGANGER

RM Skills: Climb67; Swim75; Ride54; Stalk&Hide52; Perception 61; Navigation85; Rope Mast68; Sail88; First Aid60.

FH Skills: Climbing (13-), Swimming (5"), Fam w/Riding (8-), Navigation (14-), Vehicle fam w Viking Long Ships, K/S: Weather 11-, +2 with sword, +2 with spear, Fam w/sword & spear.

OCV: 9 **DCV:** 7 **Damage:** 2D6+1K

THORMOD THE STRONG

Thormod loves his wife, father, and son despite their obvious defects and assumes that all his guests are his friends. He becomes furious when he discovers that his brother-in-law Ulf the Berserk has betrayed his hospitality and killed his father. Easily strong enough to overcome the afterganger, he will not do so unless taunted into action by his wife or guests.

Age: 23. **Eyes:** Blue. **Hair:** Red. **Build:** Muscular. **Height:** 5'11".
Race/Sex: Human/Male. **Demeanor:** Rough, tough. **True Attitude:** Hotheaded when angry.

Hits: 73. **Melee:** 115 Longsword. **Missile:** 80sp

AT(DB): 6(35) **Sh:** Y20 **Gr:** N. **MovM:** +10

Lvl: 8. **Profession:** Warrior. **Stats:** St101; Qu90; Pr78; In51; Em63; Co88; Ag80; Me73; Re68; SD63; AP61.

Skills: Climb43; Swim53; Ride65; Stalk & Hide 76; Perception56; Brawl87; First Aid48; Navigate79; Rope Mastery76; Sail90; Trade65.

+10 Longsword and +10 spear.

STR: 23 DEX: 15 CON: 16 BODY: 13 INT: 12

EGO: 11 PRE: 12 COM: 12 PD: 7 ED: 3

SPD: 4 REC: 8 END: 32 STUN: 40

OCV: 11 DCV: 7 Phases: 3,6,9,12

Damage: 2D6K Move: 7"

Skills: Climbing (12-), Swimming (4"), Fam w/riding (8-), Stealth (12-), Concealment (11-), Navigation (13-), Vehicle fam (Viking Long Ships), Fam w/Trading (8-), K/S: Weather (11-), Fam w/Common Melee & Thrown Spear, +4 with sword, +3 with spear.

Shield (+2 DCV), Fine sword (+2 OCV) and spear (+2 OCV); 3rPD/1rED Armor.

Disadvantages: Protective of/loyal to Family; Reputation: Tough.

GIZUR

Brave enough to go fight the afterganger but probably too young to win, he usually stands by the hearthfire doing nothing — not because he's a coward but because he sees nothing challenging enough to attempt.

Age: 16. **Eyes:** Blue. **Hair:** Red. **Build:** Average. **Height:** 5'9".
Race/Sex: Human/Male. **Demeanor:** Quiet, lazy. **True Attitude:** Overconfident, brave.

Hits: 41. **Melee:** 61 Longsword. **Missile:** 36Spear

AT(DB): 6(20) **Sh:** Y20 **Gr:** N. **MovM:** +5

Lvl: 3. **Profession:** Warrior. **Stats:** St78; Qu75; Pr43; In42; Em53; Co69; Ag89; Me51; Re62; SD41; AP71.

Skills: Climb56; Swim64; Ride48; Stalk & Hide59; Perception47; Brawl55; First Aid42; Navigate64; Rope Mastery54; Sail76; Trade59.

+5 Longsword.

STR: 13 DEX: 17 CON: 13 BODY: 11 INT: 10

EGO: 10 PRE: 9 COM: 13 PD: 4 ED: 3

SPD: 3 REC: 6 END: 26 STUN: 28

OCV: 8 DCV: 7 Phases: 4,8,12

Damage: 1D6+1K Move: 6"

Skills: Climbing (12-), Swimming (3"), Fam w/riding (8-), Fam w/Concealment (8-), Navigation (13-), Vehicle fam (Viking Long Ships), Fam w/Trading (8-), K/S: Weather (11-), Fam w/Common Melee & Thrown Spear, +2 with sword.

Shield (+1 DCV), Fine sword (+1 OCV); 3rPD/1rED Armor.

Disadvantages: Protective of/loyal to Family; Egotistical, Reputation: Upcoming Warrior.

EYJOLF THE LAWYER

Crafty, greedy, and normal strength, Enjolf is desperately afraid of Orm but trying to hide his fear.

Age: 22. **Eyes:** Blue. **Hair:** Blond. **Build:** Lean. **Height:** 5'7".
Race/Sex: Human/Male. **Demeanor:** Dignified, calm. **True Attitude:** Ruthless, wily.

Hits: 21. **Melee:** 32 Knife. **Missile:** -25.

AT(DB): 1(15) **Sh:** N **Gr:** N. **MovM:** +5

Lvl: 5. **Profession:** Trader/Lawyer. **Stats:** St49; Qu80; Pr83; In70; Em51; Co56; Ag77; Me76; Re78; SD43; AP79.

Skills: Swim61; Ride52; Stalk & Hide72; Perception74; Public Speak82; Seduction47; Trade77.

STR: 9 DEX: 12 CON: 11 BODY: 10 INT: 13

EGO: 9 PRE: 15 COM: 15 PD: 2 ED: 2

SPD: 2 REC: 4 END: 22 STUN: 21

OCV: 4 DCV: 4 Phases: 6,12

Damage: 1D6-1K Move: 6"

Skills: Swimming (3"), Riding (11-), Concealment (13-), Trading (14-), K/S: Viking Law (14-), Stealth (13-), Acting (12-), Forgery (11-), Fam w/Advanced Math (8-), Seduction (12-), Fam w/knife.

Disadvantages: Ruthless and manipulative, cowardly.

GERD

Beautiful, hospitable, well-spoken, she has been having an affair with Eyjolf, who has given her valuable jewelry.

RM Skills: Climb48; Swim56; Perception45; Cook87; First Aid55.

FH Skills: Swimming (3"), P/S: Cooking (12-).

OCV: 4 DCV: 4 Damage: 2D6-1N

ULF

Strong but stupid, he stammeringly defends himself when accused by Thormod.

RM Skills: Climb59; Swim62; Perception57; Brawl54; Animal Heal67; Cook50; First Aid48; Forage72; Frenzy95; Navigate65; Row67; Sail68.

FH Skills: Climbing (12-), Swimming (3"), Animal Handling (11-), Fam w/Cooking (8-), Survival (11-), Berserk Package Deal, Navigation (11-), Fam w/Viking Long Ships; +3 w/Axe.

OCV: 8 DCV: 5 Damage: 2 1/2D6K

POSSIBLE SCENARIO RESOLUTIONS

1. Someone asserts that Eyjolf killed Orm, because he really has been using false weights and doesn't want knowledge of his chicanery to get around the village. If Eyjolf is killed, Orm's afterganger will go back to its grave mound.
2. People dig up Orm's body, burn it and throw the ashes out to sea. His murder is unavenged, but at least he won't bother people any more.
3. The afterganger destroys the house while Thormod, his family, and his guests escape (except for the unlucky ones).
4. The Wild Hunt rides through the sky with Ulf the Berserk in it. After the Ride, see #3.

13.2 SCENARIO 2: THE VULTURE SETS SAIL

This Viking voyage offers opportunities to fight pirates and Saxons and to bargain at a trade mart. It's also a hide and go seek game, trying to outwit the jarl of York. It can be run as a sequel to the first scenario or independently, either later on in the campaign or to begin one.

Remember that in May in Iceland and Scotland, the sun will rise at 3AM and set about 8:45PM, with about an hour of twilight before sunrise and after sunset. In Wessex, the sun will rise at 4AM and set about 7:45PM. You may choose clear weather or fog or rain for most of the trip or roll, using Section 12.2.

THE TALE

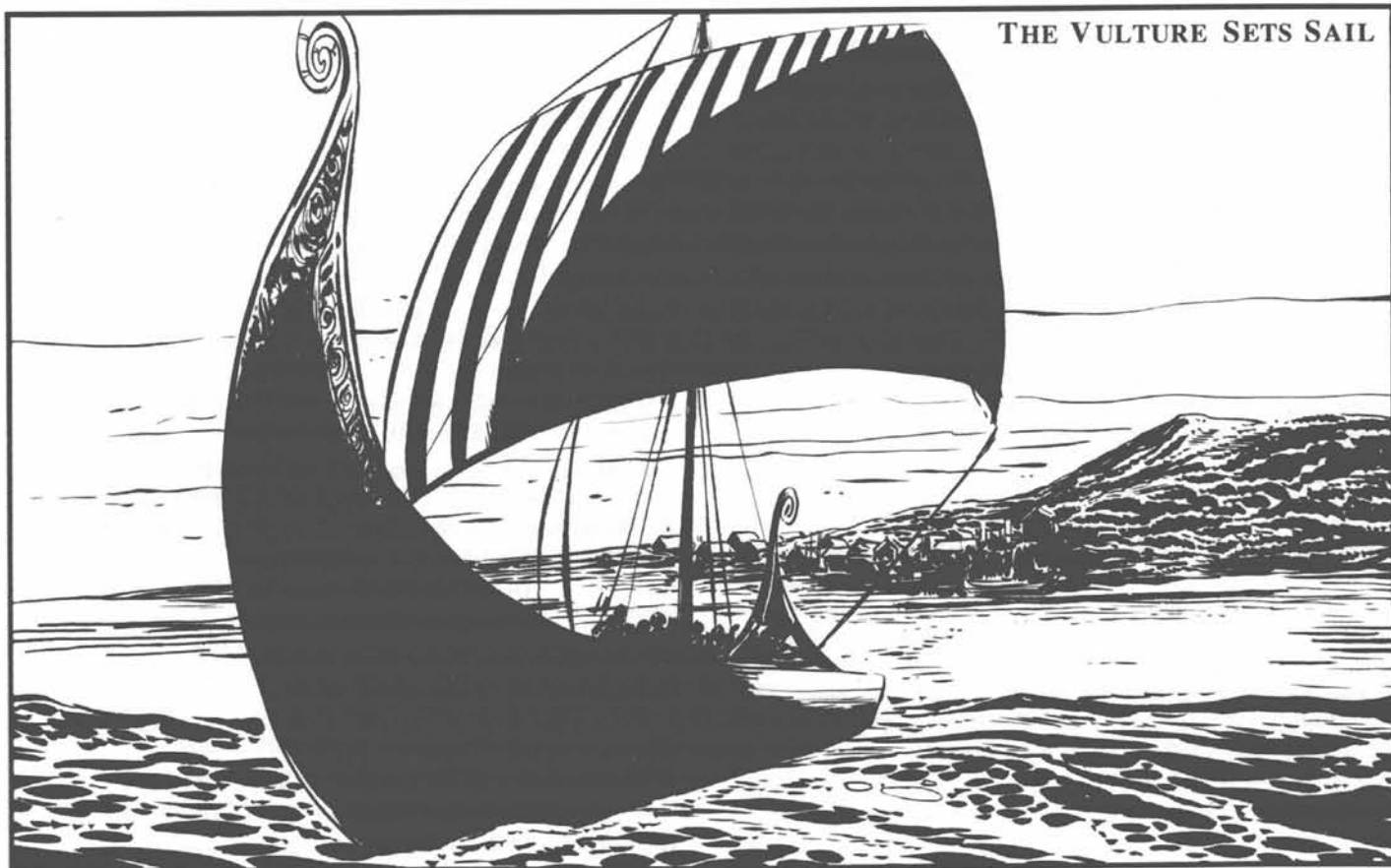
In Egg Time month, at the regional Thing, Thormod the Strong was outlawed for three years for killing his brother-in-law Ulf the Berserk. Thormod explained that it was a mistake, due to the confusion of his father's murder, and immediately paid the Ulfssons the 200 aur of silver the judges had demanded. (Depending on how the last scenario was resolved, Thormod might also offer some land from the estate of Eyjolf the Lawyer.)

Thormod has decided to go abroad for the next three years. He invites all the guests at his Yule party to go with him. He plans to return to southern England, where he was so lucky in his raiding last summer. The player characters are among the thirty Vikings aboard his ship, the Vulture.

Thormod sacrifices a goat to Thor for good luck at sea. The crew feasts on what may be their last hot food for some days, washed down with generous portions of ale. Then they stagger aboard ship.

The next morning, the Vulture rows out of the harbor at dawn and sets sail southward. As the ship picks up speed, a few of crew members are seasick. Their discomfort gets worse as the wind begins to blow harder. "A good fresh breeze," says Thormod and refuses to lower sail, even though it's too foggy to see the sun at noon and to estimate their position.

The ship sails swiftly, day and night, under an overcast sky for the next few days. Then finally, there's a dawn with blue sky, and you see land a few miles to the east. Thormod isn't sure where you are but orders the steersman to head landward.



PIRATES!

As you head shoreward, a longship rows out from behind a forested headland; the ship has a fierce dragonhead at the prow. (Your own has a winged vulture at the prow.) A man dressed in bright red and carrying a large axe bids you welcome in good Norse, and tells you that he'll land you safe and sound ashore; all you have to do is give him your ship.

"Never!" cries Thormod.

"Think again. I'm Odd Grimsson, and this is the Black Dragon!"

"I don't care who you are," cries Thormod; "I'll never surrender."

The GM should plot the resulting fight in as much detail as seems interesting. There are forty pirates in the longboat, but their morale sinks quickly if their captain is killed. Their only notable fighters are their captain, Odd Grimsson, and his only friend, Killer Kol.

If the Vulture seems to be losing the battle, Thormod's crew can try to escape by jumping overboard and swimming a mile to the shore or by rowing the ship's boat ashore. Or they can surrender and ask to join the Black Dragon as pirates. If they've fought well enough and look lucky, they will be accepted. If the Vulture wins, some of the pirates will surrender; others will try to escape.

Whoever wins now has two ships: the Vulture and the Black Dragon, which holds loot from recent raids on Ireland: silver, wool, a jeweled book written in a foreign language (a bible in Latin), wine, etc. You as GM can decide the value of the loot.

THE TRADE MART

The two ships head south along the coast. If the Black Dragon won, the pirates will stop at Scarborough, a coastal trade mart. If the Vulture won the battle, Thormod must decide (with advice from bold player characters) whether to raid Scarborough, stop to trade the pirate's loot there, or to bypass it for something bigger. If he continues down the coast, he can sail up the Humber estuary and then up the Ouse river to York, capital of Northumbria and a major trade mart.

Most Northumbrians are Christians, even the people of Viking ancestry. Scarborough has a church, and York is home to a towering cathedral with stained glass windows. How much money the pirates' loot brings depends on the bargaining skills of whoever is handling the trading. A good bargainer might get 500 marks at Scarborough, 750 marks at York (and find a wider range of goods to buy there too). The bejewelled bible is worth 50 marks at Scarborough, 75 at York — but might be worth keeping as a present for some king.

RUNAWAYS

That afternoon back at the ship, a black-bearded man carrying a large sack comes to the gangplank of the Vulture and says he wants to buy passage to wherever you're going. He offers to pay ten marks of silver and explains that he is in a hurry; he's got something in the sack that used to belong to Jarl Soti. He walks onto the deck of the ship and opens the sack. Inside is a smiling young woman with long red hair, the jarl's (pregnant) daughter. The man's name is Hauk Hrapsson; she is Sigrid Sotis-daughter. (Hauk will offer up to 25 marks of silver for passage for both of them to Norway, 20 marks to anywhere else a day's sail from Northumbria.)

If Odd Grimsson is in charge, he will take the money and offer to fight Hauk for the woman. If Thormod the Strong is in charge, he will refuse (at first) to take the pair, reminding Sigrid that a first marriage without the consent of her kinsmen will mean that her children will be illegitimate. Hauk will threaten to stand there and be slaughtered on the gangplank of the ship, disgracing Thormod's honor. Finally, Thormod will consent to take the standard passage money of 1 mark for each of them but be unable to figure out where to hide them.

Three of Jarl Soti's housecarls will arrive at the ship a few minutes later, after tracking Hauk's course. Their leader is a Skallagrim, a greyhaired, ugly man in his mid-thirties. All the men in the mart will support the jarl, so fighting would be useless. Still, none of the traders there seems able to remember what ship Hauk boarded; Skallagrim wants to search the ship where Hauk and Sigrid are hidden.

MAJOR CHARACTERS

ODD GRIMSSON

A greedy bully who's kept most of his ship's loot for himself, he is disliked by his crew.

RM Skills: Climb75; Swim73; Stalk&Hide79; Perception71; Gambling68; Row64; Sail85.

FH Skills: Climbing (12-), Swimming (4"), Stealth (12-), Concealment (12-), +1 Perception, Gambling (11-), Fam w/Viking Long Ships, Fam w/Axe, +4 with axe.

OCV: 9 **DCV:** 7 **Damage:** 1 1/2D6K

KILLER KOL

Ugly but a skilled fighter, he has a bad temper.

RM Skills: Swim74; Perception58; Gambling68; Row79; Sail84; Frenzy68.

FH Skills: Swimming (5"), Gambling (11-), Fam w/Viking Long Ships, Fam w/Melee Weapons, +4 w/spear.

OCV: 10 **DCV:** 7 **Damage:** 1 1/2D6K

HAUK HRAPSSON

A handsome, well-spoken man, Hauk is said to be good with a sword.

RM Skills: Swim72; Ride64; Perception80; Math61; Dupe79; Sail76; Seduce68; Signal60; Trade84.

FH Skills: Swimming (4"), Riding (12-), +2 Perception, Persuasion (13-), Conversation (13-), Fam w/Advanced Math(8-), Fam w/Viking Long Ships, Seduction (13-), P/S Signaling (11-), Fam w/Common Melee, +2 w/Sword.

OCV: 7 **DCV:** 7 **Damage:** 1 1/2D6K

SIGRID SOTIS-DAUGHTER

A beautiful, headstrong girl, she knows lots of legends and is good at riddles.

RM Skills: Animal Heal58; Cook74; First Aid69.

FH Skills: Animal Healing (11-), P/S Cooking (11-), First Aid (11-), K/S: Riddles 13-, K/S: Legends 13-, Familiarity w/Knife.

OCV: 4 **DCV:** 4 **Damage:** 1D6-1K

SKALLAGRIM

A fierce fighter, this large man is a fearsome foe on the battlefield.

Age: 46. **Eyes:** Blue. **Hair:** Black. **Build:** Stocky. **Height:** 6'3". **Race/Sex:** Trollblood/Male. **Demeanor:** Silent, stupid. **True Attitude:** Bitter, wily.

Hits: 40. **Melee:** 55 Club. **Missile:** 0.

AT(DB): 3(35) **Sh:** N **Gr:** N. **MovM:** +5.

Lvl: 4. **Profession:** Norse Wizard. **Stats:** St75 (101 at night); Qu75; Pr69; In55; Em60; Co62; Ag61; Me80; Re79; SD70; AP31.

Skills: Climb74; Swim65; Trick68; First Aid57; Forge78; Track81; Rope Mast89.

Spells: Enchant Rope, Enchant herbs, Breeze Call, Fog Call, Precipitation Call, Wind Mastery, Clear Skies, Storm Call, Calm Water, Cloud Scrying, No Pain, No Fatigue, No Hunger, Heat and Cold Resistance, Change to Kind, Change, Changing.

STR:15/25 **DEX:**11 **CON:**13 **BODY:**11 **INT:**13
EGO:11 **PRE:**13 **COM:**4 **PD:**5/7 **ED:**3
SPD:2 **REC:**6/8 **END:**26 **STUN:**26 **Cost:** 22
OCV:4 **DCV:**4 **Damage:** 4D6N **Move:** 6"

Skills/Spells: Trollblooded Package, AK:Troll Mounds 11-, Concealment 12-, Cultural Know: Trolls 12-, Paramedic 12-, Sleight of Hand 11-, Survival 12-, Tracking 12-, Fam w/ Clubs, K/S:Knots 11-, P/S: Weather Watching 11-, Wizard Magic. **Total Points:** 78.

Disadvantages: Loyalty to/Protective of Family (Co, St), Limited Efficiency in Sunlight, Distinctive Features: Tall, Grey Hair, Ugly (Causes Fear), Reputation: Stupid and Trollblooded (11-).

THORMOD THE STRONG: SEE SECTION 13.1.

GIZUR THORMODSSON: SEE SECTION 13.1.

POSSIBLE SCENARIO RESOLUTIONS

1. The Vikings can voluntarily return Hauk and Sigrid to Jarl Soti. They'll be made welcome at York for the rest of their stay in Northumbria.
2. The Vikings can hide Hauk and Sigrid.
 - A. If Skallagrim finds the pair, he will cut off Hauk's head and demand the fifty marks of silver Hauk stole from the jarl's treasury. (Actually, Hauk only stole thirty.) Then he will take Sigrid back home to be his bride.
 - B. If Skallagrim cannot find the fugitives, he will glare menacingly at the captain and warn him to watch his step. It might be a good time to leave Northumbria and raid Wessex.
3. Someone can challenge Skallagrim to a duel for Sigrid's hand, either keeping her for himself or giving her to Hauk.

FURTHER RAIDING (OPTIONAL)

No matter what happens to Hauk and Sigrid, the ships can now sail south to Wessex and pass the summer raiding. The GM may plot this out in as much detail as seems interesting. The Vikings might capture and loot a Benedictine monastery or a small trade mart, defeat the local Saxons, and then sail down the coast before the royal army could be summoned.

If the PCs seem to take winning for granted, the royal army might arrive on the scene unexpectedly and pen them inside a church or monastery, so that they have to fight their way free to their ships, leaving all their loot behind. Perhaps Jarl Soti's fleet could arrive and demand a share of their treasure (and maybe look for Hauk and Sigrid, if they remain on board).

Eventually, around mid-August, the English will offer the raiders danegeld of 5 marks for a crewman, 15 marks for the captain. If the Vikings refuse, there's a good chance the royal army will attack. One ship will likely be captured; the other might escape with a few Vikings (including those of the player characters not killed in the combat, plus some of their loot).

The ships will now sail back north to Norway and into the third scenario.

13.3 SCENARIO 3: WINTER AT COURT

This Christian feast features lingering pagan overtones from the Winter's Eve festival. It's also a mystery, with a character searching for a belt he needs to win the woman he wants to marry. It can be run as a sequel to the first and/or the second scenario or independently, either later on in the campaign or to begin one.

The sun will rise about 7:15AM and set about 4PM, with an hour of twilight before sunrise and after sunset.

The weather is cold and snowy. Farmers are upset because the weather has been bitter since late summer. Their crops failed, and they had very little hay to put aside for their cattle. There's barely enough food at the royal court to feed the household.

The Vulture and the Black Dragon arrive at Konungahela in early October with a cargo of English wheat and pickled pork, wine and mead, wool cloth and silver coins. The food and drink sell at twice the usual price — to the royal household. Some of the men go home to their families. The captain escorts those remaining crew members to the royal court and asks to be received among the king's housecarls. He boasts of their fighting skills. If he hasn't sold the jeweled bible, he presents it to the king, who is a Christian.

THE ROYAL COURT OF NORWAY

The king's hall is like Ornhall but built on a far larger scale. King Harald Graycloak is in his early twenties and wears a cloak of lynx fur. He is unmarried. Queen Mother Gunnhild is in her late forties but dresses like a young beauty in a bright red silk gown, jeweled with gold and amber beads on the sleeves, and a white cloak embroidered with gold thread.

The king has eighty housecarls, headed by Asolf Skull-Splitter, who sits on the lower bench's high seat. The king's standard-bearer is the shield maiden Ingunn, who sits at his left hand. Here's the seating arrangement:

high bench: - Priest - Queen - King - Ingunn - Court Poet
low bench: - housecarl - housecarl - Asolf - Housecarl - Housecarl

On the high bench, to the right of Father William the priest and to the left of Ragnar the Court Poet, are seated Queen Mother Gunnhild's handmaidens and King Harald's housecarls, in pairs. On the low bench are seated the rest of the housecarls with Asolf in their center. No one sits at the far left end of the benches, near the drafty doorway, except for Leif the Loon on the low bench. That's where the only vacant seats are, and that's where the newcomers will be told to sit, unless they want to challenge some of the housecarls for their seats.

When dinner is served, Leif gobbles his food down quickly, then puts his head on the table and puts the empty plate on top of it. A few moments later, someone slings a pig's knuckle at him; it bounces off the plate. Soon, all the housecarls are throwing the gristle and bones from their plates at Leif. There's a 5% chance that they'll miss him and hit someone near him instead. If a player character is hit, he will ask the careless thrower for an apology or challenge him to a fight.

Dinner conversation focuses on the king's plans for war next year against Jarl Hakon of Trondheim. If anyone mentions the weather, everyone hastily changes the subject. Most people are afraid that the bad weather is caused by the old gods, angered because the king has tried to stop their sacrifices.

Later that night, after the women have left, there's drinking till midnight. Some of the housecarls may brag about the great men or beasts they have slain, or of other great deeds they have done. Leif the Loon is silent in his corner, staring wide-eyed at whoever speaks. Finally he says that over the last four months he's collected five hundred pieces of bone, and not one has wounded him. Then he giggles, drains his drinking horn, and apparently passes out. (Encourage the player characters to mention their own great deeds.) Asolf Skull-Splitter and the shieldmaiden Ingunn continue the contest long after everyone else has dropped out.

THE ROBBERY

In the middle of the night, the player characters wake up to find Leif the Loon going through their chests. If asked, he'll say that he's looking for nine sisters riding a walrus that lives near a thief. The characters can kill him out of hand (and pay the king 50 aur of silver wergild) or ask him some more questions.

If the player characters seem sympathetic, they will discover that Leif is looking for a belt decorated with walrus horn carved with figures representing the nine daughters of Aegir and Ran. The belt was made by his fiancée Asta for her father Arn, who wore it to court last year but returned home without it. He now says that it was taken from him one night while he slept. Asta has sworn that she will marry the man who brings her the belt as a bride-gift. So Leif is at court, looking for the belt. The only chests he hasn't searched are those of King Harald, Gunnhild, Ingunn, and Asolf.

SEARCHING THE COURT

If PCs help to look for the belt, they will discover that the king's and queen mother's chests are kept in a well-guarded storeroom. If they can lure the guards away or get them drunk (or maybe get their help), they'll have over a hundred chests to look through, many of them locked strongboxes to which Gunnhild holds the keys. (None of the chests contains Arn's Belt.)

Ingunn's locked strongbox lies in her sleeping closet. It holds her best clothes, a string of amber and gold beads, and a large, partially completed piece of embroidery, very finely stitched, showing a flowering apple orchard. There is also a supply of fine thread and several steel embroidery needles.

Asolf Skull-Splitter's locked strongbox lies in his sleeping closet. It holds his best clothes, three gold armbands, an axe with gold-inlaid haft, and several fine belts, one of which matches Leif's description of Arn's Belt.

MAJOR CHARACTERS

LEIF THE LOON

Apparently a buffoon, he is fairly intelligent and brave, once he finds what he's looking for.

Age: 19. **Eyes:** Blue. **Hair:** Blond. **Build:** Average. **Height:** 6'0". **Race/Sex:** Human/Male. **Demeanor:** Stupid, clumsy. **True Attitude:** Brave, intelligent.

Hits: 42. **Melee:** 67 Longsword. **Missile:** 45 Spear.

AT(DB): 6(5). **Sh:** Y=20. **Gr:** N. **MovM:** +5.

Lvl: 4 **Profession:** Warrior. **Stats:** St76; Qu84; Pr69; In49; Em67; Co90; Ag48; Me81; Re96; SD62; AP64.

Skill Bonuses: Climb49; Swim52; Perception90; First Aid64; Public Speak57; Sail76; Act84; Trade90.

STR:15	DEX:9	CON:18	BODY:12	INT:18
EGO:10	PRE:12	COM:12	PD:5	ED:4
SPD:2	REC:7	END:36	STUN:30	
OCV:7	DCV:5		Phases: 6,12	
Damage: 1 1/2D6			Move: 6"	

Skills: Swimming (3"), +2 Perception, Paramedic (13-), Fam w/Oratory (8-), Fam w/Viking Long Ships, Acting (11-), Trading (13-), Fam w/Common Melee Weapons & Thrown Spear, +4 w/Swords & Spears. 3rPD/1rED Armor.

Disadvantages: Loyal to/Protective of Friends, Reputation: Clumsy Oaf.

BROTHER WILLIAM

A pious priest and a good storyteller, he has some knowledge of herbalism. He's tried to befriend and convert Leif but hasn't gotten anywhere.

Age: 31. **Eyes:** Brown. **Hair:** Grey. **Build:** Lean. **Height:** 5'8". **Race/Sex:** Human/Male. **Demeanor:** Pious, Cheerful. **True Attitude:** Pious, Friendly.

Hits: 23. **Melee:** 20 Staff. **Missile:** -25.

AT(DB): 1(0). **Sh:** N. **Gr:** N. **MovM:** 0.

Lvl: 3 **Profession:** Cleric/Leech. **Stats:** St53; Qu63; Pr79; In81; Em77; Co66; Ag51; Me67; Re86; SD97; AP51.

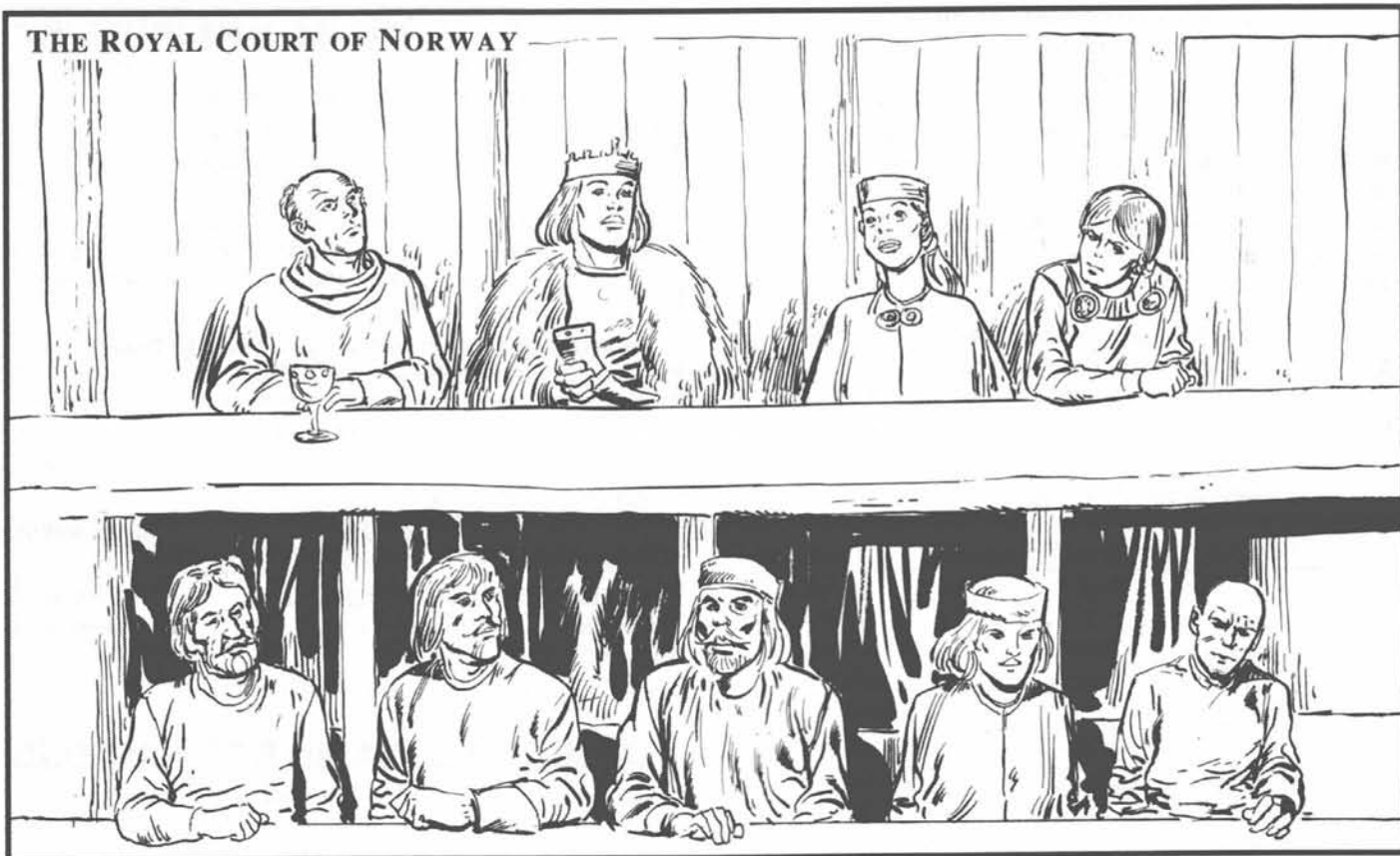
Skill Bonuses: Perception79; First Aid94; Public Speak88.

STR:10	DEX:10	CON:11	BODY:11	INT:16
EGO:18	PRE:16	COM:10	PD:4	ED:2
SPD:2	REC:4	END:22	STUN:22	
OCV: 4	DCV: 3		Phases: 6,12	
Damage: 4D6N			Move: 5"	

Skills: +2 Perception, Paramedic (13-), Oratory (12-), Riding (11-), K/S: Herbs (11-), P/S: Priest (11-), K/S: Stories&Myths (11-), Fam w/Staff, +1 w/Staff.

Disadvantages: Religious Beliefs & Doctrines (Avid Con- venger), Distinctive Features: Priest.

THE ROYAL COURT OF NORWAY



RAGNAR THE POET

A poet who knows the ancient legends and myths, Ragnar also knows a few Rune Carvings but won't use magic around Father William, the King, or any other Christian.

Age: 20. **Eyes:** Blue. **Hair:** Blond. **Build:** Average. **Height:** 5'11". **Race/Sex:** Human/Male **Demeanor:** Calm, happy. **True Attitude:** Considerate.

Hits: 25. **Melee:** 30 Longsword. **Missile:** 35 Dagger.

AT(DB): 1(5). **Sh:** N. **Gr:** N. **MovM:** +10.

Lvl: 3. **Profession:** Skald. **Stats:** St71; Qu90; Pr98; In62; Em78; Co69; Ag75; Me87; Re52; SD63; AP81.

Skill Bonuses: Swim68; Ride62; Perception78; Public Speak95; Trade81; Trick96; Seduce78; Woodcarve88.

STR: 14 DEX: 15 CON: 12 BODY: 11 INT: 13
 EGO: 12 PRE: 20 COM: 16 PD: 4 ED: 2
 SPD: 3 REC: 5 END: 24 STUN: 24
OCV: 7 **DCV:** 5 **Phases:** 4,8,12
Damage: 1D6+1K **Move:** 7"

Skills: Oratory (13-), Swimming (3"), Riding (11-), +1 Perception, Sleight of Hand (12-), Persuasion (13-), Seduction (13-), K/S: Modern Runes (11-), K/S: Ancient Runes (11-), K/S: Tales & Stories (11-), P/S: Woodcarving (11-).

Disadvantages: Loyal to/Protective of Family, Reputation: Skald.

QUEEN GUNNHILD

A fading beauty, she is jealous of the shieldmaiden Ingunn. She may try to seduce any handsome newcomer to court. Last year she had an affair with Asta's father Arn, and he gave her the belt, then lied to his daughter about what happened to it. Later, she gave the belt to Asolf. If anyone kills Asolf, she'll have him sent a drinking horn of poisoned wine. The queen was fostered by Lapps.

Age: 31. **Eyes:** Blue. **Hair:** Grey-blonde. **Build:** Slender. **Height:** 5'2". **Race/Sex:** Human/Female. **Demeanor:** Regal, hospitable. **True Attitude:** Jealous, vengeful.

Hits: 31. **Melee:** 30 Dagger. **Missile:** -25.

AT(DB): 1(5). **Sh:** N. **Gr:** N. **MovM:** +5.

Lvl: 6. **Profession:** Wizard. **Stats:** St43; Qu78; Pr61; In51; Em92; Co62; Ag71; Me90; Re93; SD80; AP88.

Skill Bonuses: Swim64; Ride54; Perception96; Public Speak82; Seduce97; Dance78; Rope Mastery92.

STR:8 DEX:14 CON:11 BODY:11 INT:18
 EGO:16 PRE:13 COM:17 PD:2 ED:2
 SPD:3 REC:4 END:22 STUN:21
OCV:6 **DCV:**5 **Phases:** 4,8,12
Damage: 4D6N **Move:** 6"

Skills: Oratory (12-), Swimming (3"), Fam w/Riding (8-), +1 w/Dagger, +3 Perception, Persuasion (13-), Seduction (14-), K/S: Knots (11-), Cooking (11-), K/S: Weather (11-).

Spells: Wizard Magic.

Disadvantages: Loyal to/Protective of Family, Reputation: Queen, Distinctive Features: Queen, Jealous of Ingunn.

INGUNN THE SHIELDMAIDEN

Willing to fight anyone to keep her place at the table, this young and beautiful woman has turned down several offers of marriage from housecarls because they couldn't defeat her in battle. The king has promised her a dowry of three ships and an island if she ever settles down. Meanwhile, she is his standard-bearer and a skilled embroiderer.

Age: 17. **Eyes:** Blue. **Hair:** Blonde. **Build:** Average. **Height:** 5'3"
Race/Sex: Human/Female **Demeanor:** Polite, dignified. **True Attitude:** Kind, honorable.

Hits: 65. **Melee:** 115 Longsword. **Missile:** 75Spear.
AT(DB): 6(10). **Sh:** Y+20. **Gr:** N. **MovM:** +10.
Lvl: 6. **Profession:** Warrior. **Stats:** St84; Qu79; Pr53; In49; Em57; Co98; Ag86; Me61; Re52; SD64; AP99.
Skill Bonuses: Swim72; Climb70; Stalk & Hide68; First Aid69; Navigate63; Sail65; Sing84.
+20 Magic Sword.

STR:18	DEX:17	CON:19	BODY:13	INT:11
EGO: 12	PRE: 10	COM: 20	PD: 7	ED: 4
SPD:3	REC:8	END:38	STUN:35	
OCV:12	DCV:9		Phases: 4,8,12	
Damage: 1 1/2D6K			Move: 8"	

Skills: Climbing (12-), Swimming (3"), Stealth (12-), First Aid (11-), Navigation (11-), Vehicle fam w/Viking Long Ships, P/S: Singing (13-), Perfect Pitch, Fam w/Common Melee & Thrown Spear, +4 Lvl's w/Sword, +2 w/Spear.

Magic Sword (+2 OCV), 3rPD/1rED Armor.

Disadvantages: Loyal to/Protective of Family, Protective of Honor, Reputation: Female Shiled Maiden, Likes to be a Warrior.

ASOLF SKULL-SPLITTER

A fierce fighter and Gunnhild's friend, he will refuse to say where he got the belt if there's any hint it was stolen, rather than injure Gunnhild's reputation.

Age: 26. **Eyes:** Blue. **Hair:** Red. **Build:** Stocky. **Height:** 6'0".
Race/Sex: Human/Male. **Demeanor:** Honorable. **True Attitude:** Honorable, protective.

Hits: 81. **Melee:** 98Axe. **Missile:** 78 Spear.
AT(DB): 5(10). **Sh:** Y+20. **Gr:** N. **MovM:** +0.
Lvl: 6. **Profession:** Warrior. **Stats:** St100; Qu70; Pr68; In54; Em61; Co90; Ag75; Me60; Re52; SD:91; AP75.
Skill Bonuses: Swim68; Climb60; Stalk & Hide72; First Aid69; Navigate87; Subdue58; Smith50; Perception60.
+20 Magic Axe.

STR: 20	DEX: 14	CON: 18	BODY: 14	INT: 10
EGO: 15	PRE: 13	COM: 14	PD: 7	ED: 4
SPD: 3	REC: 8	END: 36	STUN: 35	
OCV: 11	DCV: 7		Phases: 4,8,12	
Damage: 2D6K			Move: 8"	

Skills: Climbing (12-), Swimming (3"), Stealth (13-), First Aid (11-), Navigation (13-), Concealment (11-), Fam w/Common Melee & Thrown Spear, +4 w/Axe, +3 w/Spear. 3rPD/1rED Armor.

Disadvantages: Loyal to/Protective of Family, Protective of Honor, Reputation: Close to Royal Family.

KING HARALD

A pious Christian and good fighter, the King is not very clever or observant of court intrigue.

RM Skills: Swim58; Ride52; Perception45; Public Speak68; Sail68; Navigate79.

FH Skills: Swimming (3"), Riding (12-), Oratory (11-), Fam w/Viking Long Ships, Navigation (13-), Fam w/Common Melee & Thrown Spear.

OCV: 7 DCV: 7 **Damage:** 1D6+1K

POSSIBLE SCENARIO RESOLUTIONS

1. Someone convinces Leif to tell his story to the king and demand that Asolf's and Ingunn's chests be searched. The belt is found and given to Leif. Asolf is outlawed.
2. Someone opens Asolf's strongbox and finds the belt. He can steal the belt or challenge Asolf to a duel, for the winner gets the loser's possessions.
3. Leif suggests that they wait until the All Hallows Feast, when everyone will dress in their finest clothes, to see if someone wears the belt then.

ALL HALLOWS FEAST

The days go by, and soon it's time for the feast of All Hallows (November 1st). Everyone wears their finest clothes. Asolf wears Arn's Belt. (Remember that the hall is only dimly lit; so characters will have to get up close to see the details of the carvings.)

Father William tells a bible story, of how Saul summoned up the ghost of Samuel to see what his fate would be in an upcoming battle and learned that he and his son would die. He finishes by explaining how God has cursed all witches who divine by spirits of the dead — and everyone who consults them. (See 1 Samuel 28 for further details.) Then Ragnar the Court Poet recites a poem about one of the episodes in the tale of Sigurd Dragonslayer (see Section 5.10).

The king asks if anyone has any other good stories to tell. Emboldened, Leif spins the tale of Arn's Belt: how it was stolen, and how Asta has promised to marry whoever will return it. He then identifies it as the belt Asolf is wearing.

MORE POSSIBLE SCENARIO RESOLUTIONS

1. Leif (or one of the player characters) challenges Asolf to fight for the belt.
2. Leif calls Asolf a thief and demands justice from the king, who calls on Asolf to take an oath and asks him to submit to an ordeal (see Section 2.8).
3. Asolf insultingly offers the belt for sale, and Asta along with it, for a mark of silver.



13.4 VIKING NPCS

ROLEMASTER NPC TABLE (FOR ALL THREE ADVENTURE SCENARIOS)							
Name	Lvl	Hits	AT(DB)	Sh	Gr	Melee OB	Missile OB
Orm Viper Tongue	8	100	6(30)	N	N	90ls	60sp
Gerd	1	6	1(0)	N	N	-25	-25
Ulf	5	67	7(10)	N	N	85axe	30sp
Eyjolf	5	21	1(5)	N	N	32kn	-25
Gizur	3	41	6(5)	Y20	N	61ls	36sp
Thromond	8	73	6(10)	Y20	N	115ls	80sp
Grimsson	6	59	6(15)	Y20	N	82axe	62axe
Kol	5	49	6(5)	Y20	N	70sp	55sp
Hauk Hrappson	4	45	6(5)	Y20	N	50ls	-25
Sigrid Sotis	1	7	1(5)	N	N	10da	-25
Skalligram	Use Trollblooded Wizard Sample Character Stats						
Leif the Loon	4	42	6(5)	Y20	N	67sw	45sp
Brother William	3	23	1(0)	N	N	20st	-25
Ragnar	3	25	1(10)	N	N	30sw	30da
Queen Gunhild	6	31	1(5)	N	N	30da	-25
Ingunn	6	65	6(5)	Y20	N	115sw	75sp
Asolf	6	81	6(0)	Y20	N	98axe	78sp
King Harald	5	51	6(0)	Y20	N	75sw	60sp

FANTASY HERO NPC TABLE (FOR ALL THREE ADVENTURE SCENARIOS)														
Name	STR	DEX	CON	BODY	INT	EGO	PRE	COM	PD	ED	SPD	REC	END	STUN
Orm Viper Tongue	20	14	20	15	13	18	20	8	8	4	3	8	40	45
Gerd	9	11	11	9	10	10	10	16	2	2	2	4	22	20
Ulf	20	14	13	12	6	9	15	8	7	3	3	7	26	33
Eyjolf	9	12	11	10	13	9	15	15	2	2	2	4	22	21
Gizur	13	17	13	11	10	10	9	13	4	3	3	6	26	28
Thromond	See complete stats in Section 13.1													
Grimsson	15	15	15	13	10	10	15	10	5	3	3	6	30	32
Kol	13	14	17	12	10	10	11	6	7	3	3	6	34	31
Hauk Hrappson	14	13	14	11	13	10	18	16	5	3	3	6	28	28
Sigrid Sotis	10	11	11	10	10	13	11	18	2	2	2	4	22	21
Skalligram	Use Trollblooded Wizard Sample Character Stats													
Leif the Loon	15	9	18	12	18	10	12	12	5	4	2	7	36	30
Brother William	10	10	11	11	16	18	16	10	4	2	2	4	22	22
Ragnar	14	15	12	11	13	12	20	16	4	2	3	5	24	24
Queen Gunhild	8	14	11	11	18	16	13	17	2	2	3	4	22	21
Ingunn	See complete stats in Section 13.3													
Asolf	20	14	18	14	10	15	13	14	7	4	3	8	36	35
King Harald	15	15	17	13	10	10	13	12	5	3	2	5	34	30

APPENDIX

INDEX

Subject	Section #	Subject	Section #
advice	3.5, 5.1	dead	10.6; also see afterganger, draug, mound dead
Aegir	11.12	dead, animate	6.6
afterganger	10.6	disarm	4.2
Althing	7.4	divorce	1.4, 2.6.1
America	see Vinland	dodge	4.2
amulet	5.1	dragon	9.7
animals	9	draug	5.6, 10.6
Arab traders	8.6, see also Caliphate	drink	2.3, 4.3
armor	1.6	duel	2.8, 4.2
arrows	1.6	dwarves	5.3, 10.3
artifact, magic	6.1, see also Wizard Artificer	economy	12.3
Atila	5.10	elves	5.3, 10.3
Atlantic Islands	7.1	encounters	12.3, 12.4
aur	1.6	England	8.10
axe	1.6, 4.2	ertog	1.6
Baghdad	8.8	fame	2.3
Baldur	11.6	family	1.4, 2.6
ball games	2.3	farm	2.1, 2.2, 2.3
baptism	2.7	fast day	2.1
battles	4.1-4.2, 8.14	fate	5.1
beacon	4.1	festivals	2.1, 2.7
bearded axe	1.6, 4.2	feud	1.0, 1.1, 2.3
beggar	1.2, 2.3	fey	1.0, 5.1
berserk	*6.3, 1.0, 1.0, 1.0 1.3, 4.2, 5.8, 11.3	Finns	see Lapps
blood brothers	2.6	fire	4.3
boats	1.6	food	1.6, 2.3
bow	1.6	fortifications	4.1
breaking, shield or weapon	1.6, 1.3	foster father	1.2, 1.4
Britain	8.10	France	8.9
broad axe	1.6	freedman	1.2
Bulgars	8.6	frenzy	6.3 (see also berserk)
burial	see funeral, grave mound	Frey	2.7, 10.6, 11.7
byrnie	1.6, 4.2	Freyja	10.6, 11.9
Byzantium	8.7	Frodi	5.10
calendar	1.4, 2.1, 12.1	funeral	2.6
Caliphate	8.8, 11.6	fylgja	1.0, 5.1, 6.6, 11.12
canoes	1.6	geography	7.1
Carolingian Empire	7.2, 8.9	Germany	8.9
character	1.0	Giantland	8.12
Charlemagne	7.2, 8.9	giants	5.2, 8.12, 10.2, 11.12-11.14
chieftain	1.2	gifts	2.4
Christians	1.0, 2.7, 5.8	Glasir Plains	8.12
clothing	1.6	gods	11
compensation	2.5, 2.8, see also wergild, self-judgment	gossip	2.5
corpsefire	5.7	grave mound	5.7, 10.6
court (royal)	2.4	Great Britain	see Britain
craftsman	1.2	Greek fire	8.7, 8.14
curse	5.1, 6.6	Greenland	7.10
danegeld	3.4	Gudrun	5.10
danelaw	3.4, 7.2, 7.3, 7.3, 8, 10.3	guesting	2.3, 2.5
day of the week	2.1, 12.1	hand-axe	1.6
		healing	1.0, 4.4, 6.2, also see leech
		Hel	10.6

Subject	Section #	Subject	Section #
herbalism	4.4, 5.9, 6.2, 10.3	night-mare	10.4
hireling	1.2	nis	5.4, 10.4
history	7, 8	Njord	11.8
homefield	2.2	Normandy	3.4, 7.3
honor	1.0, 2.5	Norns	5.1, 11.4
horses	1.6, 2.3, 4.2; also see nicor	nurse	1.4
houses	2.2, 9.1	Odin	2.7, 4.12, 0.6, 11.3
housecarl	1.2, 1.3, 2.4, 3.6, 6.0	omens	1.0, 5.1
Iceland	7.3, 7.4	ordeal	1.0, 2.8
impale	1.6, 1.3, 4.2	outlaw	1.2, 2.6, 2.8
insults	2.5, 4.2, 6.4, 13.1	parrying	4.2
invisibility	see mist-cap	patron	1.4
Ireland	8.10	Pechenegs	8.6
jarl	1.2	peddler	2.3
jewelry	1.6, 1.6	Permia	8.12
Jewish traders	2.7, 8.8	platform magic	see shaman
Jomsborg	8.5	poison	4.3
karfi	1.6	poleax	1.6
kenning	1.0	power level	1.0
Khazars	8.6	prayers	1.0
knorr	1.6	prices	1.6, 1.6
landholder	1.2	priest	1.0, 2.7
languages	1.3, 8.13	primesigning	2.7
Lapps	8.3	prisoner	4.1, 4.2
latitude sailing	3.1	profession	*1.0, 1.0, 1.7
law	2.8	prophesies	12.3; also see second sight, shaman
leech	*6.2, 1.0, 1.0, 1.3, 4.4	raiding	3.4
linden trees	5.3	Ran	11.12
Loki	11.5	ransom	4.1
luck	5.1	religion	2.7
maelstrom	3.3, 5.10	revenge	2.4, also see feud
magic	*6.0, 1.0, 5.8	roads	1.6
magic artifact	6.1	rowboats	1.6
Magyars	8.6	rune carver	*6.5, 1.0, 1.0, 5.8
maps	12.6	runes	*6.4, 5.8,
mark	1.6	Rus	8.6
marriage	1.4, 2.6	Russia	8.6
meals	1.6, 2.3	Scotland	8.10
measures	1.6	scuta	1.6
mermaid/merman	5.6, 10.5	sea serpent	9.5
Midsummer	2.1	seax	1.6
missiles	1.6, 4.2	second sight	1.0, 1.0, 1.3, 5.1, 6.6
missionaries	2.7	self-judgment	1.5, 2.8
mist-cap	5.3, 10.3	shaman	*6.6, 1.0, 1.0, 5.8, 12.3
money	1.61	shapechanging	6.7, 9.4
monsters	10	shield	1.6, 4.2, 4.2
months	2.1	shield fortress	4.1
moon phases	12.1	shieldwall	4.1
moonrise, set	12.1	ships	1.6, 3.0, 4.1
mound dead	10.6	shipwreck	3.3
multi-generation	1.4	Sigurd	5.10, 9.7, 12.5
name	1.5	sleep-thorn	see herbalism
navigation	3.1, 3.2	skald	*6.5, 1.0, 1.0, 1.3, 5.10
nickname	1.5, 1.5	skates	1.6
nicor	9.6	skills	1.3
niddering	2.5	skis	1.6
niello	1.6	Skraelings	7.4, 8.2

Subject	Section #	Subject	Section #
Slavs	8.5	trollblood	*6.4, 1.0, 5.8
smallholder	1.2	trolls	5.2, 6.7, 10.1
social class	1.4, *1.2	troubles	12.3
social life	2.3	two-handed blow	4.2
Spain	8.11	Tyr	2.7, 11.2
spear	1.6	Utrost	8.12
sports	2.3	Valhalla	10.6
standard bearer	4.1	valkyrie	5.5, 10.6, 11.4
storms	3.3, 4.3	Varangian Guard	3.6, 7.2, 7.41
stromkarl	5.6, 10.5	Varangians	8.6, also see Varangian Guard
stumbling, horse	3.3, 5.1	vellum	6.5
Summer's Eve	2.1	Viking raids	7.2
sunrise, sunset	12.1	Vinland	7.4
surrender	4.2	Volund	5.10
Surt	11.14	war	see battle
Sweden	8.4	war arrow	1.2, 4.1
swimming	4.3	war fetter	4.1
swine array	4.1	water spirits	5.6, 10.5
sword	1.6	weapons	1.6
"tables"	2.3	weather	4.3, 12.2
taxes/tolls	2.4, 3.5, 8.6, 8.7	week	2.1
thief	1.0, 1.6	weights	1.6
Thing	2.1, 2.8, 7.3, 7.4	werewolf	see shapechanging
Thor	2.7, 11.1	wergild	2.8
thrall	1.2, 1.6	Weyland Smith	see Volund
timeline	1.4, 2.1	Wild Hunt	2.1, 5.5, 10.6
tracking	9.3	Winter's Eve	2.1
trade mart	1.2, 1.6, 1.6, 1.7, 8.1, 8.2	wizard	*6.7, 1.0, 1.0, 1.3
trading	2.4, 3.0, 3.5, 8	wizard artificer	*6.1, 1.0, 1.0, 1.3
trance	5.8	women	1.1
travel	3.0, 3.1, 3.2	wounds	4.4
treasure	12.5	Yule	2.1
treasure, buried	5.7, 10.6		

Recommended Reading

Sagas

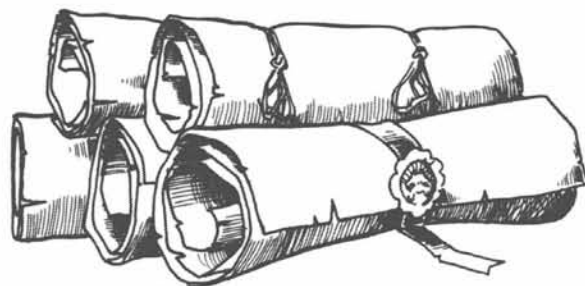
- Egil's Saga (translated by Hermann Palsson and Paul Edwards)
- Gongu-Hrolf's Saga (translated by Hermann Palsson and Paul Edwards)
- Grettir's Saga (translated by Denton Fox and Herman Palsson)
- Hrafnkel's Saga and Other Stories (translated by Hermann Palsson)
- Hrolf Gautreksson, a Viking Romance (translated by Hermann Palsson and Paul Edwards)
- King Harald's Saga (translated by Magnus Magnusson and Hermann Palsson)
- The Laxdaela Saga (translated by Magnus Magnusson and Hermann Palsson)
- Njal's Saga (translated by Magnus Magnusson and Hermann Palsson)
- The Saga of Gisli (translated by George Johnston)
- Seven Viking Romances (translated by Hermann Palsson and Paul Edwards)
- The Vinland Sagas (translated by Magnus Magnusson and Hermann Palsson)

Folklore and Myth

- Folktales of Norway, edited by Reidar Chrisiansen, translated by Pat Ivarsen
- The Norse Myths by Kevin Crossley-Holland
- The World Guide to Gnomes, Fairies, Elves and Other Little People by Thomas Keightley

History

- The Viking Achievement by P. G. Foote and D. M. Wilson
- The Vikings by Michael Gibson
- The Vikings by Johannes Brondsted



APPENDIX

Figur 1^a

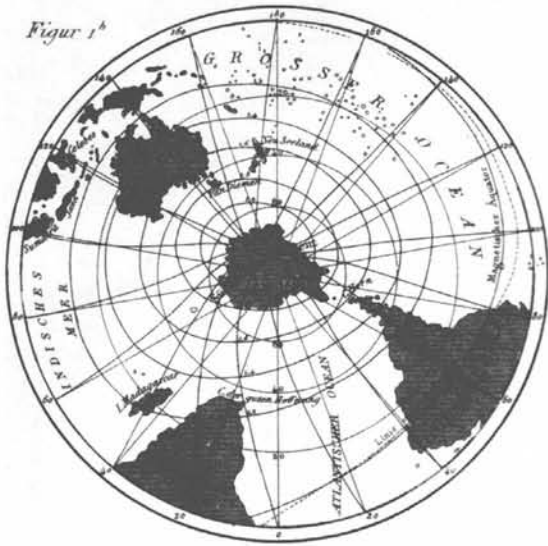
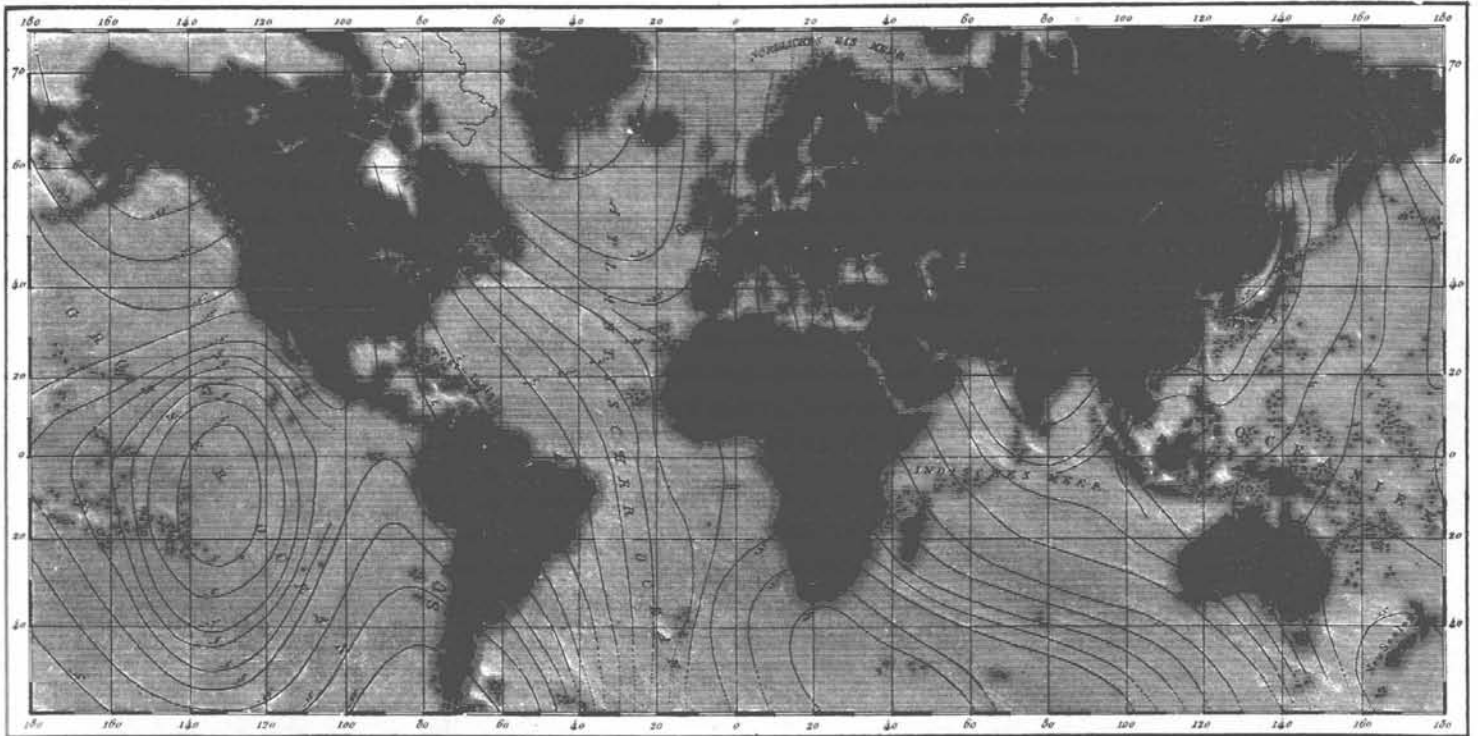
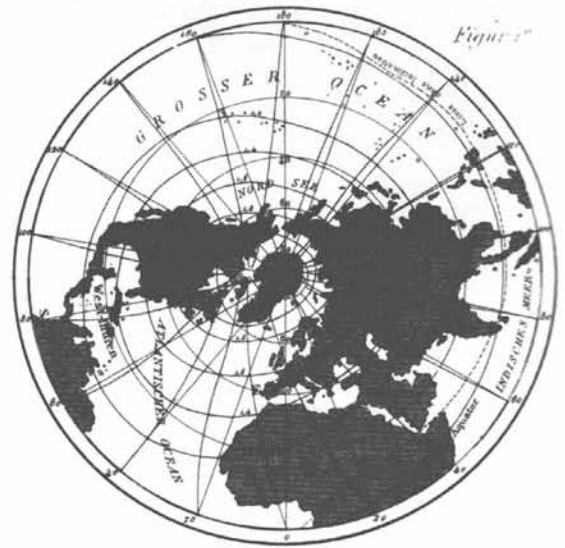


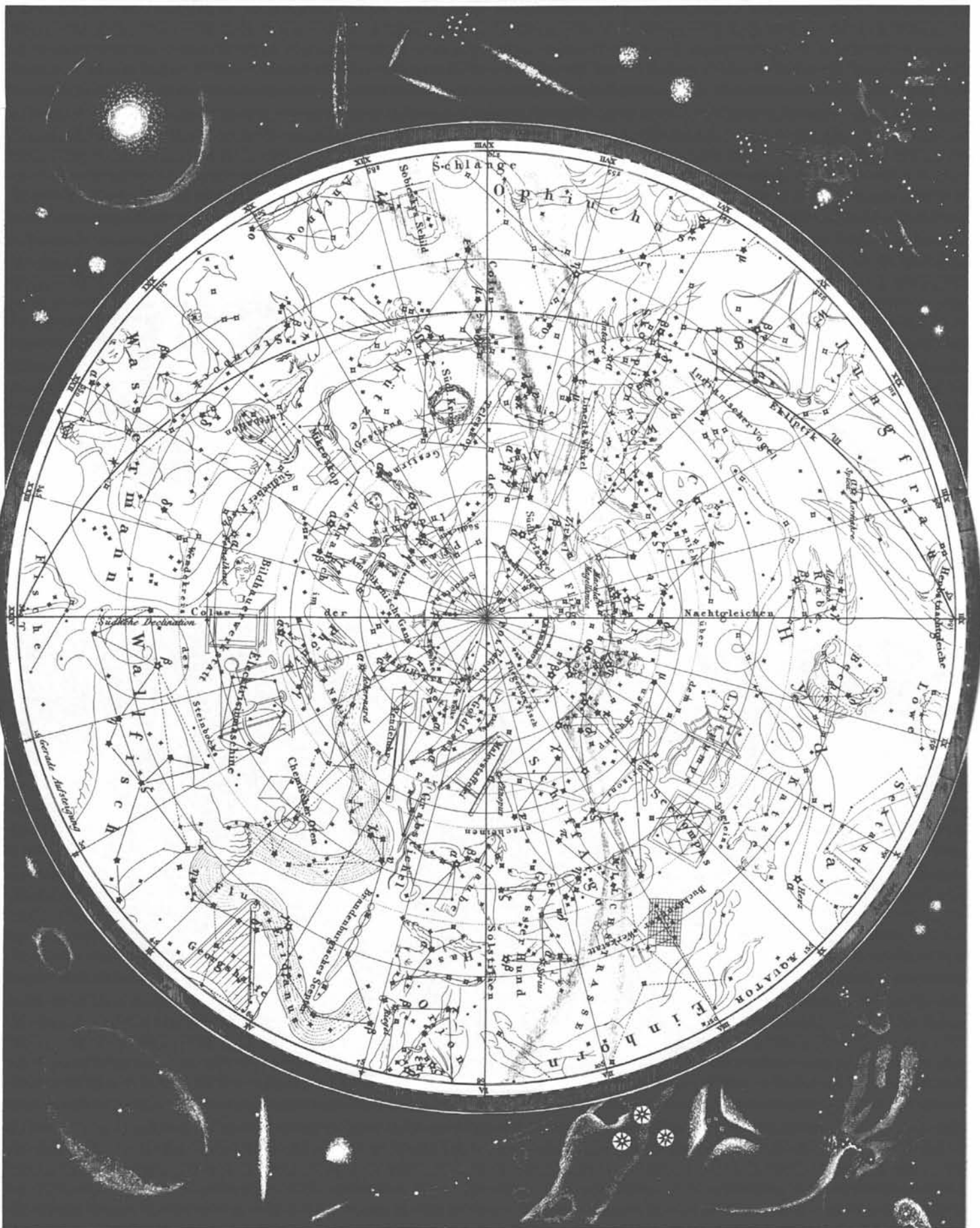
Fig 4^a

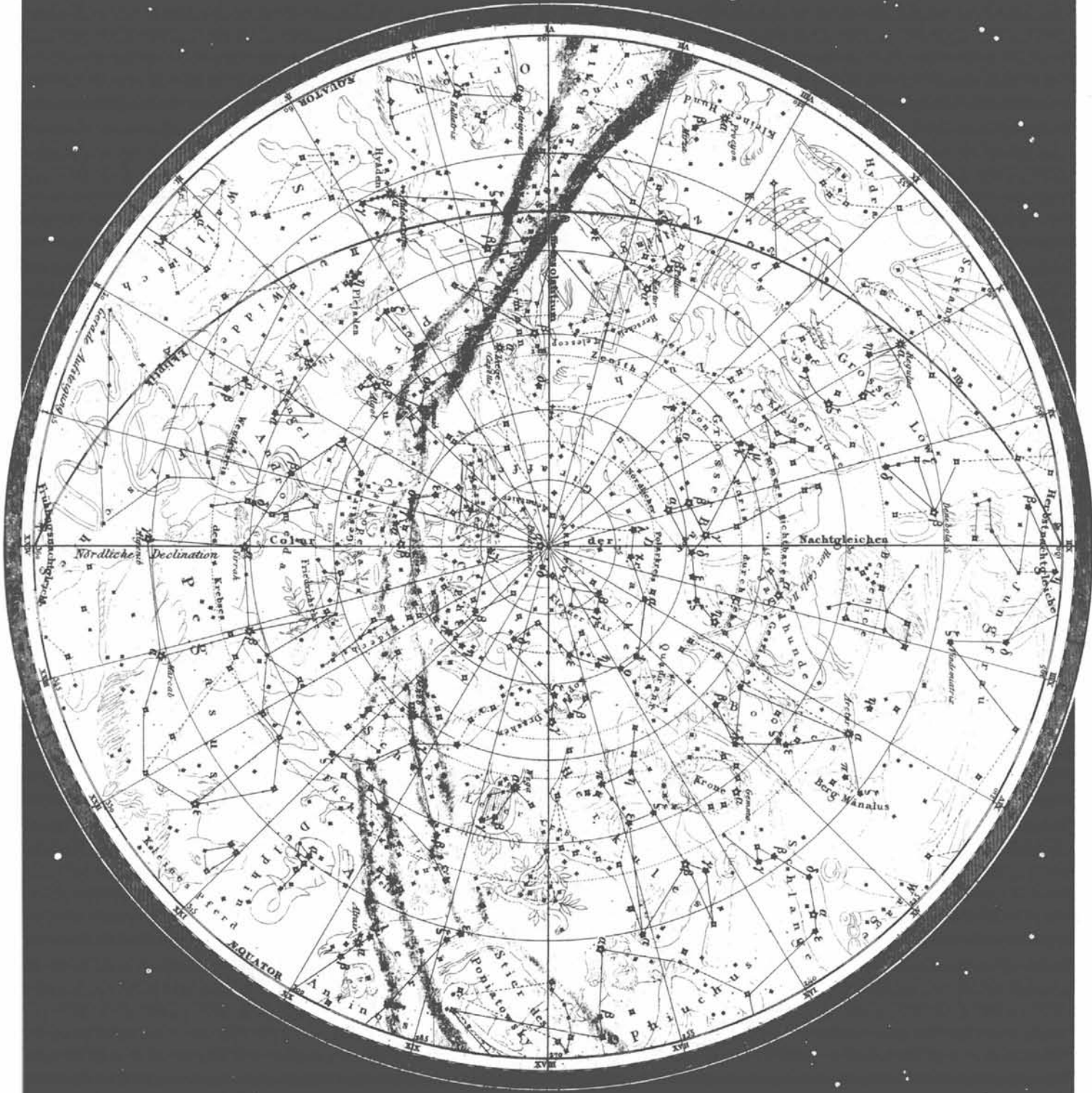


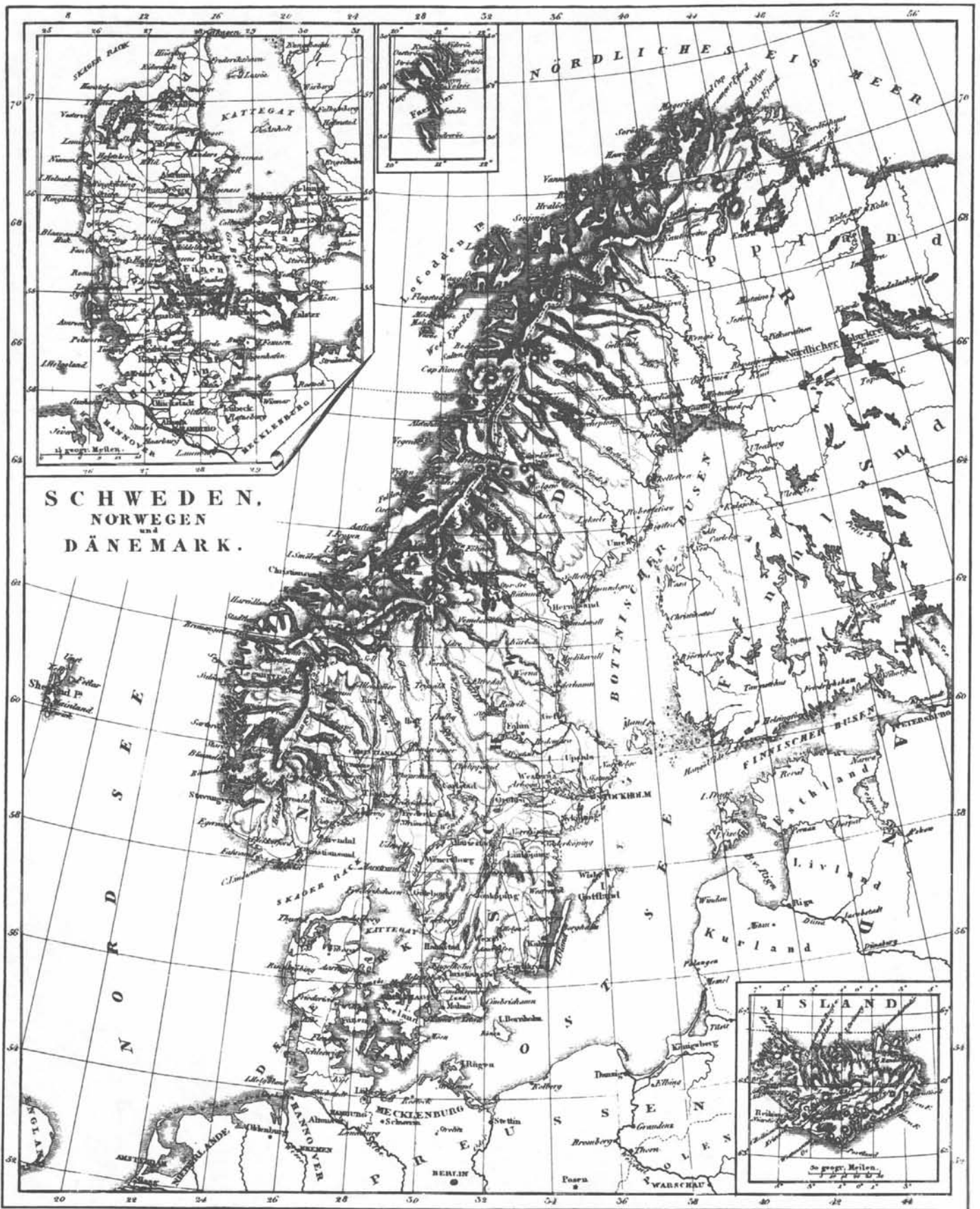
Fig 4^b

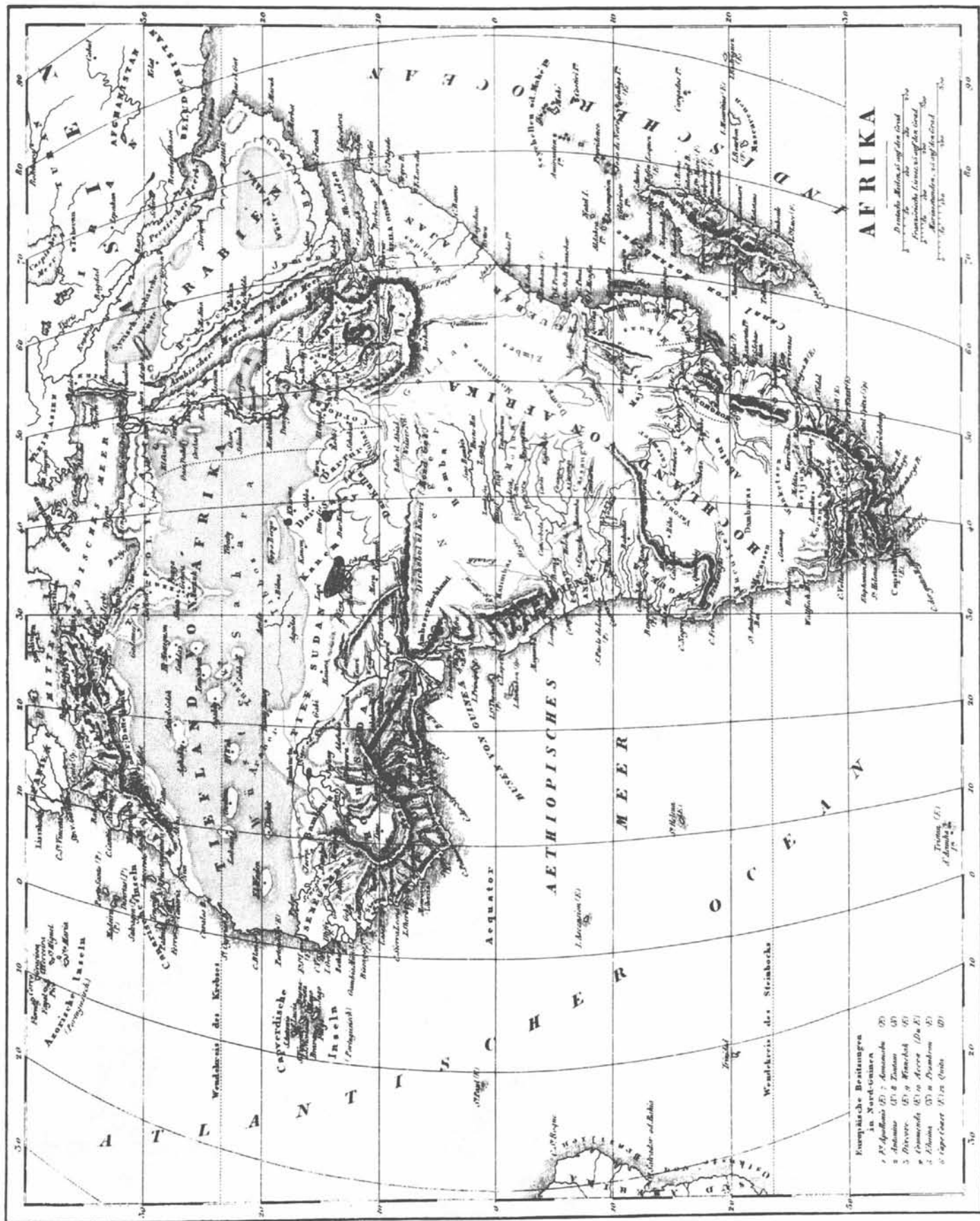
Figur 2^a



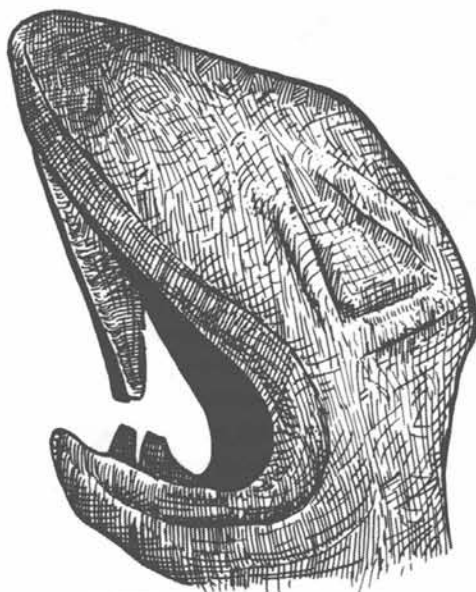
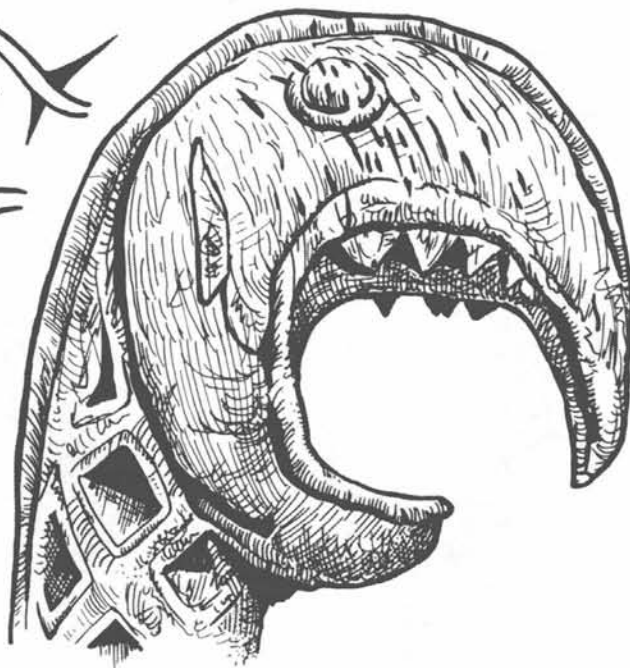
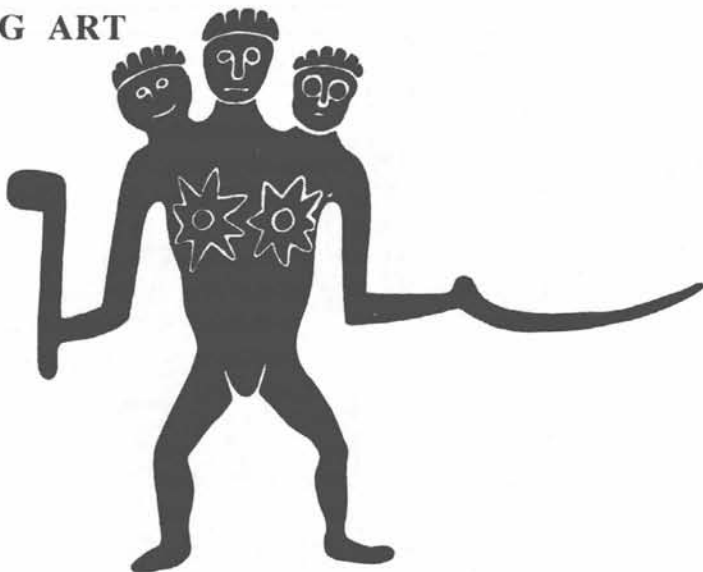
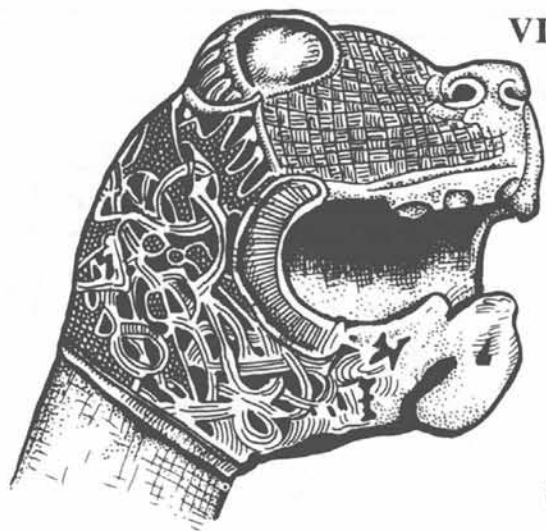








VIKING ART



HAIL, VIKINGS!

We want to hear from you. Please take a minute to photocopy this page (or tear it out and ruin the look of your nice new book), answer the questions and mail it to ICE, and we'll send you a free IQ* (which lesser mortals pay \$1.00 for). When you speak, we listen.

1. Why did you buy VIKINGS™? _____

2. What did you like best about VIKINGS? _____

3. What did you like least about VIKINGS? _____

4. Is there too much history and background information, too little, or just the right amount? _____

5. Are there too many game statistics, too few, or just the right amount? _____

6. If you are a fantasy roleplayer, how do you intend to use VIKINGS in a fantasy roleplaying campaign? _____

7. What would make this book and others like it more useful to you? _____

8. What other characters and time periods would you like to see between covers in a *Campaign Classic* edition? _____

9. If you don't mind, please state:
 your age: _____ years
 your sex: _____ male _____ female

Thanks! That wasn't so hard for a Viking, was it? Now complete the blank below, photocopy it, and mail it to: ICE, P.O. Box 1605, Charlottesville, VA 22902.

Name: _____
Street Address: _____
City, State: _____ Zip: _____

*ICE's pretentious tabloid covering industry gossip and massive disinformation.



PRODUCT LISTING



Look for these ICE products at your favorite retail outlet.

CAMPAIGN CLASSICS™

Campaign Classics are a series of specific genre works based on an historical period. They are suitable for use as campaign and source material for *Rolemaster* and most major fantasy role playing systems. If you enjoyed *Vikings* then try other sourcebooks in this great series!

Robin Hood™

First in a series of *Campaign Classic* source books designed for use with *Rolemaster*, *Fantasy Hero*, and *MERP*. Join Robin and his merry men, the greatest outlaws of all time! The generic bandit and guerilla information included is invaluable to GM's! **\$15.00**

Mythic Greece: The Age of Heroes™

Provides *Rolemaster* and *Fantasy Hero* statistics for role playing in The Age of Heroes. The Character Creation rules allow you to play extra-powerful Greater Hero and Demigod characters. It is time for you to enter Mythic Greece: the Age of Heroes! **\$15.00**

Pirates™

Sail the high seas of the Spanish Main, where life is cheap and gold doubloons flow out of Spain's New World colonies like water. Pirates can be used to create a campaign setting for *Rolemaster*, *Fantasy Hero*, *Middle-earth*, or any other major fantasy role playing system. It contains all you need to create period characters, simulate 17th century combat and design adventures in the tradition of Robert Louis Stephenson. This 160 page sourcebook contains two fully detailed campaigns, six detailed adventure scenarios, and four additional suggested scenarios. **\$15.00**

SHADOW WORLD™

Shadow World, a whole new realm of adventure! The planet *Kulthea*™ forms the *Shadow World*, a unique fantasy gaming environment supported by comprehensive stats for both *Rolemaster* and *Fantasy Hero*. The *Shadow World* is a vast planet of scattered isles and lost realms, each land isolated by forces both tangible and supernatural. Not only is it a richly designed fantasy world unto itself, but it allows the GM to insert it into his *Rolemaster* or *Fantasy Hero* campaign whole or in part. It is designed for use with most major fantasy role playing systems and has numerous expansion modules available separately. **\$20.00**

ROLEMASTER™

I.C.E.'s advanced Fantasy Role Playing Game system, *Rolemaster* is a complete set of the most advanced, realistic and sophisticated FRP rules available and they have been reformatted and reorganized in the new Second Edition. The flexibility of the system allows it to be used wholly or in part. Each of the books can be used separately to improve the realism of most major FRP systems! Look for the new complement to your *Rolemaster* game: *Shadow World*™ adventures.

Rolemaster 2nd Edition Boxed

A complete FRP system boxed with three component books: *Character Law & Campaign Law*, *Spell Law*, *Arms Law & Claw Law*. Now reformatted and reorganized, this state-of-the-art system adds realism and depth to your campaign without sacrificing playability. Experience the ultimate in role playing! **\$38.00**

Spell Law® 2nd Edition

Now reformatted and reorganized, 2nd Edition *Spell Law* is a mighty tome that can add realism and depth to your campaign without sacrificing playability. This magic system includes over 2000 spell descriptions, individual spell attack tables, critical strike tables, a power point system, detailed alchemy rules, and a variety of optional rules. **\$14.00**

Arms Law & Claw Law® 2nd Edition

A combat system that improves any game and serves as one of the three cornerstones of the *Rolemaster* system. Fast-paced and realistic, it resolves most attacks in only two die rolls. Contents include 30 weapon attack tables, ten critical strike tables, a dozen animal and martial arts attack tables, and a variety of optional rules. **\$12.00**

Character Law & Campaign Law™ 2nd Edition

Now reformatted and reorganized, 2nd Edition *Character Law & Campaign Law* is a complete character development system that includes extensive campaign and Gamemaster guidelines. It improves any game and serves as the core of ICE's highly acclaimed FRP system, *Rolemaster*. **\$14.00**

These fine products are sold at better retail outlets worldwide. Ask for them at your favorite store...or order directly from us. Iron Crown Enterprises, P.O. Box 1605, Charlottesville, VA, 22902, USA. Prices are subject to alteration without prior notice. VISA & MASTERCARD orders call (800) 325-0479. Va residents, Canadians and overseas customers call (804) 295-4280. Please make phone orders during business hours: 9am-5pm Eastern Standard Time, Mon-Fri. **Allow up to 2-6 weeks for delivery.**

CAMPAIGN CLASSICS™

Sail the "whale's track," as Vikings called the ocean, in search of Frodi's flour—gold! Raid coastal towns from England to North Africa, and seek adventure by land and sea! Blood feuds await you in your native land when you return. Count booty and trade for silk and fine weapons! Berserks and trollwise wizards, runaway Thralls and banished warriors—all these characters, plus the kings and gods of Norse legend come alive in **VIKINGS™**!

A role playing campaign set in the Europe and North Africa of 768-1066 A.D., **VIKINGS** pits adventurers against sea serpents and land dragons, warriors and shamans, Frost Giants and jealous gods!



VIKINGS™

Inside **VIKINGS**, you'll find:

- Complete Rolemaster™ and Fantasy Hero™ FRP gaming statistics, including tables and charts.
- Statistics for NPCs, including Viking warriors, Shamans, Berserks, Wizards, and Leechs (healers).
- Detailed campaign background information on the world of the Norsemen and their formidable foes!
- Gamemaster guidelines to run quests set in the age and lands of the Vikings, or in another campaign setting (such as Shadow World™).
- 3 detailed adventures set in historical perspective, including a pirate adventure on the high seas.

You don't have to be a historian to play **VIKINGS**—this book includes everything you need to sail, plunder, and fight in the spirit of the Norsemen!



Produced and distributed by
ICE, Inc.
P.O. BOX 1605
Charlottesville, VA 22902

Made in U.S.A.

#1030



ISBN 1-55806-047-2