

**GURPS**

# HUMANX

*Roleplaying in Alan Dean Foster's "Humanx Commonwealth"*



**STEVE JACKSON GAMES**



# GURPS® HUMANX

*A Generic Universal RolePlaying System Worldbook*

*Based on the "Humanx Commonwealth" Science Fiction Series by Alan Dean Foster*

*By Curtis M. Scott*

*Developed and Edited by J. David George*

*Additional material by J. David George, Steve Jackson, David Ladyman and Michael Moe*

*Cover: "Nor Crystal Tears" by Michael Whelan*

*Interior art by Dan Carroll, Steve Crompton, Michael Goodwin, C. Bradford Gorby, Paul Jaquays, Denis Loubet, Michael Surbrook, John and Jason Waltrip, and Dan Willems*

*Typography by Cynthia Freeman, Melinda Spray and Monica Stephens*

*Map graphics by Michael Goodwin*

*GURPS System Design by Steve Jackson*

*System Development by David Ladyman*

Playtesters and Humanx Advisors: W.G. Armintrout, Norman Banduch, Ray Carter, Avery Harrison, Laurie Harrison, Karen Horan, Mike Hurst, Eric Jerome, William R. Johnson, Stefan Jones, Dean Kenady, C. Mara Lee, Walter Milliken, Mike Moe, Leland F. Nichols, J. Terry Nutter, Dan Ormiston, Anthony Petit, Stephen Posey, Mary Scott, Larry Stohr, Alexander Von Thorn, Michael Vragel, Bill Williams and Martin Wixted.

To my wife, Mary, and our newborn son, Phillip Anthony Scott. Roots and Wings — Curtis Scott.

*GURPS* is a registered trademark of Steve Jackson Games Incorporated. *Humanx* is a trademark of Alan Dean Foster. *GURPS Humanx* is copyright © 1987 by Steve Jackson Games Incorporated. All rights reserved. Printed in the United States.

## TABLE OF CONTENTS

<b>1. HUMANX HISTORY</b> .....	<b>3</b>	Alaspin .....	18
<i>Commonwealth Timeline</i> .....	3	<i>The Minidrag</i> .....	19
Ancient History .....	3	Amropolous .....	20
The Xunca .....	3	Balthazaar/Beersheba .....	20
The Tar-Aiym and the Hur'rikku .....	3	Cachalot .....	21
The Alaspinians .....	4	Carmague/Collangatta .....	22
The Origins of the Commonwealth .....	5	Chikasacasoo .....	23
Human History .....	5	Dis .....	23
Thranx History .....	5	Drax IV .....	24
Humanx History .....	6	Goodhunting .....	24
<b>2. THE HUMANX COMMONWEALTH</b> .....	<b>9</b>	Hivehom .....	25
The United Church .....	9	Horseye .....	26
The AAnn-Humanx Cold War .....	10	Largesse .....	28
Other Organizations .....	11	Long Tunnel .....	28
The Lynx Society .....	11	Loser's World .....	29
The Meliorare Society .....	11	Mantis .....	29
<i>Commonwealth Time and Dating Systems</i> .....	11	Moth .....	30
The Qwarm .....	12	New Paris .....	31
Life in the Commonwealth .....	12	New Riviera .....	32
Transportation .....	12	Nineveh .....	32
<i>Communications</i> .....	13	Prism .....	33
Wealth .....	14	Repler .....	33
<i>Money</i> .....	14	Samstead .....	34
Prices .....	15	<i>Quofum, Fabled Quofum</i> .....	34
Jobs and Income .....	15	Terra .....	35
<b>3. COMMONWEALTH GAZETTEER</b> .....	<b>17</b>	Tolus Prime .....	35
Classification of Worlds .....	17	Tran-ky-ky .....	35
<i>Using the Gazetteer</i> .....	17	Ulu-Ujurr .....	37
Major Worlds in the United Church Registry .....	18	Willow-Wane .....	37
<i>Worlds within the AAnn Empire</i> .....	18	<b>4. CHARACTERS</b> .....	<b>38</b>
		<i>Creating New Species</i> .....	38
		Spacefaring Species .....	38

# STEVE JACKSON GAMES

Thranx	38
Ornithorpes	41
Tolians	42
AAnn	43
Non-Spacefaring Species	44
Cetaceans	44
Tran	45
Saia	47
Mai	47
Tsla	47
Advantages, Disadvantages, and Skills	48
Advantages	48
Disadvantages	49
Skills	49
New Skills	51
Languages	52
Equipment	52
Missile Weapons	52
Melee Weapons	56
Armor and Protective Devices	57
Credcard	57
Drugs and Medical Supplies	58
Miscellaneous Personal Equipment	59
Vehicles	59
<b>5. PSIONICS</b>	<b>60</b>
Power and Skill	60
<i>Psionics in the Commonwealth</i>	60
Using Psi Abilities	60
Fatigue Cost	60
Concentration and Time Required	61
Repeated Attempts	61
Extra Effort	61
Telepathy	62
Psi Sense	62
Emotion Sense	63

Telesend	63
Telereceive	63
Two-Way Communication	63
Three-Way Interaction	63
Mind Shield	64
Catalyst Creatures	64
Mindwipe	65
Mechanical Mindwipe	65
Limitations	66

<b>6. SPACECRAFT</b>	<b>67</b>
Distances and Travel Times	67
Sample Spacecraft	68
Commercial and Private Spacecraft	68
Auxiliary Spacecraft	68
Military Spacecraft	69
Ship Weaponry	69
Ship Systems	70
Space Combat in the Humanx Commonwealth	70
Spacecraft Combat	71
Detection and Engagement	71
Scanning	71
Factors Affecting the Battle	71
Total Firepower for Church and AAnn Spacecraft	72
Resolving the Contest of Strategy	73
Assessing Damage	74

<b>7. A MESSAGE FOR MALAIKA</b>	<b>77</b>
---------------------------------	-----------

<b>APPENDICES</b>	<b>92</b>
Humanx Characters in <i>GURPS</i>	92
A Humanx Chronology	95
Maps of the Commonwealth	94-95

<b>INDEX</b>	<b>96</b>
--------------	-----------

# INTRODUCTION

## About GURPS

Steve Jackson Games is committed to full support of the *GURPS* system. Our address is SJ Games, Box 18957, Austin, TX 78760. Please include a self-addressed, stamped envelope (SASE) any time you write us! Resources now available include:

*Roleplayer*. This bimonthly newsletter includes questions & answers, new races, rules, beasts, information on upcoming releases, and more. As of November, 1987, it is an eight-page newsletter. Subscriptions cost \$1 per issue, for up to 10 issues at a time. After September, 1989, please write for the current price — *Roleplayer* might be larger and cost more.

*Errata*. Up-to-date errata sheets for all *GURPS* releases, including this book, are always available from SJ Games; be sure to include an SASE with your request.

*Q&A*. We do our best to answer any game question accompanied by an SASE.

*Gamer input*. We value your comments. We will consider them, not only for new products, but also when we update this book on later printings!

## A Guide to the Commonwealth

The dedicated humanx fan will want to check out *A Guide to the Commonwealth*, by Robert Teague and Michael Goodwin. This 70-page manual covers every humanx story in print. Copies may be obtained from Michael Goodwin, 4987 South 2700 West, Roy, Utah 84067, USA.

Science fiction is a literature of hope. It hinges on the dream that man will survive long enough, progress far enough, to reach the stars. Alan Dean Foster's *Humanx Commonwealth* is a manifestation of that hope.

In the Commonwealth, mankind meets a race of Bug-Eyed Monsters, the insectoid thranx. But the physiological differences between man and thranx are far outweighed by the psychological and social parallels. Within a century of their first contact, human and thranx cultures fuse, becoming truly "Humanx."

Of course, the humanx stories are *science* fiction, filled with high-tech gadgetry. The life of a Commonwealth citizen is as strange and wonderful to us as ours would be to our medieval ancestors. Some of Foster's technology is comfortably familiar to long-time science fiction fans, but just as often, he presents a new idea which seems perfectly obvious — after Foster showed it to you.

But the worlds of the Commonwealth are not entirely tamed. Countless planets in humanx space have never felt human — or thranx — foot. Myriad flora and fauna decorate these wild vistas, waiting to be discovered by brave adventurers.

Despite the gadgets and creations, the Commonwealth stories are primarily about *people*. Foster's villains are bigger-than-life; in their every word and deed they drip undiluted evil. From ruthless corporate magnates to vicious AAnn, humanx antagonists personify the darker side of human nature. Blind prejudice, thoughtless cruelty, unfeeling greed, and exploitative manipulation are among their more redeeming qualities.

Opposing these tyrants are not kings, warriors, or "men of greatness," but simple men and women. Flinx — arguably Foster's most important hero — begins his adventures as a peddler, street-thief and juggler in the busy market section of soggy Drallar. Ethan Fortune is a traveling salesman — his world is made of pocket heaters, limited expense accounts and second-class fares between remote worlds. Other "heroes" are scientists, surfers, and farmers. Foster's most heroic figure, Skua September, often seems less capable than the everyday people around him.

Here, then, is the *Humanx Commonwealth*. Alan Dean Foster has written 13 Commonwealth novels and several short stories. Millions of stories remain untold. *GURPS Humanx* is an invitation to you to tell a few of them.

— Curtis Scott

# HUMANX HISTORY

# 1

## Ancient History

The Orion and Sagittarius Arms of our galaxy have known many starfaring civilizations. Some were so advanced that humanx scientists examining their artifacts find them as incomprehensible as an aborigine would a starship. However, determined archaeological investigation has revealed a few facts about these ancient civilizations.

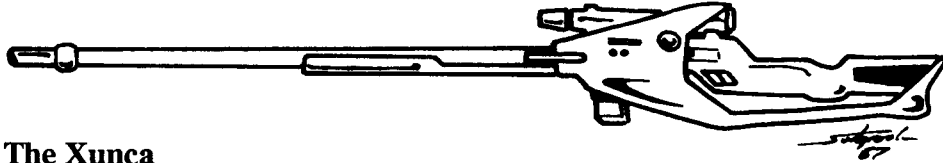

### The Xunca

The Xunca were a powerful species currently believed to have occupied the Arms until almost half a billion years ago, during the infancy of this section of the galaxy. Nothing is known of their physical form, nor is it known what destroyed their civilization. Their existence is suggested by similar legends on a hundred scattered worlds.

The Xunca are known to have traveled throughout what is now Commonwealth space, and established transmitting stations on many now-inhabited worlds. They are believed to have created the Groatamasan Ocean on Horseye.

Associated with the Xunca is another fabled species known as the Mutable. The Mutable were shapeshifting beings able to disguise themselves as any other creature. Legends about Mutable, which can be found in the folklore of most sentient species, describe a Mutable's true form as a four-meter tall column with shimmering, silvery skin and two flexible tentacles. Among hundreds of stories, no legend describes the defeat of a Mutable in combat. Some believe that Mutable exist to this day, disguising themselves as members of modern species.

### The Tar-Aiym and the Hur'rikku

Of most of the species which may have inhabited the Arms after the Xunca, nothing is known. Their artifacts have vanished into the dust of millions of years. For over four hundred million years, no civilization left a significant mark on the worlds of the Sagittarius and Orion Arms until the appearance of the Tar-Aiym and the Hur'rikku.

The Tar-Aiym arose in the Sagittarius Arm some five hundred thousand years ago. Tar-Aiym were strong, six-limbed creatures, three meters tall, with broad torsos and short, bristly, silver-white fur. Their chests were covered with shell plates. Their four rear limbs were crab-like — thick, exoskeletal limbs with protected joints. Each of their two tentacular forelimbs split into two sub-limbs terminating in four finger-like manipulative members. The Tar-Aiym had two large, slit-pupiled eyes flanked by two smaller round-pupiled eyes, and a large, sharp-toothed beak resembling that of a Terran snapping turtle.

Apparently, war was the favorite pastime of the Tar-Aiym. They conquered and subjugated every other sentient race they met. In every activity, the Tar-Aiym glorified militaristic pursuits; their sports extolled skills useful to warriors, their literature and music were designed to induce martial furor in their audiences. The empire of the Tar-Aiym lasted several millennia, and ruled hundreds of sapient species on thousands of worlds.

At the height of their power, the Tar-Aiym encountered the Hur'rikku, an older but less advanced species from the galactic center. While the Hur'rikku were technologically inferior to the Tar-Aiym, they were tremendously tena-

## Commonwealth Timeline

Old Calendar	After Amalgamation
--------------	--------------------

c. 1,000,000,000 B.C.

The Xunca Empire rules the Orion and Sagittarius Arms. The Xunca begin to set up transmitters throughout the galaxy.

c. 400,000,000 B.C.

The Xunca create the Groatamasan Ocean on the planet Tslamaina (Horseye.)

c. 950,000 B.C.

The Hur'rikku begin to explore from the Galactic Center.

c. 500,000 B.C.

The height of the Tar-Aiym Empire. The Tar-Aiym encounter the Hur'rikku and attempt to subjugate them. The Tar-Aiym/Hur'rikku war lasts a thousand years, culminating in the release of the Blight and the destruction of both races.

c. 97,000 B.C.

The Alaspinian multi-culture reaches its height. The Alaspinians explore space far beyond the boundaries of the modern Commonwealth, but never colonize a single world.

c. 75,000 B.C.

The Alaspinians disappear.

27,000-17,000 B.C.

Most recent warm cycle on Tran-ky-ky.

c. 8000 B.C.

-10,400

The "birth" of thranx civilization on Hivehom. Founding of the "Eternal City of Daret," the first thranx city made up of several Hives.

c. 7000 B.C.

-9400

Confrontation between the Twentieth Emperor Thumonstener and King Vilisvenqen erupts into war involving most of the Hives on Hivehom.

c. 6000 B.C.

-8400

The last thranx vs. thranx wars are fought. World government begins to evolve on Hivehom after this date.



## Commonwealth Timeline

Old Calendar	After Amalgamation
A.D. 1787	-613
First thranx space launch.	
A.D. 1794	-606
First thranx landing on any of Hivehom's moons.	
1844	-556
Thranx colonize three other planets in the Hivehom system.	
1897	-503
Thranx scientists develop posigravity drive.	
1940	-460
Thranx scout ships discover Willow-Wane.	
1959	-441
First human space launch.	
1969	-431
First human landing on the Moon.	
2047	-353
Launch of the first human slower-than-light "sleeper" colony ship, aimed at Alpha Centauri.	
2074	-326
Alpha Centauri sleeper ship drifts off course, reaching another star. The third and fifth planets are colonized; the colonists name the system Centaurus, in honor of their original destination.	
2101	-299
Thranx explorers first encounter the AAnn. Within five years, diplomatic relations between Hivehom and the AAnn Empire are established.	
2174	-226
Human scientists translate the languages of the whales, and develop the cetacean translator. The low intelligence of the whales is a major scientific disappointment.	
2270	-130
The Cetacean Sapiency serum is developed and administered to dolphins. Intellectual improvement in test subjects is dramatic.	
2280	-120
The terran invention of the posigravity drive by Alex Kurita and Sumako Kinoshita leads to the rediscovery of the Centaurus System colonies.	

cious and multiplied at an extraordinary rate. The Hur'rikku resisted every effort to be forced into the Tar-Aiym hegemony, made giant technological strides, and spread rapidly to systems in the Sagittarius Arm.

During the Hur'rikku confrontation, the Tar-Aiym channeled tremendous energy into weapons research. Two major results of that research have been discovered. The first is the Krang on Booster, a square-bottomed pyramid half a mile on a side and two miles high. The walls are 500-foot-thick pseudoceramic, while the 60-foot-thick doors are made of an unduplicated Tar-Aiym alloy. Inside, a colossal theater surrounds a control platform, while beneath the pyramid, hundreds of cubic miles of machinery tap the energy of the planetary core. Some Commonwealth xenoarcheologists maintain that rather than a weapon, the Krang is actually a vast musical instrument; others, considering the warlike mentality of the race, theorize that it functioned as both.

The second result of Tar-Aiym research was a bacteria which multiplied at a phenomenal rate, devouring its own kind if no other host was available. To any creature with a nervous system more complex than that of a higher invertebrate, this plague was invariably lethal.

The Tar-Aiym released the exterminating plague onto the Hur'rikku worlds, believing that they could either cure or contain the disease before it spread. They were wrong. The plague left thousands of worlds occupied by lower animals and the wreckage of past civilizations. Fortunately, the surviving spacefaring species were warned by the last remnants of the dying Tar-Aiym, and an informal quarantine of Tar-Aiym space, now known as the Blight, was established. Only recently has the Blight been hesitantly explored — the taboo lingers even though the plague consumed itself millennia ago.



## The Alaspinians

Many spacefaring cultures existed during the Interregnum between the Tar-Aiym Empire and the Humanx Commonwealth, but few controlled significant numbers of worlds. Most eventually collapsed into barbarism, losing their star-travel technologies to the ravages of war or time, and leaving only a small cluster of worlds occupied by similar societies to mark their spacefaring past.

The most interesting of these is the Alaspinian multi-culture. The Alaspinians explored many habitable worlds of the Orion Arm, though they did not colonize any of these worlds. Instead, they returned to their homeworld after each voyage.

The Alaspinians were polytheistic, and each of their myriad gods was worshipped in a small geographical area. Temples were decorated with ornate bas-relief in stone and precious metals, and often featured complex gravity-fed fountains. The Alaspinians left no image of themselves, though, nor has any of the debris common to spacefaring civilizations ever been found on Alaspin.

No one knows what happened to the Alaspinians. Their temples are all that remain of their once thriving culture — no other remains have been found. There is no evidence of a disease or natural disaster. Some xenoarcheologists believe that they "matured" as a species and simply chose to die off.



# The Origins of the Commonwealth

The intelligent species of the Humanx Commonwealth developed within the last ten thousand years. Of these species, the two most widespread are humans and thranx.

## Human History

Humans evolved on Terra from nomadic primates inhabiting the steppes of central Asia and the savannahs of northern Africa. Humans advanced slowly through most of their history, both driven and hampered by racial tendencies toward greed, violence, territorialism, religious dogmatism, and what the thranx call "a species-wide homicidal paranoia." Roughly 1,000 years prior to the Amalgamation, humans entered a period of rapid cultural and technological development, called the Renaissance. In less than 600 years, humans advanced from a feudal, pre-steam society to a sophisticated spacefaring culture. This rate of development is unparalleled in galactic history.

All of this technological development was not without peril. During the latter half of the 20th century, destructive technologies outstripped humanity's ability to manage them, plunging Terra into a continual nuclear crisis. Thranx historians are amazed that humans survived this hazardous and potentially fatal time; many sapient species with similar histories failed to do so.

Human expansion to other stars was partially hindered by scientific dogma. A major human theoretician of the 20th century had "proven" faster-than-light travel impossible; his false theory of relativity became a scientific sacred cow. In spite of this, slower-than-light "sleeper" ships left Terra in the mid-21st century, bearing frozen colonists to nearby systems.

Posigravity drive was discovered by Alex Kurita and Sumako Kinoshita in 2280 Old Calendar. Under the umbrella of the newly forming Terran World Government, humanity made its first faster-than-light leaps into interstellar space. Early expeditions visited worlds targeted by the sleeper ships of the previous centuries. Most of the sleeper ships had fared poorly; some had found habitats barely capable of supporting life, while others had never arrived at their target planets.

After their disappointing search for sleeper colonies, posigrav vessels were sent in search of habitable worlds. A wave of colonists left Terra during the early 24th century Old Calendar. Some were unhappy with the new Terran World Government, while others sought new opportunities and adventure. These colonies flourished, as scouting reports allowed them to choose their new homes.

The colonies grew more and more independent of Terran government. As time passed, colonies seceded from Terran rule. After a period of internal divisiveness, the Terran World Government reconciled itself to the loss of control over the colonies and established trade relations with them. Most were not yet fully self-sufficient, and Terra was still the sole source for many necessities. The trade and treaty ties which bound the colonies to their homeworld had evolved into a Commonwealth by the beginning of the 25th century.

## Thranx History

The thranx evolved from hive-dwelling arthropods on the planet Hivehom. In prehistoric times, thranx society centered around a single fertile Hivemother, served by sterile workers, soldiers and drones. As thranx developed intelligence, however, they evolved away from specialized forms; sexually functional females now make up half the thranx population. Modern Hivemothers are treated with great respect, but no longer bear the entire weight of reproduction.

Civilization on Hivehom developed more slowly but less erratically than it did on Terra. A much more peaceful species than humans, thranx were not

## Commonwealth Timeline

Old Calendar	After Amalgamation
2290	-110
Human explorers discover the ocean-world of Cachalot.	
2300	-100
The Terran World Government is founded. The transfer of the serum-enhanced Cetaceans to Cachalot begins.	
2310	-90
The human scout ship <i>Seeker</i> is attacked by the AAnn. Her crew is picked up by the thranx vessel <i>Zinramm</i> and taken to Hivehom. The humans escape Hivehom with the thranx Ryozenzuzex, and return to Centaurus VII.	
2316	-84
The Project, set up on Willow-Wane by Ryozenzuzex and several humans, is revealed to the human and thranx publics. The Project involved raising human children and thranx larvae together in order to avoid the development of "shape-fear" — xenophobia.	
2320	-80
The transfer of the Cetaceans to Cachalot is completed.	
2340	-60
The first trade and non-aggression treaties between Terra and Hivehom are signed.	
2355	-45
The United Church is founded, and takes a leading role in the formation of the Commonwealth.	
2360	-40
Humans make contact with the Pitar. Initial relations between the races are friendly.	
2365	-35
The Terran colony world Treetrunk (Argus V) is destroyed by the Pitar, touching off the Pitar-Humanx War.	
2368	-32
The Pitar-Humanx War ends with the extinction of the Pitar race. The defeat of the Pitar is facilitated by advances in weapon and posigrav technology made by joint human-thranx research teams.	



## Commonwealth Timeline

Old Calendar	After Amalgamation
2400	0
The Treaties of Amalgamation between humanity and thranx are signed, forming the Humanx Commonwealth.	
2506	106
Drs. Etienne and Lyra Redowl begin their historical survey of the cultures of the Skar River Valley on the planet Horseye.	
2550	150
Brisbane, Australia, becomes the capital of the Terran World Government.	
2687	287
The Blight is first encountered by Humanx survey ships.	
2889	489
Tolus Prime becomes a Class I member of the Commonwealth.	
2908	508
The Meliorare Society is established to promote experimental genetic engineering.	
2913	513
An independent prospector discovers the Idonian Mask on Alaspin.	
2923	523
Humanx and AAnn forces clash over an ornithorpe colony in the Battle of Good-hunting.	
2927	527
The Analava System War kills 120 million people before Church Peaceforcers can intervene.	
2933	533
Birth of Phillip Lynx (Flinx) as Meliorare Subject #12.	
Joao Acorizal breaks Commonwealth surfing records in the triennial surfing competition on Dis.	
2937	537
Truzenzuzex and Bran Tse-Mallory begin joint research on the Tar-Aiym.	
2941	541
Mother Mastiff narrowly outbids Skua September at a Drallar slave market, purchasing the eight-year-old Flinx. Flinx and Pip first meet.	

driven by war to develop technology. Once they had solved the problems of the moment, thranx experimented only out of philosophical curiosity.

Alliances between thranx hives developed into nations and then a world government. Rather than an elaborate bureaucracy, this government was based on a sophisticated set of laws and moral codes. These moral codes became sufficiently ingrained in thranx thought that many of the conflicts between the governors and the governed which plagued humanity were played out in parables in the individual thranx mind.

Part of the reason for the easy transition from individual hives to a world government was a cooperative mindset reaching back to primitive thranx, when the hive-creatures cooperated to fight predators. Hivehom's jungles held many more creatures to challenge thranx than Terra did for humans. The competitive spirit which drove humanity was unknown among thranx; cooperation was essential to thranx survival well into historical times.

Even so, thranx are not pacifistic; Hivehom has seen its share of inter-hive conflicts. But among thranx, war is a last resort, reserved for circumstances which diplomacy *cannot* resolve. The last war between thranx was fought over 8,000 years ago.

For millennia after the formation of a world government, the thranx lived peacefully on Hivehom. When curiosity and population pressure inspired them to develop the posigravity drive, thranx founded colonies on worlds like Long Tunnel, Everon, Calm Nursery, and Willow-Wane. They discovered one other sapient, pre-space-flight species and several proto-sapient species, all similar to thranx in biology. It was thus a great shock when the thranx first met another spacefaring species, the reptilian AAnn.

Thranx biologists had long believed that sapience could not develop in beings without exoskeletons — such creatures would be too fragile to survive. Although their scaled skins were almost as tough as thranx chitin, the AAnn were plainly endoskeletal. And while the unrelenting militarism of the AAnn was incomprehensible to them, thranx didn't hesitate to defend themselves. The AAnn raided a few thranx worlds, but were fiercely driven back.

Thranx and AAnn eventually fell into an uneasy truce. Despite periodic raids by the AAnn, there was never an overt declaration of war between the two species. This cease-fire continued until the "discovery" of humans.

## Humanx History

The first meeting between humans and thranx was anything but auspicious. AAnn raiders attacked the human starship *Seeker*, leaving the crew to die on board the badly damaged ship. A thranx exploratory vessel discovered the *Seeker*, capturing ship and crew.

The thranx at first believed the humans to be allies of the AAnn. Further complicating thranx reactions to humans was the similarity between human scent and that of the *yaryinf*, a mammalian predator native to Hivehom. *Yaryinfs* are also called "thranx-eaters."

The human crew of the *Seeker*, previously unaware of the AAnn, believed they had been both attacked and captured by the thranx vessel. Their reaction to their thranx captors was colored by the insect-like appearance of the thranx, which bore a strong resemblance to that of the "bug-eyed monster" common in human science fiction literature.

Eventually, a thranx named Ryozenzuzex managed to communicate with the captives, bringing human and thranx together for peaceful conversation. After both sides' initial revulsion had subsided and the role of the AAnn in the *Seeker* incident had been proven, thranx and humans discovered that they liked one another. Humans admired thranx calmness, rationality, politeness, and wry



humor, as well as their bright colors, graceful movements and attractive scent. Thranx were impressed by human self-confidence, intuition, and recklessness, and found that the human attributes of physical strength, flexibility and stamina more than made up for their unpleasant mammalian odor.

Human and thranx linguists developed Symbospeech, combining the clicks, whistles, and some of the rough rasps of High Thranx with most of the smoother sounds of Terranglo. Symbospeech has become a universal language throughout the Commonwealth. As an artificial language, it is relatively free of ambiguity, and its sound combinations are within the capabilities of most sapient species.

Human and thranx technology complemented one another well. Each species had developed posigravity independently, but the human engine was somewhat more efficient. Thranx-suggested improvements at the time of the Pitar war (see below) improved efficiency significantly, and the resulting KK drive became the standard for all vessels.

The philosophy of the two races fit together just as neatly. Becoming popular both on Hivehom and Terra in the years preceding the *Seeker* incident was a pragmatic but good-humored agnosticism; when the leaders of these movements among each race met, they discovered their philosophical compatibility at once. The result was the distinctly non-religious United Church, a spiritual organization offering guidance and comfort without forcing dogma. The Church quickly took a leading role in the efforts to bring the thranx and humans together.

Swiftly, as such things go, Hivehom and Terra moved towards a grand alliance: the Humanx Commonwealth. Before this dream was realized, however, its importance was reinforced by disaster.

### *The Pitar*

In 2360, fifty years after the *Seeker* incident, humans made contact with the Pitar, a humanoid race occupying two planets in the Orion sector. Physically, the Pitar were identical to humans: the men muscular and handsome, the women feminine and beautiful. Pitar technology was fairly advanced, and in a few fields — such as weaponry — rivaled that of Terra.

The Pitar seemed cordial enough, if a bit nervous and self-centered, and professions of mutual aid and undying friendship were exchanged between Terra and Pitar. The discovery of so similar a race thrilled humanity; Pitarian goods and styles became the rage on Terra. Human-Pitar friendship progressed at a rate comparable to human-thranx for five years, until the Treetrunk Massacre.

In 2365, a tramp freighter put in at the human world of Treetrunk, only to find the entire colony — six hundred thousand people — slaughtered by an unknown invader. Not a man, woman, or child had been left alive on the entire planet. Oddly, there were fewer female remains than male. Expressions of sympathy poured in from the other intelligent species, including the Pitar.

Two months later, a man was found in an antique, jury-rigged lifeboat orbiting one of Treetrunk's two moons. The story he told is now infamous throughout the Commonwealth.

The enemy struck without warning, attacking the undefended colony from space. Treetrunk had no military; her small police skiffs were rapidly destroyed, as were most of the posigravity drive ships in orbit. The remaining ships were taken as prizes. Once the colony's interstellar communication equipment had been destroyed, the invaders landed.

The survivors of the initial assault were astonished to discover that their invaders were Pitar. The aliens poured out of landing ships and began to slaughter the colonists, using life detectors to ensure a thorough job. Once all humans on Treetrunk had been slain, the Pitar collected corpses — mostly female — for hideous purposes later discovered by Commonwealth investigators. Details

### *Commonwealth Timeline*

Old Calendar	After Amalgamation
2945	545 Hyperion forests on Annubis, source of the drug bloodhype, are destroyed.
2948	548 Flinx rescues Mother Mastiff from the Meliorare Society. The last known Meliorare are killed. Ethan Fortune and Skua September are stranded on Tran-ky-ky, and play crucial roles in the construction of the icerigger <i>Slanderscree</i> and the destruction of the nomadic Horde.



2949	549 The Krang, a Tar-Aiym artifact, is investigated by Flinx, Bran Tse-Mallory, Truzenzuzex and Maxim Malaika. Fortune and September organize the Union of Ice, a confederation of tran city-states on Tran-ky-ky, in order to gain Commonwealth membership for the planet.
------	---



## Commonwealth Timeline

Old Calendar	After Amalgamation
--------------	--------------------

2950	550
------	-----

Flinx violates Church edict to visit Ulru-Ujurr, where he uncovers an AAnn plot involving Janus Jewels. As a result of Flinx's visit, the Ujurrians begin the "Game of Civilization."

Fortune and September participate in a scientific expedition to investigate climatological anomalies in the southern hemisphere of Tran-ky-ky.

2951	551
------	-----

Flinx visits Alaspin, where he encounters September.

2952	552
------	-----

Flinx accompanies Knigta Yakus to a Hallowseye mine at Dead-Place-On-Map on Moth.

2953	553
------	-----

Five human "floating towns" on Cachalot are destroyed; investigation leads to the discovery of the coelenterate intelligence, the CunsnuC.

2954	554
------	-----

Evan Orgell investigates the disappearance of a research station on the newly-discovered world of Prism.

2955	555
------	-----

Kitten Kai-Sung and Porsupah investigate the appearance of Bloodhype on Repler, and in the process become involved in the mysterious Class One Emergency on that world.

2956	556
------	-----

Today in *GURPS Humanx*.  
The Challis Company announces the discovery of ferrosilicate ore on the new world, Praxiteles IV.

c. 15,400	c. 13,000
-----------	-----------

The current cold cycle will end on Tran-ky-ky, and the next warm cycle will begin.

were never officially revealed by the Commonwealth, although the rumors which circulated in the following weeks were sufficient to enrage all humanity.

Terra assembled an armada and hurled it at the Pitar. Although the Pitar space fleet was heavily outgunned and outnumbered, the Pitar managed to hold the humans off for some time, using a defensive energy screen. The armada became a besieging force, and the invasion a war of attrition.

The thranx — who have honored their females since prehistoric times — were outraged by the Treetrunk Massacre, and joined the human invasion effort. Human-thranx teams perfected the KK-drive, and thranx researchers expanded on this technology, developing the SCCAM shell. Itself an overloaded KK drive, the SCCAM shell seeks and destroys other posigrav drives and devices. SCCAM shells brought down the Pitar defensive screen, allowing human and thranx commandos to land. Although scientists hoped to preserve Pitar culture for study, the hostility felt by the humanx soldiers — combined with the Pitarian determination to fight to the last — made the invasion one of extermination.

Studies of Pitarian relics indicate that the Pitar were incapable of comprehending such concepts as mercy and understanding, and were possessed as a race by a powerful xenophobia. Having stolen as much technology as they could from Terra, the Pitar set out to destroy humanity. Once they had done so, the Pitar would have expanded their program of genocide throughout the galaxy.

Three dead, blasted worlds — Treetrunk and the Pitar system worlds — stand in mute testimony to the Pitar-Humanx War. They are seldom visited, except by the morbidly curious.

## Amalgamation

Despite the tremendous loss of life, the Pitar-Humanx War united humans and thranx. After the war, amalgamation was resoundingly approved by the electorates of both species. The official treaty of amalgamation was signed on January 1, 2400. This date was used as the basis for a common humanx calendar, counting years After Amalgamation (A.A.). The benefits of amalgamation were soon apparent.

The efficiency of the thranx legal system was a marvel to human legal experts; thranx judges quickly cleared the backlog in Terran courts. In addition to their natural aptitude for law and ethics, thranx judges had the advantage of being impartial in most human disputes.

Thranx embraced the human pastimes of sports and games. They excelled in several sports, but viewed them as physical and mental exercises rather than competition. Thranx behavior epitomized sportsmanship, and their participation was welcomed in every form of human leisure.

Pressure from the AAnn decreased after the Amalgamation. The combined strength of the Humanx Commonwealth greatly outweighs that of the AAnn Empire. Raids on human and thranx worlds became less common, though the Empire continues to nurse its plans for galactic domination.

The Commonwealth has not been without its own internal stresses, however. There are constant attempts to circumvent Church protection of newly discovered worlds. Various heretical groups have sprung up, and traffic in illegal drugs and other contraband is a constant problem to Church Peaceforcers.

The most serious disaster in the Commonwealth's brief history was the Analava System War, which erupted in 527 A.A. over trade differences between the system's two colonized worlds. 120 million people were killed before Church Peaceforcers could intervene. Both worlds were left unable to support technological civilization. The causes of the Analava System War are still not entirely clear, but the Commonwealth continues to seek the individuals who may have incited the bloody conflict and flown before the final devastation.

# THE HUMANX COMMONWEALTH

# 2

The Humanx Commonwealth is not a government — it is an association of worlds united to promote trade and provide common defense. Formed in 2400 O.C. (0 A.A.), it offers a common currency, economic assistance to developing worlds, defense from external (and internal) threats, and a patent system to protect the intellectual achievements of creative beings. Outside of these areas, however, the Commonwealth's powers are extremely limited. Member worlds are sovereign states, free to manage internal affairs with minimal interference by the Council.

The Commonwealth is governed by a Council of representatives from all member worlds. Each Class I world appoints three representatives to the Council, while Class II worlds appoint one representative each. Class III, IV, and VIII worlds are represented by the United Church, which is itself a Class I member. Currently, the Council has 327 representatives, counting the Church.

Commonwealth activities are funded through moderate tariffs on interstellar trade. Some smuggling goes on, and customs officials sometimes attempt to conceal trade to reduce their world's payments into Commonwealth coffers. A member world which cheats is politically pressured back into line.

Although the Commonwealth is a trade organization, its members have agreed to certain non-mercantile regulations. Among these is a law forbidding member worlds from operating warships capable of interstellar travel. Although worlds are free to defend themselves as they see fit, interstellar defense is entrusted to the Peacekeeping Force of the United Church. This restriction was established early in Commonwealth history to prevent a repeat of the Pitar experience.

Commonwealth citizens who visit member worlds are guaranteed certain specific legal rights, including the right to legal counsel, the right to refuse self-incrimination, and the right to a speedy trial. This last is subject to considerable local "interpretation" — accused off-worlders have occasionally spent years in jail awaiting trial. All member (and even some non-member) worlds have a Commonwealth consulate near the major spaceport, where they can appeal for assistance in a variety of legal and business circumstances.

Commonwealth employees, from the lowest bureaucrat up to the highest Council representative, are subject to periodic standardized competency exams and an elaborate system of performance reviews. Individuals failing these exams are demoted or relieved of duty.

## The United Church

Despite its name, the United Church is a nonreligious organization; it functions as a citizens' advocate, monitoring the well-being of the population throughout the Commonwealth. From its headquarters on the Terran island of Bali, the Church wields tremendous power in the Commonwealth. It functions as a Class I member of the Council, representing the population of the Commonwealth as a whole. The United Church Bureau of Supra-Commonwealth Registry classifies newly discovered worlds and assesses the readiness of worlds for Commonwealth membership. Only the Church can propose expulsion of a member from the Commonwealth — the threat of excommunication is one of the Church's most potent political weapons.

### *Church Headquarters*

The United Church is headquartered in Denpasar, on the Terran island of Bali. The island is closely guarded; the only three classes of people allowed to visit the island are Balinese natives, officials and employees of the United Church, and representatives of Commonwealth member worlds given official permission to visit the island.

The surface installations at Denpasar are beautiful, but hardly imposing. Built in the Balinese style, most of the Church buildings are low and small. The largest — the United Church University — covers about an acre, while the tallest — the Church Astrophysics Laboratory — is only four stories high.

The true, working headquarters of the Church, however, lies beneath the surface of the island. Honeycombing Bali and the surrounding area is a subterranean complex of laboratories, offices, computer rooms, warehouses and apartments. From these facilities, the Church coordinates activities including planetary administration, scientific research, military operations, espionage and counter-espionage measures, planetary and deep-space exploration, as well as economic and census record keeping. Movement through the complex is facilitated by vertical and horizontal lifts, as well as high-speed shuttles.

Security for the underground headquarters is even more strict than for the island above. Only two entrances to the complex exist — one in the United Church Records Center, in Denpasar, the other an undersea shuttleport facing the neighboring island of Lombok. Every person entering the underground complex must be identified by retina or antenna pattern and is closely scanned for concealed weaponry. The lift system will not operate without a lift pass, which is also keyed to the proper user's retina or antenna pattern. Lift passes are normally available only to permanent church employees; thus, visitors must have a guide with them in order to travel about the complex.

The existence of the underground complex is officially a Church secret, although by 550 A.A., enough outsiders have visited it that rumors about it are beginning to spread. It is almost certain that the AAnn have learned that the Church headquarters extends underground, although they have never successfully infiltrated the facility.



## The Book

The non-religious philosophy espoused by the Church is similar to that of their Balinese hosts at Denpasar — it emphasizes gentleness, creativity, humor, tolerance, self-improvement, and cooperation between individuals and communities. The teaching of the Church is set down in its bible, *The Holy Book of Universal Truths, and other Humorous Anecdotes*, or simply *The Book*. A few of its basic tenets are:

“Man is animal, thranx is insect — both are of the species Brother.”

“If God wished man and thranx to devote themselves to Him, He would not have made the worlds so complicated.”

“Distrust anything that smacks of absolute right.”

“Self-righteousness is the key to destruction.”

“Accidents and miracles do happen, if you can find the proper place in space.”

“To be angered by evil is to partake of it — stupid.”

## Church Emergencies

For the most part, Commonwealth worlds are free to deal with their own problems and emergencies as they see fit. The United Church stands ever-ready to intervene in planetary disasters, though, and any emergency involving or threatening more than one member world *automatically* falls under the jurisdiction of the Church.

The Church has a system for classifying emergencies, based on the severity of the situation. A *Class Three Emergency* is any situation representing a threat to the peace and political stability of the Commonwealth. The Analava System War was a class three emergency, as would be a serious invasion by the AAnn. A *Class Two Emergency* represents a threat to the foundation of humanx society, the Church itself; the Church attempts to keep class two emergencies secret. A situation is considered a *Class One Emergency* only if it threatens “the race of reason” — that is, the galactic community of sentient species. The Class One Emergency was long considered purely theoretical — what single incident could cause the extinction of all sentient life in the Commonwealth? In 555 A.A., however, the Church declared the mysterious incident at Repler Class One. Doing so may have been a mistake, though, as this declaration brought *more* attention to the situation, which the Church wished to cover up.

The Church is governed by its own Council, which convenes annually at the Church Chancellory in Denpasar, Bali. The Church Council is presided over by the head of the Church, a man — or thranx — known as the Last Resort. Any decision made by an individual official affecting an entire Commonwealth world stands only until the next convention of the Church Council, at which time it may be approved as the official ruling of the Church, modified or even reversed.

The Church maintains extensive genealogical records at Denpasar, recording every birth within the Commonwealth. Agricultural research facilities on Bali simulate conditions on many worlds. Rumors indicate that the modest surface facilities at Denpasar conceal a vast underground complex housing a variety of sensitive intelligence and scientific data.

The Church also provides the Commonwealth’s military strength, the United Church Peacekeeping Force. The Peacekeeping Force is the primary defense against the AAnn Empire, and also maintains interstellar peace within the Commonwealth.

The Church maintains an extensive intelligence network, operating both within and outside the Commonwealth. This intelligence service provides data for the Peacekeeping Force, the Church Council, and the Commonwealth Council, although in emergency circumstances it can operate without pre-approval and even command non-intelligence Church forces.

The Church employs a system of testing and review similar to that of the Commonwealth bureaucracy, ensuring the competence of those who carry Church power. The tests measure psychological stability as well as competence; “problem” officials are detected early and provided educational and psychotherapeutic help.

The United Church found its philosophical basis decades before the Amalgamation, when the Radical Agnostic theologians of Terra merged with the Aesthetic Philosopher sect of Hivehom. Together, they answered the awkward question of which side the Deity might be on by proclaiming that he was likely sitting back and watching the whole business with considerable amusement.

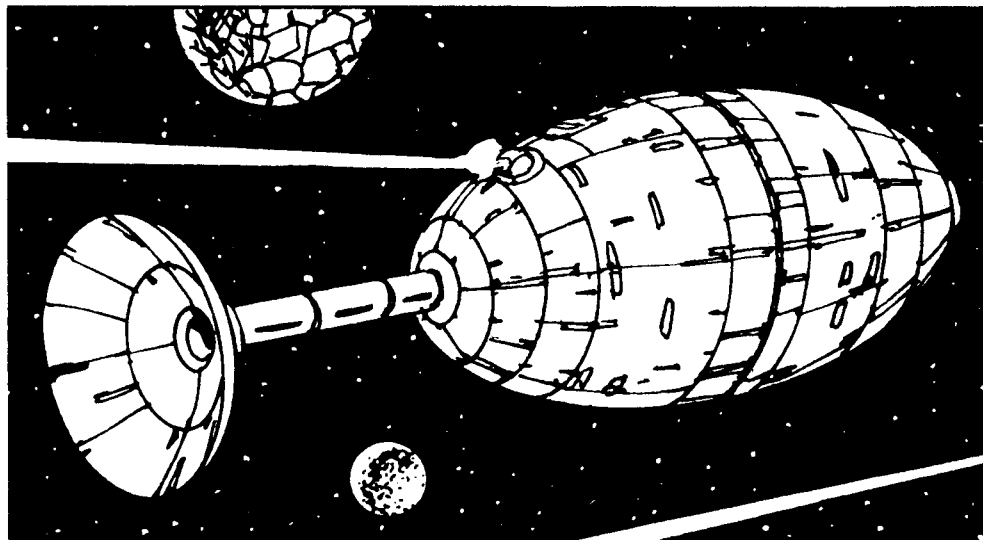

## The AAnn-Humanx Cold War

Humanx and AAnn interests have conflicted since before the Amalgamation. The AAnn view themselves as the naturally dominant species in the Orion Arm. They have been deterred from conquest of humanx worlds by the effectiveness of the Church Peacekeeping Force’s stingships and the demonstrated tenacity of humanx-controlled worlds in the face of invasion.

Lacking the resources for a military conquest of the Commonwealth, the AAnn have turned to more subtle tactics. In treaty negotiations, AAnn ambassadors aggressively seek any advantage to weaken the humanx position. AAnn spies operate deep within the Commonwealth, subverting governments, promoting criminal activity, and staging terrorist strikes, aided by self-interested humans eager to accept their rich bribes. AAnn assassins have taken the lives of military personnel, top scientists, politicians, and bureaucrats, deep within the “safety” of humanx space.

The Church Peaceforce prevents large-scale invasion by the AAnn, but cannot hope to prevent individual AAnn ships from entering Commonwealth space. AAnn vessels, operating on their own initiative and for their own gain, frequently raid and loot border colonies. Although AAnn ambassadors are quick to apologize for the “navigational errors” leading to these incursions, it is widely believed that the AAnn Empire encourages these allegedly unauthorized raids by allowing captains to keep the profits. Church Peaceforcers in border regions are ever-vigilant, ready to rush to the defense of Commonwealth worlds threatened by AAnn raiders.

## Other Organizations

### The Lynx Society

The Lynx Society, formed on Terra in 147 A.A., is an organization of women who believe that marriage is an undesirable state. Instead, Lynx seek the most successful, interesting, and exciting men in the Commonwealth for liaisons lasting anywhere from a few hours to several years. Despite their shady reputation, the Lynx deny that they are prostitutes. Lynx seek relationships with exciting men; wealth is simply one thing that makes a man exciting.

### The Meliorare Society

Although considerable progress in the field of genetic manipulation has been made since the first independent experiments on pre-Amalgamation Terra and Hivehom, humanx scientists have carefully avoided manipulating the genes of sapient beings. Church strictures expressly forbid “tampering with the genetic destiny” of an individual, except where a detectable defective gene can be replaced with non-defective tissue *in vitro*.

There are those, however, who believe that genetic manipulation is the key to human destiny. “If we fail to explore and master our own potential,” their doctrines cry, “we do not deserve to explore and master the universe.” One proponent of genetic manipulation was Henry Fowler, a Terran entrepreneur (458-508 A.A.). Upon his death, Fowler endowed the Meliorare Society, a research institute dedicated to the genetics of human psionic Talents.

But the Meliorare Society rapidly went beyond the “basic research” charter set down by Fowler. Beginning in 514 A.A., secret experiments were performed on human embryos. A selective breeding program was designed and instituted to improve the human material available for genetic manipulation.

The results of these experiments were misshapen, tormented humanoids, casually destroyed as “experimental error.” But early failures did not daunt the Meliorares; over the next two decades, more than five thousand children, many hideously deformed, were born in Meliorare experiments.

In 535 A.A., Church investigators uncovered records describing the Meliorare experiments, and closed an important Meliorare experimental facility. Society leaders were arrested, charged with multiple counts of child murder, and selectively mindwiped. The surviving experimental subjects became wards of the Commonwealth, and were treated where possible.

## Commonwealth Time and Dating Systems

To facilitate recordkeeping among hundreds of worlds, each with its own calendar and schedule of seasons, the Commonwealth has arbitrarily adopted the “T-Standard” calendar as its official year. Based on the natural Terran year, the T-Standard year has 365 days, divided into 13 months of four seven-day weeks. The thirteenth month, Enver, falls between December and January; an intercalary holiday, Midyear, is added between Enver 28 and January 1 to round the calendar out to 365 days. To keep the Commonwealth calendar in line with the natural Terran year, every fourth T-Standard year is a leap year, in which Midyear is extended to two days.

Commonwealth years are numbered from the signing of the Treaty of Amalgamation, on January 1, 0 A.A. (After Amalgamation). On the old Terran calendar, the Treaty was signed on January 1, 2400.

Most worlds keep the time of day in the hours of the most common race of the planet — usually human or thranx. The HH-Standard (Hivehom, or thranx) hour is just under 50 T-Standard minutes, and is divided into 64 “chronits” — the thranx equivalent of a minute. An HH-Standard day is a few minutes less than 20 T-Standard hours long, and is made up of 24 HH-Standard hours.

Most wrist chronometers in the Commonwealth have two digital displays — one shows the T-Standard time and date, used for scheduling interplanetary travel and communications, while the other indicates local time and date, dividing the local solar day into T- or HH-Standard hours, as appropriate. The inhabitants of each world run their lives according to the rising and setting of their local sun, referring to T-Standard time only for interstellar business.



Rumors periodically surface that the Meliorare Society still exists; the Church Peacekeeping Force maintains a Moral Operations subdivision dedicated to the location and destruction of Meliorare sites throughout the Commonwealth.

### The Qwarm

A mysterious clan of human assassins, the Qwarm offer their services to any who can afford them. Although one may be found operating as a bodyguard — few can rival a Qwarm for efficiency in this role — the stealth and guile of a Qwarm more perfectly suit the role of a hunter. It is said that all Qwarm are related, but none can be sure. Qwarm have been suspected in a number of political murders, but usually elude planetary and Church Peaceforces. Indeed, whenever an assassination goes unsolved, rumors of Qwarm invariably circulate.

While Qwarm are masters of disguise, they often appear in public in their traditional garb: a skin-tight black jumpsuit, a cape of red and black streamers, and a black skullcap decorated with red foil. Qwarm typically shave their entire heads, including the eyebrows. When they move among the citizenry, Qwarm command a wide berth. Few people even *look* at a Qwarm, for fear of offending him — *no one* wants to offend a Qwarm.

### Life in the Commonwealth

On most Commonwealth worlds, life is secure, comfortable and prosperous. Residents of civilized worlds like Hivehom, Carmague/Collangatta, and Tulus Prime can look forward to a long, productive, disease-free life, insulated from the excitement and hazards of frontier systems. Colonists on hardship worlds like Drax IV, Dis, and Horseye are not always so lucky.

Though the spaceports on these colonies are often well-appointed with TL9 equipment, life elsewhere can be very primitive. Even thranx prospectors on Drax IV find its weather oppressively hot and moist, while Commonwealth visitors to Horseye normally live among the medieval natives. Life on the stormy water-world of Dis would be impossible were it not for the advanced off-world technology making submarine cities possible. Yet totally unsettled worlds, such as Prism, make conditions on Drax IV and Horseye seem plush! On these worlds, a colonist/explorer is on his own, unable to rely on anything beyond the equipment he brought with him.

For those who want a calm, secure life, the Commonwealth provides it — but it also has plenty of room for adventurers. Humanx space is full of unexplored worlds holding both riches and dangers; many of the “civilized” worlds — especially pleasure planets like Balthazaar and Loser’s World — also offer hard-boiled characters gritty, urban challenges. Ancient artifacts and undiscovered aliens lie dormant, waiting to be awakened to devour a world or two. And just when you’ve made a system safe, the nefarious AAnn will pop up with a vicious plot to undermine the Commonwealth and the Church.

It’s fun to save a world, and the Commonwealth offers thousands of them.

### Transportation

#### *Interstellar Travel*

Regularly scheduled passenger liners and freighters run between most Commonwealth worlds. Several vessels arrive and depart every day at the spaceports of Class I and II worlds, while most lesser worlds are served by a few ships each week. At least three ships leave Terra for Hivehom — and vice versa — every day. In general, Class I worlds serve as central ports for the lesser worlds around them; to get from Willow-Wane to Cachalot, a traveler would fly first to Terra aboard a huge starliner, and then transfer to a smaller “commuter” liner for the hop to Cachalot.



Reservations on the next ship headed for any world — including any necessary connections — can be made through any spaceport. Most voyages take several days, requiring complete accommodations for the passengers. A second-class fare on a typical passenger liner — including a double stateroom and all meals — costs about \$250 per day of travel; heavily traveled routes will usually be 10 to 25% cheaper, while passage to infrequently visited worlds can be three times as expensive. Of course, first class accommodations are available on larger liners, costing from \$500 per day for a private stateroom up to \$2,500 per day for a suite of rooms and gourmet meals.

It is possible to travel more cheaply, though. Some older passenger liners feature a “steerage” fare: four to a stateroom and one unpretentious meal a day for \$150 per day of travel. Most steerage passengers carry some extra food with them, although additional meals may be purchased from the galley. Commercial freighters often carry passengers when they have room. This is very inexpensive — about \$50 a day — but often there simply isn’t a ship going in the right direction. To avoid various fees and regulations, most freighter captains do not register the availability of passenger berths with dockmasters. Thus, even if space is available on a ship going where a traveler wants to go, he must make a Streetwise or Scrounging roll to get in touch with the captain.

Getting to uninhabited frontier worlds can be a bit more difficult. Small, private spacecraft are available, but prices run into millions of credits. Most people find it more economical to charter or lease a ship. Chartered spacecraft usually come with a captain and full crew; the customer is simply along for the ride. The cost to charter a vessel is highly variable, and depends on the size and quality of the ship, the length of the charter, the route and destination, and any special hazards the ship might encounter. The cost to charter a small ship to carry half-a-dozen explorers and their gear to an unsettled world will be about \$10,000 per day of travel *each way*, plus about \$2,000 per day the vessel waits in orbit. If the captain suspects the party may not return from the planet, he will usually demand payment for the return voyage in advance.

Leasing a spacecraft similar to the one described above runs about \$7,500 per day, including fuel. Slightly cheaper rates for longer leases are available. No special skill is required to operate a leased ship; the onboard computer can operate and navigate the vessel. In fact, unless the lessee is a trained space pilot, the computer will be programmed so that manual override of the cockpit is impossible. Average skill for these computers is Pilot (Spacecraft)-12 and Navigation-12. To lease an unmanned spacecraft, a traveller must submit to extensive credit checks and sign a form allowing the leasing company to withdraw the value of the ship directly from his personal funds should he fail to return the vessel. Few companies will lease to a person whose total assets are less than half the value of the ship being leased.

For further information on spaceships, as well as travel time between various worlds, see Chapter 6, *Spacecraft*.

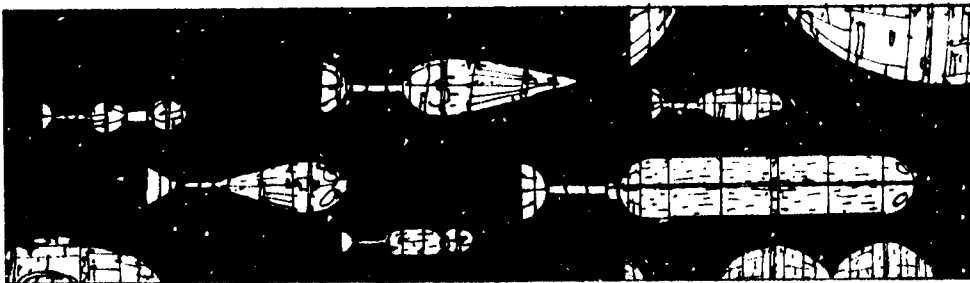

### Surface Travel

The quality and type of surface transport available depends upon the world — Hivehom is served by state-of-the-art public transportation systems, capable

### Surface Communications

The communication systems used by most Commonwealth worlds allow reasonably priced two-way communication, as well as inexpensive electronic mail. Electronic mail is usually delivered within 24 hours. The price to send an electronic letter from point to point on a single planet is usually about \$.10 per page within a city, or \$.50 per page for greater distances. A “page” holds about 250 words of text.

Two-way communication on a planet is carried out using tridees — three-dimensional transceivers. Within a city, a tridee call from a public tridee booth costs \$1 for three minutes; long distance calls average about \$1 per minute.

### Intrasystem Communications

To communicate across space within a stellar system, all spaceports and most spacecraft are equipped with TL9 tridee equipment. Tridee messages are sent via space-plus, the same alternate space traveled by posigrav spaceships (see p. 67), and can cover several million miles with no perceptible lag-time. Tridee equipment not only projects holographic images of the speaker, it can also be patched into a computer system to send digitized images. This is useful in controlling traffic around spaceports or coordinating fleet movements.

Any home or public tridee can access space-plus transmitters to call off-world within a system. An off-world tridee call costs about \$5 per minute. If the call is placed from a private tridee, the account will be billed; if the call is placed from a public tridee, the amount will be immediately charged to the caller’s credcard.

### Interstellar Communication

Interstellar communications are transmitted by deep-space beam, through an alternate space called space-minus. A vast amount of energy is required to send a message through space-minus; this energy dissipates rapidly, requiring amplification at relay stations along the route. Thus, interstellar communication is *very* expensive.

The cost to send a letter by interstellar electronic mail is \$1 per 10 parsecs per page. Instantaneous, two-way, two-dimensional visual communication via deep-space beam is far more expensive, due to the amount of information necessary to recreate a video image, and the need for transmission from both ends. The cost for two-way communication is \$1 per minute per parsec *for each speaker*. Thus, a five-minute call from Terra to Hivehom, 240 parsecs away, would cost each party \$1,200 credits.





## Money

The basic monetary unit of the Humanx Commonwealth is the credit, which has a value roughly equal to that of the US dollar in the 1980s. Throughout this book, the symbol "\$" is used to represent credits.

Most business transactions in the Commonwealth are carried out using credcards (see p. 57). When so, the Commonwealth issues both coins and bills in several denominations. Commonwealth coins are rectangular in shape, and are minted in denominations of 1/100, 1/10, 1/5, 1/2, and 1 credit; bills are printed in denominations of 5, 10, 50 and 100 credits.

Due to the convenience and security of credcards, few Commonwealth citizens carry more than a credit or so in cash. Especially on civilized worlds, the use of large amounts of cash indicates a need for anonymity; any large cash purchase is liable to attract attention and suspicion. Many worlds have laws requiring merchants to report large cash purchases, especially if they include weapons, ammunition, explosives, armor, or other "dangerous or potentially subversive items." On such worlds, a Streetwise roll is necessary to find a merchant who will — for a consideration of 25 to 50% of the total purchase price — "forget" to file these forms.

of moving people to and from any city on the planet in a few hours, while the hard-bitten prospectors in the jungles of Alaspin make do with slow all-terrain vehicles, or even pack animals.

Air travel on TL6 and 7 worlds is by plane or jet; land travel, by electric trains and buses; sea travel by fusion-powered ocean liner. (The Commonwealth avoids combustion and fission engines for ecological reasons.) On TL8 and 9 worlds, airplanes are replaced by the more convenient and comfortable contra-grav vehicles. Land travel is by train or monorail, driven by fission or magnetics, but fission-powered ocean liners continue to rule the seas on these high-tech worlds.

Private surface vehicles include the skimmer, a swift antigrav car; the mudder, a slow-but-hardy, multi-wheeled ATV; and a variety of more conventional electric cars and trucks. Again, combustion-fueled vehicles are rare on Commonwealth worlds. Any of these vehicles is readily available for rent on TL7+ worlds; on many worlds, rental cars are totally automated, requiring no skill to operate. On more primitive worlds, where a traveler needs his own transportation more desperately, rental vehicles can be very difficult to find.

## Wealth

The net worth of the average Commonwealth citizen — and therefore the starting wealth for *GURPS Humanx* characters — is \$15,000. For PCs with a permanent home and a regular job on a civilized world, 80% of this wealth will be tied up in home equity, furniture, clothing, etc., leaving only \$3,000 available to spend on adventuring gear. Of course, a Wealth advantage will increase both the PC's liquid cash *and* the quality of his home.

A few characters, especially those who live on the go, will opt to put their money into a spaceship or other "investment," rather than a home. While a spaceship will often be useful in an adventure, the PC will probably still have about 80% of his net worth tied up in the downpayment — leaving the same \$3,000 for things like handguns, armor, and walkie-talkies.

## Cost of Living

Status doesn't always correspond to a specific standard of living, but it is a general indicator. Monthly cost of living is determined by the PC's status. GMs should, however, be ready to vary the printed figures as specific situations warrant — it is not unreasonable to expect Wealthy and Filthy Rich characters to spend several times the listed amount. The table below lists the cost of living, per month, for each status level, and examples of each status level.

Note that living below your cost of living may actually reduce your Status. At the end of each month in which you pay less than the listed cost of living for your Status, roll against IQ+2; a failure means your status drops by 1. You don't "get back" the points you spent on Status to buy something else, though. If your Status drops, the point value of your character drops.

Status	Cost/Month
-2 Mothian "chattel"	negligible
-1 New Parisian serf	\$300
0 Commonwealth Citizen	\$600
1 Peaceforce Officer, Thrax Clanmother	\$1,200
2 Church Bureaucrat, Thrax Hivemother	\$2,400
3 Peaceforce Senior Officer, Thrax Eint	\$4,000
4 High Church Official, Major Spaceport Director	\$6,000
5 Corporate President, Colonial Governor	\$8,000
6 Commonwealth Councilmember, Planetary Governor	\$10,000
7 The Last Resort of the United Church	\$20,000

## Prices

A wide variety of goods and services are readily available throughout the Commonwealth. Many items unique to the humanx universe are described in the next chapter (see pp. 17-37). Prices for a sampling of more mundane items and services are listed below. As the Commonwealth credit is roughly equivalent to a modern U.S. dollar, prices for goods not listed can be easily extrapolated.

The prices here and in the next chapter pertain to civilized, well-settled worlds with significant local manufacturing capability; prices on colonies and remote worlds — anything other than Class I or II — will be 25 to 100% higher.

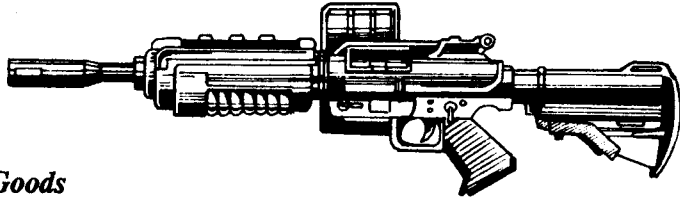

### Goods

Shovel	\$12
Wrist chronometer (dual display)	\$25
with built-in calculator	add \$40
with built-in short-range walkie-talkie	add \$30
with built-in miniature microfilm reader	add \$100
Binoculars (optical)	\$40
Binoculars (infrared)	\$120
Flashlight with ten-year power cell	\$10
Suit of men's ordinary clothes	\$50
Suit of men's formal attire	\$400
Casual women's dress	\$40
Designer dress	\$150
Formal gown	\$800
Hiking boots	\$50
Electric car (four-passenger)	\$5,000
Mudder (two-passenger)	\$7,500
Mudder (six-passenger)	\$12,500
Skimmer	\$40,000

### Services

Low-quality meal	\$5
Average meal	\$10
Top-notch meal	\$40
Bottle of cheap liquor or Ropus lymph	\$10
Bottle of good liquor or Ropus lymph	\$20
Bottle of fine liquor or Ropus lymph	\$100
Hotel lodgings, per night	
Cheap and sleazy	\$25
Average	\$40
Fancy	\$100
Rental vehicles, per day	
Four-passenger electric road car	\$30
Two-passenger mudder	\$50
Six-passenger mudder	\$75
Skimmer	\$125

## Jobs and Income

These rules replace the job and pay rules in the 1st and 2nd editions of the *GURPS Basic Set*. Future editions will reflect this change.

On "civilized" worlds, PCs may find jobs to provide income while they are not in play. Of course, not every job is available on every world — there is little call for camel-drivers on Tran-ky-ky. Jobs can help cover the PC's cost of living, as required by his Status. The Job Table lists a number of jobs; the GM may add others. Some have skill or experience prerequisites (default values don't count here; you must have at least a half-point invested in the skill).

A character earns the standard monthly wage for his job if his *wealth level* is the same as that of the job. For example, someone with Comfortable wealth and a Comfortable job earns the wage listed for that job.

However, a Struggling character, at the same Comfortable job, earns only 1/4 as much, while a Wealthy person would earn twice the listed amount. Use the following table to determine what multiple of the listed wage each PC earns. Note that low-level jobs never pay very much — you can't be a wealthy street vendor. And high-level jobs are not available to those in low brackets — no corporate executive makes merely average money.

If a character's time spent adventuring is part of his job (e.g., for a Stingship pilot or Church covert operative), his success should depend mainly on regular play, not random success rolls.

### Character's Wealth

Level	Job's Wealth Level				
	Poor	Struggling	Average	Comf.	Wealthy
Poor	1	2/5	1/5	1/10	NA
Struggling	1	1	1/2	1/4	1/10
Average	1	1	1	1/2	1/5
Comfortable	1	1	1	1	2/5
Wealthy	1	1	1	2	1
Very Wealthy	1	1	1	4	2
Filthy Rich	1	1	1	10	10

### Job Success Rolls

At the end of every month in which a character works, refer to the *Success Roll* column of the Jobs Table, and roll against the skill, characteristic or other number given there. *PR* stands for *prerequisite*; roll against the prerequisite for that job. When there are two or more prerequisites, roll against your best unless *Worst PR* is specified, ignoring advantages (e.g., Status, Charisma) unless they are specifically mentioned. One advantage that will be specified as helping some job rolls is *Reaction*: the total of all positive and negative general reaction modifiers.

Thus, a street beggar always needs to roll a 10 or less, an animal trainer rolls against his best animal skill (the PR for his job), a ruling noble rolls against his (Status + 8), and a thug rolls against either his Brawling skill or the weapon skill of his choice, minus 2.



Most jobs are with an established business or master. If you roll anything but a Critical Success or Critical Failure, simply collect that month's pay and go on. On a Critical Success, you get a 10% permanent raise to your income (but no more than one raise every 6 months). On a Critical Failure, check the table for the result.

Some occupations are freelance (or at least variable) in nature. These are marked with an asterisk on the table. For

these jobs, the base income is awarded when the skill roll is made *exactly*. For other successful rolls, increase that month's income by 10% for every point the roll was made by. If the roll is failed, reduce income by 10% for every point the roll was missed by. A Critical Success *triples* income for the month. If a Critical Failure is rolled, earn no income — and check the table for other penalties.

## Jobs Table

<i>Job (Required Skills), Monthly Income</i>	<i>Success Roll</i>	<i>Critical Failure</i>
<b>Poor Jobs</b>		
Street Beggar (no qualifications), \$250	10	-1i/3d
Street Vendor (no qualifications), \$350	IQ-1	-2i/1d
Welfare Recipient (no qualifications), \$400	10	-1i/dropped from rolls (reapply in six months)
<b>Struggling Jobs</b>		
Factory Worker (IQ 8+), \$600	12	LJ
Store Clerk (Merchant 10+), \$700	IQ+Reaction	LJ
Thug* (Brawling 11+ or any Weapon 11+), \$750	PR-2	3d/one year in jail
Petty Thief* (DX 11+, Stealth 11+, Lockpicking or Pickpocket 11+), \$800	PR	-2i/one year in jail
<b>Average Jobs</b>		
Clerk (Accounting 11+), \$900	PR	LJ
Freelance Writer* (Writing 10+, Fast-Talk 10+), \$1,000	Worst PR	-1i
Technician (Engineering or Science skill 10+), \$1,100	PR	1d/LJ
Bureaucrat (Administration 12+), \$1,200	PR	LJ
Scientist (Science skill 13+), \$1,400	PR	LJ/LJ,2d
Police Officer (Guns or Beam Weapons 12+, Law 10+, Status 0+), \$1,400	Worst PR	3d/3d, LJ
Planetary Soldier (Guns or Beam Weapons 12+), \$1,500	PR	3d/LJ
Traveling Salesman* (Merchant 13+), \$1,600	IQ+reaction	LJ/3d,LJ
Starship Crewman (IQ 10+; Pilot, Astrogation, Administration, Gunner or Weapon skill 12+), \$1,700	PR	2d/4d,LJ
Stingship Pilot (Pilot:Stingship 14+ and Gunner 13+), \$2,000	Worst PR	3d/6d
<b>Comfortable Jobs</b>		
Engineer (Engineer 13+), \$2,400	-2i/LJ	
Starship Officer (Pilot, Astrogation or Gunner 12+, Administration 12+, Status 1+), \$2,500	PR	2d/5d,LJ
Merchant Captain* (Pilot 10+, Astrogation 12+, Merchant 14+, Status 1+, a spaceship), \$3,000	IQ+reaction	-3i/3d, lose ship
Lawyer* (Law 13+, Status 1+), \$3,000	best of IQ, Law	-3i/-10i, disbarred
Corporate Executive (Administration or Accounting 13+, Status 1+), \$3,600	PR-1	-2i/LJ
Physician* (Physician 14+, Status 2+), \$4,000	PR-1	-2i/-10i
<b>Wealthy Jobs</b>		
Corporate Officer (Administration 12+, Status 2+), \$5,000	PR+Status	-2i/LJ
Member of a Noble Family* (Status 4+), \$6000	Status+6	allowance cut 20%
Ruling Nobility* (Status 5+, Administration 12+), \$7,500	Status+8	-2i/-1 Status
Corporate Investor* (Economics 14+, Status 1+), \$10,000	PR-3	-3i/-10i

### Critical Failure Key

“LJ” stands for Lost Job — you were fired, or lost the client. The “d” indicates dice of damage (“3d” is 3 dice of damage; “10d” is 10 dice, etc.) — you were in an accident, fight, etc. The “i” indicates a lost month's income (“-2i” means losing 2 months' income) — you were fined or unable to work, or a deal went awry.

If there are two entries, separated by a “/”, use the second result *only* when a natural 18 is rolled.

Note that for some dangerous jobs, the result of a critical failure can be serious bodily harm. If the GM prefers, he can play out these episodes to give the PC a fighting chance.

# COMMONWEALTH GAZETTEER

# 3

Of the dozens of worlds in and around the Humanx Commonwealth, these few have been singled out for their potential as adventure sites, and because they illustrate the variety of worlds which make up the Commonwealth. Many more worlds have been settled by humans, thranx and their allies, and an untold number of systems, both in and outside the Commonwealth, wait to be explored by brave adventurers.

## Classification of Worlds

Explored worlds within the Humanx Commonwealth are classified by the United Church Bureau of Supra-Commonwealth Registry according to a number of criteria. The classifications used by the Bureau of Registry are quite precisely defined — but, as with any bureaucracy, the guidelines can be bent, in either direction, for economic or political considerations.

**Class I: Full Commonwealth Membership.** These worlds have all rights and responsibilities of Commonwealth membership, including three representatives to the Commonwealth Council and unrestricted trade and exchange of information. This class includes planets with world governments and native populations having TL8+. Their colonies, upon reaching a population of 10,000,000 and significant manufacturing capacity (TL7+), also qualify for Class I.

**Class II: Associate Membership.** These worlds have world governments. Class II status is usually available only to worlds at TL6+, although this requirement is occasionally waived. Each planet has one representative to the Council. Limited exchange of goods and technologies between Class II planets and other systems is permitted.

**Class III: Wardship.** These worlds are under United Church protection. Status is similar to Class II, but a world government is not required.

**Class IV: Inhabited Primitive.** Trade of goods and technologies with Class IV worlds is heavily restricted. There are two subclasses, based on the technological development of the native sentient species. On *Class IV-A* worlds, the natives live at TL5, while the natives of *Class IV-B* worlds live at TL4-. Natives of Class IV worlds are not normally permitted to visit other planets.

**Class V: Unstated.** This group contains unusable planets, inhabited worlds not aligned with the Commonwealth, and newly discovered worlds about which little is known.

**Class VI: Hardship.** Planetary conditions restrict development to the point that advanced technology is required for survival.

**Class VII: Potential Colony.** This class contains registered worlds suitable for habitation and available for colonization.

**Class VIII: Frontier Colony.** These worlds are not developed enough in resources or population to qualify for Class I membership. Frontier Colonies are usually protected by Church Peaceforcers.

**Class IX: General Colony.** Class IX status is assigned to worlds deemed unlikely to develop into Class I worlds, due to planetary ecology or political instability. Commonwealth citizens living on Class IX planets are represented on the Commonwealth Council by their home planets. Natives with Commonwealth ancestry are represented by the colony's Resident Commissioner.

## Using the Gazetteer

Most of the information in the Commonwealth Gazetteer is common knowledge throughout humanx space; anyone unfamiliar with a world can easily access this information through computer libraries in any major city, star port, or interstellar vessel. Players should be allowed to read this section as thoroughly as they desire.

In the sidebars of this chapter are ideas for *Adventuring* on each world covered. Because players will probably read this chapter, use these adventure ideas as a point of departure, rather than as a whole plot. Feel free to change or embellish them in any way, so that your players won't recognize them. Many of these adventures will work on several planets, and some can be tied together. For example, "Where, Oh Where . . .," set on Moth, could easily lead into "Brothelbreak" on Balthazaar.

Most of the adventure ideas in this chapter are of planet-embracing or even Commonwealth-wide import; every adventure doesn't have to be this "significant." PCs can easily be involved in lower-key plots, tracking criminals on Terra, hunting on New Riviera, or surfing on Dis. The galactic sagas described in these sidebars might be taking place in the background of your campaign, with the PCs only peripherally involved as they tend to their own business.

But if you decide that it's the PCs who must save the Commonwealth, make sure they're personally involved as well. If the Baron Riidi WW is about to convert everyone on Repler into steak tartare, the adventure will be more interesting if the PCs' dependents are heading the menu as appetizers!

## Maps

Maps of the Humanx Commonwealth, the AAnn Empire, and surrounding space can be found in the appendix, p. 95.

## Worlds within the AAnn Empire

While the distribution and number of stars in the AAnn Empire has been known since before the first AAnn-thranx contact, the Empire is very secretive about the location of its colonized worlds and military bases. The true extent of colonization within the empire, as well as the incidence of other sapient species in AAnn space, is unknown. The following worlds, however, have been identified:

*Blasusarr* is the AAnn homeworld and the Throneworld of their Empire. United Church intelligence has narrowed the location of Blasusarr to one of a few stars in the heart of the Empire — the location indicated on the galactic map (p. 95) is approximate. Further information indicates that the planet is protected by a very efficient defense network, including military vessels, orbital mine fields and defense satellites, and particle beam projectors powered by the planetary cores of other worlds in the system.

*Pregglin* is the major military spaceport for the "Fourteenth Quadrant" of the AAnn Empire, which borders Commonwealth space around Repler and Annubis. Pregglin base has been the staging area for numerous AAnn raids on Commonwealth planets.

*Sectorcav* is a major military and scientific base with extensive facilities devoted to "technology transfer" — the analysis and duplication of humanx technology — and "archeological research" — the search for Tar-Aiym and other precursor weapon-artifacts. Most AAnn expeditions into the Blight originate at Sectorcav. Annubis lies directly across the Empire-Commonwealth border from Sectorcav, which may be located within the Fourteenth Imperial Quadrant.

*The Torsee Provinces* are a small handful of worlds bordering both the Commonwealth and the Empire. Technically independent, the Torsee Provinces are nonetheless allied to and controlled by the AAnn Empire.

*Class X: Commercial Interest.* This class contains planets, moons, and asteroids unsuitable for colonization, but available for commercial exploitation.

*Under Edict.* A restriction placed on planets that harbor a threat to the Commonwealth or otherwise warrant a strict "hands-off" policy. No communication or landing may be made. Usually one to four Peaceforcer stations (either manned or automated) are posted in-system to challenge all approaching ships. Any unauthorized vessel approaching within five planetary diameters of a world under edict will be fired upon. [Ed. note: Rumor has it that AAnn vessels have discovered a method of evading the automated Peaceforcer stations. See *Orphan Star*.]

## Other Headings

*Mean Temperature:* This is the mean temperature, in degrees Fahrenheit, of all points on the 30th parallel.

*Mean Humidity:* This is the mean humidity of all points on the 30th parallel.

*Diameter:* Mean diameter in miles.

*Gravity:* Mean gravitational attraction (1 G = gravitational attraction of Terra).

*Main Port:* Primary port for offworld entry.

*Tech Level:* Prevalent manufacturing tech level (see p. B126). Most Commonwealth worlds will have a few TL8 or 9 items manufactured off-world, regardless of the native TL. All permanent spaceports are equipped with TL9 computer, communication and repair facilities.

*Population:* Sapient beings on planet. Minor non-native populations are not included in the population figure, although most Commonwealth worlds have at least token alien populations.



## Major Worlds in the United Church Registry

### Alaspin

Class VIII

*Mean Temperature:* 86°

*Mean Humidity:* 57%

*Diameter:* 8324 miles

*Gravity:* 1.04 G

*Main Port:* Alaspinport

*Tech Level:* 2

*Population:* 15 million Otoids; 200,000 humanx

Alaspin is a crazy-quilt of thick jungles, sweeping savannahs and reedy river plains, known for two things: gemstones and history. Most people on Alaspin are researchers or fortune-hunters — Alaspinport is filled with libraries and brothels.

Alaspin's mines have produced some of the most exquisite jewels in the Commonwealth, including the million-credit Alaspinian Flame Opal. Alaspin has minerals found nowhere else, including "opalized" diamonds formed in the extremely high pressures of Alaspinian geological faults.

Equally important to the planet's economy, however, are the ruins which dot the landscape. Eighty thousand years ago, Alaspin was home to a great multi-cultural civilization (see p. 4). Each culture worshipped its own gods, and sought to make its temples the grandest on the planet. Jungle and swamp have reclaimed most, but thousands of sites remain.



Entry to Alaspin is strictly controlled; individuals with a record of serious or violent crime are not permitted on Alaspin. Despite this precaution, violence occasionally breaks out between the scientists and the prospectors. Alaspinian artifacts often contain precious metals and valuable gems which attract the “destructive Neanderthal” prospectors, while the “cloud-walking” researchers seek the objects for their historical value.

One artifact, the Idonian Mask, was the object of a series of such confrontations. This crysorillium mask is 5' on a side, and decorated with 60,000 carats of blue diamonds. A prospector discovered it in 513 A.A. Once revealed, the Mask was repeatedly stolen by researchers and prospectors alike. Sixteen people died stealing or protecting the Mask before the Commonwealth declared it a treasure of the people and appropriated it for the Pre-Commonwealth Societies Museum on Hivehom.

### *Native Sapients*

The only natives of Alaspin are the Otoids: 3-foot, brown-furred hominids, with bright green eyes, broad tails, and five-fingered hands. Their chattering language remains a mystery to humanx xenologists, as do their habits. Reports indicate that the Otoids are skilled climbers, and often ambush from treetops. Since no images of the original Alaspinians exist, it is unknown whether the Otoids are some remnant of the ancient temple-builders or another species which developed intelligence in their absence.

The Otoids seem universally hostile to humanx explorers, but they are not organized above the tribal level, and have no access to energy weapons. Instead, they use a weapon called a *sikambi*, a combination of a bow and a blowpipe. The *sikambi* fires barbed, copper-headed arrows. Otoids almost invariably attack in groups of half a dozen or more, firing from concealment. The Otoids remove the eyes of their victims, apparently considering them something of a delicacy.

The average Otoid has ST 6, DX 10, IQ 8, HT 10/7. He also has Stealth and Sikambi at DX +3, as well as Survival (Jungle) at IQ +2.

### *Interesting Creatures*

*Lance'el*. 25- to 100-foot-long segmented millipedes. While able to leap as high as 20', lance'el usually hunt by stalking to within 30 feet of their prey and then rushing upon it with a sudden burst of speed.

ST 35 to 50, DX 12, IQ 2, HT 15/70, Move 10. Its carapace gives it PD 3, DR 3. Attacks by biting (2 dice impaling damage).

*Topper*. A six-legged grazer, the topper ranges from 5 to 9 feet tall at the shoulder, and weighs between 2 and 11 tons. Toppers have hexagonal armor plates across their sides and back, and bear an ax-shaped horn on their snouts which acts as a scythe for the tall grasses the beasts eat. Toppers live in large herds. The adult males use their horns to clear a path for the rest of the herd; fallen vegetation is eaten by the herd as it passes. Immature toppers are kept in the center of the herd, while adult females bring up the rear and protect the young.

ST 60, DX 10, IQ 4, HT 17, Move 8. Toppers can trample (3 dice crushing) or strike with their horn (2+2 crushing); their armor plates provide DR 3 to their sides, back and head. They have no armor (DR 0) on their bellies.

*Vanisoars*. Vanisoars glide above grasslands on bat-like wings, seeking carcasses and exposed grass dwellers. They often kill their own meat, though they rarely attack anything as large as a man — they prefer slightly smaller prey. Flocks of vanisoars often follow topper herds, searching newly cleared territory for abandoned young or injured adults.

ST 9, DX 13, IQ 4, HT 8, Move 2 on ground, 20 in the air! Vanisoars attack with their talons (1+1 cutting damage).

## *Adventuring on Alaspin*

*In Search of . . . the Alaspinians*. The great mystery of Alaspin is the fate of the ancient temple-builders. Evidence indicates that they died out over a relatively short period of time, but no one knows why. Perhaps they left, heading underground or out among the stars. Or perhaps their society collapsed, and only the aboriginal Otoids remain, devolved from the ancient Alaspinians. Scientifically-minded adventurers might be able to find out what happened to the ancient race, and make themselves rich in the process.

### *The Minidrag*

The Alaspinian miniature dragon is a 2-foot-long, serpent-like creature from the jungles of Alaspin. About eight inches from the head are two large, multicolored wings. The minidrag is an agile flyer, but its most impressive feature is its venom.

Minidrag venom is both a lethal toxin and a highly corrosive acid. As an acid, a single dose of minidrag venom does 2 dice damage to any target, animate or inanimate. As a toxin, the venom causes its victim to make an immediate HT roll, at -10; failing this roll means death within 60 seconds. However, to function as a toxin, the venom must enter the bloodstream, either through a wound or a mucous membrane (usually the eyes). The minidrag may deliver its venom by striking — its bite does 2 points of damage — or spitting — **Ranges: PB 1 hex, Inc. 1 hex, Max 5 hexes**. Minidrags instinctively aim for the face when spitting (taking a -5 for aiming at the head). There is no antidote for the toxic effect of a minidrag's venom.

Minidrags occasionally attach themselves to humans, for reasons which are not entirely understood (see *Catalyst Creatures*, p. 64). Such attachments are for life, and chosen humans are referred to as “dragon lords” on Alaspin. Minidrags possess the psionic ability of Empathy (Telepathic Power 8-14, Emotion Sense Skill-12), allowing them to sense their human companion's feelings and to detect potential enemies. It is not known whether all minidrags have this empathic ability, or only those attached to humans.

A minidrag is ST 4, DX 15, IQ 6, HT 15/4, Speed 2 on land, 12 flying. Any attack against a flying minidrag will be at -6: -2 for size, roughly equivalent to a small dog; -3 for Speed of over 20 mph; -1 for target movement. An attack against a minidrag on the ground takes only the -2 modifier for size.

*Mean Temperature:* 108°  
*Diameter:* 8393 miles  
*Main Port:* Amropolous  
*Population:* 974 million thranx

*Mean Humidity:* 83%  
*Gravity:* 1.13 G  
*Tech Level:* 9

### Adventuring on Amropolous

*Industrial Espionage.* PCs may be hired to convey messages, data, prototypes, or scientists from place to place on-world, or between Amropolous and other worlds. Then again, they may be contracted to *acquire* these items . . . .

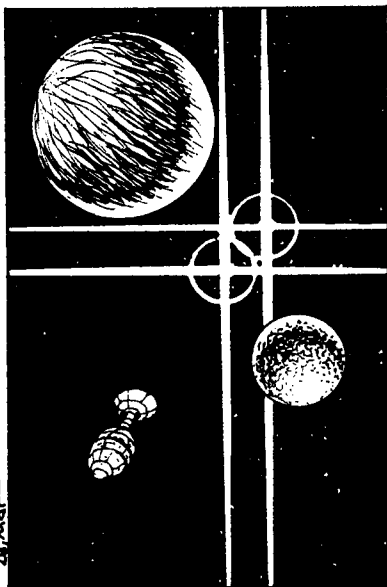

### Adventuring on Balthazaar/Beersheba

*Brothelbreak.* A prominent church official asks the PCs to free his daughter, sold into slavery by the hijackers of a humanx passenger liner. The Church is powerless in the matter, and the utmost discretion is necessary to avoid a major diplomatic incident which might endanger the safety of Commonwealth citizens vacationing on the pleasure worlds.

Along the way, the rescuers will encounter resistance from the “honest” businessmen of Balthazaar and Beersheba, and they won’t have the Church Peaceforcers to fall back on. Perhaps they will find that credcards speak louder than neuronc pistols . . . .

Amropolous is a Commonwealth success story. When discovered by the Elecseed thranx commercial complex, it seemed a paradise planet: good climate, beautiful mountains, and almost no hazardous animals. However, the survey team quickly discovered that the local flora was mildly poisonous to humanx and that certain iron-silicon compounds, called ferrosilicates, in the soil made growing humanx food crops — vital to a self-sufficient colony — virtually impossible.

During the colony evaluation, Elecseed scientists studied native organosilicates (silicon-based life forms) and derived the basic technology of thinkmachine components, for which Amropolean ferrosilicates were essential. After establishing a controlling lead in research, Elecseed announced their new discovery and headquartered their manufacturing facility on Amropolous. Several other important manufacturers followed, including Thinketics, Davidson Superconductor, Asandus, Yhu Hive, and Interstellar Metals Corporation. Many trading houses also have offices here, and there is adequate additional trade in light metals, rare seafood delicacies, and ferroconcrete.

### Interesting Creatures

*Amropolean Termite.* These hive-building insects are individually only 1/4-1/2” in length, but live in huge colonies. Termite-like creatures exist on several other worlds, but Amropolean termites naturally make their hives with ferroconcrete. Ferroconcrete is very difficult to break or cut — remote, unmanned outposts on Amropolous are occasionally buried by termite mounds, and laser cutters are needed to reopen them. Several firms are currently investigating commercial uses for ferroconcrete.

A one-hex termite swarm consists of 2000 termites, and has Move 1/2 — one hex every other turn. A single termite mound consists of dozens of swarms. Each swarm does 2 hits per turn, and is dispersed by 20 hits. The swarm will continue attacking up to 1 minute after the foe stops moving, but will not bother or pursue anyone more than 20 yards from the mound.

### Balthazaar/Beersheba

### Class V

*Mean Temperature:* 79°/68°  
*Diameter:* 7420 miles/6065 miles  
*Main Port:* Gomorrah  
 (serves both worlds)  
*Population:* 235,000 humans

*Mean Humidity:* 59%/42%  
*Gravity:* 0.88 G/0.75 G  
*Tech Level:* 9

These independent pleasure worlds are viewed by most of the Commonwealth with a mixture of titillation and disgust. While gambling, sports, and other more mundane recreations are available, the seraglios of Balthazaar and Beersheba offer any sexual experience imaginable . . . for a price. No deviation is beyond them; brothels specialize in fetishism, sadism, masochism, bestiality, and even xenorasty (sex with sapients of other species).

The two worlds remain outside Commonwealth control to avoid Church interference in their businesses. In particular, many bordello “employees” are effectively slaves (slavery is forbidden in the Commonwealth).

If anything positive can be said about Balthazaar and Beersheba, it is that most “businesses” are honest — being robbed while a client is a rare thing. Unfortunately, a few “resorts” are run by those criminals who appear wherever people come to spend money.

*Mean Temperature:* 87°

*Diameter:* 7873 miles

*Main Port:* Mou'anni

*Population:* 1 million+ cetacean; 19,000 humans

*Mean Humidity:* 74%

*Gravity:* .99 G

*Tech Level:* 8

In 2174 Old Calendar, researchers learned to communicate with Terra's only surviving non-primate semi-intelligent order: the cetaceans. Whales had fascinated humans for generations, but their child-like minds were a great disappointment to Terra's first xenologists. Nevertheless, whale poetry became a fad in the late 22nd century.

Dolphins, porpoises and orcas were used in neurological experiments considered too risky for human volunteers. Demand for cetacean subjects was so great that the populations of these species were seriously threatened. Modern cetaceans call this time the Second Holocaust (the First Holocaust was the mass butchery of whales during the 19th and 20th centuries for meat and oil).

Karl Jorgenssen was seeking a cure for Alzheimer's Disease when his porpoise test subjects exhibited sudden increases in intelligence. Jorgenssen, intent on human applications for his work, ignored these results. Eventually, the Jorgenssen porpoises made their way to another facility which recognized their intelligence and its cause and published their results in 2270.

Shortly thereafter, the moonless ocean-world of Cachalot was discovered by human explorers. No true land breaches Cachalot's watery surface, although some hexalate reefs rise as high as 32 feet above sea level. Massive storms wander Cachalot, and myriad species occupy its seas.

Terra's political leaders saw an opportunity to rid themselves of the potentially explosive cetacean issue. Every whale and porpoise was injected with the Jorgenssen serum and sent to Cachalot as part of "a magnificent experiment" — to discover the society cetaceans would develop without human interference. Humans guaranteed a "hands-off" policy toward the new civilization unless the cetaceans themselves asked for help. Cachalot is now a world of whales.

### *Native Sapient*s

The "magnificent experiment" is not complete, but cetaceans seem to be approaching civilization differently from other sapient species. Xenopsychologists speculate that no other intelligent species had quite the cathartic shock which cetaceans suffered at the hands of humankind. Cetaceans have refused all assistance, including artificial "hands" and other tools to allow them to change their environment.

Cetaceans on Cachalot travel in single-species pods. Porpoises and orcas seem to appreciate human companionship most, while larger whales shun human contact. The baleens — blues, humpbacks, rights — are the least intelligent group. The catodons, or toothed whales, seem most intelligent, but remain aloof from humans, insisting upon their cetacean privacy. The Covenant, proscribing violence among whales and porpoises, is respected by all cetaceans.

There is a small population of humans on Cachalot. Most of them are of Polynesian ancestry and live in floating towns (population 600-700). The towns support themselves by fishing, sending their catches to orbital processing plants. The cetaceans limit the number of human settlers on Cachalot, and forbid any heavy industry.

Recently, a new species, the CunsnuC, has been discovered in the deepest of Cachalot's seas. A collective intelligence of advanced coelenterates, the CunsnuC has mentally controlled baleen whales on several occasions, forcing them to attack human floating towns. Steps are being taken to design defenses against this threat, but no one knows if the whales will accept them.



### *Adventuring on Cachalot*

*Gone Fishin'.* Humans are tolerated by the cetaceans. Some humans are attracted to the many bizarre creatures which inhabit Cachalot's seas, and come to fish for sport; others come in search of the valuable ninamu pheromone. Fishing on Cachalot is somewhat more challenging than it is on Terra — some "fish" are large enough to eat a skimmer!

*Studying the Whales.* Periodically, scientists visit Cachalot to convince the cetaceans to allow themselves to be studied. So far, they have been rebuffed, but perhaps the threat of the CunsnuC will inspire at least some whale species to allow closer contact with humans.



### Interesting Creatures

*Ichthyornith.* These foot-long “flying fish” travel in flocks, carrying a transparent gelatinous sac filled with water for oxygen. They spend as little time in the water as possible — about one minute in fifteen — breeding and living in the almost predator-free aerial environment.

ST 2, DX 12, HT 10, IQ 4, Move 5 (swimming) or 8 (flying). Ichthyorniths are harmless unless they accidentally fly into you (treat as a Slam attack).

*Koolyanif.* These six-foot-long creatures float just below the surface, changing color to match the sand or deep water below them. They have an arsenal of poisoned spines which they blow outward, like arrows, paralyzing their prey.

ST 8, DX 8, HT 15/8, IQ 4, Move 3 (swimming). Koolyanif attack with their poisoned spines — **Ranges:** PB 1 hex, Inc. 2 hexes, 1/2 Dam. 6 hexes, Max. 10 hexes. A spine does 1-2 impaling damage and, if it does at least 1 HT damage to the target, delivers poison causing 2 dice Fatigue loss (resisted by a HT roll).

*Ninamu Pheromonite.* These rare, 20” long pseudoworms trail hundreds of feathery azure filaments from their flanks. Ninamu pheromonites produce a rare aromatic used in perfumes. A freshly caught pheromonite is worth \$5,000 in the market at Mou’anni; the distilled essence of a single pheromonite is worth several million credits to off-world perfume manufacturers.

ST 1, DX 10, HT 15/3, IQ 3, Move 4 (swimming). They are harmless.

*Toglut.* The toglut is a twelve-foot-long cross between an obese squid and a giant orange starfish encrusted with rough pumice-like protrusions. The toglut hides underneath the sand, ambushing passing fish with its cilia-covered tentacles. Although capable of doing considerable damage to a human, a toglut would rather run than fight.

ST 13, DX 12, HT 15, IQ 3, Move 2. Attacks by grappling (at DX +2) and biting (1-1 crushing damage).

*Mallost.* An immense kraken-like omnivore, the mallost outweighs even the largest whale. The floating towns carry sophisticated sensing systems and large underwater needlers to protect themselves from mallost depredations, among other things.

ST 500, DX 14, HT 15/100, IQ 3, Move 20. Attacks by grappling with each of six tentacles (5 dice crushing per tentacle) or by biting (25 dice crushing damage).

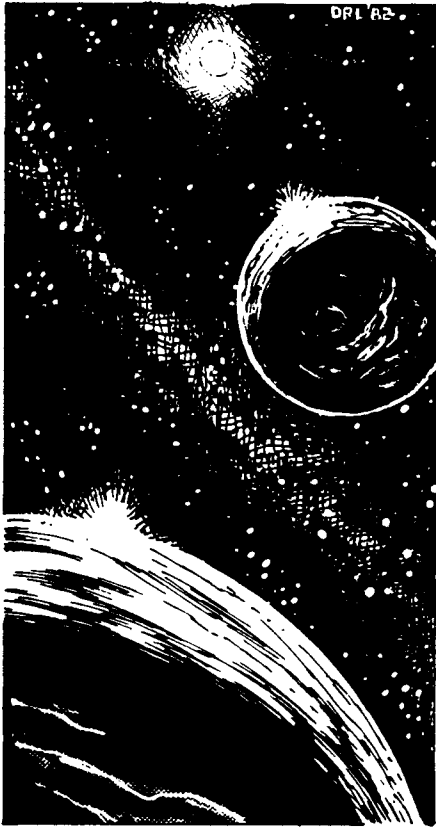

### Adventuring on Carmague/Collangatta

*The Collangatta Express.* A wealthy and eccentric posigrav engineer has hit upon a plan to end the “dangerous orbital situation” of the system. Convinced that the two planets are destined to collide, he is constructing a huge KK field generator to pull Collangatta into an orbit further from the system’s star. If successful, the plan will save both planets from eventual destruction, at the expense of pushing temperatures on Collangatta well below zero. Either way, the geological impact on Collangatta will be mind-boggling. The mission: stop this well-meaning but misguided scientist before his project destroys the planet!

### Carmague/Collangatta

Class I

*Mean Temperature:* 115°/75°

*Mean Humidity:* 77%/54%

*Diameter:* 8453 miles/8265 miles

*Gravity:* 1.04 G/1.09 G

*Main Port:* Jocastan/Rajpuntur

*Tech Level:* 9

*Population:* 1.9 billion thranx; 1.2 million humans/ 964 million humans

Carmague-Collangatta is the only stellar system in the Commonwealth featuring two Class I worlds. Carmague is the warmer of the two, although the two planets share nearly identical orbits. There is considerable evidence that Collangatta is a captured object which entered this system in the distant past.

Carmague ranks fourth in population in the Commonwealth (behind Hivehom, Terra, and Willow-Wane), and Collangatta ranks twelfth. Carmague is a pleasant thranx planet (warm and humid), while Collangatta is cooler and more suited to human tastes.

Every 100,000 years, Carmague and Collangatta pass exceptionally close to one another. Geologic records indicate that these passes cause extensive — if temporary — climatic changes on both planets, and the two planets appear to have actually switched orbits on at least three occasions. The next such pass is about 57,000 years away and is thus of little concern to the current inhabitants.

## Chikasacasoo

Class V

*Mean Temperature:* 86°

*Diameter:* 7150 miles

*Main Port:* Thrippp

*Population:* 3.9 billion quillp

*Mean Humidity:* 54%

*Gravity:* .87 G

*Tech Level:* 8

Chikasacasoo is the home planet of the quillp, or ornithorpes (p. 41), a comfortable world with temperatures at the mean for humanx (although somewhat dry by thranx standards). Ornithorpe cities are made of tall window-covered spires reminiscent of their ancient cliff-nests.

Quillp independence has been a stumbling block to full or even associate Commonwealth status. However, the ornithopes do not seem to mind; they find the "interference" of the Commonwealth in their private affairs an annoyance they can do without. Still, they travel throughout the Commonwealth, trading freely, and a small community of humanx merchants is growing on Chikasacasoo.

## Dis

Class VI

*Mean Temperature:* 86°

*Diameter:* 9195 miles

*Main Port:* Scratch Bay Towne

*Population:* 375,000 humans

*Mean Humidity:* 87%

*Gravity:* 1.21 G

*Tech Level:* 8

The surface of Dis is 93% water; only a few atolls break the world-ocean's surface. The only 'colonists' on Dis are employees of corporations participating in ocean farming and mining.

During the "season," which lasts four-fifths of the year, the tropics of Dis are battered by huge hurricanes. Winds in these storms average 120 mph, and gust as high as 250 mph. Thus, most habitations on Dis hide on the ocean floor; the facility of Ninth Circle is located 7500 feet below sea level! The only permanent surface facility, Scratch Bay Towne, is built on a 15-square-mile island at 72 degrees North longitude, beyond the reach of most storms.

Once every three years, three of Dis' four large moons conjoin with Dis' sun, producing hundred-foot tidal waves. Daredevil surfers brave these monster waves in the most grueling surfing competition in the Commonwealth. A "good" ride in the competition is 4 1/2 hours; it usually takes three such rides to win. A complete ride, from the traditional starting point to Scratch Bay, can exceed 8 hours, but few surfers ever accomplish this feat. Competitors are not judged solely on endurance, though. Personal style and defense against predators are also significant factors.

### Interesting Creatures

*Devilfish.* These 30'-40' filterers have 6' wide jaws, large eyes, and moustache-like tentacles, like a Terran catfish. Devilfish swim in deep water, and are attracted by light (phosphorescent algae is a large part of their diet). A devilfish will attack anything that glows, ramming with its massive head anything it cannot swallow. They seem uninterested in blue light, though; thus, most underwater settlements are lit in an eerie pastel blue.

ST 40 to 50, DX 10, HT 15/70, IQ 3, Move 10 (swimming). Attack by biting (2 + 1 crushing damage) or ramming (6 dice crushing).

*Vaxail.* These radially symmetrical eel-like creatures are 20' in length, with 3' wide toothy jaws set in blunt snouts, 6 longitudinal fins, and large eyes. They are predators, feeding on fish and, when they can find them, surfers.

ST 15, DX 13, HT 14, IQ 5, Move 6 (swimming). Attack by biting (1 + 2 impaling damage).

### Adventuring on Chikasacasoo

*A Feather in Your Cap.* Rumor has it that the mysterious disappearance of small ornithorpe ships in recent years may have something to do with the recent trend in AAnn fashion towards clothing ornamented with brightly colored feathers. The High Ambassador recently appeared at an AAnn-Commonwealth negotiation decked from head to toe in a robe covered with distinctly Chikasacasooan plumage. But no AAnn ships have been seen in the vicinity of the ornithorpe homeworld. Just who is supplying the AAnn with their avian adornments, and what's happening to the original owners?



### Adventuring on Dis

*Surf's Up.* Hired as lifeguards and skimmer pilots for the triennial surfing championship, the PCs find themselves trapped in a surprise storm. Their skimmer swamped and sinking, they must improvise surfboards and, with the guidance of the surfer they were guarding, hang ten all the way to Scratch Bay.

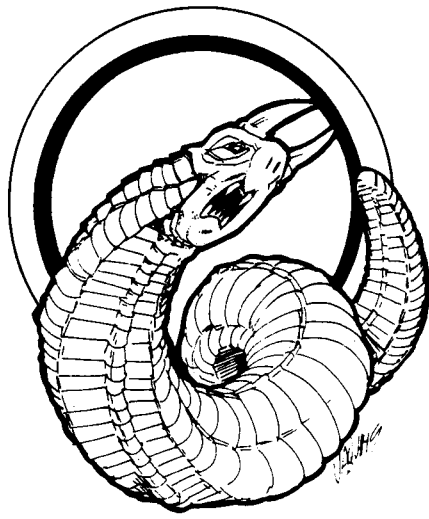

### Adventuring on Drax IV

**Thar's Green in Them Thar Hills.** Like half the population of Drax IV, the party sets out across the dangerous planet in search of a new ozmidine deposit. Along they way, they'll run into vicious creatures, ruthless competition, and who-knows-what else, lurking in the fungal jungle. On the admittedly unlikely chance that the party does come across the fabled "Second Site," they'll have to figure a way to transfer their product to market while keeping its exact location a secret; the hungry prospectors on Drax IV would be quite willing to turn claim-jumper.

### Adventuring on Goodhunting

**The Turnabout Hunt.** The party is hired as guides, guards and marksmen for a safari on Goodhunting. While tracking big game through the planet's uncharted wilderness, one of the wealthy hunters disappears . . . only to be found a day or two later, ravaged by beasts. But that's not what killed him; close inspection of the body reveals a poisoned dart, fired from a blow-gun or perhaps a more sophisticated weapon. Whoever killed the first man becomes bolder in the next few days, as attempts are made on more members of the expedition.

While it looks as if the group is being pursued by previously unknown natives — masters of stealth and wilderness survival — they always manage to hit one of the employers, never a guide or guard. Is it possible that the real culprit is a Qwarm assassin, dogging the party through the wilderness, or even working from within the group, disguised as one of the hunters?

## Drax IV

*Mean Temperature:* 122°  
*Diameter:* 9910 miles  
*Main Port:* Mining Central  
*Population:* 37,000 thranx

## Class X

*Mean Humidity:* 89%  
*Gravity:* 1.34 G  
*Tech Level:* 6

Drax IV is a hot, moldy hellhole of a planet, even by thranx standards. Its fauna and even its flora include dangerous predators, and Drax would be just another uninhabited Commonwealth system if it were not for ozmidine, a super-hard green and violet crystal found in volcanic vents. No one has been able to synthesize ozmidine, and natural deposits are known only here and on Mantis.

Ozmidine is so valuable that thranx — and even some humans — will endure the hazardous conditions on Drax IV in hopes of striking it rich. Thus far, ozmidine has only been found on one tiny island, which now harbors Mining Central and half the world's population. The remaining inhabitants are prospectors, searching the planet for another mother lode.

### Interesting Creatures

**Po'pione.** These 6-foot leeches hide just below the surface of the slime floor of Drax IV's fungus forests, ambushing anything which passes by. Po'pione are ST 7 to 11, DX 12, IQ 3, HT 8, Move 3. Their bite does 1-2 impaling damage. Once a po'pione successfully bites, it will suck blood, draining 1-4 HT per turn. A po'pione does *not* stop sucking when its victim reaches HT 0; it continues to drain blood, driving the victim's HT negative, even after the victim dies. A dead po'pione can be removed without harming a living victim, given a full minute to pry the teeth loose; to *rip* a living po'pione from a victim requires a Contest of ST — the victim's ST vs. the po'pione's ST +4! This does another 1-2 damage, against which armor does not protect.

**Turabisi Delphus.** This large fungus looks like a cross between a giant flower and a fern. Its wide fronds spread across the ground in a 10' circle around a single whip-like central stem. The turabisi is carnivorous — its fronds snap upward when any creature steps upon them, attacking with a "skill" of 12. A character who unwittingly steps onto a turabisi gets an IQ-3 roll to notice the attack in time to Dodge it — otherwise, he gets no defense, active or passive, against the attack. The central stem secretes a digestive acid.

Once captured, a victim must win a Contest of ST to free himself — the fronds are ST 16. Or his friends may attempt to cut him out by doing 12 total points of damage to the fronds; but any damage over 12 is taken by the trapped character! The acid does 1-4 damage per turn. Plastic or ceramic armor — if it is completely sealed — provides complete protection from this acid, but if there are *any* breaches in the armor, the acid will soak inside to do damage immediately. A completely sealed suit of metal or cloth armor will protect the wearer temporarily; three points of damage from the acid reduces the DR of such armor by one point. When the DR of the armor reaches 0, the wearer takes full damage.

### Goodhunting

*Mean Temperature:* 81°  
*Diameter:* 6810 miles  
*Main Port:* Phicaparamasisisi ('Phicap')  
*Population:* 330,000 quillp

## Class V

*Mean Humidity:* 47%  
*Gravity:* 0.86 G  
*Tech Level:* 7

Goodhunting is one of several ornithorpe colony worlds on the border of Commonwealth space. Like most ornithorpe worlds, it has low gravity, and supports an impressive ecosystem. Most of Goodhunting has been surveyed only from orbit. Of its millions of square miles of land, only 14,000 square miles have been settled; perhaps twice that has been physically explored.



Goodhunting's primary claim to fame, aside from some unusual spices, is the Battle of Goodhunting. This began peacefully enough — a battle group of the Enforcement Arm of the United Church made a courtesy visit to Goodhunting some years ago. Then, as now, there was no formal humanx-ornithorpe alliance. At the same time, an AAnn invasion force was approaching the planet.

The commanding Church officer, Major Gonzales of the cruiser *Altair*, refused to interfere despite repeated entreaties by the quill governor. Just before the AAnn force reached the planet, however, a malfunction occurred aboard one of the stingships accompanying the *Altair*. *Stingship #25* drifted rapidly toward the AAnn formation. When AAnn ships attacked the intruding stingship, the remaining stingship crews came to #25's defense. The AAnn were routed.

## Hivehom

## Class I

*Mean Temperature:* 113°

*Diameter:* 7896 miles

*Main Port:* Daret

*Population:* 10 billion thranx; 74 million humans

*Mean Humidity:* 85%

*Gravity:* .94 G

*Tech Level:* 9

The thranx homeworld, Hivehom is the heart of thranx history and tradition. In Hivehom's vast cities, burrows thousands of years old — constructed with regurgitated cellulose and body plaster — are still home to thranx clans, and can be found right next to the most advanced thranx architecture.

Most of Hivehom is covered with the lush, hot, humid jungles which the thranx find so pleasant. The emerald-green of growing plants is visible everywhere, even in the heart of the largest cities. Most thranx cities are underground; the extension bubbles marking their surface entrances are spaced widely enough for extensive jungle landscaping.

One section of Hivehom not used by the thranx is the Mediterranean Plateau. This large steppe is too cold and dry for thranx, but has a climate similar to that of the terran Mediterranean region. Nearly all humans on Hivehom live on the Plateau. The largest city on the Plateau is called Azerick, a thranx word meaning "frozen waste." It is fortunate that humans enjoy thranx humor.

Thranx (pp. 38-41) are the only native sapients on Hivehom.

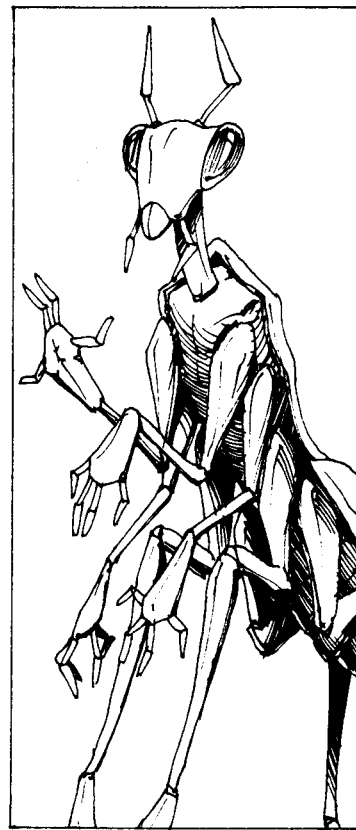

### Adventuring on Hivehom

*Larvae-nappers.* Someone is stealing thranx larvae from the nurseries of Daret, presumably training them to his own nefarious purposes. There may be a connection between these larvae-nappings and a wave of crimes sweeping through the lower, more run-down levels of the city, all perpetrated by very young adult thranx.

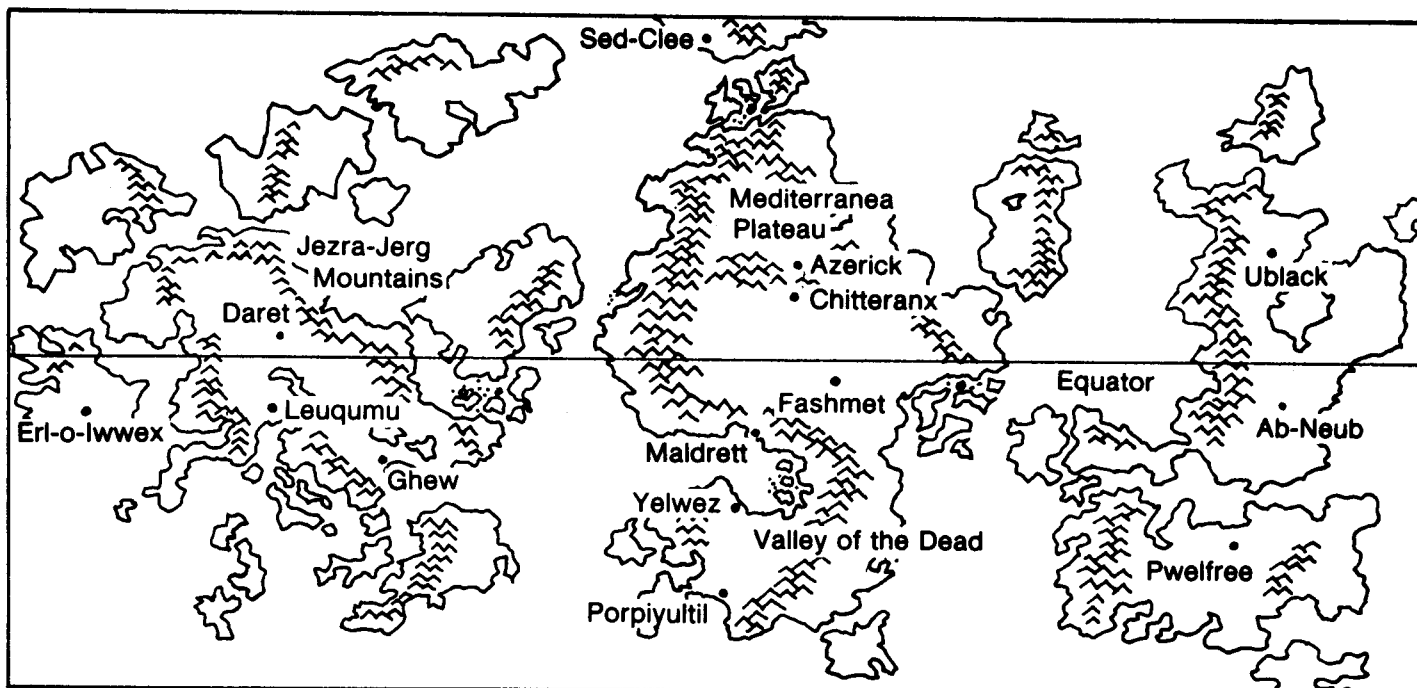

## Horseye

## Sunit

Among the greedy Mai, the ultimate measure of wealth is sunit, a heavy, dull grey metal unique to Horseye. An isotope of iridium, sunit is exothermic — even at temperatures well below freezing, sunit remains warm to the touch.

Sunit is to the Mai as gold was to medieval humans. They mint it into coins, craft it into jewelry and utensils, even decorate their buildings and monuments with it. Of course, with their relaxed attitude towards theft, confidence games and other forms of larceny, sunit tends to change hands among the Mai rather quickly.

Although current humanx technology does not allow for the manufacture of sunit, many scientists believe that the metal cannot occur naturally. This is held as evidence that a precursor race inhabited Horseye in the distant past, seeding the planet with sunit for some unknown purpose.

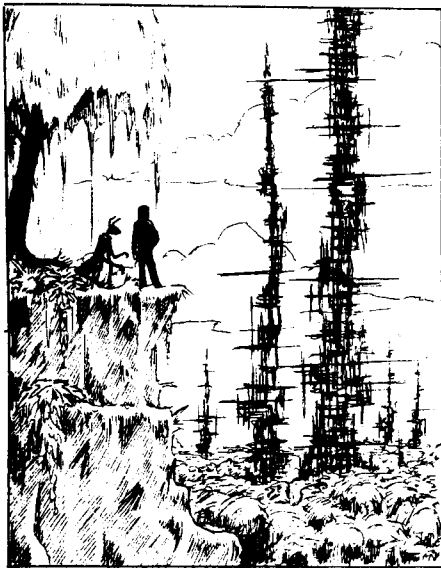

### Adventuring on Horseye

**Survey Expedition.** As part of a biological, sociological, and geological survey expedition, the PCs head up the Skar as scientists, pilots and guards. It seems everyone in the expedition is hiding something; one guide refuses to talk about his past, one of the scientists seems bent on discrediting the expedition leader, two of the guards have a chest which they refuse to let anyone open . . . . As they head upriver, the PCs find out who they can and can't trust.

This adventure is a natural for Mai or Tsla PCs — or better yet, both — as guides and bearers. The relationship between members of the two races provides an opportunity for amusing roleplaying.

**Mean Temperature:** 46°

**Diameter:** 8736 miles

**Main Port:** Po Rabi

**Population:** 10 million Mai; 8.5 million Tsla; unknown number of Na

**Mean Humidity:** 35%

**Gravity:** 1.17 G

**Tech Level:** 3

Tslamaina, called Horseye by the original human explorers, is a geological wonder. Eons ago, Tslamaina collided with a huge meteor, creating the vast south polar basin now filled by the Groalamasan Ocean. The ocean has a continuous clockwise current, driven by the tidal effects of Horseye's four moons. This facilitates trade among the cultures which surround the ocean.

High above the single world ocean is the icy Guntali Plateau. The impact with the meteor badly cracked the surface of the Guntali. Water running off the plateau for millions of years gradually carved these cracks into the most spectacular river canyons in the Commonwealth.

Of all the river canyons on Horseye, the greatest is the Barshajagad, which in the language of the Mai means "Tongue-of-the-World." Cut by the river Skar, the Barshajagad canyon extends from the north polar waste for more than 8000 miles before emptying into the Groalamasan Ocean, dropping eight miles on its journey. At its mouth, the Barshajagad is nearly 1000 miles wide, and a traveler at the middle of the Skar cannot see the sides of the canyon reach the high Guntali. This unique geology has evolved an astonishing variety of life forms organized into ecological niches not by latitude but by elevation.

The atmosphere of Tslamaina is considerably denser than that of Terra. At sea level, the weather is oppressively hot and humid for humans, though thranx find it very comfortable. The atmosphere is breathable at much higher altitudes than Terra's, however; human survival is possible eight miles above sea level (the Guntali Plateau), although at that altitude even humans find it cold and dry.

Since the Plateau covers most of the surface area of Tslamaina, average temperatures and humidities are skewed to the cold and dry. The average forecast at Po Rabi, at the mouth of the river Skar, predicts a steaming 108°, with 85% humidity.

### Native Sapients

There are three native sapient species on Tslamaina: the Mai, the Tsla, and the Na. The Mai occupy the coast around the Groalamasan Ocean and the lower portions of the river valleys, while the Tsla inhabit the valleys from 2000' above sea level almost to the icy heights of the Guntali Plateau. The Na live on the Plateau itself, although they raid the upper tribes of the Tsla.

Most knowledge of the societies of Tslamaina comes from the fieldwork of Dr. Lyra Redowl. She and her husband, Etienne, acquired permission from the native population to travel the Skar River from the delta at Losithi-Po Rabi to its source on the Guntali Plateau. Dr. Redowl's masterwork, *Morphological Sociology as a Function of Altitude: The Sapients of Tslamaina*, has done more to reveal these cultures than any previous study. (For more complete descriptions of the Mai and the Tsla, see p. 47 in the Character Creation section.)

**The Na** are 12-foot bipeds covered with thick, shaggy pelts. Their crude clothing and tools attest to their sapiency, but otherwise the Na seem little more than animals. The Na have low foreheads, blunt snouts, and many sharp teeth, indicating a carnivorous nature. The Na occasionally raid the higher Tsla cities for food (usually Tsla), but otherwise remain on the Guntali Plateau.

Na average ST 27, DX 9, IQ 7, HT 15/25. Na live at Tech Level 0. They attack with one-handed clubs (4+3 crushing) or two-handed mauls (6+1 crushing). They will often pull their blows in order to take their foes alive — the Na prefer their meat fresh!

## ***Interesting Animals***

**Arwawl.** These brightly colored river fish grow as long as 50 feet, and weigh as much as 30 tons. The arwawl are filterers and essentially harmless unless provoked. The Mai hunt them — as many as 20 to 30 vessels manipulate huge, interlocked nets to bring in the tremendous catch.

ST 75, HT 17/40, DX 12, IQ 4, Move 8 (swimming). Attacks by head butt, doing 10 dice crushing damage to large or immobile objects like boats and docks. If a person in open water is struck by a charging arwawl, he will simply bounce aside, taking 3 dice crushing; if he is trapped between the arwawl and a large object, he takes the full 10 dice — and so does the object!

**Dangui.** The dangui, or glass leech, is a six-inch worm-like parasite which inhabits lower river valleys and the coast of the Groalamasan Ocean. It has a cartilaginous backbone, and can leap onto an intended host. Dangui are transparent, except when feeding; then they take on the tinge of their host's blood.

ST 0, DX 14, IQ 2, HT 11/3, Move 1. Bites for 1 point of damage, then drains blood for 1-5 per turn. The dangui drops off after draining 3 HT from its victim (not counting the bite). The bite is quite dirty; anyone bitten by a dangui must roll against HT-2 to avoid infection (see p. B117).

**Hyral.** The hyral is a large, mammalian fisher from the highest reaches of the Skar, near the edge of the Guntali Plateau. Although its method of fishing is similar to that of the Terran grizzly bear, the hyral stands 14' at the shoulder, with six clawed legs and narrow slit-pupils.

ST 45 to 50, DX 12, IQ 5, HT 14/30, Move 7. Bites for 2+2 impaling, strikes for 5 dice crushing. Hide has PD 1, DR 3. A ten-hex creature.

**Sandrush.** This river-dweller is nearly invisible from above the surface of the water. The sandrush has powerful suckers on its ventral side, and several rows of small, inward-curving teeth in its mouth. When the sandrush strikes, it attaches itself to its prey with suckers and jaws. Once attached, the sandrush tries to swallow its victim, and will not release its hold until it or its victim dies. Its 10-foot-long body-sac is normally only two inches in diameter, but its jawless mouth stretches to engulf prey up to two feet in diameter. A sandrush is capable of ingesting an adult Mai.

ST 6, DX 14, IQ 2, HT 8, Move 8 (Swimming). Bites for 1-1 impaling damage. Once bitten, a victim can remove the sandrush by winning a Quick Contest of ST (for this purpose only, the sandrush's ST is *doubled*). Win or lose, the victim takes an additional 1-3 damage. Once it bites, the sandrush will attempt to swallow its prey; doing so takes 5 turns for each point of the victim's ST. (A character with ST 12 would be engulfed in 60 seconds.) A character may repeat the Quick Contest to free himself once per turn as long as he remains conscious.

**Strepanong.** These large scavengers soar among the upper reaches of the Barshajagad, riding the thermals which rise from the valley. They rarely fly below 7000'. The strepanong have four feathered wings (23' wingspan), a wide, multi-legged body, and large claws; one can easily fly with a human in its claws.

ST 16, DX 13, IQ 5, HT 13, Move 15 (flying). Two claw attacks (1 die cutting each); hits with both claws in a single turn allows the strepanong to carry its target away.

**Vroqupii.** These draft animals are used by the Mai to pull barges against the powerful current of the Skar. A vroqupii is about 8' high at the shoulder and 11' long, with short, bristly rose or yellow fur. Its six large, strong legs have wide pads to maximize traction. A "frill" of armor protects the vroqupii's head and neck, extending along the upper jaw, around the eyes, and down to the throat. The Mai ride behind the frill, guiding the vroqupii with voice commands and sharp raps on the frill delivered with a stiff rod. The blows do no injury to the vroqupii; in fact, anything lighter seems to be ignored by the powerful, stoic beasts. ST 150, DX 12, IQ 6, HT 17/40, Move 8. PD 2, DR 3.

## ***The Xunca on Horseye***

Almost half a billion years ago, the planet Tslamaina experienced two massive geological and astronomical upheavals which radically changed its geography. A tremendous asteroid struck the planet's surface at the south pole, creating a crater at least 15,000 meters deep. Filled to within 8000 meters of the original surface of the planet, the crater became the Groalamasan Ocean. Around this same time, the orbits of Horseye's four moons changed dramatically, setting up the clockwise currents within the Groalamasan Ocean which we know today.

Some scientists maintain that the two events were completely natural — if improbable — and that the same asteroid which hit the planet also caused the changes in the moons' orbits. Other astronomers believe that no single object, however large, could have caused the specific changes in each of the four moons which undeniably occurred. Furthermore, the odds against a drifting object hitting the planet from the angle at which the "asteroid" must have struck are . . . astronomical. Therefore, these scientists conclude that Tslamaina must have been radically altered by an alien intelligence — one of the precursor races.

It is known from evidence on other worlds that the Xunca were active in the Orion Arm during this period of prehistory, attempting to set up a network of communication stations on worlds throughout the arm. Archeologists theorize that the Xunca created the Groalamasan Ocean and its massive currents to power some sort of master station in this network, which would beam energy as well as messages to other stations. Some even believe that a Mutable was left at every station, and that the Tslamaina Mutable and its descendants may still live on the planet, hiding among the native population or at the ruins of the still-undiscovered Xunca base.

*Mean Temperature:* 86°  
*Diameter:* 8632 miles  
*Main Port:* Havaiki  
*Population:* 73 million Largessians

*Mean Humidity:* 84 %  
*Gravity:* 1.17 G  
*Tech Level:* 4

### **Adventuring on Largesse**

*King Merchant.* A human merchant has set himself up on Largesse, shamelessly exploiting the naivete of the Largessians. He lives as a king, trading worthless baubles for Largessian art, which he sells off-planet through representatives. The Church, viewing the merchant's setup as uncomfortably similar to slavery, sends in the PCs to pull the fellow off his self-made throne. Yet upon their arrival, the party finds the Largessians delighted with the merchant, and freely willing to defend him. The merchant knows, however, that he could lose his influence over the Largessians if they were to find out a certain something about him or his operation. Just what this is the merchant keeps a deep secret, although it is tied up in Largessian tradition and ethics, which are very different from our own.

### **Adventuring on Long Tunnel**

*Genetic Espionage.* The genetic labs on Long Tunnel are constantly coming up with important — and possibly dangerous — lifeforms. Adventurers might be hired to protect, or to procure, any of the latest developments, including:

- a symbiotic microorganism which converts carbon monoxide, carbon dioxide and other gases into oxygen *in the bloodstream.*

- a "living plastic," which can be bred without expensive equipment and molded and remolded without excessive heat.

- a non-contagious virus, delivered by injection, which breaks down the will of infected sapient, leaving them passive and easily manipulated.

*The One That Got Away.* Attempting to produce a beast of burden for colonizing thin-atmosphere planets, thranx geneticists crossed a huge but delicate horse-like beast with a small, vicious, but hardy predator. What they got instead of a hardy, peaceful pack animal was a huge, vicious monster, which quickly broke free of the genetic labs and is now running loose through the burrows of Hezarax. Unfortunately, the beast seems to have developed a taste for thranx . . . .

Largesse was colonized during the pre-Commonwealth human diaspora. The colonists who came to Largesse flourished in a near-paradise — a warm, watery world with three substantial continents, plenty of domesticable native flora, and only primitive land fauna.

Eventually, the colonists' attention turned to the sea. They discovered that the sea fauna was far less primitive, and included fish, reptiles, and mammals, including a large, apparently *sapient* seal-analog. Human reaction was mixed. Despite the Largessians' obvious recognition of human technology, many biologists compared Largessian intelligence with that of the gorilla. Some Largessians were captured and studied, but the findings were inconclusive.

Indirectly, however, these captures decided the matter. The Largessians of the raided tribe attempted to trade for their brethren. The exquisite coral statuary they offered made it clear that, while technologically primitive, they were sapient. The captured Largessians were released immediately, with the apologies of the Governor, and trade treaties were established.

There is now a thriving Largessian trade in "luxury" items, though it is difficult to predict what items the Largessians will want, or the use to which they will put them. They have paid huge prices for complex technological equipment to use as simple decoration, and once bought a rare perfume not for its aesthetic qualities, but because it drove off a certain predator.

### **Native Sapient**

*Largessians.* Largessian society is divided into nomadic clans which evolved out of protective herd behavior; their culture greatly resembles the behavior of pre-Serum cetaceans on Terra. Over time, clan alliances have developed to resemble a world government. Largesse is not a Class I Commonwealth member, but trades freely with Commonwealth merchants.

Largessians average ST 12, DX 8, IQ 9 and HT 12. Their Move is 12 in the water, 2 on land. Largessians have Acute Hearing (+3), but are Colorblind, Legless, and Lazy.

### **Long Tunnel**

### **Class I**

*Mean Temperature:* 130°/110°  
*Diameter:* 7680 miles  
*Main Port:* Hezarax  
*Population:* 37 million thranx

*Mean Humidity:* 31%/83 %  
*Gravity:* 0.98 G  
*Tech Level:* 9

One of the oldest thranx colonies, Long Tunnel was settled before first contact with humans. Its surface is habitable, but too hot and dry for thranx comfort. The inhabitants of Long Tunnel live in huge, underground complexes which remain comfortable for thranx with only limited climate control. (The second temperature and humidity numbers above refer to underground conditions.)

Long Tunnel's primary export is genetic-engineered life forms. Although cloning and other large-scale genetic engineering projects with higher animals are not yet possible, the scientists of Long Tunnel have managed to do amazing things with plants and lower invertebrates. One of their most famous products is Verdigion Weave: a carpet-like soft grass which grows slowly, but is highly resistant to wear. The genetic engineering laboratories are in separate caverns with extensive security procedures to keep people out and experiments in — despite centuries of continued success, the fear of genetic disaster still looms.



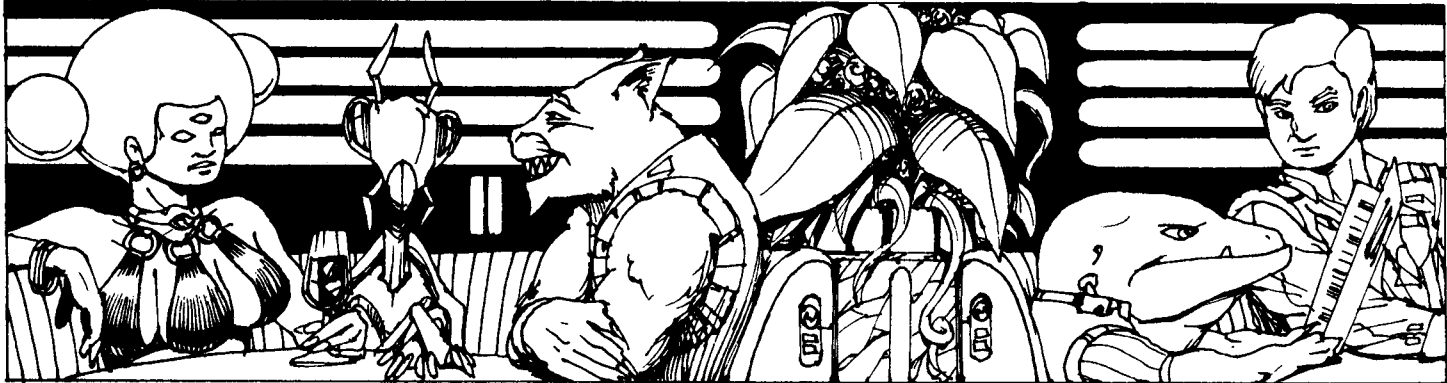

## Loser's World

**Class I**

*Mean Temperature:* 75°

*Mean Humidity:* 60%

*Diameter:* 7162 miles

*Gravity:* .87 G

*Main Port:* Jackpot

*Tech Level:* 9

*Population:* 49 million humanx

Loser's World is a pleasure planet, like Balthazaar/Beersheba, but rather than lust, Loser's appeals to the sin of avarice. Nearly every gambling game played by any sapient species can be found somewhere on Loser's World. Many traditionally non-gambling games (such as chess or Tolian waterball) are bet upon both by participants and spectators. Gambling is strictly regulated by the government, preventing cheating in exchange for a percentage of the purse. To attract gamblers with families, Loser's World offers entertainment for all ages at extremely low prices.

The law on Loser's World is relatively permissive; taxation on most activities — except gambling — is quite low, and police are concerned only with the prevention of violence. The government does require that upon their arrival, all visitors to Loser's World pre-buy a ticket home. These tickets are held by the Port Authority, and may not be gambled. Many a visitor to Loser's World has come to appreciate this official foresight.

## Mantis

**Class I**

*Mean Temperature:* 84°

*Mean Humidity:* 67%

*Diameter:* 8017 miles

*Gravity:* 1.03 G

*Main Port:* Locust

*Tech Level:* 8

*Population:* 375 million humans

Mantis was one of the first worlds targeted for colonization by humans; a generation ship was launched for Mantis long before the development of faster-than-light travel. Once humanity developed the posigravity drive, expeditions were sent to check the status of Terra's colonies. When they arrived at Mantis, the expedition found an unspoiled paradise — the colony ship hadn't made it. Humans in posigrav ships were the first to colonize this lush planet.

Mantis is home to over 30,000,000 species of arthropod. Invertebrates fill most ecological fauna niches from the smallest herbivore up to large carnivores. The colonists battled fiercely for their tenuous foothold on the new world. Gradually, technology won out over Mantis' multi-legged inhabitants. The colonists established agriculture and began to prosper. Locust, the capital city, became a minor trade stop for Terran merchants and grew to 500,000 people. Manufacturing efforts began to produce the luxuries which the colonists had previously done without.

Mantis continued as a modestly successful colony for some years, until its fortunes took a sharp change for the better — a driller pushing a new subway tunnel through the heart of downtown Locust came across deposits of ozmidine.

## Adventuring on Loser's World

*You Bet Your Life.* The PCs come to Loser's World to participate in a decathlon of sports and games, some as contestants, some as gambling spectators. The GM should tailor the event to the skills of at least one member of the party — the gamblers of Loser's World will bet on almost anything. Halfway through the competition, the leading competitors start to suffer mysterious "accidents." The PC contestants will need to find the culprit before they cash in their own chips; the PC gamblers will probably be among the suspects!

## Adventuring on Mantis

*Uncle Smiley's Claim.* A relative of one of the PCs, an eccentric old prospector known as Uncle Smiley, sends a message to his "nephew," saying that he has hit upon a deposit of ozmidine "they'll set us all up like kings." The group travels to meet him in a seedy Locust cantina, but the old prospector is late. After an hour, the old man staggers in and slumps at the table, an uncut green nugget the size of a golfball in his hand.

"Gort me, the dam' bug-huggers . . ." he whispers. "Ya gotta beat 'em ta the claim . . . I lef' the map . . . I lef' the map under the rock at the dead roach . . ." The old man expires on the table, the sting of a large, wasplike bug imbedded behind his ear. Just then, the shady-looking character at the next table hops up and hurries out of the bar.

Was Uncle Smiley the victim of a random sting, or was he murdered? Is the rock in his hand an ozmidine crystal, or just a hunk of glass? Who was the man at the next table? Just where is the "dead roach?" Has Smiley found another deposit of ozmidine?

Ozmidine, a super-hard gemstone found in igneous vents, was previously found only on a small island on the thranx world of Drax IV. On the scale of comparative hardness, diamonds rate a 10 — ozmidine has a hardness of 14! Crystallized ozmidine has a lustrous green to violet shading that makes the finest emeralds look like soapstone.

In the center of Locust, an ugly, dark, smoky hole marks the deposit and the mine. The citizens don't mind — it's making them rich.

## Moth

Class I

*Mean Temperature:* 73°

*Mean Humidity:* 84%

*Diameter:* 8159 miles

*Gravity:* 1.04 G

*Main Port:* Drallar

*Tech Level:* 7

*Population:* 200 million humans

The famous winged world of Moth was once a simple ringed planet. Some time in the distant past, Moth's rings were broken in two places, leaving two great crescents of stone and gas. From space, these crescents appear to fan out like giant wings — two triangles of lambent butter-yellow springing out from either side of the planet.

Moth is proceeded in its orbit by another, smaller body. On clear days — rare on Moth — this "moon" is visible from Moth's surface as the red-hued morning star, Flame.

Moth is smoother than most planets, lacking any great mountain ranges or deep ocean basins. Most of Moth's surface is covered by lakes of all sizes, separated by coniferous forests. Moth is perpetually overcast and rainy; the continual slow drizzle makes the planet a breeding ground for a wide variety of fungus. Moth was settled during humanity's first tenuous steps into space, and remained a "lost" colony until after the Amalgamation. Its government is a monarchy. Since most of Moth's inhabitants are nomads who pursue the great develope herds, an accurate census is impossible. Without such a census, democracy will be a long time coming to Moth.

A series of intelligent rulers, including the current king, his Driest Majesty Dewe Nog Na, have established low taxes, no tariffs, and nearly no trade regulation, bringing many great financial houses to trade on the otherwise undistinguished and somewhat inhospitable world. The government compensates for its lack of tax revenue by reducing services to Moth's inhabitants.

For example, care of the impoverished — a drain on the resources of most governments — was converted into a money-making proposition by selling indigents as slaves. Upon applying for Commonwealth membership, this practice was replaced (at Church insistence) by an "indigent care program." Any total indigent is offered to the wealthy citizens of Drallar as a "ward." These "adopted" persons are bid upon at an outdoor auction in the busy Drallar market, with proceeds going to the government. A ward must remain with his "benefactor" until such time as he pays the debt generated by his original purchase. As there is no regulation forcing a benefactor to pay a wage to his wards, many persons spend their lives in indentured servitude.

To learn more about Moth and its capital of Drallar, see *A Message for Malaika*, beginning on p. 77.

## Interesting Creatures

*Demichin Develope.* These 30-foot-long mammals stand 20 feet high at the shoulder. A develope has four legs, a long snout, and a profusion of curved, knotted horns on its low, forward-sloping head. Herds of one hundred or more develope travel through the forest, pushing evergreens over with their massive horns and short, powerful forelegs. Felled trees are scavenged for needles and



## Adventuring on Moth

*Where, Oh Where . . . ?* Left alone for half a moment, a PC's dependent is taken as an indigent and auctioned off to a benefactor in the Drallar market. Inquiry at the auctioneer's office, with some palm-greasing, gets the party the name of the purchaser, but the listed address turns out to be an abandoned warehouse in Drallar's poorer market district. Further research into the identity of the dependent's purchaser reveals, after considerable bureaucratic backscratching, that the ID was a forgery.

On the streets, the group is advised that the wealthy residents of Drallar's inurbs often arrange fake IDs to purchase wards for less-than-respectable purposes. But that's not the only possibility; word is that purchasing agents for two major off-world buyers have recently been on Moth. One is employed by one of the large brothels on the pleasure world of Balthazaar; the other is said to serve an unethical genetics research firm. Where to look first?

bark. A herd will move non-stop for a week or more, then lie down to sleep for a similar period. The develope herd does not even post sentries. No predator in its right mind would attack a sleeping develope herd — the beasts might wake up!

ST 500, DX 12, IQ 4, HT 17/80. A develope is capable of running sixty mph, although it takes them several turns to get up to this speed. Treat a develope's move as 10 on its first turn, and allow it to accelerate by 3 hexes per turn until it reaches a maximum Move of 30. A develope's hide provides PD 2, DR 2. It attacks by trampling (10 dice damage per foot) or butting (5 dice crushing, +1 per 5 hexes of *current* Move).

*Penestral*. These fish range in length from 50 to 130 feet. They are hunted with jet-boats mounting auto-loading harpoon cannons. A good food fish, a single penestral can feed one hundred people.

ST 100 to 300, DX 15, IQ 3, HT 16/150, Move 10 (swimming). Their scales provide them PD 3, DR 3. A penestral attacks by biting (8+2 dice crushing); penestrals have been known to swallow several boats at once. Of course, the penestral is by no means the biggest fish on Moth; the oboweir grows up to 350' long, and feeds on penestral! The oboweir is only found in *big* lakes, though.

*Squook*. These ground-dwelling carnivores are about 3 feet long. Their paws sport two-inch claws, and their long muzzles house sharp, needle-like teeth. Squook hide in burrows and wait for larger animals to pass by. A squook can kill a human fairly quickly.

ST 8, DX 16, IQ 5, HT 15/9, Move 6. Squook attack by biting and clawing (treat as two attacks doing 1-1 impaling damage each).

*Stupava*. These eight-foot-tall flightless birds run through the forests of Moth on two strong, splay-toed legs. A bright orange crest runs the length of the stupava's head and neck. Stupava are good foragers, and the steed of choice on Moth. A stupava is guided by reins and by sharp, whistling commands, and can carry a full-grown man, along with a limited amount of gear.

ST 25, DX 11, IQ 3, HT 13, Move 12. Attacks by biting (1+2 crushing damage) or trampling (1-1 crushing damage).

## New Paris

## Class I

*Mean Temperature:* 68°

*Mean Humidity:* 58%

*Diameter:* 8003 miles

*Gravity:* 1.01 G

*Main Port:* Triomphe

*Tech Level:* 8

*Population:* 25 million humans

New Paris is the society world of the Commonwealth, discovered and established in 2317 Old Calendar by Heinrich Nuaman, founder of Nuaman Enterprises. Holding true to Nuaman's original design, the government of New Paris remains an oligarchy of landowners. Herr Nuaman only sold tracts to wealthy and influential Commonwealth families, demanding that each landowner support the oligarchy, on pain of loss of land and title.

New Paris' exclusivity is forcibly maintained. All land sales must be approved by the government; approval is rejected if the purchaser is not of the appropriate "class." Corporations are not allowed to own land on New Paris, so all businesses on the world lease their property. Non-residents are forbidden to leave the spaceport area except by invitation of an oligarch.

Most of New Paris' businesses deal in luxury services — the planet boasts the most exclusive shopping district in the Commonwealth. New Paris has also attracted a large community of painters, writers, craftsmen, and theatrical artists seeking patronage from wealthy benefactors.

Crimes against the New Parisian "gentry" are severely punished; disturbing a noble's peace is usually punishable by several years in prison. On the other hand, it is very rare that a landowner is convicted of a crime against a commoner.



## Adventuring on New Paris

*One Phone Call*. Even on New Paris, a prisoner gets one phone call; one such prisoner places his call to an old friend, a PC. It seems the prisoner ran across some very embarrassing information about one of the New Parisian landowners, and soon found himself imprisoned on several trumped-up charges. The party must free him, either by dealing with the landowner, exposing him, or finding some other handle to put pressure upon him. They must work with the utmost subtlety, or they will find themselves making a similar call . . .

## New Riviera

Class I

*Mean Temperature:* 72°  
*Diameter:* 7616 miles  
*Main Port:* Gibraltar  
*Population:* 117 million humans

*Mean Humidity:* 44 %  
*Gravity:* .96 G  
*Tech Level:* 8

### Adventuring on New Riviera

*Excuse me, Mr. President.* The players are hired to track down a prominent public official "vacationing" in the remote wilderness of New Riviera. His opinion is needed on a crucial issue, though he may not want to give it (after all, he came to New Riviera to get away from such things). As the PCs close in, the politician becomes nervous, and sends his bodyguards after the party — he has no idea who his pursuers may be . . . .

### Adventuring on Nineveh

*Ghost Planet.* The PCs are asked by Nuaman Enterprises to investigate a series of strange events taking place on Nineveh (outside help is being enlisted because Nuaman suspects sabotage from within). Several Nineveh personnel report shadowy figures in the halls, glowing apparitions on holoivid screens, and inanimate objects moving or even *floating* through the installation. Word is beginning to circulate that an ancient Terran generation ship was lost in the Sirius system, and that the spirits of the colonists resent Nuaman's disturbance of their resting place.

Nuaman executives suspect that a rival firm is attempting to undermine the company's reputation and stability, and perhaps hopes to purchase the asteroid cheaply. But certain experiments in matter transference, or teleportation, have been conducted on Nineveh in recent years, and may be related to the occurrences in question. And among the rare creatures reputedly in the Nineveh menagerie are plants and animals from the planet Prism, which are not necessarily subject to normal physics. Of course, the ghost story could be true as well . . . .



## Nineveh

Class X

*Mean Temperature:* -110°  
*Diameter:* 629 miles  
*Main Port:* Nineveh  
*Population:* 2,700 humanx

*Mean Humidity:* 0%  
*Gravity:* 0.15 G  
*Tech Level:* 9

Nineveh is a large asteroid in the Sirius system. Airless and with minimal gravity, Nineveh should be just another bare rock, but Nuaman Enterprises chose it as its headquarters. Several pressurized domes project from its barren surface, and offices are honeycombed throughout the asteroid.

Although making Nineveh habitable was tremendously expensive, Nuaman Enterprises located here to save money. By headquartering itself on its own "planet," Nuaman Enterprises sought to avoid taxation by planetary governments.

In the landmark *New Paris vs. Nuaman Enterprises* decision, Commonwealth judges established the precedent that business dealings are subject to taxation by the world on which they are transacted. In effect, the courts decided that Nuaman Enterprises would indeed be tax-free, *if* it conducted all of its business on Nineveh. But other firms refused to travel to Nineveh, not trusting the Nuaman-owned world. "Those stupava won't even come to this damned rock!" Chanaras Nuaman complained. Thus the Nineveh scheme failed.

Few have been to Nineveh, and fewer are willing to talk about it. It is rumored to be luxurious, with rare animals and plants thriving in the low gravity.



## Prism

*Mean Temperature:* 75°  
*Diameter:* 7225 miles  
*Main Port:* None  
*Population:* Unknown

## Under Edict

*Mean Humidity:* 88%  
*Gravity:* 0.84 G  
*Tech Level:* 4 (?)

Prism was recently discovered by the Aurora Group, a thinkmachine and electronics research corporation based on Samstead. The Aurora Group tried to keep Prism a secret, but after its first survey team was lost, Aurora revealed the planet's existence to the United Church.

Only the most superficial studies of Prism's ecology have been made, and the findings of those studies are classified Church intelligence. Information available to the public indicates that a large percentage of Prism's life forms — including its dominant sapients, the Associatives — are silicon-based, and are capable of directly utilizing solar energy for biological processes. A number of these life-forms have proven dangerous or hostile to early humanx explorers.

Preliminary geological surveys indicate that Prism has an abundant supply of ferrosilicate ore. To prevent the reckless colonization that this ore might attract, the Church has placed Prism under edict until its very alien ecology is better understood. The establishment of diplomatic relations with the Associatives will also be a prerequisite for the exploitation of Prism's resources.



## Repler

*Mean Temperature:* 79°  
*Diameter:* 8195 miles  
*Main Port:* Replerport  
*Population:* 15 million humans

## Class I

*Mean Humidity:* 64%  
*Gravity:* 1.06 G  
*Tech Level:* 8

Repler lies along the border between the AAnn Empire and the Commonwealth. When Johannes Repler, a freelance scout, discovered the pleasant (if watery) world, he set his beacon and transmitted Repler's coordinates to the Bureau of Supra-Commonwealth Registry on Hivehom.

When Church investigators arrived to validate Repler's claim, his prospecting beacon had been destroyed and an AAnn colony probe had landed on the world. The planet remained under dispute between the Commonwealth and the AAnn Empire for many years.

Eventually, Repler's claim proved strongest. To speed colonization and promote a harmonious settlement, his heirs granted an AAnn demand for sovereignty over a small area south of Repler City, the eventual capital.

When the AAnn discovered that they wouldn't be allowed to use the facilities at Replerport and that the largest island in their Enclave was insufficiently bedrocked to support a shuttle station, they almost gave up the system in disgust. But to refuse after having won the concession would have made the AAnn diplomats look ridiculous, so an elaborate facility was constructed on the island.

Today, the AAnn enclave is primarily occupied by AAnn oceanologists, whom most AAnn consider congenital idiots. Nevertheless, the AAnn presence is not forgotten by the Commonwealth. A major intelligence operation maintains surveillance on all AAnn activities on Repler.

Repler was recently the site of a mysterious cosmic disaster. Although the details surrounding the incident have been classified, a Class One alert — a "threat to the race of reason" — was declared by the commander of the Church Peaceforcers on Repler. The revolution of Repler's smallest moon was reversed by the incident. Rumor indicates some AAnn involvement, but the Empire is cooperating with Church security in keeping the matter quiet.

### *Adventuring on Repler*

*Ashes to Ashes, Oceans to Dust.* The party is contacted by a mysterious official who believes that the AAnn are working on several very dangerous projects on Repler. Because the AAnn enclave is officially Imperial territory, the Church and the Commonwealth are powerless to investigate. But the Commonwealth can't be responsible for every hare-brained scheme cooked up by its citizenry . . . .

The official offers the party a substantial sum to infiltrate the Imperial Enclave, to discover what projects the AAnn are developing on Repler. Among them might be an energy weapon based on posigrav technology, a nega-grav generator, or a method to convert water-worlds to desert planets. Of course, if the PCs are caught, the Commonwealth will deny any knowledge of their mission.

## Adventuring on Samstead

*Puttin' on the Ritz.* The citizenry of Samstead has begun to notice erratic behavior in its elected officials — staunch liberals come out in favor of stricter duty suit laws, diehard conservatives skip council meetings, peculiar and unpopular trade regulations are signed behind closed doors. People are whispering that there's something strange about the fancy gold duty suits presented to the officials a few months ago by a new iryllium mining conglomerate. This conglomerate, the Abraxas Group, recently won several very lucrative contracts, which happen to force miners to work through hazardous storms; several lives have already been lost. The officials deny any wrongdoing, of course. Are the once-upstanding public officials accepting credits under the table, or is there truth in the rumor that the gold suits are brainwashing the guardians of the public trust?

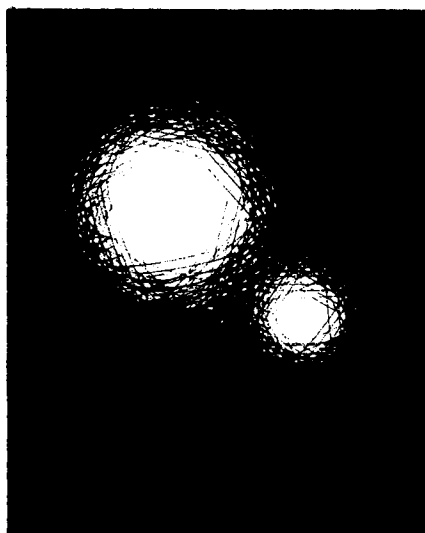

## Quofum, Fabled Quofum

Quofum is a mysterious world whose very existence is questionable. It supposedly lies far from the Commonwealth's boundaries, somewhere along the inner edge of the Orion Arm. Only a few humans and thranx have ever succeeded in visiting it. According to legend, something is wrong with space in that region, something which causes Quofum to appear only occasionally at the coordinates recorded.

Legends of Quofum include tales of alcoholic seas, flowers with euphoric qualities, and fruit free for the picking which offers near-eternal life.

Just finding Quofum, located as it is in unstable space, should prove an adventure in itself. If the party finds the mythical planet, they may be overcome by its beauty and find themselves unwilling to leave — or they might discover a serpent in paradise . . . .

*Mean Temperature:* 59°

*Diameter:* 8512 miles

*Main Port:* Korbyski

*Population:* 264 million humans

*Mean Humidity:* 87%

*Gravity:* 1.14 G

*Tech Level:* 9

Samstead was settled by humans in 164 A.A. to mine iryllium, used in the production of superconductive thinkmachine components. Had this valuable mineral not been present, Samstead might well have remained uncolonized. While temperatures on Samstead approach ideal for human habitation, its large seas generate immense storms like those on Dis and Cachalot. The near-continuous driving wind, rain, and hail make Samstead a miserable place to live.

The Samstead duty suit (p. 57) was developed to protect its wearer from Samstead's violent weather. Its water-repellent, thermosensitive fabric and mechanical stabilizers allow a normal human to operate in the heaviest gales. Even 90 mph winds will not stop the wearer of a Samstead duty suit — although maneuvering in such winds is not easy.

The duty suit became a fixture of daily life on Samstead. As time passed, the suits were customized to provide not only climate protection, but also refreshment, communication facilities, libraries, and tools needed for work. Color conventions were established so that an observer could determine the status and profession of another individual from his suit. Eventually, it became immoral and illegal to remove the duty suit outside the privacy of one's own home, even if other, non-suit clothing was worn.

Modern duty suits serve as babysitters for children, mobile telephones, and health monitors. Doctors and nurses carry enough equipment and medication in their suits to perform minor surgery wherever they go, and special "ambulance" suits are capable of even more. A suit is virtually self-maintaining, requiring only daily recharging (from a power socket at home), semi-annual maintenance checks, and replenishment of supplies such as food, drink, and medication.

Aside from the duty suit, Samstead is a fairly normal world. Since there is no significant agricultural population, status is primarily a function of one's standing with his employer. Most firms are manufacturers or heavy industrial operations; service industries have been supplanted by the duty suit.

## Interesting Creatures

*Spizard.* These 3' hunters hang in the near-continuous winds of Samstead. They have four legs and two wings. The wings trail long plumes of feathers which flutter in the wind, creating the optical illusion of "spinning." Using its wings to control its position and to slow itself, the spizard slides back and forth, devouring the small insects carried along by the winds. Spizards are gliders rather than true flyers; if a spizard lands, it must climb to the top of a cliff or other promontory to launch itself. On the ground, it is vulnerable to predation.

ST 6, DX 14, IQ 4, HT 10, Move 3 (crawling) or 10 (flying). Spizards rarely attack, but will defend themselves with bite and claw (two attacks of 1-3 cutting damage).

*Greencarpet.* Greencarpet is the name for a number of local varieties of six-foot-tall grasses which grow on Samstead. Greencarpet is generally harmless except in the fall, when the grass blades stiffen, die, and are released to carry seeds. The wind carries these two-yard-long spears of stiffened grass at tremendous speed; greencarpet blades have been known to kill an unsuited human.

Greencarpet spears do 1-3 impaling damage per blade, with a given victim being hit by 1 to 6 blades out of a "shower."

## Terra

Class I

*Mean Temperature:* 82°

*Diameter:* 7926 miles

*Main Port:* Brisbane

*Population:* 5.4 billion humans; 81 million thranx

*Mean Humidity:* 51%

*Gravity:* 1.00 G

*Tech Level:* 9

Terra is the human homeworld, and one of the two capitals of the Commonwealth. It is more than 3/4 ocean, and is orbited by a huge moon, Luna. Its population is predominantly human, but there are large thranx settlements in northern Australia and the Amazon rain forest of South America.

The United Church is headquartered on the Terran island of Bali. The Council of the Church meets once each Terran year at the Chancellory to decide matters of policy and hear specific petitions. Otherwise, Bali is closed to all but Church personnel, native Balinese, and Commonwealth government officials on special assignment.

There is a major low-energy physics and Space-plus research facility on Pluto, the outermost planet of the Terran system. Pluto only houses a few hundred scientists, but is rumored to be the site of a major Commonwealth SCCAM-shell laboratory.

Terra developed two sapient groups: humans and cetaceans (see pp. 44-45).

## Tolus Prime

Class I

*Mean Temperature:* 86°

*Diameter:* 8393 miles

*Main Port:* Chantras

*Population:* 1.8 billion Tolians

*Mean Humidity:* 87%

*Gravity:* 1.11 G

*Tech Level:* 8

Tolus Prime is a world of shallow seas and flat land masses. This, combined with a large, tide-influencing moon, makes most of Tolus a swamp.

The Tolians live harmoniously with nature, combining a respect for their swampy home with a materialism close to human. Tolian traders hawk their wares in most Commonwealth markets, specializing in the many artistic products of their homeworld.

Although Tolian firms trade throughout the Commonwealth, and Tolians frequently travel to other worlds, they seldom settle elsewhere. This is due, at least in part, to the comparatively low population of Tolus. The long-lived, slow-breeding Tolians have yet to experience serious population pressure on their homeworld.

Tolians (p. 42) are the native sapients of Tolus Prime.

## Tran-ky-ky

Class IV-B

*Mean Temperature:* -25°

*Diameter:* 7478 miles

*Main Port:* Brass Monkey

*Population:* 250,000 tran; 1,500 humans

*Mean Humidity:* 11%

*Gravity:* .92 G

*Tech Level:* 3

A newly discovered world on the fringes of humanx settlement, Tran-ky-ky is too far from its sun for humanx comfort. Even at the equator, temperatures never rise above freezing, and high winds scour the planet's ice-encrusted surface. Although a few large masses poke through the ice, most of Tran-ky-ky's exposed land is divided among thousands of tiny rock islets.

## Adventuring on Terra

*One Hand Washes the Other.* Any "adventure" taking place on the very civilized human homeworld is likely to challenge the mind more than the body. Perhaps in the course of an adventure on a less tame world, the PCs will decide to visit Terra to deliver a petition to the Church. To do so, they must run gauntlet of red tape. Even the very first step, simply obtaining permission to visit Bali, will be difficult. Along the way, the PCs must figure out which backs to scratch, strings to pull, and dead ends to avoid.



## Adventuring on Tolus Prime

*Down and Out in Chantras.* Destitute and stranded on Tolus Prime, the PCs must concoct a scheme to raise cash for passage off-world. Unfortunately, the Tolians have little use for human soldiers and stingship pilots — local demand is for craft goods better made by six-fingered native hands. The party will have to use ingenuity and non-combat skills to earn the capital necessary for an interstellar fare.

## Adventuring on Tran-ky-ky

*Ice Crystals.* The group is contacted by a big, white-haired man with a gold earring, who is looking to outfit an expedition to find "a very special something" on Tran-ky-ky. When they arrive at Brass Monkey, the big man identifies himself — Skua September — and the object of their quest — fragments of ozmidine (see p. 24) showered across the ice when the volcano at the Place-Where-The-Earth's-Blood-Boils exploded in 549 A.A.

Although he has been as secretive as possible, Skua believes he may have revealed the existence of the ozmidine deposit to a certain young lady of questionable character. If he did let it slip, you can bet there will be at least one other party racing September's to the site. In addition to these rival "prospectors," the party is liable to encounter any number of dangerous beasts, unreliable survival gear, inaccurate maps, treacherous ice, and perhaps even a marauding Horde!



### *The Slanderscree*

Aside from skating, the most common form of transportation on Tran-ky-ky is the tran iceraft. Constructed of wood, the typical iceraft is a triangular platform 20 yards long by 10 yards wide, carrying a square sail. Three runners of sharpened gray stone — one at each corner — support the raft on the ice. Downwind, a tran iceraft can move virtually as fast as the wind blows, but its square sail is very inefficient for tacking upwind, able to cover ground at only one-third of the wind velocity.

When Ethan Fortune, Skua September and Milliken Williams were stranded on Tran-ky-ky, they helped their tran rescuers to design and build the *Slanderscree*, the first true “icerigger.” Patterned after the Terran clipper ship, the *Slanderscree* is over 50 yards long and 20 yards wide. She carries three masts, each supporting several triangular and square sails. Her five runners are of duralloy, salvaged from the wreck of Fortune, September and Williams’ lifeboat.

Although she cannot exceed the wind velocity downwind, the *Slanderscree* is much more stable in heavy winds than the typical tran iceraft — in addition to her broad base, she carries two airfoils to keep her pressed firmly against the ice. Her triangular sails — an innovation on Tran-ky-ky — allow her to move upwind much more swiftly than the square-sailed icerafts; the *Slanderscree* is capable of tacking upwind at fully half the wind velocity.

Wind velocity on a typical Tran day is about 30 mph; the winds seldom drop below 15 mph, and frequently break 60 mph. In the Rifs — huge storms on Tran-ky-ky’s icy seas — wind speeds exceed 150 mph. Prevailing winds at the equator blow from the west, although weather conditions vary this somewhat.

Planetologic evidence indicates that Tran-ky-ky goes through periodic climatic changes which bring it into a more temperate state. It is estimated that these “balmy” periods begin every 45,000 years, and last about 10,000 years.

Tran-ky-ky is occupied by the tran, a race of sentient felines adapted to the planet’s cold climate. During the “balmy” periods, the tran lose their cold-weather adaptations, and a new civilization flourishes for a few millenia. But when the cold weather returns, tran society falls back into barbarism.

In 550 A.A., a movement began to unite the tran city-states and gain Class II membership in the Commonwealth for Tran-ky-ky; this process should be complete by about 558 A.A.

The Tran (pp. 45-46) and the Saia (p. 47) are the native sapients of Tran-ky-ky.

### *Interesting Creatures*

*Stavanzer*. These mountainous gray creatures, called “thunder-eaters” by the tran, grow over 300 feet long, and may have evolved from whale-like creatures. A stavanzer has a large, black eye on either side of its mouth, and moves like a slug on 10-foot-thick pads. Stavanzers swallow pika-pedan grass, air, and whatever else approaches their 30-foot maws. Stavanzers are long-lived, and no Tran legend tells of one being killed.

ST 800, DX 8, IQ 3, HT 17/200, Move 3, Move 25. Stavanzers can easily swallow several human beings at once.

*Droom*. A large and vicious nocturnal carnivore, the Droom is able to sense the body warmth of its prey. The 3-foot maw of a Droom is lined with thousands of long, needle-like teeth; three sharp claws on each of its feet are capable of carving a deep gouge in duralloy. Droom up to 25 feet long, measured head-to-tail, have been reliably reported, although they may grow larger.

ST 40, DX 12, IQ 4, HT 16/25, Move 7. The claws of the Droom do 3-1 cutting damage, and its teeth do 2+2 impaling.

*Kossief*. This squid-like beast is also called simply a grabber. A kossief melts a water-filled hole in the ice floor, crawls in, and allows a thin coating of ice to freeze over the surface. When a creature passes, the grabber bursts through the ice cover and grabs its prey with its many strong tentacles, dragging it into its lair. Grabbers of widely varying sizes have been seen; some are only a few yards long, and prey upon man-sized animals. Others, called shan-kosseif, grow up to 250 feet in length, preying upon larger creatures and occasionally attacking tran icerafts.

The small variety of kossief has ST 15, DX 11, IQ 3, HT 13, and Move 3. It will attempt to grab a victim and pull him into its watery hole to drown. The ship-eating shan-kossiefs run around ST 300, DX 12, IQ 3, HT 14/200, and Move 5. It is not known whether the two varieties represent different species, or different stages in the life-cycle of a single animal.

Often, a shan-kosseif will simply hold an iceraft to pluck the tran or other passengers off of it. To do so, the shan-kosseif attempts to grab the victim with one of its tentacles, rolling a normal attack. The target of the attack may not Parry or Block the tentacle; his only hope is to Dodge it, or to leap out of the way by making a DX roll. If he leaps away from the tentacle, he will wind up prone, about two hexes from his original location. Once grabbed, a victim is helpless; he can only hope his friends will disable the tentacle holding him by doing 50 HT damage to that tentacle, or kill the shan-kosseif. Otherwise, the beast will devour him within ten turns.

## Ulru-Ujurr

*Mean Temperature:* 37°  
*Diameter:* 8512 miles  
*Main Port:* None  
*Population:* 1 million Ujurrians

Ulru-Ujurr is concealed in a far corner of the Commonwealth, in the direction of the Rosette Nebula. This cold, lonely world is under Church Edict, due no doubt to the frightening potential of the native sapient race.

The Ulru-Ujurrians are a primitive species with huge but untapped mental capacity. They are natural telepaths, and possess a tremendous ability to learn and develop. But by nature, they are similar to Largessians — satisfied with the simpler pleasures of life.

Automated Peaceforcer equipment prevents any unauthorized visit to Ulru-Ujurr. However, a recent investigation discovered evidence of an AAnn facility to mine Janus jewels (see sidebar), and there has also been some disturbance in the native population. These are still being investigated, although the Church is suppressing the facts in the case.

### *Native Sapients*

The Ulru-Ujurrians are seven-foot-tall ursinoid quadrupeds with dense brown fur covered with black and white splotches. Their faces are ape-like, with a flat muzzle, a small black nose, short rounded ears, and huge round eyes. Each hand and foot sports seven short, claw-tipped fingers or toes. Ulru-Ujurrians travel alternately on their hind legs or on all fours.

The Ulru-Ujurrians are a brilliant race with little initiative — they have lived contentedly at TL0 for centuries, but can learn and develop rapidly when they choose to do so. Although the Commonwealth is unaware of it, one community of Ujurrians was able to design and build a working faster-than-light starship in just a few weeks.

Ujurrians average ST 14, DX 11, IQ 13, HT 14, Move 8. Most Ujurrians have at least 20 points in Eidetic Memory, as well as the Laziness disadvantage. All Ujurrians are at least somewhat telepathic, with a minimum Telepathic Power of 3. At least one Ujurrian is known to have the psionic ability to teleport.

## Willow-Wane

*Mean Temperature:* 110°  
*Diameter:* 7419 miles  
*Main Port:* Ciccikalk  
*Population:* 3.7 billion thranx

One of the earliest thranx colony worlds, Willow-Wane suffered periodic AAnn raids during its early history. Willow-Wane is an agricultural world, and trades its large crops through the markets of Ciccikalk. The planet's greatest claim to fame, however, is as the home of the thranx hero, Ryozenzuzex.

Ryozenzuzex established the first meaningful communication between humans and thranx. He recognized the humans as sapient beings distinct from the AAnn, and broke down much of the shape prejudice with a brilliant but unauthorized Project: he raised human children and thranx larvae together, proving to each species that the other was not monstrous.

The town of Paszex, home of the Hive Zex, has produced many other significant individuals, including the Eint Truzenzuzex (see p. 93). The Hive Zex receives many offers for mating with individuals of their Hive to spread their successful genes.

## Under Edict

*Mean Humidity:* 37%  
*Gravity:* 1.14 G  
*Tech Level:* 0

## Janus Jewels

Ulru-Ujurr is the source of Janus jewels — hard, mineral spheres containing a thick fluid. Suspended in the fluid are microscopic psychoreactive particles; a psionically aware mind (or one using a Janus jewel headset — \$1000) can manipulate the jewel, causing it to glow and portray images from the user's imagination. The user of a Janus jewel finds himself immersed in a vivid dream which appeals to all his senses. Janus jewels are dangerous, though. They can be "impressed" with a specific message which may influence a user as a post-hypnotic suggestion. A user who fails to resist the effect (IQ-5 roll) will follow the message, even if it leads to self-destruction. The suggestive effect of Janus jewels is not widely known among Commonwealth scientists.

### *Adventuring on Ulru-Ujurr*

*Reach Out and Touch Someone.* Passing near the Ulru system — relatively speaking — the PCs are touched by a telepathic distress call from the tortured mind of an Ulru-Ujurrian. If they decide to respond, the party must negotiate the Church Peaceforce blockade and contact the Ujurrians, who know only that several of their number have disappeared over the last few months. A second, more pitiful cry is felt, this time much nearer. The message: a plea for release from life. The cry is followed, and the party discovers that the AAnn are torturing Ujurrians, channeling their pained telepathic screams to program Janus jewels with suicidal messages. Obviously, the AAnn must be stopped and the Ujurrians freed.

## Class I

### *Adventuring on Willow-Wane*

*Hello, Sailor.* On a visit to Paszex, a thranx PC receives an amazing number of propositions from Zex thranx. Why the sudden popularity? The PC has been used to smuggle a tiny package through customs, and each of the rather forward female thranx to approach him is attempting to get close enough to reclaim the item. Once the PCs find the package on the person of their thranx companion, they will be subjected to several attempts to take the package from them, by guile, violence or stealth. And removing the package may cost the thranx PC his life!



# 4

# CHARACTERS

## Character Creation

PCs for humanx campaigns should be built on 100 character points. Players may play humans, or they may decide to play members of several alien species. Though each of these species is very different, both physically and psychologically, all are roughly equivalent to humans. Thus, there is no point cost to be a member of any of these races.

Alien characters are created using the same attribute table used for humans — but they may get *bonuses* or *penalties* to one or more attributes. These bonuses and penalties affect the final attribute level, not the point cost. For instance, a thranx has a -2 penalty on ST. That means that if he pays 0 points for ST, he gets a 10 (from the Basic Attributes table) minus 2 (this penalty) for a total ST of 8. If he pays 10 points for ST, he gets an 11 (from the table) minus 2, for a total of 9.

Many aliens have “natural” disadvantages. These do *not* count against the limit of three disadvantages/40 points for a character. To the alien, these are perfectly normal traits.

Where not described otherwise, assume that aliens are functionally identical to humans.

### Automatic Skills

Several species have, as part of their “package” of advantages and disadvantages, automatic skills. These skills are learned by *all* members of the species in their home environment; the “automatic” value is the minimum level of skill found among young adults of that species. This level may be improved by spending character points just as if the character had learned the skill in the “normal fashion” — which he, and every other member of his species, did!

For example, all Tolians automatically have Swimming at their DX level. When created, Tintopah has DX 12, giving him Swimming-12 at no additional point cost, as part of his Tolian background. In the course of adventure, Tintopah accumulates enough experience to raise his DX to 13, and does so. His Swimming skill also improves to 13. Later, during an adventure on the watery world of Cachalot, Tintopah decides to further improve his Swimming skill to 15. To do so, he pays 3 character points, the normal cost to increase a Physical/Easy skill from DX to DX+2.

## Spacefaring Species

Five species commonly travel between stars in the Commonwealth universe — humans, thranx, Tolians, ornithorpes and AAnn. Of these, the first four are particularly well-suited as player characters; they are intelligent, advanced, and cosmopolitan. Facilities designed especially for these species can be found at most major starports. Indeed, small populations of each of these races can be found on most Commonwealth planets.

The AAnn are more likely to be encountered as villains in *Humanx* adventures. The AAnn Empire is the Commonwealth’s greatest foe — only a very unusual AAnn would be found among a group of humanx adventurers.

### Thranx

The thranx evolved from burrowing, hive-dwelling arthropods on Hivehom (see p. 25). Their cities and colonies are large underground complexes built with

### Creating New Species

The Humanx Commonwealth is home to half a hundred intelligent species. Most travel only rarely; for them, Commonwealth membership means little more than an on-world spaceport for interstellar trade. GMs can easily create new species (or translate them from other sources). Those provided are described by Foster in various Humanx stories, and can be used as examples.

There is often a point value for the “advantage” or “disadvantage” of belonging to a certain species. (All the player character species in this chapter balance out to 0 points, the same as humans.) To compute this for a new species, start by calculating the value of the species’ attribute modifiers. Use the cost to a human (see p. B6). For instance, a +1 on any attribute is worth 10; a +3 is worth 30; a +4 is worth 45, and so on. Negative modifiers, of course, have negative cost.

Advantages and disadvantages have their normal point cost from *GURPS Basic Set*.

Reaction bonuses or penalties can be ignored unless they apply to *most* other species the alien will encounter. In that case, each point of reaction bonus is worth +5 character points, each point of penalty is worth -5. Other attributes which affect reaction (e.g., appearance) are treated the same way.

A species may have other strong or weak points that don’t have a direct comparison in the Character Creation section. GMs should simply allow a reasonable “cost” for these.

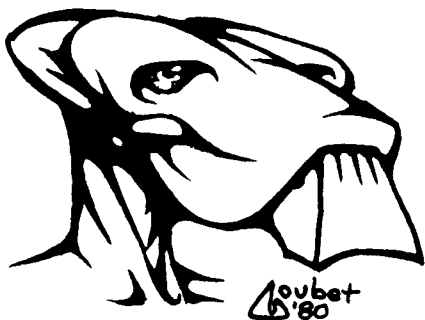

modern materials, rather than the regurgitated cellulose and body plaster used by their primitive ancestors.

Thranx hatch from eggs and grow into large larvae: 4' slug-like creatures with large black eyes, soft white skin, and thin mouth-slits. Larvae are sapient, but are colorblind, slow, and have no sense of smell or *faz*. Thranx larvae spend several years in a heavily-defended Nursery deep in the hive, where they are educated and prepared for the adult career of their choosing. Eventually, the larvae spin cocoons, from which they emerge as adult thranx several months later.

The average adult male thranx stands 4' 8" and weighs 140 lbs.; females are slightly larger. The thranx abdomen and thorax are segmented, and the triangular mantis-like head swivels on top of the neck-like "b-thorax."

Thranx have eight limbs: two arms, four legs, and two intermediary limbs which function alternately as arms or legs. The arms end in "truhands," suited for fine manipulation; the intermediary limbs end in "foothands," used for gross manipulation and heavy lifting. Both truhands and foothands have four equally opposable digits. Thranx also have vestigial wings and wing cases, which are lost with the thranx's first mating.

Evolving as they did in dark tunnels, thranx developed a sense called *faz*, which allows them to detect movement by sensing atmospheric vibrations. *Faz* receptors are located in the antennae, as are a thranx's keen olfactory (smell) receptors. The widely spaced compound eyes of thranx provide acute vision for close objects, but are less effective than human eyes at long distances.

The thranx exoskeleton darkens with age. A male hatchling's chitin is usually light blue, a female's is aquamarine; a mature adult is deep blue, while an old thranx darkens to deep purple. Beyond this natural coloring, however, the shell is decorated to show clan, job, homeworld, and personal honors.

Thranx are burrowing creatures, most comfortable in their underground

## Faz Sense

The thranx sense of *faz* allows a thranx to detect the location and size of objects by sensing atmospheric vibrations. Combined with their keen sense of smell, *faz* allows thranx to navigate quite well in the dark. Thranx recognize one another by scent as easily as humans do by sight. *Faz* is not a substitute for vision, though. While a thranx may find an opponent in a cave more easily than a human could, he will not be able to tell what color his foe is wearing, or what specific weapon he might be carrying.

Moving objects are much easier to *faz* than stationary ones, large objects are easier than small ones. A thranx in a perfectly still, dark chamber will only have a vague idea how large the room is, but will be able to *faz* a wall before he runs into it. He can easily find any doors or vents by sensing the air moving in or out of the room.

If there is a question as to whether a thranx would notice something by *faz*, the player rolls vs. IQ, just as he would to see or hear something. The following minuses should be applied to any *faz* roll:

*Range.* -1 per 3 hexes

*Size.* As per "Target Size Modifiers," back cover, *GURPS Basic Set* Adventuring book.

*Speed of object.* +1 per 1 Move

*Speed of thranx.* +1 per 3 Move (only when moving towards the object)

*Other Modifiers.* The GM may choose to assess other modifiers to the *faz* roll according to circumstances. For example, in a 20 mph wind, a thranx will be at -4 to *faz* anything upwind, and totally unable to *faz* anything downwind.

A successful *faz* roll indicates the general size, location, speed and direction of movement of an object. It may or may not reveal information about the object's shape. Once a thranx has *fazed* something, he may target it with a weapon or melee attack, taking the same penalties on his to-hit roll as he did on the *faz* roll.

The *faz* roll is affected by Alertness and Acute *Faz* (an advantage costing 2 points/+1). A thranx without antennae cannot *faz*; taken at the time of character creation, No *Faz* is a 10-point disadvantage for a thranx.



## Typical Thranx Advantages and Disadvantages

The advantages Ambidexterity, Eidetic Memory, Mathematical Ability and Strong Will are common among thranx, as are the disadvantages Honesty, Pacifism and Truthfulness. Combat Reflexes, Rapid Healing, Berserk, Illiteracy and Impulsiveness are rare among thranx; no thranx is Double-Jointed or Fat.

## Thranx Names

Thranx names comprise four parts, usually of one syllable each — a personal name, a family name, a clan name and a hive name. *Besondenbit*, for example, is Be, of the family Son, Clan Den, Hive Bit. Family and clan names are hereditary — a family takes as its name the personal name of a prominent direct ancestor. A clan is a group of related families, named for a single common ancestor.

Hive names, however, are geographical. In ancient times, before thranx hives came together to form cities, each hive was a distinct community. All the residents of the hive shared the same hive name — usually the name of the hive's founding queen. Today, most cities include several hives. The nearest human equivalent for a hive in a modern city is a neighborhood — though the feeling of community is much stronger in a hive than in a human neighborhood. Though a thranx may move during his lifetime, becoming a resident of many hives along the way, he retains the name of the hive in which he was nursed as the final syllable of his name.

Occasionally, a new family or clan will be formed. This usually happens when a family grows extremely large. The name for the new family is chosen by the clanmother, who selects from the personal names of the ancestors of the family to be named. When the time comes for Family Zen of Clan Zu to break into two families, the clanmother might well choose to honor Ryozenzuzex by naming the new family Ryo. When she does so, all of Ryo's descendants will change their family name from Zen to Ryo — Truzenzuzex becoming Truryozuzex. Of course, Family Ryo will remain a part of Clan Zu.

In familiar speech, thranx call one another by their personal name — the first part of their full name. Thus, Major Orvenalix would be Or to his friends, while Sylzenzuzex would be Syl to hers. In slightly more formal speech, such as in professional situations, thranx are called by their personal and family names. Japurovac would be addressed as Japur, while Ivenzutec would be Ilven.

cities. Most thranx suffer from *Outside*, a form of Agoraphobia (p. B28). Attacks of this ancient fear are most often seen among first-time starship passengers; experienced travelers rarely suffer. *No Outside* is a 10-point advantage for thranx which may be bought after character generation. Should an *Outside* sufferer need to travel through space, cerebroneural depressants (see p. 58) can ease his discomfort.

**Advantages and Disadvantages:** Thranx get a -2 on ST, -1 on DX, and -2 on HT. Male thranx are 6 inches shorter and 20 lbs. lighter than human *females* of the same ST, while thranx females are correspondingly smaller than human *males*. All thranx have the advantages Acute Taste and Smell (+3), Acute Vision (+2), Common Sense and Peripheral Vision, as well as the disadvantages Agoraphobia, Hemophilia, and uncorrectable Nearsightedness (which is not affected by Acute Vision).

Thranx have a tough exoskeleton (PD 2, DR 2), but their open circulatory system makes any puncture of the exoskeleton very serious — hence the Hemophilia disadvantage. Unlike a hemophilic human, though, a thranx may have a HT above 10.

Thranx are +2 DX when using their truhands, +2 ST when using their foothands. A task calling for both truhands and foothands is performed at DX+1 and ST+1. When moving on four legs, a thranx's unencumbered Move is equal to his Basic Speed, but if a thranx uses his foothands for locomotion, he gets a 50% bonus (rounded down) to his unencumbered Move.

## Thranx and Water

Thranx cannot hold their breath — the breathing spicules located on the top of the thorax cannot be closed. In water, a thranx will float until these spicules are submerged, at which point the thranx's breathing cavity fills and the thranx sinks. For those few thranx bold enough to attempt it, Swimming is a Physical/Hard skill, defaulting to ST-7 or DX-6.

In any water deeper than 4', a thranx must make a Swimming roll every minute (every *turn* in combat) to keep his spicules above the water. In surf, this roll is at -2; on open seas during a storm, it may be at -6 or more! If this roll is failed, the thranx will begin to sink to the bottom, and will pass out in HTx5 turns, dying in HTx25 turns.

A sinking thranx who keeps his head — roll vs. IQ, Strong Will helps — can *walk* along the bottom of a body of water for as long as he remains conscious. The Move of a thranx is halved underwater. If he is not too far from shore, a drowning thranx can save himself by walking out!

Resuscitating a waterlogged thranx is not difficult, if he can be recovered from the water — merely invert him and allow his breathing cavity to drain via his spicules. If unconscious, the thranx makes a HT roll every minute to come around after having been "drained." A conscious thranx can drain himself simply by turning on his back.

## Thranx Dignitaries

A Hivemother is above family and clan affiliations — to the thranx, she *is* her hive. Hivemothers choose their own successors from the females of their hive. Upon the old hive mother's death, the new Hivemother drops her family and clan names. She is known from then on by her personal name and the name of her hive. The two names are separated by an *i*, meaning "of" or "the." When Taldonzuzex became Hivemother of Hive Zex, her name became Tal-i-zex. A hive mother has Status 4.

The title Eint is bestowed by thranx upon those who demonstrate both expertise in a field of science or art *and* model citizenship and service to their fellow sapients. Thus, an Eint is a sort of Ph.D. and knight, rolled into one! Truly ex-

ceptional individuals may be awarded the title more than once, becoming Di- or Tri-Eints. Upon occasion, the title Eint has been bestowed upon non-thranx, though this is rare. An Eint has Status 3; a Di-Eint, 4; and a Tri-Eint, 5.

## Ornithorpes

The ornithorpes are intelligent, feathered, omnivorous bipeds from Chikasasoo (see p. 23). Ornithorpes range from 4' 6" to 7' tall, including their long, serpentine necks. Their short arms have three long fingers and an opposable thumb, each tipped by a hard, horny claw. In their own language, ornithorpes call themselves the *quillp*.

Ornithorpes are divided into a number of easily discernible races. While the various races cooperate in business and governmental ventures, each seems to remain sexually and socially pure. This seems to be a matter of aesthetics — ornithorpes of one race simply do not find the other races attractive. Some speculate that ornithorpes comprise more than one biological species.

Ornithorpes prefer worlds with low gravity — roughly .85 to .90 Terran gravity — but with temperatures and humidity in the comfort range of both humans and thranx. Ornithorpe worlds are thus much preferred as vacation sites, and ornithorpe visitors to Commonwealth worlds are quite common.

The ornithorpes had already established several colonies by the time they were encountered by humanx explorers. Although they maintain their independence, they are sympathetic allies, and the Ornithorpe Confederation will probably join the Commonwealth in the not-too-distant future.

Ornithorpe government is based on a form of representative democracy. However, rather than using strict territorial or clan-hive divisions like humans and thranx, ornithorpes select representatives seemingly at their convenience. If an individual becomes dissatisfied with the representation he is receiving, he withdraws support from the current representative and either supports another existing representative or, in extreme cases, goes to the council to represent himself. The more individuals supporting a given representative, the more power that representative has in council.

**Advantages and Disadvantages:** Ornithorpes are -1 ST, +2 DX, and -1 HT. Ornithorpes have Acute Vision (+5), and Peripheral Vision. However, they are Impulsive, and have mild Claustrophobia. To ease the discomfort they feel in enclosed starships, ornithorpes often project holographic images of their homeworld's sky onto ships' ceilings.

### *Typical Ornithorpe Advantages and Disadvantages*

Absolute Direction, Alertness, Danger Sense, Language Talent, and Voice are common advantages among ornithorpes. The quillp are a temperamental race; they often have disadvantages such as Bad Temper, Jealousy, Paranoia, various Phobias and Stubbornness. Common Sense, Bad Sight, Color Blindness, Dyslexia, Fat, Hard of Hearing, and Pyromania are rare among ornithorpes. Unusually large or small ornithorpe subspecies have the disadvantages of Dwarfism or Gigantism.

### *Ornithorpe Names*

The language of the quillp is made up of whistles, chirps and clicks as well as more conventional tones. Pitch is as important as tone to the ornithorpes. When represented solely by human letters and sounds, the quillp language consists mostly of vowels, separated by staccato consonants such as b, k and t. Nasal tones — n and m — are extremely rare.

Quillp names tend to be long and difficult to pronounce for humans. Chikasasoo, the quillp name for their own homeworld, is actually relatively simple by ornithorpe standards. Personal names among the ornithorpe include Ata'oor, Kik-ki'a'settsi, Quaa'illa, Raia'kaa, Ku'tio'i, Tooriu'kku, A'atuito'o and Bo'ilo'atok.

It is common for other species to simplify quillp names for ease of pronunciation; the name Bo'ilo'atok might be shortened to Bolo. While the ornithorpes tolerate these bastardizations of their names, they do not use them themselves.

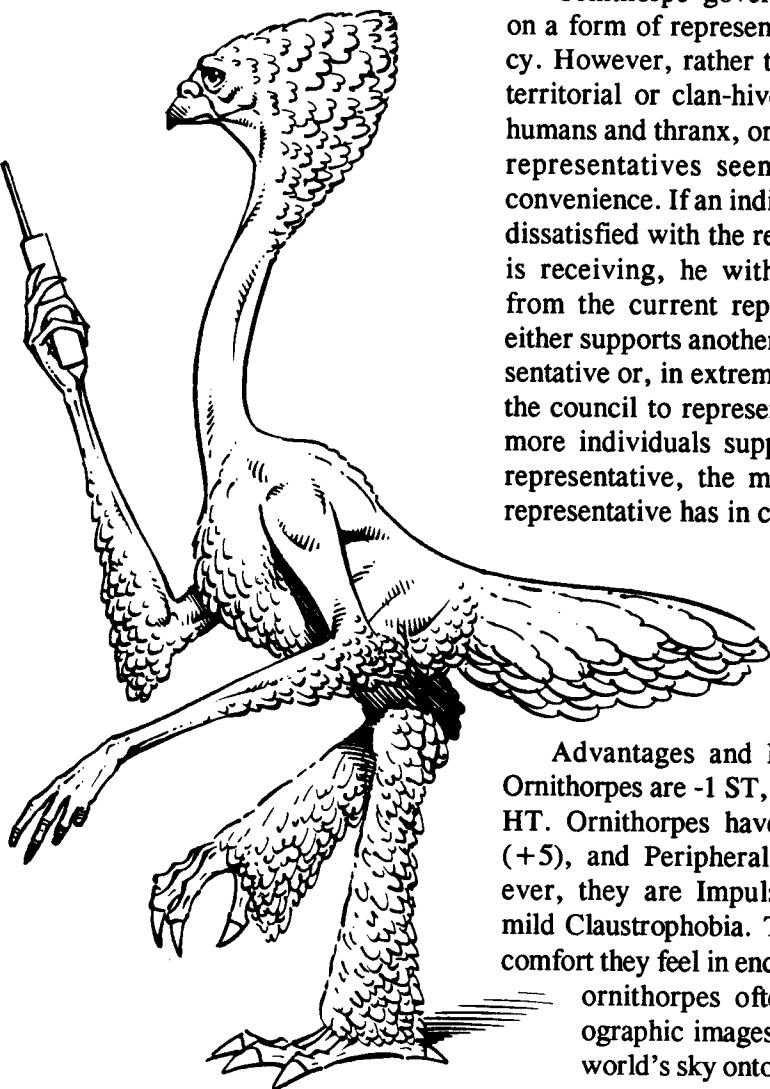

## Tolians

The Tolians are mammals resembling unmasked raccoons with massive forearms and high, intelligent brows. A Tolian measures some 4' 6" from the nose to the base of his bushy tail. Tolian ears are large and sharply pointed; their rear feet are webbed. Their personalities tend to be very similar to those of humans; Tolians are friendly, but a bit conservative.

Tolian civilization was in a TL8 technological and cultural renaissance when humanx explorers discovered their world, Tolus Prime (see p. 35). The Commonwealth offered them membership almost immediately. Tolians adapted well to space travel; some Tolian companies have successful mercantile operations throughout the Commonwealth.

The long-lived Tolians do not reach maturity until 24 (p. 49); they often live well over a century (p. 49). Tolians usually do not begin childrearing until they are in their forties, and rarely have more than two or three children per family. Due to this relatively slow life-cycle, Tolus Prime is sparsely populated for the homeworld of a sentient species. The lack of population pressure on Tolus, combined with racial conservatism, hinders Tolian colonization of other worlds.

*Advantages and Disadvantages:* Tolians get a +1 on DX, but -2 on ST due to their size. Tolians automatically have the Swimming skill at their DX level, and have the advantages Acute Taste/Smell (+2) and Night Vision.

Tolians can run rapidly on all fours, and can waddle slowly on their hind legs. To find a Tolian's unencumbered Move on four feet, multiply his Basic Speed by 1.5 (rounded down); his unencumbered Move upright is half his Basic Speed (rounded down, but never less than 1). Be sure to record *both* of these numbers, and *not* Basic Speed, in the Move box on a Tolian's character sheet.

A peculiar aspect of Tolian biochemistry — alcohol affects Tolians as a mild poison, making them ill, but failing to produce the euphoric state it does in most species. Fermented Ropus lymph, while nauseating to humans and thranx, is the intoxicant of choice among Tolians.



### Typical Tolian Advantages and Disadvantages

Tolians frequently have the advantages of Alertness, Common Sense, Intuition, and Luck. The disadvantages of Fat, Gluttony, and Stubbornness are common among Tolians, as are quirks which reflect their mellow but conservative nature. Only a rare Tolian would have Berserk, Bully, Megalomania, Overconfidence, or Skinny disadvantages.

### Tolian Names

A Tolian's name consists of a single word having two parts — his own name-part, followed by that of his same-sex parent. A vowel is inserted to bridge the two parts of the name. The Tolian Porsupah was actually Pors, son of Pah. His own son might be named Altopors.

Tolian name-parts have no inherent gender. The name Pors might just as well be given to a female Tolian. The gender of a Tolian name is determined by the bridging vowel — "u" and "o" are masculine, while "i" and "a" are feminine. It is common among Tolians to give a son and daughter the same personal name-part. Porsupah's parents, Pahotil and Maragal, might name their daughter Porsimar.

Occasionally, Tolian parents will give a child the personal name-part of his opposite-sex parent. If Porsupah had a brother named thusly, he would be Maropah.

A few Tolian names — Tarsotam, Lanaden, Mosupot, Hallohar, Tinimak, Pastuphan, Mysabar, Brefudur and Pelliwen.





## AAnn

The AAnn Empire is the Commonwealth's primary rival. The AAnn see other races as infestations of the galaxy, valuable only as a food source. Fortunately, the humanx alliance is more powerful than the AAnn war machine. Thus, the Empire bides its time, waiting for the Commonwealth to grow weak before launching an all-out campaign.

The AAnn are bipedal reptiles, with two arms ending in six-fingered hands, and a heavy tail long enough to reach the ground. AAnn are covered with green or yellowish scales, and have a spiny head-ridge and a lipless, fanged grin. Dedicated AAnn agents — their tails surgically removed — have been known to don plastic masks to infiltrate the Commonwealth disguised as humans.

AAnn prefer temperatures in excess of 90 degrees, and considerably less humidity than is comfortable for thranx. They require very little water, and dislike any body of liquid larger than a puddle — the AAnn homeworld of Blasusarr is mostly desert. AAnn bury their eggs in hot, sandy soil and allow the ambient warmth to incubate them for several months before they hatch. An AAnn hatchling is 1' long and unable to walk, although it can crawl. AAnn reach adulthood at the age of 11, and live only about 60 years. Female AAnn are rarely encountered outside the Empire; xenologists theorize a high male-to-female ratio among AAnn.

AAnn society is organized according to a strict military hierarchy. AAnn are born into a "nest," a grouping similar to a thranx hive. Although there is a definite ranking among nests, an AAnn's Status is variable throughout his life, based upon his current position and responsibilities. There is no stigma attached to low birth among the AAnn; competent individuals are promoted to higher ranks and Status, while incompetents are demoted. No position in the Empire is hereditary. Even the Emperor and the Pack of Lords — from which Imperial High Advisors are drawn — are chosen by merit and not by birth.

AAnn consider power the ultimate measure of a person's worth; their society is filled with minor ways to demonstrate power. Torturers are especially well regarded among the AAnn. Few who spend time in AAnn prisons ever return, and those who do are seldom willing to discuss their experiences.

AAnn are generally unimaginative, but brave and fast-thinking. Their technology seems oriented less towards finesse than toward brute-force methods of accomplishing their goals. Nevertheless, AAnn negotiators have proved themselves expert in the complex arena of interstellar politics.

*Advantages and Disadvantages:* AAnn characters are +1 ST, but -1 DX. They have a natural DR 1, but can still buy Toughness at normal cost. In close combat, their fanged bite is impaling (see p. B136 for biting damages) and their clawed hands do swing-3 cutting damage. AAnn have a Reputation throughout the Commonwealth and neighboring planets as aggressive, cruel and sadistic; most races react to AAnn at a -4.

The AAnn disdain for other species gives them a disadvantage called racial *Intolerance*; AAnn react to all other sentient species at -3. No AAnn can have a reaction better than Neutral towards an alien. For a more complete discussion of Intolerance, see p. F76.

AAnn are less able to adjust their wake/sleep schedule than humans. On a planet, AAnn are uncomfortable and disoriented at night. In nighttime surprise situations, AAnn suffer a -2 on initiative rolls. An AAnn with Combat Reflexes only gets a +3 bonus to his IQ to snap into action if surprised at night. In space, these penalties apply to AAnn called into action during their normal sleep shift.

## Typical AAnn Advantages and Disadvantages

The quick-thinking and aggressive AAnn frequently have the advantages of Alertness, Combat Reflexes, High Pain Threshold, Rapid Healing and Toughness, as well as the disadvantages of Bad Temper, Berserk, Bully, Enemy, Greed, Impulsiveness, Jealousy, Megalomania, Overconfidence, Sadism, and Stubbornness. Empathy, Night Vision, Cowardice, Fat, Laziness and Pacifism are almost unheard of among AAnn.

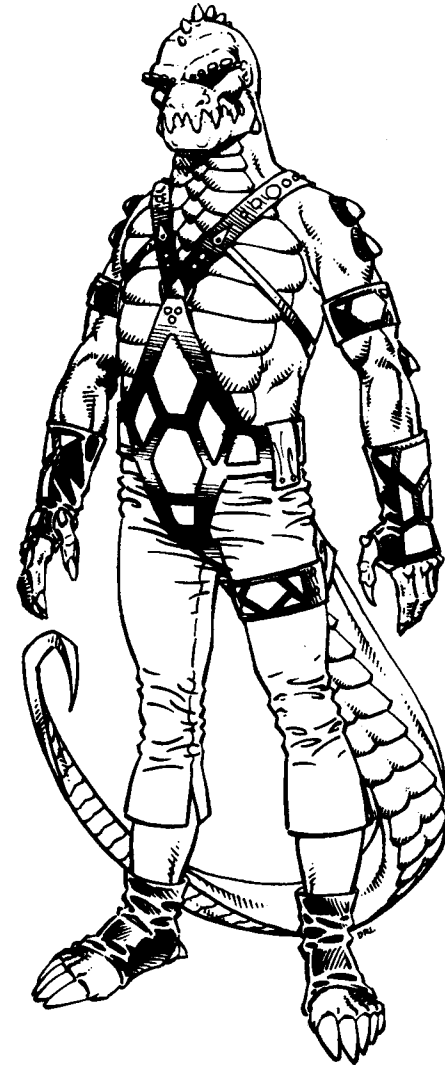

## AAnn Names

Each male AAnn bears a personal name of one or two syllables, and a status designation consisting of a series of capital letters. An AAnn chooses his own personal name upon becoming a *nye* (an AAnn word, meaning “man” or “warrior”). There is considerable variation among AAnn personal names; some may be words from the AAnn language, but others have no direct translation into any human language. A few known AAnn names are Amostam, Carmot, Cropih, Kaath, Korpt, Parquit, Pyorn, Riidi, and Tivven.

Available information on female AAnn names is very limited. One female scientist was known as Di-Vuoyyi LMMVLT. The AAnn word for a woman is “*lya-nye*,” which translates as “female man” or “female warrior.”



### Typical Porpoise Advantages and Disadvantages

Among porpoises, the advantages of Alertness, Combat Reflexes, Empathy and Intuition are common, as are the disadvantages Illiteracy and Pacifism. Skinny, Fat, Hard of Hearing, Paranoia and Sadism are found only in very unusual porpoises.

### Porpoise Names

The names of porpoises are usually descriptive epithets. They may be based on appearance, like Bentflake, Scarbelly, or Bigfins; on habits, such as Wavejumper, Deepswimmer, or Foamdancer; on deeds, such as Calfsaver or Manfriend. Occasionally, a porpoise's name will defy translation. When this happens, the cetacean translator renders the name in an untranslated form pronounceable by humans, such as Teinah, Arofa, or Iyora.

## Status Among the AAnn

Following every AAnn's name is a status designation consisting of several capital letters. When an AAnn is born, he is given as his designation the designation of his father, followed by the first letter of his father's personal name. Beyond this, the precise meaning of each letter in an AAnn's designation is not known. The significance of the *number* of letters is clear, though. The number of letters is inversely proportional to the AAnn's Status level. An AAnn of Status 0 has a seven-letter designation. Each level of Status above 0 reduces the number of letters in the designation by one. The AAnn Emperor — Social Status 7 — has no designation at all, while the High Advisors and the Pack of Lords each have Status 6 and one letter.

For example: Baron Ligram NW has a Status of 5. His son, Alant, is born with Status 4 and the designation of NWL. Were Alant NWL to prove himself worthy and hold the rank of baron, he would become Alant NW, buying his Status up to 5. If he joined the Pack of Lords, perhaps even becoming a High Advisor, he would buy his Status up to 6 and become Alant N. Were he to be chosen to succeed the Emperor as ruler of the AAnn, he would buy Status 7, and be known as Alant.

The lowest status among AAnn is 11 letters (Status -4).

## Non-Spacefaring Species

These species, for various reasons, do not ordinarily travel between stars. Many live at pre-stellar tech levels, while others have physical requirements which make space flight difficult. Generally, these species will only be encountered on their homeworld. Starfaring individuals of these species will be hard-pressed to find facilities and equipment designed for their use on other worlds. If the campaign is to be set entirely on a species' homeworld, it might be possible or even advisable to include a few native sapient among the PCs. In an interstellar campaign, these species should be reserved as NPCs.

### Cetaceans

Cetaceans are Terran sea mammals — porpoises and whales — transplanted to the planet Cachalot after their latent intelligence was awakened by the Jorgensen sapiency serum (see p. 21). Although they are air breathers, cetaceans are unable to function out of the water.

Intelligent cetaceans are pacifistic; their philosophical sensibilities preclude attack without provocation. Even so, whales seldom tolerate human interruption, and have been known to react violently when unduly annoyed. The Holocausts still live in their memory, and the cetaceans seem intent on some great task which they consider humans too insensitive to ever understand.

**Advantages and Disadvantages:** All cetaceans share the advantages Absolute Direction, Acute Hearing (+5), and Peripheral Vision, and the disadvantages of Nearsightedness, Legless, and No Hands. While they are essentially helpless on dry land, cetaceans swim very well, and have a special echo-location sense which allows them to operate in submarine darkness.

The various Cetacean species:

**Porpoises** have *double* human ST, +2 on DX, +1 on IQ, and +2 on HT. Their unencumbered Move in water is *twice* Basic Speed. A porpoise's bite does crushing damage appropriate for his ST (see p. B136), and he can ram for swing +3 crushing damage with a 6-hex “running” start. A porpoise's thin skin provides no PD or DR, but he may buy Toughness.

Porpoises spend their lives laughing and playing, and are considered frivolous by their more serious cousins, the whales. Most porpoises are Impulsive; *Non-impulsiveness* is effectively a 10-point advantage to them. Most porpoises

delight in playing tricks on humans, although they intend no harm. If they offend, they will often perform acrobatics by way of apology. Porpoises travel in pods of several thousand individuals. In a Cachalot-based campaign, a player may choose to roleplay a porpoise at no point cost.

*Orcas* or killer whales average ST 50, DX 13, IQ 12, HT 15/25, Move 15. Orcas bite for 2+2 cutting damage. An orca's blubber affords him a DR of 1. Of all the cetaceans, orcas are most friendly to man; they say that they think more like man than do any other cetacea. Orcas typically travel in pods of 3 to 10; lone males are not uncommon. Orcas and larger whales are beyond the point range for player characters in a Cachalot campaign.

*Baleen whales* are the largest Cetaceans. Typical of baleen whales, the humpback is ST 400, DX 8, IQ 8, HT 15/150, Move 10, and can ram for 12 dice crushing damage. A humpback's thick blubber gives him a DR of 6. Baleen whales seem to have improved the least with the sapiency serum, apparently content to swim the seas of Cachalot, devouring krill. Baleen pods number as many as 100 whales, all of the same species.

*Catodons*, or toothed whales such as the sperm, are ST 300, DX 11, HT 15/120, IQ 14, Move 12 (in water). They can butt for 4 dice damage, or bite (if incredibly provoked) for 12 dice impaling damage. The blubber of a sperm whale provides DR 5. Catodons are the smartest of the whales, and the most serious-minded. They brook little interference from humans, and are most concerned with their philosophical development, which they call the Great Journey. Like baleen whales, catodons travel in single-species pods of 50-100.

## Tran

The tran are vaguely feline omnivores native to ever-frozen, windswept Tran-ky-ky (see p. 35). Tran are comfortable only at temperatures below freezing, and become dehydrated if the temperature exceeds 50 degrees for an extended period of time.

Tran are about the same height and weight as humans, but almost twice as broad: their hollow bones and lighter tissues allow them to move swiftly over the ice. They have thick, greyish fur, two arms (four fingers on each hand), two legs, slitted yellow eyes, pointed ears set atop the head, a broad flat nose, high brow, and wide mouth.

Tran have important adaptations to Tran-ky-ky's ice-covered surface. The "chiv," specialized claws extending the length of each foot (three "blades" plus a fourth "braking" claw), act as a triple skate, while the "dan," wing-like membranes extending between the arm and torso from armpit to wrist and hip, act as sails to draw the tran across the ice.

The tran also build wooden cargo rafts with brightly colored sails made of the fiber of the pika-pina ice grass, which can usually keep up with individual tran. These rafts are based on an odd number of runners, with the odd runner serving as a rudder. A well-designed iceraft can travel downwind virtually as fast as the wind; upwind, icerafts tack at about a third of the wind velocity.

Most tran live in independent fortresses carved into the islands which protrude above the ice. These settlements are ruled by a Council of influential citizens, and a baron — called the Landgrave — selected by all citizens. The Landgrave holds "final" authority in a city, but often faces powerful opposition on the Council.

Although tran are extremely maneuverable on ice, their chiv and leg structure make walking on stone or earth uncomfortable. Within settlements, ice paths are formed by pouring water on the stone and allowing it to freeze. Once established, an ice path need only be refreshed, as the temperature over most of Tran-ky-ky never exceeds freezing.

Outside the fortresses, large nomadic Hordes comprising hundreds of rafts



### *Typical Tran Advantages and Disadvantages*

Alertness, Acute Hearing, Combat Reflexes, Strong Will and Toughness are all common among the feudal and warlike tran. The disadvantages of Alcoholism, Bad Temper, Berserk, Enemy, Lecherousness and Overconfidence are also frequently seen.

Cowardice is especially disgraceful among tran. Tran react at a -2 to a known coward (see p. B24); an unrevealed coward will strive to keep his fear hidden.

### *Tran Names*

Inexplicably but appropriately, trannish names have a distinctly Nordic flavor. Tran males have names like Hunnar, Kellivar, Smjor, Budjir, Ballavere, Darmuka, and Tinyak. Elfa and Sagyanak are female tran names. Tran personal names are followed by a surname. Most tran surnames — such as Sukonin, dal-Jagger, and Holtag — are similar to tran personal names, with a Scandinavian ring, but many tran use an epithet — such as Redbeard, Longaxe, Brown oak — in place of a surname.

## Tran Skating

Due to the specialized design of tran feet, tran are more comfortable — and several times faster — skating on their *chiv* than walking. For a tran, skating is a Physical/Easy skill. Skating on level ice, out of the wind, a tran's Move is equal to his Basic Speed plus 1/8 of his Skating skill. A tran may *not* further increase his skating Move by purchasing Running; the Skating skill already covers this.

The paths and hallways of tran cities and buildings are frozen into ice paths to facilitate skating. Many of these paths are inclined, allowing quick passage to lower levels. The Move of a tran on a typical sloped ice path (5-10% grade) will increase by 1 per turn, unless the tran makes a Skating +2 roll to *avoid* this increase.

On the open ice of Tran-ky-ky, tran use their *dan* to harness the wind for propulsion; their Move is limited only by the wind velocity. Using his *dan* to move downwind, a tran can move as fast as the wind blows. Upwind, a tran tacks like a sailboat, heading a few degrees off the wind, and travels up to 1/3 wind velocity. A tran can accelerate downwind by as much as his Skating Move every turn, up to current wind velocity; upwind, he may accelerate by 1/3 of his skating move, per turn.

Simple maneuvers — a gradual change in course — do not require a Skating roll. When a tran executes a difficult or complicated maneuver — a sharp turn or a hard stop — he must make a Skating roll, modified by his current speed. To find this modifier, compare the tran's speed with the "Relative Speed Modifiers" chart on the back cover of the *GURPS Basic Set*. (A useful note: 1 hex per turn equals 2 mph.) If a tran fails a Skating roll, he falls to the ice, taking 1-2 damage per whole 4 Move.

For example, Togan is riding a 44 mph wind, traveling at Move 22. He sees a large rock on the ice a few yards ahead of him and attempts a quick turn to the right. Togan has Skating-15, minus 5 for velocity, for an effective skill of 10; he rolls a 14, and falls, tumbling across the ice. Before coming to a halt, Togan takes 5 dice minus 10 damage (Move 22 divided by 4, rounded down, times 1-2 dice). A roll of 17 on the dice, minus 10, means Togan takes 7 HT from his spill; he'll practice a bit before going out in that kind of wind again.

and thousands of tran wander the ice. Over several years, Hordes circulate through a group of settlements demanding tribute: food, clothing, money, and female tran (if they can catch them). Most cities pay this tribute, but occasionally one objects; cities which cross a Horde are usually leveled.

**Advantages and Disadvantages:** Tran attributes are the same as those of humans. A tran's fur affords him DR 1, and he may add Toughness at normal cost. The keen eyes of a tran give him Acute Vision +1.

Tran are naturally Impulsive; to be *Non-impulsive* is a 10-point advantage for a tran. All tran know the Survival (Arctic) skill at IQ level, and the tran Skating skill (see sidebar) at DX level. Due to the awkwardness of the *chiv*, their unencumbered walking Move is equal to half their Basic Speed. Tran have a Reputation as barbarians among off-world visitors to Tran-ky-ky, who react to them at -3 (though off-worlders reacting negatively to tran are more likely to cheat them than to attack them). Tran buy technical skills at TL3.



## Saia

The Saia are a subspecies of tran recently encountered in the geothermally heated highlands on the island of Moulokin. The Saia live in small villages made from wood, hidden from satellite survey by volcanic smoke. It is believed that the Saia are the original form of the tran, from before the onset of the ice ages which dominate Tran-ky-ky, and that the Saia become dominant during the planet's periodic warm cycles.

The Saia lack the *dan* and *chiv* of the tran, and are covered with thin golden fur. They share the limbs, facial features, and wide builds of the tran, but are adapted to the warmer temperature range of their habitat (50-105 degrees).

Little is known of the Saia's way of life. The Saia have a much more complete knowledge of planetary history than do the tran; their legends and history suggest a fair amount of scientific sophistication. They are aware of other planets, and the chance of life on them, raising the possibility that a spacefaring civilization inhabited Tran-ky-ky in the distant past.

*Advantages and Disadvantages:* Saia automatically know the Survival (Mountains) skill at IQ level and History (Tran-ky-ky; no specialization bonus) at IQ-2, and have Acute Vision +1. Saia share the tran Reputation as barbarians; offworld visitors react to them at -3. They buy technical skills at TL4.

## Mai

The Mai are one of the three sapient species of Horseye (see p. 26). The Mai live in the lower altitudes (up to 13,000 feet) of the hot Barshajagad river valley, and along the edge of the Groalamasan Ocean. They are slender, agile, hairless humanoids, 5' tall, with large eyes, no external ears, and six long, nailless fingers. Mai bear live young, and produce milk to feed them.

Mai cities are built as a cluster of towers, superficially resembling humanx cities. However, Mai towers also extend into the earth, allowing them to be cooled by convection from the underground water table. Thus, temperatures inside these towers always hover around a brisk 90 degrees.

Among Mai, the main factor determining social status is personal wealth. The method by which wealth is gained is not important to the Mai; they freely lie, cheat and steal to enhance their status in the community.

*Advantages and Disadvantages:* Mai get -2 on ST and +1 on DX. They are 8 inches shorter than a human of the same ST. Mai have Acute Vision +3, and the disadvantages of Greed and Hard of Hearing. Mai automatically know the Detect Lies skill at IQ-1 and Scrounging skill at IQ+1. The Mai have a Reputation among both the native and alien inhabitants of Horseye as thieves, con men and petty crooks, and suffer a -2 reaction from other species. Mai learn technical skills at TL3.

## Tsla

The Tsla are another of the Horseye sapients. They live above the habitat of the Mai, ranging from 10,000 feet (mean temperature 70 degrees) to the edge of the Guntari Plateau, 26,365 feet above sea level (mean temperature 28 degrees). Tsla are strong, six-fingered humanoids covered with short, soft brown fur. They average 5' 6" tall. Their necks curve forward, and their short, round ears are set on top of their heads. Tsla have flexible, 10-inch snouts, with two nostrils and a weak gripper at the tip. Tsla use these snouts to lift food to their mouths and to show expression; a prominent snout is considered sexually attractive.

Tsla live in stone settlements with elegant arches and domes patterned after flowers. Graceful, winding walls connect the main structures, and fluted slate tiles drain rainwater from the roofs. Multicolored, geometric patterns decorate

## Typical Saia Advantages and Disadvantages

Saia frequently have the advantages of Common Sense, Eidetic Memory and Language Talent.

### Saia Names

Saia names are very similar to Tran names, with a strong Scandinavian sound. Unlike Tran, Saia seldom use epithets as surnames. When they do, they favor more peaceful, nature-oriented appellations than their ice-dwelling cousins. Examples include Greenfield, Mountainwalker, Tall-oak and Runningbrook.

## Typical Mai Advantages and Disadvantages

Common advantages among Mai are Alertness, Danger Sense, Intuition and Luck; common disadvantages include Cowardice, Impulsiveness, Jealousy, Kleptomania and Miserliness. Honesty and Truthfulness are unheard of among Mai.

### Mai Names

Common Mai have one name, usually two syllables long. It is unknown whether Mai names are associated with a gender. A few Mai names are Irquit, Homat, Changrit, Gwattwe, Langai, Kethet, Wethre, and Meduit.

The ruler of a prominent Mai city is called the *Moyt*, and carries Status 4. The master of a Mai town is called an *Oyt*, and has a Status of 2.

Among the Mai, individuals of Status 3 or greater carry more than one name. The name by which an important Mai is called comes at the end of his full name, and is preceded by the honorific pronoun *de*. Ror de-Kolwhoang, the Mai ambassador who welcomed the Drs. Rewdowl to Po Rabi, would be addressed as de-Kelwhoang; Bril de-Panltatol, a legendary Mai hero, would be addressed as de-Panltatol. The name of an individual of Status 4 or more is preceded by the additional honorific *me*; Moyt Najoke de-me-Halmur is addressed as de-me-Halmur.

Mai assume that any individual bearing more than a single name is a person of significant status, and will address them using the honorific "de" unless corrected.

## Typical Tsla Advantages and Disadvantages

Tsla frequently possess the advantages of Common Sense, Intuition, Literacy and Strong Will. Honesty and Sense of Duty are two of the few mental disadvantages found among Tsla; most others are very uncommon.



## Tsla Names

Names among the Tsla are quite simple — usually nothing more than a single three-letter syllable. As with the Mai, it is difficult to say whether the Tsla attach a gender to each name. A few Tsla names include Sau, Tyl, Swd, Uon, Mii, Ruu, Bel, Rhe, Lau, and Dea.

The Tsla place a tremendous premium on learning, and judge an individual by his knowledge rather than his strength, looks or wealth. A respected individual among the Tsla is addressed as Learned One or Teacher; knowledgeable off-worlders will almost invariably be addressed thusly. The leader of each Tsla town is known as the First Scholar; he has Status 2, and his name is followed by the honorific suffix *an*, as in Mii-an and Ruu-an. The double-vowel ending of the names of First Scholars may also be unique to the rank.

the buildings, and hundreds of chimes hang from the windows and rafters. Observation towers stand above the larger buildings; except for these, Tsla architecture rarely rises more than three stories above ground. Internal walls are glazed to keep them watertight and warm in winter.

The sophisticated Tsla tolerate a wide variety of philosophical and spiritual beliefs. The primary tenet of Tsla philosophy is that beliefs are personal things, and that each individual has a right to form his own. Yet this permissiveness has not resulted in anarchy; crime is almost unheard of among the Tsla. Criminals, when they do appear, are treated and rehabilitated rather than punished.

Although peaceful by nature, Tsla believe it meritorious to fight and defeat an enemy — someone who directly threatens you. While killing someone who wantonly violates civilized (Tsla) standards of behavior is regrettable, it is perfectly correct — as correct, say the Tsla, “as it is to raise a roof to keep out the rain.”

*Advantages and Disadvantages:* Tsla get +2 on ST and +1 on HT. They have the disadvantages of Truthfulness and Pacifism (self-defense only), and Fatalism. Fatalism is equivalent to a 5-point Delusion. (“Your wife was taken by the Na? How sad. They will surely eat her. We are truly sorry.”) Among Mai, the Tsla have a Reputation as self-righteous, pompous, and grim; Mai react to Tsla at -3. Tsla learn technical skills at TL3.

## Advantages, Disadvantages and Skills

This section develops the character creation information already presented in the *GURPS Basic Set*, with notes on special applications to the Humanx Commonwealth.

### Advantages

#### *Absolute Direction*

5 points

While Absolute Direction functions on the surface of any world, it does *not* work in deep space. Thus, there is no +3 to an Astrogation roll (see p. 51) for Absolute Direction.

#### *Literacy*

On most Commonwealth worlds, most people can read; *illiteracy* is a 10-point disadvantage in *GURPS Humanx*. Still, characters from low-tech worlds — especially members of comparatively primitive species — may very well be illiterate.

#### *Magical Aptitude*

True magic is unknown in the Commonwealth, so Magical Aptitude is of very little use to humanx characters.

#### *Status*

Status (p. B16) reflects your “official” position in society. On established, socially stratified worlds, such as New Paris and Moth, status is very important — characters of high status will have considerably more freedom than average or low-stated individuals. On hardship worlds, like Drax IV and Prism, status doesn’t mean a thing; a man is judged by the skills he possesses and how hard he uses them to help the community.

In a place as big as the Commonwealth, though, it is impossible to “verify” the status of every traveler. Thus, a character can occasionally represent himself as having a higher status than he actually possesses. Each month that a character misrepresents his Status, he pays the Cost of Living appropriate to the assumed

Status level. He must also make a Savoir-Faire or Acting roll each month, taking a penalty to the roll equal to the difference between assumed and real Status. The GM can call for additional Savoir-Faire or Acting rolls whenever he feels the imposter is in danger of revealing his true Status.

#### *Toughness*

Some alien species have a natural DR of 1 or 2. They may further increase their DR by purchasing Toughness at the regular cost: 10 points for +1 DR, 25 points for +2 DR.

#### *Wealth*

As stated on p. 14, the average starting wealth of a Humanx character is \$15,000, of which only \$3,000 is normally available to purchase adventure gear. Taking a Wealth advantage or disadvantage affects your starting wealth as well as your monthly income after play begins. There are, however, two other ways to increase your wealth:

(1) You may begin with a little extra cash, based on your monthly income. Cash equivalent to one month’s income costs 1 character point. It is not cost-effective to put many points into extra starting wealth.

(2) If you want lots of possessions, but not a high net worth, the GM may let you start out in debt to the bank.

Interest rates vary, depending on the world on which the loan was made. The monthly interest rate on a loan made on a stable, established world like Terra or Amropolous is 1% per month; on remote or unsettled worlds, like Tran-ky-ky or Drax IV, the rate is usually 3% per month. Payments must be made every month, or arranged for in advance; the Commonwealth banking network allows you to make your payment by credcard on any Commonwealth world. You may repay the principal, either in whole or part, at any time.

## Disadvantages

### Age

Most alien species have a life cycle very similar to that of humans — the attribute loss associated with old age starts at 50 (see p. B68). A character created older than 50 has the Age disadvantage, worth 3 points per year over 50. Two species differ significantly from the human norm: Tolians and AAnn.

Attribute loss does not begin for the long-lived Tolians until they reach the age of 65, at which point they begin rolling annually, just as a human does at 50. Beginning at age 90, Tolians roll every six months; at age 110, they start rolling every 3 months. Many healthy Tolians live nearly a century and a half.

AAnn roll annually for attribute decline starting at the age of 40. Beginning at 55, they roll every six months. Past the age of 70, AAnn roll every three months for attribute decline.

Thranx chitin starts to deteriorate as a thranx grows older, becoming more brittle and less resistant to puncture. Thus, when a thranx character begins to roll for attribute loss at the age of 50, he must make six HT rolls, instead of the normal four — the extra two rolls are for the PD and DR of his chitin. Once he fails the roll for his PD or DR three times — cumulative, not consecutive — that “attribute” is reduced by 1. The PD of a thranx’s chitin can *never* drop below 1, though, nor can its DR go below 0. Once these values are reached, simply stop rolling for that attribute. A thranx does not die when his DR reaches 0, but he does become *very* careful . . . .



### Phobias

The following phobias merit special attention in the Commonwealth:

**Insects** (entomophobia): Thranx are bugs — *big* bugs. Having to deal with a thranx requires a control roll at -6. You won’t even *consider* visiting a predominantly thranx world.

**Reptiles** (ophiophobia): The sight of an AAnn, no matter how far away, calls for a control roll at -4; if an AAnn pays attention to you for any reason, a control roll at -6 is required. Your ophiophobia may really be a fear of AAnn, generalized to all reptiles — which were undoubtedly planted on Commonwealth worlds by the Empire, as part of some foul, reptilian plot!

**Strange and unknown things** (xenophobia): While you are frightened by aliens, some species are a bit more familiar to you than others. Due to the close contact between humans and thranx, xenophobic members of these two species regard each other as people of another “nationality” rather than a whole other species. Thus, a human xenophobe surrounded by thranx rolls against his natural IQ, not IQ-3. The same is true for a

xenophobic thranx surrounded by humans. All other species, as well as humans and thranx to xenophobes of other races, call for a -3 on the control roll.

### Youth

Most species reach the age of majority at 18, just as humans do, but Tolians are not considered adults until age 24, while AAnn become *nye* at age 11. A Tolian character created with the Youth disadvantage receives 2 points for every *two* years under 24. Youthful AAnn receive 2 points for every six months under 11. Total value of the Youth disadvantage may not exceed 6 points. Because AAnn mature more rapidly than other races, the maximum number of points a beginning AAnn character may spend on skills is equal to *three* times his age.

Thranx PCs may not choose the Youth disadvantage — they emerge from their cocoons as young adults. Larval thranx are virtually helpless, and inappropriate as PCs.

### Skills

#### Specialization

In the technologically advanced Commonwealth, many skills require specialization (see sidebar, p. B33). Characters buying these skills must specialize in one *type* of device or equipment. This is noted on the character sheet as *Skill (Type)*.

For example, a character who takes the Pilot skill could specialize in any of several types of aircraft or spacecraft — stingships, freighters, dreadnoughts . . . . If he chooses stingships, he records Pilot (Stingships) on his character sheet.

A character may try to use a known skill with types other than his specialty. Skill penalties are given under the original skill listings in the *GURPS Basic Set*. The stingship pilot in the previous example could attempt to fly a freighter, taking a -4 to his Pilot skill for “spacecraft of an unfamiliar type.”

#### Familiarity

Many skills also take a penalty when used with an unfamiliar item of a *known* type. “Familiar” is defined as having eight hours of experience with that item. One item of a type is automatically familiar when the skill is bought, but others must become familiar by game-time use.

Under Guns, for example, there is -2 penalty for using “an unfamiliar weapon of a known type.” Someone with Guns (Pistol), who normally carries a Hornet VI needle thrower, would suffer a -2 penalty with the electrocution gun he pulled off the body of a downed foe — until he’d spent a day or so familiarizing himself with the weapon.

Where appropriate, the skill descriptions below will list the available types of vehicle or weapon for a skill.

#### Archaic Weapon Skills

*see pp. B37-39*

Many of the weapons on the Ancient/Medieval Weapons Table in the *GURPS Basic Set* are used in the Commonwealth, especially on primitive planets such as Horseye, Alaspin and Tran-ky-ky. The Fencing and Bow skills can be learned in recreational classes, and the Knife skill is common in the rougher sections of many Commonwealth cities. Training in other primitive weapons, however, is hard to come by on high-tech worlds.

#### Battlesuit

*see p. B37*

The only commonly available “battlesuit” is the Samstead duty suit, which constitutes a specialty in itself. The MHW Suit (p. 57) — really more of a man-shaped vehicle than a battlesuit — is sufficiently automated that no skill is required to operate it,

although a character with the Battlesuit (MHW) specialty can override the suit's computer to operate its systems and weapons himself.

**Beam Weapons** *see p. B37*

While there are no specialties within the Beam Weapons skill, there is a -2 penalty for using an unfamiliar beam weapon.

**Detect Lies** *see p. B51*

A character is at -2 to Detect Lies told by members of other species.

**Free Fall** *see p. B44*

This skill is not normally necessary for spaceflight, as most humanx vessels include artificial gravity equipment, linked to their posigravity drive. Most military personnel, including the Church Peaceforcers, are taught the skill, though.

**Gunner** *see p. B38*

Each weapon mounted in spacecraft — laser, paralysis beam, SCCAM shell, explosive missile — is a separate specialty of this skill.

**Guns** *see p. B38*

This is the ability to operate hand-aimed projectile weapons. Characters specialize in different types of guns. Types of guns in the Commonwealth include pistol, rifle (including assault rifles), shotgun, submachine gun, grenade launcher, and bazooka (including the Paxton V).

**Judo and Karate** *see p. B38*

These skills — especially Judo — are commonly taught to covert operatives for the United Church. Most races can learn either skill, but thranx lack the flexibility necessary for Judo.

**Medical Skills** *see p. B42*

All medical skills, except First Aid, require a specialization in a type of physiology. The most common types are mammalian (including human and Tolian), reptilian/avian (including AAnn and ornithorpe) and arthropod (thranx). When treating a patient of an unfamiliar species within his specialty type, a medic takes a -2 to all medical skills; when treating a patient of an unfamiliar type, he takes a -4 to all medical skills.

The principles of First Aid are sufficiently universal that there is no specialty within this skill. First Aid is, however, affected by familiarity. A medic takes a -2 to his First Aid roll when treating a patient of an unfamiliar species. It is not necessary to actually treat a patient to become "familiar" with First Aid for a given species; all that is required is a day spent studying various lifesaving techniques for that species, assuming such information is available.

**Navigation** *see p. B43*

A navigator must specialize in a single world. On other worlds, the navigation skill functions at -5 — the principles are the same, but the stars are different. Good local star-charts reduce this penalty to -3. Of course, a navigator can buy the skill separately for a new world, based on Navigation (old world)-5.

Navigation doesn't apply in space — for that, the Astro-gation skill is necessary (see p. 51). Navigation does, however, default to *Astro-gation-5*.

**Characters**

**Piloting**

*see p. B54*

All of the aircraft types described on p. B54 can be found in the Commonwealth, though many exist only in museums and antique airshows. The space shuttle specialization applies to streamlined craft designed to operate both within and beyond the atmosphere, used to shuttle passengers and freight between planetary surfaces and posigravity spaceships or orbital space-stations. Other spacecraft specializations include:

- Stingship
- Military corvette (50,000 tons or less)
- Military cruiser (Over 50,000 tons)
- Private freighter/yacht (50,000 tons or less)
- Private passenger/freighter (Over 50,000 tons)

Any character must have the Free Fall and Vacc Suit skills at DX level before beginning spacecraft pilot training at a military or private academy. Characters who learn Piloting "on the job" may or may not have these skills.

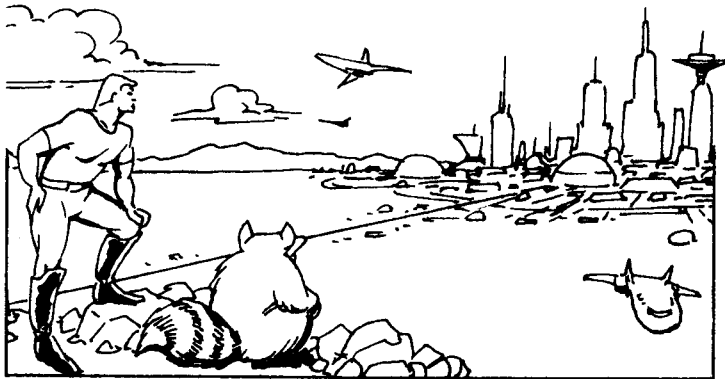

**Poisons**

*see p. B52*

A character may specialize in Poisons for a single species. If he does so, he is at +5 to predict the effects of any poison on members of his specialty species, but -1 for other species.

**Savoir-Faire**

*see p. B50*

Savoir-Faire, the knowledge of formal good manners, is different for each alien species. Exception: At any period after 50 A.A., there is no significant difference between human and thranx Savoir-Faire skills.

Learn Savoir-Faire as a different Mental/Easy skill for each alien species. Alien Savoir-Faire normally defaults to IQ-6. At the GM's discretion, the penalty may be increased for an extremely alien species. None of the spacefaring races known to the Commonwealth are that alien, though the Tar-Aiym and Mutables would have been.

**Scientific Skills**

*see pp. B46-B48*

Within many scientific fields, it is possible to specialize in a single world, although it is not necessary to do so. A few of the skills which offer "one-world" specializations are Agronomy, Botany, Biochemistry, Geology, History, and Meteorology. A scientist specializing in a single world will be at +5 to answer any question within his field pertaining to his planet, but -1 on questions regarding other planets.

**Survival**

*see p. B43*

While terrain types (Jungle, Desert, Plains) are universal, Survival is subject to familiarity. When operating within a known terrain type on an unfamiliar planet, a character takes a -2 to his Survival roll. Thus, a character who learned Survival (Arctic) on Terra would be at -2 when he crashlands on Tran-ky-ky. After



one month of “surviving” on an unfamiliar planet, this penalty is reduced to -1; after another two months, the character is fully familiar with that terrain-type on that planet, and takes no penalty to his roll. A native guide with the appropriate Survival specialty for the terrain cuts this time in half. (“Purple berries make bwana much sick.”)

## New Skills

### Area Knowledge (Mental/Easy) Defaults to IQ-4

This is the skill of familiarity with a given area. The GM should not require an Area Knowledge roll for ordinary situations — finding the spaceport, a restaurant, or your own home — but should require a roll to locate a Tolian restaurant in Daret open at 3 a.m., or to know the clearest route through an asteroid field. No default roll is allowed for those who have not had a reasonable time to become familiar with the area.

Area Knowledge can be bought for any sort of area. The larger the area, the less “personal” and more general your knowledge.

**Few Hundred Acres:** Knowledge of trails, streams, hiding places, ambush sites, flora and fauna.

**Colony Station, Spaceport or Small Town.** All important citizens and businesses, and most unimportant ones.

**City:** All important businesses, streets, citizens, public officials, etc.

**Region or Continent:** General nature of cities and towns, the sentient species found in each, governors, and most celebrities (anyone with Status 4+ and/or a well-known Reputation).

**World:** Location of its major cities, awareness of its customs, species, and languages (but not necessarily expertise); knowledge of celebrities of Status 5+, and a general understanding of its political and economic system.

**The Commonwealth:** Location of most worlds and the species dominating each, an awareness of current events, and important Commonwealth and Church officials. It is possible to have low-level Area Knowledge of a world or the whole Commonwealth simply by keeping up with the news.



### Astrogation (Mental/Very Hard)

Defaults to

Astronomy-5 or Pilot (Spacecraft)-5

This is the ability to plot a course through interstellar space. While it is common practice to refer to a ship’s astrogator as the “navigator,” the Navigation skill is useless in deep space.

Astrogation includes a thorough understanding of space-plus — the medium through which faster-than-light ships travel — as well as a familiarity with the locations of stars and planets. To use the Astrogation skill properly, one must have access to an astrogation computer (standard equipment on *all* space vessels). If an astrogator must plot a course or find his current location without the benefit of a computer, he takes a -8 to his skill! The Mathematical Ability advantage gives a +3 on Astrogation rolls.

Computer software is available containing pre-plotted courses between most major worlds. Pre-plotted courses are perfectly adequate for most space voyages, allowing smaller vessels to operate without a fully-trained astrogator on board. But this software isn’t much help if a ship goes wildly off-course or the astrogation computer breaks down!



### Electronics/TL (Mental/Average) Defaults to IQ-5

This is a Craft skill, allowing use of all electronics gear within a known specialty. For normal, everyday use of equipment, no special skill or skill roll is required. Rolls should be required in emergency situations, or for “abnormal” use of equipment, or for use of complex gear by the unskilled.

A successful roll will also let you perform repairs on known types of equipment. Time required for each attempt is up to the GM. Modifiers: -2 without plans or schematics; -5 without proper tools; -5 when working outside your specialty.

Example: Someone is jamming your null-space transmission. Roll a Contest of Skills, Electronics (Communications) vs. Electronics (Communications) — (transmitter) — to see whether or not you can get a signal clear.

Characters with Electronics skill may attempt to improvise new gadgets (like an engineer), at a -4 penalty in their specialty, or a -8 outside it.

A specialty must be chosen. Some samples include:

**Communications:** tridees, null-space radios.

**Computers:** aiming and fire control systems, calculators, artificial intelligence.

**Medical:** Mindwipe computers, life-support equipment.

**Security Systems:** This is the electronic version of the Lock-picking skill! Useful for designing (and circumventing) high-tech traps and alarms.

**Sensors:** detection gear of all types.

**Weapons:** High-tech weapons such as lasers and gauss guns. This is identical to Armoury skill specializing in these weapons.

### Neurophon (Mental/Very Hard)

No Default

Prerequisite: Physiology-10 or better. The neurophon is a musical instrument which produces a neuronc resonance capable of affecting emotion in receptive listeners. A neurophon can be used to affect reaction rolls in *either direction*. If he can get his audience to sit and listen calmly to his performance, a

neurophon player rolls against his Neurophon skill; he may adjust the reaction roll of the listeners — to him or anyone — by an amount equal to his margin of success on the Neurophon roll. If he has only a few seconds, or if the audience is not paying full attention to the sounds of his instrument, he may adjust a reaction roll by 1 only, regardless of his margin of success.

Most sapients are affected by the neurophon, but many lower animals are not. Anyone aware of the emotion-influencing ability of the neurophon, and wishing to resist, may do so with a roll vs. IQ-3. Deafness is no protection from the siren-song vibrations of a neurophon. The instrument itself usually costs \$10,000 or more.

## Languages

Each of the many sapient species of the Commonwealth speaks at least one native language, but most of these tongues are encountered only on their homeworlds. The languages of humans and thranx, however, are spoken throughout the Commonwealth, as is the artificial language Symbospeech. The AAnn tongue, although not commonly spoken in humanx space, might also prove useful to PCs from time to time.

### Terranglo

Based on English, Terranglo also borrows words and phrases from Russian, Japanese, Arabic and several other languages. Terranglo was developed in the 22nd century, and became the official language of Terra with the establishment of world government in the 23rd century. Today, Terranglo is the “native tongue” of all but the most provincial humans.

### Thranx

Due to their limited ability to produce sounds, the thranx evolved a language relying on both sound and gesture. Generally, meaning is conveyed by clicks and whistles, while gestures provide emphasis and nuance. Thranx is difficult for most other species to learn, partially because the precision of gesture used in Thranx is unique, and partially because they lack enough limbs to make many of the gestures!

The thranx language is closely tied to the well-ordered society and culture of thranx. The distinction between formal and familiar situations is very clearly defined in Thranx, even more so than in Terran languages such as French and German; to address a new acquaintance or superior familiarly is a serious *faux pas*. Formal speech is called High Thranx and familiar speech Low Thranx, although the two are really just different forms of one language. Anyone lacking *Savoir-Faire* (Thranx culture) should be required to roll occasionally when conversing with a prominent thranx to avoid addressing him improperly.

### Symbospeech

A hybrid language developed during the Amalgamation, Symbospeech is a combination of Terranglo and Thranx. As an artificially constructed language, Symbospeech has a more regular grammar and more precise vocabulary than natural tongues, and is therefore easily learned by most sapients in the Commonwealth. Over the years, a handful of words and expressions from other languages, such as ornithorpe and Tolian, have crept into Symbospeech, giving the language more color. Symbospeech is used widely in interstellar trade.

Symbospeech borrows a few of the gestures of Thranx, but simplifies them so that they may be performed by two-armed creatures. Even without the gestures, Symbospeech is perfectly comprehensible.

## Characters

## AAnn

The native tongue of Blasusarr, AAnn is a language of grunts, hisses, and rolled consonants. AAnn is used as a trading language among the subject planets of the AAnn Empire, but is not at all common within the Commonwealth. Characters not employed by the United Church are unlikely to find a teacher for AAnn, and must self-teach this language from tapes (double learning time).

### Phycode

Phycode is a form of sign language (p. B42) using only facial expression and body position. It is used primarily by humans operating on covert missions for the United Church. By twitching eyebrows, blinking in certain patterns, wrinkling the nose, pursing the lips, and similar movements, Church operatives are able to communicate in the presence of hostile beings. To an uninitiated human, a person using phycode would seem to have a nervous tic or two; most aliens will not notice at all.

Phycode is a Mental/Average skill for humans, Mental/Hard for members of other races. Thranx can learn to read Phycode, but their rigid faces prevent them from “speaking” it. Phycode is not normally taught to non-Church personnel.

## Language Table

Every language in *GURPS Humanx* is a separate Mental skill; the difficulty of each language for each species attempting to learn it is shown on the table below. Some languages are easier for one species to pick up than another; this is due to the varying ability of species to produce the sounds necessary for each language. Ornithorpes, for example, are able to produce a wide variety of sounds, and therefore master alien tongues quickly; thranx are able to produce only whistles, clicks and rough consonants, and have great difficulty reproducing the sounds of most alien languages. Native languages default to IQ, and are improved by +1 for every point invested. Thus, a Tolian of IQ 11 who invests 4 points in the Tolian language speaks it at skill 15.

Species	Language				
	Terranglo	Thranx	Symbolic speech	AAnn	Other languages
Human	Native	Hard	Easy	Average	Hard
Thranx	Hard	Native	Easy	Hard	Hard
Ornithorpe	Average	Hard	Easy	Average	Average
Tolian	Average	Hard	Average	Hard	Hard
AAnn	Average	Hard	Average	Native	Hard

## Equipment

In general, any item listed in the *GURPS Basic Set* with a TL of 8 or less can be purchased in the Commonwealth; TL9 items, and items from the upcoming *GURPS Space*, are available at the discretion of the GM. In addition, a number of items specific to the Commonwealth are available.

All prices for equipment are in credits (\$). A Commonwealth credit is roughly equivalent in value to a 1980s dollar, so modern prices can safely be used for more mundane purchases, such as food and lodging.

### Missile Weapons

All of the High-Tech and Ancient/Medieval missile weapons described in the *GURPS Basic Set* — except the Stunner — are available in the Commonwealth at the listed prices. The following weapons are also available:



## Missile Weapons Table

Weapon	— Damage —		— Ranges —				Cost	Wt.	ST	Shts	TL
	Type	Amt	PB	Inc.	1/2D	Max					
Charged-Particle Pistol	Crush	2+1	5	5	—	100	750	3	7	10	8
Dart Pistol	Spcl.	Spcl.	3	3	—	50	300	2	—	20	7
Electrocution Gun	Spcl.	Spcl.	3	5	—	50	2,500	7	—	5	8
Hornet VI	Impale	1+2	3	5	100	300	300	3	—	100	8
Laser Pistol	Impale	1 die	3	8	200	500	1,000	4	—	20	8
Marker	—	—	5	5	—	200	500	9	7	6	7
Needler	Impale	2 dice	5	20	300	800	2,000	8	—	20	8
Neurotic Pistol	Spcl.	Spcl.	1	3	10	20	2,250	4	—	25	9
Paralysis Beamer	Spcl.	Spcl.	3	3	—	25	1,500	4	—	15	9
Paxton V	Crush	3+3	10	50	—	3000	5,000	15	10	6	7
Pulsepopper	Crush	2	3	5	100	200	800	3	—	20	9
Stinger	Crush	2+1	3	6	60	120	1,200	4	—	10	8
Sikambi	Impale	Thrust+1	5	ST/2	STx10	STx15	200	3	5	1	2
MHW Shocker	Crush	1 die	3	5	15	25	—	—	—	—	8
MHW Needler	Impale	3 dice	8	30	500	1200	—	—	—	—	8
Skimmer Laser	Impale	5 dice	8	50	600	2000	—	—	—	—	8

### Charged-Particle Pistol

A thranx weapon that fires charged pellets which explode upon contacting a grounded surface. The explosion has considerable force, and is capable of cracking thranx chitin.

The Charged-Particle Pistol requires the Guns (Pistol) skill.

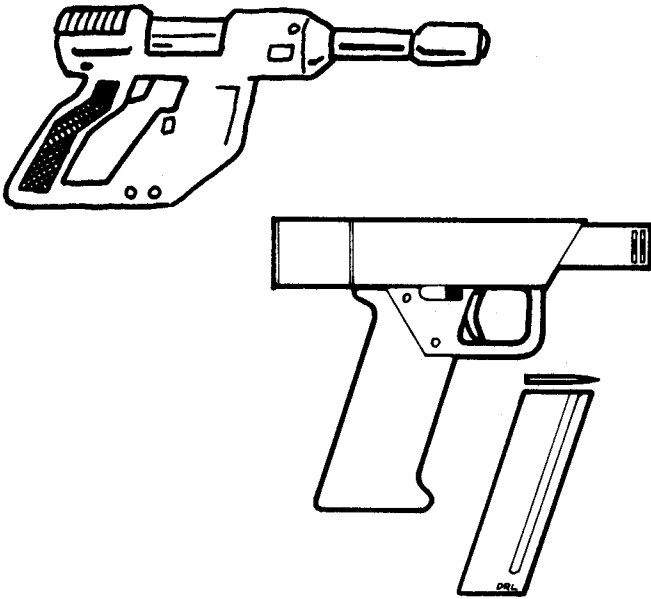

### Dart Pistol

Available at Tech Level 7, the Dart Pistol is a simple compressed-air weapon firing a small dart. The dart itself does no damage, but is used to deliver a small dose of any liquid drug or poison. If the target is unarmored — Toughness isn't "armor," but thranx chitin is — the poison is delivered on any hit. The dart will puncture DR 1 armor to deliver the drug 50% of the time, but any heavier armor is complete protection from a dart pistol.

At Tech Level 8, specialized darts become available. One type carries an explosive charge which does 2 dice crushing damage; another type, normally available only to covert operatives for the United Church, is designed to be biodegradable. This dart carries a sedative which renders the target unconscious in HT-10 turns (thus, characters with less than HT 11 fall unconscious immediately). Characters knocked out by this type of dart will recover consciousness in 20-HT hours. While the victim is

unconscious, his normal metabolism breaks down both the dart and the sedative. Within three hours, no evidence of either remains.

A dart pistol requires a cartridge of highly compressed gas to propel the darts. This cartridge is purchased separately from the darts — one cartridge costs \$5, weighs 1/2 pound, and will work for 50 shots. The Dart Pistol requires the Guns (Pistol) skill to operate.

### Electrocution Gun

This weapon consists of a supercooled dense battery pack and a pistol-like launcher firing a small needle. The needle itself does no damage, but trails a fine wire which conducts a tremendous electric shock from the battery pack to the target.

If the target is unarmored, the electric shock is delivered automatically, doing 2 dice damage. Metallic armor provides its normal PD against an electrocution gun, but no DR — if the needle sticks in metal armor, it will conduct the full 2-die shock directly to the wearer. Non-metallic armor provides its full PD and DR against an electrocution gun. The dart will puncture DR 1 non-metallic armor to deliver the 2-die shock 50% of the time. Non-metallic armor of DR 2 or better is complete protection from an electrocution gun.

Any character who takes damage from an electrocution gun must roll immediately against HT. If he fails this roll, his heart stops. He will die in HT/3 minutes (rounded down), unless another character performs CPR to save him, making a First Aid-4 or Physician roll. Naturally, this roll must be made within the HT/3 minutes before the character dies!

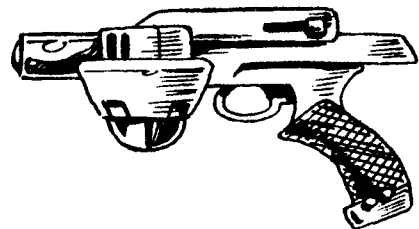

A popular rumor holds that it is possible to shoot around corners with the electrocution gun. This is not true. The rumor most probably arose from the superficial similarity of the electrocution gun to certain wire-guided, anti-vehicular missiles, which can make slight course corrections while in flight. The

electrocution gun is also a favored weapon of the Qwarm, enhancing its reputation as a weapon able to hit from complete concealment.

A special license, normally available only to law enforcement agents, is required to carry an electrocution gun. This weapon requires the Guns (Pistol) skill.

### Hornet VI Needle Thrower

The Hornet VI propels slivers of steel with an electromagnetic impulse rather than an explosive charge. The Hornet VI is nearly recoilless, giving only a -2 penalty on successive snap shots. The weapon itself is virtually silent, but the high-velocity needle projectile makes a sonic *crack* as it leaves the barrel. The source of this crack is difficult to discern, though; an IQ-2 roll (Acute Hearing and Alertness help) is necessary to locate the firer of a Hornet VI by sound alone. The replaceable magazine contains both the ammunition — steel needles — and the propulsive charge — a battery.

The Hornet VI calls for the Guns (Pistol) skill.

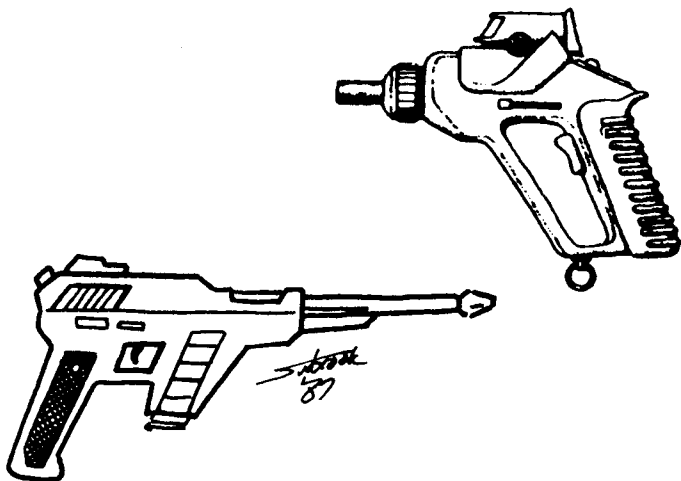

### Laser Pistol

The laser pistol described in the *GURPS Basic Set* is sometimes called a Beamer in the Commonwealth. In addition to its use as a weapon, the variable beam of a humanx laser pistol can function as a welding torch, a cigarette lighter, a flashlight, or even a heating element for cooking. Of course, all of these tasks require energy. Welding uses one "shot" every five seconds; cooking uses one shot every minute; used as a flashlight, the pistol expends one shot every five minutes. The energy used to light a small quantity of flammable material — a cigarette or kindling — is negligible.

Note that the laser pistol is completely recoilless — you don't lose your aim between successive shots. The Beam Weapons skill is required to use a laser pistol.

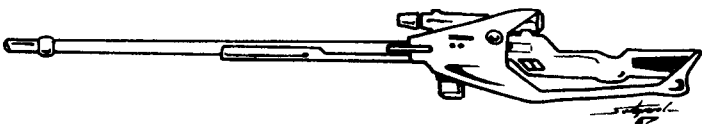

### Marker

Markers shoot a pellet, containing a special dye which adheres to the target. The dye emits a continuous low-frequency signal which can be detected with a marker scope. Markers are commonly used in sport hunting, where wounded animals sometimes cover significant distances before dying, and in police work, to track escaping criminals and vehicles. A marker scope

will give the direction and distance of any markers within range (about 100 miles). By using different frequency dyes, individuals can identify their own kills. A marker does no damage.

The Guns (Rifle) skill is required to use a marker.



### Thranx Needler

A thranx "rifle," the needler is designed for creatures with at least three hands — two-handed marksmen using a needler suffer a -2 penalty to their Beam Weapons skill, in addition to any penalty for unfamiliarity. The needler fires a coherent beam of infrared light. Normally invisible, the infrared beam ionizes trace elements in certain atmospheres, causing a faint green glow. The needler is otherwise similar to a laser, except that reflect armor is only half as effective (round down) against its beam.

The needler requires the Beam Weapons skill.

### Neuronic Pistol

This weapon creates an energy field which disrupts nerve cells. A character hit by a neuronic pistol in the head or vitals must make a HT roll. Success means the character falls to the ground in convulsions, leaving him helpless for 2 dice turns; failure means the character takes 3 dice damage *and* convulses. A hit elsewhere calls for a HT-3 roll; failure means the character suffers from convulsions, described above. Otherwise, the character is unaffected. Neuronic pistols are illegal in the Commonwealth.

The neuronic pistol requires the Beam Weapons skill.

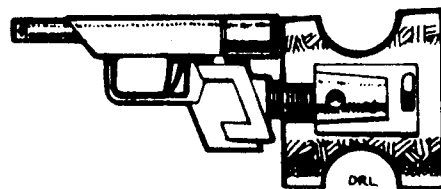
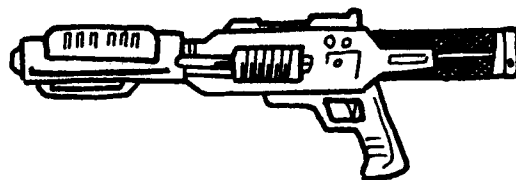

### Paralysis Beamer

Another pistol, the paralysis beamer does no physical injury to its target, but instead affects the nervous system. A character hit with a paralysis beam must make a HT roll; failure means instant paralysis lasting 30-HT minutes. Even on a successful HT roll, the target will be at -2 DX and -1 IQ for a similar length of time. Subsequent hits may paralyze a character who has resisted the paralysis beam previously, but the DX and IQ penalties are *not* cumulative. A paralyzed character retains consciousness, but is unable to move — only his autonomous nervous systems continue to function.

Armor offers no protection from a paralysis beamer unless

it is *totally* sealed, like a vacuum suit. In this case, it protects completely, regardless of its DR. The Paralysis Beamer requires the Beam Weapons skill.

### **Paxton V**

A thick-bodied, over-the-shoulder gun resembling a bazooka, the Paxton V launches tiny, self-propelled missiles armed with explosive warheads. Although the Paxton V is all but recoilless, it does not “ready” its next missile quickly enough to fire more often than once every other turn. The firer may, however, aim during the intervening turn, as the weapon loads the next round automatically.

Each Paxton missile contains its own miniature rocket engine; the weapon only aims and launches the missile. The missile has a very low muzzle velocity, accelerating as long as its fuel lasts. The Paxton V is designed to hit targets hundreds of yards away; its powerful scope and bulky shape make it difficult to hit close targets. When firing at a target within Point-Blank range, a Paxton V takes a -4 *penalty* rather than the normal +4 bonus.

The Paxton V uses the Guns (Bazooka) skill.

### **Pulsepopper**

Pulsepoppers are hand-guns which fire fist-sized globes of energy that burst into flame upon impact. Fire from a pulsepopper may well ignite flammable materials, such as clothes, papers, trash, buildings . . . .

Because of its dangerous fire-starting abilities, the pulsepopper is normally available only to military and police personnel. The pulsepopper requires the Guns (Pistol) skill.

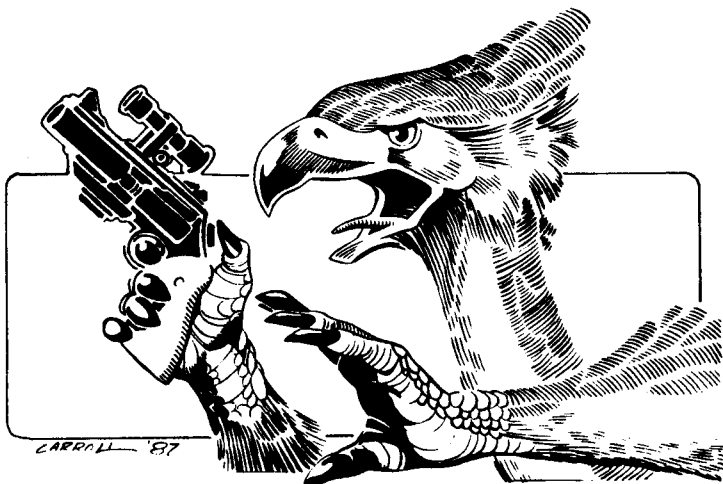

### **Stinger**

A thraxx pistol that throws a bolt of electricity to damage its target. It fires a low-power, non-damaging laser beam which ionizes the atmosphere within its beam, followed by an electrical charge conducted by the ionized air to the target. Atmospheric moisture tends to draw the electrical charge away from the path of the laser, reducing the effectiveness of a stinger under especially humid conditions. Thus, stinger fire is at a -2 in 80% or greater humidity, and -6 in actual rain, drizzle or fog.

In a vacuum, there is no atmosphere for the targeting laser to ionize, so the electric charge has no defined path to follow.

The charge will arc randomly, usually towards the nearest large, metallic object — like a duralloy space helmet! — imparting its full damage to that object.

Metallic armor provides no PD or DR against a stinger; instead, it will conduct the full electric shock directly to the wearer. Non-metallic armor provides its normal PD and DR against a stinger.

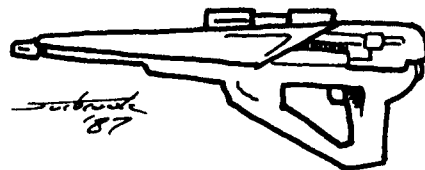

Any character who takes damage from a stinger must roll immediately against HT. If he fails this roll, his heart *stops*. He will die in HT/3 minutes (rounded down), unless another character performs CPR to save him, making a First Aid-4 or Physician roll, within the HT/3 minutes before he dies!

The Beam Weapons skill is necessary to use a stinger.

### **Sikambi**

These large, primitive, blowgun-like weapons are used by the Otoids of Alaspin. Rather than depending upon the breath of their diminutive users, sikambi arrows are propelled by an elastic bow-like construct in the “mouthpiece” of the sikambi. The Sikambi skill (Physical/Hard, defaulting to Blowgun-3) is necessary to use this weapon.

### **Ammunition and Reloading**

Most projectile weapons — including the charged-particle pistol, the dart pistol, the Hornet VI, and the Marker — are loaded in detachable box magazines. It normally takes three seconds to replace a magazine: one to remove the empty magazine (dropping it to the ground), one to Ready the replacement magazine, and one to insert it into the gun. The Fast-Draw skill can be learned for each type of magazine; a successful Fast-Draw roll cuts reload time to one second. The purchase price listed for each weapon includes one *empty* magazine.

The Paxton V does not use a magazine; instead, its shells must be loaded into the weapon one at a time. Each shell requires two seconds to load — one to ready the shell, one to put it in.

Most beam weapons — the laser pistol, the needler, the neuronic pistol, the paralysis beamer, the pulsepopper and the stinger — are loaded with a replaceable power pack. A power pack is not rechargeable, although some dealers offer a \$5-10 “trade-in” value on exhausted packs. They are replaced just like magazines; Fast-Draw may be learned for Power Packs. The listed purchase price for beam weapons *does not* include a power pack.

The electrocution gun uses a five-pound battery pack instead of a small power pack. The battery pack is usually worn on the belt in the middle of the back, stores sufficient energy for 50 shots, and can be recharged from most electrical outlets in 15 minutes (a shorter recharge will provide energy for proportionally fewer shots). The electrocution gun also requires a magazine to hold its needle missiles and their guide wires. This clip is replaced as for projectile weapons (above), but 30 minutes and an Armoury (TL8 Guns) roll is necessary to properly load the needles and wires into a magazine; for this reason, most users purchase preloaded magazines. The listed price for an electrocution gun includes a battery pack and a single empty magazine.

A Sikambi “magazine” is a quiver, which holds 10 darts.

## Ammunition Table

Weapon	Shots/Mag.	Empty Mag.		Full Mag		Ammunition for Reload/Box		
		Cost	Wt.	Cost	Wt.	Shots	Cost	Wt.
Charged-Particle Pistol	10	\$25	½	\$50	1	20	\$50	1
Dart Pistol:								
TL7 darts	20	\$10	¼	\$50	½	40	\$25	½
Explosive darts	20	\$10	¼	\$110	½	20	\$100	¼
Sedative darts	20	\$10	¼	\$70	½	20	\$60	¼
Electrocution Gun:								
Battery Pack	50	\$750	5					
Ammunition	5	\$15	¼	\$100	1	40	\$75	3
Hornet VI	100	\$30	¼	\$55	1	100	\$25	¾
Laser Pistol	20			\$50	1			
Marker	6	\$15	¼	\$21	1	24	\$24	3
Needler	20			\$65	1			
Neuronic Pistol	25			\$100	1			
Paralysis Beamer	15			\$50	1			
Paxton V						12	\$100	4
Pulsepopper	20			\$50	1			
Stinger	10			\$30	1			
Sikambi	10	\$10	½	\$30	3	1	\$2	¼

## Melee Weapons

All of the Ancient/Medieval Hand Weapons are available in the Commonwealth at the prices listed in the *GURPS Basic Set*. Because of the quality of modern steel, all weapons purchased on

worlds of TL5+ are considered to be one quality grade better than the price paid.

The following weapons are also available:

Weapon	Damage Type	Amount	Reach	Cost	Weight	Min ST	TL
AAnn Nerve Prod	Special	Special	1	—	3	—	8
Phonic Stiletto	Cutting	2 dice	C, 1	\$1,000	½	—	9
	Impaling	1+2					
Secun Vibraknife	Cutting	Swing+1	C, 1	\$350	1½	—	8
	Impaling	Thrust+2	C				
Zhaloo	Crushing	Swing	1	\$20	3	7	2

### AAnn Nerve Prod

The AAnn nerve prod is little more than a cattle prod — a five-foot rod delivering a powerful electrical shock. The nerve prod has two settings, one to stun and one to kill. The *stun* setting does 1 die damage and calls for a roll against HT-2. A target failing this roll is *stunned*. The *kill* setting does 2 dice damage and calls for a roll against unadjusted HT. Failing this roll means the victim's heart *stops*, killing him in HT/3 minutes (round down), unless someone makes a First Aid-4 or Physician roll to save him with CPR.

The nerve prod is a one-handed weapon requiring the Spear skill. It draws its power from a battery in the shaft, which holds sufficient energy for 50 stunning "shots"; an attack at the kill setting uses two "shots." Neither the nerve prod nor its batteries are commercially available in the Commonwealth, although a Mechanic, Electrician or Armourer might be able to adapt a humanx power source — such as a laser power pack or electrocution gun belt — to fit it, with an appropriate roll.

### Phonic Stiletto

This small, gray weapon appears to be a knife handle and is easily concealed in the hand. When activated, it generates an eight-inch cone of high intensity ultrasound which cuts through solid matter as though it were a knife. When inactive, the phonic stiletto emits no detectable radiation, making it a preferred weapon of the Qwarm.

Since it is an energy weapon, the phonic stiletto does a flat

amount of damage, regardless of the wielder's ST. Phonic stiletos require the Knife skill, and are illegal in the Commonwealth.

### Secun Vibraknife

The Secun Vibraknife resembles a small knife with an unusually heavy hilt and a seven-inch blade. In fact, the hilt contains a battery powered mechanism that, when activated, vibrates the blade, enhancing its cutting ability. The vibration may be activated as the knife is readied, or at any time thereafter, in no time. The battery which powers the vibration mechanism lasts for five minutes of combat time (*300 turns!*), but is not rechargeable. Additional batteries cost \$10 apiece, and weigh 1/4 pound.

When activated, the Secun Vibraknife will cut through most metals and plastics, but has no effect on ceramic materials. Used to saw through plastic or metal, the vibraknife does thrust+2 against the DR and HT of the material being cut (see p. B109 for HT of objects). For a large, flat surface, such as a wallboard or steel slab, the listed HT is the amount of damage you must do to make a 3-inch-long cut. For example, to cut a 24-inch-long slice in a slab of half-inch-thick steel, you must do a total of 320 points of damage — 40 points per 3 inches of steel cut. This damage may be done over any number of turns, but you must overcome the DR of the material *every turn*. Remember that a single vibrablade battery lasts just 300 turns.

Unactivated, the vibraknife functions as a small knife. In combat, the vibraknife requires the Knife skill.

## Zhaloo

A spiked club favored by the Mai of Horseye. Although it is scaled to Mai warriors — making it comparable in length to a hatchet — the zhaloo is relatively heavy. The zhaloo requires the Axe/Mace skill to use, and requires one turn to ready after use.

## Armor and Protective Devices

All of the armor described in the *GURPS Basic Set* is available in the Commonwealth, but it is rarely worn and often difficult to find. Your best bet is to check with military surplus companies or mail order businesses. The following suits are unique to the Commonwealth:

### Samstead Duty Suit (TL9)

The Samstead duty suit falls somewhere between a simple exoskeleton and a battlesuit. Duty suits were designed to allow humans to get around in the high winds and continuous rains on Samstead. They protect their wearer from the environment (PD 4, DR 5), filter molds and rain from outside air, and enhance the wearer's strength to help him maneuver in high winds (+3 ST, but -1 DX). The suit also incorporates a contra-grav stabilizer which allows the user to float 12 inches above any surface, moving 5 hexes per turn.

On Samstead, duty suits are customized for each wearer. The suit's color often denotes occupation, and tool kits are commonly a part of one's suit. Many suits contain such comforts as musical libraries, refreshments, library computers, and communicators. Highly specialized suits are available for purposes such as mountain climbing and deep-water diving.

The Battlesuit skill is necessary to operate in a duty suit. A basic adult duty suit costs \$4,000 and weighs 100 lbs. Various models are available, for everyone from toddlers to the largest man, at a range of prices. Tool kits, entertainment systems, and other customizations are extra.

### Samstead Mobile Hostile World Suit (TL9)

The Samstead Mobile Hostile World (MHW) Suit bears little resemblance to the Samstead duty suit — it's really a ten-foot-tall, man-shaped vehicle. The "wearer" rides in the body cavity of the suit in a semi-sitting position, controlling the movement of the MHW by inserting his limbs into waldo sockets. An MHW can lift, push or pull objects with a ST of 40. It has a built-in, artificial intelligence computer, which can operate any of the suit's systems — movement, weapons, etc. — with a DX or Skill of 12. The computer — and all its sensory equipment — function as a person with IQ 12 and a 60-point Eidetic Memory (see p. B14).

The MHW was designed for the use of explorers on hazardous planets. As such it is equipped with a variety of life support, defense and sensory equipment. An MHW will completely shield its wearer from temperature extremes from several hundred degrees below zero to several thousand degrees above. It is completely airtight and pressurized, and is capable of recycling oxygen, food and liquid to support the wearer for up to three months at a time. It is usually programmed with all known information about the world to be investigated, and records all new data; this information is available to the wearer at his request.

The clear "head" of the MHW has an adjustable polarization, capable of amplifying or reducing the amount of light reaching the wearer to within human sensitivity and tolerance. Thus, the wearer of the suit can stare at a sun for hours without harming his eyes, or see in near-complete darkness as if he had the Night Vision advantage (see p. B15). The audio and visual sensors of the suit itself are extremely sensitive, giving the com-

puter Alertness (+5 on all perception rolls). While this benefit is not transferred directly to the human wearer, the computer is very prompt to inform the wearer about what it sees and hears.

The MHW is equipped with a high-powered needler (see p. 54) for ranged defense (3 dice impaling; Ranges: P-B 8, Inc. 30, 1/2 Dam. 500, Max 1200). It also has a "shocker," a weapon which projects a small lightning bolt (1 die crushing; Ranges: P-B 3, Inc. 5, 1/2 Dam. 15, Max. 25). While the range and damage of this weapon are small, it has the advantage of stunning its target without killing it; any creature struck by the electrical bolt must roll against HT-2 or be *stunned*.

The duralloy skin of the MHW has a PD of 6 and a DR of 40. Each arm has HT 15, and each leg has HT 20; when a limb loses all its HT, it becomes inoperable. The body has a separate HT 20 in both front and back. When the HT in the front reaches 0, the suit's weapons are considered destroyed; when the back HT reaches 0, the computer is destroyed. The clear duralloy of the head is somewhat less strong than the rest of the suit — PD6, DR 20, HT 10. The suit will continue to function — minus whatever systems have been destroyed — until it loses its computer. At that point, the suit becomes inoperable; only the manual release on the belly hatch will work.

In combat, an MHW has Move 12, and occupies 3 hexes. Its computer has a Speed, Parry and Dodge of 6, but the wearer may override the computer and substitute half his Battlesuit (MHW) skill for any of these values. An MHW has no Block.

When attacking an MHW, roll location as for a human, treating all hand hits as arm hits, and all foot hits as leg hits. Hits to the limbs may render them useless, but will not harm the wearer. An MHW which loses one leg can still stand, but may not move; if it loses both legs, it falls, but may pull itself along with its arms at Move 3. An MHW that has lost one leg may voluntarily fall so that it may crawl, but it will not be able to stand back up.

A hit to the body or head of the suit will hurt the wearer only if it penetrates the suit's DR and remaining HT in that hit location. If it does so, any remaining damage is inflicted on the wearer. A hit to the suit's head which reaches the wearer will hit the wearer in the head; a hit to the body will hit the user in a random location anywhere *but* the head. Once the HT of a hit location has been eliminated, the PD and DR of the skin still protect the wearer. If a cutting or impaling hit penetrates to the wearer, it creates a breach in the MHW's skin, which may be targeted at -5. A successful hit to a breach will do damage directly to the wearer.

If the wearer lacks the Battlesuit skill, the MHW's computer can operate all its systems at Skill 12. If the wearer has the Battlesuit skill, he can override the computer's control, substituting his own skill for the computer's.

An MHW costs \$600,000 and weighs 1,600 lbs.

## Credcard

The Commonwealth uses little cash. Long before the Amalgamation, thranx invented the credit stick — a foot-long wand keyed to its owner, used to pay for transactions. The credit stick evolved into the modern credcard.

A credcard is about the size of a 20th-century Terran credit card. Banks issue credcards to their customers; each credcard carries the current balance of the assigned account, and records any transactions involving that account. Cardmeters used by merchants can transfer credit from the credcards to their own accounts, but not the other way. This diminishes the incidence of robbery and employee theft.

Credcards are keyed to the fingerprints and retina patterns of a human, ornithorpe or Tolian account holder, or the antenna



pattern of a thranx; thus, a credcard is worthless to a thief. To get a replacement card, a customer must visit his bank in person, so that his identity may be verified. While few banks are interstellar, most have arrangements with banks on other worlds to help travelers who lose their credcards.

## Drugs and Medical Supplies

### *Surgiseal (TL9)*

This hand-held device sprays a liquid form of plastiskin, which congeals over a wound, acting as bandage, disinfectant, and anaesthetic. The plastiskin also contains drugs which rapidly speed healing. Used in conjunction with a successful First Aid (TL9) roll, a Surgiseal heals 1 + 1 HT damage; with a failed roll, it heals a flat 2 HT. No HT is healed on a critical failure. It takes one minute to treat a wound with a Surgiseal; the HT is regained after five minutes.

When applied to a Crippling Wound, plastiskin repairs the flesh, but does not knit the bone; thus, a Surgiseal can only heal a character with a Crippling Wound to HT-2. Only one dose of plastiskin may be applied to a single wound; any further healing requires professional medical attention. A Surgiseal applicator costs \$100 and weighs 2 pounds; plastiskin comes in disposable canisters that cost \$50 and weigh 1/2 pound. One canister of plastiskin will treat three wounds.

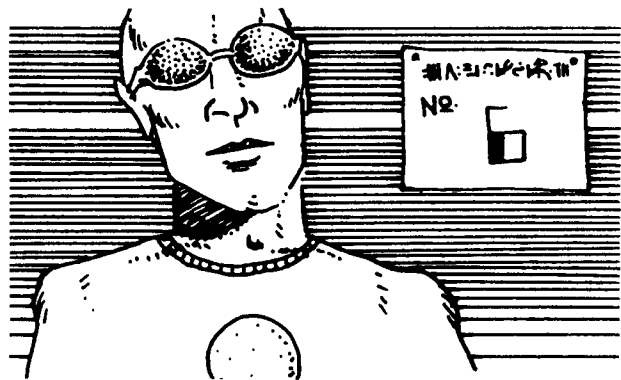

### *Debiojection*

Variations of this contraceptive medication work on most sapient species of the Commonwealth. Debiojection is administered periodically, although the frequency of medication varies according to species — human males, for example, must take it weekly, but thranx females require only two doses per year. Debiojection prevents the production of gametes, but does not interfere with sexual performance. This medication is fairly safe, but it does build up in the body; resumption of fertility may take six months to a year for long-term users. \$250/year.

### *Emodrugs*

A “dose” of emodrug is a series of numbered capsules taken 1-2 hours apart. The capsules contain complex hormones which remove the natural emotional safeguards from the mind and replace them with chemically induced emotions. Different series of capsules produce various emotions, usually violent.

The “Anger” emodrug is typical of the group. Properly administered — one capsule every hour for seven hours — it gives the user +2 to ST and +1 to HT, but makes him Bad Tempered, Overconfident and Stubborn (see pp. B23, B26 and B28). If the user takes all the pills within an hour, he is at +10 ST, +4 HT, -3 IQ, and becomes Berserk. It is not possible for a Berserk emo user to break out of his fury until the drug has run its course. Taken properly, the effects of the Anger drug last 46-HT hours; an Anger overdose runs its course in 34-HT hours.

Emodrugs are not chemically addictive, and therefore are legal in the Commonwealth. However, the Church has been lobbying for their ban, both because they seem to be psychologically addictive, and because murders, rapes and assaults have been committed by emo abusers. A streetwise roll is necessary to find a supplier for emodrugs. \$1,000/dose and up.

### *Heightened Instinctual Perception (HIP) Drugs*

Thranx endocrinopsychologists researching human behavior theorized that the human mind continually balances emotionalism and rational control. In the course of their research, they developed HIP drugs, which suppress the function of certain areas of the brain, freeing other portions to operate unrestrained. They found that when the emotional functions of the human mind are suppressed, a human becomes a vegetable, but when the rational control is eliminated, a human becomes the universe’s most aggressive killing machine.

The thranx mind, as human psychologists discovered, works similarly — a deeply ingrained moral and ethical system balances a ruthless decision-making process. When the decision-making function is suppressed, a thranx becomes a dithering mass of guilt and anxiety, but when the ethical functions are suppressed, he becomes a brilliant but amoral computer.

In cooperation, HIP-affected humans and thranx are an unequalled instrument of death — the ruthless, calculating thranx channeling the aggressive and violent human. Combined with sophisticated fire control computers, the triumvirate of machine, human, and thranx forms an unbeatable efficient stingship crew.

A human injected with HIP drugs receives a +2 to ST and a +4 to DX, and becomes Berserk. Thranx users become Stubborn and amoral, but gain +3 IQ and +2 DX. Both species gain Alertness +3 and Combat Reflexes. The effects of HIP drugs last 15-HT hours (one hour minimum), or until the antidote is injected. Stingship crews are automatically injected with the HIP antidote at the end of a battle.

HIP drugs are normally available only to Church Peaceforce stingship crews, but dangerously low-quality versions are available for \$500 to \$50,000 on the black market. A character using these illegal HIP drugs must roll against HT as the effect wears off; failure means the character permanently loses 1 from one attribute (roll randomly).

### *Medicines*

*Aelo-Vyacine* decreases the thranx heart rate and blood pressure. While under the effects of *Aelo-Vyacine*, a thranx does not suffer from the thranx Hemophilia disadvantage, but is also -2 ST, -4 DX, and -3 IQ. A single dose lasts 15 minutes. *Aelo-Vyacine* is toxic to humans; a human injected with a dose must make a HT roll or suffer 2-2 damage. \$40/dose.

*Cerebroneural Depressant* is the general name for several non-addictive depressants used as sleeping pills and tranquilizers. While under their effects, a character suffers a -2 penalty to IQ and DX, but is +4 to avoid succumbing to the mental disadvantages Bad Temper, Berserk, Paranoia and Phobias. These drugs are frequently used by thranx spacetravelers. \$10/dose.

*Exene* is an extract of formicary foam, a natural product of a reef parasite on Cachalot. When properly prepared, *Exene* dissolves arterial blockages in humans and other mammalian species, preventing most forms of heart disease. This gives a +1 to HT on the user’s next set of Aging rolls. Unfortunately, *Exene* is expensive (\$5,000/dose).

### *Recreational Drugs*

A wide variety of illegal recreational drugs are available from criminal laboratories throughout the Commonwealth.

While effects of these drugs vary, all are addictive; addiction to any of these drugs is a disadvantage worth character points (see p. B23). Specific examples include:

**Aelo**, a depressant which works on the thranx circulatory and nervous systems. A thranx user is at -2 ST and -2 IQ for 2 to 12 hours; for users of other races, Aelo has no euphoric effect, but does 1-1 damage in addition to the negative effects described for thranx. \$100/dose.

**Felturney** and **Felturney-B**, two euphorics. The user is at -2 IQ for 1 to 6 hours. Felturney is *highly* addictive (-5 penalty on withdrawal rolls), while Felturney-B is only normally addictive. Felturney costs \$200/dose; Felturney-B costs \$400/dose.

**Tween**, a euphoric used by humans and Tolians, causing extreme time distortion. A user is at -3 DX for 1 to 6 hours. Tween has no apparent effect on thranx, ornithorpes and AAnn. Tween is *highly* addictive (-5 on withdrawal rolls). \$80/dose.

**Tizone**, a very rare stimulant. Tizone doubles ST and HT for 3 to 18 minutes, but makes the user Berserk. As the drug wears off, the user loses 2 dice fatigue in addition to that lost while Berserk. Tizone use can also cause permanent damage — addicts roll monthly for attribute decline as if they were aging (see p. B68). Tizone is *totally* addictive (-10 on withdrawal rolls). \$500/dose.

### **Bloodhype**

Derived from the Hyperion trees of the planet Annubis (p. 7), the drug bloodhype affects any creature with a complex nervous system and circulating liquid in its body, including both humans and thranx. It produces an extremely pleasurable sensation, directly stimulating sensory neurons throughout the addict's body. One addict described the effect as "being the highest-pitched string on a neurophon." A light dose deadens pain and causes mild euphoria; larger doses also produce a *fire-fit*, a burning sensation that intensifies the bloodhype experience. Known in the drug trade as "jasper," "silly-salt" or "brain-up," a single dose of bloodhype costs \$1,500.

Bloodhype withdrawal is almost invariably fatal. First, the victim loses coordination as involuntary muscle contractions increase dramatically. Respiration and heart beat become irregular. The senses become distorted, and the brain undergoes manic-depressive cycles. Without professional treatment, a bloodhype addict in withdrawal must roll against HT-8 *every day* for a week, or die from the drug's after-effects. During this time, the victim cannot eat, sleep, or clean himself.

If medical personnel reach an addict in the first 12 hours of withdrawal, they can support the addict's nervous system while the drug "burns itself out." To survive this painful process, a victim must roll against HT-3 every day for 10 days. Each time the character fails this roll, he loses 1 point of IQ *permanently*. This lost IQ may be *replaced* by spending character points, but will not return "naturally." If IQ reaches 0 on or before the tenth day, the victim dies. The bloodhype detoxification costs \$2,000 per day; a successful treatment would cost \$20,000.

## **Miscellaneous Personal Equipment**

### **Cetacean Translator (TL8)**

This headset translates the singing language of cetaceans into Symbospeech, and vice versa. A microphone/speaker box receives and produces the cetacean sounds and must be held underwater to communicate with submerged cetaceans. \$1,000.

### **Microfilm Reader (TL8)**

A hand-portable device used to read microfilm cassettes,

available in sizes as small as a cigarette case and as large as a phone book. Most readers also have a built-in cassette; in large readers, the cassette holds as much information as 500 novel-length books, while the cassette built into smaller models may hold as little as 50 books. Naturally, larger readers have larger screens.

Microfilm readers of comparable quality cost about the same, regardless of size — the compactness of miniature models balances the large screen and extra features of larger models. A typical reader costs \$250 and weighs between 1/2 and 5 lbs. Additional books on universal cassettes cost about \$10 each, and are a little larger than a poker chip — weight negligible.

### **Survival Belt (TL8)**

The survival belt is a complete kit for adventures in the wilderness areas of humanx-habitable planets. It includes freeze-dried rations for one person for two weeks; vitamins and energy pills good for an additional four weeks; a dozen fishhooks and fifty feet of monofilament line; a two-quart canteen and a "safety straw," capable of filtering even microscopic impurities from wild water; a two-man, waterproof, temperature-resistant tent folded smaller than a man's fist; a compass; and a collapsible shovel, as well as a compact microfilm reader with a built-in spool containing fifty survival, language, and spiritual books. The belt also has room for a pistol and an extra power pack or ammo clip; many manufacturers include a laser pistol and extra power pack in their more expensive belts. With a laser pistol and power pack, a survival belt costs \$1,500 and weighs 13 pounds; without the gun, a belt costs \$600 and weighs 8 pounds.

## **Vehicles**

### **Skimmer (TL9)**

Skimmers are rectangular, open-topped anti-grav vehicles with short, stubby wings. There are seats for 12 passengers inside the box, and room for payloads of up to 150 cubic feet and 1,000 pounds. The front of a skimmer also sports a windshield and headlights.

These large vehicles fly by a combination of aerodynamic control and contragravity lift. Skimmers are very fast, traveling at speeds up to 75 miles per hour at heights up to 200'. A typical skimmer can travel for up to 125 hours on a single charge.

Some skimmers — especially those used in hostile environments — mount a small laser cannon and gunner position in place of six of the twelve seats. The cannon does 5 dice impaling damage, with the following ranges: P-B 8, Inc. 50, 1/2 Dam. 600, Max 2000. Extensive use of this weapon depletes the skimmer's electrical power plant, however. \$40,000.

### **Mudder (TL7)**

A mudder is a ground vehicle designed for use on swampy worlds such as Moth and Tolus Prime. Small mudders carry a driver and a passenger and an additional 50 cubic feet and 200 pounds of cargo, while larger models can carry a driver and five passengers and an additional 150 cubic feet and 1,000 pounds of cargo. Common features include a retractable transparent canopy covering the passenger section and a large searchlight mounted on the front of the vehicle.

Mudders are powered by a rechargeable electrical cell, and can travel for up to two weeks on a full charge. Mudders can travel at speeds up to 25 miles per hour over open water or land, but are usually restricted to 10 miles per hour or so on rough or swampy terrain. \$12,500.

# 5

# PSIONICS

## Psionics in the Commonwealth

Psionics are rare in the Humanx Commonwealth, but psionic humans do appear occasionally, and at least one race — the Ulru-Ujurrians — is entirely psionic. By far the most common form of psionic power in the Commonwealth is that of Telepathy; other powers are almost unknown. For this reason, *GURPS Humanx* presents complete rules for Telepathy. If the GM wants to use other powers, he should use his judgement or consult other *GURPS* worldbooks which contain rules for other types of psionics.

### Designing a Psionic Character

No spacefaring race besides humanity has demonstrated the slightest aptitude for psionic talent. Even among humans, the normal incidence of detectable, trainable power is well below one in one million. Thus, no group of adventurers is likely to include more than a single Talent.

Finding an experienced psi to train a talented PC will be *very* difficult. No telepath may begin with psionic skill above IQ-2, regardless of their level of power. Of course, once they begin play, they may freely spend character points to increase their skills and power.

Talents should be careful not to reveal their special abilities, as several groups take an unhealthy interest in psionics. The scattered remnants of the Meliorare Society (p. 11) devote themselves to tracking down and capturing psis. The Church itself will also detain Talents, believing them to be in cooperation with the Meliorares, or using them as bait to draw the Society out. The public is distrustful of and frightened by psis. These feelings can occasionally erupt into a lynching!

A Talent will have a -3 reputation from humans who recognize him as a psi, a 5-point disadvantage (everyone, occurs whenever you openly use your power — effectively a 7 or less). If he is known to the Church or to the Meliorares, he will be hunted by them. The Church is an “utterly formidable group” (-40 point base), while the Meliorares are a medium-sized group (-20 point base). If the player takes either of these groups as an Enemy, he and the GM will need to decide how often the group appears, which may modify the point value of the disadvantage.

Psionics, or “psi” abilities, are powers of the mind; *GURPS Humanx* covers one type of psionics, Telepathy. Telepathic abilities are learned just like other skills, except that, for each skill, there is an underlying *power* — an inborn advantage — which is a prerequisite. If you don’t have the Telepathy power, you can never learn telepathic skills. If you have the Telepathy power, you may learn any or all of the telepathic skills listed below.

Eidetic Memory gives *no* bonus to learn psi skills.

A character who starts with Telepathy can increase it later, at the same cost per level, by spending earned character points. But it cannot be acquired during play; you have to start with at least one level of Telepathy power if you are ever to have it. (GMs may make exceptions to this if they like — see *Latent Power*, p. 61.)

## Power and Skill

Each of your telepathic abilities is described by two factors: *power* and *skill*.

**Power** is the raw “strength” of your Telepathy, and defines its range.

Power is bought in levels. Your Power is the same for all telepathy skills. If your Telepathy power is 10, *all* your Telepathy skills have a power of 10. Telepathy (TP) costs 5 points per level.

**Skill** is bought as for normal skills; psi skills are Mental/Hard. Skill determines how well you can control your ability. A die roll is required only when there is a significant question of skill. For instance, no skill roll is needed to raise or lower a mind shield while you’re awake and not under mental attack. But a roll is required to raise or lower it while you are asleep.

*Example:* A character buys a Telepathy power of 10 (50 points); his Power is 10 for all of his telepathic skills. He buys Telesend at 9 and Telereceive at 18; these are Skill numbers, based on IQ. His power of 10 gives him good range for these skills. He can receive complex thoughts under stressful situations, but sending his own thoughts can be hard.

## Using Psi Abilities

### Fatigue Cost

Most uses of psi require no expenditure of energy, just as ordinary walking and talking require no significant effort.

Other uses are more strenuous. When use of a psionic power costs energy, it is always taken as *fatigue* — one point of fatigue per attempt, unless specified otherwise. A psi can *not* spend his own HT as energy for psi use.

Psi use costs fatigue under the following circumstances:

(a) For an “extra effort” use of psi — that is, an attempt beyond your ordinary Power. See below.

(b) For each *repeated* attempt to use a skill, when the first attempt has failed. See below.

(c) For any use requiring a Contest of Skills, *unless* you win the contest by 5 or more. In that case, the effort was so easy it cost no fatigue.

(d) For any skill specifically requiring energy expenditure.

(e) For any critical failure.

## Concentration and Time Required

Use of a psi ability requires the *Concentrate* maneuver. Unless specified otherwise, each use of an “active” psi skill requires one turn of concentration — that is, you stand for a second, doing nothing. At the beginning of the next turn, make your skill roll to see if you succeeded.

If the effect you were trying to achieve is instantaneous (e.g., detecting the use of a psi power with psi sense), it takes place as soon as you make your roll, and you may take some other action that turn (or start concentrating again).

If something — especially an injury — disturbs you while you concentrate, an IQ-3 roll is required to maintain your concentration. A failed roll means you must start over. If you are *injured* while concentrating, your effective skill for that attempt is lowered by the total number of hits you suffered.

For an effect that takes longer (e.g., reading someone’s mind), further time must be spent in concentration after the initial contact is made. If you want to do something else while you continue the psi use, you can try — but a skill roll is required every minute, at a penalty. Some examples:

Carry on light conversation: -2

Carry on intelligent conversation: -4

Do repetitive manual labor: -2

Combat at a distance (e.g., fire a gun): -6

## Repeated Attempts

When a psi tries to use a skill and fails (misses his roll), he may wait five minutes and try again without a penalty. If he wants to try again sooner, this is considered a *repeated attempt*, and costs a point of Fatigue. Furthermore, this second effort is at a -1 on skill. Should this effort fail, he can spend another point of Fatigue and try again at -2, and so on. This may go on until Fatigue reaches 0 and he falls unconscious, or effective skill drops to 2, at which point no success is possible.

Once a psi starts spending fatigue in repeated attempts to perform a feat, *every* attempt at that feat is considered a repeated effort, until he rests long enough to recover *all* lost fatigue. Fatigue is recovered at one point per 10 minutes.

Psi use is only considered a repeated attempt if the psi is trying the same feat — that is, the identical skill on the same subject. If *distance* is the only thing that changes, it is still a repeated attempt, though the new distance may modify the die roll for some powers. In case of doubt, the GM rules.

## Extra Effort

A psi can put “extra effort” into an attempt and get an effective increase in Power. For each 3 Fatigue spent on an attempt, increase effective Power by 1, but *decrease* effective Skill by 2. If the psi use continues for more than a minute, each extra minute costs another 3 Fatigue *per power level*.

## Latent Powers

Telepathy, like most other advantages, is inborn. As a rule, if you don’t start as a psi, you can’t gain psionic power later in your career.

Therefore, if you want a character to “discover” his psionic potential in the course of play, he should buy one level of Telepathic power at the time of character creation. This gives the character little Power and no Skill; he won’t be able to use his Telepathy effectively. But later in his career, he will spend character points to increase this “latent” power, and to develop several psionic skills.

## Adding New Powers

GMs who don’t care for this rule may allow PCs to gain powers they didn’t start with, as long as the appropriate character points are paid. Here are some good excuses for gaining a psi power:

Severe blows on the head

Encounters with powerful psi-users (human or alien)

Lightning strikes, radiation accidents, alien diseases

Mysterious artifacts

Deliberate experiments in creating psi powers. But there *must* be some reason why the experiment’s success was partial, unknown, accidental, or unrepeatable, or we’d all be psionic!

## Critical Success and Failure

A critical success on a psi skill roll has no special effect *except* that no fatigue is spent, even if it ordinarily would have been.

On a critical failure, roll one die and lose that many points of Fatigue, in addition to any Fatigue that the effort would normally have cost. Also, after a critical failure, a psi may not attempt the same feat again until all lost Fatigue is recovered. Some skills may have other critical failure effects.

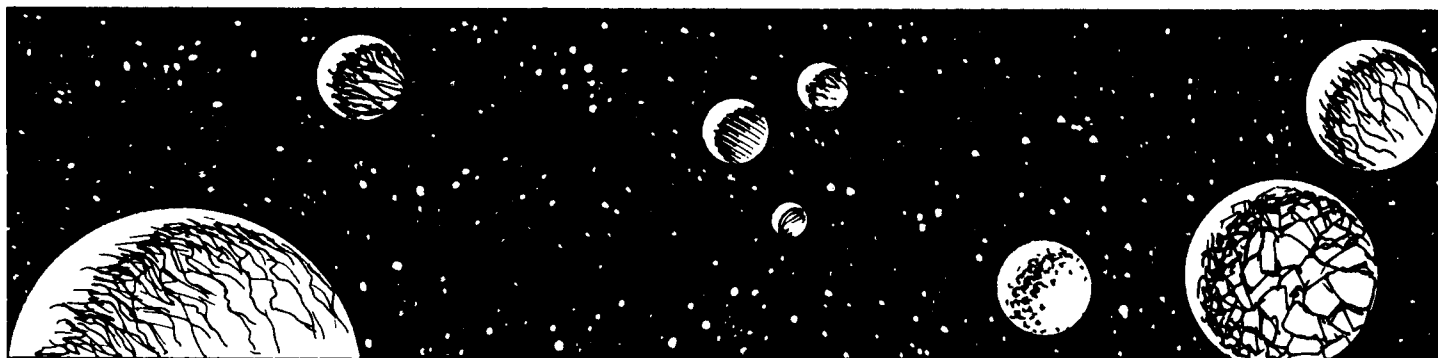

## Glossary

**Psi.** Short for "psionics" — the generic term for unusual mental powers. Also, any person who possesses a psionic power may be called a "psi."

**Empath.** A person with a small amount of Telepathic power and no psionic training, capable of limited Emotion Sense.

**Sniffer.** Someone with Psi Sense skill.

**Subject.** The person against which a psi skill is being directed.

**Talent.** A psionic ability, or a person with psionic ability.

**Telepath.** A person with telepathic ability, especially Telesend and Telereceive.

**TP.** Telepathy. The power to read, affect, control, or shield minds.

**User.** The person using a psi skill.

**Victim.** The subject of hostile psi use.

## Active and Passive Skills

An "active" psi skill is one which you use deliberately. Telesend and Mindwipe are examples of active skills. An active skill always requires a skill roll. Active skill rolls are made by the player himself.

A "passive" skill is one which works automatically when circumstances call for it. Some passive skills (for instance, the low-level emotion sense called Empathy) still require a skill roll — but the roll is made by the GM. Others (e.g., Mind Shield) always work, without the need for a roll. For instance, Mind Shield always subtracts from the skill of a telepathic attack against you, even if you don't know you are being attacked.

Extra Effort cannot be put into a passive use of skill, since it is by definition automatic.

## Multiple Feats

A psi can *initiate* only one skill use at a time. But he may do several things simultaneously, as long as they are started one at a time. For each simultaneous "feat" there is a -1 to skill.

Example: A multi-skilled telepath is using Mindwipe to alter the memories of another person. To do so, he must make a Mindwipe roll once per hour, until the process is complete. A third person — whom the telepath doesn't trust — enters the room and addresses the telepath. Believing the newcomer is lying to him, the telepath uses his Emotion Sense to check, while maintaining his Mindwipe. To do so, he must roll his Emotion Sense-2. If he is still sensing the newcomer's emotion when he must make his next Mindwipe roll, that roll will also be at a -2.

# Telepathy

Telepathy is the power of mental communication and control. For these skills, the *subject* is the person you are trying to detect, control, or communicate with. Telepathy is unaffected by physical barriers. Your Telepathy power controls the *range* at which you can use telepathic skills, as follows:

1	Touch only, and required time is multiplied by 10.		
2	Touch only	12	400 yards
3	1 yard	13	½ mile
4	2 yard	14	1 mile
5	4 yards	15	2 miles
6	8 yards	16	4 miles
7	15 yards	17	8 miles
8	30 yards	18	15 miles
9	60 yards	19	30 miles
10	100 yards	20	60 miles
11	200 yards	21	125 miles

Further increases in power continue to double range.

The above ranges are for contact with a single target. For powers involving a "global" use of psi (e.g., a Shout directed at everyone around you), divide Range by 100!

Any *skill roll* for one of these abilities will have the following bonuses and penalties:

Subject has Mind Shield skill: minus Telepathy power.

User is touching subject: +1. Exception: If your Power is 1 or 2, you *must* touch the subject, and you do not get a skill bonus.

User knows subject slightly (GM's decision): +1.

User knows subject intimately (GM's decision): +2.

## Psi Sense

This is the ability to detect use of psi ability. The possessor of the power (sometimes called a Sniffer) gets a *passive* Skill roll to detect any *active* use of psi within his range. He may also use the skill actively, by concentrating. A Sniffer has the following bonuses:

Sniffer is concentrating exclusively on detection: +5

Subject is using a Telepathic ability: +2

The success of the skill roll determines the amount of information the sniffer gets, as follows:

Failed roll: No psi use detected.

Roll succeeds: Sniffer knows psi was used within his range.

Succeeds by 1: Sniffer knows approximate direction.

Succeeds by 3: Sniffer also knows approximate distance.

Succeeds by 5: Sniffer also knows what psi power was used.

Succeeds by 7: Sniffer also knows what psi skill was used.

Succeeds by 9: Sniffer also knows what the skill was being used on or for.

Succeeds by 11: Sniffer also gets image of user's personality (or recognizes user, if he knows him already).

This skill detects only a psi *user*. A short-range Sniffer, in the same room with another person, would not know that person's mind was being read unless the spying Telepath was also within the Sniffer's range. This skill uses full range, not range divided by 100.



## Emotion Sense

This is the ability to tell, not what someone is thinking, but what he is *feeling*. When a subject is in range of your power and you hear him speak, you can tell whether he is lying — not what the truth really is, but whether he's being truthful. This is a 'passive' roll, made automatically.

You can also get a general "feeling" for someone's personality; the better your Skill roll, the more detailed a feeling you get. This is also a "passive" process; the GM rolls for you and provides the information.

Finally, you can also sense other emotions. If someone is sad but pretending to be happy, for instance, a successful Skill roll will reveal it. This is not a passive process, but requires an active attempt.

**Default use:** At a Power of 3 or better, the passive aspects of this skill can be used without training. You can sense lies, but not other emotions, by rolling vs. your IQ level. You get only one "personality" roll for each person you meet (if you are separated for more than a month, you get another roll). Note that this works exactly like the Empathy advantage (p. B14) — because they're the same thing! If you have Empathy, you *are* a psi. The 15 points you spent for Empathy make you a Telepath with Power 3 and no training, rolling at your IQ level by default.

## Telesend

This is the skill of *sending* thought. The user sends his thoughts to the subject at about the speed of talking, though simple pictures may also be sent (by visualizing them) at the speed it would take to draw them on paper.

A successful Skill Roll is necessary. If the roll fails, the psi may spend fatigue and try again (see *Repeated Attempts*).

If the psi has no language in common with the subject, the skill roll is at -4. If the roll is then failed by 4 or less, the subject feels a mental contact, but understands nothing!

**The Shout:** Telesend ability can also be used for a telepathic *Shout* which can stun those who receive it. If the Shout is broadcast, no skill roll is required. It will affect everyone within the psi's range (a lesser range can be specified, if the psi Shouts less loudly). Everyone within range of the Shout must roll vs. Health. A failed roll results in a mental Stun (p. B106). (So high HT helps you avoid a Stun, and high IQ helps you recover quickly.)

The Shout may also be aimed at one area (seen through the psi's own eyes or another's), or at one single person (seen through the psi's eyes or those of another with whom the psi has made contact through Telereceive).

## Telereceive

This is the skill of *receiving* thought — often called "mind-reading" or "peeping." Received thought comes at the speed of speech, except between two very skilled telepaths (see sidebar).

To receive thoughts from a *willing* subject within range, a skill roll is necessary. Remember the bonus for familiarity with your subject!

To receive thoughts from an *unwilling* subject, two rolls will be necessary. The first checks your subtlety. Roll a Contest of Skills: your Telereceive vs. the subject's Mind Shield skill (see below), or IQ if he has no shield up. If you win the contest, your mind-reading attempt is not noticed. If you lose or tie, the subject notices you (whether he realizes what was happening will depend on his experience with telepathy!).

The second roll is the actual attempt to enter the subject's mind. Roll your Telereceive skill, modified downward by the subject's Shield *power*, to see if you made contact with his mind. Subtract the subject's Strong Will from your Skill as well (or add his Weak Will!).

## Two-Way Communication

A two-way contact between Telepaths can be initiated with Telesend power. Once the other Telepath is aware of you, he makes his own Telesend roll, at +4 because the contact has already been made. After each minute of conversation, each Telepath must make another Skill roll, but *all* rolls to maintain a two-way contact are at +4.

For true two-way conversation, each TP must be within his own Telesend range of the other. But a very powerful TP could hold a two-way talk with someone wholly untalented, talking with Telesend and picking up subvocalized answers with Telereceive.

If two Telepaths are "talking," and each has *both* Telesend and Telereceive skills at 10 or better, they may choose to enter "full communion." Each is aware of *everything* the other thinks and perceives, and communication is some 10 times faster than speech!



## Three-Way Interaction

If two Telepaths are reading the same subject's mind, they *will* notice each other unless one is deliberately hiding. In that case, a Contest of Skills is rolled (the GM may make this roll for one or both characters, to keep secrecy). If one character is *looking* for mental intruders, he is at a +2 to his skill to notice.

If *both* characters are trying to hide, and neither is aware of the other, the GM should roll *two* contests — one to see if A notices B, and one to see if B notices A.

Even if two or more Telepaths are "in" the same mind, they cannot communicate directly through the third mind. They can use it as a "relay station" only if that third mind is another Telepath, actually listening and repeating the message from one mind to another.

## Catalyst Creatures

The power of some Talents is enhanced through a bond with a specific animal, called a catalyst creature. Flinx and Pip are an example of this. Catalyst creatures associate with a Talent on a voluntary basis; the Talents themselves consider them companions rather than pets.

A catalyst creature is a full-fledged NPC, played by the GM; you can't "buy" one with character points. When a Talent encounters an unbonded catalyst creature, the GM rolls a reaction for the creature, giving the character a reaction bonus equal to half his Telepathy power, rounded down. A Talent with Animal Empathy receives a further +2 bonus. If the reaction is *excellent*, the creature bonds with the Talent.

Once bonded with a catalyst creature, the Power of the Talent's psionics increases by an amount equal to the creature's psionic Power. Thus, a Talent with a Telepathic Power of 4 bonded with a minidrag with Telepathic Power 8 would function as if his Power was 12. Similarly, the creature's power is increased by an amount equal to the Talent's power. A Talent and his catalyst creature both receive a +4 to their skill when using any telepathic ability — except Mindwipe — on the other.

A character may have only one catalyst creature at a time. The only such creature described in the *Humanx* novels is the minidrag (see p. 19); the GM may invent other catalyst species, using the minidrag as a guideline.

The death of a catalyst creature can have a devastating effect on a Talent. At the moment of its death, the creature's telepathic "scream" will mentally stun (see p. B106) the Talent, regardless of the distance between them; the roll to recover from this stun is IQ-4. The Talent will also develop mental disadvantages and/or quirks relating to the event, with a point value equal to at least the number of months the Talent and creature were bonded, to a maximum of -15 points. These disadvantages do not count against the normal 3-disad, 40-point limit. Choice of the disadvantages is left to the player, subject to GM approval. The Talent does not gain any advantages or skills from these disadvantages.

For example, Merritt Rupoe has been bonded to Spike the minidrag for 11 months. Escaping a burning building, Merritt and Spike are caught in a tremendous explosion, in which Spike is killed. Merritt is thrown to the floor by the mental impact of Spike's death. Once Merritt recovers from this mental stun, his player must assign him 11 points worth of mental disadvantages resulting from the loss of Spike. The player selects brontophobia (-10 points) — due to the explosion — and a 1-point quirk, "Dislikes fire." These disadvantages are in keeping with the circumstances of Spike's death, and the GM approves them.

Thus, it is possible for an intruder to bounce off a powerful shield without being noticed, or penetrate a skillful shield yet be observed.

If the subject is talking, or even *subvocalizing* (talking under his breath), you get a +2 to all skill rolls.

If you get into your subject's mind, the level of thought you get depends upon the amount by which you make your skill roll:

0-2: Surface thoughts only. If the subject is talking or subvocalizing, you pick up only what he is saying.

3-4: All surface thoughts, plus occasional mental associations and background. You can also pick one of subject's senses (sight, hearing, telepathy, etc.) to "tap into" and perceive.

5-6: As above, but with all significant mental associations and background (but still only if the subject thinks about it!). You can also pick up all subject's sense impressions.

7-8: The subject's subconscious mind is also exposed.

9-10: The subject's memories of the last day are also exposed.

11-12: The subject's memories of the last week are also exposed.

13+: All the subject's memories are exposed, though a separate skill roll is necessary to "locate" any particular memory over a year old. A failure means the memory cannot be located; try again another day.

A new skill roll is required each minute that you stay in the subject's mind, but this does *not* cost Fatigue. If a roll fails, contact is broken.

## Mind Shield

This is the ability to hold a mental "shield" that warns you of telepathic attacks, and helps defend as well. This involves a Contest of Skills and a Telereceive roll by the invading psi, as described under Telereceive.

You may turn your shield on or off at will; this may be done at any time, *even* when it is not your turn during combat phasing. When you go to sleep or become unconscious, your shield remains as it was set. If there is some need for your shield to come up or go down while you are asleep or unconscious, you get a *single* Mind Shield skill roll (at -2 if you are unconscious rather than merely asleep). If the roll fails, your shield stays as it was until you awaken.

**Power of Shield:** Your Telepathy power is the shield's strength. Subtract this number from the Skill of any psi use affected by the shield (see below). Example: A Telepath with skill 18 is trying to read your mind. Your Telepathy power is 5. The TP rolls at an effective skill of 13.

**Repeated Attacks:** If a telepathic attack meets a Mind Shield and fails, each repeated attempt is at a -2 (not the normal -1) to skill, and costs 1 Fatigue point.

**Effects of Skill:** The user's *skill* with Mind Shield determines the *type* of protection it gives:

8 or less: Interferes with all uses of Telepathy, friendly or hostile, against *or* by the subject. In other words, when the user's shield is up, it interferes with his own telepathic abilities!

9 to 11: Interferes with all use of Telepathy, friendly or hostile, when Mind Shield user is the subject — but not with the user's own Telepathy.

12 to 14: Interferes with all uses of Telepathy when Mind Shield user is the subject, unless user consciously designates a use as "friendly." That use then suffers only half the normal interference (round up).

15 to 17: The shield automatically discriminates between friendly and hos-

tile contacts. Friendly contacts are detected, but can work through the shield without opposition. The user can decide, at any given time, whether “neutral” contacts will be treated as friendly or hostile.

18 to 20: As above — and if a “friendly” contact turns hostile, the attacker must make a new skill roll, against the shield.

Over 20: As above, but any psi contacting the shield must win a Contest of Skills (Telereceive vs. Shield) even to perceive that the user is psionic. Otherwise, he will merely perceive surface thoughts appropriate to a non-psi. This is called “cloaking.” A successful Mindwipe roll will penetrate the cloak — possibly to the surprise of the invading psi!

### “Get Out Of My Mind!”

It can happen that a hostile psi penetrates your shields with Telereceive, and that you *later* become aware of his presence — for instance, because he failed a Telecontrol or Mindwipe roll. Or he might have entered your mind while your shields were down. In either case, you may attempt to close him out of your mind. Roll a contest: your Telepathy Power + Mind Shield skill, vs. his Telepathy Power + Telereceive skill. If you win, you push the intruder out of your mind, and he will be at a -2 (repeated attempt) if he tries to return.

But if you lose, the enemy psi is in your mind for as long as he likes. And you must make an (IQ+4) roll to control your own thoughts, or you will immediately think of whatever it is you fear he is trying to learn — which can give your secrets away even to an unskilled attacker.

## Mindwipe

**Prerequisite: Telesend and Telereceive at 12+**

This is the ability to edit or remove a subject’s memories. To use this skill, you must first make contact with the subject, using Telereceive, and get past his shields, if any. Then try your Mindwipe skill (once per hour for long processes). A failed Mindwipe roll will alert the subject that his mind is being tampered with. If you make several rolls but then fail one, the subject will lose memory, but it will return in (3 dice) days.

The time required to do (or undo) a memory change, or to find traces of a change in the subject’s mind, varies with the complexity of the change. The more subtle the change, the harder it is to make, repair, or find:

Delete all the subject’s memories (leaving a babbling idiot): 2 hours.

Delete all subject’s memories *permanently*: 1 hour.

Delete a lot of memory (e.g., several weeks of time): 3 hours.

Replace a lot of memory with a false memory: 5 hours.

Find and remove a single memory: 1 hour.

Find and change a single memory: 2 hours.

Plant a *compulsion* (a single order the subject will have to follow at an appropriate time): 4 hours.

### Detecting Mindwipe

Total memory deletion, of course, is obvious. You may detect lesser tamperings when you are in mental contact with the victim. The GM will make a skill roll for you: Mindwipe, or Telereceive-5 if you don’t have Mindwipe. You only get one such “passive” roll — the first time you contact the person after the tampering takes place. You are at -2 to notice a compulsion, and -4 to notice a single memory has been changed. You are at a further -1 for every week since the tampering took place, up to 6 weeks.

If you are deliberately looking for mental tampering, having failed the passive roll to notice it, you must make mental contact using Telereceive, and then make the above skill roll. This effort takes an hour, and any further check within a day is a “repeated attempt.”

## Using Psi With Other Skills

Psi skills can be used in a number of creative ways. The GM should let a successful psi roll give a *bonus* on an appropriate skill roll. Players should be creative in their use of psionics, but the GM has the final word on what will and won’t work.

In general, the psi roll must be made first. If it is successful, the real task is made easier. A failure does not affect the task, but a critical failure gives a penalty equal to the bonus that would have been gained. Some examples:

A successful Emotion Sense roll gives a +2 to skill rolls involving negotiation, such as Diplomacy or Merchant.

Reading a foe’s mind would be good for a +2, or better, on a Strategy or Tactics roll — the trickier the foe’s plans, the better the bonus.

### Mechanical Mindwipe

Within the Commonwealth, those convicted of capital crimes are no longer put to death. Instead, especially violent and dangerous criminals are sentenced to be mind-wiped.

According to Commonwealth law, a felon must be subjected to extensive psychological analysis prior to mindwiping. This analysis determines the minimum amount of memory which must be deleted in order to prevent repeated violent behavior; while some governments are very careful about this testing, others have been known to omit it entirely. Properly administered, this analysis lasts 3 to 6 weeks, at the end of which the mindwipe is performed.

The mindwipe itself can be performed in a single day by a psychiatrist and a programmer. The patient is linked to a mindwipe computer by four to six needles, inserted directly into the brain. The programmer accesses the patient’s memories, and the psychiatrist determines exactly which should be eliminated. The patient may or may not be conscious through the operation; most psychiatrists consider it worthwhile to question the patient during the process. Afterwards, the only visible signs of the mindwipe are half a dozen pinpricks on the scalp, which heal in a few days. Memory deleted in a mechanical mindwipe is lost forever; it cannot be replaced or restored by mechanical or telepathic means.

After a mindwipe, the government is obligated to rehabilitate the patient so that he may live a normal life. In cases of minor memory deletion, this usually consists of post-operative counseling and perhaps job training; in cases of radical memory deletion, the patient may need complete re-education. Again, some governments fail to live up to this obligation, shoving their mindwipe patients into mental institutions or out onto the streets.

## Pside Effects

Psi skills can have "side effects" that are unique to a particular character. That is, your Telesend (for instance) has a special side effect that occurs when you use it.

Side effects are optional, and are determined when a character is created. There are two general categories:

### Special Effects

A *special effect* is a side effect which is essentially unimportant, though it may occasionally inconvenience the user. For example, if your Telesend skill makes a low humming noise, those nearby will notice something (and those who know you will know you're using your Telesend). A special effect is worth 1 point as a trivial disadvantage, or 2 if the GM feels it might be a bit more inconvenient. You may take up to 5 points worth of special effects for all your psi skills combined.

### Drawbacks

Drawbacks are side effects that cause real trouble to the user or those around him. For instance, if your use of Telesend causes mild headaches in everyone within 20 feet, that's a problem!

A drawback is worth points as a disadvantage — but only if it makes *real* trouble for the character. 15 points is the maximum allowed for *all* damaging special effects. As an example, the effect described above might be worth 5 points — mostly because it keeps the psi from using his power up close without being noticed.

A really obnoxious special effect will give its possessor a reaction-roll penalty. This is worth 5 points per -1 of reaction if it is always in effect (which would be rare), 5 points per -2 reaction if it is noticeable only some of the time, and 5 points per -3 reaction if it is relatively rare.

### Character Points

Points for special effects do *not* count against the normal (suggested) disadvantage limit. Thus, a psi character can have up to 20 points worth of extra disadvantages — 5 for side effects and 15 for drawbacks.

### Illegal Side Effects

No character may take a side effect which is obviously useful as a controllable weapon or advantage. If a player finds a clever way to make a seemingly worthless side effect *very occasionally* useful, that's all right.

## Undoing Mindwipe

Any memory alteration except a deliberate, permanent mindwipe can be undone. This requires as many *weeks* as the original process took *hours*. The psi trying to reconstruct the memories must make his own Mindwipe skill daily; failed rolls mean the day doesn't count, and critical failure means the process must start over. A critical success counts as a full week of success. A psi is always at +4 to undo his own work.

## Limitations

You can take a *limitation* on Telepathy power, which makes it cheaper but less useful. A limitation cuts the cost to buy that power. It affects all skills under that power. Cost to *learn* individual skills is not affected.

You may take more than one limitation on the same ability. However, the total cost modifier may never go to less than 1/4.

The cost modifier is applied to your *total* Power cost, and *then* rounded up. Example: You have a cost modifier of 1/2. You are buying Telepathy (5 points per level). Your first level costs 3 (half of 5, rounded up). Your second level costs 2 more, for a total of 5 (exactly half of 10). Your third level costs 3 more, your fourth level 2 more, and so on.

### One Skill

Half Power cost

You can learn only *one* of the skills associated with the Power.

### Untrainable

Half Power cost

Although you have psionic power, you can't learn to control it well. You learn all skills under the affected power as though your IQ was only 8. You can never learn any skill at more than 10.

### Emergencies Only

Half or 2/3 Power cost

The power is triggered by the user's fear or excitement. It cannot be used under "routine" conditions — only when the psi is angry, frightened or otherwise full of adrenalin. If the power works at half Power under normal conditions and at full Power only under stress, it is 2/3 cost (round up).

### Fickle

Variable

A "fickle" power sometimes deserts the user for no apparent reason. It does not affect momentary uses of the ability. But any time you use a psi skill (one use, or a series of uses) for more than a couple of minutes, the GM rolls every two minutes or so (game-time). As long as he rolls the *fickleness* number or less, your skill continues to work. If he rolls *above* the number, your power leaves you! Usually you will know — for instance, if you are reading someone's mind, the information stops coming in. But if your Telesend suddenly fails, you may not know that the person you were sending to didn't get the whole message . . .

Once your power leaves you, it will not return for at least an hour. Every hour, roll again. If you roll less than or equal to the Fickleness number, the power has returned, and may be used normally until the next time it fails under continuous use.

Fickleness	Cost Modifier
5	1/4
8	1/3
11	1/2
14	2/3

# SPACECRAFT

# 6

The invention of the posigravity drive — also known as the KK drive — made faster-than-light travel possible. Thranx and AAnn each developed the drive around -400 A.A.; humans developed it in 2280 A.D. Working together, human and thranx scientists made a number of improvements in the drive.

A KK drive spacecraft looks like a balloon stuck on the end of a plumber's helper. The "suction cup" of the plumber's helper is a generating fan for the drive field. The "handle" contains the reactor that powers the drive. On ships with defensive shields, the handle also contains the shield projectors. The "balloon" holds the ship's bridge, living quarters, weapons, cargo bay, etc.

Power from the reactor is channeled to the Caplis generator at the bottom of the fan. The Caplis generator creates a powerful gravity field at the nose of the ship, which draws the ship forward. The gravity generator maintains the field at a constant distance in front of the ship by continually cutting the field off and recreating it further ahead. Thus, the ship actually moves in a series of jerks that occur so rapidly as to feel like a smooth, steady motion.

As the ship approaches the speed of light, the posigravity field distorts into a forward-pointing teardrop shape. In the stressed space behind the posigravity field, it is possible for matter to move faster than light. The moment at which a vessel exceeds light speed and enters "space-plus" is called "changeover."

The gravity generated by the drive field is very powerful and can have devastating astronomical effects. A KK drive ship must enter and leave space-plus well outside stellar systems to avoid disturbing planetary orbits; within a system, the vessel uses only a fraction of the drive's strength. A ship cannot land on a planet while on KK drive. The interaction of the drive field with the planet's gravitational field would destroy the ship and gouge out a chunk of the planet's crust, causing major earthquakes, tsunamis, and hurricane winds.

Should a ship's posigravity field fall too close to the ship, the vessel can be destroyed. If a large mass impinges on the drive field at the moment of changeover, a field inversion can occur, turning the ship inside-out. Sophisticated piloting computers normally check for such debris, however.

If the KK drive should fail, the fan can be converted into an ion drive, using the hydrogen sparkplug in the fusion reactor. On ion drive, a ship could make it to a nearby world — but the trip would take a long time. It would take twelve years to get from Moth to its nearest neighbor, Powerline. Life support systems on humanx vessels *can* last this long, if the crew can take the isolation.

With the advanced computers and automation existing in the Commonwealth, the ships practically run themselves. They almost *have* to — interstellar navigation is much too complex for the humanx mind to handle. The pilots are there to provide instructions, make decisions, and troubleshoot in unforeseen situations. The smaller ships need only one or two people to pilot them, while bulk freighters may be *totally* automated. Some yachts are so fully automated they can be handled by voice commands from a totally untrained pilot.

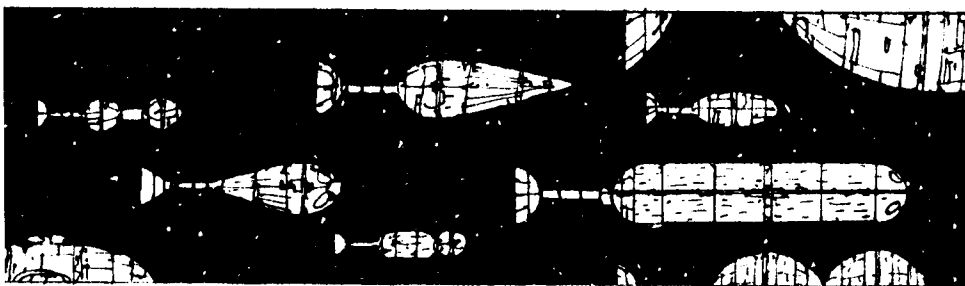

## Distance and Travel Times

This table shows some of the popular interstellar passenger flights, outbound from Terra and Hivehom. Return trips and other destinations are available as well. Distances are listed in parsecs (1 parsec = 3.262 light years.) Travel times are listed in days, assuming the speed of a passenger-freighter — 25 parsecs per day. Other vessels will have different travel times.

	Distance in parsecs	Travel time in days
<b>Terra to</b>		
Amropolous	225	9
Carmague/ Collangatta	525	21
Cachalot	40	1.6
Hivehom	240	10
Mantis	60	2.4
Moth	150	6
New Paris	95	3.8
Samstead	250	10
<b>Hivehom to</b>		
Alaspin	380	15
Balthazaar/ Beersheba	50	2
Chikasacasoo	710	28
Long Tunnel	300	12
Moth	150	6
New Riviera	350	14
Repler	1,225	49
Tolus Prime	405	16
Willow-Wane	175	7
<b>Amropolous to</b>		
Loser's World	425	17
<b>Chikasacasoo to</b>		
Goodhunting	375	15
Largesse*	325	14
Repler	550	22
Tolus Prime	350	14
<b>Dis to</b>		
Tran-ky-ky	325	14
<b>Loser's World to</b>		
Drax IV*	110	4.4
<b>Repler to</b>		
Annubis*	275	11
Prism*	75	3
<b>Samstead to</b>		
Carmague/ Collangatta	375	15
Dis	200	8
<b>Willow-Wane to</b>		
Ulru-Ujurr*	540	22

\* destinations not normally offered by commercial passenger spacecraft.

# Sample Spacecraft

## Commercial and Private Spacecraft

**Yacht.** Yachts are small vessels, usually built as pleasure boats for the rich. On more populous worlds, yachts may be available for rent — though a single day's rental costs \$7,500 or more! A typical rental yacht is 110 feet long, weighs 1,000 tons, and occupies 2,500 cu. yd. It has a small, fully-automated bridge, and can be piloted by voice command. It has 2 luxury staterooms and a lounge/dining area, and carries a small shuttle. Cost \$1.5 million; speed 50 parsecs/day.

A typical private yacht is 250 feet in length, weighs 7,500 tons and takes up 25,000 cu. yd. The ship's bridge is semi-automated, requiring two pilots. The ship holds a lounge area, a galley, a dining room, a rec room, 2 crew staterooms and 8 luxury staterooms. It also has an interstice laser for defense. It has a 15,000 cu. yd. cargo bay and two tractor beams, and carries a medium shuttle. Cost \$12 million; speed 60 parsecs/day.

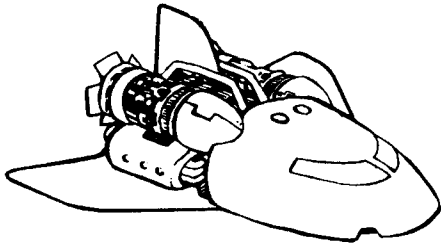

## Auxiliary Spacecraft

### Lifeboat

Carried on passenger liners to allow the ship to be abandoned in case of catastrophe. They are not capable of interstellar travel — they will merely allow the passengers to survive until help arrives. A lifeboat can make a planetary landing — once. Afterwards, it is not reusable — and it cannot take off from a planet's surface. A lifeboat is 30 feet long, weighs 15 tons, and has a capacity of 125 cu. yd. It carries 2 pilots and 20 passengers as well as emergency rations for 200 man-days.

### Shuttlecraft

Most Commonwealth spaceships are not equipped for making planetary landings. They carry shuttlecraft for transferring passengers and cargo to and from orbit. Shuttles are most commonly a jet-scamjet-rocket combination. They take off under jet power; the scramjet takes over once they reach the speed of sound — about 740 mph. The rockets are used to give them the final boost out of the atmosphere and into orbit. Shuttles come in several sizes:

**Small Shuttle.** A two-man shuttle. It is 50 feet long, weighs 25 tons, and is 250 cu. yd. in volume. In atmospheric flight, it is capable of speeds of up to 3,500 mph.

**Medium Shuttle.** 125 feet long, weighs 100 tons, with a volume of 1,500 cu. yd. It can carry 10 passengers, and can take off with 100 tons of cargo in its 750 cu. yd. cargo bay. In atmosphere, it can fly at speeds up to 2,500 mph.

**Large Shuttle.** 250 feet long, weighs 500 tons, and occupies 10,000 cu. yd. It can carry 25 passengers, and can take off with 1,000 tons of cargo in its 5000 cu. yd. cargo bay. In atmosphere, it flies at up to 1,750 mph.

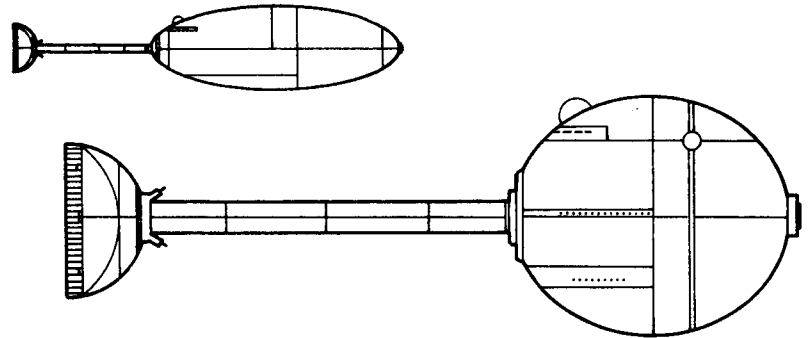

**Tramp Freighter.** These independent ships carry cargo on a for-hire basis for companies that cannot afford their own fleets. Cut-rate "cargo passage" (p. 13) is often available on tramp freighters.

A typical tramp freighter is 500 feet in length, weighs 35,000 tons and has a volume of 125,000 cu. yd. It is designed for a crew of twelve, although it can operate with half that. The crew is quartered in 2 single staterooms and 5 double staterooms. In addition, there is a bunkroom holding as many as 20 bunks. The ship also has a small sickbay and a large common area. It carries a large shuttle, and has a 90,000 cu. yd. cargo bay and four tractor beams. Cost \$15 million; speed 30 parsecs/day.

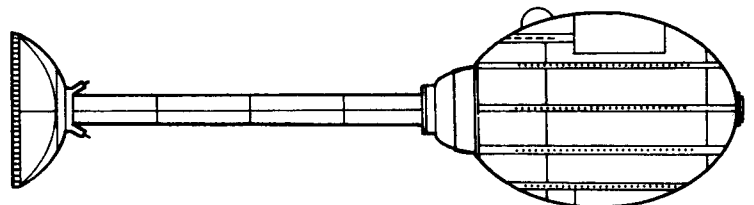

**Passenger-Freighter.** The passenger-freighter is a huge craft, carrying hundreds of passengers in quarters that range from cramped cubicles to luxury suites. A passenger-freighter also carries thousands of tons of cargo.

A typical passenger-freighter is about 750 feet long, weighs 175,000 tons and has a volume of 500,000 cu. yd. It has a crew of 500 and carries 1,500 passengers. Most of the crew serves passengers, rather than the ship. It has restaurants, shops, gaming halls, lounges and theaters for the passengers. The vessel has a 225,000 cu. yd. cargo bay and mounts five tractor beams. It carries a large shuttle and 100 lifeboats. Cost \$180 million; speed 25 parsecs/day.



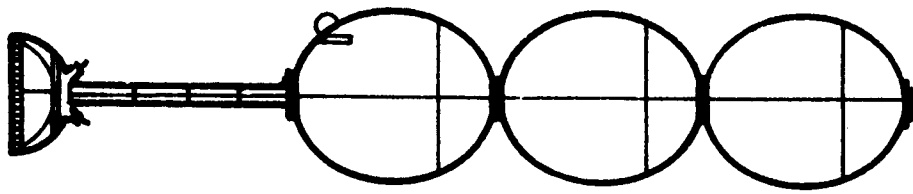

**Heavy Freighter.** These highly automated ships are the largest — and slowest — vessels in the Commonwealth. Operating with crews of a dozen or less, they carry millions of tons of bulk cargo.

A typical heavy freighter is 1,000 feet long, weighs 350,000 tons and occupies 1,500,000 cu. yd. Accommodations are similar to those on a tramp freighter. The heavy freighter has a cargo capacity of 1,200,000 cu. yd. and ten tractor beams. It carries a large shuttle. Cost \$150 million; speed 20 parsecs/day.

Additional freight modules may be attached to a heavy freighter. Each spherical freight module is 400 feet in diameter, weighs 50,000 tons, has a total volume of 1,250,000 cu. yd. It requires no crew, and increases cargo capacity by 1,200,000 cu. yd. Each module has 10 tractor beams. The ship's speed is decreased by 5 parsecs/day for each additional module. No more than 3 modules may be attached to one freighter. Cost \$20 million per module.

## Military Spacecraft

**Stingship.** Stingships are highly maneuverable fighter craft operating from cruisers or dreadnoughts. With its HIP-drugged thrax pilot/human gunner team and SCCAM missiles, the Church stingship is ton-for-ton the most deadly vessel in space. The AAnn have no counterpart to the stingship.

A stingship measures about 50 feet overall; the main body is 30 feet long and 15 feet in diameter. The ship occupies 250 cu. yd. and weighs 150 tons. It is equipped with an automated small particle beam and a single SCCAM projector with 10 SCCAM missiles. Cost \$2.5 million; speed 75 parsecs/day — but stingships carry only enough oxygen, rations and water for 3 days.

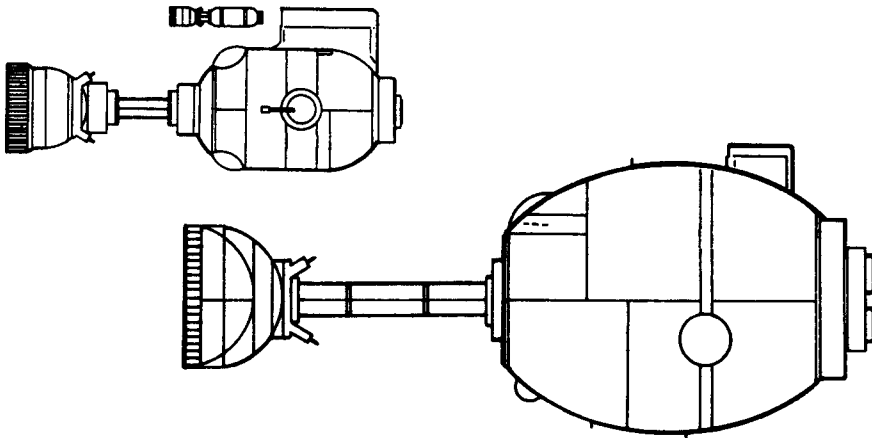

**Corvette.** These small ships are usually used for intrasystem law enforcement and defense. The 125-foot-long corvette weighs 2,500 tons and has a total volume of 4,000 cu. yd. It carries a crew of 25, a SCCAM projector and 25 SCCAM missiles, two particle beams, and two small shuttles. It is lightly armored and has no defensive shields. Cost \$15 million; speed 75 parsecs/day.

The AAnn counterpart to the corvette is the *attack ship*. In place of the SCCAM projector and missiles, an attack mounts a disruption beam and a paralysis beam; it is otherwise identical to the Church corvette.

## Ship's Weaponry

**Disruption Beam.** The most devastating weapon in the AAnn arsenal, the disruption beam reverses the attractive forces which bind molecules, causing them to repel from one another in a spectacular explosion. The Commonwealth has disruption technology, but does not mount disruption beams in its vessels — SCCAM shells are more efficient weapons.

**Interstice Laser.** The interstice laser fires a high-intensity beam of greenish light. A heavy version is also available.

**Missile Tube.** The missile tube is used to launch explosive projectiles — simple thermonuclear warheads. The projectiles lack the KK drive of a SCCAM missile, relying on the launching ship's velocity and a conventional rocket to propel them to the target.

**Paralysis Beam.** The paralysis beam is a short-range weapon used by the AAnn to disable the crew of a ship without damaging the vessel. The beam's area of effect is 50,000 cu. yd. Anyone within this area must roll against HT-3. Anyone failing this roll will be paralyzed for 100-(3xHT) minutes. Anyone who makes his HT roll will be at -6 DX and -3 IQ for a similar length of time. Defensive shields provide complete protection against the effects of the beam.

**Particle Beam.** The particle beam fires a beam of charged particles. The beam is more powerful than a laser, but spreads much more rapidly, drastically reducing its effective range. It is used primarily for shooting down incoming missiles. A heavy version is also available.

**SCCAM Projector.** SCCAM stands for Severely Concentrated and Catastrophic Accelerated Motion. The SCCAM projector is used to launch a SCCAM missile. SCCAM projectors are usually carried only on stingships and corvettes.

The manufacture of the SCCAM missile is one of the Church's most closely-guarded secrets. The SCCAM shell is a thermonuclear bomb mounted on a small KK drive unit, with an alloyed osmium casing. It uses the launching vessel's drive field as its initial propelling force. At a predetermined distance from the launching ship, the SCCAM shell's own drive kicks in, immediately going into a deliberate overload. The overloaded field is attracted to the nearest large gravity well — the drive field of the targeted ship. Coupled with the uncontrolled energy of a fusion explosion, the two intersecting drive fields instantly destroy the target ship.

SCCAM shells are 10 feet long by 2.5 feet in diameter. They take up 1.5 cu. yd. and weigh 5 tons.

## Ship's Systems

**Tractor Beam.** Commonwealth ships often carry several tractor beams for loading and unloading, each of which can handle 250,000 tons of cargo. The tractor beam is powered by the ship's drive and cannot function if the drive is not operational.

**Defensive Shields.** Most large warships carry shields to protect against weapons fire. Because shields draw their power from the KK drive system, they reduce the ship's maximum speed when used. Used at half power, shields reduce maximum speed by 10%; at full power, maximum speed is reduced by 25%. Shields may be used at minimum power to protect the ship from debris. At this setting, they provide no protection against weapons fire — but they don't decrease travel speed either.

**Automated Weaponry.** Weapons are usually fully automated — a gunner does not have to fire them. Automated weapons are most often used for defensive purposes — to shoot down incoming explosive projectiles and SCCAM missiles.

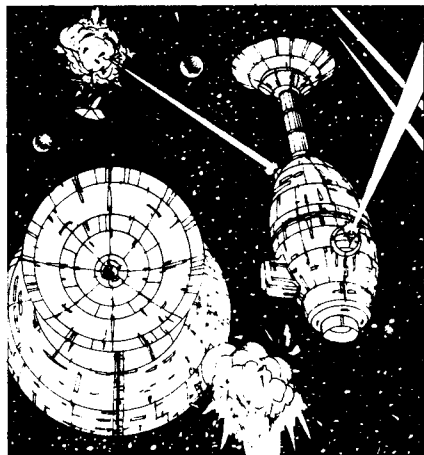

## Space Combat in the Humanx Commonwealth

Pitched space battles are not a major element in humanx adventuring. In Foster's books to date, only two such battles occur, both in *The Tar-Aiyem Krang*. The first is a flashback to Tse-Mallory's and Truzenzuzex's heroics at the Battle of Goodhunting, the second a lightly armed yacht's single laser shot at an AAnn warship.

Therefore, we haven't taken the twenty pages necessary for a detailed, second-by-second starship combat system in this worldbook. You'll find that in *GURPS Space*. What we do offer is a quick and simple system for determining the *outcome* of space battles, and their effects on the PCs. Using the rules presented here, you'll be able to find out how the PCs did in a space battle *fast*, so you can get back to your roleplaying as quickly as possible!

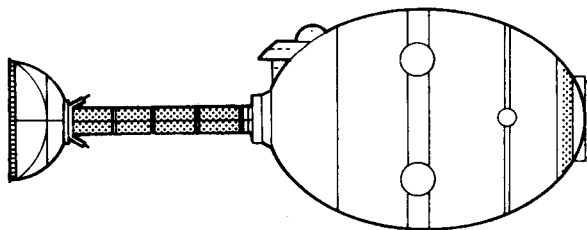

**Scout.** These small, fast ships are used for extended research and exploration missions. Church scouts are equipped with two medium shuttles; AAnn scoutships are equipped with rockets for planetary landings.

A typical scout is 250 feet long, weighs 10,000 tons and occupies 25,000 cu. yd. It is equipped with scientific laboratories and computers that give a +5 bonus to any science or research skill roll. It carries a crew of 150, including 100 scientists. The ship has a cargo bay of 5,000 cu. yd. capacity and a single tractor beam. A scout carries a single missile tube and a heavy laser, as well as a defensive shield. Cost \$40 million; speed 80 parsecs/day.

AAnn scouts mount a disruption beam and a heavy particle beam in place of the Church scout's missile tube and laser. Crew complement on an AAnn scout is equally divided between ship's crew, scientific personnel, and marines.

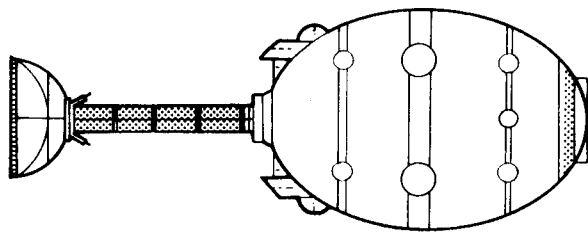

**Destroyer.** These warships are roughly the same size as scouts, but are more heavily armed and armored. A typical destroyer is 250 feet long, weighs 15,000 tons and has a volume of 25,000 cu. yd. It carries a crew of 100. It has a defensive shield, and mounts 4 missile tubes, 4 heavy lasers and 2 heavy particle beams. It carries two small shuttles and a medium shuttle. Cost \$75 million; speed 75 parsecs/day.

An AAnn destroyer mounts 2 disruption beams, 1 paralysis beam, 2 heavy lasers and 4 heavy particle beams.

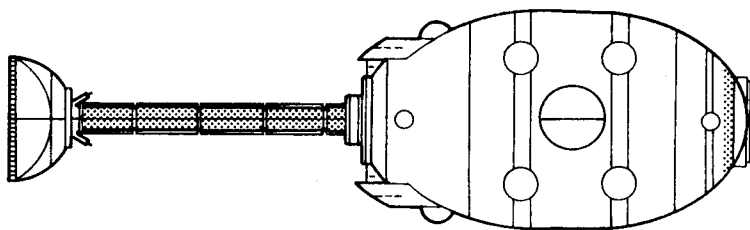

**Cruiser.** This class is the workhorse of the Church and AAnn fleets. A cruiser is 500 feet long, weighs 75,000 tons and has a volume of 175,000 cu. yd. It carries a crew of 450. In the Church fleet, a cruiser carries a squadron of 10 stingships, as well as a large shuttle. It is armed with 8 missile tubes, 8 heavy lasers, and 4 heavy particle beams. It has heavy armor and shields. Cost \$260 million; speed 70 parsecs/day.

An AAnn cruiser mounts 8 disruption beams, 10 missile tubes, 4 paralysis beams, 6 heavy lasers and 12 heavy particle beams, but has no stingships.

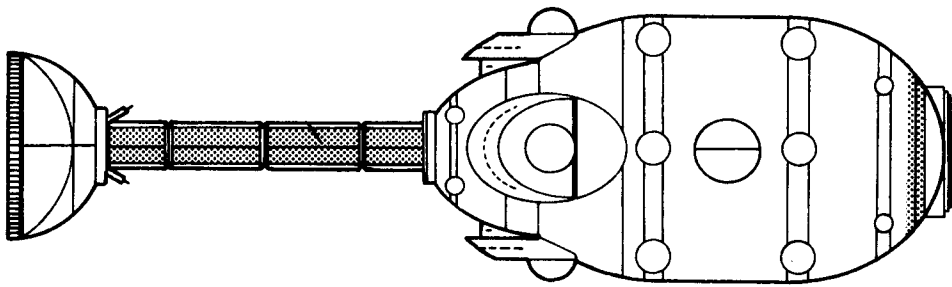

**Dreadnought.** The flagships of the AAnn and Church fleets, dreadnoughts usually command a battlefleet of 50 or more ships. A dreadnought is 750 feet long, weighs 250,000 tons and has a volume of 600,000 cu. yd. It is equipped with a deep-space beam for rapid long-distance communications. The dreadnought has a crew of 1,000 and carries 50 stingships. It also carries 2 medium shuttles and a large shuttle. The dreadnought is armed with 12 missile tubes, 12 heavy lasers, and 8 heavy particle beams. It has heavy armor and shields. Cost \$750 million; speed 60 parsecs/day.

AAnn dreadnoughts mount 10 disruption beams, 6 missile tubes, 4 paralysis beams, 12 heavy lasers and 20 heavy particle beams. They lack stingships, but are otherwise similar to Church dreadnoughts.

## Spacecraft Combat

### Detection and Engagement

Before any combat between spacecraft can occur, the opposing forces must detect each other. To do this, the scanner operator on each force rolls against his Electronics (Sensors) skill (see sidebar). If one or both forces detects the other, they then decide whether they will engage in combat. If neither detects the other, no combat will occur, unless the forces are closing unwittingly. In this case, each makes another Sensor roll each time the distance between them closes to the next smaller Scanner Range Increment. It is possible for two forces to pass within a few billion miles of one another and never detect each other.

If either force detects the other, the next step is to determine whether combat occurs. Speed is the most important factor in this; Commonwealth vessels travel in *billions* of miles per *second*, but their weapons are effective only within a few million miles. A fast ship can easily close with a slower one, but a slow ship will never get a shot at a faster vessel that wants to avoid conflict.

Thus, the decision to fight usually lies with the commander of the faster force. If the two forces have the same top speed but only one wishes to fight, the question of engagement is resolved by a Contest of Piloting skill. If there is more than one vessel in a force, use the *worst* pilot's skill in this contest; especially poor pilots may choose to drop out of the chase.

Should only one side detect the other, and the detecting side prefers *not* to fight, it can simply alter course to avoid closing before the other force detects it. If only one side detects the other, but does wish to engage, it can close the space between the two forces. As it closes, the opposing force will get additional Sensor rolls to detect its approach; once each side has detected the other, the final decision to engage once again falls to the commander of the faster force.

### Factors Affecting the Battle

If there is a battle, whether one-on-one or fleet against fleet, the following system resolves the action with one set of die-rolls, based on a Quick Contest of Strategy between the opposing commanders. If there are fewer than ten vessels in the battle, each force commander substitutes his Tactics skill for Strategy.

## Scanning

To determine whether the two forces detect each other, the scanner operator on each ship rolls against his Electronics (Sensors). The first roll comes when the two forces are 2 parsecs apart (2 billion miles, in system) — the maximum effective range for null-space scanners. This roll is at a base -8, although it may be modified by factors such as the opposing vessel's size, the intensity of its posigravity field, etc. Each scanner operator is permitted an additional roll each time the range between the ships crosses a scanner range increment. Note that scanner ranges in deep space are much greater than ranges within a stellar system.

### Scanner Range Increments:

Deep Space	In System	
.01 parsecs	10 million miles	0
.02 parsecs	20 million miles	-1
.04 parsecs	40 million miles	-2
.08 parsecs	80 million miles	-3
.15 parsecs	150 million miles	-4
.3 parsecs	300 million miles	-5
.6 parsecs	600 million miles	-6
1 parsec	1 billion miles	-7
2 parsecs	2 billion miles	-8

### Other factors affecting scanner rolls:

Target is <i>not</i> under posigravity drive	-5
Target is using posigravity drive at more than half power	+1
Target weighs more than 50,000 tons	+1
Target is at least "moon-sized"	+3
Target is at least "Terra-sized"	+5
Target is at least "star-sized"	+15
Target is within 10,000 miles of an object weighing 1,000 times target weight	-3
Target is behind an object weighing 1,000 times target's weight	-5
Target has already been located with a previous scanner roll	+5

## Shadowing

If only one force detects the other at the 2-parsec range (2 billion miles, in system), the detecting force may attempt to *shadow* the other, following its movements and staying on the very edge of scanner range. To do so, the shadowing scanner operator must make an Electronics (Sensors) roll every fifteen minutes, including all appropriate modifiers, to keep a fix on the shadowed craft. Failing this roll means that scanner contact with the shadowed craft has been lost. If the roll is successful, the shadowing pilot must then roll a quick contest of skills against the shadowed scanner operator, Pilot vs. Electronics (Sensors), to avoid being detected.

There are, of course, several modifiers to each commander's Tactics skill. All of these modifiers are cumulative.

## Total Firepower for Church and AAnn Spacecraft

### Church Vessels

Stingship	21
Corvette	22
Scout	8.75
Destroyer	40
Cruiser*	80
Dreadnought*	125

\* Not counting stingship complement.

### AAnn Vessels

Attack	16
Scout	12.5
Destroyer	42.5
Cruiser	212.5
Dreadnought	310

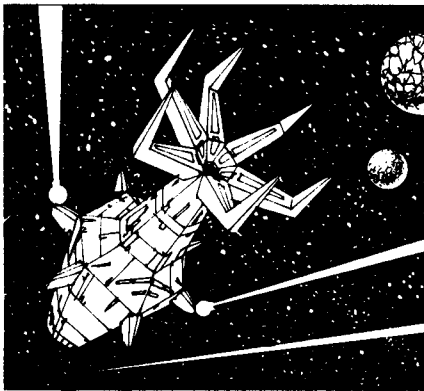

### Sample Battle

In a typical session, two PCs — Harmon, a human, and Pilmansizex, a thrax — are on separate stingships in a patrol of a border system near AAnn space. Making an Electronics (Sensors) roll, Pil detects a posigravity drive on his screen, coming directly toward the squad. Its configuration corresponds to that of an AAnn destroyer.

Harmon, the squad commander, attempts to communicate with the approaching vessel. The AAnn commander, Shiil PAK, hurls insults at Harmon, deliberately provoking an incident. Harmon decides to hold her ground. If the AAnn insists on closing, there will be sufficient cause to open fire. She instructs the squad to spread the formation, so that the destroyer won't have head-on shots against all five ships. The AAnn continues to close. Pil requests HIP injections, and Harmon orders the entire squad to boost.

*Continued on next page . . .*

### Relative Firepower

To find the relative firepower of the two forces, find the firepower rating of each vessel, total the firepower rating for all vessels on each side, and then find the ratio of the larger firepower to the smaller.

The firepower rating of a vessel is determined by adding the firepower rating of all its weapons. The ratings for the various humanx/AAnn weapons are:

SCCAM Projector	20	Missile Tube	5
Disruption Beam	8	Heavy Laser or Particle Beam	2
Paralysis Beam	6	Laser or Particle Beam	1

A vessel with shields receives a 25% bonus to its firepower rating. If a vessel's total firepower is fractional, do not round off.

Add the firepower on each side, and find the ratio of larger to smaller in the first column of the table below. Then read across to the second number to find the Relative Firepower Modifier for the quick Contest of Tactics roll, which is added to the Tactics skill of the larger force's commander.

less than or equal to 1.2	—
more than 1.2, but not more than 1.4	+1
more than 1.4, but not more than 1.7	+2
more than 1.7, but not more than 2	+3
more than 2, but not more than 3	+4
more than 3, but not more than 5	+5
more than 5, but not more than 7	+6
more than 7, but not more than 10	+7
more than 10	+8

If one side has *no* firepower, the opposing force gets a +8 for better than 10 to 1 superiority.

### Player Character Glory

In the course of a battle, each PC makes two die rolls: one for daring in battle — the Glory roll — and one for survival. The Glory roll is made *before* resolving the Contest of Strategy (or Tactics); the Survival roll is made *after* the contest. A PC may choose to take extra risk during the battle, or to play it safe, choosing any number from -6 to +6 as a modifier to his Glory roll. However, the *opposite* modifier applies to the Survival roll. Naturally, these modifiers must be chosen before the Glory roll is made.

The Glory roll is made against "Battle" skill. This is not a skill which can be studied in itself. It is the average of the PC's Tactics skill (defaulting to IQ-6) and the primary skill the PC uses in the action (Pilot, Gunner, etc.). If no particular skill applies, roll against the average of Tactics and IQ. The result can modify the Quick Contest of Tactics which determines the outcome of the battle.

#### Glory Roll

#### Modifier to Quick Contest of Strategy

made by 10+ or a Critical Success	+5/+3/+1
made by 7-9	+4/+2/—
made by 4-6	+2/+1/—
made by 0-3	—/—/—
missed by 1-3	-2/-1/—
missed by 4-6	-4/-2/—
missed by 7+ or a Critical Failure	-5/-3/-1

Use the first modifier if the PC is the force commander, the second if he is a combatant, and the third if a noncombatant. If more than two PCs are involved

on one side, apply only the *best* and *worst* resulting modifiers to the contest of tactics. Note that the best result may be a negative modifier, or the worst result may be a positive modifier. Apply both, anyway.

The effect of Glory rolls can extend beyond the battlefield. If your daring helps carry the day (and you are lucky enough to be noticed by the Right People), you might receive a decoration, a promotion, or even a patron. Cowardice in the face of the enemy will have obvious negative effects.

The Survival roll is detailed below, under *Battle Results*.

### Special Circumstances

The GM assigns bonuses in the Quick Contest of Strategy, or subtracts penalties, for any circumstances which affect the battle. A few examples:

- HIP drugs: +2
- Attack totally by surprise: +5
- Partial surprise — less than 3 minutes warning: +2
- Familiar space: +1 to +3 (Fighting in a familiar asteroid field, for example, is worth +2.)
- Defending your home system: +2
- One or both sides have stingships:
  - 2:1 superiority in stingships: +1
  - 3:1 superiority in stingships: +2
  - 5:1 or better superiority in stingships: +3
- Opposing force has *no* stingships: +3

### Battle Plans

Finally, the GM should require the *players* to give him a battle plan (or plans, if there are PCs on both sides). If, in his opinion, these plans are especially good or bad, he may apply from +3 to -3 in the Strategy contest.

### Resolving the Contest of Strategy

Having noted all these modifiers, the quick Contest of Strategy — or Tactics, if less than 10 ships are involved in the battle — is rolled. The winner of this quick contest is the winner of the battle. The *difference* in the amounts by which the leaders make or miss their rolls determines how decisive the outcome is.

A second roll (on one die) determines the intensity of the battle, and the degree of damage suffered by each force. Degree of damage ranges from A (none) to F (near total). The GM may decide to assign the intensity of the battle, based on the details of the encounter, rather than rolling randomly. For example, an inconclusive 10-second strafing run is likely to have an intensity of 1, while the intensity of an hour-long dogfight between stingships and AAnn attack ships would be 5 or 6.

The table below lists several pairs of damage degrees. The damage for a battle is determined by cross-referencing the battle outcome — inconclusive, marginal, definite, or decisive — and battle intensity — 1 to 6. In each pair of letters, the first indicates damage taken by the winner, and the second indicates damage taken by the loser. (Thus, a result of “B/F” indicates minimal damage to the winner and crippling damage to the loser.)

Difference	Outcome	Battle Intensity and Degree of Damage					
		1	2	3	4	5	6
0-3	inconclusive	A/A	B/B	C/C	D/D	E/E	F/F
4-10	marginal	A/B	B/C	B/C	C/D	D/E	E/F
11-20	definite	A/C	B/D	B/E	C/E	C/E	D/F
21+	decisive	A/E	A/F	B/E	B/F	C/F	C/F

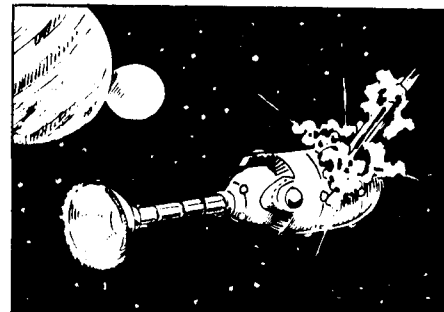

### Sample Battle (continued)

To resolve the battle, the commanders must roll a Quick Contest of Tactics. (Had the battle involved more than 10 ships, each commander would use Strategy instead of Tactics.) The GM figures the modifiers to each commander's roll:

*Relative Firepower:* Each stingship has a SCCAM magazine (20) and a light particle beam (1), for a total firepower of 85 (21 x 5) in the squad.

The AAnn destroyer has two disruptor beams (8 each), two heavy lasers (2 each), four heavy particle beams (2 each), and a paralysis beam (6), for a total of 34. Since it has shields, this is multiplied by 25% to get 42.5. A ratio of 85:42.5 is exactly 2:1, so Harmon gets a +3 for relative firepower.

*Glory:* Harmon chooses to add +3 to her Glory roll. Her Gunner skill is a 15, as is her Tactics skill; the average is 15, so she is rolling against an 18. Unfortunately, she rolls an 18, a Critical Failure, resulting in a -5 modifier on her roll in the Contest of Tactics. She froze at a critical moment! Pil is pilot, not gunner, on his stingship, so he rolls against his Piloting (Stingship) skill of 15, averaged with his Tactics skill. Lacking the Tactics skill, Pil substitutes his default of IQ (15)-6, or 9. Choosing to take no modifiers on his Glory roll, he rolls an 8, making his roll of 12 by 4 — a +1 modifier to the Quick Contest roll. Had a third PC rolled a +2 or +3 modifier to the quick contest, his modifier — being better than Pil's — would have been used in place of Pil's.

*Special circumstances and battle plan:* In open space, with no asteroids to avoid, targets to defend, or what-have-you, there are no modifiers for battle situation. The GM decides that Harmon's decision to spread the formation out earns her a +1. Harmon's force includes stingships, for +3, and is operating under HIP for another +2. Total modifiers here are +6 for Harmon.

## Resolving the Battle

Harmon's Tactics skill is a 15; Shiil has a Tactics Skill of 17. Modifiers, all applied to the humanx squad in this instance, are +3 for firepower, -4 for glory, and +6 for special circumstances — a total modifier of +5. Harmon is rolling against a 20; Shiil against his base 17.

Continuing a string of bad rolls, Harmon rolls a 16. The GM rolls a 7 for Shiil. Harmon made her roll by 4; Shiil made his by 10. Shiil wins the contest by 6 — a marginal victory for the AAnn. Obviously, they avoided all SCCAM shells fired at them this time!

Checking for intensity of damage, a 5 is rolled, resulting in "D" class damage to the AAnn and "E" class damage to the Commonwealth squad.

For Harmon and Pil, this means that Survival rolls will be made at an additional -2 — not good when the Survival roll for a stingship is already at -2, and Harmon chose earlier to deduct 3 from that roll! With HT 13, Harmon is rolling against a 6 and rolls a 12. Harmon has missed by 6, so takes two 2-dice injuries, which leave her unconscious. Pil, HT 10, is rolling against a 6, having chosen not to modify either his Glory or his Survival roll. He rolls an 8, missing by 2, and takes a 1+1 injury.

## Damage to Ships

Moving on to damage for individual ships, a major drawback of the stingship reveals itself: with no shields, all damage rolls are worsened. What would normally have been two LD (Light Damage) hits, two MD (Medium Damage) hits, and one HD (Heavy Damage) hit becomes two MD hits and four HD hits. Since both Pil and Harmon are in stingships, the GM rolls one die on the *Ship Damage Tables*.

For Pil's ship, the medium damage rolls are 5 and 6 — the ship's computer is at -3 until repaired, and the ejection system is destroyed. The heavy damage rolls are a 5 and three 6s — the ship's computer is damaged and the weapon computer is destroyed but, relatively speaking, Pil was lucky.

For Harmon's ship, the medium damage rolls come up 1\* and 6 — one hit rocked the ship, reducing the effectiveness of all ship functions by 4, while the other destroyed the ejection system. The heavy damage rolls are a 1\*\*, 3\*\*, 4, and 5 — the power plant is destroyed, leaving the ship dead in space; the SCCAM projector is reduced to scrap metal; the particle beam is destroyed; and the ship's computer took a hit, reducing its effectiveness by another 5, on top of the overall reduction of 4 from medium damage.

*Continued on next page . . .*

## Assessing Damage

Three types of damage are important in a *GURPS Humanx* space battle: personal injury to PCs, specific damage to the PCs' ship or ships, and the casualty percentage suffered by each force.



## Player Character Survival

Each player character must make a survival roll at the conclusion of the battle, based on his HT. This number is modified by the size of the PC's ship, and the intensity of the damage it suffered.

Degree of Damage	Survival Roll Modifier	Ship Size	Survival Roll Modifier
A	No roll	Dreadnought	+2
B	+5	Cruiser	+1
C	+2	Destroyer	—
D	—	Scout	—
E	-2	Corvette	-1
F	-5	Stingship	-2
		Any non-military ship	-2

*Combat Reflexes* also helps a PC avoid injuries in space combat, giving a +2 on the Survival roll.

Having determined the appropriate Survival roll for each PC, roll against that number and find the injuries incurred during action, below:

Survival Roll	Injury
made by 5+ or a Critical Success	unhurt
made by 1-4	1 hit
made exactly	2 hits
missed by 1-2	1+1
missed by 3-4	two 1-die wounds
missed by 5-6	two 2-dice wounds
missed by 7+ or a Critical Failure	three 2-dice wounds



## Ship Damage

To determine damage to individual ships, the GM rolls on the Ship Damage Tables on p. 76. The number of rolls on each table — light, medium, and heavy — is determined by the degree of damage suffered by the vessel.

Degree of Damage	Ship Damage Rolls
A	None
B	1 Light Damage
C	1 Light Damage, 1 Medium Damage
D	2 Light Damage, 2 Medium Damage
E	2 Light Damage, 2 Medium Damage, 1 Heavy Damage
F	2 Light Damage, 2 Medium Damage, 3 Heavy Damage

If a ship has no shields, Light and Medium Damage rolls become Medium and Heavy rolls, and any result *normally* requiring a Heavy roll calls for an *additional* Heavy roll. Thus, an unshielded ship receiving an “F” column result (normally requiring 2 Light Damage rolls, 2 Medium Damage rolls, and 3 Heavy Damage rolls) must make 2 Medium and 6 Heavy Damage rolls.

When rolling on the Ship Damage Tables, roll 1 die for stingships, corvettes, attacks and yachts, 2 dice for destroyers, scouts and tramp freighters, and 3 dice for cruisers, dreadnoughts, passenger-freighters and heavy freighters.

Lighter damage rolls are made before heavier damage rolls. Damage to weapons and computers is cumulative. Ignore — and do *not* reroll — results which damage a component that has already been destroyed.

If a PC is in an area which takes damage marked by an \*, he must make another Survival roll. If he is in an area marked by \*\*, he must make another Survival roll at -5 for *each* \*\*. A PC might make several Survival rolls in the course of one battle.

## Fleet Casualty Percentage

Damage to a fleet as a whole is determined as a “casualty percentage”: the percentage by which the fleet’s firepower rating is reduced. To find the fleet casualty percentage, consult the table below.

Fleet Casualty Percentage	Degree of Damage					
	A	B	C	D	E	F
	None	1 die + 5%	2 + 10%	4 + 20%	8 + 40%	12 + 60%

If it is important to the adventure, the GM decides how this loss of firepower is allocated among the fleet, based on the circumstances of the battle. For example, a fleet of five AAnn attack ships is soundly thrashed by three Church stingships and a corvette — fleet casualties 57%. The GM decides that two of the AAnn vessels — 40% of the fleet’s firepower — were completely destroyed by SCCAM shells, while the remaining 17% lost is divided among the weaponry of the remaining three vessels.

Damage to vessels without *any* firepower can be assessed in credits. The cost to repair a non-military vessel after a battle is equal to the casualty percentage times the value of the vessel, in credits.

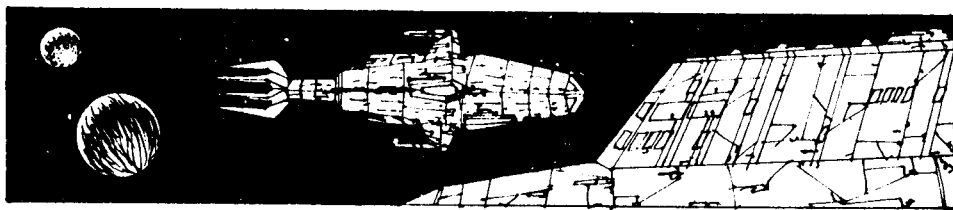

## Resolving the Battle (continued)

### Additional Survival Rolls

Harmon must also make two more Survival rolls because of her proximity to two of the \*ed results above (MD-1\* and HD-3\*\*). For the first, Harmon rolls a 5, making her roll by one and only taking another 1 hit — the GM tells Harmon’s player that an AAnn missile detonated dangerously close to her stingship, throwing her against the bulkhead.

Her next roll is at a 1 (HT 13, -3 for Glory, -2 for the stingship, -2 for the battle result, -5 for the \*\* hit). When the SCCAM projector is destroyed, she rolls a 13, missing by 7 or more and taking three more 2-dice wounds, which the GM describes thusly:

A direct hit from an AAnn disruption beam catches the stingship’s projector near the main body of the vessel, driving the control consoles into the gunner compartment. Harmon is crushed between her controls and her seat for 7 points of damage. The damaged console bursts into flame and Harmon is trapped within the blast, taking 8 more points of damage. Unfortunately, the exploding console also ruptures the already damaged hull of the ship, subjecting Harmon to explosive decompression — and 10 more points of damage. Her HT now driven to -27, Harmon must make three HT rolls to avoid death. She rolls a 15 on the second and expires.

### Casualty Percentages

For the squad as a whole, the casualty percentage is determined by 8 dice plus 40. A 27 is rolled, so the five stingships take 67% casualties. The GM interprets this to mean that two of the ships — including Harmon’s — have been destroyed, and each of the remaining three damaged.

The story is somewhat better, and shorter, for the AAnn destroyer. It loses 35% efficiency (by rolling four dice plus 20). If specific information on its damage is needed, roll twice on the LD table and twice on the MD table.

As the humanx attack lost cohesion, Pil, assuming command from the unconscious Harmon, ordered a quick retreat and regrouping. Escaping from the AAnn, they beat a hasty retreat back to base.

## Ship Damage Tables

### LD — Light Damage

- 1 Ship rattled — *all* subsequent rolls involving ship operations at -1.
- 2 Drive Fan damaged — ship at -10% drive power.
- 3 Main weapon jammed — an Armoury +3 roll unjams it (1 roll per hour).
- 4 Life support damaged — all skill and attribute rolls at -1. \*
- 5 Ship scanners damaged — all scanner rolls at -3.
- 6 No damage.
- 7 One weapon in six (but at least one) damaged — each at -1 to hit. \*
- 8 One accessory damaged.
- 9 Main shuttle damaged — apply one meaningful Medium damage result. \*
- 10 One area (not otherwise mentioned on this table) damaged.
- 11 Galley (or fuel bay, on carrier) damaged.
- 12 Intership communication damaged — all attempts at -2.
- 13 Cargo area (hangar deck or passenger area) rattled. \*
- 14 Passenger area (cargo area or hangar deck) rattled. \*
- 15-16 Hangar deck (passenger area or cargo area) rattled. Each shuttle and stingship takes one Light Damage roll. \*
- 17-18 Drive Fan damaged — ship at -10% drive power.

### MD — Medium Damage

- 1 Ship rattled — *all* subsequent rolls involving ship operations at -4. \*
- 2 Drive Fan damaged — ship at -50% drive power.
- 3 Main weapon damaged — all fire at -4. \*
- 4 Life support damaged — all skill and attribute rolls at -3. \*
- 5 Ship's computer damaged — all rolls using ship logic systems are at -3.
- 6 Lifeboat system (or ejection system) destroyed.
- 7 One weapon in six (but at least one) damaged — each at -1 to -6 to hit. \*
- 8 One area (not otherwise mentioned on this table) damaged. \*
- 9 Bridge damaged — all bridge functions at -3. \*
- 10 One area (not otherwise mentioned on this table) damaged. \*
- 11 Galley (or fuel bay, on carrier) damaged. \*
- 12 Intership communication ability destroyed.
- 13 Cargo area damaged (lacking that, hangar deck, or passenger area). \*
- 14 Passenger area damaged (lacking that, cargo area, or hangar deck). \*
- 15-16 Hangar deck damaged (lacking that, passenger area, or cargo area). \*
- 17-18 Drive Fan damaged — ship at -50% drive power.

### HD — Heavy Damage

- 1 Power plant destroyed. \*\*
- 2 Drive Fan destroyed — ship blows up. \*\*, \*\*, \*\*
- 3 Main weapon destroyed. \*\*
- 4 Shield projector destroyed — if already no shields, particle beam system is destroyed.
- 5 Ship's computer damaged — all rolls using ship logic systems are at -5.
- 6 Weapon computer destroyed — all weapon fire at -10.
- 7 One weapon in six (but at least one) destroyed. \*\*
- 8 One area (not otherwise mentioned on this table) destroyed. \*\*
- 9 Bridge destroyed — ship is dead in space, unless auxiliary bridge is available. *All* functions at -5 when operated from auxiliary bridge. \*\*
- 10 One area (not otherwise mentioned on this table) destroyed. \*\*
- 11 Galley (or fuel bay, on carrier) destroyed. \*\*
- 12 Shield projector destroyed — no shields.
- 13 Cargo area destroyed (lacking that, hangar deck, or passenger area). \*\*
- 14 Passenger area destroyed (lacking that, cargo area, or hangar deck). \*\*
- 15-16 Hangar deck destroyed (lacking that, passenger area, or cargo area). \*\*
- 17-18 Drive Fan destroyed — ship blows up. \*\*, \*\*, \*\*

# A MESSAGE FOR MALAIKA

# 7

Adventure by Curtis and Mary Scott and J. David George

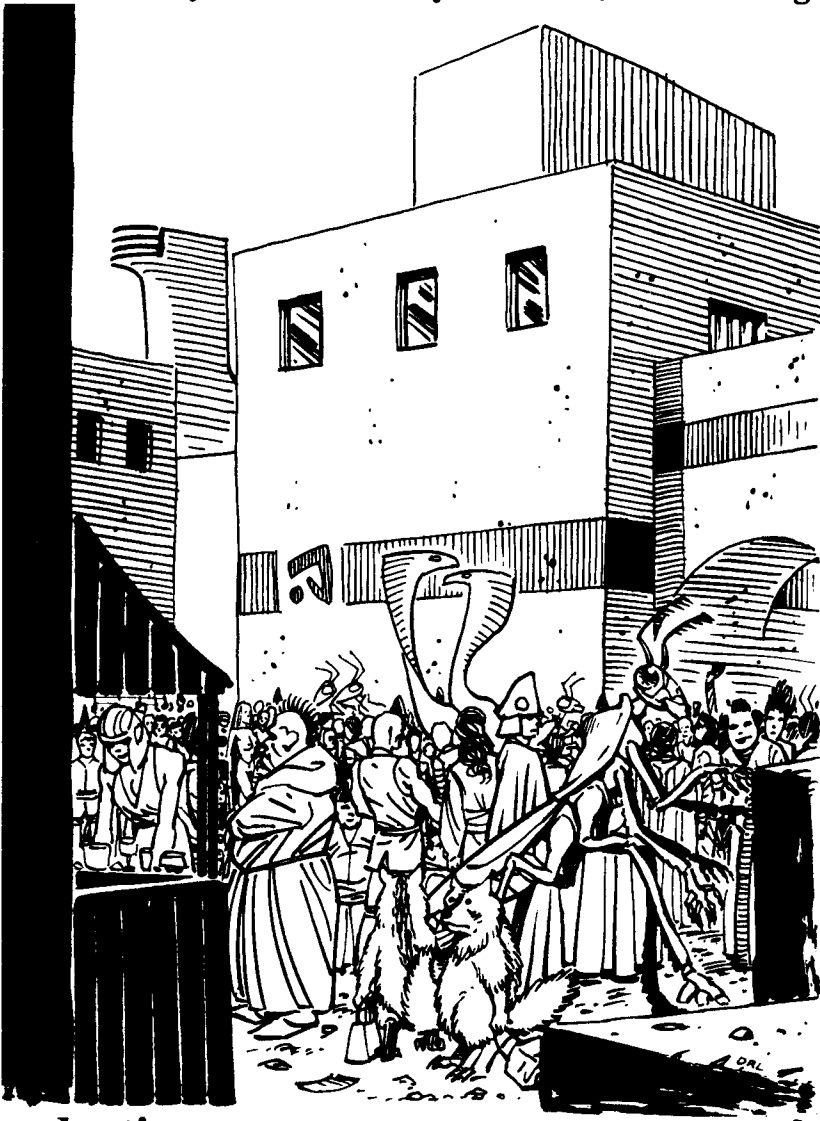

## Introduction

*This introduction should be read to the players, preferably before character creation. The rest of the adventure is for the GM's eyes only.*

His Driest Majesty Dewe Nog Na XXIV, King of Moth, recognizes the importance of interstellar trade to the economic health of his soggy world. Without abundant natural resources, the king attracts the major conglomerates through tax incentives — Moth is known throughout the Commonwealth as the cheapest place to do business. Of course, in order to offer tax incentives sufficient to attract the richest men in the Commonwealth to a world where the sun shines less than once a month, His Majesty has to cut services to the bone.

The first government services to go were luxuries — like welfare. But His Majesty does provide for his less fortunate subjects. The burden of indigent care is shared by the wealthier citizens of Moth, who bid for the right to feed, clothe, and look after those who are down on their luck. In exchange, a beneficiary is obligated to work for his benefactor in whatever capacity the benefactor sees fit.

Slavery, you say? Of course not. All a beneficiary must do to satisfy his obligation is to repay his benefactor any expenses incurred on the beneficiary's behalf, including the

## About the Adventure

This is a *GURPS Humanx* adventure for three to six 100-point characters. It is set in the city of Drallar, capital of the world of Moth. For further information on the setting, read *The Tar-Aiym Krang* and *For Love of Mother-Not*.

*A Message for Malaika* is intended to be played over several sessions, and can easily serve as the first adventure in a continuing Commonwealth campaign. In the course of the adventure, the player characters will meet at least one powerful patron and come up against three classic Humanx villains.

## Character Creation

Characters for this adventure should be Poor or Struggling; anyone designing a wealthier character will have to explain to the GM why a financially secure person would become involved in this affair.

The following skills will be useful; those marked with an \* will be very useful. After hearing the introduction, the players may figure this out on their own; if not, you may want to offer some hints.

Lockpicking	Streetwise*
Combat Skills*	Fast-Talk*
Diplomacy	Physician/First Aid*
Economics	Stealth*
Electronics (Security Systems)	
Area Knowledge (Drallar)*	

## Replacement Characters

If a PC dies along the way, or is so badly wounded that he cannot continue, the GM may allow the player to create a new 100-point character. This could either be a friend of the newly-deceased, or an "acquaintance" who smells a chance to make some money. Once the PCs' true employer has been revealed, a new character could be one of Malaika's personal agents sent along to "make sure things go all right."

Alternatively, the player could pick up one of the NPCs as a player character. Good candidates for PC status are Tessa and Akrano. Or, if the PCs look too weak to handle the final encounters, these characters will tag along to help them out.

government fee paid for the right to care for the beneficiary. Now, since most benefactors don't pay any sort of wage, it can take a long time for an indigent to put together that kind of money . . . .

## The Black Nebula

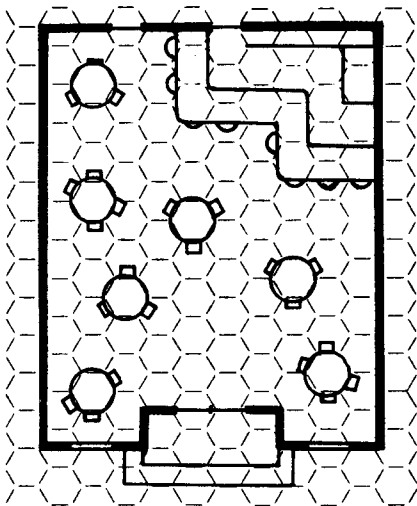

The Black Nebula is a dirty, grimy, dark little bar. Teague — the owner and bartender — survives by keeping his mouth shut and keeping the shotgun behind the bar loaded.

Most of the bar's clientele are prostitutes, smugglers and thieves. Assault and even murder are not uncommon among the clientele, although Teague's shotgun makes sure any trouble gets "taken outside."

The Neb could easily become a regular haunt of PCs on Moth. A map of its common room is provided, in case things ever get out of hand . . . .

### Possible encounters in the Neb:

1. An attractive woman sidles up, introduces herself as Nikara, and asks the PC to buy her a drink. If he agrees, she orders a champagne cocktail — with New Parisian champagne. Teague keeps the stuff especially for Nikara. The drink costs \$15!

2. A beady-eyed little man approaches a PC, offering "the thrill of a lifetime for only \$50." The so-called thrill is really heavily diluted Felturney. If a PC tries it, he will become mildly high, suffering a -1 to IQ for 1 die hours. He is not in danger of addiction from this dosage.

3. If any of the PCs orders an "unusual" drink, the poorly maintained portabar won't produce it properly. The PC must roll against HT. Failing the roll will make the character ill, leaving him at -2 DX and HT for 2 to 12 hours.

Any of the encounters from p. 3 of *Caravan to Ein Arris* — in the *GURPS Basic Set* — may also be used in the Neb.

So you learn to get by, trying to avoid the auction block. Thirty credits a week for an 8-by-8 room over a tourist junk-shop — meals extra. As the credits get fewer, you get less picky. You spend a lot of time in the bazaar, watching the tourists and the residents. It's easy to tell the difference: tourists have money, the residents don't. The only thing a resident has that a tourist doesn't is a slickertic that keeps him dry — if it doesn't leak.

You spend your evenings in bars; they're warm and relatively dry. And sometimes, somebody comes in looking for the kind of help you can offer. Like this thranx, Kergantardeb — a little paranoid, perhaps, but offering good money for a simple, legal job. And you never turn down a job in Drallar.

## A Night on the Town

The party — either individually or collectively — has been contacted by a thranx named Kergantardeb, who offers them each \$100 for one night's work. He has assured them that he requires nothing illegal of them, but has been evasive about the specific nature of the "job." Still, work is hard to find in Drallar, and a hundred creds will keep you clear of the auction block for at least a couple of weeks.

Kergantardeb has instructed his employees to meet him at 6:00 p.m. in his room at The Spacer's Wife, a bar and hotel in one of the nicer sections of Drallar's market.

Kergantardeb's room is fairly large. The bed has been retracted into the wall, and a table is set up with enough chairs for the PCs and Kergan. Papers are arranged on the table in neat, orderly stacks. The thranx gestures for the PCs to sit. As soon as they sit, he begins to pace.

Kergan explains that he has arranged a meeting with a man named Horvens to collect a package. He doesn't trust Horvens, and has hired the PCs to ensure his safety, and to make sure Horvens adheres to the original deal. Kergan assigns half of the group to scout the bar where the meeting will take place to make sure it is safe. If all is clear, they are to signal him to enter. The rest of the group will act as his "muscle" — Kergantardeb believes a tough appearance will prevent trouble. The PCs who precede him into the bar are to remain nearby, as backup, but they are not to contact him unless there is trouble.

The meeting is to occur at the Black Nebula — called "The Neb" by locals — at 7:30 tonight. (A Streetwise or Area Knowledge (Drallar) roll allows a PC to recognize the Neb as a popular hang-out for smugglers, hoods and other dangerous types.) Kergantardeb gives the group a brief description of Horvens, and instructs the scouting party to arrive at the Neb at 7:00. He and the remainder of the group will be waiting two blocks up the street for the signal, which should be given at 7:15. Kergan will not reveal the contents of the package unless a PC Fast-Talks it out of him.

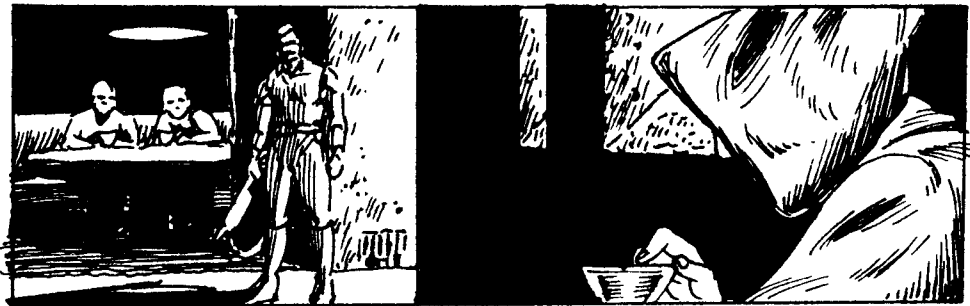

### Stood Up

When the scouting party enters the Black Nebula, the bar is sparsely populated by an assortment of rough space-cantina types — mostly human, but with a few thranx and other aliens thrown in. No one seems to fit Horvens' description, though. At this point, you may hassle the PCs with any of the nuisances described in the sidebar, or you might save them until after Kergantardeb arrives at 7:15.

Once the advance party gives Kergan the signal, he enters the bar with his entourage of PCs. He takes a seat, orders a white wine, and waits silently for Horvens.

7:30 comes and goes with no sign of the contact. By 7:45, Kergan is fuming. He stands suddenly (several people in the bar reach for weapons), and leaves. If the PCs don't follow him, he stops at the door, turns, and glares at them until they do come.

Once outside, Kergantardeb begins to mutter to himself. After a few minutes of thranx swearing, he tells the PCs that he has no more time to waste on Horvens. He pulls a slip of paper out of his pocket and stuffs it into the hand of one of the PCs.

"That's Horvens' address," the thranx clicks. "I can't afford to just wait around for him. I'll be at the Spacer's Wife. Bring him to me." Kergan wheels and stalks off.

## A Little Too Late

Horvens keeps a room on the third floor of a run-down apartment building 10 minutes' walk from the Black Nebula. As the PCs climb the stairs, three big thugs with ominous bulges under their slickertics are coming down. If the PCs attempt to engage the thugs in conversation, they will be greeted with threatening grunts. Should the situation develop into a combat, the stats for the thugs can be found in the sidebar on p. 80.

A knock on Horvens' door will go unanswered. The door may be broken down with a ST roll, broken through with weapons (it is DR 2, HT 8), or its simple lock may be picked with a Lockpicking +2 roll. If the characters make a lot of noise entering the room, they may attract the attention of the elderly landlady, who will attempt to keep them from entering her tenant's room — unless she is duly compensated. For \$25, she will ignore the PCs intrusion; for \$50, she'll unlock the door! (She won't offer either of these — the party will have to bring up any bribes.) If the woman is not appeased, she will threaten to call the police. In this neighborhood, the cops won't arrive for several hours, but a Streetwise roll is necessary to realize this.

Inside, it is obvious why Horvens missed his meeting — he is lying face down on the floor in a pool of blood. The room is littered with papers, clothes, mattress stuffing and overturned drawers. A light breeze is blowing in through the window. If anyone asks, or if any makes an IQ-5 roll (Alertness and Acute Vision help) within two minutes of entering the room, they will notice a thin, black rope being pulled up outside the window from the roof.

Any PC who immediately looks up out the window will see a black-masked face withdrawing from the edge of the roof. The sound of footsteps can be heard from the rooftop as the figure retreats. Should any of the PCs attempt to pursue the black-masked figure, they must either climb the wall to the roof or find the door to the roof in the hall. In either case, they will reach the roof just in time to see a figure clad in a black jumpsuit and cape drop into an alley several buildings away.

Once the PCs have realized the futility of pursuing the figure in black — if they noticed it at all — they will turn back to Horvens. There is a large, neat stab wound in his back. In fact, the wound is too neat to have been delivered in a fight — Horvens was plainly murdered. Turning the body over reveals two dozen shallow, parallel cuts on Horvens' bare chest. None of them are deep enough to be fatal, but any of them would certainly be painful. The obvious conclusion is that Horvens was tortured before he was murdered.

Horvens' wallet lies on the floor next to his body. Inside are three Commonwealth IDs, in the names of Anais Horvens, Jergo Yost, and Kalen Chalmers. Each bears the photo of the dead man. There is also a credcard in each name, and a business card for Char Mormis of Arcadia Organics.

Next to the wallet is an appointment book. The pages for every week prior to the current have been ripped out. On the page for this week, a note is made for Tuesday, reading "9:00: Akrano/Neb/\$300." Next to the appointment is a hastily scrawled, "Cancelled — Reschedule — Top Priority." For Wednesday — today — the appointment with Kergan is listed as, "7:30: Kergan/Neb/Disc."

One of the overturned drawers pulled out of Horvens' desk has a false bottom. Anyone searching the drawers for such a hidey hole will spot it with an IQ roll. If no PC searches, give each a roll against IQ-5 for the drawer to catch his eye. Concealed within the drawer are Horvens' handwritten ledgers, recording payments to "Akrano," "Jorgentilmoth," and "Westril," and from "HM/Chenwill," "Elec/Chagotuvaz," and "CC/Netril," all going back several years. About three months ago, "HM/Kergantardeb" replaced "HM/Chenwill."

There is nothing in the room which looks like a "package" ready for delivery, although the PCs haven't heard a good description of just what Horvens was to deliver.

Should the group decide to search anywhere else in the room, make it up! If they look in the closet, describe Horvens' clothes; if they open the refrigerator, tell them about his food. If they dally too long, though, the landlady will eventually arrive (or return). If she has not seen the characters before, she will automatically assume they killed Horvens and run off to call the police — who won't show up for hours.

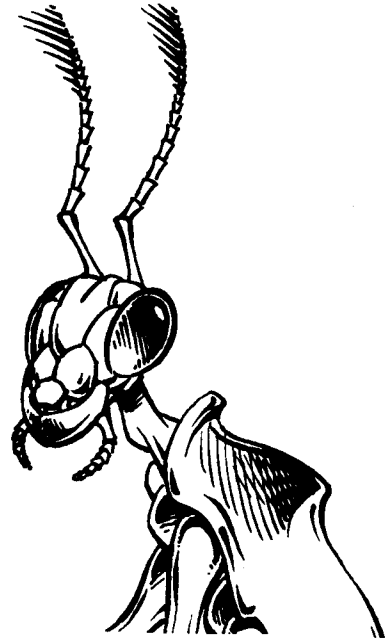

## Kergantardeb

Thranx — royal blue chitin, carefully groomed antennae. 5'3", 125 lbs — 85 points.

ST 8, DX 10, IQ 14, HT 8.

Basic Speed 4.5; Move 4.

Dodge 4; Parry 6.

Exoskeleton: PD2, DR2.

Advantages: Acute Taste and Smell (+3); Acute Vision (+2); Wealth (Comfortable); Common Sense; Mathematical Ability; No Outside; Peripheral Vision.

Disadvantages: Bad Temper; Thranx Hemophilia; Nearsighted; Overconfidence.

Quirks: Excessively punctual; Very neat; Cheap; Paces when nervous; Likes white wine.

Skills: Economics-20; Karate-10; Beam Weapons-12; Computer Operation-20; Computer Programming-18; Administration-15.

Languages: Terranglo-14; Symbolic-speech-14; Thranx-15.

Weapons: Laser pistol: 1 die impaling.

Kergantardeb is a young, up-and-coming business administrator. He went to work for House Malaika on Hivechom eight years ago; he was transferred to the home office 18 months ago, where he has been doing an exceptional job. Malaika wants to develop Kergan by giving him more "field experience," so he put the thranx in charge of the courier system.

## The Nick of Time

At this point, the group *should* report back to Kergantardeb. For what happens if they don't, see the sidebar, *Too Late Again*.

As the PCs approach Kergantardeb's room at The Spacer's Wife, each should make a roll against IQ-2 (Alertness and Acute Hearing help). Anyone making the roll hears a muffled *thump*, followed by a low groan, coming from Kergan's room. If they run down the hall to Kergan's door, they will lose any chance to surprise whoever is inside. If they sneak up to the door, rolling against their Stealth, they will have the opportunity to burst into the room. The door is locked, so one character will have to break it down by making a roll against ST. If *no one* hears the noise in Kergan's room, they will probably knock on Kergan's door, alerting those inside to their presence.

Inside the room, three thugs — the same three from Horvens' building — and a Qwarm (see p. 90) are "questioning" Kergan. If they heard the party coming or if the party knocked, they will be ready. The thugs will be waiting for the party with their knives drawn, while the Qwarm will be heading out the window. Kergan will have been hastily knocked unconscious by one of the thugs.

Even if the party gets to the door without making any noise, the Qwarm is ready for trouble. One thug will be near the door with a ready weapon, while the other two are holding Kergan down for the Qwarm. The assassin is bent over the thranx, about to stab a steel sliver into the soft flesh where one arm joins the thorax.

The Qwarm is not interested in a fight — just in escape. Once at the window, the assassin will spend one turn to crawl out and grab a rope hanging from the rooftop. The Qwarm will then spend 3 turns to scramble up to the roof, and attempt to disappear as at Horvens'. This time, however, the rope is left behind. Should one of the PCs free himself from the brawl with the thugs, he may try to shimmy up the rope in pursuit of the Qwarm. This takes 3 turns and a roll against Climbing skill.

The Qwarm is almost certainly faster than the rescuers, but because there is very little cover on rooftops, the assassin remains in sight for 15 turns after gaining the rooftop. Once a PC gets to the roof, he sees the slim, short, black-garbed figure running away across the rooftops.

If the PC attempts to fire at the fleeing Qwarm, figure the range as 3 yards for each turn after the Qwarm made it to the rooftop. Thus, if the PC gains the roof four turns after the Qwarm, the range will be 12 yards, and will increase by 3 yards every turn thereafter. Be sure to figure in penalties for poor lighting (-2, unless the firing PC has Night Vision), bad footing (-2), and for the running target (-1).

If the brawl with the thugs in Kergantardeb's room is going against the PCs, other hotel patrons may intervene on their behalf — the PCs are supposed to win this one. After the dust has settled, the PCs should probably check on Kergan. The blow to his head is severe, and he is barely conscious. He whispers to the PC who checks him.

"Malaika . . .," the thranx rasps. "Tell Malaika . . . my keycard . . ." He strains to pull something from his purse, but passes out from the effort. In the purse is his wallet, including his ID, his personal credcard and one for a House Malaika account, and a keycard — a credcard-sized plastic card used to open electronic locks. A careful inspection of the wallet and an IQ roll will reveal the number 3743 written in small numerals inside one flap. A character handling the wallet but not inspecting it closely will notice this only on an IQ-5 roll.

The PCs may also search the thugs, and question any that are alive and conscious. One of the thugs happens to be carrying an uncashed paycheck from the Challis Company in his wallet. Another was wielding a large, heavy blade with a bone handle carved with a reptilian motif. An IQ-3 roll will recognize that the weapon is probably AAnn-made; an IQ-6 or Physician-3 roll will reveal that the bone is a human femur!

Should the PCs question any or all of the thugs, they will insist that they were hired by the "little fellow in black" to help on an "acquisitions assignment." The one carrying the Challis check says he has a "day job" for that company, but that it has nothing to do with this. The fellow with the AAnn knife claims he bought it in a pawn shop in the Drallar market. The thugs will admit to nothing else, even when threatened with the police. In actuality, they are all security guards for the Challis Company (p. 88), and are confident that their employer will smooth over any legal troubles.

The proprietor of the Wife appears a few minutes after the fight ends, and recognizes one of the thugs as the hotel guest who specifically requested the room number next to Kergan's. After looking the situation over, he disappears once again to phone the police. In this neighborhood, police protection is a bit more efficient — with a Streetwise roll, a PC will realize that the cops should arrive within a half hour. If Kergan is in need of medical attention, that too will arrive in about 30 minutes.

## The Qwarm's Thugs

Human — big and ugly — 35 points.

ST 12, DX 11, IQ 9, HT 10.

Basic Speed 5.25; Move 5.

Dodge 5; Parry 6 (Knife), 8 (Brawling).

Wears Kevlar vest: PD 2, DR 4 (torso only).

Skills: Beam Weapon-13; Fast Draw (Pistol)-12; Knife-12; Brawling-12; Stealth-11; Area Knowledge (Drallar)-10.

Languages: Terranglo-9; Symbospeech-9.

Weapons: Laser pistol: 1 die impaling; Large knife: 1 die cutting, 1-1 impaling.

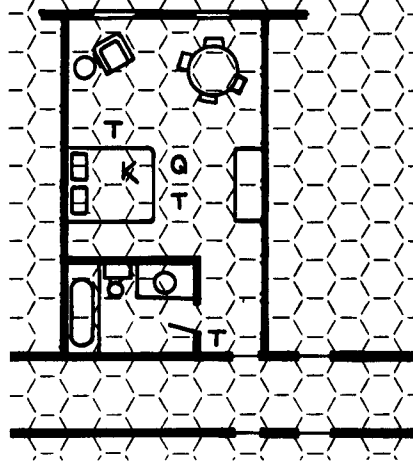

**Kergantardeb's Room**

T = Thug

Q = Qwarm

K = Kergantardeb

## Too Late Again

If the PCs fail to report back to Kergantardeb immediately after visiting Horvens' apartment, they will be too late to save the thranx from the same fate his contact suffered. When they do arrive, they will get no answer at the door. Inside, Kergan lies dead upon his bed — two dozen thin slivers of steel stabbed into the soft flesh of his joints, and a fatal crack in the chitin of his abdomen. The room has been thoroughly searched, as Horvens' had. If the PCs check Kergan's belongings, they will find a number of ledgers and papers pertaining to his job. It is evident from the papers that Kergan was a field representative for House Malaika.

They will also find his wallet, containing all the cards described in the main text.

Kergan left one other clue. Clenched in his dead truhand is an ichor-stained business card. Scrawled on the back of the card is a message: "Go to Malaika. Tell him Qwarm . . ." If this message is brought to Malaika, he will recognize Kergan's handwriting.



# Uptown, Downtown

## The Exposition

The next obvious step — considering Kergantardeb's last words — is to report to the thranx's employer, Maxim Malaika. If they have Kergan's keycard, this is simple. If they don't, or if they prefer not to show it, this may be a bit more difficult.

The direct approach is the best, in this case. If the party calls House Malaika — the number can be looked up in any tridee booth in Drallar — and displays the keycard, they will be connected directly to Malaika, day or night. Malaika will ask who they are and how they came into possession of Kergan's card. Once they have answered to his satisfaction, he will ask that they come early tomorrow morning to the House Malaika tower in the Braav Inurb. (If they fail to make an appointment after showing the keycard, Malaika will have the call traced. A sufficient group of Malaika's guards will soon issue a personal invitation which they will not be able to refuse — see *The Big Man*.)

If the PCs call Malaika on tridee *without* displaying the keycard, they will get a typical bureaucratic run-around. It should quickly become apparent that they'll never get through to Malaika without the card. If they have the card and decide to show it after all, they will be transferred to Security, and then directly to Malaika, who will question them as above. Otherwise, they should pursue their investigation in another direction.

## The Big Man

To get to House Malaika, the party will probably enter Braav Inurb through its one security gate. There they will be met by a large, surly-looking guard, who asks their business in Braav. If the group has already arranged an appointment with Malaika, the guard checks their IDs and admits them to the inurb — he was told to expect them. If they show the keycard but have no appointment, the guard takes it and disappears into his security booth. He returns a moment later, asking the group to remain here. Five minutes later, three House Malaika security guards, including Wolf, arrive to escort the group to the Malaika tower. These guards will remain with the party throughout their meeting with Malaika.

If the party has no appointment and does not show the keycard, they will not be admitted to Braav Inurb. They could try to sneak into House Malaika Tower (see sidebar), or simply proceed with the investigation without consulting Malaika.

Within Braav Inurb, a few dozen luxury homes and office buildings are separated by carefully landscaped parklands. The streets are cobbled with grey stone, and wind from building to building among trees, streams and waterfalls. The only vehicles moving about the inurb are small, electric-powered cars, and an occasional skimmer — heavy trucks and mudders are not permitted within inurbs. If the characters are unescorted, they may walk to House Malaika — the guard will offer directions if the PCs seem lost. If they are escorted by Malaika security, they will be taken directly to the tower in a car.

Along the way, the group passes several businesses. The Challis Company occupies a tall blue glass and steel tower in Braav, and the Elecseed facility — a shorter, broader building of green glass and stone — is also there. House Malaika is an imposing structure — 50 or more stories of smoked glass and black-glazed steel, broken only by balconies of rose crystal near the top.

The lobby of the Malaika tower is well appointed with statuary, paintings, and mindgrams. Aside from the crystal archway to the outdoors, the only exit from the lobby is an elevator door of rich dark wood inlaid with platinum. An unseen receptionist will ask the party its business — or greet the guards, if the group is being escorted to the tower — and then the elevator door opens to whisk them to an upper floor, where Malaika awaits.

When the elevator comes to a stop and opens, the party is met — or led — by Wolf, who guides them into a luxurious living room and office decorated in the black and crimson colors of House Malaika. Behind a broad, mahogany desk is a huge, black leather chair, facing away from the door. The chair turns about, revealing a dark-skinned, bearded giant of a man — Maxim Malaika.

“Well, my friends,” the merchant begins, “it seems you can shed some light on a few matters that trouble me, *ndiyo?*” Malaika will question the PCs regarding their connection with Kergantardeb, what they know of his attacker and of the package he was to acquire, the name of the thranx's contact, and anything else they can tell him about the situation. How Malaika behaves towards the characters depends upon the degree of cooperation he receives — he wants answers, and is more than willing to call His Majesty's police if he's not getting them.

## Climbing the Walls

If the PCs are unable or unwilling to enter the Braav Inurb through the security gate, they can always sneak in. First, they must climb the fifteen-foot-high wall which surrounds the inurb; a roll against Climbing-3 is necessary to climb up or down the smooth surface. No roll is required to drop from the top of the wall — simply lower yourself as far as you can, then drop the remaining three yards. The drop does 3 dice minus 9 points of damage to your feet. A successful Acrobatics roll eliminates this damage.

If any of the PCs has Area Knowledge (Braav Inurb), he *knows* where the Malaika tower is. Otherwise, the party rolls twice per hour against the best Area Knowledge (Drallar) or IQ-4 among them. If they split up, each group rolls separately, but if one group finds the tower, it will have to decide whether to wait for the others or to go looking for them. During their search, they will encounter a Braav security patrol once every fifteen minutes. You may play out these encounters, or simply represent them with a contest between the best Stealth among the PCs and the IQ of the guards. Braav guards are identical to Malaika's guards (p. 82), and patrol in pairs. They carry radios and can call for reinforcements, which arrive in 2 to 12 minutes.

When the PCs have located the Malaika tower, they will have to figure a way in. There are only two entrances — the main lobby and the service doors on the back of the building. The service entry is unlocked only to accept deliveries, and is guarded at all times.

If the PCs walk into the lobby — described in the main text — without being announced first by the Braav guard at the security gate, they will be taken into custody by a dozen of Malaika's guards, led by Wolf. Wolf will interrogate the party individually regarding their presence in the inurb without proper clearance. If their stories seem to agree and indicate involvement with Kergan, he will take the PCs — under guard — before Malaika, who will question them further. If their stories seem fishy, Wolf will simply hand the PCs over to the Drallar police.

## Wolf

Human — well over 40, white hair, pale skin, blue eyes; 6'3", 130 lbs. — 130.5 points.

ST 11, DX 14, IQ 13, HT 10.

Basic Speed 6; Move 6.

Dodge 6; Parry (Baton) 7, (Karate) 10.

Wears reflex jumpsuit under uniform: PD 6, DR 2 (lasers only).

Advantages: Alertness +2; Combat Reflexes; High Pain Threshold; Strong-willed +5; Toughness (DR 1); Double-Jointed.

Disadvantages: Skinny; Fanaticism (for Malaika); Truthfulness; Severe Ophiophobia; Unattractive Appearance.

Quirk: Only speaks when there is something important to say.

Skills: Beam Weapons-18; Shortsword (for baton)-14; Karate-15; Climbing-16 (includes Double-Jointed bonus); Jumping-16; Pilot (Yacht)-15; Gunner (Laser)-15; Free-Fall-14; Vacc Suit-14; Computer Operation-15; Mechanic (Starship Drive)-13.

Languages: Terranglo-13; Symbo-speech-13; AAnn-11.

Weapons: Laser pistol: 1 die impaling; Baton: 1+1 crushing (swing), 1-1 crushing (thrust).

Wolf is a tall, thin, wraithlike man with a skull of a face. He is Maxim Malaika's personal bodyguard and assistant, as well as the chief of security for the Malaika tower. Wolf had survived five years in an AAnn prisoner-of-war camp when Malaika rescued him. In return, Wolf pledged his lifelong service to Malaika.

## Tower Security for House Malaika

Malaika employs a cadre of 60-point human security guards:

ST 12, DX 12, IQ 10, HT 10.

Basic Speed 6.625; Move 6.

Dodge 6; Parry (Baton) 6, (Judo) 8.

Wears reflex jumpsuit under uniform: PD 6, DR 2 (lasers only).

Advantage (pick one): Combat Reflexes or Alertness +2.

Disadvantage (pick one): Sense of Duty to House Malaika, Overconfidence, or Honesty.

Skills: Beam Weapon-15; Judo-12; Shortsword (for baton)-13; Running-9; Stealth-11; Interrogation-10; Area Knowledge (Braav Inurb)-11.

Languages: Terranglo-10; Symbo-speech-10.

Weapons: Laser pistol: 1 die impaling; Baton: 1+2 crushing (swing), 1-1 crushing (thrust).

Tower Security works in teams of three, with five teams on duty in the tower at any one time.

When the group makes it clear that they were hired by Kergan, Malaika asks for their names again. He turns and punches a few buttons on the terminal next to him, waits a moment, and then visibly eases — Kergantardeb mentioned them in his last report.

"Then that makes you *my* employees, *ndiyo*?" he asks rhetorically. "I pay my employees generously, and, in exchange, I expect complete loyalty. Those who betray me — well, that doesn't come up very often. Let me fill you in a bit, so you will be of more use to me . . ."

Malaika explains that the "package" Kergantardeb was to acquire was an important message from one of his operatives in the area of the Commonwealth near the AAnn border. The operative, a prospector named Howard Bidir, sent a null-space message from Replersport stating that he had discovered "substantial deposits of valuable minerals on an unclaimed planet near Repler." Bidir went on to say that he would be registering a claim for the world on the next morning. Bidir died before he could file that claim. Bidir included code phrases in the null-space message indicating that a more detailed report on microfilm disc would follow, arriving through a series of couriers. Malaika expects the message to contain precise coordinates of the world and system, as well as a preliminary geological survey. That disc was to be delivered to Kergan last night.

Interestingly, Malaika continues, the Challis Company filed a claim on a planet near Repler — Praxiteles IV — just four weeks after Bidir's death. Although the Challis press releases claim that the supplies of ferrosilicate ore on Praxiteles IV are "meager," they have been discovered on only two other worlds — Amropolous (p. 20) and Prism (p. 33) — making *any* deposit extremely valuable.

"*Kijanai*, I have a business proposal for you," he concludes. "I want that message, and I want whoever dusted Kergan. I'll pay \$5,000 for the disc, and another \$1,000 for the identity of the thranx's killer."

Malaika is a merchant; the prices he's offered are less than he would be willing to pay. With some determined haggling, Malaika might be convinced to double his offer. In any case, he will give the group a 10% advance — "for expenses, *ndiyo*?"

The disc, if any PC thinks to ask, is a dark blue circle an inch and a half in diameter and an eighth of an inch thick. It can be read by any microfilm reader, but its text is encoded. Malaika has the code, but will not hand it over to the players under any circumstances.

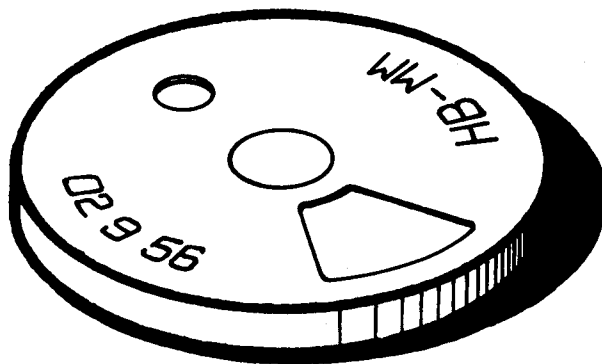

## Legwork

The next step is to follow up on the leads the group has — the names from Horvens' appointment book and records. Only the name Akrano will lead to Malaika's message disc. The others are false leads. The results of inquiry regarding any of the other names is detailed in the sidebar, *Red Herrings*.

Finding Akrano is not easy. Any local, including PCs with Area Knowledge (Drallar) or (Moth), will recognize "Akrano" as a nomad name. Although the nomads of Moth spend most of their lives in pursuit of the roaming herds of huge devilopes, one section of Drallar is distinctly nomad. A single first name, however, is not much to go on in the nomad quarter, where Akrano is a very typical name. If the PCs try to find Akrano by simply asking around the neighborhood, they will be greeted by a universal lack of cooperation — the nomads do not trust *ghareeb*, as they call outsiders. If, however, one of the PCs *is* a nomad, he will be able to locate *several* Akranos. The *real* Akrano is out of town — see *Devilope Country*, p. 84 — but a PC nomad might be able to find his family.

The PCs might also try asking around at the Black Nebula — after all, that was where Horvens was to meet Akrano the night before he died.

Asking the patrons will turn up nothing. They are an extremely tough and tight-lipped bunch, whose safety often depends on not seeing the things that happen right in front of them. The bartender, a quiet fellow named Teague, won't talk for free, but will tell what

he knows for a "gratuity" of twenty creds — cash only. Teague says that a fellow matching Horvens' description, but calling himself Yost, is a regular customer at the Neb, and often drank with a young nomad by the name of Akrano, a thranx named Jorgentilmoth, and an older man called Westril. As a matter of fact, Jor arrives at about 9:15 almost every night for dinner.

Teague knows that Akrano's family lives in the nomad quarter, but does not know the address. Teague helped Yost carry the nomad home one drunken evening, and offers directions to his home. Unfortunately, Teague's directions are vague and muddled. ("Turn left at the third — no, the fourth, streetlight . . . ") An Area Knowledge (Drallar) or IQ-4 roll is necessary to find Akrano's house working only from Teague's directions. Repeated attempts may be made by continuing to search the quarter; each attempt takes one hour.

## The Nomad Quarter

The nomad quarter is on the outskirts of Drallar. Although they spend most of their lives following fur-bearing animals through Moth's soggy wilderness, most nomad clans keep a house here, to use when they come to Drallar to sell furs, buy equipment, and trade news. Pregnant women, nursing mothers, small children and the elderly spend their time in the quarter, waiting for their chance to go back out to the hunt, or remembering the hunts of their youth.

In the quarter, Terranglo and Symbospeech fade away. The air is filled with a constant gabble of the nomad tongue — a hybrid of Turkish, Arabic, Swahili, and Russian. The buildings are lower than the tall towers of the inurbs, but are built with more craftsmanship and decoration than the hovels of the market denizens. Even the clothing is different. Instead of the polyvex slickertic of inner Drallar, nomads wear jackets and hoods with water-repellent fur to the outside.

As the party approaches Akrano's home on Penestral Street, several small children who had been playing in the street run into the house. The PCs are met at the door by three burly young nomads led by a middle-aged man with iron grey hair.

"I am Petrah," the older man begins in halting Terranglo. "What do you want here, *ghareeb*?" Petrah doesn't care much for *ghareeb*, reacting to them at -3.

The PCs will probably spend some time trying to convince Petrah to tell them where Akrano is. As the conversation progresses, several more nomads gather around, some from within the building, others from the street. Any Demophobes or Xenophobes among the PCs must make control rolls to keep their cool in the swelling crowd. As Petrah and the PCs talk, several nomads can be heard quietly translating the conversation for those who speak no Terranglo.

Petrah tells the PCs that Akrano has gone on a hunt, and will not return for several days or even weeks. He will deny any knowledge of where the hunting party might be. Petrah will not accept bribes, nor can he be coerced into telling — the nomad is on his own turf. The only way the PCs are likely to get any cooperation from Petrah is if a nomad in the party can convince him that they are trying to *help* Akrano. This will not be easy even for a nomad PC — first he'll have to explain why he is in the company of *ghareeb*.

The best the PCs are likely to get out of Petrah is a promise to deliver a message to Akrano when he returns from the hunt. Petrah asks how they might be reached, so that Akrano may contact them if he desires. Then the old nomad curtly bids the PCs good day and turns back into the house. Gradually, the murmuring crowd disperses, leaving the PCs relatively alone on Penestral Street.

As the group leaves the nomad quarter, each PC should make an IQ-4 roll, modified by Alertness and Acute Vision. This roll is half of a quick contest of skills between the PCs' perception and the Shadowing skill of . . . *someone* with a skill of 13. Anyone who wins the contest will notice a small figure attempting to follow the party inconspicuously. PCs who make the roll by 4 or more get a better look, seeing that the shadower is an attractive nomad girl of about 20. Anyone who gets this good a look will get another roll against IQ to recognize her as one of the nomads from the group outside Petrah's home; anyone with any degree of Eidetic Memory (or Lecherous males) will recognize her automatically. If anyone notices the girl, she will turn down another street, and will not attempt to follow the party again.

By the time the PCs have tracked down Akrano's family, talked with Petrah, and completed any other investigations they may wish to make, it should be well past dark. Tell them to go to bed.

## Red Herrings

Several names appeared among Horvens' records. While only Akrano and Jorgentilmoth are any help in locating the missing message disc, the PCs have no way to know this at first. Other names to be checked out include:

*Anais Horvens, Jergo Yost, and Kalen Chalmers.* Chalmers was born in Drallar 42 years ago. An inquiry to the Drallar police — along with a Fast-Talk roll and a bribe — reveals that he was arrested for a number of petty offenses during his youth, but has remained clean for the last fifteen years. In fact, there are no addresses on Drallar for Chalmers during that time.

Anais Horvens and Jergo Yost both died as infants roughly 40 years ago. Since that time, each has been occasionally picked up for minor crimes such as bribery, bookmaking and fencing. Interestingly, neither one has ever been arrested while the other was serving time . . .

*Char Mormis of Arcadia Organics.* Arcadia is one of the firms offering Drallar's indigents for sale to wealthier citizens. Mormis recognizes both Horvens' name and photo, saying that he had visited Arcadia on three occasions, seeking a well-mannered, off-world girl to "teach a nomad friend of his some civilized ways." Mormis hasn't seen Horvens in a week or more.

*Jorgentilmoth.* A regular at the Neb, Jor is rather surly for a thranx. Jor works for Horvens, using his position as a security guard at Drallar's shuttle port to smuggle small packages past customs. He is deathly afraid of losing his job and winding up on the auction block. If the PCs hint that they know about Jor's tie with Horvens, he will spill everything he knows, including Akrano's address — 17 Penestral Street.

*Westril.* The only person having any information on Westril is Teague, at the Neb. Westril, a sly old con man and gambler, used to play cards at the Neb on Thursday nights. He hasn't been around for several weeks.

*HM/Chenwill, Elec/Chagotuvaz, and CC/Netril.* Chenwill, Chagotuvaz and Netril are all employees of the Moth offices of the megacorporations House Malaika, Elecseed and Challis Company. Their employment is not secret; if the PCs can connect each name with a corporation, the company will freely admit to employing each man. Malaika may recognize the companies by Horvens' notes — give him a roll vs. IQ to do so.

Malaika will tell the PCs that Kergan replaced Chenwill upon Chenwill's retirement. Since his retirement, Chenwill has left Moth for New Riviera.

If the PCs call Elecseed or Challis Company, they will be promptly connected with Chagotuvaz — a thranx — or Netril. Each will deny knowing anyone by the name of Horvens, Yost, or Chalmers.

# A Day in the Country

## Tessya's Plea

*Note: The opening seconds of this encounter involve only one of the PCs. If the PCs never noticed the girl trailing them from the nomad quarter last night, the encounter could happen to any PC. If any of them did see her, and by doing so, frightened her off the trail, only those sleeping at the address the party gave to Petrah are liable to be caught in this encounter. In either case, the encounter will happen to a character sleeping alone, unless no one has a private room — in which case the intruder will attempt to cover whichever character seemed to be in charge of the group last night at Petrah's.*

### Typical Nomad

Dark complexion, hair and eyes — 60 points.

ST 12, DX 11, IQ 10, HT 11.

Basic Speed 5.5; Move 5.

Dodge 5; Parry 6.

Advantages: Alertness +1; Combat Reflexes.

Disadvantages: Social Stigma (Minority Group); Struggling.

Quirk: Distrustful of *ghareeb*.

Skills: Beam Weapons-13; Guns (Rifles)-13; Knife-12; Stealth-12; Survival (Mothian Woodlands)-12; Tracking-12; Area Knowledge (Wilderness around Drallar)-11; Area Knowledge (Drallar)-10; Area Knowledge (Nomad Quarter)-10.

Languages: Nomad-10.

Weapon (in town): Large knife: 1 die cutting, 1-1 impaling.

Weapons (on hunt): Large knife; Laser pistol: 1 die impaling; Laser rifle: 2 dice impaling, *or* Marker, *or* Paxton V: 3+3 crushing.

The nomads are a close-knit people, distrustful of outsiders, but kind and generous among their friends. If you threaten or harm a nomad, all his relatives — and he'll have dozens — will be after you. But if you make a friend of a nomad, you have a friend for life.

Nomads seldom go unarmed. Even around town, they will carry their large hunting knives; some carry a laser pistol as well. On the hunt, nomads use weapons big enough to make even a devilope take notice. Laser rifles (described in the *GURPS Basic Set*) are common, and most hunting parties include one man with a Paxton V. One man in every hunting party will be carrying a marker, to help follow the wounded devilope — as if it didn't leave an obvious trail!

At 6:00 the next morning, one of the PCs is awakened by a cool damp breeze on his face. As he reaches to rub the sleep out of his eyes, a sharp, cold point touches his Adam's apple.

"Don't move, *ghareeb*," an accented female voice hisses into the PC's ear, "or I'll cut you another smile." The assailant shifts position until her face is only a few inches from the PC's. If this PC saw the shadower last night, he will recognize this girl as the same person; otherwise, on an IQ-2 roll, he will recognize her as one of the people from the crowd outside Petrah's. It occurs to the PC that — were her dark features not so hardened by anger — she would be quite attractive.

"Why do you seek my brother?" she demands. "And what do you know of the boy in black who killed my uncle this night?"

The girl with the knife at the PC's throat is Tessya (p. 85), Akrano's sister and old Petrah's niece. Petrah was murdered last night, and the girl thinks the PCs did it! Exactly how to defuse this situation is left to the player — he might try to break away and wrest the knife from Tessya, call for help, or convince her to put the knife away. While Tessya is very serious about her demands, she won't execute a helpless man. She has no qualms about killing in a fair fight, though.

Once the PCs have satisfied Tessya that they are not in league with Petrah's murderer and that they want to help Akrano, the nomad girl will be willing to cooperate with the party. Feel free to make the task of convincing Tessya as easy or difficult as you like — while she is much more accepting of outsiders than her very traditional uncle was, she is still a nomad by birth.

When the PCs begin to compare knowledge with Tessya, she tells them that at about three this morning, a scream of pain came from Petrah's room. When family members came to help, they found the door locked. By the time they could break it down, Petrah was beyond help. As Tessya and two of her cousins rushed into the room, a lithe, black-clad figure slipped out the window, up a rope to the roof and off into the night. Petrah had been tortured before he died — his chest and arms were marked by more than twenty long, shallow, parallel cuts. Petrah's torture was in every way similar to that of Horvens and Kergan.

Despite what Petrah told the PCs the night before, he did know where Akrano was. The hunting party Akrano met is scheduled to pick up supplies this afternoon at a nomad outpost on Lake Kossup, sixty miles north of Drallar. Tessya knows the spot. While Petrah would never have betrayed Akrano to the assassin, Tessya feels she must warn her brother that a Qwarm is looking for him. The nomad girl will be only too glad for the PCs to come with her, to rid her brother of the disc so many people have died for.

### Devilope Country

Traveling in a mudder belonging to Tessya's uncle, Teves, the PCs and the nomad girl head for the Kossup outpost. The weather is overcast and drizzly — typical for Moth — and a thin mist puts a grey curtain around the coniferous trees which cover most of the countryside. The trail to the outpost is relatively clear and solid, so the mudder makes good time, averaging better than 15 mph. At one point, a squook appears in the trail in front of the mudder, baring its fangs and snarling until the last second, when it realizes that the mudder isn't going to give way. A bit later, half a dozen wild stupava can be seen running parallel to the trail, dodging through the mist just at the edge of visibility.

The mudder arrives at Lake Kossup a little before noon — about four hours after leaving Drallar — and follows the shore around to the north side. Kossup is a tiny lake by Moth standards, too small to support even a single penestral. Its swampy shoreline slows the mudder somewhat as it travels around the lake. The outpost turns out to be little more than a fire pit and a small shelter housing a limited store of supplies and emergency medical equipment, located on a relatively solid patch of shoreline.

A little before four o'clock in the afternoon, a lone stupava and rider arrive at the outpost. Tessya jumps up, calls out Akrano's name, and runs to meet the stupava.

"Tessya," the young man on the stupava calls back. "What are you doing here?" Tessya and the young man meet a hundred yards from the outpost. Akrano (p. 86) — for who else could it be? — embraces his sister warmly, obviously happy to see her. The young man's smile fades, though, as Tessya tells him of the events of the previous night.

About this time, any PCs who have followed Tessya to meet Akrano will reach the pair; if none have followed her, then the nomads will have walked back to the outpost.

"I am Akrano," the nomad says. "Tessya says we should talk."

Tessya tells Akrano the full story of Petrah's death, and of how the PCs came to be involved in the matter. She then asks them to tell Akrano what they know about the disc and the attacks on Horvens and Kergan.

"Well," Akrano begins, at the conclusion of the PCs' tale, "it looks like Tessya was right about old Yost getting me into trouble some day." He pauses, digging at a rock with his toe. "But there's not much we can do about it tonight. The rest of the hunt will be getting here soon, and we're on a fresh deviloep trail. Petrah wouldn't want us to lose a herd just because we were sitting around feeling sorry for him."

If the PCs ask for the message, Akrano will hand over an unlabeled blue disc. This isn't Bidir's message — it's a mudder repair manual. Akrano keeps the real disc hidden.

Forty-five minutes later, the other six members of the hunting party arrive — four on stupava, two driving a large mudder. Although greatly saddened by Petrah's death, they agree that the old man would not wish the hunt cancelled. In another half-hour, the group has packed the supplies from the outpost and is heading northwest, towards the hundred-yard-wide trail of destruction left by a feeding deviloep herd.

The hunting party is about an hour behind the herd, which is settling down after a week's feeding. The usual method for bringing down a deviloep is to select a single animal on one side of a sleeping herd. A single hunter — called the "cow" by the nomads — circles the herd and releases a quantity of musk oil and blood saved from a previous kill. Musk from a female in heat is the most effective for this purpose. The scent of the blood and musk rouses the groggy herd, beginning a stampede towards the "cow." At this point, the "cow's" part in the hunt is finished — all he has left to do is get clear of the charging deviloep herd.

At the moment that the herd begins to rise and chase the musk and blood scents, the rest of the hunting party opens fire on the one deviloep selected as prey. Usually, a party won't be able to do more than injure the animal. While it will invariably run, a wounded deviloep rarely manages to follow the herd. Since the injured beast may run for a day, one of the hunters will be firing a marker rifle instead of a "real" weapon. That way, the hunters will be able to track the deviloep until it falters. Even then, a deviloep is dangerous game. Maddened by pain and terror, the huge grazer often kills several members of a hunting party before it dies.

If you want to make the adventure a bit longer and add an extra — and rather unusual — combat, feel free to play out the deviloep hunt. If not, then simply describe it vividly. In either case, the chosen deviloep is a small one, with ST 250 and HT 16/50. The final confrontation with the beast should take place about sunset that same day.

## Things that Go Zzap! in the Night

Petrah's recent death made the day's hunt a grim affair, but the successful kill of a deviloep by such a small hunting party raises the nomads' spirits appreciably. A feast of deviloep steaks is prepared, and a surprising quantity of liquor is pulled out from various packs and bags. Petrah is not forgotten in the festivities — about one toast in three is proposed to him, and all his favorite nomad songs are sung. But the cause of his death, and its dangerous implications, quickly loses importance in the ever-increasing merriment. It might be a good idea to roleplay at least a bit of this revelry. If, for example, the PCs played an important role in the hunt, the jovial nomads might invent a ritual to make them honorary tribesmen, teaching them nomad words, phrases and songs.

By two in the morning, the fire has died to coals and most of the camp has drifted off to sleep. A single sentry is posted to watch for prowling animals. Any PCs who want to stay up are welcome to try — if they participated in the evening's revelry, they will need to make a Carousing roll to keep their eyes open.

At about 4 a.m., anyone awake should make a roll vs. IQ-3 — Alertness and Acute Hearing and Vision help. Anyone making the roll will hear movement in the undergrowth to the west of camp; anyone making the roll by 4 or more will catch a glimpse of

## Tessya

Nomad — 19 years old; olive skin, long, black hair, deep brown eyes; 5'8", 135 lbs. — 90 points.

ST 10, DX 13, IQ 11, HT 11

Basic Speed 6; Move 6.

Dodge 6; Parry 7.

Advantages: Alertness +1; Attractive; Combat Reflexes; Common Sense; Strong Will +1.

Disadvantages: Social Stigma (Minority); Struggling.

Quirk: Protective of Akrano.

Skills: Beam Weapons-15; Guns (Rifles)-15; Knife-15; Stealth-14; Climbing-12; Shadowing-13; Tracking-11; Survival (Mothian Woodlands)-11; Area Knowledge (Wilderness around Drallar)-11, (Drallar)-11, (Nomad Quarter)-11.

Languages: Nomad-11; Terrango-9; Symbospeech-10.

Weapons: Large knife: 1-2 cutting, 1-2 impaling; Laser pistol: 1 die impaling.

Tessya is Akrano's older sister. She is a strong-willed young nomad, valued on any deviloep hunt. She is a naturally attractive woman; with fine clothes and make-up, she would be even more beautiful, but she will not use her appearance to get what she cannot get otherwise.

Since their mother died several years ago, Tessya has become very protective of her brother. Although she could control him when they were younger, Akrano is independent — even rebellious, some would say — today. In Tessya's opinion, the friends Akrano has been making outside the nomad quarter are sure to get him into trouble. She is especially concerned about an older *ghareeb* who calls himself Yost. Akrano denies it, but Tessya is convinced that Yost is using Akrano for some illegal task. On more than one occasion, Akrano has bounced into the house after "visiting Yost," carrying large sums of cash — not credit, but *cash*.

Tessya is among the crowd at Petrah's when the party talks to the old nomad. Believing that the PCs are somehow tied to the trouble Akrano is in, she makes a point of memorizing the address they give, and of following them home.

## Akrano

Nomad — 17 years old; Brown hair, green eyes, olive skin; 5' 9", 150 lbs — 85.5 points.

ST 11, DX 12, IQ 12, HT 11.

Basic Speed 5.75; Move 5.

Dodge 5; Parry 7 (Knife), 8 (Brawling).

Advantages: Attractive; Alertness +2;

Animal Empathy; Combat Reflexes.

Disadvantages: Impulsiveness; Overconfidence; Social Stigma (Minority); Youth.

Quirks: Wants to be "independent"; Conceited.

Skills: Beam Weapons-15; Guns (Rifles)-14; Knife-14; Brawling-12; Streetwise-13; Scrounging-11; Fast-Talk-12; Sex Appeal-11; Stealth-13; Shadowing-10; Tracking-11; Survival (Mothian Jungles)-12; Riding (Stupava)-16 (includes Animal Empathy bonus); Area Knowledge (Wilderness around Drallar)-11, (Drallar)-12, (Nomad Quarter)-12.

Languages: Nomad-11; Terranglo-10; Symbospeech-11.

Equipment: Large knife: 1-1 cutting, 1-1 impaling; Laser pistol: 1 die impaling; Marker.

Akrano is not a *bad* kid — he's just a little full of himself. In an effort to break free of his sister's "oppression," Akrano has set out to make his fortune. To do so, he takes frequent "odd jobs" for men like Horvens (whom he knew as Jergo Yost). Akrano actually does make a fair bit of money, running "errands" and delivering "packages." For Yost, Akrano usually holds packages for a time, keeping them safe from theft by taking them with him when he goes out for a hunt with his cousins. That is how he became involved in the current adventure — Yost gave him a message disc to hold for one week.

He was to return the disc to Yost three days ago, but Yost had been followed to the rendezvous. Akrano isn't sure who was following Yost — the older man simply gave the "no contact" signal and ignored him.

Akrano heard yesterday that Yost had been killed. Thinking that the killer was the same man who had been following Yost on the night of the rendezvous, Akrano decided he'd best get out of sight with the disc. So he packed up and joined his cousins on a develope hunt leaving that morning.

Akrano is the best NPC candidate for a replacement PC. He will be eager to hear the PCs' account of what has gone on, and will want to join them in the attempt to regain the disc. (Regain the disc, you ask? Read on . . .)

a man-shaped shadow dashing from one tree to the next, about 50 yards away. Characters noticing the movement have two seconds in which to act before the figures in the trees fire.

Suddenly, four laser beams blast from the trees to the west, near where the noises and shadows may have been detected. The lasers will be aimed at any waking characters first, one shot per character, then at the pole of the canopy over the sleeping nomads (-3 to hit for size), with the remainder divided among the sleeping characters. The four attackers are firing laser pistols from 30 yards away, and have been aiming for one extra turn (+1 to hit); they are identical to *The Qwarm's Thugs*, p. 80, having Beam Weapons-13. Any attack is at -3 for darkness; shots at the figures in the trees will be at an *additional* -2. Once their cover is blown, the attackers will stop trying to be sneaky and attempt to close to the edge of the camp clearing.

Any PCs or nomads who were sleeping at the time of the attack are taken by *total surprise* (p. B106). Their IQ roll to recover from the surprise will be at a -2 for starting the encounter asleep.

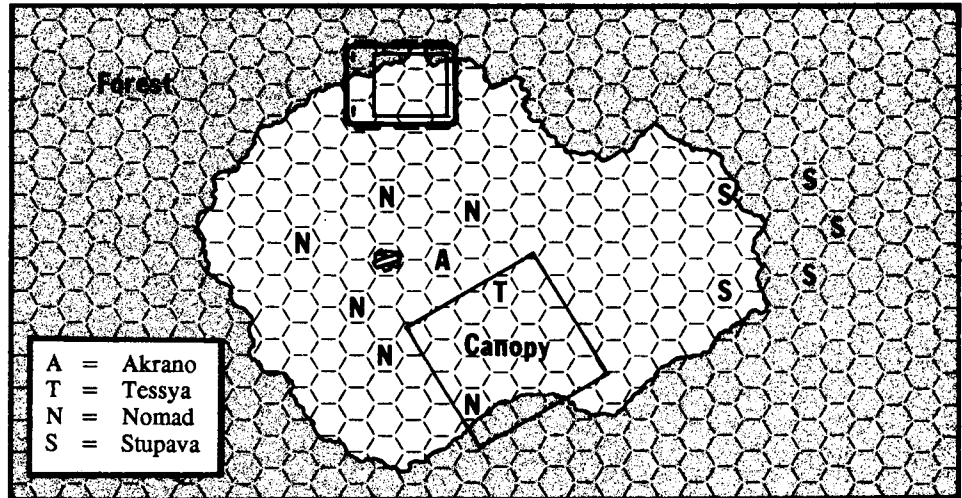

About five turns into the combat, the five stupava tethered on the east side of camp spook and stampede through the camp. Although their 1-1 trampling damage is unlikely to really hurt any of the nomads or PCs, the big birds may run into a character, destroying his aim or knocking him to the ground.

Akrano runs off in pursuit of his own bird, following it into the trees south of camp. "The stupava!" he yells. "The disc is on the stupava!" Then he turns and runs deeper into the forest.

Immediately after Akrano's foolish announcement, a sharp whistle can be heard from the forest — with an IQ-4 roll (Alertness and Acute Hearing help), people in the clearing can tell it came from the south. In immediate response to the whistle, the assault from the woods intensifies. Two more gunmen begin firing from the north. These gunmen have Beam Weapons-13; their weapons are functionally identical to thrax needlers, leaving a brief line of glowing ions to mark the passage of the otherwise invisible beam. Most of the PCs should be pinned down by the attack, although one or two may get away to follow Akrano into the woods.

The assault on the camp is actually a distraction, allowing the Qwarm — who is leading the attackers — to get the message disc. As the battle rages within the clearing, Akrano and any PCs who are with him move through the woods after the stupava. As they search vainly through the brush, they hear the scream of an injured stupava. Akrano immediately runs in the direction of the sound.

When Akrano and the PCs find the stupava 10 turns later, it is lying in a heap on the forest floor. A large, burned wound gapes across its breast, and its saddle is slit to ribbons. Akrano pokes through the tattered leather, then slumps to the ground behind the dead bird.

"He got it," Akrano says resignedly. "Whoever it was, they got the disc."

Just then, a skimmer can be heard lifting off a short distance away. Those at the dead bird can barely see it through the trees as it passes overhead. The skimmer heads for the camp, making one pass before banking around to head south. Anyone in the camp will have sufficient warning and time to squeeze off a single shot at the skimmer as it sails by — but normal hand weapons are unlikely to damage the vehicle. If, however, anyone has the presence of mind to grab a marker rifle and shoot the skimmer, he *will* hit; if none of the PCs thinks of this, Tessya will.



Once the skimmer has left, any remaining gunmen also flee into the trees. If the party managed to down any of the laser squad, searching the body will reveal no clues as to identity, except for a Challis Company belt buckle on one man, and a Challis nametag in the pocket of another. If they managed to put down one of the two men with the unusual weapons, they are in for a surprise — the downed “man” turns out to be an AAnn! His weapon is the AAnn version of a needler.

By the time the camp is mopped up, the wounded bandaged, and the stupava rounded up again, it will be dawn. The PCs will most probably want to head back to Drallar immediately; Tessya and Akrano will accompany them, while their cousins remain behind to skin and dress the devlope. If no one asks him to do so, Akrano will take it upon himself to flip on the marker scope as the mudder heads towards Drallar. At first, the signal is very weak, but as the group approaches Drallar it becomes stronger, assuring that the skimmer has headed for the city.

## A Business Call

### Back in Braav

The group arrives back in Drallar early in the afternoon. When Akrano and Tessya return the mudder to their uncle, Teves, in the nomad quarter, Akrano attempts to make his sister stay home and leave the dangerous work to “us men.” Tessya will have no part of her brother’s chauvinism, though; she has been in this all along, and intends to see it through. She does, however, suggest that reckless children such as Akrano should be left out of such dangerous activities, especially when they have proven their inability to take care of themselves . . . .

Having returned the mudder, the group will no doubt set about following the marker signal to its source. After a bit of triangulation, it will become apparent that the skimmer has been taken into Braav Inurb. The group has an “in” at Braav, of course — Maxim Malaika.

Whether the PCs give Malaika a tridee call or simply show up at the Braav gate, Malaika will ask them to report directly to him before taking any other action. If they refuse, he will inform the Braav guard not to admit them. Malaika can’t afford to have uncontrolled hooligans running around loose in the inurb on his permission.

If the PCs take the time to track down the marker signal before going to Malaika tower, they will find that the skimmer has been parked in the garage under the tower belonging to the Challis Company. While Malaika won’t be happy that the group was late getting to his office, he will forgive them when they share this bit of information.

When they arrive at Malaika tower, Wolf escorts them once again to Malaika’s office, where the merchant is waiting for them. Malaika bids them sit and tell their story. He listens carefully, interrupting only a few times for clarification. When the PCs mention the Qwarm, Malaika just nods his head silently. But the AAnn, if the PCs managed to identify them, are a complete surprise to him.

“A Qwarm in the employ of my rival, Mr. Challis, then?” Malaika mumbles thoughtfully. “That makes sense. But how do the AAnn fit in? Hmmm . . . .” He turns his attention back to the PCs. “At any rate, we had an arrangement.”

Malaika pays them whatever was agreed upon for the information about Kergan’s killer, and gives them a 10% bonus for their efforts to recover the message disc. He then reaches into his desk and pulls out a small device similar to the marker reader Akrano was carrying earlier.

“I would dearly love to have that disc,” Malaika says. “But to try to take it from the Challis complex would be to break the law. I would happily pay *twice* what we agreed earlier for it, but you cannot get it without breaking the law either. This device,” he indicates the machine on the table, “can locate the disc from up to a hundred yards away, but no one can get close enough to use it.

“Life is difficult, *ndiyo*?” he muses. “I have lost a world, it seems, and you have lost an opportunity.” He gets up and walks to the window, turning his back to the PCs. Wolf leaves the room with the dishes from Malaika’s breakfast.

Malaika is suggesting that the PCs steal the disc, without actually saying it. His back is turned so that the PCs can help themselves to the tracking device without his giving it to them. This way, if the PCs are caught sneaking into Challis Company, Malaika can truthfully deny that he hired them to recover the message disc. Should the PCs offer to get the disc for him, he will reply that they are “free citizens” and may do as they wish.

Malaika will, however, answer any casual question the group might have about the

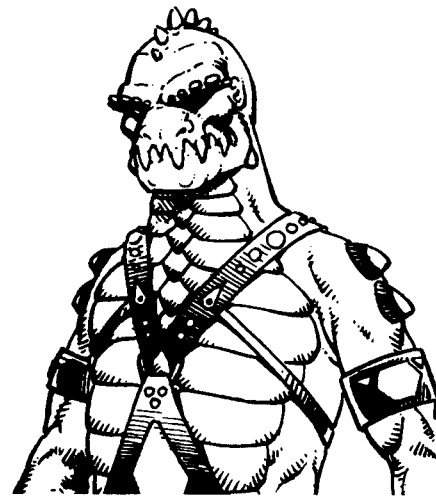

### AAnn Soldier

Big and reptilian — 80 points.

ST 13, DX 11, IQ 9, HT 12.

Basic Speed 7.125; Move 7.

Dodge 7; Parry 5 (Knife), 8 (Brawling).

Wears leather harness: PD 2, DR 2 (torso only); No encumbrance.

Advantages: Natural DR 1; Combat Reflexes; High Pain Threshold.

Disadvantages: Racial Intolerance; Reputation (Cruel and Sadistic; -4 reaction).

Quirk: Likes to eat humans, thrax, etc.

Skills: Beam Weapons-13, Knife-11; Spear (for nerve prod)-11; Brawling-12, Running-11.

Languages: AAnn-9.

Weapons: AAnn Needler: 2 dice impaling; Large knife: 1 +1 cutting, 1 die impaling; Nerve prod: special.

Unarmed Damage: Bite: 1-1 impaling; Claw: 1 die cutting.

These are enlisted nye under the command of First Claw Gressa WWR. They have no status, so their names are followed by a seven-letter status designation. These AAnn are to support the Qwarm and the thugs working for her; they are under orders *not* to be killed or captured, which would reveal the AAnn presence on Moth.

AAnn soldiers are fierce combatants. They believe themselves superior in every way to humanx opposition. They especially relish hand-to-hand combat, and will fight up close if they can do so without getting caught.

## The Challis Company

The Challis Company is one of the largest, most powerful commercial operations in the Commonwealth. Its origins date back to pre-Amalgamation times, when the Challis Company operated an extensive mercantile and delivery service to the colony worlds of expanding human space. The intervening centuries have seen The Challis Company thrive and grow under a succession of brilliant, well-educated owners.

The Challis bloodline, however, seems finally to have gone bad with Conda Challis. Meruba Challis, the previous owner, died when Conda was very young, leaving the entire corporation to his only son. Since he was five years old, Challis has held tremendous financial power. Naturally, Challis has become something of an eccentric, and his bizarre and often violent sexual habits have become legend in the Commonwealth.

### Challis Company Security

The security guards in the Challis company are identical to *The Qwarm's Thugs*, p. 80, except that they wear Challis Company uniforms. In fact, the strongmen working for the Qwarm were actually Challis Company guards putting in a little overtime.

### Waltrip Quintain

Human — late 40s; Pasty skin, balding pate, flabby physique; 5'8", 210 lbs. — 41 points.

ST 8, DX 10, IQ 13, HT 9.

Basic Speed 5.75; Move 2.

Dodge 5.

Heavy Encumbrance, due to Fat disadvantage.

Advantages: Eidetic Memory; Mathematical Ability; Status 4.

Disadvantages: Unattractive; Cowardice; Fat; Gluttony.

Skills: Accounting-19; Administration-15; Computer Operation-18; Computer Programming-16; Fast-Talk-14; Mathematics-17; Merchant-14; Running-8. (All skills include Mathematic Ability bonus.)

Languages: Terranglo-14; Symbolic-speech-13; Thranx-12.

Waltrip Quintain is a divisional vice president for Challis Company. He has obviously enjoyed the good life since he was born — he dresses in New Parisian suits, eats very well, and is accustomed to ordering people around.

Quintain does not know quite how to deal with those who are not intimidated by his money and power, though. To Conda Challis, his employer, Quintain is a cringing yes-man; to Gressa WWR, he is a whining coward. Confident PCs are likely to intimidate him as well.

Challis Company. He even has a set of blueprints to the building. The plan may be a bit out of date, Malaika cautions; the security information especially is likely to be inaccurate.

## The Challis Company

The Drallar headquarters of the Challis Company is an office tower some 77 stories high. The building contains no manufacturing equipment or significant warehouse space — these facilities are located outside the Braav Inurb. Instead, the building comprises office space, computer banks, and apartments, all used by the central management personnel of the interstellar conglomerate. The office quarters are occupied 24 hours a day; during business hours, they are full of customers and management and office personnel, while at night the cleaning and maintenance staffs are busy throughout the tower.

Just how the PCs get into the Challis Tower is left to them. They could break in, or they could come in as repair personnel, customers, janitors, whatever. Any reasonably subtle plan is likely to work. External security at the tower is lax, and most of the personnel — including lower-level security guards — do not know there are AAnn in the building. Waltrip Quintain, the division vice president, doesn't want to call undue attention to the company at this crucial time. About the only sort of plan that *won't* work is one in which the PCs stroll in the front door with Paxton Vs over their shoulders, shooting or bullying their way into the building.

Once inside the building, the group can use the tracking device to determine that the message disc is somewhere below ground level, presumably in some sort of basement facility. This should come as a relief to the party, who might have otherwise had to search 77 floors for the disc!

Even though getting into the building should be relatively simple, it's a good idea to keep the infiltrators on their toes. A couple of suggestions:

1. To avoid a roving patrol, the PCs slip into a darkened office. The "office" turns out to be a telefax closet. There is barely enough room for the group, and they are pressed to fit in. The person in the back accidentally starts the telefax machine, which sounds like a jet aircraft is landing in the room. Looking through a small window in the room, the people in the front can see the guards approach, pass by the closet, and then turn down another hall — the fax closet is soundproofed!

2. To get down to the basement, the party enters an elevator. Suddenly, the car begins to go *up*. After about 25 feet, the paneling on the wall opposite the door parts to reveal a floor-to-ceiling window looking onto the building's 50-story-tall lobby. The elevator goes clear to the fiftieth floor before heading back down. (A control roll is necessary for any Acrophobes in the group.) The elevator stops several times along the way to let passengers on and off. On the trip back down, two security guards ride from the 42nd to the 11th floor. As long as the PCs remain calm, no one will pay them any attention.

### Finding the Disc

It is not difficult to *find* the restricted, subterranean offices beneath the Challis Corporation — the lobby and guard station for the area is the bottom stop for the elevator which runs through the main lobby up to Conda Challis' penthouse apartment. The trick is getting in.

At the security post in the underground lobby, a guard checks the badges of anyone entering the restricted offices. His station also has several monitoring screens, which show other portions of the building. The PCs will have to disable the security guard to get by. When they do, the videophone at the guard station starts ringing. The caller could be a security check, or it could be the guard's wife asking what time he'll be home. The PCs will never know — unless they answer the call. (If they *do* pick up the phone, make the call awkward but non-incriminating.)

The underground facility is not tremendously large — by following the disc's signal with the tracking device, the PCs should be able to determine where it is fairly quickly. If you want the search to go quickly, simply let the party find the room and guards below; if you want to make the PCs' lives a bit tougher, let them try to evade a couple of wandering security guards or civilian office workers.

Finally, the PCs will pinpoint the disc in a conference room, which is protected by two security guards. The door to the conference room is located at the head of a "T" intersection; the guards are positioned so that they can see down all three hallways leading to the conference room. While the PCs can, with Stealth rolls, gain a firing position

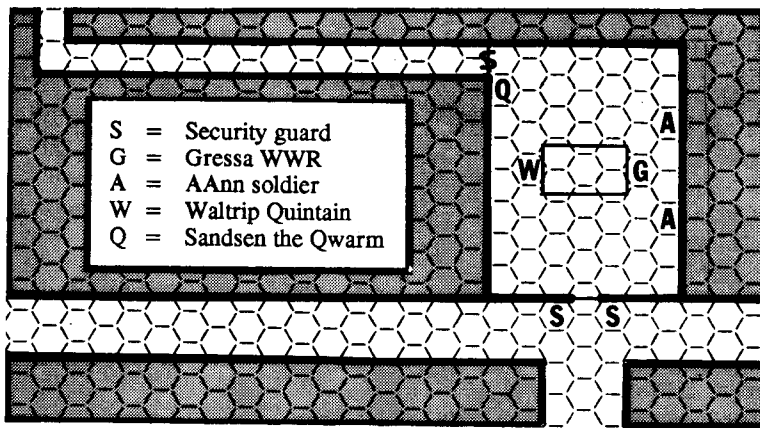

down any of the corridors, they will not be able to approach any closer than 15 hexes without being seen. There is no other apparent entrance to the conference room.

If, in eliminating the guards, the party makes a great deal of noise, those inside the room will no doubt hear, and will act immediately — see below. If the PCs manage to dispatch the guards quickly and quietly, the people inside the room will not be aware of the party's presence. Once the guards are silenced, the party will find the door to the conference room locked. The lock is a dead bolt, operated by a key panel beside the door. A roll against Lockpicking-4 or Electronics (Security Systems) will open the lock. Failing this, the lock can be blown with an energy weapon or cut with a vibraknife (DR 3, HT 5), or the door itself can be smashed in (DR 6, HT 15). Picking the lock is relatively silent; blowing the lock or breaking the door will naturally alert those within.

Should the PCs listen before they leap (by making an IQ roll with their ears pressed against the door), they will hear a heated discussion. One speaker is a whiny-voiced human; the other has a deep, rasping voice, and speaks Terranglo with a thick accent.

"But you don't understand," the human protests. "The old prospector's claim marker must be found and destroyed! Otherwise, Malaika has a legitimate claim to Praxiteles. If you will not find the marker, then I must send a mission to do so — to protect us both."

"You have the disc, human," the alien voice hisses. "The threat of discovery has been dealt with. No one of the Commonwealth — human, thranx or other — will set foot on our planet."

"The disc means nothing!" pleads the human. "Malaika will deduce the content of Bidir's message, even without receiving it. He'll send an expedition to Praxiteles, to find the marker himself! When that expedition discovers your miners, we're both finished!"

"The Baron's nye are quite capable of dealing with anyone the black trader might send," the alien concludes. "You will continue to deal with the Commonwealth legal system, *keeping all humanx off Praxiteles IV*. For this, you will continue to receive your 20% share of the ferrosilicates mined there. This discussion is complete."

If the PCs burst in, they find an AAnn officer, First Claw Gressa WWR, and the Challis Company division head, Quintain, sitting at a conference table. The only light in the room is a lamp over the table, suspended on a long cable from the ceiling. Gressa is flanked by two AAnn bodyguards; Quintain seems to be alone. Any PC making a roll against IQ, modified by Alertness and Acute Vision, will notice a black-clad figure lurking in the shadows in the northwest corner of the room. This is, of course, the same Qwarm which has been harrying the party throughout the adventure.

If the PCs do not enter the room immediately, the human will continue to beg the AAnn to do something about Bidir's marker. The AAnn coldly refuses, stating that such matters are Challis' responsibility. After two minutes of this, the door will suddenly slide open revealing two heavily-armed AAnn soldiers!

As soon as Gressa sees the PCs, he pulls his weapon — either a laser pistol or a large knife, depending on whether you want the coming fight to be a gun battle or a melee. His bodyguards follow his cue.

"Are these your men?" he demands of Quintain. When the human whines negatively, Gressa leaps for the PCs, bellowing, "Then they die!" Gressa and his nye will fight fiercely, but they won't die for Quintain. If they are clearly beaten, they will surrender to await an eventual prisoner exchange between the Church and the Empire.

While the AAnn and the PCs mix it up, the Qwarm grabs Quintain and ushers him through a hidden door. Anyone who watches them leave will be able to find the door easily; if no one saw them go, an IQ roll, modified by Alertness and Acute Vision, is necessary to locate the door.

## First Claw Gressa WWR

AAnn — late 20s; tan hide, green eyes; 6'2", 190 lbs. — 150 points.

ST 14, DX 12, IQ 12, HT 12.

Basic Speed 6; Move 5.

Dodge 6; Parry 7 (Knife), 6 (Spear), 8 (Brawling).

Wears scale harness: PD 3, DR 4 (torso only); Light encumbrance.

Advantages: Combat Reflexes; High Pain Threshold; Strong Will +2; Status 4; Natural DR 1, plus Toughness DR 1, for a total of DR 2.

Disadvantages: Racial Intolerance, Reputation (Cruel and Sadistic; -4 reaction); Bad Temper; Bully; Overconfidence; Sadism.

Quirks: Likes to eat humans, thranx, etc.; Especially disgusted by whiners (like Quintain).

Skills: Beam Weapons-15; Knife-14; Spear-13 (for nerve prod); Brawling-12; Tactics-13; Strategy-12; Administration-13; Leadership-14; Diplomacy-12.

Languages: AAnn-14; Terranglo-11; Symbospeech-11.

Equipment: Large knife: 1+2 cutting, 1 impaling; Laser pistol: 1 die impaling; Nerve prod: special.

Unarmed Damage: Bite: 1-1 impaling; Claw: 1+1 cutting.

First Claw Gressa WWR is a rising star in the AAnn Empire. A son of the Baron Riidi WW, Gressa has been entrusted by his father with overseeing the Moth end of the ferrosilicate arrangement with the Challis Company. So far, he has done well for the Empire. He is easily able to intimidate Waltrip Quintain, the Challis representative to the AAnn, and has won several concessions for the Empire.

Gressa came up through the military ranks; this is his first diplomatic assignment. If he does well — and so far he has — he can expect to follow in his father's footsteps, someday becoming a Baron, and perhaps even a member of the Pack of Lords. The only thing that might stop Gressa is his own intolerance for cowardice and incompetence, which can prompt him to act rashly. On more than one occasion, Gressa has nearly slit Quintain's throat with his bare claws.



## Sandsen the Qwarm

Human — early 30s; bald, brown eyes, light skin; 5' 7", 140 lbs — 209 points.

ST 12, DX 14, IQ 13, HT 12.

Basic Speed 8; Move 8.

Dodge 8; Parry 8 (Knife), 10 (Karate).

Wears kevlar vest: PD 2, DR 4 (torso only).

Advantages: Alertness +4; Danger Sense; High Pain Threshold; Night Vision; Peripheral Vision; Toughness (DR 1).

Disadvantages: Social Stigma (Out-law); Bully; Fanaticism (Qwarm); Overconfidence; Sadism; Duty (to Qwarm).

Skills: Beam Weapons-16; Fast-Draw (Pistol)-15; Guns (Pistols)-16; Karate-15; Knife-16; Throwing-14; Climbing-15; Jumping-15; Running-12; Swimming-15; Acting-15; Fast-Talk-15; Disguise-14; Escape-13; Interrogation-13; Lockpicking-15; Poisons (Human)-12; Shadowing-15; Stealth-16; Traps/TL4-13; Piloting (Skimmer)-11; Electronics (Security Systems)-14.

Languages: Terranglo-15; Symbolic speech-15; Thranx-12.

Weapons: Phonic stiletto: 2 dice cutting, 1+2 impaling; Paralysis beamer: special; Electrocutation gun: special.

Although the Qwarm looks like an adolescent boy, she is actually a slim-figured woman named Sandsen. While Qwarm are usually hired as assassins, Sandsen is never specifically instructed to kill the PCs. Early in the adventure, she is after the package. At this point, she wants to avoid a fight, trusting to her Stealth and the three expendable goons with her to keep her out of the line of fire. Later in the adventure, when her function is that of bodyguard, she will attack the players if they threaten her employer, Waltrip Quintain.

Sandsen's fanaticism refers to her strict adherence to the Qwarm way of life — never betraying a fellow Qwarm, never appearing in public in anything other than the Qwarm uniform, shaving the entire head, dying to protect the honor of the Qwarm. She is *not* fanatically loyal to Quintain — if he's dead, she won't hang around to die with him.

Should Sandsen meet an untimely end, another, similar Qwarm will be hired to take her place.

## Shots in the Dark

The exit Quintain and Sandsen used is a metal interior door (DR 3, HT 8), disguised as a wall panel. The door only locks or unlocks from the opposite side — there is no lock to be picked.

On the other side of the door is an unlit corridor, extending out of sight. 50 feet down the corridor, the corridor turns 90 degrees to the right. As soon as one of the characters appears around the corner, a laser blast ricochets off the wall a few inches from his head. Shots will continue to blast into the wall at the corner, two per turn. Apparently, at least two gunmen are firing on the PCs from a position of cover some distance up the hall. Actually, it is only a terrified Quintain, a laser in each hand, firing unaimed shots from the next corner, 25 yards down the hall. Quintain has no Beam Weapons skill — once all penalties are applied, he will be hitting only on a 3 or 4. This should become obvious after only a few turns.

Quintain is only providing a distraction from the real danger — the Qwarm. The assassin is hiding six feet above the heads of the characters, behind the grate of a heating duct. Three turns after Quintain's first shot, the Qwarm will shoot the PC at the back of the party with a Paralysis Beamer. Each turn thereafter, each PC should make an IQ roll, modified by Alertness, to locate the Qwarm. Once the PCs have spotted and begun to attack the assassin, she will do one of two things — if there are fewer than three or four PCs still standing in the corridor, she will drop from the duct, phonic stiletto in hand, to engage in close combat in the narrow corridor; if the PCs seem strong, she will retreat through the duct system, emerging near Quintain. There, she will defend him as best she can. As soon as he realizes the party has been distracted by Sandsen, Quintain will flee down the corridor to his office.

In his haste to escape the PCs, Quintain has left the door from his office to the darkened corridor open; the office can be easily found by following the light from the open doorway. When the PCs arrive, Quintain will be frantically smashing microfilm and computer discs with a large paperweight. As soon as he notices the PCs — which may not be for three or four seconds — he will hurl the paperweight at one, hitting for 1-3 damage on a 7 or less. What Quintain does from here depends upon the GM. If you prefer him to be taken alive, he either collapses on his desk, sobbing, or madly rushes the PCs empty-handed. If you don't mind him dying, he will grab for one of the laser pistols lying on his desk and begin firing at the PCs in All-Out attacks. In any case, he should not be difficult for a party which has survived three AAnn and a Qwarm to subdue.

Once all the foes have been dealt with, the PCs should gather up the evidence — the discs which Quintain hadn't got to smashing — and get out of the Challis building. You can make this as easy or hard for them as you like. By now the building will be in an uproar — this may provide just the cover the PCs need, or it may be one more obstacle between them and safety. A good guideline is the party's condition after getting the discs. If, in your opinion, they have not paid enough for their victory, throw a few more guards at them, possibly backed up by a handful of AAnn and a Qwarm or two. If, on the other hand, they're already pretty shot up, you might decide to let them walk out relatively unchallenged.



# Epilogue

After they've escaped the Challis Company complex, the PCs will either go to the authorities — Church or local — or report to Malaika. Either way, this is what they'll find out:

Bidir's message to Malaika — which must be decoded by Malaika's computer — reads: *Discovered substantial ferrosilicate deposit on planet IV, Praxiteles system. Claim marker placed at site, 37 degrees north, 129 degrees west. Upon departure, found previously unknown mining colony, approx. 5 degrees south, 62 degrees west. Mining colony is apparently manned by AAnn — no Commonwealth species sighted. Will file claim for House Malaika tomorrow a.m. with Church Registry here on Repler. Hope you'll enjoy owning a planet-full of lizards! Bidir. (Date).*

The discs from Quintain's office include a complete record of his dealings with the Baron Riidi WW of the AAnn Empire regarding Praxiteles IV. Apparently, Quintain was initially contacted by the Empire eight months ago. The AAnn scoutship *Hzzr* had crashlanded in the Praxiteles system while observing the Church fleet near the Tundra V, and discovered the planet to be rich in ferrosilicates. Lacking any source for the precious compounds within the Empire, the AAnn began to mine the planet covertly.

In order to prevent Commonwealth interference with the mine on Praxiteles IV, the Empire had reached an agreement with the Challis Company. Challis would send a scoutship to "discover" the planet and claim it. The AAnn would continue to mine the planet, giving Challis a 20% cut in exchange for a legitimate front for the operation. The Challis cut would be prepared for Challis company vessels once every two months. Otherwise, no Challis personnel were to set foot on *Hzzr*. AAnn freighter traffic between *Hzzr* and the Empire would blend in with the regularly scheduled ships supplying the AAnn base on Repler.

Also among Quintain's records are copies of the Challis press release announcing the discovery of a new world, including a survey of the planet detailing its "modest" ferrosilicate deposit. Another survey, prepared by the AAnn and kept secret by Challis, indicates that *Hzzr* may be richer in ferrosilicates than either Prism or Amropolous.

Once all this information has been handed over to Church authorities — which Malaika will do if the PCs haven't already — Quintain and his immediate assistants are dismissed from the Challis Company and arrested on charges of treason against the Commonwealth, as well as a variety of lesser commercial crimes. Conda Challis himself pleads innocent of any knowledge of Quintain's activities and, upon relinquishing any claim to Praxiteles IV, is cleared of any misdoing.

Several AAnn — including Gressa WWR, if he survived — are apprehended and interrogated, revealing the existence of the AAnn base on Praxiteles IV. The AAnn eventually face trial on espionage and conspiracy charges. Several months later, Gressa and his nye are returned to the Empire in a prisoner exchange.

Howard Bidir's claim marker is found, verifying the Malaika claim to Praxiteles IV. Malaika names the world Bidir, and begins to license mining rights to several companies, most of them based on Amropolous.

## Rewards

Upon receiving the disc intact, Malaika pays the PCs the agreed finders' fee. Malaika thanks them, asking them to keep in touch, in case he has need of their services again.

PCs should also receive character points, based on their performance. This adventure is designed to be played in three sessions. At the conclusion of each session, each character should be awarded up to 3 character points — 2 for furthering the mission, 1 for roleplay within character conception. The final session, in which the disc is recovered, the Challis-AAnn plot revealed, and Malaika's claim to the ferrosilicate world proven, should be worth about 5 points — 4 for *completing* the mission, and 1 for roleplay within character conception. Of course, you should adjust these numbers to fit the scale of your campaign and the quality of play.

If any player would like — and has the character points available — he can add Maxim Malaika as a patron. Malaika heads a very powerful organization (20 point base), but unless the PC goes to work for him full time, he will only appear on a 6 or less (real cost — 10 points). House Malaika has offices on most Class I worlds, and sends field representatives throughout the Commonwealth. Malaika can intervene on the PC's behalf in legal or financial matters, or supply equipment for missions. From time to time, the PC may be called upon to help Malaika in some adventurous capacity.

## Further Adventure

The resolution of this adventure still leaves a few loose threads. For one thing, an AAnn colony is currently mining precious ferrosilicates from a Commonwealth world. An expedition to remove them might bring the PCs face-to-face with the notorious Baron Riidi WW — who will no doubt bear a grudge against them for uncovering the Praxiteles arrangement and embarrassing his son.

The PCs may also have captured or killed a Qwarm. This is an unbearable stain upon the honor of that order of assassins, who will no doubt wish to set it right. To do this, they must exact vengeance upon each PC, in the form of a slow, painful death. This should keep the PCs watching the shadows . . . .

Although Conda Challis managed to wriggle out of any personal punishment, he has taken a considerable financial loss in this affair. Who knows what nefarious scheme he may concoct to recoup his investment? No doubt the PCs, for whom the old man has a special place in his heart, will be caught in the middle of it.

## The Price of Failure

Should the PCs fail to recover the disc and gain conclusive evidence of the Challis-AAnn deal, all is not lost. By this point, Malaika has a good idea what's going on in the Praxiteles system; all he needs is proof.

After the PCs' unsuccessful attempts to recover Bidir's message, Malaika reasons, Quintain will no doubt have destroyed the disc. The only proof of the Praxiteles conspiracy — Bidir's claim marker and the AAnn mining colony — is on Praxiteles IV. Malaika will outfit an expedition to find the marker and obtain photos or other evidence of the AAnn mining operation.

Of course, this mission will be a bit tougher. Praxiteles IV is an airless, frozen world, inhabited only by a few dozen AAnn. The expedition must enter the system, land, find the marker, scout the AAnn base, and return to a Commonwealth world, all without being seen by either AAnn vessels or the Challis freighters, which arrive regularly.

But then, the PCs did so well the first time around . . . .

# APPENDICES

## Humanx Characters in GURPS



### Flinx

Human — 15 years old; Red hair, brown eyes, olive skin; 5'7", 140 lbs — 101 points.

ST 9, DX 13, IQ 13, HT 10.

Basic Speed 5.75; Move 5.

Dodge 5; Parry 7.

No armor; no encumbrance.

Advantages: Alertness +1; Charisma +1; Danger Sense; Intuition; Language Talent +2; Luck; Telepathy Power 5. Flinx has no training with Telepathy — it functions only as longer-range Empathy.

Disadvantages: Dependent (Relative — Mother Mastiff); Enemy (Meliorare Society — Medium-sized group, appears on a 6 or less); Pacifist (Self-defense); Poverty (Struggling); Sense of Duty (Friends); Youth (3 years).

Quirks: Looking for his parents; Doesn't like being treated like a kid; Has expensive tastes in liquor; Doesn't trust authority figures (police, etc.).

Skills: Acting-12; Acrobatics-12; Area Knowledge (Drallar)-14; Bard-12; Climbing-12; Fast-Talk-14; Knife-14; Merchant-12; Shadowing-12; Sleight-of-hand-12; Stealth-13; Streetwise-14; Throwing-13; Pickpocket-8 (Default).

Languages: Terranglo-15; Symbospeech-14; Thrax-12; Nomad-14.

Flinx is a young orphan whose origins are a mystery to him. At the age of 8, he was bought in Moth's slave market by Mother Mastiff, who treated him like a son. Now on the verge of manhood, Flinx takes care of Mother Mastiff.

Flinx is accompanied on his adventures by Pip, an Alaspinian miniature dragon (p. 19) that befriended the boy just after he was purchased by Mother Mastiff. Pip has ST 4, DX 15, IQ 6, HT 15/4, Speed 2 on land, 12 flying,

a Telepathic Power of 10 and Emotion Sense-14. Pip acts as a Catalyst Creature (p. 65) for Flinx, adding his Telepathic Power to Flinx's. Thus, each functions with a Power of 15.

This is a young Flinx, from the beginning of *The Tar-Aiyem Krang*. After his experiences with the Krang (*The Tar-Aiyem Krang*), the Ulru-Ujurrians (*Orphan Star*), and the Guardian (*Bloodhype*), Flinx becomes extremely powerful. If portraying Flinx after *Bloodhype*, assume he has a Power of 10 (functioning as if he had a Power 20, due to Pip) in Telepathy. The older Flinx has psionic skills of Emotion Sense-15, Mind Shield-15, Mindwipe-10, Psi Sense-15, Telesend-15, and Telereceive-15. He views mind-control as a form of assault, and will not use his Talent to force people to obey or agree with him (this is an ethical restriction, not a power limitation).



### Maxim Malaika

Human — 53 years old; dark skin, curly black hair, short beard, brown eyes, deep bass voice; 6' 1", 215 lbs. — 245 points.

ST 12, DX 12, IQ 13, HT 11.

Basic Speed 5.75, Move 5.

Dodge 5; Parry 6 (Knife), 8 (Brawling).

Advantages: Charisma +2, Empathy, Filthy Rich, Language Talent +3, Reputation (honest merchant) +2, Status +5.

Disadvantages: Impulsiveness, Overconfidence, Truthfulness.

Quirk: Lapses into Nomad language; Easily distracted by beautiful women; Hates liars; Sensitive about his artificial leg; Gallant.

Skills: Accounting-14; Administration-16; Area Knowledge (Commonwealth)-14, (Moth)-13, (Drallar)-12, (Braav Inurb)-12; Beam Weapons-14; Brawling-13; Carousing-13; Computer Operation-15; Detect Lies-15; Diplomacy-16; Economics-15; Fast-Talk-15;

Gunner (Spacecraft weaponry)-14; Knife-12; Leadership-15; Merchant-17; Piloting (Small Private Spaceship)-12; Savoir-Faire-13.

Languages: Nomad-16; Terranglo-15; Symbospeech-16; Thrax-14; Tolian-14; Ornthorpe-14.

Maxim is the owner and chief executive officer of House Malaika. Born and raised a nomad of Moth, he went offworld at the age of 17 to seek his fortune. At 30, he returned with sufficient starting capital to establish House Malaika. The company has become one of the largest trading concerns in the Commonwealth, due in large part to Maxim's bold leadership and good business sense.

At 53, Malaika is still a strong man, with the build of a wrestler. His dark skin and broad features mark his African ancestry, but his hairy arms and stocky build reflect other influences. His left leg ends at the knee — he lost it to an ice-lizard. His TL9 prosthetic limb functions as well as a real leg, but does not quite match his skin color — a sensitive point for Malaika.

### Bran Tse-Mallory

Human — 55 years old; Black hair with graying temples and one streak of pure white; black, slanted eyes; darkly tanned skin; 6' 3", 190 lbs — 251 points.

ST 12, DX 13, IQ 14, HT 12.

Basic Speed 6.25; Move 6.

Dodge 6; Parry 10.

No armor; no encumbrance.

Advantages: Alertness +2; Combat Reflexes; Patron (United Church — "National" government, appears on a 6 or less); Status +3 (Retired Chancellor Second); Strong-Willed +2.

Disadvantages: Overconfidence; Sense of Duty (Friends).

Skills: Administration-14; Anthropology-15; Archaeology-15; Area Knowledge (Com-





monwealth)-15; Beam Weapons-16; Brawling-14; Computer Operation-15; Fast-Talk-13; Free Fall-13; Gunner (SCCAM)-16; History-16; Karate-15; Leadership-16; Piloting (Stingship)-13; Psychology-14; Shadowing-14; Stealth-13; Strategy-14; Streetwise-14; Tactics-14; Vacc Suit-13; Xenology-16.

Languages: Terranglo-14; Symbospeech-14; Thrax-14.

Bran Tse-Mallory began his career as a stingship pilot in the Church Peacekeeping Force. However, after he and his ship-brother Truzenzuzex interfered in an AAnn invasion of a non-Commonwealth world, he was dismissed from the service — after being awarded the Church Order of Merit, one star cluster. Tse-Mallory was formally inducted into the Zex clan and later joined the Church's Chancellory of Alien Sociology, where he rose to the rank of Chancellor Second. Ten years passed before he and Truzenzuzex were reunited. They have been together ever since, exploring the mysteries of the ancient Taryim civilization.

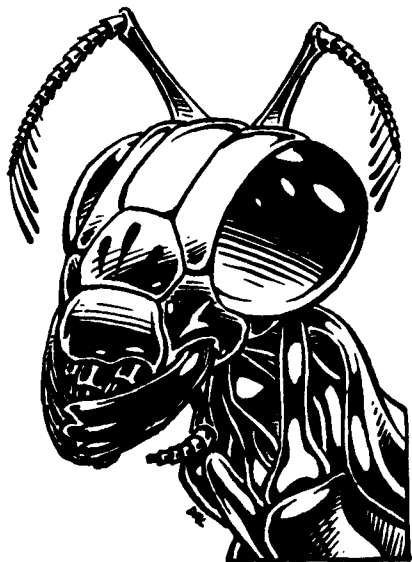

## Truzenzuzex

Thrax — 58 years old; dark purple chitin, drooping antennae, two sets of wing cases; 5' 4" tall (6' 6" long), 165 lbs. — 254 points.

ST 10, DX 12, IQ 15, HT 10.

Basic Speed 5.5, Move 5 (7 using foot-hands).

Dodge 5; Parry 8.

No armor; No encumbrance.

Advantages: Natural PD 2, DR 2; Acute Taste and Smell +3; Acute Vision +2; Combat Reflexes; Common Sense; No Outside; Patron (United Church — "National" government, appears on a 6 or less); Peripheral Vision; Status +3 (Eint).

Disadvantages: Thrax Hemophilia; Near-sightedness; Sense of Duty (Friends).

Skills: Anthropology-16; Archaeology-16; Area Knowledge (Commonwealth)-16, (Willow-Wane)-15; Beam Weapons-16; Computer Operation-15; Diplomacy-16; First Aid-16;

Free Fall-12; Gunner (SCCAM)-14; History-17; Karate-12; Leadership-15; Piloting (Stingship)-17; Psychology-17; Shadowing-14; Stealth-11; Strategy-13; Tactics-13; Teaching-14; Vacc Suit-14; Xenology-16.

Languages: Thrax-15; Symbospeech-15; Terranglo-15.

Truzenzuzex is truly a giant among his species — in more ways than one. At 5' 4" in height, he is much larger than the average male thrax. After he and Tse-Mallory were honorably dismissed from the Peaceforcers, the thrax returned to his home planet, Willow-Wane. There he resumed his studies in psychology and theoretical history, and was eventually awarded the title of Eint. These days he can usually be found in the company of his former ship-brother, Bran Tse-Mallory.

## Skua September

Human — mid-fifties; white hair, black eyes; 6'7", 250 lbs. — 218 points.

ST 16, DX 13, IQ 12, HT 13.

Basic Speed 6.5, Move 6.

Dodge 6; Parry 10 (Brawling), 7 (Two-handed Axe).

Advantages: Alertness +2; Charisma +2; Combat Reflexes; Empathy; Strong-Willed +3; High Pain Threshold; Toughness (DR 1).

Disadvantages: Enemy (United Church — utterly formidable group, appears on a 6 or less); Impulsiveness; Overconfidence; Sense of Duty (Friends); Poverty (Struggling).

Quirks: Bloodthirsty in combat; Calls young men "feller-me-lad"; Close-mouthed about his past; Doesn't like to lie; Heavy drinker.

Skills: Area Knowledge (Commonwealth)-14, (Tran-ky-ky)-12; Bard-12; Beam Weapons-16; Brawling-15; Broadsword-13; Carousing-15; Detect Lies-15; Diplomacy-11; Fast-Talk-12; Interrogation-12; Leadership-13; Naturalist-10; Piloting (Skimmer)-11; Shadowing-12; Stealth-13; Strategy-11; Streetwise-13; Survival (Arctic)-12; Tactics-11; Two-handed Axe/Mace-14.

Languages: Terranglo-12; Symbospeech-12; Tran-11.



September won't reveal his age, but he looks to be in his mid-fifties. He is secretive about his past — he has been involved in a few things he isn't proud of. Not the least of these was the Analava System War. Church investigators have been searching for September ever since he fled the Analava System at the outbreak of that conflict.

September's six-and-a-half-foot frame carries 250 pounds of solid muscle. He appears to be of mixed English and Arabic — possibly Bedouin — blood. His obsidian eyes twinkle beneath bushy brows. A large, aquiline nose dominates his deeply-lined face, and a gold earring glints from beneath his thick shock of snow-white hair.



## Ethan Frome Fortune

Human — 31 years old; brown hair, blue eyes; 5'11", 155 lbs. — 141 points.

ST 11, DX 12, IQ 13, HT 12.

Basic Speed 6; Move 6.

Dodge 5; Parry 6 (Broadsword), 8 (Judo).

Advantages: Charisma +1; Empathy; Patron (du Kane Enterprises — Giant, multinational organization, appears on a 6 or less).

Disadvantages: Claustrophobia; Honesty; Sense of Duty (friends); Truthfulness.

Skills: Accounting-14; Administration-13 (default); Area Knowledge (Commonwealth)-13, (Tran-ky-ky)-14; Bard-15; Beam Weapons-14; Broadsword-12; Judo-12; Diplomacy-16; Fast-Talk-15; Leadership-13; Merchant-16; Psychology-12; Survival (Arctic)-13.

Languages: Terranglo-16; Symbospeech-13; Tran-14 — 61 points.

Ethan Fortune was a traveling salesman for House Malaika until he was marooned on the frozen surface of Tran-ky-ky. With the help of Skua September and tran from the native fortress of Wannome, Fortune led his fellow castaways around the planet to the humanx base at Brass Monkey. Along the way, he and September helped the tran set up their world government, and were largely responsible for Tran-ky-ky's application for Class II status in the Commonwealth. Fortune recently married Colette du Kane, head of du Kane Enterprises.

## Baron Riidi WW

AAnn — 37 years old; green eyes, scaly green skin; 5'11", 170 lbs. — 246 points.  
ST 13, DX 11, IQ 14, HT 12.

Basic Speed 5.65; Move 4.

Dodge 6; Parry 6 (Spear or Knife), 8 (Brawling).

Wears scale harness: PD 3, DR 4 (Torso only); Light encumbrance.

Advantages: Natural DR 1; Common Sense; Language Talent +3; Status 5; Wealth (Very Wealthy).

Disadvantages: Reputation (AAnn); Racial Intolerance; Unluckiness.

Quirks: Proud; Persistent; Disregards military protocol; Studies Humanx cultures.

Skills: Acting-14; Administration-15; Area Knowledge (Commonwealth)-15, (AAnn Empire)-15, (Torsee Provinces)-16; Astrogation-13; Bard-14; Beam Weapons-14; Brawling-12; Computer Operation-14; Diplomacy-14; Disguise-14; Interrogation-15; Knife-12; Law-15; Leadership-16; Piloting (Military craft under 50,000 tons)-13; Politics-15; Psychology-14; Savior-Faire (AAnn)-15,



(Humanx)-15; Spear-12 (for AAnn nerve prod); Strategy-16; Tactics-15.

Languages: AAnn-17; Symbospeech-15; Terranglo-15; Thranx-15.

Unarmed Damage: Bite: 1-1 impaling; Claw: 1 die cutting (includes Brawling bonus).

An important AAnn noble and general, the Baron Riidi WW has commanded several AAnn operations against the Commonwealth. As the ruler of the Torsee Provinces, Riidi has his own command of trained soldiers, pilots and spies. He is a devoted student of humanx culture — not because he is more fond of humans and thranx than any other AAnn, but because he is a firm believer in “knowing thy enemy.” Like most warlords, Riidi is very conscious of his honor and reputation; brave adventurers have occasionally baited him into irrational actions by insulting him.

## Humanx Chronology

The Humanx Commonwealth is an ever-growing entity. As of Fall, 1987, Alan Dean Foster has written 13 novels and several short stories set in the Commonwealth; more humanx tales are sure to follow. This list describes each Commonwealth novel or story, in historical order, *not* in order of publication.

Italicized titles are novels. Titles in quotation marks are short stories, which can be found in the anthologies, “With Friends Like These . . .” and “. . . Who Needs Enemies?”

*Nor Crystal Tears.* 2311 O.C. — The first meeting between man and thranx, including Ryozenzuzex’s Project, in which thranx larvae were raised with human children.

Describes an AAnn attack on the thranx colony, Willow-Wane; Daret, capital of Hivehom; and Sed-Clee, a top-secret military installation near Hivehom’s north pole.

*Voyage to the City of the Dead.* 106 A.A. — The planet Horseye boasts the most spectacular river valley in the known universe and is home to three intelligent races. Etienne and Lyra Redowl travel up the River Skar to the legendary City of the Dead, where they discover the last relic of the ancient Xunca.

Describes Po Rabi, the most populous city on Horseye; the Barshajagad river valley; and the cultures of the Mai, the Tsla, and the Na.

“Surfeit.” 533 A.A. — The story of Joao Acorizal and his record-breaking surfboard ride on the Monster wave of Dis.

Describes Dis’s surfing competition.

*Midworld.* 543 A.A. — Midworld is a jungle planet inhabited by the descendants of a lost colony ship. When an off-world Company seeking an immortality elixir upsets the natural balance, the natives — human and otherwise — fight back.

Describes Midworld, a planet unknown to the United Church.

“The Emoman.” 548 A.A. — The story of Sawbill September, who sells emodrugs — and of what happens when they’re misused.

Describes the very civilized world of Thalia Major, and the effects of the Anger drug.

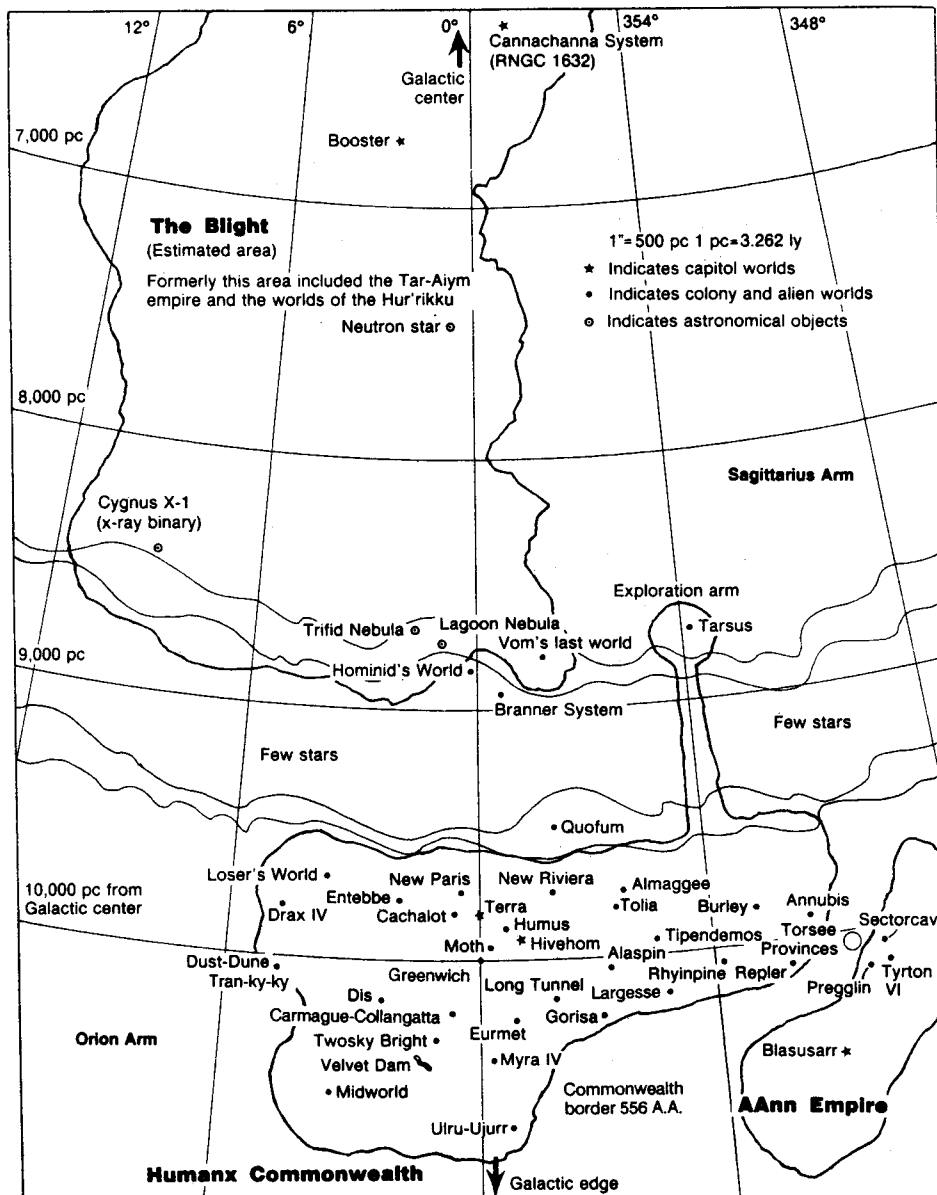

**Cachalot.** 553 A.A. — Cachalot is a water-world where humans live on floating towns and the descendants of Terra's cetaceans swim the seas. Now, something is destroying the floating towns. A team of experts is recruited to find the cause of the disaster.

Describes the floating towns of Cachalot; the Great Journey of the whales; and the discovery of the CunsnuC.

**Sentenced to Prism.** 554 A.A. — Corporate troubleshooter Evan Orgell is sent to the planet Prism to find out what happened to the research station there. His investigation is complicated by encounters with organosilicate life forms and by industrial espionage.

Describes the planet Samstead; the Samstead Mobile Hostile World Suit; and the silicate life-forms of Prism.

### The Flinx Saga

**For Love of Mother-Not.** 546 A.A. — The story of Flinx's early years on Moth, in which he is purchased by Mother Mastiff and meets the minidrag Pip. Flinx must rescue Mother Mastiff from the Meliorare Society, who are using her as bait to capture him.

Describes the world of Moth, including the Drallar bazaar and the wilderness near that city; the Mothian indigent care system; and the last known cell of the Meliorare Society.

**The Tar-Aiym Krang.** 549 A.A. — Flinx meets Bran Tse-Mallory, Truzenzuzex and Maxim Malaika. The foursome and their companions travel to Booster, in the heart of the Blight, to investigate the Krang, a mysterious artifact. Flinx discovers its purpose, and in the process his mental powers are awakened.

Describes the only two spaceship combats in any humanx novel to date; the first appearance of Baron Riidi WW; the Braav Inurb offices of House Malaika; and the Battle of Goodhunting.

**Orphan Star.** 550 A.A. — Flinx discovers a clue to the identity of his mother. His search brings him into conflict with Conda Challis, of the Challis Company, and takes him to both Hivehom and Terra, as well as the proscribed world of Ulru-Ujurr. There he uncovers an AAnn plot to undermine the Commonwealth.

Describes the Balinese headquarters of the United Church; the Janus Jewels; and the culture of the Ulru-Ujurrans.

**The End of the Matter.** 551 A.A. — Flinx searches for his natural father. Along the way, he acquires a strange alien companion named Abalamahalamatandra — Ab for short — and is hunted by Qwarm assassins. He travels to Alaspin, where he meets Skua September, from whom he learns more about his origins. The two are rescued from a native attack by Tse-Mallory and Truzenzuzex, who are trying to avert a literally cosmic disaster.

Describes the world of Alaspin; the Qwarm; and the birth of a litter of minidrags.

**"Snake Eyes."** 552 A.A. — Flinx and Pip aid an old prospector who has discovered a

hallowseye lode in the High Desert of Moth's Dead-Place-on-Map.

**Bloodhype.** 553 A.A. — Kitten Kai-Sung and Porsupah are sent to Repler to track down a source of bloodhype, a highly addictive and deadly drug. They — and Flinx — meet the Guardian, last survivor of the Tar-Aiym, and become embroiled in his struggle to destroy an almost invulnerable foe.

Describes a United Church intelligence mission; the effects of bloodhype; the planet of Repler; and a Class One Church Emergency.

### The Icerigger Saga

**Icerigger.** 547 A.A. — Ethan Fortune, Skua September, Milliken Williams, and Hellespont and Colette du Kane are marooned on the frozen world of Tran-ky-ky. They must make it to the humanx settlement of Brass Monkey, halfway around the planet. To get there, they must enlist the aid of the native tran, build an ice-ship large enough to make the journey, and battle a barbarian Horde.

Describes the tran; the fortress city of Wan-nome; the Horde of Sagyanak the Death; the

building of the icerigger *Slanderscree*; and the mysterious Brotherhood of Evonin-ta-ban.

**Mission to Moulokin.** 549 A.A. — Ethan and Skua discover that the tran are being exploited by off-world profiteers. They decide to help the tran gain Commonwealth representation by organizing the independent city-states into a confederation. In the process, they learn more about the history of Tran-ky-ky.

Describes day-to-day life in Brass Monkey; the first human contact with the Golden Saia; and Poyolavomaar and Moulokin, two of the largest tran city-states.

**The Deluge Drivers.** 550 A.A. — Ethan, Skua, Milliken, and their tran friends are recruited to carry a group of scientists to the southern continent to investigate a climatological anomaly. Again, Ethan and Skua are forced into heroics against their better judgment.

Describes the tran refugee city Yingyapin and its ruler, Massul fel-Stuovic, self-proclaimed emperor of all Tran-ky-ky; the bureaucratic processes of the Commonwealth; and further details of life on Tran-ky-ky.

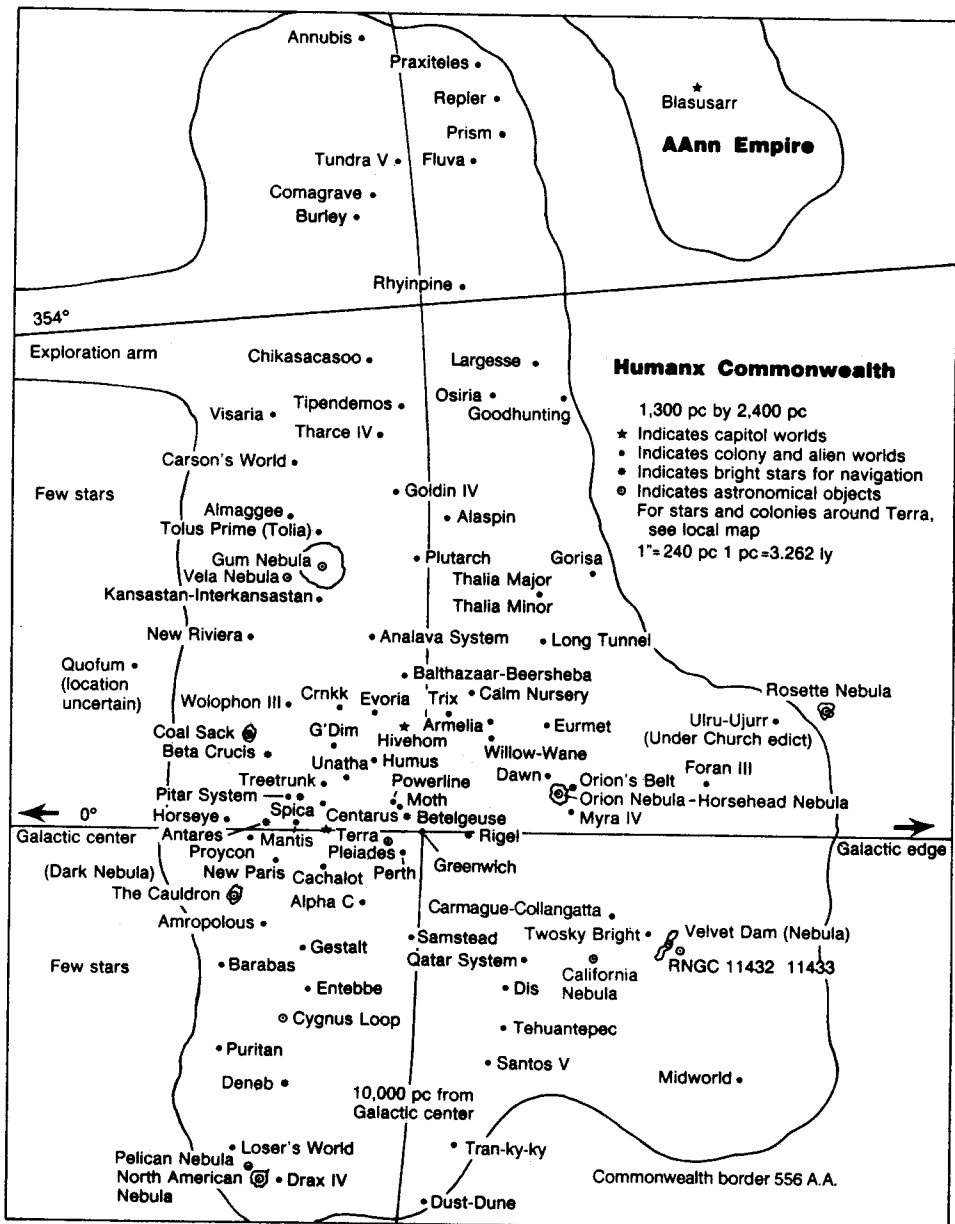

# INDEX

- AAnn, 4, 6, 8, 23, 25, 33, 37, 38, 43, 49, 50, 67;  
*AAnn-humanx cold war*, 10-11; *advantages and disadvantages*, 43; *language*, 52; *names*, 44; *status designation*, 44
- AAnn Empire, 18, 33, 43
- Absolute Direction advantage, 48
- Advantages, 48
- Aelo, 59; *aelo-vyacine*, 58
- Age, 49
- Alaspin, 4, 6, 8, 14, 18-19, 49, 67
- Amalgamation, 8, 30; *treaties of*, 6, 11
- Ammunition, 55; *Ammunition Table*, 56
- Amropolous, 20, 48, 67; *termite*, 20
- Area Knowledge skill, 51
- Armor, 57
- Arwawl, 27
- Astrogation skill, 50, 51
- Balthazaar/Beersheba, 12, 20, 67
- Battlesuit skill, 49-50
- Beam Weapons skill, 50
- Black Nebula, the, 78
- Blasusarr, 18, 52
- Blight, 3, 4, 6
- Bloodhype, 7, 8, 59
- Cachalot, 5, 8, 21-22, 44, 58, 67
- Carmague/Collangatta, 12, 22, 67
- Catalyst creatures, 64
- Cerebroneural depressants, 58
- Cetacean translator, 59
- Cetaceans, 21, 44-45
- Challis Company, 8, 88
- Charged-particle pistol, 53, 55, 56
- Chikasacaso, 23, 41, 67
- Classification, *of worlds*, 17-18
- Communications, 13
- Credcard, 57
- Credit, 52
- Dangui, 27
- Debiojection, 58
- Detect Lies skill, 50
- Dart pistol, 53, 55, 56
- Devilfish, 23
- Devilope, 30-31
- Dis, 6, 12, 23, 67
- Distances, *and travel times between worlds*, 67
- Drax IV, 12, 24, 48, 67
- Droom, 36
- Duty suit (Samstead), 49, 57
- Eint, 40-41
- Electrocution Gun, 53-54, 55, 56
- Electronics, 51
- Equipment, 15, 52-59; *prices*, 15
- Emodrugs, 58
- Emotion Sense, 63
- Exene, 58
- Faz sense, 39
- Felturney, 59
- Ferrosilicates, 20, 33
- First Aid, 50
- Flinx, 6, 7, 8, 92
- Fortune, Ethan, 7, 8, 36, 92
- Free Fall, 50
- Goodhunting, 24-25, 67; *battle of*, 6, 25
- Greencarpet, 34
- Gunner skill, 50
- Guns skill, 50
- Heightened Instinctual Perception (HIP) Drugs, 58
- Hivehom, 3, 12, 25, 38, 67; *map of*, 25
- Hivemother, 40
- Horseye, 12, 26-27, 47, 49; *Xunca on*, 3, 27
- Hornet VI Needle Thrower, 53, 55, 56
- House Malaika, 81
- Human, 5, 29, 34, 35, 38, 50, 67; *human psionics*, 60
- Humanx Commonwealth, 8, 9, 17, 38, 60; *Commonwealth Council*, 9
- Hur'rikku, 3
- Hyrall, 27
- Ichthyornith, 22
- Janus Jewels, 8, 37
- Jobs, 15; *Jobs Table*, 16
- Judo, 50
- Karate, 50
- KK drive, *see Posigravity drive*
- Koolyanif, 22
- Kossief, 36
- Lance'el, 19
- Languages, 52; *Language Table*, 52
- Largesse, 28, 67; *Largessians*, 28
- Laser pistol, 53, 54, 55, 56
- Literacy, 48
- Long Tunnel, 28, 67
- Loser's World, 12, 29, 67
- Lynx Society, 11
- Malaika, Maxim, 7, 92
- Mallost, 22
- Mantis, 29-30, 67
- Marker, 53, 54, 55, 56
- Mai, 26, 47; *advantages and disadvantages*, 47; *names*, 47
- Medical skills, 50
- Mediterranean Plateau, 25
- Meliorare Society, 6, 7, 11-12
- Microfilm Reader, 59
- Mind Shield, 64
- Mindwipe, 65; *mechanical*, 65
- Minidrag, 19
- Mobile Hostile World Suit (Samstead MHW Suit), 49, 57
- Moth, 8, 30-31, 67, 77-78; *Mothian nomads*, 83
- Mother Mastiff, 6, 7
- Mutables, 3, 50
- Na, 26
- Navigation skill, 50
- Needler (Thranx), 53, 54, 55, 56
- Nerve Prod (AAnn), 56
- Neuronic Pistol, 53, 54, 55, 56
- Neurophon, 51-52
- New Paris, 31, 67
- New Riviera, 32, 67
- Ninamu pheromone, 22
- Nineveh, 32
- Nuaman Enterprises, 31, 32
- Orcas, 45
- Ornithorpes, 23, 24, 38, 41, 50; *advantages and disadvantages*, 41; *names*, 41
- Otoids, 18, 19
- Outside disadvantage (phobia), 40
- Ozmidine, 24, 29-30, 35
- Paralysis beamer, 53, 54-55, 56
- Parsec, 67
- Paxton V, 53, 55, 56
- Penestral, 31
- Phobias, 49
- Phonic stiletto, 56
- Phycode, 52
- Piloting skill, 50
- Pitar, 5, 7-8
- Poisons, 50
- Po'pione, 24
- Porpoises, 44-45; *advantages and disadvantages*, 44; *names*, 44
- Posigravity drive, 4, 67
- Pregglin, 18
- Prism, 8, 12, 32, 33
- Psi Sense, 62
- Psionics, 60-66; *active and passive skills*, 62; *limitations*, 66; *and the Meliorare Society*, 11; *multiple feats*, 62; *side effects*, 66
- Pulsepopper, 53, 55, 56
- Quofum, 34
- Qwarm, 12, 24
- Reloading, 55
- Repler, 33, 67
- Riidi WW, Baron, 17, 89, 91, 94
- Ryozenzuzex, 5, 37
- Saia, 47; *advantages and disadvantages*, 47; *names*, 47
- Samstead, 33, 34, 67
- Sandrush, 27
- Savoir-Faire skill, 50
- Scanning, 71; *shadowing*, 71
- SCCAM, 8, 35
- Scientific skills, 50
- Sectorcav, 18
- Secun Vibraknife, 56-57
- September, Skua, 6, 7, 8, 36, 92
- Sikambi, 19, 53, 55, 56
- Skills, 49; *automatic*, 38; *new skills*, 51-52
- Squook, 31
- Spacecraft, 67-76; *charters and leases*, 13; *commercial and private*, 68-69; *combat*, 71-76; *lifeboats*, 68; *military*, 69-71; *Ship Damage Tables*, 76; *shuttlecraft*, 68; *stingship*, 69; *weaponry*, 69;
- Space-minus, 13
- Space-plus, 13, 51, 67
- Spizard, 34
- Status, 48; *and cost of living*, 14
- Stavanzar, 36
- Stinger, 53, 55, 56
- Strepanong, 27
- Stupava, 31
- Sunit, 26
- Surgiseal, 58
- Survival, *skill*, 50; *belt*, 59
- Symbospeech, 7, 52
- Tar-Aiyim, 3, 50; *Tar-Aiyim Krang*, 4, 7
- Telepathy, 62-66
- Terra, 35, 48
- Terrango, 52
- Thranx, 5-6, 25, 28, 35, 37, 38-41, 49, 50, 67; *advantages and disadvantages*, 40; *and water*, 40; *language*, 52; *names*, 40
- Tizone, 59
- Time and Dating, 11
- Toglut, 22
- Tolian, 35, 38, 42, 49, 50; *advantages and disadvantages*, 42; *names*, 42
- Tolus Prime, 6, 12, 35, 42, 67
- Topper, 19
- Torse Provinces, 18
- Toughness, 48
- Tran, 36, 45-46; *advantages and disadvantages*, 45; *names* 45; *skating* 46
- Tran-ky-ky, 3, 7, 8, 35-36, 45, 47, 48, 49, 67
- Transportation, 12-14; *interstellar*, 12-13; *surface*, 13-14
- Truzenzuzex, 6, 93
- Tse-Mallory, Bran, 6, 92
- Tsla, 26, 47-48; *advantages and disadvantages*, 47; *names*, 48
- Tslamaina, *see Horseye*
- Turabisi delphus, 24
- Tween, 58
- Ulru-Ujurr, 8, 37, 67; *Ulru-Ujurrians*, 37, 60
- United Church, 5, 9-10, 35, 52, 53; *Bureau of Supra-Commonwealth Registry*, 17, 33; *chancellory*, 10; *Church Council*, 10; *church emergencies*, 10; *headquarters*, 9; *Last Resort*, 10, 14; *Peacekeeping Force*, 9, 10, 11
- Vanisoar, 19
- Vaxail, 23
- Vehicles, 59
- Vroqupii, 27
- Wealth, 14, 48, 52; *cost of living*, 14; *starting*, 14, 48
- Weapons, *archaic weapons* 49; *missile weapons*, 51-56; *Missile Weapons Table*, 53; *melee weapons*, 56-57; *Melee Weapons Table*, 56
- Whales, *see Cetaceans*
- Willow-Wane, 4, 37, 67
- Xunca, 3; *on Horseye*, 27
- Zhaloo, 56, 57



# Man's Best Friend is a Bug!

600 years ago, in the early 24th century, mankind met alien intelligence — the insect Thranx. Despite their physical differences, humans and thranx soon found they had much in common. Within a hundred years, they had united as the *Humanx Commonwealth*. Today, humans and thranx stand shoulder-to-thorax against the ruthless reptilian AAnn, defending the dozens of intelligent races and hundreds of inhabited worlds that make up the Commonwealth.

*GURPS Humanx*, a worldbook for the *Generic Universal RolePlaying System*, takes you planet-hopping through Alan Dean Foster's *Humanx Commonwealth*, where Ethan Fortune and Skua September sailed the *Icerigger* across the frozen wastes of Tran-Ky-Ky, Flinx and his minidrag Pip activated *The Tar-Aiyim Krang* and solved the mystery of *Bloodhype*, and the great whales still swim the seas of *Cachalot*.

- *The Commonwealth Gazetteer*, a spacefarer's guide to humanx space, detailing 28 worlds within the Humanx Commonwealth. The Gazetteer describes the climate, sentient races, interesting creatures, spaceport facilities and adventure possibilities on each of these worlds.
- Complete rules for player characters of nine alien races: Thranx, Ornithopes, Tolians, AAnn, Dolphins, Tran, Saia, Mai and Tsla.
- Basic rules for psionics.
- A complete galactic history and timeline, from half a billion years in the past through the six centuries of the Commonwealth.
- Equipment from the Commonwealth novels, ranging from the Cetacean Translator to the Samstead Duty Suit, plus weapons like the Phonic Stiletto and the Neuronic Pistol.
- Complete *GURPS* stats for humanx characters, including Flinx and Mother Mastiff, Maxim Malaika, Bran Tse-Mallory and Truzenzuzex, and their AAnn nemesis, the Baron Riidi WW.
- A complete multi-session adventure set in Drallar, on the world of Moth.

Based on the *Humanx Commonwealth* stories by Alan Dean Foster  
Written by Curtis M. Scott  
with J. David George  
Cover by Michael R. Whelan

6009 960995 6009



0 80742 06009 8

ISBN 1-55634-086-9

# STEVE JACKSON GAMES