



D&D Gamemaster's Aid & Screen



This set presents a perfect combination of tools for *D6 System* gamemasters: The 32-page, black-and-white book contains tips on making worlds, customizing skills and damage in the *D6 System*, and converting between the three *D6 System* genre attribute and skill sets. Plus, a three-fold screen offers the beautiful panoramic scene of the three genre rulebook covers on one side and handy charts common to all of the genre rulebooks on the other.

For use with the D6 Adventure Rulebook, D6 Fantasy Rulebook, or D6 Space Rulebook.



\$0.00 U.S. • WEG 51019 • ISBN 1-932867-08-2
Version 1.0 • First Printing August 2004

CONTENTS

- 1. CREATING YOUR OWN WORLD • PAGE 2**
Paul Sudlow
- 2. MODIFYING THE D6 SYSTEM • PAGE 25**
George Strayton and Nikola Vrtis
- 3. D6 GENRE CONVERSION • PAGE 31**
Nikola Vrtis

CREDITS

SCREEN EXTERIOR GRAPHIC DESIGN

Eric Gibson

SCREEN INTERIOR AND BOOK GRAPHIC DESIGN

Nikola Vrtis

SCREEN EXTERIOR ART

Chris Dien

BOOK INTERIOR ILLUSTRATIONS

Thomas M. Baxa (p. 28), Elizabeth T. Danforth (p. 13),
Tim Eldred (p. 22), Jaime Lombardo & Ron Hill (p. 6),
Fil Kerney (p. 24), John Paul Lona (p. 7),
Aaron McClellan (p. 1), Allen Nunis (pp. 12, 14),
Karl Waller (p. 5)

PUBLISHER

Eric Gibson

SPECIAL THANKS TO

Rachel Gibson; Shane Hensley; Steven Marsh; screen
playtesters Ron Fricke, Max Hattuer, & Rodney Leary

PDF CONVERSION

Whill

WEST END GAMES

For free support, information about books for this
game system and other WEG systems, links to fan sites,
details on licensing this system, and much more,
visit our Web site at www.westendgames.com!

WEST END GAMES • www.westendgames.com

© 2004 Purgatory Publishing Inc. All Rights Reserved. West End Games, WEG, and D6 System are trademarks and properties of Purgatory Publishing Inc.

When you think about it, the whole process of generating a campaign world is aimed at one single goal: to give the players enough bang for their buck in the very first session to bring them back for more. That's it. If they don't like what they see, the campaign dies, if not by the end of the first adventure, then sooner or later. It's a harsh world, but that's how it is.

With this point in mind, some world-creation methods advocate expending initial creative efforts in establishing the immediate locale of adventuring, be it a small mountain village or a backwater planet out somewhere in a distant star system. The chief benefit in using this creation method is that you waste no time in work that will not be immediately utilized — almost all that you do will pay off in the first few adventures.

with a past, present, and future. Who has time and patience for all of this?

Obviously, a compromise is in order. The following world-creation method shows you how to rough out the outlines of your campaign world enough to define it in broad strokes, leaving you time to narrow your development to an immediate area. With luck, you'll be through the world-creation process before the thrill and excitement of the creative process turns to the plodding methodical work of nipping and tucking and making everything fit together just so. That sort of thing can wait until the campaign really is underway.

Right-Brained World Creation

The Human brain is separated into two lobes, a right lobe and a left lobe. The left side of the brain is the side

1. Creating Your Own World

This is an important consideration for those who have limited time for developing a campaign world, and it accounts for the popularity of commercial game settings. Many gamemasters would rather get right to adventuring than spend time fleshing out continents and language histories.

However, if you leave world development for later, your world quickly begins to take on a patchwork appearance as later innovations and ideas are cobbled in and retrofitted to mesh with previously established canon. Questions of why, say, a fanatical pantheistic kingdom peacefully coexists with the characters' home state, a martial monotheistic republic, are better answered in the design stages than in the midst of a campaign, when the gamemaster decides to pop the kingdom in over the next mountain ridge or in the next solar system.

Time spent now in planning ahead can pay big dividends later on in the campaign. It is therefore equally important to flesh out the greater world in detail, so you can deal with potential contradictions and credibility gaps ahead of time. Extensive work done in the creation stage can also provide a richer gaming environment. With campaign background worked out in advance, for example, you can sprinkle into play, not generic goodies from bygone days, but customized artifacts of enchantment or technology, each with a history and secrets to unearth.

So, on the one hand, the initial campaign setting and attending adventures need to be scathingly clever, astoundingly exciting, and marvelously mind-expanding. On the other, the macro campaign world must be developed to present the illusion of a consistent universe

that discerns patterns, processes mathematical equations, and makes rational arguments. The right side of the brain is where you combine and juxtapose unrelated ideas and past experience to synthesize new variants and analyze new situations (this generates what we call creativity). If you want it boiled down to one sentence, think of the left side of your brain as the computer, and the right side the poet.

There have been dozens of articles and essays published over the years that present excellent guidelines for developing game worlds, most of which present some sort of orderly checklist-oriented model: first, develop flora and fauna, then graduate to epic histories and socio-economics, then go on to develop languages, aliens, and what-not. This is a left-brained approach to world creation. That's a perfectly valid approach to the task at hand, especially if you are used to spending a lot of time in the left side of your head. But the right side of the brain has a lot to offer as well.

Some prefer a more chaotic and freewheeling style of creation — the right-brained. With nary a plan in sight, they crash haphazardly from here to there, yanking an idea from one source, fitting it in with another, seeing how that impacts a third, and gradually assembling a complex model that sort of works the way they thought it might. It's sort of like the sculptor who "sees" the elephant statue still hidden in the block of marble — he doesn't have a particular plan or strategy when he picks up his chisel, he simply chips away everything that doesn't look like an elephant.

Those who favor a more predictable and orderly creation methodology may feel a little uncomfortable with the right-brained technique at first, while others will take to it immediately. Wherever you fall in the scheme of things, give the system a try. Think of it as an opportunity to stretch your mental muscles and use the right side of your brain a bit.

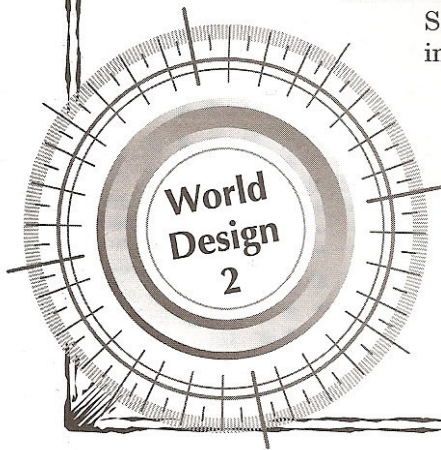

Starting at the Beginning

First, you need to decide, in a very general sense, what sort of campaign you want to run, and what genre you intend to set it in. Will it be a fantasy world of barbarian kingdoms, or a Flash Gordon-style science fantasy world filled with war rocket navies, man-eating plants, and raygun-wielding heroes?

Every gamemaster has a little mental list of campaigns he or she would someday like to run (given the time and a group of similarly interested players). Dust one of those off, and walk it through the following exercises.

The Brainstorm List

You probably have some very specific ideas about what you want to go into your campaign. In fact, there are likely about a hundred ideas darting around in your head all at once, vying for your attention. The brainstorm list is a way of tapping into all of these great ideas burbling around in your head, and getting them down on paper where you can deal with them. These ideas — features, characters, scenes, genre elements, themes, and so on — serve as the building blocks of your campaign. Once you have them where you can see them, you can organize them and settle on those that you might like to incorporate into your campaign at your leisure.

The brainstorm list is the heart of the right-brained creative method. It works just the way it sounds it should. You take a deep breath, clear your mind a bit, and then begin jotting down everything you might even remotely be interested in seeing in your campaign.

Don't analyze what you are writing, don't stop and try to develop the ideas too much at this stage; just get it all down, one point after the other. Begin with the ideas you definitely want to include in your campaign, and then move on to less crucial but interesting ideas. Get wild. Get crazy. Don't hold back.

The items on your list need not link together in a coherent fashion to begin with — indeed, the unusual juxtapositions of unrelated ideas can spark a great idea you haven't thought of. (If this sounds like you're in right-brain territory, it's because you are). One of the most entertaining aspects of this method is establishing the links between the various ideas.

You may be surprised at some of the ideas that pop out. This method, like the word-association parlor game, tends to engage your subconscious, and can produce some very interesting ideas and concepts that you haven't consciously been thinking about. It makes sense, really, since you are, just a little, stepping into a part of your brain that usually waits until you are asleep to manifest itself in the form of dreams. It doesn't happen all the time, but when you really get into it, some fairly weird but fascinating ideas can bubble up to the surface.

Speaking of convention, don't feel obligated to include anything in your world that does not interest you. Your

World Building and the Real World

If you are planning to set your adventures in the real world, the big work is already done for you — you already have your continents, histories, beasts, and languages, and everything else other gamemasters have to generate on their own.

For you, the task ahead lies more in the realm of research than world creation. Happily, this shouldn't pose much of a problem, since most of the eras (and attendant genres) of interest to gamers have already been processed into game-related sourcebooks for one system or another. You can find sourcebooks (or even entire games) devoted to everything from ancient Greece to present-day martial art empires. To uncover more resources, try searching a large library, the Library of Congress (www.loc.gov), the Internet, or bookstores (if you want to own your resources).

Alternatively, you may desire to set your game in a world developed by your favorite author. The research in this situation is mostly a case of closely reading the novels and taking careful notes.

world will benefit greatly if you spend your energy in exploring the ideas that interest you (and how they might work together) than ideas and campaign elements that don't much appeal to you but you feel obligated to include because of genre conventions.

Leave the well-trodden path and strike out into new territory. Not every fantasy world requires Dwarvish strongholds or fallen empires, and it is even possible to have a space opera setting that doesn't feature mechanical spaceships and laser guns. If the idea of a nation state of Minotaurs intrigues you more than a nation of Ogre tribes, toss the Ogres. Bored by the idea of a galactic empire ruled by aliens or a neo-Rome? You'd rather have a galactic empire ruled by evil genies freed from the bottles of King Solomon? Do it! Your players will certainly lose that jaded attitude fairly quickly. (And nothing warms the heart of a devious gamemaster more than the thought of shaken players, right?)

A bit of cross-pollination is one of the best things you can do to break yourself out of some of the clichés and stereotypes of your chosen genre (assuming you find that desirable). Say you're plotting out a fairly standard fantasy campaign, but you like the gritty, cut-throat megacorporate world of cyberpunk. So, right alongside Elvish forests and crystal mountains on your list, you write "cyberpunk." Later on, you might decide that your world is dominated not by kingdoms, but by powerful guilds controlled by sorcerers. As you can see, even the introduction of just one such concept lifted from another genre can juice up the setting and send it off into new and interesting directions.

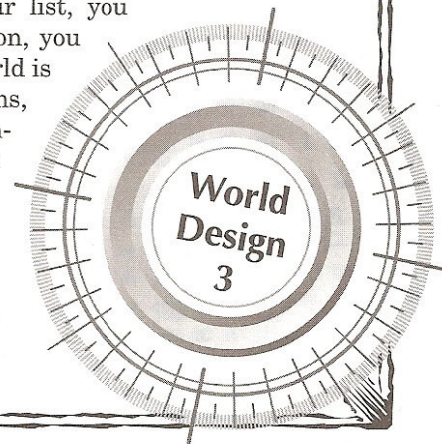

Books on Writing as World-Building Resources

Reference books on writing in general are excellent resources for the serious world builder. The brainstorm list idea presented herein grew out of an essay from *Zen in the Art of Writing* by Ray Bradbury, and other great ideas and helpful suggestions await the intrepid explorer. Especially useful to the world designer are the genre-specific books that address various areas of concern. For a general manual that delves into world creation more than this chapter, try Stephen L. Gillett's *World-Building*. When you're ready for more specifics, you'll find that there are books containing the major cultural details you might need to recreate America from 1850 to 1900 or other places (such as the *Writer's Guide to Everyday Life* series from Writer's Digest Books). Others explain how the modern police and judicial systems work (such as the *Howdunit Series* and *Behind the Scenes Series*, both from Writer's Digest Books). Still other books address issues of interest to the science fiction and fantasy writer, such as *How to Write Science Fiction and Fantasy* by Orson Scott Card.

Keep an eye on the monthly writing magazines. Every few months, they offer an article by a prominent genre writer on world building and design, often written by best-selling authors.

It is helpful in developing your brainstorm list to jot down a phrase or two that evokes one or more of the five senses, usually linked to a specific locale. Using sensually stimulating key words can help you really visualize your world, which is essential in bringing it alive for your players.

Your list will very likely change a bit as the world-creation process continues. Some ideas will be folded into others, some altered to fit the new scheme of things, and some ultimately rejected because they do not belong in the world that is emerging.

But you have to start somewhere, so don't reject ideas now you think might not fit. If they even remotely interest you, go ahead and jot them down. The worst that can happen is that you toss them out later. Ideally, their presence will create a synergy of new ideas.

Involving the Players in World Creation

Since you won't be the only Human being using the game environment you are creating (hopefully), it might be a good idea to get the players in on the brainstorm-list phase of the world generation process. The players will be far more interested in adventuring in and exploring a world they had a hand in creating, especially if you incorporate major elements they suggest into the campaign world.

Involving the players also gives you a chance to see sort of plots and adventures they'd like to see. Keep your ears open when your players are offering suggestions — they will

likely express their true hopes and expectations for the campaign at some point (though you might have to read between the lines sometimes).

For example, you may be planning a 1930s Chicago gangland campaign, and discover in the brainstorming process that while your players are excited about

the idea, what **really** interests them is the possibility of participating in a globe-trotting pulp campaign. Now you have a chance to adapt your ideas to appeal to your players **before** the campaign starts — and provide something to make everyone happy. In this case, perhaps you may start the action in Chicago like you had planned, but introduce an international shadow syndicate that is attempting to take over the gangs in Chicago. This give you an opportunity to shift the action to places like London, China, and Japan later in the campaign, to please the would-be Doc Savages in the group.

Another benefit in harnessing the creative powers of your players is that your players may come up with interesting ideas and spins on your ideas that you might not have thought of. Let the players do some of your creative work for you. You have enough to do as gamemaster as it is.

Try not to reject ideas or suggestions during the brainstorming process. Go ahead and jot them down whether you like them or not (you can discard the stinkers later). Shooting down your players' ideas during the brainstorming process because they don't jive with your vision of the game world will only frustrate your players and discourage them from making any more suggestions. The bold suggestion that takes your campaign into an entirely new and exciting direction may be just around the corner, and you don't want to risk never hearing it by being too rigid and inflexible.

Obviously, players are capable of coming up with bad ideas, or ideas calculated to give them undue advantages in the game. If you catch your players doing either, guide them back into more constructive territory and move on. But be flexible. Allow yourself to be persuaded to change your ideas a bit if the players seem very enthusiastic about an alternative plan, if you yourself see some interesting potential in it.

Don't fear that by allowing the players to participate in the creation of the brainstorm list, you are losing control of your world. You are free to discard ideas that don't work for whatever reason, whether you came up with them or not. You are the final arbiter on what will and will not occur in your game world. Keep in mind, though, that you are dependent on your players to make a campaign work

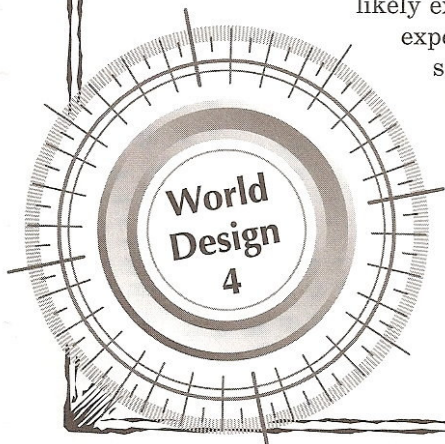

at all. Once you invite their input, make a good faith effort to use it.

Likewise, don't fear that by accepting outside input, you have lost the element of surprise and mystery. Even if a player-provided element contains information the characters wouldn't know of initially (our 1930s international criminal organization, for example), you can still tweak and twist things enough to keep the players in the dark when they **should** be in the dark.

In fact, you can use the players' familiarity with the concept against them. In our example, suppose the shadow organization was conceived by a player during the brainstorming session as a Moriarty-type organization run from England. The other players like the idea, and you decide to use it. However, you decide secretly that instead of a European organization, it is really run by a Chinese mastermind working out of the London Chinatown (shades of Fu Manchu). If your players allow their preconceptions of the organization to color the actions of their characters, you can easily manipulate them by introducing red herrings that fit their preconceptions (gamemasters have to be devious creatures).

Getting the players involved in the creative process can pay big dividends. It's simple to do when you use the right-brained process.

Sample Brainstorm List

Now that you've had a crash course in brainstorming, it's time you saw one. So let's make a sample list and see what we have. We'll include both the initial idea with a bullet and in bold, followed by an explanation to help you see where each idea came from. Normally, each element of the list is a personal shorthand notation which represents a host of ideas, images, concepts — and even smells and sounds — which, for now, exist only in your mind. When making your own list, you can jot down just enough to capture a certain thought, theme, or idea in your mind.

In this list, we'll take the first bullet and use it to establish the dominant genre of the world.

• **A fantasy world in a South Seas colonial setting.**

The stereotypical European fantasy nations may exist in this world, but they are far away. Here, the seaside forts of the Westerners are surrounded by troubled seas, deep jungles, wild port towns, and restless natives (few of them Human). The main business of the day is keeping the trade routes from the tropical spice fields and diamond mines to the western nations clear of pirates and the privateer craft of enemy nations. Magic will definitely put the locals on a more equal footing with the colonizers than were their historical counterparts in southeast Asia.

• **Fighting-sail stories: elements from the worlds of Jack Aubrey and Horatio Hornblower, with a bit of Harry Flashman mixed in for good measure.**

The works of Patrick O'Brian, C.F. Forester, and George MacDonald Fraser also would be useful in creating a fantasy take on this kind of world. Instead of cannon and grapeshot, how about sorcerers schooled in the arts of naval warfare? All officers, of course.

• **Ogre king of Siam.**

A civilized Ogre king attempts to bring his backward barbaric nation into the "modern" world as projected by the Western colonizers. This could be a non-Human version of King Mongkut (the nineteenth-century king of Siam immortalized in Rogers and Hammerstein's *The King and I*), or the various Tokugawa and Meiji-era daimyo of Japan.

This fellow is cultured, urbane, well-educated, and desperate to modernize his nation fast enough to keep Westerners from invading and colonizing his kingdom. Our Ogre king will be an important figure in the local balance of power.

His warriors and farmers are probably not as urbane, though Ogres in the tropics are likely not as fierce as their northern cousins (the hospitable environment and plentiful food sources have softened their culture). This could lead to some interesting culture clashes with the colonizing northerners, who are more used to the violent Ogres of the northern plains of their home continent.

• **Turn an Earth convention on its head — literally.**

For a change of pace, turn the globe upside down, and put the pseudo-European powers in the far south rather than the far north.

Let the backward colonies lie to the north for a change. If this little departure from the European model serves to remind the players not to make assumptions about the campaign environment, it serves the purposes of making the campaign more intriguing.

• **Aztecs.**

Let's give the colonists a bit of an Aztec flavor just for fun. Let's not be too conventional here!

• **Giant swans.**

Talk about avoiding convention! On the face of it, giant swans sound silly. Hopefully the players will think so, too — until the massacre begins.

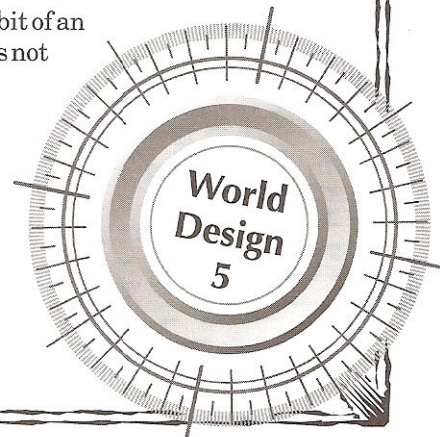
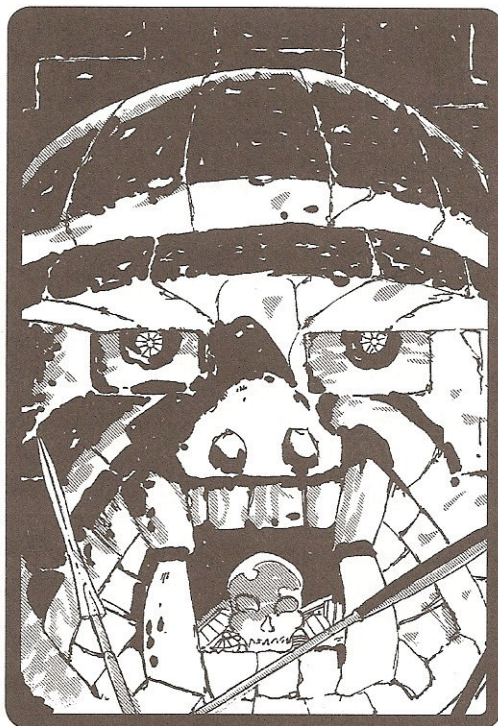

In a book on children's book illustrators, Kay Neilson had a fanciful painting featuring several fierce roc-sized swans swooping down to devour a party of panicked Persians. Despite their common image as peaceful tranquil animals gliding along on glassy lakes, swans can be fierce birds. Normal swans eat tiny fish, but what might huge swans eat? People, maybe? Pelicans might work better than swans in a sea setting.

- **Mermaids.**

Mermaids definitely have their appeal, and they certainly fit the genre. There ought to be something a little different about them, though. We'll figure it out later.

- **Pirates.**

Of course. They may have their own war mages.

- **Elements from southeast Asian cultures and myth, and maybe a bit lifted from Persian culture.**

Things like giant turtles, bird gods, and so on. Then again, the colonists might have a bit of this themselves, depending on how closely I decide to stick with the Aztec idea.

- **Bamboo glades, bright green and misty.**

Picture a verdant and peaceful forest of bright green bamboo stalks, gently tonking and clacking against one another in the breeze. This is a little atmospheric element I'd like to work in somewhere (not all of your elements need to be major).

- **The presence of an equally distant pseudo-Chinese empire.**

It has a complex culture and Byzantine political structure, with endless ranks of skilled bureaucrats, diplomats, and governors. The assignment to the campaign area is seen by the government officials and merchants of this nation as an exile. Perhaps they are out of favor at Court.

Could lead to political intrigue.

As you can see, this list is more developed than most initial brainstorming lists will be.

As long as you write the phrase or sentence in such a way that seeing it again will bring to mind all of the associated details you want to include, you've put enough down. If you want

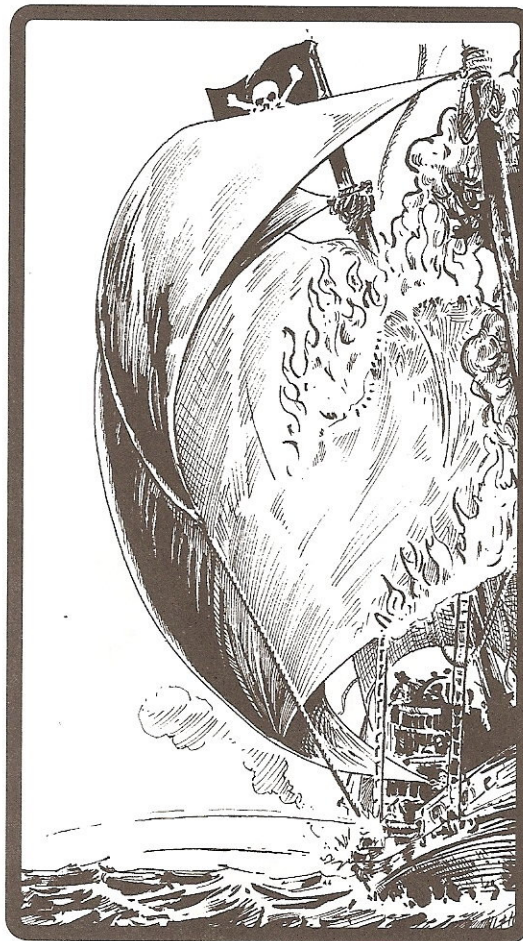

to go ahead and flesh an idea out a bit at this stage, by all means do so, but don't get distracted from the task at hand, which is to get as much of your world down on paper as possible. When you are more interested in fleshing out the ideas already on your list than in adding more, regard this as a sign that you are ready to move on to the next step in the world-creation process.

Deciding where to stop the brainstorm list is occasionally difficult. Usually, you'll know to stop when you run out of ideas, or again, when you feel ready to develop ideas already on the list. It is definitely time to stop when one ridiculous idea after another finds its way onto paper (a few ridiculous ideas can liven up a campaign; too many are just, well, ridiculous).

Note that there are no restrictions on how long or short a brainstorm list should be. Don't stop just because you think 10 pages of ideas is too much. If the great ideas keep coming, keep writing them down. If you get too much for one campaign, you can always reserve some ideas

for future installments in the game world.

World Development

Once you have your brainstorm list finished (more or less), the world-creation process begins to settle into the traditional checklist method. It's time to get more left-brained and procedural, in other words, and start making sense of what you just wrote down and seeing how it might fit together. From there, you'll move on to create cities, societies, strange beings and gamemaster's characters, continents and planets, and a host of other people, places, and things that can serve a purpose in your campaign.

Focusing the Campaign

Look over the brainstorm list again. By now, the broad outlines of your campaign should be emerging. Decide what the general focus of the campaign will be. Will it be on the grand events you have plotted out, or on a smaller stage, with the grand events occurring in the background? Which element of your brainstorm list will serve as the centerpiece of your campaign?

You also need to decide what role the players' characters will play in this new world. Will the players be major players, or small-timers just trying to make a living?

Let's use the South Seas playing environment we cooked up in our sample brainstorm list to highlight key points in

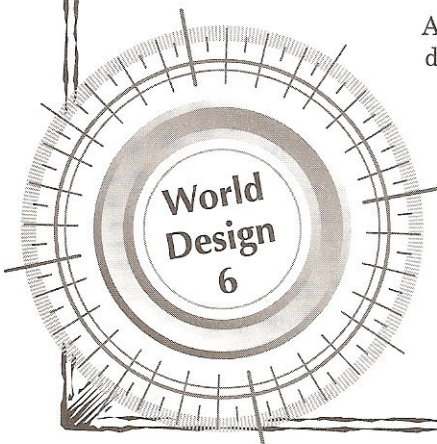

the world-creation process. To make referencing it easier, we'll give our world the name of Javarta.

First, we need to decide on the general focus of the campaign. Look over the list again. Where would you focus the campaign? On the swashbuckling elements of the fighting sail yarn — pirates, ships laden with the riches of the "orient," vibrant islands filled with tropical splendor, ancient lost kingdoms ruled by killer apes, volcanoes, and so on? On the intricate diplomatic maneuvering between the Ogre king, the great Eastern Empire, and the representatives of the Southern colonizers? You may as easily settle on another focus altogether.

As we mull this over, we also need to consider what we want the characters to be doing, both to begin with and further down the line. I kind of like the idea of starting them off at the low end of things; it has a traditional feel to it. I do intend to move the characters up in the world eventually. I'd like them to take on diplomatic missions, fight off the invading armada of a foreign sea power, and perhaps even wind up running things.

That's some time in the future, however. For now, let's start the characters off on a lowly tramp freighter, running goods from the single open port of the Eastern Empire to Javarta, the main port of the Colonies. This means the focus is relatively tight on the characters, and other minor players. Major events in the Colonies will occur in the background.

Notice how the campaign world is already taking shape...

By the way, we could have as easily started the characters off as second sons or daughters of noble houses sent to the Colonies to supervise their families' investments. They could have even started off as minor Ogre or merfolk diplomats. Go with whatever strikes your and your players' fancy.

The Campaign Format

Before really getting into the gritty details of world construction, you need to make a basic decision on the sort of campaign you feel will best complement the campaign setting and your group of players. There are three general campaign formats we need to talk about: episodic, series, and epic.

These are not hard and fast divisions, and a campaign might shift from one format to another at just about any time, or lie somewhere between. For example, a casual campaign begun as an episodic campaign might shift into a series or epic campaign as interest in it increases, the players have more time to game, and so on. You do need to settle on one or another to start things off, however.

Which sort of campaign you pick largely depends on the sort of campaign you want to run, the sort of players you have, and time. Time is the biggest constraint on a campaign, and if you cannot devote a great deal of time to developing intricate story arcs and settings, the episodic route is the way to go. The episodic campaign is also a good place to start if you don't have a lot of experience at gamemastering.

Episodic Campaigns

These are loosely-linked, if they are linked at all. Like the typical television series, the only common elements running from adventure to adventure are the characters and their game setting and, occasionally, a few major villains and allies.

The episodic format suits a group that meets irregularly, desires only a casual gaming experience, or has several gamemasters who want to tag-team from adventure to adventure. This style of campaign also suits certain genres, especially those involving some sort of pseudo-military organization that sends the characters out on commando-like missions, few of which tend to be related.

Series Campaigns

Series campaigns feature story arcs that stretch over a number of sessions. They include many recurring gamemaster's characters and situations. Story arcs overlap, and new arcs are introduced as old ones conclude or fade into the background. Soap operas are the perfect model for the series campaign, as are comic books.

Major story arcs are those that involve all the characters, such as a war ravishing the play area, a plot to take the crown, or a quest. They may or may not affect the game world itself, but they definitely have major affects on the futures of our heroes.

Minor story arcs (or subplots) run in tandem with the major story arcs, and usually they focus on specific characters or small groups of characters. It is not unusual to have many minor story arcs going at once. Examples of minor story arcs include a romance between characters, a character's induction into an exclusive secret society, a character's quest to avenge her parents or simply to discover who they are, and a character's attempts to avoid an assassin or bounty hunter trailing him.

Minor story arcs are, often as not, initiated by the players. If your players enjoy

developing their characters, and investing in them desires and goals that transcend the immediate adventure, the series campaign may be the right choice for your group.

The series campaign is probably the most common format of campaign play out there. It allows characters to develop, permits the gamemaster to weave a grand tapestry for the players to enjoy, and is flexible enough to adapt to the changing interests of both players and gamemaster.

Epic Campaigns

Epic campaigns center around the Grand Quest. This is familiar territory to readers of fantasy fiction,

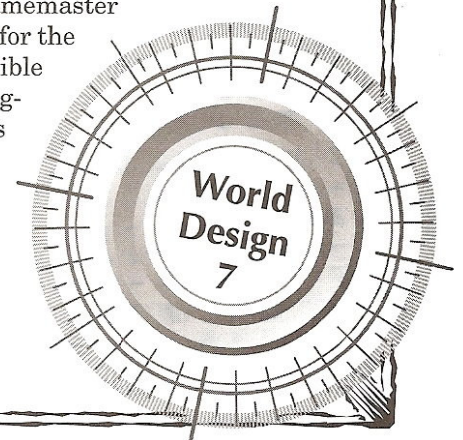
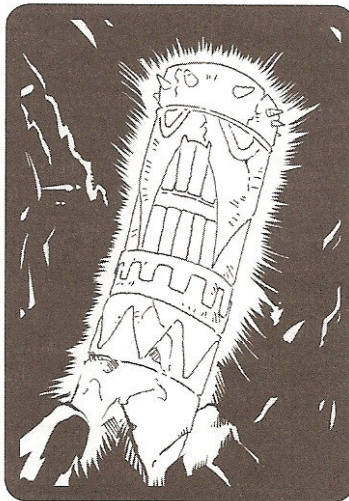

but it is equally present in space opera as well. The Grand Quest may feature a search for a highly sought-after artifact, a need to defeat a mighty enemy, or even the quest for self-identity. If the foil of the Grand Quest is personified by some sort of arch-villain, this figure is often extremely powerful (not to mention hubristic to the max), possibly with one unseen but extremely exploitable weakness.

Each adventure builds upon prior adventures and brings the characters closer to their goal (though there will likely be numerous setbacks, digressions, and red-herrings along the way). The characters may begin the campaign as humble nobodies, only to rise to greatness as the campaign nears its end. The climax of an epic campaign should be truly memorable.

The epic campaign is much like a series campaign, except that it only has one major story arc, which is the Grand Quest. Once the quest is resolved, the campaign is over. Like the series campaign, it features many recurring gamemaster's characters. These characters, however, are designed to serve specific purposes in the campaign. They may rise to do famous or infamous deeds, or die along the way in a suitably glorious or horrible or random way, whichever serves to advance the plot.

The construction of an epic campaign requires a great deal of advance work by the gamemaster. You don't need to write every single adventure ahead of time, but you must plot the main events of your campaign out in advance, develop the gamemaster's characters you need to bring about these events, and figure out enough of your world background so you can anticipate how things will go. You may also wish to design backgrounds for each of the players' characters (instead of letting them create their own). You must **definitely** have a good idea of how you want to wrap up the campaign before you start it.

The epic campaign is very literary, and it can be made to evoke the grand stories of fiction and legend. It isn't easy to pull off, however, and requires dedication from both players and gamemaster. Once begun, there can be no significant deviation from the plot line (though short "breather" adventures are certainly appropriate from time to time). The campaign will either go on to its climax, or die on the way.

Our Example World

Let's assume that the gaming group meets once a week. This means that the group will get together often enough so that details from the last session will not be forgotten in the interim. The campaign can therefore be fairly intricate, and numerous subplots and story arc can be carried over from session to session.

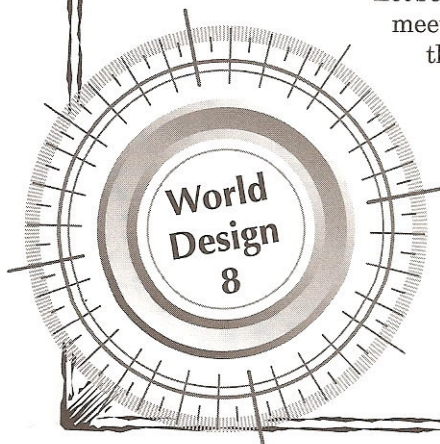

World Details and the Real World

If you are setting your campaign on Earth with little deviation from current history, technology, and so on, most of your world building is already done for you. About the only thing you need concern yourself with, aside from the research you have to get done, is determining if and where your reality deviates from that of the real world.

This isn't even a consideration in some cases. If you are recreating a certain historical era or mood — say, the swashbuckling swordplay of Dumas' French court, or espionage adventures of World War II — you are playing history relatively straight. The only considerations you need take into account is how realistic your version of the real world is — or how cinematic.

However, there are plenty of great subgenres and campaign ideas out there that tweak Earth's laws and history just a bit. Earth-with-a-twist genre are modern-day tales featuring some unusual or strange aspects, such as vampire inspectors, immortal swordsmen, UFO-hunting FBI agents, and time-leaping scientists. In these cases, you might find the sections on supreme beings and special effects thought provoking.

In cases like these, you need to explain, at least to yourself, how these things came to be, and why they have not readily impacted history as we know it — yet. (Of course, if you are developing an alternate history campaign, they may have already changed things.) For example, say you decide to develop a world set in modern America featuring Elves who abduct people and dissect them in underground laboratories. You need to explain where these Elves come from, why they are doing what they are doing, what allies they might have in the upper world (maybe they are helping Irish revolutionaries, the Russian government), or the like.

Unfortunately, it also means that, as the gamemaster, I will have only so much time between sessions to develop future adventures. We'll settle on a series campaign for now. This means I only have to stay one or two weeks ahead of the players. It also means the group can easily temporarily stop the campaign between major story arcs if, say, vacations, school breaks, or holidays are coming up.

Narrowing the Focus

To this point, we've played kind of fast and loose with things, but now it's time to start getting a bit more selective and detailed. It's time to start making sense of the brainstorm list.

It's also time to start thinking about what stays and what goes. Unfortunately, this isn't a single step that can be taken now, or at any specific time during the world-creation process (of course, you now can toss the elements that obviously don't fit with everything else). The decision to develop or reject ideas will come up again and again as you proceed. Sometimes, it won't become apparent that an idea is not working out until relatively late in the process.

These decisions will come to you as you continue creating your world.

The World as We Know It

We are now at the point where other folks usually begin their world building. As before, there is no one way to proceed, because there are as many ways of organizing and building on the information you are generating as there are gamemasters out there doing it.

Some gamemasters start with a map, where they can lay out their ideas of nations, adventure locations, and so on. From there, they might extrapolate histories, trade routes, alien or monster locales, and so on. Other gamemasters prefer to begin with the raw materials of the game world — cities, strange sites and beasties, conflicts, landmarks, and so on — and build up a world out of that, only coming back to a map at a later point. Still others start with the world's history, or the beginning adventure locale, or pantheons and religions and cults, or... The bottom line is that there are plenty of logical places to dig in and start working. The brainstorm list gives you a foundation to build on, but where you start the actual construction is up to you.

From here we will tackle a number of issues which need to be addressed at one point or another. Read them all through, and start in wherever you want to. Of course, since we have to build on our sample world in some sort of logical manner, we'll have to favor one order over the others, but keep in mind that everything is flexible.

Supreme Beings

Gods as a force are most common in fantasy worlds, and the following discussion is weighed toward that genre. However, other genres feature gods and their equivalent — super-advanced alien species and extradimensional beings — and we'll touch on those as well in a bit. If you don't intend to include supernatural aspects in your campaign, you can skip this section. Religious organizations as political and economic (i.e., secular) forces can be developed at a later point in the world-creation process, along with other political bodies. We are focusing on the actual supernatural aspects of religion here.

Gods play a large role in the shaping of most fantasy worlds, and you'll likely want to spend quite a bit of time developing a pantheon and a thumbnail history of the gods if you intend to make a fairly typical fantasy environment. Did they create the worlds and races of your campaign? Do they meddle in the affairs of men and women?

The gods may or may not play a direct role in the day-to-day lives of mortals at the time of the campaign, but they usually make their presence known to some extent or another — by blessing temples and champions, granting miracles and powers to their priests and shaman, and so on.

Polytheism. The religions of the ancient world featured a plethora of gods and goddesses, each with his or her own territories, specialties, and interests. In the polytheistic model, one god might concern himself with storms,

the sea, and travelers of all stripes, while another might be the patron goddess of the harvest, fertility, and cats. Polytheism exists as a popular option for many fantasy worlds, because it presents a familiar model with many colorful options.

Pantheism. In primitive forms of pantheism, everyday objects, locations, and activities are imbued with minor deities who must be placated, paid homage to, and worshipped. A bridge or forge might be possessed by a spirit its users would be wise to acknowledge and respect. Often, the demands of such gods are minor — a few annual observances and ceremonies, a short ritual before use, and an occasional minor sacrifice are all that are necessary in most cases. Those living in a pantheistic world do well to observe these modest demands, since ignoring them risks angering the gods, which is seldom healthy (a farmer neglecting to pay homage to the spirit in his well might discover that it has run dry).

Totemism and **animism** are related aspects of pantheism. Communities each have their own gods and spirits that are bound to them and protect them. These gods are given anthropomorphic features and (in animism) animal identities and worshipped. When a community goes to war or sets out on a long journey, the totem, or a fetish of the totem, is taken along.

The spirit of the totem can be counted on to grant favors, fend off attacks by evil spirits, and otherwise aid its community. The demands of the totem

spirit usually reflect the character of the community (or vice versa): Totem spirits of tranquil and peaceful communities require only sacrifices of animals and grain, while those from more violent and savage communities might demand a great deal more, from castration to Human sacrifice.

Monotheism. A monotheistic campaign is one featuring only one supreme deity, perhaps served or opposed by lesser supernatural beings of His, Her, or Its creation. The monotheistic option is a good one if you are interested in creating a world with significant elements found in our historical past, such as a strong central church, or crusades between factions who worship differing aspects of the same supreme deity. You may desire to pattern your religion after the Jewish, Christian, or Muslim faiths, or you may want to design your own flavor.

Atheism. There may be no gods at all in your universe, of course. The universe is a colossal but random accident. Religious organizations may be led by sincere believers

Creating Your Own Religions

For suggestions on detailing your own religions, including a worksheet and a method of generating miracles, see the "Miracles" chapter of the *D6 Fantasy Rulebook*.

or charlatans, but all of them are in reality nothing more than secular Human-driven organizations with their own agendas and goals.

There may or may not be powers greater than Humans in the universe, but if they exist, they aren't gods. This idea dovetails into the next area of our discussion, greater beings.

Greater Beings. Gods tend to be rather absent from the science fiction genre. You can do a lot of campaigning in an science-fiction setting without even once suggesting that there are things greater than Humankind and other species at their level of development.

Many futuristic universes have other beings pinch-hitting for gods, however — these are beings and aliens so far ahead of us on the evolutionary scale that they might as well be gods for all the power they have over mere mortals. These “gods” may play a minor role in your campaign if you include them. Perhaps the only signs of their existence are mysterious ruins found on isolated and desolate worlds, or other artifacts. In this capacity, they serve to add color to your campaign.

They can also play a more active role in the campaign as well. A classic space opera theme features two teams of super beings vying for unknowable goals, using people as pawns — pawns who are largely unaware of the great struggle going on above them.

Our Example World

The Javarta campaign lends itself well to emphasizing a clash of cultures — between the Colonists, the Ogre kingdoms, and the Eastern Empire. I am going to mix categories a bit, and suppose that long ago, when the gods were developing the world, they split it into distinct zones and regions. The south is dominated by gods who cleave close to the polytheistic model: There are storm gods, gods of childbirth and harvest, and gods of the hearth and weaponry.

The same holds true in the Northern hemisphere, where the Eastern Empire is based. There, the gods are organized in a complex bureaucratic order that is reflected in the Human civilization of the Eastern Empire. Education and culture

are revered by these gods more than brute strength and prowess with weapons (the education, of course, allows the Imperial armies access to more powerful and technologically advanced weapons and magical forces).

In the tropical climes, pantheism holds sway. Though the local gods are not as powerful as their

Northern and Southern cousins, the gods of the two poles are weaker here, so things are rather evenly matched. There are minor spirits everywhere — in the forests, in the lakes and springs, in bridges, on roads, in fields — everywhere. Traveling into the wilds ignorant of the methods of placating these spirits can be perilous (just try to cross a rope bridge without paying homage to its spirit), and knowledgeable guides are crucial to any expedition setting out into the wilds. In the colonial cities, things are more orderly and predictable (from a Southerner's point of view), since the number of Southern worshippers boosts the power of some of the Southern gods.

The Laws of God and Nature

While you're settling on the role of the gods of your world (if any), you need to give some thought about its form and natural laws as well — some of which may vary from those of our own Earth. How much time you spend on this sort of thing really depends on what sort of genre you are setting your campaign in. In general, it is safe to

assume that your world or worlds obey the real world's laws of physics until and unless you say otherwise. That is, water runs downhill, planets orbit suns, and π is never a round number.

Just how far you deviate from the Earth model depends on what sort of genre you are developing.

Historical/Contemporary. This world is, for all setting purposes, the real world as we know it (though you can, of course, invent new organizations, historical figures, and so on).

What you need to do is decide how cinematic or realistic your campaign will be. What are realistic campaigns? People die easily from gunshots. Heroes can't jump from a bridge onto the back of a Harrier jet and expect to make it. A game set in a historical medieval Europe resembling Umberto Eco's *The Name of the Rose*. What are cinematic campaigns? Bigger than life — taking multiple gunshots, jumping from a bridge onto the back of a Harrier jet, and jetskiing down Niagara Falls are all in a day's work. The cinematic historical medieval Europe more resembles Hollywood's *Robin Hood* pictures.

Science Fiction. In most science-fiction universes, the physical laws operate more or less as they do in ours. However, there are many conventions of science fiction we know or suspect to be impossible, among them faster-than-light-travel, matter transmission, and time travel. (Special mental powers, such as ESP, PSI, and so on, are also a staple of science fiction, which we'll tackle in the next section.) Isaac Asimov used to maintain that he allowed himself one physical impossibility per story (he usually opted for hyperspace travel), but there isn't any reason you can't expand the list. Certain deep-space franchises certainly do.

Panentheism

Panentheism is most obviously seen as a related version of monotheism, in which the universe is a part of a larger divine being, which also created it. However, polytheism also can be panentheistic, where various parts of the world are considered visible portions of different divine entities (such as the moon existing the eye of a particular god and mountains as the backbone of another god).

Religion in Contemporary or Futuristic Campaigns

Contemporary or science-fiction campaigns may follow one of these models (especially monotheism, since contemporary and future histories are derived from our own largely monotheistic culture). However, most contemporary or science-fiction campaigns tend to treat religious organizations as nothing more than secular organizations, more political than religious. Few concern themselves with actual religious aspects of religion (i.e., miracles, answered prayers, and so on). It might be interesting to tackle a modern or futuristic campaign where higher spiritual powers exist (in some form) and prayers are answered. C.S. Lewis had an interesting take on Christian science fiction worth looking at as an example.

Not all science fiction is the same. The emphasis on physical laws is more pronounced in a nuts-and-bolts hard science-fiction environment than in a true space opera.

Fantasy. Fantasy worlds tend to, by definition, be a little, well, **fanciful**. Fantasy tales and myths before Tolkien were largely centered on Earth itself — an Earth somewhat like our own, but one ruled by capricious gods, unpredictable fey folk, fairy tale witches, and the like. Tolkien's generation introduced a new concept, a world that is patently **not** Earth, but behaves, for the most part, as if it were.

Patterning your world after Earth makes your job easier if you want to follow in a similar vein, but doesn't get you entirely off the hook. You still need to define how the laws of your world differ from those of Earth. Do the planets travel through space through the force of gravity, or are they carried about on the backs of mighty gods? Did the flora and fauna of your world evolve, or spring into being at the command of the gods? One big decision facing you in developing a fantasy world is the role of magic. We'll move on to that topic in the next section.

You don't necessarily have to use Earth as your model, of course. You might as easily make your "world" a hollow planet, an ocean world of many small islands or no land at all, a string of asteroids suspended in an ether of breathable air, or a flat disk spinning through space on the back of an immense turtle. All of these possibilities raise some thought-provoking questions about economics, military history, and so on, which can add many interesting elements when answered.

Our Example World

Let's keep at least **one** aspect of Javarta simple! The world the island Javarta is located on is very Earth-like. It has a similar mass, a similar climate, and one moon. Just to make things a little different, let's pop in something new: a red comet that orbits the planet at a distance roughly twice that of the moon. It was captured by the planet's gravity ages ago, and caused a great deal of upheaval at the time. This event could work in nicely when we get to nailing down some of the planet's history.

Mixing Genres

Don't forget the trick of mixing genres for stirring up some old themes a bit. Remember our example about King Solomon's genies ruling a galactic empire? You **can** play with things a bit, if you like.

Special Effects

If you intend to introduce into your world special effects — magic, psionics, super-science, superpowers — you need to spend some time actually determining how they will work. You have two tasks before you: to determine how the special effects work in terms of game mechanics, and how they work in terms of world logic. The difference is this: game mechanics explains the

rules of the system (establishing, say, the rule that a mage must use a special ingredient to cast a spell). World logic explains the **reasons** for the rule in the context of the **game** (i.e., that using the special ingredient to cast the spell is necessary because the mage is using sympathetic magic, which in your world requires an ingredient with a link to the target, like a lock of hair or personal effect).

Determining the rules of the special effects system is your job — you, perhaps along with your players, must develop magic spells, PSI powers, and other aspects of the supernatural to suit your campaign. You can use the rules for various special effects presented in the rulebooks, or you can make up your own. You can find a magic system in the *D6 Adventure* and *D6 Fantasy* rulebooks, psionics in *D6 Adventure*, and reality manipulation (metaphysics) in *D6 Space*. All of the books contain Special Abilities suited for low-level super-powers and super-science games, and you can use them to create your high-level versions.

Before you are ready to go shopping for special effects system mechanics, though, you need to ask yourself some basic questions about how and why that system will work in your world. That brings us back to the question of how special effects work in terms of world logic.

We'll break the discussion into three common applications of special effects: magic, miracles, and psionics.

The Science of Sorcery

You've decided to include magic in your world. Where does the magical energy come from? Another plane of existence? A finite pool of mana? The gods? Is it drained from other living beings? Or is magical energy an integral component of the universe that is readily available?

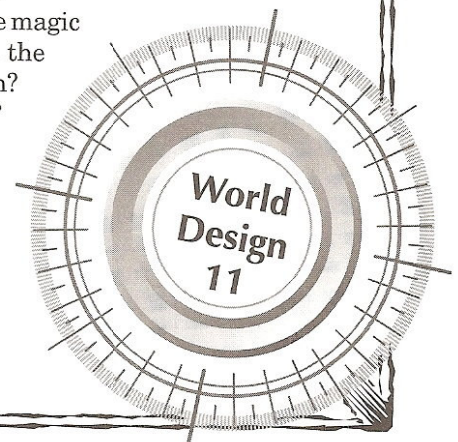

How does magic work? Is it an inborn talent passed from parent to child through the bloodlines, or is it a trade anyone can learn? Does use of magic require years of careful, specialized training, or can anyone pick it up after a few tries? How dangerous is it to use? Can things go drastically wrong for the unwary, clumsy, or distracted, or is a fizzled spell harmless? (In other words, what happens on a failure or Critical Failure result?)

How do mages use and channel magic energy? Do they use artifacts and totems? Do they cast spells they have memorized, or can they cast any spell at any time, as long as they have the requisite knowledge and power? Do they use props to work their magic, like rings, idols, scrolls, or crystal balls? Does the use of magic come with hidden costs? Does the use of powerful sorceries warp nearby plant life, or corrupt the body and hasten aging? Answering these questions helps you determine what sort of aspects (particularly gestures, incantations, components, and feedback), if any, are required when designing spells, as well as determining an appropriate starting Spell Total.

How common is magic in your world? The more common it is, the more your world will differ from our own. Yes, that's a fairly obvious point, but it does have far-reaching ramifications you need to think through. For example, if you really want to include traditional castles in your world, but you also want to fill the skies with flying magical contraptions, you'll need to figure out why the open-air castle design has developed when it now has numerous weaknesses and vulnerabilities it never had before from aerial assaults.

Low-entropy worlds are those where magical power is rare and seldom seen, and a magical ring or enchanted sword is a mighty treasure worth fighting wars over. High-entropy worlds, on the other hand, feature floating cities, teleportation rings on every finger, and unicorns for horses. Obviously, these are the two extremes. You need to decide where on the scale you plan on coming down. Here are a few more details on the two extremes.

Low Entropy. In a low-entropy world, magic is quite rare, probably only accessible to a few trained specialists.

Society is very similar to our own feudal period, since there isn't enough magic to present viable alternatives to the regular, mundane ways of transporting goods, healing the sick, fighting wars, protecting castles and towns, and so on. A handful of communities supporting an accomplished wizard might have a couple new

ways of handling problems, but there aren't nearly enough of them to have a real effect on the way things are done elsewhere.

Maybe magic is just plain weak, and most practitioners are simple hedge wizards. Alternatively, mages might be naturalists who seldom leave their groves and mountain retreats to traffic with mortal beings, except to seek apprentices and offer their services just often enough to provide for themselves.

The general populace, unaccustomed to magic, probably regards mages with considerable distrust and fear, even if the mages serve a useful and appreciated function in society. Rulers tend to appreciate mages if they control them, and fear those outside their spheres of control. Wizards are likely secretive and have developed a variety of ways to communicate amongst themselves without revealing their powers to others. Some might use carrier birds, while others employ crystal balls.

High Entropy. In a high-entropy world, magic is everywhere. Every maid knows a cantrip or two to brush her hair or lace her bodice, and every warrior has a spell

memorized that cleans and sharpens his sword after combat. Poor traders may still travel by horse-drawn cart, but the wealthy merchants travel from town to town in flying houses and ships. Mighty engines of war float above the earth, ready to rain fireballs, siege stones, and magical blights upon enemies below.

This is a rather extreme example of a high entropy world, but the point is clear. The more magic is present, the less the culture will resemble our own historical past.

Entropy need not be static. Larry Niven's *The Magic Goes Away* presents a world where magic is fueled by a finite supply of mana. Once, mana was plentiful, and mighty sorceries possible. Now, however, thanks to generations of selfish

and short-sighted wizards drawing on huge amounts of mana to work their miracles, mana is nearly gone. Even simple spells are now failing, and the creatures of legend such as the centaurs and unicorns, which depend on magic-rich environments for survival, are dying.

In your world, too, the presence of magic may be less than it once was, though you need not use mana as a source of magic to make it work. Maybe a comet — a great lodestone — is approaching the planet, dampening the powers of magic as it draws near. Alternatively, the presence of magic may be growing. Maybe the comet disrupts a protective dampening field the gods placed around the planet to keep Humans from destroying one another with sorcery. Imagine a campaign in which magic has been on the rise for two generations as a strange comet approaches. However, as it nears, the elation of the scholars and mages fades as they realize that the comet is on a collision course with their world. The characters must travel from state to state in an attempt to stop the many magic wars that broke out

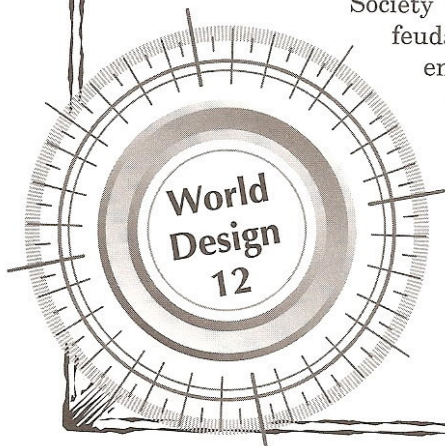
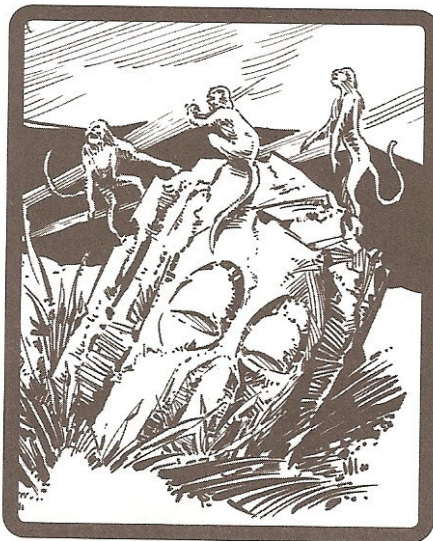

as governments flexed their new muscle, in an attempt to get enough wizards enlisted in the effort to repel the comet from its fixed course. If they fail, the comet will smash into their continent and wipe out all life on their planet! That's drama for you.

Whether magic is tolerated or not depends on more than just entropy — the history of magic is also important to consider. Is the use of magic associated with some great cataclysmic event in the past? If so, modern users will be viewed with suspicion at best, and violence at worst; common people fear that if the use of magic is tolerated, the disasters of the past may be repeated. On the other hand, if magic was used to save the world as its inhabitants know it (say, in a great Goblin war that threatened to destroy all Human civilization), contemporary citizens may have a tolerant view of the magical arts, even if it is rarely practiced in their time.

Our Example World

Magic in Javarta is quite rare. This is important to establish, since too much power would begin to undermine the rationale for sea clippers, island forts guarding harbors, and other trappings of the South Seas environment that this setting is trying to capture.

The Colonists use a very mathematical, cabalistic approach to magic. Southern magic is methodical, formulaic, and relies heavily on maintaining a calm, emotionless state. Southern mages tend to become extremely specialized as they advance.

The Eastern Empire mages use a similar approach (both schools of magic spring from common ancient roots), though astrology figures more in their calculations. The Easterners have mastered the art of capturing their magical incantations on parchment, something the Southerners have not yet discovered how to do.

Developing a comprehensive magical system for the world of Javarta is beyond the scope of our exercise, so we'll leave our comments at that. Developing three magical systems (the shaman "magic," or wonder-working, is developed in the next section) will certainly be a bit of work, but can go a long way toward establishing the different moods and traditions of the three cultures.

A benefit of developing more than one system is that you can keep the specifics of foreign magic traditions secret from the players. This can introduce an authentic aura of uncertainty when players' mages (from the South) encounter their counterparts from the East or Ogre tribes — they can

never be quite sure what a foreign mage is capable of. This uncertainty is difficult to capture in systems featuring just one magic system, since the players soon learn all of the capabilities of that system.

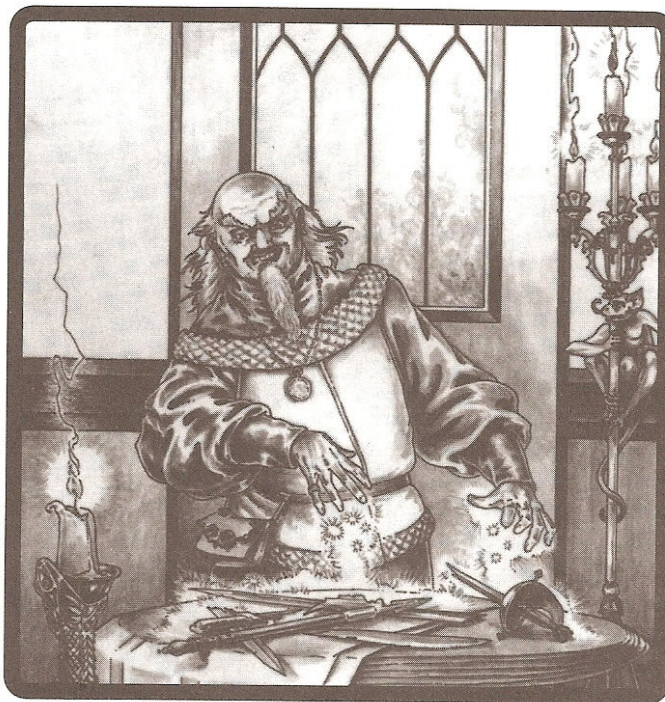

Religious Wonder-Working

Religious wonder-working is power granted to worshippers by their gods. Whereas mages obtain their power from the universe itself (in most models, anyway), worshippers obtain it directly from their deities, or the supernatural agents of those deities.

In terms of the rules, there is little difference between magic and miracles. The difference is in the flavoring and trappings, as it were. What do the faithful have to do to obtain special favor from their gods? Pray? Protect a sacred site or object? Slay or convert infidels? Make sacrifices or offerings? Do deeds pleasing to the god in

question? Go on holy quests and crusades? Many gods will demand most of these acts from worshippers at one point or another, but what specific procedures must a worshipper go through to obtain power in the form of miracles, spells, boons, and so on?

Who can obtain such favor? All members of the clergy? A specialized segment of the clergy? Devout laymen? Anybody professing a faith? Does it depend on the situation? Does religious doctrine restrict access to this power, even if the unordained faithful can obtain it?

What form does the power take? Outstanding good luck and good fortune? (This would be better reflected by requiring devoted characters to take Good and Great Luck rather than the *Miracles Extranormal* attribute.) Consistent and repeatable invocations? Rare but powerful miracles? Some sort of blanket protection or immunity against certain dangers and harm?

Addressing such questions, as you weigh the decisions you made in establishing your pantheons, and as you develop the political aspects of organized religion below, will help you give shape and substance to your religious wonder-working system. Note that if you have different answers for different faiths, the powers each has access to may vary a bit.

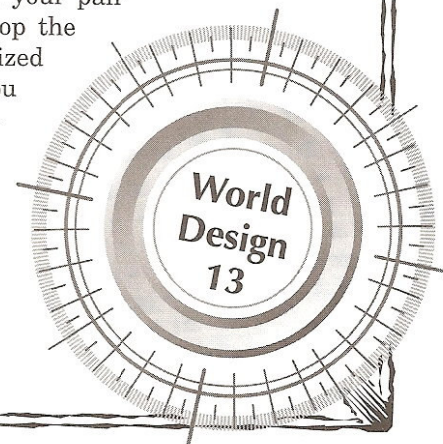

Our Example World

This setting won't emphasize the religions of the Southern world much (and here we depart from the historical model of the Catholic missionaries in Asia), so the pantheon of Southern gods will be painted with broad strokes. Besides, the churches of the South have not established a significant foothold in the Colonies, because the local gods have the advantage in their own lands, and have weakened and undermined the powers of the encroaching Southern gods (and to be fair, the Northern gods as well). So, there isn't as great a need to develop all that now at the beginning. Perhaps later, if I think adding a significant religious element to the campaign will take the group in interesting directions, I can work some of that in. The accompanying system will resemble the magic system of the South in terms of casting spells and praying for more (though actions will affect how much power a character may be entrusted with).

On the other hand, I consider it important to develop a system for the local Ogre shaman. Shaman wonder-working, as practiced by the Ogre tribes of Javarta, is a raw, emotion-based talent. Its priests learn at the feet of tribal elders, and many die in training. Shaman miracles, which tap into the power of the totem, are extremely versatile, but less predictable than Southern magic. It can be very powerful on one occasion, and very weak in another. The power of the shaman is less a factor of experience than strength of will and emotional state, perhaps requiring a *willpower* skill roll before attempting to invoke a miracle. This sort of unpredictability keeps Southern and Northern mages alert and wary when encountering an Ogre shaman prepared to protect his village or shrine.

Psionics

Many genres, especially science fiction and science fantasy, feature "magic" in the form of mental powers — psionics, ESPer powers, metaphysics. Like magic in its many forms, the rationale of psionics must be explained convincingly, and its manifestations quantified and explained, again both in terms of world logic and game logic.

How will psionics work in your campaign? Will you have a list of psi skills characters can master, or are they limited to using certain innate talents they are born with? Do characters have to be in a certain state of mind to use their talents, or are their gifts accessible at all times?

Does using the talent fatigue the ESPer in any way, or task his resources?

Is there some outside element that the ESPer must rely on to use his talent? Drugs, crystals, machines, and other ESPers all exist as examples of such outside elements that novels and films have required. In some stories, the ESPer might not need such props to harness his talent, but they might serve to boost his powers immensely.

How tolerated are ESPers? Does the public know they exist? If so, are they feared, or tolerated and accepted? Is there any regulation of ESPer activity? Are there special programs or organizations which recruit and train ESPers?

And, the big question: What role will psionics play in your campaign? Do you want it to serve as a background element, or will you bring it into the fore of play, by allowing players to run ESPer characters?

Our Example World

Two magic systems and one miracle system are enough to keep track of, and they fit the setting well. We won't add psionics to the mix.

The Lay of the Land

Having established some of the broad themes of your world — in terms of genre, campaign format, how the universe operates, and so on — it's time to devote some attention to the traditional foundations of the campaign, such as histories, politics, ecology, nations states, maps, and so on. Whereas before we pulled way out to get an extreme macroview of our creation, now we want to zoom in again, and start building up that brainstorm list.

As you tackle these various foundation topics, keep in mind that you don't necessarily need to provide a great amount of detail. The basic point of all this is to think the major aspects

through before game play begins. You can add more later, if you need to.

Cartography

Many campaigns depend on a map for definition. When you create a world out of whole cloth, it exists only in your mind and in your notes. However adroitly and elegantly you employ the bardic skills to bring your world to life, it is still important to give the players a tangible aspect of the world they can interact with and analyze visually. The most basic of these is the world map.

A good place to start with is the overall campaign world map. The map serves as a way to organize information as you go through the remaining areas of world creation, and

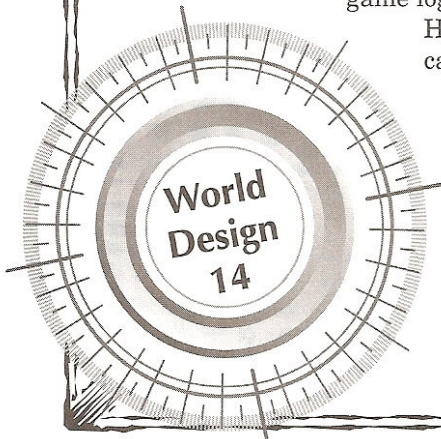
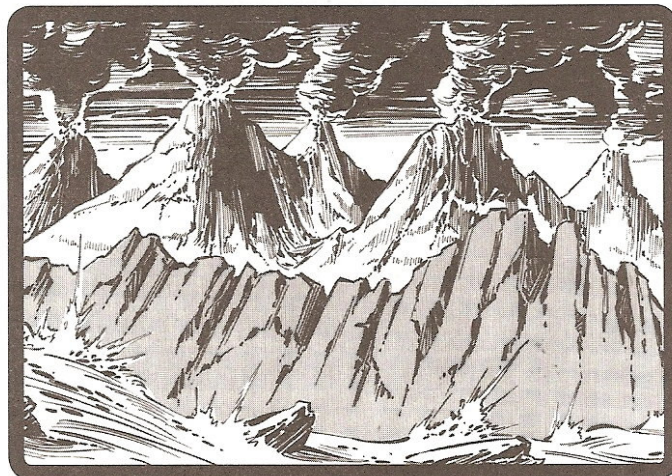

Computers and Cartography

Many gamers have computers these days, and there are plenty of programs available that can be used to make some fairly spiffy maps. Drawing programs can be used to render some decent maps (many game companies use such programs as Freehand, Photoshop, Painter, and Illustrator to make their maps. You'll have to hand craft your own symbols and terrain features, but the ability to select, duplicate, and move items such as forest patterns, city icons, and so on is a great help.

You can also incorporate fonts into your design. There are many fonts available online in a variety of styles, from Elvish runes and Egyptian icons to gothic script and futuristic computer-like designs. Most of the fonts available online are shareware, so be sure to pay the shareware fee for the fonts you use in your game (the price for shareware fonts seldom exceeds the \$10 to \$15 range).

Another alternative is to use one of the few CAD packages and map-making software programs that are designed especially for the roleplayer. (RPGNow, www.rpgnow.com, has a number available in their "Software" section, as well as preconstructed maps in their "Accessories" section.) These aren't that simple to use either, but they come with everything you need to generate some dandy-looking maps.

Finally, there are programs people have placed on the Internet that can generate country and city maps based on parameters you select. You can find some online by searching for "roleplaying map generator," among other key word combinations.

can do this without making your landmasses obviously derivative of Earth ones (many commercial products do this to good effect). The trick is to capture the character but not the exact look of real landmasses. If you do it right, the map will feel "right" for the players when they see it (because they have subconscious expectations as to how certain world areas should look), and the whole thing will resonate with more authority with your players.

Later on, you may wind up drawing several maps of the same area, to convey physical, political, and ecological details of your world. But your first map is a sort of rough draft, so go ahead and put all of your information on it. Give some thought as to how things evolved the way they did: why names of cities and rivers changed over time, how territorial borders evolved, why this group hates that group, and so on. Go into as much or as little detail as you like, but the more you put into the back history of the setting, the richer it will be.

When you've completed your campaign creation, redraw the map to clear things up. Again, you might want to spread the information on your map over several maps to keep things clear. It is also nice to make a map for the players, with all the information their characters would know. If you are really feeling ambitious (and if it is appropriate for the genre), draw the player map on parchment (with waterproof ink), soak it in a pan of weak tea to "age" it, allow it to dry, then burn the edges with a match (being careful not to burn yourself in the process). Players love that stuff.

Many game universes have little or no need of map development, of course. For example, I seldom develop much more than a vague doodle of star systems, political boundaries, and hyperspace routes when laying out the bones of a science fiction campaign. Other campaigns, namely those set in the real world, don't need maps either. I may have to do a little research to unearth an appropriate period map if the campaign is a historical one, but otherwise, this step is unnecessary in terms of defining the game world itself.

Our Example

Here is the initial map of the Javarta campaign region. It isn't all that pretty, but it does show the way you can use the initial map to sort details out.

I have patterned the layout of the landmasses in a rough approximation of the islands of southeast Asia around the South China Seas. Most people do not know exactly where the Philippines are in relation to Java and Sumatra, and so on, but they have a vague notion of how island archipelagos

you refer back to it and tinker with it as you go through the other steps.

Knowing a bit about geology when making your maps is a bonus, but not necessary. Just keep in mind that water runs downhill, and that swamps and deserts seldom mix, and you'll probably be fine.

You don't have to do all the work yourself. One ingenious shortcut suggested at a con seminar is to obtain a U.S. Geological Survey (www.usgs.gov) map for your own state and county — which features lines that mark different levels above sea water — and raise the water level a few or tens of meters. This transforms your coastline, rivers, and lakes to an extent that the map will be unrecognizable to your players, while allowing you to adhere to real-life geological data (it also makes it easier to describe seasons, flora, fauna, and so on to your players, since you can simply look out the window). Of course, you won't have as much control over the actual shape of your landmasses, but you get a lot of work done for you in exchange for this relatively minor inconvenience. It's a nifty idea worth looking into, especially if you don't have a lot of time or interest in developing your own maps and physical details, but are reluctant to purchase a ready-made campaign environment.

A related idea is to lay out your landmasses in such a way that they roughly correspond to Earth locales. You

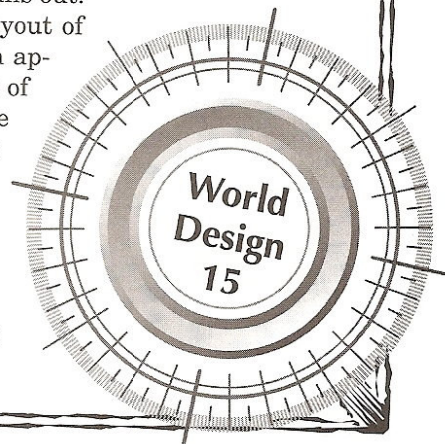

THE WORLD OF JAVARTA



KEY

- ▲ City of the Eastern Empire
- Ⓜ Pirate town
- Colonial town
- * Ogre settlement

and other South Seas landmasses should look. I want the look to be right.

Climate, Terrain, Flora, and Fauna

Once you begin nailing down the approximate location and size of your landmasses, you can begin to flesh out the makeup and features of these landmasses. What is the climate? Are there mountains there? Swamps? Deserts? What sorts of plants and trees grow there? What kind of animals root about in the undergrowth and gallop across the plains?

Using a U.S. Geological survey map is one way to get a lot of this work done without a lot of effort, and if you have based your landmasses on actual locations, you get a similarly big boost. Once you have a specific location tied to a real locale, you can use an encyclopedia or other reference to look up pertinent facts on this area. For the basic details on terrain features, natural resources, and so on, the CIA World Factbook can prove useful, which is available online (www.odci.gov/cia/publications/factbook/) or on a number of CD-ROMs. Other reference books can provide details on wildlife, the sorts of crops people raise, and what animals populate the region.

You might opt to adhere primarily to creature and vegetation found on Earth, even if your setting is not Earth as we know it. This sameness may be just what you are looking for. It is easy to justify and maintain, and it evokes a feeling of familiarity that can comfort players. Players must absorb a great deal of information at the onset of a campaign, and it is much easier for them to get their bearings if their characters are riding their horses to the fair than if their characters are riding their shagolyths to the *tan'ramok* Rite of the Seventh Sun.

On the other hand, a world just like Earth lacks a certain sense of excitement, of exploring the unknown. A few variances might serve to remind your players that they can't take your environment for granted. Make up a few useful or common plants and animals that are unique to your world. Perhaps there is an herb that is used in brewing many magic potions, or a small rodent that burrows in stone. Maybe there is a vine that seizes and strangles its prey, or a species of boar with poison tusks.

If your world is distinctly different from Earth in some way, reflect this in the decisions you make regarding the physical world. For example, if the gravity of your world is quite light, similar to that of the moon, perhaps, some plants may be very delicate in appearance (since they require less strength to hold themselves aloft) and exceptionally tall (they can grow higher without collapsing). If the world has several small continents separated by immense oceans, plant and animal life on them might be quite divergent (think of the unique path life took on Australia as opposed to Africa and Europe, or even North and South America, which are more closely linked).

Our Example

As this setting is going for a South Seas theme, it makes sense to have the physical attributes of the region patterned after those of southeast Asia. Javarta, for example,

is based loosely on Malaysia or Java. Looking up some data on those locations, I discover that Javarta would be subject to monsoons in the summer and winter months, that the terrain ranges from coastal plains to hills and mountains in the interior, and that natural resources include coffee, sugar, tobacco, tin, timber, exotic spices, and rubber (a rare and much sought-after product in the South). Most of the island is given over to the jungle, but the rich soil generated by volcanic ash results in highly populated regions where numerous crops are grown. There are many extinct volcanoes on the island, and a few that are active but currently dormant. Other islands and landmasses in the area get the same treatment.

Because this isn't Earth, the region needs a few new plants and animals, such as a species of large mobile plants (which the locals herd like cattle), a species of butterflies equipped with poisonous stingers, a spice that helps preserve meats (it only grows in the tropics and is understandably in high demand in the Southern kingdoms), and a certain tuber the Ogre shamans use to boost their power.

Civilizations

It's time to define the peoples and nations and other civilizations that inhabit your world. You could attend to this before settling the geographic issues, but it is somewhat easier to define a civilization and its people once you know something of the local climate, natural resources, and physical barriers that might protect the state from invasion. After all, these factors are what permit a people to become what they are, for better or for worse.

Impact of the Physical World

Climate affects development of the culture in profound ways. For example, settlements developing in harsh environments, such as the northern climes, tend to advance more quickly technologically out of necessity. They must devise complex farming techniques to coax grains and vegetables from the soil, learn how to preserve them through the long winters, develop textile production to clothe themselves, mine metals, and trade with other communities to make up for local deficiencies. Complex hierarchies grow up around such communities, as the people band around leaders who can assure them survival against the climate and other communities.

People living in the balmy tropics, on the other hand, have fewer incentives to trouble themselves with such things. Food is plentiful and grows in the wild for the taking year round.

There are fewer reasons to develop clothing, trade, and other aspects of a more advanced civilization.

Desert cultures tend to be nomadic and hospitable to travelers (no one knows when he himself might need the aid of a stranger for survival, and so grants

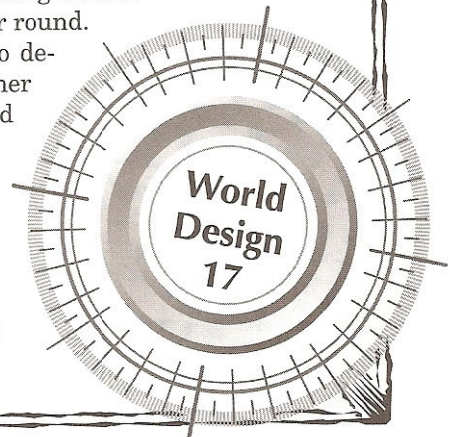

Superstition

Superstition, which arises out of uncertainty, is an aspect of culture that can be useful in detailing a culture. Communities tend to take for granted activities which have a high certainty of success. Dangerous tasks, however, or those that have a much lower or random chance of success are often surrounded by ritual. Consider a small fishing community. Fishing in the small bay is perfectly safe and yields crabs and small fish aplenty. As a result, there are no superstitions or rituals associated with fishing in the bay. However, when fishermen venture out into the wild open sea for bigger catches, they face an environment fraught with danger and uncertainty. A hundred things may go wrong. The boat might leak or sink. The nets might break. A storm may sweep them out to sea. They might not find any fish. Those who fish in the open sea steep themselves in ritual and superstition, which may include wearing special clothing, making sacrifices to sea gods, and so on. No one is more superstitious than a sailor.

Superstition does not confine itself to primitive societies, or people facing danger, however. Contemporary baseball players parallel exactly the fishermen we just looked at: They are extremely superstitious when it comes to batting, which is an activity with a high degree of uncertainty. A batter on a good streak may do any number of activities he feels are responsible for his good fortune, from hitting the plate with his bat a certain way before each swing, to wearing the same underwear every game.

How can you use superstition to define your cultures? Look for areas of risk and uncertainty. If a sector of space contains dangers that result in the destruction or disappearance of numerous space ships, pilots who travel into that sector may observe certain rituals born of superstitions, such as not taking certain passengers or cargoes, or refusing to go without a lucky hat or belt. A guide to a network of ancient dwarf mines might insist that those he leads all wear a certain color of clothing, or remove all items made from animal skin.

Superstitions (as opposed to major religious tenets, which come out of doctrine rather than uncertainty) will seldom impact a culture on a macroscale. They can, however, add flavor to a society and serve to spark adventure ideas and complications. (What if the space pilot who is to take the characters out of an area where they are being sought by the authorities can't find his lucky hat, and refuses to leave without it?)

that aid freely to others). By the same token, their justice is swift and brutal — faced with the terrible enemy of the desert, there is no time for vagaries in the law, as there might be in stable urban environments.

Natural resources also play a major role in the development of the state. We have already talked about what might be present in a particular area. What effect will these resources have on a society? A society with no metal ores in its territory will have a tough time fielding an effective army once technology leaves the stone age and their enemies trade in their stone axes for bronze swords. Nations with arid climates and poor soil have difficulty in raising crops.

Of course, plentiful and abundant natural resources are no guarantee that a society will be successful. Many African and Latin American civilizations 200 years ago were overflowing with the wealth of nature, from valuable metals to splendid natural harbors and fertile soil. The reason they did not thrive by taking advantage of these resources has already been noted — they didn't have the incentive. It was not until the northern powers, driven by a culture that depended on innovation and invention, arrived that

these resources were harnessed (for better or worse). Some civilizations, such as Japan and Ethiopia, had enough time to get up to speed technologically before being annexed, but most didn't.

Do not, by the way, underestimate the impact of agriculture on the development of a society. For example, raising wheat and rice place entirely different demands on a culture. Sowing, caring for, and harvesting wheat (and similar grains) requires only a few people per acre, and perhaps a beast of burden or two. Growing rice, however, is an intense effort which requires a great many people working in a small area. What impact will these two agricultural traditions have on culture?

Well, those living in a wheat culture might tend to be rather independent, because grain can be grown by small groups, even by one extended family (extended families include aunts, uncles, grandfathers, cousins, and so on, while nuclear families are limited to immediate relatives — father, mother, and children). Even in cultures where feudalism or slavery is practiced, there is a significant value placed on caring for oneself and one's own, at every level of society. Individual rights might be valued more highly than the rights of the group, since survival depends more on the efforts of individuals than the group.

Those living in a rice culture, on the other hand, value the group over the individual, since the cohesiveness of the group is necessary for survival — the nail that sticks out **will** be pounded down, because individuality endangers the unity of the group. Rice cultures tend to place less value on

privacy, at least as members of a wheat culture might see it, because they must live in close quarters with one another. They will either not value privacy at all, or channel it into new avenues, such as pointedly ignoring what everyone can see but would be embarrassing to acknowledge (you can see where the idea of saving face comes from).

Weather can have an impact on culture. Societies that face frequent disasters such as earthquakes, tsunami, and hurricanes place less value on tangible assets (which can be lost), and more on intangible ones such as learning and education (which will survive if the person possessing them does). Literacy and books might be more valued by a society plagued by typhoons than one which enjoys relatively stable weather.

Consider, too, the impact physical assets will have on the development of a society. A nation-state surrounded by tall mountains or trackless swamp will not need to worry about invasion by enemy armies as much as a state located on plains might, for example. Spain is a real-life example of such a state — though it was invaded from the east by the Moors, it was protected from invasion from the northern European powers by a range of mountains. Deep natural harbors, extensive networks of rivers, and so on are other physical assets that give a society a boost over neighbors who lack them.

Island states and nations likewise tend to be left to develop their civilizations in relative peace, since they face no danger until and unless another nation develops a significant navy. Interestingly, anthropological studies suggest that isolated island nations tend to develop the notion that they are exceptional specimens of Humanity (they cite the example of Britain and Japan as their primary exhibits).

Obviously, the statements and observations made here are not absolute, and do not apply across the board (there are many exceptions to the “rule”). Hopefully, however, the discussion has sparked some ideas and has helped show how various aspects of a society can affect the development of its culture and character, as well as dictate its place in the world order.

We’ll touch on other factors that can influence the development of a society and its culture, including population, history, and religion. We’ll then move on to actually developing political entities such as nations, churches, and guilds.

Populations

While it is entirely possible you have designed your world around intelligent rabbits or talking hedgerows, it is likely that humanoids are the main focus of your campaign, if not the primary power of the immediate game environment. You need to spend some time deciding where both Human and non-Humans live, and why. Now is also a good time to decide what languages are spoken in your world.

Start with the Human settlements, since these are likely to be the primary focus of your campaign, at least in its early days. Decide roughly how many Humans there are in each area, and how much land is devoted to support them. In a primitive wheat culture, a lot of land is required to support a population, while a rice culture can support the same number of people using less land. More advanced

cultures may require more land devoted to agriculture, or even less (perhaps none at all, if the society in question raises its food in ocean kelp and fish farms).

Then move on to the other species you want to feature. Keep in mind that to include hostile species as well as benign ones. That is, not only elves, but goblins as well; not only friendly aliens, but hostile ones as well. Other species may place different demands on the physical resources than Humans, and may even impact the locale environment differently.

Rivers and other waterways are important in laying out your population. If a civilization has grown up from primitive beginnings, its major settlements will be located on the banks of major rivers, in the mouths of sheltered harbors, and so on. This is because waterways served as an important transportation network in the days before motorized transportation. Even if your campaign is set in a more advanced setting, if the local towns and cities predate that advanced status, they will tend to fall into these patterns. Of course, if your settlements were established as colonies by an already-advanced civilization, this pattern may not apply.

Take some care in populating your world. A region can only support so many divergent sentient species and remain stable — there is only so much arable land, so many good watering holes or animals to hunt. If you put five species in the same area, it is unlikely that they will not soon go to war over these limited resources, expelling the losers until the resources can support everyone. In areas where more than one species live, it is best to keep it to two, at most three, species. This doesn’t mean that you are limited to two or three species for the entire campaign setting — you can have nine or 10, if you like. Just try to spread them out a bit, perhaps separated by various physical barriers such as mountains, mighty rivers, and seas.

Obviously, there are exceptions to the rule. We are operating on the assumption that the various species are living off the land and competing for the same physical resources — things will obviously be different if we are speaking of a cosmopolitan area populated by a variety of aliens. High-entropy worlds, too, will tend to have more mixing between Humans and other species, such as Cyclopes, Centaurs, and unicorns. Also, if the species in question enjoy a close and symbiotic relationship, they may be able to exceed this limit.

Our Example

Humans are not the most common species in Javarta. Ogres are much more common and populate all of the islands of the region. Most of these societies are small and based on clan or tribe. They are swidden (slash-and-burn) cultures, which means that they cut down segments of the rainforest, burn the timber into ashes, and

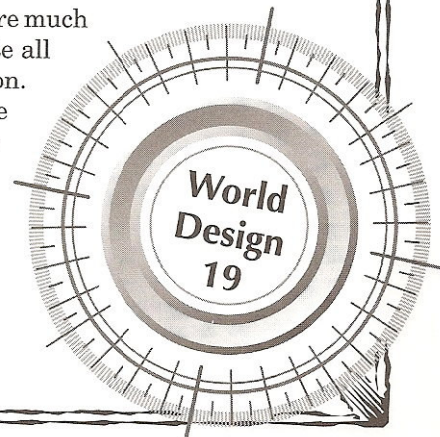

use the ashes as fertilizer for growing their crops (they have to move on after a year or two, since the soil is soon leached of nutrients). Deforestation is a big problem, but it is lessening as the Humans introduce them to alternative agricultural methods. Some of the tribes capture and pen wild pigs and other livestock, but most hunt for their meat on a day-to-day basis.

Jazantiland is a large and relatively civilized Ogre kingdom located on the mainland. King Mundikan has built his kingdom into an advanced nation of small cities, a developed agricultural base, and a network of trade routes.

There is a mermaid kingdom in the oceans south of Timora (these are Asian Mermaids). The Mermaids (there are only Mermaids, no Mermen) believe themselves to be above land dwellers. They trade with Humans and Ogres alike at certain isolated islands (and even have a diplomatic corps), but are aggressive at protecting their own waters. The Ogres respect their desire for privacy, but Humans (especially merchants and pirates) have largely ignored requests to stay away, and have a history of attempting to trespass in their domain. Such intrusions have slackened off in recent decades, since Humans entering in Mermaid waters uninvited began to disappear without a trace, their ships found months later, empty and deserted, some distance away. The Mermaids themselves offer no explanation for what befalls the crews, but they firmly remind the inquirer of their isolationist policy.

Histories

So far, we have examined the underpinnings of nations — the factors that serve to make it what it is today, such as climate and weather, natural resources, physical attributes, and population mixes. Now we focus on using these factors (and others) to fashion a history for the nations and entities of your world.

History is not simply a mound of dry records concerning events that occurred in the past. History is the story of how a nation came to be what it is. Favorable emphasis is placed on events and figures who represent steps taken toward the values and culture held dear in the contemporary age.

Usually, the victors write the history, but this doesn't always last forever. Ideas can fall out of favor, and when they do, history is often rewritten or reinterpreted to reflect the new paradigm — and inconvenient events and figures are de-emphasized or ignored. For example, Colonel Custer and General Cromwell are not quite the heroes they were in bygone days. The actual birthdays of Washington and Lincoln

are no longer observed holidays, while other figures representing ideologies currently in vogue are so honored.

If such assertions strike an emotional chord in you, or seem controversial, or even outrageous and in bad taste, then the point has been successfully made: History is controversial, and occasionally

dangerous, because it can ignite passions which can bring together a society, or tear it apart. This is kind of a wonkish point to make, but interesting gaming can grow out of a change in historical ideology, or when unpopular but morally correct ideas, represented by the characters, go up against established and commonly held values. (Joel Rosenberg's *Guardians of the Flame* series features a group of heroes who struggle to overturn the pervasive slave trade in their society.)

You may not want to spend a lot of time on history, and that's fine — you don't need to, really. It is often enough to describe events and people who will impact the campaign in some way, either by providing background color or by providing excuses for adventure. Any devoted adventurer will know what to do when an old coot tells the tales of bold Captain Gardon, who single-handedly saw to the defeat of the city state of Harbonya and then disappeared, along with his entire regiment, in the western swamps as he brought back the spoils of war to the Crown.

Focusing only on certain events and people in developing your histories is a big help, since you can ignore a host of events that will have little or no bearing on your contemporary world. There is no need to detail a series of councils or moots that occurred several centuries ago, unless they had some significant impact on history which continues today (such as when the current laws concerning public use of magic were established), or unless some significant but unrelated event happened there (such as the king and his family being poisoned, allowing the current dynasty came into power).

It is useful to sketch out a few previous wars, dynasties, and crusades, if only to put current events in a context. This is also a good time to draw your thoughts about the development of the culture together, in light of the various topics discussed herein.

Our Example

Javarta doesn't have much of a track record when it comes to history. The indigenous Ogres and Humans kept (and keep) oral traditions, which mix myth and actual events. Most are jumbled and feature figures of interest only to small population groups. Even Mundikan's kingdom, advanced as it is, is less than 100 years old. Naturally, the Eastern Empire and the Southern powers have a rich historical tradition, but these histories will have little or no immediate bearing on the campaign, which is focused on the Colonies of Javarta.

It might be a good idea to develop a few notes on the histories of the Empire and the Southern kingdoms anyway, to add flavor. Perhaps there are two rival dynasties in the Eastern Empire, one of which (the Tang dynasty) has long been out of power. The Chaong dynasty, which calls the shots, assigns lords of the Tang dynasty to outlying precincts and diplomatic posts to prevent them from scheming in the capital and their regional power bases. Most of the Imperial diplomats in Javarta are of the Tang dynasty, which can lead to some interesting political skullduggery later in the campaign, when the characters start mixing with the more important figures in the Javarta region.

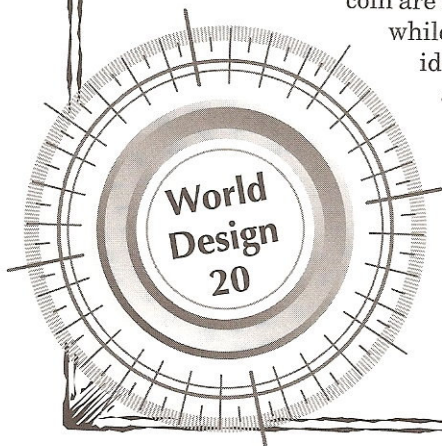

Two State Templates

Here are two sample generic state templates you might find useful in developing your own. These two templates are by no means all-inclusive, but they do embrace a wide variety of variant possibilities.

Notice that in each of these variants, there is an underlying philosophy or belief that leads a nation to do what it does. Countries don't do things without a reason, and they don't operate in a vacuum. Always establish reasons why nations are like they are. Not only does it make the place more believable, but it makes it much easier to establish the character of its citizens.

Expansionist State

Expansionist states focus on influencing and subjugating other nations. They may do this with good intentions (although the recipient of the attention may not agree). For example, one advanced nation might feel obliged to take over and civilize less advanced nations. They may also do so for selfish reasons (a nation conquers others just because it wants the land). A common variant of the expansionist state is the religious nation that sees its people as the Chosen of some deity, and the world's nations as theirs to conquer and rule by virtue of their superior status in the cosmos.

The expansionist state only feels it is performing its right and proper duty if it is **expanding**. If it stops expanding for some reason (war, changing seasons, a powerful enemy, natural barriers, and so on), it becomes unstable and either changes or becomes increasingly fractured.

Status Quo State

This state has few if any overtly aggressive tendencies, and it is content to let things run along in pre-established channels in military and foreign policy, philosophy, culture, and so on. The status quo state might be set in its ways for a number of reasons: It believes its civilization cannot be improved upon; it has become stagnant and inward-looking; or it simply has no interest in those lying beyond its borders. Perhaps it fears angering other states. One variant of the status quo state is the empire in decline, more absorbed in its own internal diversions than in maintaining its strength and sprawling territories. Another is the state that maintains a huge military, not to annex adjacent states, but simply to protect its borders and continue an isolationist policy. The status quo state need not be a military power, of course. Like Switzerland, it may survive simply because it is more useful to neighboring states as an independent country than as an annex of another nation.

Nations and Governments

You have already done the difficult work in giving form to the nations, kingdoms, city states, and empires you mean to establish in your world. What remains is mostly a matter of filling in some details, establishing a few personalities and leaders, and giving the nations drive and an identity. Let's focus on the latter point.

With what you have already, you can probably get away with simply drawing political borders on your map and establishing a republic here, a theocratic dictatorship there, and so on. This method has its merits, the first of which is simplicity — no muss, no fuss, just instant nations. Since most campaigns only feature governments and states as window dressing (at least in the early stages), this method serves many gamemasters nicely. If you want to take this route, you need only decide what sort of political bodies are governing your populations. Are they empires or kingdoms? Democracies or socialist states? Utopias or dystopias? How do the Human governments differ from those of other species? Sort this out, and you're good to go.

However, a more complex system can serve you well in the long run, especially if you anticipate politics, wars, trade, or espionage playing a major role in your campaign at some point. By more fully fleshing out your nations, you can create a more dynamic environment where governmental policies change with changing conditions in the campaign world. It doesn't take all that much work, either. In fact, if you use the above method of creating states, you're halfway there. All you'll really be doing is creating a thumbnail of a state, which tells you all you need to know about its character, capabilities, and intentions. Think of it as a giant gamemaster's character.

When creating a gamemaster's character, you come up with hooks that quickly establish her personality and help you decide how she will react in a variety of situations. These hooks might be a few words that quickly sketch out her personality and preferences: brave, headstrong, shy with strangers, fond of wine, and so on. Alternatively, the hook may be that you are basing the character on an actual person (someone you know, maybe, or someone from history or perhaps a media personality), or a fictional character from a novel or movie. The hook may be a combination of the two or something else altogether.

You can give your state the same treatment. Decide with a few key words what sort of place your state is: how it behaves in the international (or intergalactic) arena, what it values in allies, what its goals are, and so on. Be sure to incorporate the factors and histories you have already established. (Of course, you can also go in the opposite direction, and write histories to suit your states.)

Let's tackle an example: Assume our state is a small pocket empire bordering a much larger

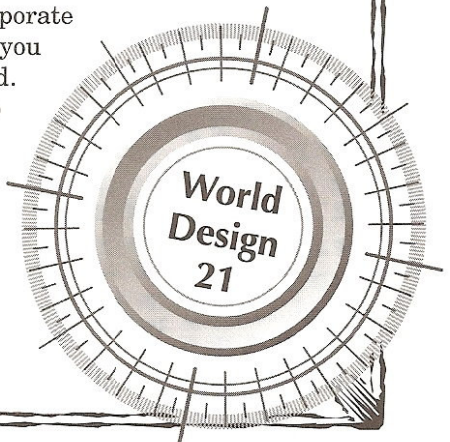

galactic republic. So, a few words to capture its personality: it is not easily intimidated by aggressive gestures by other states (even those much more powerful); it is rather impulsive and reactionary in its foreign policy (it tends to react to the actions of other states rather than set its own agenda), its people are somewhat distrustful of and uncomfortable around foreigners and they are ardent patrons of the arts. Already we can see the character of the state emerging. As importantly, we can anticipate how typical citizens may react to the players' characters. Notice that the descriptions parallel those of the gamemaster's character (more or less). See how easy it is to use what you already know about generating gamemaster's characters in generating states?

You can as easily base your state on an existing state, one from history, or one from literature, just as you might base a character on a person. Perhaps your state is patterned on the Russia of 300 years past: a large but backward kingdom ruled by a nobility desperate to ape the fashions and culture of more "civilized" kingdoms in pursuit of legitimacy, with a very aggressive policy of instigating border wars and external conflicts to channel the natural aggressiveness of its people and leaders outward rather than inward toward the crown and civil war. You might as easily pattern your state after modern Bolivia or Narnia's Calormen.

Summarize your findings in a mission statement. Every business has a mission statement, which establishes what the business is supposed to accomplish and how. A national mission statement establishes a nation's character and encapsulates what it sees itself accomplishing in order to consider itself successful. Having everything in a small neat paragraph will be helpful whenever you are called upon to decide how a nation or its body politic may react to your characters or world events.

Our Example

The Eastern Empire is a large state, which has been built up over centuries. Obviously, it is patterned after China. It is a very civilized and orderly country that reveres teachers and education, the physical and magical

sciences, civil engineering, and well-maintained governmental systems and organization. Easterners believe themselves to be superior to the other civilizations they have yet encountered, though they aren't sure about the magic-wielding Southerners yet.

The Eastern Empire is closed to foreigners, and only the large port city of Xintau is open to traders and other outsiders. Southerners and Ogres found within the Eastern Empire are slain unless accorded special diplomatic status. The Empire maintains a huge army of mounted troopers, who can be found in great numbers garrisoned in every port settlement along the Xintai coast. Its goals are to prevent alien (i.e., inferior) cultures and ideas from taking root on its soil, and to extend its influence throughout the region.

You could stop there if you like. Most states you are developing won't play an immediate role in the campaign, since they are on the periphery of the action. Maybe the state the players' characters are

starting in itself isn't going to do much more than serve as background color. In cases like these, you probably have enough to go on with just the mission statement.

If you want to take things a bit further, you can. Assign actual characteristics and factors that describe the state in detail, including population breakdowns, political alliances, imports and exports, and so on. Develop the regional balance of power, and determine what influences and power certain states have over others.

You can get as focused as you like. Remember, though, that the idea is to present the **suggestion** of a complex and fully realized state, not to actually construct a model that realizes this state down to the finest detail.

Organizations, Guilds, Churches, and Societies

Once you have established your states, or as you are establishing them, develop the key economic, political, religious, and social organizations that are active in your campaign world. Again, there is no need to go into exhaustive detail; it is enough to get the major ideas down on paper. This will give you something to build on later, when more detail is required.

Political Organizations. Political organizations are those, obviously, that exist to influence the government to a greater or lesser extent. They take many forms. In

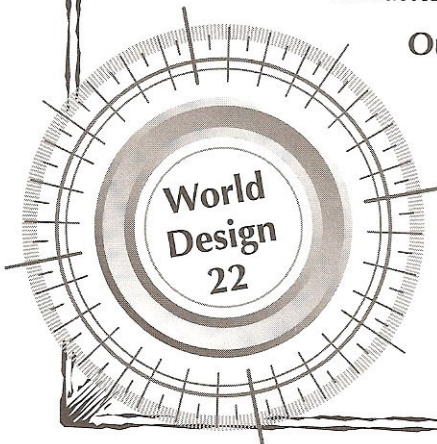
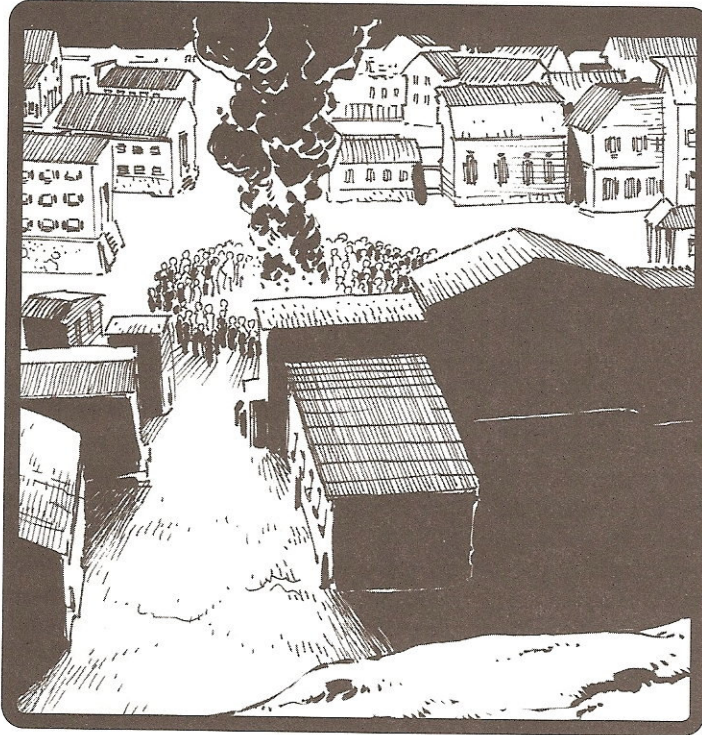

pre-industrial societies, many organizations are centered around noble families. In more advanced societies, political parties are more common examples of the political organization, and various think-tanks and lobbyist groups may also qualify.

Obviously, there are many organizations that focus on economic, religious, or social issues that also seek political power, but to keep things clearly defined, we will assume that they do so to advance their own agendas, not to rule themselves; for political organizations, on the other hand, political influence is the reason for existing

Some of these other types of organizations (or, more commonly, suborganizations and splinter groups) may become so wrapped up in pursuit of power that they cross the line and actually become political organizations. This occurs when they cease focusing on their original goals and begin dictating public policy for the sake of exercising power.

Economic Organizations. Economic organizations include unions, guilds, and professional (e.g., medical, legal, and magical) organizations. Membership is often regulated by certain prerequisite skills or educational achievements. Economic organizations exist to represent its members before the government and to ensure that they are free to go about their businesses with a minimum of governmental regulation and interference.

Religious Organizations. We've already gone through the actual pantheon of the game world, but what about the actual structure of organized religion? Religious bodies must develop organizations to serve its worshippers, both directly, and by representing them before the government (assuming that they aren't themselves the government).

These organizations can take many forms, from a state-mandated religion run from a centralized church or temple, to a decentralized system of local village priestesses. Don't forget cults. Though too small to be thought of as an organized religion, a cult may wield power incommensurate with its size if it counts among its members influential members of society.

Social Organizations. Social organizations are sort of a catch-all for organizations that don't fall neatly into one of the above categories. They seldom exist to wield political power directly, though a club made up of elite community leaders may exercise a certain influence simply because its members bring with them their own power bases and networks.

Social organizations include goodwill societies that raise money and perform acts that benefit some group in severe need, like orphans or the homeless. They also include clubs organized around common interests like hobbies. However, social organizations that attempt to alter public policy (Greenpeace, for example) should be considered political organizations, because they more closely fit the definition of that category.

There is no hard and fast rule that all of the political, economic, religious, and social organizations need be legal. Secret societies, cabals, and cults may exist that would be destroyed if outsiders knew they existed. The Bavarian Illuminati and the ubiquitous Thieves Guild (which has

pervaded urban fantasy since Fritz Leiber first came on the scene over half a century ago), are two well-known examples of secret organizations from literature.

Our Example

The most important organization operating in Javarta is the Lambodian North Seas Company, which has a charter from the Crown of Lambodia (the kingdom that first sent explorers into the Javarta region). The charter empowers it to conduct trade, enforce the laws of the company and of the Crown, and represent the Crown in the region. The representatives of the North Seas Company are imperious sorts, and their employees are sent for a number of years to the colonies and then shifted back home. Law is enforced by the powerful Lambodian Navy.

Frandeaux, a competing Southern Kingdom, has a similar company operating in the islands further to the north. There are frequent clashes between the navies of the two powers.

Setting the Stage

As we near the end of the world-creation process, we focus less on the background and spend more time on the immediate environs of the campaign, where the characters will begin their adventures in your world. Depending on the scope of the campaign, this might be a small village, a city, a planet, a star system, or even a sector of space or entire dimension.

Some of the work you do at this level will be background development, but it will be more detailed and developed than most of the stuff you've done so far, because, unlike the macroscale stuff like nations and gods, the immediate environment must be ready for game play from the very start. Now is the time to detail the local landscape. What settlements are nearby? Who are the local rulers and big shots? Where do people go to buy food, supplies, and transportation? What kind of trade passes through the area? What professional resources the characters might want to take advantage of are in the area?

The Initial Story Arcs

While you are answering these sorts of questions, set up some of the story arcs you want to get the characters into in the first few adventures. These aren't complete adventures but events going on around the characters that are designed to take place between or during other adventures. They can be fairly minor at first if you like: For example, the characters see a young waif being beaten by a big bruiser of a man, and rescue her from his clutches. Depending on who the waif and the man are, this might set into motion a whole series of events that may pop into play from time to time. The man might be

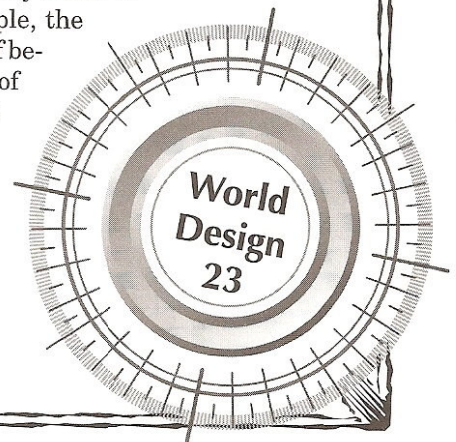

the son of a wealthy merchant, or an influential member of the local crime syndicate. Either way, he might serve as a regular foil for the characters from then on, or at least when they are in the neighborhood. The girl might become a source of information for the characters, or she may develop other talents useful to them. She may even be a princess of a distant land, sold into slavery by her jealous siblings, or in hiding and on the run. Your call.

You can also get some major story arcs rolling that you don't plan to really use for some time. For example, you might decide a war is going to take place in your world in a game year or two. Now is the perfect time to begin developing hints and events you can drop into the campaign that will suggest to the characters that events are becoming less stable over time.

Generate some major gamemaster's characters and groups to go along with the arcs. In our waif example, the bruiser and the waif should definitely be developed. In the war example, at least develop the primary players of the soon-to-be warring parties, as well as the source of their dispute.

Using Your World

By now, you should have enough notes together to start adventuring in your world—and enough players who want to visit there.

Ideally, try meeting with each player separately a week or two before the campaign is scheduled to get underway. Use this one-on-one time to generate the character and develop a customized background for him or her. You can even take each character through a short adventure that establishes part of his or her background, and may set in place a gamemaster's character or two. This very short adventure might take place immediately before the campaign begins, or may even take place 10 years before, when the

character is only eight years old. It can explain why one character is on the run (she was falsely accused of murder back home), or why another fears Centaurs (he saw his entire family die at the hands of a marauding band of centaur outlaws when he was young).

It is always a good idea to start each character with one or two minor contacts that might prove to be a useful resource during the campaign. In many campaigns, the character's mentor, parent, or former master might be one appropriate contact. Other good starting contacts are professional: a fence, a former brother in arms who now smuggles weapons, a former lover, a classmate at the Academy who now works in the military cabinet, and so on.

If you don't opt to meet with the players ahead of time, you can instead generate a few generic character backgrounds, complete with some custom information other characters might not know. The players can use this background in designing their own characters. This background shouldn't dictate the background of the character as much as reveal information that character might know by growing up in the region or because of past activities. A good way to make these up is to anticipate what sort of characters the players are likely to run, or regions where they are likely to hail from, and generate background with these in mind. By starting each character off with a slightly different background, you can start the group off with a good bit

of background information without overwhelming any one player.

If the players participated in the brainstorm list, they might already have an idea of what the world is like. If not, you can use this time to brief the players on their world, and even provide each player and character information the others might not have (not everyone will bring into adulthood the same knowledge about events and surroundings, even if they grew up in the same small village).

Whether or not you meet with the players before the campaign begins, you might want to generate a short gazetteer of the game world (two or three pages is plenty), which includes a thumbnail map of the area, and a few brief notes on local culture, nations, religions, and so on, for the players read before they arrive to generate characters.

As you begin to use your world, keep notes on various events that you make up during adventures, along with the results of what the players do. This can help you keep the world consistent—which is why you went through the world-creation process before beginning your campaign.

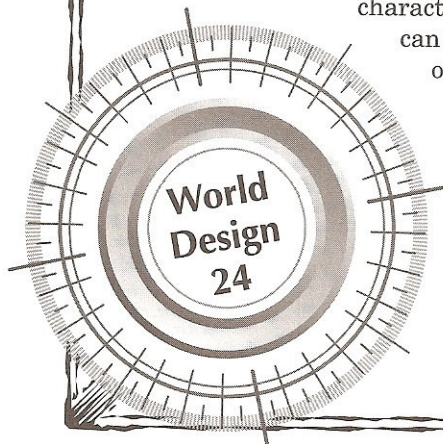
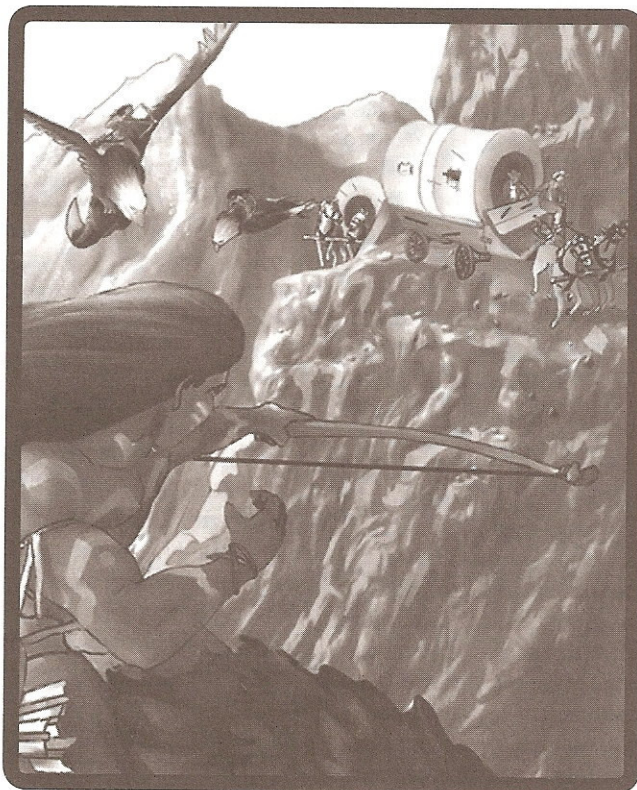

As you can see by the three core genre rulebooks currently available for the *D6 System*, this set of game mechanics is quite flexible. You can add or subtract many elements without changing the underlying rules. The damage chapter in each rulebook provides reasons for choosing one system over another and options for increasing or decreasing the amount of injury characters can take. The *Extranormal* attributes, Advantages, Disadvantages, Special Abilities, and cybernetics mechanics have been designed to be easily included in any genre or dropped entirely. For some gamemasters, that amount of fussing with the system might not be enough and they want to tweak the available set of attributes and skills to better reflect their game setting ideas. This chapter offers a guide to doing just that.

Example: You want to use the *driving* skill, which could fall under the *Mechanical* attribute, but you already have seven attributes and you don't want to have to add another. So, you decide that *driving* now falls under Coordination (an attribute you've already recorded on my Modifications Worksheet).

A list at the end of this chapter offers a number of popular skills and the attributes under which they could fall. (Which attribute you choose depends on the attributes you're including in your version and the most important applications of the skills you want to have.) The rulebooks provide more extensive lists, and the conversion information in this book can likewise help you select skills and their associated attributes.

2. Modifying the D6 System

Attributes

All skills in *D6 System* games rely upon base attributes. A character can perform any skill that falls under a particular skill by using the die code of the attribute itself. It just means that he doesn't have any particular expertise above and beyond his basic aptitude.

Example: Even though my aristocrat doesn't have any skill dice in *dodge*, he can still attempt to leap out of the way (using his *Reflexes* dice, since that's the attribute *dodge* falls beneath in my game).

Attributes can represent any ability from physical strength to mental prowess to magical control. You determine which of these attributes applies to your world, and how complex you would like your characters to be. For example, you may design a science fiction universe where magic doesn't exist, and therefore, you don't include *Magic* as a character attribute. Or, you could create a fantasy world in which the characters will spend all of their time crawling through dungeons and battling monsters. In this case, you don't really need any attributes other than *Reflexes* and *Strength* — the purely physical aptitudes — since the players won't care about their characters' ability to charm people or remember the average airspeed of an African swallow (or was that European?).

Characters normally begin play with a number of attribute dice equal to the number of attributes times 3. For example, if you choose seven attributes for the characters in this particular game world, they would each begin with a total of 21 attribute dice ($7 \times 3 = 21$). These can be split among a character's attributes as detailed in the "Character Basics" chapter in any *D6 System* genre rulebook.

If you want to incorporate the game mechanic of a particular ability, but don't want to add another attribute to your game, you can always decree that the skills falling under that ability are covered by one or more of the attributes you've already selected.

Suggested Attributes

When customizing the *D6 System* character aptitudes, you must determine which aptitudes most affect play. If your game world has magic, you may want to include the *Magic* attribute in character creation. If you want the players to rely on their own knowledge—if, for example, you've set your game in the real world where the players take on the roles of characters similar to themselves—you won't include the Knowledge attribute.

Choose those aptitudes that you would like to have reflected by die codes, that is, abilities that require a die roll to determine their success or failure. If, for example, characters in your game world can use psionic powers consistently with no potential for failure, then don't include the *Psionics* attribute. Instead, inform the players that they have the ability (or specific skills under the ability) and may use it without fail, subject to whatever other restraints you have imposed (once per day, only during a full moon, and so forth).

Example: You've created a game world that combines fantasy with science fiction: magic-powered technology exists in small quantities; characters carry mostly ancient-style weapons (swords, knives, and other blades); and most people have some affinity for magical bindings.

You begin creating a character creation template by selecting these attributes: *Coordination*, *Endurance*, *Reflexes*, *Strength*, *Knowledge*, *Magic*, *Perception*, and *Technical*. (You record these names in the spaces provided on the Modifications Worksheet.) The rest of the attributes don't apply to the game world or you've decided to fold them into other attributes.

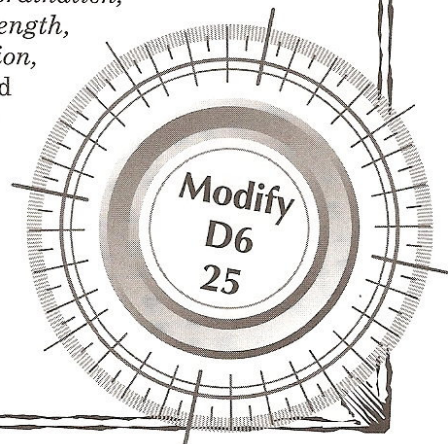

Now you determine the starting attribute dice. You have eight attributes, which you multiply by 3 to get a total of 24 in starting attribute dice.

The following list of attributes includes an “alternate names” entry (a thesaurus can provide you with more options). You can opt to use one of these names if you think it more closely matches the tone and feel of the particular game world for which you are creating this game system. For example, rather than using the name *Knowledge* in your fantasy game, you may instead call it *Lore*.

You might also wish to combine certain attributes, to limit the number of base aptitudes everyone needs to keep track of (see the sidebar for some suggestions). The minimum recommended number of attributes is two, which could be *Reflexes* and *Strength* (if your world focuses solely on combat) or *Mind* and *Spirit* (if your world focuses only on non-physical character interaction) or *Body* and *Mind* (if you want to cover the widest range of character interactions with the fewest attributes). You equally decide to do away with attributes altogether — see the sidebar for details on the “no attribute” option.

Charisma

Alternate Names: Charm, Charisma, Fellowship, Influence, Presence

This attribute represents a character’s personal effect on others. It covers such skills as oration, acting, and grooming. It can also encompass the ability to read the emotions or logical reasoning of others (taking this aptitude from *Perception*).

Confidence

Alternate Names: Cool, Ego, Mental Fortitude, Spirit, Willpower

A character’s *Confidence* represents his ability to withstand mental attacks, whether they come from situational pressures, like stress, or direct assault, like mental or psychic phenomena.

Coordination

Alternate Names: Aim, Dexterity

Coordination represents a character’s ability to perform feats that require manual dexterity or hand-eye cooperation, that is, fine motor skills. Such tasks include firing a bow or gun, picking a lock, and throwing a grenade.

Endurance

Alternate Names: Constitution, Health, Stamina, Toughness

Endurance is a measure of a character’s bodily resistance, that is, how well his body stands

The “No Attributes” Option

You can forego the use of attributes and instead create characters with skill die codes only. Treat all skills as if they had a base attribute equal to the species average of a particular character (for Humans, use 2D). Players then select the skills they wish to increase (following the normal rules for distribution of starting skill dice).

The recommended starting skill dice with the “No Attributes” option is 15D. Increase or decrease this die code depending on the tone of your game world. Also, you may increase the spending limit to 5D per skill.

Example: Your Human barbarian character has 15D in starting skill dice. You decide to apply 5D of that to lifting, giving him a total of 7D in *lifting* (the base of 2D plus the 5D you spent), 4D to *brawling*, giving a total of 6D in *brawling* (the base of 2D plus the 4D you spent), and another 5D to *melee combat*, giving a total *melee combat* skill of 7D (2D + 5D). You have 1D left to spend on another skill.

As certain attributes serve special purposes in the *D6 System*, you’ll either need to include skills to represent these applications or have some other skill cover that area. For example:

- *Perception* or *Reflexes* for initiative: new — *initiative*; existing — *search* or *dodge*
- *Endurance* to resist damage: new — *resist damage*; existing — *stamina* or *willpower*

This option works extremely well for dimension-hopping, time-faring, or genre-crossing games. If a character arrives at a place (or time or whatever) where a skill is known, he can learn it and the player can add it to his skill list. Additionally, you can pick up any game and just use the skill names without having to spend time determining the attributes that govern each — in fact, you don’t have to worry about the attributes used in the game at all. To translate characters from a *D6 System* game, just use the skill value listed (such as *omen interpretation* 4D+1) and treat all other skills (skills that would normally rely on an attribute die code) as having the average species dice.

up to attack, whether from direct injury or more insidious sources like poison, disease, or magical sickness. Endurance is often combined with *Strength*.

Knowledge

Alternate Names: Intellect, Lore, Mind, Science, Wisdom

The *Knowledge* attribute represents a character’s strength of memory and ability to learn. Skills under this attribute generally measure the level of education in various fields, from scientific pursuits like physics to philosophical concepts, from history and languages to magical lore and planetary systems. Any information a character could know in the game world could fall underneath this attribute.

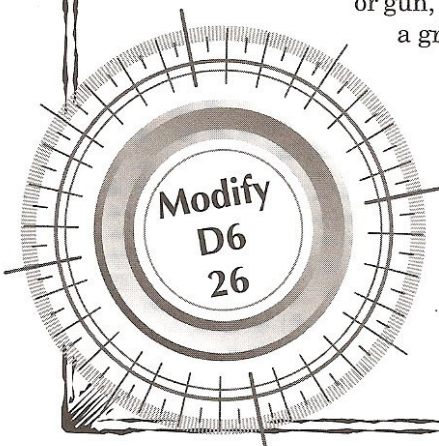

Common Attribute Combinations

Common Term	Includes...
Coordination	Coordination, Mechanical skills using hands and arms
Charisma	Confidence, Charisma, interaction Perception skills
Knowledge	Knowledge, Technical
Reasoning	Reasoning, noninteraction Perception skills
Reflexes	Reflexes, Mechanical skills using the whole body
Strength	Strength, Endurance
Mind	Knowledge, noninteraction Perception skills, Reasoning, Technical
Reflexes	Coordination, Mechanical, Reflexes
Spirit	Charisma, Confidence, interaction Perception skills (may also include Psionics and Magic)
Body	Coordination, Endurance, Mechanical, Reflexes, Strength
Mind	Charisma, Confidence, Knowledge, Perception, Reasoning, Technical

Magic

Alternate Names: Dweomercraft, Mysticism, Witchcraft

The *Magic* attribute gauges a character's affinity for the use of mystical forces. Most skills based on this attribute are spells, though others do exist, for example, the ability to determine what incantation another character is attempting to perform. See the "Magic" chapter in the *D6 Adventure* or *D6 Fantasy* rulebook for details on using this attribute.

Mechanical

Alternate Names: Mechanics, Sensory Extension

Mechanical can also measure ability in skills that require a combination of *Reflexes* and *Knowledge*, like shield operation, riding, and driving (you must first learn how to operate the device, but then you must rely on quickness to use the device to its potential).

Perception

Alternate Names: Acumen, Awareness, Cognition, Observation, Reasoning Sense, Smarts

Sometimes a character may have the opportunity to notice something in her surroundings that might provide an important piece of information. For example, a character might spot a bulging pocket on an adversary, which may indicate the presence of a concealed weapon. The *Perception* attribute covers such instances. In games with few mental attributes, it can also include those skills that require the ability to read the emotions or logical reasoning of another, like bargaining, commanding, or persuading.

Psionics

Alternate Names: ESP, Psionic Power, Psy, Psychic Ability, Psychics

Like *Magic*, this attribute applies only in game worlds where this phenomenon exists, and represents a character's ability to wield extraordinary mental powers, from danger sense to pyrotechnics to telekinesis. See the "Psionics"

chapter in the *D6 Adventure* rulebook for details on this attribute. For slightly different take on psionics, check out the "Metaphysics" chapter of the *D6 Space* rulebook, which crosses psionics with magic to get a type of reality-manipulation ability.

Reasoning

Alternate Names: Intellect, Smarts, Reasoning

This attribute measures the mathematical, conceptual, and deductive capabilities of a character. Typical skills that it could govern include estimation (mentally figuring out values), deciphering languages, or code-breaking.

Reflexes

Alternate Names: Agility, Balance

Reflexes gauges a character's gross motor coordination, that is, the ability of his mind and his muscles to react to a potential threat or a sudden occurrence. Examples of skills that rely on *Reflexes* include dodging an attack, fighting with a melee weapon (a sword, a knife, whip, etc.), and balancing on a tight rope.

Strength

Alternate Names: Athletics, Body, Physique

Strength represents a character's physical power — her ability to lift heavy objects and to inflict damage with a close-combat weapon (like a fist or a knife).

Technical

Alternate Names: Tech, Technics, Technology

The *Technical* attribute measures a character's aptitude for technological equipment, from computers to electronic listening devices to electronic security, as well as those skills that require a combina-

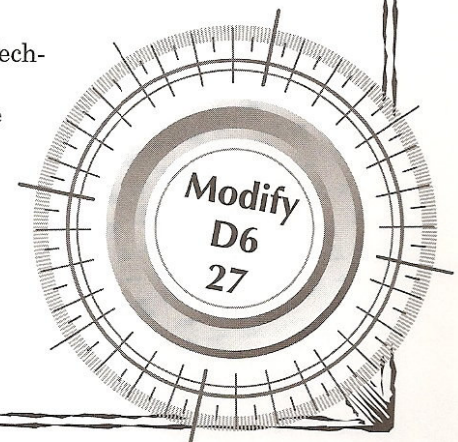

tion of *Knowledge* and *Coordination*, like first aid and demolitions. It also represents a character's ability to repair machinery, vehicles, weapons, armor, androids, and so on.

Skills

Characters who are slightly above the average Human begin play with 7D to distribute among the list of skills available to them. Gamemasters may allow more experienced characters to start with additional skill dice (possibly for the price of having a greater number of flaws).

This chapter contains a short list of skills and the attributes upon which they could be based. As with everything else in the *D6 System*, this catalog and the lists in the rulebooks give you starting points; create new skills as the need arises, and alter existing skills to suit your game world.

Record the skills you wish to use for a particular game world beneath their appropriate attributes on the Modifications Worksheet (if you don't have enough room, you may want to write them on a separate piece of paper).

Note that some skills can fall under different attributes. Since the *D6 System* allows you to select which attributes work with your game world, some entries contain several choices. Just use the one that makes the most sense. If you find a skill that would fit better beneath an attribute not listed in its entry, then by all means put it where you think it belongs. Don't feel obligated to blindly accept what you find here. No inflexible game system can fit every conceivable game world, so at one point or another you're going to have to adjust the information provided.

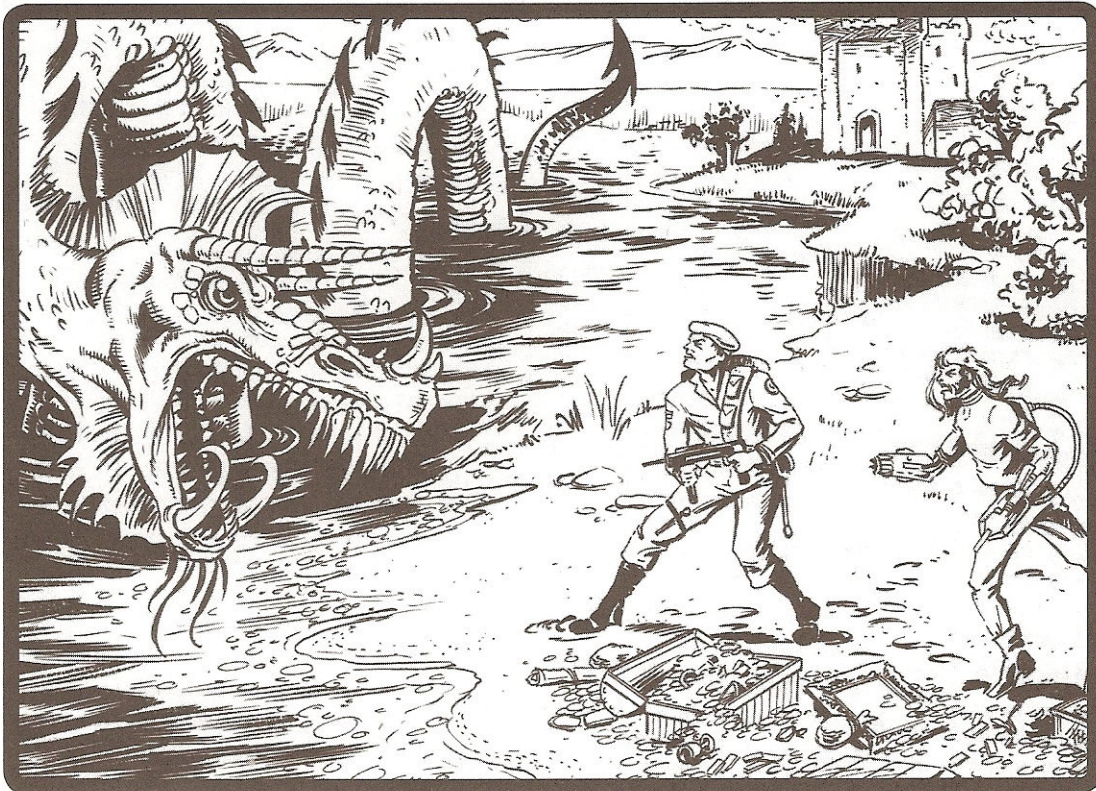

kinds of skills, a player needs to select a focus for the skill before she can give it to her character.

You may wish to mark the macroskills on your Character Creation Template and record some of the more obvious possible foci for these skill types. For example, in a twentieth-century spy game, you might languages and missile weapons to be included on your macroskill list. You would then write "language <any currently spoken language>" and "missile weapon <pistol, rifle, machine gun, grenade>" on the template sheet.

Free Skills

You may decide to give beginning characters some "free" skills, that is, skills they get without buying them with their starting skill dice. A standard example is a character's native language. You can either give the character automatic success when speaking his language or give him a 10D or 12D die code in an appropriate specialization of his *language* skill. You could just as well decide that all children in your game world learn this incantation during elementary school, even though all characters must purchase the *Magic* attribute and, if they want to use other spells, the related skills.

Damage Systems

The *D6 System* has two standard ways to represent the amount of damage a character can suffer (whether from physical assault, magical spells, poison, etc.) before dying. Choose the system that most coincides with the nature of your universe (though this particular choice relies more on

Macroskills

Any of the skills presented in the skill list can be macroskills. Macroskills are groupings of many related skills under one category name. You might decide that for added realism in your game that some or all of the skills should be macroskills. For these

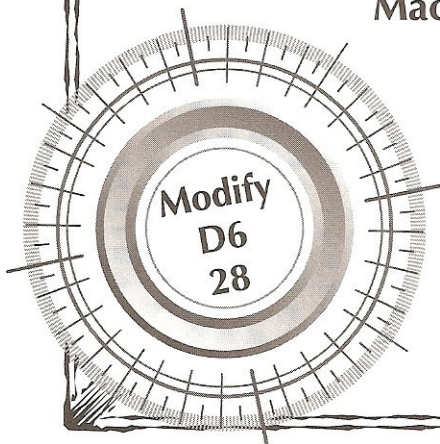

personal preference than anything else). And don't forget to record on the Modifications Worksheet which system you choose. See the "Damage" chapter of any genre rulebook for more details on the different systems.

Both systems can have damage resistance totals. If you don't want your players to roll extra dice, derive a static value based on what their characters' damage resistance total would normally be, generally 3 or 4 times the die code (plus pips), depending on how easily you want the characters to sustain injury.

Wounds

With this damage system, characters can take up to five wounds before dying. You can increase or decrease that number to make your game world more or less lethal. Whenever a character suffers a wound, he also receives a

penalty to nearly all of his skill and attribute rolls until he heals.

Adding Wound Levels

The "Damage" chapter in each rulebook discusses how to remove levels, but it offers few details on how to add levels. This section provides a couple of ways to do this.

One method is to duplicate levels (such as Stun 1 and Stun 2). Like Wounded and Severely Wounded, they share the same range that the damage total needs to reach, but getting a second instance of the level increases the modifier by one pip to one die (depending on how many levels there are and how debilitating you want each level to be).

A second method is to add levels between existing levels. First, you need to split one or more current ranges to accommodate the new levels. Then you need to determine each level's effect. This could be none (i.e., no additional effect other than what that level already has), an increased modifier to actions, or a modifier to difficulties. Review the official Wound levels for ideas.

Adjusting Wound Level Deadliness

In addition to changing the effect of each Wound level, gamemasters can make Wounds less deadly by requiring that the difference between the damage and the damage resistance total must equal the character's current level before the character can get bumped to the next level. (If the damage indicates a higher level, the character simply goes to that level).

Body Points

Characters begin play with a number of body points equal to 20 plus a roll of *Endurance* (or *Strength* or *Physique*, depending on which attribute you've included in your game). Increase or decrease the base value of 20 to alter the lethality of your game world.

Additionally, by default characters do not get a damage resistance roll when affected by the Body Points system. Allowing this roll makes the game less deadly.

Sample Skill List

Skill (Alternate Names)

brawling (fighting, unarmed combat)
 climbing
 disguise
 dodge
 flying
 hide
 intimidation
 investigation
 jumping
 languages (speaking, reading)
 lifting
 lockpicking
 marksmanship (firearms, fire combat)
 medicine (first aid, healing)
 melee combat
 missile weapons
 navigation
 persuasion (con, charm)
 piloting (driving, vehicle operation)
 repair (crafting)
 riding
 running
 search
 sleight of hand
 sneak
 stamina
 streetwise

 survival
 swimming
 throwing
 scholar
 security
 tech (devices, computer ops)
 tracking
 willpower

Attribute

Reflexes, Strength
 Reflexes, Strength
 Charisma, Perception
 Reflexes
 Reflexes, Strength
 Perception
 Confidence, Perception
 Perception, Reasoning
 Reflexes, Strength
 Knowledge, Reasoning
 Strength
 Coordination, Technical
 Coordination
 Knowledge, Technical
 Reflexes, Strength
 Coordination
 Knowledge, Mechanical
 Charisma, Perception
 Coordination, Mechanical
 Reasoning, Technical
 Coordination, Mechanical
 Reflexes, Strength
 Perception
 Coordination
 Reflexes, Perception
 Endurance
 Charisma, Knowledge, Perception
 Knowledge, Perception
 Reflexes, Strength
 Coordination
 Knowledge
 Knowledge, Technical
 Knowledge, Technical
 Perception
 Confidence, Knowledge, Perception

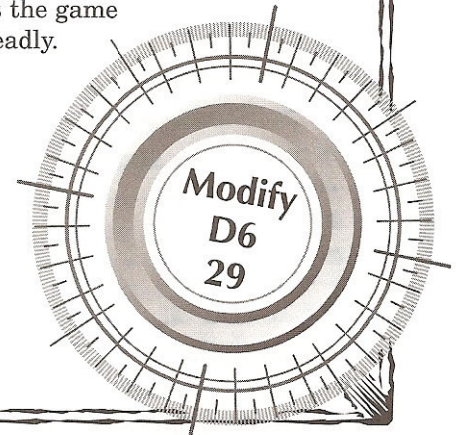

Because the skill resolution and damage mechanics are the same in all of the genre rulebooks, the only parts you need to convert to use supplements or characters for one genre in another are skills and attributes.

As with all conversions, this one gives you a starting point. Once you've made the conversion, you may want to move some pips around, so that they better reflect your idea of that character's abilities.

Base Attributes

The attributes used in *D6 Space* do not correspond directly to the attributes specified in *D6 Adventure* or *D6 Fantasy*. The accompanying tables offer the best and quickest equivalents for each attribute. The top one is for characters, and the bottom one is for animals and monsters. Animals and monsters with 0D in *Technical* receive 1D in *Knowledge*.

3. D6 Genre Conversion

Base Skills

Some skills convert smoothly from one genre to another, though you might need to move them from one attribute to another. With others, one genre rules set represents them with one skill while another uses two or more. (For example, *marksmanship* in *D6 Fantasy* translates to *firearms*, *gunnery*, and *missile weapons* in *D6 Space*.) Skills that translate to only one skill in another system are marked by stars. For all other skills, be sure to look over the entire list to make certain that you know your conversion options. The lists are sorted alphabetically by the name of the *D6 Space* skill, for space reasons. You can download from our Web site (www.westendgames.com) lists sorted by the other genres.

When you have to move a skill from one attribute to another or split the skill among multiple abilities, you need to know the number of **skill adds**. You can figure out this by subtracting the old skill from its governing attribute. This is the value of the skill adds for that skill. (Remember that three pips equal one die.)

Example: *Disguise* is under *Presence* in *D6 Adventure* and under *Acumen* in *D6 Fantasy*. If your *D6 Adventure* character has 4D+1 in *disguise* and 2D+2 in *Presence*, she has 1D+2 skill adds in *disguise*.

If two or more skills translate to a single skill in the new genre, there are two methods of handling this:

1. The new genre's single skill receives the skill adds from the **highest** skill in the old genre. If this is a player's character, reserve the other dice for skills that equate to

two or more skills in the new genre. Extra dice that cannot be used to purchase skills may be converted to Character Points on a "one pip for one point" basis. For gamemaster's characters, ignore the extra dice.

2. The new genre's single skill receives the skill adds from the **lowest** skill in the old genre. Other skills equivalent to the new skill become specializations of the new skill with specialization bonuses equal to the difference between the single skill's die code and the old skill's die code (minimum of +1). This is best for gamemaster's characters where you aren't concerned about the total number of dice used to make the character.

If the old skill equates to multiple different skills in the new genre, either put all dice into the skill that best fits the character concept or divide the dice from the old skill among the various skills. If you have dice leftover from converting multiple skills to a single skill, you may divide the extra dice among the multiple new skills.

You can, of course, add any skill from any genre to any other genre, if you think that it will get sufficient use in your adventures to warrant including its ability category.

Extranormal Attributes and Skills

Extranormal attributes and skills can be ported as-is to the new genre set.

Attribute Conversion for Characters

D6 Space	D6 Adventure	D6 Fantasy
Agility	Reflexes	Agility
Knowledge	Knowledge	Intellect
Mechanical	Coordination	Coordination
Perception	Presence	Charisma
Strength	Physique	Physique
Technical	Perception	Acumen

Attribute Conversion for Creatures

D6 Space	D6 Adventure	D6 Fantasy
Agility	Reflexes	Agility
Knowledge	Presence	Charisma
Mechanical	Coordination	Coordination
Perception	Perception	Acumen
Strength	Physique	Physique
Technical	Knowledge	Intellect

(0D = 1D)

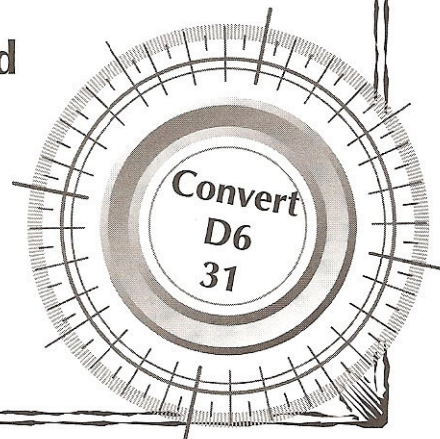

Skill Conversion List

D6 Space	D6 Adventure	D6 Fantasy	D6 Space	D6 Adventure	D6 Fantasy
acrobatics (Agility)	acrobatics (Reflexes)	acrobatics (Agility)	melee combat (Agility)*	melee combat (Reflexes)*	melee combat (Agility)*
acrobatics (Agility)	contortion (Reflexes)	contortion (Agility)	missile weapons (Agility)	missile weapons (Coordination)	marksmanship (Coordination)
aliens (Knowledge)	scholar (Knowledge)	scholar or cultures (Intellect)	navigation (Mechanical)	navigation (Knowledge)	navigation (Intellect)
artist (Perception)	artist (Perception)	artist (Acumen)	persuasion (Perception)	persuasion (Presence)	persuasion (Charisma)
astrography (Knowledge)	scholar or navigation (Knowledge)	scholar or navigation (Intellect)	persuasion (Perception)	charm (Presence)	charm (Charisma)
bargain (Perception)	persuasion (Presence)	persuasion (Charisma)	piloting (Mechanical)	piloting (Coordination)	charioteering (Coordination)
brawling (Agility)*	brawling (Reflexes)*	fighting (Agility)*	riding (Agility)	riding (Reflexes)	riding (Agility)
bureaucracy (Knowledge)	scholar (Knowledge)	scholar or cultures (Intellect)	riding (Agility) or persuasion (Perception)	animal handling (Presence)	animal handling (Charisma)
business (Knowledge)*	business (Knowledge)*	trading (Intellect)*	running (Agility)*	running (Physique)*	running (Physique)*
climb/jump (Strength)	climbing (Reflexes)	climbing (Agility)	scholar (Knowledge)	scholar (Knowledge)	scholar (Intellect)
climb/jump (Strength)	jumping (Reflexes)	jumping (Agility)	search (Perception)	search (Perception)	search (Acumen)
comm (Mechanical)	tech (Knowledge)	devices (Intellect)	search (Perception)	tracking (Perception)	tracking (Acumen)
command (Perception)	command (Presence)	command (Charisma)	security (Technical)	security (Knowledge)	traps (Intellect)
con (Perception)	con (Presence)	bluff (Charisma)	security regulations (Knowledge)	security (Knowledge)	scholar or cultures (Intellect)
con (Perception)	disguise (Presence)	disguise (Acumen)	sensors (Mechanical)	tech (Knowledge)	devices (Intellect)
cultures (Knowledge)	scholar (Knowledge)	cultures (Intellect)	shields (Mechanical)	tech (Knowledge)	devices (Intellect)
demolitions (Technical)	demolitions (Knowledge)	traps (Intellect)	sleight of hand (Agility)	sleight of hand (Coordination)	sleight of hand (Coordination)
dodge (Agility)*	dodge (Reflexes)*	dodge (Agility)*	sleight of hand (Agility)	lockpicking (Coordination)	lockpicking (Coordination)
exoskeleton operation (Mechanical)	piloting (Coordination)	charioteering (Coordination)	sneak (Perception)*	sneak (Reflexes)*	stealth (Agility)*
firearms (Agility)	marksmanship (Coordination)	marksmanship (Coordination)	stamina (Strength)*	stamina (Physique)*	stamina (Physique)*
flying/0-G (Agility)*	flying (Reflexes)*	flying (Agility)*	streetwise (Knowledge)*	streetwise (Perception)*	streetwise (Acumen)*
forgery (Perception)	forgery (Knowledge)	reading/writing (Intellect)	survival (Knowledge)*	survival (Perception)*	survival (Acumen)*
gambling (Perception)*	gambling (Perception)*	gambling (Acumen)*	swim (Strength)*	swimming (Physique)*	swimming (Physique)*
gunnery (Mechanical)	marksmanship (Coordination)	marksmanship (Coordination)	tactics (Knowledge)	scholar (Knowledge) or command (Presence)	scholar (Intellect) or command (Charisma)
hide (Perception)*	hide (Perception)*	hide (Acumen)*	throwing (Agility)*	throwing (Coordination)*	throwing (Coordination)*
intimidation (Knowledge)*	intimidation (Presence)*	intimidation (Charisma)*	vehicle operation (Mechanical)	piloting (Coordination)	charioteering (Coordination)
investigation (Perception)*	investigation (Perception)*	investigation (Acumen)*	vehicle operation (Mechanical)	piloting (Coordination)	piloty (Coordination)
know-how (Perception)*	know-how (Perception)*	know-how (Acumen)*	willpower (Knowledge)*	willpower (Presence)*	mettle (Charisma)*
languages (Knowledge)	languages (Knowledge)	speaking (Intellect)	interface/repair skills (Technical)	tech (Knowledge)	devices (Intellect)
languages (Knowledge)	languages (Knowledge)	reading/writing (Intellect)	repair only skills (Technical)	repair (Perception)	crafting (Acumen)
lift (Strength)*	lifting (Physique)*	lifting (Physique)*			
medicine (Technical)*	medicine (Knowledge)*	healing (Intellect)*			







DIEN

Combat Summary

See the "Combat" and "Combat Options" chapters for additional information and modifiers.

Determining the Difficulty

Base combat difficulty = defense total

- Defense total = (passive defense value or active defense value) plus combat difficulty modifiers
- Passive defense value = 10
- Active defense value = full defense value or partial defense value
- Full = any defense skill roll + 10
- Partial = any defense skill roll

Determining Success

If the attacker's combat skill total plus any modifiers equals or exceeds the target's defense roll, the attack succeeds and may do damage.

Determining Damage

- **Damage total**
 - For attacks that do damage not modified by strength: damage total = roll of weapon damage die code plus damage modifiers
 - For attacks that do damage modified by strength: damage total = roll of weapon damage die code plus character's Strength Damage die code plus damage modifiers
- **Damage resistance total**
 - Body Points: roll of Armor die code plus defense modifiers
 - Wounds: roll of *Physique* plus Armor die code plus defense modifiers
 - If the damage total is greater than the damage resistance total, the target was injured. If the damage total is less than or equal to the damage resistance total, the target was not injured.
 - If the target was injured, subtract the damage resistance total from the damage total. Then either subtract this from the target's current Body Total or compare the value on the "Wound Levels" chart.

Breaking Things Option

Compare the amount of damage done or the demolitions total with the object's damage resistance total (its Toughness modified by size, thickness, flaws, supports, etc.). Items that take at least two to three times their damage resistance total are severely damaged, if not destroyed. Items taking less than that are weakened, and another attempt against it may be made (with the object having a reduced damage resistance total and possibly other problems).

Object Construction	Toughness
Flimsy (plywood door)	1D
Tough (hard wooden door, most guns)	2D
Sturdy (bolted steel door, personal safe)	3D
Very sturdy (a few layers of steel)	4D
Reinforced (numerous layers of steel)	6D

Range Modifiers



Point Blank Range

Distance to Target: 0-1 meter
Combat Difficulty Modifier: -5

A target is within a few steps of the attacker.

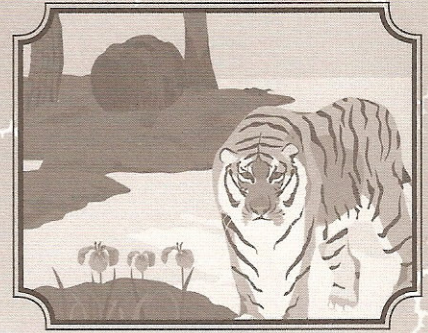

Short Range

Distance to Target: 1 meter to first value*
Combat Difficulty Modifier: 0

An attacker fires a rifle or long bow at a target across a large chamber.



Medium Range

Distance to Target: First to second value*
Combat Difficulty Modifier: +5

An attacker throws a knife or fires a handgun at a target across a large chamber.



Long Range

Distance to Target: Second to third value*
Combat Difficulty Modifier: +10

Most projectile combat taking place outdoors.

*Range Note: "Distance to Target" values refer to values given in the weapon's range listing.

Scale Option

Participant Size	Value
Small moon	96
Aircraft carrier	50
Jumbo jet, space yacht	46
Eight-story building	24
War galley	21
Four-story building	20
Two-story house	14
Longship	12
City bus, tank	10
Elephant	8
Average car, carriage	6
Motorcycle, horse	3
Average Human	0
Human child, guard dog	3
Small keg, house cat, briefcase	6
Fashion doll, rat, small laser pistol	9
Action figure, mouse	12
Plastic army figure, coin, cred-key	15
Ant, computer chip	21

Hit Location Option

Modifiers

Option	Difficulty Modifier	Damage Modifier
Head	+1D (+3)	+12
Heart	+4D (+12)	+12
Chest, abdomen	0	0
Left or right arm	+1D (+3)	-2
Left or right leg	+1D (+3)	-1
Left or right hand	+4D (+12)	-2

Effects

Sufficient damage to a particular hit location can affect the target's ability to use that part. Except for blows to the chest, the modifier lasts until the character heals that portion. Hit location modifiers are in addition to Wound level modifiers. If you are using them instead of the Wound level modifiers, then all -1 modifiers increase to -1D modifiers.

Chest: The character can do no more than passively defend in the next round.

Foot or leg: -1 to all *acrobatics*, *sneak*, movement, and initiative totals.

Hand or arm: -1 to all *acrobatics*, *brawling*, *climbing*, *melee combat*, *missile weapons*, *sleight of hand*, *throwing*, *lifting*, and any other rolls involving the hand or arm.

Head: -1 to all *Knowledge*, *Perception*, and initiative totals.

WEST END GAMES • www.westendgames.com

Cover Option

Situation	Modifier
Light smoke/fog; poor light; twilight	+1D (+3)
Thick smoke/fog; moonlit night	+2D (+6)
Very thick smoke/fog; complete darkness	+4D (+12)
Object hides 25% of target	+1D (+3)
Object hides 50% of target	+2D (+6)
Object hides 75% of target	+4D (+12)
Object hides 100% of target	*

* If cover provides protection, the attacker cannot hit the target directly, but damage done to the cover might exceed the Armor Value it gives the target, and, indirectly, the target receives damage. Most of the time, the attacker must eliminate the cover before having a chance to hit the target.

Called Shot Option

Target is...	Modifier	*
10 to 50 centimeters long	+1D (+3)	*
1 to 10 centimeters long	+4D (+12)	*
Less than a centimeter long	+8D (+24)	*

* See "Combat Options" chapter for options.

Wound Levels

See the "Combat" and "Damage" chapters for additional damage information and modifiers.

Effect	Wounds*	Body Points†
	Damage Total ≥	Body Points Left
Bruised	0 or less	81% – 99%
Stunned	1–3	60% – 80%
Wounded	4–8	40% – 59%
Severely Wounded	4–8**	20% – 39%
Incapacitated	9–12	10% – 19%
Mortally Wounded	13–15	1% – 9%
Dead	16 or more	0

*Note: Any additional damage less than or equal to the character's current level moves the character up by one level.

**A character moves to the Severely Wounded level if the difference is between 4 and 8 and she already has the Wounded level.

†Note: This is an optional chart for use with Body Points. The "Body Points Left" column is based on the character's maximum Body Points. Round up or down so that no overlap exists between levels.

Penalties imposed by each level are not cumulative; do not include them when determining the stun or damage resistance total or any total not involving a skill or attribute.

Bruised: Character's toughness absorbed most or all of the attack. However, the gamemaster may decide that a result that misses by a few points against a defender with no protection (natural other otherwise) instead inflicts a Stunned level.

Stunned: Character either gets -1D for all remaining actions this round and next round or may only defend or retreat in the next round.

Wounded: Character is at -1D to all actions until healed.

Severely Wounded: Character is at -2D on all actions until healed.

Incapacitated: As a free action before losing consciousness, the character may try to stay up with a Moderate (15) *stamina* or *mettle* roll. If he succeeds, he may continue to act, but all actions have a -3D penalty. If he fails, he is knocked out for 10D minutes.

Mortally Wounded: Character is near death and knocked unconscious with no chance to keep up. Roll the character's *Physique* each round, the character finally dies if the roll is less than the number of minutes he's been at this level.

Dead: The character has perished.

Die Code Comparisons

1D: Below Human average for an attribute
2D: Average Human attribute
3D: Average adventurer attribute
2D+1 to 3D+2: Average skill level
4D to 5D+2: Competent skill level
6D to 7D+2: Professional skill level
8D to 9D+2: Highly skilled
10D to 11D+2: Exceptionally skilled
12D or more: Legendary skill level

Die Code Simplification

See page 142 for details and chart.

Die Code	5D	Wild Die
1D	0	0
2D	0	+4
3D	0	+7
4D	0	+11
5D	0	+14
6D	+4	+18
7D	+7	+21
8D	+11	+25
9D	+14	+28
10D	+18	+32
11D	+21	+35
12D	+25	+39
13D	+28	+42
14D	+32	+46
15D	+35	+49

Task Resolution

Roll a number of six-sided dice equal to the character's skill or attribute score. If the total plus modifiers equals or exceeds the difficulty number, then the character succeeds.

Generic Standard Difficulties

Automatic (0): Almost anyone can perform this action; no need to roll.

Very Easy (1–5): Nearly everyone can accomplish this task.

Easy (6–10): An untrained character may find it challenging.

Moderate (11–15): Tasks of this type require skill, effort, and concentration.

Difficult (16–20): Those with little experience in the task must have a lot of luck to accomplish this type of action.

Very Difficult (21–25): The average character only rarely succeeds at these kinds of task. Only the most talented regularly succeed.

Heroic (26–30), Legendary (31 or more): Nearly impossible, but there's a slim chance that lucky average or highly experienced characters can accomplish them.

Generic Modifiers

Situation Helps/Hinders Character ...	Modifier
Slightly	+/-1–5
Significantly	+/-6–10
Decisively	+/-11–15
Overwhelmingly	+/-16 or more

Success Levels

Minimal (0): The character hardly succeeded at all, and only the most minimal effects apply. If "minimal effects" are not an option, then maybe the action took longer than normal to succeed.

Solid (1–4): The action was performed completely but without frills.

Good (5–8): The results were better than necessary; there may be added benefits.

Superior (9–12): There are almost certainly additional benefits to doing an action this well. The character performed the action better, faster, or more adeptly than expected.

Spectacular (13–16): The character performed the action deftly and expertly. Observers would notice the ease or grace with which the action was performed (if applicable).

Incredible (17 or more): The character performed the skill with such dazzling quality that, if appropriate to the task, it could become the subject of conversation for some time — it's at least worth writing home about. Gamemasters should dole out some significant bonuses for getting this large of a roll.

Result Points Option

Result points = skill/attribute total - difficulty

Skill bonus = result points/2 • Damage bonus = result points/5

See the "Game Basics" chapter for more game mechanics on task resolution. See the "Example Skill Difficulties" chapter for more difficulties.

Interaction Difficulty Modifiers

Base Difficulty: 10 or target's Charisma or mettle roll

Situation	Modifier
Target is friendly or trusting	-5
Target is neutral toward character or of equal standing	0
Target is hostile or has superior standing	+5
Target is an enemy	+10
Target is in weakened position	-10
Request is something target would do anyway or target feels is of minor importance	0
Request is illegal or highly dangerous	+10
Target is on guard or actively resisting*	+10

*Do not include this modifier if you are using the active mental defense described in the "Mental Defenses" section.

Information Difficulties

Amount of Information	Difficulty
Basic or common information; unconfirmed rumors	5
Theories; generalities	10
Complex concepts; moderately detailed information	15
Professional level; extensive (though not complete) information	20
Cutting-edge topics; extensive information, including peripheral details and extrapolations	30

Condition	Modifier
Age of information (per century in the past)	+5
Closely guarded secret	+15

Observation Difficulties

See page 73 for additional information and modifiers.

Situation	Difficulty
Noticing obvious, generic facts; casual glance	5
Noticing obvious details (ex. number of people)	10
Noticing a few less obvious details (ex. gist of conversation)	15
Spotting a few specific details (ex. identities of individuals)	20
Spotting a few obscure details (ex. specifics of conversation)	25
Noticing many obscure details	30 or more

Movement Difficulty Modifiers

See the "Movement" chapter for additional information and modifiers.

Base Difficulty for Characters: 0 (running); 5 (other movement)

Situation	Modifier
Easy terrain (flat surface, smooth water, using a ladder, light breeze, light rain or fog)	0
Moderate terrain (uneven surface, small obstacles, choppy water, climbing a tree, strong winds, heavy rain or fog)	+5
Rough terrain (large but negotiable obstacles, strong undercurrent, climbing a rough wall, flying near unyielding obstacles such as pillars or trees)	+10
Very rough terrain (dense and large obstacles, stormy weather, a few airborne hazards, hail)	+15
Hazardous terrain (minefield, narrow walkway, many airborne hazards, large waves, climbing a smooth surface, complete darkness)	+20
Very hazardous terrain (corridor filled with falling debris and explosions, swimming or flying in a hurricane)	+25 or more

Abbreviated Healing Chart

See the "Healing" chapter for additional healing information and modifiers.

Healing Total	Body Points Recovered	Current Wound Level
1-5	2	—
6-10	1D	Stunned, unconscious
11-15	2D	Wounded, Severely Wounded
16-20	3D	Incapacitated
21-25	4D	Mortally Wounded
26-30	5D	—

Abridged Lifting Table

Weight	Difficulty
1 kg	1
10 kg	3
50 kg	7
100 kg	12
120 kg	13
200 kg	17
250 kg	18
500 kg	23
750 kg	28
1000 kg (1 ton)	33
1100-2000 kg	34-43
(+1 to base of 33 per 100 kg over 1000 kg)	
2500-10,000 kg	44-59
(+1 to base of 43 per 500 kg over 2000 kg)	
15,000-100,000 kg	60-77
(+1 to base of 59 per 5000 kg over 10,000 kg)	

Quick Index

<i>A</i> = D6 Adventure, <i>F</i> = D6 Fantasy, <i>S</i> = D6 Space	improving characters, A43-45; F44-46; S52-54
Advantages, A16, A27-33; F16, F27-32; S16, S27-31	lifting fatigue, A78; F79; S91
aiming/preparing, A51, A59; F52, F61; S60, S73	miscellaneous damage, A61; F63; S75
attribute list, A10-11; F10-11; S10	movement
Character Point use, A46-47; F47-48; S55-56	character, A54-55; F55-56; S63-65
characters, sample generic, A126-127; F42-43 (non-Human), F125-126; S42-44 (aliens), S127	vehicle, A55-57; F56-59; S65-67, S68-71
combat, A58-60; F60-62; S72-74	multiple actions, A49; F51; S58-59
combat options, A66-70; F68-71; S80-83	price difficulties, A112; F113; S103
Critical Failure, A46; F47; S55	related skills, A51; F52; S59-60
Critical Success, A46; F47; S55	result points, A53; F54; S62
damage bonus, A60; F62; S74	rewards, A126; F125; S126
difficulties for basic skills, A71-82; F73-82; S84-94	rushing, A51; F52; S60
Disadvantages, A16, A18-27; F16, F17-27; S16, S18-27	scale, A70; F71; S83
Fate Point use, A46-47, A47; F47-48, F48; S55-56, S56-57	skill list, A12-13; F12-13; S12-13
initiative, A48-49; F49-50; S57-58	Special Abilities, A17, A33-42; F17, F32-41; S17, S31-40
	Spell Measures chart, A87; F87
	Strength Damage, A60; F62; S74
	stun damage, A62; F63, F64; S75, S76
	unskilled (untrained) actions, A48; F49; S57



West End Games, WEG, and the D6 System are trademarks of Purgatory Publishing Inc. These trademarks are used under the D6 System Trademark License, available at www.opend6.com.

DESIGNATION OF PRODUCT IDENTITY

The following items are hereby designated as Product Identity in accordance with Section 1(e) of the Open Game License, version 1.0a: Any and all West End Games, WEG, and D6 System logos, identifying marks, and trade dress; all cover and interior art and illustrations.

DESIGNATION OF OPEN GAME CONTENT

The following items are hereby designated as Open Game Content in accordance with Section 8 of the Open Game License, version 1.0a: All text and tables in this document, with the exception of material specifically excluded in the declaration of product identity, is open game content.

OPEN GAME LICENSE Version 1.0a

The following text is the property of Wizards of the Coast, Inc. and is Copyright 2000 Wizards of the Coast, Inc ("Wizards"). All Rights Reserved.

1. Definitions: (a) "Contributors" means the copyright and/or trademark owners who have contributed Open Game Content; (b) "Derivative Material" means copyrighted material including derivative works and translations (including into other computer languages), potation, modification, correction, addition, extension, upgrade, improvement, compilation, abridgment or other form in which an existing work may be recast, transformed or adapted; (c) "Distribute" means to reproduce, license, rent, lease, sell, broadcast, publicly display, transmit or otherwise distribute; (d) "Open Game Content" means the game mechanic and includes the methods, procedures, processes and routines to the extent such content does not embody the Product Identity and is an enhancement over the prior art and any additional content clearly identified as Open Game Content by the Contributor, and means any work covered by this License, including translations and derivative works under copyright law, but specifically excludes Product Identity. (e) "Product Identity" means product and product line names, logos and identifying marks including trade dress; artifacts; creatures characters; stories, storylines, plots, thematic elements, dialogue, incidents, language, artwork, symbols, designs, depictions, likenesses, formats, poses, concepts, themes and graphic, photographic and other visual or audio representations; names and descriptions of characters, spells, enchantments, personalities, teams, personas, likenesses and special abilities; places, locations, environments, creatures, equipment, magical or supernatural abilities or effects, logos, symbols, or graphic designs; and any other trademark or registered trademark clearly identified as Product identity by the owner of the Product Identity, and which specifically excludes the Open Game Content; (f) "Trademark" means the logos, names, mark, sign, motto, designs that are used by a Contributor to identify itself or its products or the associated products contributed to the Open Game License by the Contributor (g) "Use", "Used" or "Using" means to use, Distribute, copy, edit, format, modify, translate and otherwise create Derivative Material of Open Game Content. (h) "You" or "Your" means the licensee in terms of this agreement.

2. The License: This License applies to any Open Game Content that contains a notice indicating that the Open Game Content may only be Used under and in terms of this License. You must affix such a notice to any Open Game Content that you Use. No terms may be added to or subtracted from this License except as described by the License itself. No other terms or conditions may be applied to any Open Game Content distributed using this License.

3. Offer and Acceptance: By Using the Open Game Content You indicate Your acceptance of the terms of this License.

4. Grant and Consideration: In consideration for agreeing to use this License, the Contributors grant You a perpetual, worldwide, royalty-free, non-

exclusive license with the exact terms of this License to Use, the Open Game Content.

5. Representation of Authority to Contribute: If You are contributing original material as Open Game Content, You represent that Your Contributions are Your original creation and/or You have sufficient rights to grant the rights conveyed by this License.

6. Notice of License Copyright: You must update the COPYRIGHT NOTICE portion of this License to include the exact text of the COPYRIGHT NOTICE of any Open Game Content You are copying, modifying or distributing, and You must add the title, the copyright date, and the copyright holder's name to the COPYRIGHT NOTICE of any original Open Game Content you Distribute.

7. Use of Product Identity: You agree not to Use any Product Identity, including as an indication as to compatibility, except as expressly licensed in another, independent Agreement with the owner of each element of that Product Identity. You agree not to indicate compatibility or co-adaptability with any Trademark or Registered Trademark in conjunction with a work containing Open Game Content except as expressly licensed in another, independent Agreement with the owner of such Trademark or Registered Trademark. The use of any Product Identity in Open Game Content does not constitute a challenge to the ownership of that Product Identity. The owner of any Product Identity used in Open Game Content shall retain all rights, title and interest in and to that Product Identity.

8. Identification: If you distribute Open Game Content You must clearly indicate which portions of the work that you are distributing are Open Game Content.

9. Updating the License: Wizards or its designated Agents may publish updated versions of this License. You may use any authorized version of this License to copy, modify and distribute any Open Game Content originally distributed under any version of this License.

10 Copy of this License: You MUST include a copy of this License with every copy of the Open Game Content You Distribute.

11. Use of Contributor Credits: You may not market or advertise the Open Game Content using the name of any Contributor unless You have written permission from the Contributor to do so.

12 Inability to Comply: If it is impossible for You to comply with any of the terms of this License with respect to some or all of the Open Game Content due to statute, judicial order, or governmental regulation then You may not Use any Open Game Material so affected.

13 Termination: This License will terminate automatically if You fail to comply with all terms herein and fail to cure such breach within 30 days of becoming aware of the breach. All sublicenses shall survive the termination of this License.

14 Reformation: If any provision of this License is held to be unenforceable, such provision shall be reformed only to the extent necessary to make it enforceable.

15 COPYRIGHT NOTICE

Open Game License v 1.0 Copyright 2000, Wizards of the Coast, Inc. D6 Space Copyright 2004, Purgatory Publishing Inc.