

DATAFORTRESS 2.0.2.0

Presents:

ULTIMATE SUBMACHINEGUNS

Written by Deric Bernier (droc@mc2k.com)

UPDATED: 4-30-13

The complete collection of all the Submachineguns created for the various articles and sourcebooks by Deric Bernier found on Datafortress 2020.



This is just one of many articles for the Cyberpunk 2020 Roleplaying Game you can find on Datafortress 2020, the largest, most comprehensive Cyberpunk 2020 site in the world.

Visit it at:

<http://datafortress2020.oliwy.net>

LIGHT SUBMACHINEGUNS

5MM



TSUNAMI ARMS KSAP-1 260eb
SMG - -2 - J - P - 1D6 (5mm caseless) - 25 - 1/3/15 - ST
Now here is something new. A front loading helical magazine which allows this pistol sized smg to carry much more ammo than you could imagine in such a small size. Granted its a light caliber, but still against an unarmored foe this could be devastating, and the whole thing fits in a shoulder holster easily concealed under a jacket.

7MM



FABRICA DE ARMES CHIVRE 475eb
SMG - +1 - L - P - 1D6+2 (7mm caseless) - 50 - 1/3/20 - VR
The light ammo load of this weapon makes for a very accurate machine pistol. Popular among assassins due to the built in suppressor making the weapon no louder than a cough.

.22 CALIBER

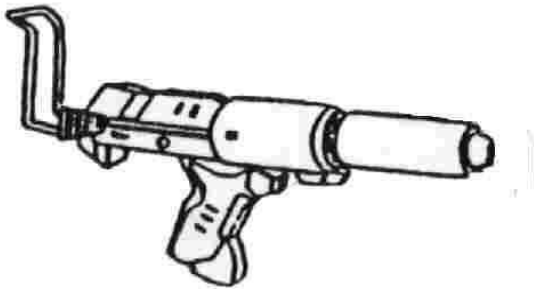

MUSTANG ARMS MOUSE 345eb
SMG - +2 - L - 1D6-1 (.22cal subsonic caseless) - 25 - 1/3/15 - VR
Using the same principles as the Whisper, Mustang Arms developed this incredibly silent smg. It comes with a retractable wire stock and has the same noise reduction offered by the Whisper.

.25 ACP



SEBURO "FIRE SPLASH" 295eb
SMG - 0 - L - E - 1D6+1 (.25acp caseless) - 100 - 1/3/10 - ST
As if in precognitive response to our views of the MW-0206, Sebuoro also released this compact little number. The same firing mechanism, but a much more compact package and lighter load. Ideal for airplane security, though the lack of forward grip was ill conceived as it could lead to many a lost fingertip from the supporting hand.



RUSSIAN ARMS "AK-MICRO" 115eb
SMG - +2 - N - E - 1D6+1(.22cal cased) - 35 - 1/3/20 - ST
This extremely underpowered weapon from Russian Arms is finely crafted, but really useful only for target shooting and beginners. Although with the addition of a suppressor it makes an ideal assassination weapon.

MEDIUM SUBMACHINEGUNS

9MM



ARASAKA AASW-9F 275eb
SMG - +2 - N - C - 2d6+1(9mm caseless) - 15/30 - 1/3/15 - VR

A light simple submachinegun, common to security forces all over the world, both private and federal. Sleek clean lines are all that distinguish this weapon from the vast multitude of other 9mm subs around the globe.



ARES FMG 395eb
SMG - 0 - P - R - R - 2D6+1 (9mm cased) - 25 - 1/3/20 - ST

One of the oddest weapons ever made, the entire gun folds in on itself, the advantages to this are simple.....concealability. This firearm can be left in plain view and most people still wouldn't be able to recognize it as a weapon. A number of custom cases are available exclusively from Autumn Blade, to further conceal this weapon, such as semi-working radio, cellphone, laptops etc...

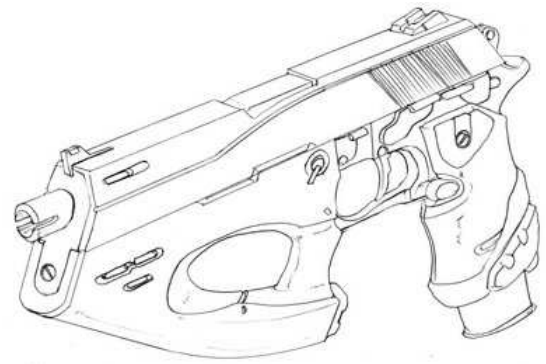

BARETTA 102-SR 415eb
SMG - 0 - L - P - 2D6+1 (9mm caseless) - 20 - 1/3/15 - ST

Beautifully crafted, and the additional weight provided by the oversized, but ergonomic, fore grip makes recoil almost imperceptible, even when firing one handed. An extended 35 round capacity (10eb) magazine is available, as is a 50 round drum magazine (25eb). Other available options include an integral laser sight built into the fore grip.



BUDGET ARMS "BALTA" 120eb
SMG - -1 - L - E - 2D6+1 (9mm caseless) - 35 - 1/3/30 - UR

Third world dictators and low level crime lords love arming their men with these horribly cheap and unreliable weapons. They jam frequently, occasionally blow up when fired full auto, and the metal is so subpar you can easily bend it with your bare hands. But its really cheap, fires extremely common ammunition, and comes with a folding stock, and when you're on a really tight budget does anything else matter.

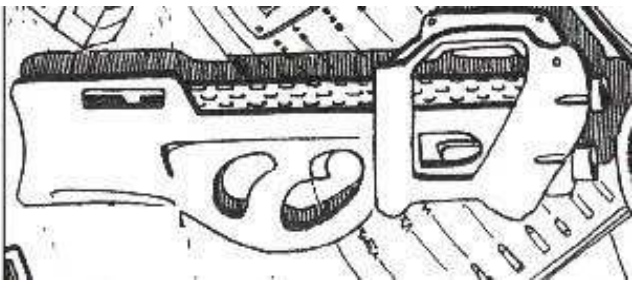

CCMMC CSG-L432 220EB
 SMG - 0 - L - P - 2D6+1 (9MM caseless) - 50 - 25/3/1 - R

Chinas version of the FP90 submachinegun is the standard issue to Chinese special forces and vehicle crews. It features an integral laser sight and accepts a suppressor. It's large ammo capacity, relative small size, and reliability make it a sought after weapon.



DAI-LUNG 150eb
 SMG - -1 - L - E - 2d6+1 (9mm caseless) - 20 - 1/3/20 - UR

For a weapon that fires caseless ammunition, this sure does tend to jam a lot. Which can be a major pain in the ass since you have disassemble the weapon completely to free the mechanism. Still, it's cheap, so its everywhere.



DIES SMS-65 550eb
 SMG - +1 - N - P - 2d6+1 (9mm caseless) - 50 - 1/3/20 - UR

An excellent sub from Dies, another in a line of fantastic products from a name that is making an immediate impact in the community for style, innovation, and quality.



FEDERATED ARMS P-18 240eb
 SMG - -1 - J - P - 2D6+1 (9mm cased) - 14/30 - 1/3/10 - ST

Very tiny for an smg, made to be fired with one hand. The magazine, available in either 14 or 30 rounds, of this bullpup weapon acts as an arm brace for helping to steady aim. Oddly enough, this weapon has almost no muzzle climb.



FEDERATED ARMS P-19 310eb
 SMG - 0 - L - P - 2D6+1 (9mm cased) - 14/30 - 1/3/10 - ST

Just a tad larger than the P-18, this weapon adds a bit longer of a barrel, plus a front grip and retracting stock for even greater accuracy.



HECKLER AND KOCH "BRAIDER" 345eb
 SMG - +1 - L - P - 2D6+1 (9mm caseless) - 50 - 1/3/15 - ST

Taking a note from Sebuco by copying there magazine style and reversing it, the Braider is an excellent example of ingenuity and refinement. The folding foregrip allows the weapon to be stored in a leg holster without suffering a loss of stability

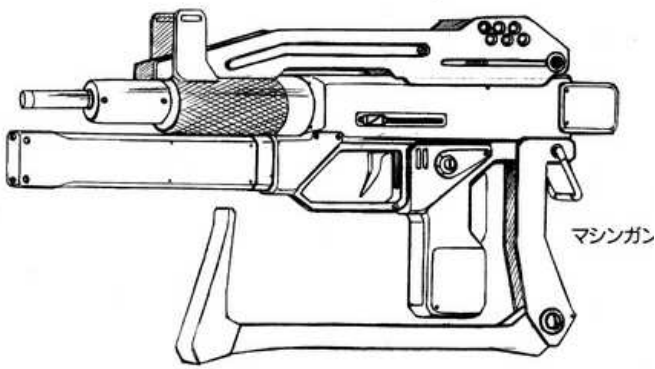

IMI "NUZI" 275eb

SMG - 0 - J - P - 2D6+1 (9mm caseless) - 35 - 1/3/15 - VR

The forward mounted clip is a radical departure from previous UZI incarnations., but it works wonders for reducing the overall profile of the weapon.



NOMAD ACTION JACKSON 200eb

(From Nomad Market)

SMG - 0 - L - C - 2D6+2 (.45 cal cased) - 50 - 1/3/15 - ST

A simple, easy to clean and operate submachine gun with a large capacity drum magazine. A favorite among the nomad community.



LOTEK NEGATIVE 9 45eb

(From Nomad Market)

SMG -3 L E 2d6+1 10/2030 1/15 UR

Chambered in 9mm, these hand made SMG's are a staple of the nomad community. They make for a cheap, easily distributable weapon for families on a budget, though no self respecting pro would ever so much as touch one. The rate of fire is kept low to maximize controllability and to keep the number of stray shots to a minimum. Regardless it's an incredibly inaccurate weapon, but its cheap and easy to make. In fact, nomads who make these usually end up selling more of them to street gangs on a budget than to nomads, who usually know better. The guns jam frequently but usually won't backfire or explode. These weapons vary wildly in appearance, du to being hand made by numerous sources, it seems every nomad market makes their own style, but they are all pretty much identical in terms of performance, cheap and crappy.



NOMAD DEADLY CROSS 400eb

(From Nomad Market)

SMG - +1 - L - U - 2D6+1 (9mm caseless) - 30X2 - 1/6/40 - VR

This weapon features dual clips which feed 9mm caseless ammunition at a staggering rate of fire. As much art as it is a weapon.



NOMAD SMG 150eb

(From Nomad Market)

SMG - -1 - L - U - 2D6+1 (9mm caseless) - 20 - 1/3/20 - ST

This is a handmade submachine gun, probably crafted on the road due to the crude nature of the weapon. It's probably one of a kind, and can be found on a blanket being sold by one of the nameless merchants against the wall.



NOMAD OUTRIDER SMG 100eb

(From Nomad Market)

SMG - -1 - J/L - C - 2D6+1 (9mm cased) - 15/30 - 1/3/20 - VR

These nomad built submachine guns accept any uzi magazine and are highly reliable.

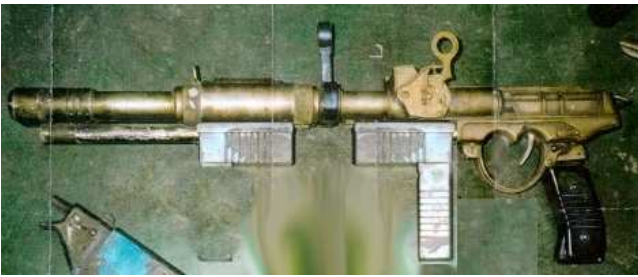

NOMAD OUTRIDER SPECIAL 50eb

(From Nomad Market)

SMG - -1 - L - U - 2D6+1 (9mm caseless) - 30 - 1/3/20 - ST

A very very crude but reliable submachine gun.



RUGER BM-57 550eb

SMG - +2 - N - C - 2D6+1 (9mm caseless) - 40 - 1/3/20 - VR

Rugers latest smg is a sturdy and reliable workhorse, perhaps a bit heavy but the weight is more than worth it for the accuracy and ammo capacity of this excellent weapon. The adjustable stock is nice, though the apparatus is a bit overly done.



NOMAD TECHNOMANCER 9mm 200eb

(From Nomad Market)

SMG - 0 - L - C - 2d6+1 (9mm cased) - 15/30 - 1/3/30 - VR

Those Technomancers are an odd bunch. This is their standard weapon. And it appears to be a heavily modified micro-uzi. Only the barrel has been greatly extended, a new stock has been fitted, and a 40mm grenade launcher has been affixed to the underbarrel.



NOMAD UZI 430eb

SMG +1 L R 2D6+1(9mm cased) 20 1/3/15 ST

This Micro Uzi has been modified to the point it is no longer recognizable. I comes with scope, bayonet (1d6), folding stock, and an extra magazine.

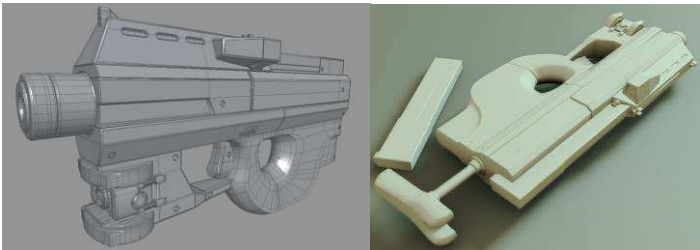

REMINGTON M-8LCAW 425+eb

SMG - -1 - N - E - 2D6+1 (9mm cased) - 66 - 1/3/20 - ST

With a 66 round top mounted helical magazine, and more options than you can shake a stick at, this weapon is the perfect smg for those looking for a cheaper alternative than the Sebuoro.

SEBUORO AW-726 1799eb

RIF - -2 - N - R - 2D6+1 (9mm caseless) - 100 - 1/40 - VR

Yet another example of why Sebuoro is quickly becoming the favored manufacturer among professionals. This bullpup styled 9mm 8 barreled minigun is the best in its class. The latest most state of the art in anti-cyborg weapons, these combat bastards are being tested as we speak by NCPD C-SWAT. The digital ammo counter is a welcome and necessary feature, and the center point built in laser sight is a nice addition in compensating for the weapons inaccuracy. When the magazine is removed, the stock slides into the weapon for easy storage.



SEBURO 9mm PARA 480 EB
 SMG * +1 * L * R * 2D6+1(9mm) * 100 * 20 * ST *
 Submachine gun used against lighter cyborgs, equipped with a large suppressor for quiet fire. Useless against larger combat borgs or landmates.



STERNMEYER MUZ-12 875eb
 SMG - - 0 - N - P - 2D6+1/varies (9mm / 40mm gl) - 16/30 - 1/3/15 / 1 - ST
 A cheap reliable submachine with a built in 40 mm grenade launcher. The beauty of this weapon is that it accepts any 9mm UZI magazine. The weapon shown has the 16 round magazine loaded, which sits flush with the grip, and shows how concealable the weapon can be. The weapon also features a folding stock for greater concealability and accuracy.



SEBURO J9 540 EB
 SMG * +1 * L * R * 2D6+1(9mm) * 100* 30 * VR *
 An improved version of the 9mm para, re-enforced to fire HV ammo. This SMG is made for use against armored infantry.



SEBURO MW-0206 389eb
 SMG - - 1 - N - P - 2D6+2 (9mm caseless) - 75 - 1/3/20 - VR

It seems even Sebuoro can make an ugly weapon, though what it lacks in looks it makes up for in durability. Designed for vehicle crews in the Japanese Self Defense Force, we rolled a tank over this weapon, then picked it up and shot through 2000 rounds without a glitch. A smaller 40 round magazine is available.



STEIN AND WASSERMAN "GEPARD" 230eb
 SMG - 0 - L - C - 2D6+1 (9mm cased) - 25 - 1/3/20 - ST

Cross an Uzi with an AK, and you have this weapon with which to confuse illiterate gangsters the world over. The retracting stock and wooden accents make it a comfortable weapon, and it is suitably reliable for any situation.



STERNMEYER 89SG 255eb
 SMG - 0 - J/L - E - 2D6+1 (9mm cased) - 15/35 - 1/3/20 - ST

A simple, yet cheap and effective smg. This is the standard issue weapon of the Cuban elite forces.



STERNMEYER MS-71 250eb
SMG - +1 - L - C - 2D6+1 (9mm caseless) - 25 - 1/3/20 - ST
A very small weapon with a very high rate of fire. Inexpensive and concealable this is a very popular weapon among gangs and organized criminals, as well as terrorists.

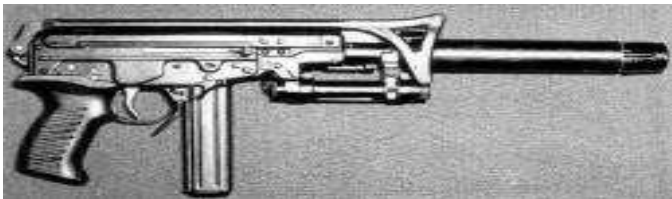

STURM KR-404 169eb
SMG - +1 - J - C - 2D6+1 (9mm cased) - 25 - 1/3/15 - ST
Folding stock, available suppressor, and integral laser sight all come standard with this weapon. The KR-404 is accurate and can be found in the service of many police and military forces all over the world.



TOWA MTR-11 200eb
SMG - 0 - J - P - 2D6+1 (9mm caseless) - 40 - 1/3/15 - ST
A Chinese knock-off of an Ingram, with an interesting barrel shroud design.



TOWA XAIO-14 360eb
SMG - +1 - N - E - 2D6+1 (9mm cased) - 35 - 1/3/15 - ST
Common all over Asia with military and police personnel, the XIAO-14 is an accurate, if visually unappealing submachinegun.

.45 ACP



COLT "THOMPSON-2" 420eb
SMG - -1 - N - C - 2D6+3/4d6 (.45ACP cased/12ga.) - 30-5 - 1/3/30-1 - ST

The venerable Tommy gun has long been respected for its reliability and sturdiness. It has now been reintroduced as a combat weapon after being given a facelift and an underbarrel 12 gauge pump shotgun. Both wooden and metal folding stocks are available.



NORINCO BXP-22 299eb
SMG - -1 - L - E - 2D6+2 (.45cal caseless) - 30 - 1/3/12 - ST

A good affordable smg, reminiscent of the Uzi. Chambered in .45 caliber the weapon is a bit hard to control, but the addition of the flat oversized grip pad is a nice touch.

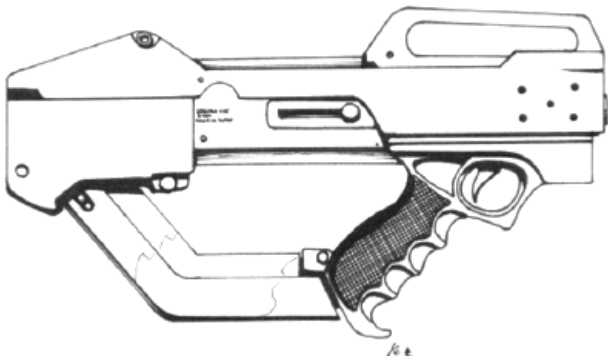

SEBURO FS-12 495eb
SMG - 0 - J - P - 2D6+2 (.45acp caseless) - 25 - 1/3/20 - VR

A nice, and extremely comfortable bullpup weapon, with almost no felt recoil and good durability. A weapon equally at home on the streets and in the bush.



pimpmygun.doctornoob.com

STERNMEYER POC-18 275eb
SMG - 0 - J - P - 2D6+2 (.45acp caseless) - 15/25 - 1/3/10 - VR

A typical smg from Sternmeyer, uninspired but inexpensive. Available with fifteen or 25 round clips.



STOVOLBOY STS-45 359eb
SMG - -1 - L - C - 2D6+2 (.45ACP caseless) - 30 - 1/3/12 - ST

Reminiscent of Ingrams Mac-10, this weapon is insanely popular due to its low price and simple firing mechanism. The sliding stock is cheap, but works as well as it has too. The only downside is lack of forward grip, don't blow off your fingertips.



pimpmygun.doctornoob.com

TSUNAMI ARMS "TAYLOR-19" 460eb
SMG - -2 - N - E - 2D6+2 (.45cal caseless) - 40 - 1/3/15 - ST

Named after its designer, the Taylor -19 is an inexpensive, easy to maintain weapon. Not very accurate, but moderately reliable it serves well to small armies and police forces, mostly in Mexico and South America.

10MM



ARMALITE "CASPIAN" 310eb
SMG - -1 - J - C - 2D6+3 (10mm caseless) - 16/30 - 1/3/10 - ST

No larger than a standard handgun, capable of single shot, burst, or full auto, and featuring folding front grip and optional suppressor, the Armalite Caspian is the ideal choice for you undercover needs.

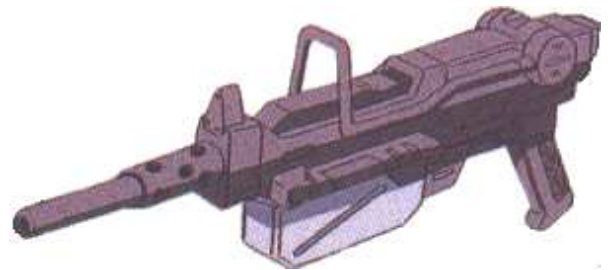

BUDGET ARMS RX-79 240eb
SMG - -2 - L - E - 2D6+3 (10mm cased) - 40 - 1/15 - UR

Unfortunately due to the extremely low cost, high rate of fire, and large ammo capacity this weapon has become very popular among street gangs. It is also barely concealable under most long trenchcoats. The sad thing is this weapon has a 30 percent chance of blowing up in your face anytime is fired full auto for more than 6 seconds. It features a folding stock, and while the rest of the weapon is crap, the unique magazine and loading design are noteworthy.



AMERITECH "DRYFIRE-2" 1745eb
SMG - 0 - N - C - 2D6+3 (10mm caseless) - 30 - 1/3/10 - ST

Utilizing the same materials as the "Riverman", the Dryfire-2 takes it a step further, the entire weapon is made from this special bouyant material. The 10mm caseless firing weapons action and moving parts are completely watertight. Even the barrel features special rubberized seals which allow the bullet to exit, but allow nothing to enter. This means the weapon can be fired safely even underwater with no fear of water getting inside the weapon and fowling or rusting the interior. Because it was designed for the US Coast guard, the weapon is only available as shown, bright yellow and all. The retracting plastic stock is removable.



CALICO "GRINDER" 620eb
SMG - +1 - L - C - 2D6+3 (10mm caseless) - 50/100 - 1/3/15 - ST

Calico does it again. This rendition features a retractable stock, and is chambered for the venerable 10mm. With its large ammo supply and high rate of fire, this is the perfect toy to keep your opponents heads down. This weapon is a bullpup version of the classic helyndrical magazine system, allowing for greater accuracy and range. An addition 100 round magazine is available.



BIZON-3 SMG 759eb
SMG - +1 - LC/N - P - 2d6+3 (10mm caseled) - 60 - 2/3/35 - VR

An updated version of the Soviet Bizon Submachinegun, this weapon has accessory options such as a folding stock, electronic scope (capable of being smart gunned), and suppressor.

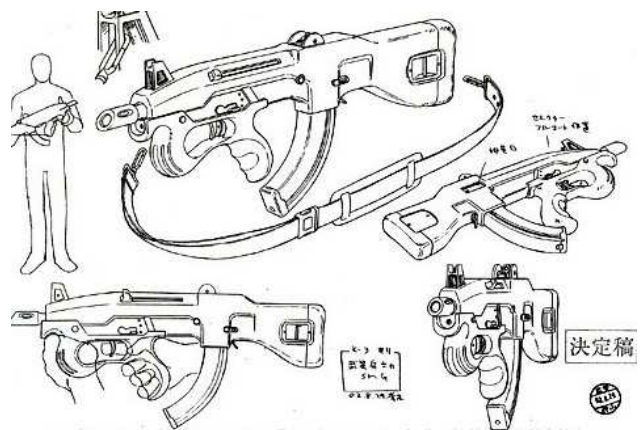

CESKA ZVBROJOVKA CZSM-477 475eb
SMG - 0 - N - C - 2D6+3 (10mm cased) - 40 - 1/3/10 - ST

This bullpup style 10mm smg from our friends in Czechoslovakia serves with most eastern European militaries faithfully.



FABRICA DE ARMES "DRUMMER-BOY" 875eb
 SMG - -1 - N - C - 2D6+3 (10mm cased) - 100 -
 1/3/20 - ST
 A compact smg with a staggering ammo capacity.



GLOCK 53 375eb
 SMG - -1 - L - R - 2D6+3 (10mm cased) - 18/30 -
 1/3/12 - VR
 Glock keeps pushing forward while retaining the look and performance that make them instantly recognizable. This fully automatic capable Glock features a front grip for added stability and accuracy. 30 round magazines are available for an addition 20eb apiece.



FABRICA DE ARMES "GURPS" 475eb
 SMG - -1 - N - E - 2D6+3 (10mm cased) - 30 - 1/3/20 - ST
 With a side loading magazine and high rate of fire, the GURPS bears a fond resemblance to the classic Sten. However with state of the art construction and firing the hard hitting 10mm ammunition this weapon exceeds the standard.



H&K BP-425 745eb
 SMG - +1 - N - C - 2D6+3 (10mm cased) - 30 -
 1/3/18 - VR
 A beautiful and compact weapon, with built in suppressor and extending stock. Perfect for those occasions when stealth is of the utmost importance.

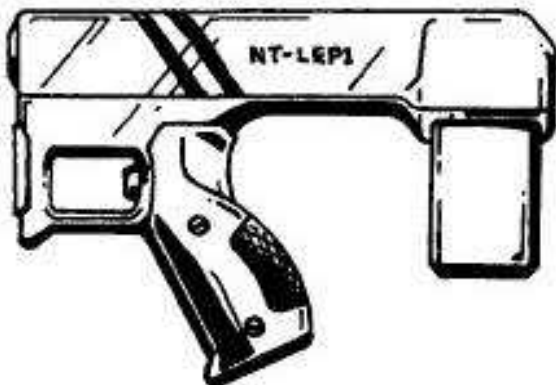

FEDERATED ARMS NT-LEP1 410eb
 SMG - -1 - J - P - 2D6+3 (10mm cased) - 14/30 -
 1/3/20 - ST
 Slight cosmetic differences are all that distinguish this weapon from the NT-MM01. This new line of weapons from Federated Arms is causing quite a stir in the community.





H&K MP-72 560eb
 SMG - +1 - L - C - 2D6+3 (10mm cased) - 40 - 1/3/20 - ST
 Another in a long line of smg's in Heckler and Kock's MP series of weapons. This one loads 11mm ammunition and has a built in foregrip and folding stock.

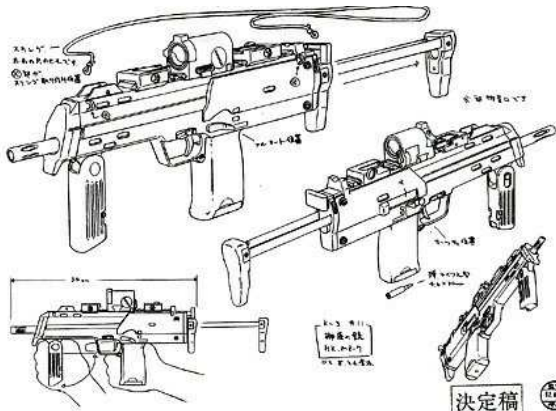

H&K MS-81 360eb
 SMG - +1 - L - C - 2D6+3 (10mm cased) - 20/35 - 1/3/20 - ST
 This is the military version of the "Braider". It uses a standard box magazine instead of the reverse Seburo style, and features a sliding adjustable stok for greater accuracy. A 35 round magazine is also available.



H&K SR-678 420eb
 SMG - +1 - L - C - 2D6+3 (10mm cased) - 40 - 1/3/20 - ST
 A standard H&K submachine gun, chambered in 10mm. This weapon is popular among law enforcement and anti terrorist circles for its smooth action and high ammo capacity.



LUCZNIK AND RADOM SCORPION-450 575eb
 SMG - 0 - L - P - 2D6+3 (10mm caseless) - 30 - 1/3/15 - VR
 Smartchipped as standard, this is one of the finest submachineguns in Eastern Europe, and a staple of the Russian, Czech, and Polish militaries

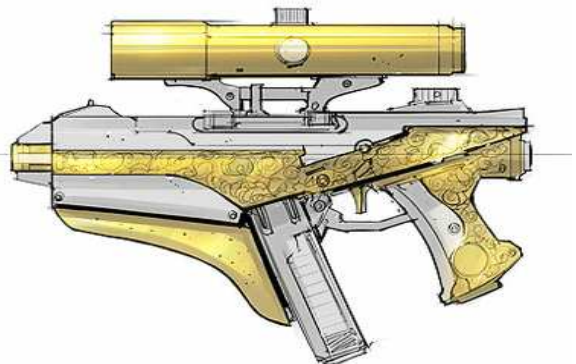

MALORIAN RGM-179 959eb
 SMG - +2 - L - R - 2D6+3 (10mm caseless) - 25 - 1/3/12 - VR
 An extremely accurate submachine gun, but what else would you expect from Malorian. This weapon looks like something out of a sci-fi movie and shoots like a dream. There is almost no muzzle climb whatsoever and the built in laser sight ensures you hit what you are aiming at every time.



MAUSER 10mm 320eb
 SMG - +1 - J - P - 2D6+3 (10mm cased) - 20 - 1/3/5 - VR

Recently Autumn Blade came across a stockpile of WWII Mausers that had been left behind in a warehouse in Germany and found by a European colleague. Since their acquisition they have been rebored and made to fire the more common 10mm round. The weapon can be set to fire semi-auto, 3 round burst, or fully automatic.

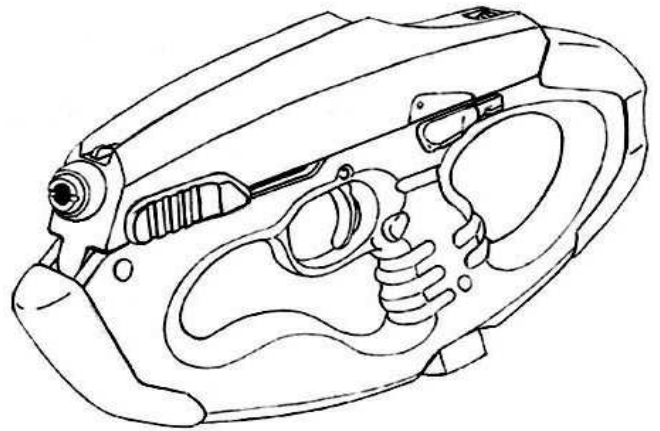

SEBURO RPNC-607 580eb
 SMG - +1 - J - P - 2D6+3 (10mm cased) - 20 - 1/3/10 - VR

Another innovative design from the people who revolutionized the way a submachinegun should feel and perform. Security specialists, vehicle crews, and police agencies around the world are taking notice of this weapon, and to offset the low ammunition capacity, a 50 round drum magazine is available.



NORINCO BRAWL-10 355eb
 SMG - -1 - J - E - 2D6+3 (10mm caseless) - 24 - 1/3/8 - ST
 A cheap 10mm, prone to frequent jams, but it remains popular due to it's looks and the built in laser sight and flashlight.



SEBURO TK513 670eb
 SMG - +1 - N - C - 2D6+3 (10mm caseless) - 200 - 1/3/45 - VR

The next logical step from the J-11, the TK513 holds a staggering 200 rounds, and barely sacrifices any power with the 10mm round. It's a bit long for a submachinegun, but it comes with a removable stock (not shown) to help balance it out a little more. The barrel length does create an extremely accurate weapon, especially for its staggering rate of fire.



RUGER G-201 375eb
 SMG - +1 - J - C - 2D6+3 (10mm caseless) - 28 - 1/3/10 - ST

A sleek and well made submachine pistol from Ruger, the G-201 makes the perfect weapon for bodyguards and security personnel. For easier concealment a 12 round magazine is also available (shown).



SKORPION VZ-72 365eb
 SMG - 0 - J - C - 2D6+3 (10mm caseless) - 25 - 1/3/20 - ST

The popular Czech smg line finally makes the grade after years of underpowered ammo loads. Switching at last to the ever popular 10mm and going modern by using the caseless ammunition that's all the rage. A facelift and folding stock complete the package.

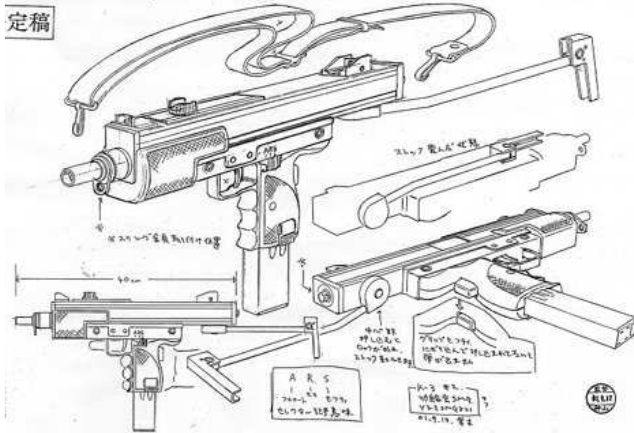

STERNMEYER ARS-11 225eb
 SMG - 0 - L - C - 2D6+3 (10mm caseless) - 30 - 1/3/20 - ST

While IMI is tossing out their old look, it appears as though Sternmeyer is picking it out of the trash and recycling it for themselves. The simple folding stock can get a bit persnickety, but it is easily removed.



STERNMEYER SK-VASH 325eb
 SMG - -1 - L - E - 2D6+3 (10mm cased) - 20 - 1/3/10 - ST

A standard submachinegun, perfect for police and security work. Its small size also makes it ideal for less legal activities.

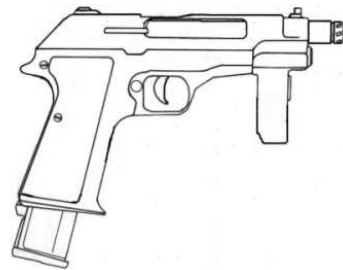

TAURUS 2020 STANDARD SS 375eb
 SMG - 0 - J - P - 2D6+3 (10mm cased) - 20 - 1/3/10 - ST

Taurus upgrades their classic 9 & 10mm frame with a new look and more. Using the mechanics of the Barretta 93R this firearm is a 10 mm submachine gun in the size and form of a pistol. Available with detachable folding stock and select fire switch, in full auto this gun becomes very hard to control and the muzzle climb is fierce. The three round burst is recommended.



TULA ARSENAL SPGR-9 660eb
 SMG/P - -1 - L - R - 2D6+3 (10mm cased) - 16/32 - 1/3/10 - ST

Developed for Russian military vehicle crews and pilots, this offers a lot of bang in a compact package, as such it has replaced the sidearm for some Neo-Soviet Special Forces personnel, and is a favorite among Neo-Sov intelligence operatives and military officers. An extended 30 round magazine is available.



TSUNAMI ARMS AP-707 525eb
 SMG - -1 - N - C - 2D6+3 (10mm cased) - 40 - 1/3/20 - ST
 A nice looking, if somewhat oversized, submachinegun from Tsunami Arms.



TSUNAMI ARMS SHOU-01 510eb
 SMG - 0 - J - P - 2D6+3 (10mm cased) - 20 - 1/3/10 - ST

This automatic pistol from TA reaches near Sebuo levels of customization options, some merely aesthetic, others quite useful, such as the stock which can be interchanged with the grips in less than 30 seconds. As an added feature, there are two varieties of stock, (both add a +2 to accuracy) one which stores 1 extra magazine, and the other which stores 2. A 32 round magazine is available, and the storage spaces on both stocks will accept them.



TSUNAMI ARMS FLUX 465eb
 SMG - -2 - J - C - 2D6+3 (10mm caseless) - 10/25 - 1/3/10 - ST
 An extremely compact SMG from Tsunami, Able to fit in the large pocket of a coat. A 25 round mag is available as well.



TSUNAMI ARMS SLIDER 600eb
 SMG - 0 - J - C - 2D6+3(10mm cased) - 15/30 - 1/3/10 - ST
 This weapon folds up into a perfectly unassuming package, but is ready at a moments notice. A perfect emergency weapon to keep in the vehicle, or hidden in plain sight. A 25 round magazine is available, though it must be removed and stored separately when the weapon is folded.

HEAVY SUBMACHINEGUNS

11MM



ARASAKA DE-MAG 380eb
 SMG - 0 - L - P - 3D6 (11mm caseless) - 40 - 1/3/18 - ST
 A very compact, but controllable submachine gun with a high ammo capacity and an above average rate of fire.



BARRETA "INTRUDER" 465eb
 SMG - +1 - L - P - 3D6 (11mm caseless) - 30 - 3/15 - ST
 In addition to featuring a built in suppressor, this gun sports a rather odd innovation. To increase concealability, the designers created a sideways curving, top loading magazine. This design reduces some of the "snag" problems many smg's encounter when kept under clothing, or worn on a sling.

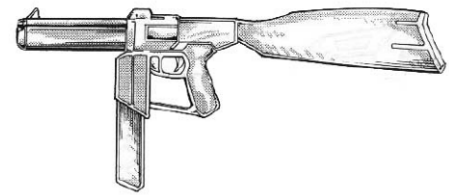

BERETTA SHEPPARD 387eb
 SMG - +1 - L - 3D6 (11mm caseless) - 35 - 1/3/30 - VR
 A very nice weapon made by the fine craftsmen at Barreta. Featuring a removable butt stock, this submachine gun has become the standard issue to many European police forces. The stock, and suppressor are removable, and a smaller 15 round magazine is available.



CMCC MSF-14 395eb
 SMG - 0 - L - E - 3D6 (11mm caseless) - 20 - 3/10 - ST
 A Chinese knockoff of a European smg, the MSF-14 is chambered in 11mm and features a removable fore grip. Used extensively by Chinese military and police.



Colt Cobra 475eb
 SMG - -1 - L - E - 3D6 (11mm cased) - 30 - 1/3/15 - ST
 Popular for its size, fair price, and heavy load, the Cobra also features an extending stock.



FEDERATED ARMS P-27 275eb
 SMG - -1 - J - P - 3D6 (11mm caseless) - 14/30 - 1/3/15 - ST
 Stepping even further up the food chain, the P-27 retains the same action, yet upgrades again into 11mm.



HECKLER AND KOCH MP-55 625eb
 SMG - 0 - N - C - 3D6 (11mm cased) - 30 - 1/3/15 - VR
 As long as weapons are using conventional ammunition, the H&K MP line will never die. This latest weapon is chambered in 11mm and accepts all MP accessories.



FEDERATED ARMS TA-14 565eb
 RIF - +1 - L - E - 3D6 (11mm caseless) - 30 - 1/3/20 - ST
 A commonly seen smg similar in shape and performance to the Mac-10/11 from Ingram. Comes with retracting stock and available with either 12 or 30 round magazines



HECKLER AND KOCH SBP-15 565eb
 RIF - 0 - J - E - 3D6 (11mm cased) - 14/30 - 1/3/20 - VR
 A beautiful and comfortable fully automatic machine pistol. Perfectly suited for professional's engaging in network or security.

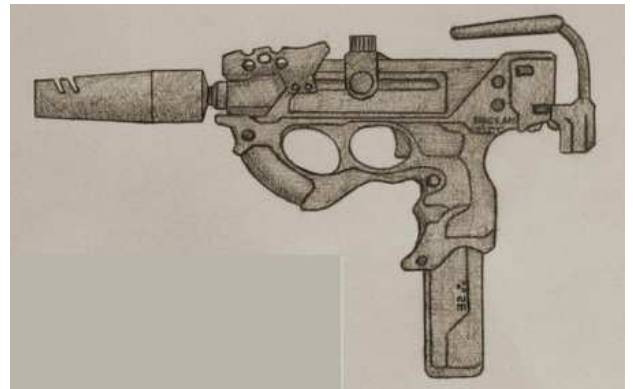

IMI SCARAB 680eb
 SMG - -1 - N - C - 3D6 (11mm cased) - 28 - 1/3/15 - ST
 IMI's latest smg is a total reworking of the UZI system, using the latest innovations in polymer materials, recoil compensation, and barrel shrouding. Heavily influenced by Sebuo designs, this weapon has become an instant favorite among Mossad agents. A suppressor is available for an additional 50eb, and it also accepts any Uzi capable suppressor or option



MAKAROV UMZ-55 705eb
 SMG - -1 - N - C - 3D6 (11mm cased) 40 - 1/3/20 - ST

This Russian surplus SMG is the standard for Chilean armed forces. It's chambered in 11mm, which is compatible with their handguns, and features a large ammo capacity.



IMI "UZI 2023" 645eb
 SMG - +1 - J - P - 3D6 (11mm caseless) - 15/30 - 1/3/15 - ST

The latest weapon in the UZI line, chambered in 11 mm, though 9 and 10mm versions are available. A fixed and comfortable foregrip make this Uzi much easier to control than some of its predecessors.



MALORIAN RGM-193 1150eb
 SMG - +1 - N - R - 3d6 (11mm caseless) - 60 - 1/3/20 - ST

The big brother to Malorians RGM-179, the RGM-193 (and the 179 for that matter) was designed for use by the U.S.A.F. in spacebourne military installations. The weapon turned out to be to powerful for most duties, but the U.S.A.F. still orders them, so production continues. Now the weapon is available to the public. Firing 11mm caseless rounds from a 60 round drum magazine this space age weapon is a pinnacle of perfection.



IMI "UZI-FORCE" 425eb
 SMG - 0 - L - P - 3D6 (11mm caseless) - 30 - 1/3/20 - VR

IMI pushes another Uzi, in an even larger caliber through to the edgerunners on the streets and in the field. Firing caseless ammunition, and with a handy front grip, this latest Uzi brings is a welcome addition to the family.



MATSUCORP XSG-50 875eb
 SMG - +1 - L - C - 3d6 (11mm caseless) - 35 - 1/3/15 - ST

Smartlinked as standard, this radical and innovative weapon features a front loading enshrouded magazine providing extra recoil compensation.

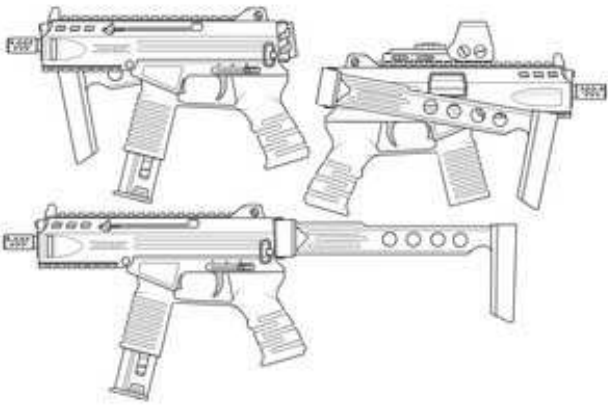

MEXICAN METALS CRKT-PW43 650eb
 SMG - +1 - N - C - 3D6 (11mm cased) - 20/35 - 1/3/20 - ST

Standard issue SMG to Mexican military and police forces. Available with either a 20 round magazine that fits flush with the foregrip, or a 35 round mag. Also features a folding stock.

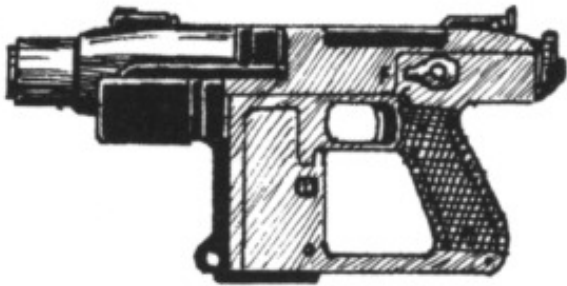

MILITECH BULLFIGHTER 560eb
 SMG - +1 - J - P - 3D6 (11mm cased) - 20/30 - 1/3/15 - VR

This compact submachine pistol is a true favorite in the professional community. Light enough, and with enough of A controlled recoil to fire one handed, and compact enough to wear under a large jacket in a shoulder holster.



MILITECH DPLS-7 790eb
 SMG - +1 - N - 3d6 (11mm caseless) - 35 - 1/3/15 - VR

Militechs latest submachine gun, very comfortable to fire, perfect for close quarters combat. The stock is extendable, but as you can see when it is retracted it rests seamlessly against the weapon, in fact the weapon itself has very few exterior moving parts, and the only real snag points are on the sighting system. It also accepts a suppressor making it ideal for covert ops.



MILITECH MP605 675eb
 SMG - 0 - J - P - 3D6 (11mm caseless) - 30 - 1/3/15 - VR

A compact smg from the people who know war. Very stylish, and heavy enough to get your point across.



MILITECH SPOILER 645eb
 SMG - +1 - L - C - 3D6 (11mm caseless) - 30 - 3/15 - ST

A common submachine gun with a good service record from Militech.

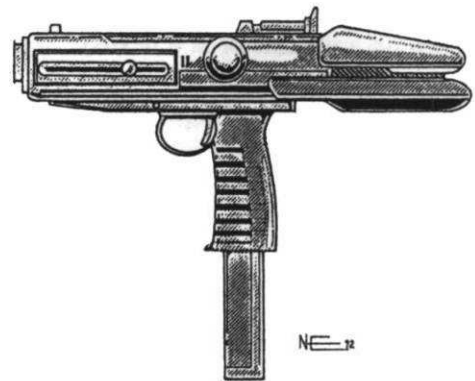

NOVA "HODGES" 395eb
 SMG - 0 - J/L - E - 3D6 (11mm caseless) - 15/30 - 1/3/15 - ST

An inexpensive and common smg favored with street gangs and third world nations.

Brass catcher on top.



SEBURO C-25A AND C-26A 820eb
*RIF/SMG *+2 *J *R *3D6 (11mm)* 50 *20 * VR **
The Seburo is probably the weapon Shirow talks about most, and it seems to be his favorite. The C-25a and the C-26a are both submachine guns the only real difference being in the outer appearance. The C-25a appears to be more geared towards combat and rough use, while the C-26a seems to be for security and service in less hostile environments. Both guns are equipped with brass catchers because of the fact that the spent shells are ejected forward (very unusual). These guns are also made to fire H/V ammo.



SEBURO C-27 1125eb
SMG - +2 - L - C - 3D6 (11mm caseless) - 40 - 1/3/20 - VR
Obviously a Seburo, an excellent smg with a high rate of fire and large amo capacity. A truly fine weapon, but we would expect nothing less from Seburo. Features a built in laser sight.



SEBURO C-28A 1870eb
SMG - +1 - N - C - 3D6 (11mm cased) - 30 - 1/3/15 - VR
Its hard not to love Seburo. Designed for special forces, the C-26A is a premiere submachine gun, perfectly balanced and built for comfort and accuracy. And with the suppressor attached it is far quieter than you can imagine. The C-26B is the sniper variant, and comes with built in scope and extended barrel. All parts are interchangeable, and the suppressor for the C-26A fits the extended barrel. An underbarrel single shot 25mm grenade launcher is also available for an additional 200eb.



SEBURO J-11 1550eb
SMG - +1 - N - C - 3D6 (11mm cased) - 150 - 1/3/15 - VR

A calico styled submachinegun from Seburo. With a 150 round helical clip, built in suppressor, and extending stock this is the ideal weapon for covert ops.

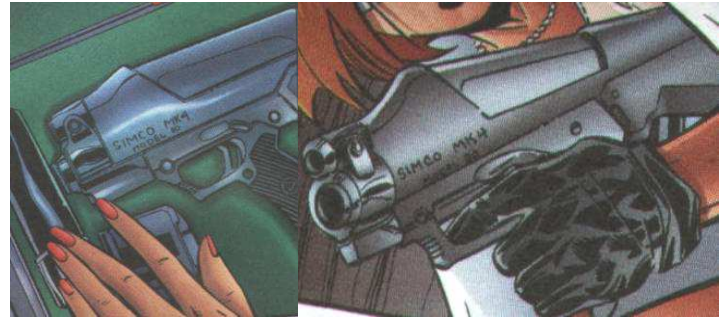

SIMCO MK4 575eb
SMG - +1 - J - C - 3d6 (11mm caseless) - 25 - 1/3/15 - VR

A short bullpup weapon, the first from this manufacturer. This weapon was recently featured in SOF and received rave reviews, it high caliber makes for an intimidating tool, and the weapon itself is extremely comfortable, with very little felt recoil.



SHPAGIN SGZ-79 810eb
SMG - +1 - N - C - 3D6 (11mm cased) - 30 - 1/3/20 - VR
Popular with Russian special forces and vehicle crews alike, this submachine gun fires the powerful 11mm round and featured a single shot 25mm GL/ shotgun. It's rail system allows for a variety of scopes, laser sights, bayonets, or other attachments, and the weapons bullpup configuration make it ideal for close quarters.



STEYR TMP A212 615eb
 SMG - +1 - J - P - 3D6 (11mm cased) - 12/30 - 1/3/20 - VR
 A breeze to shoot, comfy in your hand, and boy does it sure look cool. Available with or without the fore grip, and for an additional charge of 50eb you receive a suppressor.



TSUNAMI ARMS M-3061 575eb
 SMG - +1 - L - C - 3d6 (11mm caseless) - 25 - 1/3/15 - ST
 A rather unremarkable weapon, most used by tank and vehicle crews. The folding stock is a bit awkward, and has a tendency of becoming loose fairly quickly with use.

.357 MAGNUM



STEYR XM-14 760eb
 SMG - -1 - L - P - 3d6 (11mm cased) - 40 - 1/3/20 - ST
 A built in laser sight and 40 rounds of 11mm cased make this compact and extremely well designed smg the pride of any collection. The only complaint is lack of a fore grip, but if you are comfortable firing smg's one handed, and can handle this beast, then this is the weapon for you.



Cent'ry 500eb
 (From Nomad Market)
 SMG - 1 - L - U - 3D6+1 (.357 magnum cased) - 15/30 - 10/3/1 - VR
 Sometimes, you find a handmade nomad weapon so well built, you wonder why the hell the gunsmith doesn't have a corporate job living the comfortable life in an office somewhere in suburbia. The designer of this weapon, known only as PRF, is currently being sought by the R&D departments of Militech, Armalite, and Matsucorp. As it stands this weapon is one of a kind, but keep your eyes peeled, if one of the Arms corporations gets their hands on him, we may see many more.



TOWA CPOS-1120 425eb
 SMG - 0 - L - E - 3D6 (11mm caseless) - 35 - 1/3/20 - P
 This weapon. Although poorly made, sells very well due to its very low cost. Its only real feature is its built in suppressor. This is a very common weapon found in the hands of pirates, gangs, and other groups whose priorities value low expense over quality.

VERY HEAVY SUBMACHINEGUNS

12MM



ARASAKA AS-225 940eb
SMG - 0 - N - P - 4D6+1 (12mm cased) - 25 - 1/3/10 - VR

Available with a wide variety of options and configurations, the Arasaka AS-225 SMG is currently being marketed to special forces and police agencies around the world, especially to anti-cyborg teams who are interested do to its large caliber chambering of the 12mm round.



ARASAKA FA-43 940eb
SMG - +1 - J - P - 4D6+1 (12mm cased) - 14/32 - 1/3/10 - ST

A beautifully crafted and designed machine pistol. Perfectly capable of fitting under most large jackets and a smooth firing action that is sure to win over even the most hardened pro.



ARASAKA "KANZAKI" 885eb
SMG - +1/-1 - J - C - 4D6+1 (12mm cased) - 16/32 - 1/3/30 - VR

A high rate of fire, and an extremely comfortable feel define this weapon. Arasaka continues its standard of being first and foremost when it comes to arms manufacturing, and this weapon sees ever increasing service with overseas military and police forces.

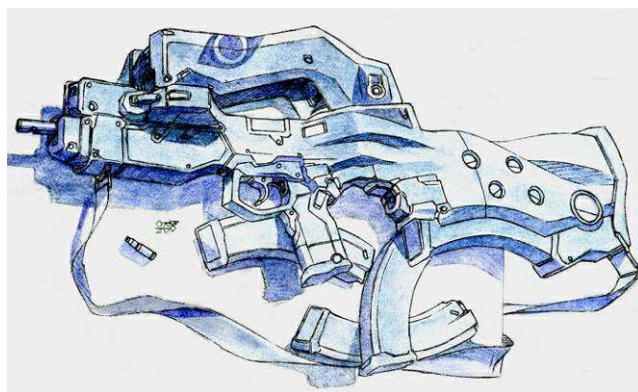

ARASAKA MCS-42 925eb
SMG - +1 - N - C - 4D6+1 (12mm caseless) - 30 - 1/3/18 - VR

Another high caliber smg, this one from Arasaka. An excellent weapon firing 12mm ammunition at 580 rounds per minute. And with caseless ammunition you leave no evidence behind. Features removable stock and foregrip and comes smartchipped as standard.



ARASAKA MZ-045 815eb
SMG - -2 - L - C - 4D6+1 (12mm cased) - 25 - 1/3/30 - ST

Even the retracting stock doesn't do much for the accuracy of this heavy combat SMG. Still, it's better to be holding this weapon than having it pointed at you, the damage it can do is devastating.



DAI LUNG DBDF-12 345eb
 SMG - -3 - L - P - 4D6+1 (12mm caseless) - 60 - 1/6/30 - UR

The designers at Dai Lung must be lunatics. The DBDF-12 is an over/under double barrelled smg firing 12mm ammo. The ammo is fed from a divided clip, front and back, each holding 30 rounds. Firing this weapon is about as close as you can legally come to attempting suicide.... except that even owning this weapon is considered a felony in almost every civilized country in the world. Even most gangs are afraid to carry this weapon. It is so unreliable, that if fired at full auto the barrels heat up so fast and so hot that they warp each other as they alternate fire, since the barrels are so short they also tend to cook off the ammo in the breach setting off the other rounds as well. This weapon has a 60 percent chance of blowing up in your face when fired full auto. You would think that no one at all would use these, but there is always the lunatic fringe out there, and if Autumn Blade can sell these to a rival group through subterfuge, then it chances are they will do more damage to themselves than anyone else. Want to get rid of someone you hate, give them one of these. Oh yeah, it also features a folding stock, nifty huh.



IMI MICRO-UZI 2020 1035eb
 SMG - +1/-1 - J - 4D6+1 (12mm cased) - 16/32 - 1/3/30 - VR

"A new Uzi for a new world," that's what the ad says. After 80 years of stagnation Uzi once more becomes the name synonymous with submachine gun. Upgrading its ammo to the heavy hitting 12mm and a complete redesign in mechanics and appearance have brought the Uzi back from obsolescence and back into its former title of the greatest submachine gun ever made. Made from all modern materials and sporting a built in collapsing stock, the new Uzi also accepts a wide range of suppressors. IMI only manufactures the Uzi in micro, the larger versions had a slower rate of fire and were less concealable. The new Uzi retains the former micro's high rate of fire but even though advancements were made to restrict muzzle climb, due to the large caliber of the round, firing this weapon full auto is somewhat difficult to control.



HECKLER AND KOCH MP-99 760eb
 SMG - 0 - L - P - 4D6+1 (12mm caseless) - 30 - 1/3/15 - VR

Yet another in a long line of H&K submachineguns in the MP series. Chambered in 12mm, and packing one hell of a punch, this is a favorite among EDF tank crews.



INGRAM MAC-34 855eb
 SMG - 0 - L - P - 4D6+1 (12mm caseless) - 15/30 - 1/6/20 - ST

In effort to combat the high muzzle climb of the Mac-2021, Ingram went back to the drawing board, this time adding muzzle brakes and a large under-barrel lug. This helped a great deal in balancing the weapon and making it more accurate under full auto fire

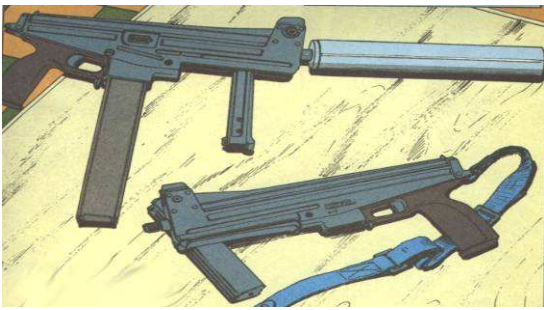

JATIMATIC L-53 660eb
 SMG - +2 - L - C - 4D6+1 (12mm cased) - 20/30 - 1/3/10 - VR
 Along with the obvious higher caliber of ammunition, the L-53 has another improvement which makes it vastly superior to its predecessor. Unlike the original Jatimatic, the front grip no longer needs to be extended to fire the weapon. This makes it easier to control one handed and to reduce recoil the far handle is made from a heavier metal. A shoulder rig and thigh holster is available for this weapon as well as 20 and 30 round magazines.



MAUSER BH-2024 575eb
 SMG - -1 - L - E - 4D6+1 (12mm caseless) - 30 - 1/3/10 - ST
 Some weapons can never be forgotten. The broomhandle Mauser is one of those. Finally it's back, firing 12mm ammo and featuring a large front grip for increased stability, the old dog has definitely learned some new tricks.



MILITECH "COLLINS" 1220eb
 SMG - +1 - L - C - 4D6+1 (12mm caseless) - 25 - 1/3/30 - VR
 The "Collins" has had all of its components treated with a chemical compound to prevent the ill effects of humidity on the weapon. It was created for use in tropical climates and rainforests. So if you are planning on outfitting a team for a trip to the Amazon, this weapon is highly recommended.



MILITECH FURI-12 515eb
 SMG - +1 - L - C - 4D6+1 (12mm cased) - 15 - 1/3/30 - ST
 A very compact 12mm smg, extensively used by special ops teams around the world.

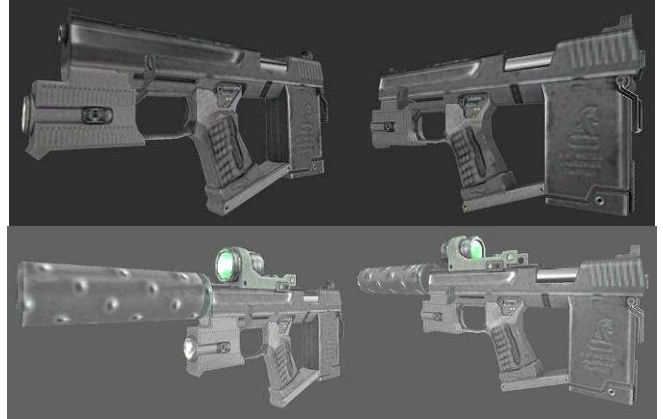

MILITECH P-505 545eb
 SMG - -2 - L - C - 4D6+1 (12mm cased) - 20 - 1/3/20 - ST
 Lots of power in a small size, the object of every submachinegun designer on the plane. Though in this case it might just be too much, too little. The weapon design is nice, and on single fire performs very well. But there is no compensation for the massive recoil of the 12mm on full auto fire. The suppressor helps somewhat (+1 to accuracy).



MILITECH SMG-207 1160eb
 SMG - +1 - N - C - 4D6+1 (12mm cased) - 25 - 1/3/15 - VR
 A somewhat large, but impressive submachine gun from Arasaka, chambered in 12mm. The weapon comes with a removable folding stock, and insulated barrel. This weapon was designed with hard use in mind, and can take abuse like you wouldn't believe.



SEBURO M-CX06 2655eb
 SMG - +2 - J - P - 4D6+1 (12mm cased) - 20 - 1/3/10 - VR

Another masterpiece from Sebuo. This is the select fire version of the semi-auto J-9. Chambered in 12mm with a very reasonable and controllable full auto rate. Accuracy is increased due to the bullpup design. This beautiful machine pistol is scoring high marks and impressing the shooting community with its style and functionality. The only downside is that you have to be careful not to blow the finger of your supporting hand. But this is a small price to pay since the weapon is extremely controllable even when firing one handed.



SEBURO SM-40 1599eb
 SMG - 0 - L - P - 4D6+1 (12mm caseless) - 25 - 1/3/10 - VR

Sebuo once again showing that when it comes to looking good, and working perfectly, you can have the best of both worlds. It's relatively slow rate of fire and ergonomic design make this weapon a dream to fire, even one handed. The removable suppressor is an additional 30eb.



TSUNAMI ARMS "WORKHORSE" 1415eb
 SMG - 0 - L - C 4D6+1 (12mm cased) - 20/30 - 1/3/10 - ST

This bullpup submachine gun is quickly garnering attention due to its large caliber and relative low cost. Very popular with anti-terrorist agencies and paramilitary organizations.

.440 COR-BON MAGNUM



MATSUCORP/INGRAM "BIG-MAC" 1740eb
 SMG - -2 - L - E - 4D6+3 (.440 Cor-Bon magnum caseless) - 10/30 - 1/3/15 - ST

The biggest Mac ever, firing monster .440 Cor-bon magnum rounds this weapon has a muzzle climb thats insane, even as heavy as it is. A 25 round magazine is available.



SEBURO PSEGG-5 2775eb
 SMG - 0 - N - R - 4D6+3/varies (.440 Cor-Bon mag caseless/25mm grenade) - 25/8 - 1/3/15-1 - VR

This is an extremely overdone weapon, the barrel shrouds seem to serve no real purpose other than aesthetic, though it's possible it is simply extra weight to keep recoil down, But the weapon is very hard hitting and has a built in 8-shot grenade launcher.

ANTI-CYBORG SUBMACHINEGUNS



ARASAKA KIRIN 3275eb
SMG - 0 - N - R - 6D6(14mm cased) - 10/25 - 1/3/10 - ST
A similar design to the old Kriss SMG, the Kirin features an updated design and is chambered in 14mm, for hard hitting action, guaranteed to put down whatever stands against you. And extended 25 round mag is available.

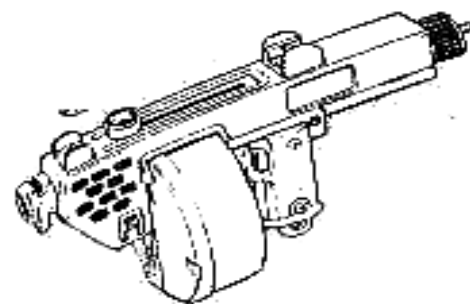

MILITECH DSL-14 4750eb
SMG - -3 - N - R - 6D6 (14mm cased) - 40 - 1/3/12 - ST
Militech's DSL-14 is a monster that feeds from a 40 round drum magazine. It is highly recommended that no one with out a least highly augmented strength and a cyberarm attempt to fire this beast on full auto,



ARASAKA KIRIN-CARBINE 4250eb
SMG - +2 - N - R - 6D6/Varies (14mm cased/25mm Grenade Launcher) - 10/25-1 - 1/3/10 -1 - ST
The Kirin Carbine is the much bigger, much more accurate big brother to the Kirin. It accepts the same 10 and 25 round magazines as the smaller weapon, and also has a built in 25mm grenade launcher. The weapon also has a removable stock and suppressor, both of which will fit the smaller Kirin.



MILITECH MMP-80 3275eb
SMG - +1 - N - R - 6D6 (14mm cased) - 30 - 1/3/12 - ST
A huge gun firing the enormously powerful 14mm round. This weapon is capable of taking down almost anything, and if your enemy sees he will probably be so intimidated you won't have to fire a shot, which is good, because at the price of 14mm ammo you don't want to waste money unnecessarily.

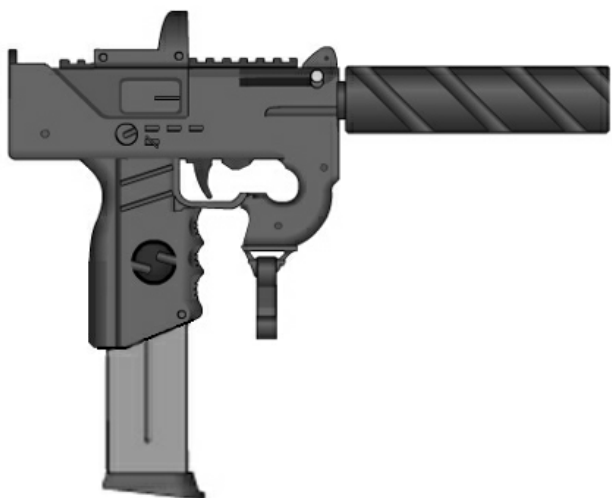

INGRAM MAC-DDY 3500EB
SMG - 0 - N - R - 6D6 (14mm cased) - 20 - 1/3/12 - ST
The classic MAC-10 operation, geared up to 14mm... Full conversion beware... everyone else, beware of full conversions armed with these.



TSUNAMI ARMS BRINK-5 2980EB
SMG - +2 - N - R - 6D6 (14mm caseless) - 25 - 1/3/12 - ST
This impressive SMG is able to fire the 16mm monster shell with a decent degree of control, the bullpup design helps steady the weapon and increase its accuracy.

(Created and written by Deric Bernier, images from Deric Bernier, Appleseed, Cyberpunk 2077, Macross, Masamune Shirow, Gundam, Dirty Pair, Dark Minds, Men In Black, American Flag, Aliens: Colonial Marines, Deathwish, Deathstroke the Terminator, Starman, Kite, Space: Above and Beyond, Star Wars, Ice Pirates, Akira, Backlash, Babylon 5, Burn Up W, Dave Dorman, DS9, Dream Wave, Neon Cyber, Earth 2, Grendel: Devils Legacy, Hardboiled, Nausicaa, Secret Of Blue Water, Negative One, Punisher: Big Nothing, Runaway, L-gaim, Layzner, Ghost In The Shell, Catwoman, Titan AE, Wildcats, Stark Future, Total Recall 2070, Windaria, Rifts, Gurps, Trigun, Alien series, No Escape, Akira, Killzone, Firefly, Doom, Bubblegum Crash, Humanoid, Punishers Armory, Halo, Alien Legacy, The 5th Element, Time Cop, Shadowrun, Tomb Raider, Equilibrium, Intron Depot, Final Fantasy, Hellsing, Parasite Dolls, Bubblegum Crisis, Kappowwe Toys, Gungrave, AD Police, Bubblegum Crisis 2040, Grimjack, Project Snowblind, Bubblegum Crisis, S.I.N., Dirty Pair, Gundam, Doom, Gasaraki, Blue Gender, Hellboy, Blade series, Escape from New York, Escape from L.A., Eatman, G.I.T.S.: Stand Alone Complex, Jon Sable: Freelance, I Robot, Nomad, Mystery Men, D20 Future, D20 Apocalypse, Deadlands: Hell On Earth, Car Wars, Demolition Man, Fortress, Iria Zieriam, Natural City, Space, Above and Beyond, Stealth, Unreal Tournament, Moonwalker, Gunm, Southern Cross, Grifter, Battle Lords, Lensman, SeaQuest, Robocop, Aspen, Homeboys, Judge Dredd, Terminator: Burning Earth, Edison Giacotolli, Vortex, Soldier, Back To The Future II, Echo, Event Horizon, Starship Troopers, The Saint, Robotech: Sentinels, Deathlock, Hunter, Black Ops, James Bond, Death's Head, X-Men, Firearm, Nick Fury: Agent Of Shield, Dirty Pair: Flash, Silent Mobius, Mafia Wars, Army Of Two, Capcom, Hitman, Fatal Fury, Street Fighter, Deus Ex, Quake, Air Gear, Btoom, Tekken, Perfect Dark, Fallout, Bouncer, Frontlines, Crysis, District 9, Zatoichi, Bleach, Blame, The Rundown, Avengers, Green Arrow, GI-Joe, Call Of Duty, Brink, Doom, Eon Flux, Haze, Poseidon Arms, Nerf, Starhawk, Bayonetta, Bionic Six, Hudson Hawk, Avatar, Command And Conquer, Wastelands, Borderlands, and other various manga, Anime, Comic book, video game, film, and RPG sources, Raben-Aas, Sharp-n-pointy, Biometal79, Phatandy, Bordon, Shimmering Sword, Vulnepro, El Pinoy, Br0uHaHaasdsada, Larkabella, licataknives, meandmunch, Devilita Andree Wallin, Fuchsiart, imDRUNKonTEA, Guilty Spark, Refrigerador, Italiener, Pascal Eggert, Josh Nizzi, Bokuman, Machine56, Kunkka, Johan Bergstrom, Slipgate Central, Dominic Marko, Francis001, platypusgreen, jimmypham, Warrenlou, flipation, digimech, molybdenum, Spoonboy, Doll Fac3, Eikochan, bakanecone, teh dave, SC4V3NG3R, solkee, molinaro, KaranaK, genekruger, theelphin, garanum, 2ngaw, shed2602, gorrem, moyachiche, inception08, vietnguyen, rgus, archie, David Nakey, Kuroitora, aerpenium, Dead Robot, teruchan, acidburn08, Markovah, Mort Janu, MishaMoStyle, Blitz Bot, k hos, James Lemay, Gun0runner, Gneocidal Penguin, Kalor, ionen, djake, jett0, cyzrauk8, windridex23, firestoned, anjinanhut, regis, libertyspikesv5, rimancreative, deutscherherbst, hexonal, Ryujiin10, Raverunner, daisukekazama, dannortonart, bringmeasunkist, Merkaba998, tovenius, Message2god, peterku, nervousgryphon, knightwatch, Brian Rogers, tsukijin, talros, Michael Kingery, ygolochysp, Swatninja, Cyber999, marcwf, WarmGunMod, bcjfla76, bullseye breon, Carlo Arellano, Special thanks to Matsuo, Darth Brass, darcjedi, Tom_Braider, thedap, wuher_da_brewer, Capt_MarVel, Glim999, Pulseriflefan, TK513, gunnerk19, Tommin, BritNerfMogul, Tigadee, Johnson Arms, Wolverine_solo, and all the many fine prop replica builders of Mastucorp, the RPE, Nerfhaven, Nerfhq, and BBC)

For more of the best Cyberpunk 2020 goodness available, go to

DATAFORTRESS 2.0.2.0

<http://datafortress2020.oliwy.net/>

To e-mail the author:

droc@mc2k.com

