

# DATAFORTRESS 2.0.2.0

Presents:

## ULTIMATE RIFLES

Written by Deric Bernier ([droc@mc2k.com](mailto:droc@mc2k.com))

UPDATED: 4-30-13

The complete collection of all the Rifles created for the various articles and sourcebooks by Deric Bernier found on Datafortress 2020.



This is just one of many articles for the Cyberpunk 2020 Roleplaying Game you can find on Datafortress 2020, the largest, most comprehensive Cyberpunk 2020 site in the world.

Visit it at:

<http://datafortress2020.oliwy.net>

# HUNTING/SNIPER RIFLES

## .22 CALIBER



**BROWNING SURVIVAL RIFLE 100eb**  
RIF - 0 - N/L - C - 1D6 (.22cal cased) - 10 - 1 - VR  
This .22 caliber rifle breaks up into it's component pieces, which all fit into the weapons stock, including ammunition. Keep one in the trunk, or in your tackle box, take it with you camping...



**REMINGTON BLUE RIDGE 75eb**  
RIF - +1 - N - C - 1D6 (.22cal cased) - 5 - 1 - ST  
A small caliber varmint rifle.

## 9MM

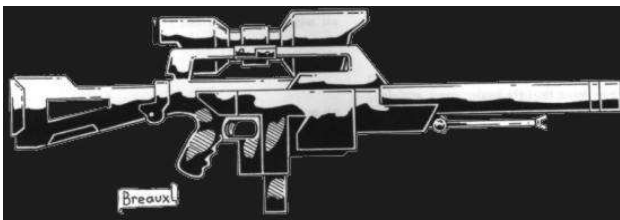

**WALTHER SPR-96 550eb**  
RIF - +3 - N - R - 2D6+1 (9mm caseless) - 30 - 1 - VR  
Originally designed for decathlon shooters in the Olympics, this sport/target rifle has become world renowned for its performance and accuracy. The weapon is also popular as a sniper rifle, though the ammo choice of 9mm is a bit underpowered for some work.



**MILITECH SPW-32 125eb**  
RIF - 0 - N - P - 2d6+1 (9mm caseless) - 30 - 1 - VR  
Like all survival rifles, this weapon breaks down and is stored in a regular sized briefcase. It was developed for pilots as survival/hunting weapon in case they were downed and on their own.

## .45 ACP



**LUIGI-FRANCHI PANMATIC 295eb**  
RIF - +1 - N - E - 2D6+2 (.45 cal cased) - 10 - 1 - VR  
A light hunting rifle, common around the world for hunting small game. Accurate and reliable, tube fed and perfect for a beginner's first weapon.



**DARRA-POLYTECHNIC RADIO GUN 305eb**  
RIF - -1 - N - E - 2D6+2 (.45 cal cased) - 8 - 1 - VR  
This is a rifle, that folds up into a working am-fm radio. Not much good in modern areas, but enough people in lower class areas, particularly in the combat zone, still listen to radio, that this won't garner a second glance.

## .44 MAGNUM

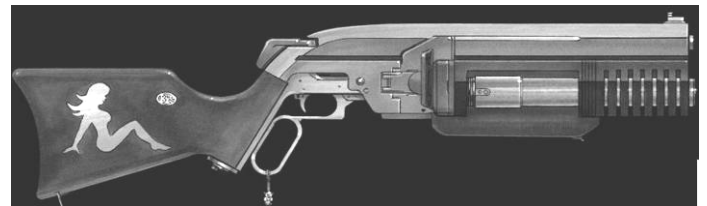

**BONEJACK 750eb**  
(From Nomad Market)  
RIF - 0 - L - E - 4D6/varies (.44magnum cased/40mm grenade) - 8/1 - 1/1 - ST  
Named after its maker, who can be found here in the Market, this is a lever action rifle chambered in .44 magnum with a single shot under-barrel 40mm grenade launcher. Ideal for outriders and scouts, or anyone really.



**LUIGI-FRANCHI DURANGO 675eb**  
RIF - +2 - L - R - 4D6 (.44mag cased) - 8/1 - 1/1 - VR  
An extremely well made revolver rifle combination from the finest name in firearms.

## 4.5MM

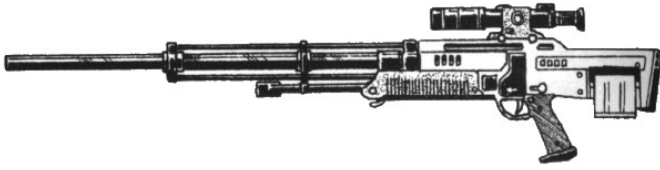

**CCMMC SRI-17 520eb**  
RIF - +4 - N - P - 4D6 (4.5mm cased) - 10 - 1 - ST  
This bullpup sniper weapon from China is one of the most accurate rifles in the world, and that's just straight out of the box. Built in folding bipod, standard scope, and small but powerful ammunition makes this a true winner. Many professional snipers purchase this weapon and then have it electro-thermally enhanced.



**FABRIQUE NATIONALE FN-R99 "Watchmaker" 910eb**  
RIF - +4 - N - R - 4D6 (4.5mm caseless) - 80 - 1/3/20 - VR  
Built from the action of the old and much respected P90, the R99 is extremely accurate. Some may consider the ammunition caliber a bit low for sniper work, but in reality it is ideal, especially when loaded with hypervelocity rounds or used against unarmored targets. The smaller bullets make for excellent armor piercing capabilities, and the large magazine and full auto feature means you can be sure what you are aiming at goes down.



**FABRIQUE NATIONALE "PINPOINT" 480eb**  
RIF - +2 - N - C - 4D6 (4.5mm caseless) - 10 - 1 - ST  
This is a very accurate sniper rifle from our Dutch friends. Sleek, attractive, and guaranteed to drive nails.



**SEBURO LONGSWORD 202 2420eb**  
RIF - +5 - N - R - 6D6 (4.5mm ETE cased) - 20 - 1 - VR  
The Sebuero Longsword is an incredibly precise weapon, smartlinked and equipped to fire Electro-thermal ammunition as standard options, with laser rangefinder tied directly into the scope, that allows the rifle to make the necessary adjustments automatically.



**TSUNAMI ARMS QUANTIS-88 475eb**  
RIF - +2 - N - R - 4D6 (4.5mm caseless) - 8 - 1 - ST  
Tsunami Arms gives us a very straightforward marksman's weapon with the Quantis.



**TOWA MANUFACTURING "TOSHONI" 720eb**  
RIF - +3 - N - R - 4D6 (4.5mm caseless) - 20 - 1 - VR  
A world class target rifle, the Toshoni also makes an excellent sniper weapon.

## 3.5MM

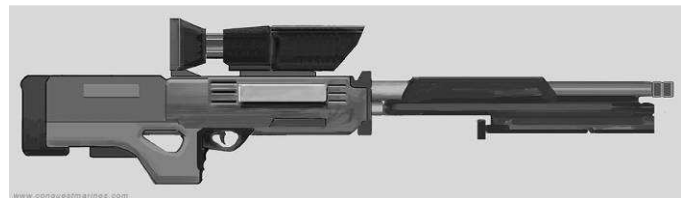

**WALTHER WA-2017 1020eb**  
RIF - +2 - N - R - 5D6 (3.5mm ff) - 30 - 1 - ST  
Using the same controversial ammunition as Arasakas WSSA sniper system, (see Blackhands Streetweapons), the Walther WA-2017 was never widely received. There are still a few floating around out there, although finding ammunition for it is almost as difficult as finding the weapon itself.

## 5.56MM



**AMERITECH NEW FRONTIER 150eb**  
RIF - +1 - N - C - 5D6 (5.56mm cased) - 6 - 1 - VR  
A very reliable weapon from Ameritech, the New Frontier is a revolver rifle chambered in 5.56, and is ideal for hunters, and outdoorsmen. This rifle is fast becoming a favorite in the nomad community due to its simplicity and durability.

[pimpmygun.doctormoob.com](http://pimpmygun.doctormoob.com)

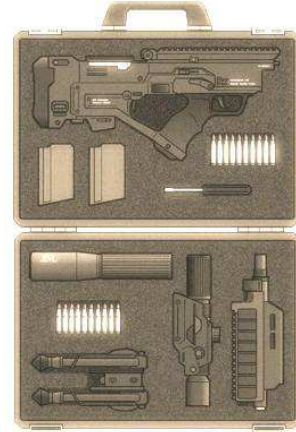

**HECKLER AND KOCH G38 980eb**  
RIF - +3 - N - P - 5D6 (5.56mm cased) - 20 - 1 - VR  
A complete sniper system that fits in a large briefcase, complete with scope, suppressor, bipod, and 2 magazines. The case it comes in is the same type of attache used by diplomats, and as such is lead shielded against x-ray. This weapon is the perfect choice for covert work



**ARASAKA CMR-2 1220eb**  
RIF - +3 - N - P - 5D6 (5.56mm caseless) - 10 - 1 - VR  
A very accurate, very quiet weapon, with custom venting and a redesigned suppressor to minimize noise without loss of range or accuracy.



**BUDGET ARMS R-187 200eb**  
RIF - 0 - N - E - 5D6 (5.56mm cased) - 20 - 1 - UR  
Budget Arms tries to break into the precision weapons game with laughable results. The assault rifle styling and 20 round magazine appeal to Budget Arms customer base, who don't care if the gun jams, or even blows up in their face, as long as it's cheap and looks cool.



**HECKLER AND KOCH ARCHER 940eb**  
RIF - +3 - N - P - 5D6 (5.56mm cased) - 15 - 1 - VR  
The archer is a simple, but very accurate, bolt action rifle ideal for both hunting and sniper work.



**COLT M-1632 875eb**  
RIF - +2 - N - C - 5D6 (5.56mm cased) - 25 - 1 - VR  
A sniper rifle built around the AR-15 frame. Comes standard with scope, bipod, and select fire switch. The full auto setting has been removed to save wear and tear on the barrel and action.



**HECKLER AND KOCH SL-9 820eb**  
RIF - +2 - N - R - 7D6+3 (5.56mm ETE cased) - 15 - 1 - ST  
H&K seems to be fully embracing electrothermal enhancement, as this sniper rifle can attest. Regardless this weapon is more than competent.



**MILITECH SS-54 829eb**  
 RIF - +2 - N - C - 5D6 (6.5mm caseless) - 20 - 1 - ST  
 This Militech sniper weapon is ideal due to the overall short length of the gun. The suppressor actually aids in accuracy, and broken down, the whole weapon fits inside a large briefcase.



**MILITECH MRS-42 829eb**  
 RIF - +3 - N - C - 5D6 (6.5mm caseless) - 20 - 1/3 - VR  
 The MRS-42 is a very well respected combat sniper rifle, capable of pinpoint precision even under the most adverse conditions and circumstances. It is very popular among Militech marksmen, as well as professionals around the world.



**NOMAD NEWBLOOD 150eb**  
 (From Nomad Market)  
 RIF - 0 - L - E - 5d6 (5.56mm cased) - 8 - 1 - ST  
 This sawn off magazine fed, lever action, rifle is almost short enough to be used as a handgun.



**NORINCO SW-33 395eb**  
 RIF - +1 - N - C - 5D6 (5.56mm caseless) - 12 - 1 - ST  
 For a company not exactly known for quality work, the SW-33 is actually a passable bolt action sniper rifle. It's not the best weapon for the job, but if budget is an issue, you could do worse.



**REMINGTON MODEL 2022 500eb**  
 RIF - +2 - N - C - 5D6 (5.56mm caseless) - 4 - 1 - ST  
 The Model-2022 is a popular rifle for hunters, marksmen, and outdoorsmen alike. It got a modest price and it's not over done or complicated... just a simple and accurate weapon.

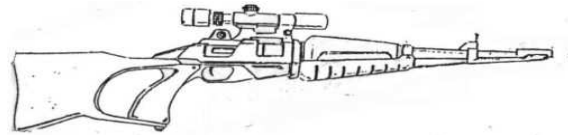

**STERNMEYER ASW-68 575eb**  
 RIF - +3 - N - C - 5D6 (5.56mm caseless) - 5 - 1 - VR  
 A very nice sniper rifle from Sternmeyer. Kalishnikov origins are obvious when looking at this weapon and it shoots like a dream.



**TSUNAMI ARMS ISS-556 865eb**  
 RIF - +3 - N - C - 5D6 (5.56mm cased) - 20 - 1 - VR  
 Tsunami continues to garner attention for their precision weapons with the ISS-556. This bullpup chambered in 5.56mm is one of the smoothest firing weapons in its class, and has a proven track record of accuracy and reliability.

## 6MM



**AMERITECH SWR-40 750eb**  
 RIF - +3 - N - R - 5D6 (6mm cased) - 20 - 1 - ST  
 Highly accurate right out the box, and equipped with a 12x lowlight scope, this rifle is ideal for sportsmen and military/police sharpshooters alike.



**CAVIL M-386 750eb**  
 RIF - +1 - N - R - 5D6 (6mm cased) - 8 - 1 - VR  
 Elegant, exquisite, unique.... Words do not do Cavil's first long arm justice.



**DRAGUNOV COGR-65Z 2050eb**  
 RIF - +5 - N - R - 7D6 (6mm ETE cased) - 10 - 1 - VR  
 The latest Russian sniper weapon, a bullpup configured bolt action rifle with an extended barrel and built in flip down bipod. The weapon also has built in smart link and comes electrothermally enhanced straight out of the box. This is one of the most accurate rifles in the world, it's only real downfall is its rare ammunition. 6mm is hard enough to find, much less ETE, but at least you don't have to worry about your enemy picking up your spare ammo and using it against you.



**HECKLER AND KOCH M989 1595eb**  
 RIF - +3 - N - C - 5D6 (6mm caseless) - 40 - 1/3/10 - VR  
 A highly accurate sniper rifle utilizing the firing system of the M986.



**STERNMEYER SSR-34 620eb**  
 RIF - +2 - N - P - 5D6 (6mm caseless) - 15 - 1 - VR  
 Unlike the SSR-32 which was capable of fully automatic fire, the 34 is a totally dedicated sniper weapon. Streamlined for comfort

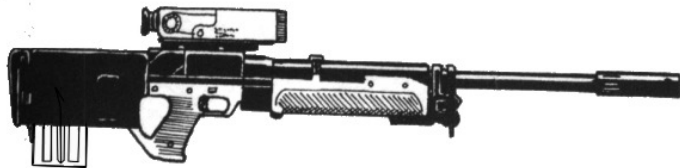

**STOBOLVOY "OKTOBER" 1320eb**  
 RIF - +3 - N - R - 5D6 (6mm cased) - 30 - 1 - ST  
 This Russian sniper rifle is the replacement for the Dragunov in the Russian military. Every bit as accurate, and manufactured to exacting standards.

## 7MM FEDERAL

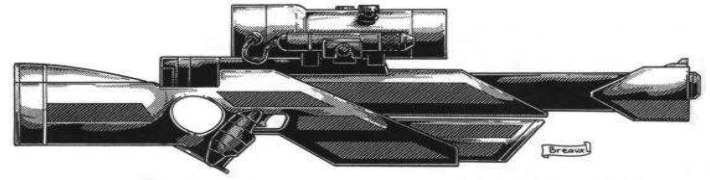

**KENDACHI "AURORA" 1865eb**  
 RIF - +2 - N - R - 5D6 (7mm caseless) - 75 - 1/3/30 - VR  
 A very odd, but finely tuned instrument from Kendachi. At first glance one will notice the odd magazine placement and feed design of the weapon, but don't let it fool you. Created primarily as a sniper weapon, a job at which it excels at, the weapon is also fully capable of acting as an assault rifle. The barrel is shrouded and insulated, and acts as an effective suppressor.

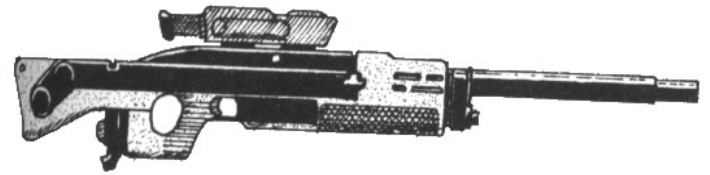

**MILITECH "ARBUS" 1650eb**  
 RIF - +3 - N - R - 5D6 (7mm caseless) - 10 - 1 - VR  
 This sniper rifle utilizes state of the art materials in its construction and comes smartchipped as standard. A bit heavy, but very accurate and reliable.



**TSUNAMI ARMS RS-73 520eb**  
 RIF - +2 - N - P - 5D6 (7mm caseless) - 25 - 1 - ST  
 This is a very accurate weapon, with a suppressed barrel and a second suppressor for extra quiet work.

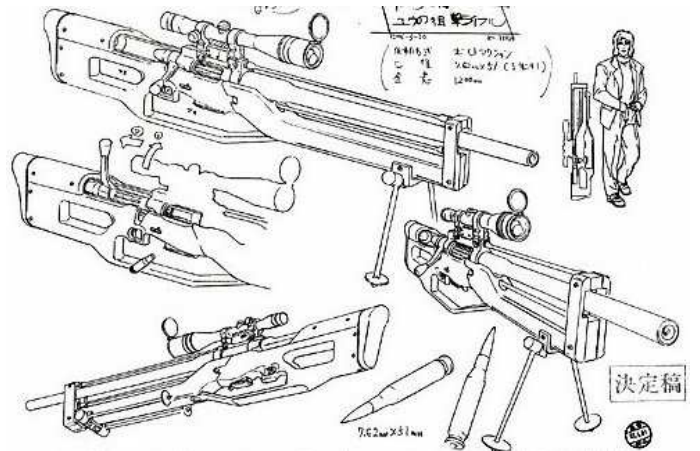

**WALTHER WA-2022 935eb**  
 RIF - +4 - N - R - 5D6 (7mm cased) - 5 - 1 - VR  
 One of the most accurate sniper rifles ever built. Walther's rifle division continues to show us why they are so highly respected.

## .30-06



**AZTECH QUETZALCOATL 435eb**  
RIF - +5 - N - C - 6D6 (30.06 cased) - 10 - 1 - VR  
The standard sniper rifle of the Mexican Military and police, and an extremely well respected weapon for both snipers and hunters all over the world.



**ARMALITE AF-47 935eb**  
RIF - +3 - N - P - 6D6 (30.06 cased) - 8 - 1 - VR  
A bolt action marksman's rifle, popular with police and professionals alike.



**LUIGI-FRANCHI GRAND ROYALE 4275eb**  
RIF - +5 - N - P - 6D6 (30.06 cased) - 1 - 1 - VR  
One would think that asking 5 grand for a single shot rifle would be absurd... and in any other case you would be correct, but this is the flagship model of Luigi-Franchi's catalogue. Every rifle is hand made by Augustino Fachelli, then engraved to the buyers shims by Gaspari Petrino. This is, simply put, one of the most elegant and exquisite firearms ever made, and no two are identical.



**LUIGI-FRANCHI HIGH PLAINS 1350eb**  
RIF - +3 - N - P - 6D6 (30.06 cased) - 6 - 1 - VR  
The finest quality and style, Luigi-Franchi's elegant revolver style hunting rifle chambered in 30-06 will make you the envy of your lodge.



**REMINGTON ADAMS 350eb**  
Rifle - +2 - N - E - 6D6 (30.06 cased) - 5 - 1 - VR  
One of many varieties of different hunting rifles which are commonly used by rebel forces.

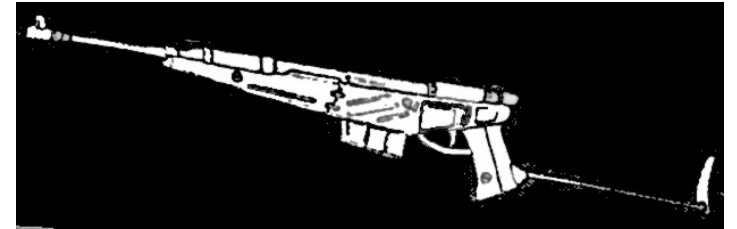

**REMINGTON "SURVIVOR" 225eb**  
RIF - +1 - N - C - 6D6 (30.06 cased) - 10 - 1 - VR  
A simple yet effective weapon, primarily designed for extended hunting trips. It easily and quickly breaks down into five separate sections for convenient transportation.



**WINCHESTER M-222 365eb**  
RIF - +2 - N - C - 6D6 (30.06 cased) - 10 - 1 - VR  
A wonderfully accurate hunting rifle from Winchester, the M-222 makes the perfect addition to any sportsman's arsenal. For professionals it also makes an excellent sniper rifle.

## 7.62MM



**ARASAKA AXSR-7 1220eb**  
RIF - +1 - N - R - 6D6+2 (7.62mm caseless) – 30 - 1 - ST  
Now here is an original innovation. Tracer rounds are expensive, and they are a pain to load. This weapon solves that problem by coating every fifth shell with a harmless bio-luminescent, extremely adhesive liquid derived from Teflon and Cyalume called Teflume. The Teflume cylinder is good for 200 rounds (needing to be replaced after firing 1000 rounds through the weapon) and the injection mechanism can be switched off when not necessary. The system for injecting Teflume is relatively simple, though it costs 200eb, and another 300eb to have a gunsmith install it to any weapon. Replacement cylinders of Teflume run for 50eb apiece. This assault rifle was specifically built around the Teflume injection system to test its capabilities. For field use, opaque non glowing Teflume cylinders are available. The green light on the side of the weapon indicates the system is on.



**Dragunov SVD-2 Sniper Rifle 1150eb**  
Rifle - +2 - N - C - 6d6+2 (7.62x54mm cased) - 20 - 1 - VR  
An updated version of the Soviet Dragunov sniper rifle, it can be smartlinked and even equipped to a remote rig to provide a sniper remote operation of his/her weapon. Has an operating range of about 900 meters when scoped.



**H&K S/SR-53 985eb**  
RIF - +3 - N - P - 6D6+2 (7.62mm caseless) - 5 - 1 - VR  
Exquisite craftsmanship and fine hand tuning is just one of the things that set this weapon above the competition. Unlike most sniper rifles this firearm was not developed from a hunting or assault rifle, it was built from scratch for the sole purpose of sniper warfare. Oddly enough it has been converted into a hunting rifle.....ironic isn't it!



**FABRIQUE NATIONALE SE-SR 1320eb**  
RIF - +3 - N - C - 6D6+2 (7.62mm cased) - 20 - 1 - ST  
A low maintenance sniper rifle from FN, used by many European police sharpshooters.

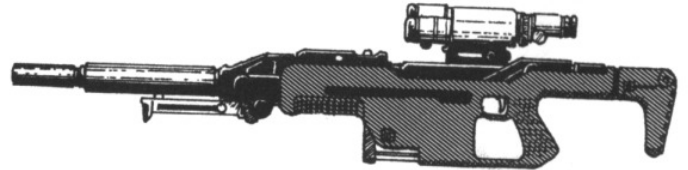

**FEDERATED ARMS "CRUSERAS" 1000eb**  
RIF - +2 - N - R - 6D6+2 (7.62mm cased) - 10 - 1 - ST  
A rugged sniper rifle for use in the most harsh of terrains. Comes standard with a bipod.



**MILITECH ACS O610 1985eb**  
RIF - +3 - N - E - 6D6+2 (7.62mm cased) - 25 – 1/3 - VR  
The Militech ACS is a hard hitting sniper rifle with a proven track record and it is sturdy enough to withstand the harshest abuse. Capable of 3 round burst for long range suppressing fire, as well ridiculously precise single shots.

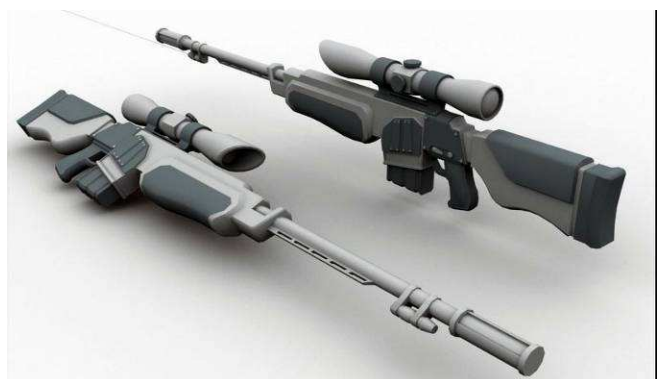

**RUGER CSP-76 775eb**  
RIF - +2 - N - E - 6D6+2 (7.62mm caseless) - 12 - 1 - ST  
A confident and comfortable weapon from Ruger. At such an affordable price, you get more than you pay for.



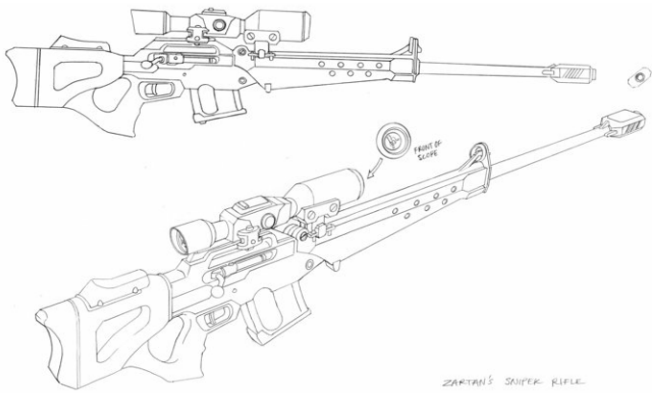

**SKODA SR-449 765eb**  
 RIF - +2 - N - P - 6D6+2 (7.62mm caseless) - 10 - 1 - VR  
 No it's not much to look at, but this eastern European sniper rifle definitely gets the job done. And it is almost impossible to hurt it, we dropped one off a 40 cliff onto rocks and it still fired perfectly.

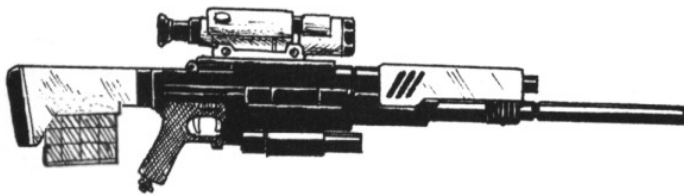

**STERNMEYER "MISON" 859eb**  
 RIF - +3 - N - P - 6D6+2 (7.62mm caseless) - 20 - 1 - VR  
 Pinpoint accuracy out to 1000 yards and an ammo capacity of 20 rounds make this sniper rifle the weapon of choice among many marksmen.



**STERNMEYER SSR-32 510eb**  
 RIF - +1 - N - C - 6D6+2 (7.62mm cased) - 10 - 1/10 - ST  
 Stermeyer brings us this well designed sniper rifle chambered in 7.62 ammunition. Its bullpup design and use of state of the art polymer ceramics makes this a lethally accurate weapon.

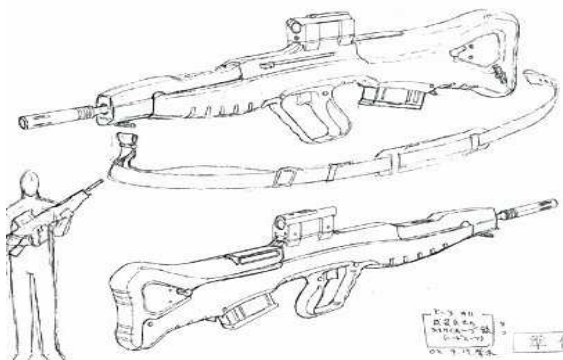

**TSUNAMI ARMS CR-25 560eb**  
 RIF - +1- N - C - 6D6+2 (7.62mm cased) - 10/25 - 1 - ST  
 A heavier version of the CR-21 chambered in 7.62mm. They also fixed most of the flaws for this version. A 25 round magazine is available.



**TOWA MS-70 640eb**  
 RIF - +3 - N - E - 6D6+2 (7.62mm caseless) - 8 - 1 - ST  
 Towa gives us a respectable marksman's rifle chambered in 7.62. A favorite among Asian shooters that won't break your bank.



**WALTHER WA-256X 1280eb**  
 RIF - +4 - N - P - 6D6+2 (7.62mm cased) - 15 - 1 - VR  
 While some may claim this weapon is overpriced, it's accuracy speaks for itself. A bullpup with an extremely long barrel, this weapon is capable of driving nails from 800 meters.



**WINCHESTER CODY 850eb**  
 RIF - +3 - N - C - 6D6+2 (7.62mm cased) - 8 - 1 - VR  
 A popular weapon among hunters and snipers alike, accurate and able to withstand rough treatment.

## .300 WINCHESTER MAGNUM



**ARASAKA "CHEYENNE" 5620eb**  
RIF - +4 - N - R - 7D6+3 (.300mag cased) - 4 - 1 - VR  
This complete and hard hitting sniping system is a benchmark of weapon technology. Smart linked as standard, with a long range scope, computerized rangefinder and windage meter, starlight, and highly accurate.



**ARASAKA "MORITA-II LR" 1450eb**  
RIF - +2 - N - R - 7D6+3/varies (.300 magnum cased/40mm micro-missile) - 6-1 - 1-1 - VR  
Built using a reinforced and accurized Morita frame, this sniper version of the popular assault rifle has become a favorite of marksmen. The 40mm micro missile launcher is a new addition to the Arasaka line of weapons as well, and options are the same as the standard 25mm versions, only with 40mm damage.



**ARASAKA "SPIRIT LR-4" 6980eb**  
RIF - +5 - N - R - 7D6+3 (.300mag cased) - 5 - 1 - VR  
The built in computer of this magnificent rifle automatically measures range, wind speed, and even factors in target speed and adjusts the scope accordingly, so all you have to do is put the crosshairs on the target and you are guaranteed to hit. This is quite possibly the most advanced sniper rifle in the world in terms of accuracy.



**CONSTITUTIONAL ARMS S51 "AASITH" 4455eb**  
RIF - +4 - N - R - 7D6+3 (.300mag cased) - 6 - 1 - VR  
Chambered in the same round that their Rev-6 made so famous, the S51 utilizes a bullpup revolver configuration for maximum accuracy, and removable cylinders for faster reloading. The cylinders on this weapon are longer than those of the Rev-6, allowing for specialized loads, and because it's a revolver you can mix and match rounds for any situation that might arise. Each re-usable cylinder can be programmed with the precise type of round loaded, which will display in the scope, or via smartlink, allowing you to select the round you need quickly.

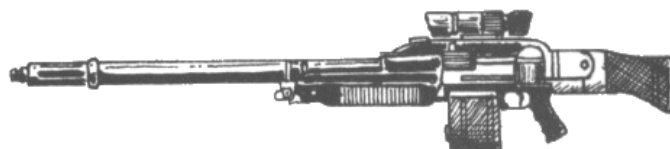

**DARRA POLYTECHNIC "HORIZON" 1575eb**  
RIF - +2 - N - R - 7D6+3 (.300mag cased) - 10 - 1 - ST  
A very large rifle, with enormous stopping power and dead on accuracy. Often used against light armor and full conversions, this weapon is a favorite among snipers.



**MAUSER SEK-41 1970eb**  
RIF - +2 - N - P - 7D6+3 (.300mag cased) - 5 - 1 - ST  
A large caliber sniper/hunting rifle, originally intended to bring down big game, but often used by anti-cyborg police sharpshooters.

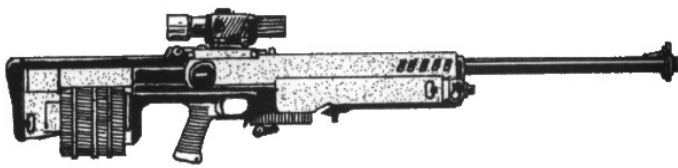

**REMINGTON "HALEY" 3120eb**  
 RIF - +3 - N - R - 7D6+3 (.300mag cased) - 5 - 1 - ST  
 Drop a full conversion without breaking a sweat. With the Haley chambered in .300 magnum you can drop pretty much anything you have too, and with 25 shots you can keep it up all day long.

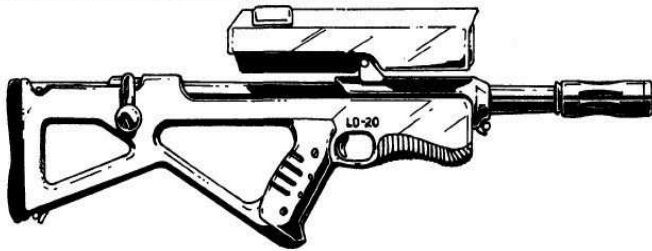

**ROYAL ENFIELD ORDINANCE LO-20 650eb**  
 RIF - +1 - N - R - 7D6+3 (.300 magnum cased) - 1 - 1 - ST  
 Single shot bolt action, this compact sniper rifle is ideal for making the statement "1 shot, 1 kill". A longer barrel would increase accuracy, but MI-6 was adamant that it be kept to a minimum for ease of concealment.



**SEBURO HSR-1 3210eb**  
 RIF - +3 - N - R - 7D6+3 (.300mag cased) - 4 - 1 - VR  
 Sebueros first sporting rifle, this bolt action weapon was originally conceived at the request of a prominent Japanese film icon who was planning a safari to Africa. The requests from people who had seen it during photo ops and video journals poured in, and soon Sebuero began to manufacture these weapons, selling them at a hefty price to anyone who could afford them. The weapons stock and frame are made from real hardwood, and the action and accuracy must be experienced to be believed

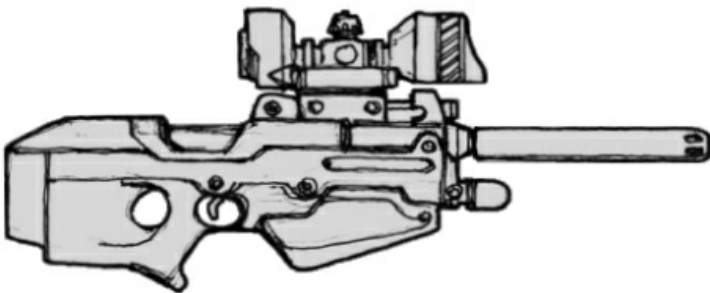

**SEBURO QUICK-MAG 825eb**  
 RIF - +1 - N - P - 7D6+3 (.300mag caseless) - 4 - 1 - ST  
 Sometimes a sniper needs a compact weapon, something that hits hard, but can move without restriction. The Quick-Mag fills that roll, fitting devastating power in a small package.



**TSUNAMI ARMS MANDOLIN 6490eb**  
 RIF - +5 - N - R - 7D6+3 (.300mag cased) - 6 - 1 - ST  
 Tsunami took a look at the Constitutional Arms S52 and decided they could do it better. The weapon features the same cylinder design though it lacks the onboard computer to display the ammo information on the scope, but it will still display that information to the integral smartlink. With the removable barrel extension attached



**TOWA MR-94 1090eb**  
 RIF - +2 - N - R - 7D6+3 (.300mag cased) - 5 - 1 - ST  
 A four shot bolt action sniper rifle from Towa, often used by police in Asia against cyborgs and as a light anti-armor rifle.

## 18MM GYRO-JET



**MILITECH BSW-10 1320eb**  
 RIF - +3 - N - R - 7D6API (18mm gyrojet) - 5 - 1 - ST  
 A very large, very ugly sniper system from Militech. Still it's hard to beat the accuracy, and it comes smart chipped standard. Made to compete with Remington's system.

## 10MM RIFLE



**ARASAKA MAD-8 6,235eb**

P - +3 - N - R - 8d6/12d6 (10mm rifle cased/ETE) - 10 - 1 - VR

Using the same technology as the Charon, this weapon too is an electrothermally enhanced weapon that disengage to fire normal ammunition at the flip of a switch. Highly accurate and built around the Arasaka developed 10mm rifle round, this weapon is not available for sale on any market, and like with the Charon, Arasaka has announced it has no intentions of making it available. This weapon will reach x10 price to collectors and professionals. Issued only to Elite Arasaka Marksmen,



**ARASAKA MMSR LONGSTRIKE 3,500eb**

P - +2 - N - R - 8d6 (10mm rifle cased) - 10 - 1 - ST

Continuing with their modular weapon systems, Arasaka has released the MMSR Longstrike. With a wide variety of stocks, barrel extensions, and other accessories, the Longstrike is the ideal sniper weapon capable of handling any situation. The base component of the Longstrike system can be used by itself, as a ridiculously large and powerful anti-cyborg handgun, however it is not recommended that anyone without at least a cyberarm attempt such a thing, as the recoil will likely break their wrists. (Without both barrel extension and stock attached, accuracy is reduced to -1)



**ARASAKA/SEBURO ODA-10 2,450eb**

P - +3 - N - R - 8d6 (10mm rifle cased) - 12 - 1 - VR

Arasaka and Sebuoro once again teaming up to bring you a superb sniper weapon system, accurate and lethal.



**DRAGUNOV M-855 580eb**

RIF - +1 - N - C - 8D6 (10mm caseless) - 50 - 1/3/20 - ST

Rostovics first weapon to use the 10mm rifle round developed by Arasaka. This weapon is an early attempt to keep current with the modern military trend started by the Arasaka Morita and the Militech M-52AR. While demand was initially high, the weapon was ultimately rejected by the Neo-Soviet military in favor of the KAAR system for its greater durability. The weapon also makes use of the Chinese style drum magazines, another reason its popularity sank among Russian field testers, as the spare mags were heavy and cumbersome. The ICMF however has shown great interest in the weapon, buying up as many as it can for its bigger punch equivalent to EDF and US arms.



**MILITECH ER-12 2800eb**

RIF - +3 - N - C - 8D6 (10mm caseless) - 7 - 1 - ST

Militech has released a weapon that is almost a carbon copy of the Arasaka Longstrike. It lacks the modularity, but is a more accurate weapon. Arasaka is already talking lawsuit over what they are claiming is a stolen early prototype design.



**MILITECH M-55S 2175eb**

SMG - +2 - N - E - 8D6 (10mm cased) - 60 - 1 - ST

The sniper rifle variant of the M-52 system. The ammo counter has been replaced with the display for the laser range finder built into the fore grip of the weapon.

## 20MM LIGHT



**MALORIAN FLAMBERGE 7760eb**

RIF - +3 - N - R - 4D10 (20mm light caseless) - 10 - 1 - VR

Malorian should stick to designing guns for corporate executives and rich socialites. There I said it. Yes this is a beautiful gun, yes it fires amazingly well. But damn it, all that flies out the window when you realize that every weapon Eran Malour designs is only available with a chrome finish. Especially when for half the price you can always find a weapon that is almost as reliable and accurate, and doesn't reflect Venus.

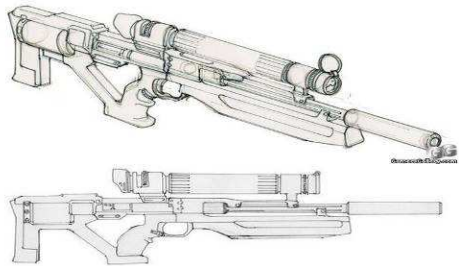

**CCMMC SPR-23 8800eb**

RIF - +5 - N - R - 4d10 (20mm caseless) - 10 - 1 - VR

China's premiere sniper rifle is a heavily advanced precision weapon built on a HAR model rifle. The 10 round helical clip sits far to the rear of this bullpup weapon for greater accuracy. While not as powerful as its American and European cousins, it is every bit as accurate.



**NOMAD "MA BELLE" 1200eb**

RIF - 0 - N - P - 4D10 (20mm cased) - 4 - 1 - ST

Reach out and touch someone...

## .50 BMG



**AZTECH HSR-50A2 7585eb**

RIF - +3 - N - R - 6d10 (.50cal cased) - 8 - 1 - VR

The Mexican militaries heavy sniper rifle, easily equivalent to the American Barrett.



**BARRETT P-50 & P-50B 4325eb**

RIF - +2 - N - R - 6D10 (.50 BMG cased)- 5/10 - 1 - VR

Want to hit something from a mile away, don't want to carry a 5 foot long 40lb behemoth. Try Barrett's P-50. At 4 feet 25 pounds, this monster feels just right. The P-50B is the bullpup version, and it is even lighter at just under twenty pounds. Both weapons accept the 5 and 10 round magazines. A powerful scope is highly recommended as this gun has an effective range of 1.5 miles.



**DAI LUNG R-604 2520eb**  
 RIF - 0 - N - C - 6D10 (.50bmg caseless) - 5 - 1 - P  
 What if the Barrett "50" had been designed by a third world nation firm? Introducing the Dai Lung R-604, the Malaysian manufactured knock off of the venerable Barrett. This weapon is made from stamped sheet metal and recycled steel. And while mishaps are not as common as you might expect, they are usually final. What do you expect when a .50 caliber rifle blows up in your hand. Still these weapons are extremely popular to third world militaries, terrorists, and street gangs all over the world. Just the sort of cheap tool to take down that NCPD "Constable" that is coming your way.



**FABRIQUE NATIONALE BRAR-501 8200eb**  
 RIF - +4 - N - P - 6D10 (.50 cal cased) - 6 - 1 - ST  
 A heavy European sniper weapon favored by the ICMF.



**SEBURO MSR-50 9720eb.**  
 RIF - +3 - N - R - 6D10 (.50 BMG cased) - 12 - 1 - VR  
 Seburo makes its move into the Heavy Sniper Weapon field in a big way with this magnificent weapon. No expense was spared in creating this weapon and bestowing upon it maximum comfort, reliability, and accuracy. The front grip is set in an adjustable slide allowing the user to adjust the weapon to his reach. The only downside to this weapon is its weight, though thanks to the state of the art poly ceramics used, it is only slightly heavier than the Barrett M-80

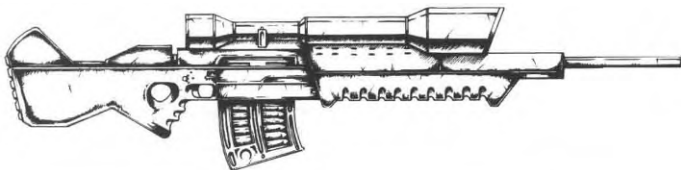

**WALTHER DRAGONLANCE S-402 4200eb**  
 RIF - +5 - N - R - 6d10 (.50 cal. cased) - 12 - 1 - vr  
 The European Heavy sniper rifle, chambered in .50 cal. this is one of the most accurate weapons in the world. It comes with a 3 foot suppressor for situations when stealth is important. This weapon outperforms the Barret M-90 in almost every way. One of the few weapons the EDF uses that isn't made for caseless ammunition, mostly due to the immense surplus and availability of .50 caliber ammunition. It also comes standard with a Lockson scope, one of the most powerful in the world. In fact, looking at this finely engineered weapon, one would sooner believe it is made for competition shooting, not wading through the jungle in a war zone



**TRUCK STOPPER 200eb**  
 (From Nomad Market)  
 RIF 0 N P 6D10/4D10 (.50 BMG/20mm Light) 1 1 ST  
 These hand made single shot bolt action sniper rifles are chambered either in cased .50 BMG or light 20mm, and are used to stop vehicles by putting a round through their engine block. For being hand made from scrap metal they are reasonably accurate. They don't come with a scope, and although one can be mounted it is a point of pride among nomads to shoot them using nothing but the iron sights.

## 15mm



**HECKLER AND KOCH DRS-4 14,520eb**  
RIF - +2 - N - VR - 7D10 (15mm BMG caseless) - 10 - 1 - ST

The impact of the 15mm round is unbelievable, and is usually enough to destroy whatever it hits. With the bullpup DRS-4 sniper rifle you have all the cover your team needs. The only drawback is the weapon could have bit a bit larger for stability sake, but it is still an excellent weapon. Of course the ammo is a bit hard to find, but you are resourceful aren't you?



**LUCZNIK RADOM TARS-20 3230eb**  
RIF - +3 - N - R - 7D10 (15mm cased) - 1 - 1 - ST  
A single shot, bolt action, heavy sniper rifle from Poland. Made from lightweight materials and breaks down easily into a package small enough to fit into a suitcase. You only get one shot, but its accurate enough that a competent sniper shouldn't need more anyway.

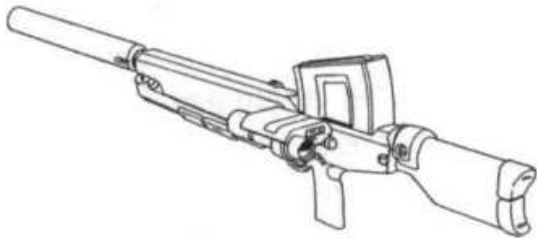
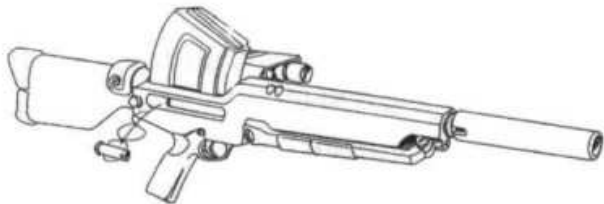

**MILITECH ATR-97 11,590eb**  
RIF - +2 - N - R - 4D10+3 (15mm caseless) - 8 - 1 - VR

While not really the anti-tank rifle it claims to be, it is an excellent choice for putting down the rampaging borg or the even the stray light ACPA you might come across. Police agencies and military forces all over the globe have determined this weapon to be a valuable deterrent to the war on Cyborg crime.



**ROSTOVIC AVR-13 9580eb**  
RIF - +1 - N - P - 7D10 (15mm cased) - 10 - 1 - ST  
The Rostovic AVR-13 is a heavy anti-armor sniper rifle, they recently replaced this weapon as the Russian militaries standard heavy sniper rifle, but surplus has seen excellent foreign sales, particularly to Africa and South America.



**STEIN & WASSERMAN 52-AMSR 13,515eb**  
RIF - +3 - N - R - 7D10 (15mm cased) - 10 - 1 - VR  
The simplicity of this weapon is what makes it so appealing, that and the fact that it fires full sized 15mm rounds with astonishing accuracy.

## 20MM



**COLT HR-444 10,920eb**  
RIF - +1 - N - C - 8D10 (20mm) - 10 - 1 - ST  
A standard 20mm anti-tank rifle, also extensively used as a borg suppression weapon by the military, C-SWAT, and corporations.

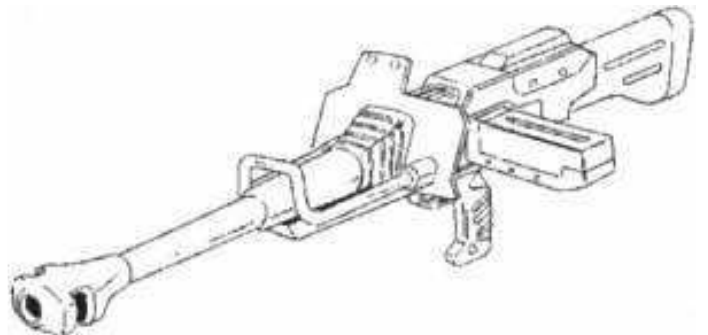

**DUTCH ARMS "VANDALIZER" 16,900eb**  
RIF - +1 - N - P - 8D10 AP (20mm AP) - 20 - 1 - VR  
An effective anti-armor rifle, common to European troops, especially mounted on vehicles.

## 25MM

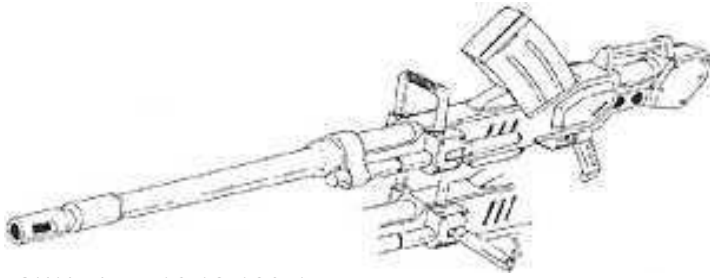

**TOWA ATR-16** 12,180eb  
RIF - -1 - N - C - 5D10+10 AP (25mm) - 15 - 1 - ST  
A very large, and effective anti-tank rifle.

## 30MM

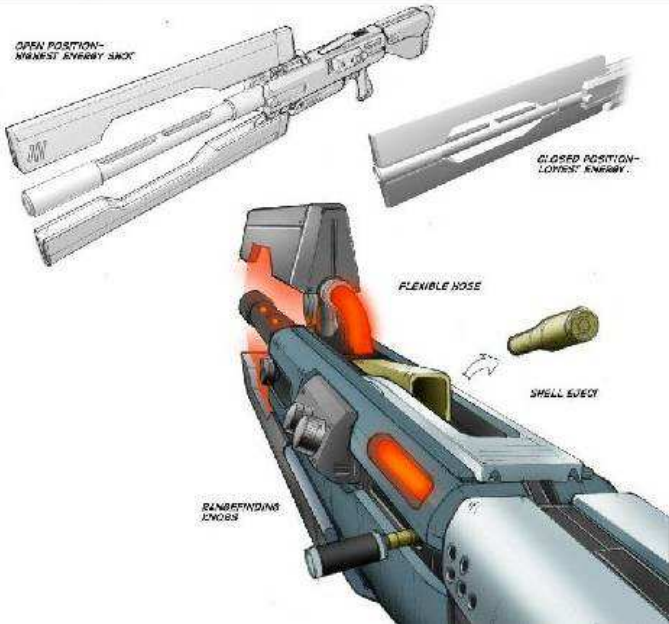

**ARASAKA HADES-7 ENERGIZED PROJECTILE SNIPER SYSTEM** 125,525eb  
RIF - +3 - N - VR - 20D10API\* (30mmETE titanium cased \*SPECIAL\*) - 5 - 1 - VR  
This weapon is still in the experimental stages, but has been issued to the US Military for testing. The barrel of the weapon is made from the same material used in creating the heat shield tiles for spacecraft re-entry. It electrothermally fires titanium rounds with gold cores which are superheated to 2500 degrees Fahrenheit by laser. The superheated bullet will punch or burn through almost anything. As a result this man portable rifle is capable of demolishing anything it sets its sights on. The lasers power supply must be recharged after every 10 shots, and the titanium 30mm shells are 80eb apiece. The bullets remain superheated for up to 30 seconds, and will ignite any flammable object they come across. After 2 minutes they are room temperature again.

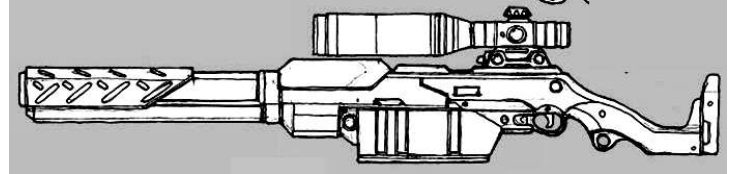

**ARASAKA "YARI"** 23,775eb  
RIF - +2 - N - R - 10D10 (30mm cased) - 5 - 1 - VR  
The most powerful sniper rifle available. Use of at least a bipod is strongly recommended, as is never attempting to fire the weapon from anything but a prone position. The immense recoil of this weapon is easily capable of dislocating a shoulder, or worse. Standard load for the weapon are teflon coated armor piercing shells, able to penetrate tank armor. Using this on a human target is like shooting a bazooka at a spider, though the weapon is extremely effective against powered armor and full conversions, even military models.



**MILITECH ABR-78** 16,000eb  
EXP - +1 - N - P - 9D10 (30mm cased) - 10 - 1 - ST  
Militechs formidable anti-tank rifle, comes standard with a bipod. Non-augmented persons need to brace this weapon to fire it, either with the bipod, or in some other way. (BOD min 14)

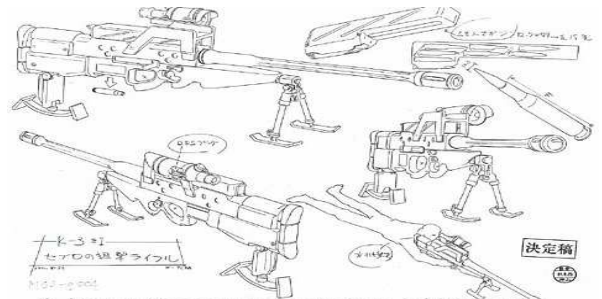

**STOVOLBOY BRZ-76** 26,520eb  
RIF - +3 - N - R - 10D10(30mm cased) - 10 - 1 - ST  
The premiere Russian anti-armor sniper weapon. The top mounted helical magazine is a nice touch, and the Seburo style firing assembly and grip configuration insure ease and comfort when firing.



# ASSAULT RIFLES

## 4.5MM



**ARASAKA BAR-54 810eb**  
RIF - +2 - N - P - 4D6/varies (4.5mm cased/40mm gl)  
- 40-4 - 1/3/20-1 - VR

This bullpup assault rifle is a favorite among police and SDF forces in Japan, and with its built in 40mm grenade launcher you can go in prepared for anything.



**ARASAKA "BOX-4" 550eb**  
RIF - -1 - N/L - P - 4D6 (4.5mm caseless) - 30 -  
1/3/20 - ST

These weapons are highly illegal outside of military and government use almost everywhere in the world due to their high concealability. Fully loaded the weapon folds up into an easy to store shape that most people would never assume to be a weapon.



**CESKA ZJOBROVKA CZ-SSP 475eb**  
RIF - 0 - N - E - 4D6 (4.5mm caseless) - 80 - 1/3/25 - ST  
A simple short assault rifle with a staggering ammo capacity and high rate of fire. A 30 round magazine is available, allowing the weapon to be concealed under a long coat.



**DAI LUNG DR-40 280eb**  
RIF - 0 - N - E - 4D6 (4.5mm cased) - 60 - 1/3/30 - ST

An inexpensive, but not poorly designed rifle, popular with many third world militaries, police forces, and civilians worldwide.



**FABRICA DE ARMES BR-412 365eb**  
RIF - +1 - N - P - 4D6 (4.5mm caseless) - 50 -  
1/3/25 - ST

The BR-412 is a very compact assault rifle, almost capable of fitting under a long coat. Popular with vehicle crews and extraction teams due to its compact nature, which unfortunately also makes it popular with criminals and terrorists.



**FABRICA DE ARMES "GMCC-4" 620eb**  
RIF - +1 - N - R - 4D6-2/special (4.5mm subsonic glaser cased/motion restraint) - 40-3 - 1/3/15-1 - ST  
Last year Crystal Palace put out the call for an assault rifle to be designed for their security teams. This is the first choice. The stock is adjustable, the weapon fires subsonic 4.5mm glaser shells designed to break apart against any hard surface, and the weapon features a 3 shot Bio Askari motion restraint caster.



**FABRIQUE NATIONALE "STANDARD-13" 180eb**  
 RIF - 0 - N - C - 4D6 (4.5mm caseless) - 25 - 1/3 - ST  
 FN sells a lot of these weapons around the world, to hunters, to militias, rebel forces, third world militaries, to anyone who needs a reasonably reliable, but cheap and no frills, assault rifle.



**HECKLER AND KOCH LIGHTNING CHAIN 1280eb**  
 RIF --2- N - C - 4D6 (4.5mm caseless) - 100 - 50 - ST  
 The most compact personal gatling gun firing rifle ammunition available on the market.

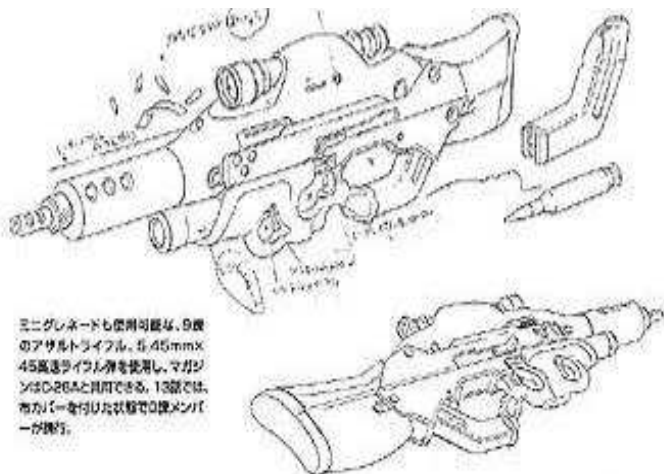

**SEBURO C-30 2360eb**  
 RIF - +3 - N - R - 6D6 / SPECIAL (4.5mm cased ETE/40mm grenade) - 40 / 1 - 1/3/15 / 1 - VR  
 Specifically designed to fire electrothermally enhanced ammunition at full auto rates thanks to radical construction of the barrel shroud, the Sebuco C-30 is also more than accurate enough to serve as a sniper weapon. The built in grenade launcher only increases its effectiveness as once again Sebuco proves they are the innovative weapon designers to be found.



**SEBURO MN-EP1 680eb**  
 RIF - +1 - N - C - 4D6 (4.5mm cased) - 45 - 1/3/30 - ST  
 Specifically designed for European police work, this latest in the MN line was developed after hearing the wish lists of polled European SWAT officers.



**SILENCED RIFLE 340eb**  
 (From Nomad Market)  
 RIF - 0 - N - C - 4D6 (4.5mm cased) - 10/35 - 1/3 - ST  
 This Nomad made rifle is built for stealth, with an integral suppressor built into the barrel as standard. With sub-sonic ammo, it barely makes a sound.



**STEYR R-282 340eb**  
 RIF - +1 - N - C - 4D6 (4.5mm cased) - 45 - 1/3/30 - ST  
 A popular assault rifle, particularly with European police and military forces.



**TSUNAMI ARMS F2020 and F2020B 520 / 640eb**  
 RIF - +1 - N - C - 4d6/varies (4.5mm cased/40mm grenade) - 25-1 - 1/3/20-1 - ST  
 Trying to stay competitive, Tsunami released this weapon, available with or without the single shot under barrel grenade launcher.

## 5.56MM



**ARASAKA "AW-65" 465eb**  
RIF - +2/-1 - N - P - 5D6/varies (5,56mm cased/40mm grenade) - 30/1 - 1/3/20-1 - VR  
Short, fat, and menacing is the only way to describe this rifle. Arasaka developed this weapon with maximum kill ratio's in mind, and succeeded. Its large suppresser keeps the noise down while it unleashes its load of 5.56 ammunition, and for larger obstacles, the underbarrel grenade launcher is just the trick. Comes standard with a low light telescopic sight.

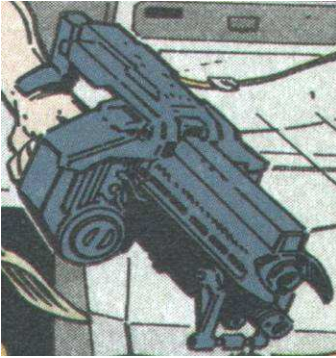

**ARASAKA AW-374 720eb.**  
RIF - +1 - N - C - 5D6 (5.56mm caseless) - 200 - 1/3/30 - VR  
The AW-374 is a very short weapon with an outrageous ammo capacity, made possible by the huge double drum magazine. With this you won't have to worry about running out of ammo, so can fire away till whatever it is stops moving. Makes an ideal support weapon in urban environments.

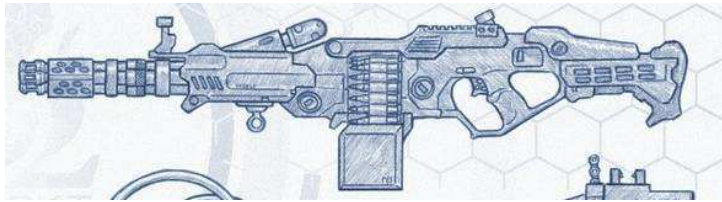

**ARASAKA BSW-556 780eb**  
MG - 0 - N - C - 5D6 (5.56mm caseless) - 100 - 20/40 -ST  
Arasaka's 6 barreled squad support weapon firing 5.56 ammunition. The weapon operates on an ACPA battery cell, and has 2 speed settings for varying rates of fire between 400 and 800 rounds per minute. The weapon is normally mounted, but is man portable and squads with full conversions, or a strong gunner, often with a gyro mount and a back mounted ammo hopper have been known to utilize them as well.



**ARASAKA HACHIMAN 950eb**  
P/RIF - 0/+1/+2 - J/L - C - 5D6(5.56mm cased) - 50 - 1/3/20 - ST

The Arasaka Hachiman is a revolutionary new weapon, with virtually nothing like it in its class. The 50 round "eaten donut" magazine feeds through an innovative loading mechanism, and when folded up, the weapon is the size of a large handgun. The weapon is fully functional when folded up, however if greater control is desired, at the flip of a switch and a jerk of the wrist, the stock slides around the circular magazine frame to lock into place, and the fore grip folds down for greater stability(+1 accuracy). The weapon comes with a removable barrel extension, which provides even greater accuracy (additional +1) but makes the weapon less concealable.



**ARMALITE URM-7 500eb**  
RIF - +1 - N - C - 5D6 (5.56mm cased) - 40 - 1/3/10 - ST

Designed for urban warfare, this is a competent and reliable weapon. The adjustable stock is a nice touch.



**ARMALITE "VOREX" 415eb**  
RIF - 0 - N - C - 5D6 (6mm caseless) - 30 - 1/3/30 - ST

The Vortex is a light assault rifle built to take abuse. Perfect for when you find yourself in a harsh environment.



**AZTECH SASG-15 860eb**  
RIF - 0 - L - R - 5D6 (5.56mm caseless) - 32 - 1/3/12 - VR

Arguably the finest weapon ever made in Mexico, and one of the finest weapons of its kind in the world. It is in fact this weapon, and its Manufacturer Aztech, that has reversed the shoddy stigma that Mexican weapons and equipment used to leave. One of the most modular weapon in the world, the basic system is no larger than a submachine gun without suffering serious loss to accuracy. However the weapon comes with a host of accessories which allow complete and total customization. 2 different length barrel extensions, the 6inch comando extension, and the 12 inch Rifle extension add accuracy (+1 and +2 respectively), 2 varieties of stock attachments (folding and solid), and a wide variety of scopes, sights, foregrips, barrel shrouds, suppressors, and other options make this one of the most sought after weapons in the world. Mexican Special Forces use this weapon as their SMG, and it is available equipped with an integral smartlink for only and additional 100eb. In addition to the standard magazine, 10 and 20 round magazines are available as well.



**CALICO M-3000 335eb**  
RIF - +1/-1 - N/L - C - 5D6 (5.56mm caseless) - 50 - 1/3/20 - VR

A 5.56mm firing version of the popular line of weapons, comes with a folding stock and telescopic sight. The barrel and stock are removable, dropping the weapons concealability, and accuracy.



**CCMMC HAR-22 "HELGHAST" 489eb**  
RIF - 0 - N - C - 5D6 (5.56mm caseless)/ 4d6 (.10 ga) - 60/5 - 20/3/1 1 - VR

This is the standard assault rifle of the Chinese military, and it has a vast surplus of these weapons which it sells around the world, making it as common today as AK-47 knock-off's were in the 80's and 90's. It's popularity has good reason. It is a reasonably accurate and reliable weapon, with a large magazine capacity and an underbarrel pump action shotgun, also capable of accepting 25mm grenades. Its only drawback is that the bulky helical magazines are somewhat cumbersome to carry.



**CCMMC KS-32 320eb**  
RIF - +1 - N - E - 5D6 (5.56mm cased) - 30 - 1/3/15 - ST

This is a Chinese heavy assault rifle, used by chinese troops and their allies worldwide.

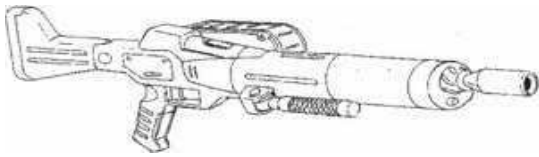

**CCMMC MGR-42 975eb**  
 MG - +1 - N - C - 5D6 (5.56mm caseless) - 80/100 - 1/3/25 - VR  
 A chinese military machinegun, the folding foregrip is a nice touch. Able to accept an 80 round magazine or belt fed ammunition.

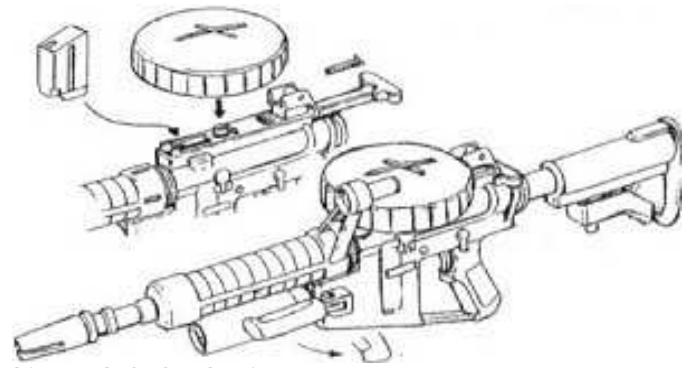

**COLT MG-678 525eb**  
 RIF - +1 - N - C - 5D6 (5.56mm cased) - 30/100 - 1/3/20 - VR  
 A very nicely designed, easy to maintain machine gun from colt, the MG-678 accepts either a 30 round box magazine, a 100 round drum, or belted ammunition.



**CCMMC R57 480eb**  
 RIF - 0 - N - C - 5D6/special (5.56mm caseless/40mmgren) - 30/1 - 1/3/30-1 - VR  
 A Chinese assault rifle grenade launcher combo, serves extensively with the Chinese military and her allies.



**COLT SMAR-15 325eb**  
 RIF - -1 - L - C - 5d6 (5.56mm cased) - 30 - 1/3/25 - ST  
 The newest version of the M-16/AR-15 weapon system is no larger than a submachine gun, and has the carrying handle removed. As small and powerful as the weapon is, accurate one handed firing is still possible.



**CESKA ZBROJOVKA CZR-163 420eb**  
 RIF - +2 - N - C - 5D6 (5.56mm cased) - 44 - 1 - VR  
 The extra long barrel of this light assault rifle increases the accuracy quite a bit. It is common to see this weapon issued to Eastern European police and military personnel.

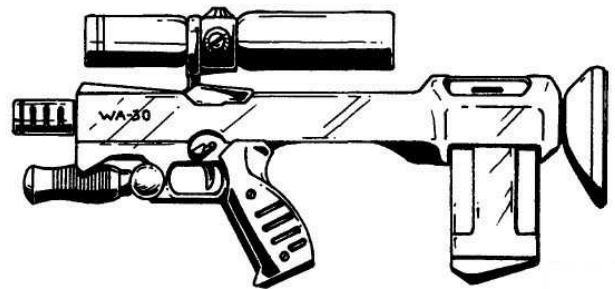

**DARRA-POLYTECHNIC WA-30 460eb**  
 RIF - -1 - L - C - 5D6 (5.56mm caseless) - 30 - 1/3/20 - ST  
 One of the simplest, most straightforward weapon designs we have seen in a long time. No extras, and the slim compact design makes it easy to carry under a long coat. A favorite among undercover police and criminals alike.



**CESKA ZBROJOVKA "00GR" 365eb**  
 RIF - -1 - L/N - P - 5D6 (5.56mm cased) - 30 - 1/3/25 - ST  
 With the stock folded, this weapon easily fits under a large coat or jacket, originally developed for the Russian military, it has since become a favorite with criminals all over the world.



**CHADRAN ARMS RR-504 450eb**  
 RIF - 0 - N - E - 5D6 (5.56mm cased) - 25 - 1/3/15 - ST  
 A standard assault rifle with a nicely adjustable stock. Strictly no frills, but seen everywhere.



**DYEGTARYEV DFST-845 590eb**  
 SMG - +1 - L - P - 5d6 (5.56mm cased) - 30 - 1/3/18 - VR  
 Compact enough to work as a submachinegun, this weapon is commonly issued to special forces, guards, tank crews, and anywhere else where inflicting maximum damage is as important as space preservation.



**FABRICA DE ARMES "MALACHAI" 520eb**  
 RIF - +1 - N - P - 5D6 (5.56mm cased) - 30 - 1/3/15 - ST  
 A very sleek, highly maneuverable assault rifle with a removable stock for close quarters work.



**FABRICA DE ARMES TAVOR-2 435eb**  
 RIF - -1 - N - C - 5D6 (5.56mm cased) - 25 - 1/3/10 - ST  
 The most innovative feature of this weapon is the built in suppressor, comprised of a heavy baffling drum that fits over the barrel.



**FABRIQUE NATIONALE "GRUNTER" 935eb**  
 RIF - +1/-1 - N - P - 5D6/varies (5.56mm cased/40mm gren) - 30/1 - 1/3/30 /1 - ST  
 A new rifle from FN, comes complete with underbarrel grenade launcher. A true workhorse for the battlefield.



**FEDERATED ARMS "HOMEBOY" 430eb**  
 RIF - 0 - N - E - 5D6 (5.56mm cased) - 50 - 1/3/30 - ST  
 A commonly seen rifle, especially among street gangs and nomads. Its popularity is mostly due to its high ammo capacity and ease to clean and maintain.



**FEDERATED ARMS LR-44 545eb**  
 RIF - +1 - N - C - 5D6/4d6 (6mm caseless/12ga.) - 30/3 - 1/3/20-1 - ST  
 This light assault rifle fires caseless 6mm rounds and features a 3+1 round shotgun for entry purposes. The weapon is commonly seen in use by EDF military police and the Canadian RMS.



**FEDERATED ARMS MA-25 520eb**  
 RIF - 0 - N - C - 5D6 (5.56mm caseless) - 25 - 1/3/10 - ST  
 A cheap fairly reliable assault rifle, popular in 3rd world militaries, nomads, and urban gangs.



**FEDERATED ARMS SRMG-46 415eb**  
 RIF - -1 - N - C - 5D6 (5.56mm caseless) - 30 - 1/3/20 - ST

The size of a submachine gun, yet packing the punch of a rifle. Federated arms is trying to sell these to swat teams and militaries, but meeting with limited success so far.



**H&K AG-62 580eb**  
 RIF - +1 - N - C - 5D6 (5.56mm cased) - 30 - 1/3/30 - VR

A submachine gun sized assault rifle featuring a retracting stock and integral laser sight. Common among black op and extraction teams.



**H&K BARR-4 780eb**  
 MG - -2 - N - C - 5D6 (5.56mm caseless) - 75+75 - 40 - ST

This four barreled dual fed machinegun is more overkill than can be believed. If you don't have the strength to carry and fire a minigun, but want to put as many holes into something as possible then this is the weapon for you. The 4 barrels are on left and right opposite rotation, this means that the upper right and lower left barrels fire simultaneously, then the upper left and lower right. The weapon was designed this way to prevent overstressing the barrels while still maintaining a maximum rate of fire.



**H&K CAWS-62 965eb**  
 RIF - 0/-1 - N - P - 5D6/varies (5.56mm cased/40mm gren) - 30/3 - 1/3/30 /1 - ST

A new model in the aging CAWS line of weapons, this is a 5.56mm assault rifle with underbarrel pump action grenade launcher.



**HECKLER AND KOCH G38R 410eb**  
 RIF - +1 - N - P - 5D6 (5.56mm cased) - 30 - 1/3/15 - ST

Tight and compact, the G38 is an assault system geared to fit in your budget without sacrificing quality or reliability.



**H&K "GOBLIN" 935eb**  
 RIF - +1 - N - P - 5D6 (5.56mm caseless) - 40 - 3/20 - VR

An odd bullpup design, this is a fairly accurate certainly cost effective assault rifle. Unfortunately it is a high maintenance weapon, not recommended for anything other than urban environments. Because of this the weapon has yet to make a single contract with any military or government.



**HECKLER AND KOCH GR-90 815eb**  
 HVY - +1 - N - C - 5D6 (5.56mm cased) - 200 - 1/40 - VR

Part machine gun, part sniper rifle, the H&K GR-90 is the latest in multi-task weaponry.



**H&K SPARTAN-SX6 660eb**  
 RIF - +2 - N - P - 5d6 (5.56mm cased) - 30 - 1/3/15 - VR  
 Another fine assault rifle from H&K, sturdy and dependable, with adequate accuracy and well deserved reputation as a professionals weapon.



**H&K MPH54 TOJIMA CUSTOM 1895eb**  
 SMG - 0 - L - R - 5D6 (5.56mm cased) - 25 - /3/20 - VR  
 A couple of years back Scott was after a full body conversion, but when he had finally managed to corner him a firefight ensued. (This was early on in Scotts career) Unfortunately Scott had lost his rifle in an earlier skirmish and was down to one smg and two pistols. Scott's bullets simply bounced off the borg. Luckily Scott was able to escape and caught the target later but he never forgot the harsh lesson of that night. With the exception of rifles and shotguns Scott prefers to shoot everything one handed. He also prefers to carry an smg in a holster on his right hip when knowingly going into a combat situation. So Scott and Tojima sat down and redesigned an HK series rifle. They cut the barrel down to nearly the receiver and gave it the retractable stock and barrel shroud of the MP2000. Then they dropped the high ROF from 700 rpm to a more controllable 400 rpms to increase stability and help compensate for the lost accuracy do the short barrel. Lastly Tojima used every trick in the book to optimize accuracy, recoil, and quality. So the finished product is an assault rifle the size of a large pistol or smg. Exclusively hand made by Autumn Blade, no more than 10 of these are sold per customer and there is a six month waiting period.



**H&K MPXS1 560eb**  
 RIF - +3 - N - P - 5d6 (5.56mm cased) - 30 - 1/3/10 - VR  
 Loosely designed around the GS series of weapons, the MPXS1 from Heckler and Koch is a full sniper/assault system. The MPXS1 is capable of scoring dead on at well over 150 meters, and the bullpup design makes for a more stable trajectory due to longer barrel allowance. It is also capable of 3 round burst and full auto fire for suppression. It comes complete with scope and barrel shroud is fully insulated to act as a suppressor.



**H&K "MR-89" 625eb**  
 RIF - +2 - N - P - 5D6 (5.56mm cased) - 30 - 1/3/35 - VR  
 Another fine weapon form Heckler and Koch, commonly seen in military and corporate use.



**LUCZNIK RADOM RASP-28 1080eb**  
 RIF - 0 - N - P - 5D6/special (5.56mm caseless/40mmgren) - 30/3 - 1/3/30-1 - ST  
 A polish assault rifle/grenade launcher combo, what sets it apart is the 3 round magazine capacity of the underbarrel gl.





**MALORIAN "NORTON" 839eb**  
 SMG - +1 - L/J - P - 5d6 (5.56mm caseless) - 30 - 1/3/20 - VR  
 More of an smg than an short assault rifle, this weapon packs a powerful punch. This is a small weapon indeed, and the sans stock version can be concealed under a jacket. Malorian integrated every last piece of cutting edge technology when they developed this weapon. It is made mostly from ceramic and polymer plastics, while the barrel and other metal pieces are made from titanium. It is somewhat heavy, and expensive, but well worth the price.



**MEXICAN METALS TSR-44 650eb**  
 HVY - -1 - N - E - 5D6 (5.56mm cased) - 40/100 - 10 - ST  
 Feeding from either a 40 round magazine or a 100 round belt, the TSR-44 is a popular light machinegun from Mexico, a favorite with militaries all over the world.



**MILITECH CGW-06 860eb**  
 RIF - 0 - N - R - 5D6 / SPECIAL (5.56mm caseless/ 40mm grenade) - 40 / 3 - 1/3/10 / 1 - VR  
 Designed to stand up to any abuse, the harshest conditions, and the worst climates, the Militech CGW-06 is a workhorse. The built in grenade launcher and high capacity double thick magazine keep this weapon on the forefront of the battleground.



**MATSUCORP "NEO" 615eb**  
 RIF - -1 - N - P - 5D6 (5.56mm cased) - 120 - 1/3/35 - VR  
 With its dual drum 120 round magazine, and overall compactness, this short assault rifle is ideal for special forces work, although even with the front grip it is still a bit hard to control on full auto.



**MILITECH EMR-16 389eb**  
 SMG - -1 - L - P - 5D6 (5.56mm caseless) - 25 - 1/3/10 - VR  
 More of a shortened rifle than an smg, the EMR-16 fires the full sized 5.56mm rifle round and features an extending stock. A bit hard to control in any setting, this weapon could truly benefit from a forward grip.



**MILITECH AR-900 1235eb**  
 RIF - +2 - N - P - 5D6 (5.56mm caseless) - 35 - 1/3/30 - VR  
 Recently Militech unveiled its newest assault rifle. And while the weapon is still generally unavailable, Autumn Blade has managed to "acquire" a large shipment. Supplies are going fast so order now. While no major militaries have made any contracts several have expressed interest, including the USAF.



**MILITECH M-77 775eb**  
 HVY - 0 - N - C - 5D6 (5.56mm cased) - 100 - 20 - VR  
 A very standard squad support weapon from H&K, belt fed and very durable.



**MILITECH MAR-26 550eb**  
 RIF - +1 - N - C - 5D6 (5.56mm caseless) - 20 - 1/3/15 - ST

Yet another assault rifle from Militech, their R&D boys must get paid by the hour.



**MILITECH M-408 "MARINE" 815eb**  
 RIF - +1 - N - C - 5D6 (5.56mm cased) - 60 - 1/3/25 - VR

The M-408 assault rifle is currently undergoing trials and testing for possible standard issue to the U.S.M.C. This weapon is tried, tested and true by many professionals around the world and military forces are beginning to take note of it. Its incredibly large magazine is capable of holding 60 rounds, yet the weapon is still light and durable enough for combat use in the field.



**MILITECH CGW-06 960eb**  
 RIF - +1 - N - P - 5D6 / SPECIAL (5.56mm caseless/ 40mm grenade) - 40 / 3 - 1/3/20 / 1 - VR

A smartlinked Militech assault weapon with integral 40mm grenade launcher and built in flashlight/laser sight combo.



**NOMAD BOOMSHALACK 160eb**  
 (From Nomad Market)  
 RIF -1 N R 5D6 (5.56mm caseless) 10 1 VR

The buttstock has been sawn off this hand made rifle, reducing it's accuracy drastically, but this is still a fine weapon.



**NOMAD HEAVY METAL 120eb**  
 (From Nomad Market)  
 RIF - -2 - L - U - 5d6 (5.56mm caseless) - 35 - 15/3/1 - UR

Technomancers are a gutsy crew, and I pity whoever had to testfire this weapon till they got it right. This totally custom gun is an assault rifle the size of submachinegun. It's inaccurate, it's ugly, I wouldn't trust it, and it only comes with 2 magazines, any more would have to be custom built, but you sure can't beat the price for that kind of firepower.



**NOMAD MG-31 800eb**  
 HVY - +2/0 - N - C - 5D6 (5.56mm cased) - 100 - 1/20 - ST

There are tons of these floating around the nomad community, most notably within the Raffin Shiv. This German made machine gun features a double drum magazine and on single fire it's accuracy raises to +2. It's also very light weight, and easy to maintain.



**NOVA ARMS FLAK-5 510eb**  
 RIF - 0 - N - E - 5D6 (5.56mm caseless) - 30 - 1/3/10 - VR

A simple to use bullpup with minimal maintenance needs. Ideal for security work, or for equipping men who haven't had time for extensive training.



**NOVA ARMS UCTR-601 475eb**  
 RIF - -1 - N - E - 5D6 (5.56mm cased) - 30 - 1/3/14 - ST

The reasonable price and solid sturdy design keep this a popular weapon with mercenaries and private militaries the world over.



**NOVA ARMS "VERIA" 275eb**  
 RIF - -1 - N - E - 5D6 (5.56mm cased) - 30 - 1/3/10 - ST

Simple, affordable, and common. Everything you would expect from the worlds most generic arms manufacturer.



**ROSTOVIC KHR-28 625eb**  
 RIF - 0 - N - C - 5D6/varies (5.56mm cased/25mm grenade) - 40 - 1 - 1/3/25-1 - ST  
 Specifically designed for full Borg commando units, the KHR-28 is an assault rifle with an astounding 50 round magazine in a package the size of a submachine gun. The single shot underbarrel grenade launcher is a nice touch as well.

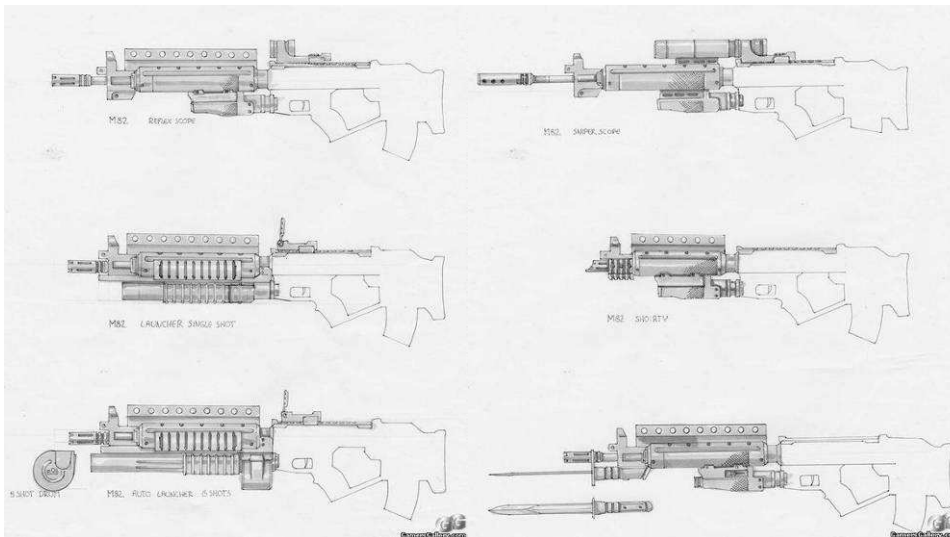

**ROSTOVIC M-802 775eb**  
 RIF - +1 - N - P - 5D6 (5.56mm cased) - 30 - 1/3/20 - ST

A Russian assault rifle in direct competition to the Arasaka Morita, but with even more versatility. This bullpup is able to be configured for virtually any role necessary. Optional accessories include a 40mm grenade launcher, a 25mm grenade launcher/10.ga shotgun, a 25mm micromissile launcher, bayonet, shortened commando barrel, optimized sniper barrel, etc.

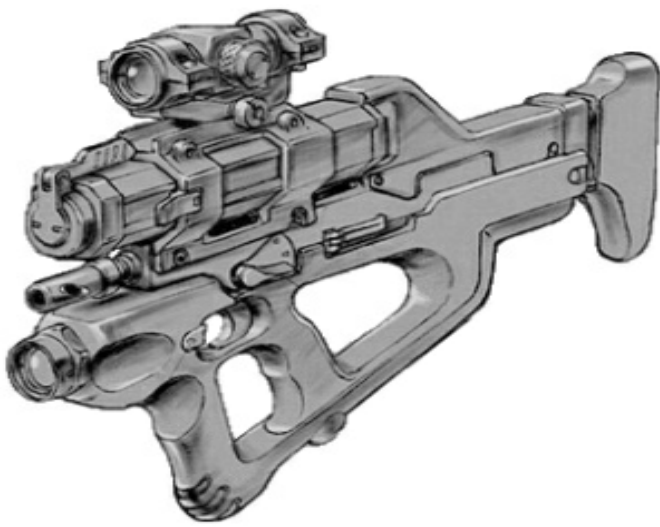

**SEBURO ACR-556 1140eb**  
 RIF - +2 - N - C - 5D6-varies (5.56mm cased-40mm grenade) - 75-1 - 1/3/30-1 - VR  
 Feeding from a large, top mounted, helical clip, this bullpup assault rifle is making serious waves in the police and military communities. While generally too expensive for mass issue in the military, special forces and SWAT teams drool over them. Its high ammo count, relatively compact size, built in grenade launcher, and Sebuoro quality and accuracy make it a highly sought after weapon.

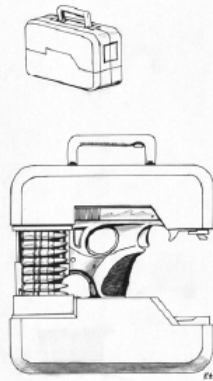

**SEBURO Briefcase Gun \* 1400EB**  
 RIF \* -2 \* N \* ER \* 5D6 (5.56mm) \* 50 \* 25 \* ST  
 This gun looks like an ordinary briefcase until it is needed, then a switch in the handle is activated and the bottom of the case falls out.



**SEBURO "CALLY" 755eb**  
 RIF - +2 - N - P - 5D6 (5.56mm cased) - 75 - 1/3/20 VR  
 Sebuoro's version of what a calico style rifle should be. With its ergonomic styling and favorable accuracy, this gun makes the wish list of professional's all over the globe.



**SEBURO MN-24 & MN-24B 845eb**  
 RIF - +2 - N - P - 5D6 (5.56mm cased) - 30 - 1/3/20 VR

An excellent light assault weapon. While still a new design, the MS series is quickly gaining a reputation as one of the finest automatic weapons in the world. The MN-24 is a bullpup weapon that is just as virtually the same weapon at home in the jungle as on the streets. Popular to militaries and police departments the world over. A fine weapon indeed, the MN-24B is almost identical but has a shorter barrel.



**SEBURO MNAR-15 710eb**  
 RIF - +1 - N - P - 5D6 (5.56mm cased) - 30 - 1/3/15 - VR

Sebuoro's compact assault rifle, chambered in the extremely common 5.56mm round means you never have to search to find ammunition, and because its Sebuoro you never have to worry about quality or reliability. As always from Sebuoro, this is an excellent and effective weapon



**SEBURO MNAR-16FW 835eb**

RIF - +2 - N - P - 5D6 (5.56mm cased) - 30 - 1/3/15 - VR

A full sized version of the MNAR-15 assault rifle system from Seburo. All the quality of its little brother in a more controllable and intimidating package. In addition the longer barrel provides for more accuracy.

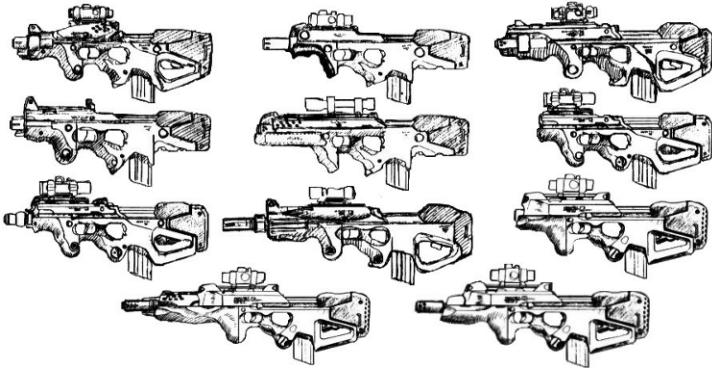

**SEBURO "MN -PERFECT" 780eb**

RIF - +1 - N - C - 5D6 (5.56mm cased) - 30 - 1/3/30 - VR

Lover your Seburo, but hate making the choice between which one you want. With the MN-Perfect you no longer have to choose. With the simple purchase of one the conversion kits (25eb apiece) you can now tailor your weapon to exactly fit your needs. From short rifles for commando purposes, to long versions for sniper work and hunting. Never waste your money again. Also available for the weapons are easy chamber conversion kits, which will allow you to choose between 4mmcl, 5.56mm or 7.62mm ammunition (150eb apiece).



**SEBURO MS-25A, B, & C 865eb**

RIF - +2 - L - P - 5D6 (5.56mm cased) - 30 - 1/3/25 - VR

The compact versions of the MN series of weapons from Seburo. These weapons are basically exactly the same as the MN-24 differing only slightly in size and appearance. The version A is the standard, the B was designed for tank and air crews, and the C was made specially for the Navy SEAL's. All versions are roughly the size of a large submachine gun and can be concealed under a large overcoat.



**SEBURO RA-60 799eb**

RIF - +1 - N - P - 5D6 (5.56mm cased) - 30/15 - 1/3/15 - VR

Once again Seburo proves their weapons are the most versatile in the world. The RA-60 system is customizable for any duty on the planet. If Seburos weapons weren't so expensive, then they would be seeing major military use all over the world. As it is, they are rated number one by most Special Forces and police units worldwide. Seburo, becoming synonymous with "the best".



**SEBURO WR-10 445eb**  
 RIF - +2 - N - P - 5D6 (5.56mm cased) - 35 - 1/3/20 - VR

One of the finest assault weapons on the market today. You can easily see that the WR-10 had a lot of its advanced design inspired from the FN90. Thanks to the bullpup design the weapon is very short yet accurate and easy to maintain.

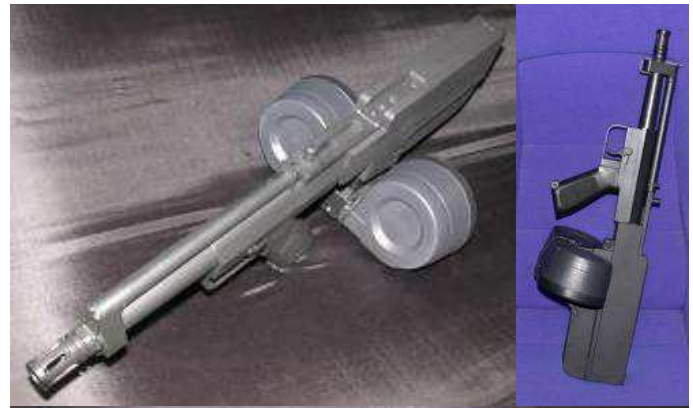

**STERNMEYER BMP-8 360eb**  
 RIF - -1 - N - P - 5D6 (5.56mm caseled) - 25/100 - 1/3/15 - ST

This light, compact, assault rifle doubles as a support weapon with the optional 100 round drum magazine. A very cost effective alternative to a squad support weapon.

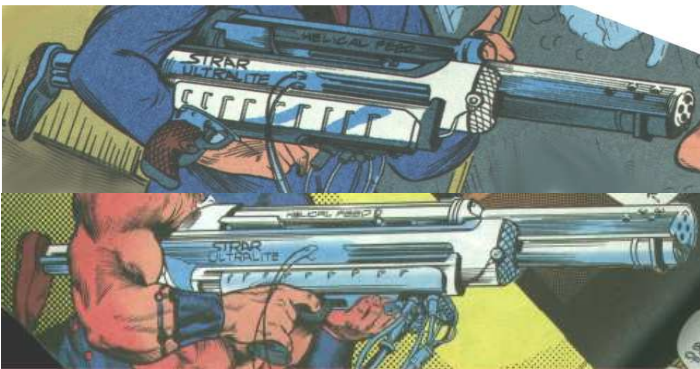

**STAR "ULTRALITE 2780eb**  
 MG - +1 - N - R - 5D6 (5.56mm caseless) - 150 - 50 - VR

A truly innovative weapon, the Ultralite is a 4 barreled, helical fed machinegun chambered in 7.62 caseless ammunition and capable of spitting out 10,000 rounds of ammunition per minute. Comes standard with smart chipping and is currently gaining interest from many military forces, including the EDF and U.S. military.



**STERNMEYER G8V 620eb**  
 RIF - 0 - N - R - 5D6 / SPECIAL (5.56mm caseless / 25mm grenade) - 30 / 1 - 1/3/20 / 1 - ST

A simple but compact bullpup assault rifle from Sternmeyer with a built in grenade launcher.



**STERNMEYER "AR-892 460eb**  
 RIF - +1 - N - C - 5D6 (5.56mm caseless) - 30 - 1/3/10 - ST

A light bullpup assault rifle, a fine weapon from Sternmeyer, more attractive than their usual faire.



**STERNMEYER HIW-34 1185eb**  
 MG - +3 - N - C - 5D6 (5.56mm cased) - 100 - 1/20 - ST

A belt fed heavy machine gun, capable of firing rounds at up to 4000rpm. Comes standard with bipod. Use this weapon to lay down an impressive field of fire, and keep their heads down as your boys are advancing.



**STERNMEYER SHW-52 545eb**  
 RIF - +1 - N - C - 5D6 (5.56mm caseless) - 30 -  
 1/3/15 - ST  
 A short assault rifle primarily designed for guard duties and patrol units.

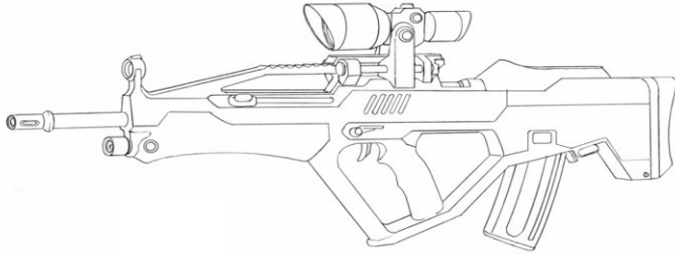

**STEYR KR-27 600eb**  
 RIF - +2 - N - C - 5D6 (5.56mm caseless) - 30 -  
 1/3/15 - VR  
 The KR-27, another damn fine assault rifle from Steyr, with elegant style and a rugged expression of functionality and form.



**STEYR ARG-687 650eb**  
 RIF - +1 - N - C - 5D6 (5.56mm caseless) - 30 -  
 1/3/12 - ST  
 Steyr, always a first name in bullpup assault weapons, releases their latest model... a simpler design, which along with its price makes it ideal for equipping men without extensive training on the weapon.



**STOBOLVOY "HAMMERBURST" 2780eb**  
 RIF - -1 - N - R - 7D6+3 (5.56mm ETE cased) - 30 -  
 1/3/30 - ST  
 With a computer controlled liquid nitrogen cooling system, Stovolboy is attempting what was said to be impossible, a fully automatic electrothermally enhanced assault rifle. The liquid nitrogen cylinder is good for 300 rounds of fully automatic fire, and after the cylinder is depleted the computer shuts down its full auto and 3 round burst capabilities. The weapon is smartlinked as standard, and also comes with an integral laser sight and removable stock (not shown). Liquid nitrogen cylinders are 40eb apiece, and replacing one in the gun is a ten second action.



**TOWA MANUFACTURING UTF-667 620eb**  
 RIF - 0 - N - R - 5D6 (5.56mm cased) - 35 - 1/20 -  
 ST  
 A nice respectable Chinese made assault rifle.



**TSUNAMI ARMS ALB-46P 220eb**  
 RIF - 0 - N - E - 5D6 (5.56mm caseless) - 25 - 1 -  
 ST  
 A simple assault weapon from Tsunami Arms, not very accurate, but one of the cheapest around that won't blow up in your face.



**TSUNAMI ARMS BR-404 835eb**  
 RIF - +1 - N - P - 5D6/varies (5.56mm cased/40mm  
 gl) - 30-3 - 1/3/10-1 - ST  
 This Japanese battle rifle features a suppressed barrel and built in grenade launcher and integral laser sight. Smartchipping is available.



**TSUNAMI ARMS OZ06 345eb**  
 MG - -2 - N - C - 5D6 (5.56mm caseless) - 250 - 1/30 - ST  
 A very simple MG, with a huge drum magazine. For less snag, and ease of carrying the shoulder stock unfolds.



**TSUNAMI ARMS "SHADOWRUNNER" 395eb**  
 RIF - +2 - N - P - 5D6 (5.56mm caseless) - 30 - 1/3/15 - ST  
 A simple and affordable assault rifle.

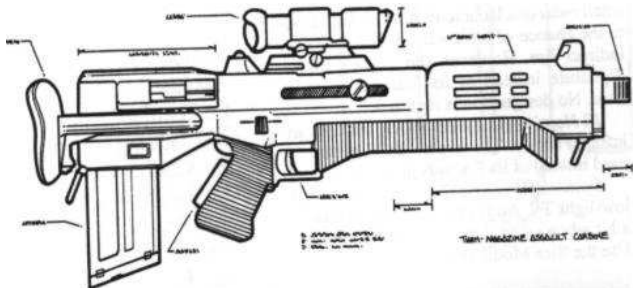

**WALTHER BR-3000 580eb**  
 RIF - +1 - N - C - 5D6 (5.56mm cased) - 30 - 1/3/30 - VR  
 Based off the Walther 3000 sniper rifle, this weapon lives up to the expectations of its craftsmen. And its short enough to almost be considered a submachine gun.



**WWA "KEI" 675eb**  
 RIF - +3 - N - P - 5D6 (5.56mm caseless) - 30 - 1/3/15 - VR  
 A bit heavy, but a very comfortable assault rifle. One interesting thing to note, is that the barrel shroud actually extends past, and completely conceals the barrel, so keeping this area of the weapon free from obstruction is very important. It also comes standard equipped with a laser sight.

## 6MM



**ARASAKA "TOMMIN" 750eb**  
 RIF - +1 - N - E - 5D6 (6mm caseless) - 30 - 1/3/10 - ST  
 Built like a handgun, this fully automatic weapon also comes with a removeable stock (not shown). While most people can't, and wouldn't try to handle the weapon on full auto without the stock, it is possible. Making it popular with those with cybernetic arms as a sidearm.



**ARASAKA KIARA 1275eb**  
 RIF - +1 - N - C - 5D6/5D6 (6mm cased/12 Gauge) - 40-8 - 1/3/25-1 - ST  
 This is a stunning assault rifle with a built in 8 shot 10 gauge shotgun. The shotgun also accepts 25mm grenades.



**BUDGET ARMS "CLAWS" 165eb**  
 RIF - -1 - N - E - 5D6 (6mm caseless) - 25 - 1/3/30 - UR  
 The claws is the polymer one shot version of the H&K CAWS weapon system. While the original system was designed to accept a variety of different ammunition, the CLAWS is only chambered for 6mm rounds. The weapon jams frequently, and has a reputation for explosively misfiring during full auto fire,



**BPSMG-1 WITH ATTACHED AGL-1**

Call  
09/18/04



RML

**COLT BPSMG-1 765eb**

RIF - 0 - N - E - 5D6/varies (6mm caseless/25mm grenade) - 20/1 - 1/310 / 1 - ST

A compact assault weapon with a built in grenade launcher as standard. Low cost means you can equip your troops without breaking your bank.



**HECKLER AND KOCH GR-56 645eb**

RIF - +2 - N - C - 5D6 (6mm caseless) - 30 - 1/3/20 - VR

H&K is always trying new things, and this new assault rifle is one of the most accurate fully automatic weapons we have ever seen.



**HECKLER AND KOCH M986 825eb**

RIF - +1 - N - C - 5D6/varies (6mm caseless / 40mm grenade) 40 / 1 - 1/3/20 / 1 - VR

A very reliable assault weapon from H&K. Its bullpup configuration makes for a more accurate weapon in a smaller package and its high ammo capacity is an added bonus to an already fine weapon. The 40mm built in grenade launcher ensures a trooper carrying this weapon will be prepared for any contingency. The only drawback to this weapon is its ammunition. 6mm is fine for most situations, but it is underpowered in comparison to EDF and U.S. assault weapons, and has trouble penetrating armored targets. The newer M986B version features an 8 shot magazine fed shotgun/25mm gl and is chambered in more conventional 5.56mm.

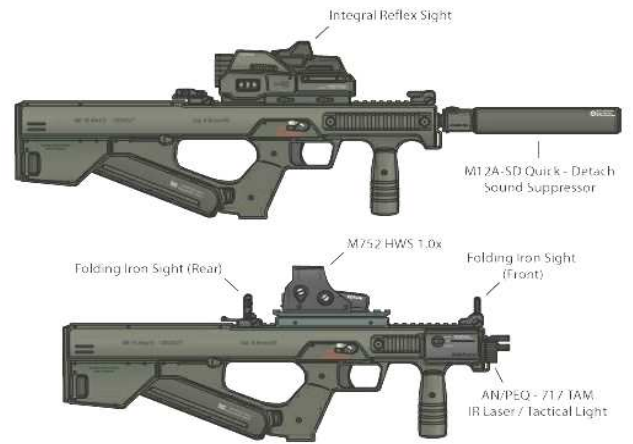

**HECKLER AND KOCH M988 495eb**

RIF - +1 - N - C - 5D6 (6mm caseless) 40 - 1/3/20 - VR

The compact commando version of the M986, used by Special Forces and vehicle crews in lieu of an SMG.



**LUCZNIK RADOM RAS-390 525eb**

RIF - 0 - N - C - 5D6 (6mm caseless/ 25mm grenade) - 30-1 - 1/3/25-1 - ST

A compact weapon assigned to Eastern European commandos, it comes smart chipped as standard.



**METACORP AUR-333 510eb**

RIF - 0 - N - C - 5D6 (6mm cased) - 30 - 1/3/20 - VR

Simple, easy to use, highly reliable, and the bullpup configuration creates a lower profile for the user.



**MILITECH AR-68 625eb**  
 RIF - +1 - N - C - 5D6 (6mm cased) - 30 - 1/3/20 - ST

A workhorse one the field and a trusted friend off. This weapon is perfect for security and police forces, as well as a light battle rifle with troops.



**MILITECH CRM-6 675eb**  
 Rif - +1 - N - C - 5D6/Varies (6mm caseless / 40mm gl) - 45 / 1 - 1/3/20 / 1 - VR

A new weapon undergoing testing by Militech, issued to their soldiers in the field, particularly in low conflict areas of South America. It fires 6mm caseless ammo from a 45 round bullpup configured magazine and features a removable 40mm grenade launcher. Unavailable for private sale at the moment, this weapon will fetch x3 the cost.



**MILITECH M-2CICW & M-12CC 875eb**  
 SMG - -1 - N - E - 5D6 (6mm cased) - 60 - 1/3/20 - ST

The only real difference between these 2 weapons is the M-2CICW features a 5 shot 20 gauge shotgun attached to the underbarrel. Otherwise both feature the same 60 round top mounted helical magazine.



M3/ M30 Underbarrel Shotgun  
 (C) Bryon D. Rogers



M3A1/ M30D Special Application Indirect Fire Weapon  
 (C) Bryon D. Rogers

**MILITECH M3A1 750eb**  
 RIF - 0 - N - P - 5D6 (6mm cased) - 30 - 1/3/12 - ST  
 Available with a wide variety of options (including a 5-shot magazine fed underbarrel grenade launcher (R), or 5-shot magazine fed underbarrel shotgun(L) as shown), the new Militech M3A1 is chambered in 6mm, and is ideal for any situation, from assault to security.



**MILITECH MAR-20 720eb**  
 RIF - 0 - N - C - 5D6 (6mm caseless) - 30 - 1/3/20 - ST

And Militech keeps churning them out. You would think they are trying to beat Arasaka with production numbers instead of sales.. The integral laser sight is a nice touch, as is the overall compact size of the weapon, though a trigger guard is always recommended. The built in Motion Detector is also a unique addition.



**RUGER "STECKER" 450eb**  
 RIF - +1 - N - E - 5D6 (6mm caseless) - 30 - 1/3/10 - ST

A finely crafted German assault rifle with bullpup frame and easy action. The rate of fire on full auto is kept low so as not to waste ammunition, and the weapon is commonly seen serving in many European military and police forces.

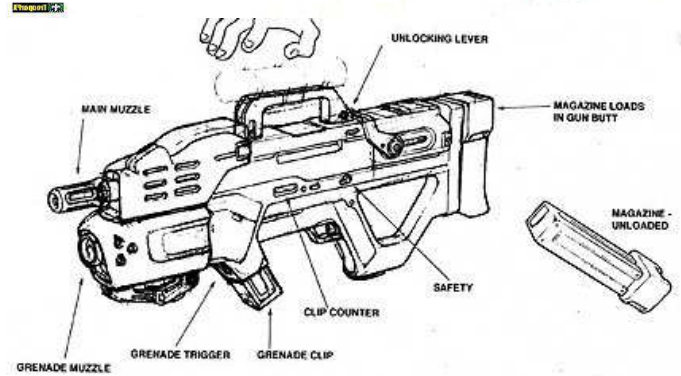
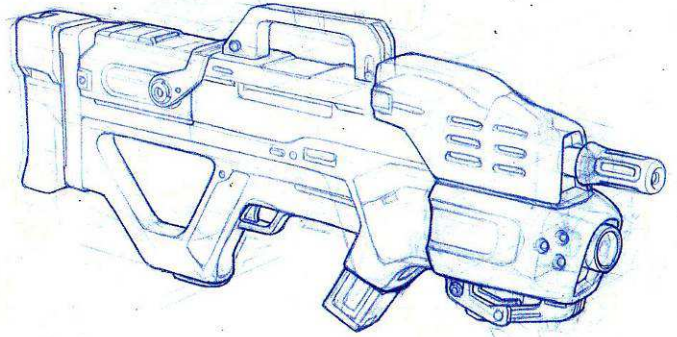

**STOVOLBOY DROZ-6 830eb**  
 SMG - 0 - N - P - 5D6/varies (6mm caseless/25mm grenade) - 12-6 - 1/3/20-1 - ST

Another Russian equivalent of the Militech M-52AR and the Arasaka Morita. A rather unique innovation is the fact that the assault rifles magazine loads into the rear of the stock. It also features a magazine fed 6 shot 25mm grenade launcher.



**STERNMEYER HRO-113 715eb**  
 RIF - 0 - N - C - 5D6/varies (6mm cased/25mm grenade) - 40-8 - 1/3/25-1 - ST

A simple if effective assault rifle, the only thing really worth mentioning is the magazine fed 8 shot 25mm grenade launcher.



**STEYR ST-97 620eb**  
 RIF - +1 - N - P - 5D6 (6mm cased) - 30 - 1/3/15 - ST

Steyr once again moving the next step in radical design and sleek sensibility with the ST-97. A very pretty, and very effective, weapon at home in the jungles or on the street.



**TSUNAMI ARMS CR-21 329eb**  
 RIF - +1 - N - C - 5D6 (6mm caseless) - 30 - 1/3/15 - UR

The CR-21 is barely a step above being classified as a polymer one-shot. Tsunami Arms tried to create a rifle with no unnecessary snag points, and started with a weapon that was purely designed for smartchipping. This allowed them to do away with iron sights, as well as a safety and selector switch. A bold move, and the design probably would have worked, but Tsunami couldn't get past feed problems. It seems the ammo will occasionally be off seated in the chamber, leaving the firing pin striking nothing to strike. Of course fixing the minor problem usually only requires a sharp slap to the butt of the weapon, but in combat it can get you killed. And while there is no record of a CR-21 ever blowing up due to feed malfunction, the time lost unjamming the weapon, and the frequency with which jamming occurs drop the weapons otherwise standard reliability down to unreliable.

## 7MM FEDERAL



**ARASAKA SA-456 865eb**  
RIF - 0 - N - C - 5D6/varies (7mm caseless/ 40mm grenade) - 60-1 - 1/3/30-1 - ST

Arasaka's newest assault rifle, with built in 40mm underbarrel grenade launcher. The 60 round drum magazine almost makes this a light squad assault weapon, but the weight, size, and versatility keep in nicely in the assault rifle realm.



**BUDGET ARMS 125eb**  
RIF - -1 - N - E - 5D6 (7mm cased) - 35 - 1/3/25 - ST  
Uninspired and inexpensive, but at least it won't blow up in your face (we hope).

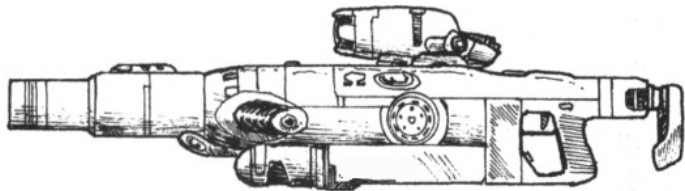

**COCKERIL MGAC-06 4,950eb**  
HVY - +1 - N - R - 5D6+3 (7mm caseless) - 100 - 3/60 - VR

This European assault cannon is a scaled down version of the same sort of cannon usually mounted to the nose of helicopters. Yet it is fully man portable, and fireable. Accuracy drops by 3 if not using a gyrostabilizer mount or tripod however.



**LUCZNIK RADOM RAS-390 725eb**  
RIF - 0 - N - C - 5D6/varies (7mm caseless/ 40mm grenade) - 60-1 - 1/3/30-1 - ST  
Eastern Europe's answer to Militech's M-52. The weapon is more compact, but is still a sturdy and reliable machine.



**MALORIAN/STRATOCASTER "FIRE-AXE" 2345eb**  
RIF - -3 - N - E - 5D6 (7mm cased) - 35 - 1/15 - ST  
Apparently Malorian has been dealing with a fair number of Rockstars with security concerns... or maybe he believes himself to be one... regardless he teamed up with Stratocaster to create the worlds first fully automatic electric guitar... It's a pretty crappy rifle, but a decent instrument.

## 7.62MM

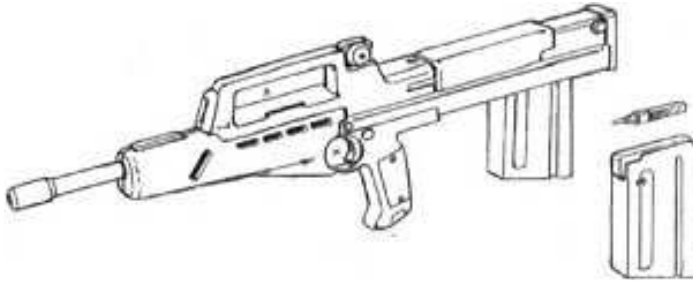

**ARASAKA AR-629 520eb**  
RIF - +1 - N - C - 6d6+2 (7.62mm cased) - 25 - 1/3/20 - VR

Lightweight, reliable and accurate, a commonly seen weapon worldwide from Arasaka.



**ARASAKA/SEBURO JGG-5 1225eb**  
RIF - 0 - N - P - 6D6+2/varies (7.62mm cased/40mm grenade) - 50-5 - 1/3/25-5 - VR

The Sebuuro styling and magazine configuration and 5 round 40mm grenade launcher set this assault rifle a touch above the competition. Hopefully this cooperation between Japans two best arms manufacturers is the start of something wonderful to come, it could just as easily turn sour.



**ARASAKA "MAXIMUS" 1975eb**  
MG - +2 - N - R - 9D6+3 (7.62mm cased ETE) - 30/100 - 1/15 - ST

Now here is a scary concept, a fully automatic machine gun that comes electrothermally enhanced. Yeah, we thought it was impossible too, but Arasaka is trying it out anyway. It seems they have overcome the heat problem by utilizing a special refrigeration system on the barrel and action of the weapon. The cooling system kicks in as soon as the weapon begins firing and is controlled by an electrical switch in the trigger mechanism. Thinking ahead the cooling system was designed along with the ETE battery, so both power source and freon charge must be recharged after every 1000 shots.



**ARASAKA SA-460 1025eb**  
RIF - +1 - N - C - 6D6+2 (7.62mm caseless) - 40 - 1/3/20 - ST

The big brother of the SA-456. Chambered in 7.62mm. A bit more accurate due to the longer barrel.

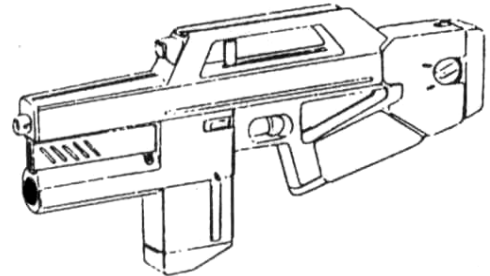

**ARASAKA STORM 1040eb**  
RIF - +1/-1 - P - 6D6+2/5D6 (7.62mm cased/.10 gauge) - 40/8 - 1/3/30 /1 - VR

Similar to the LBR in appearance this weapon features a butt loading magazine for the 7.62 barrel and regular clip feed for the shotgun. It is part of Arasaka's new line of assault weapons and is highly recommended. Also included is an integral laser sight. Barrel selection is a switch at the butt of the weapon on the magazine shroud.



**ARMALITE "ENTERPRISE" 765eb**  
RIF - -2 - N - R - 6d6+2 (7.62mm cased) - 20 - 1/3/15 - ST

Exactly what the hell Armalite was think when they created this monster is anyone's guess. It seems possible this is their way of competing with Colt over the SMAR-15, and going overboard. Firing 7.62 ammo and weighing in at 29 lbs. loaded, no one but full conversion cyborgs and extremely augmented persons can even fire this thing.

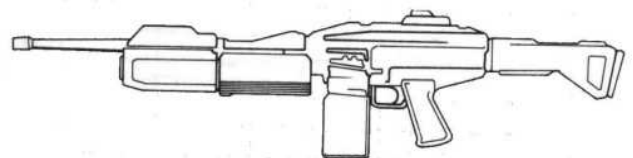

**BROWNING 435LMG 945eb**  
RIF - +1 - N - C - 6D6+2 (7.62mm cased) - 30 - 15 - ST

An assault rifle with worldwide popularity due to its proven track record.



**BROWNING MG142 1150eb**  
 MG - +1 - N - P - 6D6+2 (7.62mm cased) - 50/100 - 3/20 - VR

The MG142 is the latest machinegun from Browning. Chambered in 7.62 ammo this weapon is perfect for any support or suppresion needs.

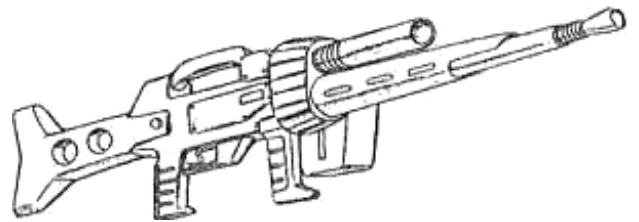

**CCMMC TYPE MG14 725eb**  
 MG - +1 - N - C - 6D6+2 (7.62mm cased) - 50/100 - 1/3/20 - ST

This Chinese machine gun is the most prevalent support weapon found among chinese military units and accepts belt fed ammunition or 50 round magazines. A very sturdy, albeit heavy weapon.

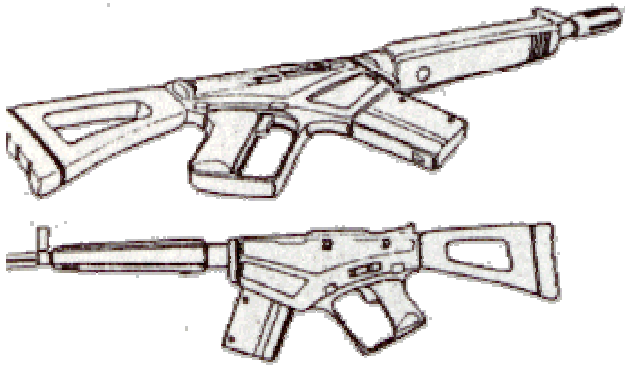

**COLT AR-55 695eb**  
 RIF - +1 - N - E - 6D6+2 (7.62mm caseless) - 30 - 1/3/20 - ST

A standard assault rifle manufactured by Colt.

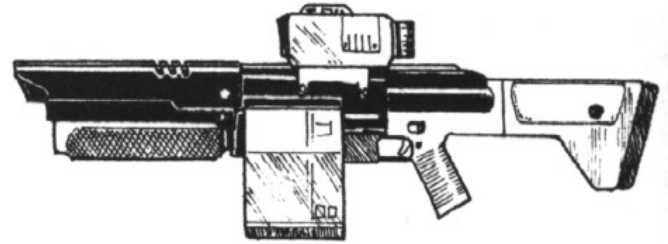

**COLT "MANTORA" 915eb**  
 RIF - +1 - N - C - 6D6+2 (7.62mm caseless) - 45 - 1/3/20 - ST

Very heavy, very hard hitting, and very durable. The Colt Mantora is an excellent example of Colt craftsmanship and high standards. The weapon comes with a cleaning kit stored in the butt of the rifle.



**CCMMC LBMG-84 1450eb**  
 HVY - +1 - N - P - 6D6+2 (7.62MM caseless) - 100 - 20 - ST

A Chinese light machine gun, serving as standard issue to the Chinese military. The helical magazine and adjustable stock are very nice features indeed, and have served to promote this weapon to a well respected status in it's field. Commonly used as both a squad weapon, and mounted on vehicles. The weapon accepts either the standard 100 round magazine, or can be belt fed, increasing the weapons capability.



**DAI-LUNG BLT-24 475eb**  
 RIF - -2 - N - C - 6D6+2/varies (7.62mm cased/40mm grenade) - 40-1 - 1-1 - UR

Someone really needs to perform a less than surgical strike on Dai-Lung, their weapons are simply too dangerous to both user and target to ever be justified. A prime example is this assault rifle. Presumably they neglected to add a stock to make the weapon more concealable, though with its size that isn't an issue anyway. The grenade launcher only works about half the time, and the weapon jams like crazy. Still among street gangs, who's philosophy seems to be "the bigger a gun the better" this weapon sells like hotcakes. Rumor has it the weapon also has a large distribution to rebels in central Africa.



**DAI-LUNG "ORUBES" 345eb**  
 SMG - 0 - N - E - 6D6+2 (7.62mm caseless) - 30 - 1/30 - UR

It had to happen sooner or later, a cheap knock-off company trying to cash in on Sebuoro's popularity by poorly copying their design. Since this weapon hit the market it has been almost impossible to keep in stock. Street gangs and weekend warriors buy this weapon like crazy trying to look like professionals. Word has it Dai-Lung has started receiving death threats and two of their factories have been destroyed since this weapon hit the street, rumors all point to Sebuoro, but no evidence has been found to support this.

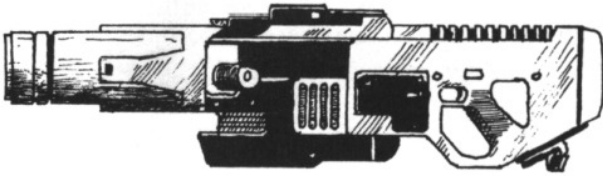

**GE HMG 9000 9,255eb**  
 HVY - +1 - N - R - 6D6+2 (7.62mm caseless) - 100 - 1/50 - VR

Do you really need to lay down a field of fire that will absolutely destroy anything in its path, then you need the HMG 9000. This electrically fired heavy machine gun is man portable, and with the aid of a gyro stabilizer you can even fire it on the run. For more accurate fire you can mount it on a vehicle or tripod. It accepts belt fed ammunition only and for an extra 200eb you can get it smartchipped. (-3 to accuracy if firing the weapon without gyro stabilizer or tripod.)



**FEDERATED ARMS BR-328 615eb**  
 RIF - -1 - N - P - 6D6+2 (7.62mm caseless) - 30 - 1/3/20 - ST

A decent assault rifle from Federated arms, although it falls short in the accuracy department. A retracting stock is standard.



**FEDERATED ARMS "SQUAT" 495eb**  
 RIF - -2 - L - C - 6D6+2 (7.62mm caseless) - 20 - 1/3/20 - ST

Always trying out new ideas, this extremely short assault rifle probably won't be received well by any military. A 7.62mm rifle with no barrel to speak of is simply inaccurate for military application. Terrorist groups and criminals however love this weapon due to its concealability.



**HECKLER AND KOCH HM-722 1200eb**  
 HVY - +2 - N - P - 6D6+2 (7.62MM caseless) - 60/100 - 20 - VR

The standard man portable machine gun used by EDF forces. Chambered in 7.62 to best utilize the abundance of ammunition and featuring a high rate of fire this is one of the best squad support weapons available anywhere. It features reinforced ceramisteel barrels with specially designed insulation which makes sustained fire possible without fear of overheating the barrel. Accepts magazines and belt fed ammo, and has the added bonus of being able to switch between left and right hand firing modes (allowing the belted ammunition to be fed from either side of the weapon at the flick of a switch).



**HECKLER AND KOCH MANTEL BSW-72 510eb**  
 RIF - +2 - N - R - 6D6+2 (7.62mm cased) - 32 - 1/3/A5 - ST

An excellent assault weapon from H&K, able to accept a variety of options. Extremely accurate for an assault rifle right out of the box.

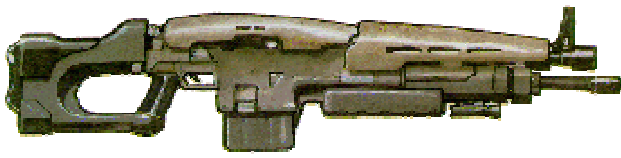

**H&K VGR-13 799eb**

RIF - +1 - N - C - 6D6+2/special(7.62mm caseless/25mm gren) - 30/4 - 1/3/30-1 - VR

A superbly designed assault rifle from Heckler and Koch, chambered in 7.62 and featuring a built in 25mm grenade launcher. Truly a premiere weapon able to make itself perfectly at home on any battlefield.

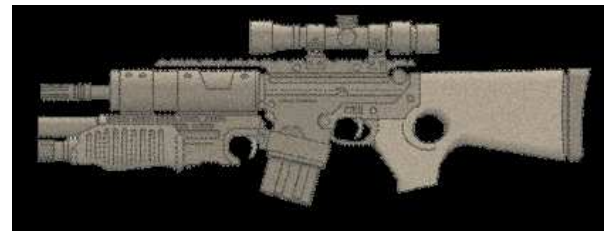

**ROSTOVIC G701 875eb**

RIF - 0 - N - C - 6D6+2/varies (7.62mm caseless / 12mm grenade) 30 / 5 - 1/3/20 / 1 - ST

A reliable and effective weapon, this is the standard assault rifle used by Chilean troops



**KALISHNIKOV AD-10 Assault Rifle 530eb**

Rifle - +1 - N - E - 6d6+2 (7.62x54mm cased) - 30 - 2/3/20 - VR

A Neo-Soviet replacement for the old AK variants as it has a better operating range and better penetration. It can be equipped with a variety of attachments: the GP-43 Grenade launcher attachment (which fires standard 40mm grenades), a larger trigger guard can be equipped for use by full-borgs, ACPA, and troops wearing heavy gloves, a folding stock (giving it long coat concealment), and a bayonet. A shorter barrel model is used for close combat operations. The weapon system has become the weapon of choice for South American revolutionaries



**MAKAROV RIPPERLANCE 1235eb**

RIF - -1 - N - R - 6d6+2 (7.62mm caseless) - 45 - 1/3/20 - ST

Quite possibly the strangest assault weapon being issued to any military in this day and age. The ripperlance is a standard assault rifle, but it features a built in diamond edged chainsaw (4d6 ap halved, damage full). Issued almost exclusively to troopers wearing the Deep-Eyes armor, it is supposed to be for cutting through barbed wire, fencing, and other obstacles, of course if a human being happens to get in the way, well thats dogfood...



**MALORIAN EAW-09 955eb**

RIF - +3 - N - R - 6D6+2 (7.62mm cased) - 40 - 1/3/20 - VR

The best name in firearms brings us another fine example of their craftsmanship. The EAW-09 assault rifle is constructed from the latest in composite polymers and ceramics, and is as accurate as a sniper rifle while maintaining the durability and rate of fire of a world class battle rifle. Comes standard smartchipped.



**KALISHNIKOV AKZ-103 500eb**

RIF - 0 - N - E - 6D6+2 (7.62mm cased) - 30 - 1/3/20 - ST

The last weapon in the Kalashnikov line, upholding tradition and reliability on the battlefield.



**MALORIAN SAR-7 1065eb**

RIF - +2 - N - P - 6D6+2 (7.62mm caseless) - 40 - 1/3/10 - VR

Malorians first assault rifle. Its comfort and reliability are without par, and its accuracy is fantastic. While the weapon is a bit long for combat duty, it is a small price to pay. Ideal as either an assault rifle, or as a sniper weapon.



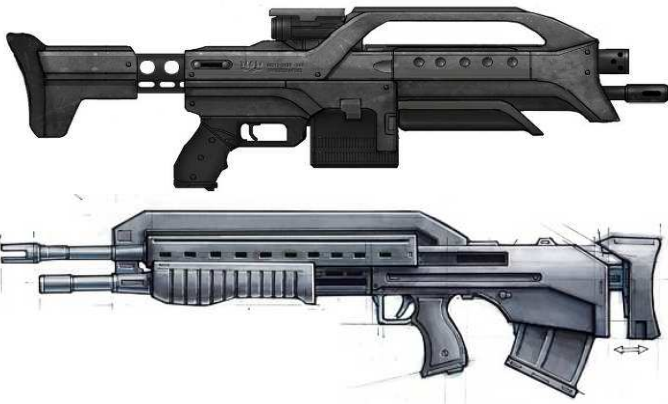

**MEXICAN METALS ACR-461 730eb**  
 RIF - 0 - N - E - 6D6+2/varies (7.62mm caseless / 25mm gl) - 35 / 5 - 1/3/30 / 1 - VR  
**THE STANDARD ASSAULT RIFLE OF THE MEXICAN MILITARY.** The ACR-461 fires the 7.62mm round in caseless, and features a pump action underbarrel 25mm grenade launcher/.10 gauge shotgun. A sturdy and reliable weapon, well respected and capable of holding its own against all threats. A more compact and streamlined "B" version is available.



**MEXICAN METALS SUMW-76 1050eb**  
 HVY - -2 - N - P - 6D6+2 (7.62mm cased) - 50/100 - 20 - ST  
 The standard squad support weapon for the Mexican military. Fires 7.62 ammunition, and can either be magazine (50) or belt(100) fed.



**MILITECH CR45 625eb**  
 RIF - +2 - N - C - 6D6+2 (7.62mm cased) - 30 - 1/3/30 - ST  
 Militech's response to the Arasaka "Morita". It has become the second most favored in the military trials to find a new assault weapon. It loads from a left side mounted magazine, and features a built in arm brace on the stock for improved control and grasp on the weapon



**MILITECH HIW-34 1185eb**  
 MG - +2 - N - C - 6D6+2 (7.62mm cased) - 50 - 1/3/15 - ST  
 Militechs latest heavy machine gun is bullpup in design, and accepts a 50 round magazine. For extended engagements, it will also accept belted ammo.



**MILITECH M-56AR 1935eb**  
 RIF - +1 - N - P - 6D6+2/varies (7.62mm caseless/25mm gl) - 30-5 - 1/3/10-1 - ST  
 This is actually a step down from the M-52AR, whose ammunition is shorter but more powerful.. Still this weapon is more accurate, and the 7.62 ammunition is far more common. It's also a bit cheaper, making this a far more suited to urban combat. Like the M-52, the pump action 25mm grenade launcher also accepts 10ga. shells.



**MILITECH M-60MAR 5,635eb**  
 RIF - +1 - N - R - 6d6+2/varies (7.62mm caseless) - 100-1 - 20 - ST  
 The latest update to the ever faithful M-60 weapon.



**MILITECH MACH-12 680eb**

RIF - -1 - N - E - 6D6+2 (7.62mm caseless) - 30 - 1/3/35 - ST

A sturdy assault rifle built to withstand the harshest of environments, and the harshest of abuse. You can use this weapon as a club against your enemy, then turn around and empty the clip into him. In fact one memorable story comes out of Australia where a group of mercenaries had gotten lost in the outback, all but one survived, and without any other tools he was able to use his weapon as a shovel to bury his three companions and still use it to shoot his way to the nearest town during an aborigine uprising.



**MILITECH TBR-3 595eb**

RIF - +2 - N - C - 6D6+2 (7.62mm cased) - 50 - 1/3/20 - ST

A very rugged and reliable weapon, with a high ammo capacity and a telescoping stock. This rifle packs more than enough punch to deal with whatever problem you come across. Popular in military and professional circles.



**NOVA RMG-23 925eb**

RIF - +1 - N - C - 6D6+2 (7.62mm caseless) - 40/50 - 1/3/20 - ST

Just shy of being a full fledged support weapon, the RMG-23 is a rather large rifle built for sustained fire and supportive use. The weapon is very versatile, and accepts a 40 round magazine or belt fed ammunition.



**ROSTOVIC Auto-Dragnov ADSW-10 Support Weapon**  
Hvy/Rifle - +3 - N - C - 6d6+2 (7.62x54mm cased) - 100 - 3/20/40 - VR

A machine gun variant of the AD-10 with a heavier barrel and bipod, it has served successfully in many countries as a support weapon. It has two levels of automatic fire ROF. The highest rate of fire often melts the barrel after a minute or more of consecutive fire. Spare barrels are often carried by machine gun crews for this reason.

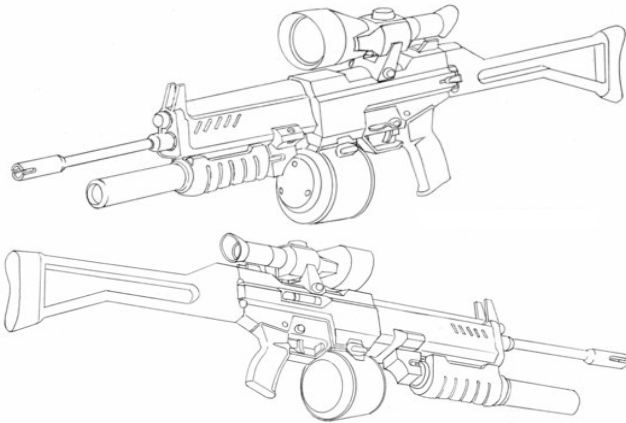

**MILITECH GNG-H01 950eb**

RIF - +2 - N - C - 6D6+2/varies (7.62mm cased/40mm grenade launcher) - 30/50-1 - 1/3/30-1 - ST

An assault rifle for general infantry, sturdy, rugged and comes with 40mm Grenade launcher and starlight scope mounting, as well as the option for 30 round mags or 50 round drums.



**MILITECH SMMN-40 1175eb**

SMG - +2 - N - E - 6D6+2/varies (7.62mm caseless/40mm grenade) - 60-5 - 1/3/30-1 - ST

Always trying to stay ahead of the competition, this new release from Militech is a powerhouse. Chambered in the common 7.62mm and featuring a 5 shot magazine fed 40mm grenade launcher. Actually this may be a case of too much gun, as it is rather an awkward weapon to hold based on its size.



**ROSTOVIC HUR-101/KAAR-60 965eb**  
 RIF - 0 - N - C - 6D6+2/varies (7.62mm cased/ 40mm grenade) - 40-3 - 1/3/30-1 - ST  
 Rostovic putting a grenade launcher on everything, is getting old. It's makes the weapons to big and unwieldy for most ops. Still this is one of their better designs as of late. This is next in line to become the next Neo-Soviet standard issue rifle. It accepts all the magazines and accessories of the HUR line of rifles, most with little more than a screwdriver.



**ROSTOVIC HUR-364 985eb**  
 RIF - 0 - N - C - 6D6+2/varies (7.62mm cased/ 40mm grenade) - 40-1 - 1/3/30-1 - ST  
 A simple and reliable assault weapon, favored by Neo-Sov units operating in urban warzones. The hand guard to protect against hot shells is a welcome innovation.



**ROSTOVIC HUR-400 1050eb**  
 RIF - 0 - N - C - 6D6+2/varies (7.62mm cased/ 25mm grenade) - 120-5 - 1/3/35-1 - ST  
 Enormous ammo capacity makes this almost more a squad automatic than an assault rifle. Rostovic has implemented special heat shields to keep the barrel from overheating, and the 5 round grenade launcher doubles with the 100 round magazine means any soldier carrying this weapon is a one man army.



**ROSTOVIC ROCR-5 815eb**  
 RIF - +2 - N - C - 6D6+2/varies (7.62mm cased/ 40mm grenade) - 35-3 - 1/3/20-1 - ST  
 A bit heavy for an assault rifle, it is actually accurate enough on single fire to double as a sniper rifle. Overall however, the 3 shot integral grenade launcher is a bit too much, and hinders this weapon more than aids it.



**ROYAL ENFIELD BAR-45 1,750eb**  
HVY - +1 - N - R - 6D6+2 (7.62mm) - 30/100 - 1/20 - ST

This bullpup battle rifle pack one hell of a wallop, and in addition to the 30 round magazines it also accepts belt fed ammunition for sustained fire.



**"SHITSHOOTER" 265eb**  
(From Nomad Market)  
RIF - -3 - N - C - 6D6+2 (7.62mm cased) - 40 - 10 - UR  
These nomad built support weapons are inaccurate, jam frequently, and ugly as sin... but they are cheap as hell, and everywhere.



**SEBURO MN-29 875eb**  
RIF - +2 - N - C - 6D6+2 (7.62mm cased) - 25 - 1/3/20 - VR

A larger caliber version of the MN-24, continuing the line of Sebuoro's most powerful line of assault weapons.



**STEIN AND WASSERMAN 7-212 580eb**  
RIF - -1 - N - E - 6D6+2 (7.62mm caseless) - 30 - 1 - ST

This compact assault rifle from Sternmeyer is a popular choice among mercenaries and terrorists, as well as more legitimate consumers.

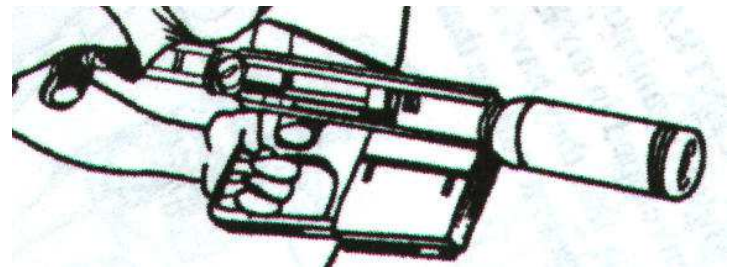

**STERNMEYER NHR-12 595eb**  
RIF - -1 - N - P - 6D6+2 (7.62mm cased) - 25 - 1/3/10 - ST

A large caliber, but perhaps too short a weapon, as its barrel length detracts from its accuracy too heavily. Comes with a folding stock.



**SEBURO MN-31 735eb**  
RIF - +2 - N - P - 6D6+2 (7.62mm cased) - 30 - 1/3/15 - VR

Yet another in the Sebuoro MN family, this works equally well as either an assault, or sniper weapon. Although for sniping purposes, mounting a scope is recommended.



**STONER "SABER" 565eb**  
RIF - +1 - N - P - 6D6+2 (7.62mm caseless) - 25 - 1/3/25 - ST

A dual purpose weapon from Stoner. They assure us that it works equally well as either a sniper rifle, or as an assault weapon.



**STOVOLBOY M-714-38PK 650eb**  
**RIF - 0 - N - C - 6D6+2 (7.62mm caseless) - 30 - 1/3/20 - ST**

A case of too many gadgets, not enough thought. This weapon features a display which acts as a range finder, ammo count, digital compass, temperature and humidity gauge, and even displays which select fire mode the weapon is in. Unfortunately, while kinda neat, all that is useless, since lack of a proper stock rule out its any sniper capabilities the weapon might have, and the big glowing screen make it poorly suited for any type of stealth work. Must be why they are selling them so cheap. It does feature an integral smartlink, which is nice I suppose.

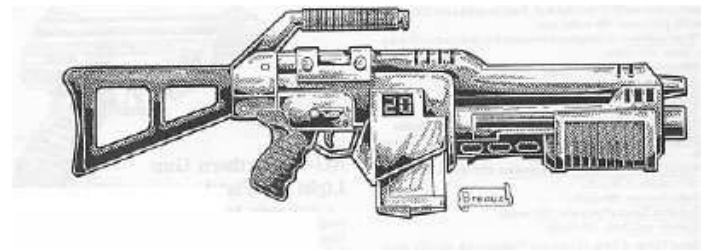

**TOWA TYPE-121 890eb**  
**RIF - -1 - N - C - 6D6+2/varies (7.62mm caseless/25mm grenade) - 60-5 - 1/3/25-1 - ST**  
 This is basically the Chinese version of the H&K M-52, and other than being chambered in the more common 7.62mm caseless and a few cosmetic changes, the weapons are virtually identical. The high ammo count, just as in the M-52, is achieved by triple stacking the ammunition in the magazine.



**STOBOLVOY NTAR93 520eb**  
**RIF - 0 - N - E - 6D6+2 (7.62mm cased) - 30 - 1 - ST**

An inexpensive powerful assault rifle. A common sight among Russian troops.



**STOBOLVOY PAC-431 1100eb**  
**HVY - -1 - N - P - 6D6+2 (7.62mm cased) - 50/100 - 20 - ST**

The standard squad support weapon for the Neo-Soviet military. Fires 7.62 ammunition, and can either be magazine (50) or belt(100) fed.

# 10MM RIFLE



**ARASAKA ADVANCED RECON 1100eb**  
P/RIF - -2/-1/0 - J/N - P - 8d6 (10mm caseless) - 6/12/25 - 1/3 - ST

Arasaka's MMR-6 has proven so successful, that the company is trying new approaches. The Advanced Recon is Arasaka's latest response to the problem of Cyborg crime, and is every bit as modular as the MMR-6 but with a much base mechanism. At it's smallest, the Advanced Recon is an anti-cyborg handgun. But when the retractable shoulder stock is attached, the weapon is capable of three round burst fire, turning it from handgun to assault rifle. A number of barrel extensions are available as well, and numerous accessories. (The shoulder stock and barrel extension each add +1 to the weapons accuracy.)



**ARASAKA 10-TS 1550eb**  
RIF - 0 - N - P - 8d6 (10mm caseless/25mm grenade) - 35 - 1/3/10 - ST

The 10-TS is the dedicated assault rifle version of the Advanced Recon. It loses some of the modularity, but retains the short package and is capable of sustained auto-fire.

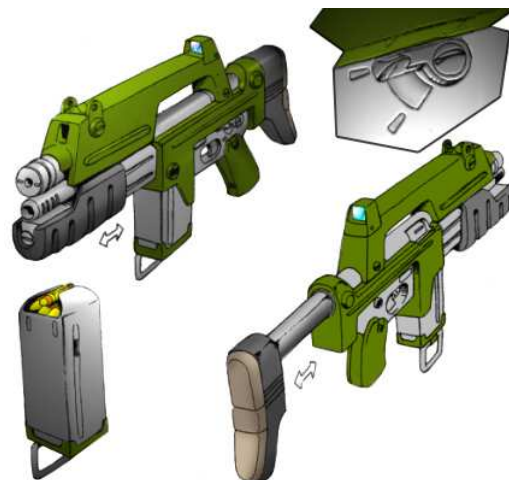

**ARASAKA LBR-84 1259eb**  
RIF - +1 - N - C - 8d6/varies (10mm caseless/25mm grenade) - 50 - 1/3/20 - VR

Made for the battlefield this assault rifle / grenade launcher combo is has become a staple in many militaries around the world. It features a retracting stock, pump action grenade launcher, and an integral laser site.



**ARASAKA M-429 2,245eb**  
HVY - -1 - N - P - 8D6 (10mm cased) - 50/100 - 20 - VR  
Standard Squad Support Weapon from Arasaka designed around the Arasaka developed 10mm rifle round. Hard hitting and able to throw up a curtain of lead guaranteed to keep their heads down or make them wish they had.



**ARASAKA R-6 STAMPEDE 1275eb**  
RIF - +1 - N - C - 8d6 (10mm caseless) - 30/40/100 - 1/3/20 - VR

Arasaka has taken the 10mm Rifle round and run with it, this latest rifle I garnering attention from several military and police organizations, as well as professionals everywhere.



### ARASAKA MMR-6 1275eb

Rif - +1/+2/+3 - N - C - 8D6 (8mm caseless) - 15/30/45 - 1/3/20 - ST

Arasaka's latest weapon, the Multi-Modular Rifle system, is the single most customizable weapon ever built. Straight out the box it will accept virtually any accessory, from sights and scopes to grenade launchers, shotguns, and bayonets. But where the weapon really gets interesting is its dual magazine capability. A revolution in design, the barrel actually consists of 7 separate but interlocking pieces, 2 large pieces, and 4 small pieces. The small pieces allow the user, when the weapon is in bullpup mode, to adjust the stock length to fit his or her needs. One of the larger pieces is simply removable, to allow the user to make use of the extended barrel shroud, but for weight conservation the barrel can be attached without the shroud. The final 2 barrel pieces are where the real innovation lies. This allows the weapon to be switched from standard to bullpup ammo feed with the simple pull of a lever. This allows the soldier to not only have a reserve of ammo if he needs it, but also to tailor his loads specifically, such as having the bullpup mag loaded with standard ammunition, while the forward magazine is loaded with armor piercing. Or, again to save on weight, a soldier can simply chose to load only one magazine, either standard or bullpup, and the magazine wells spring loaded flaps will prevent dirt from entering and fouling the weapon, the flaps can even be locked in place providing a watertight seal. (in short standard mode, the weapon gets a +1 to accuracy, in long mode it gets a +2, the bullpup configuration adds another +1 to either mode) The standard magazine well even accepts belt fed ammunition, allowing it to serve as squad or vehicle mounted weapon. So in all the weapon can serve as a standard assault rifle, a short commando operation rifle, a squad automatic, and in bullpup mode with the extra barrel attached it even makes a passable sniper weapon. A host of accessories specifically for the weapon have already been introduced, including a 3 and 5 shot pump or semi-auto action 25mm grenade launcher/shotgun (that can attach to the weapon in short or long barrel configuration), a single shot 40mm grenade launcher, suppressors, folding bipod, and more. Chambered in the Arasaka developed 10mm rifle round, this weapon is not yet available to the general public, there are rumors it will not be made available at all, which has driven professionals and collectors to offer as much as 10 times the listed price for the weapon. 3 magazine sizes available, 15, 30, and 45. The weapon has no trigger guard, instead featuring a grip safety that simply will not allow the trigger to be pulled unless the grip has appropriate pressure on it; this was to allow borgs and users wearing winter gloves easier firing abilities. On top of everything else, the weapon is remarkably simple, in fact Arasaka has begun using the old standard, "Even a child can operate it!" in their advertising. Militaries and police departments around the world are taking notice.





**ARASAKA "MORITA" 935eb**

RIF - +2/-1 - N - C - 8d6/4D6 (10mm caseless/12ga) - 30/8 - 1/3/25-1 - VR

Arasaka's premiere assault rifle, and favored entry for the next military standard issue battle rifle. There are two versions, the Morita A, the standard unit, and the Morita B, full assault unit. The only difference is that Morita B is equipped with an 8 round underbarrel shotgun and is a little longer. This is a beautiful weapon, lightweight, sturdy, and extremely reliable, and its bullpup construction makes for a more accurate weapon. Firing the caseless 10mm ammo it packs more than enough punch to do the job.

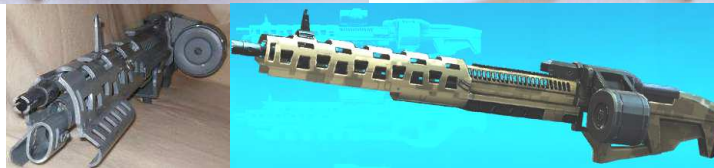

**ARASAKA SWAM-101 2,450eb**

HVY - +1 - N - P - 8d6 (10mm caseless) - 50/100 - 15 - ST

Primarily used as in MG mounts on vehicles or with Gryo Stabilization harnesses, the SWAM-101 is formidable battlefield weapon.



**FEDERATED AMRS SK19 840eb**

RIF - 0/-1 - N - P - 8D6/varies (10mm cased/40mm gren) - 40/1 - 1/3/30 /1 - ST

A nice design from FA, but too way heavy for extended use in the field.



**HECKLER AND KOCH TMBR-56 1456EB**

HVY - 0 - N - P - 8D6/varies (10mm caseless/40mm grenade) - 100/3 - 1/30-1 - VR

A bit oversized, but extremely reliable, this heavy assault machinegun was designed specifically for EDF deployment. It also features a 3 shot pump action 40mm grenade launcher. The machinegun loads from either belt or from a 100 round box magazine.



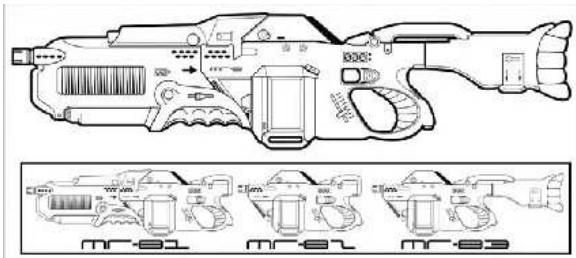

**HECKLER AND KOCH MR-80 SERIES 3250eb**  
 RIF - +1 - N - R - 8d6 (10mm caseless) - 50 - 15 - VR  
 This squad support heavy machine gun comes in a variety of flavors. The standard is MR-81 being the most common, and featuring a 4 shot pump action grenade launcher, the M-82 is a shortened version used by Full Conversion and ACPA, and the MR-83 is a short barrel version for use by special forces.



**MALORIAN LSR-12 2000eb**  
 RIF - 0 - N - R - 8D6 (10mm cased) - 30 - 1 - ST  
 An overpriced (aren't all Malorian weapons overpriced?) assault weapon designed specifically for Malorian Security personel. I think Eran is losing it, it's not a bad weapon, but the colors make it look like a toy. Malorian claims this was to lessen anxiety around the weapon, so visitors wouldn't feel as apprehensive. It is supposedly available in standard grey, but we have yet to see it



**MILITECH M-52AR 1150eb**  
 RIF - +2 - N - P - 8D6/varies (10mm cased/25mm grenade) - 60/120-5 - 1/3/35-1 - VR  
 An assault weapon built for the urban environment. The grenade launcher is slide cocked and is able to alternate between grenades and 10 gauge shells with no modification or adjustment. The rifle features digital ammo counter along with a retractable stock (now available with fixed stock for greater aesthetic and comfort) and the highest ammo capacity and caliber of an weapon in its class. Also available is a 150 round magazine. A shorter commando version is available, with a one shot grenade launcher and reduced barrel, and an officers model, with 3 shot grenade launcher.



**MILITECH M-58BAR 1240eb**

RIF - -1 - N - C - 8D6 (10mm cased) - 150 - 1/3/30 - ST

A squad support weapon built on the M-52AR system. Militech owes its subcontractor Matsucorp for this one, as this innovation came from their tinkering.



**MILITECH NCAR-534 1320eb**

RIF - 0 - N - R - 8D6/8d10(10mm cased/20mm cased) - 30-5 - 1/3/20-1 - VR

Militech loves its assault rifles, and this is no different. Used exhaustively during the Natural City campaign in Hawaii, it proved its battle effectiveness and durability. The built in 5-shot 20mm allows infantry to take down enemies behind cover or even light armor.



**SEBUORO DRX-23 2950eb**

HVY - +2 - N - P - 8D6 (10mm caseless) - 50/100 - 1/20 - VR

One of the most accurate heavy machineguns ever created. However, the weapon is very heavy and somewhat unwieldy for extended field work, and while it accepts belt fed ammunition, it requires a special "false magazine" through which the belt is fitted through, to do. Fitting the belt through the false magazine takes twice as long, though you can always buy extra "false mags" and pre fit them for a very quick change out indeed. The weapon features a standard pinpoint laser sight, but is also features a UV wide beam light, that puts a thick beam downfield, visible only with UV, this allows for a much easier to control target acquisition, as the thick beam doesn't get lost in the recoil like the standard laser sight, making it an excellent choice for a vehicle mounting.



**ROSTOVIC MR-68 3250eb**

RIF - +1 - N - P - 8d6 (10mm caseless) - 100 - 20 - ST

A standard machinegun, able to accept 100 round drums or belted ammo. A high rate of fire and above average accuracy makes this one of Rostovic's top military products.



**SEBUORO 10mm ASSAULT VULCAN 3700 EB**

HVY \* 0 \* N \* R \* 8D6(10mm) \* 300 \* 60 \* ST \*

10mm gatling gun generally used against the more powerful cyborgs. Most opponents give up if it is pointed at them.



**SEBUORO RAYVEN COMPACT 1375eb**

RIF - -1 - N - P - 8D6 (10mm caseless) - 30/50 - 1/3/20 - VR

This is the most compact fully automatic weapon chambered in the 10mm rifle round available. An excellent weapon for close quarters work against full conversion targets. The weapons barrel extension is removable, lowering the weapons accuracy (-1).



**SKODA "SQUAD SHORT" 5680eb**  
 RIF - -2 - N - R - 8D6 (10mm cased) - 30 - 1/3 - ST  
 The magazine shroud on this monster is purposely overbuilt, to add extra weight to act as a compensator against muzzle climb from recoil in 3 round burst mode. It seems the research teams at Skoda wanted a weapon that even the best armor would have no defense against, and it seems they wanted the whole thing in a small enough package to conceal. Originally this was supposed to be a handgun, but since no one could fire the prototype without injury, a stock was added. Even still, this weapon is way too short to be firing the rounds it does at 3-round burst. Which would explain why production for this weapon was incredibly limited. Only 300 of them are known to exist, Autumn Blade has 20.

## .50BMG



**ARASAKA/MALORIAN "ASSAULT .50" 6960eb**  
 RIF - -2 - N - P - 6D10 (.50bmg caseless) - 25 - 1/3/10 - ST  
 The Assault .50 is the joint venture product of Malorian and Arasaka. It is basically a less expensive and more combat engineered version of the Malorian "Aspen". It uses standard steel and ceramic construction and does not come smartchipped as standard.

## 15MM



**MALORIAN "ASPEN" 8999eb**  
 RIF - +1 - N - R - 7D10 (15mm cased) - 25 - 1/3/15 - VR  
 Everyone knows that when you want the best you turn to Malorian. Now the premiere arms company in the world has completely outdone themselves. Introducing the Malorian Aspen, a 15mm assault rifle that is guaranteed to get the job done, and with all the style expected from a true professional. Available chrome plated only, the weapon is constructed almost entirely from titanium. Use of a shoulder strap, assisted harness, or some means of support suggested when firing full auto

## RAILGUN



**ARASAKA X-61 (prototype) 144,375eb**  
 RLG - +4 - N - VR - 4D10 (1.5cm projectile) - 10 - 1 - P

Arasaka finally did it, they have created a true man-portable railgun roughly the same size and weight as a large assault rifle. This weapon is in its very earliest stages of testing and uses a 1.5cm nickel cadmium projectile. A total of 100 were produced and sent to Arasaka's testing facility, somewhere along the way 20 got "lost" and somehow managed to fall into Autumn Blades lap. 18 are left so hurry and get yours. A word of warning, Arasaka has installed fail-safe devices to ensure that no one can tamper with the guns. Any attempt at disassembling the weapon will result in the gun exploding (as the loss of two Autumn Blade lab assistants will testify). The weapon is smartchipped, and contains its own power supply which must be recharged for 2 hours after every 20 rounds fired. From confidential sources inside Arasaka we have learned that the weapon is nowhere near perfected, and malfunctions are common. This can be very dangerous, extreme caution is advised when using and handling this weapon.



**MALORIAN/MILITECH "DOOM" 89,975eb**  
 HVY - 0 - N - R - 6D10 (EAP) - 5 - 1 - ST  
 Now for something scary. In a joint venture funded by the American Military, Malorian and Militech have taken Railgun conclusion another frightening step forward. 3 large electro-magnets power the weapon, and it is easily reloaded using easy to produce slugs made from ball bearings. It's pump action, and only slightly larger and more cumbersome than a heavy assault rifle, though the recoil is much more severe (BOD minimum of 8). So far only 20 have been produced, but we managed to get our hands on six of them. How they managed to make a man portable railgun this small is anyone's guess

Created and written by Deric Bernier, images from Deric Bernier, Appleseed, Cyberpunk 2077, Macross, Masamune Shirow, Gundam, Dirty Pair, Dark Minds, Men In Black, American Flag, Aliens: Colonial Marines, Deathwish, Deathstroke the Terminator, Starman, Kite, Space: Above and Beyond, Star Wars, Ice Pirates, Akira, Backlash, Babylon 5, Burn Up W, Dave Dorman, DS9, Dream Wave, Neon Cyber, Earth 2, Grendel: Devils Legacy, Hardboiled, Nausicaa, Secret Of Blue Water, Negative One, Punisher: Big Nothing, Runaway, L-gaim, Layzner, Ghost In The Shell, Catwoman, Titan AE, Wildcats, Stark Future, Total Recall 2070, Windaria, Rifts, Gurps, Trigun, Alien series, No Escape, Akira, Killzone, Firefly, Doom, Bubblegum Crash, Humanoid, Punishers Armory, Halo, Alien Legacy, The 5th Element, Time Cop, Shadowrun, Tomb Raider, Equilibrium, Intron Depot, Final Fantasy, Hellsing, Parasite Dolls, Bubblegum Crisis, Kappowwe Toys, Gungrave, AD Police, Bubblegum Crisis 2040, Grimjack, Project Snowblind, Bubblegum Crisis, S.I.N., Dirty Pair, Gundam, Doom, Gasaraki, Blue Gender, Hellboy, Blade series, Escape from New York, Escape from L.A., Eatman, G.I.T.S.: Stand Alone Complex, Jon Sable: Freelance, I Robot, Nomad, Mystery Men, D20 Future, D20 Apocalypse, Deadlands: Hell On Earth, Car Wars, Demolition Man, Fortress, Iria Zieriam, Natural City, Space, Above and Beyond, Stealth, Unreal Tournament, Moonwalker, Gunm, Southern Cross, Grifter, Battle Lords, Lensman, SeaQuest, Robocop, Aspen, Homeboys, Judge Dredd, Terminator: Burning Earth, Edison Giacotolli, Vortex, Soldier, Back To The Future II, Echo, Event Horizon, Starship Troopers, The Saint, Robotech: Sentinels, Deathlock, Hunter, Black Ops, James Bond, Death's Head, X-Men, Firearm, Nick Fury: Agent Of Shield, Dirty Pair: Flash, Silent Mobius, Mafia Wars, Army Of Two, Capcom, Hitman, Fatal Fury, Street Fighter, Deus Ex, Quake, Air Gear, Btoom, Tekken, Perfect Dark, Fallout, Bouncer, Frontlines, Crysis, District 9, Zatoichi, Bleach, Blame, The Rundown, Avengers, Green Arrow, GI-Joe, Call Of Duty, Brink, Doom, Eon Flux, Haze, Poseidon Arms, Nerf, Starhawk, Bayonetta, Bionic Six, Hudson Hawk, Avatar, Command And Conquer, Wastelands, Borderlands, and other various manga, Anime, Comic book, video game, film, and RPG sources, Raben-Aas, Sharp-n-pointy, Biometal79, Phatandy, Bordon, Shimmering Sword, Vulnepro, El Pinoy, Br0uHaHaasdsada, Larkabella, licataknives, meandmunch, Devilita Andree Wallin, Fuchsiart, imDRUNKonTEA, Guilty Spark, Refrigerador, Italiener, Pascal Eggert, Josh Nizzi, Bokuman, Machine56, Kunkka, Johan Bergstrom, Slipgate Central, Dominic Marko, Francis001, platypusgreen, jimmypham, Warrenlou, flipation, digimech, molybdenum, Spoonboy, Doll Fac3, Eikochan, bakanecone, teh dave, SC4V3NG3R, solkee, molinaro, KaranaK, genekruger, theelphin, garanum, 2ngaw, shed2602, gorrem, moyachiche, inception08, vietnguyen, rgus, archie, David Nakey, Kuroitora, aerpenium, Dead Robot, teruchan, acidburn08, Markovah, Mort Janu, MishaMoStyle, Blitz Bot, k hos, James Lemay, Gun0runner, Gneocidal Penguin, Kalor, ionen, djake, jett0, cyzrauk8, windridex23, firestoned, anjinanhut, regis, libertyspikesv5, rimancreative, deutscherherbst, hexonal, Ryujiin10, Raverunner, daisukekazama, dannortonart, bringmeasunkist, Merkaba998, tovenius, Message2god, peterku, nervousgryphon, knightwatch, Brian Rogers, tsukijin, talros, Michael Kingery, ygolochysp, Swatninja, Cyber999, marcwf, WarmGunMod, bcjfla76, bullseye breon, Carlo Arellano, Special thanks to Matsuo, Darth Brass, darcjedi, Tom\_Braider, thedap, wuher\_da\_brewer, Capt\_MarVel, Glim999, Pulseriflefan, TK513, gunnerk19, Tommin, BritNerfMogul, Tigadee, Johnson Arms, Wolverine\_solo, and all the many fine prop replica builders of Mastucorp, the RPE, Nerfhaven, Nerfhq, and BBC)

For more of the best Cyberpunk 2020 goodness available, go to



<http://datafortress2020.oliwy.net/>

To e-mail the author:

[droc@mc2k.com](mailto:droc@mc2k.com)

