

DATAFORTRESS 2.0.2.0

Presents:

ULTIMATE HANDGUNS

Written by Deric Bernier (droc@mc2k.com)

UPDATED: 4-30-13

The complete collection of all the handguns created for the various articles and sourcebooks by Deric Bernier found on Datafortress 2020.



This is just one of many articles for the Cyberpunk 2020 Roleplaying Game you can find on Datafortress 2020, the largest, most Comprehensive Cyberpunk 2020 site in the world.

Visit it at:

<http://datafortress2020.olivy.net/>

LIGHT HANDGUNS

4MM



LUIGI-FRANCHI ABRESCO 450EB

P - -4- P - R - 1D6/2 (4mm cased) - 6 - 1 - VR

This gun, masquerading as a ring, is too small to do much damage to anything, even at point blank range, but it might buy you the time you need to get yourself a better weapon. Truly a last ditch defense. It is a mystery why Luigi-Franchi felt the need to give it six shots, but it is made to the incredible standards one expects from them.

5MM



BUDGET ARMS CHANGEPURSE 15eb

P - -2- P - C - 1D6 (5mm cased) - 3 - 1 - UR

Sometimes we just have to shake our heads and wonder..... what the hell were they thinking? This itsy bitsy semi-automatic doesn't have a magazine; instead the rounds must be loaded manually through the ejection port one at a time, with the third round actually remaining in the chamber. If that wasn't bad enough, the safety is a removable pin attached to a key ring. Like we said... what the hell were they thinking?



COLT PALM-6 65eb

P - -3- P - C - 1D6 (5mm cased) - 2 - 1 - ST

Teeny tiny, 2 shots, and fits in the change pocket of your jeans. Of course trying to hit anything further than 3 meters is almost impossible, but if you are pulling this chances are the situation is desperate enough that getting close shouldn't be a problem.



NOVA ARMS UL-5 50EB

P - +2 - J - P - 1D6 (5mm cased) - 28 - 1 - VR

A very accurate weapon, perfect for hunting small game.



STEIN AND WASSERMAN AP-204 225eb

P - -1 - J - P - 1D6 (5mm cased) - 30 - 1 - ST

A compact assassins pistol chambered in the tiny 5mm round, perfect for getting up close and personal, though for target with the slightest armor, or from a distance of more than 20 feet we suggest something larger.



TSUNAMI ARMS ULI 40eb

P - -1 - P - C - 1D6 (5mm cased) - 25 - 1 - ST

A light gun, it's practical uses are limited, but it is perfect for practice or just plinking away.



WALTHER PP-1724E 145eb

P - +1 - P - C - 1D6 (5mm caseless) - 20 - 1 - VR

Walther is getting experimental again, they not only added a built in laser sight /flashlight to this weapon, but it comes smartlinked as standard.

.22 CALIBER



CIA CIGARETTE 50eb

EX - -2 - P - R - 1D6 (.22cal caseless) - 1 - 1 - ST
A cigarette with a .22 caliber caseless round and firing mechanism hidden in the filter. To fire one simply pulls the filter with his/ her teeth or fingers.



FABRICA DE ARMS AVP-11 150eb

P - 0 - P - C - 1D6 (.22 LR cased) - 8 - 1 - VR
Popular in home defense and casual circles, this revolver is small, comfortable in a woman's hand, and easily portable. For those who don't need a monster man-stopper, this is weapon fits the bill.

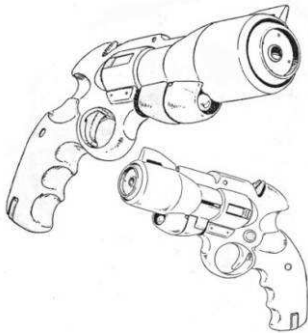

MUSTANG ARMS "WHISPER" 520eb

P - +3 - J - R 1D6 (.22 cal. cased) - 8 - 1 VR
Billed as the quietest handgun ever made, the whisper certainly lives up to its reputation. It is possibly the perfect handgun for close quarters assassination. The revolver is fully enclosed and features a built in silencer. Hammerless and sporting a built in laser sight along with a digital display on the rear of the gun which counts the number of rounds fired. This gun is so silent that even with audio enhancement you cannot hear it from more than twenty feet away, without audio boost you would have to be standing next to it in a silent room to hear it. It fires cased .22 caliber subsonic rounds which must be individually loaded.



ZIP GUN 15eb

(From the Nomad Market Sourcebook)
P - -1 - P - C - 1D6 (.22cal caseless) - 12 - 1 - ST
Made entirely from old engine parts and other scrap, these small holdout weapons are a perfect example of nomad ingenuity.

6MM

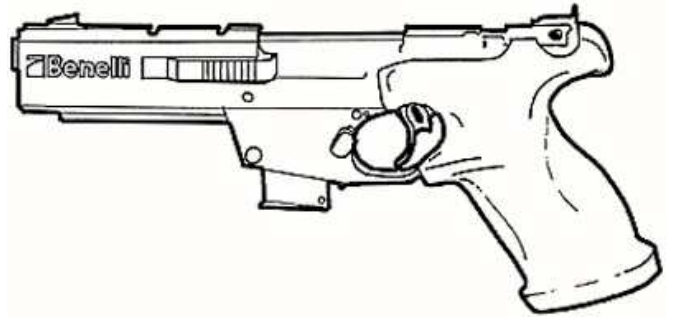

BENELLI "DA VINCI" 2360eb

P - +3 - L - R - 1D6+1 (6mm caseless) - 20 - 1 - VR
This is one of the most accurate semi-automatic target pistols ever made. Not as pretty as a Luigi-Franchi weapon, but the edge it gives in competition is considerable.



DARRA-POLYTECHNIC VA-4 60eb

P - 0 - J - P - 1D6+1 (6mm caseless) - 22 - 1 - ST
An odd gun, popular among poser gangs and anyone on a tight budget. No professional would be caught dead with this weapon, however Autumn Blade sells them to small military groups and gangs like hotcakes, mainly due to the fact that almost no maintenance at all is needed to keep the gun working, and the fact that at 60eb anyone can afford it. The low caliber ammunition is a bonus as well, as it means the cost is kept low.



LUIGI-FRANCHI TCP-22 1375eb

P - +4 - J - R - 1D6+1 (6mm cased) - 25 - 1 - VR
This fine handgun is more a piece of art than a weapon. A target pistol made to exact standards by hand and one of the most accurate handguns in the world. Used by competition shooters all over the world.



MALORIAN GZ65N 750eb
 P - +3 - P - P - 1D6+1 (6mm caseless) - 20 - 1 - VR
 It looks like something from a Flash Gordon comic strip, but the GZ65N 6mm caseless is actually an incredibly accurate and smooth firing weapon, with zero recoil and action so precise that you barely even feel the new round being cycled. Designed by Malorian for use aboard orbital colonies, sub aquatic vessels, and any other environment where over-penetration could pose a hazard.



NOVA ARMS "6&6" 80eb
 P - -2 - P - E - 1D6+1 (6mm caseled) - 10 - 1 - ST
 This is a tiny tiny backup semi-auto. Perfect for a purse or pocket.



NOVA ARMS 660 180eb
 P - 0 - P - P - 1D6+1 (6mm caseled) - 35 - 1 - ST
 35 rounds of plinking fun make this a favorite among weekend shooters.



SEBUERO M71A2 125eb
 P - +1 - P - E - 1D6+1 (6mm cased) - 20 - 1 - VR
 A very nicely designed compact handgun. Popular among Japanese and European undercover officers.

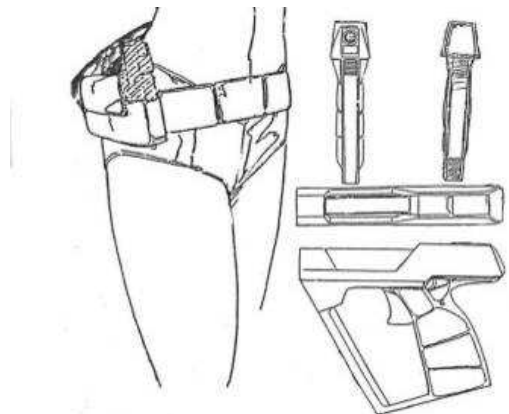

STEIN AND WASSERMAN "CHALLENGER" 300eb
 P - 0/+1 - P/J - P - 1D6+1 (6mm caseless) - 8 - 1 VR
 A compact pistol made for use in space and lunar and Martian colonies. Available in either long or short barrel versions (short barreled version is shown).



WALTHER SPM3 300eb
 P - +2 - J - P - 1D6+1 (6mm caseless) - 28 - 1/3 VR
 This 6mm handgun features a selector switch allowing for 3 round burst fire, and with its high ammo capacity and almost zero recoil, its accuracy is ridiculous. A testament to Walther engineering.

.25 ACP



SEBURO "LADIES CHOICE" 80eb

P - 0 - P - E - 1D6+1 (25ACP caseless) - 10 - 1 - VR
 A Seburo everyone can afford, perfect for a purse, a holdout, even stuff it in your undies, its so small it can go just about anywhere. And with almost zero recoil, even a child can fire it accurately.



CCMMC OPZ-R66 160eb

P - -1 - J - C - 1D6+1 (.25ACP caseless) - 30 - 1 - ST
 Chinese Police officers are issued this weapon. The small caliber and high ammunition count keep costs down, and the somewhat flashy styling make it popular among the public.

4MM FLECHETTE



ARMALITE CENTAUR 585eb

P - +2 - J - P - 1D6+2 (4mm flechette SPx1/4) - 20 - 1 - VR

Designed as competition for the Malorian Slivergun this heavy flechette gun is finding popularity as an officers sidearm in the USAF.

7MM



COLT ACE 38eb

P - -2 - P - P - 1D6+2 (7mm cased) - 2 - 1 - ST
 Truly an Ace up the sleeve beats a dead man's hand every time...



LUCZNIK RADOM ATTA-3000 295eb

P - +1 - J - C - 1D6+2 (7mm cased) - 28 - 1 - VR
 Quite possibly the most stylish light caliber handgun we have ever seen. If you like the ease and comfort of small caliber weapons, but still like carrying a mean looking piece, this is the weapon for you. The transparent plastic magazine is a very nice touch, allowing you to know exactly how many rounds you have left at a glance.



NORINCO "Lil Brudda" 75eb

P - 0 - P - E - 1D6+2 (7mm caseless) - 10 - 1 - ST
 A lean little compact, fits nicely in purse or pocket, or any other small space you need to conceal a weapon.

.38 CALIBER



BUDGET ARMS MEGADEATH 75eb

P - -1 - J - E - 1D6+2 (.38cal cased) - 6 - 1 - UR
 Proof positive that Budget Arms customers are idiots is the fact that the Megadeath is one of their most popular firearms. Presumably the only reason this is so, is due to the guns size and the name, as the actual weapon itself is woefully oversized and ridiculously heavy for the round it fires. The quality of the frame is somewhere below potmetal, as we have heard reports of people shattering these things with their bare hands. But if you don't have much money, it does make sense to get the biggest meanest looking gun you can find, and hope that the mere sight of it is enough to scare them away.

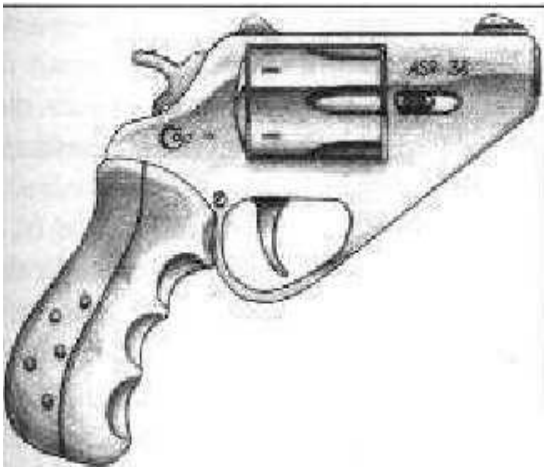

COLT ASP-11 125eb

P - 0 - P - E - 1D6+2 (.38cal cased) - 6 - 1 - VR
 A nice revolver, still if they went to all the trouble of making the front of the weapon as snag free as possible, the least they could have done was add a hammer shroud.



FABRIQUE NATIONALE OPA-38 55eb

P - -2 - P - C - 1D6+2 (.38cal cased) - 5 - 1 - ST
 A very small handgun, perfect for a back up piece or a woman's purse.



GEIND EL-EL552 125eb

P - +2 - P - E - 1D6+2 (.38cal cased) - 5 - 1 - ST
 Geind is a new name in firearms manufacturing, but the new kid is coming out swinging, and catching everyone's eye with their stylish weapons. The EL-552 is no exception. This break open .38 is extremely well made, and more accurate than a gun this size should be,



LUIGI-FRANCHI GAVIL HVS-64 150eb

P - 0 - P - E - 1D6+2 (.38cal cased) - 6 - 1 - VR
 This pocket revolver does not disappoint, with all the refined style and performance one expects from a Luigi-Franchi firearm.



LUIGI-FRANCHI GAVIL Z01 140eb

P - 0 - P - E - 1D6+2 (.38cal cased) - 6 - 1 - VR
 A more traditional, but still extremely stylish pocket revolver from Luigi-Franchi, the second in their Gavil line.



NOVA ARMS "POCKET II" 55eb
 P - -1 - P - C - 1D6+2 (.38 cal cased) - 3 - 1 - ST
 The Pocket II is chambered in .38, which eases the recoil drastically, making this weapon at least moderately effective now. In all other ways it is identical to the original.



RUGER "FLATFOOT" 70eb
 P - 0 - J - E - 1d6+2 (.38cal cased) - 6 - 1 - ST
 A simple 6 shot .38 revolver, sold to police departments around the world. While in America and most of Europe this gun is seen as extremely underpowered due to body armor, drug induced frenzies and the cyborg threat, most of the world doesn't have these problems and this weapon is plenty powerful enough.



REVOLOBALL 12,200eb
 P - -1 - P - U - 2D6 (.38cal caseless) - 8 - 1 - UR
 One of the oddest and most unconventional weapons ever built, it is a revolver that fires caseless ammunition. It is also not a revolver in the tradition sense of the word, while the spherical cylinder does rotate, it does not spin to a new chamber, instead the bullets are loaded into the nodules on the ball, which tumbles each bullet in turn into the firing chamber. It takes 30 seconds to reload the weapon fully, but only one round to put one bullet into a chamber. One of a kind.



RUGER GUMSHOE 60eb
 P - -1 - P - E - 1d6+2 (.38cal cased) - 6 - 1 - ST
 Truly classic style, this small revolver evokes all the feelings of a dime store novel, a hard bitten 2 fisted detective surviving by wits and luck. Unfortunately in the modern age, it is too underpowered for a primary weapon in most circumstances, but it makes an excellent backup piece.



SEBURO DEFIANT .38 110eb
 P - -2 - P - C - 1D6+2 (.38 cal cased) - 2 - 1 - VR
 This tiny yet surprisingly attractive 2-shot derringer is the latest in pocket protection. Not sure why anyone would want one with a laser sight but anything to help with the horrible accuracy (+1) can't hurt. Makes a perfect backup weapon



SEBURO VERMILLION 150eb

P - +2 - P - C - 2D6 (.38 cal cased) - 6 - 1 - VR
 This .38 special emphasizes the special. One of Seburo's very few revolvers, this weapon features a built in laser sight and ergonomic designed grip from maximum comfort while shooting. The extra weight around the laser acts as an unerbarrel lug, giving this weapon almost no recoil at all. All that in a package so small it's almost classified as a derringer. The snag free hammer shroud is also a nice touch.



STERNMEYER "POCKET CHAP" 65Eeb

P - -1 - P - C - 1D6+2 (.38 cal cased) - 5 - 1 - VR
 Available in a variety of finishes and an assortment of grips, the Pocket Chap from Sternmeyer is discrete protection for the discerning gentleman or lady. Available with 1 or 3 inch barrels. (1-inch barrel is -2 accuracy.)

9MM BOLT

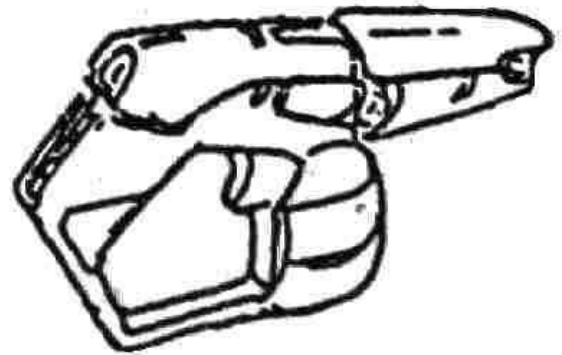

ARASAKA AG-15 440eb

P - +1 - J - P - 1D6+2 (9mm bolt) - 10 - 1 - VR
 Rising in popularity, this is Arasaka's answer to the Hammer M-11.



MILITECH "MARTIAN" 750eb

P - +2 - J - P - 1D6+2 (9mm bolt) - 10 - 1 - VR
 Designed specifically for use in orbit, this odd looking weapon has become a hot item for those wishing to travel around in space. Perfect for self defense on the Crystal Palace, but don't get caught with it.

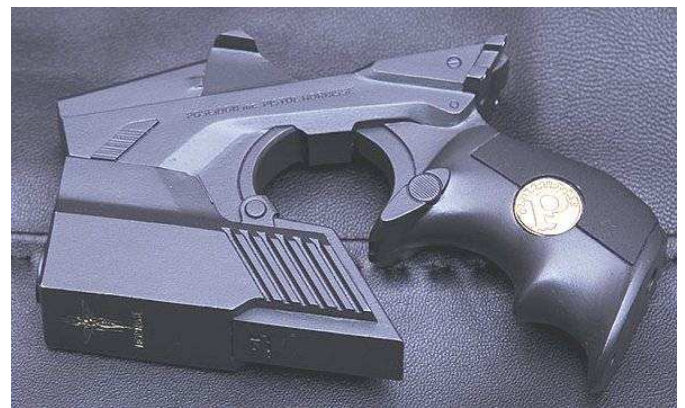

MILITECH HORONISSE 350eb

P - -1 - P - R - 1D6+2 (9mm bolt) - 4 - 1 - VR
 A highly concealable, and very unconventional weapon for use with the 9mm bolt ammunition. Spacer detectives and investigators need something light and small, and this weapon fits that bill. Planetside, regardless of the weapons minimal combat effectiveness, the gun is sought after due to its unusual action and innovative looks.

MEDIUM HANDGUNS

9MM



ARASAKA R-209 645eb
P - +2 - L - C - 2d6+1 (9mm cased) - 25 - 1/3 - VR
This is a very large, and very heavy auto-pistol chambered in 9mm. not very concealable, but with a large ammo capacity, and high rate of fire, its a fairly good weapon.



BERETTA LP-102 110eb
P - -1 - P - E - 2d6+1 (9mm cased) - 10 - 1 - ST
A compact that fits nicely in any pocket or purse, makes an excellent holdout weapon, but is powerful enough, and holds enough ammo, to serve as your primary.



BERETTA HAMMER 310eb
P - 0 - J - E - 2d6+1 (9mm cased) - 14 - 1 - VR
A rugged and reliable combat handgun from Beretta, developed with special forces in mind.



BERETTA KENDO 675eb
P - -1 - J - R - 2d6+1 (9mm cased) - 20 - 1/3 - ST
This specialized update to the M-92 system consists of a highly stylized frame, and a unique foregrip, which acts normally, until a button is pressed, at which point a small claw springs out of the front of the weapon, to inflict horrific wounds in close quarters combat. The weapon also features a selector switch, allowing for 3-round burst fire.



BERETTA WPK-9 250eb
P - 0 - J - C - 2D6+1 (9mm caseless) - 14 - 1 - ST
The WPK-9 is one of the sleekest, smoothest pieces to ever hit the Beretta catalog, and sales have been superb.



BUDGET ARMS "BLING BLING" 145eb

P - -1 - L - E - 2D6+1 (9mm caseless) - 16 - 1 - UR
 The gold and chrome plating on this POS starts to flake off the first time you fire it. But budget arms sells them like there's no tomorrow. Its size and shininess seem to be its major attraction among people who simply don't know any better. They even plated the ejection port, which flakes off inside the weapon causing it to jam frequently.



BUDGET ARMS P-1145 140eb

P - 0 - J - C - 2D6+2 (9mm cased) - 12 - 1 - VR
 A Mexican knockoff of a Russian Makarov design. While Budget Arms is by far the largest handgun manufacturer in Mexico, this is the only Budget Arms weapon issued by the government to any of its forces, in this case the weapon is issued to police and military officers. However most choose to replace it as it doesn't have the stopping power, or the ability to penetrate any type of armor at all. Not to mention no one really wants to carry a weapon from a company known worldwide for producing the worst of the Polymer One-Shot weapons. The weapon is equipped with a built in laser sight.



BUDGET ARMS "CHESTER" 140eb

P - +1 - J - E - 2D6+1 (9mm cased) - 18 - 1 - ST
 A weapon from Budget arms that is barely one step above being a disposable, its selling points are its low price and its "purple beam" laser sight. It is very popular among teenagers and gang members.



BUDGET ARMS "TOY" 30eb

P - -2 - P - E - 2D6+1 (9mm caseless) - 6 - 1 - UR
 This is a perfect example of what you get when you buy a weapon from a vending machine. This gun, and we use that term loosely here, is an abomination in terms of safety. It blows up on a whim (20% chance on a fumble), but its extremely cheap, therefore its extremely popular on the streets.



BUDGET ARMS "GOLDENROD" 250eb

P - +1 - J - E - 2D6+1 (9mm caseless) - 14 - 1 - UR
 This weapon is a true testimony as to what's wrong with disposable one-shots. First its design is horrible, the grip is larger than it needs to be and the barrel shroud too thin. The trigger guard is too small making the gun uncomfortable to fire to anyone but a small woman or child, and it has no front sites and worthless rear sites. And to top it all off the weapon is coated in shiny gold paint that begins to flake the minute you take it out of the box. Still the gold coat must work, because even at a price of 250eb it sells like hotcakes to gangers.



CESKA ZBROJOVKA CZ-7718 460eb

P - 0 - L - E - 2D6+1 (9mm cased) - 14 - 1/3 - ST
 From our Czech friends comes this work horse. Capable of three round burst with integral laser sight. This weapon is well at home in the trenches or on the streets.



CZ "PENGU" 1045eb
P - +1 - P - E - 2D6+1 (9mm caseless) - 16 - 1 - ST
Popular with European military and police forces due to the built in laser sight/flashlight, the weapon also comes smartchipped.



COLT "HUSH" 385eb
P - +1 - J - C - 2d6+2 (9mm caseless) - 10 - 1 - R
This weapon was developed by Colt along the same lines as the "Handout", but with stealth in mind. The "Hush" features a built in suppresser, and laser sight, and makes for a nice disposable assassin's weapon.



DAI LUNG "BALLA" 200eb
P - -2 - J - P - 2D6+1 (9mm caseless) - 15 - 1 - UR
A suppressor accessory and built in tac light are the only remarkable features of this gun. It would almost be a decent weapon if it didn't jam so much and it wasn't so damn shiny.



CCMMC JW-4 KOW LOON 250eb
P - +1 - L - E - 2D6+1 (9mm caseless) - 20 - 1 - VR
This is the handgun most commonly issued to officers in the Chinese military, it is very reliable and can stand a lot of abuse. A bit low powered for most of us in the states, but more than enough for Europe and Asia, as well as the rest of the world.



DAI LUNG CRP-22 50eb
P - -2 - J - P - 2D6+1 (9mm caseless) - 16 - 1 - UR
A typical Dai Lung disposable, it is true garbage, it jams frequently, it has no sights whatsoever, maintenance on it is a bitch, and its ugly as sin. Still it sells well in the third world due to its extremely low price.



COLT "HANDOUT" 125eb
P - -1 - J - E - 2D6+1 (9mm caseless) - 12 - 1 - ST
This is the result of Colts dabbling in the "One-shot" market. This is actually a fairly decent weapon, just a very cheap one. Colt developed these to use in much the same way as the Liberator's were used in WWII, but that plan never saw fruition, instead these guns are sold on the open market and are extremely popular to those who need a decent gun cheap. Comes with a very cheap laser sight and scope, it is recommended that these be either removed or replaced with a better versions.



DAI-LUNG LP-402 150eb
P - 0 - J - E - 2D6+1 (9mm caseless) - 16 - 1 - ST
A professional looking gun at a very reasonable price. A nice change from a company that is known for its one-shots and junk pistols.



DAI LUNG "POORMAN" 176eb
 P - +1 - J - E - 2D6+1 (9mm cased) - 10/30 - 1/3 - ST

This is probably the cheapest automatic pistol on the market today. Made entirely from stamped metal, this is a strictly no frills weapon as just one look will emphasize. Still it's fairly durable, and sells well to third world armies and terrorist groups, as well as gaining popularity on the streets. A thirty round clip is available, and only single shot and three round bursts are possible.



DAI-LUNG SQ-67 69eb
 P - -2- J - C - 2D6+1 (9mm caseless) - 20 - 1/3 - UR

Dai-Lung weapons should come with a mandatory disclaimer stating "if you are stupid enough to use this weapon, you deserve to have it blow up in your face." And here is yet another example of why. The exterior of the weapon is made from what appears to be stamped aluminum, with a steal barrel and firing mechanism. We have heard rumors that some of these coming off the production line have misaligned or warped barrel, and will simply explode the first time they are fired. The magazines, also made from the same aluminum used in soda cans, have a tendency to bend and tear, causing all sorts of jamming problems. To further illustrate what a joke these weapons are, the plastic grips are glued on.



DAI-LUNG ZIPZAP-4 110eb
 P - -2- J - R - 2D6+1 (9mm caseless) - 16 - 1 - UR

Posers love this thing, and customize it heavily.



DIXIE DEATHWISH 5eb
 (From the Nomad Market Sourcebook)

P or R -3 V E Varies 1 1 UR
 Also known as Mississippi Suicide notes or 'Bama Zippers, these home made guns are a scourge across the nation. Due to anything higher caliber than a .22 or shotguns being illegal, it is common practice for survivalists, Raffin Shiv, and bored rednecks in the Dixie region to build their own guns out of old engine parts and pieces of scrap metal. In fact in most Raffin Shiv gangs in Dixie you aren't considered a full member until you have not only built your own gun, but used it on someone. Nomads travelling through the region that encounter resistance from civilians or Raffin Shiv and win tend to come back with armloads of these things. Most are single shot, though double barreled versions do exist. And most fire either 9mm, .45 cal, or 12 gauge. All are more likely to blow up in your hand than hit your enemy. Of particular humor is that some particularly suicidal boostergangs are actually arranging fights where everyone involved uses nothing but these weapons as a show of bravery.



FABRICA DE ARMS AVP-11 295eb
 P - +1 - J - C - 2D6+1 (9mm caseless) - 18 - 1 - ST
 A common handgun, found worldwide. Extremely popular due to its low price, and the fact that it comes standard with smartchipping.



FEDERATED ARMS SH-40 1495eb
 P - -1 - L - C - 2D6+1 (9mm caseless) - 16 - 1 - ST
 The built in suppressor and integral laser sight make this a popular weapon for network duties.



GLOCK "SPEARHAMMER" 375eb
 P - +1 - J - O - 2D6+1 (9mm caseless) - 16 - 1 - VR
 Another variation on the classic Glock design, we aren't sure exactly what the spikey front end is supposed to do for the weapon, but it does look cool.



GLOCK V-166 375eb
 P - +2 - J - O - 2D6+1 (9mm caseless) - 16 - 1 - VR
 A long barrel Glock, more accurate than its predecessors.



HECKLER AND KOCH C-823 375eb
 P - 0 - P - P - 2D6+1 (9mm cased) - 10 - 1 - VR
 A very well made compact from H&K, The built in laser sight definitely helps with the accuracy problems inherent to such a short barrel.



HECKLER AND KOCH S350 STORMER 405eb
 P - 0 - P - P - 2D6+1 (9mm cased) - 10 - 1 - ST
 Another extremely stylish 9mm compact from H&K, featuring a built in laser site/ flashlight combo and molded grips.



H&K "TACTICAL" 575eb
 P - +1 - L - P - 2D6+1 (9mm caseless) - 15 - 1 - VR
 Designed specifically for wet work, this caseless ammunition firing 9mm is making waves in the professional community. An add-on suppressor is available to police and military for an additional 50eb.



HECKLER AND KOCH "VULNEPRO" 875eb
 P - +1 - J - P - 2D6+1 (9mm caseless) - 14 - 1/3 - VR
 H&K once again proves they are on top of their game. In addition to the unique styling and ergonomic feel that makes this weapon more like an extension of your arm than a hunk of metal, it is also capable of 3 round burst, activated by extending the thin folding fore grip.



MATSUCORP HEAT 490eb
 P - +1 - L - C - 2D6+1 (9mm caseless) - 16 - 1 - ST
 A surprisingly comfortable 9mm handgun made with corporate security and home defense in mind. The built in flashlight and laser make it very popular among young and old alike.

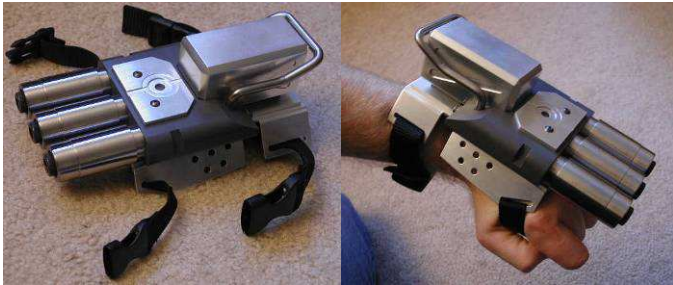

KNUCKLE BOMBER
 (From Nomad Market)
 P - -3 - J - C - 2D6+1 (9mm cased) - 3 - 1 - ST - 80eb
 These things are everywhere in the nomad community, extremely popular with outriders and anyone who spends most of their time on a bike. The box on top holds 3 extra bullets, which must be individually loaded by hand into each barrel, while the lever around the box can be pushed forward, allowing it to fire all three barrels at once.



MATSUCORP MP-39 360eb
 P - +1 - J - C - 2D6+1 (9mm caseless) - 12 - 1 - ST
 Matsucorp again makes a splash. This somewhat compact 9mm is a fine weapon in its own right, but what really makes it stand out is the camera/monitor mounted on it. A Matsucorp innovation, the doohickey that at first glance is a backwards scope is actually a camera able to switch between thermograph and IR, with zoom and image enhancement for even greater accuracy. The image from the camera is projected on the rear lens. Making it a truly electronic scope, and remains effective without hampering low light visual acuity



LUCZNIK RADOM ASI-9 145eb
 P - -1 - P - E - 2D6+1 (9mm caseless) - 16 - 1 - ST
 A compact 9mm perfectly concealed in a pocket, or ideal as a backup piece.

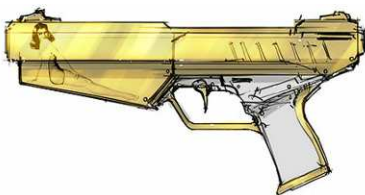

MALORIAN PPM-721 750eb
 P - +2 - J - R - 2D6+1 (9mm caseless) - 15 - 1 - VR
 A Malorian 9mm with built in suppressor. A bit shiny for wet work, but its a Malorian, so who's gonna complain.



MILITECH HALO-M06A & HALO-M06B 210eb 260eb
 P - 0 - J - C - 2d6+1(9mm caseless) - 18/25 - 1 3/1 - ST
 The latest sidearm from Militech, the M06A is a standard 16 shot 9mm, streamlined and accurate. The M06B has an extended magazine and 3 round burst capability. Magazines are interchangeable.



MILITECH "RAT" 460eb
 P - +1 - J - E - 2D6+1 (9mm caseless) - 14 - 1 - VR
 Militech developed this weapon specifically for use in extremely harsh conditions, it can fall 100 meters onto concrete without being damaged, will fire under water, and after 20 hours submersion, is guaranteed never to rust, and only needs cleaning after extreme abuse. While ugly as sin, this gun works, and if climbing a mountain, slogging through a jungle, traversing a desert, or making your way across the frozen tundra are in your future, this is the gun you want at your side.



MUSTANG ARMS OSHI-592 435eb
 P - +1 - P - P - 2D6+1 (9mm caseless) - 10 - 1 - ST
 The OSHI is yet another gun made for security in orbital installations but has also found popularity as a light handgun for women and children. It sports an integral laser sight for quick target acquisition and its state of the art ceramic polymer construction keeps its recoil low. While this handgun is an excellent choice for its role, it is quite susceptible to jamming when not kept properly cleaned.



MILITECH "TWO-STEP" 360eb
 P - +1 - L - P - 2D6+1/3d6 (9mm caseless/.20gauge) - 14-1 - 1/3-1 - ST
 A fine handgun by itself, the "Two-Step" also features a single shot .20ga underbarrel shotgun for emergency situations. The shotgun will accept any .20 ga shell, and the main weapon features select fire with the choices of single fire or 3-round burst.



NORINCO "EDUARDO" 325eb
 P - -3 - C - C - 2D6+2 (9mm cased) - 1 - 1 - ST
 A crude one shot holdout common among nomads.

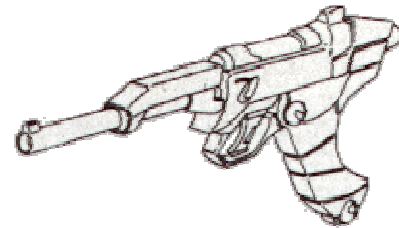

NORINCO "EDUARDO" 325eb
 P - 0 - J - C - 2D6+2 (9mm cased) - 14 - 1 - VR
 An inexpensive 9mm, reminiscent of the Luger. It looks a bit odd, but has found a following with many of the youth gangs, especially since it comes standard in gold and chrome.



MILITECH VECTRA-4 345eb
 P - +1 - J - C - 2D+1 (9mm caseless) - 25 - 1 - ST
 A bit larger and heavier than necessary, but an effective weapon nonetheless. The high ammo capacity almost makes up for the weight.



NOVA ARMS HHP-11 225eb
 P - 0 - J - C - 2D6+1 (9mm caseless) - 18 - 1 - ST
 Another "wondernine" from Nova.



NOVA M-39 625eb
 P - +1 - J - e - 2D6+1 (9Mm caseless) - 16 - 1 - ST
 A simple, though odd looking "wondernine" from the company that makes odd looking weapons there stock in trade.



NOVA XP-89 525eb
 P - -1 - J - C - 2D6+1 (9mm caseless) - 25 - 1/3 - ST
 An advanced version of the "88", and resembling a calico even more with its helical top mounted magazine.

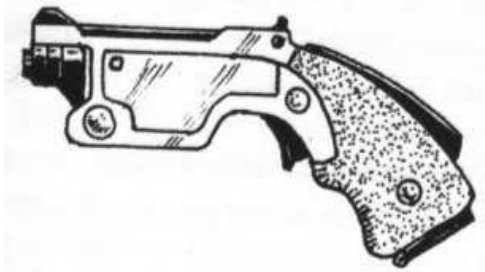

NOVA ARMS "MIDGET" 630eb
 P - -2 - P - P - 2D6+1 (9mm caseless) - 4 - 1 - ST
 A small derringer, perfect for your pocket, purse, or up your sleeve.



ROSTOVIC JADER-9 365eb
 P - 0 - J - C - 2D6+1 (9mm caseless) - 20 - 1 - ST
 Nicknamed the Stub-9 by professionals, this smart linked as standard 9mm is making waves.



NOVA "TITUS" 505eb
 P - +2 - J - E - 2d6+1 (9mm cased) - 15 - 1 - ST
 A weighted barrel and a modern look give the Titus a place on the market. The tapered handle is comfortable and for an extra 50eb Nova will install an integral laser sight.



ROSTOVIC "LEMANS" 560eb
 P - 0 - J - E - 2D6+1 (9mm caseless) - 18 - 1 - ST
 Favored in Europe by security personnel and police, the Lemans is a trusty sidearm, if somewhat underpowered against cybered opponents.



NOVA X-88 375eb
 P - -1 - J - E - 2D6+1 (9mm caseless) - 14 - 1 - ST
 This weapon slightly resembles a calico, and features a very fast trigger pull, not very accurate, but fairly inexpensive.



ROSTOVIC PP-101 205eb
 P - 0 - J - C - 2D6+1 (9mm caseless) - 16 - 1 - VR
 This Russian firearm may look a tad strange, but it is effective and battle proven nonetheless. This is the standard officers sidearm in the Russian military.



RUGER "COLONIAL" 255eb
P - +1 - J - C - 2D6+1 (9mm caseless) - 18 - 1 - ST
A nice fairly compact piece that serves well as either a backup or as a main sidearm.



STERNMEYER M295 135eb
P - -2 - J - E - 2D6+1 (9mm caseless) - 16 - 1 - ST
A common but unremarkable firearm from Sternmeyer. Not a professional's weapon, but an honest one. For it's price it's a steal.



RUGER SPITZ 485eb
P - +1 - J - E - 2D6+1 (9mm caseless) - 10 - 1 - VR
A common pistol for corporate and private security.



STERNMEYER P-2013 120eb
P - -1 - P - E - 2d6+1 (9mm cased) - 8 - 1 - ST
A small handgun, perfect fit in a purse or even a good sized pocket. Not very accurate or hard hitting, but its enough when it's needed.



SMITH AND WESSON LEOPARD-MATIC 85eb
P - -1 - P - E - 2d6+1 (9mm caseless) - 10 - 1 - VR
A superb, if somewhat hideous, compact at an excellent price. It is a hammerless design, so the only snag points are the sights.



STEYR RX-15 320eb
P - +1 - J - P - 2D6+1 (9mm caseless) - 18 - 1/3 - ST
A less expensive competition model to the Malorian PPM-721. Features built in scope and suppressor, and while it is not quite as reliable or accurate as the Malorian, it does have a 3-round burst setting and holds more ammo.



TOWA MANUFACTURING "NEOTOKYO" 480eb
 P - -2 - L - C - 2D6+1 (9mm caseless) - 40 - 1/3 - ST
 Not flashy, not pretty, but this weapon doesn't have to be either. Designed by Towa specifically for private security, this handgun features single shot and 3-round burst capabilities.



WALTHER LUGAZI 175eb
 P - 0 - J - C - 2D6+1 (9mm caseless) - 14 - 1 - ST
 Like the bastard child of a P-38 and a Luger, this weapon is a favorite of German and Austrian black ops teams as well as WW2 enthusiasts around the world. While illegal almost everywhere, the silencer is available for an additional 20eb.



TSUNAMI ARMS "LEXMAN" 850eb
 P - +2 - J - R - 2D6+1 (9mm caseless) - 15 - 1 - VR
 Originally designed as a target pistol, the Lexman has gained popularity among professionals recently due to its high accuracy. Comes smartchipped as standard.



WALTHER P8-120 140eb
 P - 0 - P - E - 2D6+1 (9mm caseless) - 8 - 1 - ST
 Walther still makes compacts like no ones business. An ideal holdout weapon or ladies purse gun.



WALTHER XP-108 140eb
 P - +1 - P - E - 2D6+1 (9mm cased) - 8 - 1 - VR
 An excellent subcompact from Walther, an ideal backup piece for police officers and security personnel.

.45 ACP



AMERITECH "RIVERMAN" 715eb

P - 0 - J - C - 2D6+2 (.45ACP cased) - 10 - 1 - ST
You would never know it by looking at this weapon, but it floats. The heavy lug at the back and the odd looking barrel wrap are made from a special material with a foam core. The exterior is rigid and dense, but the interior is more bouyant than Styrofoam. All the interior and exterior surfaces of the weapon are also treated and sealed, so the gun will continue to work perfectly even after prolonged submersion in saltwater, As a result the weapon floats. Specifically designed for the Coast Guard this weapon is gaining popularity with waterborne smugglers and divers.



BROWNING DB-271 295eb

P - +1 - J - C - 2D6+2 (.45ACP cased) - 12 - 1 - ST
Browning moving back into play with this semi-automatic handgun. The fat magazine makes it a little uncomfortable at first, but with practice it feel like a dream.



COLT 2022 450eb

P - 0 - J - C - 2D6+2 (.45 ACP cased) - 10 - 1 - VR
Another design for military use, using an upgrade 1911 frame, with available suppressor and easy add/remove on laser sight with magnetic spots weird directly into the frame of the gun.



COLT AMT-2018 410eb

P - +1 - J - C - 2D6+2 (.45ACP caseless) - 12 - 1 - ST
Sticking with the system that has worked for them so well for so long, colt added more comfortable grips, an integral laser sight and a flash compensator. Proving once again Colt is still combat savvy.



COLT SEEDER 45 ACP 480 EB

P * 0 * P * C * 2D6+2 (.45ACP caseless) * 7 * 1 * ST *
A .45 caliber weapon used as a backup. Too under-powered for use against most cyborgs



COLT "BLUE" 310eb

P - 0 - J - C - 2D6+2 (.45 ACP cased) - 10 - 1 - VR
The blue tint of this weapon is actually the metal, and it goes through a special oxidation process to achieve it. The bright blue, which actually glows under black light, is not popular among most professionals, but the weapon itself is a capable design.



COLT "EDGE" 595eb
 P - 0 - J - C - 2D6+2 (.45ACP caseless) - 10 - 1 - VR

The hammer of the 1911 redesign has been enshrouded to prevent snagging, the frame has been reinforced, and the barrel shroud has been serrated for "intimidation" reasons.



COLT "RENAISSANCE" SPECIAL 1510eb
 P - +1 - L - R - 2D6+2 (.45ACP cased) - 12 - 1 - ST
 These magnificent handguns were released as a limited edition celebration of the 1911's combat service. Only 2000 were made and each includes the pinnacle of modifications to the 1911. Chambered in 12mm, these weapons are both extremely combat effective and a collectors item.



COLT PEACEMAKER 2021 795eb
 P - +1 - L - P - 2D6+2 (.45cal cased) - 6 - 1 - VR
 Colt is riding a wave of nostalgia, and catering to its fanbase. The Colt Peacemaker 2021 is a tribute to the gun that made them a legend. A double action revolver with a mix of classic and modern styling, the Peacemaker 2021 is turning quite a few heads.

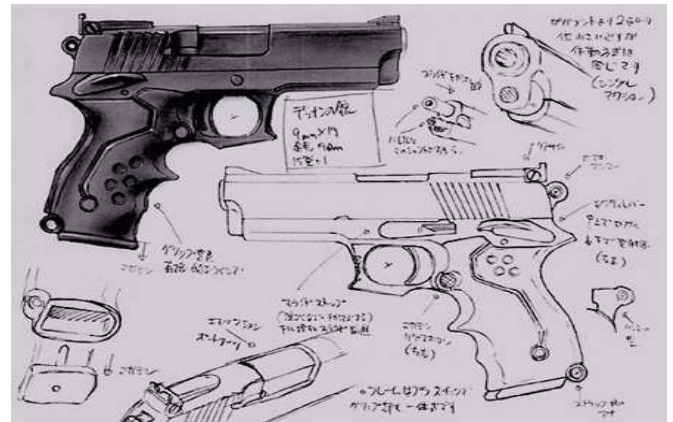

COLT/SEBURO DNP-5 595eb
 P - 0 - J - C - 2D6+2 (.45ACP cased) - 8 - 1 - VR
 This beautiful redesign of the 1911 combat pistol is the brainchild of a joint venture between Sebuero and Colt. This is what happens when the masters of old work with the masters of new.



COLT "POCKET MONSTER" 275eb
 P - -2 - P - C - 2D6+2 (.45ACP caseless) - 6 - 1 - ST
 A small but powerful handgun, made with Colt's exacting quality and durability. Comes with built in Pachmeyer grips and a rounded hammer to prevent snags. Never be caught defenseless again.



DUTCH ARMS "FIREFLY" 475eb
 P - 0 - J - U - 2D6+2 (.45cal cased) - 10 - 1 - ST
 With it's unusual styling, reminiscent of a time past, the Firefly is popular with corporates. Mostly it's hung on the wall, or taken along at corporate events at shooting ranges, even hanging on a wall, owning this gun is a statement of style, though it is a perfectly decent handgun.

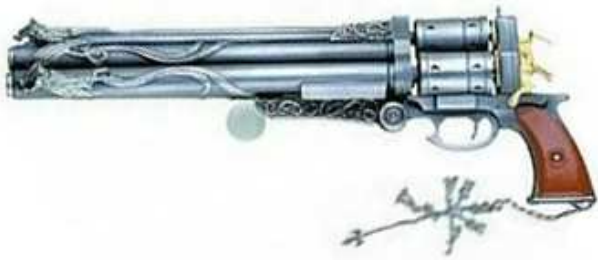

ESPERANTO 1500eb
(From Nomad Market)

P +1 L R 2D6+2 (.45 cased) 18 1 VR

This weapon is made by an old engraver and gunsmith in Mexico. He apparently makes a few of these every month, each with unique designs engraved into them. They are beautifully and lovingly hand crafted and are of the finest quality, however this does not change their ridiculousness. An 18 shot six shooter... the joke would be much funnier if the guns weren't so darn pretty. This guy is apparently the same one who makes the Black Beauty, as it uses the same basic frame and design.



NOMAD 2020 PEACEMAKER 300+eb
(From Nomad Market)

P - +1 - J - R - 2D6+2 (.45cal cased) - 6 - 1 - VR
Handmade to exacting standards and available with any customization option you can think of, the old west lives again with the 2020 Peacemaker. A merchant in the southwestern section of hand makes these fully functioning replicas, updated to accept modern ammunition. Also available in .357 and .44 magnum. Look for Paleriders.

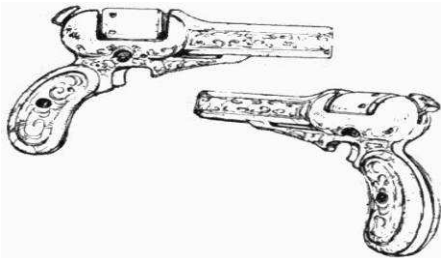

LUIGI FRANCHI "GENTLEMAN'S DUO" 3500eb

P - -1 - J - VR - 2D6+2 (.45 cal cased) - 6 - 1 - ST

Always designing their weapons for the upper class, Luigi Franchi does it again with The Gentleman's Duo. A pair of ornate matched dueling revolvers, with a very finely crafted plush case and cleaning kit to complete the set. The weapons are plated in gold, silver, or platinum and the engravings on each set is different, and for an additional 300eb will be customized to the owner. Even the cleaning tools are engraved and the entire set is perfect for display. The weapons are single action and work beautifully, just so they know your serious. Among the upper crust dueling has come back into vogue, and these are some of the premiere pieces available. Though most prefer the more traditional single shot flintlocks.



NOMAD MARE'S LEG 150eb
(From Nomad Market)

P - 0 - L - E - 2D6+2 (.45 cal cased) - 6 - 1 - ST
Shotguns aren't the only weapon that gets the "sawn-off" treatment, these old style lever action hunting rifles are a favorite among nomads. While most nomads keep the stock, for hunting accuracy, sawing it off is popular among those who like their weapons to take up as little room as possible. These weapons are everywhere, also available in .357, .44, and in the rifle calibers 30-06, and 30-30 (only 3 shot capacity).



MILITECH BANDICOOT 290eb

P - +1 - J - C - 2d6+2 (.45ACP cased) - 10 - 1 - ST

A popular though nonremarkable handgun. Sells mainly as a home defense weapon.



NOVA PT-145 115eb

P - 0 - P - E - 2D6+2 (.45ACP cased) - 6 - 1 - ST

This compact, chambered in .45 ACP, has been growing in popularity among street gangs and personal defense buyers.



RUGER MR. 45 115eb

P - -1 - P - C - 2D6+2 (.45ACP caseless) - 6 - 1 - ST
 Need a backup, can't go wrong with this compact from Ruger. It's surprisingly comfortable in your hand, while still remaining combat effective firing .45cal ACP ammunition.



NOVA PS-202 340eb

P - 0 - J - C - 2d6+2 (.45ACP cased) - 8 - 1 - ST
 Not remarkable, even with it's built in laser sight, this weapon is still a respectable firearm.



RUGER RD-DRGN 340eb

P - +1 - J - P - 2d6+2 (.45ACP cased) - 10 - 1 - ST
 A long, heavy, hard hitting weapon from ruger.



SEBURO "BOBSONS " 480eb

P - -1 - P - C - 2D6+2 (.45ACP caseless) - 6 - 1 - VR
 One of the finest backup pieces ever made. Perfect for that leg holster, a woman's purse, or even hidden up your sleeve, and powerful enough to drop whatever you may come across. This gun is manufactured to Seburo's exacting quality, and is itself a measure of success.

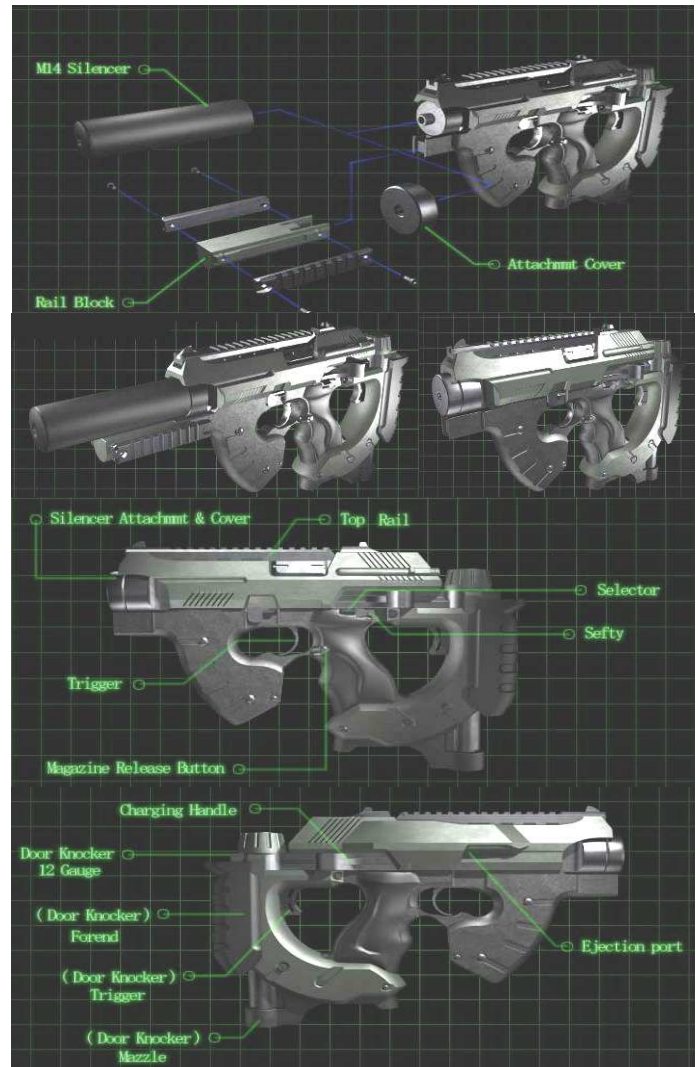

SEBURO PEL-M10 1125eb

P - +2 - P - C - 2D6+2 / 4d6 (.45 ACP cased/.12 gauge) - 20-1 - 1/3-1 - VR

Seburo's innovation never ceases to amaze. A standard (for Seburo anyway) combat pistol, chambering 20 rounds of .45 cal ammo, plus a single shot kinetic fired .12 gauge for breaching doors. To use the .12 gauge you hold the weapon gripping the rear portion, depress the trigger, then slam it down on the surface you want to breach.



TAURUS "SCOURGE" 575eb

P - +2 - J - E - 2D6+2 (.45ACP cased) - 10 - 1 - VR
 A nice all around combat pistol, it sells well worldwide. This handgun is relatively new to the market, and several military and police forces are taking interest. Supplies are going fast, order yours while you can. Comes standard with a laser sight.

10MM

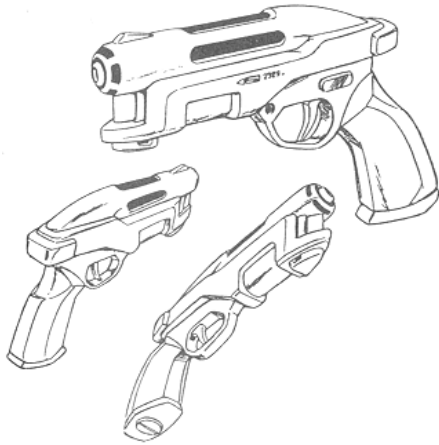

ARASAKA 253 495eb

P - +1 - J - C - 2D6+3 (10mm caseless) - 16 - 1 - ST

The barrel shroud of this weapon doesn't move, and instead is specially vented and baffled to act as a limited suppressor, reducing report considerably. The slide is the small protrusion on the rear of the weapon.



ARASAKA "BUDO" 580eb

P - +1 - J - P - 2D6+3 (10mm caseless) - 12 - 1 - VR

Another fine high powered handgun from Arasaka. This has become a favored weapon of Yakuza muscle. Comes standard with a laser sight.



ARASAKA CWS-10 680eb

P - +1 - J - C - 2D6+3 (10mm cased) - 18 - 1 - VR
Arasaka stays competitive with the CWS-10. Accurate, extremely reliable, and stylish.

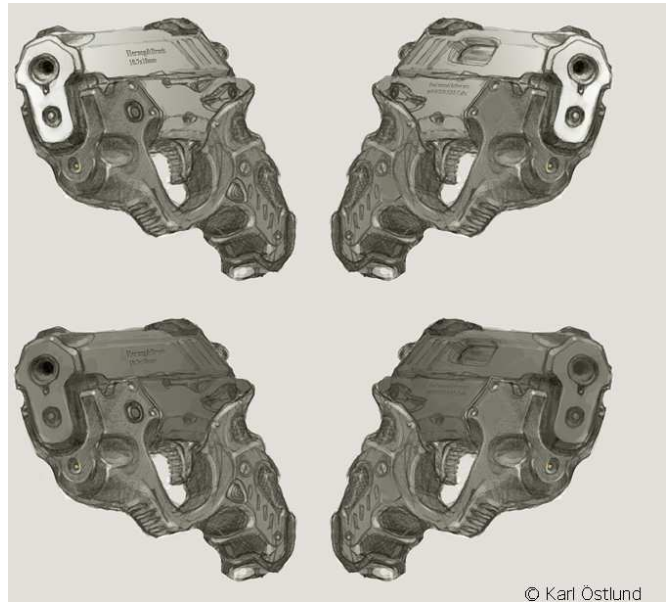

© Karl Ostlund

ARASAKA GCP-H 870eb

P - +2 - J - R - 2D6+3 (10mm cased) - 16 - 1 - VR

Not yet available to the general public, this 10mm handgun is the standard issue sidearm to Arasaka Combat Personnel at the moment. Extremely comfortable to fire, this weapon also features an integral laser sight built into the barrel shrouding and comes equipped with grip pressure safety and smartlinked as standard. Unavailable for private sale at the moment, this weapon will fetch x3 the cost.



ARASAKA "MASTER" 650eb

P - +2 - J - C - 2D6+3 (10mm caseless) - 12 - 1 - VR

A nice smooth firing combat weapon, designed for their elite corporate Black Ops teams. Comes standard with a laser sight, and was designed with a hair trigger for rapid fire.

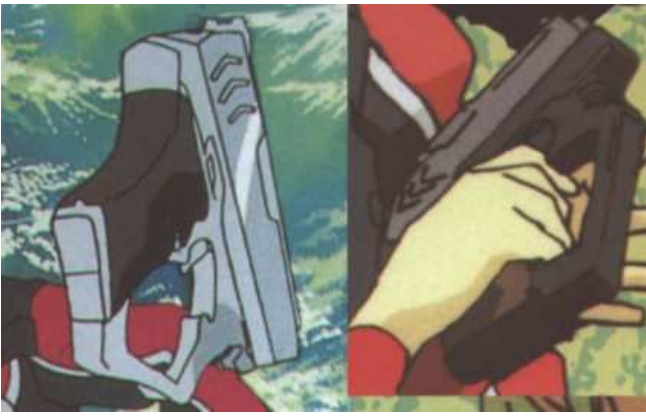

ARASAKA "MISA" 620eb

P - +1 - L - P - 2D6+3 (10mm cased) - 10 - 1 - VR
 This weapon was originally designed as a large caliber purse gun, after female operatives complained that most of the guns were either too large to conceal in a small purse, or didn't pack enough of a punch. It has also become popular with men as a holdout, or backup piece.



ARASAKA PDW-77 935eb

P - +2/-1 - J/L - C - 2d6+3 (10mm) - 16/34 - 1/3/25 - ST
 A fully automatic pistol that accepts a variety of options, including detachable stock, scope, fore grip, flashlight/laser sight combo, and suppressor. A standard 18 round mag and 36 round extended magazine is available. Popular with ICMF officers.



ARMALITE TKS-1 875eb

P - +3 - L - P - 2D6+3 (10mm caseless) - 10 - 1 - ST
 This weapon is a classic example of way too much. It comes standard with a built in scope, laser sight, tactical flashlight, and smartchipping. While revolutionary, the weapon is also very large, and if something electronic breaks repairs are very difficult.



ARMALITE "KNUCKGUN" 2375eb

P - -1 - J - C - 2D6+3 (.10mm caseless) - 12 - 1 - ST
 The only gun manufactured today that serves as both fire-arm and brass knuckles, rumor has it that it was designed by and for gun-fu practitioners. By flicking a switch, you lock the trigger in place, and the barrel extension becomes the new trigger, firing the round upon impact, very nasty stuff, just don't forget which setting its on and accidently drop your piece.



BERETTA CPC-8 325eb

P - 0 - J - C - 2D6+3 (10mm caseless) - 10 - 1 - VR
 This sleek Beretta has an integral laser sight and fires caseless ammunition. It is a beautifully designed gun, the best we have seen from Beretta in a long time.



BERETTA M-2017 325eb

P - +1 - J - C - 2D6+3 (10mm caseless) - 14 - 1 - VR
 This heavy Beretta was made for combat and abuse, and since its introduction it has gained a measure of popularity, particularly in Europe.



BROWNING "PALUN" 565eb

P - +1 - J - E - 2D6+3 (10mm caseless) - 8 - 1 - ST
Very lightweight, but reliable, the Palun from Browning is a popular choice among professionals and guards who have to carry a sidearm for extended periods of time.



COLT 10mm COMPACT "NEW STANDARD" 250eb

P - 0 - P - E - 2D6+3 (10mm cased) - 10 - 1 - VR
A simple compact 10mm, easily concealed. This firearm is popular with booster gangs and as a purse gun for women.



BUDGET ARMS PRO-GAT 215eb

P - -3 - L - E - 2D6+3 (10mm caseless) - 8 - 1/3 - UR
One of the most absurdly inaccurate guns on the market. It comes with a laser sight, but even that is garbage. At the flip of the switch you can have 3-round burst fire, but that just drops the inaccuracy down another point. For gods sake, won't someone please close down Budget Arms...



COLT GOVER 190 EB

P * +2 * J * C * 2D6+3(10mm) * 6 * 1 * VR *
There isn't a whole lot of data on the Gover but I believe it to be 10mm. Commonly loaded with A/P ammo.



CESKA ZBROJOVKA "LUG" 485eb

P - +2 - J - P - 2D6+3 (10mm caseless) - 10 - 1 - ST
Maximized for accuracy, this handgun is popular among shooting enthusiasts.



COLT RASCAL 380eb

P - +1 - J - P - 2D6+3 (10mm cased) - 12/30 - 1/3 - VR
This is the revamped version of the failed Colt Scamp. It offers a more powerful and common cartridge in 10mm. A select fire switch allows a choice of semi-auto or 3-round burst. A 30 round clip is available.



CLARIDGE HI-TEK MODEL X&X-2 620/760eb

P/SMG - +2 - J - C - 2D6+3 (10mm cased) - 16/30 - 1/10 - VR

A late 1980's design, this firearm is the successor to the original Hi-tek in 9mm. The model X is a semi-auto pistol while the X-2 is select fire. Due to superior gun design, the 30 round magazine reduces recoil by adding and balancing the weight, allowing for more controllable full auto firing. The gun already weighs 4 pounds so some upper body strength is needed to continuously carry this hefty pistol.



CONSTITUTIONAL ARMS "COMRADE" 630eb

P - -1 - J - P - 2D6+3 (10mm cased) - 12 - 1 - ST
Well crafted and incredibly stylish, the Comrade from Constitutional Arms is a common sight in military and private security forces around the world.



CONSTITUTIONAL ARMS LDD-4 995eb
 P - +2 - J - C - 2D6+3/varies (10mm caseless/12mm cased) - 12/4 - 1/1 - VR

The DD-MAP is a huge, heavy weapon. Most street cops don't want or need to carry that much firepower. So for police operating in the corporate zone and other lower risk areas, Constitutional arms created the LDD-4. The main barrel is chambered in 10mm, while the lower barrel, still chambered in 12mm, has had its capacity reduced by 2. Overall this weapon weighs about half that of the DD-MAP.

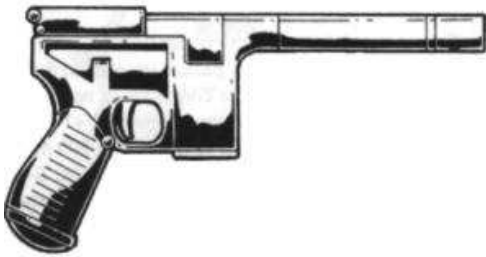

DAI LUNG "HAN" 225eb
 P - 0 - J - P - 2D6+3 (10mm caseless) - 8 - 1 - ST
 This Mauser inspired handgun is a popular weapon amongst Asian smugglers, pirates, and bandits.



DUTCH ARMS P-10 550eb
 P - +1 - J - E - 2D6+3 (10mm caseless) - 14 - 1 - ST

An inexpensive but fairly reliable weapon, with a nice ammo capacity and decent caliber, this weapon sells well, and is common with professionals as well as on the street.



FEDERATED ARMS "SA-58" 580eb
 P - +2 - L - P - 2D6+3 (10mm caseless) - 12 - 1 - VR
 Not attractive, but effective. Comes with a built in laser sight, and is guaranteed to stand up to abuse.



HECKLER AND KOCH "BASILEA" 840eb
 P - +2 - J - C - 2D6+3 (10mm caseless) - 15 - 1/3 - VR

Police and federal agencies are fast becoming enamored with this masterfully crafted and elegant firearm, and its 3 round burst capability and swing down front grip are nice additions.



H&K MP-505 655eb
 P - +1 - L - C - 2D6+3 (10 mm caseless) - 16 - 1/3 - ST
 Heckler and Koch are always expanding on their MP series of weapons. This time they are taking it in a new direction. The action remains virtually the same, the clip however has been placed inside the grip, and the weapon chambered for 10mm caseless. This makes the gun a bit smaller and more concealable. It is a select fire weapon, firing either single shots or 3-round bursts, and comes standard with a removable scope.



H&K SP-25 450eb
 P - -1 - J - C - 2D6+3 (10mm cased) - 16 - 1 - ST
 Another well designed firearm from Heckler and Koch. the removable barrel lug with laser sight and muzzle flash compensator make it a hot seller.

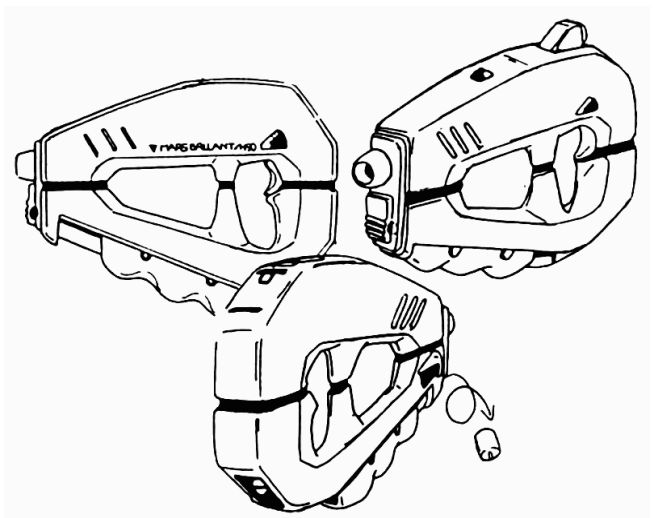

MALORIAN GALLANT 1050eb
 P - -1 - L - R - 2D6+3 (10mm caseless) - 10 - 1 - VR
 Now this is truly a different design of weapon. The magazine for the Gallant stacks the rounds in an almost half moon pattern in the back of the gun, and the barrel is actually curved slightly. One would think this would drastically reduce the accuracy of the weapon. However while there is some loss of accuracy, the state of the art engineering of the weapon keeps it comparable to standard handguns. The Gallant was built on a whim by Eran Malour himself, (just to see if it was possible as the rumor goes), and was not originally intended for production. However, the design drew such attention that Malour decided to put it out on the market in limited quantities.



IMI "BULLSEYE" 1285eb
 P - +4 - J - P 2D6+3 (10mm caseless) - 5 - 1 - VR
 An assassin's weapon derived from a target pistol. It features two telescopic sights, one for closer targets while the larger is used for shots at a longer distance, and an ultrathin, but very powerful laser sight. Venting along the barrel uses the weapons own discharge to keep in place while firing and the molded grip is so comfortable you will think you were born with it in your hand.



IMI "PEACE OFFICER" 625eb
 P - 0 - J - C - 2D6+3 (10mm cased) - 14 - 1 - ST
 Israeli police are issued this sidearm. It's a bit clunky, but what do expect from the people behind the desert eagle.



MALORIAN "SHIELD" 810eb
 P - +1 - J - P - 2D6+3 (10mm caseless) - 12 - 1 - VR
 Suitable for both target shooting and combat, the Malorian Shield is a master of firearm technology.



MATSUCORP BSGP A1 665eb

P - +1 - J - P - 2D6+3 (10MM) - 12 - 1 - VR

This is the standard sidearm issued to EDF military pilots, who demand style on their hips over functionality. The odd magazine design, which is loaded from the front just under the barrel, is innovative in a weapon of this size. The weapon is quite accurate and reliable, though reloading takes some getting used to. The molded grips are available in either a wood finish, or with a rubberized coating. This weapon uses caseless ammunition.



MATSUCORP "ISAAC" 515eb

P - +1 - J - C - 2D6+3 (10mm caseless) - 10 - 1 - ST

This caseless 10mm is yet another beautiful release from Matsucorp, whose fine innovative weaponsmiths crank out innovation in both function and form. The Isaac features integral laser sight and large ammo capacity. Extremely popular in law enforcement circles.



MILITECH M-701 1235eb

P - +2 - P - C - 2d6+3 (10mm) - 12/24 - 1/3 - R

Standard sidearm for military pilots and USAF personnel, featuring an integrated scope and laser sight. This is an extremely reliable handgun, it has to be, it is a pilots last desperate hope in the event of a crash. Militech mass produces this weapon solely for the United States Military. The weapon comes with detachable scope and stock, and a 35 round magazine is available.



MILITECH MPP-21 435eb

P - +1 - J - C - 2D6+2 (10mm cased) - 16 - 1 - VR
 Another in a long line of extremely reliable and durable handguns from Militech. Often given to pilots, officers, and bodyguards. It is an attractive, though simple looking weapon, with an incredibly smooth feel to it.

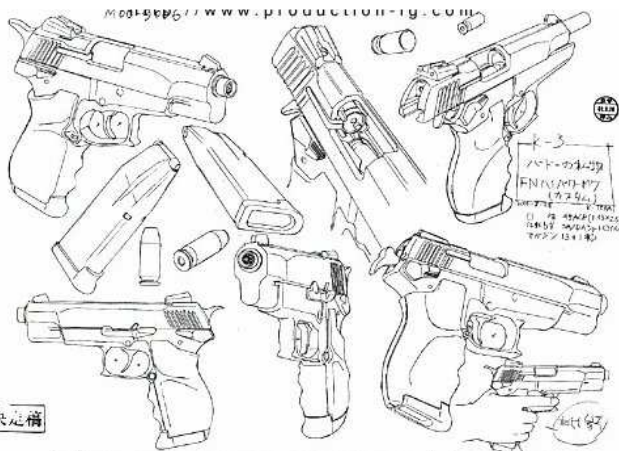

MILITECH P-343 380eb

P - 0 - J - C - 2D6+3 (10mm cased) - 16 - 1 - ST
 A very nice, very comfortable sidearm from Militech. Popular among its security officers as well as police and military. A professional's handgun through and through.



MUSTANG ARMS BFP-10 485eb

P - +1 - J - E - 2d6+3 (10mm cased) - 15 - 1 - ST
 This semi auto features a large underbarrel lug for stability with a built in laser sight.



NORINCO 167 850eb

P - 0 - J - P - 2D6+3 (10mm caseless) - 10 - 1 - P
 This is a decent, although somewhat jumbled weapon. It looks like something someone jury rigged together, but it is fairly cheap, and popular on the streets.



NORINCO 170 160eb

P - +1 - J - E - 2D6+3 (10mm cased) - 14 - 1 - UR
 This gun is even cheaper than the 167, and technically qualifies as a polymer one-shot, but is in high demand on the streets and in underdeveloped countries.



NORINCO VAD1 289eb

P - 0 - J - E - 2D6+3 (10mm caseless) - 10 - 1 - ST
 Another 10mm from Norinco, firing caseless ammunition and sporting no unnecessary options to keep prices down.



NORINCO BRK-3 360eb

P --1 - J - E - 2D6+3 (10mm caseless) - 12 - 1 - UR
 This could almost be a decent gun, but in the end it's a Norinco. The most common complaint is that too much stress on the trigger will break it and cause it to fall out completely. There have been reports that replacing the trigger with a higher quality piece actually makes it a pretty fair weapon.



NOVA ARMS "BLACKLINE" 650eb
 P - +1 - J - P - 2D6+3 (10mm cased) - 12 - 1 - VR
 A very reliable handgun, ideal for both security and combat roles. Although this is a fine weapon, two small points of discontentment have arisen, one being its left side ammo ejection, and the other being its incredibly touchy trigger.



RONIN ARMS "WHITE CRANE MK-II" 790eb
 P - +2 - L - R - 2D6+3 (10mm caseless) - 16 - 1 - VR
 The first white crane was so popular, they decided to do it again, this time chambered in the slightly smaller 10mm, but the gun is much more accurate now, and holds more rounds as well. In addition the grips are molded for comfort, although it is still unsure know how you carry that thing without cutting the crap out of yourself.



NOVA "OTTO" 550eb
 P - +1 - J - P - 2D6+3 (10mm cased) - 10 - 1 - VR
 Nova Arms released this sidearm in late 2014, its only remarkable feature is that it can be set to eject spent shells to both the right and the left side of the weapon with the flick of a switch. Ideal for left-handed or ambidextrous professionals.



ROSTOVIC CZ176 720eb
 P - 0 - L - C - 2D6+3 (10mm caseless) - 16 - 1/3 - ST
 Oversized, this Russian weapon is still attractive and well performing. A selector switch allows it to fire 3-round bursts.



REMINGTON "PINPOINT" 1150eb
 P - +3 - L - P - 2D6+3 (10mm caseless) - 5 - 1 - VR
 Another weapon, that was originally designed for target shooting, this gun has become a signature weapon of several European solo's. Its accuracy is phenomenal right out of the box, and its named is derived from being able to repeatedly hit the head of a pin at 20 yards with minimal bracing.

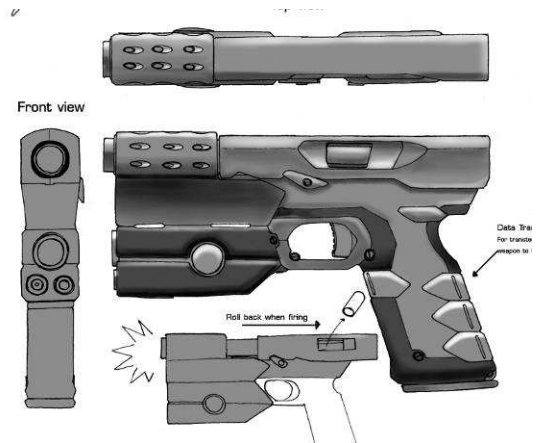

ROSTOVIC GD-35S 575eb
 P - +1 - L - C - 2D6+3 (10mm caseless) - 14 - 1 - ST
 The integral laser and flashlight combo is a nice addition to an already excellent piece of Russian weapons manufacturing.



RUGER "WILSON D-6" 700eb

P - +2 - J - C - 2D6+3 (10mm caseless) - 14 - 1 - ST
 A sturdy, though perhaps overly elaborate, weapon from Ruger, designed for the German police forces.



RUGER "BREN TEN" 620eb

P - +1 - J - C - 2D6+3 (10mm cased) - 14 - 1 - ST
 Somewhat clunky looking, but effective. Chambered in 10mm the Bren Ten is affordable and reliable, perfect for self defense.



RUMBLEFISH 75eb

(From Nomad Market)

P - -3 - P - C - 2D6+3 (10mm cased) - 1 - 1 - UR
 Brass Knuckles with a built in single shot gun. Horribly inaccurate and wildly dangerous, if armed they tend to go off if dropped. Popular with Raffeen Shiv.



RUGER "RACEGUN" 650eb

P - +2 - J - C - 2D6+3 (10mm cased) - 12 - 1 - VR
 Designed specifically for competition shooting, this weapon is nail driving accurate right out of the box.



SEBURO AP-506 420eb

P - +1 - P - C - 2d6+3 (10mm cased) - 10 - 1 - VR
 Sebuero is making its presence known. This latest handgun is a more standard designed weapon, though it retains all of Sebuero's style and reliability. It's relatively compact size and makes it an excellent backup piece, though it is fully capable of serving as a primary weapon as well. It makes the ideal service weapon for intelligence officers and detectives.



RUGER "TITAN" 615eb

P - +1 - J - P - 2D6+3 (10mm cased) - 12 - 1 - VR
 Another fine weapon from Ruger, the Titan is very comfortable and its smooth action and restrained recoil make it very accurate as well.

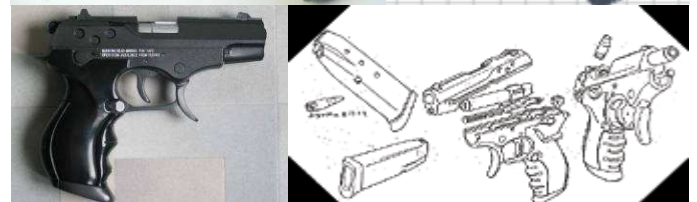



SIG SAP 845eb
 P - +2 - J - C - 2D6+3 (10mm cased) - 18 - 1 - VR
 Sleek powerful and effective, Sig remains at the forefront of manufacturing popular handguns.

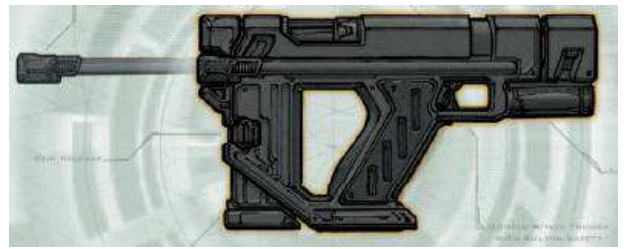

STERNMEYER TYPE 82 750eb
 P - 0 - J - E - 2D6+3 (10mm caseless) - 20 - 1 - ST
 While a bit larger than it needs to be, the Type 82 is a good weapon with a reliable record. It also boasts a very high magazine capacity, and rarely needs maintenance.



SMITH AND WESSON 6969 480eb
 P - +1 - J - C - 2D6+3 (10mm caseless) - 14 - 1 - ST
 Equally popular on the street as in the professional community, this S&W handgun is a solid and affordable choice.



STEYR MAYA-13 650eb
 P - +1 - J - C - 2D6+3 (11mm caseless) - 18 - 1 - ST
 A very affordable and well performing weapon with a built in laser sight. The extended clip is the only magazine available, however to better its aesthetic appearance the magazine fits snug into the barrel and beautifully extends the handle. So you don't have to sacrifice style for more ammo, unfortunately the longer magazine slightly hinders concealability.

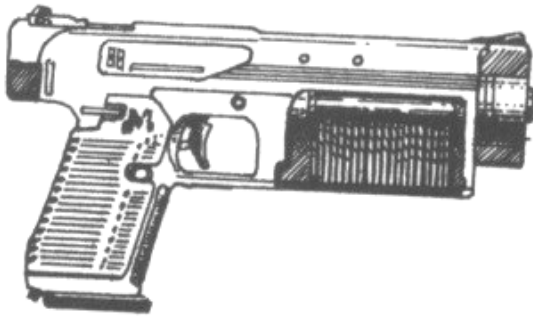

SMITH AND WESSON PS-3 620eb
 P - +1 - J - C - 2D6+3 (10mm cased) - 14 - 1 - ST
 A fine combat pistol designed with comfortable and accurate shooting in mind. Features built in underlug to reduce recoil, laser sight, and pachmayer grips.

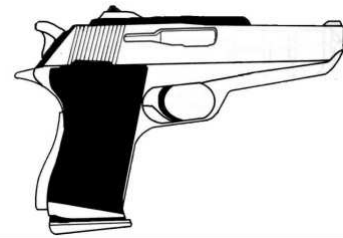

STURM RUGER VZ-98 190eb
 P - +1 - P - E - 2D6+3 (10mm caseless) - 10 - 1 - VR
 Yet another 10mm compact.



STERMEYER TYPE 45 525eb
 P - +1 - J - P - 2D6+3 (10mm cased) - 8 - 1 - ST
 A simple but effective design, the Type 45 relies heavily on the M-1911 frame for inspiration. A standard weapon, the only thing of note is that it comes with an integral laser sight.



TAURUS "LONG JIM" 475eb
 P - +1 - J - C - 2D6+3 (10mm cased) - 16 - 1 - VR
 A long slide 10mm, perfect for both combat and target shooting. Another in a long line of fine Taurus weapons.

.40 SMITH AND WESSON



TSUNAMI ARMS CRP-22 750eb
P - 0 - J - C - 2D6+3 (10mm caseless) - 16 - 1 - ST
This respectable release from Tsunami Arms is a born contender. The weapon's barrel is a bit long, but it features an integral laser sight and is extremely well balanced.



BROWNING ARCHOS 490eb
P - +1 - J - C - 2D6+3 (.40 SW cased) - 12 - 1 - ST
A classically designed semi-auto very reminiscent of the old Browning Hi-Power.



CESKA ZBROJOVKA CZ-100 596eb
P - +1 - J - C - 2D6+3 (.40 S&W cased) - 12 - 1 - VR
Smith and Wesson's latest semi-auto, the complete CZ system includes integral laser sight, and large magazine capacity.



TSUNAMI ARMS "GAIJIN" 658eb
P - +2 - J - C - 2D6+3 (10mm caseless) - 8 - 1 - R
A different looking gun to be sure, but a nice one none the less. They sell well.



TSUNAMI ARMS XP-65 535eb
P - +1 - J - P - 2D6+3 (10mm caseless) - 10 - 1 - ST
An unnecessarily large weapon, it is quite popular due to its intimidating looks.



DIES IKARIUS 600eb
P - 0 - J - C - 2D6+3 (.40 S&W cased) - 14 - 1 - VR
Word has it Dies was founded by a former H&K designer, and the relationship between the two companies is downright hostile. However if Dies can put out a gun like this, it's no surprise HK isn't happy about him being their latest competition.



FABRIQUE NATIONALE "DISTINCTION" 225eb
 P - 0 - J - P - 2D6+3 (.40 SW cased) - 6 - 1 - VR
 The French have long been the leaders in Style over Substance, and this antique styled sidearm merely goes further to reinforce that fact. Similar to an old Webley, American gun collectors have been known to pay a pretty penny to import these, some have paid as much as 5 times the cost.



SMITH AND WESSON "LIONMATIC" 425eb
 P - +1 - J - C - 2D6+3 (.40 S&W cased) - 10 - 1 - VR
 This relatively compact sidearm is a favored choice among police and security professionals. Its high ammo capacity and straight forward design make it ideal for everyday carry.



SMITH AND WESSON LP-4 464eb
 P - +1 - J - C - 2D6+3 (.40 S&W cased) - 12 - 1 - VR
 Smith and Wesson's latest showcase piece for their .40 SW round, a caliber of ammunition that has never really struck the public fancy.



SMITH AND WESSON SEA-LION 1325eb
 P - 0 - J - C - 2D6+3 (.40 S&W cased) - 16 - 1 - ST
 This experimental Smith and Wesson design does not need an atmosphere to operate, therefore it will work both in a vacuum, and deep underwater. It manages this by using compressed air, which it injects into the firing chamber. Testing is being done now to find out the limits of its effectiveness; however they have put the weapon on the market already in limited supply, in order to get customers to do some of the testing for them.



TSUNAMI ARMS DXP-40 730eb
 P - +1 - J - C - 2D6+3 (.40 S&W cased) - 10 - 1 - VR
 A very odd looking but effective and striking design sets the DXP-40 apart from the competition. It was hoped the weapon would be popular among police departments; however the reception on that front has been rather lukewarm at best. It has however become very popular in the private section, not just due to its looks, but the innovative barrel porting and integral flashlight, as well as standard smartlink, make it a more than adequate weapon.



VECTOR VICTOR 520eb
 P - 0 - J - P - 2D6+3 (.40 S&W cased) - 10 - 1 - ST
 Simple, effective, affordable.

HEAVY HANDGUNS

11MM



THE AHAB 475eb

P -1 L C 3D6 (11mm caseless) 8 1 ST

This hand built weapon was designed for a Thelas Tribal leader, but he never claimed it, so now it is here for sale. It comes with 3 ten round magazines, and 2 twenty round mags. It will not accept any options whatsoever.



ARASAKA "COYOTE" 580eb

P - +1 - P - C - 3d6 (11mm caseless) - 8 - 1 - VR

Arasaka developed the "Coyote" two years ago, and its popularity has skyrocketed. Its appearance is one of the biggest reasons for its popularity, and has caused it to be widely utilized on both the large and small screens. It is equally as popular to the professional as to the amateur, and has become quite a high seller for Arasaka, and of course Autumn Blade.



ARASAKA ESCHELON 750eb

P - +1 - P - P - 3d6 (11mm caseless) - 8 - 1 - VR

This beautiful weapon is often issued to Arasaka employees as reward for their service to the company.



ARASAKA JS-92 865eb

P - +2 - J - C - 3D6 (11mm cased) - 12 - 1 - VR

This finely crafted handgun is one of the best 11mm weapons on the market. Hard hitting and extremely accurate right out of the box. Short (-100eb), standard, and extended barrel (+145eb) versions are available, as well as caliber conversion kits for each model, allowing you to interchange between 9mm (25 shot), 10mm (18 shot), 12mm (12 shot), and 14mm (10 shot). Rechambering the weapon is simple and can be done in less than two minutes.

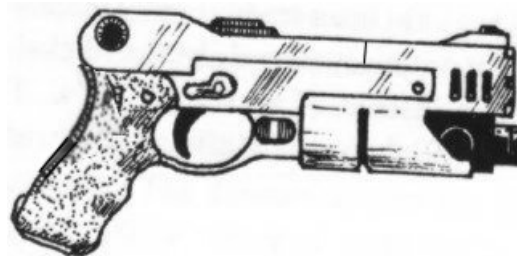

ARASAKA "MARSON" 975eb

P - +2 - J - C - 3D6 (11mm caseless) - 12 - 1 - VR

One of the high selling points of this weapon are the molded grips, available in either wood or rubber. It also features built in tac-light and laser sight. Smartchipping is available.



ARASAKA "OTOMO" 580eb

P - +1 - J - E - 3D6 (11mm caseless) - 14 - 1 - VR

A fairly normal weapon, nothing remarkable, but a good gun, with decent accuracy and ammo capacity.



BERETTA "EQUILIBRIUM" 730eb

P - +1 - J - P - 3D6 (11mm caseless) - 12 - 1 - VR
 Never let it be said the Beretta doesn't build a beautiful weapon. While the gun itself is more than worth talking about, what is really interesting is the special addition of "melee spikes" in the magazines. At the flip of a switch, these spikes pop out, allowing your handgun to effectively be used as a club when the ammo runs out. While we are not sure of the actual necessity of such a device, it does act as testament to ingenuity.



BERETTA M-192 620eb

P - +1 - J - C - 3D6 (11mm cased) - 12 - 1 - VR
 Beretta returns to its roots with this weapon, bringing back its classic style to this finely crafted and powerful handgun.



BERETTA M-197 620eb

P - 0 - J - C - 3D6 (11mm cased) - 12 - 1 - ST
 Beretta continues to make its mark with style and performance, the M-197 has a solid record and is a favorite among European security professionals.

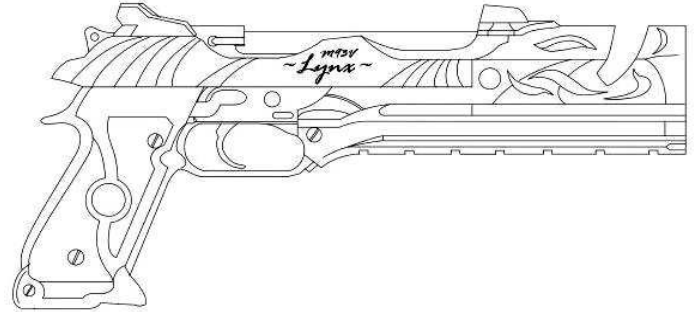

BARRETTA/LUIGI FRANCHI M-93V "LYNX" 1479eb

P - +2 - P - R - 3D6 (11mm caseless) - 14 - 1 - VR
 The most respected weapon manufacturers in Italy got together to release a custom anniversary limited run of the M-93. Chambered in 11mm and incapable of 3-round burst, this gun is maximized for accuracy and elegance. A true talking piece for wealthy executives. The solid gold accenting, red suede grips, and custom barrel porting make this weapon one of the most prized in the world. A standard black, teflon coated, model is available for 200eb less



BUDGET ARMS "CYBERDROP" 245eb

P - 0 - J - E - 3D6 (11mm cased) - 10 - 1 - UR
 By using styling similar to much heavier firearms, Budget Arms has managed to make quite a profit selling this weapon. The problem with it is, the slide is too heavy, and often the blowback of the 11mm round is not sufficient to work the action properly, resulting in frequent jamming problems.



BUDGET ARMS "CYBERDROP-2" 260eb
 P - 0 - J - E - 3D6 (11mm cased) - 14 - 1 - ST
 They fixed the slide problem, and redesigned the grip, allowing for 12 rounds in the magazine. Which actually turned this into a fairly decent weapon. Amazing, Budget Arms actually got it right for once.

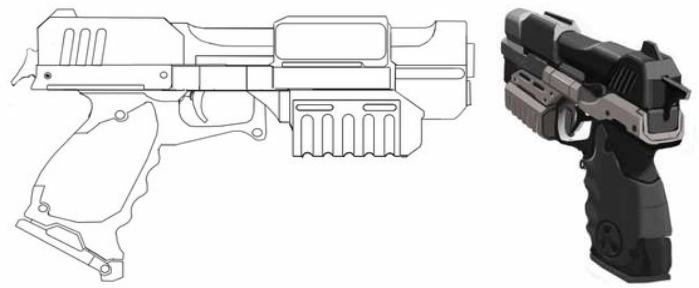

CESKA ZBROJOVKA CZ-105 575eb
 P - 0 - J - P - 3D6 (11mm cased) - 12 - 1 - VR
 With its heavy barrel shroud acting as a counterweight against recoil, and the integral laser sight, this is a weapon that is very accurate at driving its 11mm ammunition home.



BUDGET ARMS "THUNDERCAP" 325eb
 P - -1 - J - E - 3D6 (11mm caseless) - 14 - 1 - UR
 Proving that they can screw up anything, BA took one of their few non-junk designs, and then crapped all over it. Even with the built-in sight (read cheap piece of Taiwanese crap welded to the frame) this weapon is still only slightly less accurate than camel spit, and it has a tendency to jam if fired rapidly.



CESKA ZBROJOVKA CZ-185 680eb
 P - 0 - J - C - 3D6 (11mm cased) - 10 - 1 - VR
 A very popular sidearm among eastern European military and police personnel. Its style, reminiscent of a Colt 1911, but with that European flair, can be very intimidating. So much so that it is equally popular among eastern European criminal organizations. The fact that it is reliable as hell doesn't hurt either.



CCMMC CYF-11 650eb
 P - +3 - J - P - 3D6 (11mm cased) - 12 - 1 - ST
 While it's true that the Chinese police and military rarely have need for any handgun larger than 9mm on their own soil, it became apparent fast that in order to combat the west China would have to equip their soldiers with something with a little more punch. The Chinese developed the CYF-11, an 11mm handgun that comes complete with integral laser sight, and removable IR scope and tac light. A suppressor is also available, making the weapon ideal for Chinese special forces. Not quite as attractive or well built as the SOCOM 2020, but a fine weapon none the less.



CESKA ZBROJOVKA CZ-468 710eb
 P - +1 - J - C - 3D6 (11mm cased) - 14 - 1 - VR
 The standard sidearm for most eastern European police forces. Accurate and reliable and just a little bit showy.



CCMMC HCP-76 765eb

P - 0 - J - C - 3D6 (11mm caseless) - 10 - 1 - ST
 A large somewhat unwieldy handgun with an integral laser sight. The Chinese began issuing these as a response to the overwhelming firepower of the weapons issued by US and EDF armed forces. The price for this weapon makes it worthwhile, and it is a fairly sturdy design.



COLT "PANTHRO" 605eb

P - 0 - J - E - 3D6 (11mm cased) - 10 - 1 - ST
 The legacy of the 1911 frame never dies, it just gets better and better. This weapon is maximized for accuracy and the barrel venting helps aid in reducing recoil.



CCMMC ZP-68 490eb

P - 0 - J - 3d6 (11mm caseless) - 12 - 1 - ST
 A cheap but decent handgun, sold in bulk from China to SAA forces. For an additional fee the weapon comes with a lasersight/flashlight combo (25eb) and/or a suppressor (15eb). These weapons, in their standard form, have become as common as cockroaches in Central and South America, though the upgraded versions are usually reserved for officers, cartel officials and their bodyguards, and the most elite of SAA soldiers.



COLT "VIGOR" 650eb

P - 0 - J - P - 3D6 (11mm caseless) - 12 - 1 - ST
 The Colt Vigor is an excellent weapon chambered in 11mm, and capable of serving whatever requirements you might have of your sidearm.



COLT "MARMADUKE" 640eb

P - +1 - J - C - 3D6 (11mm caseless) - 12 - 1 - ST
 A very sturdy and reliable weapon from Colt, America's best known manufacturer of firearms. Its considerable heft and intimidating looks keep it popular among professionals.



DAI-LUNG ODII-11 470eb

P - +1 - L - e - 3D6 (11mm caseless) - 13 - 1 - ST
 Made for Korean police, this simple, somewhat oversized weapon has all the aesthetic value of lead paperweight, but it functions rather well considering the manufacturer.



FABRIQUE DE NATIONALE GP-80 740eb
 P - +1 - J - P - 3D6 (11mm cased) - 14 - 1/3 - VR
 3-round burst capability and delicious styling make this a popular weapon, especially in the private security world where corporates want to make an impression with their visible security guards carrying it. The integral laser sight, switchable between standard red beam, and UV beam visible only with cyberoptics, is another nice addition.



FEDERATED ARMS "ELEMENT" 720eb
 P - -1 - J - P - 3D6 (11mm caseless) - 14 - 1/3/15 - ST
 Perhaps a bit oversized, this weapon from Federated Arms remains effective. Its internal battery powers both the integral laser and the somewhat redundant ammo counter. Federated Arms has promised that in the next six months there will be a back mounted 200 round ammo hopper.



FEDERATED ARMS BP-24 665eb
 P - +1 - J - C - 3D6 (11mm cased) - 10 - 1 - ST
 This weapon features a built in laser sight and the magazine has a large lip for easier grasping, especially in the case of cybernetic hands which sometimes slip.



GLOCK 39F 650eb
 P - +2 - P - C - 3D6 (11mm caseled) - 12 - 1 - VR
 A more conventional Glock, going back to the roots, chambered in 11mm. The weapon retains all the characteristics expected of the Glock, and the sleeker design prevents snagging.



FEDERATED ARMS "BABY-1" 90eb
 P - +1 - P - C - 3D6 (11mm cased) - 1 - 1 - VR
 An extremely small 1 shot derringer chambered in 11mm. Makes a perfect holdout piece. To reload it you screw off the rear cap and manually insert a single bullet (takes 3 rounds).



GLOCK 94 880eb

P - +1 - J - C - 3D6 (11mm cased) - 14 - 1/3 - VR
 The newest addition to the Glock line of semi-automatic handguns. This model is featured in 11mm cased ammunition, an integral laser sight, and select fire switch allowing for single shot or three round burst.



H&K "MAXTER" 710eb

P - +1 - J - P - 3D6 (11mm cased) - 10 - 1 - VR
 Heckler and Koch, one of the finest gunmakers of all time proudly presents the Maxter. A slim, relatively compact 11mm that feels like a dream in your hand. Comes smartchipped as standard and features an integral laser sight for quick target acquisition. This gun is sleek, and is made from state of the art ceramics.



GLOCK 124 725eb

P - +1 - L - C - 3D6 (11mm cased) - 12 - 1 - VR
 Glock is keeping it fresh without abandoning their origins. This latest weapon, chambered in 11mm is an ideal sidearm. They gave a facelift to their model this time around, yet it still is one of the most reliable sturdy weapons on the market.



H&K SOCOM 2020 785eb

P - +1 - P - E - 3D6 (11mm caseless) - 12 - 1 - VR
 The SOCOM 2020 possesses all of the same features as its late 20th century counterpart, with the only difference being its larger ammo size.



GLOCK 2022 420eb

P - +2 - J - C - 3d6AP (11mm caseless) - 12 - 1 - VR
 Another Glock triumph, with just a hint of Colt influence. A perfect sidearm for any occasion and you know since it's a Glock it can stand up to the harshest abuse. And at 12+1 rounds you can keep firing till you're sure the threat is gone.



HECKLER AND KOCH "SHETLAND" 875eb

P - +1 - P - P - 3D6 (11mm caseless) - 12 - 1 - VR
 Another fine weapon from H&K that feels like it was made specifically for you when firing.

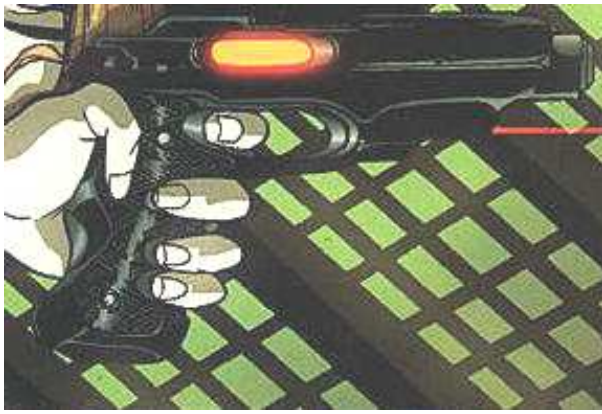

H&K "STAMMER" 625 eb

P - +2 - J - C - 3D6 (11mm cased) - 14 - 1 - VR

This weapon is a bit showier than it should be, with a luminescent ejection port (supposedly designed as a measure against burning yourself). Still it is stylish, and style sells big these days. Comes with an integral laser sight, and the ejection port light feeds of the same battery. Very comfortable action, and soft rubber grips insure a firm grasp.



H&K "TEMPER" 375eb

P - +1 - L - C - 3D6 (11mm cased) - 12 - 1 - ST

A good combat handgun, a little long, but quite effective. With a built in laser sight this is a fine weapon to own.



HECKLER AND KOCH "VECTOR" 625eb

P - +1 - J - C - 3D6 (11mm cased) - 11 - 1 - VR

Truly a finely crafted work of art, the Vector is sleek and smooth with no overt snag points and a feel while shooting that won't be denied. Very few moving parts and the exterior of the weapon consists of only two pieces, the slide and the frame making for a very sturdy and low maintenance handgun. The perfect size for concealability the Vector is gaining immense popularity with body guards and undercover agents.



H&K VP-80 625 eb

P - +2 - J - C - 3D6 (11mm cased) - 14 - 1 - VR

Once again in 2012 H&K entered their VP design of handguns for the U.S. Forces handgun trials. Although this time they used the much more powerful 11mm round. Unfortunately H&K lost the bid again, this time to Colt. However the VP-80 reached popularity in many other markets and now serves as standard sidearm to many militaries and police agencies around the world. Like its predecessor the VP-70, when fitted with optional shoulder stock (200eb) takes on the ability to fire 3 round bursts.



LUCZNIK RADOM LRP-234 665eb

P - 0 - L - C - 3D6 (11mm cased) - 12 - 1 - ST

A bit oversized, but still combat worthy. And its intimidating styling is plain for all to see.



LUIGI-FRANCHI "CRUSADER" 1995eb

P - +1 - J - R - 3d6 (11mm cased) - 12 - 1 - VR

An absolutely beautiful limited edition (600 made) collectors piece, but make no mistake, it is very much combat capable, it would just be a shame to see its beautiful patina, or gold filigree, get damaged. Unlike the cheap one shots who try to imitate the "bling", this handgun sets the standard they, and their customers, only wish they could attain.

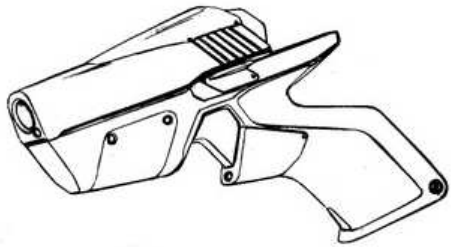

MALORIAN MX POCKET 395eb

P - -1 - P - R - 3D6 (11mm caseless) - 8 - 1 - VR

The first Malorian pocket gun lives up to their reputation. This weapon is a miniature work of art. A bit pricey, but the Malorian name alone makes it worth it.



MILITECH MPP-22 235eb

P - +1 - J - C - 3D6 (11mm cased) - 10 - 1 - VR

Just like the MPP-21, only chambered in 11mm as opposed to 10mm.



MILITECH "OFFICER" 450eb

P - +1 - L - E - 3D6 (11 mm caseless) - 12 - 1 - VR

This handgun was designed for officers as an alternate to the normal issued handgun.



MATSUCORP MATT-404 1175eb

P - +1 - J - P - 3D6 (11mm caseless) - 10 - 1 - VR

Newcomer Matsucorp makes a stunning entry into the large caliber handgun field with this 12mm monster. Beautifully designed and comfortable in your hand, this weapon is quickly gaining popularity in police and professional circles. The integral laser sight is a definite plus, and the sleek styling is as appealing as it is effective.



MILITECH "SEWER RAT" 550eb

P - -2 - J - C - 3D6 (11mm caseless) - 14 - 1 - VR

Militechs larger brother to the Rat, made with the same standards of durability and purpose. Submerge this gun in freezing water for 24 hours, drag it through the muck, have an elephant stomp on it, the gun will still fire perfectly every time.



NORINCO T-38 NORCOM 340eb
 P - 0 - J - C - 3D6 (11mm cased) - 13 - 1 - ST
 This is the standard handgun for all Chilean Military and Police forces. It features an integral laser sight and available suppressor.



ROSTOVIC JADER-11 460eb
 P - 0 - J - C - 3D6 (11mm caseless) - 10 - 1 - ST
 Exactly the same as the Jader-9, only chambered in 11mm.



NOVA ARMS PS-108 285eb
 P - -1 - J - C - 3D6 (11mm caseless) - 6 - 1 - ST
 This large weapon is popular with private security forces and anyone else looking for a little punch. Not very accurate, but reasonably affordable.

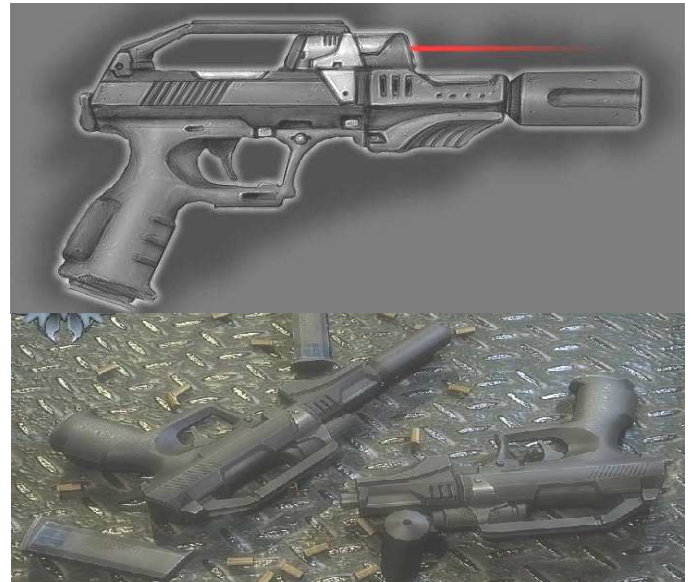

ROSTOVIC UTF-15 795eb
 P - +2 - J/L - R - 3D6 (11mm caseless) - 14 - 1 - VR
 Designed specifically for Russian special forces, the UTF-15 features an integral laser sight and removable suppressor for black ops work. It also comes smart chipped and the rail on top accepts a variety of scopes.



RONIN ARMS "WHITE CRANE" 490eb
 P - +1 - L - R - 3D6 (11mm caseless) - 13 - 1 - VR
 Ronin arms is a newcomer to the industry, former bosozuka turned weaponsmiths, they have an eye for style. Their trademark is attaching blades to their weapons. This makes them extremely popular among street gang leaders and yakuza.



SEBURO "TTA TERRAN" 820eb
 P - +1 - P - E - 3D6 (11mm cased) - 12 - 1 - VR
 Another fine semi-automatic handgun from Sebuero, with an integral laser sight/flashlight and smartlinking as an available option.



SEBURO "YOSHINO" 650eb
 P - +1 - J - C - 3D6 (11mm cased) - 12/18 - 1 - VR
 Smooth design and exacting quality make this a truly beautiful handgun. Sebuo style is in full effect and the weapon comes with a standard 12 round clip and an extended 16 round magazine as well.



SMITH & WESSON HP654 520eb
 P - +J - J - C - 3D6 (11mm caseless) - 12 - 1 - VR
 A reliable hard hitting weapon that never fails to impress. The HP654 is the sidearm of choice for the corporate body guard set, and its reasonable price insures its success in the market.



STEIN AND WASSERMAN DRM-47 620eb
 P - +1 - J - C - 3D6 (11mm caseless) - 12 - 1 - ST
 An overly large 11mm handgun firing caseless ammunition. The oversized design makes it popular with gangs and anyone else who needs more bark than bite.



SURVIVOR 600eb
 (From Nomad Market)
 P/RIF - +1/+2 - L/N - R - 3D6 (11mm caseless) - 10 - 1 - VR
 A gunsmith from Oregon makes these. The rifle barrel and stock are removable, but increase the accuracy rating by one increment when attached. It comes standard with a thermoptic scope attached. Excellent for both defense and bringing down small game.



TOKAREV BCPP-2017 540eb
 P - +1 - J - C - 3D6 (11mm caseless) - 12 - 1 - VR
 Standard military sidearm Neo-Soviet army. A smartlinked version is available for an extra 50eb, and both versions come with integral laser sight / flashlight combo.



TSUNAMI ARMS CLAB-4 480eb
 P - -2 - J - E - 3D6 (11mm caseless) - 8 - 1 - ST
 Not very accurate, mostly due to its complete lack of sights, but more reliable than most of Tsunami's wares. On the plus side, it is fairly compact and easily concealable.



WALTHER NEO PISTOLET 12 665eb
 P - +1 - J - P - 3D6 (11mm caseless) - 13 - 1 - ST
 Walther gives us a glimpse into their perceived possible future with this weapon. Other than the way it looks though, there is really nothing special about this gun except for the fact that is constructed with lightweight ceramisteel and polymers.



WWA "YURI" 465eb
 P - +1 - J - P - 3D6 (11mm caseless) - 12 - 1 - ST
 WWA presents their newest handgun, comprised almost completely of ceramic and polymer plastics, this weapon is state of the art, and packs enough punch for any party. Integral laser sight is standard.

.357 MAGNUM



COLT M-720 400eb

P - +1 - J - P - 3D6+1(.357 magnum cased) - 6 - 1 - VR
 A very large gun, originally designed for the military, but it has since gained a following in the civilian market.



CONSTITUTIONAL ARMS B34P 335eb

P - +1 - J - C - 3D6+1(.357 magnum cased) - 6 - 1 - ST
 An oversized .357 with a built in laser scope. From looking at the gun it would seem that it is chambered for a much larger round, perhaps this is the main reason it sells.

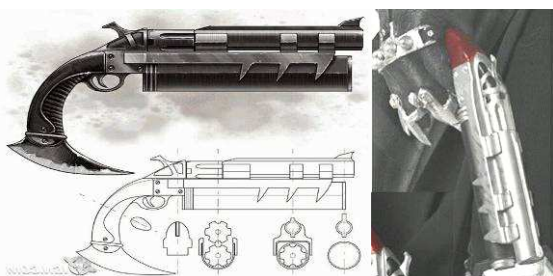

DARKWATCH 940eb
 (From Nomad Market)

P - +2 - L - U - 3D6+1(.357magnum cased) - 30 - 1 - VR
 This has to seriously be one of the most inventive, unique, and just plain neat whiz bang guns I have ever seen. Want the reliability of a revolver but don't want to sacrifice ammo count, well pardner, this is the gun you have been waiting for. The firing mechanism acts like any other revolver, chambered for the always common .357 round. Where it gets different is the long tube underneath that actually holds another 4 fully loaded cylinders. At the touch of a lever the empty cylinder is ejected upwards from the gun, and the next cylinder just cycles right into place. In other words, in the time it takes you to pull the trigger you can reload your weapon. Cylinders are replaced by pulling the rear of the tube down and pushing them in one at a time. And just for that extra bit of cool, whoever built this thing put a blade on the bottom of the grip, so you can use the gun like an axe in close quarters combat. Although be careful of the quick draw, might lose a finger.



FEDERATED ARMS "PONYBOY 357" 210eb

P - +1 - J - C - 3D6+1 (.357 magnum cased) - 6 - 1 - VR
 A nice revolver from FA, with a weighted barrel to keep muzzle climb down and rubber grips for better aim and comfort. A fine weapon popular in many circles. Perfect for police work and home defense.



GEIND EL-528 900eb

P - +2 - P - P - 3D6+1 (.357 magnum cased) - 4 - 1 - VR
 Genetically grown Ivory grips, gold accent, and absolute precision. This weapon is the flagship of the Geind catalog. Watch out Luigi-Franchi...



GEIND EL-645 420eb

P - +2 - P - C - 3D6+1 (.357 magnum cased) - 5 - 1 - VR
 The EL-645 is a workhorse of a weapon, and makes the perfect back up for just about anyone. Comfortable grips, accurate, and hard hitting chambered in .357.



GUNBLADE KNIFE 320eb

(From Nomad Market)

P/MEL - +2/NA - J - U - 3D6+1/1D6 (.357 magnum / melee) - 6 - 1 - VR

Someone was apparently inspired by the Paladins gunblade, or perhaps this itself is one of the Paladins signature weapons. Having a blade only the size of a bowie knife would probably be a lot more wieldy in combat



LUIGI-FRANCHI "TIGRE" 1345eb

P - +3 - L - R - 3D6+1 (.357 magnum cased) - 4 - 1 - VR

Old world style, modern age function. Luigi-Franchi shows once again why they are the most respected firearms manufacturer in the world. Luigi-Franchi guns aren't just works of art, they are meticulously accurate. There is a reason why Luigi-Franchi weapons are status symbols sought after by the wealthy and influential, this is an example of that reason.



LUIGI-FRANCHI "ECCENTRIC" 525eb

P - +3 - L - P - 3D6+1 (.357 Magnum cased) - 6 - 1 - VR

An incredibly accurate, though not overpowered, and beautifully styled weapon from Italian artisans Luigi-Franchi. When the simple act of owning a gun needs to make a statement, buy the best.



MUSTANG ARMS DIAMONDBACK .357 875eb

P - +2 - L - P - 3D6+1 (.357 magnum cased) - 8 - 1 - ST

This very large revolver is remarkable in that it holds 8 shots of .357 instead of the usual 6, but you pay for that with weight and loss of concealability. Still it is a very accurate weapon, and extremely intimidating. The gun also has one innovative design that sets it apart from the competition completely. To load, the weapon breaks open sideways, and you can either reload one chamber at a time, or release the catch and simply switch out the entire cylinder. But this is the interesting bit, Specifically for this gun, Mustang Arms has developed a cylinder, factory loaded, that holds sealed electro thermally enhanced ammunition, and the firing mechanism. You simply pop the cylinder in as you would a normal cylinder, and bam, you bang just got a lot bigger. When the cylinder is empty, just pop in a normal cylinder again, and either throw the ETE cylinder away, or take it to your nearest Mustang Arms Dealer and get a 10 percent discount off on your next cylinder. (ETE Cylinder is usually 25% above cost of ammunition.) Rumor has it they are working on a .44 Mag version.



LUIGI-FRANCHI CZ-105 575eb

P - +1 - J - R - 3D6+1 (.357 magnum cased) - 6 - 1 - ST

Each one of these beautiful revolvers comes hand engraved, a stunning collectors piece for any enthusiast. Once again Luigi-Franchi brings the style of the old world into the new, and never fails to impress.



"LOGAN'S GUN" 420eb

(From Nomad Market)

P - +1 - J - U - 3D6+1/4D6 (.357 magnum cased/12 gauge) - 6/2 - 1/2 - ST

Some crazy nomad welded 2 shotgun barrels to the sides of this old break open 3.57.



MUSTANG ARMS WHISPER III 1440eb
 P - 0 - J - R - 3D6+1 (.357 magnum cased) - 6 - 1 - ST
 Sitting on either side of this weapon are clamps, which seal the firing chamber, venting the gasses through the bottom of the weapons handle. The shrouded barrel is heavily insulated and serves as an effective sound baffle, creating a very suppressed weapon that cannot be heard from more than 20 feet away without augmentation.



NEWBLOOD 150eb
 (From Nomad Market)
 P - 0 - J - U - 3D6+1 (.357 magnum cased) - 4 - 1 - ST
 Hand made using a rifles firing mechanism, and with a scope attached directly to bolt lever. The magazine is loaded just in front of the trigger guard, holding 4 .357 rounds.

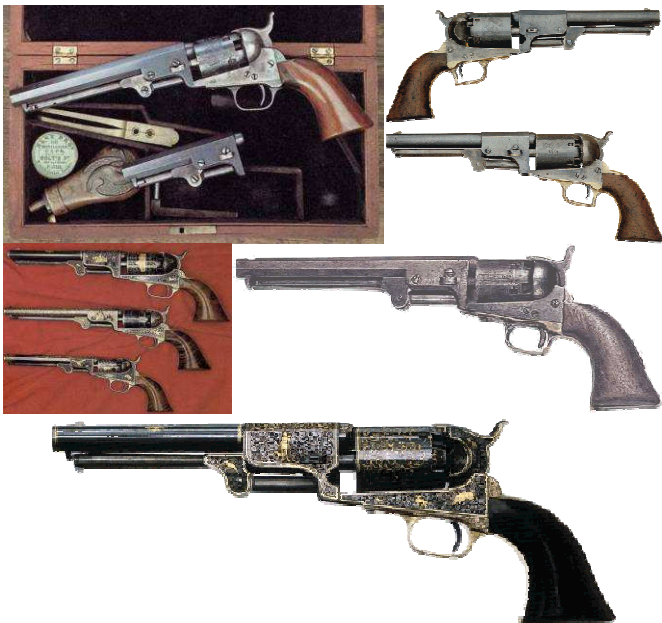

NOMAD COLT MODEL 1851 NAVY 2020 300+eb
 (From Nomad Market)
 P - +1 - J - R - 3D6+1 (.357magnum cased) - 6 - 1 - VR
 Also made by Paleriders, this model as well has the classic look upgraded to modern standards, and is also available in .45 cal and .44 magnum.



NOMAD SATURDAY NIGHT SPECIAL 75eb
 (From Nomad Market)
 P --2 - P - E - 3D6+1 (.357magnum cased) - 5 - 1 - ST
 A very cheap, but surprisingly reliable weapon. The lack of any real sights whatsoever, and the hammerless design, are a bit odd, but for a back up piece, or emergency defense, it does the trick just fine. Of course many nomads use this weapon as their main sidearm, but that is probably more due to cost than anything else. Made by Technomancers and sold here in the market. No two are ever exactly the same. (actual caliber of weapon varies, from .38 special to .44 magnum)



SEBURO "VERMILLION II" 420eb
 P - 0 - P - C - 3D6+1 (.357 magnum cased) - 6 - 1 - VR
 A compact snub nose revolver with a built in laser sight. Seburo once again garners the attention with their comfortable and streamlined design. A very popular back up piece or purse gun.



SMITH AND WESSON ALF 120eb
 P - -2 - P - E - 3D6+1 (.357 magnum cased) - 5 - 1 - ST
 The ALF is an extremely compact revolver, designed as an emergency back up weapon to be kept in the car, home, or office.



SMITH AND WESSON "DUNO" 345eb
 P - +1 - P - E - 3D6+1 (.357 Magnum cased) - 6 - 1 - VR
 Another fine snub nosed revolver from the people who know them better than anyone else.

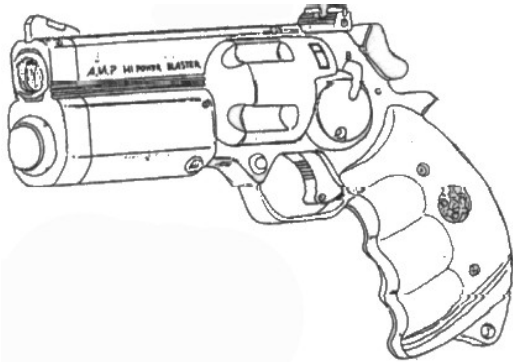

SMITH & WESSON "COLDSNAP" 320eb
 P - +J - J - C - 3D6+1(.357 magnum cased) - 6 - 1 - VR
 Another fine revolver from Smith and Wesson, very stylish with clean lines and hard hitting enough to serve all your needs.



SMITH AND WESSON "HESTON" 310eb
 P - +1 - J - C - 3D6+1 (.357magnum cased) - 6 - 1 - VR
 This revolver was created in memory of Charlton Heston as recognition of his service to the NRA. The weapons heavy barrel shroud is distinctive, and creates a unique profile that screams style.



SMITH AND WESSON "DEVIL'S CEASAR" 475eb
 P - +1 - L - C - 3D6+1 (.357 magnum cased) - 6 - 1 - VR
 A very attractive, well performing weapon from Smith and Wesson. Ideally suited for the harsher climes of the desert or jungles that lead to so many jammed semi-automatics. Hi-Way cops love these things, as do nomads.



SMITH AND WESSON MODEL 286 200eb
 P - 0 - P - C - 3D6+1 (.357magnum cased) - 5 - 1 - VR
 An exceptional weapon for pocket or purse, very popular among women as a self defense gun. Also popular with professionals as a holdout weapon, it's small size means it can fit just about anywhere, although watch out for snags, and the finger foregrip can easily get caught up.



SMITH AND WESSON "SARGE" 150eb
 P - -1 - J - P - 3D6+1 (.357 magnum cased) - 6 - 1 - ST
 This compact revolver is a popular police back up weapon.



SMITH AND WESSON LA SHARP 310eb
 P - +1 - P - C - 3D6+1 (.357magnum cased) - 6 - 1 - VR
 This revolver is low barreled, in the Mateba style, which helps center balance the weapon and reduce recoil... this in addition the to the heavy frame, makes for a more accurate weapon, even with the snub nose barrel length.



TSUNAMI ARMS WG-8 250eb
 P - 0 - L - E - 3D6+1 (.357magnum cased) - 6 - 1 - VR
 A simple revolver, commonly issued to police forces around the world.



TSUNAMI ARMS "WHITNEY" 275eb
 P - 0 - J - E - 3D6+1 (.357 magnum cased) - 6 - 1 - UR
 Available with wood or rubber grips, this is a decent weapon, and exceedingly common due to the relatively low price. However the open trigger has been known to snag and/or cause accidental discharge.

.41 MAGNUM



NORINCO FP-27 520eb
 P - +1 - J - C - 3D6+2 (.41magnum caseless) - 14 - 1 - ST
 Smartlinked standard, this weapon is an ideal combat sidearm for those on a budget.



ROSTOVIK GRIMJACK II 750eb
 P - +1 - J - P - 3D6+2 (.41 mag cased) - 14 - 1 - ST
 A reputable handgun from our friends in eastern Europe.



SIG SAUER SP2340 650eb
 P - +1 - L - C - 3D6+2 (.41 mag cased) - 14 - 1 - ST
 Integral laser sight and large ammo capacity make this a popular urban combat weapon.

VERY HEAVY HANDGUNS

.44 MAGNUM



ARASAKA LEH-451 645eb
P - +2 - J - C - 4d6 (.44 Mag cased) - 6 - 1 - VR
A common police issue sidearm, this revolver was made to compete with the Constitutional Arms police revolver and accepts the same variety of ammunition. This weapon is better received by the Police of Night City due to its more comfortable feel and lighter construction.

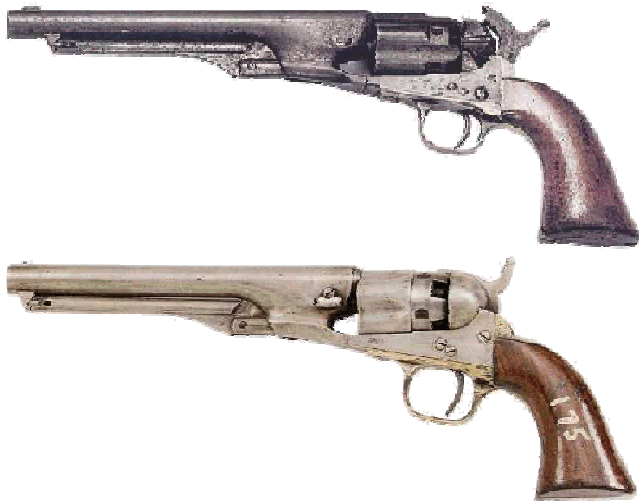

COLT 1860 2020 300+eb
(From Nomad Market)
P - +1 - J - P - 4D6 (.44 mag cased) - 6 - 1 - VR
Yet another of the Palerider guns, this time an 1860 model updated to accept the modern .44 magnum load. The simplicity and the style of these guns appeal to many nomads, especially the ones roaming the New American West. Available with any add on features you can think of, including variable barrel length and engraving. Extra cylinders are available for fast reloading, and the weapon is also available in .45 caliber, and .357 magnum. A 5 shot .454 Casull version is in the works.



COLT "BURMA" 610eb
P - +1 - L - C - 4D6 (.44 magnum cased) - 6 - 1 - VR
A very weighty handgun manufactured to grueling standards. It's big, it's intimidating, and it's beautiful. What more could you ask for from Colt.



C.O.P. .44 175eb
P - -1 - P - C - 4D6+1 (.44 mag cased) - 4 - 1 - ST
An upgrade of the popular pepperbox style derringer. A common Backup weapon. This gun has an interchangeable barrel clusters down to .22 cal and in either version this gun makes use of state of the art construction and is not detectable by even airport metal detectors.



DAI LUNG DW-14 460eb
P - -2 - J - C - 4d6 (.44 magnum cased) - 6 - 2 - ST
An inexpensive, unremarkable handgun, the sort of thing you would expect from Dai Lung. There is nothing special about the weapon, except maybe for its habit of not blowing up in your hand, a true rarity for Dai Lung.

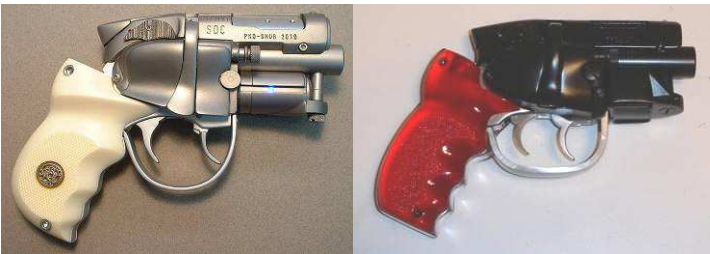

DECKARD CENTR'Y 500eb

(From Nomad Market)

SMG - +1 - J - C - 4D6 5D6+1-3d6 (44 magnum cased - 30-06 or 20 ga.) - 5/1 - 1 / 1 - VR

A man named Deckard builds these guns right here in the Nomad Market. He used to be a cop in a simpler time, one of the first members of LA's C-SWAT teams. After getting injured due to the inefficient firepower, he took his disability pay, and hit the road, and dreamed up this little baby. Firing a full sized 30-06 round, this weapon packs enormous wallop. NCPD originally looked into a contract with Deckard, but Norse Technologies quickly made his weapon obsolete for these purposes. Still this gun is a legend, and among cop circles, owning one is a symbol of pride. The weapon holds 5 rounds, and has an extra bonus of a 30-06 single shot for emergencies. This is one of the few weapons built by nomads which is seen with any regularity outside the community. Deckard makes about ten of these a month, and has recently hired a woman named Rachel as his assistant, so it's possible production may increase. A snub nose version is also available with a single shot 20ga replacing the 30-06.



GEIND EL-631 500eb

P - +1 - J - P - 4D6 (.44 mag cased) - 4 - 1 - VR

It only holds four shots, but it's incredibly accurate and reliable right out of the box.



IMI R-81 625eb

P - +2 - L - P - 4D6(.44 magnum cased - 6 - 1 - VR

A revolver from the people who brought you the Desert Eagle. Big, heavy, accurate, and bound to turn a few heads. Originally developed for Mossad, it is now available to you.



LUIGI-FRANCHI "BACKHAIL" 760eb

P - 0 - J - R - 4D6 (.44magnum cased) - 6 - 1 - VR

This Italian revolver is a beautifully designed weapon. The large frame hides an integral laser sight, and gives the entire weapon a smooth and elegant feel to it.



LUIGI-FRANCHI "NOBLEMAN" 2375eb

P - +1 - J - P - 4D6 (.44 mag cased) - 6 - 1 - VR

This gun leaves us breathless in its elegance and beauty. It harkens back to a time of honor and chivalry. Of course using it in combat is not recommended, though it is fully capable. It is one of the most highly sought after collector's pieces being produced today. Each one is hand made from scratch and uniquely engraved. Real ivory grips, solid 24 karat gold adornments, and more style than should be possible in a weapon



Revolt Kaiser
LUIGI-FRANCHI REVOLT KAISER 945eb
 P - +2 - J - P - 4D6/5D6+1 (.44 mag cased/30-06 cased) - 6/1 - 1/1 - VR
 The Safari 14 utilizes the same design as the 12 and 13, only with slight cosmetic alterations and rechambering. The main gun is a revolver chambered in .44 magnum, while the underbarrel is chambered in 30-06. The gun is available in either wood or Matter carbon, and comes with a free removable telescopic sight.



MILITECH "CLOVER" 885eb
 P - -1 - J - C - 4D6 (.44 mag cased) - 14 - 1 - ST
 Once again Militech is trying something new. At first glance one might think that this weapon has 3 barrels, in truth on the top one is the barrel, the middle being a laser sight, and the bottom a flashlight. The weapon has a very unique look to it, and rumor has it that it was originally designed for use in orbit by the military. However its large caliber of ammo renders these rumors unlikely.



NOMAD AUTO-44 400eb
 (From The Nomad Market)
 P - +2 - J - U - 4D6 (.44mag cased) - 7 - 1 - VR
 Part target pistol, part manstopper. Handmade and maximized for accuracy.



NOMAD CAPTAIN HARLOCK 650eb
 (From Nomad Market)
 P - +1 - J - U - 4D6 (.44 mag cased) - 6 - 1 - VR
 This electrothermally enhanced Colt Dagoon was made for Captain Harlock, one of the first pirates to emerge after the fall. His recent death in Lost Angeles has made this weapon available for purchase.



NOMAD FLINTLOCK 80eb
 (From Nomad Market)
 P - 0 - J - U - 4D6 (.44 mag cased) - 3 - 1 - VR
 This isn't actually a flintlock, but we were at a loss as to what else to call it. Ammunition for this weapon is loaded from the front just under the barrel. A single action weapon, only a nomad would carry this weapon... or possibly a lunatic.



NORSE TECHNOLOGIES "HELA" 1435eb
 P - +1 - J - C - 4D6 (.44 magnum cased) - 6 - 1 - ST
 The HELA is the lightest of Norse Technologies "GOD" line of revolvers, firing the .44 magnum. Can you believe they advertise this as a ladies gun, going so far as to cast the gun in red steel. Those Norwegians can be a scary bunch sometimes.

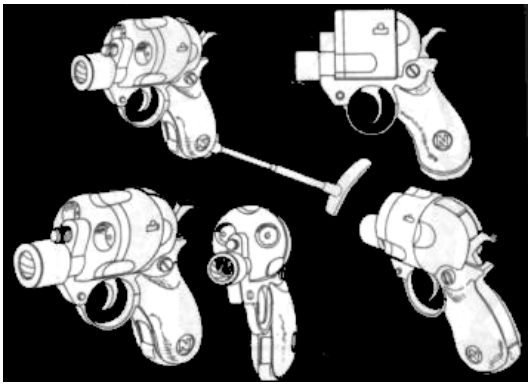

NOVA ARMS "POCKET" 155eb

P - -2 - P - P - 4D6 (.44 mag cased) - 3 - 1 - VR

This is a very small revolver, especially for the round it fires. Street gangs and women are especially fond of this weapon. To reload, you must remove the cylinder, and hand reload it, although for 10eb, additional cylinders can be purchased. For some reason, the weapon comes with a detachable stock.

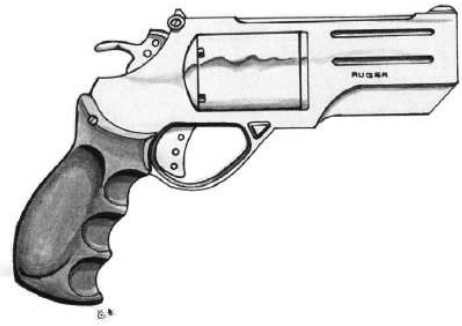

RUGER "RANGER" 445eb

P - +1 - J - P - 4D6 (.44 mag cased) - 6 - 1 - VR

An extremely reliable wheelgun from Ruger, popular with nomads, law enforcement, survivalists, hunters, and anyone who never wants their weapon to fail at the wrong time. Pack enough of a punch to get you out of near anything.



REMINGTON "LONER" 550eb

P - +2 - N - P - 4D6 (.44magnum cased) - 6 - 1 - VR

While technically a rifle due to the stock, its obvious that this is a finely made, and very accurate revolver. The stock can be removed in under a minute with a screwdriver, and the weapon's barrel is specially baffled with a built in suppresser. It comes standard with telescopic sight.



RUGER WB-44 485eb

P - 0 - J - P - 4D6 (.44 mag cased) - 6 - 1 - VR

Supposedly the WB stands for Wild Bill, whether that is the truth or not remains to be seen, what is known however is that this is a damn fine gun, comfortable, ridiculously reliable, and punches like heavyweight.



RUGER "BISON" 625eb

P - +1 - L - C - 4D6 (.44magnum cased) - 6 - 1 - VR

Available in 3 different styles, the Bison is making a name for itself among the law enforcement and hunting communities.



RUGER "VIKING" 645eb

P - 0 - L - P - 4D6 (.44 magnum cased) - 6 - 1 - VR

Designing a gun similar to one of the Norse Godline series of revolvers is Rugers way of taking a shot at their rivals dominance of the oversized handcannon market. It actually sells well to people who want to look like they have gun big enough to take down a rampaging borg, but don't really ever need to. For a high end wanna be, this is actually a very impressive weapon.

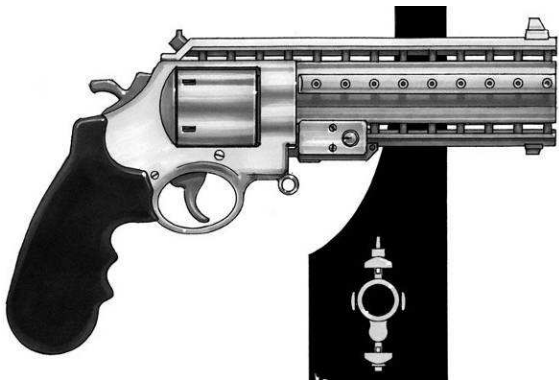

SMITH AND WESSON "BEEFEATER" 575eb
 P - +1 - J - C - 4D6 (.44 magnum cased) - 6 - 1 - VR

And intimidating and ugly wheelgun, big enough to get the job done, without breaking your wrist.

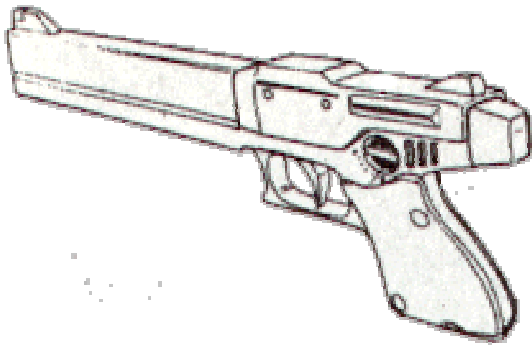

SMITH AND WESSON "BULLY" 695eb
 P - +2 - J - R - 4D6 (.44 mag caseless) - 8 - 1 VR

This is a nice weapon, very impressive accuracy, although the recoil is a bit much. Also its barrel is a bit long, which hampers its concealability, but its a fair trade for accuracy.



SMITH AND WESSON FISTER 160eb
 P - -3- P - C - 4D6 (.44 mag cased) - 3 - 1 - ST

This three shot weapon isn't meant to be fired normally... instead one arms it by pressing down on the buttons above and below the barrel, the thumb button is the safety, and you punch someone... the barrel itself is the trigger... when the barrel is pushed I slightly, it fires the weapon, point blank, into the target.



SMITH AND WESSON "KARMA" 660eb
 P - 0 - J - C - 4D6 (.44magnumm cased) - 5 - 1 - VR

Old cops, or anyone who loves the feel of a powerful snub nosed revolver, is going to love this weapon. Quite possibly the best in its class. It's heavy enough to feel meaty in your hands, yet compact enough to keep in a large jacket pocket.



SMITH AND WESSON ALDECALDO 560eb
 P - +1 - J - C - 4D6 (.44magnumm cased) - 5 - 1 - VR

This weapon is a replica of the gun the Mayor of Mexico City had commissioned to commemorate the 10 year anniversary celebration of the Aldecaldo's rebuilding the city after the quake, and the ongoing relationship the city and the nomads have enjoyed since. Now you can own a duplicate of this historic weapon... the weapon Santiago still carries today.

12MM

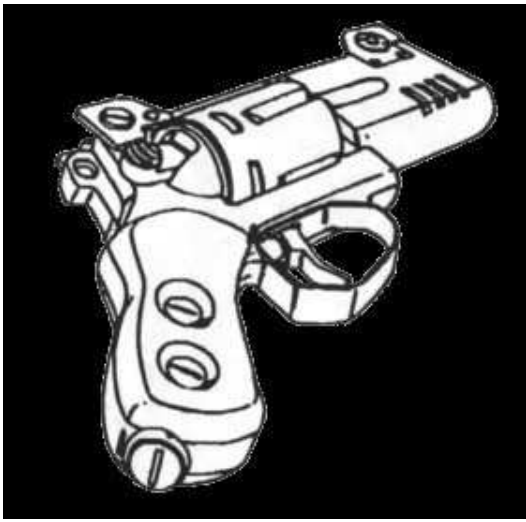

SMITH AND WESSON "SATYR" 485eb
P - +1 - J - P - 4D6 (.44 mag cased) - 5 - 1 - VR
This is a short, sturdy revolver, popular with detectives and professionals the world over, makes a fine backup weapon, comes with barrel mounted counterweight, with built in laser sight.



SMITH AND WESSON SCP-44 525eb
P - +1 - J - C - 4D6 (.44magnum cased) - 6 - 1 - VR
Large, comfortable, intimidating, and reliable. The scope comes with the weapon, as does a well-deserved reputation for its combat effectiveness.

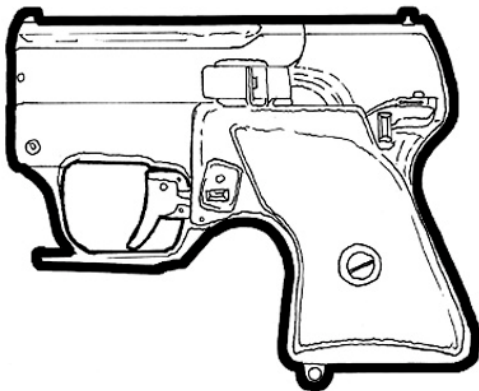

TSUNAMI ARMS D-76 250eb
P - -1 - P - E - 4d6 (.44 Mag caseless) - 5 - 1 - ST
An inexpensive .44 magnum holdout popular as a back up piece to both police and the criminal element.



ARASAKA "AKI" 980eb
P - +1 - J - P - 4D6+1 (12mm cased) - 10/16 - 1 - VR
Militech's Halo line of weapons garnered so much attention that Arasaka developed its own weapon based on a similar style. The Aki fires a larger round, and is an overall larger more ergonomically designed weapon. However, the similarities between the two companies' designs have added even more fuel to the ever growing feud.

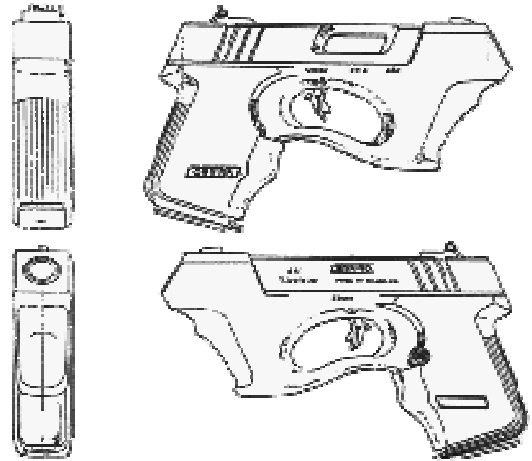

ARASAKA "ARMITAGE" 860eb
P - +2 - J - P - 6D6 (14mm cased) - 5 - 1 - VR
Smaller than the "Misa", and more powerful, this seemed to be exactly what the women of Arasaka were asking for. This is a really nice weapon, very comfortable to shoot, and fairly easily concealable, it almost fits in your pocket.



ARASAKA CHARON 4769eb

P - 0 - J - R - 4D6+1 / 6D6+2 (12mm standard cased / ETE) - 10 - 1 - VR

A revolutionary design, the Charon is the first weapon to ever feature the ability to alternate between standard operation and electrothermally enhanced at the flick of a switch. What this means is that the owner of this weapon can load and fire his electro-thermally enhanced ammunition, and when he runs out of ammo he can instantly switch to standard fire and use any normal 12mm cased ammo he can find. Since the EDF, the U.S. Armed Forces, and most American Police departments use 12mm ammunition, you can begin to see the implications. Only the most elite of Arasaka's personnel have been issued this weapon, and Arasaka has announced they have no intention of selling this weapon to the general public, or to police or militaries. Whether this is a clever ploy to drastically increase demand for the weapon, or merely their way of holding an edge over their competition is anyone's guess, but demand for this weapon is so high it will fetch x10 the price among collectors and professionals. As an added bonus, the weapon comes with its own suppressor

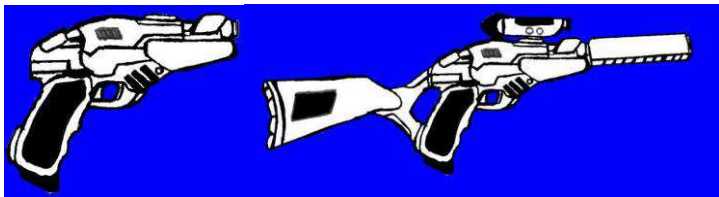

ARASAKA "DAISHO" 1150eb

P - +2/3 - J/N - P - 4D6+1(12mm caseless) - 10 - 1 - VR

Named after the infamous sword pair of the traditional Japanese samurai, this gun comes with a detachable stock, scope and suppressor for when you want to reach out and touch someone.



ARASAKA DEF-10 840eb

P - 0 - J - C - 4D6+1 (12mm cased) - 10 - 1 - ST

This is the standard handgun for all Argentinean Military and Police forces. It features an integral lasersight/flashlight and available suppressor.



ARASAKA BRIGADE 1240eb

P - 0 - J - C - 4D6+1 (12mm caseless) - 14 - 1 - VR

Arasaka's latest sidearm is also one of their most elegant and reliable. It is expected that this weapon may soon be standard issue for Arasaka Troops.



ARASAKA FF-10 860eb

P - +1 - J - P - 4d6+1 (12mm caseless) - 10 - 1 - ST

A large caliber handgun from Japan's largest arms manufacturer. Very popular among corporates who like a bit of flair and intimidation that only a big gun can provide. Whether for personal defense or for making your point at the next board meeting, this weapon will provide.



ARASAKA GUARDIAN 795eb

P - 0 - J - P - 4d6+1 (12mm cased) - 10 - 1 - VR
 Arasaka ups the stakes with another heavy combat pistol. Sturdy and extremely reliable, reasonably accurate, and best of all affordable. A little large for most, but at least no one will be asking if you "brought enough gun."



ARASAKA "KEMONO" 725eb

P - =2 - J - R - 4d6+1 (12mm caseless) - 8 - 1 - VR
 A very large handgun for serious professionals, favored the world over by those who appreciate the accuracy and intimidation factor such a large weapon brings.



ARASAKA "MIDNIGHTER" 1020eb

P - +2 - J - C - 4D6+1 (12mm cased) - 12 - 1 - VR
 Arasaka's newest entry into the field of large caliber handguns, this weapon comes standard with removable flashlight, and a laser sight. Perfect for those opponents who just don't want go down

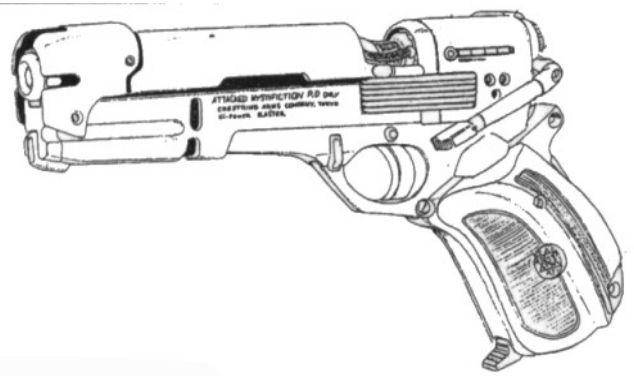

ARASAKA P-237 730eb

P/SMG - +2 - J - C - 4d6+2 (12mm cased) - 12 - 1/10 - VR

A nice handgun, comfortable in the hand with very negligible recoil and a nice ammo capacity. Arasaka has begun arming its forces in explosive locales with this firearm due to its large caliber. It has also gained a following in the professional community for its out of the box accuracy and reliability. Comes equipped with an integral laser sight.

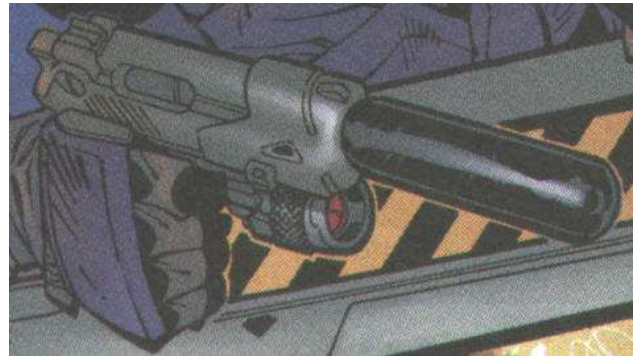

ARASAKA "SENSEI" 750eb

P - +2 - J - C - 4D6+1 (12mm cased) - 12 - 1 - VR

This is the cased ammunition firing version of the Master, it is equipped with an infrared flashlight, and comes with a silencer. In all other ways it is identical to the "Master."



ARASAKA "URBAN" 880eb

P - +2 - J - P - 4D6+2 (12mm cased) - 10 - 1 - VR

This is Quite possibly Arasaka's most popular handgun line in years. Favored by professionals and amateurs alike. With molded grips, and an integral laser sight, this gun perfectly captures the look and feel of the street. Winner of "Solo Of Fortune's" "Gun Of The Year Award" for 2020.



ARASAKA ZENITH 880eb
 P - +1 - J - C - 4D6+2 (12mm cased) - 10 - 1 - VR
 Arasaka is the leading developer in 12mm handguns, and as the threat of cybernetic crimes and augmented militaries becomes more prevalent its not hard to see why. The Zenith is a beautiful gun, and does not disappoint in its performance.



BERETTA SPECFOR-15 720eb
 P - +2 - J - P - 4D6+1 (12mm cased) - 10 - 1 - VR
 Beretta is moving into competition with Heckler and Koch's SOCOM 2020 with this latest entry. It features a larger caliber round of ammunition and a built in IR tac light, though it does not have an integral laser sight, nor does it come smart chipped as standard. It does however come with a suppressor for an extra 200eb



BUDGET ARMS "PRESTON" 262eb
 P - -2 - L - E - 4D6+1 (12mm caseless) - 8 - 1 - UR
 Gang members love getting their hands on these. The large caliber, and large size puts it in high demand on the streets, the ridiculously low price tag is matched only by its frequency to jam. Oh, and it has a built in flashlight.



ARMALLITE CHP-11 795eb
 P - 0 - J - P - 4D6+1 (12mm cased) - 12 - 1 - VR
 A very stylish, very comfortable, very large 12mm. A favorite weapon among corporate bodyguards.



BERETTA "COMBAT" 785eb
 P - +2 - J - C - 4D6+1 (12mm cased) - 10 - 1 - VR
 Beretta released this weapon early last year, and the response has been outstanding. A very fine piece indeed, fully deserving of the Beretta name. This weapon is being issued to police and military forces all over the world, and fires exquisitely smooth, very accurate, and beautifully styled.



COLT "CLYDESDALE" 730eb
 P - +1 - J - C - 4D6 +1 (12mm cased) - 12 - 2 - VR
 An ammunition upgrade and a few cosmetic changes have turned the classic M1911A1 frame into this combat monster.



COLT "DOMINATOR" 850eb
 P - +1 - J - R - 4D6+1 (12mm cased) - 10 - 1 - VR
 A no frills 14mm from Colt. This weapon is beautiful, its heavy barrel design makes shooting the big bullet almost as comfortable as shooting a .45, and its slim, sleek design make concealing it much easier. This gun is also about as reliable as a semi-auto can get, and for an added bonus it comes with two slides, easily interchangeable, one with the ejection port on each side to allow for left or right handed shooting.



COLT L-36 2375eb
 P - +3 - J - P - 4D6 (.12 mm cased) - 10/16 - 1 - VR
 Not about to be left in the cold to replace the H&K SOCOM 2020, Colt introduces the L-36. With Heckler and Koch supplying the Europeans, which only makes sense seeing as how they are euro themselves, the US is discreetly looking for a new special forces sidearm, preferably American made, though they are talking to Arasaka as well. This weapon is the running favorite so far, with integral lasersight/flashlight, optional smart-link, and custom suppressor, as well as optional 16 round extended magazines, it is the one to beat.



COLT M-20BA1 595eb
 P - 0 - J - C - 4D6+1 (12mm cased) - 10 - 1 - VR
 An integral laser sight built into the solid frame of this weapon keeps Colt on the map. A trustworthy reliable weapon, an excellent example of why Colt has a reputation for its workhorses.



COLT MODEL 501 750eb
 P - -1 - L - R - 4D6+1 / 4d6 (12mm caseless/.12 gauge) - 15-1 - 1/3-1 - VR
 A heavy 12mm with an extended magazine and a single shot .12 gauge shotgun underbarrel mount with independent trigger. Breach the door, drop the target.



COLT OOM-S 790eb
 P - +1 - L - C - 4D6+1 (12mm caseless) - 10 - 1 - ST
 Colt tried and failed to win the military sidearm contest with this weapon. It was reliable enough, but too clunky to serve the military needs. Still it is a decent weapon, and sells relatively well in the civilian market.



CONSTITUTIONAL ARMS DDMAP 2125eb
 P - 0 - L - R - 4D6+1/4D6+1 (12mm caseless/12mm
 cased) - 12 / 5 - 1 / 1 - ST

Constitutional arms saw a problem. They had had created a revolution in police weapon functionality with their Multiple Ammunition Revolver, but it left behind the problem that most cops were now carrying 2 sidearms. A standard handgun and a revolver carrying specialty ammunition. This was obviously problematic, and was the source of endless union complaints. Now it seems they have found a rather unorthodox, but supremely effective solution. They combined both weapons into a single firearm. The main portion of the weapon is a 12mm semi-automatic firing caseless rounds. A secondary revolver is featured under the main barrel, also chamber in 12mm, but specifically designed for Constitutional Arms Specialty Ammunition. Orders are already pouring in. The weapon is large and heavy, but it beats the redundancy of carrying two sidearms. Night City is currently testing the weapon on a limited basis.



CONSTITUTIONAL ARMS "STUB" 375eb
 P - -1 - P - E - 4D6+1 (12 mm caseless) - 5 - 1 - VR
 It might be small and ugly, but it packs a wallop. The perfect back up piece.



DARRA-POLYTECHNIC P-12 685eb
 P - 0 - J - C - 4D6+1 (12mm caseless) - 10 - 1 - ST
 A large, but otherwise unremarkable handgun, although its price makes it a popular weapon, and a sure seller.

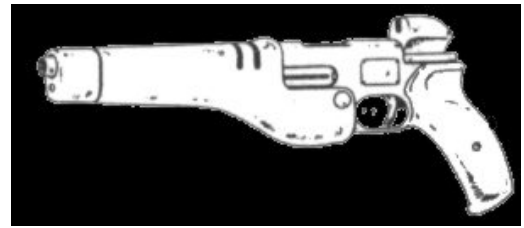

DUTCH ARMS "LONGFELLOW" 890eb
 P - +3 - L - R - 4D6+1 (12mm cased) - 8 - 1 - VR
 An oddly designed hunting pistol from Dutch Arms. Mounting a scope is almost required; in fact the handgun was built for it. The rear sights line up perfect with a mounted scope for dead on accuracy. Odd that it doesn't come with one.



GUNGRAVE 4000eb
 (From Nomad Market)
 P - -1 - L - U - 6D6+1 (12mm cased ETE) - 10 - 1 - VR

This pair of firearms were once carried by the infamous mad priest known only as Pilgrim, who used to wander the wastelands enacting vengeance on anything and anyone he perceived as a sin. He met his end when he tried to confront a small group of Raffin Shiv without realizing they were just the forward scouts of a larger raiding party. Own a piece of nomad history. The weapon must be loaded one shell at a time from the front of the barrel shroud, like an old Winchester rifle. (Takes 20 seconds to reload).



HECKLER AND KOCH M625 720eb
 P - +2 - J - P - 4D6 (12mm caseless) - 14 - 1 - VR
 An excellent weapon for the price, available with or without the integral laser sight/flashlight and a suppressor is available for 30eb extra.



HECKLER AND KOCH "MAJESTIC-12" 1125eb
 P - +1 - P - E - 4D6+1 (12mm cased) - 8 - 1 - VR
 A very smooth and clean looking weapon, uncommon in a caliber this size. Absolutely gorgeous and fires like a dream.



H&K P-11 A & B 1095/1250eb
 P - 0 - J - P - 3D6 (12mm flechette) - 5 - 1 - VR
 This handgun was designed from scratch expressly for the purpose of underwater combat. It uses 5-shot disposable barrel clusters and electrically fires 3 inch long 12mm square, caseless, smokeless finned flechettes. Completely waterproof this weapon has an effective range of 30 yards. At point blank to 6 yards damage is 3D6, for every 6 yards beyond the damage drops 1D. Range on land is 40 yards. Additional barrel clusters cost 25eb apiece. The only difference between the A and B models is the B model is a bit flashier and features a revolving cylinder instead of a static barrel.



HECKLER AND KOCH VP-101 620eb
 P - +1 - J - C - 4D6+1 (12mm cased) - 12 - 1 - VR
 Heckler and Koch make some of the finest handguns in the world, and this is no exception. The handle is a bit large, but otherwise the weapon is well balanced and smooth firing.



IMI JERICOHO 2020 800eb
 P - +1 - J - P - 4D6+1 (12mm caseless) - 10 - 1 - ST
 The little brother to the Desert Eagle is back, and this time it punches a big enough hole all on it's own. With a 10 round ammo capacity this weapon is a heavy combat dream.

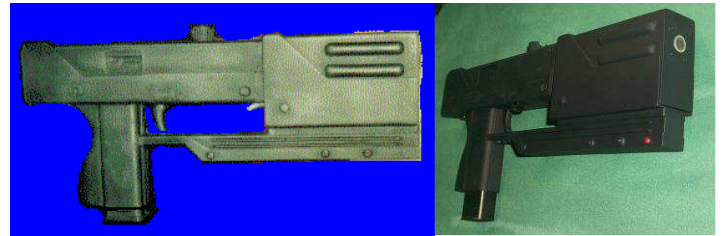

INGRAM "MAC-2021" 1750eb
 P - +1 - L - P - 4D6+1 (12 mm cased) - 14/25 - 1/3 - VR
 Also available in full automatic, this handgun is the newest Ingram to bear the MAC name. The higher powered ammo, unfortunately limits the capacity, but 25 round clips are available



LUCZNIK RADOM ZPM-32 740eb
 P - 0 - J - C - 4D6+1 (12mm cased) - 13 - 1 - VR
 Sidearm preferred by Neo-Soviet Special forces team, made available thanks to good relations with EEC. Hard hitting and incredibly reliable. The scope costs an extra 25eb, and the weapon also has an available suppressor for 50eb.



HEAVILY CUSTOMIZED MAUSER 2020 800eb
 (From Nomad Market)
 P - +1 - J - U - 4D6+1 (12mm cased) - 8 - 1 - VR
 Well, the only thing for certain is that this weapon started out as an old German Mauser, but has since undergone such radical reworking that it only barely resembles the gun it once was. Rebored to fire 12mm ammo, cosmetically enhanced, and heavily engraved. This weapon is another example of the fine artistry available in the Nomad Market



MILITECH KITE-14 950eb

P - +1 - L - P - 4d6+1 (12mm caseless) - 10 - 1 - VR
 A rather attractive weapon from Militech. While most of Militechs weapons seem to be designed purely for utilitarian purposes, it looks like some thought went into the final design of this weapon, available in Black, Gray, or pink (????). The only drawback we can find to this otherwise superb weapon is that its awkward shape makes it rather difficult to fit into a standard holster, so you must buy the holster with the gun.



MILITECH RNA-12 890eb

P - +2 - J - P - 4D6+1 (12mm cased) - 10 - 1 - VR
 Designed specifically for their own special forces division, this weapon is incredibly reliable, nail driving accurate right out of the box, sturdy, and features an integral laser sight. The hammerless design and high ammo capacity are just icing on the cake for this combat beast. Militech is hoping once again to win Military contracts, and with the US on the brink of war in South America, they may get their chance.



MILITECH "SELINA" 720eb

P - +1 - J - E - 4D6+1 (12mm cased) - 8 - 1 - VR
 This relatively compact weapon from Militech is fast gaining popularity in the private security sector due to its light weight and heavy stopping power.



MILITECH "STARBUCK" 1220 eb

P - +1 - J - P 4D6+1 (12mm caseless) - 6 - 1 VR
 Militech went some new directions with this weapon, both from a design standpoint, as well as the obvious visual ones. It incorporates its own suppressor, and flash baffling system, comes standard with smart chipping, a built in micro computer, designed to keep track of maintenance needs and rounds fired, (information displayed via a small readout on the back of the weapon, and through your cyber optic if you are equipped for it). While demand has so far been low, Militech hopes that this line will take off.



MILITECH STI-12 700eb

P - +1 - J - C - 4D6+1 (12mm cased) - 8 - 1 - VR
 A combat weapon using colts classic 1911 frame, bored to fire 12mm ammo. This weapon is a man stopper, and will shoot forever.



MILITECH TAC-50 750eb

P - +2 - J - P - 4D6+1 (12mm cased) - 7 - 1 - VR
 This beautifully crafted Militech handgun is a superb weapon. Stylish and capable, and durable enough for the harshest conditions.



NOVA ARMS "DOMINUS" 795eb

P - +1 - J - C - 4D6+1 (12mm caseless) - 8 - 1 - ST
 Large and in charge, this combat handgun chambered in 12mm is just the thing to let the enemy know you mean business.



MILITECH TR-12 789eb

P - +1 - J - C - 4D6+1 (12mm cased) - 10 - 1 - ST
 A simple, reliable 12mm handgun, popular with professionals the world over. Comes with an integral laser sight, and is available smartchipped for an extra 250eb.



NOVA SF-304 590eb

P - +1 - J - e - 4D6+1 (12mm caseless) - 8 - 1 - ST
 Nova's knock-off of the Arasaka Urban, not quite as reliable or accurate, it is considerably less expensive. If you want to look like a pro, but not spend like one, this is the weapon for you.



MILITECH VECTRA-7 925eb

P - +1 - J - C - 4D6+1 (12mm caseless) - 10 - 1 - ST
 A larger caliber version of the Vectra-6. More comfortable, heavier hitting. The Vectra-7 is the combat weapon that the Vectra-6 should have been. The weight and size of the weapon in this chamber makes far more sense.



ROSTOVIC JADER-11 1460eb

P - +2 - J - P - 4D6+1 (12mm cased) - 10 - 1 - VR
 Most Russian handguns are simple, easy to operate, and have all the style of a roadkill fur coat. With this weapon they attempt to change that image, and go a long long way towards that goal. Smart-chipped as standard, this 12mm pistol apparently started out as a target shooting designed, but was rechambered with the heavy combat round to deal with their ever increasing cyborg problem. It is insanely accurate for a weapon in this caliber, and shoots like a dream. It even features a 3-round burst mode, and an extended 20 round clip is available for the small fee of 25eb. Lack of any iron sights is the only problem this weapon has, so if you do not have a smart link, or it somehow becomes disabled, the accuracy drops drastically (becomes -1).



RUGER H240 920 eb
 P - +1 - J - P 4D6+1 (12mm caseless) - 10 - 1 VR
 Just released earlier this year, this sleek powerful gun is becoming, quite popular. Ruger proves once again what a fine handgun they can produce.



RUGER "LAWMASTER" 940eb
 P - +1 - L - P - 4D6+1 (12mm caseless) - 10 - 1 - ST
 Rugers "little brother" to the Lawgiver, chambered in 12mm, and lacking the integral laser sight and tac light, but still packing more than enough punch for the job.



RUGER XP-445 880eb
 P - +2 - J - P - 4D6+1 (12mm cased) - 8 - 1 - VR
 A relatively compact yet extremely accurate 12mm, its advanced design make this Ruger a weapon to be feared and admired.



SEBURO JP-15 1620 eb
 P - +3 - J - P - 4D6+1 (12mm cased) - 20 - 1 - VR
 A beautifully styled handgun, one of the finest on the market. Seburo is fast proving itself to be one of the finest weapon manufacturer's on the planet. Its odd clip is truly unique, giving it unheard of ammo capacity for its caliber and size. And the bullpup design makes the weapon much more accurate. However the odd design also might provide a problem when trying to fit the gun in a holster, luckily one is available in both shoulder and hip variety for an extra 80eb

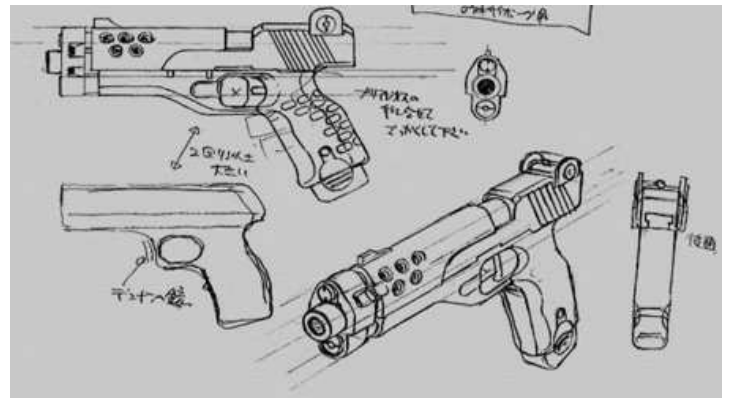

SEBURO "MANDRAKE" 1045eb
 P - +1 - P - E - 4D6+1 (12mm caseless) - 12 - 1 - VR
 A very nice heavy combat pistol from Seburo. They don't usually make weapons in this high of a caliber, but this weapon delivers all you would expect from Japans finest gunsmiths.



SMITH AND WESSON 6040C 795eb
 P - +1 - J - C - 4D6+1 (12mm cased) - 8 - 1 - ST
 A premiere handgun from Smith and Wesson with an integral laser sight and optional smartlink.



STRONTIUM DOG 180eb
 (From Nomad Market)
 P - 0 - L - U - 4D6+1 (12mm cased) - 15 - 1 - VR
 Another handbuilt single loading pistol, this time chambered in 12mm caseless. It also features an integral laser sight and flashlight. Reloading the weapon requires individually sliding the rounds into the weapon underneath the barrel, like a shotgun, and takes 15 seconds.



STATIC 12 630eb
 (From Nomad Market)
 P - -2 - J - U - 4D6+1 (12mm Caseless) - 6 - 1 - VR
 There are many times that nomads are brought into conflict with statics, and as such caseless ammunition is a frequent spoil of war, since so many of the modern guns utilize it. For the most part caseless ammunition is distrusted by the nomad community due to residue buildup and jamming issues, but sometimes you gotta make due with what the road gives you. This weapon, chambered in 12mm caseless is a nomads attempt to make use of the surplus caseless ammo floating around. It is easy to clean and comes with a kit which includes several barrels which allow you to rechamber the weapon to fire any caseless ammunition from 9mm to 11mm. Changing out the barrel takes about 30 seconds with practice. The magazine for the weapon also has variable settings allowing it to hold ammo of carrying types, although only one type of ammo may be loaded at any given time, so you can't mix 12mm with 9mm, at least not without blowing your own face off.



TOJIMA FIRESPIITTER (not for sale)
 P - +3 - J - ER - 6D6+2 (12mm ETE) - 8 - 1 - VR
 This is Char's personal firearm, it is a one of kind custom .44 magnum semi-automatic. The gun features Electro-Thermal Enhancement and a built in laser sight, it is smart chipped and can only be fired after a custom brace is attached (in the shape of a bracelet around Char's arm which represents the dragons tail.) and Char's fingerprints have been recognized on the touchpad of the grip. The gun is molded and etched to look like a dragon and the dyna-porting on the barrel shroud is the dragons nose, when the gun is fired it truly looks like it is spitting fire. The weapon is included here simply because Char loves to show it off.

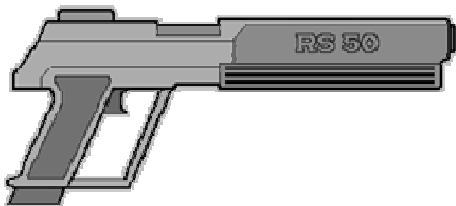

STERNMEYER RS-50 650eb
 P - -2 - L - P - 4D6+1 (12mm cased) - 12 - 1 - VR
 A very large, but reliable and hard hitting handgun from Sternmeyer. While there really isn't anything remarkable about it, it is quite intimidating.



WANDERER METAL 100eb
 (From Nomad Market)
 P - -1 - J - C - 4D6+1 (12mm caseless) - 6 - 1 - ST
 Hand made from stamped metal, this is a very simply gun designed to fire caseless 12mm ammunition. They pound these out by the dozens here in the Market. Despite the shoddy appearance, it's actually a pretty decent weapon. Comes with a scope as standard.

.50 ACTION EXPRESS



COLT DIAMONDBACK-50 725eb
P - 0 - J - P - 4D6+2 (.50 AE caseless) - 10 - 1 - VR
A large handgun, officially marketed as a hunting weapon, though it does just fine as an anti-cyborg weapon too.



COOPER 80eb
(From Nomad market)
P -2 J R 4D6+2 (.50AE) 2 1 VR
Elegant in its absolute simplicity. This double barrel weapon is chambered in .50 Action Express and its design could not be more straightforward. It's a break loading weapon, and each barrel is armed by pulling back the lever on the side. Of course it's only good for close distances, and with only two shots you better make them count. Not sure what you would use this for, as it's too big for a pack up piece, too inaccurate for hunting, and its ammo is too limited for a primary. But it is a nice, very reliable and well made piece. Named for the nomad it was bought from, its designer is unknown.



DIES AGOMOS CS-831 925eb
P - +2 - J - P - 4D6+2 (.50 AE cased) - 8 - 1 - VR
An extremely beautiful and well performing handgun from Dies. It features an integral combination laser sight/tac-light and smart link.



MILITECH CASPIAN 825eb
P - +1 - L - P - 4D6+2 (.50 AE cased) - 12 - 1 - VR
Militech shows an uncharacteristically stylish side with the Caspian. Don't let it's pretty appearance fool you, this weapon is a beast.



NORSE TECHNOLOGIES "FANDRALL" 1150eb
P - 0 - J - P - 4D6+2 (.50 AE cased) - 6 - 1 - VR
Yet one more entry is Norse Technologies "GOD" line. This one fires .50 action express, and is viewed as one of the lighter weapons in the line.

.440 COR-BON MAGNUM



CONSTITUTIONAL ARMS SWAT-440 950eb
 P - +1 - J - P - 4d6+3 (.440 Cor-Bon caseless) - 10 - 1 - VR
 The finest handgun in the Constitutional Arms inventory. This weapon is quickly gaining favor in police circles, especially in C-SWAT forces where it is preferred 4 to 1 over the Armalite 44. In Night City where the Armalite is still the weapon issued, many officers prefer to purchase the SWAT-44 (of course they still have to get it outfitted to police specifications) with their own money. Its built in laser sight, larger ammunition capacity, and more powerful cartridge all make it a superior weapon. The only drawback is the relative rarity of ammunition.



DIRTY HARRY 200eb
 P - -1 - J - U - 4D6+3 (.440 Cor-Bon cased) - 5 - 1 - VR
 (From Nomad Market)
 This nomad revolver appears to be hand tooled from scratch, but it is still a fine weapon. The hammer shroud and lack of sights eliminate any possible snag issues allowing for a quick, clean, draw every time.



NORSE TECHNOLOGIES "HOD" 2435eb
 P - +1 - J - C - 4D6+3 (.440 Cor-Bon cased) - 6 - 1 - ST
 Just a hair above the "Fandrall" in terms of power, it also is smoothest styled of the "God" line making it instantly recognizable. Norse Technologies remains on top of the market.



STEYR "RAZORBACK" 1289eb
 P - -1 - L - P - 4d6+3 (.440 Cor-Bon caseless) - 10 - 1 - ST
 Another odd design from Steyr. The most significant thing about this weapon is that its action is completely enclosed. The only visible moving part is the trigger. The slide is enclosed in a hollow airtight shell. Steyr indicates that the reason for this is to maximize muzzle energy, of course this makes for a rather well felt recoil, but range is increased, as well as theoretical damage potential. They also claim that as long as the barrel plug is in place, that the gun may withstand indefinite submergence with no adverse affects.

.454 CASULL



ARASAKA "BIG GAME" 1750eb
 P - +1 - L - P - 4D6+3 (.454 Casull cased) - 6 - 1 - VR
 Arasaka doesn't make very many revolvers, and when they do, they are revolutionary. This bullpup large caliber revolver hits hard, and hits straight. While it may feel a bit awkward at first, with practice this is a fine weapon indeed.



ARASAKA "URBAN-II" 1810eb
 P - +2 - J - P - 4D6+3 (.454 Casull caseless) - 8 - 1 - VR
 A slightly reworked and rechambered version of the ever-popular Urban from Arasaka, firing the .454 Casull rounds. A caseless weapon, it is available with built in smartlink. Despite its slighter higher damage capacity, many professionals still prefer the original Urban over its new caseless progeny.



ARASAKA C750 1220eb
 P - 0 - p - P - 4D6+3 (.44 Cor-Bon caseless) - 5 - 1 - ST
 A compact semi-auto in .454 from Arasaka.



ARMALITE "LUG" .454 1485eb
 P - +2 - J - P - 4D6+3 (.454 Casull cased) - 7 - 1 - ST
 Heavy and mean are the only words to describe this weapon. And while it is very heavy, it is also very comfortable to fire, and will feel right at home in the hands of any professional. The only thing wrong with this gun is the scarcity of ammunition, although rumors are circulating that it will soon be available in 12mm.



ARMALITE "SAINT" 1320eb
 P - +1 - L - P - 4D6+3 (.454 Casull cased) - 7 - 1 - ST
 You can't have a Sinner without the Saint, and here it is. As big as the sinner, only slightly less powerful. Where the sinner is only available in black, the Saint is only available in silver.



COLT SUPERHERO 1250eb
 P - +2 - L - P - 4D6+3 (.454 Casull cased) - 6 - 1 - ST
 The Colt Superhero is long and heavy, but extremely accurate revolver firing the ubiquitous .454 Casull round, which means it hits hard enough to bring down just about anything smaller than an elephant.



DIES 640 1535eb
 P - +2 - J - P - 4D6+3 (.454 Casull cased) - 8 - 1 - ST
 Dies proving that even though it's a new company, it can run with the pack with this monster handgun.



LUIGI-FRANCHI SCARBOROUGH FAIR 565eb
 P - -1 - P - R - 4D6+3 (.454 Casull cased) - 2 - 1 - VR
 Luigi-Franchi's overly ornate, gold and jewel trimmed, 2-shot derringier. When even the ace up your sleeve must reflect your personal style.



LUIGI-FRANCHI "SAFARI-12" 1995eb
 P - +3 / -2 - L - R - 4D6+3/5d6+1 (.454 Casull cased / .30-06 cased) - 5 / 1 - 1 / 1 - VR
 From Europe's most elegant gunsmiths comes the Safari 12. With a .454 Casull revolver over a single shot .30-06, this is the perfect sidearm for hunting. Available with black matte or wood accents.



MAGNUM OPUS W.A.S.P. 1875eb
 P - +2 - L - R - 4D6+3 (.454 Casull cased) - 5 - 1 - ST
 The W.A.S.P. is not only a hard hitting weapon, but it features an electronic teleoptic scope with IR, UV, Low-Light, Thermograph, and a Rangfinder. It also features smatlink and a combination laser/flashlight.



LUIGI-FRANCHI "SAFARI-13" 1995eb
 P - +3 / -2 - L - R - 4D6+3/5d6+1 (.454 Casull cased / .30-06 cased) - 5 / 1 - 1 / 1 - VR
 In function this weapon is exactly the same as the Safari-12, it just varies slightly in appearance, with more of classic look.



MAGNUM OPUS LEGATE 1500eb
 P - +1 - L - R - 4D6+3 (.454 Casull cased) - 6 - 1 - VR
 Another huge and heavy revolver from Magnum Opus. Ridiculously powerful, obnoxiously intimidating.



MATEBA .454 CUSTOM 1200eb
 P - +2 - L - U - 4D6+3 (.454 Casull cased) - 6 - 1 - VR
 (From Nomad Market)
 The master engraving on this massive revolver was done by one of the many master artisans in the Market, the handgun itself has been rebored for greater accuracy.



MUSTANG ARMS "STOIC" 1150eb
 P - 0 - J - R - 4D6+3 (.454 Casull cased) - 5 - 1 - ST
 This large, intimidating manstopper gives a major boost to the reputation of Mustang Arms. It's ugly and brutish, perfect for getting your point across, or for having the final word.



MATSUCORP MARK.454 1650eb
 P - +2 - L - P - 4D6+3 (.454 Casull cased) - 6 - 1 - VR
 Matsucorp strikes again, with this massive handgun. Long barreled for greater accuracy. This weapon kicks like a mule. Once again proving why they are the talk of the streets among professionals, often compared to Sebuo.



NORSE TECHNOLOGIES "HIEMDALL" 1850eb
 P - +2 - L - P - 4D6+3 (.454 Casull Cased) - 6 - 1 - VR
 This weapon is almost identical to the "Fafnir", with only a few minor cosmetic differences and a different load.



MUSTANG ARMS RHINO 1150eb
 P - -2 - J - R - 4D6+3 (.454 Casull cased) - 6 - 1 - ST
 A large bore revolver that can be purchased in an assortment of barrel lengths from 2,4,6, and 8 inches. (Stats shown for 2, increase accuracy by +1 for each longer barrel increment.)

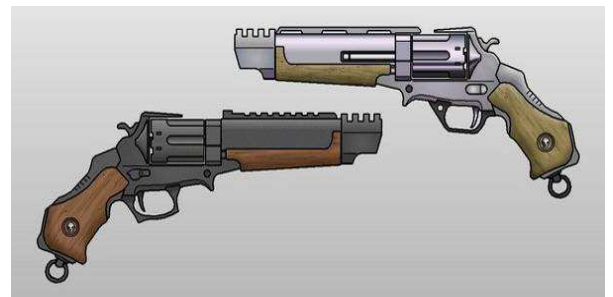

NORSE TECHNOLOGIES HÖGGSPJÓT 1260eb
 P - 0 - J - P - 4D6+3 (.454 Casull cased) - 6 - 1 - VR
 A new revolver design from the leading name in anti-cyborg handguns. A particularly intimidating one at that. This weapon, while more powerful than most weapons out there, is one of the tamer models to come from Norse Technologies, take heart, they have announced they will be releasing a 5 shot version in .577 boomer mag around Christmas time for only an additional 400eb.



RUGER .454 CASULL CLASSIC 982eb
 P - +2 - J - P - 4D6+3 (.454 cased) - 5 - 1 - VR
 A large heavy bore revolver, popular to many nomads and handgun hunters.



SMITH AND WESSON "BIG HARRY" 850eb
 P - 0 - L - C - 4D6+3 (.454 Casull cased) - 5 - 1 - VR
 Retailing all the classic style of the gun that made Smith and Wesson a household name, with a new twist and even larger punch, smith and wesson asks once again "You feelin' lucky punk? Huh, do ya?"



RUGER "WARHAWK" 1250eb
 P - +1 - L - R - 4d6+3 (.454 CASULL CASED) - 5 - 1 - ST
 A large revolver, designed for hunting, though it's combat effectiveness is obvious. Even counting for recoil compensation it is a bit heavy.



SMITH AND WESSON POWER BISON 1690eb
 P - +2 - L - C - 4D6+3 (.454 Casull cased) - 6 - 1 - VR
 Far more accurate than it's size should allow, the Power Bison is one of Smith and Wesson's premiere hunting handgun.



SMITH AND WESSON DAN-84 1250eb
 P - +1 - L - P - 4D6+3 (.454 Casull cased) - 5 - 1 - VR
 Another large caliber revolver from the people who wrote the book on them. The heavy underbarrel lug holds an integral laser sight and helps fight recoil.



SMITH AND WESSON WHIPSHOT 1500eb
 P - +1 - L - C - 4D6+3 (.454 Casull cased) - 6 - 1 - ST
 A Mateba styled heavy revolver from Smith And Wesson. This isn't their usual design style, but they have never shied away from innovation.



SMITH AND WESSON RAVAGER 4780eb
 P - +2 - L - C - 6D6+4 (.454 Casull ETE cased) - 6 - 1 - VR
 Smartlinked and electro-thermally enhanced as standard, this is a ridiculously large and powerful weapon.

ANTI-CYBORG HANDGUNS

.500 MAGNUM



MALCOM 1100eb

P - 0 - J - U - 5D6-1 (.500 S&W magnum cased) - 3 - 1 - VR

This was once a revolver, but has since been extremely heavily modified and mated with the firing mechanism of a Chinese hunting rifle, rebored for .500 magnum. It loads from a magazine just in front of the trigger. It would seem to be possible to create an extended magazine, but the gun would lose that elegant western feel.



NORSE TECHNOLOGIES "TYR" 4680eb

P - 0 - J - P - 5D6-1 (.500 S&W magnum cased) - 6 - 1 - VR

Another in the popular "God" line of revolvers from Norse Technologies. People love these weapons. If you are in the market for a massive handgun guaranteed to put them down and make sure they stay down..... or stop a truck, you can't go wrong with Norse Technologies.



RUGER .500 MAGNUM 3895eb

P - +2 - J - R - 5D6-1 (.500 magnum cased) - 5 - 1 VR

This massive revolver fires a bullet made from a cut down .345 Winchester case mated to a 450 grain bullet. You feel the recoil of this gun down to your toes. The ammunition must be specially made and costs 200eb for a box of 50.



SMITH AND WESSON .500 MAMMOTH 1900eb

P - +1 - L - R - 5D6-1 (.500 S&W magnum cased) - 5 - 1 - VR

And Smith and Wesson enters the anti-cyborg handgun market once again, with a pistol load guaranteed to drop just about anything. The .500 magnum is an extended .50 AE slug in a rifle length casing, and trust us when we say this can make one hell of a mess. S&W markets this as a hunting weapon, though what you would hunt with this monster remains in debate.

.525 MAGNUM EXPRESS

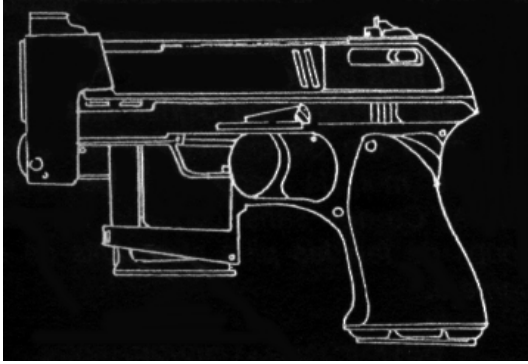

ARMALITE CCPP-48 3380eb
P - 0 - J - P - 5D6 (.525 mag express caseless) - 6 - 1 - ST
Solid and heavy hitting, this weapon is increasingly popular among mercenaries and C-SWAT officers.



ARMALITE "SINNER" 2625eb
P - +1 - L - R - 5D6 (.525 mag express cased) - 6 - 1 - VR
Sometimes a weapon can almost be too big. This 14mm monster makes up half of the Saint and Sinner line from Armalite. The weapons extreme barrel length raises accuracy, but kicks up the recoil considerably. Still, it's impressive, and when it's pointed in your direction you tend to listen, or lose control of your bowels.



ARASAKA LMP-4 2650eb
P - -1 - L - P - 5D6 (.525 magnum cased) - 8 - 1 - VR
Another anti-cyborg handgun from Arasaka. The smooth styling and ergonomic design truly stand out in a crowd. Also features an integral laser sight and smartgun link.



COLT "CANNON" 1860eb
P - +2 - L - C - 5d6 (.525 mag express cased) - 5 - 2 - VR
This revolver is large, it was originally designed for game hunting, but has found a niche in the hands of professionals as an effective weapon against cyborgs, and armored foes. It features a large underbarrel counterweight, with internal laser sight, and a telescopic sight.



COLT "HORSE PISTOL" 2150eb
P - -1 - L - R - 5d6 (.525 mag express cased) - 5 - 1 - ST
Colt takes a totally new approach to keeping guns out of kids hands, they simply make it so large and heavy that no child can lift it. All kidding aside, this is truly a monster revolver, and fully lives up to its name. The weight of the weapon, combined with the kick means that it is a very hard gun to aim and control.

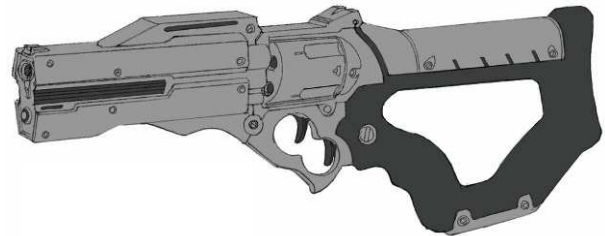

COLT KENYAN 2475eb
P - +2 - L - R - 5d6 (.525 mag express cased) - 5 - 1 - ST
A huge revolver with a short stock, the extra trigger is to activate the integral laser sight.

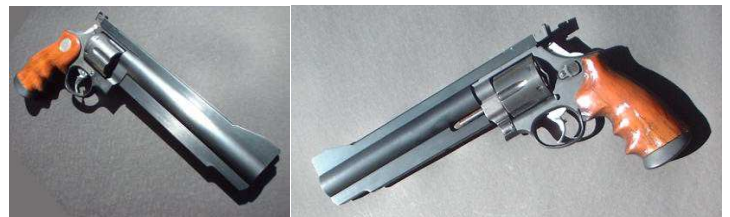

CONSTITUTIONAL ARMS "MCKINLEY" 1250eb
P - 0 - L - E - 5D6 (.525mag express cased) - 5 - 1 - VR
Specifically designed for big game hunting in Alaska, this is a huge and powerful revolver. It is also very clean and beautiful looking, and some have taken to using it as an anti-cyborg weapon.



CONSTITUTIONAL ARMS "SAMARITAN" 1175eb
 P - 0 - J - R - 5D6 (.525 mag express cased) - 4 - 1 - VR
 Tired of losing money in the anti-cyborg weapons market, the nations leading manufacturer of police service revolvers introduces the Hellboy. This breach loading 4 shot revolver is massive. Already growing popular in C-SWAT circles, it will be interesting to see how it competes with Norse Technologies

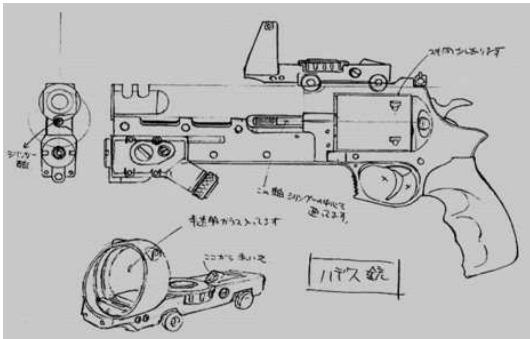

NORSE TECHNOLOGIES "ASGARD" 2810eb
 P - 0 - L - E - 5D6 (.525mag express cased) - 5 - 1 - VR
 Another anti-cyborg handgun from the team at Norse Tech. One begins to think they really hate full conversions.



NORSE TECHNOLOGIES "BALDUR" 2560 eb
 P - +2 - J - C - 5D6 (.525 mag express cased) - 4 - 1 - VR
 The largest of Norse Technologies "GOD" line of revolvers, it fires the mighty .525 cartridge. If you need more than 4 shots from this bitch to stop them, you probably should have stayed home.



NORSE TECHNOLOGIES "SIGURD" 2650eb
 P - -1 - L - R - 5D6/varies (.525 magnum cased) - 4 / 1 - 1 / 1 - VR
 Norse Technologies, leading the way in anti-cyborg firearms production. A special feature of this weapon is the single shot 25mm grenade launcher mounted under the barrel. It also comes with smartlink.



SEXECUTIONER 2200eb
 (From Nomad Market)
 P - +3 - L - U - 5D6 (.525 magnum express cased) - 5 - 1 - VR
 Yes, that's what the owner of this weapon really calls it. It seems it was custom built for someone who never came to collect it. Now this one of a kind weapon is available to you. Everything about this gun has been customized, and outfitted for accuracy and style. It's heavy though, definitely not a gun for the weak.

.577 BOOMER MAGNUM



LUCZNIK RADOM MRVL-577 3495eb
P - -1 - J - C - 5D6AP (.577 caseless) - 10 - 1 - ST
The heavy magazine of this massive handgun serves as an underbarrel lug to reduce recoil. Unfortunately it makes the weapon hard to aim in the first place due to the overall weight. Still it's the largest caliber weapon to come out of Eastern Europe, which tells us they may be facing their own Cyborg problems.

14MM



ARASAKA ACH-43 2965eb
P - -1 - L - C - 6D6/varies (14mm caseless/25mm micromissile) - 6 / 1 - 1 / 1 - ST
Simple, smooth, kinda clunky looking, but packing 14mm caseless and an underbarrel single shot micro-missile launcher. The perfect mouthpiece for rogue boomer relations.



MILITECH LGP-204 2560eb
P - +2 - L - R - 5D6AP (.577 caseless) - 8 - 1 - ST
The latest anti-cyborg weapon from Militech. Designed for C-SWAT and Militech's own private forces. This exceedingly large handgun will stop even full conversions in their tracks. Well most of them anyway.



ARASAKA AKUMA 2250eb
P - +1 - L - C - 6D6 (14mm caseless) - 6 - 1 - ST
Another fine weapon from Arasaka, this gun is similar in looks and performance to the Ruger Lawgiver, and features built in flashlight, laser sight and standard smart chipping.

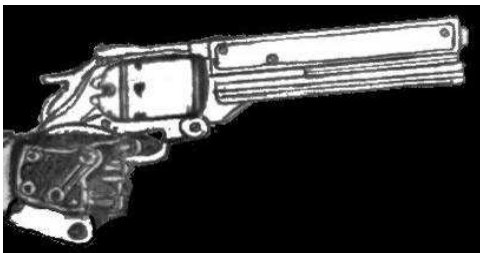

NORSE TECHNOLOGIES "FAFNIR" 2,320eb
P - +3 - L - R 5d6AP (. cased) - 5 - 1 VR
Norse Technologies has always been known for their preference for manufacturing large caliber weapons, and there newest line of revolvers is no disappointment. The "Fafnir" like its mythological counterpart, is huge. Firing the massive .577 boomer magnum, this weapon is more than a match for most of the tin cans you come across, and with enough style to ensure you look good. It features removable cylinders for fast reloading. (Additional cylinders are 15 eb apiece)



ARASAKA "ANIMAL" 3650eb
P - +1/-2 - L - P - 6D6 (14mm caseless) - 12 - 1/3 - VR
This weapon from Arasaka is a monster 14mm capable of single shot or 3-round burst. In single shot mode the weapon is fairly accurate, however in burst mode the accuracy drops significantly due to the incredible recoil of the round being fired and the short barrel design.

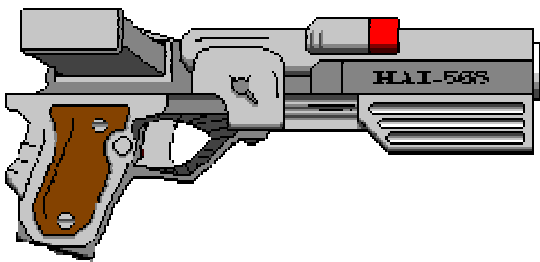

ARASAKA HAI-565 3095eb

P - -1 - N - R - 6D6 (14MM caseless) - 10 - 1/3 - VR
 A side loading 14mm from Arasaka, capable of 3 shot burst. A nice if somewhat large weapon, a bit hard to control, and the side mounted magazine make concealment almost impossible



CCMMC Q-77 2450eb

P - -2 - L - P - 6D6 (14mm cased) - 6 - 1 - P
 The largest pistol manufactured in China.



ARASAKA "OYABUN" 2850eb

P - -1 - J - P - 6D6 (14mm caseless) - 8 - 1 - VR
 Built for the ever increasing number of full body conversions and subsequent cyborg crimes, Arasaka beefs up its arsenal with this powerful handgun. Built around the 14mm round this firearm is designed expressly for cyborg suppression.



COLT RWY-4 1750eb

P - 0 - L - R - 6D6 (14mm cased) - 8 - 1 - ST
 A very heavy, very sturdy gun firing the massive 14mm. The gun is made almost entirely of titanium and the large underbarrel lug houses a laser sight. Smart chipping is available.

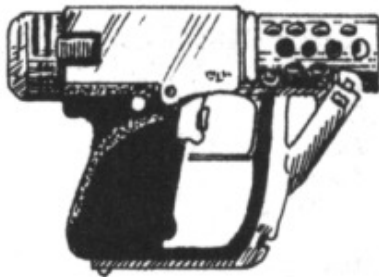

BUDGET ARMS "PRIMO" 480eb

P - -3 - P - P - 6D6 (14mm caseless) - 3 - 1 - UR
 This pocket sized 14mm is possibly the most dangerous handgun ever made, to the user as well as the target. The materials it is constructed out of aren't strong enough for the round fired, and there is no slide mechanism to reduce recoil. Instead the barrel is heavily vented. This weapon has a 1-in-8 chance of blowing up every time it is fired.



DAI-LUNG "CHANGO" 2250eb

P - -1 - L - C - 6D6 (14mm caseless) - 12 - 1/3 - UR
 Since it's introduction, this weapon has become the police's worst nightmare. It's reached almost epic popularity among gangs due to its incredible low price and extremely high caliber. This weapon has given even the cheapest thugs a way to fight back against the most heavily armored police. Its folding stock and 3-round burst capability make it even more lethal. Of course you get what you pay for, this weapon has a tendency to blow up (every fumble rolled using this weapon has a 50% chance of causing it to explode in your hands). This tendency increases when on 3-round burst (anytime the weapon fumbles, it explodes). The high lethality of this gun, both to enemy and user, have not stopped it from being imported.



DAI LUNG "JUMBO" 2350eb

P - -1 - L - P - 6D6 (14mm cased) - 6 - 1 - UR
 Dai Lung finally went to far. They never should have attempted to make a 14mm but here it is anyway. A word of warning, while a 350eb price tag for a 14mm gun may seem attractive, you get what you pay for. This gun is rumored to malfunction almost 50% of the time, usually blowing up in the users face. Still the appeal is there, and the weapon finds favor among gang kids who not only are fond of its large caliber, but also treat carrying and using the weapon as a test of personal courage



IMI DESERT EAGLE 14mm 2675eb

P - +2 - J - P 6D6 (14mm cased) - 6 - 1 - VR
 Desert Eagle has been the first name in high caliber handguns since the series hit the market. So it came as no surprise that when Malorian introduced the 14mm pistol cartridge IMI would take their premier handgun to the next step. They introduced the new Desert Eagle in 14mm. This gun is big and heavy, but the recoil is smooth making this gun a joy to fire.



ESPINOZA ONE-SHOT II 350eb

P - -2 - P - E - 6D6 (14mm cased) - 1 - 1 - ST
 The most famous Polymer One-Shot is back, with a slightly altered design (now featuring extending handle) and chambered in the monster 14mm round. If you oly get one shot, make sure it counts, you can worry about the broken wrist later.



MAGNUM OPUS "BIG CITY" 3650eb

P - -1 - L - P - 6D6 (14 mm caseless) - 8 - 1 - VR
 The "Big City" is Magnum Opus' competition for the Lawgiver. It sports identical features, and is virtually the same weapon, although cosmetically the two are different.

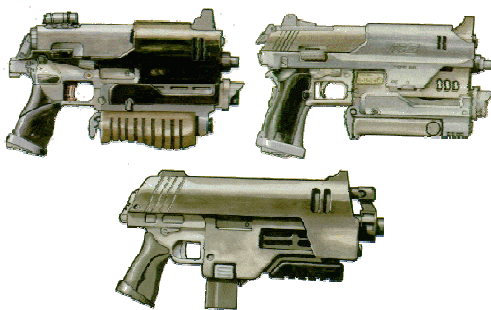

H&K "SCOUT" 1625eb

P - -2 - L - P - 6D6/special (14mm caseless/special) - 6/? - 1/? - ST

Another example of too much gun. This weapon comes in three forms, firstly consisting of a large 14mm as the main weapon, then you can choose either the single shot 10 gauge shotgun, single shot 25mm grenade launcher, or 20 round 9mm submachine gun with a ROF of 6. All 3 weapons also come with integral laser sight and vary slightly in outward appearance. The name is rumored to be derived from the Boy Scout motto of "always be prepared".

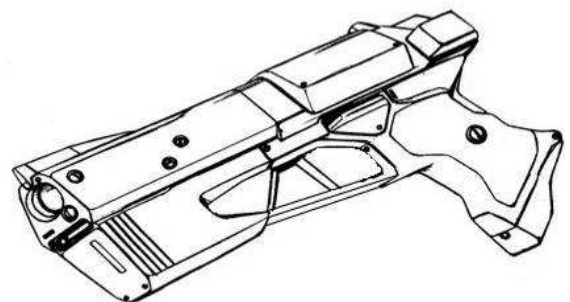

MALORIAN MXP 5740eb

P - +1 - L - R - 6D61 (14mm caseless) - 6 - 1 - VR
 Malorian made headlines with the 3516, but apparently the lack of aesthetic appeal was a black stain that Malorian felt they had to correct. Now with the release of the MXP all questions about the artistry that is Malorian have been answered. Now Malorian has a proper weapon to fire the 14mm round that made them famous.



MALORIAN "TRINITY" 3350eb
 P - +2 - L - P - 6D6 (14mm caseless) - 6 - 1 - ST
 Contrary to popular belief, the Malorian trinity does not have 3 barrels. The lower two cylinders are the built in laser sight and flashlight. Malorian once again proves that style is everything. Never sacrificing function, but ensuring the form is something people talk about in all the right circles.

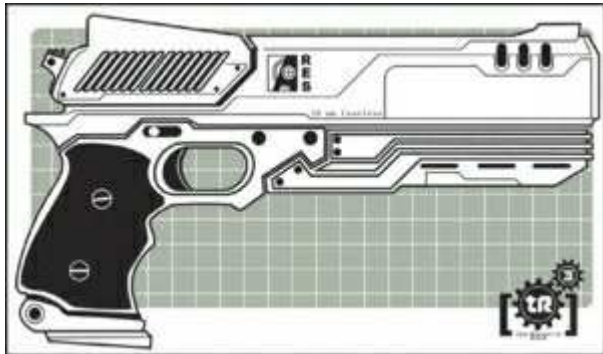

MATSUCORP DECON-14 485eb
 P - 0 - J - P - 6D6 (14mm caseless) - 6 - 1 - VR
 This anti-cyborg weapon, chambered in 14mm, is the latest in a promising line of weapons from one of the bright rising stars in Handgun manufacturing. For an extra 50eb you can have it equipped with a single shot 25mm/.12ga underbarrel launcher.



MILITECH PRED-6 2835eb
 P - -1 - J - P - 6D6 (14mm caseless) - 6 - 1 - ST
 Yet another large bore sidearm from Militech. The leather padded grips for extra comfort are a nice touch, as is the flip down laser sight on the front of the trigger guard.



NOMAD BIGGER BRUTE 5500eb
 (From Nomad Market)
 P - -1 - J - U - 9D6 (14mm cased ETE) - 5 - 1 - VR
 Obviously made by whoever came up with the Elegant Brute, since it uses the same frame, this version of that weapon has been specially reinforced to fire Electrothermally Enhanced ammunition. Unlike the Brute this weapon has an underbarrel removable tube magazine. Just to illustrate how big this gun is, we placed an off-the-shelf desert eagle beside it. I wish I knew who was building these things; I would like to give them a few ideas.



NOMAD ELEGANT BRUTE 2500eb
 (From Nomad Market)
 P - -1 - J - U - 6D6 (14mm cased) - 5 - 1 - VR
 Large, heavy, and completely custom. This weapon was totally built from scratch and accepts the massive 14mm round. An odd round for nomads considering its relative difficulty to get. It is reloaded from the right side, one shell at a time. The firing mechanism is remarkably simple and virtually unbreakable. A very large gun, but stylish enough to garner respect wherever you find yourself. (10 second reload time)



NOMAD RIVET GUN 600eb

(From Nomad Market)

P - -2 - L - U - 6D6 (14mm caseless) - 7 - 1 - ST

Malorian isn't the only one capable of creating a monster. And while this weapon certainly isn't as pretty as any of Erin's designs, it is one of the most intimidating things we have ever seen. It's also the heaviest pistol we have ever heard of. Not very accurate, and finding 14mm caseless rounds in the wastelands could be tricky, but with this big boy you usually only need to point it at someone to get your message heard.



RUGER "LAWGIVER" 960eb

P - +2 - L - C - 6D6 (14mm caseless) - 7 - 1 - VR

Ruger makes the jump to the extreme handgun market with the Lawgiver. Chambered for 14mm caseless, and possessing a nice ammo capacity, this gun is very intimidating. The weight under the barrel is heavy enough to keep the gun straight while firing, and contains a flashlight and laser sight to ensure you hit the mark.



NORINCO "SPEAR" 1250eb

P - +1 - L - P - 6D6 (14mm cased) - 8 - 1 - ST

This is an ugly hard hitting mother of a gun. Its huge and it would seem from its oversized grip that the weapon was manufactured with cyborgs and ACPA in mind. It fires the monster 14mm round and is able to carry 12 in its magazine. The wood grips and barrel shroud are a nice touch and do a lot to take away from the hideous appearance of this monster.

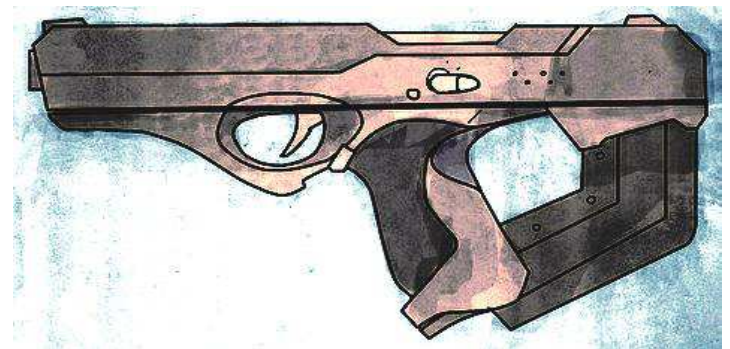

SEBURO AC-56 1450eb

P - +1 - L - C - 6D6 (14mm caseless) - 14 - 1 - VR

Sebuco, not to be left out of the 14mm market, introduce the AC-56, and devastates the competition.



RONIN ARMS "AXE" 2245eb

P - -2 - L - R - 6D6 (14mm caseless) - 6 - 1 - ST

Just what everyone needs, a giant beast of a gun with a giant beast of an axe blade attached to it. The Kanji is an old Japanese saying which roughly translates to "die well". Bosozuka headmen love this weapon.



TSUNAMI ARMS HP513 589eb

P - -1 - J - P - 6D6 (14mm cased) - 6 - 1 - ST

A Tsunami 14mm with an odd addition. The integral tac light (able to toggle between standard, IR, and green at the flip of a switch) has a laser sight built right into it. An innovative and space saving concept, however you can only use one or the other, and not both at the same time.

RIFLE ROUND FIRING HANDGUNS

5.56MM



CCMMC PRACP-2 1150eb

P - -2 - L - R - 5D6 (5.56mm cased) - 10 - 1 - ST
The first Chinese military anti-cyborg handgun. It's not much to look at, but its action is simple and the weapon is effective.



COLT "BORG DROPPER" 1950eb

P - -1 - J - R - 5d6 (5.56mm cased) - 8 - 1 - VR
This gun uses the familiar colt 1911 action to fire full sized 5.56 mm cased shells. This gun is a combat machine, and accepts both the regular 8 round clip, and all standard M-16 magazines. Due to its extremely short barrel length accuracy is poor, Colt is considering development of a bullpup version.



COLT "MOOSE" 785eb

P - -2 - L - R - 5D6 (5.56mm cased) - 4 - 1 - ST
Moose, the largest American land animal and now one of the largest handguns in the world. The Moose fires full sized 5.56 rifle ammunition and while it only holds 4 rounds it is rare that you will ever need more. Designed for serious Game hunting this weapon is as rare as the large animals it was named for.



HECKLER AND KOCH XP-305 1155eb

P - -2- J - C - 5D6 (5.5mm caseless) - 20 - 1 - ST
Chambered for the 5.5mm rifle round, H&K releases this light anti-cyborg handgun. If you love H&K styling, and need something with a bit more bite, this is the weapon for you.

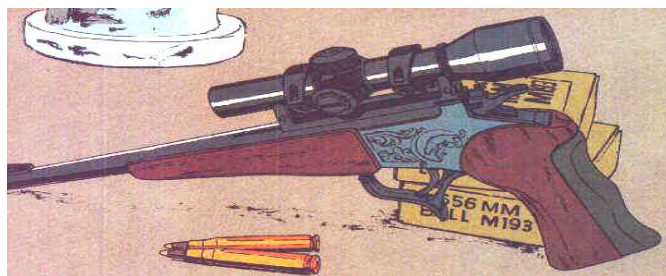

LUIGI-FRANCHI "BASTARD" 2456eb

P - +3 - J - R - 5D6 (5.56mm cased) - 1 - 1 - VR
Handmade by the experts at Luigi-Franchi this gun is for serious handgun hunters only, to own this gun is to own a piece of art. This weapon fires a single .223 cal. hunting round at a range of 1000 meters. These guns are precision crafted to fit perfectly in the hand and are incredibly accurate. This handgun is worth every penny of its high cost.



LUIGI-FRANCHI AMOD-8 2700eb

P - -2 - L - P - 7D6 (5.56mm ETE cased) - 8 - 1 - ST
Luigi-Franchi's customers demanded a weapon that would reliably eliminate any threat, but still retained the style and grace of they positions demanded. Luigi-Franchi gave them the AMOD-8...



MILITECH "DEATHSTROKE" 1480eb
 P - -3- L - R - 5D6 (5.56mm cased) - 50 - 1/3/10 - ST

And now for something completely different. The Deathstroke is a belt fed fully automatic weapon built the size of a rather large handgun. Firing this thing is a bitch, and exactly what you would use it for is beyond anyone in this organization, since it is so inaccurate and has such a horrific muzzle climb that hitting anything with it is a miracle unless you are severely augmented.



MILITECH "SHADOWKILLER" 920eb
 P - +2- L - P - 5D6 (5.56mm cased) - 10 - 1 - VR

An outstanding weapon made for penetrating body armor and full conversion shells, the Shadowkiller from Militech fires the full sized 5.56 rifle round, has an ammo capacity of 10+1 and features a built in wrist brace to ensure accuracy. While it is not very concealable it is effective.



MUSTANG ARMS GREN-53 1500eb
 P - +1 - L - R - 5D6/5D6 (5.56mm/10ga. cased) - 5/1 - 1/1 - ST

The Gren-53 is a very large, very awkward handgun. It features two barrels and fires 5+1 shots of 5.56mm rifle ammunition fed from a top mounted clip through the upper barrel, while the lower barrel holds and fires a single 10 ga. shell of any type. Comes standard with smartchipping and is very popular among bounty hunters and those who find themselves up against full borgs.



NOMAD SABERTOOTH 610eb
 (From Nomad Market)
 P -1 L R 5D6 (5.56mm caseD) 2 1 VR

An over under hand built handgun chambered in 5.56mm cased. The dual bayonets make it just a little more vicious looking. Comes with a bulky custom hip holster.



NOMAD SCRAPPER 120eb
 (From Nomad Market)
 P -1 L C 5D6 (5.56mm caseless) 20 1 UR

As full conversion cyborgs and other cybernetically enhanced or armored individuals are becoming slowly more prevalent in the Nomad Community, so is the necessity for weapons that will stop them. This hand made handgun fires the 5.56mm rifle round, which will not only take out even full conversions, but also makes a pretty good vehicle stopper. Unfortunately it's not very reliable and prone to jamming.



NORSE ARMS LOKI 1225eb
 P - 0 - L - R - 5D6 (5.56mm cased) - 6 - 1 - ST

Another ridiculously oversized and powerful revolver from Norse Arms.

.30-06



ROAD BUSTER 650eb
(From Nomad Market)
P - -2 - L - U - 5D6 (5.56mm cased) - 6 - 1 - ST
A hand crafted piece, built from scratch and featuring a rotating 6-barrel action and enough punch to serve as both weapon and hunting implement. The biggest downside is the awful rudimentary sights, but an added bonus of the system is that it will fire underwater without problem or failure, due to the individual barrel system.



NOMAD ONE SHOT, ONE KILL 125eb
(From Nomad Market)
P - -1 - J - P - 6D6 (30-06. cased) - 1 - 1 - VR
This single shot weapon made from stamped metal is a one shot firearm chambered in 30-06. According to the man selling it, it is made specifically for those who want to show off their skill when hunting, or even in combat. How they are supposed to accomplish this is beyond even me, as this weapon isn't very accurate. Still, there is a certain sense of style to only needing one shot.



SEBURO CBB-32 3140eb
P - +1 - L - VR - 5D6 (5.56mm caseless) - 10 - 1 - VR
Once again Japan's most respected gun maker branches out. This time with an extremely impressive anti-cyborg handgun. This fires full sized 5.56mm rounds. Comes smart linked as standard, also includes built in flashlight and laser sight. The flashlight switches between standard, UV, and IR light



LUIGI-FRANCHI "CARIBOU" 1715eb
P - +2 - L - R - 6d6 (.30-06 cased) - 1 - 1 - VR
A single shot pistol firing the 30-06 rifle round. Made by Italy's finest for hunting big game in style.



"HORSE WHISPERER" 80eb
(From Nomad Market)
P - -3 - L - C - 5D6 (5.56mm cased) - 1 - 1 - ST
If you aren't the one driving, or riding shotgun, the road can be pretty boring sometimes, and I guess that explains how this gun design got started, some nomad tech with too much time on his hands.... Now they are everywhere in the nomad community.

6MM



NORSE TECHNOLOGIES "BIGHORN" 1365eb
P - -1 - L - R - 5D6 or Varies (6mm cased or 40mm grenade) - 6 or 1 - 1 - VR
This weapon uses the same cylinders and ammo as their prior release, the Fenrir, however, as an added bonus, instead of loading it with the cylinder, you now have the option of flipping a switch which activates the center firing pin, allowing it to fire 40mm grenades. Versatility and ultimate stopping power is the rule of thumb when dealing with anti-borg weaponry, and this item has both in spades.



NORSE TECHNOLOGIES "FENRIR" TWIN 6 1500eb
P - -2 - L - R - 5D6 (6mm cased) - 12 - 1 - ST
Norse Tech just loves giant guns, and this is no exception. This dual revolver holds twelve rounds of 6mm rifle ammo, and the cylinders act as the barrel. Yes it's true, it's not very accurate, but with 12 shots, and quick change cylinders in a break open design, how accurate do you need it to be, especially in a package this small.



NORSE TECHNOLOGIES "LITTLE BIGHORN" 1280eb
P - -2 - L - R - 5D6 or Varies (6mm cased or 40mm grenade) - 6 or 1 - 1 - ST
A smaller, more compact version of its big brother the Big Horn, but it retains all the same functions, including the ability to fire 40mm grenades with the flick of a switch and a simple reload.

7.62MM



ARASAKA "BRIAREOS" 3150eb

P - -2 - L - P - 6D6+2 (7.62mm cased) - 4 - 1 - VR
Now this is a handgun, quite possibly one of the largest revolvers available, this fires the full sized 7.62 round. It was designed for use by full conversions and ACPA, but some brave souls have taken it upon themselves to try and fire this thing without augmentation (usually resulting in a broken wrist). A Bod min of 14 is needed to fire this extremely large weapon.



AZTECH DBL-26 DIABLO 3340eb

P - +1 - L - C - 8D6 (7.62mm short cased ETE) - 6 - 1 - ST
The only anti-cyborg handgun issued to Mexican C-SWAT, this weapon from Aztech is reinforced to fire 7.62 mm eletro-thermally enhanced ammunition. Mexico doesn't play around when it comes to Full Conversions or cybersychos.



COLT "THUNDER" 1525eb

P - +2 - L - R - 6d6+2 (7.62mm cased) - 1 - 1 - VR
A single shot, bolt action, hunting pistol chambered in 7.62mm. It looks kinda neat, like an old fashioned space laser blaster, but other than that its appeal is pretty limited.

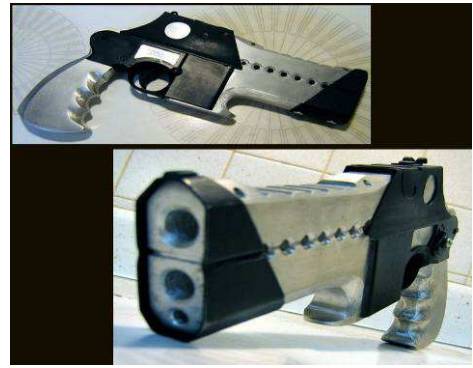

"HONEST ABE" 235eb

(From nomad Market)

P - -2 - J - U - 6D6+2 (7.62mm cased) - 2 - 1 - UR
Sometimes you folks scare the hell out of me. What we have here is a solid frame, 2 shot, over under handgun, built to fire high powered rifle rounds. It is a break open design, and is simple to operate; it also weighs 6 lbs before you load it. From what I understand it is a captured Raffan-Shiv gun, used to stop vehicles by putting bullets into their engine blocks, from close range. I call it "Honest Abe", but I wouldn't trust it as even a paperweight. This is truly the nomad version of a Polymer One-Shot, but if you are looking for firepower without the cost, and safety isn't an issue, this is the gun for you.



NORSE TECHNOLOGIES "ODIN" 2285eb

P - 0 - J - P - 6D6-2(7.62 mm short cased) - 3 - 1 - VR
The "Odin", another ridiculously high powered handgun, designed for C-SWAT to act as a sidearm. and while it is as useless for the larger borgs as the standard firearms but for the lighter borgs it is more than effective. It fires cut down 7.62 rifle shells and while the ammo capacity is low, its break-apart design and full moon style speed loaders make reloading a snap.

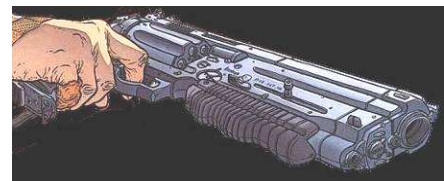

SMITH AND WESSON "BRUTE" 3960eb

P - +1 - L - C - 6D6-2(7.62mm short cased) - 4 - 1 - VR
Not to be outdone by anyone, S&W brings us there newest heavy revolver. It holds more shots than anything in its class, and more power than anything save the mighty Magnum Opus. With this gun S&W also premieres the new 7.62mm short cartridge, which is simply a shortened version of the standard rifle round, but packing almost as much punch. This is the Godzilla of handguns.

.300 WINCHESTER MAGNUM



ARASAKA STRONGARM 3800eb

P - +1 - L - P - 7D6+3 (.300 Winchester mag) - 6 - 1 - VR
Arasaka is in a current legal battle with Constitutional Arms over this weapons design, which seems to be nearly identical to one of the American companies prototypes for the Rev-X. Somehow it manages to also incorporate all the features of the Rev-X, but at a lower cost...



CONSTITUTIONAL ARMS REV-X 4500eb

P - +1 - L - P - 7D6+3 (.300 Winchester mag) - 6 - 1 - VR
Constitutional Arms updates their world famous design, giving a much more comfortable weapon that operates off the same mechanical concept, only with even better results and sleeker, cleaner lines all around. This weapon is only slightly longer than it's predecessor.

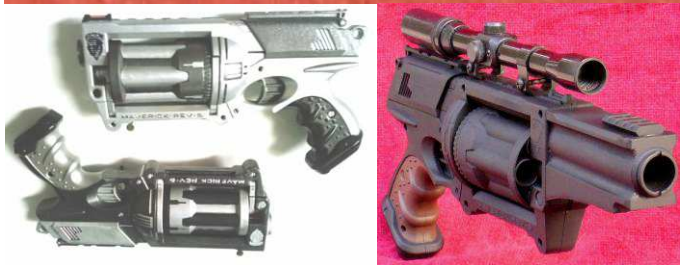

CONSTITUTIONAL ARMS REV-6 3410eb

P - -1 - L - P - 7D6+3 (.300 Winchester mag) - 6 - 1 - VR
And with this entry, Constitutional Arms makes its second attempt at the anti-cyborg handgun market. This extremely large revolver fires the full sized .300 Winchester magnum rounds. It has almost nothing in the way of a barrel, so it's not very accurate at all, but with the firepower it's packing little else can even compete. Available in a variety of different finishes. A longer barrel accessory is now available, giving the weapon a +1 accuracy.



MAGNUM OPUS "SATAN'S FIST" 4250eb

P - +1 - N - R - 7D6+3 (.300 Winchester mag) - 8 - 1 - ST
Using the same frame and action of the Magnum Opus .10 Gauge Pistol, but with a slimmer magazine, the Satan's Fist fires the ridiculously powerful .300 Winchester, pretty much destroying whatever it hits. The Magazine itself is specially designed to accept and load the lipped revolver cased ammo.



MILITECH BARRICADE 4600eb
 P - +1 - N - R - 7D6+3 (.300 Winchester mag) - 6 - 1 - ST
 The heavy frame of the Militech Barricade hides a complex recoil absorption system, allowing virtually anyone to fire it. However the weapon is still very heavy, which makes steady aim difficult. To compensate for this, the gun comes smartlinked, features removable barrel extension, removable adjustable stock, and adjustable wide-eye scope (each gives a +1 to accuracy). And it's so big and bulky that it's almost impossible to conceal, so you don't have to worry about criminals sneaking it around.



NORSE ARMS JORMUNGAND 3800eb
 P - 0 - L - R - 7D6+3 (.300 Winchester mag) - 5 - 1 - ST
 Norse Arms develops their own .300 Winchester Magnum, and defies the competition for supremacy in anti-cyborg defense.



STEIN AND WASSERMAN "SCYTHE" 895eb
 P - -2 - L - R - 4D10 (.50cal cased) - 3 - 1 - VR
 A three shot .50 caliber pistol, designed specifically for cyborg suppression, its a fairly well made piece, although it lacks accuracy do to its short barrel.



TAURUS JUDGMENT 3275eb
 P - -2 - L - R - 7D6+3 (.300 Winchester mag) - 4 - 1 - ST
 Taurus enters competition with Constitutional Arms and their Rev-6 with the more conventionally designed Judgment. It only holds 4 shots, but it's considerably less expensive. It does not have the blowback compensator that the Rev-6 does, so recoil on this monster is ridiculous. It is strongly recommended that if you do not have at least a cyber arm, you do not even attempt to fire this weapon. Available in long or short barrel versions and with fluted or smooth cylinders.



TEXARKANA TROUBLE 2500eb
 (From Nomad Market)
 P - -3 - L - R - 7D6+3 (.300 Winchester mag) - 5 - 1 - ST
 So... a nomad apparently got hold of a REV-6 and liked the idea... now a nomad gunsmith out of North Texas is making these monstrosities... With no recoil compensation whatsoever, be prepared for broken wrists... if you can even hold the damn thing up long enough to aim it...

10MM RIFLE

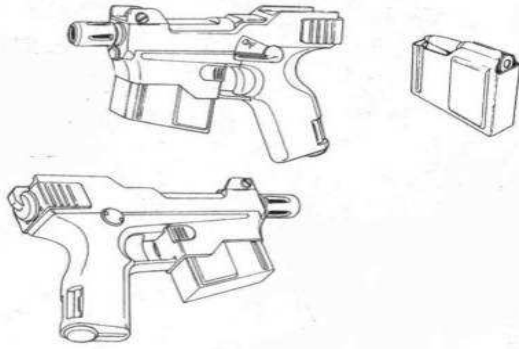

ARASAKA "MURAMASA" 3850eb
P - -2 - L - P - 8D6 (10 mm caseless) - 5 - 1 - VR
Arasaka's semi-auto answer to the "Mjolnir." Unlike its brethren this weapon fires full sized 10mm caseless rounds and offers a superior ammo capacity, unfortunately it also suffers from the heavy construction and even heavier recoil. Still it is very popular in C-SWAT circles as the sidearm of choice.

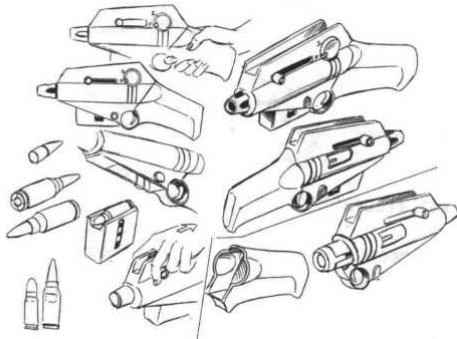

NORSE TECHNOLOGIES "MJOLNIR" 3460eb
P - -3 - L/J - P - 8D6 (10mm cased) - 4 - 1 - VR
This gun was originally designed as a sidearm for C-SWAT investigators and when broken down into its three separate parts can be concealed in a normal jacket, assembling this weapon takes just three seconds and gives superior firepower to any other sidearm allowed on the force, so powerful in fact many officers of C-SWAT have taken to carrying this as their sidearm.

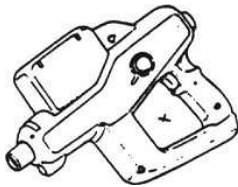

RUGER RP-107 3235eb
P - -2 - J - R - 8D6 (10mm rifle caseless) - 5 - 1 - VR
Drop that full borg, or stop that Mack truck in its tracks. This gun fires the same 10mm rifle shell used in the Arasaka Morita and packs one hell of a wallop. Its short barrel design and heavy load make for an extremely well felt recoil, so accuracy is a little troublesome, but the power of this gun, combined with its conceal ability make it extremely popular with borg hunters and C-SWAT officers.

10MM RAMJET

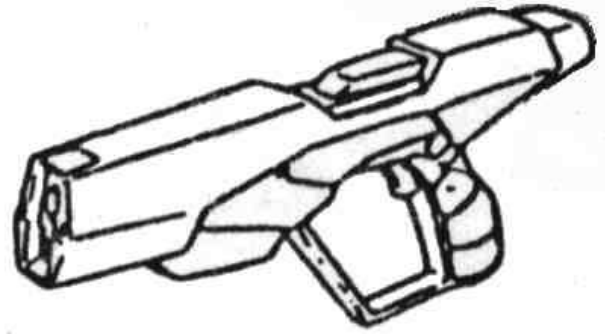

MALORIAN "ELITE" 4225eb
P - +2 - L - R - VARIES (10mm ramjet) - 10 - 1 - VR
(damage= 5d6 close, 6d6 +3 medium, 7d6 long, and 7d6+1 at extreme range, all damage is AP)
Malorian designed this weapon for the USAF space program. It uses specially designed armor piercing ramjet rounds. The guns sole purpose is to tear through the armor and outer hulls of spacecraft, and lunar/Martian stations. To date this weapon has never been used in combat.

.50 BMG



MAUDI-GRIFFIN TNX CARBINE 5395eb
P - +3 - L - R - 6D10 (.50 BMG cased) - 1 - 1 - VR
Firing the full sized .50 caliber BMG round this is without a doubt the most powerful handgun in the world. To reload it, you must completely remove the bolt. Exactly what you would need this gun for is unclear, but one shot is all you need, and if its not enough start praying.

(Created and written by Deric Bernier, images from Deric Bernier, Appleseed, Cyberpunk 2077, Macross, Masamune Shirow, Gundam, Dirty Pair, Dark Minds, Men In Black, American Flag, Aliens: Colonial Marines, Deathwish, Deathstroke the Terminator, Starman, Kite, Space: Above and Beyond, Star Wars, Ice Pirates, Akira, Backlash, Babylon 5, Burn Up W, Dave Dorman, DS9, Dream Wave, Neon Cyber, Earth 2, Grendel: Devils Legacy, Hardboiled, Nausicaa, Secret Of Blue Water, Negative One, Punisher: Big Nothing, Runaway, L-gaim, Layzner, Ghost In The Shell, Catwoman, Titan AE, Wildcats, Stark Future, Total Recall 2070, Windaria, Rifts, Gurps, Trigun, Alien series, No Escape, Akira, Killzone, Firefly, Doom, Bubblegum Crash, Humanoid, Punishers Armory, Halo, Alien Legacy, The 5th Element, Time Cop, Shadowrun, Tomb Raider, Equilibrium, Intron Depot, Final Fantasy, Hellsing, Parasite Dolls, Bubblegum Crisis, Kappowwe Toys, Gungrave, AD Police, Bubblegum Crisis 2040, Grimjack, Project Snowblind, Bubblegum Crisis, S.I.N., Dirty Pair, Gundam, Doom, Gasaraki, Blue Gender, Hellboy, Blade series, Escape from New York, Escape from L.A., Eatman, G.I.T.S.: Stand Alone Complex, Jon Sable: Freelance, I Robot, Nomad, Mystery Men, D20 Future, D20 Apocalypse, Deadlands: Hell On Earth, Car Wars, Demolition Man, Fortress, Iria Zieriam, Natural City, Space, Above and Beyond, Stealth, Unreal Tournament, Moonwalker, Gunm, Southern Cross, Grifter, Battle Lords, Lensman, SeaQuest, Robocop, Aspen, Homeboys, Judge Dredd, Terminator: Burning Earth, Edison Giacotolli, Vortex, Soldier, Back To The Future II, Echo, Event Horizon, Starship Troopers, The Saint, Robotech: Sentinels, Deathlock, Hunter, Black Ops, James Bond, Death's Head, X-Men, Firearm, Nick Fury: Agent Of Shield, Dirty Pair: Flash, Silent Mobius, Mafia Wars, Army Of Two, Capcom, Hitman, Fatal Fury, Street Fighter, Deus Ex, Quake, Air Gear, Btoom, Tekken, Perfect Dark, Fallout, Bouncer, Frontlines, Crysis, District 9, Zatoichi, Bleach, Blame, The Rundown, Avengers, Green Arrow, GI-Joe, Call Of Duty, Brink, Doom, Eon Flux, Haze, Poseidon Arms, Nerf, Starhawk, Bayonetta, Bionic Six, Hudson Hawk, Avatar, Command And Conquer, Wastelands, Borderlands, and other various manga, Anime, Comic book, video game, film, and RPG sources, Raben-Aas, Sharp-n-pointy, Biometal79, Phatandy, Bordon, Shimmering Sword, Vulnepro, El Pinoy, Br0uHaHaasdsada, Larkabella, licataknives, meandmunch, Devilita Andree Wallin, Fuchsiart, imDRUNKonTEA, Guilty Spark, Refrigerador, Italiener, Pascal Eggert, Josh Nizzi, Bokuman, Machine56, Kunkka, Johan Bergstrom, Slipgate Central, Dominic Marko, Francis001, platypusgreen, jimmypham, Warrenlou, flipation, digimech, molybdenum, Spoonboy, Doll Fac3, Eikochan, bakanecone, teh dave, SC4V3NG3R, solkee, molinaro, KaranaK, genekruger, theelphin, garanum, 2ngaw, shed2602, gorrem, moyachiche, inception08, vietnguyen, rgus, archie, David Nakey, Kuroitora, aerpenium, Dead Robot, teruchan, acidburn08, Markovah, Mort Janu, MishaMoStyle, Blitz Bot, k hos, James Lemay, Gun0runner, Gneocidal Penguin, Kalor, ionen, djake, jett0, cyzrauk8, windridex23, firestoned, anjinanhut, regis, libertyspikesv5, rimancreative, deutscherherbst, hexonal, Ryujiin10, Raverunner, daisukekazama, dannortonart, bringmeasunkist, Merkaba998, tovenius, Message2god, peterku, nervousgryphon, knightwatch, Brian Rogers, tsukijin, talros, Michael Kingery, ygolochysp, Swatninja, Cyber999, marcwf, WarmGunMod, bcjfla76, bullseye breon, Carlo Arellano, Special thanks to Matsuo, Darth Brass, darcjedi, Tom_Braider, thedap, wuher_da_brewer, Capt_MarVel, Glim999, Pulseriflefan, TK513, gunnerk19, Tommin, BritNerfMogul, Tigadee, Johnson Arms, Wolverine_solo, and all the many fine prop replica builders of Mastucorp, the RPE, Nerfhaven, Nerfhq, and BBC)

For more of the best Cyberpunk 2020 goodness available, go to

DATAFORTRESS 2.0.2.0

<http://datafortress2020.oliwy.net/>

To e-mail the author:

droc@mc2k.com

