

# DATAFORTRESS 2.0.2.0

Presents:

## THE ILLUSTRATED REFERENCE GUIDE VOLUME 4 CYBERPUNK 2020 VEHICLES

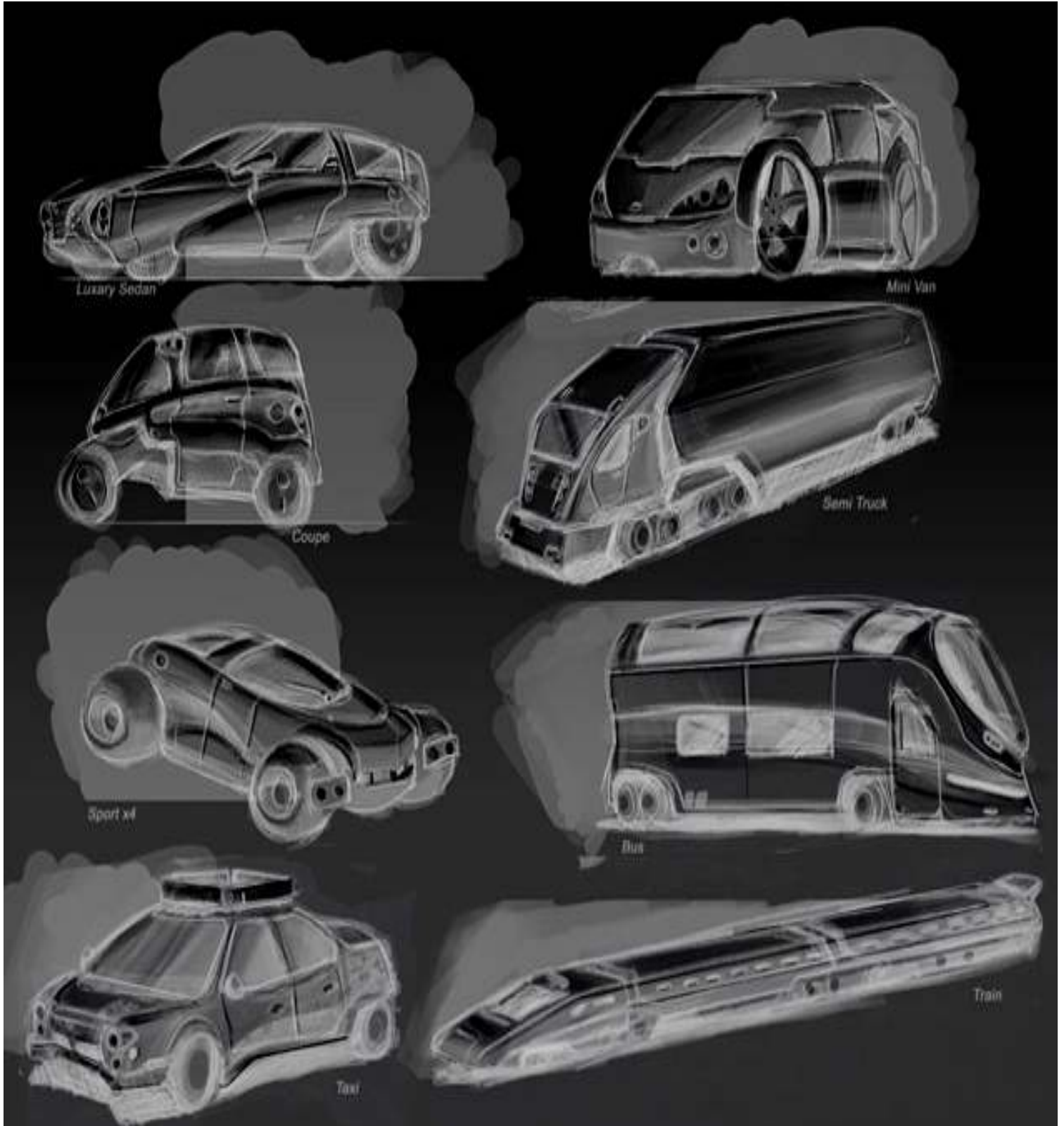

## Welcome

As the title says, this is an illustrated reference guide to every weapon ever presented in a Printed Cyberpunk 2020 product, including the 2013 books, Cybergeneration, the Atlas and Ianus books, Interface Magazine, and Punk 21 Magazine.

Every item is given the basic stats, a reference to the book it came from to further research it, and for the first time ever for 90% of them, an image.

There have been a few minor edits, the most major of which have been to drug costs and vehicle stats, to more closely resemble the flavor text, or original image, of the item, or to keep pace with real world technology.

The main reason for this project was that quite simply, in it's own words, Cyberpunk 2020 is all about Style. And when you add a visual representation to the mix, every item, every piece of gear, is literally an extension, an expression if you will, of the characters style. Without the image, it's all just numbers on a page. An image makes the choice more important than just stats. Unfortunately, most of the technology found in the sourcebooks is woefully lacking in visual representation, and some of the images that are present are simply not on the same level as others. Wherever possible I tried to use the original image, and in cases where the original image was replaced, or no image existed, I tried fervently to come as close to the item as I could based on it's description in the source text.

I would especially like to thank Node 16 for compiling the lists of items, without the Cyberpunk 2020 Reference Guide, I never could have done this.

<b>Table Of Contents</b>	
Motorcycles	3
Cars	7
Pickups	12
Trucks	16
APC	18
IFV	19
Tanks	20
Hovers	22
Aerodynes	23
L. Helicopters/Gliders	26
Medium Helicopters	27
Heavy Helicopters	28
Ospreys	28
Airplanes	29
Jets	30
Airships	31
Cyberwalks	33
Snowmobiles	33
Spinners	34
Watercraft	35
Submersibles	36
Weapon Systems	39
Powered Armor	42
ACPA Melee Weapons	45
ACPA Weapons	46
WADS	48
Remotes	49
Cyberforms	52
Space Surface Vehicles	54
Space Craft	54
Vehicle Alterations	57
<b>Legend</b>	<b>60</b>
<b>Credits</b>	<b>61</b>

Some Items represent a significantly higher tech level than others, particularly items from When Gravity Fails, the Cybergeneration books, the Firestorm books, Interface 2.2 and the Ianus books. It is up to the GM to decide which of these items to allow in his game, they should be included with caution.

# MOTORCYCLES

Vehicle Top Speed Acc/Dec Crew Range Passengers Cargo Man. SDP (Body)  
SP (Armor) Mass Cost Source



**Mitsubishi C21 Kenada**  
200 31/45 1 533 0 13kg, .75 +4 20 (1) 0 40kg 7550/10,550  
Chr4

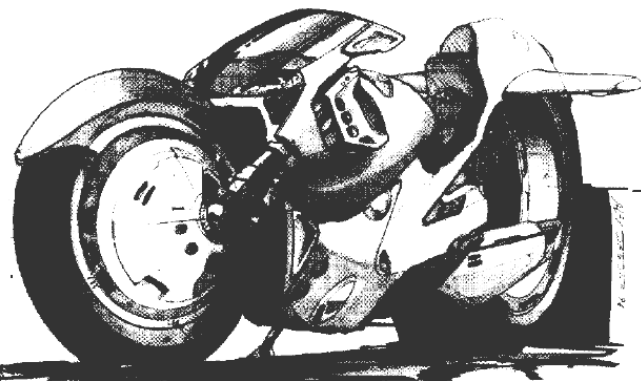

**Mitsuzuki MSX900 "Bakushin"**  
192 25/45 1 400 0 20kg, 1 +3 15 (1) 1 (0) 60kg 6600/9200  
Chr4



**Honda R400 Trail**  
120 25/38 1 400 0 10kg, 1 +2 15 (1) 0 30kg 3000 Chr4



**BMW "Volksrad"**  
60 18/30 1 400 0 13kg, .5 +1 20 (1) 0 40kg 1150 Chr4



**Kundalini GSR1200 Tetsuo**  
204 36/45 1 533 0 45kg, .4 +4 34 (2) 10 (0) 136kg 25,000  
Chr4

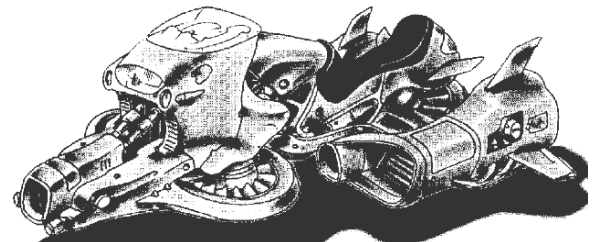

**Bensen Violator Hovercycle**  
150 30/15 1 400 1 330kg +0 20 (1) 0 1 ton 100,000 Chr3



**Mitsubishi Portabike**  
40 18/30 1 135 0 None +1 9 (0) 0 35kg 250 Chr3



**Kundalini Roadworks 'Dart'**  
120 18/30 1 270 1 30kg +1/+3 25 (1) 10 (0) 100kg 10,000  
Chr3

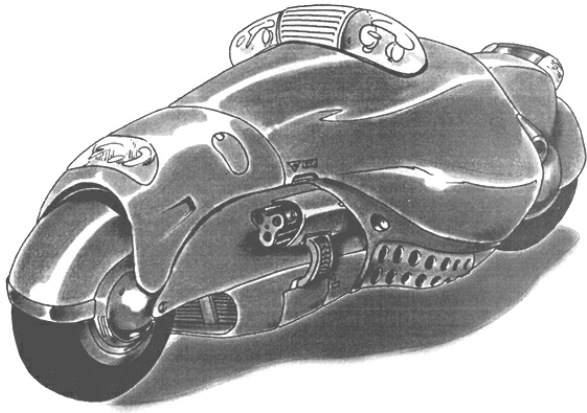

**Kundalini Police 'Torpedo'**  
 180 25/30 1 270 0 None +1/+3 30 (1) 15 (1) 120kg 36,000  
 Chr3



**Sports Eurasia 'Microbike'**  
 80 18/30 1 135 1 20kg, 1 +1 7 (0) 0 15kg 100 Chr3

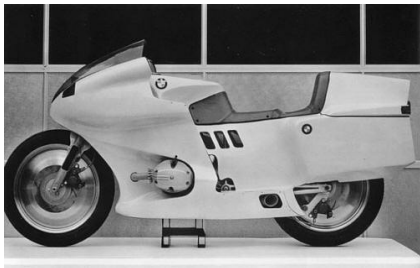

**Brennan 'Hermes' Courier**  
 72 18/30 1 270 0 Special +2 20 (1) 0 80kg 2500 Chr3

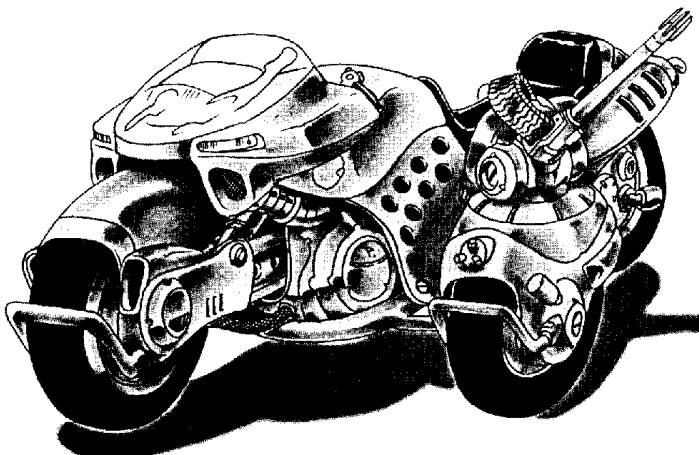

**Brennan 'Ares' Combat Bike**  
 (Gunpod Military only, sold without for 17,500eb)  
 95 27/30 1 130 0 45kg +2 37 (2) 12 (1) 148kg 21,000 Chr3



**Nasuko Datacycle**  
 60 18/30 1 270 0 12kg +2 20 (1) 0 40kg 6000 BB

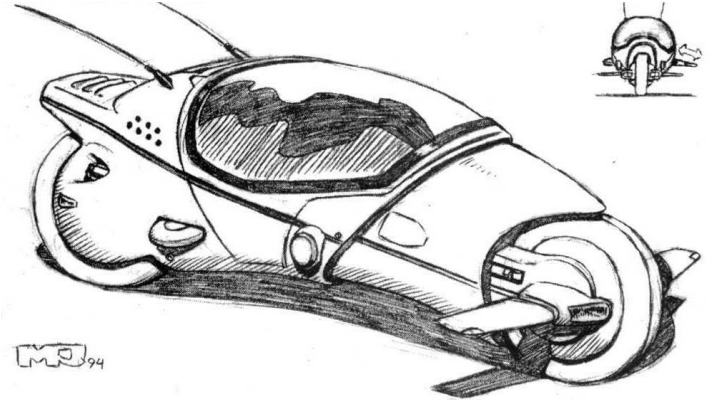

**Bell Sandpiper**  
 190 18/60 1 400 0 None +3 36 (2) 0 144kg 12,380 SOF2



**LongRider Generic 500cc**  
 120 18/30 1 400 1 54kg +0 25 (1) 0 100kg 3500 Neo



**Kawasaki Blitzkrieg**  
 190 18/30 1 500 1 60kg +1 35 (2) 5 (0) 160kg 15,000 Neo



'Sidewinder' Custom Recumbent  
140 20/30 1 400 0 None +3 40 (2) 10 (0) 180kg 32,000  
Neo

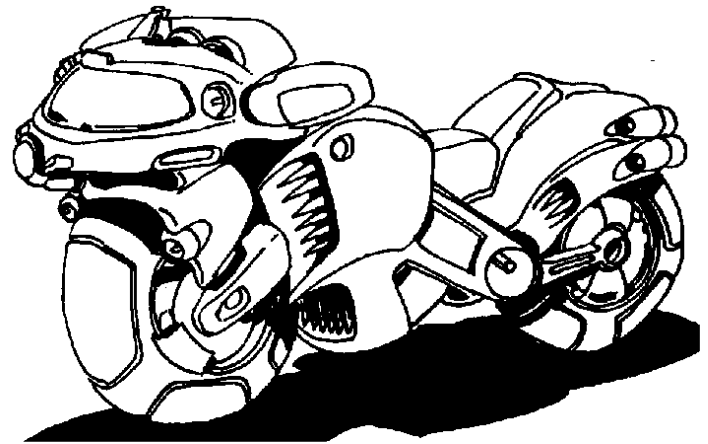

Harley-Davidson Darkwing  
100 18/30 1 400 0 45kg +1/+3 35 (2) 5 (0) 140kg 4,500  
Chr2

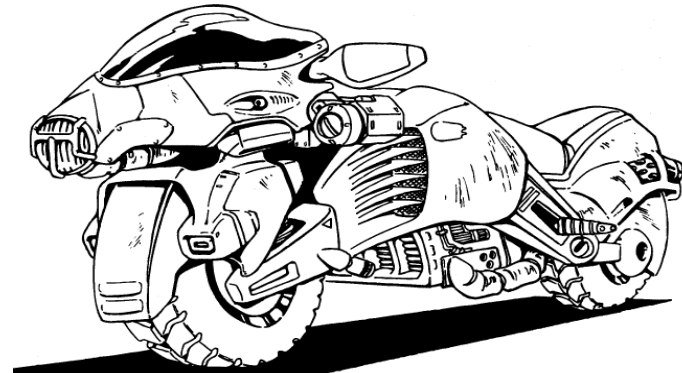

Harley-Davidson Darkwarrior Assault Motorcycle  
100 18/30 1 400 0 45kg +1 35 (2) 5 (0) 140kg 13,350 MM

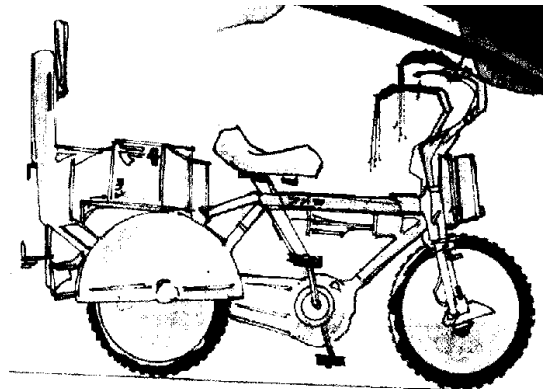

Pedicab  
15-25 5/10 1 - 1 or 20 kg +1 15 (1) 0 30kg 1200 Chr1

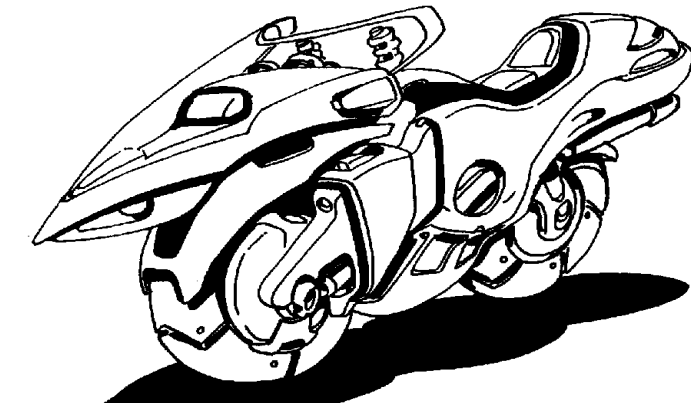

Mitsuzuki Ashigaru  
100 18/30 1 8hr 0 25kg +1 20 (1) 0 80kg 1750 Chr2



Harley-Davidson Thundergod  
100 18/30 1 370 1 45kg +1 35 (2) 0 140kg 5,040 Chr1

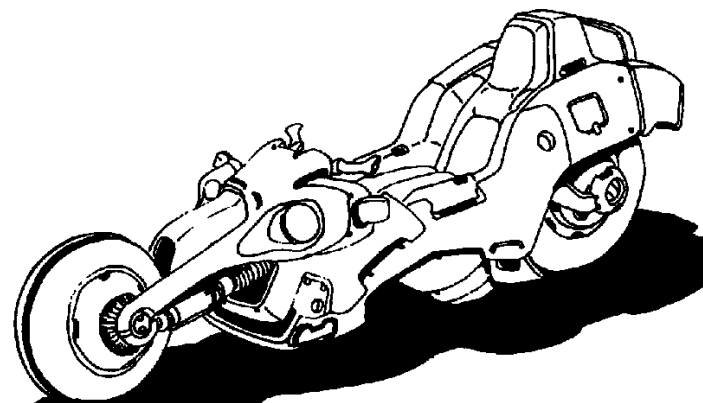

Delta Motors Bermuda  
165 18/30 1 300 1 or 100kg +2 40 (2) 0 160kg 3200 Chr2

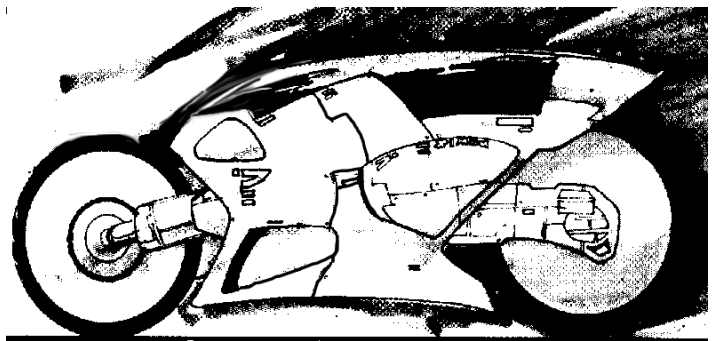

Kundalini Roadworks Shiva  
160 18/30 1 250 1 None +4 32 (2) 0 128kg 8,000 Chr1



**Kawasaki KZS-1000 Kamikaze**  
 120 18/30 1 400 0 50kg +1 40 (2) 10 (0) 160kg 13,750  
 CB1\*



**Hellfire Cyberbike**  
 160 20/33 1 400 0 20kg 0 30 (1) 0 133kg 8400 Cgen

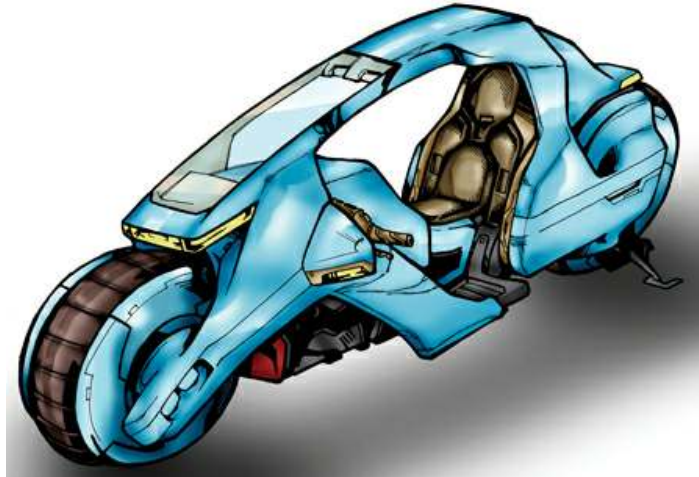

**Apache Cyberbike**  
 140 36/42 1 1600 0 40kg +1 30 (1) 5 (0) 120kg 11,500  
 Cgen



**Harley-Davidson Blue Knight**  
 160 18/30 1 300 0 45kg +1 36 (2) 15 (1) 144kg 6,000 P&S



**Nunchaku Cyberbike**  
 110 36/42 1 400 0 18kg 0/-2 27 (1) 0 54kg 4000 Cgen



**Lark Mini-Scooter**  
 70 14/30 1 200 0 20kg +1 15 (1) 0 60kg 1650 Cgen

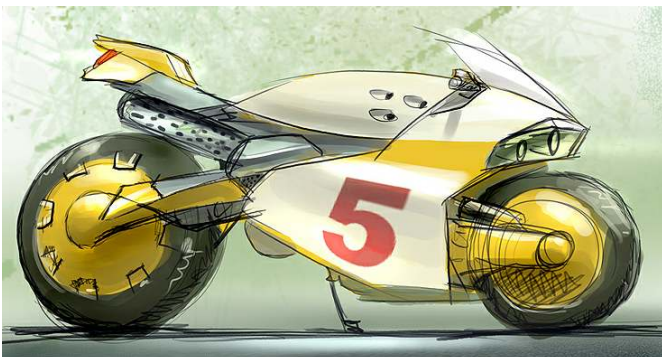

**Akira Cyberbike**  
 130 18/30 1 400 0 16kg +2 25 (1) 0 50kg 8750 Cgen

# CARS

Vehicle Top Speed Acc/Dec Crew Range Passengers Cargo Man.  
SDP (Body) SP (Armor) Mass Cost Source

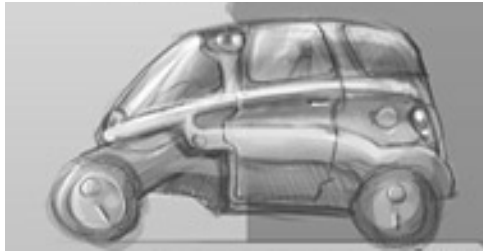

**Toyo-Chevrolet Hopper**  
50 15/40 1 300 3 86kg, .5 +0 13 (1) 0 260kg 1625 Chr4



**BMW Cohort**  
80 21/40 1 300 3 267kg +0 20 (1) 1 (0) 800kg 5500 Chr4



**GMI Sierra Hatch**  
80 15/40 1 300 3 453kg +0 34 (2) 10 (0) 1360kg 13,950 Chr4



**GMI Sierra GL**  
70 15/50 1 300 3 453kg +0 34 (2) 10 (0) 1360kg 20,350 Chr4



**Mitsuzuki Fuji**  
75 15/50 1 300 3 533kg, 1 +0 40 (2) 10 (0) 1600kg 17,450 Chr4

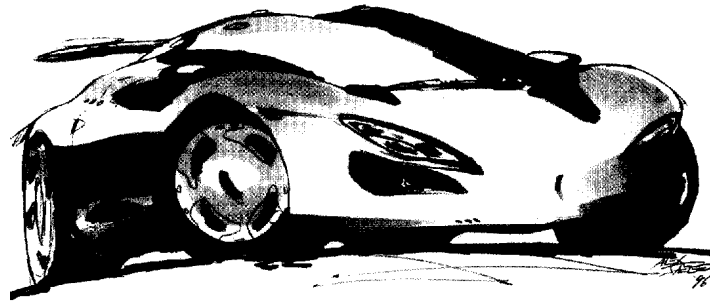

**Mitsuzuki Bushi**  
180 25/40 1 300 4 800kg, 2 +0 60 (3) 20 (1) 2400kg 27,000 Chr4



**GAZ/LADA Cossack**  
135 15/40 1 500 4 1065kg, 3 +0 80 (4) 20 (1) 3200kg 34,000 Chr4

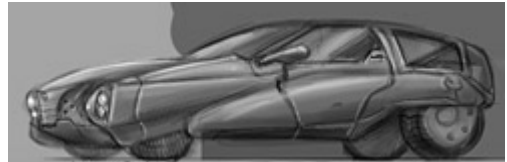

**Toyo Chevrolet Corpora**  
80 15/40 1 200 3 800kg, 2.3 +0 60 (3) 20 (1) 2400kg 41,000 Chr4  
**Corpora Sports**  
80 20/60 1 200 3 800kg, 2 +0 60 (3) 20 (1) 2400kg 46,000 Chr4

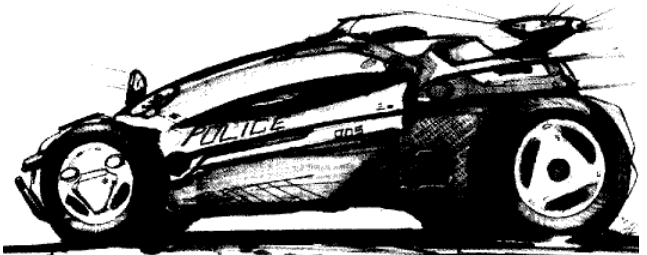

**M/J XJ220C-P Police Interceptor**  
200 25/80 2 350 1 1330kg, 1.5 +1 100 (5) 30 (1) 4000kg 165,000 Chr4

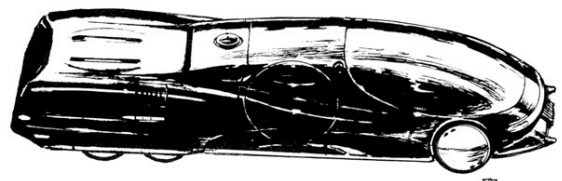

**Spinelli Autotech Spirit**  
100 21/80 2 267 4 1660kg, 0 +3 100 (5) 40 (2) 5000kg 235,000 Chr4



**Paneurope VBL APC (M)**  
70 24/70 2 435 2 1067kg, 1 +2 80 (4) 40 (2) 3200kg  
145,000 Chr4

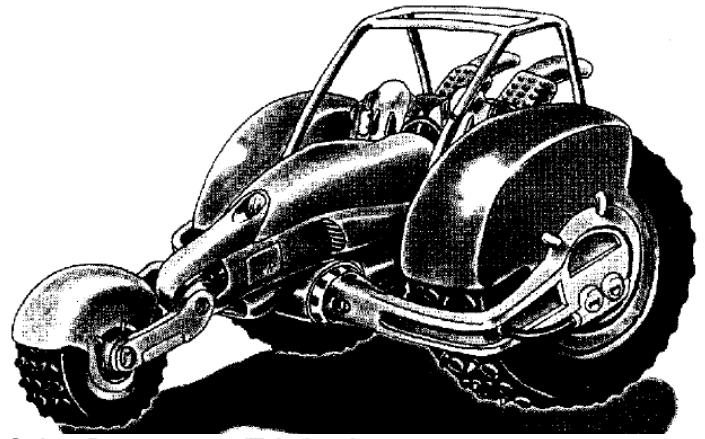

**Scion Dunemaster/Triwheel**  
10 100 30/40 1 600 1 525kg, 1 +2 40 (2) 12 (1) 1.6 tons  
40,000 Chr3

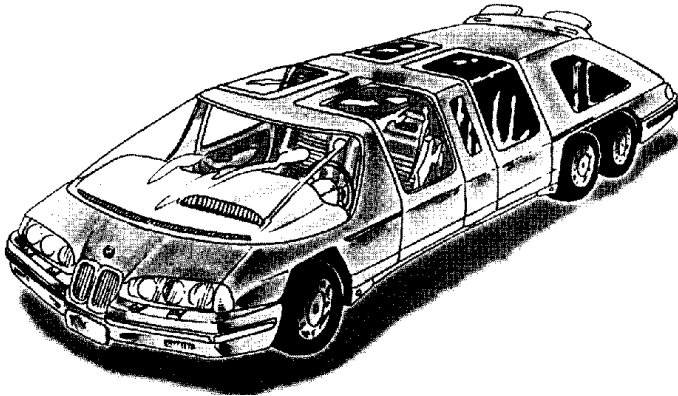

**BMW Burowagen HSR**  
110 15/50 1 200 5 9600kg +3 75 (4) 12 (1) 2.9 tons 90,000  
Chr3



**GMI Dust Devil**  
80 30/40 1 600 1 525kg, 1 +2 40 (2) 20 (1) 1.6 tons 46,000  
Chr3

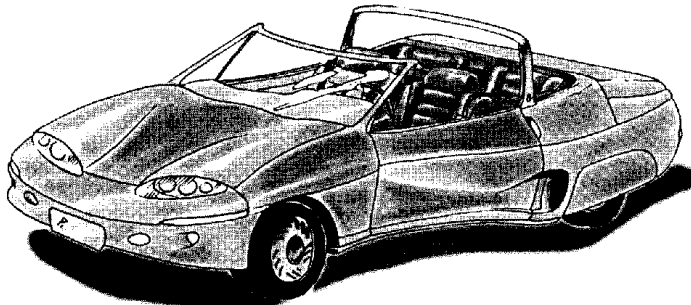

**Takaya Daimyo**  
150 15/40 1 300 3 500kg +1 40 (2) 8 (0) 1.6 tons 44,000  
Chr3

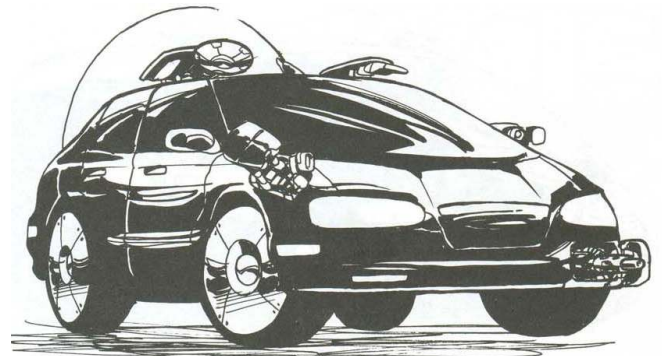

**Covert Operations Car**  
150 40/40 1 300 5 100kg -2 40 (2) 20 (1) 1.5 tons 99,000  
SF



**New American Autos Roadcar**  
80 15/40 1 600 1 300kg +0 25 (1) 0 1 ton 5500 Chr3



**Nissan Metrocar**  
50 3/10 1 200 1 90kg +0 25 (1) 10 (0) 1 ton 6000 ER





**Red Cab Taxi**  
 80 15/50 1 400 6 240kg, 2.75 +0 40 (2) 20 (1) 1.6 tons  
 36,500 ER



**BAE Electric Metro 2**  
 100 15/40 1 300 3 200kg, 1 +0 25 (1) 10 (0) 1 ton 7500  
 UK

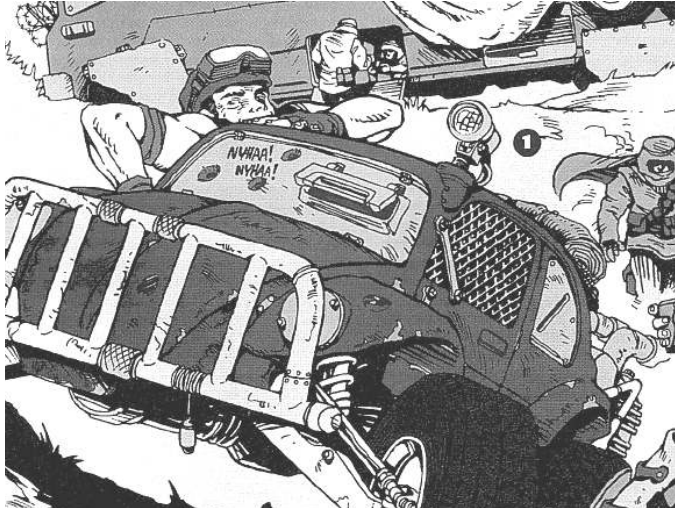

**The Bug**  
 80 18/30 1 400 2 200kg +0 32 (1) 16 (1) 1.2 tons 10,000  
 Neo

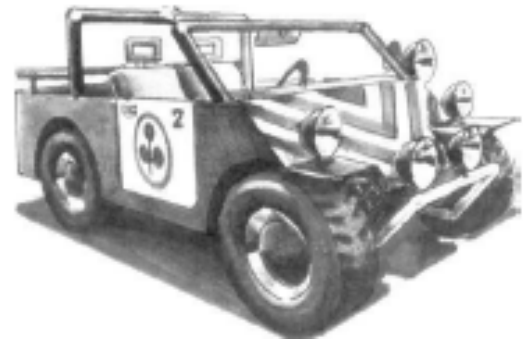

**Arasaka Kuma Land Rover**  
 90 15/40 1 400 3 650kg, 2 +0 50 (2) 20 (1) 2 tons 28,000  
 MM



**Scorpion Fast Attack Vehicle**  
 100 15/40 3 400 0 400kg +1 30 (1) 0 800kg 12,000 Neo



**Militech Commando**  
 80 15/40 2 300 2 1 ton, 1 -3 80 (4) 20 (1) 3 tons 60,000  
 MM



**BAE Police Pursuit Crusier**  
 180 25/50 2 300 2 500kg, 2 +2 100 (5) 25 (1) 4 tons  
 490,000 UK

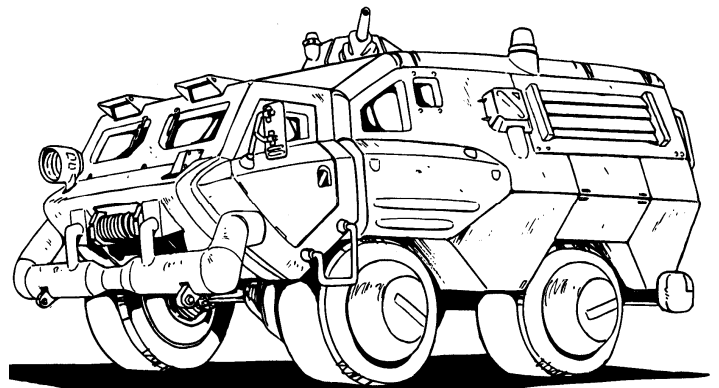

**BMW 2020**  
 100 15/40 2 300 4 1000kg, 2 -1 75 (4) 30 (1) 3 tons  
 90,000 MM

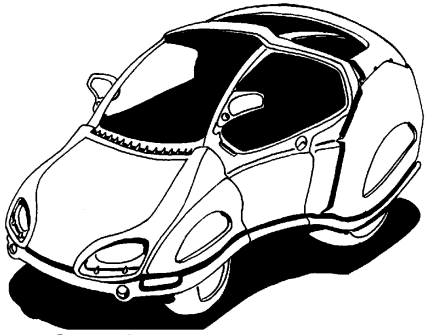

**New American Crowder**

40 15/40 1 5hr 1 100kg -1 25 (1) 10 (0) 1 ton 3000 Chr2



**Mitsubishi Sedan**

100 15/40 1 400 5 300kg +1 60 (3) 15(1) 1 ton 70,000 NWP



**Lincoln Sedan**

100 15/40 1 400 5 300kg +0 40 (2) 10 (0) 1.5 tons 80,000 NWP

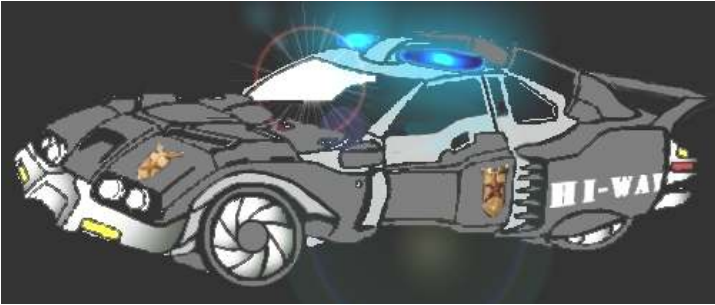

**Max Interceptor**

180 15/40 1 800 3 500kg +1 60 (3) 15 (1) 2.4 tons 40,000 Chr2



**Alaska State Patrol Car**

120 20/40 1 400 3 400kg +1 60 (3) 15 (1) 1 ton 80,000 NWP

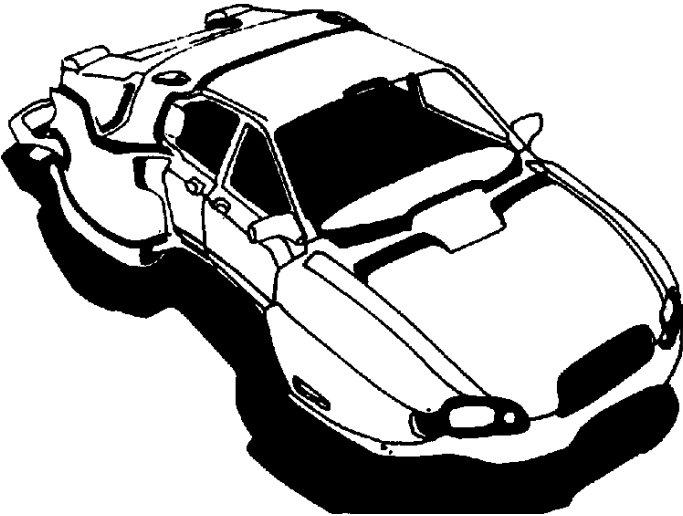

**Toyo-Chevrolet '17 Chevy**

110 15/40 1 300 3 150kg +0 50 (2) 10 (0) 2 tons 10,000 Chr2

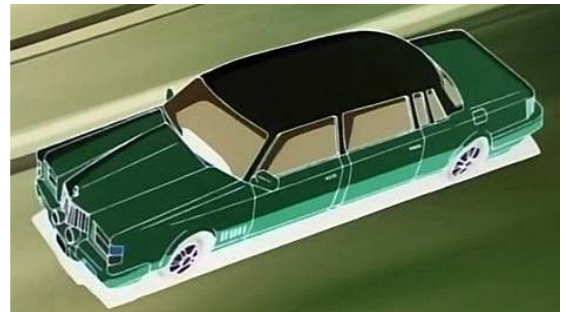

**Ford-Mazda Luxus 16**

90 15/40 1 300 5 960kg -2 72 (4) 20 (1) 2.88 tons 65,000 PB

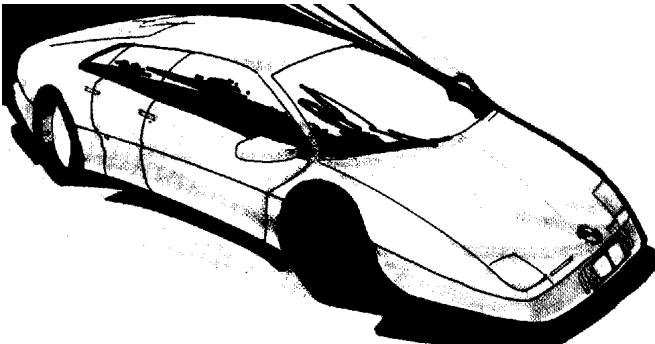

**BMW 9018s**

120 15/40 1 300 5 1000kg +0 90 (4) 24 (2) 3.6 tons 100,000 Chr1



**Lexus ZS-5000 Security Retrofit**

140 20/60 1 200 4 1000kg -1 100 (5) 30 (1) 4 tons 180,000 CB1\*

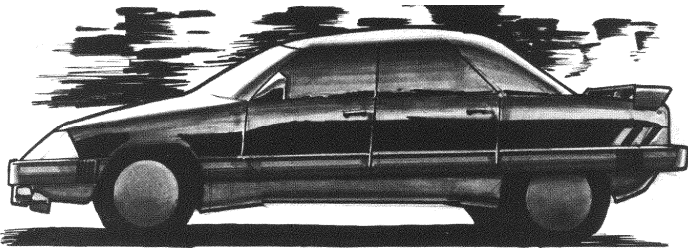

**Toyo-Chrysler Omega**  
90 15/40 1 300 3 400kg +0 40 (2) 0 1 ton 11,000 CP20\*

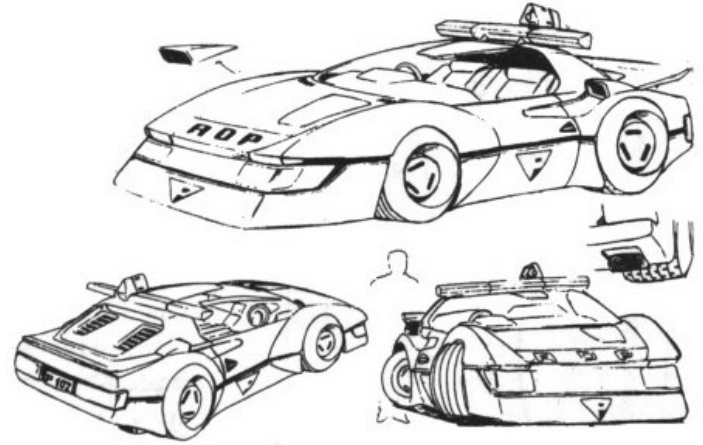

**BMW 9 Performance Interceptor**  
210 20/50 2 500 0 500kg, 1 +0 40 (2) 0 800kg 55,000 P&S\*

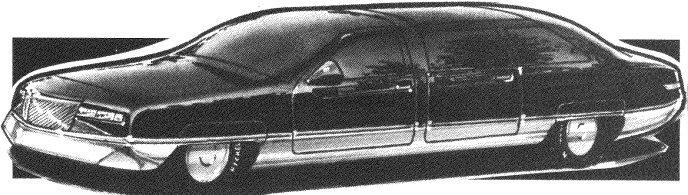

**Ford-Mazda Luxus 14**  
110 15/40 1 300 5 790kg +0 60 (3) 10 (0) 2.4 tons 140,000 CP20\*



**Limousine**  
120 15/40 1 400 8 1000kg -3 80 (4) 20 (1) 3.2 tons 57,000 LoF\*



**Toyota Avante**  
200 15/40 1 100 1 100kg, 1 +0 40 (2) 0 800kg 39,000 CP20\*

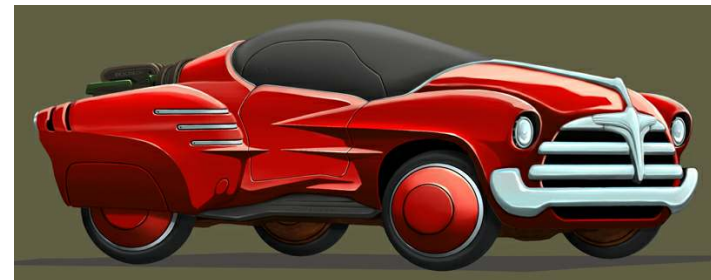

**Ford-Mazda Thunderbird IV**  
120 15/40 1 500 4 600kg +0 60 (3) 20 (1) 2.4 tons 47,000 FH\*



**Honda Metrocar**  
40 18/30 1 100 1 100kg, 4 +0 25 (1) 0 500kg 2500 CP20\*



**AMT Baja Blaster Off-Road**  
120 15/40 1 300 2 500kg, 2 +0 40 (2) 5 (50%) 1.6 tons 23,000 FH\*

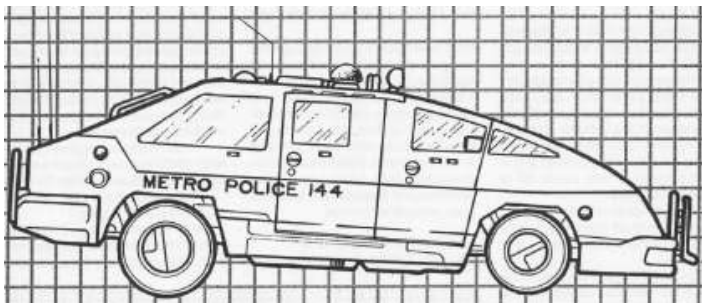

**BMW 600 Patrol Crusier**  
60 15/40 2 300 2 600kg, 2 +0 50 (2) 20 (1) 2 tons 26,000 P&S\*



**Aston Martin Lagonda DB50**  
 170 20/40 1 600 1 500kg +3 45 (2) 14 (1) 1.8 tons 75,000 P1\*



**NAM 2027 "Sentry"**  
 130 18/40 1 600 1+4 850kg +0 65 (3) 30 (1) 2.6 tons 38,000 BDay



**NAM 2027 "Blazer" Squad Car**  
 130 10/40 1 600 1+4 850kg +0 65 (3) 30 (1) 2.6 tons 34,000 BDay

# PICK-UPS

Vehicle Top Speed Acc/Dec Crew Range Passengers Cargo Man.  
 SDP (Body) SP (Armor) Mass Cost Source



**Kundalini "Bedouin" Truck**  
 60 15/40 2 500 4 1500kg, 5 -3 112 (5) 20 (1) 4480kg 105,000 Chr4



**Imperial Metro Agriculture Nomad**  
 75 15/40 1 300 2 1056kg, 11 -3 80 (4) 20 (1) 3200kg 51,000 Chr4



**Spinelli Auto Shiltron Twin Cab**  
 70 15/50 1 300 3 1056kg, 16 -3 80 (4) 10 (0) 3200kg 55,000 Chr4



**Paneurope Zobel EuroLAV II (M)**  
 60 20/60 2 435 2 1067kg, 10 +1 80 (4) 40 (2) 3200kg 105,000 Chr4



**Cadence Industries Wanderer**  
 80 15/40 1 500 4 650kg -3 50 (2) 20 (1) 2000kg 50,000  
 Chr3



**"Hearse"**  
 80 15/50 2 300 11 None -3 80 (3) 20 (1) 1600kg 265,000  
 SW



**New American Nautilus**  
 RV 80 15/40 1 500 4 600kg -3 60 (3) 12 (1) 2400kg 32,000  
 Chr3

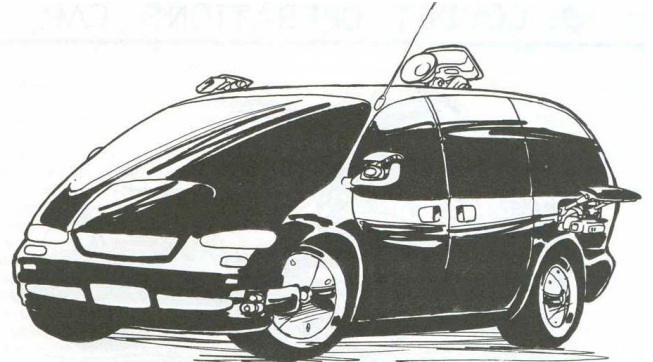

**Covert Surveillance Van**  
 75 30/40 1 100 4 300kg -3 75 (4) 20 (1) 2 tons 550,000 SF

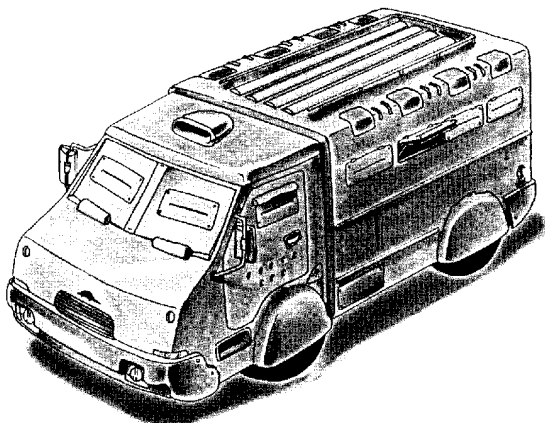

**New American Armadillo RV**  
 80 15/40 1 500 6 1200kg, 2 -3 90 (4) 27 (1) 3600kg 85,000  
 Chr3

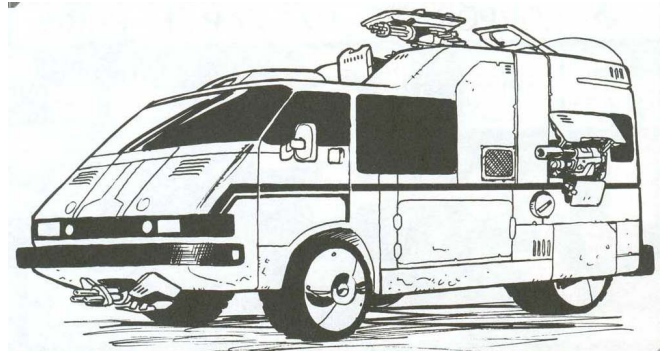

**Covert Assault "APC"**  
 90 30/50 1 300 9 500kg -3 75 (4) 38 (2) 3 tons 450,000 SF

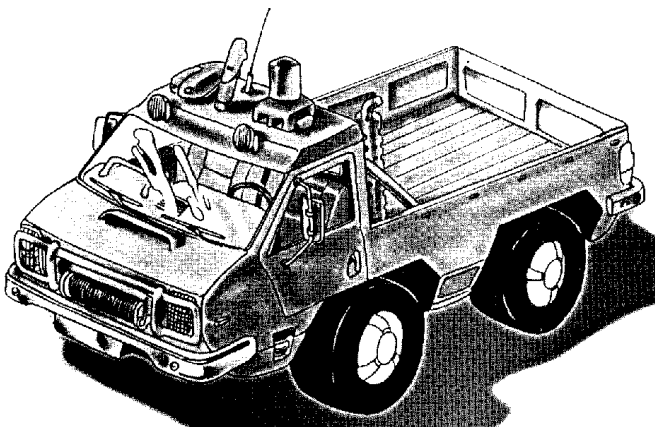

**Spinelli Autotech Nomad**  
 100 15/40 1 500 1 525kg, 3 +0 40 (2) 8 (0) 1600kg 55,000  
 Chr3

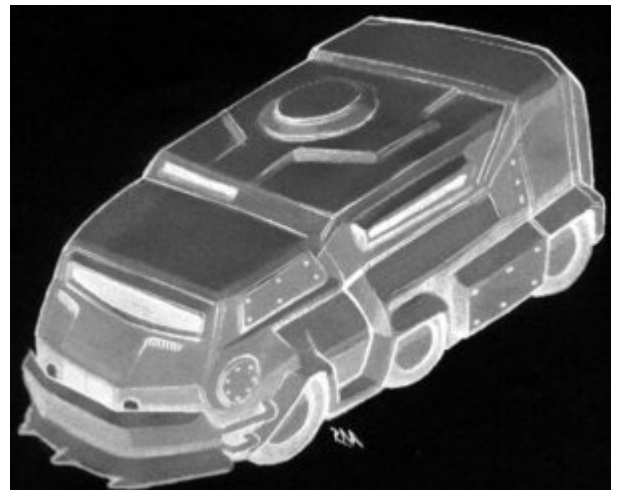

**Netrunner "Drifter" Mobile Environ.**  
 80 15/40 1 700 1 640kg, 3.5 -2 80 (4) 10 (0) 3200kg  
 80,000 BB



**MedWagon**  
100 10/30 2+2 700 6 1 ton -2 60 (3) 20 (1) 3 tons 50,000+  
Neo



**Affirmative Action Van**  
72 10/30 1 800 9 3000kg, 2 -3 140 (7) 40 (2) 10 tons  
100,000 ER



**BRDM-10 Scout Car**  
60 15/40 2 180 2 1.2 tons, 14 -2 90 (3) 31 (2) 3.6 tons  
125,000 SOF2  
**BRDM-11 'Cannon'**  
60 15/40 3 180 0 1 ton, 12 -2 90 (3) 31 (2) 3.6 tons  
140,000 SOF2  
**BRDM-12 'Anti-Tank'**  
60 15/40 4 180 0 1 ton, 8 -2 90 (3) 31 (2) 3.6 tons 170,000  
SOF2  
**BRDM-13 'Anti-Aircraft'**  
60 15/40 4 180 0 500kg, 10 -2 90 (3) 31 (2) 3.6 tons  
390,000 SOF2



**Sankey Police Landrover**  
70 10/30 2 300 6 None +0 60 (3) 24 (1) 2.4 tons 65,750  
UK



**HMMWV 'Hummer'**  
100 15/40 1 400 5 150kg, 4 +0 60 (3) 10 (0) 2.25 tons  
30,000 MM



**Custom Pre-Collapse Van**  
80 15/40 1 300 2 1155kg, 6.5 -3 40 (2) 20 (1) 1.75 tons  
40,000 ER



**New American Ambunaught**  
72 10/30 1 300 5 3000kg -3 120 (6) 40 (2) 4.8 tons 76,000  
Chr1

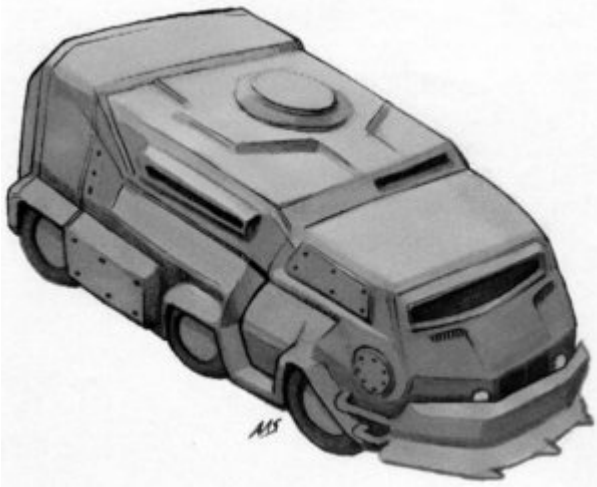

**New American Drifter RV**  
 80 15/40 1 930+200 2 640kg, 3.5 -3 80 (4) 10 (0) 3.2 tons 41,000  
 P&S\* 24,995 Chr1



**BMW 1010 Police Minivan**  
 75 15/40 1 300 3 460kg, 2 -3 35 (2) 15 (1) 1.4 tons 41,000  
 P&S\*



**Pickup Truck**  
 100 15/40 1 400 2 1500kg +0 45 (2) 10 (0) 1 ton 20,000  
 NWP



**Mercedes Spacewagon**  
 2000+ 50 15/40 1 300 3 600kg -3 25 (1) 5 (0) 1 ton 18,000  
 P&S\*



**Ford 1/2-Ton Pickup Truck**  
 100 15/40 1 400 2 1000kg +1 40 (2) 10 (0) .5 ton 30,000  
 NWP

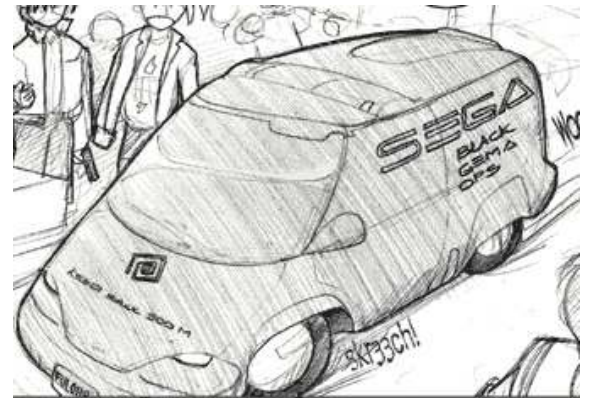

**Corporate Van**  
 110 15/40 2 400 5 930kg -3 70 (3) 20 (1) 2.8 tons 68,000  
 LoF\*



**Toyota Light Truck**  
 90 15/40 1 400 2 1000kg +0 45 (2) 10 (0) .5 ton 20,000  
 NWP



**Daihatsu Family Cruiser**  
 100 15/40 1 450 7 1000kg, 7 -3 80 (4) 0 1.6 tons 36,000  
 FH\*

# TRUCKS

Vehicle Top Speed Acc/Dec Crew Range Passengers Cargo Man.  
SDP (Body) SP (Armor) Mass Cost Source

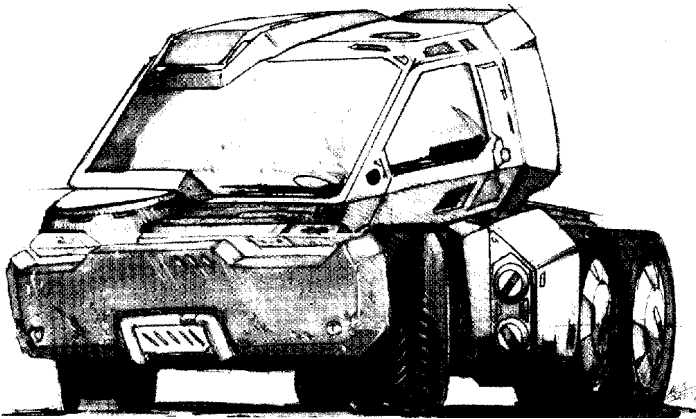

**Mac-Deux "Monster"**  
100 10/30 1 800 4 36,000kg +0 180 (9) 20 (1) 10 tons  
240,000 Chr4

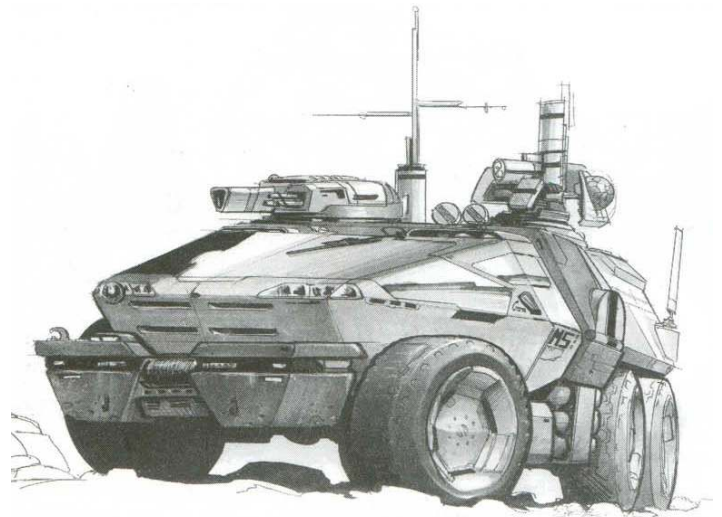

**Militech "Comscan" Command**  
70 10/30 4 300 0 None -2 200(10) 40 (2) 20 tons 2.7M SW

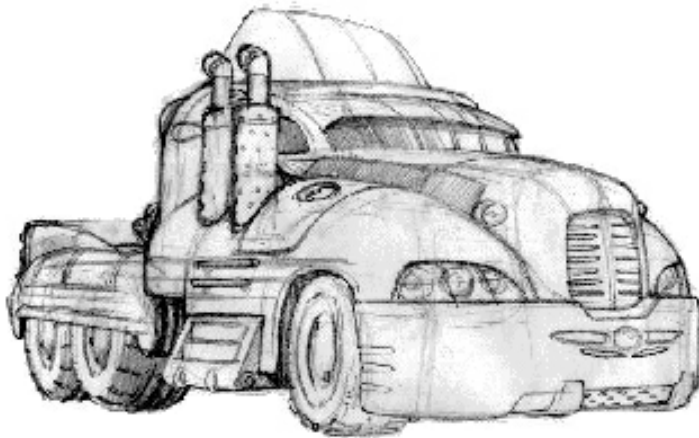

**Tetracorp DR2100 Longnose**  
101 10/30 2 1300 0 36,000kg -4 140 (7) 20 (1) 9300kg  
200,000 Chr4



**'The Big Bus'**  
70 10/30 1 400 40 5 tons, 10 -2 300 (15) 10 (0) 15 tons  
140,000 Neo



**40-Ton 8x8 Truck**  
60 10/30 2 400 varies 40 tons, 76 +0 300 (15) 20 (1) 15  
tons 185,000 Neo



**NA 'Vulture' Tow Truck**  
80 10/30 1 500 1 2.75 tons, 5 -4 125 (6) 40 (2) 8.3 tons  
215,000 Chr3



**Crash Wagon**  
100 10/30 2 300 2-6 6 tons -2 60 (3) 20 (1) 5 tons 30,000  
Neo





**2&1/2-Ton Truck**  
 80 10/30 1 800 1 2,500kg -4 75 (4) 10 (0) 5 tons 60,000 MM

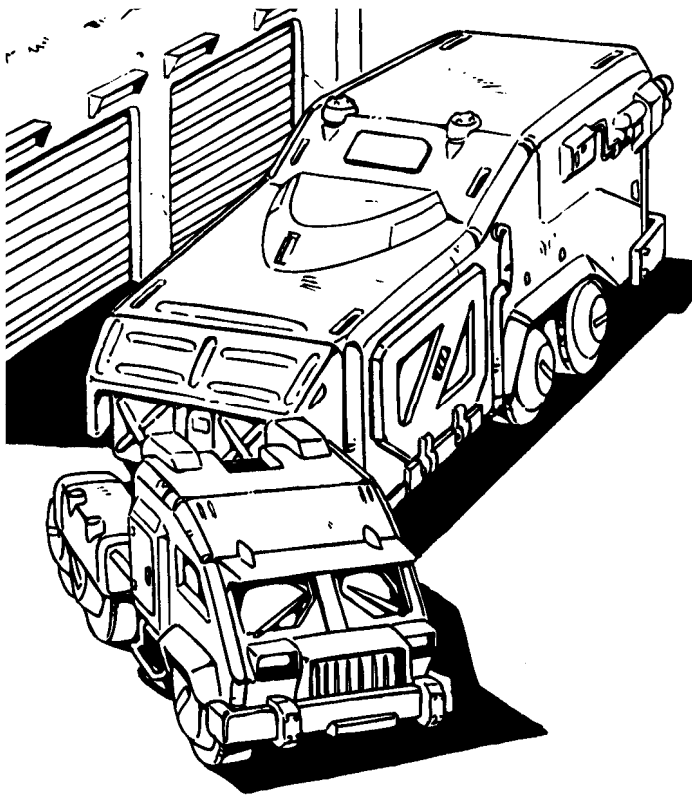

**Peterbilt 2000**  
 100 10/30 1 960 1 36 ton trailer -4 100 (5) 20 (1) 6.7 tons 110,000 MM



**Grizzly Off-Road Vehicle**  
 80 10/30 1 400 2+6 500kg +0 45 (2) 15 (1) 2.5 tons 30,000 NWP

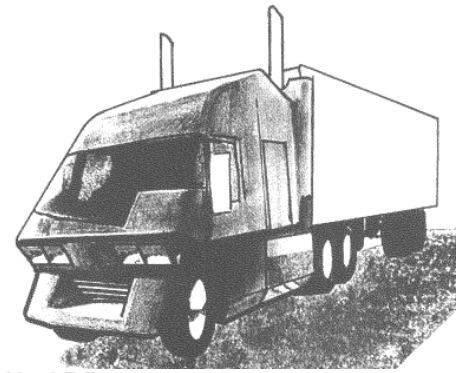

**Yakurichi-Ural BR-70**  
 110 10/30 1 800(1600) 1 36,000kg -4 125 (6) 60 (3) 8.3 tons 650,000 CP20\*

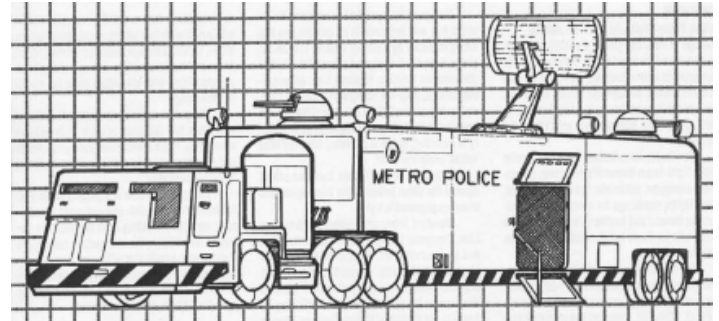

**Militech IV Mobile Control Center**  
 50 10/30 6 800 None -4 75/200 (4/10) 20/30 (1) 18.3 tons 250,000 P&S\*

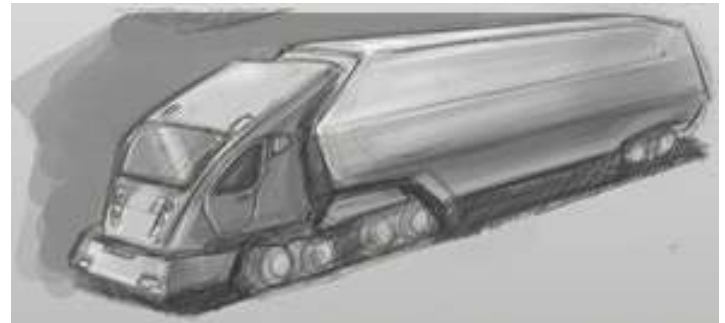

**Komatsu-Peterbilt KP-10**  
 100 10/30 1 500 3 36000kg, 2 -4 120 (6) 40 (2) 8 tons 260,000 FH\*



**IMA Titan Prime Mover (const)**  
 30 5/10 0 - 2 None -1 500 (25) 30 (1) 83 tons 1.75M UK



**Street Grader/Snowplow**  
 40 10/10 1 20 0 200kg -2 90+100 (4+) 25/100 (1/5) 3 tons  
 60,000 NWP

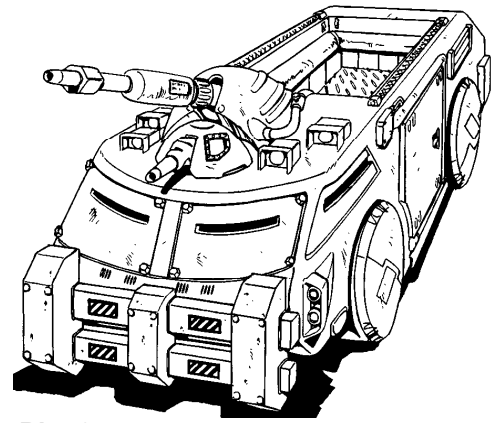

**Arasaka Riot 8**  
 120 10/30 2 300 8 2000kg -2 200 (10) 30 (1) 20 tons  
 575,000 MM



**GMI Wolverine**  
 110 15/30 3 300 0 2500kg, 1 -2 75 (4) 35 (2) 7.5 tons  
 360,000 MM



**Electric Tunnel Digger (const)**  
 10 5/10 1 200 1 None -2 200 (10) 30 (1) 33 tons 900,000  
 ET\*

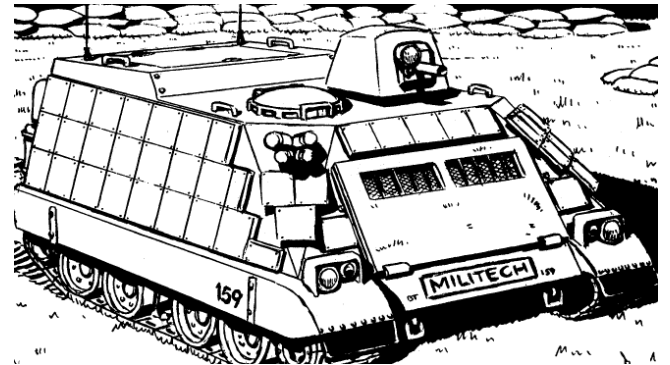

**Militech Behemoth APC**  
 60 10/50 2 300 10 2 tons +2 120 (6) 40 (2) 12 tons  
 480,000 MM

## APC

Vehicle Top Speed Acc/Dec Crew Range Passengers Cargo Man.  
 SDP (Body) SP (Armor) Mass Cost Source



**Yakurichi-Ural BTR-15 APC**  
 80 10/30 2 300 8 1000kg +0 100 (5) 40 (2) 10 tons  
 310,000 MM

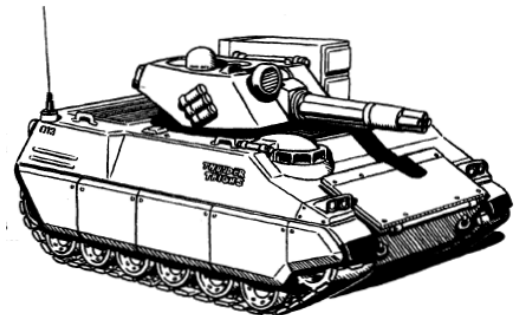

**M113 APC (tracked, amphib)**  
 40 10/50 2 300 8-10 None +2 150 (7) 20 (1) 15 tons  
 550,000 SW\*



**BMP-2**  
 55 10/30 3 300 6 13 spaces -2 120 (6) 30 (1) 12 tons  
 145,000 TCB\*



**Arasaka Combat 10**  
 10 80 10/30 2 300 10 2.5 tons int -2 250 (12) 50 (2) 25  
 tons 965,000 SW



**Saab/Scania GSG "Stomper"**  
 145 10/30 1 300 7 None +1 80 (4) 35 (2) 8.5 tons 418,000  
 P2\*

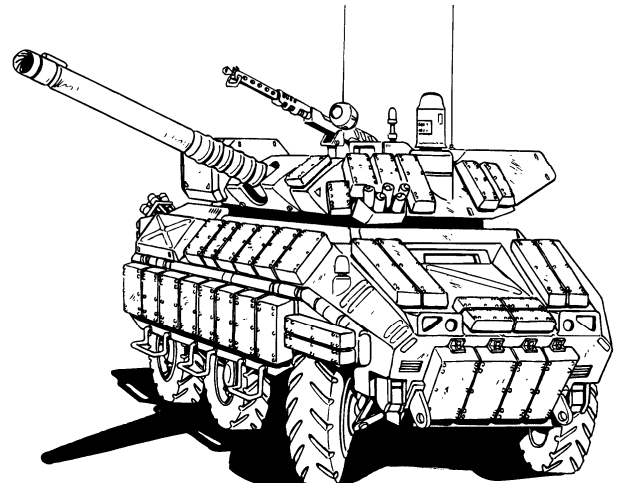

**Paneurope Gladiator Armored Car**  
 60 10/30 3 300 0 2000kg ext -2 200 (10) 80 (4) 20 tons  
 1.1M MM

## IFV

Vehicle Top Speed Acc/Dec Crew Range Passengers Cargo Man.  
 SDP (Body) SP (Armor) Mass Cost Source

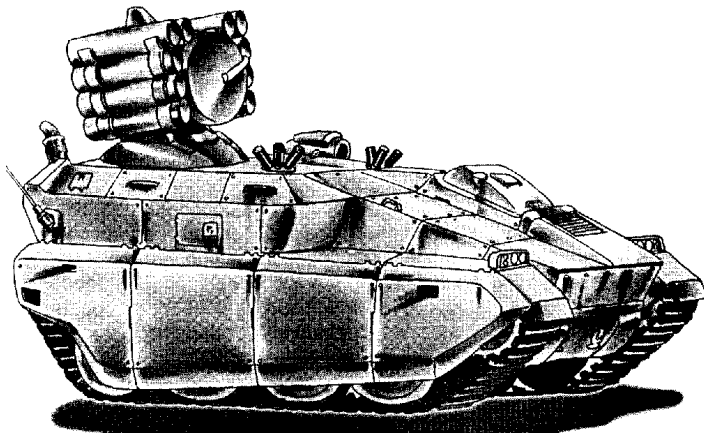

**M-62 'Volcano' SAM Launcher**  
 40 13/50 2 300 0 2.5 tons, 1 +2 140 (7) 40 (2) 14 tons  
 950,000 Chr3

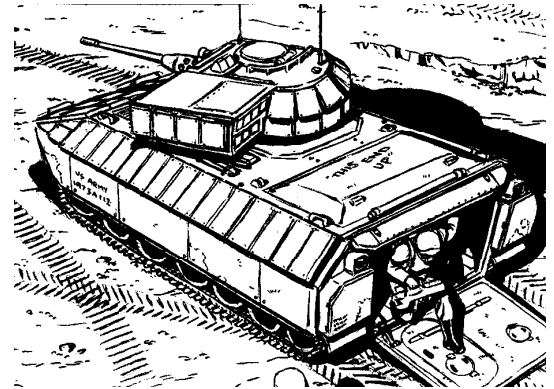

**Army M-15 IFV**  
 80 13/50 2 300 8 6 tons +2 200 (10) 100 (5) 20 tons 1.6M  
 MM

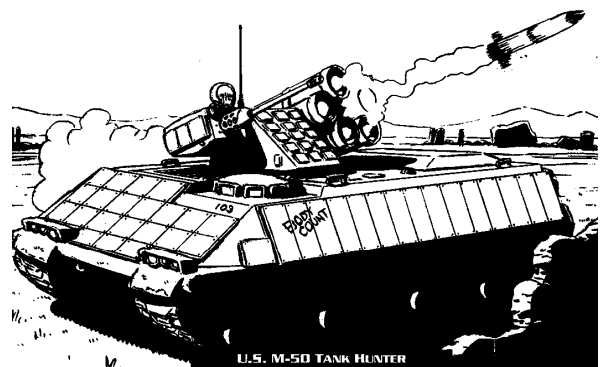

**US M-50 Tank Hunter**  
 80 13/50 2 300 0 4,500 +2 140 (7) 40 (2) 14 tons 1M MM  
 1.4M SOF2

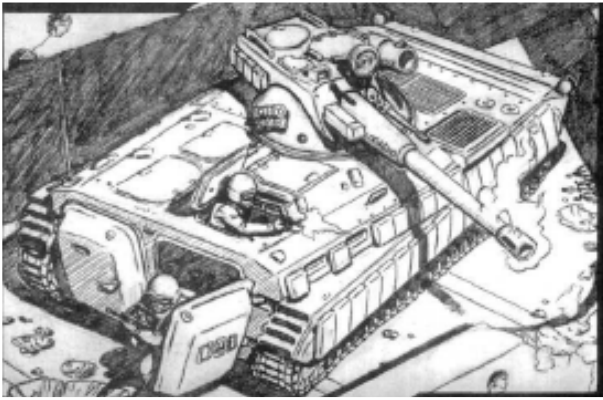

**BMP-3 IFV**  
 30 12/30 3 370 7 None +2 187 (9) 37 (2) 18.7 tons  
 950,000 SOF2

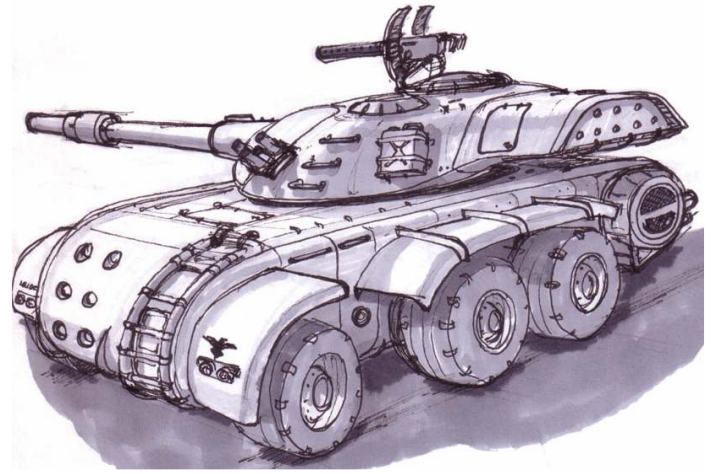

**Marder Infantry Fighting Vehicle**  
 50 13/50 2 300 10 1 space +2 180 (9) 50 (2) 18 tons  
 800,000 TCB\*



**BMW 910a Police Combat**  
 50 10/30 2 300 10/16 None -2 80 (4) 30 (1) 8 tons 100,000  
 P&S\*  
**BMW 910b Perpetrator Transport**  
 50 10/30 2 300 12 None -2 80 (4) 30 (1) 8 tons 100,000  
 P&S\*

## TANKS

Vehicle Top Speed Acc/Dec Crew Range Passengers Cargo Man.  
 SDP (Body) SP (Armor) Mass Cost Source

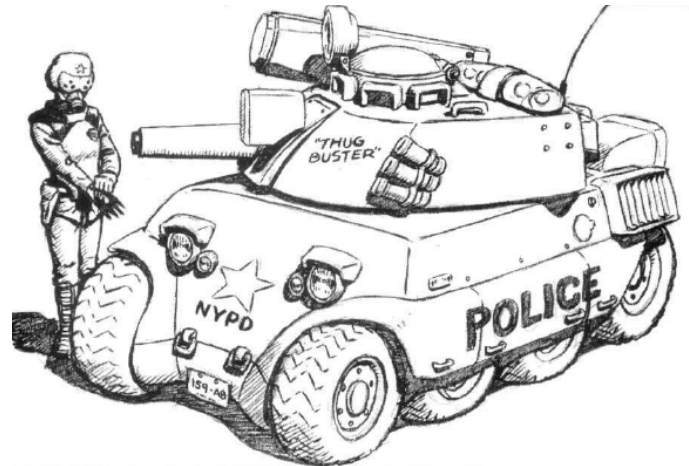

**Mitsubishi Musashi SWAT Mini-Tank**  
 50 13/50 2 200 5 or 6500kg +2 200 (10) 100 (5) 8 tons



**Militech 'Buzz' Patrol Vehicle**  
 80 10/30 2 300 0 6 spaces -2 140 (7) 50 (2) 14 tons  
 550,000 TCB\*

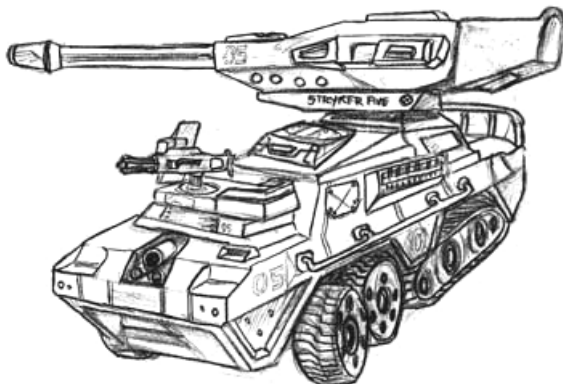

**Panhard Hunter**  
 60 10/30 2 300 0 5 spaces -2 200 (10) 50 (2) 20 tons  
 950,000 TCB\*



**T-100 MBT**  
 50 10/50 4 380 0 1 space +2 335 (17) 160 (8) 56 tons  
 9.8M SOF2

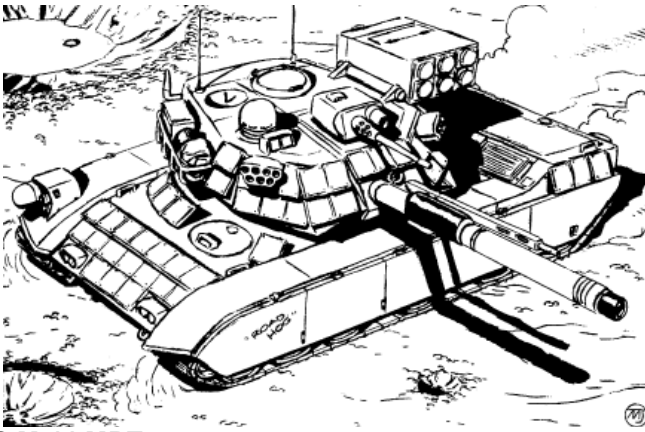

**US M-11 MBT**  
 60 10/50 3 300 0 None +2 360 (18) 225 (11) 60 tons 16.4M MM



**M1 Tank**  
 60 10/50 4 200 0 None +2 300 (15) 200 (10) 50 tons 9.1M SW\*

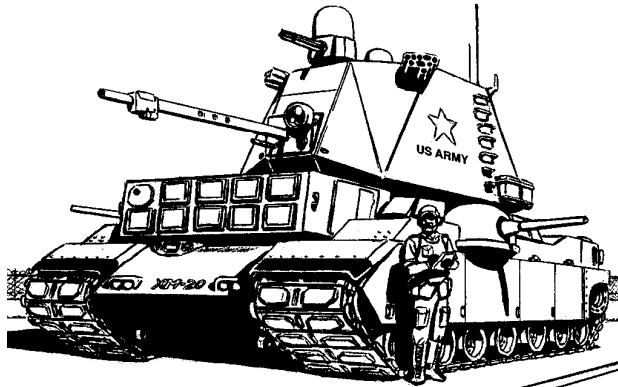

**US M-20 Superheavy**  
 40 10/50 3 200 0 None +2 600 (30) 375 (19) 100 tons 23.5M MM



**Engesa-A MBT**  
 50 10/50 3 300 0 None +2 300 (15) 80 (4) 50 tons 2.15M TCB\*

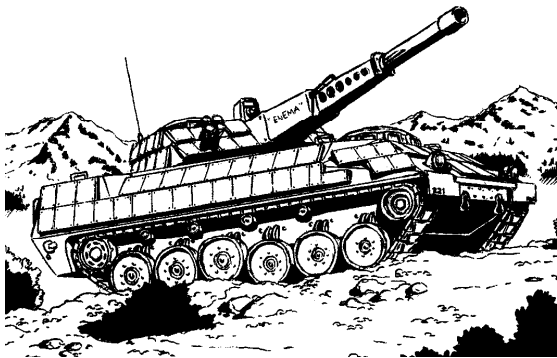

**US M-75 Light Battle Tank**  
 80 10/50 2 200 0 None +2 140 (7) 60 (3) 14 tons 1.4M MM



**T-72 Soviet Tank**  
 36 10/50 3 300 0 25 spaces +2 200 (10) 60 (3) 33 tons 1.75M (new) TCB\*

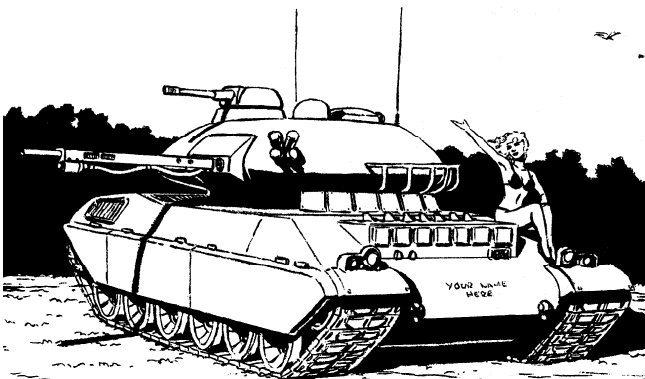

**Militech MT-4 MBT**  
 60 10/50 4 200 0 None +2 250 (12) 160 (8) 41 tons 9M MM

# HOVERS

Vehicle Top Speed Acc/Dec Crew Range Passengers Cargo Man.  
SDP (Body) SP (Armor) Mass Cost Source

codama2001\_030



**Kundalini Roadworks GevHog**  
90 15/10 1 405 3 216kg, 1.6 -2 13 (1) 0 650kg 16,100  
Chr4



**Navy M-40 GEV**  
180 15/10 4 400 0 3000kg ext -1 100 (5) 50 (2) 10 tons  
1.89M MM

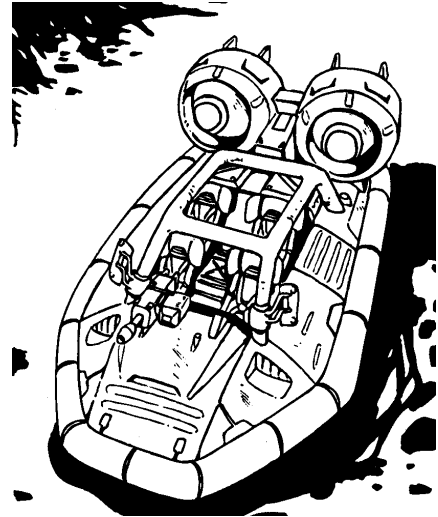

**GEB Duster**  
150 15/10 1 400 3 800kg int, 1 -1 25 (2) 10 (0) 2.5 tons  
85,000 MM

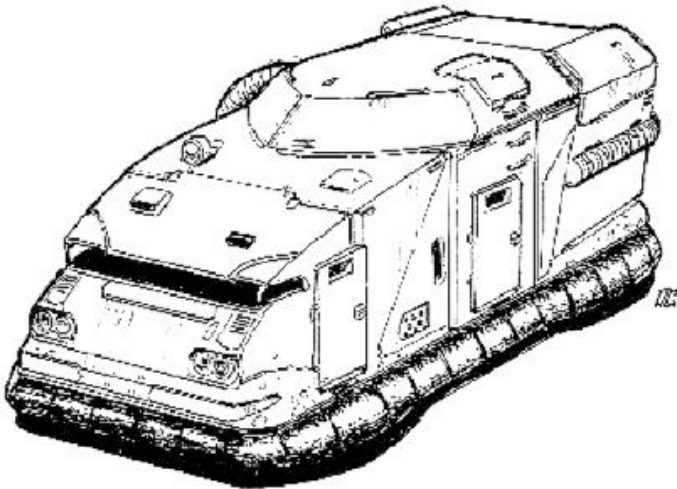

**Cadence Industries HoverVan**  
75 15/10 1 400 3 1330kg, 7 -2 50 (2) 20 (1) 5000kg  
105,000 Chr4

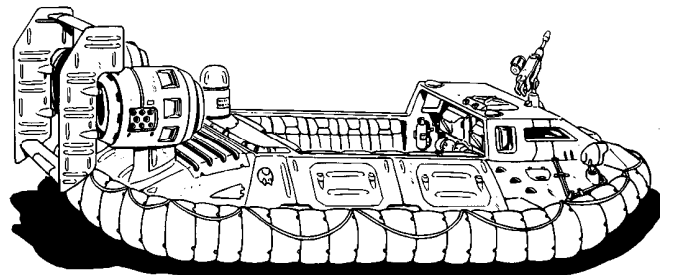

**GMI Hovertruck**  
100 15/10 2 400 12 or 5 tons int, 12 -2 100 (5) 20 (1) 10  
tons 220,000 MM

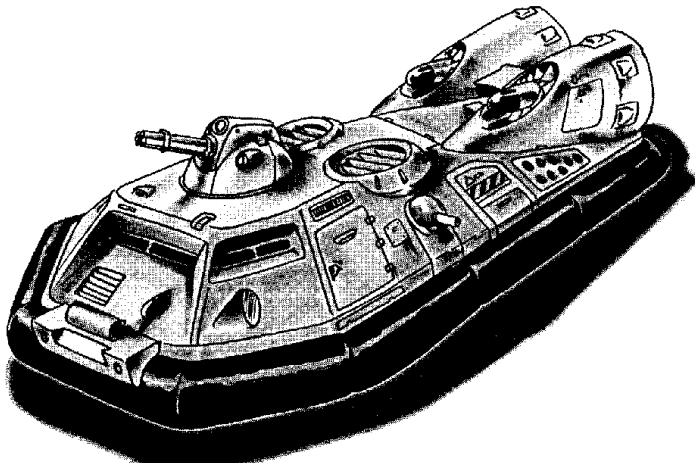

**GMI HovTransport**  
150 15/20 2 400 10 2500kg, 1 -2 100 (5) 40 (2) 10 tons  
360,000 Chr3

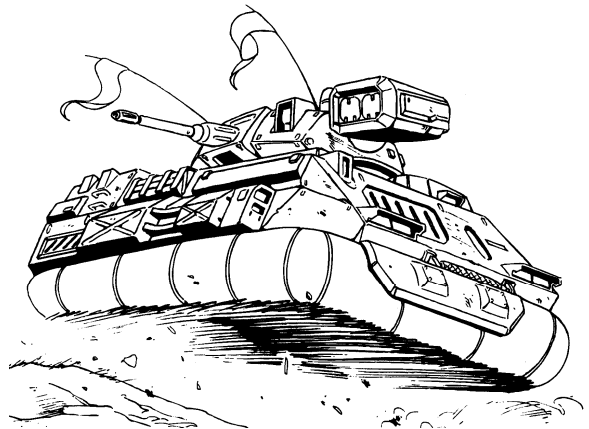

**Militech A-20 ACAV**  
200 20/10 3 650 0 3 tons int, 10 +0 100 (5) 50 (2) 10 tons  
730,000 MM

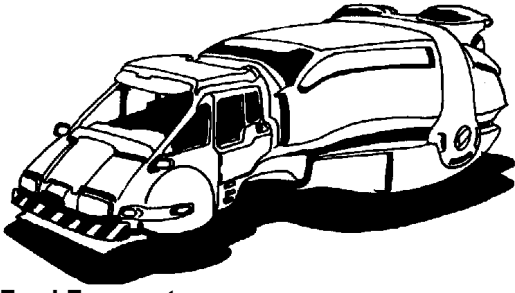

**Nissan Ford Fanmaster**  
 100 12/12 1 500 2 750kg -2 75 (3) 15 (1) 7.5 tons 20,000  
 Chr2

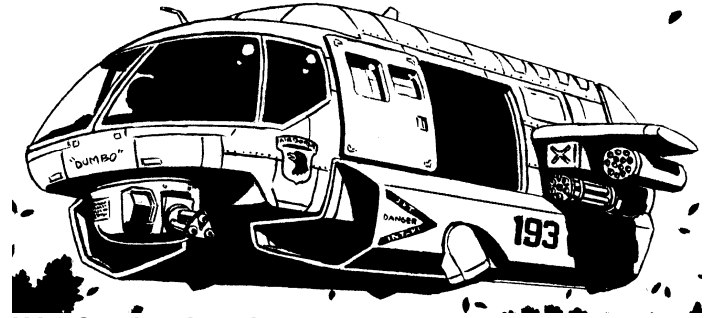

**AV-6 Combat Aerodyne**  
 495 50/50 2 1200 10 or 1300kg int, 1 +1 100 (5) 40 (2) 4  
 tons 850,000 MM



**Bensen Cascade**  
 260 15/20 1 300 3 300kg -2 40 (2) 12 (1) 3 tons 58,000  
 Chr1

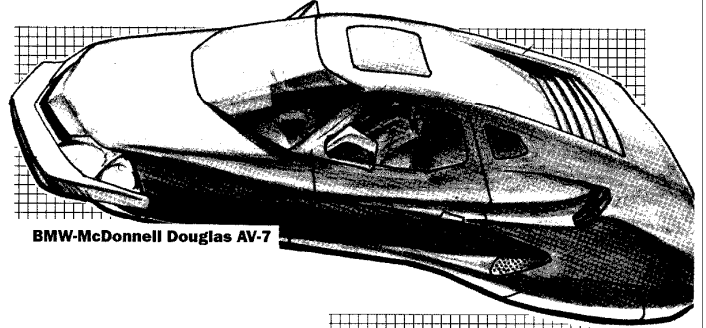

BMW-McDonnell Douglas AV-7

## AERODYNES

Vehicle Top Speed Acc/Dec Crew Range Passengers Cargo Man.  
 SDP (Body) SP (Armor) Mass Cost Source

**BMW/McDonnell-Douglas V-7 Personal Aerodyne**  
 250 70/75 1 500 1 200kg, 9 +2 50 (2) 15 (1) 2 tons  
 400,000 CP20\*

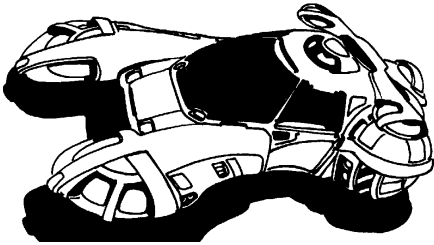

**AV-3 Aerocop**  
 150/75 25/25 15/20 2 525 3 650kg int, 1 +1/+0 50 (2) 20  
 (1) 2 tons 90,000 MM

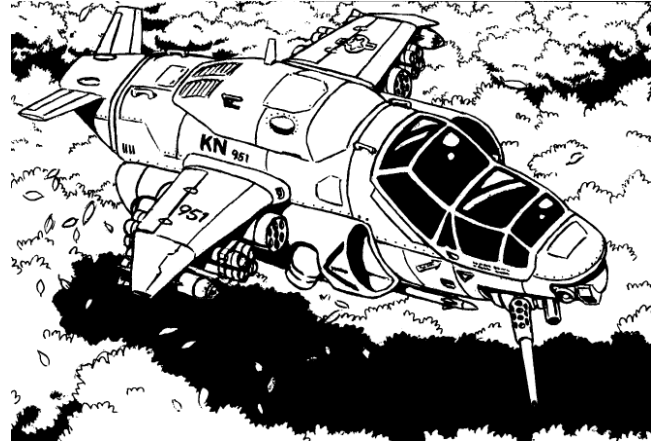

**AV-8 Assault Aerodyne**  
 495 50/50 2 1320 0 None +1 120 (6) 40 (2) 4.8 tons 2.4M  
 MM

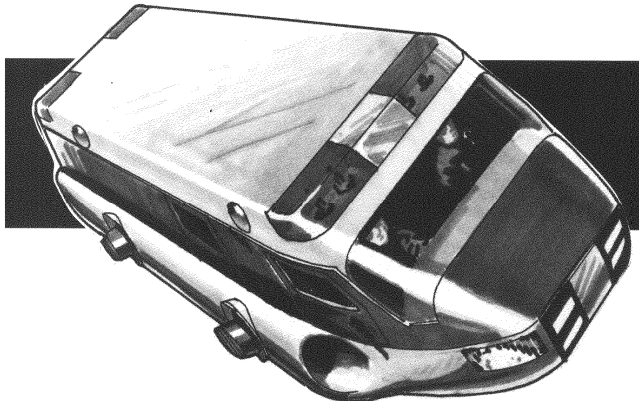
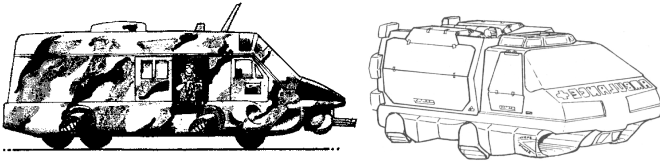

**AV-4**  
 350 50/50 1-2 800 6 1300kg int, 15 +0 100 (5) 40 (2) 4  
 tons 600,000 MM

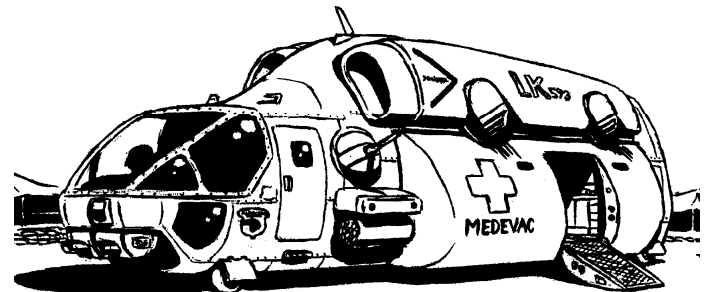

**AV-9 Multi-Purpose**  
 405 50/50 2 800 2 2400kg in pod +0 180 (9) 45 (2) 7.2  
 tons 1.75M MM



**AV-11 Combat Aerodyne**  
 405 50/50 2 1060 9 None +3 140 (7) 45 (2) 6 tons 3.5M  
 SOF2

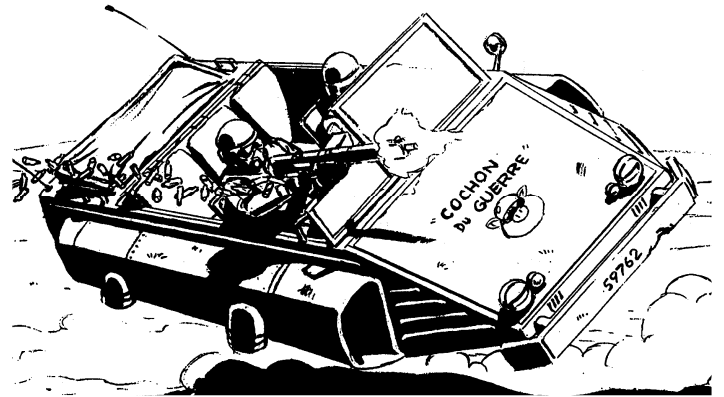

**EEC Airjeep**  
 150 50/50 1 525 5 650kg int, 2 +0 50 (2) 15 (1) 2 tons  
 25,000 MM



**Militech AVX-9C Viper**  
 540 50/50 2 800 0 None +2 125 (6) 60 (3) 5 tons 2.76M  
 MM



**Mi-50**  
 225 50/50 1 800 6 1450kg int, 20 +0 110 (5) 45 (2)  
 4,400kg 650,000 MM

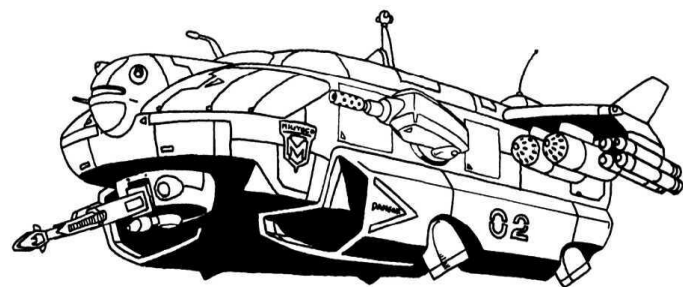

**Militech AVD (Remote/Drone)**  
 500 75/75 0 800 0 None +3 100 (5) 50 (3) 4 tons 9M  
 SOF2



**Mi-52**  
 230 50/50 3 800 3 500kg, 3 +0 110 (3) 55 (3) 4,400kg  
 850,000 SOF2

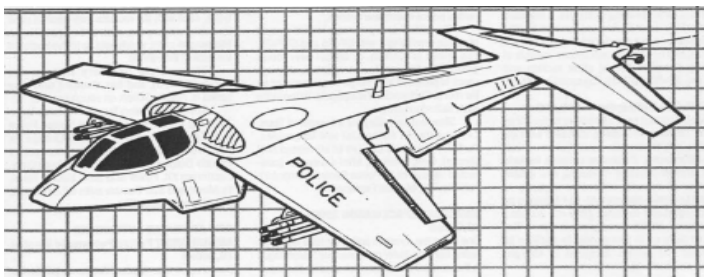

**Boeing Cityhawk UAAV**  
 360 50/50 2 800 0 1000kg int, 12 +2 85 (4) 40 (2) 3.4 tons  
 920,000 MM

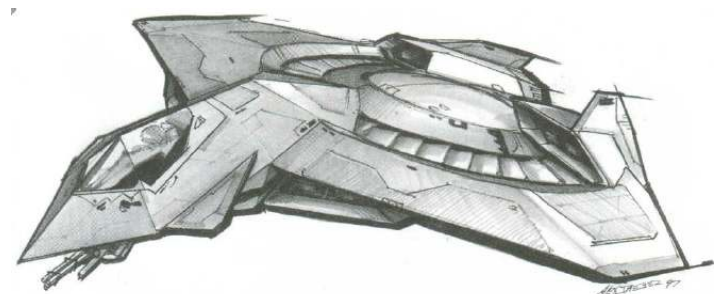

**Lockheed Nimbus Stealth Warfare**  
 330 50/50 1+1 800 0 None +1 120 (6) 30 (1) 5 tons 10.1M  
 SW



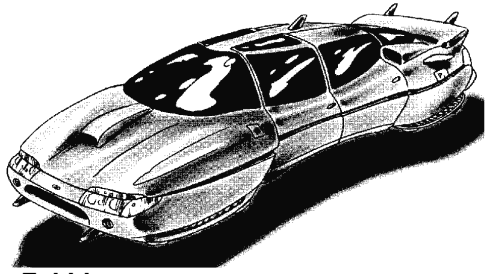

**Tetracorp Fei Lien**  
 100 450 50/50 1 800 3 660kg +1 50 (2) 25 (1) 2 tons  
 290,000 Chr3



**MacLaren/Jaguar Sports AV**  
 810 100/75 1 1200 1 650kg, 1 +3 50 (2) 10 (0) 2000kg  
 1.5M Chr4

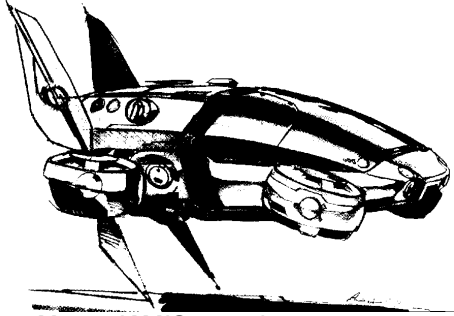

**Bell-Boeing Aircar (AV/Osprey)**  
 360 10/20 1 1330 5 None +2 40 (2) 8 (0) 1 tons 300,000  
 Chr4



**TV News Van**  
 250 50/50 1 400 5 1300kg -1 100 (5) 40 (2) 4 tons  
 750,000 LD



**British Aerospace AV FAB**  
 225 50/50 2 1600 4 3333kg, 4 +0 250 (12) 25 (1) 10 tons  
 840,000 Chr4

**British Aerospace Military FAB**  
 270 50/50 2 1600 4 3333kg, 4 +0 250 (12) 40 (2) 10 tons  
 3.15M Chr4

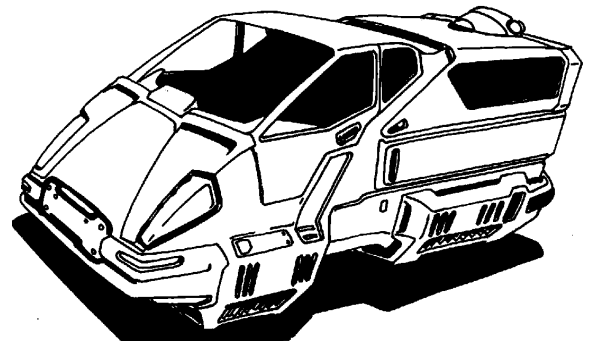

**VMW Family Flyer**  
 150 50/50 1 525 5 650kg, 2 -2 50 (2) 15 (1) 2 tons 50,000  
 Chr2



**Mexican Metals Llama**  
 100 50/50 1 800 1 173kg, 6 +0 15 (1) 1 (0) 520kg 33,000  
 Chr4

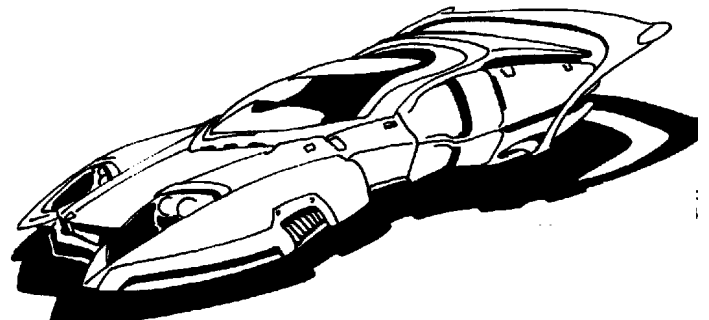

**Lambo-Fiat Mach**  
 500 100/75 1 300 1 300kg +2/-5 40 (2) 10 (0) 1.6 tons  
 650,000 Chr2

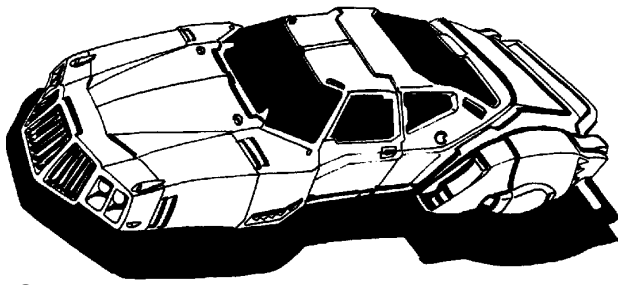

**The Swan**  
 200 50/50 1 600 2 100kg -1 65 (3) 20 (1) 2.6 tons 200,000  
 Chr2

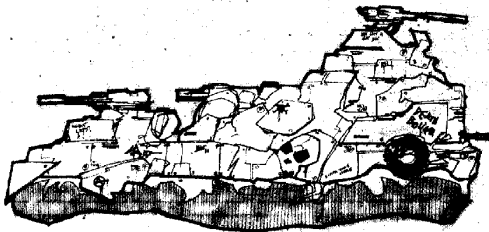

**The Dreaded Punknaught**  
 40 25/25 12 270 20-30 0 -3 60-80 /unit 20 (1) 2.4+ tons  
 Unknown Chr1

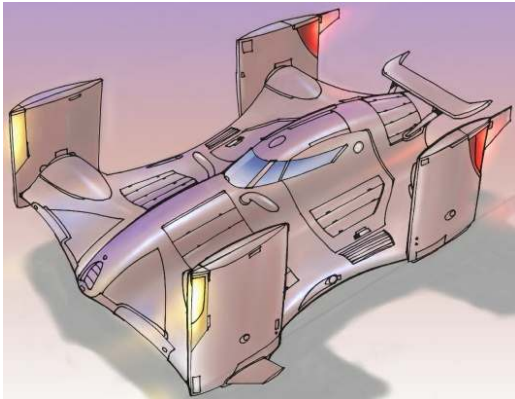

**Dassault-Futures Aeromobile**  
 360 50/50 2 800 5 1000kg, 8 +0 85 (4) 35 (2) 3.4 tons  
 1,050,000 ES\*



**Hover Bike - Aerodyne**  
 195 50/50 1 6 (20m high) 0 0 +1 35 (2) 5 (0) 140kg 7,000  
 KCJ  
 - Wheeled 80 18/18 1 240 - 20kg +0 - - - - -

# LIGHT HELICOPTERS/GLIDERS

Vehicle Top Speed Acc/Dec Crew Range Passengers Cargo Man.  
 SDP (Body) SP (Armor) Mass Cost Source

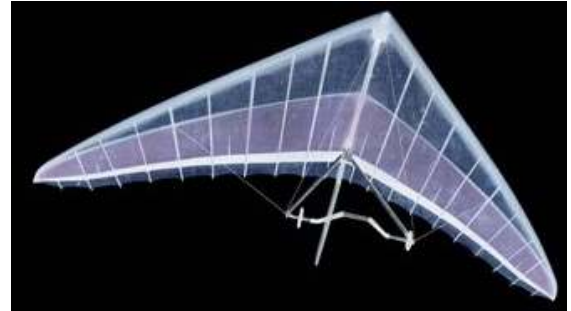

**Techjager F81 "Paradactyl" Cyber-Glider**  
 5 - 35 5/5 1 - 0 None +2 10 (0) 0 14.3kg 2300 SF



**Ultralight**  
 50 5/5 1 200 0 10kg -2 10 (0) 0 50kg 2500 Neo

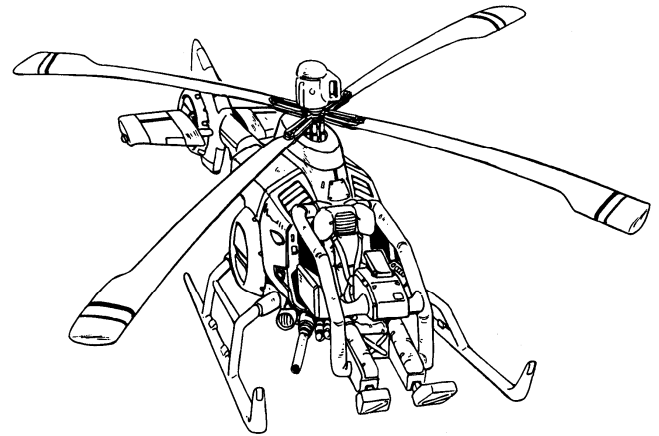

**Bell F-152 Autogyro**  
 195 15/15 1 50 0 None +1 40 (2) 0 1,500kg 145,000 MM



**Hyundai Minicopter**  
 120 15/15 1 200 0 330kg +0 30 (1) 6 (0) 1000kg 55,000  
 Chr3

# MEDIUM HELICOPTERS

Vehicle Top Speed Acc/Dec Crew Range Passengers Cargo Man.  
SDP (Body) SP (Armor) Mass Cost Source



**Kestrel Crowd Control 'Copter**  
150 15/15 1 400 0 None +2 80 (4) 20 (1) 8 tons 1,780,000  
UK



**Bell Huey Cop-Chopper**  
150 15/15 2 400 4 2000kg int, 1 -2 80 (4) 20 (1) 6,500kg  
420,000 MM



**MI-32 Hitter**  
180 16/16 2 400 0 None -2 80 (4) 40 (2) 8 tons 650,000  
SOF2



**Bell Spy-Eye**  
18 180 15/15 1 400 3 2000kg +2 65 (3) 12 (1) 6,500kg  
206,000 Chr1



**TV News Chopper**  
210 40/40 1 400 3 2000kg +2 65 (3) 12 (1) 6,500kg  
206,000 LD



**Bell Evil-Eye**  
19 180 15/15 2 400 2 2000kg int, 2 +1 65 (3) 20 (1)  
6,500kg 555,000 MM



**Apache Attack Helicopter**  
160 15/15 2 400 0 None -2 80 (4) 40 (2) 8 tons 800,000  
SW\*

# HEAVY HELICOPTERS

Vehicle Top Speed Acc/Dec Crew Range Passengers Cargo Man.  
SDP (Body) SP (Armor) Mass Cost Source

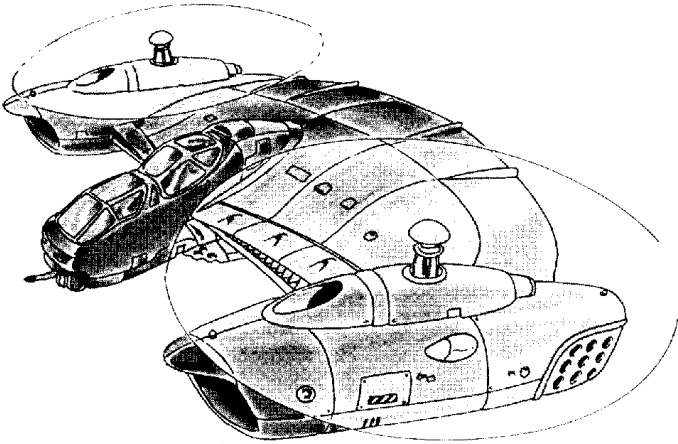

**Bell UH-10 PAPA**  
135 10/15 2 1000 0 5 tons, 12 -2 250 (12) 40 (2) 10 tons  
1.85M Chr3



**Bell UH-9**  
165 15/15 2 600 20 2500kg int -1 200 (10) 40 (2) 8 tons  
2.45M MM

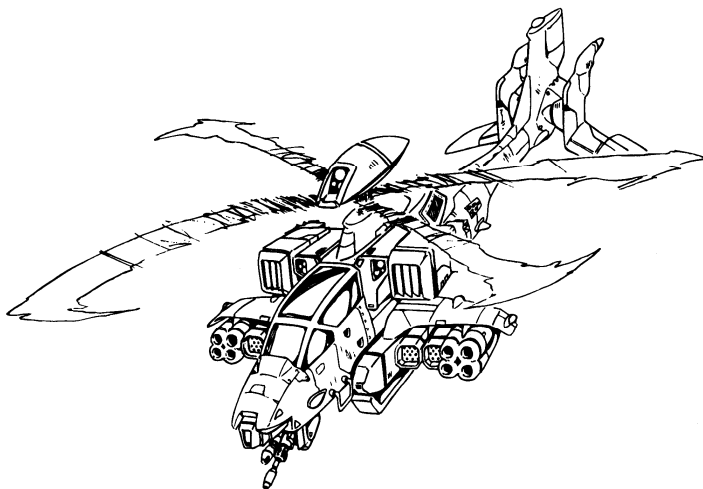

**Bell AH-99 Gunship**  
180 10/15 2 600 0 None -2 100 (5) 40 (2) 4 tons 2.3M MM

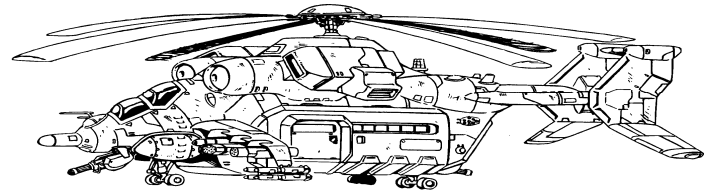

**SM-Dragon**  
120 10/15 2 600 30 or 4 tons int -2 300 (15) 80 (4) 12 tons 8.3M MM



**Firefly Assault Helicopter**  
200 10/15 2 200 0 1000kg -1 100 (5) 30 (1) 4 tons  
1,050,000 TCB\*



**Hippo Troop Helicopter**  
180 10/15 5 200 25 None -2 120 (6) 40 (2) 4.8 tons  
750,000 TCB\*



**Agusta-Eurocopter AE-47**  
180 10/15 2 600 8 1000kg -2 100 (5) 40 (2) 4 tons 1.7M  
ET\*

# OSPREYS

Vehicle Top Speed Acc/Dec Crew Range Passengers Cargo Man.  
SDP (Body) SP (Armor) Mass Cost Source

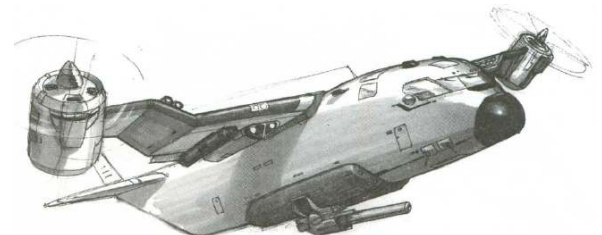

**Fed-Boeing Gyr Falcon Gunship**  
315 10/20 2 1000 8 Pod -1 100 (5) 20 (1) 12.5 tons  
600,000+ SW

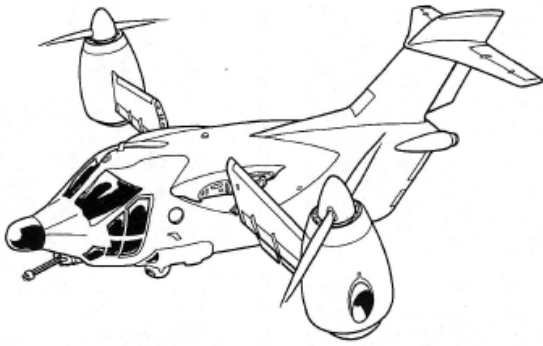

**BA/Westland Wyvern (M)**  
 315 10/20 2 1200 20 or 5 tons, 20 +0 120 (6) 20 (1) 15  
 tons 407,000 UK

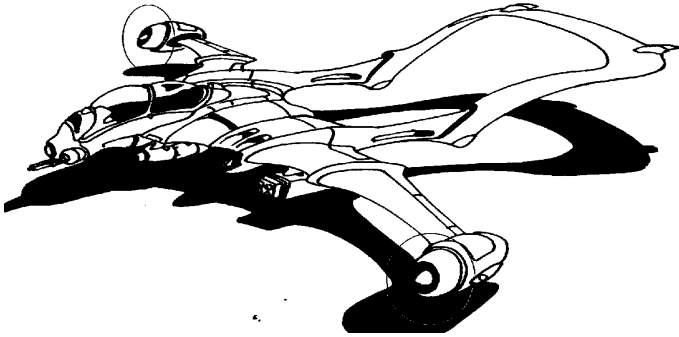

**Lockheed-Cessna Pinto**  
 450 10/20 2 1600 2 6250kg +2 150 (7) 20 (1) 18.75 tons  
 2.4M MM

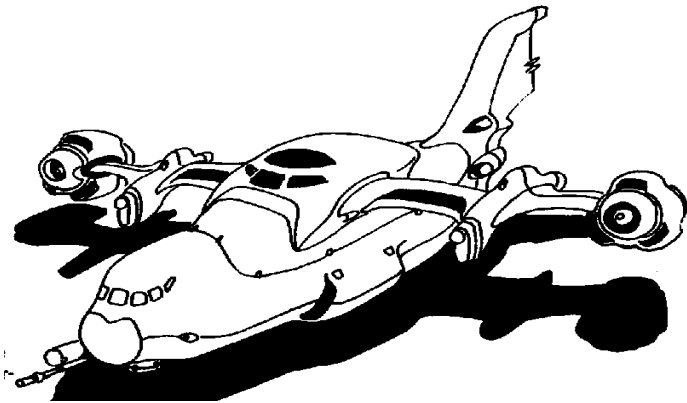

**Bell-Boeing Falcon-B**  
 315 10/20 1 1000 9 4 tons int, 10 +0 100 (5) 20 (1) 12.5  
 tons 600,000 MM

**Bell-Boeing Falcon**  
 315 10/20 1 1000 9 4 tons int, 12 +0 100 (5) 10 (0) 12.5  
 tons 425,000 Chr2\*

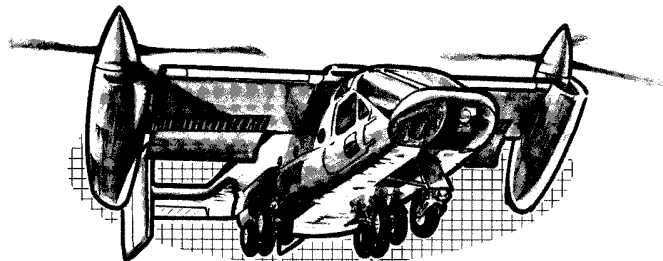

**Bell-Boeing V-22B Osprey**  
 315 10/20 2 1200 20 9 tons int, 28 +0 200 (10) 0 25 tons  
 650,000 MM



**Bell-Boeing Guillotine Osprey**  
 315 10/20 2 1200 20 None +0 200 (10) 0 25 tons 1.4M

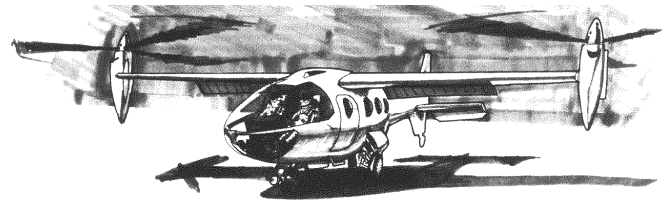

**Sukhoi SU-441 Tiltrotor**  
 315 10/20 2 1200 20 9 tons, 27 +0 220 (11) 10 (0) 27.5  
 tons 1.17M CB3\*

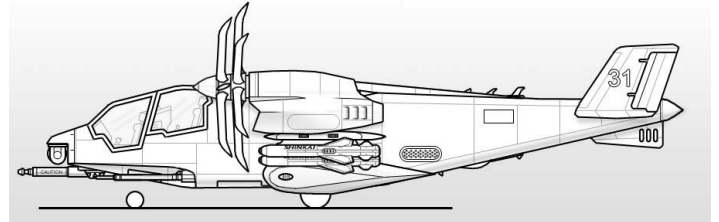

**Orion Ground Attack Aircraft**  
 420 10/20 1 2400 0 30 pods +0 260 (13) 50 (2) 30 tons  
 3.35M TCB\*

## AIRPLANES

Vehicle Top Speed Acc/Dec Crew Range Passengers Cargo Man.  
 SDP (Body) SP (Armor) Mass Cost Source

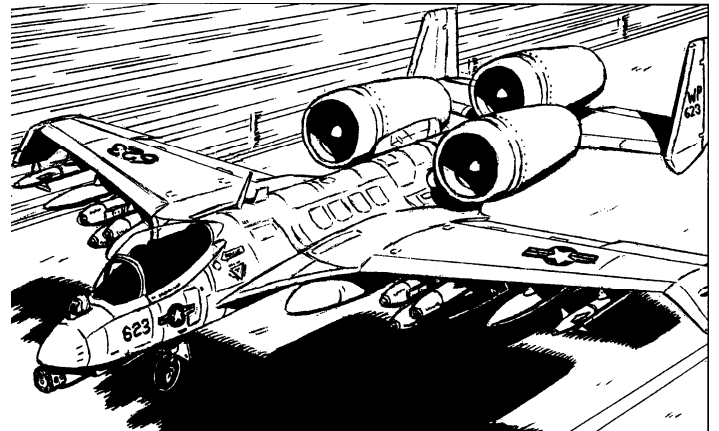

**A-01 Blitz airplane**  
 560 10/35 1 1600 0 None -1 160 (8) 60 (3) 20 tons 3.7M  
 MM



**Dehavilland Twin Otter**  
 190 15/20 2 450 6 2000 kg +0 80 (4) 40 (2) 8 tons 150,000  
 NWP

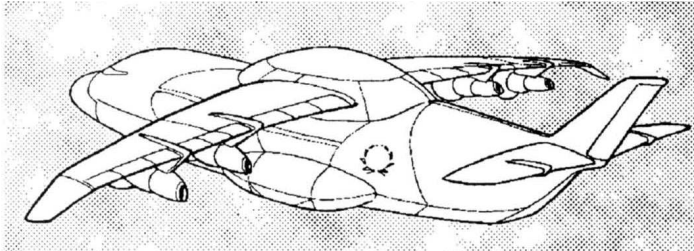

**Fed-Boeing C-25 Cargo Plane**  
 540 20/31 3 6960 43 or 38 tons, 43 -4 180 (9) 30 (1) 72  
 tons 10.2M PB

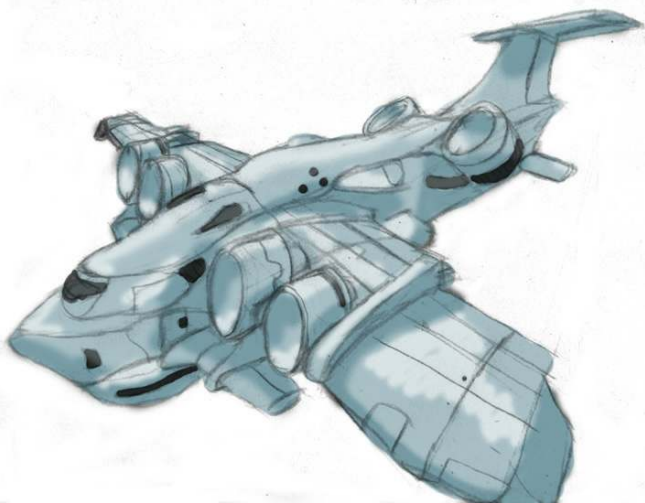

**Boeing C-27 Cargo Aircraft**  
 600 20/25 4 8000 500 or 100 tons -4 500 (25) 25 (1) 200  
 tons 15.1M CB1\*



**Highlord Fire Support Aircraft**  
 200 10/25 12 1000 0 +20 pods -3 90 (4) 20 (1) 11.25 tons  
 300,000 TCB\*

# JETS

Vehicle Top Speed Acc/Dec Crew Range Passengers Cargo Man.  
 SDP (Body) SP (Armor) Mass Cost Source



**Dornier F-128 Thundercloud Jump Jet**  
 600 20/25 1 1100 0 None +2 100 (5) 20 (1) 8 tons 25.5M  
 SW

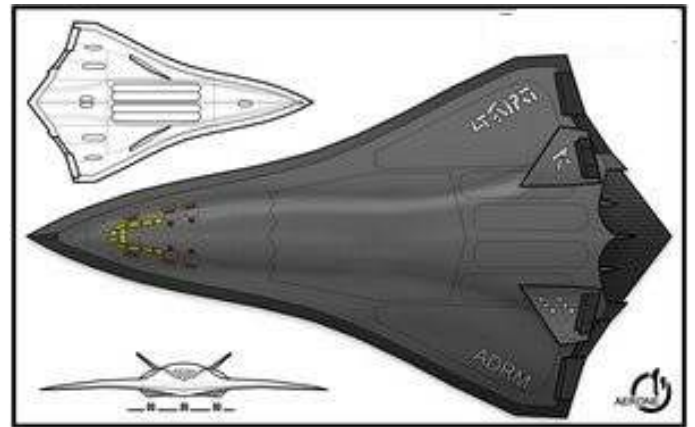

**McDonnell F-39 Phoenix**  
 1440 20/25 2 1600 0 None +1 250 (12) 25 (1) 20 tons 10M  
 SW

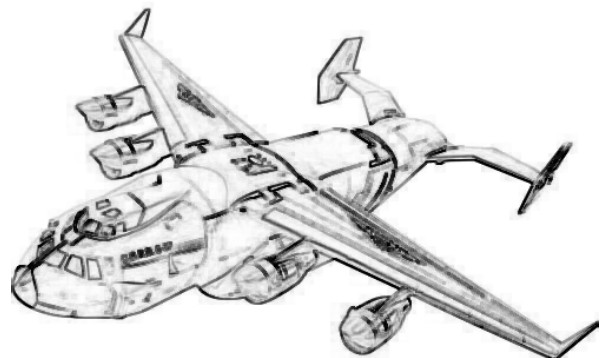

**Lockheed C-200 Universe**  
 600 20/25 3 4000 100 or 42 tons, 150 -4 200 (10) 5 (0) 8  
 tons 6.1M SW



**ATF-37B Thunderhawk**  
1040 20/25 1 2656 0 None +3 250 (12) 20 (1) 20 tons  
12.5M Chr3



**MacDonald F-33 Wasp**  
1200 20/25 1 1000 1 None +3 100 (5) 20 (1) 8 tons 4.6M  
MM



**GD F-36 Comet**  
1440 20/25 1 1600 0 None +4 175 (8) 20 (1) 14 tons 9.5M  
Chr2\*



**Bell-Mit Stratosphere Lift Aircraft**  
1143 (1.5) 100/100 5 8000 5 200 tons +0 150 (7) 25 (1)  
100 tons 10M GW



**Roland Executive SST**  
1040 20/25 2 6400 14 500kg +1 100 (5) 25 (1) 8 tons  
2.55M CB1\*



**Lockheed-Cessna Alysee**  
720 20/25 2 3184 8 5.3 tons +2 200 (10) 20 (1) 16 tons  
5.9M PB

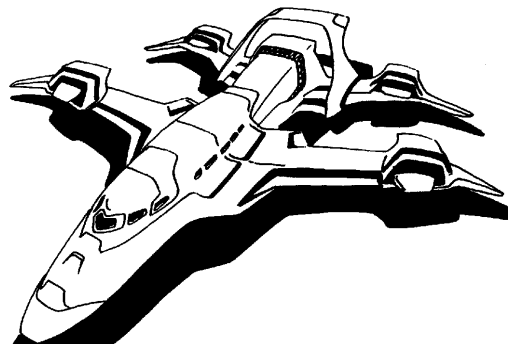

**Shorts-Dassault Shorthauler**  
800 20/25 2 3200 22 2000kg +1 150 (7) 15 (1) 12 tons  
4.9M ET\*



**Saab Gustav Jet Fighter-Bomber**  
1280 40/38 1 2650 0 16 pods +1 100 (5) 40 (2) 8 tons  
4.3M TCB\*



**Mitsubishi Shadow Jet Fighter**  
 1280 20/25 1 3200 0 +14 pods +1 150 (7) 60 (3) 12 tons  
 22.2M TCB\*

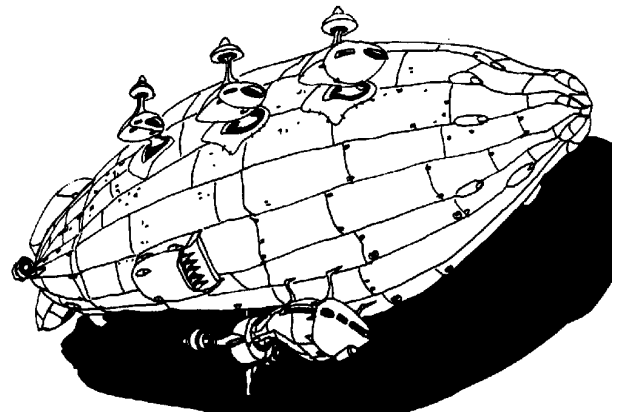

**India Sky-Barge**  
 60 5/30 6 990 0 150 tons +2 750 (37) 0 18,750kg 10M  
 Chr2

## AIRSHIPS

Vehicle Top Speed Acc/Dec Crew Range Passengers Cargo Man.  
 SDP (Body) SP (Armor) Mass Cost Source

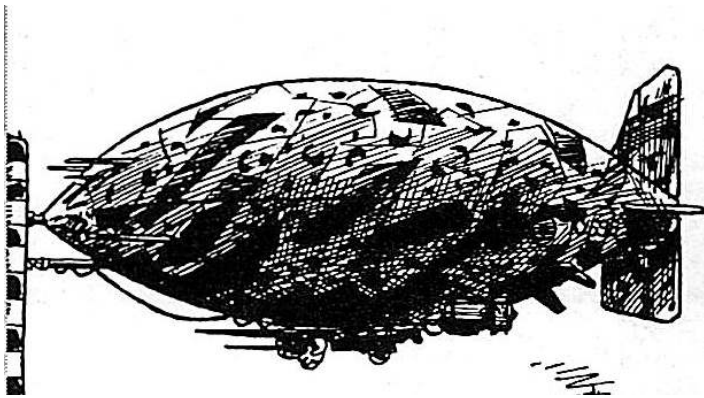

**Goodyear ETB Blimp**  
 70 5/30 5 1500 1 2.5 tons +0 200 (10) 20 (1) 10 tons  
 900,000 UK

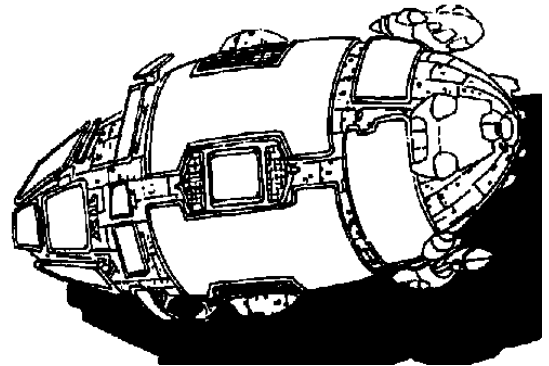

**Madison Avenue Advertblimp**  
 35 5/30 0 500 2 None +2 500 (25) 0 12.5 tons 2.5M Chr2

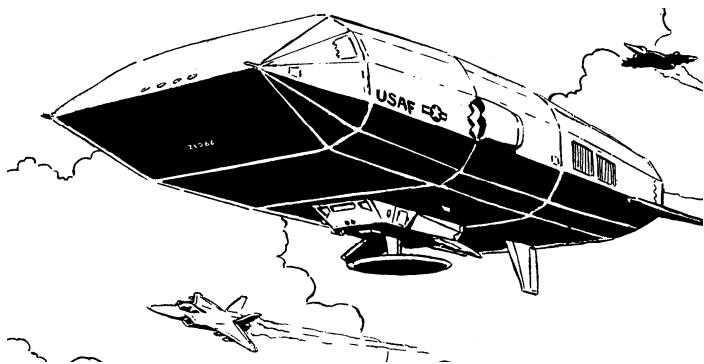

**Dayton Overlord Airship**  
 80 5/30 10 1500 2 50 tons ext +5 1000 (50) 20 (1) 50 tons  
 100.6M MM



**Dayton Sky-Queen Cruiser**  
 100 5/30 20 2000 150 25 tons +4 1000 (50) 0 25 tons 20M  
 Chr2\*

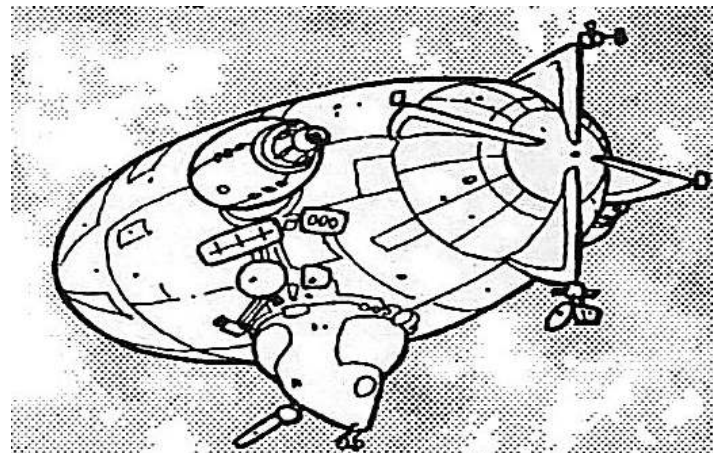

**Monitor Blimp**  
 40 5/30 0 1500 4 None +5 60 (3) 30 (1) 3 tons 90,000 DM\*



# CYBERWALKS

Vehicle Top Speed Acc/Dec Crew Range Passengers Cargo Man.  
SDP (Body) SP (Armor) Mass Cost Source

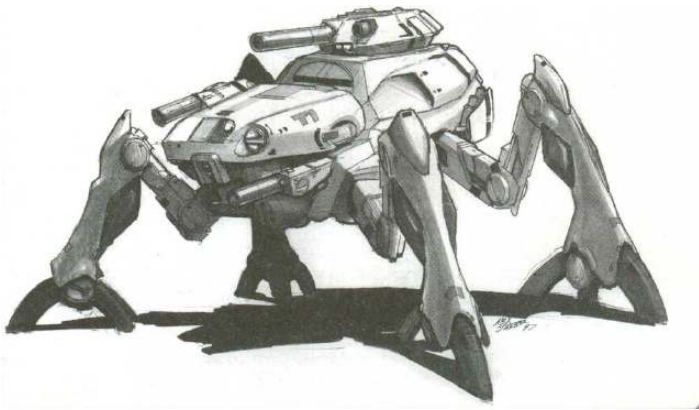

**Arasaka Daisasori (4 legs & wheels)**  
36 (90) 15/15 (20/40) 2 200 0 None +3 80 (4) 40 (2) 4 tons  
680,000 SW

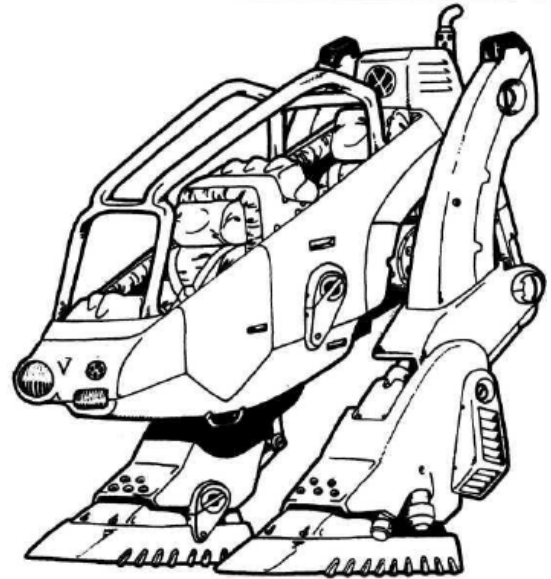

**Volkswalker (2 legs)**  
40 15/15 1 200 1 None -3 20 (1) 5 (0) 650kg 52,500 SOF2

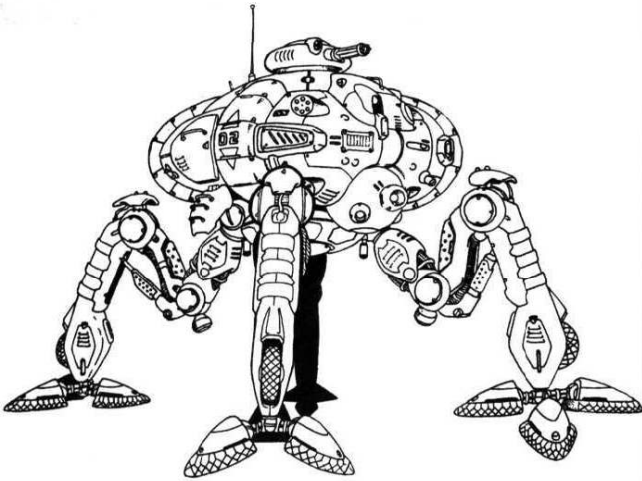

**Arasaka Daikani (4 legs & wheels)**  
40 (100) 20/15 (40) 2 200 0 None -1 80 (4) 40 (2) 3 tons  
1.1M SOF2



**XML-20 Support Walker (2 legs)**  
40 15/15 2 400 0 None -1 40 (2) 40 (2) 2.6 tons 332,700  
SOF2

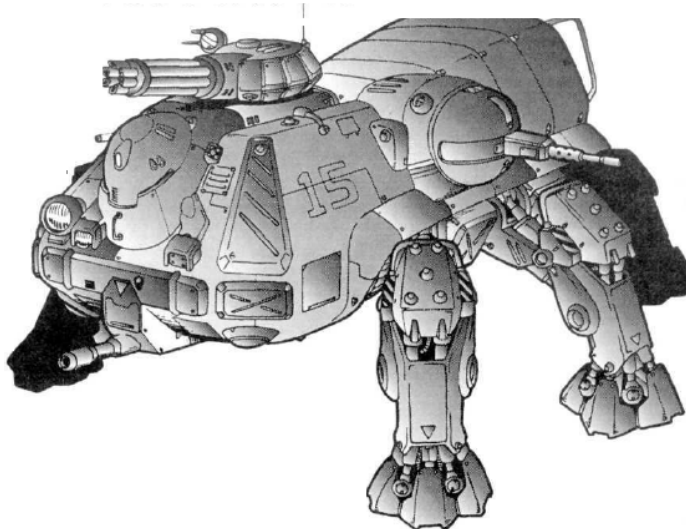

**KPV-R PanzerKraken (6 legs)**  
30 15/15 3 300 4 None -3 120 (6) 60 (3) 8 tons 1.24M  
SOF2



**Toyo-Chrysler Wolverine**  
100 10/30 1 400 1 200kg +1 20 (1) 10 (0) 300kg 15,000  
NWP

# SNOWMOBILES

Vehicle Top Speed Acc/Dec Crew Range Passengers Cargo Man.  
SDP (Body) SP (Armor) Mass Cost Source



**Skidoo Snowmobile**  
 90 10/10 1 400 1 100kg +0 15 (1) 10 (0) 400kg 10,000  
 NWP

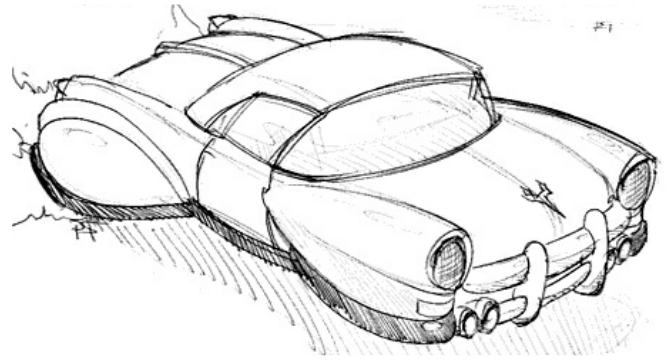

**Crystar Falcon Spinnercoupe**  
 200 15/25 1 400 3 100kg +0 45 (2) 0 2.8 tons 175,000  
 Cgen



**Arctic Cat DuraCat Ice Crawler**  
 20 5/5 1 100 7 1000kg -2 30 (1) 15 (1) 1 ton 40,000 NWP



**Boeing VS-3 Serrato**  
 250 30/30 1 400 3+2 or 100kg +2 70 (3) 20 (1) 8.75 tons  
 750,000 EF

## SPINNERS

Vehicle Top Speed Acc/Dec Crew Range Passengers Cargo Man.  
 SDP (Body) SP (Armor) Mass Cost Source



**Puddle Jumper**  
 100 15/20 1 900 1 50kg +0 20 (1) 0 1.2 tons 18,000 EF



**Avante SportSpinner**  
 320 15/20 1 400 1 50kg +0 40 (2) 0 2.5 tons 200,000  
 Cgen



**Infiniti Spinnerbike**  
 300 15/20 1 900 0 50kg +0 20 (1) 0 1.2 tons 44,000 Cgen

# WATER CRAFT

Vehicle Top Speed Acc/Dec Crew Range Passengers Cargo Man.  
SDP (Body) SP (Armor) Mass Cost Source

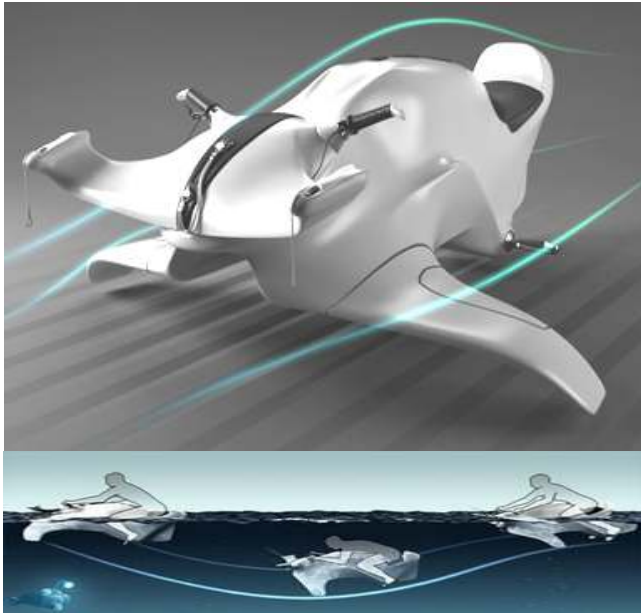

**Covert Hydro-Ski**  
200 30/30 1 50 (30m) 1 100kg -1 20 (1) 5 (0) 80kg 20,000 SF

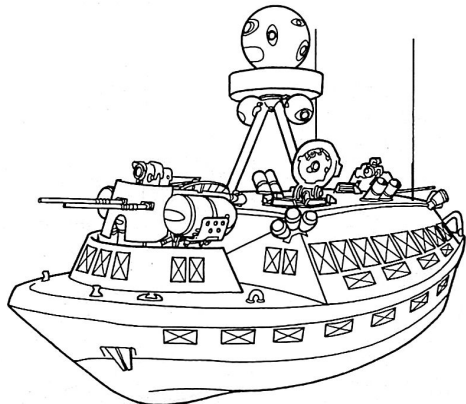

**Vosper/Wolf Riverine Patrol Boat**  
30 15/10 5 400 1 1.6 tons +1 100 (5) 40 (2) 5 tons 600,000 UK

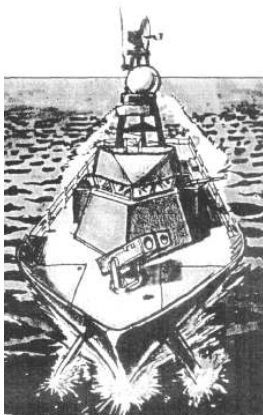

**SNB Fast Patrol Boat**  
32 25/15 10 1500 10 10 tons +0 210 (10) 30 (1) 14 tons 210,000 CB3\*

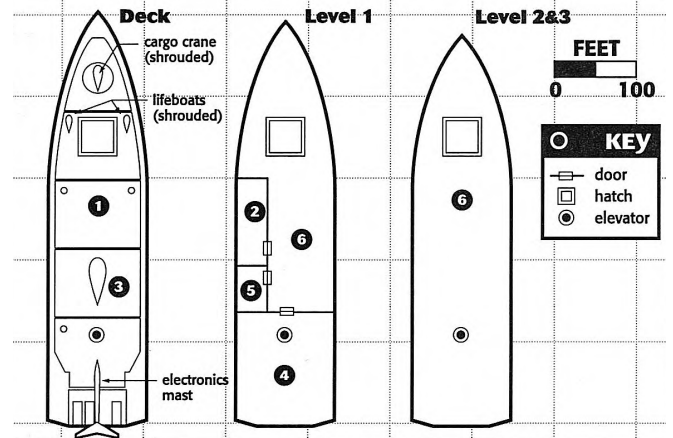
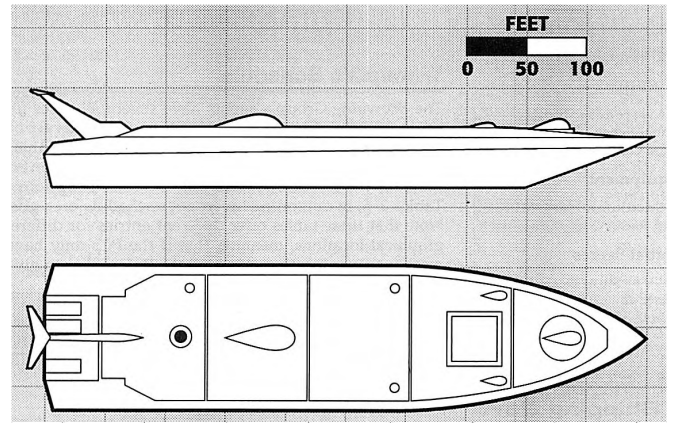

**Cetaen Cargo Vessel**  
30 5/5 25 4000 20 15,000 tons -3 500 (25) 40 (2) 2500 tons 20M GW



**Corporate Riverine Powerboat**  
60 25/15 1 100 5 3750kg +0 75 (4) 15 (1) 5 tons 65,000 LoF\*



**Skimmer**  
40 30/15 1 100 3 750kg +0 40 (2) 15 (1) 1 ton 17,000 LoF\*

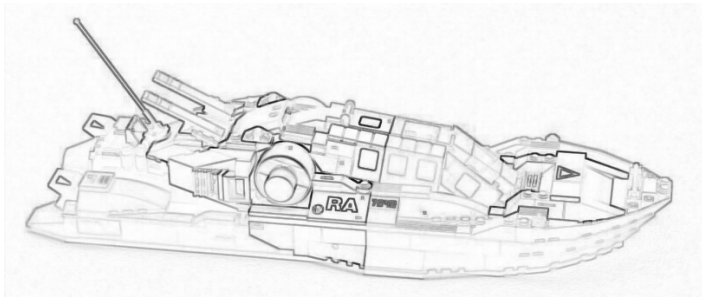

**RPV-101 Patrol Boat**  
 50 25/15 1 300 5 4200kg +0 85 (4) 10 (0) 5.6 tons 110,000  
 LoF\*



**Converted Fishing Boat (Varina)**  
 20 10/15 1 360 6 4200kg +0 170 (8) 15 (1) 5.6 tons  
 140,000 LoF\*



**Spearas Maritime Whaler**  
 50 14/24 3 1400 3 75m<sup>3</sup> +0 150 (7) 0 150 tons 30,000 P3



**Samson Marine Tech "Hunter"**  
 50 11/21 3 4000 15 250m<sup>3</sup> +0 500 (25) 0 500 tons 100,000  
 P3

# SUBMERSIBLES

Top Speed Acc/Dec Crew Range/Depth Pass Cargo Man. SDP SP  
 Disp Det Sig Cost Source

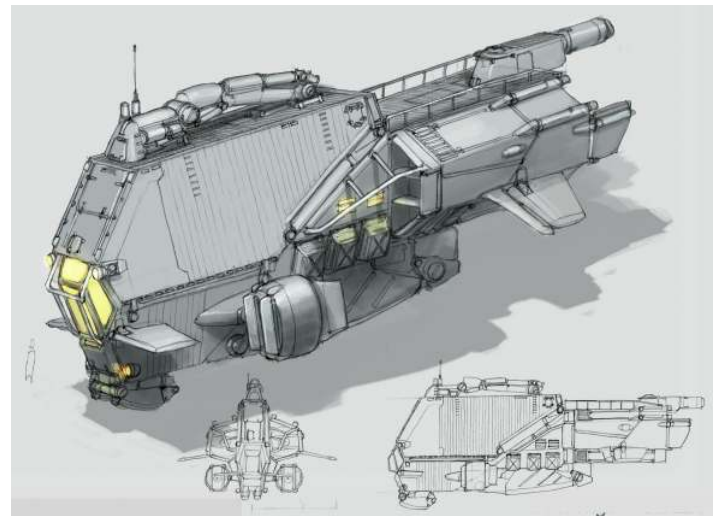

**"Pelagic" Mining Sub**  
 33 8/8 1 40 (400m) 0 220kg -3 240 (12) 60 (3) 22 ton -0 -0  
 2.4M SF

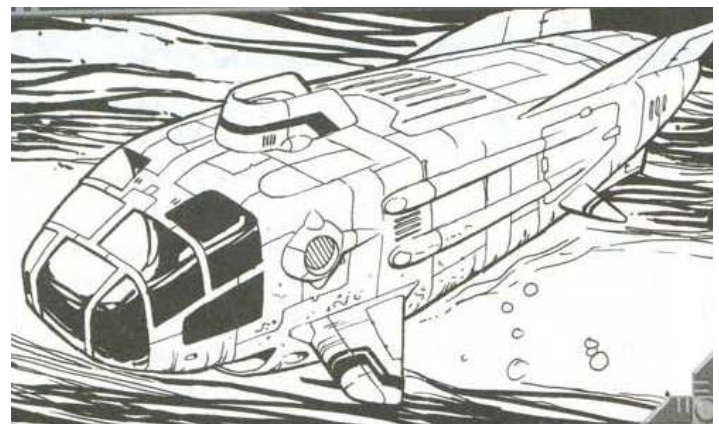

**CINO "Moray"**  
 67 12/12 1 40 (300m) 0 260kg -2 250 (12) 100 (5) 26 ton -  
 0 -2 7.21M SF

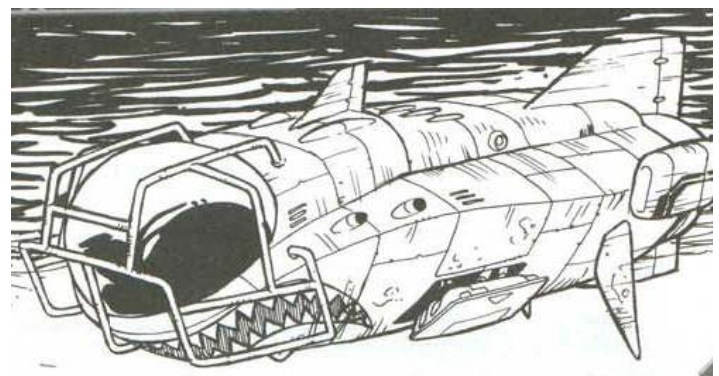

**OTEC "Shark"**  
 56 10/10 1 33 (300m) 0 205kg -2 275 (14) 105 (5) 20.5 ton  
 +1 -1 7.93M SF

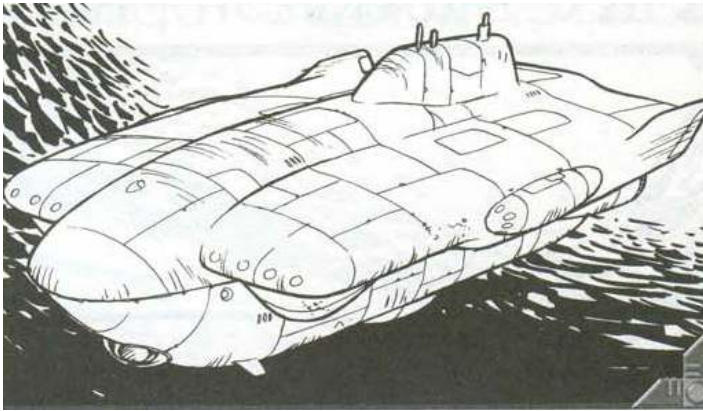

**Hydrosubsidium "Orca"**  
 28 5/5 5 1200 (900m) 15 415kg -6 650 (32) 100 (5) 914 ton +4 -1 18.315M SF

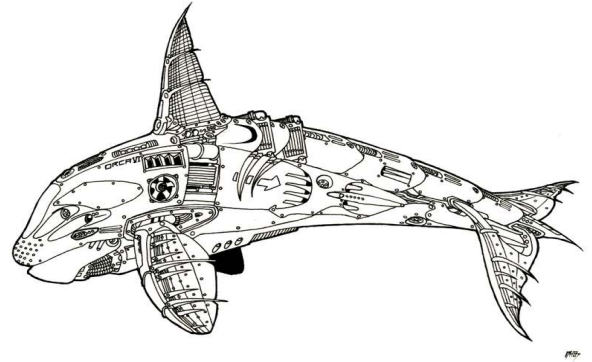

**Prototype Ceta-Sub**  
 50 12/12 1 150 (80m) 1 50kg -1 120 (6) 30 (1) 15 ton -2 -6 expensive SF

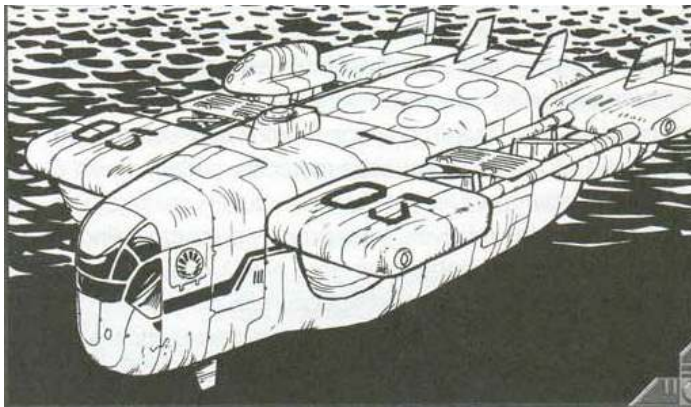

**OTEC "Hammerhead"**  
 33 4/4 8 500 (600m) 15 315kg -5 560 (28) 85 (4) 652 ton +2 -0 4.1M+ SF



**IEC Container Sub**  
 40 5/30 30+ 5yrs (750m) - 600 tons -2 5000 (250) 80 (4) CB1\*

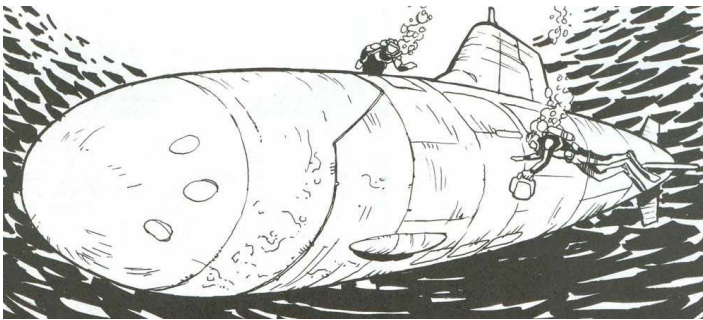

**IEC "Rockfish" Stealth Sub**  
 45 5/5 2 1500 (400m) 10 605kg -2 400 (20) 80 (4) 140 ton +3 -2 10.5M SF

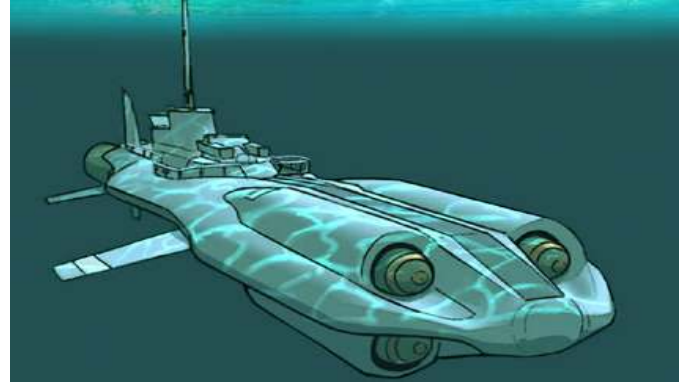

**IEC Tactical Mini-sub**  
 16 5/30 3 1120 6 or 400kg +1 300 (15) 60 (3) CB1\*

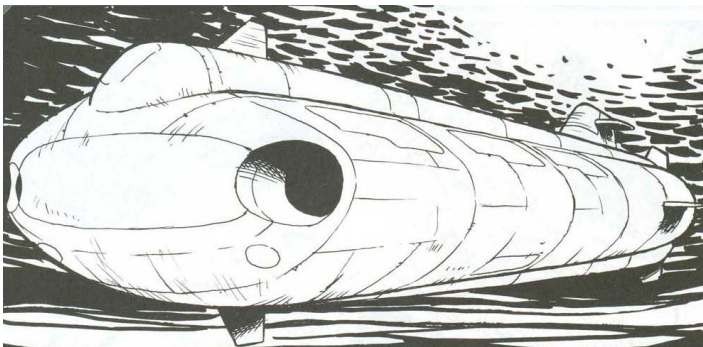

**CINO "RELaCS" Cargo Sub**  
 56 10/10 36 3500 (800m) 4 22,105kg -5 4000 (200) 60 (3) 25k ton +3 +2 30.47M SF

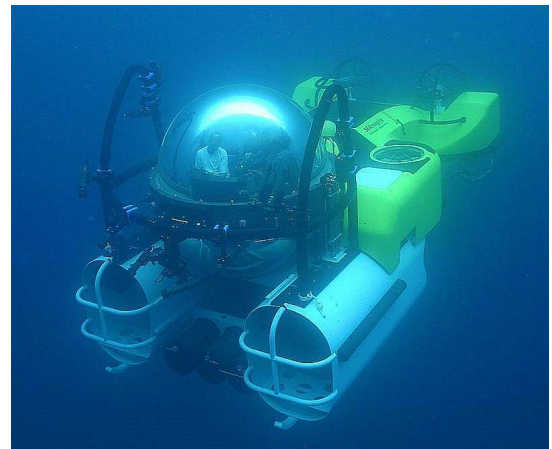

**Shirakawa Type 1**  
 20km 1 12hrs 1 60 (3) 40 (2) CB3\*

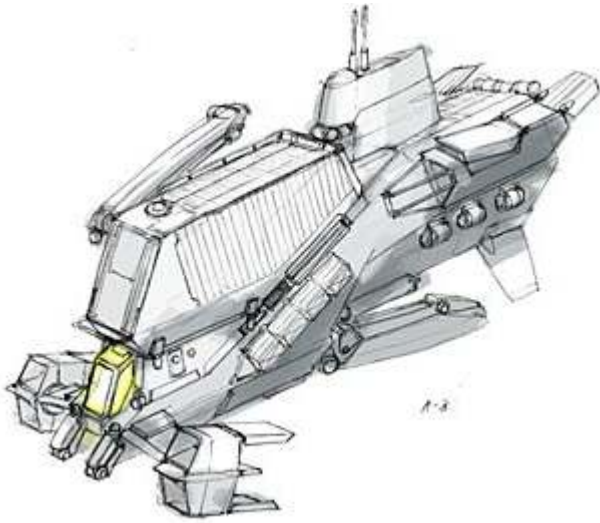

**Shirakawa Type 2**  
 16km 1 16-18hrs 5 80 (4) 40 (2) CB3\*

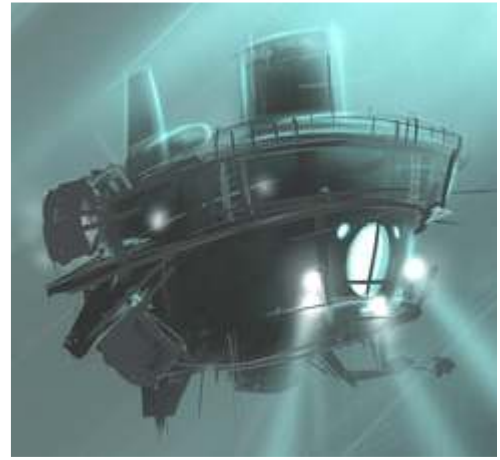

**Aquanox Lamprey**  
 70 7/30 2 960 (2200m) 2 0 +3 325 (16) 25 (1) 2.7M SA\*

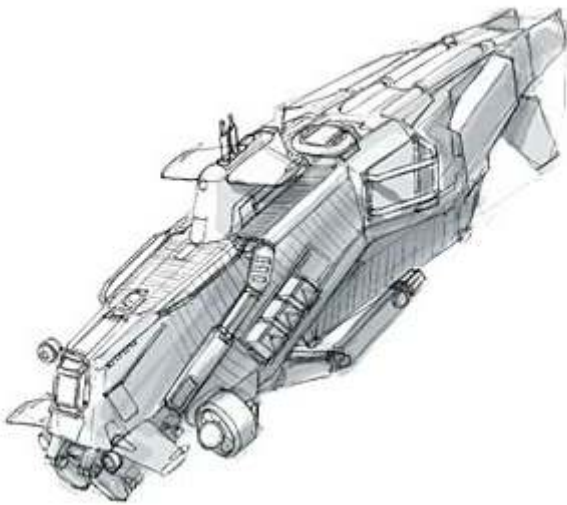

**Shirakawa Type 3**  
 16km 2 12-20hrs 10 100 (5) 45 (2) CB3\*

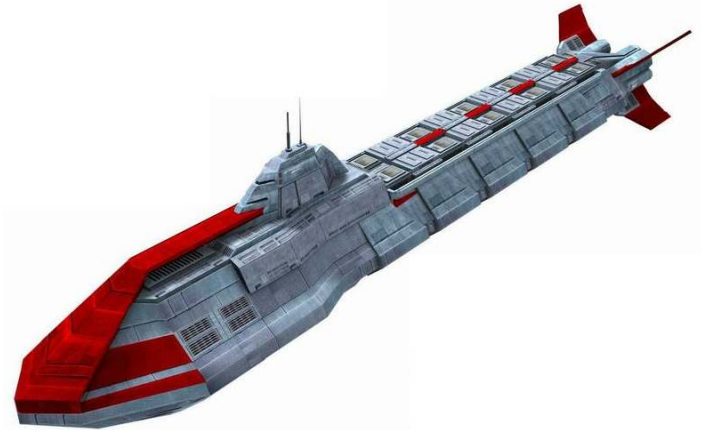

**Cyclocean Cargo Vessel**  
 50 5/15 10 6000 (3800m) 0 200 ton +0 500 (25) 50 (2)  
 7.5M SA\*

Entries with a '\*\*' next to their listed source were originally presented with limited stats and have been altered to fit within the vehicle creation rules presented in Maximum Metal.

Watercraft presented with limited stats have been altered using the 'Maximum Metal on the High Seas' rules by Dana Jorgensen, in the Neo City netbook.

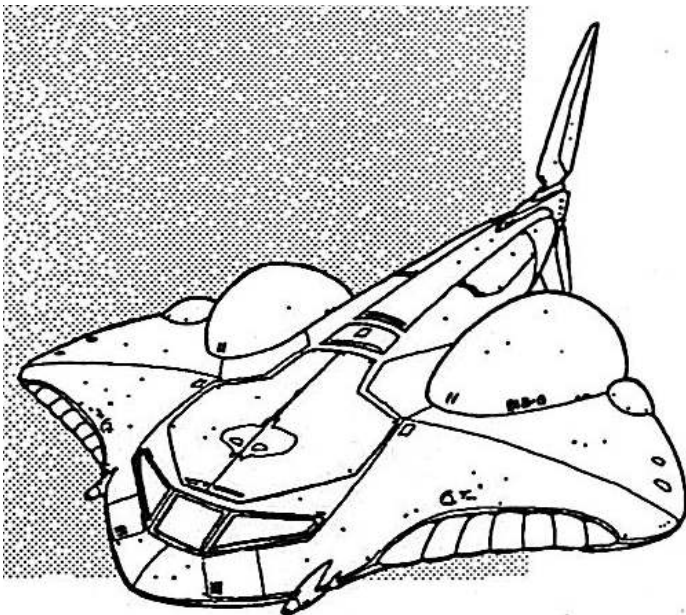

**Dynalar Manta Cruiser**  
 55 6/30 1 1440 (1900m) 4 .5 ton +2 200 (10) 30 (1)  
 1,250,500 SA\*

## WEAPON SYSTEMS

### HEAVY WEAPONS

Name Type WA Con. Avail. Damage(Ammo)(BodMin) #Shots ROF  
Rel. Range Cost Source  
Kendachi Flamer v2  
EX +0 N P 3d6x2/1d6x1 8 1 ST 8m 990 MM  
Arasaka EMF Launcher  
HVY -2 L P 10d10 special 1 1 ST 100m 550 SW  
Arasaka EMF Launcher  
HVY -2 N P 20d10 special 1 1 ST 100m 1500 SW  
5.56mm Machinegun  
HVY +1 N P 5d6 (5.56)(B5) 100 10 VR 450m 1200 MM  
7.62mm Machinegun  
HVY +0 N P 6d6+2 (7.62)(B6) 100 10 VR 500m 1200 MM  
12.7mm/50. Machinegun  
HVY +0 N R 6d10 (12.7)(B11) 100 10 VR 600m 2000 MM  
14.5mm Machinegun  
HVY +0 N P 7d10 (14.5)(B13) 100 10 VR 550m 2500 MM  
5.56mm Minigun  
HVY +0 N P 5d6 (5.56) 1000 100 ST 450m 2000 MM  
7.62mm Minigun  
HVY +0 N P 6d6+2 (7.62) 2000 100 VR 500m 4000 MM  
M-134 Minigun  
HVY +0 N P 6d6+2 (7.62) 2000 100 VR 500m 4000 SOF  
KA F-253 Flamethrower  
HVY -2 N R 2d10 10 1 ST 50m 1500 CP20  
Barrett-Arasaka 20mm  
HVY +0 N R 4d10@ (20mm)(B4) 10 1 VR 450m 2000  
CP20  
S-Arasaka Nova Photon  
HVY +4 N R 4d10 (laser) 1 1 UR 500m 50,000 SW  
Enfield 25mm Cockerill  
HVY +1 N R 5d10+10@ (25mm) 12 1 ST 1500m 7400 UK  
12.7mm/50. Gatling  
HVY +0 N R 6d10 (12.7)(B18) 1000 100 ST 500m 6000  
MM  
Barrett-Arasaka ET 20  
HVY +1 N R 6d10@ (20 ET) 10 1 VR 750m 3800 SOF2  
60mm Light Mortar  
HVY +0 N P 8d10 (60mm), 5m 1 2 VR 1000m 750 HoB  
Colt-Mausier M2X  
HVY +0 N R 8d10 (20mm) 8 1 ST 600m 3050 Chr2  
Vulcan 20mm Gatling  
HVY +0 N R 8d10 (20mm) 1000 100 VR 500m 6000 MM  
20mm Machine Cannon  
HVY +0 N P 8d10 (20mm) 2300 30 VR 500m 6000 SOF  
20-25mm Autocannon  
HVY +0 N R 8d10 (20-25)(B14) 100 10 VR 500m 3000 MM  
Tsunami Arms Type-17  
HVY +1/3 N R 8d10@ (20mm) 12 1 ST 1200m 7500 PAC  
Militech Anti-Matter Rifle  
HVY 0/+1 N R 9d10 (30mm) 5 1 ST 1600m 6000 Chr2  
Militech 7-Barrel Gatling  
HVY +0 N R 9d10@ (30 DPU) 1000 100 VR 2000m 10,000  
SW  
27-30mm Autocannon  
HVY +0 N R 9d10 (27-30)(B16) 100 10 VR 600m 4000 MM  
30mm Gatling  
HVY +0 N R 6d10@ (30 DPU) 1200 30 VR 600m 25,000  
MM  
Hughes M230B-2  
HVY +0 N P 6d10@ (30 DPU) 1200 30 VR 600m 25,000  
SOF

### 37mm LATG

HVY +3 N R 6d10@ (37 DPU) 10 1 VR 800m 10,000 MM  
Militech BMFG 30mm  
HVY +0 N R 9d10 (30 ET)(B9) 5 1 ST 600m 4500 SW  
30mm ET Gatling  
HVY +0 N R 9d10@ (30 ET) 1200 30 VR 900m 37,500  
SOF2  
37mm ETE LATG  
HVY +3 N R 9d10@ (37 ETDPU) 10 1 ST 1200m 15,000  
SOF2

### GRENADE LAUNCHERS

Name Type WA Con. Avail. Damage(Ammo)(BodMin) #Shots ROF  
Rel. Range Cost Source  
Militech "Cowboy" U-55  
HVY +0 N P (25mm)(B4) 12 3 ST 150m 900 CB2  
Militech Mini-GL (Pump)  
HVY -1 L C (25mm/10ga)(B4) 4 2 ST 150m 225 Chr1  
Militech Mini-GL (Drum)  
HVY +0 N P (25mm/10ga)(B4) 16 2 ST 150m 475 Chr1  
Tsunami Type-18 AGL  
HVY -1 N P (25mm)(B10+) 30 10 ST 200m 2000 PAC  
Arasaka WCCA Susano  
HVY +0 N P (25mm)(B4/7) 9 2-9 VR 200m 450 SW  
Commercial 40mm GL  
HVY +0 L R (30-40mm)(B6) 1 1 ST 225m 150 CP20  
Mk19 Grenade Launcher  
HVY +0 N R (40mm belt)(B12) 50 20 ST 500m SOF  
M-32 Auto GL  
HVY +0 N R (40mm)(B16-18) 50 20 VR 1600m 2500 HoB  
M-205 Underbarrel GL  
HVY +1 L P (40mm)(B6) 1 1 VR 200m 250 HoB  
M-212 Grenade launcher  
HVY +1 N P (40mm)(B6) 8 2 VR 200m 500 HoB  
Towa Type-9 GL  
HVY +0 N P (40mm)(B6) 8 2 VR 200m 750 PAC  
Arasaka Combat 10  
HVY +0 N R 8D6 (40mm HE)(B6) 10 1 ST 250m 10,000  
MM

### MISSILE / ROCKET WEAPONS

Name Type WA Con. Avail. Damage(Ammo)(BodMin) #Shots ROF  
Rel. Range Cost Source  
Rostovic Wrist Racate HVY +0 N P 5d6 (30mm) 6 3 ST  
250m 380 Chr1  
Urban Missile Launcher  
HVY +2 L P 4d6 (micromissile) 12 2 ST 200m 900 Chr2  
U-barrel Micromissile  
HVY +1 L P 4d6 (micromissile) 1 1 ST 200m 200 Chr2  
Lance Mini-Missile (50%)  
HVY +2 P C 4d6HEAT, 2d6 1 1 UR 300m 100 SOF2  
Militech Porcupine Mine  
HVY 15 N P 4d6HEAT 400 400 ST 100m 30,000 SW  
Militech Porcupine Shell  
HVY 15 N P 4d6HEAT 100 100 ST 100m 7500 SW  
Militech Porcupine Bomb  
HVY 15 N P 4d6HEAT 200 200 ST 100m 15,000 SW  
LAW XCL  
HVY -1 L P 5d6, 2m (30mm) 3 1 ST 250m 600 I1.2  
LAW  
HVY -2 L P 4d10HEAT, 2m 1 1 VR 200m 300 MM  
Scorpion 16 SAM  
HVY -1 N P 7d10, 6m 1 1 VR 1000m 1000 MM  
Smart Missile

A 18 N R 8d10+20 1 1 1000m SW  
 HLAW  
 HVY -2 N P 11d10HEAT, 4m 1 1 VR 200m 800 MM  
 Stinger V Missile  
 HVY -2/+2 L R 12d10, 10m 2 1 VR 1000m P1  
 Milan-C LATGM (1 shot)  
 HVY +2 N P 12d10HEAT, 4m 1 1 VR 3000m 3000 UK  
 Militech Hotshot LATGM  
 HVY +2 N P 12d10HEAT, 4m 1 1 VR 1000m 2500 MM  
 Arasaka AP-87 LATGM  
 HVY +2 N P 12d10HEAT, 4m 1 1 VR 1000m 2500 SW  
 Vehicle-Mounted SAM  
 A 15rt N P 15d10, 10m 1 1 VR 5000m 10,000 MM  
 Adder Air-to-Air Missile  
 A 15rt N P 15d10, 12m 1 1 VR 15km 15,000 MM  
 Homing AAMRAM  
 A 20r N P 17d10, 12m 1 1 VR 80km 250k MM  
 Militech Anvil-2 HATGM  
 HVY +2 N P 18d10HEAT, 4m 1 1 VR 3000m 10,000 MM  
 Militech Sure-Shot  
 HVY +2 N P 18d10HEAT, 4m 1 1 ST 3000m 75,000 SW  
 Hellfire Laser-Guided  
 HVY var N P 20d10HEAT, 4m 1 1 VR 3000m 10,000 MM  
 Militech 4-Pack Missile  
 HVY 15 N P 20d10HEAT, 6m 1 1 ST 3000m 11,000 SW  
 E-Harpoon  
 HVY +1 N R Pen 20 & Special 1 1 ST 500m 10,000 MM  
 Militech RPG-A  
 HVY -2 N R 6d10HEAT, 4m 1 1 VR 750m 1500 MM  
 Militech RPG-B  
 HVY -2 N R 9d10HEAT, 4m 1 1 VR 500m 1500 MM  
 2" Rocket (100eb)  
 HVY -2 N P 6d10, 3m 1-19 1-19 VR 500m 200ea MM  
 2.75" Rocket (200eb)  
 HVY -2 N P 8d10, 6m 3-19 1-19 VR 500m 500ea MM  
 3.5" Rocket (400eb)  
 HVY -2 N P 9d10, 8m 3-9 1-9 VR 600m 750ea MM  
 5" Rocket  
 HVY -2 N P 13d10, 15m 1 1 VR 2000m 1000 MM

#### CANNON

Name Type WA Con. Avail. Damage(Ammo)(BodMin) #Shots ROF  
 Rel. Range Cost Source  
 75mm Recoilless  
 HVY +0 N R/P 8d10HEAT, 2m 1 1 VR 500m 15,000 MM  
 75mm Cannon  
 HVY var N R 8d10, 5m (75mm) 10 2 VR 750m 75,000 MM  
 75mm Low Velocity  
 HVY +0 N P Var. (75mm) 10 1 VR 600m 100K SOF2  
 75mm ET Cannon  
 HVY +1 N R 10d10@ (75mmET) 10 2 VR 1000m 115K  
 SOF2  
 90mm Cannon  
 HVY +0 N R 9d10, 6m (90mm) 1 1 VR 750m 150K MM  
 90mm Cannon  
 HVY +0 N R 9d10, 6m (90mm) 10 2 VR 750m SW  
 105mm Recoilless  
 HVY +0 N R/P 10d10HEAT, 2m 1 1 VR 800m 30,000 MM  
 105mm Cannon  
 HVY +0 N R 11d10, 6m (105mm) 1 1 VR 1000m 250K MM  
 105mm Cannon  
 HVY +0 N R 11d10, 6m (105mm) 10 2 VR 1000m SW  
 105mm ET Cannon

HVY +1 N R 15d10@ (105mmET) 1 1 VR 1500m 375K  
 SOF2  
 120mm Cannon  
 HVY +0 N R 12d10, 6m (120mm) 1 1 VR 1250m 500K MM  
 120mm Cannon  
 HVY +0 N R 12d10, 6m (120mm) 10 2 VR 1250m SW  
 120mm ET Cannon  
 HVY +0 N R 19d10@ (120mmET) 1 1 VR 1900m 750K  
 SOF2  
 140mm Cannon  
 HVY +0 N R Var. (140mm) 1 1 VR 1500m 1M MM  
 140mm ET Cannon  
 HVY +0 N R 24d10@ (140mmET) 1 1 VR 2250m 1.5M  
 SOF2

#### RAILGUNS

Name Type WA Con. Avail. Damage(Ammo)(BodMin) #Shots ROF  
 Rel. Range Cost Source  
 Militech XR-1 Mag Pulse  
 RIF +2 N P 3d10EAP (B6) 20 1 UR 800m 8000 SW  
 Rhinemetall EMG-85  
 HVY +3 N R 5d10+10EAP (B11) 5 1/2 ST 1500m 11,370  
 Chr2  
 Rhinemetall EMG-83  
 HVY +2 N R 5d10+10EAP (B11) 100 1 ST 1200m 17,500  
 MM  
 Rhinemetall EMG-84  
 HVY +1 N R 5d10+10EAP (B21) 500 10 UR 1000m  
 25,000 MM  
 1cm Rail Cannon  
 HVY +2 N R 10d10EAP (10mm) 50 2 ST 1000m 750K MM  
 2cm Rail Cannon  
 HVY +1 N R 16d10EAP (20mm) 50 1 ST 1500m 1.5M MM  
 3cm Rail Cannon  
 HVY +0 N R 20d10EAP (30mm) 50 1/2 UR 1500m 3M MM  
 4cm Rail Cannon  
 HVY +0 N R 28d10EAP (40mm) 50 1/2 UR 1500m 6M  
 SOF2

#### INDIRECT FIRE / ARTILLERY

Name Type WA Con. Avail. Damage(Ammo)(BodMin) #Shots ROF  
 Rel. Range Cost Source  
 Militech Backpack Mortar  
 HVY 17 N P 7d6/3d6 (40mm) 20 1/3 ST 500m 1250 SW  
 MRL 70mm Artillery  
 HVY -3 N P 8d10, 6m 40 spc 500m 9500+ SW  
 60mm Mortar  
 HVY +0 N P 8d10, 5m 1 2 VR 2000m 750 MM  
 80mm Mortar  
 HVY +0 N P 9d10, 6m 1 1 VR 3500m 1500 MM  
 120mm Mortar  
 HVY +0 N P 13d10, 6m 1 1 VR 6000m 5000 MM  
 105mm Howitzer  
 HVY +1 N P 11d10, 6m 1 1 VR 17km 100K MM  
 150mm Howitzer  
 HVY +1 N P 13d10, 6m 1 1 VR 24km 150K MM  
 200m Howitzer  
 HVY +0 N P 28d10, 8m 1 1/2 VR 20km 250K MM  
 Militech Man-Pack  
 HVY 15 N P 13d10, 15m 1 1 VR 2000m 1500 SW  
 5" Rocket (1000eb)  
 HVY -2 N P 13d10, 15m 1 1 VR 2000m 500 MM  
 230mm Rocket (2500eb)  
 HVY +0 N P 4d10HEAT, 45m 12 12 VR 28km 175K MM



## **ORTILLERY / SATELLITE WEAPONS**

Name Type WA Con. Avail. Damage(Ammo)(BodMin) #Shots ROF  
Rel. Range Cost Source

### **CH-19 Sniper**

- "Frag" HVY 95% N R 10d6\*, 50m 10 1 ST 130mi 900K  
SW

- "Crowbar" - - - - disables vehicle 40% 10 - - - - -

- "Bomb" - - - - 5d10, 20m (3 floors) 10 - - - - -

## **STATIC & AUTOMATED DEFENCES**

Name Type WA Con. Avail. Damage(Ammo)(BodMin) #Shots ROF  
Rel. Range Cost Source

### **APEX Mobile Defense**

HVY spec N P 2d6+4 (9mm LC) 400 40 ST 200m 10,000  
Chr1

### **Arasaka WXA Sentry**

HVY +0 N R 6d6+2 (7.62mm) 500 20 VR 400m 3000 CB1

### **ADA Gun**

HVY 14/+0N P 12d10HE 1200 30 VR 600m SW

### **Missile Launchers**

HVY 12/-1 N P 7d10, 6m 8 2 VR 500m SW

### **Anti-Air Missiles**

HVY 20 N P 8d10 2 1 VR 1000m SF

### **Multi-Purpose Missiles**

HVY 15 N P 8d10 2 1 VR 500m SF

### **Anti-Air Missile Battery**

HVY 20 N P 8d10 4 1 VR 2000m SF

## **SUBMARINE / STATIC UNDERWATER WEAPONS**

Name Type WA Con. Avail. Damage(Ammo)(BodMin) #Shots ROF  
Rel. Range Cost Source

### **Multi-Torpedo Platform**

HVY 15/+2N P 9d10AP (3000m) 3 1 VR 1km 10000 SF

### **Smart Torpedoes**

HVY 8/+1 N P 12d10 1 1 VR 3.2 mi SF

### **HEAT Subrocs**

HVY +0 N P 10d10HEAT 100 10 VR 800m SF

### **Militech AHUCS**

HVY +0 N P 10d10~ 60 10 VR 850m SF

### **AMC Guided Torpedoes**

HVY 10/+2N P 30d10 (3 attempts) 2 1 VR 30 mi SF

### **Torp-Launcher**

HVY 8/+0 N P 30d10 10 1 VR 20 mi SF

### **Underwater Mine**

HVY +0 N P 15d10 1 1 VR 50m SF

### **AP Torpedo Launcher**

HVY 15 N P 8d10 (2500m) 4 1 ST 1 km SF

# POWERED ARMOR

SIB DFB REF STR Punch Crush Kick Tough Head/Arms Legs Torso  
SP Total Weight

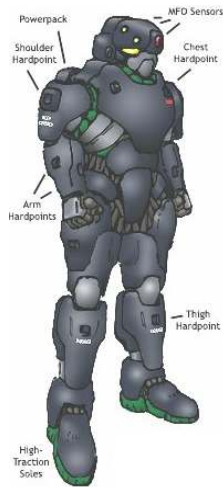

Army General Unit

- 12A2 Grunt +0 +2 +1 25 3d10 4d10 5d10 -7 6 12  
18 40 885kg 139,400 HoB

Raven Microcyb Pit Viper

+0 +2 +0 16 2d10 3d10 3d10 -5 4 8 12 30 350kg 26,000  
SOF2

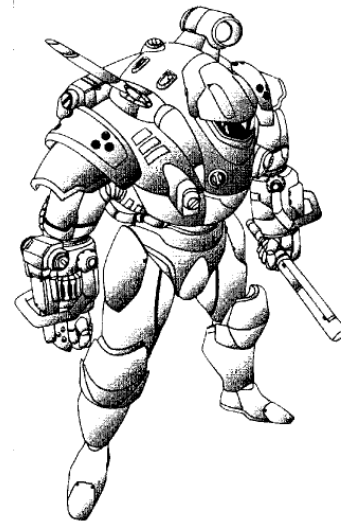

Arasaka Type-17K "Guardian"

+5 +2 +1 25 3d10 4d10 5d10 -7 6 12 18 25 440kg 76,260  
Chr3

Raven Microcyb Hooded Viper

+3 +3 +2 16 2d10 3d10 3d10 -5 4 8 12 30 350kg 48,000  
SOF2

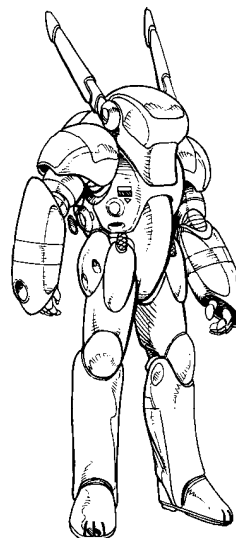
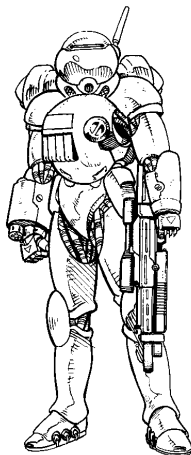

Orbital Air/Raven Microcyb Spider

+4 +3 +2 27 3d10 4d10 4d10 -7 7 13 20 40 620kg 789,830  
MM

Dynalar/Zetatech Grasshopper

+2 +2 25 3d10 4d10 5d10 -7 6 12 19 30 462kg 54,742 MM

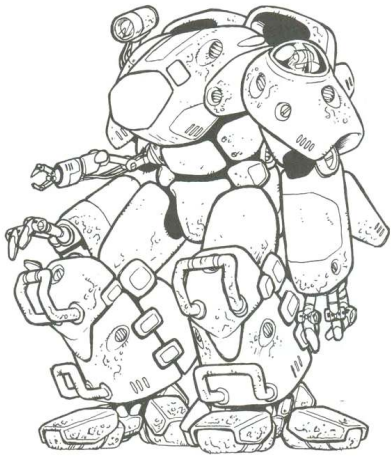

**Hydrosubsidium "Gorgon"**  
 28 3d6-1 -7 7 14 21 35 621kg 78,912 SF



**Militech War Commando**  
 +3/4 +3 35 4d10 5d10 6d10 -9 9 18 27 65 951kg 116,000 SW

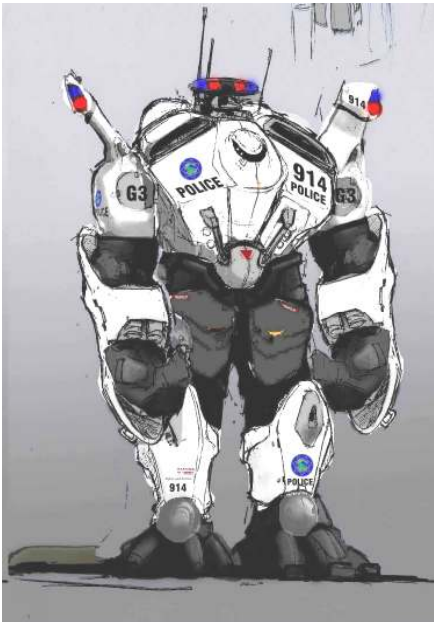

**Militech & TT Tb/0 "Lifeline"**  
 +3 +2 +1 30 4d10 5d10 6d10 -8 7 15 22 40 699kg 99,000 Chr3

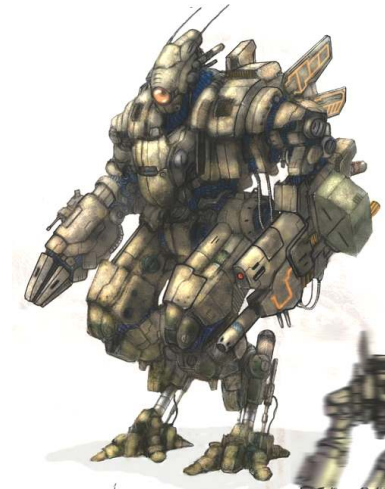

**USAF General EVA Unit**  
 - 12NT +3 +2 35 4d10 5d10 6d10 -9 9 18 26 40 824kg 211,600 HoB

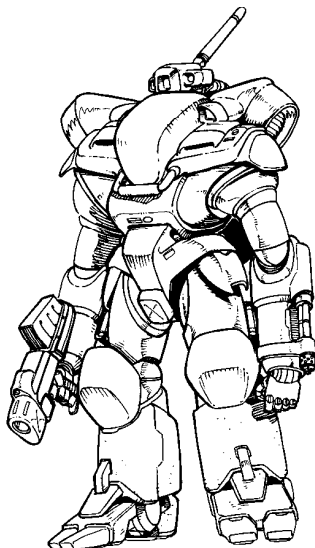

**Militech Commando**  
 +3/4 +3 35 4d10 5d10 6d10 -9 9 18 27 65 945kg 108,306 MM



**Amphib Unit AAU-3A2 Landshark**  
 +1 +2 35 4d10 5d10 6d10 -9 9 18 26 65 934kg 137,000 HoB

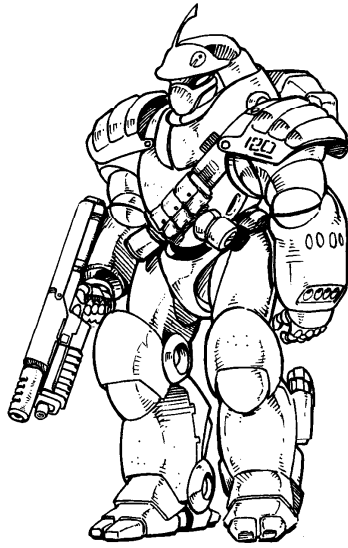

**Arasaka Standard B, Mohanjin-B**  
 +1 +2 37 4d10 5d10 6d10 -9 10 19 26 50 691kg 89,050  
 MM

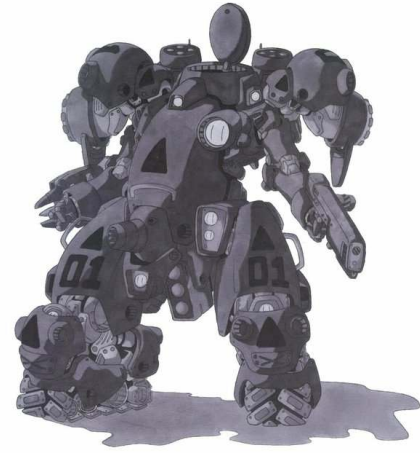

**Chiba Custom "Superjack"**  
 +4 +3 +2 40 4d10 5d10 7d10 -10 10 20 30 50 881kg  
 2.16M SOF2

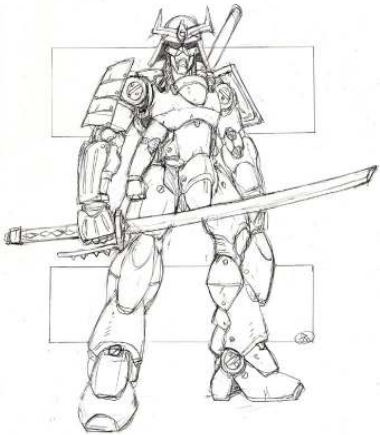

**Arasaka Standard C, Mohanjin-C**  
 +3 +3 +2 37 4d10 5d10 6d10 -9 10 19 26 50 705kg  
 100,000 SW

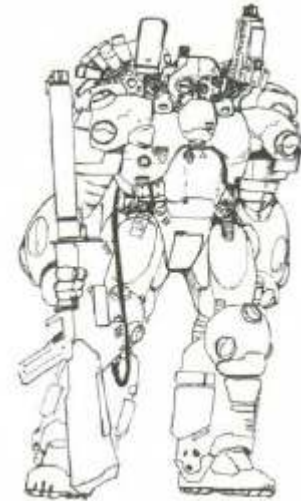

**Raven & Tsunami Arms Magus**  
 +4 +3 +2 40 4d10 5d10 7d10 -10 10 20 30 65 920kg  
 1,447,530 SW

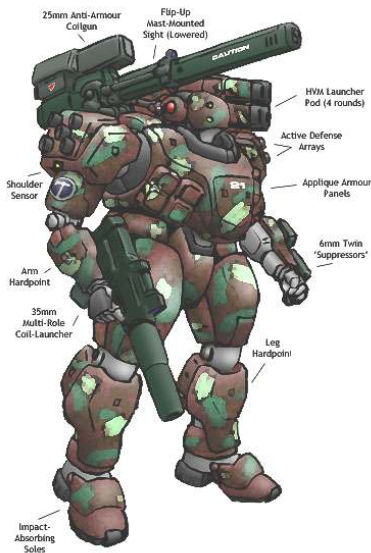

**Army Gun Unit - 10D Pigman**  
 +0 +2 +1 40 4d10 5d10 7d10 -10 10 20 30 40 1566kg  
 246,700 HoB

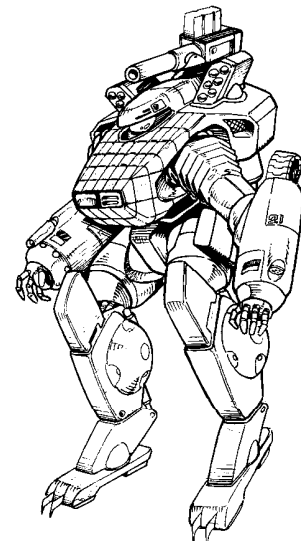

**Mexican Metals Nemesis Assault**  
 +3 +3 45 5d10 6d10 7d10 -11 11 22 34 80 1481kg  
 146,693 MM

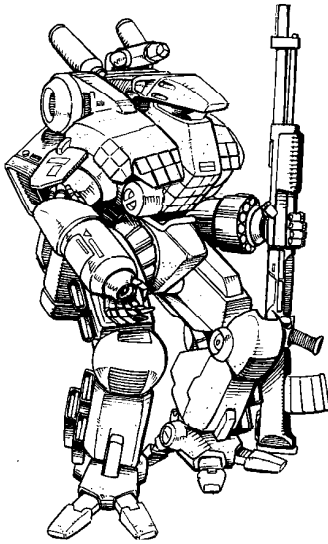

**Russian Arms Boris**  
 +1 +2 50 6d10 7d10 9d10 -12 12 25 37 65 1235kg  
 116,027 MM



**Russian Arms Bombardier**  
 +2 +3 +1 52 6d10 7d10 9d10 -12 13 26 39 80 1340kg  
 208,367 SW



**Arasaka "Daioni" PA Conversion**  
 +6 +3 52 6d10 7d10 9d10 -12 13 26 39 80 1120kg  
 810,000 SW

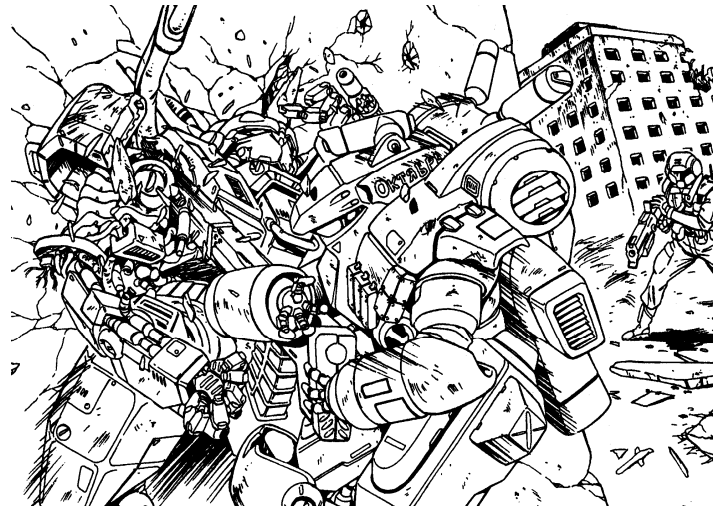

## ACPA MELEE

Name Type WA Con. Avail. Damage(Ammo)(BodMin) #Shots ROF  
 Rel. Range Cost Source

### ACPA Punch

Punch +0 - - (STR/9)d10 - 2 - 1.2m - MM

### ACPA Kick

Kick -1 - - (1.5xPunch)d10 - 2 - 1.2m - MM

### ACPA Crush

HH +0 - - (Punch+1)d10 - 1 - 1m - MM

### Climber Claws

MEL +1 N C 1d10\* + Fist/Kick - 2 VR 1.5m 1000 MM

### 2 Handed Pointed

MEL +0 N C 3d6+Fist 1/2SP 1/4P - 1 50% 5m 225 MM

### 1 Handed Blunt

MEL +0 N E 4d6 + Fist - 1 15% 2m 200 MM

### 1 Handed Blade

MEL +1 N E 4d6~ + Fist - 1 10% 2m 550 MM

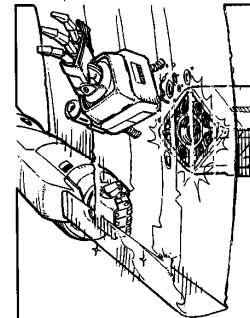

### Mono PA Sword

MEL +1 N R 4d6# + Fist - 1 30% 2m 2000 MM

### 2 Handed Blade

MEL -1 N C 6d6~ + Fist - 1 10% 3m 1000 MM

### 2 Handed Blunt

MEL -1 N E 6d6 + Fist - 1 15% 3m 500 MM

### Large Power Saw

MEL -2 N P 8d6~ (1/3SP) - 1 VR 2m 1250 MM

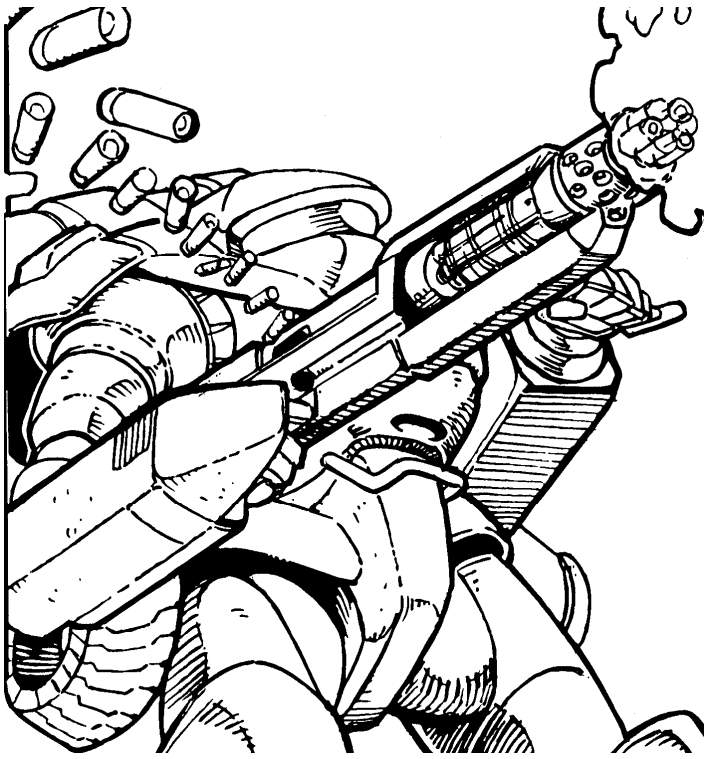

## ACPA WEAPONS

### SMALL ARMS

Name Type WA Con. Avail. Damage(Ammo)(BodMin) #Shots ROF  
Rel. Range Cost Source

#### Auto-Flechette Pistol

P +2 J P 1d6x1d6\* 100 1/3/30 ST 200m 900 MM

#### 12-Gauge Pistol

P -2 J/L P 4d6 (12ga)(B12) 9 2 ST 30m 1000 SOF2

#### 10-Gauge Pistol

P -2 L P 5d6 (10ga)(B15) 9 2 ST 30m 1200 SOF2

#### "Big Boomer"

P +1 L P 5d6@ (.477) 8 2 VR 100m 550 MM

#### 14mm Pistol

P +0 L P 6d6 (14mm) 20 2 ST 75m 2260 MM

#### MO Big Government

P +0 J P 6d6 (14mm)(B12) 13 2 VR 60m 2000 SOF2

#### MO Hellbringer .666

P +1 J/L P 7d6+3 (.666)(B15) 3 1 VR 80m 4000 SOF2

#### 5.56 caseless SMG

SMG +1 L/N P 5d6 (5.56)(B10) 50 25 VR 200m 1200 SOF2

#### Malorian 3600 Super

SMG +0/-1 L P 6d6 (14mm)(B11) 20 1/3 VR 50m 3000 SOF2

#### Arasaka Rage 15mm

SMG -1/-2 L P 4d10+3 (15)(B15) 20/50 10 VR 100m 4500 SOF2

#### Militech M-31PA Rifle

RIF +2 N P 4d6 300 1/3/30 ST 400m 1800 MM

#### Micro-Missile Launcher

HVY +2 L P 4d6, 2m 8 2 ST 200m 900 MM

#### "Dragon" Flamer

HVY +0 L P 3d6/1d6 8 1 ST 8m 990 MM

## ACPA WEAPONS

Name Type WA Con. Avail. Damage(Ammo)(BodMin) #Shots ROF  
Rel. Range Cost Source

#### ONI Autoshotgun

SHT +0 P 4d6+3 (10ga) 180 5/20 VR 75m 1350 MM

#### Tsunami Arms Helix

SHT +0 N P 5d6 (10ga)(B18) 60 43 VR 60m 3000 SOF2

#### United Arms CLAW

SHT +1 N R 8d6 (4ga)(B11) 28 1/4 VR 60m 1600 SOF2

#### 5.56mm Lt Machinegun

HVY +1 N P 5d6 (5.56) 100 10 VR 450m 1200 MM

#### 5.56mm Minigun

HVY +1 N P 5d6 (5.56) 1000 100 ST 450m 2000 MM

#### 7.62mm Lt Machinegun

HVY +0 N P 6d6+2 (7.62) 100 10 VR 500m 1200 MM

#### 7.62mm Minigun

HVY +0 N P 6d6+2 (7.62) 2000 100 ST 500m 4000 MM

#### G-20 Caseless 10mm

HVY +0 N P 8d6 (10mm) 200 20 VR 600m 3000 MM

#### HIVE 10mm Gatling

HVY +0 N R 5d10@ 2400 60/120 ST 500m 12,500 MM

## ACPA BEAM WEAPONS

Name Type WA Con. Avail. Damage(Ammo)(BodMin) #Shots ROF  
Rel. Range Cost Source

#### Painting Laser

HVY +3 N C NA NA NA VR LOS 1000 MM

#### "Photon" Laser Cannon

EX +2 N R 1-10d6AP 30 2 UR 300m 80,000 MM

## ACPA HEAVY MACHINEGUNS & RIFLES

Name Type WA Con. Avail. Damage(Ammo)(BodMin) #Shots ROF  
Rel. Range Cost Source

#### 12.7mm Assault Rifle

RIF +1 N P 6d10 (12.7)(B12) 50 10 VR 400m 2000 SOF2

#### 14.5mm Assault Rifle

RIF +1 N P 7d10 (14.5)(B14) 50 10 VR 400m 2500 SOF2

#### 12.7mm Machine Gun

HVY +1 N P 6d10 (12.7mm) 100 5/10 VR 550m 2000 MM

12.7mm Gatling  
HVY +0 N P 6d10 (12.7mm) 500 100 VR 500m 6000 MM

13.9x99mm Hvy Rifle  
HVY +2 N R 6d10+5 (13.9mm) 60 3 ST 600m 2400 MM

14.5mm Machine Gun  
HVY +0 N P 7d10 (14.5mm) 100 3/5 ST 550m 2500 MM

BRG-15  
HVY +1 N R 7d10 (15mm) 100 10 VR 650m 2800 MM

### ACPA CANNON

Name Type WA Con. Avail. Damage(Ammo)(BodMin) #Shots ROF  
Rel. Range Cost Source

4mm Railgun  
HVY +3 N R 5d10+10EAP 5 1/2rnd ST 1500m 11,370 MM

EMG-83 Improved Railgun  
HVY +2 N R 5d10+10EAP 10 1 ST 1000m 17,500 MM

Deathwind Railgun  
HVY +3 N R 5d10+10EAP 30 2 VR 1250m SW

BCL-20 Light Cannon  
HVY +1 N P 8d10 (20mm) 20 2 VR 550m 2700 MM

20-25mm Autocannon  
HVY +0 N P 8d10 (20-25mm) 100 10 VR 500m 3000 MM

BHC-G8 30mm Rifle  
HVY +0 N P 9d10 (30mm) 10 1 ST 600m 3500 MM

27-30mm Autocannon  
HVY +0 N P 9d10 (27-30mm) 50 10 VR 600m 4000 MM

LATG 37mm  
HVY +3 N P 6d10@ (37DPU) 10 1 VR 800m 10,000 MM

60mm Mortar  
HVY +0 N P 8d10 (60mm) 6 2/1 VR 2000m SW

75mm Recoiless HVY +0 N R 8d10@ (75mm) 4 1 VR  
500m 15,000 MM

### ACPA GRENADE LAUNCHERS

Name Type WA Con. Avail. Damage(Ammo)(BodMin) #Shots ROF  
Rel. Range Cost Source

Tsunami 25mm  
GL HVY +0 N P (25mm) 20 1/3/5 ST 1500m 1700 MM

Arasaka Tsunami  
HVY +0 L P (25mm HP)(B11) 6 1 ST 200m 1250 SOF2

40mm Auto-GL  
HVY +1 N P (40mm) 50 3/20 ST 1600m 2500 MM

30mm Auto-GL  
HVY +0 N R (30mm) 30 1/10 ST 1300m 2000 MM

30mm HiVel Auto-GL  
HVY +0 N P (30mm)(B12) 25 15 VR 300m 2000 SOF2

Super Rakate  
HVY +0 N P 5d6, 3m 8 1-8 ST 300m 700 MM

Saucer Shooter  
HVY -1 N P 2d6+3 30 1 ST 250m 1500 MM

EMP Grenadier  
HVY +0 N R Special 5 1 ST 300m 2000 MM

### ACPA ROCKETS & MISSILE

Name Type WA Con. Avail. Damage(Ammo)(BodMin) #Shots ROF  
Rel. Range Cost Source

IFAR  
HVY -2 N R 8d10, 6m 1 1 ST 500m 200 MM

IFAR 3-Pod  
HVY -2 N R 8d10, 6m 3 1-3 ST 500m 2100 MM

IFAR 6-Pod  
HVY -2 N R 8d10, 6m 6 1-6 ST 500m 4200 MM

Mini-Roc 6  
HVY -2 N R 6d10, 3m 6 1-6 ST 500m 1800 MM

Mini-Roc 15C  
HVY -2 N R 6d10, 3m 15 1-15 ST 500m 4500 MM

LAW-III  
HVY -2 N P 4d10HEAT, 2m 1 1 VR 200m 300 MM

Light ATGM  
HVY +2 N P 12d10HEAT, 4m 1 1 VR 1000m 3000 MM

Militech Spectre ATGM  
HVY 15o N P 18d10 HEAT, 4m 1 1 VR 3000m 10,000 MM

Scorpion 16 SAM  
HVY -1 N P 7d10, 6m 1 1 VR 2000m 1000 MM

Scorpion 16 Backpack  
HVY -1 N R 7d10, 6m 3 1 VR 2000m 4800 MM

Red Knight SAM  
HVY 15t N P 10d10, 10m 1 1 VR 4500m 4600 MM

Arasaka ACPA Bazooka  
HVY -1 N P 20d10HEAT, 4m 1 1 VR 350m SW

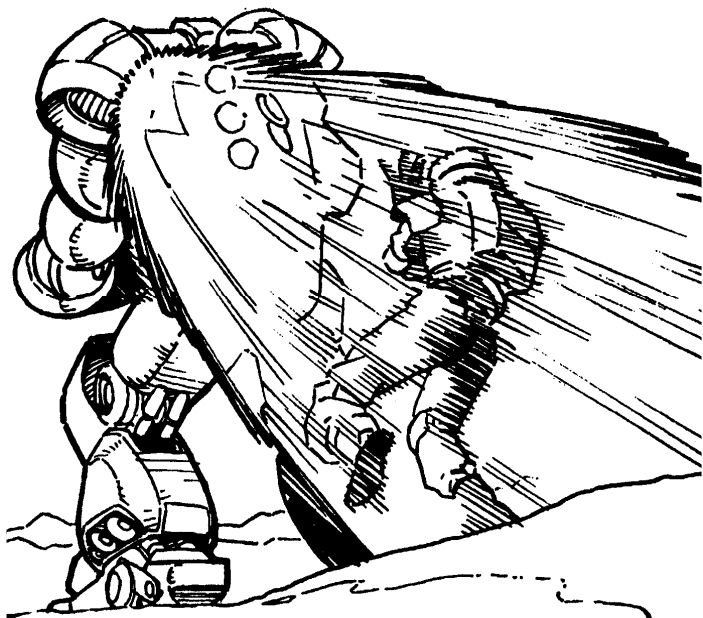

### ACPA SCATTER PACKS

Name Type WA Con. Avail. Damage(Ammo)(BodMin) #Shots ROF  
Rel. Range Cost Source

#### BSP Smoke Pellets

HVY +3 N P 5 min cloud 1x50 1d6 VR 50m 300 MM

#### BSP Paint Pellets

HVY +3 N P varies 1x50 1d6 VR 50m 300 MM

#### BSP Pyrotechnic Pack

HVY +3 N P 20% chance 1d6 1x50 1d6 VR 50m 300 MM

#### BSP Rubber Pellets

HVY +3 N P 1d10 stun 1x50 1d6 VR 50m 300 MM

#### BSP Phosphorous

HVY +3 N P 1d6 x 3 rounds 1x50 1d6 VR 50m 300 MM

#### BIM Minelet Volly

HVY +3 N P 4d6 (1) 1x50 1d6 VR 50m 1000 MM

#### BSP Delayed Minelets

HVY +3 N P 4d6 (1) 1x50 1d6 VR 50m 300 MM

#### BFC-3 Fletch Cloud

HVY +9 N P 1d10@ (1) 1x288 4d6 VR 30m 300 MM

#### BFCWA Cloud

HVY +5 N P 2d10@ (2) 1x144 2d6 VR 30m 300 MM

#### BFC-2 Fletch Cloud

HVY +6 N P 2d10@ (2) 1x144 3d6 VR 25m 300 MM

#### Ripple Fletch Pack

HVY +4 N P 3d10@ (3) 6x24 2d6 VR 15m 500 MM

#### BFC-4 Fletch Cloud

HVY +3 N P 4d10@ (4) 1x72 1d6 VR 20m 1200 MM

### ACPA UTILITY PACKS

Name Type WA Con. Avail. Damage(Ammo)(BodMin) #Shots ROF  
Rel. Range Cost Source

#### BOM Wire Obstacle

HVY -1 N P 1d6x1d6 (4m<sup>3</sup>) 1 1 VR 5m 100 MM

#### BPL Plastic Obstacle

HVY +0 N C .5m/rnd movement 1 1 VR 10m 10 MM

#### BLP Breech Spray

HVY -1 N P 3kg C-6 1 1 VR 2m 300 MM

#### BSS Silicon Spray

HVY -1 N C 3kg glue 1 1 VR 5m 30 MM

#### BES Epoxy Spray

HVY -1 N C 3kg epoxy 1 1 VR 2m 30 MM

## WORKING ASSISTANT DROIDS (WADS)

SIB DFB REF STR Punch Crush Kick Tough Head/Arms Legs Torso  
SP Total Weight



#### Duroi/Janvier "Frelon"

(MA 4) +3 +2 +0 r 30 3-2d10 3-4d10 - -8 5-8 8 22 30  
543kg 67,280 Chr3

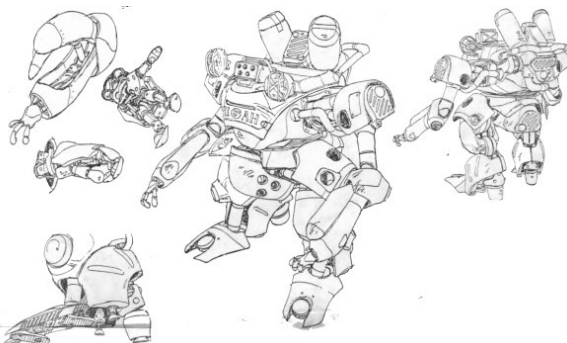

#### Fiat "Nova"

(MA 5) +2 +1 -3 r 40 4d10 5d10 7d10 -10 10 20 30 25  
443kg 78,390 Chr3

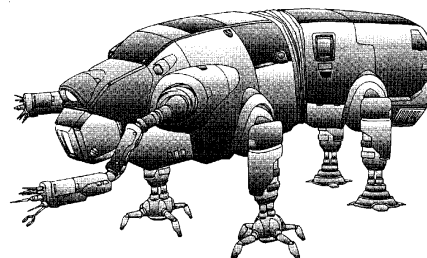

#### IEC "Newport Mk. II"

(MA 4) +3 +2 +0 cl 25 3d10 4d10 5d10 -7 7/13 13 19 0  
322kg 56,440 Chr3



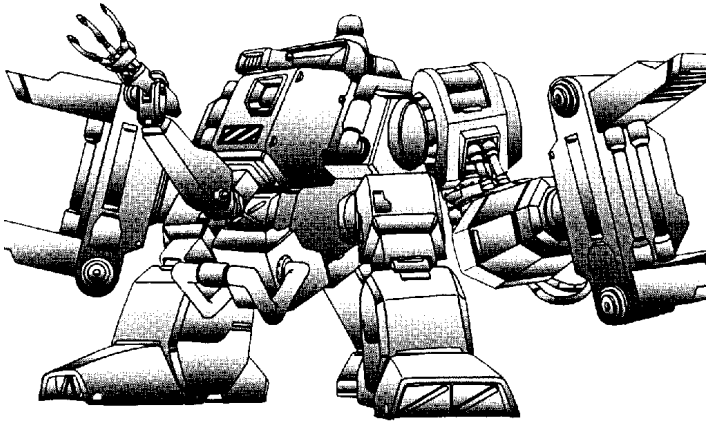

**Duroi/Janvier "Scarabee"**  
 (MA 5) +1 +1 -3 cb 30 3d10 4d10 5d10 -8 8 16 24 25  
 482kg 76,640 Chr3

**WADS**  
 Extra Limbs ..... 10%frame  
 Android Control Circuits .....  
 500eb/limb  
 WAD Controller ..... 1000eb

## REMOTES / ROBOTS

Top Speed A/D Cont. Range Options Included Man. SDP SP Mass  
 Cost Source



**Brandt-Neumann Washbot**  
 - I Home Washes glass and tiles - 4 2 1.5kg 425  
 Chr 3



**Carolli M-bot**  
 - I Home Cleans an entire flat - 10 3 12kg 1150  
 Chr 3

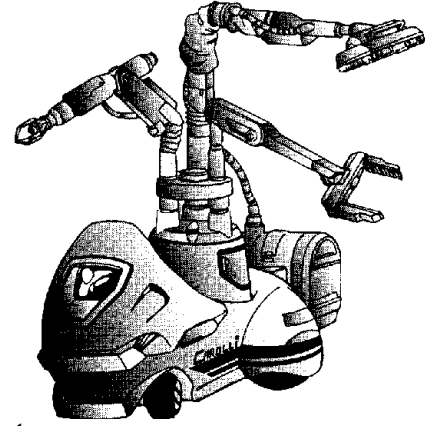

**Carolli V-bot**  
 - I Home Smart vacuum cleaner - 9 3 6kg 650  
 Chr 3

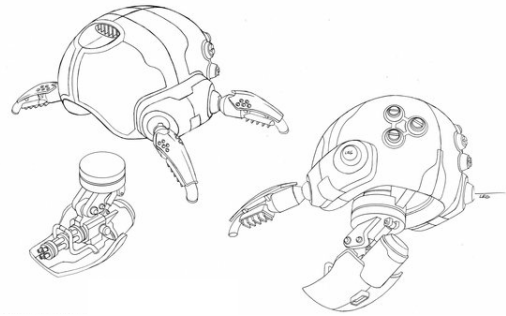

**"Deathdrone" Assassin (air)**  
 MA 8 - R/I 6km, 8hr REF 8, Aware/Weapon +6 -3 5 5 -  
 10,000 SF

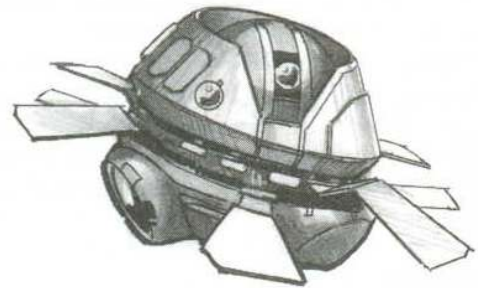

**Bell "Minibee" Rotorcraft (air)**  
 100 mph - R 20miles IR, TH, LL, AD, 10xT, 1kg cargo -2  
 3 0 5kg, 30cm 2500 SW

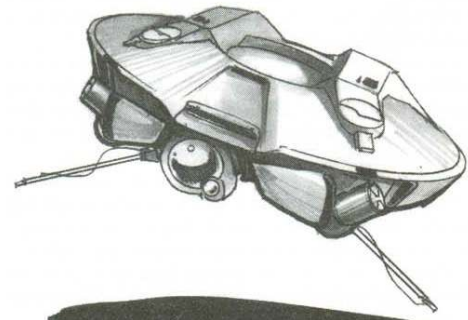

**Microtech Attack Drone (air)**  
 40 mph - R 20miles TH, LL, AD, 10xT, 2xGRL -2 5 0  
 15kg, 1m 3500 SW

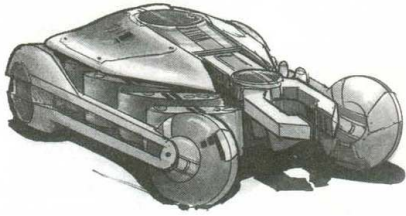

**Militech M-010 Minelayer**

- 1 - 10AP mines, stealth, cameleon - - - 10+10kg  
10,000 SW

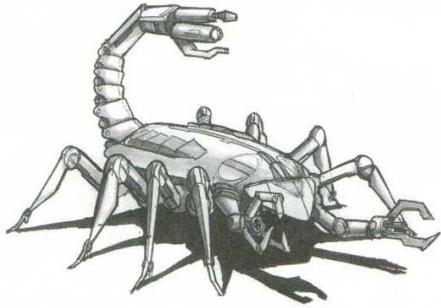

**Microtech "Scorpion" Remote**

MA 8 - R 300m IR, LL, AD, MS, claws, small -1 8 2 -  
15,000 SW

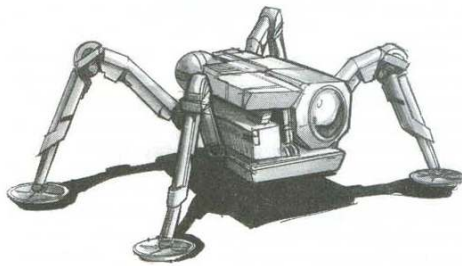

**Microtech Grid Bug**

MA 1 - R 100m IR, MS, int plug, small -2 1 0 - 9000 SW

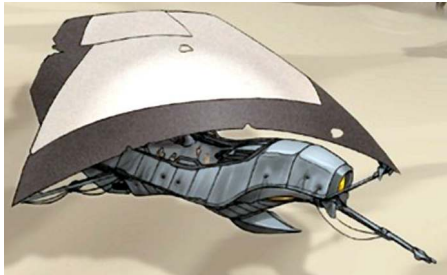

**Bulldog RPV (air)**

25 mph 5/5 R 100 +0 5 0 20kg 1000 Neo



**AVD - Aerodyne Vehicle Drone**

500 mph 75/75 R/I 800 IR, LL, IE, TH, TS, EMG85,15mm  
MGs +3 100 (5) 50 (3) 4 tons 9M SOF2

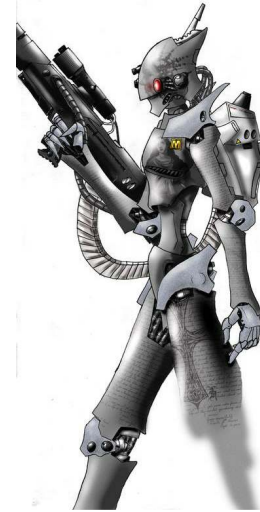

**Adrek "Lawdog" RAPD-1**

20 mph - R/I 100km REF 6, 2 arms (40), 4 legs (35,  
SP15) +0 40/50 30 375kg 125,000 SOF2

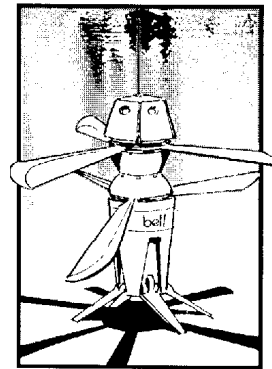

**Bell "Bumblebee" Rotorcraft**

120/MA15 5/5 R 250miles IR (+2 Aware), SMG or HVY +5  
-2 25 6 35kg 4000 Chr 2

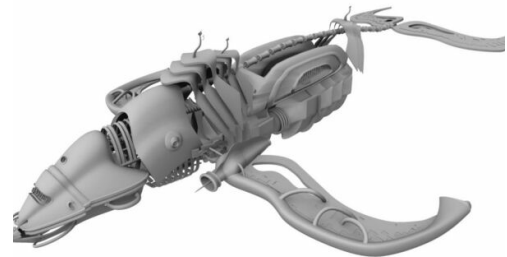

**Bell "Aquabee" Subaquatic**

20 mph 5/5 R 2miles IR (+2 Aware), SMG or HVY +5 -2  
25 6 35kg 4000 SA

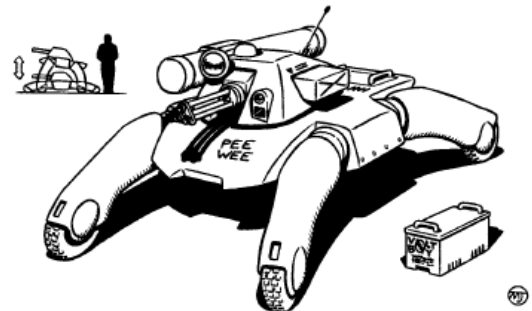

**Mitsubishi "Rover" Wheeled**

45 mph - R/I -3 35 20 60kg 9000 Chr 2



**Militech RPV-400 Trilrotor**  
 210 mph 10/10 R 450miles +2 65 25 - 150,000 Chr 2

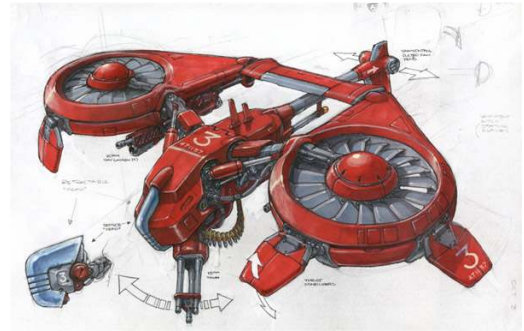

**Oracle (air surveillance)**  
 35 mph 5/5 R/I 60km, 10hr 4 Vid Cams, 4 Mikes, -1 to hit  
 +0 8 4 6kg 1500/1700 P&S

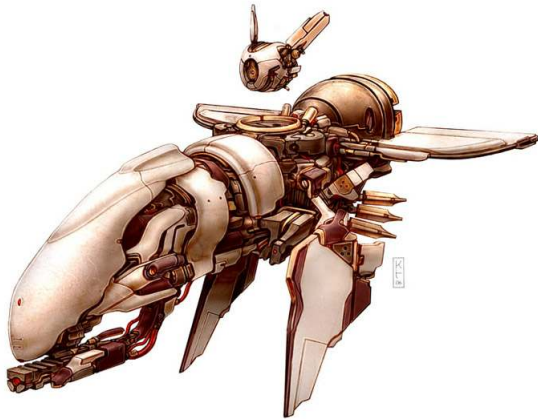

**Constitution Arms Hummingbird**  
 30 mph 5/5 R 10km M.SMG, Paint Laser +0 15 20 - VF



**H-7 Hazardous Material Handling**  
 30 mph - R 20km +0 35/40 35 600kg 50,000 P&S

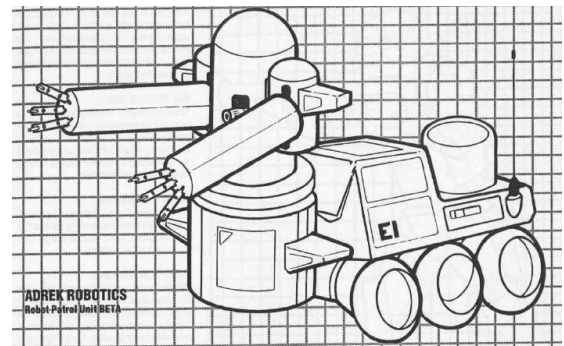

**Adrek Robot Patrol Unit Alpha**  
 30 mph - R 80km Taser, Needle, Paint gun +0 40/50 20  
 120kg 75,000 P&S



**Pesthunter Remote**  
 MA 3 - I Stealth 10, Tranq Gun 15, Notice 18 - 5 15 -  
 ECO



**Pseudo Dragon (air surveillance)**  
 35 mph 5/5 R 30km, 6hr Vid Cam, Boom Mike, -2 to hit  
 +0 4 2 5kg 800 P&S



**Adrek Robot Patrol Unit Beta**  
 25 mph - R 80km K&K MPK9, +4 ext mts +0 35/45 25  
 300kg 95,000 P&S

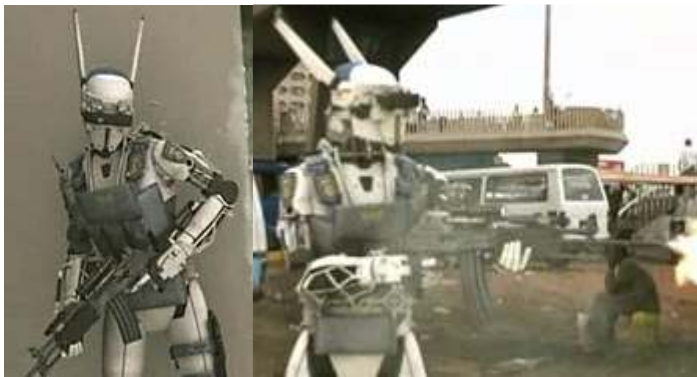

**Adrek Robot Patrol Unit Gamma**  
 20 mph - R 80km H&K 2013, MPK11, Ripps +0 40/50 25 -  
 105,000 P&S

# CYBERFORMS

Top Speed A/D Cont. Range Options Included Man. SDP SP Mass  
 Cost Source

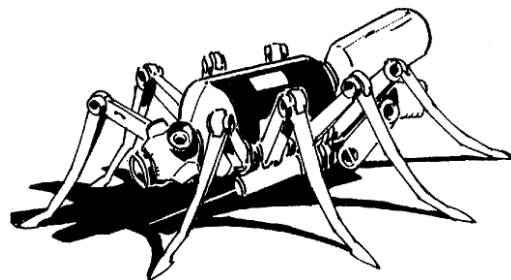

**Arasaka RDAK Spy/Assassin Remote**  
 MA 12 - CC/R 300m, 5hr INT 7, Needler, Melee +3,  
 Stealth +7 -1 10 10 - 12,000 Chr 2



**Lawtech Police Robohound**  
 MA 20 - I REF 10, BOD 10, Bite 4D6AP - BOD10 20 -  
 3625 P&S

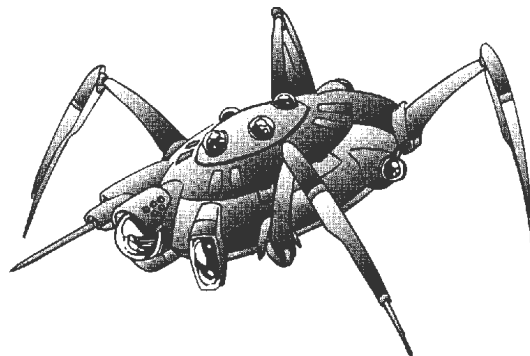

**Mini-Cyberform A-2 "Tarantula"**  
 MA 10 - CC 4km, 8hr INT 7, REF 8, Needler +2 +0 6 6 -  
 4000 Chr 3

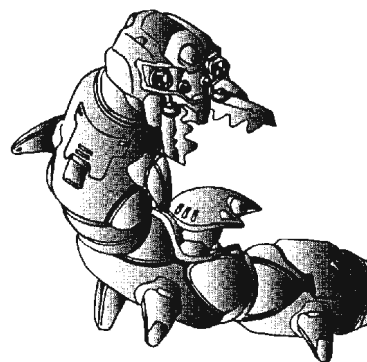

**Mini-Cyberform B-2 "Centipede"**  
 MA 8 - CC 4km, 30day INT 7, REF 10, Air Gun +3, Micro  
 Mis +0 15 15 - 10,000 Chr 3



**Bumblebee Drone**  
 200 mph - R 300miles 4 Missiles, Light Machine Gun +0  
 100 40 - 1,000,000 TCB

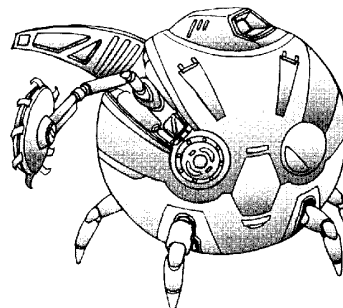

**Mini-Cyberform A-3 "Beetle"**  
 MA 5 - CC 10km, 30d INT 7, REF 10, Laser/Saw +2 +0 10  
 10/30 - 10,000 Chr 3



**Adrek 100 Series Humanoid**

**MA 15 - CC 144 hrs INT 6, REF 12, BOD 10, rippers, rifle - 30/40 25 - 118,000 SOF2**

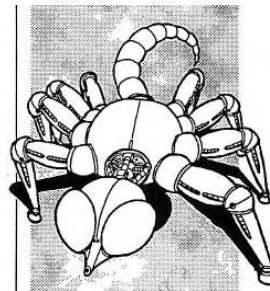

**Arach-Mk 2**

**MA 12 - CC - INT 2, REF 7, BOD 8, tail 1d6 +0 16 3 5 lbs 10,000 MJ2**

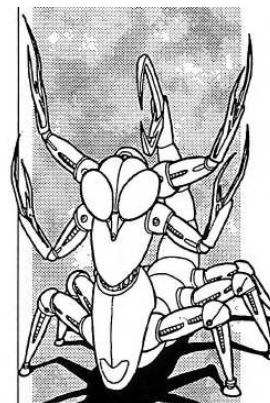

**Arach-Mk 4**

**MA 10 - CC - INT 4, REF 9, BOD 10, claw 1d6/2+2 +2 30 4 95 lbs 15,000 MJ2**



**Chacmool Security Cybercat**

**MA 16 - CC 72 hrs INT 4, REF 11, BOD 5, claws, rifle - 15/20 12 - 62,000 SOF2**

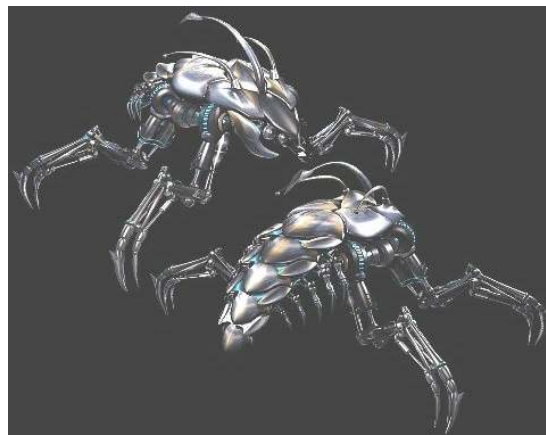

**Arach-Mk 7**

**MA 4 - CC - INT 6, REF 7, BOD 12, polymer spray +3 48 5 295 lbs - MJ2**



**Adrek "Max" Police Dog**

**MA 14 - CC 72 hrs INT 4, REF 11, BOD 5, claws, 2 SMGs - 15/20 12 - 62,000 SOF2**

**Control System: R=Remotely controlled, I=Independent CPU operation, CC=Ceretronic core (SOF2, pg.73)**

# SPACE SURFACE VEHICLES

Vehicle Top Speed Acc/Dec Crew Range Passengers Cargo Man.  
SDP (Body) SP (Armor) Mass Cost Source

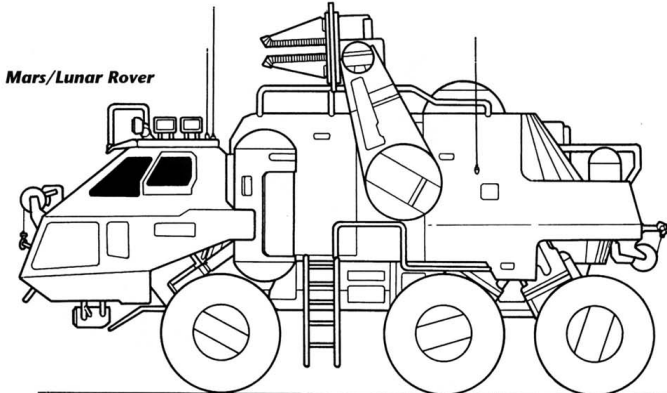

Mars/Lunar Rover

**Lunar Rover**  
50/60 2 310/373 20 or 2000kg 20 6-50 150,000 DS  
**Mars Rover**  
37 2 497 20 or 1000kg 30 10-40 150,000 DS

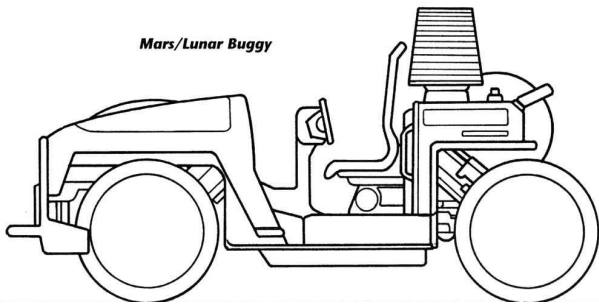

Mars/Lunar Buggy

**Lunar Buggy**  
19 1 93 1 100kg 10 3 5000 DS  
**Mars Buggy**  
16 1 31/22 1 100kg 14 5/15 6500 DS

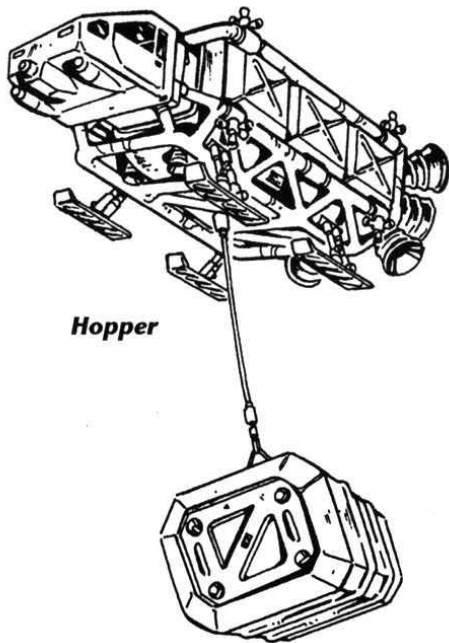

Hopper

**Hopper**  
75 1 248, 4 burn 3 1500kg ext 15 0 350,000 DS

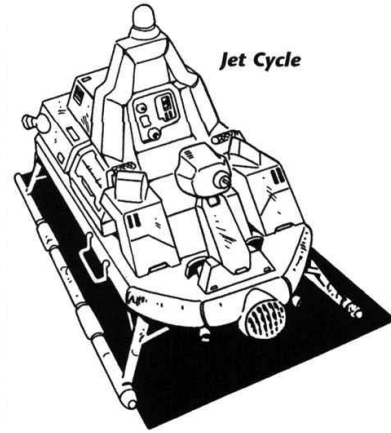

Jet Cycle

**Jet Cycle**  
186 1 1863 1 None 8 0 2000 DS

# SPACECRAFT

Crew Pass Drive Burns Power Sensors Comp Cargo Actions Weaps  
SP DP OKP Cost Source

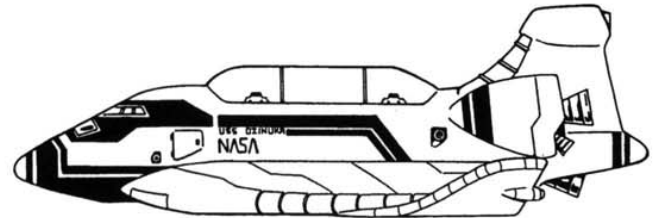

**Shuttle II**  
2 0 C 10 B, FC 50% 3 200m<sup>3</sup>, Flitter 2 6 2 12 4 200M DS

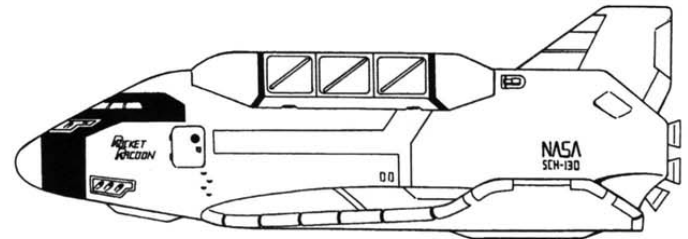

**HL-25 Shuttle**  
2 2 C 5 B 50% 2 50m<sup>3</sup> 2 4 1 7 3 100M DS

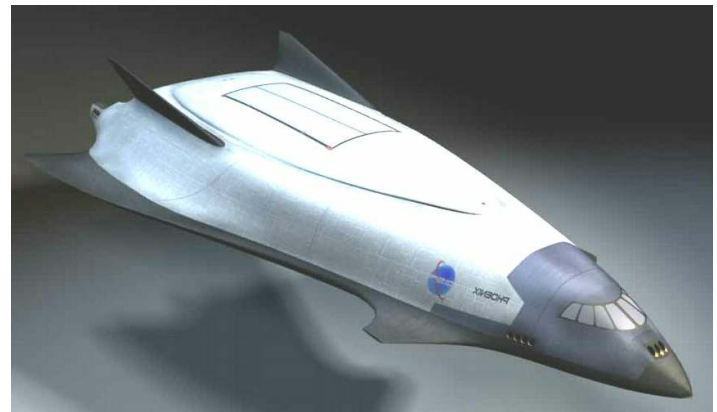

**Hermes I-b Shuttle**  
2 12 C 5 B 50% 2 20m<sup>3</sup> 2 4 1 7 3 120M DS

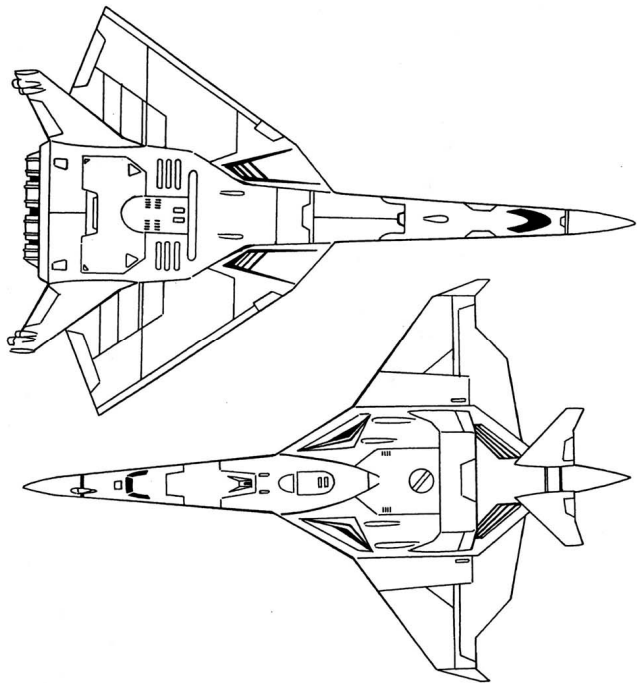

**Delta**  
1-2 0 C 7 B, FC 55% 2 2m<sub>3</sub> 2 8 1 5 2 80M DS



**Luna Landers**  
2 6 C 8 B, FC 50% 2 15m<sub>3</sub> 1 3 2 5 3 50M DS

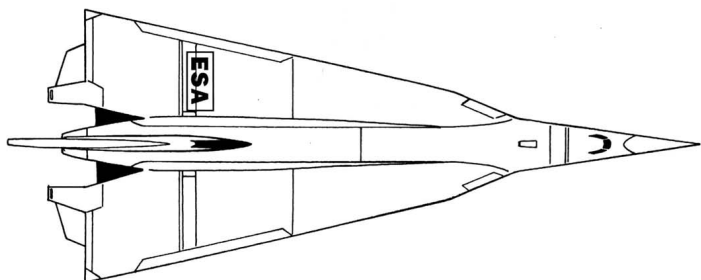

**Aries II Spaceplane**  
5 48 C 8 B, FC 50% 3 30m<sub>3</sub> 3 4 0 7 3 350M DS

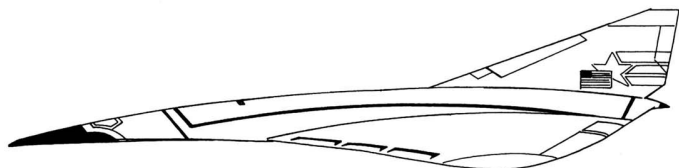

**TAV-12 Spaceplane**  
3 4 C 8 B, FC 50% 3 30m<sub>3</sub> 3 4 0 7 3 220M DS

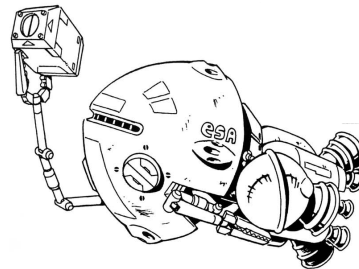

**Cargo OTV**  
2 1 C 10 B, FC, S 50% 2 (10MU) 2x30m<sub>3</sub> 1 3 1-3 5 3 40M DS

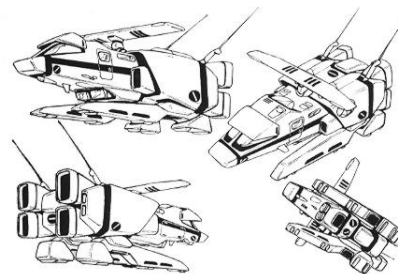

**Passenger OTV**  
4 16 C 10 B, FC, S 50% 2 (10MU) 2x10m<sub>3</sub> 1 0 1-3 5 3 50M DS

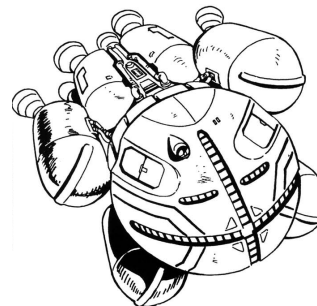

**Deep Space OTV**  
2 16 C 10 B, FC, S 50% 2 (10MU) 10m<sub>3</sub> 1 0 2-4 7 4 70M DS



**Flitter**  
2 2 C 3 B 30% 1 (10MU) 4m<sub>3</sub> 1 0 0 3 1 10M DS

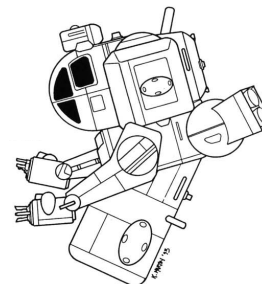

**Work Module**  
1 0 C 2 B, S 30% 1 4m<sub>3</sub> 1 1 1 4 2 5M DS

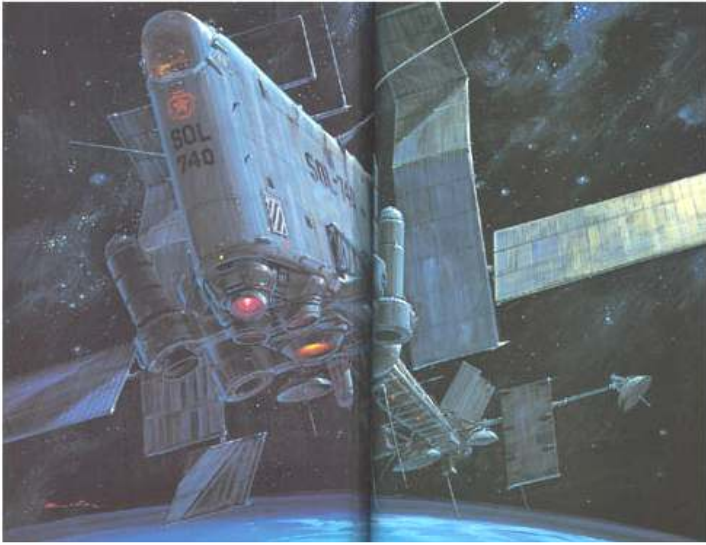

**Battle Satellite**

0 0 C 3 B, S 65% 2 None 1 10 4 6 2 40M DS

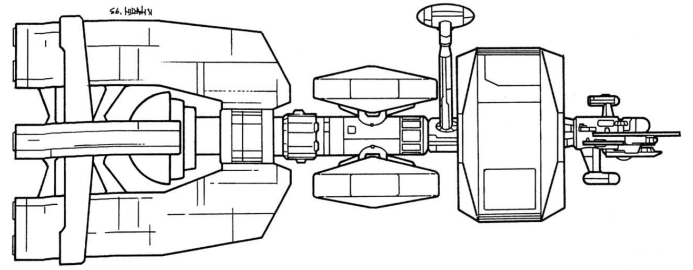

**Clipper**

2 2 C, N 6, 12 B, FC, S 60% 2 50m<sup>3</sup>, 1 OTV 2 0 0 6 2 70M DS

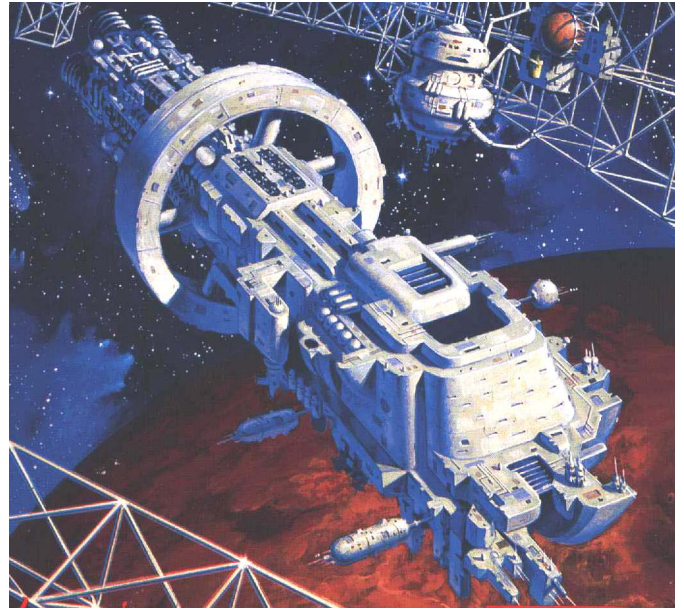

**Carrier**

6 6 C, N 6, 12 N, FC, S 80% 3 125m<sup>3</sup>, 6 Delta 4 7 3 15 4 1400M DS

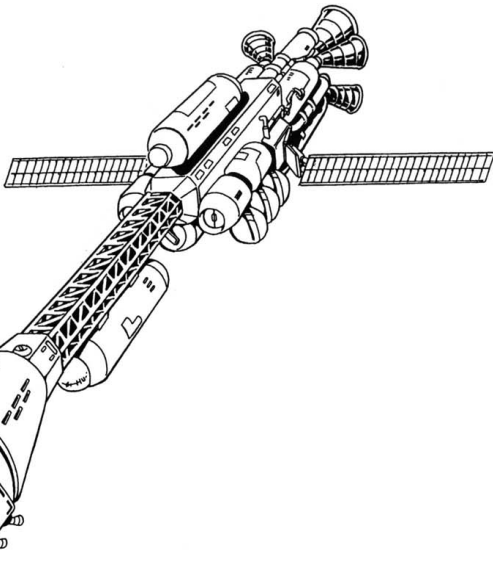

**Deep Space Explorer**

8 60 C, N 8, 12 N, S, FC 90% 5 113m<sup>3</sup>, 4 craft 3 0 0 15 6 2500M DS

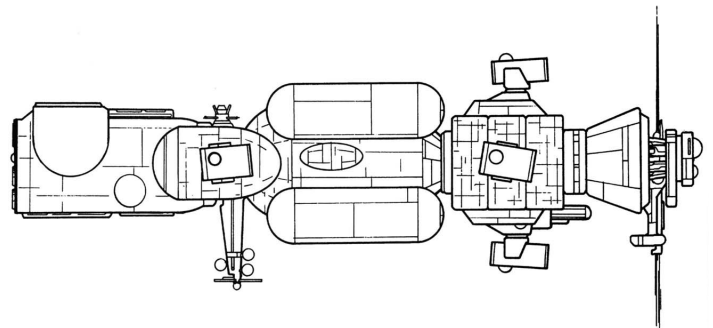

**Gunship**

8 4 C, N 8, 15 B, N, S 80% 4 200m<sup>3</sup>, 4 Delta 6 14 4 20 7 2500M DS

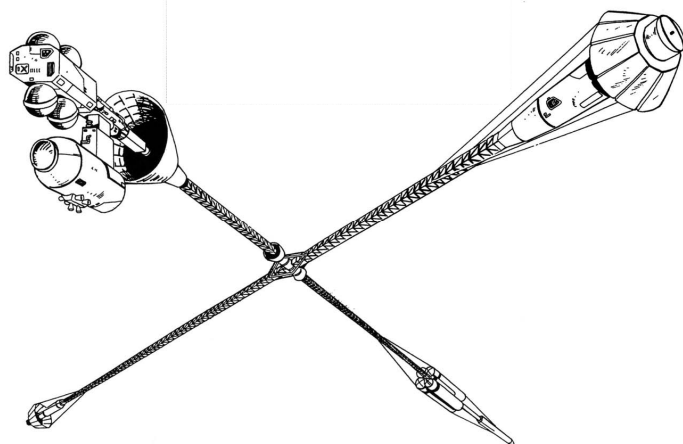

**Cycler (one half)**

4 20 C, I 6, 2 B, S 60% 3 1000m<sup>3</sup>, 6 craft 2 0 0 8 4 250M DS

Drive Type Power Type

C Chemical engines N Nuclear reactors

I Ion engines S Solar power

N Nuclear engines BS Brayton solar dynamic generators

S Solar dynamic drives FC Fuel cells

L Lightsails B Batteries

A Anti-matter engines



## VEHICLE ALTERATIONS

Name Avail. Cost Spaces Description Source

### Added Structure

C x2 SDP - Increases maximum SDP by 25% MM

### Weaker Structure

C - - Minimum SDP is decreased by 50% MM

### Added Top Speed

C 25% b 5% 10% increase in Top Speed (max +100%) MM

### Lowered Top Speed

C -10% b -10% 10% decrease in Top Speed MM

### Boosted Acceleration

C 5% b - 10% increase in Acceleration (max +100%) MM

### Heavy-Duty Breaks

C 5% b - 25% increase in Deceleration (max +100%/+50% aircraft) MM

### Better Handling

C +50% b - +1 Maneuver (max +3) MM

### Off-Road Capability

C +15% - Can be operated off-road at 1/3 top on-road speed MM

### Cargo Capacity

C - - Each 10% cargo, subtracts 10% Speed (max 50% mass) MM

### Aircraft Cargo Capacity

C - - Each 33% cargo, subtracts 10% Speed MM

### Truck Mass Rating

C - - Each 10% mass rating, subtracts 20% Speed (max +20%) MM

### Additional Range

C - 10% 33% increase in range MM

### Shortened Range

C - -10% 33% decrease in range MM

## ARMOR

Name Avail. Cost Spaces Description Source

### Composite Armor

R 400% b 0 +25% SP, 1/2 shaped charges MM

### IR Baffling

P 10%-25% b 0 Reduces IR signature MM

### Reactive Armor

P 1% b 0 2-10 =1/2 penetration MM

### Stealth

R 1,000% b 1/8 Absorbs radar MM

### Puncture-proof Tires

P 1 SDP 0 1/2 vehicles SDP and SP Chr3

### Bulletproof Glass

C 200/side 0 SP15 Chr3

## ENVIRONMENT

Name Avail. Cost Spaces Description Source

### Amphibious Modification

P 50% b 2 Floats at 1/10th speed MM

### Crash Control Systems

E 250/person 0 SP40 vs collision MM

### Damage Control

P 100% 1/10 6-10 system undamaged MM

### Ejection Seats

C 1000/seat 0 100m MM

### Ejection Seat w/o chute

C 750/seat 0 100m MM

### Civilian Environment Cont.

E 500 0 Controls heat, humidity, but no filters or gas protection SOF2

## Environment Control

E 2500 1 Air tight plus filtration MM

### Fire Extinguisher

C 500 1 Prevents vehicle catching on fire MM

### External Foam Cannon

C 1000 2 30 shots, 50m range MM

### External Water Cannon

C 750 5 30 shots, 50m range, BOD 15+ to stand MM

### Life Support System

C 500 1 4 man hours, air and water tight MM

### Wet Bar

E 500 1 MM

### Fold-Down Bed

E 250 1 2 people, 1/2 space +100 eb per person MM

### Jacuzzi

E 2,500 3 Holds 2 people MM

### Seat Massager

E 200 0 MM

### Mini-Galley

E 1,000 2 MM

### Toilet

E 500 1 Chr4

### Shower

E 500 2 Chr4

## COMMUNICATIONS

Name Avail. Cost Spaces Description Source

### Cellular Phone

E 500 0 Regular cellphone with longer range (20km) MM

### Laser Communicator

P 7,000 0 Line of sight untappable communication MM

### Radio

E 200 0 80km MM

### Long Range Radio

E 1,000 0 500km MM

### Military Radio

P 2,500 0 500km, only jammed on a 1D10 roll of 4-10 MM

### Satellite Uplink

C 5,000 1 Can uplink directly to a comms satellite MM

### Scrambler

C 500 0 Allows coded communication MM

### Computer Decoder

P 500 0 Provides scrambler combination 20% of time MM

### Loudspeaker

E 250 0 Mounted externally, 5 SDP SOF2

### Armored Loudspeaker

E 400 0 Mounted externally, 20 SDP SOF2

## ELECTRONICS

Name Avail. Cost Spaces Description Source

### "AI" Robotic Control

R 1,000,000 1 1D10+15+Modifiers MM

### Auto-Pilot

C 250 0 Drive/Pilot roll 1D10+5 MM

### Cybernetic Linkage

C 40% total 0 +2 to control and combat rolls, -1 per extra action MM

### ECM 100m

P 500,000 1 Jams civilian radar and radio automatically, for... MM

### ECM 500m

P 1,000,000 1 ...Military radar and radio roll 1D10/turn,  
 4-10: jammed MM  
 ECM 1,000m  
 R 2,000,000 2 Also jams radar-guided missiles, +15  
 difficulty to hit MM  
 ECM 10,000m  
 R 5,000,000 5 MM  
 ECM 100km  
 R 15 million 10 MM  
 ECM 250km  
 R 50 million 20 MM  
 ECCM  
 P 100,000 1 Roll 1D10, 4-10: punches thru jamming MM  
 Stereo/Entertain System  
 E 500 0 Good stereo MM  
 Stereo Plus  
 E 1000 0 Audiophile's dream MM  
 Video Player & Screen  
 E +150 0 MM  
 Hologram  
 E +750 0 MM  
 VR Hologram  
 E 10,000 1 'Changes' the inside of the vehicle MM  
 Civilian Navigation Sys  
 C 250 0 80% accurate in "uncivilized" off-road areas  
 Chr3  
 Military Navigation Sys  
 C 1,000 0 Nav computer and satellite uplink MM  
 Simple Security System  
 E 200 0 1m-touch, siren/remote beeper. (15+  
 Elec.Security) MM  
 Shocker Security System  
 E 500 1 Plus stun to 6D6 shock damage. (20/25+  
 Elec.Security) MM  
 Shooter Security System  
 P 1000 0 Attacks with vehicle weaponry (20+  
 Elec.Security) MM  
 Searchlight  
 C 300 0 External searchlight. Small target, 5SDP. 200m  
 MM  
 Armored Searchlight  
 C 500 0 External searchlight. 10SP and 10SDP. 200m  
 MM  
 Halogen Headlights  
 C 150 0 Same effect as spots except mounted straight  
 forward MM  
 Mini-Comp  
 E 1000 0 Equal to EBM "PCX" w/30 MU Chr3  
 External Vidcam  
 P 500 0 Wide-angle video camera. 245 hours of  
 recording Chr3  
 Winch System  
 C 1500 1 100m cable and winch that can pull up to 15  
 tons, 30SDP Chr3  
 Chute  
 P 2000 1 Deceleration of 75mph. Skill roll of 15+ to  
 control Chr3  
 Ram  
 P 1000 1 Adds one point of Penetration to ramming  
 attacks Chr3  
 Homing Beacon/Tracer  
 P 500 0 5km. Jammed by ECM, roll 1D10/turn 3-10  
 signal lost Chr3

## SENSORS / DETECTORS

Name Avail. Cost Spaces Description Source  
 Image Enhancement  
 C 2500 0 +2 Awareness/Notice MM  
 Infra-Red Sensors  
 C 1000 0 Treat as Thermograph at -3 MM  
 Active IR Sensors  
 C 1500 0 Includes IR spotlight and headlights MM  
 Laser Detector  
 P 1000 0 Detect lasers 90% of the time MM  
 Light Amplification  
 C 500 0 Negates darkness modifiers and polarizing  
 dampers MM  
 Magnetometer  
 P 3,000 1 Detects large masses of metal within 200m  
 MM  
 Microwave Detector  
 P 5,000 0 Detects focused microwaves 90% of the time  
 MM  
 Radar  
 C 1,000 0 10km range MM  
 Military Radar  
 P 10,000 0 50km range MM  
 Look-Down Radar  
 R 10,000 0 Detects aircraft less than 200m above the  
 ground MM  
 Radar ID  
 R 100,000 0 After 2 turns computer identifies target MM  
 Terrain-Following Radar  
 C 1000 0 Allows detection of obstacles in darkness/by  
 autopilot MM  
 Radar Detector  
 E 50 0 Detects civilian 90%, military 10%. 150% radar  
 range MM  
 Military Radar Detector  
 P 5,000 0 Detects civilian 100%, military 50% MM  
 Sonics  
 P 2,000 1 50m (500m underwater). Listen to  
 conversations at 200m MM  
 Telescopic Optics  
 C 500 0 Televisual scanning at -1 Awareness/800m MM  
 Thermal Imaging  
 P 2,000 0 Negate darkness penalties. See through walls  
 at 10m MM  
 Gas Spectrometer  
 R 1000 0 Identifies airborne chemicals, Chemistry +5  
 Chr3  
 Radiation Detector  
 P 250 0 95% reliability, 25m range Chr3

## COUNTERMEASURES DISPENSERS

Name Avail. Cost Spaces Description Source  
 Anti-Laser Aerosol  
 P 1,000 1 30 uses (100eb), works 90% of the time MM  
 Chaff  
 P 1,000 1 20 uses (250eb), works 70% vs radar-guided  
 MM  
 Flares  
 P 1,000 1 20 uses (100eb), MM  
 Smoke  
 C 500 1 30 uses (10/300eb), -3 to hit MM  
 Smoke Launchers  
 C 250 0 1 use (25/300eb), 50-100m range MM

## ACTIVE COUNTERMEASURES

Name Avail. Cost Spaces Description Source

### Active Gatling AMS

R 30,000 1 Detects with radar 90%, 4-10 missile destroyed MM

### Active Galting AMS

R 35,000 1 Detects with sonar and radar MM

### Active Explosive AMS

R 15,000 0 Detects 90%, destroys 90%, 5D6 over 4m MM

### Anti-Personnel Charges

P 1,000 0 20 fragmetation grenades MM

## FIRE CONTROL

Name Avail. Cost Spaces Description Source

### Autoloader

C 50% gun 1/4 gun A robotic autoloader reduces gun crew to 1 MM

### Computer Sights +1

C 2,500 0 Must be installed on separate weapons MM

### Computer Sights +2

C 5,000 0 MM

### Computer Sights +3

P 10,000 0 MM

### Computer Sights +4

P 15,000 0 MM

### Computer Sights +5

P 25,000 0 MM

### Weapon Stabilization

P 50% gun +50% +2 to hit when in motion MM

### Visual Rangefinder

C 3,000 0 +1 to hit with all weapons except missiles MM

### Radar Rangefinder

P 10,000 0 +2 to hit with all weapons except missiles MM

### Laser Rangefinder

P 12,000 0 +2 to hit with all weapons except missiles MM

### Microwave Rangefinder

P 15,000 0 +2 to hit with all weapons except missiles MM

### Multi-target

P 50,000 0 Can fire radar or active missiles at 10 targets MM

### Remote Targeting

P 1200 0 Real-time link for use with a forward observer MM

### Robotic Weapons

Control P 25,000 0 1D10+10+WA MM

### Firing Port

C 100 0 Anything upto a LMG, -3 WA. -4 to hit port. MM

## PERSONAL GEAR

Name Avail. Cost Spaces Description Source

### Artillery Computer

P 1,500 0 +10 to Artillery attacks MM

### Personal Painting Laser

P 1,000 0 Guides laser seeking missiles MM

## WEAPON MOUNTS

Name Avail. Cost Spaces Description Source

### Jury-rigged Mount

E - 100% 1 space weapon maximum, WA -2, one direction, exposed MM

### Pintle Mount

C 500 0 1 space max, full WA, traverse limited to room, exposed MM

### Fixed Mount

P 10% 100% Any size weapon, WA -1, one direction, behind armour MM

### Articulated Mount

P 25% 0 2 spaces max, full WA, fire from one side, behind armour MM

### Open Mount - 1 direction

P 5% 10% WA -1, exposed, penetration in 10 chance of being damaged MM

### Open Mount - rotate

P 50% 10% Full WA, exposed, chance of being damaged as above MM

### Turret

P 100% 50% Full WA, can mount 1/3 rd of vehicle spaces in weapons, etc MM

### High-Angle Traverse

P 100% 0 Modifies turret/rotating open mount so they can shoot upward MM

## DEFENSE SYSTEMS

Name Avail. Cost Spaces Description Source

### Oil Slick Generator

C 300 0 +20 driving difficulty I1.3

### Caltrop Thrower

C 150 0 1d6 damage I1.3

### Bomber Hawk

R 500 1 10 mini grenades, 2d6 damage area I1.3

### Kamikaze Bomb Hawk

R 500 2 8d6 damage area, +3 to hit I1.3

### Vehicle Color Change

P 350 0 I1.3

### Neuraweave Seat Covers

C 150 0 As taser I1.3

### Gas Jets

C 100 0 Fills passenger compartment or whole vehicle with gas I1.3

### Bulletproof Seals

C 350 0 SP15 screen between passengers and driver I1.3

### Auto-Return

C 250 0 Vehicle returns if driver reaches Mortal, Diff 25 to override I1.3

### Auto-Weapons

C 350 0 Vehicle systems shut down if driver dies, Diff 30 to override I1.3

## MILITARY EQUIPMENT

Portable Laser Rangefinder ..... 500eb

Laser Designator and DMD (5kg)..... 900eb

Fire Control Net ..... 10,000eb

Gyro Mount ..... 250eb

Portable Painting Laser ..... 1000eb

Artillery Computer ..... 1500eb

Power Exo-Mount..... 5000eb

## LEGEND

### CYBERPUNK 2013 & 2020 BOOKS Code No

**CP13** Cyberpunk 2013 CP3001  
**CP20** Cyberpunk 2020 CP3002  
**BH** Blackhand's Street Weapons CP3461  
**Chr1** Chromebook 1 CP3701  
**Chr2** Chromebook 2 CP3181  
**Chr3** Chromebook 3 CP3331  
**Chr4** Chromebook 4 CP3471  
**CB1** Corpbook 1 CP3111  
**CB2** Corpbook 2 CP3151  
**CB3** Corpbook 3 CP3161  
**DS** Deep Space CP3211  
**NO** Near Orbit CP3301  
**ER** Edgerunners Inc. CP3391  
**ES** Eurosource CP3901  
**ES+** Eurosource Plus CP3421  
**SF** Firestorm: Stormfront CP3481  
**SW** Firestorm: Shockwave RT03491  
**HoB** Home of the Brave CP3221  
**LU** Listen Up Primitive Screwheads CP3291  
**LD** Live & Direct CP3431  
**MM** Maximum Metal CP3191  
**NEO** Neo Tribes CP3371  
**NC** Night City CP3501  
**PAC** Pacific Rim CP3311  
**P&S** Protect and Serve CP3171  
**BB R** Bartmoss' Brainware Blowout CP3521  
**NET** Rache Bartmoss' Guide To The Net CP3241  
**RB** Rockerboy CP3401  
**UK** Rough Guide to the U.K. CP3281  
**SOF** Solo of Fortune CP 3101  
**SOF2** Solo of Fortune 2 CP3361  
**WS** Wildside CP3271  
**ET** Euro Tour (c) CP3131  
**LoF** Land of the Free (c) CP 3231  
**FH** Tales from the Forlorn Hope (c) CP3121  
**WCD** When the Chips are Down (a) CP3801  
**HW** Hard Wired (w) CP3201  
**WGF** When Gravity Fails (w) CP3601

### ATLAS GAMES SUPPLEMENTS Code No

**AB** The Arasaka Brainworm (a) AG5000  
**AFD** All Fall Down (a) AG5040  
**BON** The Bonin Horse (a) AG5050  
**TCB** The Chrome Berets (c) AG5025  
**CF** Cabin Fever (a) AG5065  
**CD** Chasing The Dragon (a) AG5035  
**GW** Greenwar (a) AG5055  
**NCS** Night City Stories (c) AG5005  
**NWP** Northwest Passage (a) AG5070  
**OC** The Osiris Chip (a) AG5010  
**STF** Street Fighting (a) AG5020  
**TTB** Thicker than Blood (a) AG5045

### WEST END GAMES SUPPLEMENTS Code No

**ATM** Alice Through The Mirrorshades (a) 12017

### IANUS SUPPLEMENTS Code No

**DM** Dark Metropolis (w) ICP116  
**GCT** Grimm's Cybertales (w) ICP110  
**NE** Night's Edge (w) ICP101  
**CP** Crash Point (a) ICP112  
**HF** Home Front (a) ICP119  
**KOCJ** King Of The Concrete Jungle (a) ICP106  
**MJ1-2** Media Junkie 1-2 (a, c) ICP107,14  
**N1-3** Necrology 1-3 (a, c) ICP102,4,5  
**PG** Playground (a) ICP115  
**PB** Premature Burial (a) ICP117  
**RM** Remember Me (a) ICP118  
**SA** Sub Attica (c) ICP120  
**SUR** Survival Of The Fittest (a) ICP103

### CYBERGENERATION Code No

**CGen** Cybergeneration 1st Ed. CP3251  
**Eco** EcoFront CP3341  
**Med** MediaFront CP3351  
**Vir** VirtualFront CP3441  
**BDay** Bastille Day (a) CP3261

### MAGAZINES, NETBOOKS, ETC

**I1.1 to I2.2** Interface. Vol 1 # 1-4, Vol 2 # 1-2  
**P1 to P3** Punk '21. # 1, 2, and 3 (UK)  
**RPI** Role Player Independent, July (UK)

### KEY

**(a)** Adventure  
**(c)** Campaign  
**(w)** Alternate World Book

(All vehicles created by R. Talsorian games and their respected authors. Vehicle List Compiled by Node 16, images compiled by Deric Bernier. Images by Deric Bernier, R. Talsorian Games, KingBouyah, Vulne Pro, Power Rangers, Laser Tag, Glitchwerk, Duelisto, Codi\_t, Crisis, Gears Of War, Halo, Ghost Recon, Torvenius, Nuclear Dawn, OutfoxedTW, Killzone, GI Joe, Praetoris, Gundam, Macross, Flyingdebris, Malaveldt, Tetra Vaal, Akira, Mospeada, Render422, RyujinDX, Lynx2174, sharp\_n\_pointy, farhatali, SpiderPrince, Anthony Colard, and other various Manga, Anime, Comic Book, Video Game, Film, Artists, and RPG sources. )

For more of the best Cyberpunk 2020 goodness available, go to

# DATAFORTRESS 2.0.2.0

<http://datafortress2020.110mb.com/>

