

NIGHT CITY



A CITY SOURCEBOOK FOR

CYBERPUNK[®]

**R. TALSORIAN
GAMES, INC.**

NIGHT CITY

CITY SOURCEBOOK FOR CYBERPUNK®



R. TALSORIAN
GAMES, INC.

CYBERPUNK®

INTRODUCTION

Night City. Awwwwoooo.

I think we put as much work into this project as we did the original *Cyberpunk 2020* game. It started two years ago as a simple idea: take a dark-future city and dissect it, block by block, function by function, in a way that had never been done before. Call it the NIGHT CITY SOURCEBOOK.

This isn't just a list of buildings thrown down on a page; Night City is the result of a long and evolved city-building process. Buildings are placed with their own internal logic, then illustrated with 3D (actually orthographic) maps that are indexed to show not only what a place looks like, but the layout of surrounding buildings and even where the dataterms and other utilities are.

The NIGHT CITY SOURCEBOOK is also usable: no more hunting around for something buried on a back page somewhere. Instead, start at the **Dataterm** section on the next page, just like you were using a real database. Pick the general topic and jump to the flagged page. If you want to know even more about the subject, or about a related topic, there are all kinds of sub-references right there on the page where you need them (in fact, in my games, when a player wants to use a dataterm, I just hand them this book and say "look it up yourself; don't forget to pay your eurobuck use-fee." You may want to do this yourself and save a lot of extra Ref work).

Need to find a hot club? Check out the **Flashmaps**—minimaps that tell you the locations of what your players need to know fast—then tell them where to go for a closer look. Want the lowdown on a specific area? Check out the **Personalities, Contacts and Encounters** sections at the end of each **Neighborhood** section. What's doing on in the **America of 2020**? There's an entire breakdown, plus articles on the **People of the City, Gangs, Security**; even a little **Night City History**.

So what are ya waiting for? Pick this up right now and start using it! Because it's midnight in America, and the mean streets of the City are there for you.

—Mike Pondsmith

To William Gibson for giving us something fun to do, and to Raymond Chandler, without whom there wouldn't be any "mean streets" at all.

Night City Sourcebook
ISBN #0-937-279-11-0
Product #CP 3501

CONTENTS

Dataterm Intro	03
Night City Overview Map	04-05
Fax on File™	06
America 2020	29
A Brief History of Night City	33
People of Night City	35
Threat Levels, Codes & Security	40
Gangs of Night City	42
Flashmaps	13
Night City Controlled Urban Zones	56
Dataterm Utilities	182

CREDITS

WRITERS

Mike Pondsmith
 Ed Bolme
 Sam Shirley
 Anders Swensen
 Colin Fisk
 Will Moss
 John Smith
 Mike Mac Donald
 Lisa Pondsmith

ARTISTS

Chris Hockabout
 Mike Jackson
Interior Graphics: Phil "Nacho" Hernandez
 Ted Talsorian
Cover: © 1991 Doug Anderson
Cover Graphics: Matt Anacleto
Map: TK Scott

LAYOUT & PRODUCTION

Art Director: Matt Anacleto
Page Design: Mike Pondsmith & Ted Talsorian

EDITING

Editor in Chief: Derek Quintanar
Editor: Will Moss
Continuity Editor: Mike Mac Donald

R. TALSORIAN GAMES, INC.

Published by R.Talsorian Games Inc.
 P.O. Box 7356, Berkeley, CA. 94707.
 Copyright © 1991, by R.Talsorian Games, Inc.
Cyberpunk®, *Chromebook*™, *Netrunner*™, and *Night City*™ are trademarks of R.Talsorian Games, Inc. All Rights Reserved under the Universal Copyright Code. All situations, governments and people herein are fictional. Any similarities portrayed herein without satiric intent are strictly coincidental.

WELCOME TO YOUR DATATERM

A Dataterm is a public information access module and computer. Placed in heavily armored cases on most U.S. city street corners, they are linked by fiberoptic landlines to centrally located computer databases. Dataterms provide news, information, weather reports, entertainment news, Net cyberaccess ports and computer terminal use (by the minute). They are the corner market of the future, serving information (rather than produce), to the busy world of the Street.

This Dataterm section is designed to simulate in hardcopy form the role of a Dataterm in a Cyberpunk® game. For starters, it allows players to quickly access the rest of this book. It also allows players to engage in "research" into the type of information they may need during game play, by putting the most commonly known facts at their fingertips. Lastly, some sections are direct access keys, providing maps and layout of important areas in Night City itself.

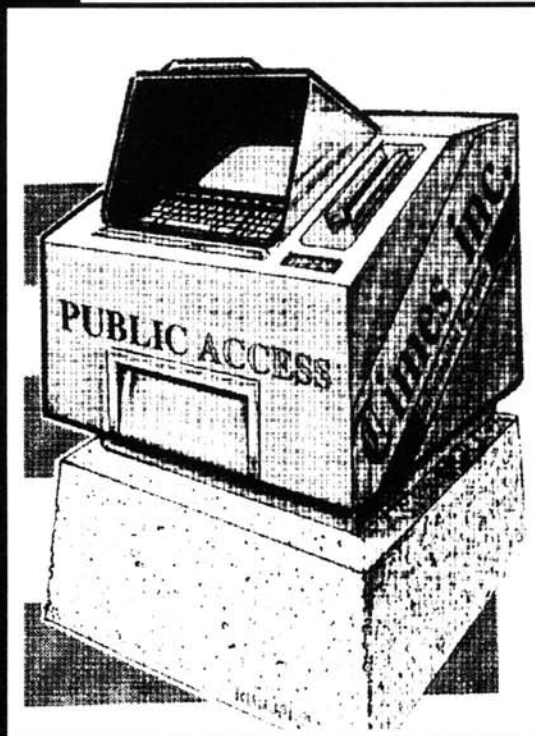

INSTRUCTIONS

- 1 The Dataterm Master Entry (see margin) will send you to a particular category and page screen.

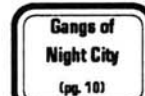

- 2 Within each Master Page screen, there will be Topic Dialogue boxes.

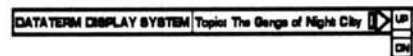

- 3 Some Topic dialogue boxes direct you to related topics.



MASTER ENTRY INDEX

Fax on
File™
(pg. 08)

America
in 2020
(pg. 28)

History of
Night City
(pg. 33)

People of
Night City
(pg. 35)

Threat &
Security
(pg. 40)

Gangs of
Night City
(pg. 42)

Flashmaps
(pg. 13)

Controlled
Urban Zones
(pg. 58)

Phone Access
(pg. 162)

Net Access
(pg. 163)

Message Mail
(pg. 164)

NIGHT CITY

DATATERM



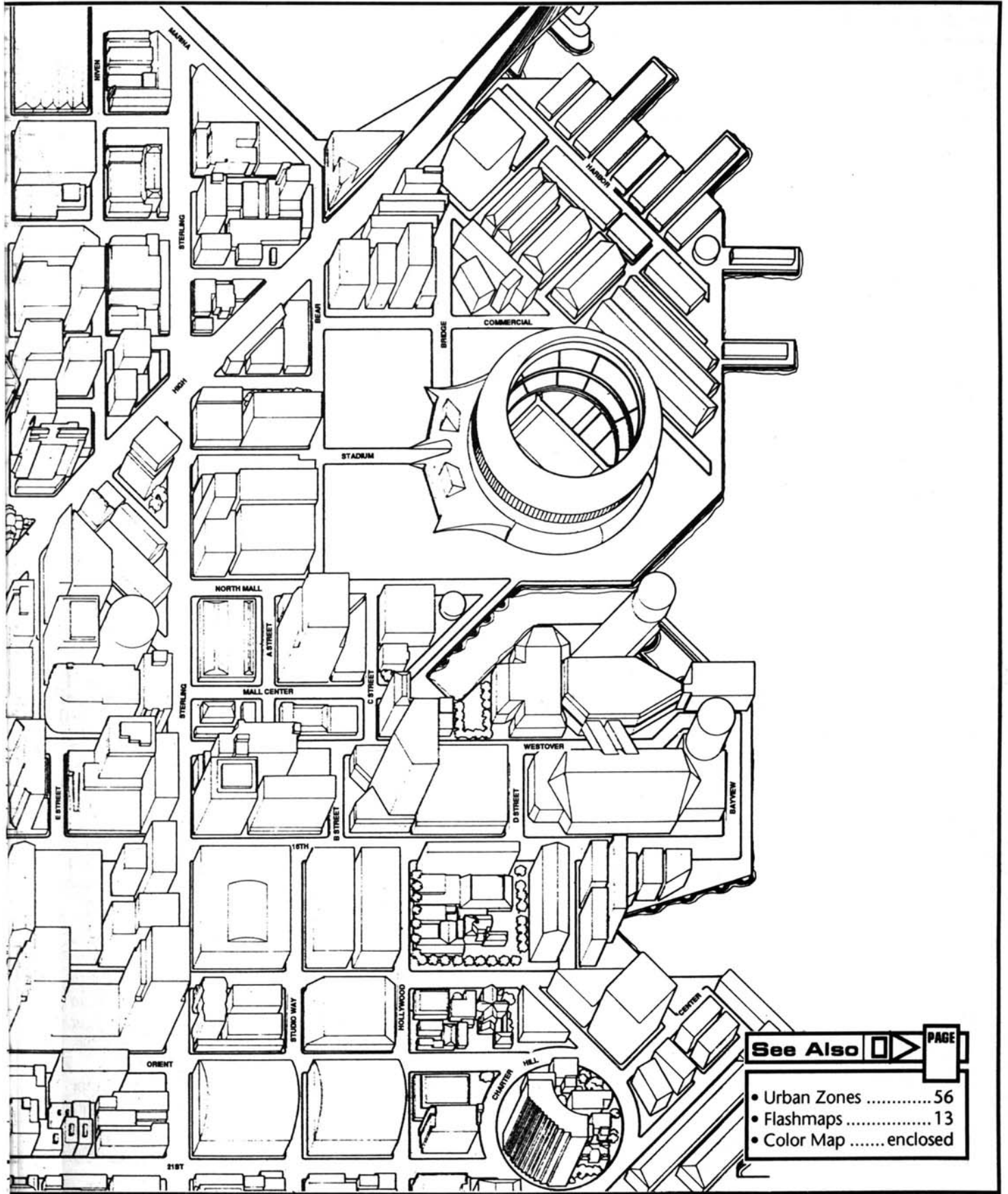

See Also  **PAGE**

- Urban Zones 56
- Flashmaps 13
- Color Map enclosed

FAX ON FILE™

DATATERM DISPLAY SYSTEM

Topic: General Background



UP

DN



NIGHT CITY
Founded 1994
Population: 5,000,000

Government: New City Democratic Mayorality, with corporate-controlled city council. Popular votes are cast via dataterm, using IdentiCard registration software. The city council is made up of representatives chosen by the ten largest (in terms of per capita taxes paid) megacorporations with offices in the City.

Businesses: Technical, light industry, international trade, information services, electronic technologies.

Background: A planned urban community founded in 1994 by the late entrepreneur Richard Alix Night (1954-1998). Established at the head of Del Coronado Bay (dredged to current capacity in 1999), and facing the Pacific Ocean to the west, Night City is a modern city of the twenty-first century. Its wide streets and ultra-modern towers are home to over a million people, with another four-and-a-half million living in the greater Night City area cities of Westbrook, North Oak, Heywood, Pacifica, South Night City and Rancho Coronado.

An exciting and vibrant place to live, Night City is even more fun to visit; world famous for its slogan "The City on the Edge of Tommorrow," the area hosts almost nine million tourists, conventioners and corporate travellers every year. A planned community with an advanced rapid transit system, its own Net LDL, and a Corporate Center boasting representatives from over a dozen of the world's most powerful megacorps, Night City is a shining example of Technology Triumphant over the Troubles of the Past.

See Also **PAGE**

- Night City History 33
- City Center 68
- Personalities (Mayor, Asst. Mayor) 73

DATATERM DISPLAY SYSTEM

Topic: Location



UP

DN

See Also **PAGE**

- America 2020 29
- California 2020 13

Night City is located on the central coast of the western United States. As negotiated in the Northern Separation Treaty of 2012, Night City is considered to be part of the Free State of Northern California; however, access is guaranteed to travellers from the Free State of Allied Southern California.

DATATERM DISPLAY SYSTEM

Topic: Weather



UP

DN

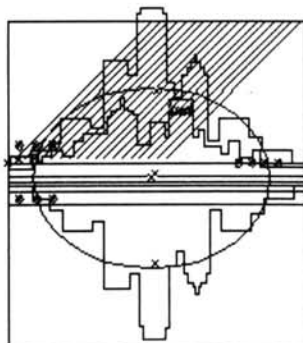

Night City's temperate Northern California location gives it one of the most pleasant climates in the western United States. Normal temperature ranges are in the mid 80's to low 50's, with misty white fog blanketing the City in the early mornings and evenings. Rainfall is usually about 21 inches per year. Of this, only an average 35% contains an acid/toxicity factor higher than current government standards for U.S.-produced clothing and vehicles. In general, if your vehicle and clothing are rated above SP 12, adverse effects (staining, ablation) will be negligible.

When visiting Night City, you should wear light to medium weight clothing, with a light armor jacket or ballistic-cloth overcoat optional. A filter mask and supplemental oxygen are highly recommended as a hedge against inversion smogs and acid rain fog. However, acid-proof slickers, umbrellas and airmasks are readily available from sidewalk vendors during smog warning periods at moderate (20-35eb) costs.

DATATERM DISPLAY SYSTEM

Topic: **Services**



UP

DN

The following services are available through any Net Access Node, videophone link or dataterm access: **Alcoholics Anonymous** (555-DRNK), **Wire Heads Anonymous** (WYR-HEAD), **Dorphers Hospice** (555-DRUG) and **Emergency Services** (555-3458). For further information about local dataterms, contact your local Net Information Node, or access the **Dataterm Section** of this hardcopy for details.

See Also



PAGE

- Net Access..... 183

DATATERM DISPLAY SYSTEM

Topic: **Location**



UP

DN

For the casual visitor or business traveller, there are a number of ways to reach the Night City Area. By air, rail, or ground, Night City is a major hub of international commerce.

Aircraft:

Night City is home to Night City Metropolitan Airport, with connecting flights worldwide. Direct connections with San Francisco leave at 4am, 6am, 1pm, 8pm, 9pm and 10pm; flights to and from Allied SoCal and Los Angeles Metroplex are scheduled at 6am, 12pm, 6pm and 12am, weather and airpirate intercepts permitting. Suborbital flights to the Johnson Space Platform may be booked via Los Angeles International for connection with the Mojave Orbital Air Facility. Security on all flights is at the passenger's own risk; bring low-velocity rounds and plan accordingly.



NIGHT • CITY
METROPOLITAN
AIRPORT

Dirigible:

Night City International is also a terminal for Pan-Pacific Airway's new Phoenix-class aero-zeps. These floating leviathans offer comfort and security unavailable on jet aircraft or aerodynes, with luxuriously appointed staterooms, grand dining rooms and recreational facilities. Security is tight (expect a full cybertech and weapon lockdown), and crews are extremely capable, making this second only to private jet as the choice of the corporate elite. Flights leave once a week for Hawaii, Tokyo, Washington and New York.

See Also



PAGE

- Night City Metro Airport Flashmap 15
- California 2020 13

MagLev:

Night city is also an end terminus for the transcontinental Planetran® maglev tunnel. Daily maglev trains enter the City at 6 am and 12am, leaving at 12pm and 6pm, with connections to Kansas City, St Louis, Atlanta and Washington D.C. Maglev travel is relatively safe and reliable; improved screening and weapon security has reduced terrorist actions by over 96%; by comparison, aircraft incidents (particularly involving airpiracy) have increased by 18% in the last eighteen months.



PLANETRAN

Water:

Although Night City maintains a modern port facility in San Morro Bay, most of this traffic is in cargo-container ships and hovercraft; passenger ships are almost unheard of. There are facilities for private cargo ships and yachts in the Marina District; contact the Harbormaster's Office for slip information and mooring fees. **Traveller's Advisory:** It is wise to contact the Harbormaster's office before docking; a recent rash of gunrunning has forced the Night City Harbor Police to employ stringent measures in an attempt to control smuggling traffic.

See Also



PAGE

- Night City Transit Building 17
- MaglevMap 19-20



Ground:

Night City is on Interstate Highway 828, which runs southeast to connect with Interstate Highway 5, the major north/south artery of both Californias (Highways 1 and 101 were destroyed in the Northern Separation War of 2011). As a rule, Interstate 828 is open to free transit by civilian vehicles; airpatrols based out of the NorCal Highway Rangers Fortress Compound in Gilroy have reduced the marauding Nomad population to half its 2013 strength. I-5 North is usually clear; Ranger patrols against illegal immigration from SoCal make regular sweeps. Travel on I-5 South is chancy at best;

See Also



PAGE

- East Marina 86
- Ferry/Marina Map 16

See Also [] [] [] **PAGE**

- California 2020 13
- Freeway Flashmap 14

check your Travel Advisory warnings on the Net for details on Nomad movements and attacks by terrorist groups. Carrying sufficient euro for "licence fees" and "transit taxes" to SoCal border inspectors is highly advised; but make sure it's on electronic media, not in cash. Travellers with AAA coverage be advised: NorCal Triple A requires policy holders to armor vehicles to an SP of 30 and carry weapons of at least light assault rifle class before they will send a Road Team to assist disabled vehicles.

DATATERM DISPLAY SYSTEM **Topic: Driving Vehicles** [] [] [] **UP**
DN



See Also [] [] [] **PAGE**

- Freeway Flashmap 14
- Public Services 25

If You're Driving: Traffic Regulations & Agencies

Motor Vehicles Department: Unlike many free states or urban megaplexes, the Free State of Northern California maintains a government-run agency to help drivers with licencing and registration of all vehicles. Registration of out-of-state vehicles (including groundcars, fixed wings, aerodynes, aerogyros and dirigible aircraft) is by appointment only (Monday thru Friday, 9-5). All vehicles within the Free State must be registered within 90 days of entry. There is a \$1000eb mandatory licencing fee for all groundcars; 2200eb for all aerodyne, aerogyros and dirigibles. The Night City DMV is located at 346 High Street.

Drivers Licences:

You must possess a valid driver's licence for the class of vehicle you intend to drive. Valid visitor licences include any and all licences from western nations currently part of the Sino-Euro-American Treaty of 2016 (with the exception of Latvia, Kampuchea and the People's Republic of Hong Kong); a valid licence authorizes the driver to operate a vehicle of the specified class for up to six months. The Free State of NorCal will issue a licence to any Class 1-A immigrant (proof of employment and residence required) upon completion of a State-mandated Driving Test for the vehicle class. The test is rated as a DIFFICULT task. There is a \$100eb nonrefundable licencing fee for each licence applied for. Licences must be updated every four years.

Traffic Regulations:

As a signatory of the Free State of NorCal's Uniform Vehicle Code, Night City observes all NCUVC traffic regulations. Download of the Traffic Code can be obtained by accessing InfoNet Code 251.1, from the NCUVC Net Node LDL/Night City, or in both hardcopy and video forms from any City dataterm. As a visitor to Night City, you are responsible for knowing and understanding all NCUVC regulations. As signatories to the NCUVC, the Night City Police (and deputized corporate security units), are empowered to use maximum force if necessary to uphold traffic regulations.

Curb Markings:

As in most modern cities, colored curbmarks and holographic signals are used to indicate free and controlled parking zones. **Red** indicates no stopping or parking, subject to tow away and subsequent dismantling or sale of the vehicle. **Yellow** indicates a half hour loading limit for vehicles with corporate plates. **Blue** indicates a reserved space for vehicles with NorCal issued Disabled holoplacards (**Travellers Advisory:** as of the Free Access/Handicapped Self Sufficiency Act of 2018, legitimate holoplacard owners may use weapons to clear illegally parked vehicles from a blue zone). **Green** markings indicate a ten minute limit for all vehicles except police. **Red and black** indicates no parking during a Free Fire Emergency only; a Free Fire Emergency is always designated by the strobing red and black holos mounted on adjacent structures. Vehicle parked in these areas may be subject to bulldozing, demolition or barricade use by Police and corporate units engaged in a declared Free Fire Emergency.

Towaway Zones:

The Night City Police Department (NCPD) takes parking infractions seriously, and



See Also [] [] [] **PAGE**

- Threat Levels (NCPD) 40
- Public Services
Flashmap 25



improperly parked vehicles will be subject to tow away. Improper parking fines range from 100-200eb, depending on the severity of the infraction, plus 200-300eb for towing fees. There are no storage fees; towed vehicles are stored by the Night City Towing Company for a 24 hour period, after which City Ordinance 27632.1990 permits the Tow Company to strip, sell or dismantle the impounded vehicle as desired. **Traveller's Advisory:** It is unwise to interfere with the legitimate impounding and removal of a vehicle; tow units are generally well armed and authorized to employ deadly force in the conduct of their lawful duties.

Parking:

Parking for groundcars is available in a number of underground City garages. Telephone for availability and rates; 5-8eb per hour is considered average.

Pad storage for aerodynes, helicopters, aerogyros and light dirigibles is available on the top floors of many of the buildings within the City. It is advisable to contact the specific pad owner for availability and landing rights; most buildings within the Center have been upgraded to automated Phalanx weapons systems and a pass code is required to avoid being fired upon. Pad Fees range from 100 to 150eb per day, depending on the owner.

If You're Parking on the Street, Lock Your Vehicle: There's only one way to rest easy with your vehicle parked on Night City streets—Full Urban Lockdown Mode. When leaving the vehicle, be certain to activate all passive movement sensors and active alarm modes. Make certain if using an active countermeasures defense system (such as light-plastic fragmentation grenades, Apex units or stun-chem sprays) that sufficient room is left between the system's free fire zone and other vehicles to permit other drivers to move about freely. Even the best ACM system can sometimes overreact; thus, this "courtesy" practice is law in Night City, and carries a \$1000eb fine and a mandatory 4 day jail sentence.

See Also	▶	PAGE
• Parking Flashmap 28		



DATATERM DISPLAY SYSTEM	Topic: Public Transportation	▶	UP
			DN

Night City Transit Corporation:

The Night City Transit Corporation (NCTC) is a city-managed public corporation providing bus services to the Greater Night City Area. Based in the new Night City Transit Center at 18th and Effinger, NCTC's bus fleet is considered to be one of the most modern in the United States, with over thirty Mercedes Urban Transporters in operation. In addition to their wide, spacious seats, holographic advertising display boards, and state of the art, computerized ticket processing units, each Transporter also boasts the highest armor protection (SP 36) available on a public transporter vehicle, a driver operated anti-personnel fragmentation belt around the suspension line, and cabin mounted sleepgas sprayers for the maximum in passenger protection. Buses stop every 20 to 30 minutes at each of the over 200 local "bus bunkers" throughout the NCTC system. Tickets are 1eb.

**NCART (Night City Area Rapid Transit):**

A city corporation with major funding from several corporate sources, NCART provides maglev rail service throughout the greater Night City Area, including Heywood, Westbrook, North Oak, Pacifica, South Night City and Rancho Coronado. As a mass transit system, NCART's record is quite good; in the period between 2019 and 2020, the corporation logged over a million travel miles with only eight major accidents, ten transit-related fatalities, and only eleven incidents of terrorist activities or other security breaches. Tickets are .25 eb per station travelled.



See Also	▶	PAGE
• NCART Flashmap 19		
• NCART City Stations 20		

Operating out of the substreet level of the Night City Transit Center, NCART trains stop an average of every 20 minutes at each of the 25 stations. Corporate-owned "suburban" trains also enter the Transit Center as well; connections can be made by entering through a corporate security gate and using your company-issued pass to gain access.

DATATERM DISPLAY SYSTEM

Topic: Location

UP

DN

REDCAB

Taxis:

Night City offers visitors a choice of three local taxi services. The largest is **Red Cab Inc.**, which has a fleet of well-maintained, well-armored urban groundcars. Red Cab units can be summoned by either dataterm or phone, and will usually arrive within five minutes.

Aerocab

Pad to Pad Service, 24 Hours a Day

AeroCab is Red Cab's main competition; most of its taxi force consists of reconditioned AV-4's, aerogyros and a few new AV-7 vehicles; the ground units are mostly used to take customers into areas where a flying vehicle would find landing too dangerous. AeroCab units can be called by phone, dataterm, or from most buildings in the Corporate Plaza.

Combat Cab

Only one taxi service operates in the Combat Zone: the now-famous **Combat Cab**® **Company**. Thanks to DMS's long running comedy-drama series, Combat Cab has become a household name throughout America; many people take CC rides into the Zone just to say they've done it. With some of the best battledrivers in the business, CC's taxi force is guaranteed to get you where you want to go, when you want to go there. As their slogan says, "And leave the combat to us..."

Ground taxi rates in Night City are generally around 3eb per mile; AV-taxi services are from 10 to 15 eb per mile, depending on destination. Taxis are available 24 hours a day.

Vehicle Rentals:

Two international corporate chains serve the vehicle rental market in Night City; **Honda-Avis** ("We're Still Number One"), and **Renta-Robo Inc.** Honda-Avis, a division of the popular Japanese automaking zaibatsu, specializes in its own brand of inexpensive, electric-driven Metrocars®; although unarmored, each holds two people and can travel up to four hours on a charge. HA charges a flat 100eb per day fee with no mileage fees. HA office are located at

See Also	PAGE
• Vehicle Rentals	22
• Taxi Services	22

Renta-ROBO

The AI-operated Renta-Robo® chain can be found in its familiar grey and white stations throughout the City. As in any RR outlet, a computerized vendor takes your debit card number, signs out a car, and uses its robotic driving mechanism to bring it from the central garage to the specific RR office. When the car is ready to be returned, simply press the red button in the dash; the AI will remote-read the vehicle's onboard recorder, debit the charges from your account, and autodrives the car back to the garage. While a bit more expensive, Renta-Robo® is the choice of most discerning Corporate visitors. Vehicles include most Euro-made luxury sedans, Japanese imports, and U.S.-Japanese hybrids. A Ford-Mazda Luxus rents for about 220eb per day; a Nissan Chrysler Omega about 150eb. Mileage rates (all Renta-Robo® vehicles are CHOOH2 powered), are .60eb per mile.

DATATERM DISPLAY SYSTEM

Topic: Hospitals

UP

DN



There are two public hospitals (City Medical Center and Crisis Medical) in Night City. Both are public operations in that you need not be a registered policy holder with their Health Maintenance Organization (HMO). There are four other private hospitals in the City, as well as many corporate-run clinics within the Corporate Plaza. As with most American cities of the 2000's, there are also a wide number of less formal medical services. Romantically nicknamed "ripperdocs" by the popular media, these mini-clinics provide emergency medical services, cyberwear installation, and drug prescriptions at reasonable prices (5-600eb for an average visit). In addition, offices of **TraumaTeam™** and **REO Meatwagon** are well established in the Night City area.

See Also	PAGE
• Public Services Flashmap	25

DATATERM DISPLAY SYSTEM

Topic: Police Services



UP

DN

Night City differs from many other American cities in that police services are not provided by a contract corporation. Instead, the City maintains its own independent police force (NCPD), with three precinct offices within the urban core area, while deputized corporate forces patrol the Corporate City Center. Although it suffers from a chronic lack of staff, the NCPD maintains order within the City through the ingenious use of monitor cameras and **Controlled Urban Zones**. Unlike the more obvious walled Zones of Detroit and Chicago, these Controlled Zones are kept relatively crime free through electronic security, aerial patrols with AV and aerogyro vehicles, and close contact with deputized security forces in the Corporate Zone. Unlike many other urban areas throughout the U.S., you may actually find any personal protection beyond a light caliber handgun unnecessary; Night City is *safe*.



Traveller's Advisory: As of May 12, 2020, it is inadvisable for visitors to the Night City area to enter the area designated the Combat Zone. Recent budgetary cutbacks have reduced NCPD presence in this area, and although regular "sweeps" are made to control the worst problems, the Mayor's Office cannot guarantee the complete safety of anyone entering the Zone at this time.

Police Department Callboxes:

We're sure your stay in Night City will be free of worries and cares. However, should a problem arise that involves the police, you'll find them easy to contact and ready to help you in any way possible. Inspired by the pictureque "call boxes" of the London Metroplex, the NCPD has erected access boxes on most (40%) streetcorners. Simply punch in 911, your Net Access Code (a one eb coin can be used as a substitute), and your location. An officer will soon be on the line to answer your call. It's as simple as that!

See Also

PAGE

- Public Services Flashmap 25
- Night City Gangs Turfmap 43

DATATERM DISPLAY SYSTEM

Topic: Personal Services



UP

DN

Liquor and Drugs

Local liquor outlets, FoodStores® and and corner VendMats™ sell prepackaged alcoholic beverages and nicotine sticks 24 hours a day. Most restaurants, bars and nightclubs are licenced to serve the full line of legal beverages, poppers, sniffers, crystals and brainstims during business hours, but some establishments' permits limit sales to beer and wine only. The legal age of indulgence is 18; IdentiCard proof (available at the Night City Justice Court or the DMV) is required.

Child Care

Child Creche: Offering child care at an affordable price, with cryotanks are inspected weekly by licenced, credentialed members of Trauma Team®. Choose from a wide variety of braindance tapes for your child's enjoyment, including *A Trip to Disneyland*, *Pirate Island*, *Mister Fuzzy's Neighborhood* and *Your Urban Ranger Adventure*. \$50eb per day. Child Creche is located at 144 8th St.

Safe Child: EuroTheatre-trained nannies and on-site child psychotechs provide an exciting play environment in a secure setting (24 hour Arasaka Security with on-call Tactical Squad support means you can rest easy knowing your child is in no danger of extraction or kidnapping). High quality Prepack meals standard; fresh available for a slightly higher price. \$350eb per day. Safe Child is located at 1242 High St.



Call Me! I'm Ready to Interface
With YOU!
VIRTUAL VICKIE ESCORTS
LDL 2543.9280

DATATERM DISPLAY SYSTEM

Topic: Financial Services



UP

DN

Banking:

As one of the major commercial markets of the Pacific Rim, Night City offers a wide variety of banking and financial services. For travellers from the Euro-Theatre, there is a branch of **Euro World Bank** located near the Corporate Plaza on 5th Street; this branch can handle all types of transactions including stocks, bonds, currency exchange and digital commodity trading.

See Also

PAGE

- Bank Block 110



For financial advice and brokerage services, visit the Corporate Center offices of **Merrill, Asukaga & Finch**, the world wide investment group. In addition to these worldwide financial giants, Night City boasts a number of local banking institutions, including the **First Bank of Night City**, **West City Bank Corp.**, the state-supported **Wells Bank-America** chain, and the Night City seat of the World Stock Exchange.

Unique to the NorCal area, Night City also has over a hundred Magic Wall™ instant-teller outlets throughout the downtown area (60% chance). These computerized cash machines can be used to deposit, withdraw or transfer money from any debit card account using the Magic Wall™ symbol.

DATATERM DISPLAY SYSTEM	Topic: Media	
--------------------------------	---------------------	--



TOP 10 RADIO

- 105.9 KZNT- Hi Power Rock
- 104.7 KKID- Top 40 rock.
- 99.2 KLIJ- News/radio drama (ala 30's and 40's)
- 101.1 KKIA- Hard rock
- 98.6 KHIV- New Wave, avant guard, just plain weird.
- 107.2 KCP2- Chromer Rock
- 88.2 KMPS- Syntho-pop
- 100.2 KLTV- Music, big star interviews.
- 89.4 KEDL- Hard Rock
- 109.8 KJBR- Pop Rock



TOP 10 VIDEO

- Ch 3- MTVV -All music videos
- Ch 6- NT54 -Network 54
- Ch 7- NHTV -Japanese
- Ch 8- EURO- EuroTheatre
- Ch 9- KNOL- public TV
- Ch 10- KOMB- combat sports programming)
- Ch 11- STV (Pay-per-view sex channel)
- Ch 12- KMIL (Militech Home Shopping Network)
- Ch 13- KSPY (All news network)
- Ch 14- KFLM (Late nite movies)

Broadcast Media:

As in any modern twenty-first century metroplex, the Media is everywhere in Night City. Videoboards are conveniently mounted on every available building face; their gigantic holographic displays and surround-sound systems broadcasting the news, sports, vidshows and advertising of a hundred channels. Advanced broadcast beacons float high in the night sky, receiving comsat, videoboard, and cellphone signals from all over the globe. Robot-controlled advertising blimps drift lazily over the City, their videoboards broadcasting the latest trends, fashions, fads and facts. No matter where you're headed, you'll never be out of touch in Night City!

Night City accesses over one hundred and ninety-eight major video/audio broadcast stations. Most of these stations are licenced and accredited by the State Communications Commission (SCC) for broadcast in the Night City Area, and provide news, information, weather and entertainment from a variety of Corporate sponsors. In addition to these Corporate affiliate stations, both NET 54 and World New Service maintain extensive service bureaus in the City. Based on recent ratings sweeps during the 2019-2020 advertising period, the top ten stations in the Night City Area are listed in the sidetext of the page screen.

Although not officially sanctioned, there are almost two hundred other unauthorized or "pirate" video operations in the Night City Area. Most of these are run by unscrupulous agitprops and media-hype artists, who are usually tracked down by SCC Security Inspectors after a few days of operation. However, a number of the most notorious "video pirates" have maintained their on-air presence for many years, including the Full Metal Network (FMN), MAX-TECHNO, and the Classic Pomo Movie Channel (CPMC).

Digital Media:

Night City has two main sources for digital information and faxpress, regularly updated at 6:00 am, 12:00pm, 5:00pm and 10:00pm. The most popular of these is NIGHT CITY TODAY. Known for its timely reporting, insightful commentary, and world-famous columnists like Gary Stafford (THE REAL STORY), Alexis Tong (THE FIFTH COLUMN) and Walter Pickering (NIGHT CITY STREETS), NIGHT CITY TODAY is available at all corner data vendors throughout the City for .01 eb per page.

Night City's other "screamsheet", FACE THE FAX, is less a well known, but equally intriguing underground publication. Considered to be the "real" screamsheet of Night City, it is an eclectic blend of gossip, investigative reporting, political commentary and radical agitprop. Its readership is primarily made up of Edgerunners, Movers and other streetmart cybernauts looking for a paper with its jacks plugged directly into the Edge. FACE THE FAX is available at corner data vendors; there is also a Net Access bulletin board (CDL 762-1982-1762) for trading stories and swapping information.

FLASHMAPS

DATATERM DISPLAY SYSTEM Topic: California in 2020

UP
DN



NORTHERN CALIFORNIA

ECOTOPIA FREE STATE

Capitol: Sacramento.

Status: Free State in 2002. Separated from Southern California in 2012.

Major Cities: Sacramento, Tahoe, Stockton, San Francisco, Eureka, Oakland, Monterey, Santa Cruz, San Jose, Night City.

Industries: Electronics, light industry, financial markets, software, cybertech, bioengineering tech, logging, rice, water, food crops, wine.

SOUTHERN CALIFORNIA

MEGALOPOLIS FREE STATE

Capitol: San Diego.

Status: Free State in 2002.

Major Cities: Los Angeles Metroplex, San Luis Obispo, Santa Barbara†, Bakersfield, San Diego

† now a suburb of LA

Industries: Moderate to heavy industry, military hardware, food crops, entertainment, oil drilling/processing, chemical production.

DATATERM DISPLAY SYSTEM | Topic: Night City Area Freeways

UP

DN

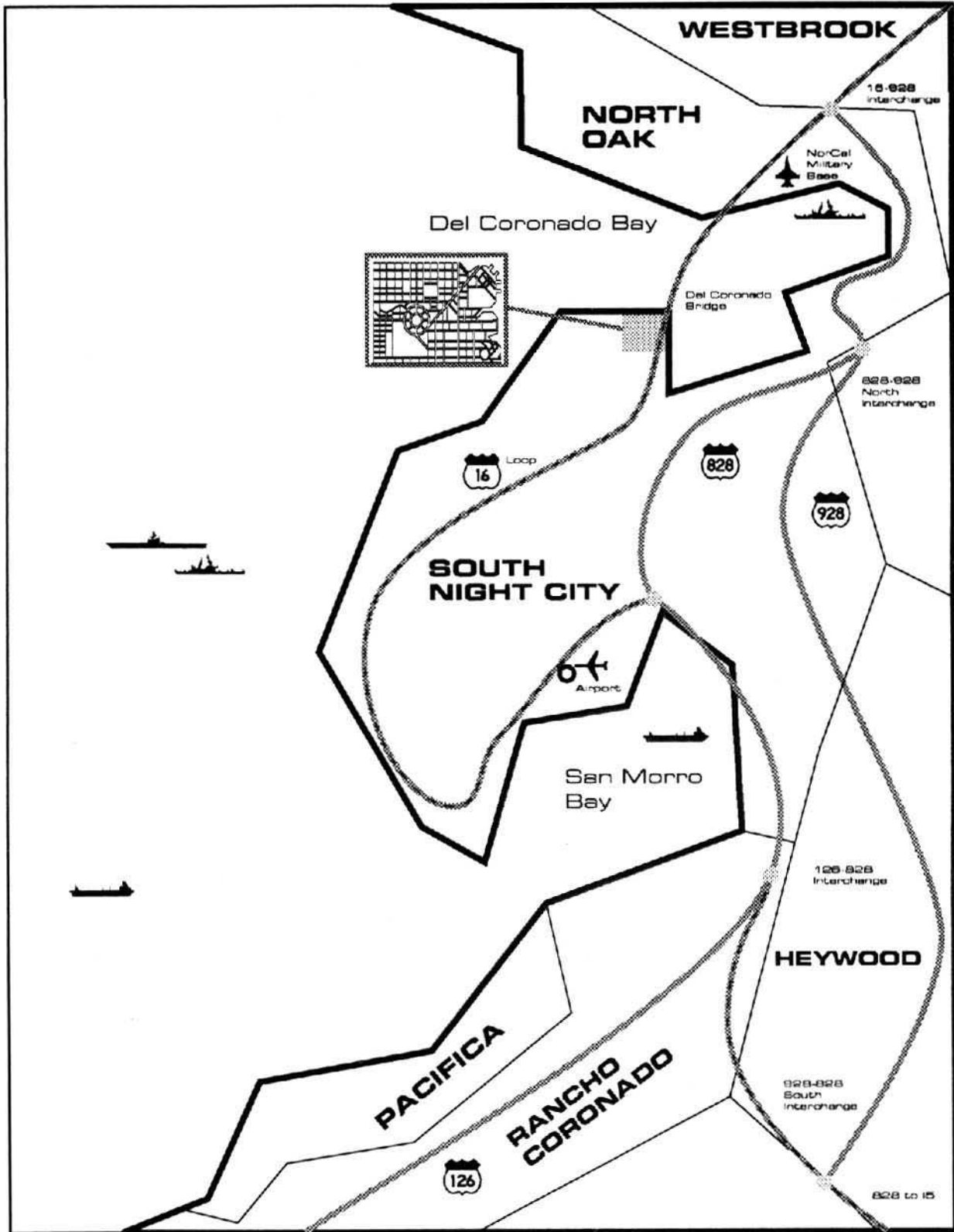

DATATERM DISPLAY SYSTEM Topic: Night City Metro Airport

UP
DN

See pg. 7 for aero-zep schedules

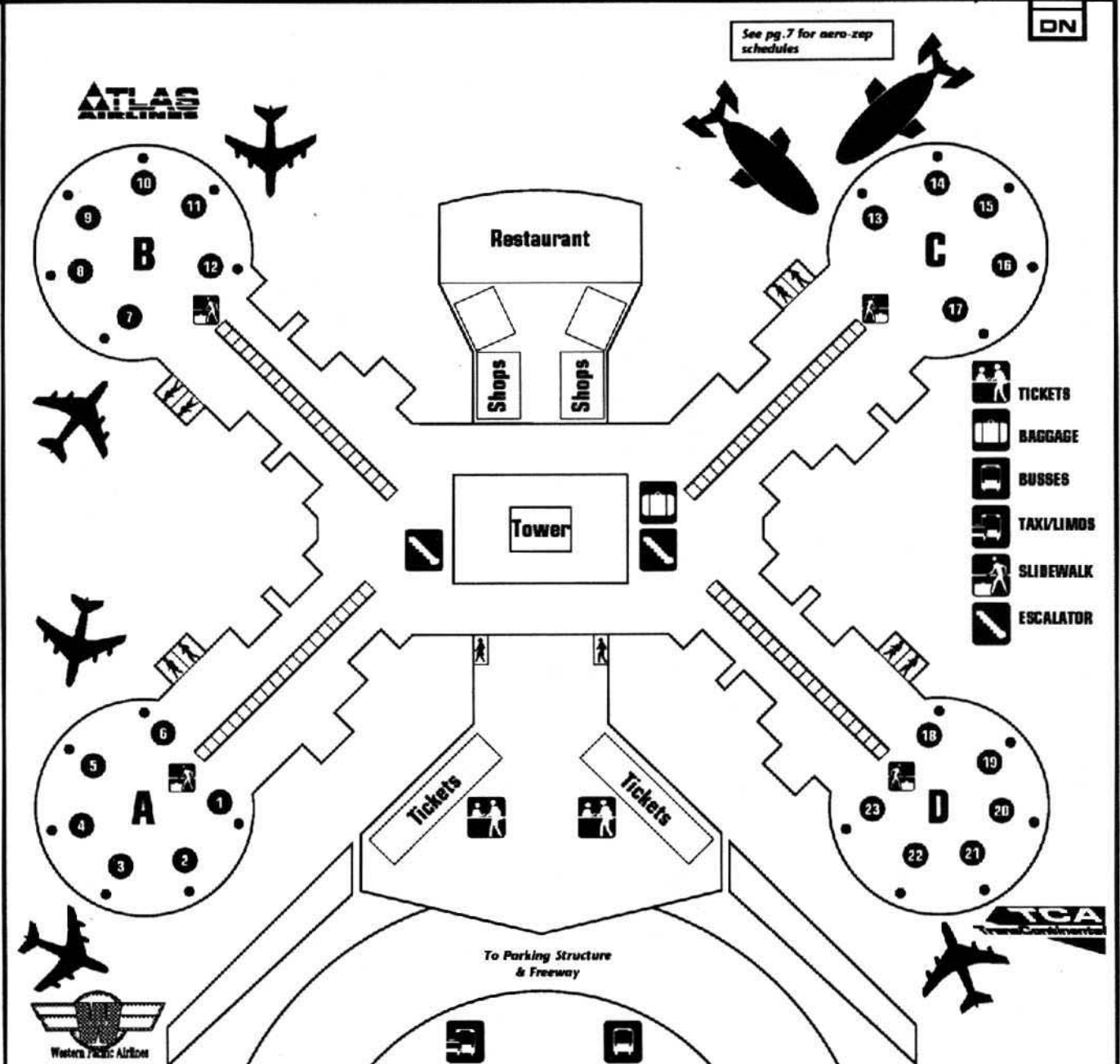

Western Pacific Airlines

Based out of the free state of North California, Western provides domestic flights between Nor and SoCal.

• Flight times from Night City to:

LA	Seattle	San Fran	Sacto	Denver	S.Lake
6am	7am	6am	5am	9am	5am
12pm	12:30pm	1pm	2pm	1pm	3pm
6pm	7pm	8pm	6pm	9pm	6pm
12am	1pm	10pm	3am	2am	1am



Based out of Hawaii, covers flights between the western U.S. and the Pacific Rim.

• Flight times from Night City to:

LA	Hawaii	Seattle	San Fran	Austr.	Tokyo	Guam
6am	5am	3am	4am	6am	7am	9am
12pm	11am	12pm	1pm	11am	12pm	3pm
6pm	7pm	6pm	8pm	9pm	4pm	11pm
12am	11pm	12am	1:30am	1:15am	2am	4am



Based out of Denver, TCA covers the western US, connecting to the East Coast.

• Flight times from Night City to:

LA	St.Louis	Dallas	San Fran	Atlanta	Denver	S.Lake
5am	6am	7am	4am	6am	7am	8am
1pm	2pm	3pm	1pm	2pm	3pm	4pm
6pm	7pm	8pm	9pm	8pm	7pm	8pm
12am	11pm	10pm	1am	12am	1am	11pm

DATATERM DISPLAY SYSTEM Topic: Night City Ferry Building ▶ UP

DN

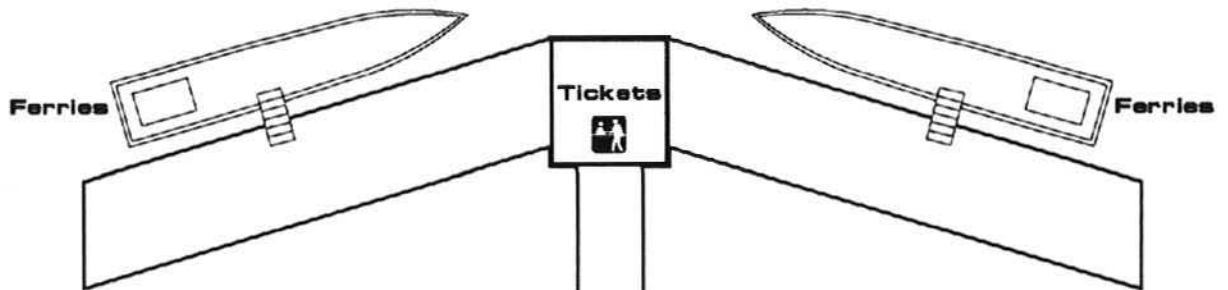

Both lines leave Ferry Building at same times

LEAVE	ARRIVE	ARRIVE
Night City	North Oak	Pacifica
6:00am	7:00am	10:30am
9:30am	10:30am	12:00pm
12:00pm	1:00pm	2:30pm
5:00pm	6:00pm	7:30pm
9:00pm	10:00pm	11:30pm

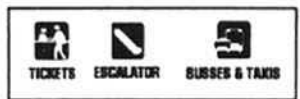

DATATERM Topic: The Marina Area ▶ UP

DN

LEAVE	LEAVE	ARRIVE
North Oak	Pacifica	Night City
5:00am	4:00am	6:30am
8:00am	6:30am	9:00am
10:00am	8:30am	11:00am
3:00pm	1:30pm	4:00pm
7:30pm	6:00pm	8:30pm

The Marina Area

- A) Ferry Building
- B) Yacht Club
- C) Start of Combat Parcourse
- D) Marina Green Jogging path

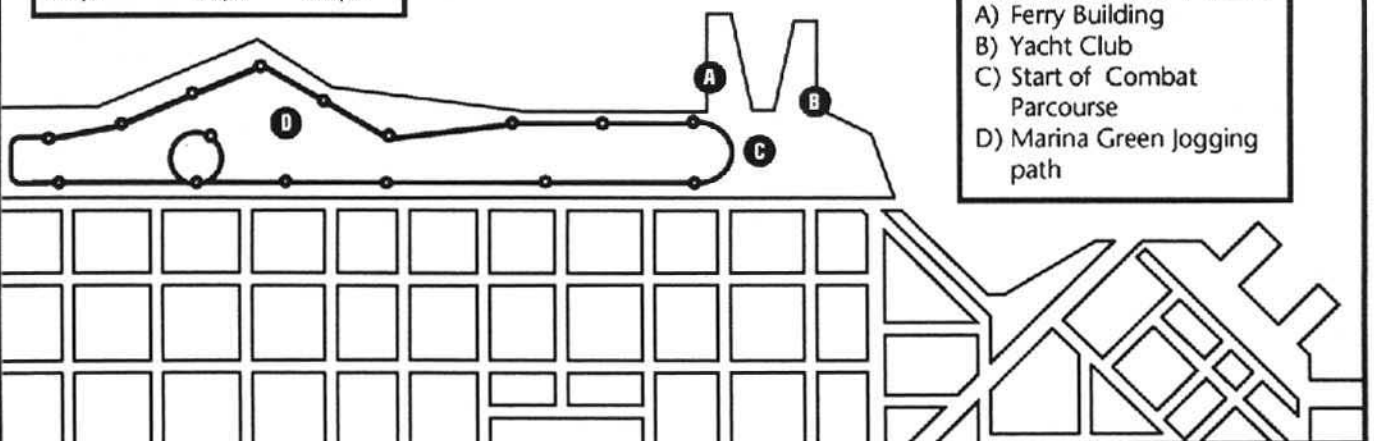

DATATERM DISPLAY SYSTEM | Topic: Night City Transit Center

UP
DN

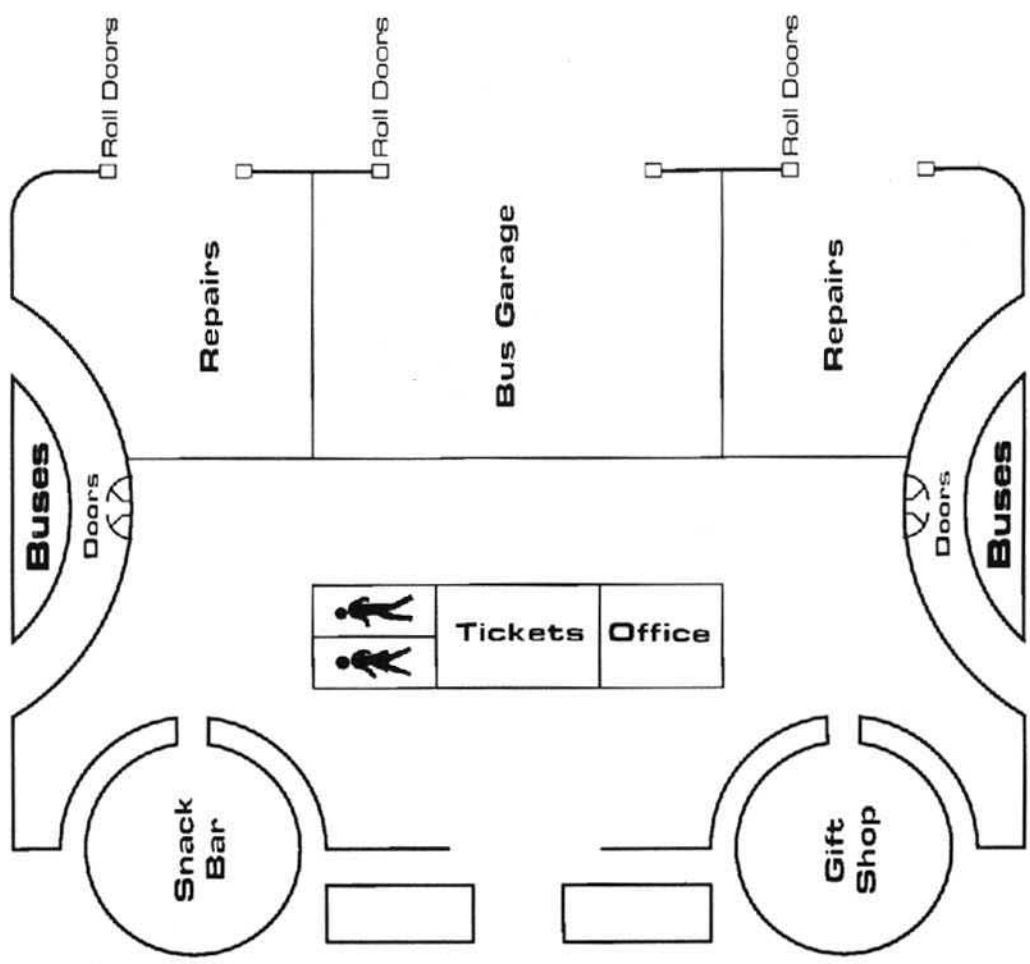

**Mercedes
Urban
Transporter**

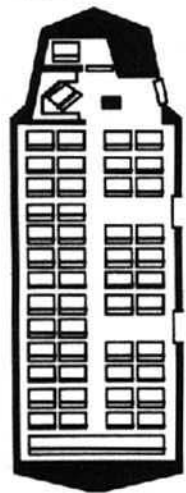

Speed: 65mph
Length: 60feet
SP: 36
Armament: Anti-personnel fragmentation belt, cabin sleepgas sprayers, rear driver cabin.

**NC
TC**

NIGHT CITY TRANSIT CORPORATION

TRANSIT CENTER

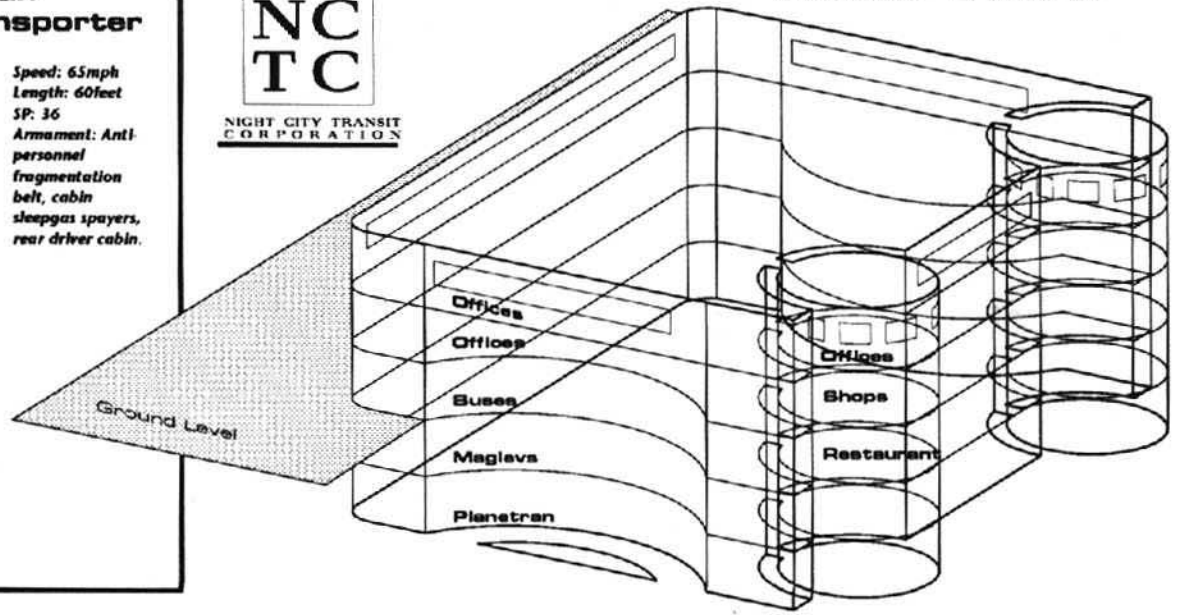

DATATERM DISPLAY SYSTEM Topic: Bus Route Map

UP

DN

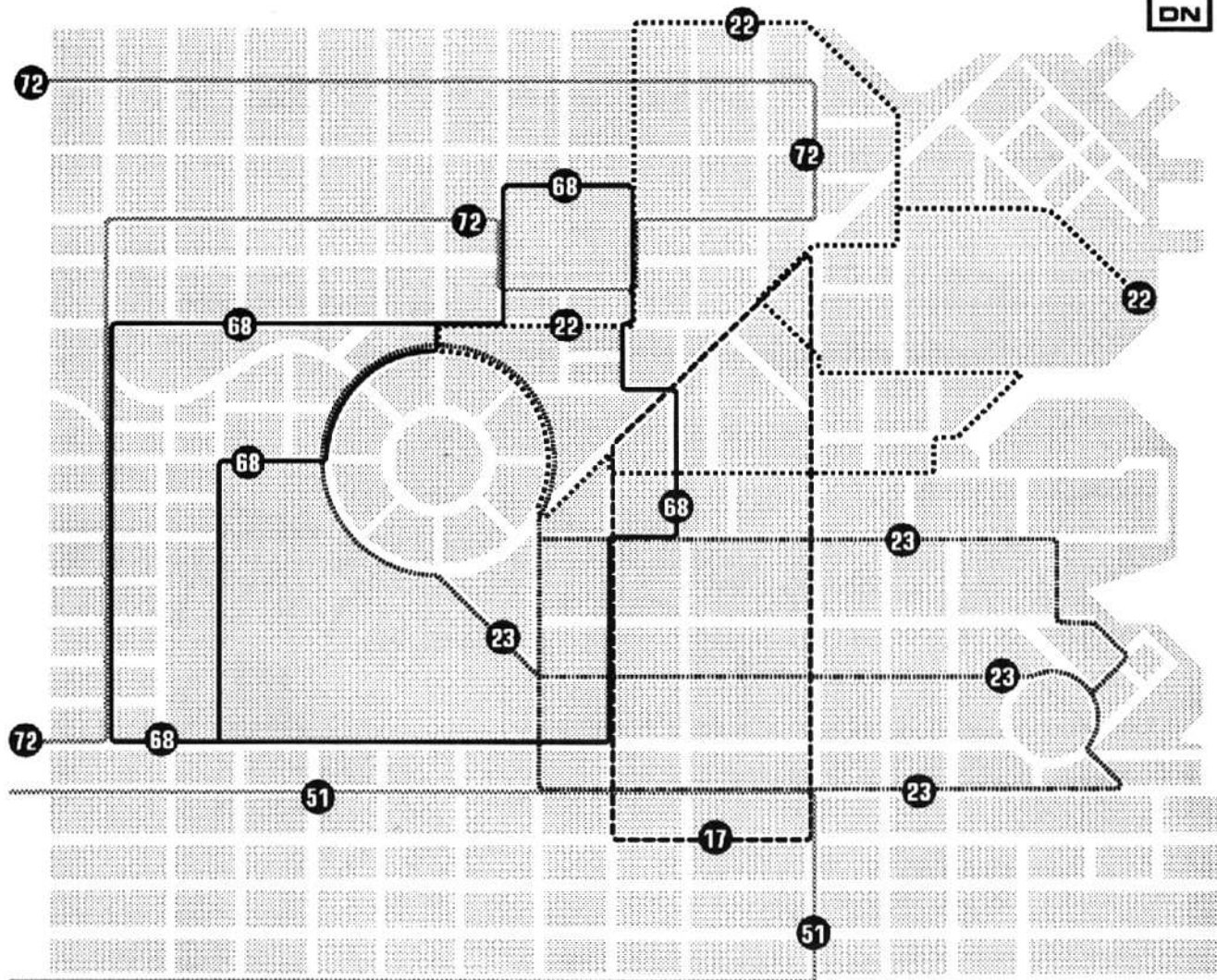

72 Western Addition

51 South Night City Ext.

68 ——— City Center

23 Corp Plaza /Charter Hill

22 City Center / Upper East

17 ----- Old Downtown



BUS SCHEDULES

Time Table

General times when busses arrive at stops, starting at 5am.

5:00am—8:00am. Every 20 minutes, 20% chance of delay.

8:00am—4:00pm. Every 35 minutes, 20% chance of delay.

4:30—7:00pm. Every 10 minutes, 20% chance of delay.

7:00—12:00am. Every 30 minutes, 40% chance of delay.

Delays

A) Roll 3 D10 for minutes delay.

B) Roll 1D6 for type of delay:

- | | |
|----------------------|----------------------------|
| 1 Riot blocks street | 2 Holdup/Hostage situation |
| 3 Bus Breakdown | 4 Crash |
| 5 Hijacked bus | 6 Operator's strike |

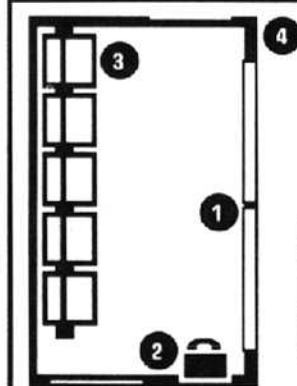

NC TC

NIGHT CITY TRANSIT CORPORATION

BUS BUNKER

- 1) 30 SP armored glass sliding doors with crashbars.
- 2) 24 SDP phone box with line to NCPD
- 3) SDP 20 steel seats mounted on concrete
- 4) SDP 60 reinforced concrete walls with SP 30 armored glass 2'x2' panels

DATATERM DISPLAY SYSTEM Topic: NCART System Map

UP
DN

NCART

NIGHT • CITY • AREA • RAPID • TRANSIT

Time Table

General times when trains arrive at stations.

5:00am—8:00am

Every 10 minutes, 30% chance of delay.

8:30am—12:00pm

Every 15 minutes, 20% chance of delay.

12:30pm—4:00pm

Every 30 minutes, 10% chance of delay.

4:30—7:00pm

Every 10 minutes, 50% chance of delay.

7:30—12:00am

Every 30 minutes, 30% chance of delay.

Delays

A) Roll 3 D10 for minutes delay.

b) Roll 1D6 for type of delay:

- 1 Riot on the train
- 2 Holdup/Hostage situation
- 3 Mechanical breakdown
- 4 Collision
- 5 Suicide on tracks
- 6 Operator's strike

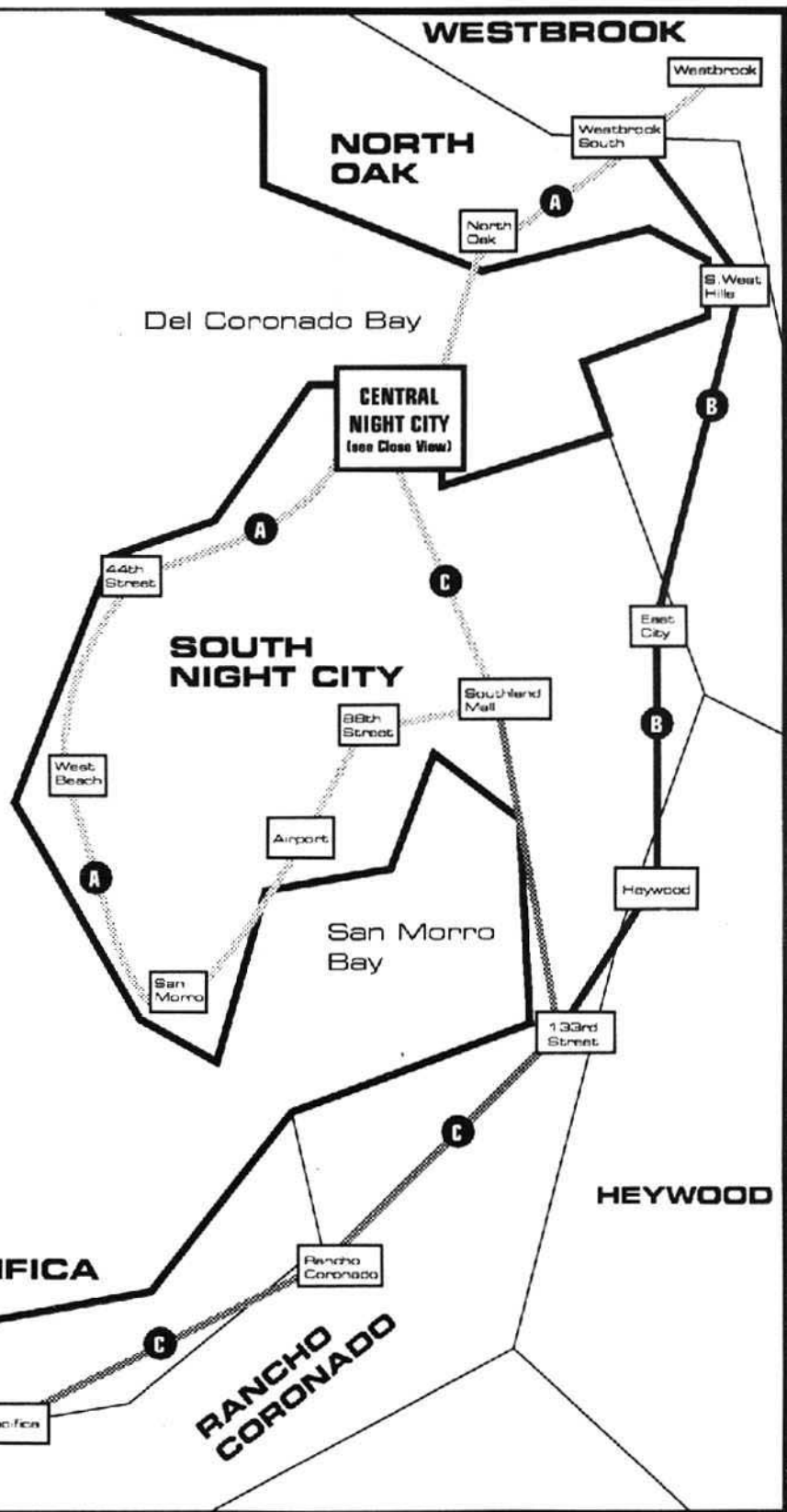

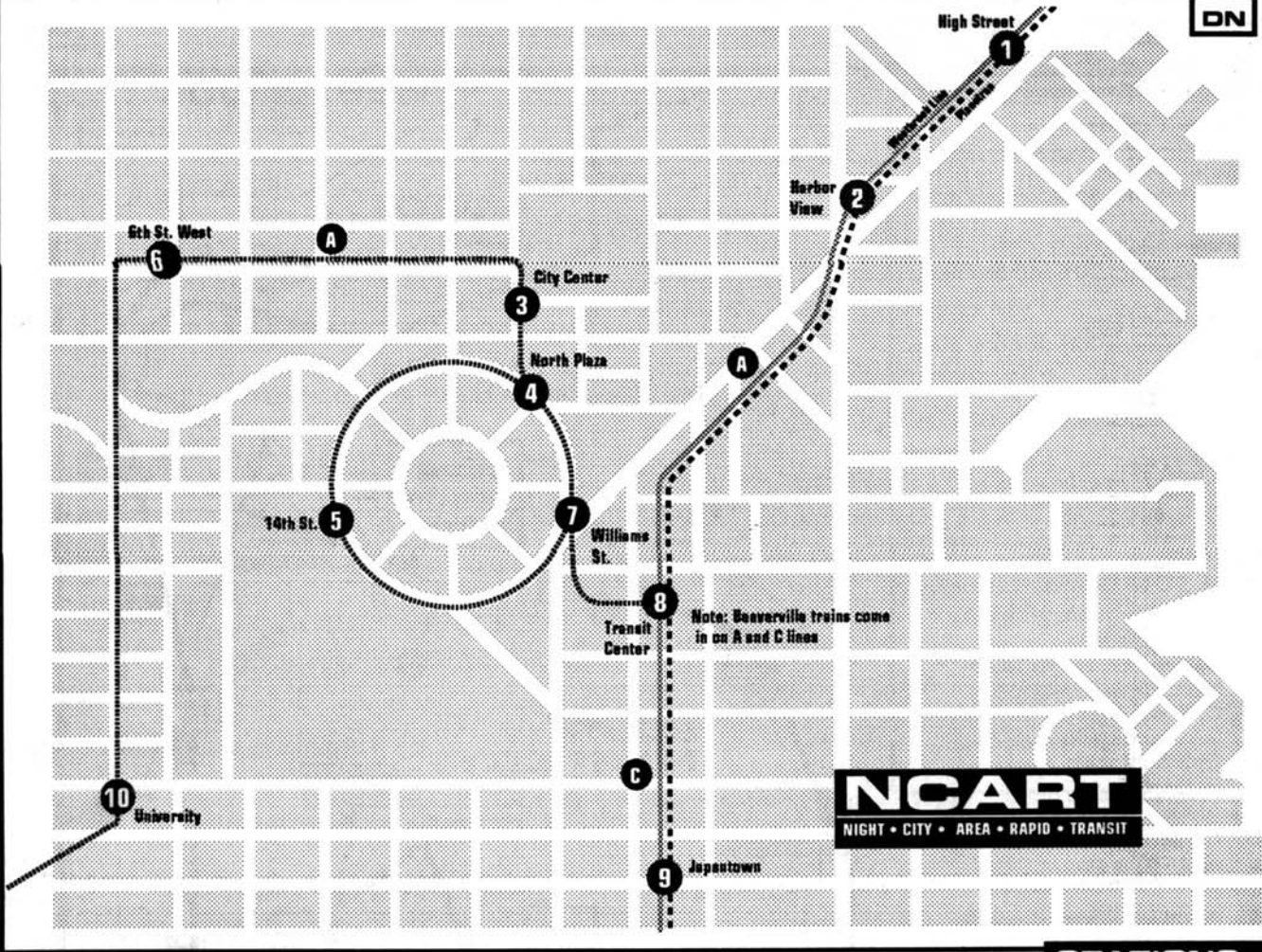

STATIONS

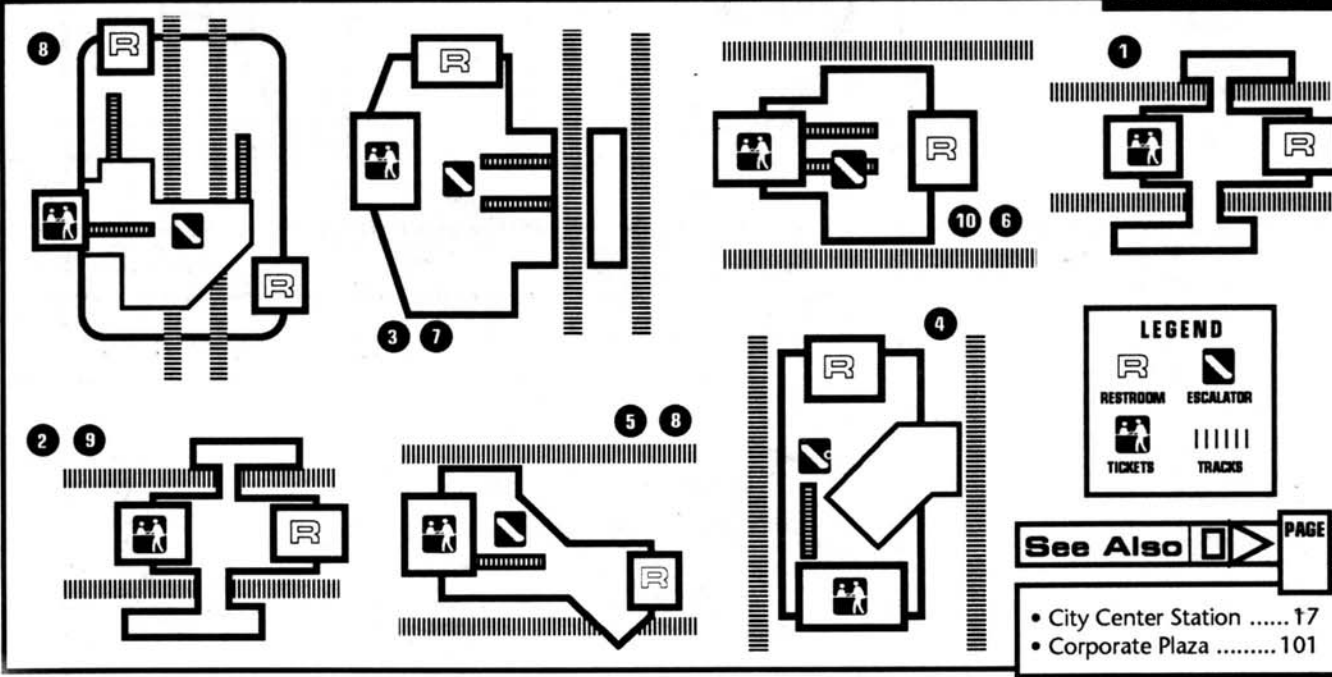

- City Center Station 17
- Corporate Plaza 101

DATATERM DISPLAY SYSTEM Topic: Colleges & Fine Arts

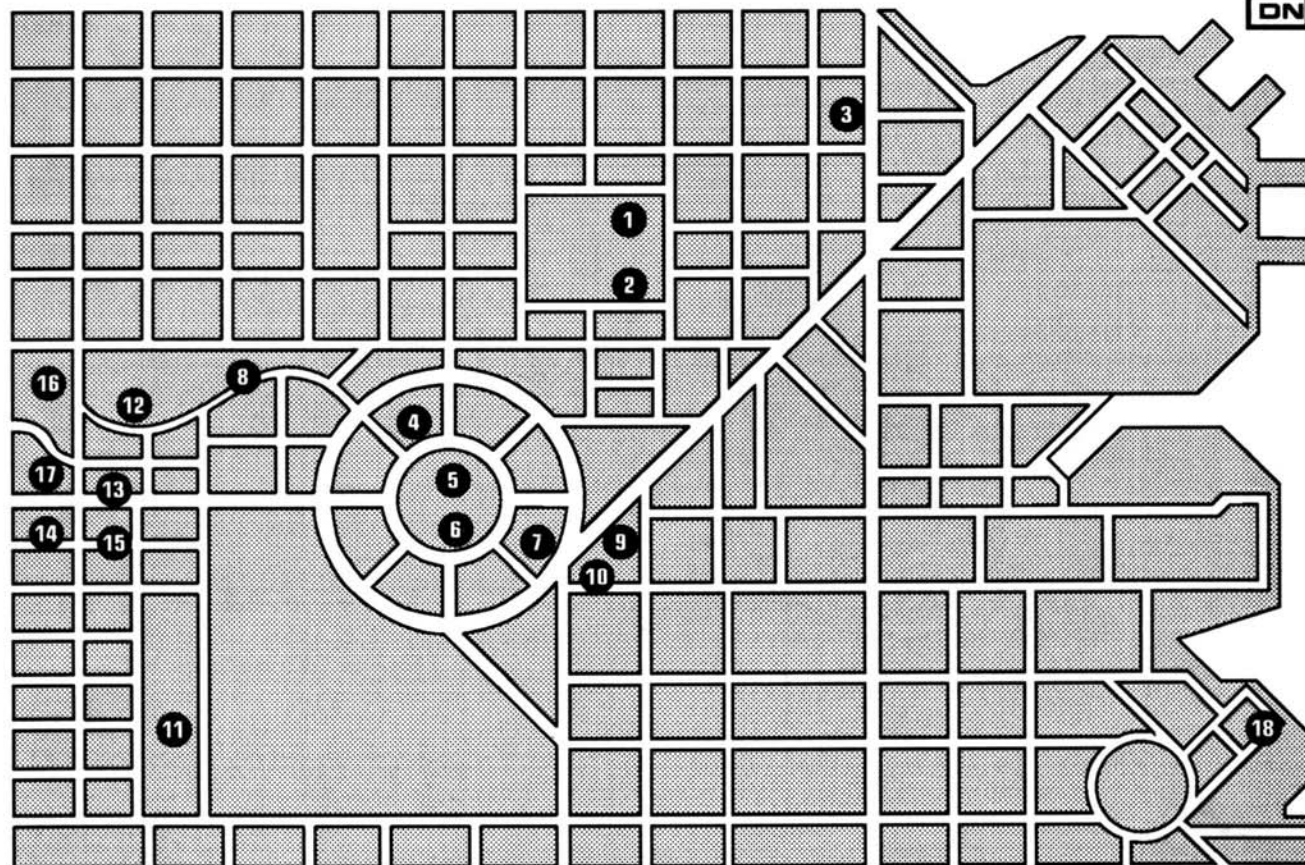

KEY

- 1) Night City Museum, pg. 68
- 2) Burroughs Municipal Library (limited showcase space), pg. 68
- 3) Whindemere's (gallery), pg. 79
- 4) "History of Computing" museum (Microtech Center), pg. 102
- 5) "Petroleum Museum" (Petrochem International), pg. 104
- 6) Mitifer/Plaza Business Tower (showroom/gallery), pg. 104
- 7) "History of Aerospace Tech" museum (Orbital Air), pg. 106
- 8) Kuramoto Galleries, pg. 99
- 9) Medical School/Night City Med Center, pg. 112
- 10) N.C. Technical School, pg. 112
- 11) Night City University, pg. 136-9
- 12) 2 Art Gallery-Showrooms/ Pinewood Bazaar, pg. 90
- 13) Continuous Street Artists' show, pg. 93
- 14) Serengeti Gallery, pg. 92
- 15) Mixed minor art studios, pg. 92
- 16) Petrochem Fine Art Museum, pg. 93
- 17) NCU Fine Art Campus, pg. 93
- 18) The Matsouka Gallery, pg. 169

DATATERM Topic: Night City Schools



In addition to its fine universities and technical schools, Night City also has four high schools.

- Richard Night HS—3rd and Warren
- G. Lucas High—23rd & Effinger
- South City High—43rd & Moran
- Del Coronado High—70th & Warren

DATATERM Topic: Leisure Activities



Bicycling: Lake Park and the University District are the best places for bike touring. Be sure to carry light clothing and weapons in case you encounter the many colorful streetpeople who inhabit this area.



Fishing: the waters around Night City have recently been cleared by the NorCal Environmental Protection Agency for all types of recreational fishing.



Hiking: The hills around Westbrook and North Oak are filled with many trails and parks. With APEX protection, you can be assured of enjoying nature in a peaceful and safe setting.



Boating: Check out the Night City Yacht Club for tips on the best (and most pirate free) sailing spots!



Hunting: Whether using assault rifles or autocannon, the hills of nearby Westbrook offer plenty of sport, including Biotechnica's new Mule Deer 2000™.



Combat Sports: Whether its paintball, combat handball, or arena sports, Night City has it all!

NIGHT CITY

FLASHMAPS

DATATERM DISPLAY SYSTEM Topic: **Hotels & Lodgings**

UP

DN

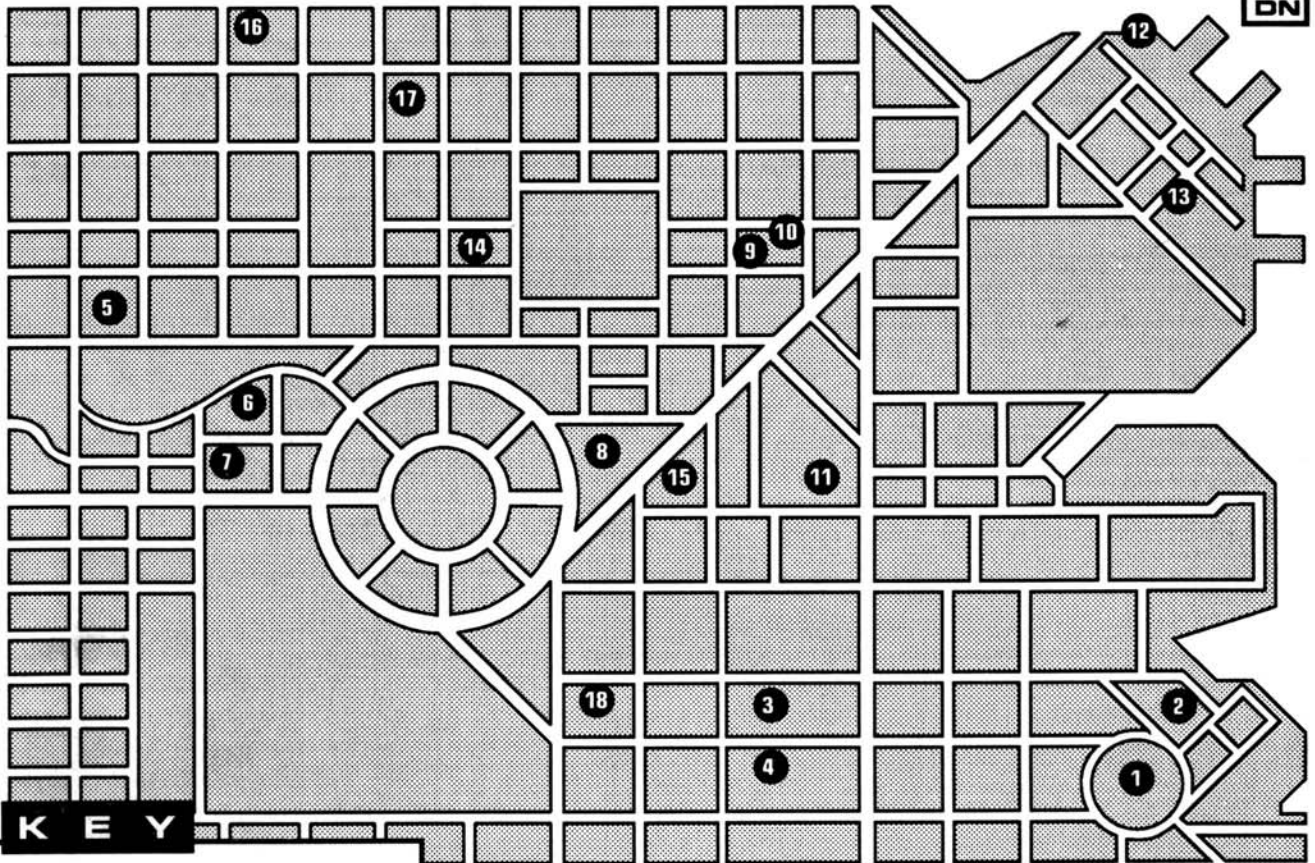

KEY

- 1) The Hacienda ☆☆☆, pg. 168
- 2) Night City Hilton☆☆, pg. 166
- 3) Highcourt Plaza Hotel ☆☆☆, pg. 155
- 4) Red Door Inn ☆, pg. 157
- 5) Knight-Marriot Hotel ☆☆☆, pg. 93
- 6) Regal Hotel ☆☆☆, pg. 99
- 7) The Kuroshita Hotel ☆☆☆, pg. 99
- 8) The Ashcroft ☆☆☆, pg. 112
- 9) The Havenford ☆☆☆, pg. 80
- 10) The Advocet ☆☆☆, pg. 80
- 11) The Jellical Inn ☆☆, pg. 117
- 12) Pier 3 Paradise Rent-a-Space ■, pg. 86
- 13) Good Night Rooms/Coffins ☆, pg. 88
- 14) Burlson Tower ☆, pg. 70
- 15) Hotel Hamilton ☆☆☆, pg. 118
- 16) Widmark ■, pg. 62
- 17) Sandorf ■, pg. 65
- 18) Hotel Yamagumi ☆☆, pg. 148

- ☆☆☆☆ Best in the City, very expensive
- ☆☆☆ Highly rated, expensive
- ☆☆ Very good, with higher rates
- ☆ Fair, with moderate rates
- ☆ Low quality, but cheap
- Scumhole

DATATERM Topic: **Rentals & Taxis**

UP

DN

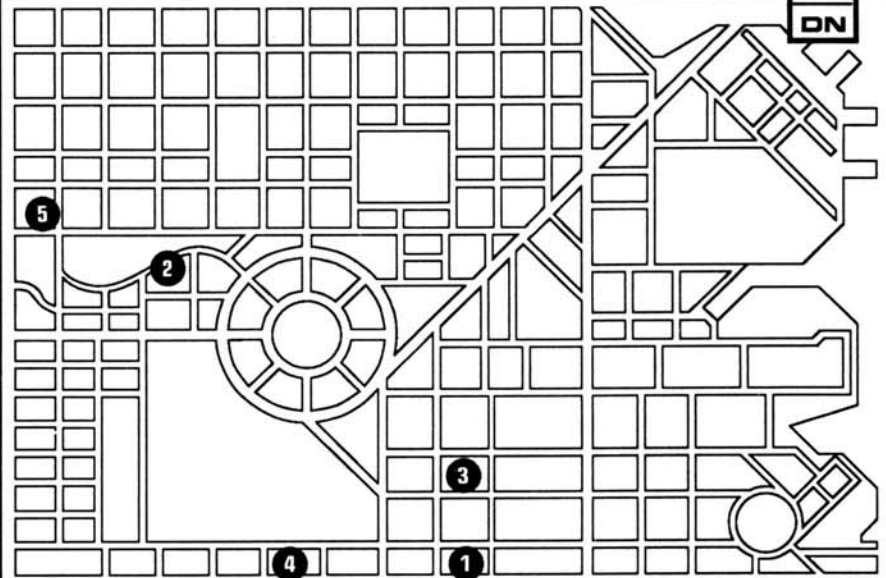

Renta-ROBB
1 pg. 157

REDOCAB
2 pg. 101

Aerocab
3 pg. 157

Combat Cabs
4 pg. 142

HONDA/AVIS
5 pg. 93

DATATERM DISPLAY SYSTEM | Topic: Clubs & Nightlife

UP

DN

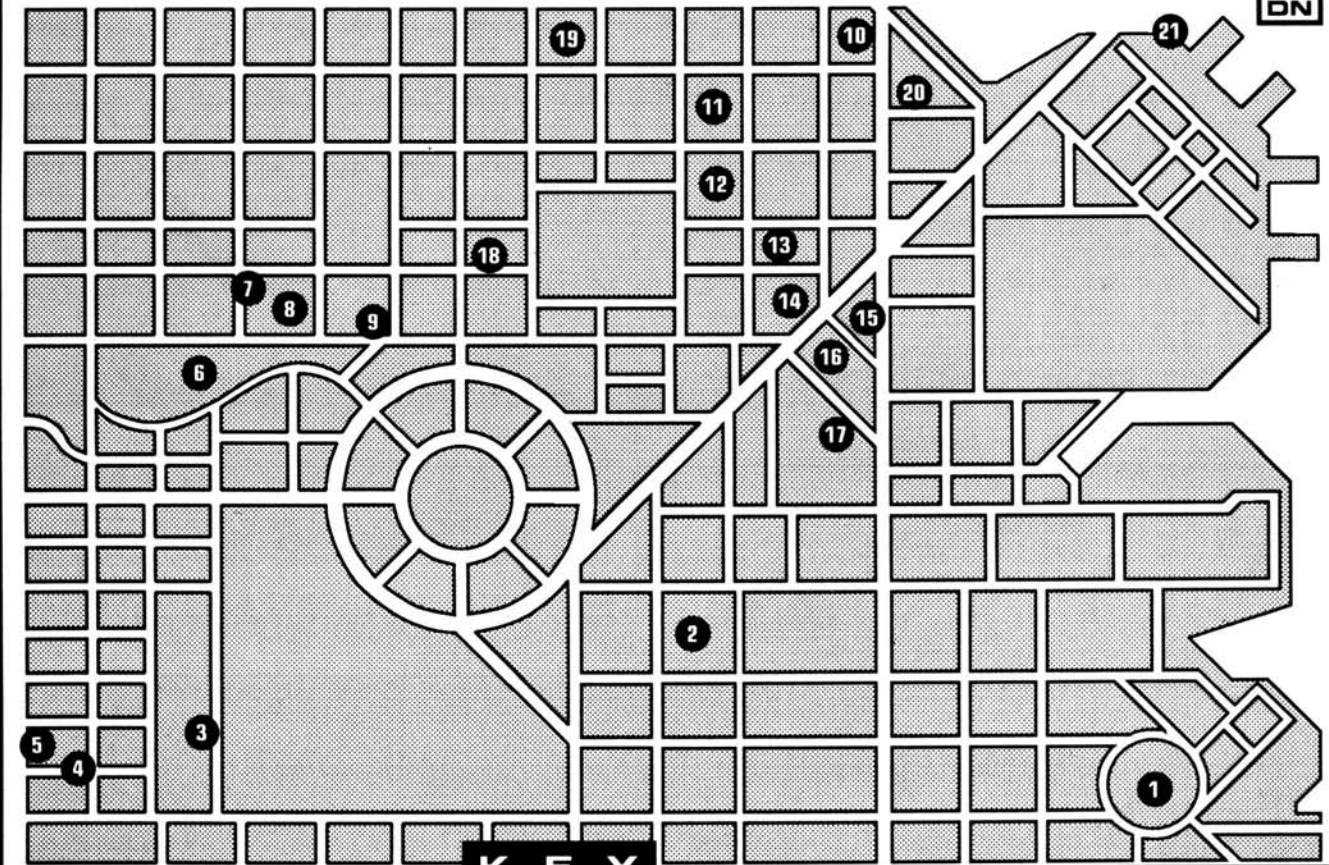

KEY

Some drinks you may find on (or off) the menu of a Night City bar.

The Silverhand: A shot of vodka mixed with brandy, and a few drops of CHOOH₂ thrown in for flavor. 5eb

The Nomad Special: Jack Daniels with a greasy nut thrown in to add that "metallic" taste Nomads are so fond of. 4eb

The "Killer": A popular drink among the Corpzoner set. The purchaser of the drink is given five small metal hoops; he then tosses them at a line-up of well drinks behind the bar. The barkeep then mixes all the hooped drinks in one glass, and serves it up. 10eb

The Night City: Only served in the more "unwholesome" bars in the City area. The N.C. is a mixture of tequila, raw wood alcohol, and several drops of turpentine, garnished with a dead worm. The Night City has been known to kill boosters of substantial endurance, and is often used as a test of stamina for gang members throughout the city. 6eb

The "Blood Razor": Named after the infamous gang, this drink is a mixture of red wine, brandy, red food coloring, and cherry soda. The garnish is a chicken bone. The final concoction has a color similar to dried human blood; hence the name. 4eb

A "Pansy": Any single well drink, or just a beer on tap. 3eb

The Armageddon: The name says it all—possibly the deadliest drink on tap at the moment. Only served at *Totentanz*, the exact ingredients are unknown, but theories range from roach killer and anti-freeze to human blood. Reports say that the drink is powerful enough to get anyone drunk on one glass. Served in a rusty tin can. 5eb

The Braindance: Popular among Edgerunners, the Braindance is a mixture of raw alcohol and citrus juices.

- 1) The Hacienda—casino, pg. 168
- 2) Club Atlantis—nightclub, pg. 154
- 3) The Ratskellar—NCU student union bar, pg. 138
- 4) Newgate Prison and The Paragon—college bar and nightclub, pg. 140
- 5) Hababas—bar, pg. 140
- 6) Pinewood Bazaar/Manhattan's—bar, pg. 90
- 7) L'Etranger—nightclub, pg. 96
- 8) Sunset Bar & Grill—bar, pg. 96
- 9) Rainbow Nights—major dance club, pg. 98
- 10) The Slammer—booster club and arena, pg. 75
- 11) Metalstrom—nightclub, mainly chromers, pg. 77
- 12) Café Chrome—nightclub, pg. 78
- 13) The Advocet—nightclub, pg. 80
- 14) The Grand Illusion—major dance club, pg. 116
- 15) The Night Owl—bar, pg. 116
- 16) The Afterlife—bar, mainly solos, pg. 116
- 17) Short Circuit—bar, mainly netrunners, 117
- 18) Totentanz—booster club, pg. 70
- 19) West Block minor bars and clubs, pg. 71
- 20) American Bar—bar, pg. 84
- 21) Pier 3 Paradise/All-Night Bar—bar, pg. 86

Called the Braindance because after two or three the drinker feels like going out and finding some action. A good drink to have if you want something strong that probably won't kill you. 4eb

The Sea Breeze: A non-fatal, pleasant mixture of white wine and a bit of lemon juice. Often considered a "ladies" drink, but also popular among some of the Yakuza set (watch who you're calling a sissy, chomba!) 4eb

A SoCal Special: A mixture that is 90% water and 10% anything else. Only bought as a joke, usually for people from the South. Also, any bar that serves watered down drinks is usually called a SoCal Special. 1eb

The Ripper: A hard liquor drink popular among the Rocker and Chromer set, usually served at parties. The Ripper is a powerful mixture of whiskey, ouzo, and a random type of citrus juice. 6eb

The Blade Runner: CHOOH₂ and champagne mixer, served in a cocktail glass with mealworms in the bottom. 6eb.

The 'Euro: A drink imported from France, the 'Euro is gaining popularity among the corporate rich. A blend of different fruit juices, mixed with bourbon, and served over ice cubes of gin! A very expensive drink (the bar needs a special freezer to get the gin frozen.) 15eb

DATATERM DISPLAY SYSTEM Topic: Performing Arts/Sports ▶ UP
DN

KEY

- 1) The Stars Theatre—movies, pg. 169
- 2) Piper Memorial Sports Arena—wrestling, boxing, gladiatorial sports, pg. 154
- 3) Colonial Studios—TV, movie production (under renovation), pg. 160-2
- 4) Libertine Lanes—bowling, pg. 163
- 5) Biograph Theater—movies, pg. 140
- 6) Pinewood Bazaar Cinema—movies, pg. 90
- 7) CiNemaXUS—movies, braindance, pg. 79
- 8) McCartney Stadium—football, baseball, soccer, wrestling, pg. 125
- 9) Reunification Hall & Social Club—recreational space, pg. 88
- 10) Bodakkan Performing Arts Center—plays, concerts, etc., pg. 146

Tickets may be purchased at the individual box offices, or through this Dataterm from TICKETSCALP or CARP. Please select by pressing one of the icons to the right.

DATATERM Topic: Ticket Agencies ▶ UP
DN

TICKETSCALP is the agency to use when buying opera, symphony, lecture and recital seating. Very expensive, but with excellent availability.

Availability %				
1 week	3 days	2days	1 day	Show
100%	80%	50%	30%	25%

Prices (basic seating)			
Super Star	Star	Concert	Lecture
\$150	\$100	\$75	\$30

CARP is the ticket agency of choice for the up and moving crew, covering most big rock concerts, sporting events and stadium shows. Beware of overbooking (15%).

Availability %				
1 week	3 days	2days	1 day	Show
80%	40%	20%	10%	5%

Prices (basic seating)			
Mega Act	Major Act	Concert	Game
\$100	\$75	\$50	\$25

DATATERM DISPLAY SYSTEM Topic: Public Services

UP
DN

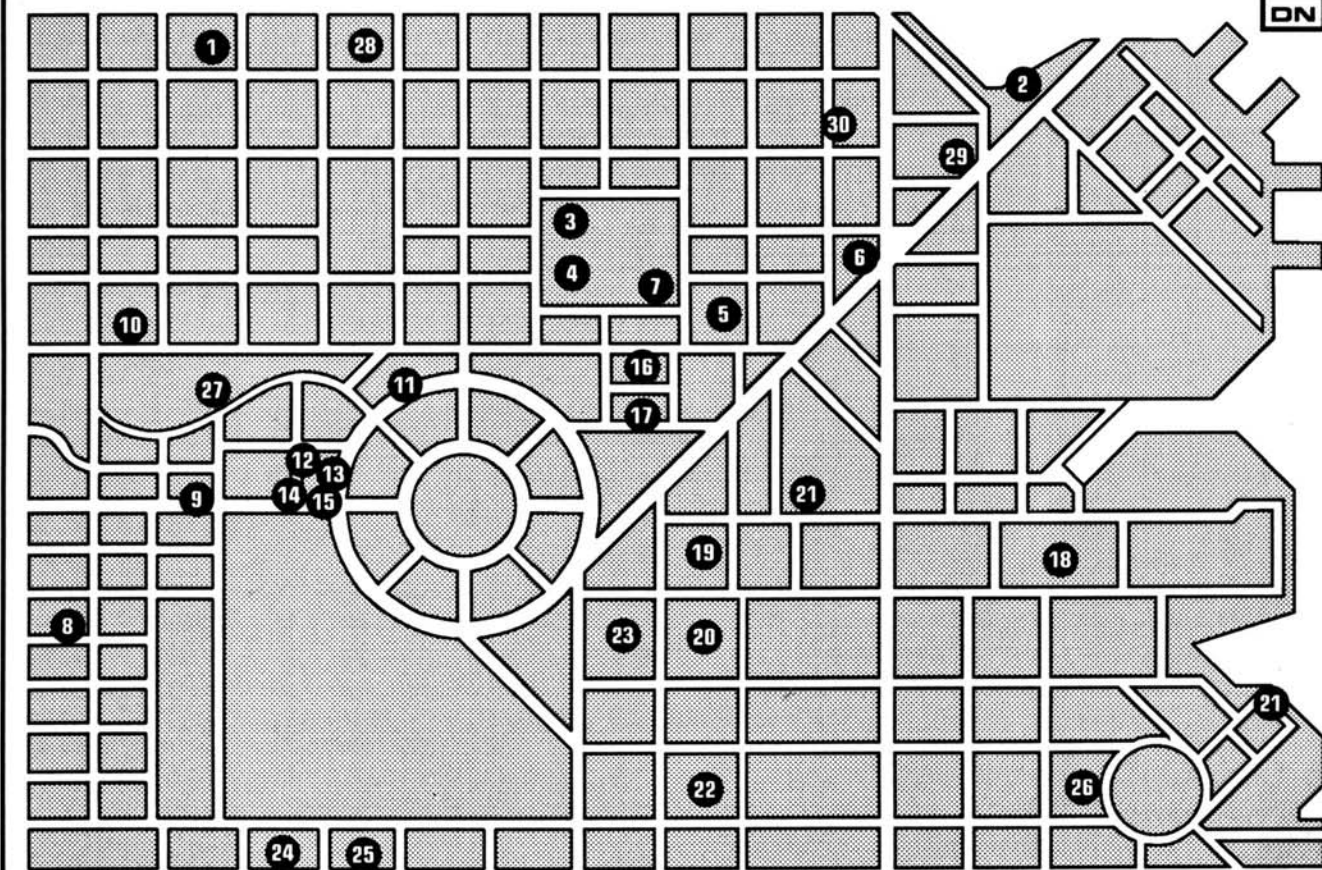

KEY

- | | |
|--|---|
| 1) NCPD Precinct #2, pg. 57 | 18) Night City Municipal Convention Center, pg. 117 |
| 2) Harbormaster's Office, pg. 84 | 19) Night City Transit Center, pg. 156 |
| 3) N.C. Court of Justice, pg. 68 | 20) Crisis Medical, pg. 117 |
| 4) Night City Hall, pg. 68 | 21) Michael Knight Memorial Aquarium, pg. 166 |
| 5) NCPD Precinct #1, pg.114 | 22) NCP Precinct #3, pg. 151 |
| 6) Night City Fire Station #1, pg. 80 | 23) Bodakkan Performing Arts Center, pg. 146 |
| 7) Municipal Library (main branch), pg. 68 | 24) Fire Station #2, pg. 142 |
| 8) Stuart Hospital, pg. 141 | 25) Night City Transit Corporation Office, pg. 142 |
| 9) West Hill Library, pg. 92 | 26) Non Denominational Church of God, pg. 162 |
| 10) Knight-Marriot Convention Center, pg. 93 | 27) West Hill Church of God, pg. 90 |
| 11) EEC Consular Building, pg. 100 | 28) Holy Angels Catholic Church, pg. 62 |
| 12) Soviet Consulate, pg. 100 | 29) Department of Motor Vehicles, pg. 84 |
| 13) Chinese Consulate, pg. 100 | 30) Night City Postal Service, pg. 114 |
| 14) Mexican Consulate, pg. 101 | |
| 15) Federal Building, pg.110 | |
| 16) Japanese Consulate, pg. 110 | |
| 17) City Medical Center and Annex, pg. 124 | |



Civic Information



- Appointments with the Mayor may be requested (M-F, 10:00 am to 3:00pm) by contacting the City Center Bulletin Board, LDL 2544. 5526



- City Council Meetings are held every Tuesday night from 7:00pm to 11:00pm.



Fallout shelters are located in the subbasement of the City Center and the Corporate Plaza. Occupancy is @ 5,000.



Mail delivery (via service contractor FEMS) is between 9-5, Mon—Sat.

NIGHT CITY

FLASHMAPS

DATATERM DISPLAY SYSTEM | Topic: Restaurants

UP
DN

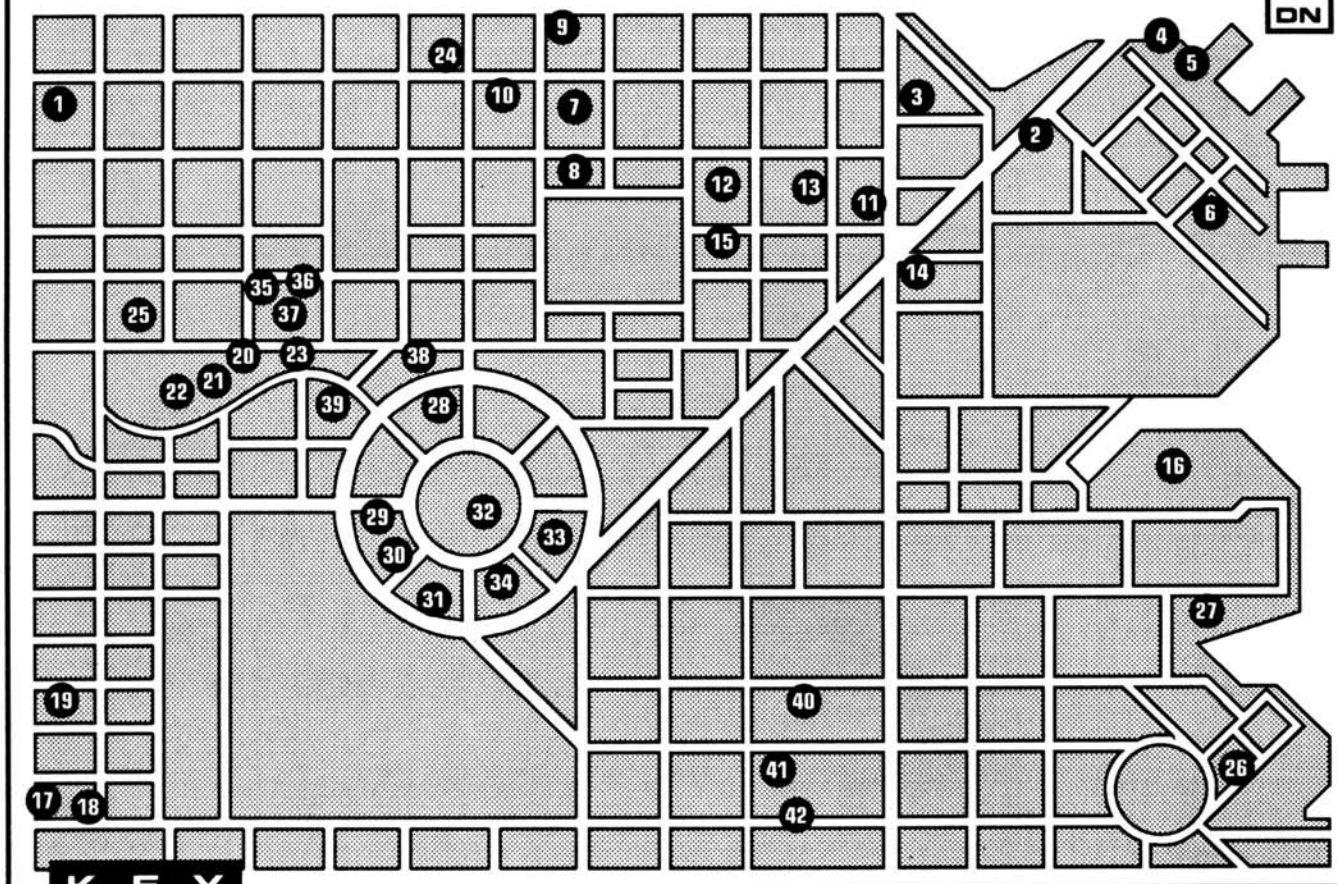

KEY

- | | | |
|---|---|--|
| <p>1) Franciscini's Cafe—Eurohip (E.European / Scandinavian)☆☆☆, pg.59</p> <p>2) 24 Hour Cafe—Truck stop ☆☆, pg.82</p> <p>3) American Bar—Sandwiches ☆☆, pg.84</p> <p>4) Joe's Diner—Family fare ☆☆, pg.86</p> <p>5) Pier Three Paradise—Samoan ☆, pg.86</p> <p>6) Arcade Arcade—Fast food ☆, pg.88</p> <p>7) Wing Chang—Chinese ☆☆☆☆☆, pg.71</p> <p>8) La Croix—French ☆☆, pg.71</p> <p>9) Metropolitan Barbecue and Grill—Steak house ☆☆☆, pg.71</p> <p>10) Meridian Square Shops—Multiple Fast food establishments ☆☆, pg.72</p> <p>11) Global Foods—International smorgasbord and to-order ☆☆☆, pg.79</p> <p>12) Café Chrome—New-wave Californian ☆☆☆, pg.78</p> <p>13) Manfreds—German ☆☆☆, pg.79</p> <p>14) Guevarra's—Mexican ☆☆☆, pg.122</p> <p>15) Hari-Kiri Sushi Bar—Japanese ☆☆☆, pg.120</p> <p>16) New Harbor Mall Food Court&Plaza—Fast food/Family fare/International sit-</p> | <p>down (over two dozen establishments) ☆, pg.133</p> <p>17) MacDonnell's—Fast food ☆, pg.140</p> <p>18) Carriage St. Coffee House—Sandwiches☆☆, pg.140</p> <p>19) Metro Cafe—Family fare☆☆, pg.140</p> <p>20) Pinewood Bazaar/Thai House—Thailand ☆☆, pg.90</p> <p>21) Pinewood Bazaar/Little Italy—Italian ☆☆, pg.90</p> <p>22) Tijuana Cafe—Mexican ☆☆, pg.90</p> <p>23) Nino Tea House—Japanese☆, pg.92</p> <p>24) Taco Hut—Fast food, pg.65</p> <p>25) Kilimanjaro Peak—African ☆☆☆, pg.93</p> <p>26) Casa de Seville—Spanish ☆☆☆, pg.169</p> <p>27) The Marina—American seafood ☆☆, pg.169</p> <p>28) Microtech Center Restaurant—Seafood and sandwiches ☆☆☆, pg.102</p> <p>29) EBM Rooftop Restaurant—Eurohip ☆☆☆, pg.103</p> <p>30) EBM Pavilion—Mixed Family fare ☆☆, pg.103</p> <p>31) Network 54 Restaurant—Haute Viennese ☆☆☆, pg.104</p> <p>32) Plaza Business Tower—Biggest mix of restaurants in one spot in entire city</p> | <p>(over a dozen establishments) ☆, pg.104</p> <p>33) Orbital Air Restaurant—Airline food ☆, pg.106</p> <p>34) Merrill, Asukaga, & Finch Restaurant—Japanese ☆☆☆, pg.107</p> <p>35) International Cafe—Californian ☆☆, pg.96</p> <p>36) Sunset Bar & Grill—Family fare ☆☆, pg.97</p> <p>37) Robbie's Monster Subs—Sandwiches ☆☆, pg.98</p> <p>38) 10th St. Center—2 Fast food establishments ☆, pg.99</p> <p>39) The Town Center—2 cafes, pg.99</p> <p>40) Le Fountainbleu—Haute French ☆☆☆, pg.155</p> <p>41) Chen's Oriental Gardens—Chinese ☆☆☆, pg.156</p> <p>42) The Silver Dragon—Exclusive Chinese ☆☆, pg.158</p> |
|---|---|--|

☆☆☆☆ Best in the City, very expensive
 ☆☆☆ Highly rated, expensive
 ☆☆☆ Very good, with higher rates
 ☆☆ Fair, with moderate rates
 ☆ Low quality, but cheap

DATATERM DISPLAY SYSTEM Topic: Shops & Services

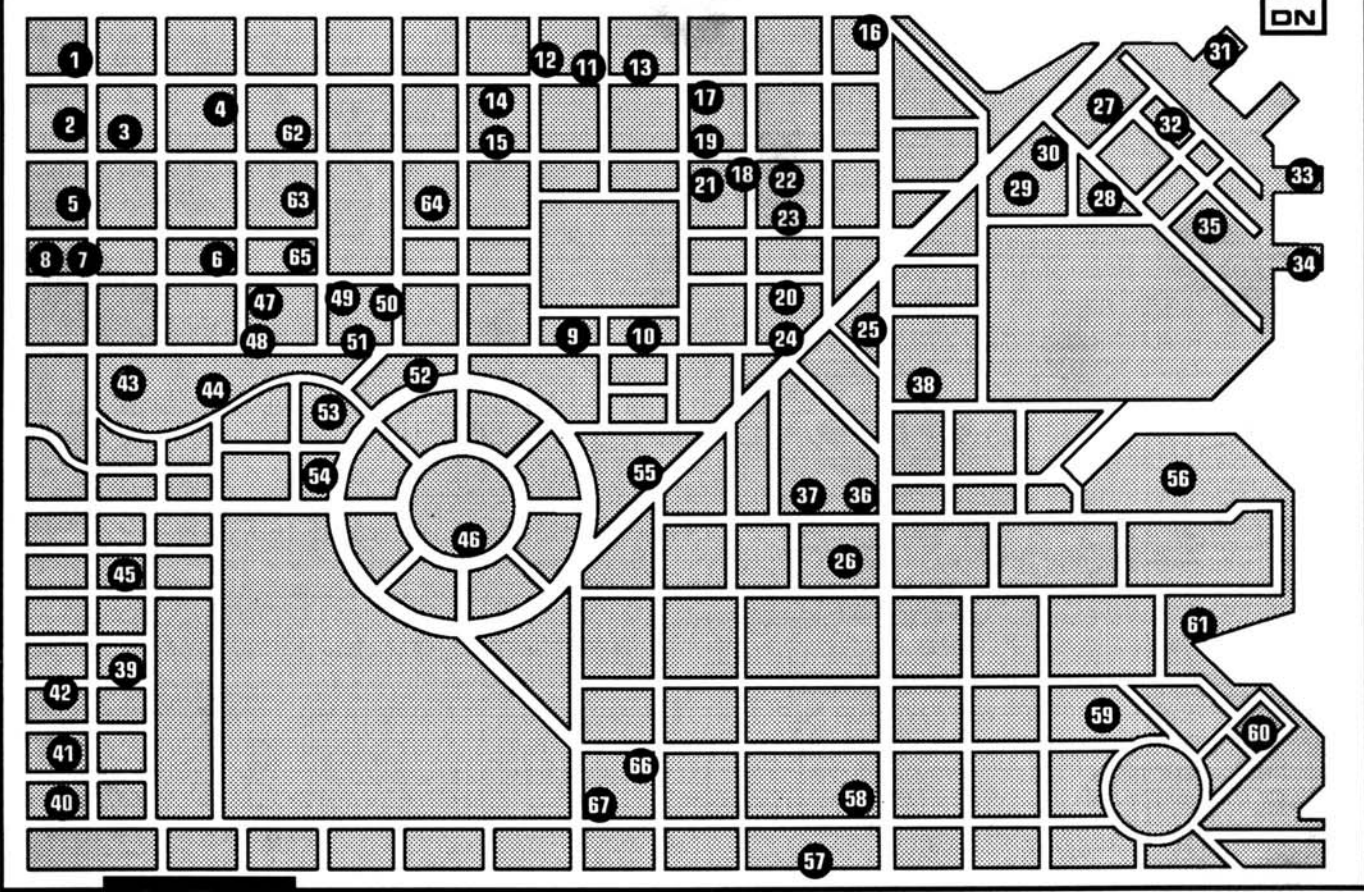

KEY

- | | | |
|--|---|--|
| <ul style="list-style-type: none"> 1) Julius Electronics—retail, pg. 57 2) Cybertemps—temporary business help, pg. 57 3) Continental Detective Agency—private investigators for hire, pg. 57 4) Guido's Fashion Trim—hairstyles, pg. 57 5) The Clinic—surgery parlor, pg. 59 6) Protective Lightning—automated security, pg. 59 7) Warder's Travel Agency—travel broker, pg. 59 8) Wilson and Co.—investments, pg. 59 9) Marcini's—expensive, upscale dept. store, pg. 68 10) Grandmill—corporate fantasy/specialty store, pg. 70 11) Fantasy Unlimited—wish-fulfillment service, pg. 71 12) Puddleforge's—used book store, pg. 72 13) Revere Courier Service—deliveries, pg. 72 14) Meridian Square—mixed shopping mall, pg. 72 15) FutSure—investments, pg. 72 16) Barstow Enterprises—trucking, pg. 77 17) Metal Haven—music instruments store, pg. 78 18) All-RX Drugs—pharmacy/chain drugstore, pg. 79 19) Kitty Liquors—discount warehouse, pg. 77 20) Long Last Books—out-of-print, hard to find books, pg. 80 21) Systems Original—software, pg. 79 22) Delany Transport Plaza—car, plane, motorboat sales, pg. 79 23) Parkinson's Place—custom furniture & electronics, pg. 79 24) MacMillian Bldg.—Psychological services, pg. 116 25) Mark 24—major convenience chain, pg. 116 | <ul style="list-style-type: none"> 26) Medical Technologies—cybernetics and body banking, pg. 117 27) C. Donut Express Co.—trucking, pg. 82 28) Chrome Cross—medical equipment, pg. 82 29) Cleanroom—corporate office maintenance, pg. 82 30) SensuTours—travel agency, pg. 84 31) Wierd Stuff—spare parts wholesale/retail, pg. 86 32) United Express—deliveries, couriers, pg. 86 33) Lucky Barber Shop—barber, pg. 86 34) Eastern Star Novelty Co.—exotic toys, pg. 88 35) Blue Light Special Sales—music equipment, pg. 88 36) Argus Inc.—computer software, pg. 117 37) Trauma Team—paramedic pickup, pg. 117 38) REO Meatwagon—paramedic pickup, pg. 120 39) Lombardy Groceries—food store, pg. 139 40) Clothes in Modern—trendy junior fashions, pg. 140 41) Market Drugs—neighborhood drug store, pg. 140 42) Fashion Cuts—hairstylers, pg. 141 43) Pinewood Spa—exercise, pg. 90 44) Pinewood Bazaar—mixed Yuppie shops, pg. 90 45) Mixed artist's coffee and art supply shops, pg. 92 46) Plaza Business Tower—100+ mixed businesses, pg. 104 47) The Balingier Building—mixed financial, pg. 96 services 48) Dean Warner, Inc.—investments, pg. 98 49) Xian Electronic Exchange—personal electronics store, pg. 98 | <ul style="list-style-type: none"> 50) Rael's Bodysculpting and Tattoo—body shop, pg. 98 51) Marshall's Dept. Store—upper-class dept. store, pg. 98 52) 10th St. Center—middle-class minimall, pg. 99 53) The Cavalier—upscale clothing store, pg. 99 54) World Travel Agency—travel brokers, pg. 100 55) Ashcroft & Hammersmith, LTD—luxury dept. store, pg. 112 56) New Harbor Mall—the city's biggest mallplex, pg. 127 57) Wu Chi Lee & son Apothecary—traditional medical and health items, pg. 156 58) Ling Po Imports—Far East exotic and luxury items, pg. 156 59) N:alorian Firearms, Inc.—gun dealer, pg. 163 60) Shaito Imports—Far East import goods, pg. 169 61) Synop-Tel—telecommunications research and invention, pg. 170 62) Deveron Showroom—AV dealership, pg. 65 63) Ron Walker—groundcar dealership, pg. 65 64) Recording Systems—audio electronics, pg. 66 65) Night City Tech Exchange/Everything & More/Mexal Cyberoptics/Psychol-cyberpsychologists, pg. 65-66 66) Michiko's—fashion, pg. 149 67) Hasagumi's Beauty Salon, pg. 148-149 |
|--|---|--|

DATATERM DISPLAY SYSTEM Topic: Parking & AV Facilities

UP

DN

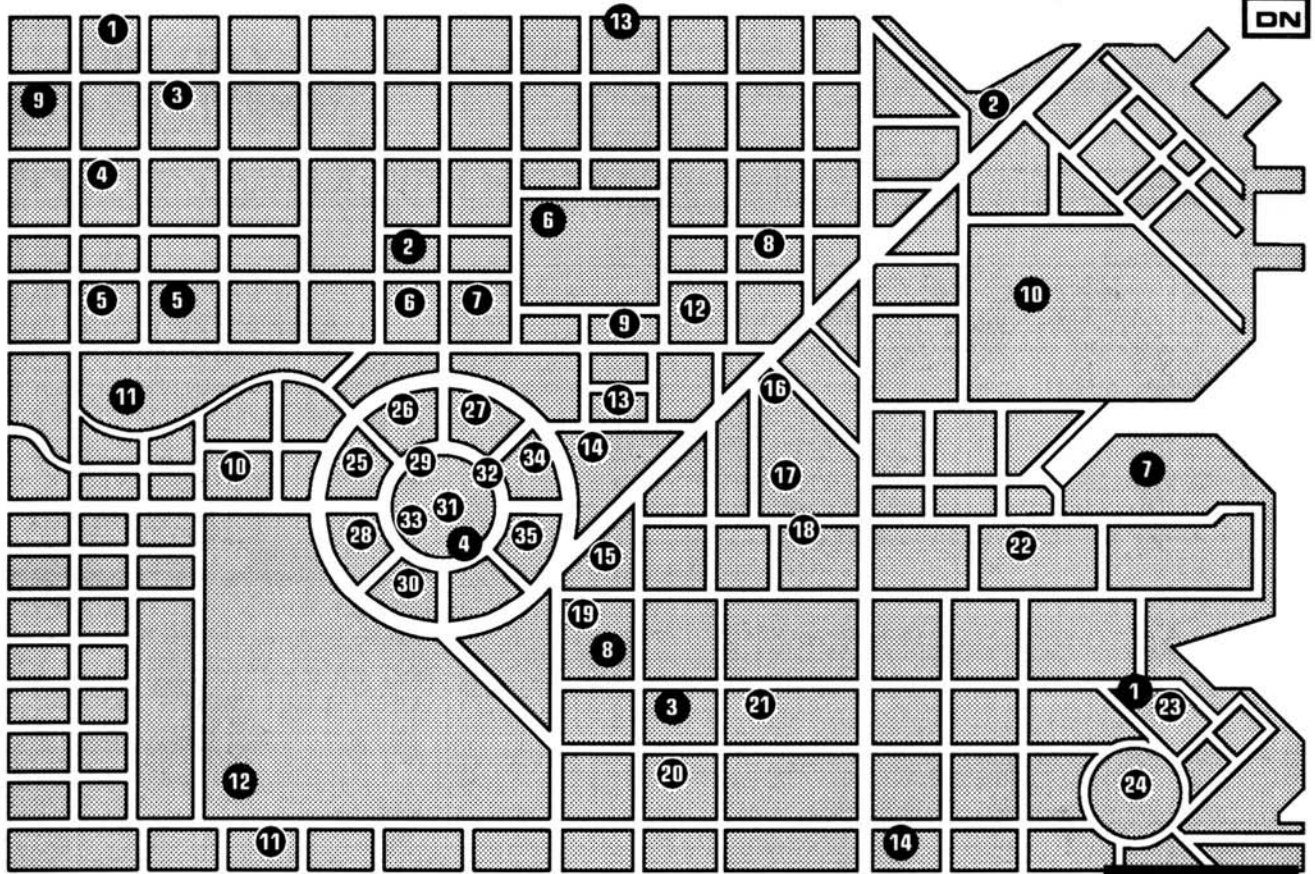

KEY

① Landing Pads

Landing pads marked with a (☆) are private facilities, and public landings are allowed only in emergencies. All public parking facilities are given with the daily fee for their use. Most pads hold @15 vehicles at one time. There is a 70% chance that any single parking facility will be full during the day and a 20% chance at night.

- 1) NCPD Precinct#2 (☆), pg. 57
- 2) Harbormasters office. (☆), pg. 84
- 3) Deveron Showrooms. (100eb), pg 65
- 4) KJBR Studios. (100eb), pg. 59
- 5) Knight-Marriot. (120eb), pg. 93
- 6) CitiBank Tower. (140eb), pg. 110
- 7) Advocet. (110eb), pg. 80
- 8) Grandmill. (140eb), pg. 70
- 9) Parkview. (150eb), pg. 100
- 10) Fire Station #2. (☆), pg. 142
- 11) Muckluck. (☆), pg. 114
- 12) Japanese Consul. (☆), pg. 110
- 13) Ashcroft Hotel. (130eb), pg. 112
- 14) Night City Med Center Annex (☆), pg. 112
- 15) Night City Convention Center. (110eb), pg. 117
- 16) Crisis Medical. (☆), pg. 117
- 17) Medical Technologies. (☆), pg. 117

- 18) Bodakkan. (140eb), pg. 146
- 19) NCPD Precinct#3. (☆), pg. 151
- 20) HighCourt Plaza. (150eb), pg. 155
- 21) City Medical.(☆), pg. 124
- 22) Night City Hilton.(110eb), pg. 166
- 23) Hacienda.(145eb), pg. 168
- 24) Raven.(☆), pg. 101
- 25) MicroTech. (☆), pg.102
- 26) Arasaka. (☆), pg. 103
- 27) EBM. (☆), pg. 103
- 28) PetroChem. (☆), pg. 103
- 29) Net 54. (☆), pg. 104
- 30) Plaza Business Tower. (150eb), pg. 104
- 31) West City Tower. (150eb), pg. 104
- 32) Infocomp. (☆), pg. 106
- 33) WNS. (☆), pg. 106
- 34) Orbital Air. (☆), pg. 106

- 1) Hilton/Hacienda aboveground lots (10eb), pg. 166
- 2) Aboveground parking garage (8eb), pg. 66
- 3) Aboveground parking garage (6eb), pg. 155
- 4) Corporate Center underground lot (10eb), pg 104
- 5) Independent, aboveground parking garage (7eb), pg. 93
- 6) City Center underground lots (8eb), pg. 68
- 7) Mallplex underground lot (5eb), pg. 127
- 8) Bodakkan underground lot (10eb), pg. 146
- 9-14) CitiPark® underground facility(7eb). This is a citywide chain providing parking throughout the Night City Metro Area, including the Airport lots (50eb/day)

① Public Parking

Due to space constraints, most parking structures are underground. Many are operated by a nearby business at a tidy profit). There is a 40% chance that any lot will be filled during the day, and a 15% chance at night.



UP

DN

So What's America Like in 2020?



Gary Stafford. Photo by Alexiz Lork

From Gary Stafford's syndicated column The Real Story

If you listen to the Euro-trash, the United States is a seething hellhole of drug addicts, psychopathic killers and wandering homeless packs armed to the teeth. If you listen to the corporate-controlled media, it's a place of "new challenges and exciting beginnings". If you listen to the punk on the Street, it's neither one, but a mix of both.

Let's take a look at what things are really like, neh?

The Environment

First, the physical parameters. During the last thirty years, a series of ecological disasters has taken the greatest toll on the United State's infrastructure. Global warming has melted much of the polar icecaps, resulting in higher sea level. Large parts of the East Coast and the South are now underwater or partially swampland; New Orleans is on stilts and Houston has an alligator population. Rising temperatures have thawed out much of southern Alaska, central Canada and the upper U.S.; these are the new breadbasket areas, producing the verdant fields of bioengineered grain that is the basis of much of the U.S. economy. However, these same changes in climate have dried up even more areas than they have helped. In the Great Plains and Southwest, whole regions have become desert in only a few years; unhampered by tree cover, violent winds scour the land with driving sandstorms.

The Pacific Northwest has suffered through twenty years of drought-stricken forests and water shortages. From Seattle to San

Diego, the main issue is *water*: how much, who owns it, and where to get more. In Los Angeles, shifting ocean currents have diverted rainfall from the central coast; the result is dense groundfogs mixing with smog to create a acidic, poisonous soup over the LA basin. Only sixty miles away, that same shifting current has left San Diego (capitol of the Free State of Allied South California) a desert city. Night City, straddling the area between NorCal and SoCal, gets a mix of everything—sweltering dry summers and cool, dry winters, punctuated by periodic acid rainstorms and choking poison ground smogs.

It doesn't stop there. Sloppy pollution controls in the latter half of the 20th century left permanent environmental scars. Massive acid-rain stormfronts still batter the Midwest, poisoning drinking water and crops. Two entire regions of the Eastern seaboard are wasteland, as power companies abandoned nuclear reactors during the Collapse and let their contents leak into the water table. Abortive "rock strikes" from the ESA's lunar-based massdrivers have obliterated Tampa and Colorado Springs; the explosive impacts blasted millions of tons of dust and heat into the atmosphere to further aggravate global warming. Toxic spills on both coasts, the dumping of medical wastes from the years of the Wasting Plague; all of these have contributed to a steep die-off of ocean life, including marine mammals, food fish and the phytoplankton necessary to replenish Earth's oxygen supply.

Plagues have decimated large sections of the population; the AIDS problem of the 1990's escalated into the AIDS II crisis of the early 2000's. Stalling by politicians and academic infighting among researchers delayed a cure so long that in the intervening years, the disease mutated to a more virulent form. The Wasting Plague, (now known to be a tailored bioweapon developed by several Arab nations during the Mideast Meltdown), further reduced the population, until it stabilized at its current level of one hundred and ninety-five million people.

The Government

The United States is pretty much a nation in name only. Of its three branches, the Executive Branch is the only effective part of the Federal Government: it controls the military. The Executive Branch is governed by a host of advisors and appointed agency heads; for the last three Administrations, the President has been chosen in a backroom. It doesn't matter, only 12.6% of the U.S. population bothers to vote any more, and that's only in the states that are still part of the Union. Both of the Californias, Texas, Utah, Alaska and Nevada have become what are called **Free States**; they

pretty much set their own rules and write their own laws while giving lip service to the idea of a United States (as long as the honchos in Washington don't try to tell them what to do).

The Supreme Court has absolutely no effect on the laws of the United States; with the resurgence of state's rights, local law supersedes Federal law in all but the Uniform Civilian Justice Code. Congress isn't much better off. Most states don't even bother to send Representatives to the House; there hasn't been a census in fifteen years, and no one can determine congressional districts anymore. There's still a Senate, made up of senators from each state in the remaining Union. Some places elect theirs, others simply keep the same guys in office year after year. Congress' real power comes in its ability to legislate U.S. business and trade law— rules for international corporations operating in the U.S., banking law, communications and transportation law, tradelaws and international tariffs. It's a lucrative position, with the international megacorps trading cash and favors for legal advantages.

Although the U.S. Government doesn't control what happens in the States, it still controls the borders of the U.S. A powerful volunteer military (left over from the Gang of Four days) makes sure of this. The Federal Government has a loose taxation structure to maintain the Washington infrastructure and the military. In practice, each state collects its own taxes, then sends a proportion of its state revenues to Washington. How much varies by the state and its clout in Washington; for example, the powerful Pacific Northwestern states pay high taxes in exchange for nearly complete autonomy, while the economically devastated Eastern Seaboard pays low taxes, but is constantly toeing the Federal line.

The States
Twenty-four years after the Collapse, most States are busy making their own way in the world and thumbing their noses at Washington D.C.

State governments vary wildly all over the U.S. In most of the South, they remain unchanged: good-old-boy networks passing cronyist laws that keep the rest of the population in the dark. In the Pacific Northwest, there are actual elections, complete with campaigns and candidates. The East Coast and Midwest are a jumble of political wards, local machines, and lobbyists for the

most powerful corps and citizens; elections are infrequent and usually corrupt. The Western and Mountain States are probably the most honest; there's not much to steal, and the public has little patience with political shennanigans.

The one thing all of these state governments seem to have in common is a Governor, a State Assembly or some kind of Senate, and *lots* of lobbyists. Having a state capitol is probably a good thing; it keeps the worst political elements in one place where you can keep an eye on them.

All the state governments collect taxes; these are taken directly from the cities, which raise their shares through sales activities. For their tax dollars, most States provide a State militia for defense (usually former National Guard armed with used and somewhat out of date hardware). The Guard is only brought in when a city government has lost control. Some States also maintain freeways, bridges and transportation services. These are usually delegated to the contractor who pays the highest bribe. The Free State of Northern California actually has its own state-run CalTrans department, which accounts for its uniformly well-cared for roads.

Most states still have a State Police; depending on the region, these can be Highway Patrolmen or Rangers who control the freeways but have little authority in the cities (California), or a powerful "State Police Agency" which has spies in every city and has arrest powers in all municipalities. The most extreme examples of the latter are The Free State of Texas' Rangers, and the Southern California Highway Patrol; both are known nationwide as the toughest, meanest law enforcement agencies ever to shine a badge.

The Cities
Good News: Most American cities survived the Collapse. Bad News: Most unincorporated or non-urban areas were obliterated.

The key was inertia. No matter how many problems (economic, social, whatever) a big city had, it had far more resources than a small town. For example: when Seattle's Boeing plant was shut down in 1995, thousands lost their jobs, but others were still working for Microsoft, Equis, Prototech and Arasaka. By comparison, when the Kellogg cereal plant in Battle Creek, Michigan went belly up during the Collapse, the entire town dried up and blew away.

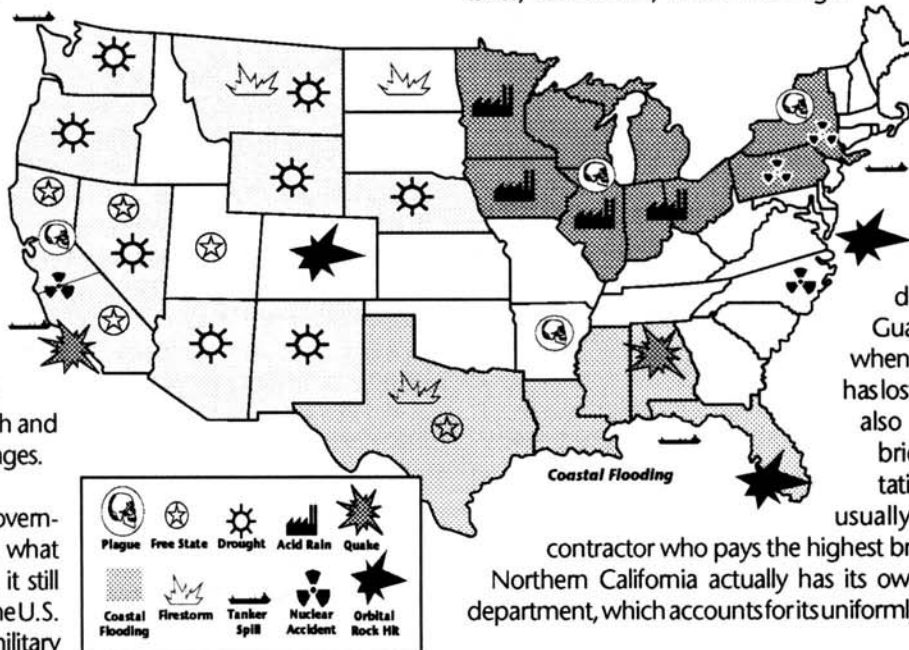

In the economy of urban scale, big is definitely better. Most small towns in the U.S. became isolated pockets in the middle of an ecological wasteland. Some fell to the ravages of marauding nomad packs. Some were wiped out by the Wasting Plague. Still others were destroyed as drought swept through their borders, obliterating farms, homes and businesses. Of the thousands of small, rural towns and cities throughout the U.S., almost 70% have been abandoned or destroyed. As a statistical rule, it seems that if a town had a population greater than 100,000, its chance of surviving the collapse was about 35%, rising 10% for every additional 10,000 people present.

The result was the America of today: a few large, densely packed urban areas, surrounded by vast ecological wastelands, ghost towns, Agricorp farmland and abandoned suburbs. This change in the American landscape has created three distinct types of urban environments; **Old Cities**, **Corporate Cities** and **New Cities**.

Old Cities are urban areas where the economic base was strong enough to weather the Collapse. An Old City is a lot like a late 20th century city; there's a Mayor, Supervisors, a City Council, a School Board, and committees for most civic tasks. Some Old Cities are more corrupt and degraded than others; New York, for example, is a literal hellhole, rife with racial strife, interborough warfare and a government so undermined by corruption that it is virtually paralyzed. On the other hand, San Francisco's civic leaders are relatively untainted, well-organized (some would even say ruthless) and handle their responsibilities with an efficiency to rival many megacorps.

Most Old Cities are pretty much like they were in the 20th century; a mix of old and new buildings, factories and shopping centers. Often, Old Cities have more burned-out tenements, ruined apartment buildings and seedy businesses. But that's only a generalization; some Old Cities are kept scrupulously clean, while others live up to the hellhole image of an American city as popularized by the Euro-media.

One variation of an Old City is the **Neo-Feudal City** or **Ward**. These are cities where one powerful clique or old-boy network controls most of what goes on in the city. In the old days, Chicago would have been a perfect example of this; in 2020, urban areas like San Diego (with its hereditary Mayorality, passed between the four leading families) and Denver (with a ruling oligarchy chosen from the most powerful local leaders), are examples of modern wards.

Corporate Cities are municipalities whose civil governments came apart at the seams during the Collapse. One or more powerful corporations moved in to fill the power vacuum, providing police, fire and medical services in the interim. In some cases, the corporations openly run the city; Detroit, for example, is fully owned by its Corps. They collect taxes for services, establish city ordinances, and contract police and fire departments as needed. In other cases, a corporation controls the city indirectly, financing certain favored political candidates, pushing its own

agendas on crime control, zoning and taxation, and occasionally using strongarm tactics where necessary.

Corporate Cities tend to be kept clean and crime-free in the inner city areas; the Corporate elite doesn't like having to step over dead bodies and trash on the way from the limo to the company skyscraper. Where the corporations don't have a stake in an area, they leave things pretty much alone. This can result in a burned-out battlezone or a nice family neighborhood, depending on the type of residents and their access to defensive firepower.

Where the Corporations aren't able to control the entire city, they sometimes resort to the next best thing, a **Zoned Corporate City**. The entire municipality is broken into heavily controlled areas, often with checkpoints between them, and guards patrolling the perimeters. Chicago is a good example of a Zoned City; each neighborhood is zoned according to the directives of the Corporate Council, and the Combat Zone is actually walled-off from the rest of the city.

New Cities are urban areas established during or after the Collapse. There are a lot more New Cities than you might think, encompassing large tract housing developments, arcologies, and private estates. New Cities are very much a mix of Old and Corporate. In some, the development agency or corporation retains absolute control over all aspects of the government. In others, the occupants of the city hold stock in the development corporation, and vote in new laws the same way they would a board of directors. Still others have been established as religious or philosophical retreats.

New Cities are characterized by modern buildings, urban planning and well laid-out streets. But that isn't a guarantee of a safe, pleasant environment. If the city government is corrupt or its economy unsound, even a New City can rapidly become a rat-infested, crime-ridden scum hole. Night City, for example, began as a planned "model city," but when its visionary designer was murdered by organized crime, it rapidly degenerated into an urban nightmare known worldwide as one of the worst cities of the early 2000's.

City Life Today

The road back from the Collapse has been a long one, filled with famine, plague, violence and destruction. It hasn't been pretty. But it is getting better.

It's Not All Burned Out Tenements and Gangs

No matter what the Euro-media tells you. Even Detroit (voted the Most Dangerous City of 2019 by NET 54's YOU DECIDE! poll), has a few nice areas.

Life in the urban areas depends a lot upon the type of city you're in and where you're living in that city. Some cities, like Detroit and Chicago are urban fortresses; the neighborhoods are broken into walled "zones," and patrolled by heavily armed security forces.

Others like San Francisco and Denver are clean, pleasant places with a booming tourist trade.

Often, the buildings tell the story. Old City buildings are relics of the twentieth century; shambling rococo mausoleums of brick or concrete. New City buildings are modular steel and glass constructs spearing out of the streets below. Both types bristle with a clutter of aerodyne landing pads, solar collector panels, microwave dishes, generator fans and automated weapons pods. Add a few rooftop gardens, and your average city building is a self-sufficient urban module with energy storage, defense and communications systems tacked right on. It isn't always pretty. But it works.

Even down in the ubiquitous Combat Zone (present in every U.S. city), there's more than just trashed masonry. Makeshift rooms are often tacked onto decaying apartments, while burned-out facades hide conapts and studios. Boarded-up windows are quietly guarded by sophisticated personal alarm sensors. Deserted warehouses are converted overnight into loft apartments, twelve person flophouses, and temporary drug and weapons factories. In weed-overgrown vacant lots, local fixers throw up banks of modular living "coffins" for the Streetscum to rent. It takes all kinds.

It's Even Pretty Modern, by Euro Standards

You can expect to find all the modern conveniences of a European city in any major U.S. urban area. Video stations, cell phones, aerodyne vehicles, biosculpt parlors, cyberware—whatever you could expect to find in Paris, you can probably find in Night City as well.

Maybe what bothers Europeans most about American cities isn't the level of technology, but the *amount* of it. Huge videoboards scream from every building. Monster ad-blimps cluster overhead, booming messages down twenty-four hours a day. The streets are packed with pedicabs, taxicabs, metrocars and cyberbikes, while the skies are a maze of speeding aerodynes, helicopters, aerogyros and light dirigibles. There's a screamsheet box on every corner, and a dataterm every block, both surrounded by holograms screeching out the latest headlines.

And the Weather Isn't Half Bad Either

In most cities, the acid rainfall percentage has been steadily dropping. As more and more cars are converted over to non-petroleum fuels like CHOOH_2 and methane, the dense, poisonous fogbanks that used to shroud American cities have become less common. You don't have to buy air on the Street everyday, just during the heat of summer when the inversion layers move in. Winters in the temperate zones are cold, bright and clear. All you have to do is worry about freezing to death as you sleep in your packing case hovel.

American Cities Live by the Rule of the Gun.

A little history: at the end of 1990, the number of murders in the moderate-sized city of Oakland, California, had topped 140. A large number of these incidents involved drug-related shootings, gang turf wars, and vengeance killings. New York was even worse, with 1,905 murders reported in one year alone.

In a depressed urban area rife with gangs, drugs and turf disputes, firefights soon become an everyday occurrence. Eventually, the beleaguered citizens stop depending on the police to defend them and take up arms to defend themselves. This is what has happened in the America of the 2000's; a conversion from a police-based society to an armed society where everyone is responsible for the protection of their own home and property.

An armed society isn't a new thing in America; for most of the United States' history, civilians could and did openly carry firearms for personal protection. Until the 1930's, firearms could be openly carried in major cities. Thanks to two world wars and three lengthy "police actions" in Korea, Vietnam and Central America, a large percentage of the adult male population had carried arms in battle and knew how to use them. In retrospect, the period between the 1930's and the 1990's can be seen as only a brief moment of peace on the American scene. By the late 2000's, it was back to bullets as usual.

An armed society imposes new rules on its urban areas. Certain parts of many cities, for example, have been designated Free Fire Zones; these are places where weapons can be freely used to settle disputes. You shoot first and the cops pick up the pieces later. Urban shootings for self defense are so common that a new device has recently been added to the American combat scene; the gun camera. Like the gun cameras of fighter planes, this takes a picture of what the gun's pointing at when the trigger is pulled. It's no coincidence that in many American courts, a gun camera photo of your (now dead) victim pointing a weapon at you is almost enough to get a case dismissed. The logic is, if he was pointing a gun at you, he knew the risks.

The Wrapup

So much for an overview of the American scene today. But face it, this only describes the America you get from a fast holo shot taken out the window of a speeding AV. It doesn't give you a slice into the minds of the people themselves, just the environment they live in. For that, you'll need to get down on the Street and meet a few. The invitation's open. Don't take the word of the Europress on it. Go on out there and meet the real America today; the people you live with. Get to know them. It's a tough world out there, and you oughta know the neighbors.





Vision & Fire

A Brief History of Night City

by Dr. Edward Michaels Ph.D. Dean of
Night City University

Reprinted from an article in *Night City Today*. Originally uploaded May 17, 2019, celebrating the city's 25th anniversary.

ON the upcoming occasion of our fair city's 25th anniversary, the Night City Historical Society has requested that the University prepare and present a brief, but complete historical reference for the Night City Municipal Library System's database.

It should be understood from the onset that the history of any city (even one as relatively young as our own) cannot be accurately represented in a few datascreens. We recommend that anyone who would like to know more about the history of the City read the following two books, both used as reference in the writing of this article; *2009-2011: The Mob War* and *Richard Night: Visionary*. Both are available from your public library or from any local bookstore.

Night City was incorporated in May of 1994, but its history proceeds that date by a few years. Night City was originally conceived by Richard Night, at the time a young partner in the construction company of *Halsey, Ferris and Night*, a firm dedicated to massive corporate construction projects. With an excellent work record, the firm grew and all three men soon grew rich. However, by 1990, working on mainly corporate-funded projects such as office plazas and banks began to pale, and Night soon departed to found his own development firm, *Night International*.

The Dream City

Richard Night had a dream; a dream of creating the ideal city, a city of the future so grand that all other cities built before or after would be compared to it. His design and vision were immense, and so were the plans he drew up for Night International. The next step would be to secure the staggering

capital that would be needed to finance Night's gargantuan project. Luckily, history and the forces of a collapsing society worked on the wily entrepreneur's side.

With the Collapse, many megacorps were starting to look at establishing their own urban areas; controlled zones free of crime, poverty and debt. City governments would be corporate-run, allowing optimum zoning and no anti-business elements to interfere with corporate growth. Night's plan was tailor-made for their purposes; he provided the design and construction capacities they didn't have, and the megacorps provided the raw cash. By 1992, Arasaka, EBM, and Petrochem had all tossed their hats into Night's ring. Now he needed a place to build.

Coronado City

From the beginning, Night had focussed on the Central California coast; it had seaport potential, rolling hills and the Planetran intercontinental maglev coming closer every day. As fate would have it, while working up the buy-in package for Petrochem, Night discovered that the megacorp owned both drilling rights and most of the land surrounding the moderately populated Del Coronado Bay region. A leveraged 132 million dollar purchase secured the remaining parcels, and by 1993 Coronado City, Night's dream city, was under construction.

Night's plan involved dredging the shallow Del Coronado bay to accommodate bulk carriers, while extending the upper peninsula on which the old town stood with bay-bottom fill. The existing township of Del Coronado, with a population of about twenty-eight thousand, was to be integrated into a picturesque "Old Downtown", while a gigantic Corporate Plaza would become the new nexus of the city. The old suburbs would be merged with larger residential groupings, involving planned growth and preserving the neighborhood feel. The plan was, to say the least, ambitious, and his chances for success small. But he had the best odds money could buy, thanks to the Corporations.

Night Falls

Unfortunately for Night, his story doesn't have a happy ending. During its construction of Coronado City, *Night International* employed a large number of innovative building styles and techniques. This resulted in the exclusion of many "old-boy" companies, including that of Halsey, Ferris and Skiv (Nights old partners, short on money, had unwisely joined with a local Mob figure dominating the NorCal region). During the first four years of construction, there were daily threats against Night's life. A proud and self-reliant man, he typically ignored them. When the threats escalated to the level of sabotage and intimidation, he called in his Corporate allies, who dealt with the threats in a ruthless, but limited manner.

Finally, Night's luck ran out. On September 20th, 1998, he was shot and killed in his penthouse suite at the top of the newly constructed Parkview Tower. Night's killer was never apprehended. In his memory, the newly appointed City Council officially renamed Coronado City as Night City.

Then the scramble for power began.

The next seven years were chaotic as the powers that were battled for control of the City. The corporations controlled the civic government and the Corporate Center; the Mob controlled almost all service-related businesses. The City Police, forced to kowtow to both Mob and Corporate interests, became totally ineffective. During this time, the gangs, backed by Mob and Corporate sponsors, established themselves in the remaining suburbs of the old city; the one area that had never had the chance to be added to Night's urban plan. The result is the infamous Combat Zone of today, with gangs so firmly rooted that the only way to remove them now would be to demolish the entire area.

Mob Rule

By 2005, the Mob had become the king of the hill. The corporations established their strongholds in the outlying "Beavervilles" and their lofty Corporate Plaza fortresses. They had little or no interest in running the City, and the civic leaders were unable to lead without corporate masters to pull the strings and provide the muscle.

The next four years were the "dark ages" of Night City, with more murders in that four year span than there were for most cities in ten. The Mob ruled the city with an iron fist, killing anything in its way. Gang activity was at an all time high—during this time, such notorious gangs as the *Blood Razors* and the *Slaughterhouse* made their debut. Night City soon became the closest thing to hell on earth; a war zone where you were just as likely to have your car blown up as have its radio stolen. The number of unsolved murders documented by the police rose into the thousands.

Mob War

After four years of street warfare, the corporations finally decided they'd had enough. From 2009-2011, during the period of conflict now called the *Mob War*, the corporations battled the underworld for control of Night City. It must be understood that the corporations didn't go to war over such lowly concerns as people or basic human decency. This was business. Like a rival corporation, the Mob had its own goals, and these didn't fit into the Corporate agenda. If the Mob wouldn't play by the rules, the corporations could deal with them on the same level. Led by Arasaka-trained paramilitary troops in assault vehicles, fan tanks and AV combat aerodynes, a wave of bombings, assassinations and outright street battles descended upon the Mob's ill-prepared cadres. When the smoke cleared, the corporations had utterly destroyed the Mob's power base in Night City. From then on, any time the Mob crossed one of the Corps, they made sure to do it by the rules of Big Business.

At the end of the Mob War, the corporations placed a puppet mayor in power and started cleaning up the City. Their draconian policies contributed to the City's now chronic homeless problem—if you didn't have enough money to pay for the renovated version of the place you were living in, you were kicked out by force. This ultimately put hundreds on the street, as affordable housing was upgraded and used to house the troops the Corporations needed to maintain order. In recent years, this situation has eased, as fewer enforcers and security teams are needed to keep the streets safe.

Night City Today

Today, Night City has all but healed from the ravages of its rocky birth. The Corporate Plaza is always beautiful, and the police force has enough power to keep the downtown streets fairly safe during the day. But it should never be forgotten that Night City, like most of America, has devolved into an armed society. It is not uncommon to see as many guns as briefcases on the crowded city streets, and while the days of chaos may be over, the danger remains. Society's rule collapsed before, and may do so again. History *can* repeat itself, and there is always another gang just around the corner, waiting for its chance to come out on top, no matter what the cost.



DATATERM DISPLAY SYSTEM

Topic: The American Scene



UP

ON

People of Night City

From *The Conapting of America* (2020 edition),
by James M. Weiss Jr.

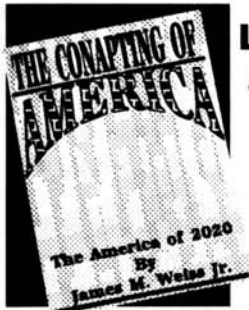

Like a coral reef, each area of the City holds its own type of native lifeform. Some are strong, secretive and deadly: the sharks of the urban future.

Some wrap themselves in the camouflage of the Street, the better to get the jump on their prey. Others go for protection; like hermit crabs, they take their heavy armor and bristling weapons wherever they go. In twenty-first century America, socio-techs and demographics experts recognize seven distinct types of urban reef dweller: *Powerdealers, Corpzoners, Movers, Edgerunners, Mallplexers, Beavers, and Streetscum.*

Let's take a stroll now through the Urban reef. Maybe you'll recognize some familiar faces, or even your own. For whether you live in the shadow of an urban arcology megastructure, or an Agricornp grain storage tower, you'll soon see that in 2020, where you live determines who you are.

POWERDEALERS

Elusive. Powerful. Secretive. Powerdealers are the elite; Corporate Presidents and CEO's of the major multinational corporations, world-famous media personalities, and the most influential of international politicians. Powerdealers live in one-of-a-kind suites at the top of the towering monoliths of the Corporate Center. Lavishly appointed with Euro-designer

furniture, expensive rugs, hardwood floors from the South American rainforests, and the best technotrimmingseuro can command, the world of the Powerdealers starts at the 50th floor and never descends to street level unless the AV-7 is in the shop (then you'll take the armored Rolls fanlimo).

Powerdealers dine in only the best restaurants; the sort where even popular luminaries like Johnny Silverhand can't get in. They maintain expensive yachts, townhouses and island estates all over the corporate world. Their faces are rarely seen, and their movements never reported. They are the rulers of the 21st century; remote, powerful, and guarded by the ultimate in both physical and etheric security.

If you're a Powerdealer—

Where you work: Anywhere you want. You have an entourage of flacks, flunks and freaks just waiting to carry out your orders. Work for you is a telephone call to the president of one of the EuroNations to suggest a change in trade tariffs.

What you eat: Real food, prepared by real people. Beef grown on ranches, guaranteed to be toxic-free. Fruits and vegetables from hydroponic gardens and South American farms.

What you do for fun: Concerts. Operas. Expensive banquets. Occasionally decadent pleasures, like bioengineered sex toys and exclusive bloodsports.

What you buy and where you get it: You don't have to go out to get anything; you demand it, and a flunk goes and buys it for you. When you shop at all, it's at the most exclusive stores, such as *Grandmill* or *Ashcroft & Hammersmith Ltd.* Most of your flacks and flunks spend their time decoding your grunts and gestures, and rushing to get you anything you want, immediately.

CORPZONERS

Corpzoners are executives who've arrived; they live in exclusive apartments in and around the Corporate Zone itself, although

not in the penthouses of the Powerdealers. Whether a townhouse or an apartment, Corpzone living is elegant, and cutting edge. *United Express Delivery*, *Continental Catering*, *Execu-Clean* services are all standard, and most people also have personal servants as well. Corpzoners travel from expensive nightclub to the theater by armored company car, lobby-summoned taxi, or occasionally, AV-7 personal aerodyne. If you don't have a vehicle, you can rent one with driver from *Executive Transportation Services*. If you don't have a date, you can rent that from *International Companion Network* ("Look like a model—or just shoot like one!")

Security is tight, but restrained. Corpzoners don't have to carry ID cards like the Mallplexers; your doorman is trained to know everyone who is everyone in the Zone, and he'd better not screw up and let some Edgerunner sneak into your condominium. In the Zone itself, corporate police regularly sweep the area to roust out the nomads and streetscum: Armed solos and personal bodyguards maintain a vigilant but unobtrusive eye on everything around you. Most buildings in the Zone have remote cameras, but these are trained on the streets, not the expensive windows of the Corporate hierarchy. Many Corpzoners rely on private protection firms like *Arasaka Security* and *Cleansweep Security*.

If You're a Corpzoner—

Where you work: In the Corporate Zone, of course. As a Corpzoner, you're one of the Executives, and you rate a real office with a view over the smog line. For you, working involves making the hundreds of management decisions that control the departments in your megacorp. Unlike a Powerdealer, who makes decisions involving nations, you just have to manage a mere multinational corporation.

What you eat: You actually eat fresh food four nights a week or more. The rest of the time, you're eating the best prepack euro can buy; prepared by name chefs (Grey Clairborne, Misaki Izumiyaki, Enriqu  Sabastiani) and sold out of the best markets. When you have time, you populate the upper scale of restaurants, like *Wing Chang* and *Kilimanjaro Peak*.

What you do for fun: Travel to Europe and the Far East. Vacation at private resorts in Mexico. Watch movies in your private screening rooms. Attend concerts of the latest artists. Go to gallery openings. Play tennis and handball.

What you buy and where you get it: Your suits are *Marcini's* originals, bought at *Grandmill* or *Marshall's*. Your private AV-7 comes from the *Deveron Showrooms*, while your armored groundlimo is from *Weatherford Transport*. Private shopping firms buy gifts for your relatives, while your servants handle your food shopping. Your drugs and vices are purchased for

you by your personal trainers, maids, bodyguards; you never get your fingers dirty.

MOVERS

At the lowest rung of the corporate ladder are the Movers; ambitious young men and women on the way up—fast. The Mover is into housing for status; he wants location, security, and a place to stash the expensive toys required to impress other Movers on the way up.

For a Mover, getting ahead is everything. Competition is fierce; one slip and you could be back in the Services Department and sleeping in the Mallplex. You want to maximize your housing advantage; it's got to be as expensive as you can get, near the watering holes where the senior execs meet, and it's got to have access to housekeeping, food delivery and the drycleaners. After all, you don't have time to cook or clean yourself. You've got to get to the next rung where someone else sends out the laundry and orders your meals.

Movers usually live in cheaper apartments on the fringe of the Corporate Zone. Occasionally, they'll colonize a loft or townhouse near the Combat Zone, but never too far from the most important services, shops and clubs. A typical Mover tactic: three or four low level execs pool their euro and buy a rundown tenement near the Zone, then use their combined resources to convince Company security to "clean up" the surrounding neighborhood. The Movers buy the vacated housing for nada, sell it to other Movers, and the cycle begins again; gentrification at gunpoint. For this reason, an ambitious Mover relocating to an Edgerunner neighborhood is usually cause for alarm (not to mention assassination at the earliest opportunity).

As a Corpzoner, your doorman is trained to know everyone who is everyone in the Zone, and he'd better not screw up and let some Edgerunner sneak into your condominium.

If You're a Mover—

Where you work: In one of the lower offices in the Corporate Center. You have a cubicle at least, with your own terminal and access to the secretarial pool. If you've made Department Manager, you've got an office, a secretary, and maybe a set of company-financed interface plugs for your work.

What you eat: Middlegrade pre-pack, but not by anyone with a name. Most of the time, you don't have *time* to eat any

better; you're on the run to the next meeting or teleconference. When you're home (rarely), you eat more of the same. Sometimes, you spring big-time for real lettuce or meat to impress a client or a date; you've got a "French Chef" MRAM chip just for the occasion. You don't get off on food though; you're after power. Food can wait.

What you do for fun: Any kind of competitive sport (combat handball is a favorite). You exercise three days a week at the club, or run the indoor track. Sometimes you do some drugs: the high speed, dangerous stuff that gets you the edge for beating out the competition at work (those who haven't burned themselves out already). Most of the time, you can be found in expensive watering holes like the *Atlantis* or *Hari-Kari*, slamming down imported alk, working the connections and trying to pick up a sex partner (with a clean biomonitor) for the night.

Edgerunner Fun— avantgarde braindance, arena kill-sports, Neo-primitive artwork, combat dance, violence painting or pure Post Apocalypse nihilism. The moment it's reported on FAX ON FILE, it's history.

What you buy and where you get it: You frequent the more avante-edge stores, where you can get the best gadgets; *Xian Electronics*, *Parkinson's Place*. Sometimes the *New Harbor Mallplex* when you have to pick up something for the parental modules back home. You're always looking for the newest cybergadget, the hottest drug, and the edgiest personal electronics; there's an entire circle of sleek, high priced fixers who exist just to provide you and your friends with new toys to blow your euro on.

EDGERUNNERS

That's probably you. Edgerunners are wealthy and successful members of the Underground City. The Cyberpunks.

Edgerunners make it the unorthodox way: a rockergirl with a string of braindance and holo hits; a well-known and respected solo; a freelance media with a hot show on the vid. You don't often find nomads on this list, unless they're successful smugglers. Fixers make it here as high level talent agents, organized crime chieftains and junk bond kings. The thing that sets Edgerunners apart from the Movers and Corpzoners is their occupations; often illegal or dangerous, Edgerunner money gives their Zones a "here today, dead tomorrow" air of excitement.

Unorthodox jobs mean unorthodox housing and lifestyles. Edgerunners rarely live near the Corporate Zones; the closest

they want to get to the "suits" is an expensive downtown apartment. A lot of them recondition Combat Zone houses, or take over abandoned warehouses and factories. Edgerunner homes are always eclectic; each one shows the unique stamp of its occupant, whether in the African deathmasks smuggled in with a load of autoweapons, or the maximum-edge light sculptures picked up from a fellow artist in the Edge Zone. Edgerunners hang out in the wild clubs; the new places the Movers haven't stumbled on; the places that are still in play. Entertainment? We're talking the latest; whether it's avante-garde braindance, arena kill-sports, neo-primitive artwork, combat dance, violence painting or pure Post-Apocalypse nihilism. The moment it's reported on FAX ON FILE, it's history. And you're outa there.

Security in the Edge Zone is loose and varies from location to location; these are people who don't want to be watched and take violent exception to being restricted in anyway. Cameras, security drones and guard patrols are very rare. Edgerunners are among the most heavily armed segment of 2020 society; the average Edgerunner couple packs enough firepower to waste a boostergang, and has the attitude to use it.

If You're an Edgerunner—

Where you work: Depends. It could be illegal (smuggling, assassination, netrunning, extraction). It could be legal (the music scene, the art scene, or any other free-form creative thing). Doesn't matter; it's considered impolite for anyone to ask unless they know the right passwords and they want to hire you.

What you eat: When you're jacked high, you eat fresh. When you're powered down, it's kibble and canned soy. Most of the time, it's prepack of all varieties; good stuff on the underground market, stolen out of Misaki Izumiyaki's personal warehouses, basic stuff from the corner *FoodStore*™. When you eat out, you eat international; Japanese-French one night, the new Czech-Italian cuisine the next. Food isn't food to you. It's just one more way of defining the Edge.

What you do for fun: Old black and white flat films. Video games. Erotic braindance. Combat handball (you *love* to kick Mover ass). High speed cyberbike racing. Performance art. Hitting the clubs. Destroying the clubs. Experimenting with the latest in "chemical enhancement" (the more outrageous, the better). Taking the megaviolence to the Street and raising the Body Lotto® count. You know. Things.

What you buy and where you get it: Anywhere except *Grandmill* (where the Corporate Dead shop). You know all the hole in the wall shops where the underground market sells things. Weapons. Black cyber and software. You know. Things.

MALLPLEXERS

The Mallplexes are either mini-arcologies or mega-shopping malls; no one's sure exactly which. Most began life as heavily secured urban shopping malls around large, corporate-owned chain stores. Later, a business office tower would be added, followed by residential condos and apartments. By the early 2000's, Mallplexes were established in most American cities: Through the Collapse, they remained heavily patrolled citadels of capitalism, impervious to gang warfare, food riots and urban decay.

The stability of the Mallplexes wasn't without a cost, however. As more and more corporations used the Mallplexes as urban fortresses, that paramilitary mentality began to govern their construction. Mallplex walls became impervious to anything short of an ICBM strike; sophisticated sensors and Apex automated weapons systems swept the surrounding streets. Mallplex cops became feared throughout urban America as the most draconian police forces since the Nazi *stürmtuppen*. Inside the Mallplexes, crowded living conditions reduced the average condominium apartment (or conapt) to a single 12'x10' room with attached bathroom facilities, built-in furniture, and white walls. For extra, you can even rent a window conapt with a real 3'x5' window!

Mallplexes are home to the majority of the struggling middle class of the 21st century. Low level managers from the megacorps, service technicians in semi-skilled jobs, secretaries and clericals, salespeople from the mall and surrounding business; these are a typical cross section of Mallplexers (as they're derisively tagged on the Street). Packed two to five people deep into small, antiseptic studio apartments, Mallplexers are the faceless hordes of the urban jungle.

Night City's Mallplex was officially established in 2010 as the *New Harbor Shopping Redevelopment and Residential Complex*; most citydwellers simply call it the New Harbor Mallplex. Built on the ruins of a previous shopping center destroyed in the 1990's, it is home to roughly ten thousand inhabitants, as well as service workers and salespeople. The Mallplex is huge; it contains hundreds of conapts, stores, recreational complexes, schools, broadcast stations, its own fire department and a private police force. Most of the residential and government offices are on the upper floors; a pass card is required to enter any area except the two ground levels (which are open to the public at large). Access to Mallplex pass cards is tightly controlled; a lost or stolen card carries a 1,000eb replacement fine; second offenses will result in automatic eviction from the Mallplex.

If You're a Mallplexer—

Where you work: If you're lucky, in a clerical job in the Corporate Center. If you're not so lucky, in any one of a million boring sales, service or clerical jobs throughout the

City. At the lowest end of the scale, you work in the Mallplex itself, moving boxes, selling vids to Beaver brats, or flipping soya burgers in the Food Court.

What you eat: Reprocessed soy formed to look like restaurant food. Low grade pre-pack: the stuff in yellow packages that say "FOOD" on the front. During a bad week, kibble. You knew someone who ate fresh once. He still talks about it.

What you do for fun: Watch the vid. Hit the arcades, play a few games, jack into the latest Slade McCallahan braindance. Hang out at the Mall. Join a juviegang and raise a little hell.

What you buy and where you get it: The Mall. It's cheap.

BEAVERS

A derogatory Streetslang word derived from *Leave it to Beaver* (an old 20th century vidshow). Beavers are the suburbanites of the 2020 decade. Made up of low-level corporate managers, mid-level Executives and high-level techs, "Beavs" live in Corporate-owned and controlled housing developments on the outskirts of the urban area. Corporate-controlled is the watchword here; minicams mounted on every light pole continuously monitor the perfectly manicured greenbelts and hundreds of identical single-family homes, while Corporate Police vehicles patrol the miles of wide, landscaped streets. If you're an Edgerunner, you'd be smart to stay clear of Beaverville; the Corporate Police will usually run you out of town after dark. If you're Streetscum, you'd better not show your face around here at all; they're constantly building in Beaverville and the landfill always has space for another body.

Around the Night City area are several Beavervilles; home to the thousands of drones who man the keyboards of the Corporate Center. Given picturesque names like WestWind Estates (In Pacifica), The Oaks (Northoak), Apple Corporate Valley (Heywood), Del Coronado Harbor (Rancho Coronado) and Executive Estates (Westbrook), they are all connected to the Corporate Center by various private maglev lines. These

As a Mallplexer, you eat low grade pre-pack: the stuff in yellow packages that say "FOOD" on the front. During a bad week, it's kibble. You knew someone who ate fresh once. He still talks about it.

lines enter the City through the lower level of the Night City Transit Center. To enter a Beaverville train requires a special pass card which is keyed to each Corporate development; riders must pass through an entry gate constantly scanned by security monitors. All of the Night City Area Beavervilles are within twenty minutes of the City.

Life in Beaverville isn't *unpleasant*. It's very clean, quiet, and a great place to raise a family. Maybe the neat, orderly procession of shopping center, housing tract, shopping center and park bothers the Edgerunners, but to a Beaver, it's a lot better than living in the Mallplex. The homes are relatively comfortable (if a little small), inexpensive (the low rent is automatically deducted from your salary), and easy to keep up (corporate maintenance services are available at a nominal fee). There *are* some class divisions; Executive homes are clustered in one area and have rents strategically set to be outside of a Manager's salary. Most upper management lives outside of the Corporate Development, but the Developments are open to all races, creeds and colors. Just as long as they work for the Corporation, that is.

When things get too bad...the Corps send a few ops squads in to "clean things up". ...the boosters fight back, and the whole thing disintegrates into a free-for-all terrorfest with the bodies piled man-high.

If You're a Beaver—

Where you work: In the Corporate Center as a midlevel manager, or at one of the Corporation's subsidiaries around the City. You have a desk, a terminal, and maybe even an office. You're sort of like a Mover with a family and a lot less social life.

What you eat: Middle of the road pre-pack. Sometimes you blow out the family budget and buy some real meat steaks for you and the spouse and hamburgers for the kids. You don't have to worry about eating kibble; the Corporation makes sure of that by providing supplementary food coupons for employees.

What you do for fun: Picnics in the greenbelts and parks around your housing tract. Watching the video with the family. Softball games.

What you buy and where you get it: At the local, corporate-owned mini-mall in your suburb. Sometimes you pick up something nice for the family at the *New Harbor Mallplex*. You once went to *Grandmill* to buy the spouse a new outfit for a Company dinner.

STREETSCUM

They call themselves Streetscum; the urban poor who can't make the rent on a Mallplex conapt. Most live in the Combat

Zone, clustered in decaying, half destroyed tenements. Those are the lucky ones; the unlucky ones are crammed into 6'x3'x3' "coffins"— ubiquitous sleeping cubes erected as mass storage modules for the millions of homeless littering 21st century America. The really unlucky are living right on the street, in packing crates, under overpasses, and in dumpsters.

Not all the Streetscum are victims; a lot of them are the victimizers. The Combat Zone is the home of the worst gangs: mondo cybered-up boosters, screaming dorphers, crazies, culties, killers, hate groups— you name it. The chromers and posers stay uptown with the Edgerunners, Corpzoners and Movers. Down in the Combat Zone, the gangs play for *keeps*.

Security? Dream on. The City police don't even make patrols down here in the Combat Zone. The Corporate Law rounds up the worst of the scum and dumps it down here with suggestions like "Don't let us catch you uptown again, scumbag." There are a few places where the City or the ruling corporations have mounted minicams up on high steel poles, but the scavengers usually tear them down and sell the cameras, pole and all, for salvage. The minicams hidden on the sides of buildings are sometimes

missed, but hey, no one's watching the monitors anyway, right?

In the worst cities, ten foot high concrete walls divide the Combat Zone from the rest of the city. Heavily armed checkpoints straddle the few streets in and out, while AV-4 patrols sweep overhead pinning the inhabitants in the glare of arc-spots. When things get too bad in the Zone, the Corps send a few ops squads in to "clean things up". Or maybe the boosters fight back, and the whole thing disintegrates into a free-for-all terrorfest with the bodies piled man-high.

You know the drill here in the Combat Zone. Stay low. Take no risks. Survive as long as you can. One day, you're going to get your hands on the power; the cyber and weapons you need to take back the Street. One day, the Streetscum will rise and conquer the City. You plan to be there.

If You're Streetscum—

Where you work: Work?

What you eat: Kibble. Canned soy. Rats.

What you do for fun: Drink Smash™. Do cheap drugs. Get together with your choombas and do the megaviolent thing on the losers in the tenement down the Street.

What you buy and where you get it: You steal it.



Threat Level, Threat Codes & Security

Threat Level is a NCPD term used to define the level of deadliness of an opponent. It is rated from AA to E, AA being rated the most deadly and E being the least. Along with the threat level rating, NCPD uses a code that uses a combination of letters and numbers to designate the combat capabilities of an opponent. This code is called a Threat Code.

When dealing with building security and defensibility, the NCPD assigns each building in the City with a Security Level. The Security Level is a 0-4 digit code, corresponding to the level of stationary security measures a building or compound will have available.

Threat Levels

In Night City, Threat Levels and Threat Codes are used to profile some of the many armed opponents encountered within the City. This system also provides a simple way for Referees to measure the danger level of any opponents the players may face. The Threat Level and Threat Code system described below is a compact and simple way to create mass gangs and other organizations for *Cyberpunk*.

- AA- Special combat troops, elite solos and elite corporate troops, Psycho Squad.
- A- Military troops, SWAT, corporate high security troops.
- B- Corporate security troops, corporate bodyguards, experienced solos.
- C- Armed corporate guards, average solos, city police.
- D- Boosters, novice solos, non-corporate security guards.
- E- Unarmed door guards, street thugs.

Threat Codes

After the basic Threat Level of an opponent is assigned, the next step is to delegate a three character alphanumeric code, representing in order: **Skill, Availability of Weapons** and **Type of Armor** the opposition has access to. To determine the code characters, use the following tables.

1. OPPONENT'S SKILL

Note: This table assumes an 8 REF and a 7 Body Type

- E- Novice: (2 pts. in weapon skill)+(8 Reflexes) = skill roll of 10
- D- Average: (4 pts. in weapon skill)+(8 Reflexes) = skill roll of 12
- C- Above Average: (6 pts. in weapon skill) +(8 Reflexes) = skill roll of 14
- B- Experienced: (8 pts. in weapon skill)+(8 Reflexes) gives a skill roll of 16
- A- Veteran: (10 pts. in weapon skill)+(8 Reflexes) = skill roll of 18

2. WEAPONS AVAILABILITY

- 5- Bare hands, improvised weapons.
- 4- Melee weapons, small pistols.
- 3- Large handguns, bolt-action rifles, etc.
- 2- Automatic weapons.
- 1- Assault weapons, exotic weaponry (monoblades, lasers, etc.)

3. ARMOR AVAILABLE

- E- Normal clothing (SP 0-3)
- D- Leather to kevlar vest (SP 4-10)
- C- Light armor jack to heavy armor (SP 10-20)
- B- Door gunner to Metal Gear (SP 25)
- A- Power-assisted Armor (SP 30)

Thus a boostergang whose members have a Weapon Skill roll of 10, use small handguns, and are armored with Kevlar vests would be represented by the Threat Code **E4D**.

Security Levels

The basic security level of a building or buildings is based on a combination of the Threat Level of the guards, combined with the type and number of security systems the location possesses. This is expressed as a 0 to 4 value, as in **2-Corporate Standard Security** for example. Numbers in parentheses (next to locks or other traps) represent the Difficulty Number needed to bypass that particular alarm, trap or lock.

0-Personal Security

- Locks: Mechanical locks (10)
- Traps: Alarms (15)
- Monitors/Sensors: None
- Guards: None
- Patrol Size: None
- Vehicles: None

1-Private Security

Locks: Simple Electronic Passkey (20)
Traps: Alarms (20)
Monitors/Sensors: Recording Cameras
Guards: Threat Level C Guards
Patrol Size: 1-2
Vehicles: None

2-Corporate Standard Security

Locks: Complex Electronic Locks and/or Traps (25)
Traps: Alarms (25)
Monitors/Sensors: Monitor Cameras checked every five minutes
Guards: Threat Level B Guards, Dogs
Patrol Size: 2-6
Vehicles: Patrol Cars, Autogyros

3-Corporate High Security

Locks: Highly Sophisticated Locks and/or Traps (30)
Traps: Incapacitating (25)
Monitors/Sensors: Monitor Cameras checked constantly
NET Security: Black Programs only
Guards: Threat Level A Guards
Patrol Size: 5-10
Vehicles: Vehicles up to AV-4 level

4-Corporate Maximum Security

Locks: Top Security (35)
Traps: Fatal (30)
Monitors/Sensors: Monitor cameras+IR sensors checked constantly
NET Security: Black programs, netrunner guard
Guards: Threat level AA guards, mobile robotic systems
Patrol Size: 7-15
Vehicles: Vehicles up to AV-6 level

Night City Security

Listed below are six of the best security forces in the City, provided to give a scale to the operations that go on in the City from day to day. These are also the organizations who will most often be set up as opposition to a given player character group, and may be used to model other security force opponents.

Night City Police Department (NCPD): The police forces in Night City are very formidable indeed, equipped with state of the art armor and firepower, and with excellent training. The weakness of police comes from lack of numbers; there are simply not enough of officers to cover all the crime on the streets, plus a continuing problem with graft and corruption. As a result, only high-profile criminal activities, or those unable to be hidden from the ever vigilant media, get full police attention.
NUMBER OF AVAILABLE AGENTS: 1800 (Including all administrative.)
THREAT LEVEL: Basic Officer C, Cyberpsycho Squad A
THREAT CODE: B2B

Arasaka Security: The best security money can buy. State of the art weapons and technology, combined with a unique singlemindedness makes Arasaka Security worth their gigantic employment fees. Totally mercenary, these forces can always be

counted on to fulfill their contract—no more, no less.

NUMBER OF AVAILABLE AGENTS: 1000 (with capacity to call in another 3000 within 2 hours)
THREAT LEVEL: Basic Agent C, to Elite AA
THREAT CODE: A1A

The Max's (NCU Campus Police): In the old days campus security consisted of 4.75eb an hour rentacops, drinking coffee in the cafeteria and watching the coeds walk by. No longer. The University Police (affectionately dubbed the "Max's" by the students) take the job of campus security very seriously. Easily a match for any gang, and probably a match for most corporate security, the Max's patrol the campus year-round, 24 hours a day. If you run into problems on-campus, the Max's will always help. However, off-campus they have no authority and will usually call in the NCPD if possible.
NUMBER OF AVAILABLE AGENTS: 110
THREAT LEVEL: A
THREAT CODE: B2B

Hacienda Security: With perhaps the finest non-corporate force in the City, the Hacienda is well known for its tight security. The success of the Hacienda is due to the high-level training each agent receives, and a strong personal loyalty to the man who commands the group, ex-solo Andrew Scythe. Andrew has hand-picked and personally trained every man on the force. This, in combination with the large amount of money owner Isabel Vargas has invested in the force, makes the Hacienda one of the single best protected buildings in the entire City.
NUMBER OF AVAILABLE AGENTS: 100
THREAT LEVEL: AA
THREAT CODE: A1B

The Harbor Police: Perhaps the only "incorruptible" City-run police force, responsible for the Harbor districts of Night City, including the San Morro Bay cargo port. The Harbor Police are a rough and independent lot, resembling a combat gang more than a police organization. They strictly enforce the law, and will go to any extreme necessary to see that the law is upheld. Thanks to this, Harbormaster Mahan Jones, the leader of the Harbor Police, is intensely disliked by City Hall, and there have been numerous unsuccessful attempts to replace him with a "more cooperative officer".
NUMBER OF AVAILABLE AGENTS: 50
THREAT LEVEL: A
THREAT CODE: B1A

Militech: This arms corporation is in constant competition with Arasaka, and there is no love lost between the two rivals. Often, running gun battles are the result of these "business" clashes. Militech does not have the raw manpower available to Arasaka, but does have the advantage in equipment, thanks to its pre-eminence as an arms manufacturer. It should be noted that Militech supplies most of the NCPD with their equipment, and the Police Department is often forced to overlook "small" indiscretions on the part of the corporation.
NUMBER OF AVAILABLE AGENTS: 850 (can airlift in another 1,500 in two hours)
THREAT LEVEL: A
THREAT CODE: A1B

DATATERM DISPLAY SYSTEM Topic: The Gangs of Night City

UP

DN

THE GANGS OF NIGHT CITY

The streets of Night City are alive and crawling. With gangs.

By day, the Street is the province of Corporate movers and commuting Beavers. But at night, the predators slither out from under their rocks and trash heaps, and the City howls.

Call them gutterats, night crawlers, trash or streetscum; the gangs are the ultimate rulers of the city's night. Whether it's a small pack of a dozen, or an army of two hundred, each gang in Night City is as diverse as the Street itself; guardians, chro-mers, dorphers and freaks, all thrown together in a lethal cocktail, mixed and sprinkled liberally with blood.

Following is a list of some of the gangs in Night City, from the harmless to the truly psychotic. Know them and fear.

DATATERM DISPLAY SYSTEM Topic: The Black Queens

UP

DN



This gang has staked out "The Hole" at City Center as its home turf. Rather harmless in this violent day and age, the Black Queens are a small-time gang of street hoodlums. Deep in the middle of Sacred Blade territory (the Blades consider B.Q. members to be "beneath a warrior's notice"), the gang has no regular enemies, and are rarely, if ever, involved in any turf struggles.

Big time crime to the Queens is having an occasional member turn tricks as a joygirl or sell cheap drugs to local businessmen. Since none of the drugs have gone bad yet, the N.C.P.D. leaves the Queens pretty much alone.

But the Queens can be useful at times. Scattered throughout City Center, they are often a very good information source for the area, and both the local cops and corporate police have taken advantage of this in the past. As long as they're paid for the work, the Black Queens will be happy to do your job.

Switchblades are the only weapons carried by low-ranking gang members (if any weapons are carried at all). Firearms are reserved for the ganglords. Gang membership policy is open, but in general, the Queens shy away from violent, highly combative people.

Tag: A black crown with a capital "B" superimposed over it. Always in black spray paint.

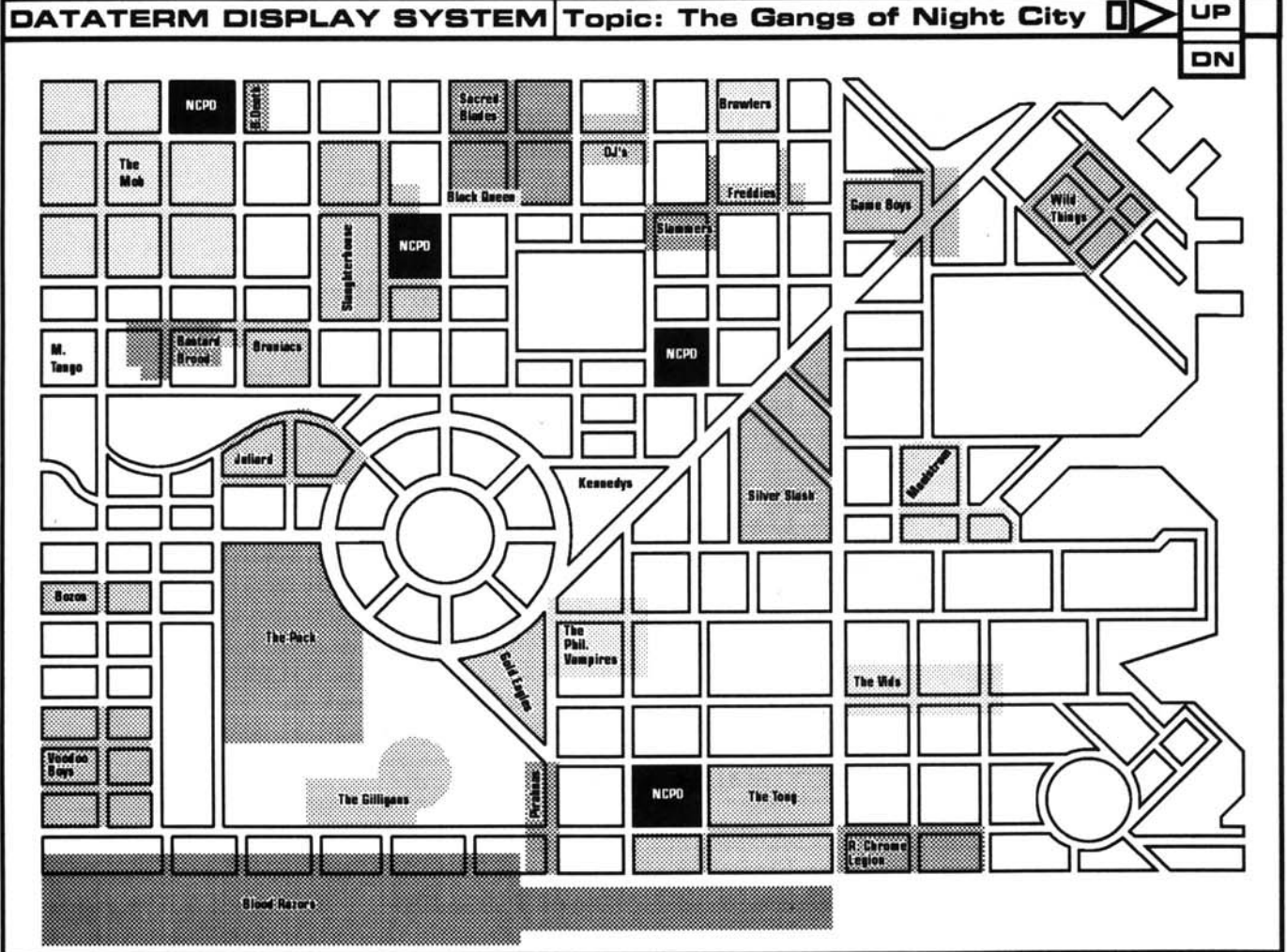

Colors: All-black clothing. Members dye their hair to match. Any makeup worn is also black.

STATS FOR AN AVERAGE BLACK QUEEN MEMBER.

INT 7, REF 7, TECH 4, COOL 5, ATT 6, LUCK 6, MA 4, BODY 6, EMP 7,

SKILLS: Melee Weapon 3, Stealth 4, Streetwise 3, Fast Talk 2, Gamble 1, Dance 2.

CYBERWARE: None



There are about one hundred 'dorpher gangs in Night City, sharing drug sources and quick (illegal) ways of raising funds for more drugs. Mostly clones of each other, they burn through their members as fast as their bodies fail and leave space for the next fresh 'dorphhead.

The Wild Things are distinctive because they are survivors. Initiation is only



open to seasoned 'dorphers who are known on the streets, and who have been on the streets for a year with another 'dorpher gang.

The Wild Things claim the entire East Marina as their exclusive territory. They've been in some small battles in the recent past, but are not involved in any turf wars at this time. Unlike most dorpher gangs, these guys are not pushovers. With a street-tested membership, the Wild Things are bad company; cynical and predatory. They've been around a *long* time.

Tag: A red circle with a white dot in the center.

Colors: There is no uniform for the Wild Things; they all know each other and they *know* who belongs in the East Marina. Members are allowed to carry any weapon of choice, including firearms. When a crime is committed, the gang gets 10% of the take; the rest goes back to the individual members involved in the action.

STATS FOR AN AVERAGE WILD THING

INT 5, REF 4, TECH 6, COOL 6, ATTR 6, LUCK 8, MA 7, BODY 5, EMP 6

SKILLS: Locate Drug 9, Pistol 3, Rifle 2, Melee Weapon 2, Streetwise 6, Fast Talk 2, Stealth 1.

CYBERWARE: 20% chance of random implants.

DATATERM DISPLAY SYSTEM Topic: The Brainiacs



The Brainiacs are the thinking man's boostergang, always choosing skill chips over other, clumsier cybernetics. They live for knowledge, and are willing to obtain it in any way possible. It is believed that upper level members of the gang are so enhanced that they have become walking computers, hovering on the edge of cerebral cyberpsychosis. If you've got a new skillchip the Brainiacs haven't seen before, getting their help will be a cakewalk.

Generally not as violent as your average boostergang, the Brainiacs can be just as deadly, preferring elaborate traps or complicated schemes, to killing their victims outright. The Brainiacs almost wiped out a chapter of the Blood Razors once by "arranging" for their rivals to cross paths with a heavily armed Arasaka security force.

Despite multiple attempts by other gangs to wipe them out, the Brainiacs have always outsmarted their opponents. This savvy's earned them a measure of respect in other places besides the Street; high-ranking Brainiacs will occasionally hire themselves out to corporations for a few weeks to gain supplemental income.

The Brainiacs claim a group of blocks north of the Corporate Center as home. They're not involved in any turf wars right now, but are hated by most other boostergangs in the City (who will kill any Brainiac caught alone).

The Brainiacs will only take new members that pass a rigorous IQ test. (applicant's INT is 9+)



Tag: Stylized human brain, usually burnt into something with a laser cutter.

Colors: The only mark of a Brainiac is a small, easily hidden silver coin worn around the neck. Each coin has the member's name on the back and the Brainiac tag on the front.

STATS FOR AN AVERAGE BRAINIAC.

INT 9, REF 6, TECH 8, COOL 6, ATTR 7, LUCK 6, MA 6, BODY 6, EMP 3

SKILLS: Skills for a Brainiac differ from person to person, but each will always have one personal speciality chipped to 10, and two others chipped to 6. Most members have Knowledge skills in the 5-7 range.

CYBERWARE: Any and all possible skill chips.

DATATERM DISPLAY SYSTEM Topic: **The Slaughterhouse**



Among the many boostergangs in the Northside District, the Slaughterhouse are considered the worst of the bad news, specializing in rippers, vampires, and any other cybernetic implant that is long and has a sharp edge. Most hardcore members skirt the edge of cyberpsychosis, and will kill at a moment's notice. If not for a lack of initiative, the Slaughterhouse would be the most dangerous gang in the city, freely committing crimes ranging from armed robbery to first degree murder.

For some time, this gang has been in an ongoing war with the Sacred Blades; both groups hate each other and will attack on sight. Most other gangs in the immediate area are afraid of the Slaughterhouse, and leave them well alone.

The Slaughterhouse's only membership requirements are a desire to pack as many blades into (or onto) your body as possible, and a total disregard for human life.

Tag: A butcher knife done in red.

Colors: All members of the Slaughterhouse wear black and red leathers. They also make a great show of their ripper implants, popping them in and out at random in public places.

STATS FOR AN AVERAGE MEMBER OF THE SLAUGHTERHOUSE.

INT 5, REF 9, TECH 7, COOL 7, ATTR 5, LUCK 5, MA 8, BODY 8, EMP 2

SKILLS: Melee Weapon 9, Stealth 4, Intimidate 9, Awareness 5, Endurance 6, Martial Arts (Karate) 5.



CYBERWARE: Anything on the implant list; the higher the level in the gang, the more implants.

DATATERM DISPLAY SYSTEM Topic: **The Back Alley Brawlers**

UP

DN



This protective "gang" was created when the Slaughterhouse went on a killing spree at the local subway station a few years back. By the time the cops arrived, the gang had killed over two dozen people. The Back Alley Brawlers were formed in reaction to this bloodbath, and have been at war with gangs like the Slaughterhouse ever since.

The Brawlers are old fashioned vigilantes (good-hearted street toughs helped out by the occasional well-armed businessman, retired solo, or local juvieganger), fighting fire with fire. Most gangs in the area avoid the Brawlers, hoping someone else will take them out, But so far no one has been able to do the job.

There are unsubstantiated rumors of Brawlers running a protection racket in the area. But the NCPD chooses to ignore this darker side of the gang in light of their positive effects. Membership is open to anyone who can take care of themselves on the Street, and are willing to help.

Tag: "If you're going to do it, make sure we don't find out." Spray painted in white.

Colors: The only piece of uniform clothing the Brawlers wear is a black beret.

STATS FOR A BACK ALLEY BRAWLER.

INT 7, REF 7, TECH 5, COOL 8, ATTR 6, LUCK 5, MA 6, BODY 7, EMP 8

SKILLS: Brawling 7, Melee Weapon 6, Martial Arts (Random) 3, Handgun 3, Streetwise 4, Stealth 4.

CYBERWARE: Any combination (or none), depending on the individual member.

DATATERM DISPLAY SYSTEM Topic: **The D.J.'s**

UP

DN

The D.J.'s claim to fame is their musical ability. Too bad they don't have any.

A "Born to Lose" Chromer band toting overpriced boom boxes and synthetic instruments, the DJ's are mostly a pack of wanna-be rockerboys (ages 15 to 20), choreographed by an equally no-talent leader dubbed Johnny B. Good. Small time larceny, ticket scalping, fake rock star autographs and bootleg music chips are the DJ's forte, and pays for their expensive musical toys.

The D.J.'s inhabit squalid basement digs under the floor of Kitty Liquor, trading minor street muscle for living space. Their tech, Rif, handles the forging and bootlegging activities from the basement (which contains a formidable stash of equipment). Their only big worry is what to do when they run across a more dangerous gang with better pitch.



The DJ's occasionally extend some protection to Metal Heaven in the hope of hi-tech handouts from that musical mecca. They're also not above planting a few nubile DJ's outside Metal Heaven just in case any local celeb drops by for new strings or some disposable groupies. (The high point of the DJ's career came a couple years ago when a few of the ladies got to party with Johnny Silverhand. But you can't build a gang rep on just one night.

If you can stand their musical assault, the D.J's can tell you where the Rock action is in Night City. They can also tell you where the after gig parties are, and where the Rockerboys hang out (of course, this doesn't mean they can get you in!). They can even sell you a ticket cheap...if you don't mind a 40% chance that you're not the only person who paid for that seat. Watch out for the brand-new "autographed" pictures of James Manson.

Colors: a red silk scarf tied midway up the right upper arm

Tag: electric guitar and slogan "Elvis lives"

Average Member:

INT 6, REF 6, TECH 7, COOL 5, ATTR 8, LUCK 4, MA 6, BODY 5

SKILLS: Play Instrument 1, Wardrobe and Style 4, Streetwise 5, Persuasion and Fast Talk 7, Perform 3, Brawling 7, Dance 7, Handgun 4.

CYBERWARE: Random, varying on individual member taste. Look out for the neon musical tatoos.

DATATERM DISPLAY SYSTEM Topic: **Maelstrom**



This combat gang has formed around the remnants of the Metal Warriors, a gang virtually wiped out in one night by the Inquisitors. It has since drafted members of the Red Chrome Legion and Ironsights who have violent personal grudges against the Inquisitors (although other targets are randomly savaged as well). Members dress in the traditional black leather and chrome, sport visible cyberwear and simply look dirty, primitive and dangerous. Maelstrom's leader, Hammer, was originally thrown out of the Metal Warriors for breaking their combat code—now anything goes. About 30% of the gang are registered cyberpsychos, and another 35% are hovering near the edge. If you're being chased by Inquisitors you might be glad to see these guys, but that's the only time.

Recently Maelstrom has taken over the deserted building that used to be Barley's, on the west side of town near the docks. They have made this area their turf, but the situation is volatile at best because of the large number of businesses in this area serving the covert needs of corps and solos. The gang is bright enough to realize this, and choose the targets of their "business security charge" visits quite carefully (observers still can't understand why Maelstrom has never put the squeeze on the three elderly ladies who run R, D & F Floral Creations). Other than nighttime sweeps for Inquisitors, the gang is into small-time crimes, but a need for new cyberware and combat drugs threatens to drive them to hit larger targets (like Guevarra's, the Mexican restaurant where weapons are dealt out the back door). If this happens, expect



a bloodbath as the professionals are pitted against the cyberpsychos for the best two out of three.

Colors: Black leather and chrome chains, studs etc.

Tag: a fist clenched around handle of an old-style hammer, in a whirlwind.

Average Member:

INT 5, REF 8, TECH 4, COOL 6, ATTR 4, LUCK 6, MA 6, BODY 9, EMP 3

SKILLS: Handgun 6, Rifle 6, SMG 3, Brawling 5, Melee Weapon 5, Weapon-smith 5, Endurance 5, Strength feat 4, Streetwise 5, Heavy Weapons 4, Cybertech 2.

CYBERWARE: The average member has at least 4 cyberenhancements of one sort or another. The external ones are frequently chromed.

DATATERM DISPLAY SYSTEM Topic: **The Silver Slash**



The Silver Slash is a guardian Chromer gang named after the popular metal band. The band's first single in 2017, *Stand For Your World* (an anthem with lyrics in English, French, Swahili and Japanese) was a raging platinum hit worldwide and put many people onto positive action in the streets.

The Silver Slash is an example of people deciding to "act locally" by taking responsibility for public safety in the Medical Center area. Any number of people arrive each day at the Night City Transit Center knowing nothing about Night City; these people are perfect targets for street gangs. In addition, the Children's Hospital, the Convention Center, and a few local night spots also draw in people who would be hard pressed to fight off a booster attack. The Slash protects these people and keeps the streets around the Med Center safe.

The Slash and its guardian status are recognized and accepted by the Night City Police. As a showpiece group for city reformers, they get a lot of press. Victories are high for the Slash and mortalities are low, thanks to tight organization and a training program which is long on martial arts and subdual, but also includes deadly force.

Group headquarters is a room at the Bay Bridge Residential Hotel, provided free of charge by the management in return for protection. It is a pretty well known secret that the gang is subsidized by local businesses who wish to keep the area safe without goon squads or Arasaka-style killer security. Among these "concerned citizens" are the Grand Illusion, Argus Electronics, Hotel Hamilton, and others.

Gang "leaders" Marion and Jake Maxwell's only son was shot and killed in a scuffle two blocks from the Children's Hospital. Although Jake and Maria accepted the loss, they started the Slash to prevent a similar situation from ever happening again. They have adopted the members of the Slash as their new family, making for a pretty tight and cohesive group.

The average member of the Silver Slash could be male or female and is probably between 16 and 28. There are even several University-educated members. The Slash believes in peace and fair play, so don't try to involve a member in any shady scams.

Colors: Light blue shirt, rainbow suspenders, One-World emblem (blue and green earth with a ring of light blue around the outside). Most wear long hair.

Tag: One-world emblem

Average Member:

INT 7, REF 7, TECH 5, COOL 8, ATTR 7, LUCK 5, MA 7, BODY 6, EMP 7

SKILLS: Karate 8, Athletics 7, Martial Arts 6, Handgun 5, Dodge & Escape 5, Streetwise 7, First Aid 4, Shadow 3, Education & Gen. Know 4.

CYBERWARE: Reflex boosters, if any.

DATATERM DISPLAY SYSTEM

Topic: The Philharmonic Vampyres

UP

DN



The Vamps are a prankster gang who were dubbed the "Philharmonic Vampyres" a few years ago when five members clad in tuxedos, capes and vampire teeth flew up on wires behind the Night City Symphony on Halloween night. These are the people who climb corporate headquarters to leave giant signs, plant gardens in convertibles left on the street and release giant, naked, inflatable dolls of the governor over City Hall during his tours of Night City. Notable rockerboys, fixers and corporates have all been known to take part in Vampyre extravaganzas.

Are they artists, hoodlums or social commentators? Are those teeth part of the costume or not? Who knows? It is believed that the Vamps meet (or perhaps live) in the uncharted maze of access tunnels, storage rooms and sound baffles below the Bodakkan. As a result, they spend a lot of time dodging humorless Arasaka elite security. The Vamps defend no turf, although they exhibit an odd intolerance for street mimes, which pits them against the Juillard on occasion. Drive-by shootings with paint guns and shaving cream launchers are not unusual.

While the Vamps are considered to be far more witty than dangerous, it is rumored that their membership overlaps with a more serious gang—The Werewolves of London. As much urban myth as reality, "everyone" knows that for the last two years, on nights of the full moon, at least one victim is found literally torn apart as though with tooth and claw. Witnesses have reported seeing elegant gentlemen with tuxedos and black masks in the area and occasionally there is the report of wolves howling. Of course, the NCPD will tell you that's ridiculous....

Colors: black tuxedo (for both sexes)

Tag: Fanged penguin with cane and top hat.

Average Member:

INT 6, REF 7, COOL 7, TECH 6, ATTR 8, MA 6, BODY 6, LUCK 10

SKILLS: Wardrobe and style 7, Human Perception 5, Awareness 6, Seduction 4, Social 5, Perform 9, Dodge and Escape 6, Martial arts 3, Handgun 2, Drive 4, Basic Tech 5, Stealth 7, Fencing 3

CYBERWARE:Varying, depending on role of member.

NOTES:

Assume that members of this group might be of any other character class as long as they have style and a sense of humor.

DATATERM DISPLAY SYSTEM Topic: The Julliard



The Julliard is a gang-collective for street performers in Night City. As you can guess, it's *tough* to be a street performer in 2020. The boosters *used* to just steal your money. Now they steal your instruments and a small family moves into your cello case. Many of the urban poor resent irrelevant artsy types anyway, and there's always a premium on panhandling room on the Street.

It's also hard to protect yourself while juggling.

Thus, the Julliard was formed. This gang takes the motto "Kill a mime, go to jail" seriously. Performers travel in armed pairs, while weighted juggling clubs and machineguns in viola cases are not uncommon. Molest a street performer, and you can count on a broken leg from a surprise attack later that evening. Even if you *are* a Wild Thing.

Fifteen percent of the take (from street performances) goes to the group. Gang elders are in charge of assigning individual turfs during a weekly signup meeting (usually on the weekend). If you're new in town and are selected to join the gang (following an audition) you'll sign up for your performance spots last until you rise in the society.

The Julliard is primarily a self-protection organization, but they defend the rest of the City from other street performers as well. Get caught playing the Julliards' town without permission, and you may become a guitarist with seven fingers. These people don't fool around. On the other hand, the Julliard doesn't pick on the D.J.'s because they are so bad.

The Julliard's turf, in an area between the upper-class neighborhoods and the Corporate Center, has been chosen for maximum visibility to people most likely to give a street performer a break. This choice turf is held against all other gangs both for the Julliard's safety, and to create a protected neighborhood for the foot traffic most likely to be their audience.

The Julliard's most plum assignments are on the steps of the various performance halls throughout the City. The Bodakan, unfortunately, has very intolerant security and at the other venues there is always the chance of run-ins with Vampyres and Bozos on big show nights.

Gang central for the Julliard is in a couple of cheap apartments over the International Cafe. It's affordable and close to the affluent Parkside Residential Block and the Consular Block, where elegant corps are likely to notice a young genius with a violin. Last year a member of the Julliard who specialized in street corner Kabuki was taken back to Japan by a visitor staying at the Kuroshita Hotel. With a lot of work, anybody can get lucky.





Colors: Members of the Julliard wear small bells on shoes, hat or sash.

Tag: Black and white masks of tragedy and comedy, with the motto "Kill a mime, go to jail."

Average Member:

INT 7, REF 7, TECH 8, COOL 6, ATTR 5, MA 6, BODY 5, LUCK 6, EMP 4

SKILLS: Perform 7, Play Instrument 7, Social 6, Human Perception 5, Awareness 4, Personal grooming 3, Wardrobe and Style 4, Submachinegun 5, Persuasion 5, Dance 3, Martial Arts 6, Dodge 4.

CYBERWARE: Small inexpensive options only.

DATATERM DISPLAY SYSTEM Topic: **Sacred Blades**



The Sacred Blades are a combat gang favoring large Bowie and machete-style blades. Much like Heidelberg Sabre Scars, no member of the Sacred Blades would be seen without multiple battle marks all over the body. Open slashes won in honorable combat are rubbed with "ceremonial" substances to cause scarring. The gang is all male, but tolerates female followers to do domestic chores.

Though organized on a stereotype of Amerind culture, the gang is extremely multi-ethnic in nature. The use of mind-altering drugs for rituals to purify the heart and mind, accompanied by mild self-inflicted torture (to inure the body to pain), are not uncommon. Peyote is preferred but very hard to get and is often replaced by any obtainable hallucinogen.

In order to prove bravery, strength, quickness and personal will, a novice who wishes to join the gang must publicly defeat a member of a rival gang with only his hands and blades, held or thrown. The Blades' most common combat form, however, is "counting coup". A member paints his hand red, and then attempts to leave a red print on a rival gang member or NCPD officer without being stopped or caught. They must be wearing traditional face paint (which is different for each member) while doing this.

Some of the Blades carry cyberweapons and guns but it is deemed dishonorable to use these unless it's an absolute emergency. The gang exists purely for individuals to show-off physical prowess and has no socially redeeming features. On the other hand, a gang organized to show off while fighting other gangs is less of a problem than a gang organized to do incredible cybered-up violence for no reason at all.

The Sacred Blades' headquarters is in an old general store east of Burselon Tower. Their turf overlaps with that of the Black Queen (whom they don't consider fit competition), but who have access to good drug connections. The Steel Slaughter Slammers and the Slaughterhouse (both of whom are good manhood challenges) are just blocks away. Members of the Blades frequently journey off their turf to the Slammer for contests, but they prefer picking a fight at Totentanz where there are no restrictions.

Tag: Red hand-print



Colors: Long hair, ritual scarification, large feathers tied into the hair. (These *should* be eagle or hawk, so convincing a Sacred Blades that you can get some is a money-making proposition. Most are seagull.)

Average Member:

INT:5 REF:9 TECH:4 COOL:8 ATT:6 MA:7 BOD:5 LUCK:7 EMP:6

SKILLS: Melee weapon 8, Rifle 4, Handgun 4, Brawl 7, Intimidate 4, Resist torture 7, Streetwise 5, Awareness 6, Athletics 6, Dodge 4, Endurance 4

DATATERM DISPLAY SYSTEM Topic: **The Bozos**



When they first appeared three years ago, the Bozos were a prankster gang living in the artist's colony, between elegant restaurants and hotels to the north and the University to the south. Dressed, well, actually *biosculpted* to look like circus clowns with red bulbous noses, wild red hair and long flat feet (no, not shoes) and costumed to the part, the Bozos became impromptu slapstick theatre in this already colorful area. They splashed paint on street painters; they dropped water balloons on parked cars from several stories above; they snuck up behind well-dressed women from the Corporate Zone and slapped velcro on their stockings. It was irritating if it happened to you; it was funny if it happened to somebody else, but it wasn't really dangerous.

Then things changed. The population of Night City should have known that anybody who would voluntarily have white skin grafted onto his or her face to form a perpetual frown shouldn't be allowed to walk around loose. A year ago, the Bozos took a new leader, known only as the "Great Bozo". Rumor has it that he was an Arasaka research tech who went cyberpsycho and now creates "devices" for the Bozos. However it happened, the Bozos have since become the ultimate killer clown organization.

People living on Bozo turf have learned the hard way that if you see a pack of Bozos—just run. Bozos enjoy playing on people's greatest fears: lurking in apartments in the dark, locking victims in small spaces filled with rats, stopping elevators in skyscrapers and filling them with water. Bozos take candy away from children, slash tires, and microwave little old ladies with artificial hip joints. There are no good Bozos (yeah, we know what you're thinking, but you're wrong. All Bozos have small explosive charges rigged to heartbeat monitoring devices. Sometimes the most dangerous Bozo is a dead Bozo). Some are cyberpsychos, some are naturally crazy; all are the sort of people who like to watch horror movies just before going to sleep. Bozos...no joke.

The Bozos don't systematically terrorize the artist's colony where they live (unlike the Voodoo Boys), but are more random. Sometimes they become obsessed with one victim, littering his life with "pranks" at unexpected times until he has a nervous breakdown. If the police are called in, the Bozos will fade ... until the police leave.

Very patient, Bozos are.

Incidentally, Bozos are occasionally seen in the Net. Think about it.

Colors: They're Bozos, Jim.

Tag: Frowning clown face with slogan "Let's have some fun!"



Average Member:

INT 7, REF 7, TECH 5, COOL: Do crazy people truly have cool?,
ATTR: How do you feel about Bozos? LUCK 8, MA 6, BODY 8, EMP 2

SKILLS: Intimidate 6, Juggling 7, Hide/Evade 7, Handgun 6, Melee 7 Brawling 7, Basic Tech 7, Awareness 6, Electronics 5, Pharmaceuticals 4

CYBERWARE: Any body-enhancing cyberware.

DATATERM DISPLAY SYSTEM Topic: The Voodoo Boys



It was inevitable that an organization would form to sell drugs to Night City University students. Major crime contacts in Florida and the Caribbean may have been the beginning of the Voodoo Boys, a terrorist gang with ritual magic overtones; feeding its bizarre tastes by dealing primarily non-synthetic drugs. The Voodoo Boys kill, torture, rape and burn without rhyme or reason, preferring to maim victims or dissect the dead with machetes, leaving body parts as warnings. Sometimes victims are given notice by finding chicken blood and feathers on their doorstep, and sometimes they're not. The nihilism and exotic drug use of the Voodoo Boys attracts some students. They may even find themselves accepted by the gang, let in on low-level jobs only and milked for funds from home.

A high priority of the NCPD for some time (but with little success), the gang itself is small and thinly spread. Because of increasing police pressure, there are no set meeting places or crash pads. The location and time for the next meeting is chosen at each conclave. No outsider is known to have attended a Voodoo Boys meeting and lived to tell the tale. Two well-known Night City medias are believed to have died violently trying to cover this gang. Don't ask the local merchants where to find them, it might be worth their business or their life.

The best place to find a member of the Voodoo Boys (if you must) is at *Hababas*, an ex-biker bar. The Boys hold sway over the place with threats of random violence and a twisted sort of celebrity. This is also where much of their dealing is done—the Boys are known to give better prices to any middle American university student who makes it through the jeering and harassment to the bar. Hint: Don't take your girlfriend.

Despite the bones through the noses and ears, feather implants in the scalp, and tattoos, the majority of the members are average white boys with an occasional female. It's never good to run into a female Voodoo "Boy" because they have twice as much to prove as the guys.

There are no other gangs in the University area, but some analysts suggest that if the Bozos expand their turf from the north that there could be trouble between the clowns and the Boys. If this happens, NCPD and University security can expect a street war between terrorist thugs and psychotic jokesters.

Colors: A bone through the septum of the nose, black chicken feathers.

Tag: Exceptionally crude. Usually a chicken being decapitated or crude human figure being cut with large blade with much blood, with VOODOO BOYS or VOODOO BOYZ. Some people claim that there is a rudimentary Voodoo Boys code among the load of graffiti covering the walls of businesses

around the University and that this is why the authorities make such an effort to keep the walls clean.

Average Member:

INT 5, REF 7, TECH 4, COOL 6, ATTR 4, MA 6, BODY 6, LUCK 6, EMP 4

SKILLS: Melee Weapon 7, Handgun 4, Brawling 6, Intimidate 8, Human Perception 5, Persuasion 7, Dodge 5, Stealth 7.

CYBERWARE: Usually low-level modifications, cyberaudio, etc.

DATATERM DISPLAY SYSTEM Topic: The Smaller Gangs



Following are some of the smaller gangs of Night City. They are by no means the only other gangs in the city, and it is recommended that the referee fill Night City with gangs of his own devising. The gangs listed below go from the ridiculous to the downright deadly. Use them to fill out the City and give your city streets that edge that's uniquely *cyberpunk*.

Bradi Bunch: A small time family posegang, based on an old vidshow. The older members protect the "children" of the gang. Membership consists of runaway or orphaned children.

Threat Level:D Threat Code:D3D

Red Chrome Legion: A militant skinhead gang that spend most of their time terrorizing those different than themselves.

Threat Level:D Threat Code:C2D

Steel Slaughter Slammers: A chromer gang working out of a club on the edge of the Combat Zone. The Slammers spend all their time engaging in random acts of violence inspired by the band *Total Anarchy*.

Threat Level:D Threat Code:D3D

The Gilligans: A militant gay posegang, also based on an old vid show. Members include *Skippers* (leaders), *Professors* (techs), *Maryanns & Gingers* (transsexuals) and *Gilligans* (initiates) The Gilligans have recently moved from the Marina District (forced out by the Wild Things.) and have settled in the park.

Threat Level:D Threat Code:C2D

The Kennedys: A posegang centered around the famous Kennedy family of the late 20th century. The Kennedys have no turf, and can be found in any part of the city, from JFK in the Corprate zone to Bobby in the Combat Zone. Many suspect the leader of the gang is going to run for mayor next term.

Threat Level:D Threat Code:C3D

Warrior Heart: A bad news combat gang in the Zone, the Warriors spend all their time fighting other gangs (they are

in a long-term feud with the *Blood Razors*) to hone their combat skills.

Threat Level:C Threat Code:B2C

Piranhas: A party gang that runs its activities out of an old convenience store in the Zone. The Piranhas live to party and love to have fun (admittedly, no one is quite sure what constitutes fun in the Piranhas' book). If you don't bug them they'll leave you alone.

Threat Level:E Threat Code:D4D

Inquisitors: This gang is unique in all of Night City. Not only do they believe that cybernetics are "evil" (using only training and biotech), but they also have a war going on with every other gang in the city. Everyone hates these guys, from the *Slaughterhouse* to the *Givers of Pain*. No one can find their home turf, and no one can find the leader of the gang. There is a standing reward of 25,000eb to the man who brings the Inquisitor's leader to the Hack Man, leader of the *Blood Razors* (it is rumored that the leader of the Inquisitors caught and killed the Hack Man's younger brother).

Threat Level:A Threat Code:A1B

Willow Sisterhood: This group of young women are as deadly as they are beautiful, and are often hired as assassins by the corps. The Willow Sisterhood is by definition a posegang, with its members' sculpted to resemble famous beauties from past and present. In addition to the 'sculpting, all members undergo extensive training in the deadly arts. Many of the "Sisters" are kept as mistresses and bodyguards by powerful men.

Threat Level:A Threat Code:A2D

Second Comming: The Second Comming was a powerful

millennium cult, but after the turn of the century came and went they turned their ambition to other things. They now believe that the Second Coming will arrive during the final episode of *Combat Cabb*™.

Threat Level:E **Threat Code:**D4D

Blood & Tears: Another combat gang in the Zone. B&T members must have at least three years combat experience before they become "full" members. The gang is one of the nastiest in the area. B&T trademark is the removal of eyes, both natural and cyber, from their victims.

Threat Level:B **Threat Code:**B1C

Tygers Claw: A combat gang in the Japanese community in the residential zone below Japantown. The gang also occasionally protects the Japanese community at large (it is rumored that they are financially backed by Arasaka). The Tygers use enhanced reflexes and martial arts as their weapons.

Threat Level:C **Threat Code:**A4D

Sinners N' Saints: A chromer gang based around a band that has recently made its way to the big time. S. N' S. uses the band's old studio on the edge of the Combat Zone as its headquarters.

Threat Level:D **Threat Code:**C3D

Golden Knights: A guardian gang in the lower residential area. The Golden Knights use high tech and solid strategies to keep a four block area safe. The gang is lead by an ex-soldier who lost his wife and daughter to a local boostergang.

Threat Level:B **Threat Code:**B1C

Arzin Tynon: This gang is a newcomer to the streets of Night City, spending most of their time terrorizing anyone who is weaker than themselves. Other boostergangs in the city treat them with contempt. They have not established any solid turf as of yet.

Threat level:D **Threat Code:**C3D

Death in the Afternoon: Other than *Bay Area Rapid Terror*, Death P.M. is Night City's only true Nihilist group in action. Once there was a third group, but it attacked an Arasaka facility. As the nursery rhyme says, *and then there were two*. Death P.M. operates out of a series of condemned buildings in the Combat Zone, and does most of its damage in areas outside the city proper.

Threat Level:B **Threat Code:**B2C

Edison's: This posergang patterns itself on famous inventors. They relish the ingenious and sadistic. Second only to the Brainiac's for ingenuity, they excel in the construction of

deathtraps and the like. Their turf is located in the eastern residential district.

Threat Level:D **Threat Code:**A3D

The Fangs of Justice: This group of psychotics patterns itself after famous crimefighters of fiction. They like to think of themselves as a guardian gang, but in truth, will terrorize anyone they can get their hands on.

Threat Level:C **Threat Code:**B2C

Western Stars: A combat posergang that idolizes western gunfighter philosophy, and mimics great gunslingers from film and video. The Stars use revolvers and are big on "fair" one-on-one gunfights. They keep their turf in the upper westside of South Night City.

Threat Level:D **Threat Code:**B3D

Jack the Rippers: From all accounts, the Ripper's are responsible for the deaths of over a hundred joygirls in the Night City area in the last three years. Witnesses claim that the killer is one man, but the NCPD has decided that the killings are in fact the work of a very deranged gang. The "Rippers" are all dressed the same; long old-fashioned overcoat and a silk tophat. They have no turf and strike randomly; always at night, and always when the victim is alone.

Threat Level:C **Threat Code:**A4D

The Valentino's: This is a poser gang dedicated to the pursuit and seduction of the most attractive women in Night City. Experts in seduction, the more unattainable a woman is the more they try to bed her. The Valentino's only meet once every three months, to compare scorecards. The only danger the Valentinos pose is to men whose wives or girlfriends have an ATT of 9 or more. They will pursue these women until they bed them, or are scared off.

Threat Level:E **Threat Code:**D3D

The Water Rats: This gang operates around the docks of Night City, and have clashed with the Harbor Police on occasion. The Water Rats make their living helping the pirates smuggle stuff into the city.

Threat Level:C **Threat Code:**C2D

Personalities: One of the strangest poser gangs in the City. When someone joins the Personalities, the person he will be biosculpted into is picked randomly; if you get Lana Turner, you're Lana, if you get Abraham Lincoln, be ready to wear stovepipe hats. Your rank in the gang depends on how well you adjust to your role. These people are the ultimate posers; once dropped into their roles, they live the life. All members can be recognized by the fine steel neck band they wear.

Threat Level:D **Threat Code:**C3D

Controlled Urban Zones

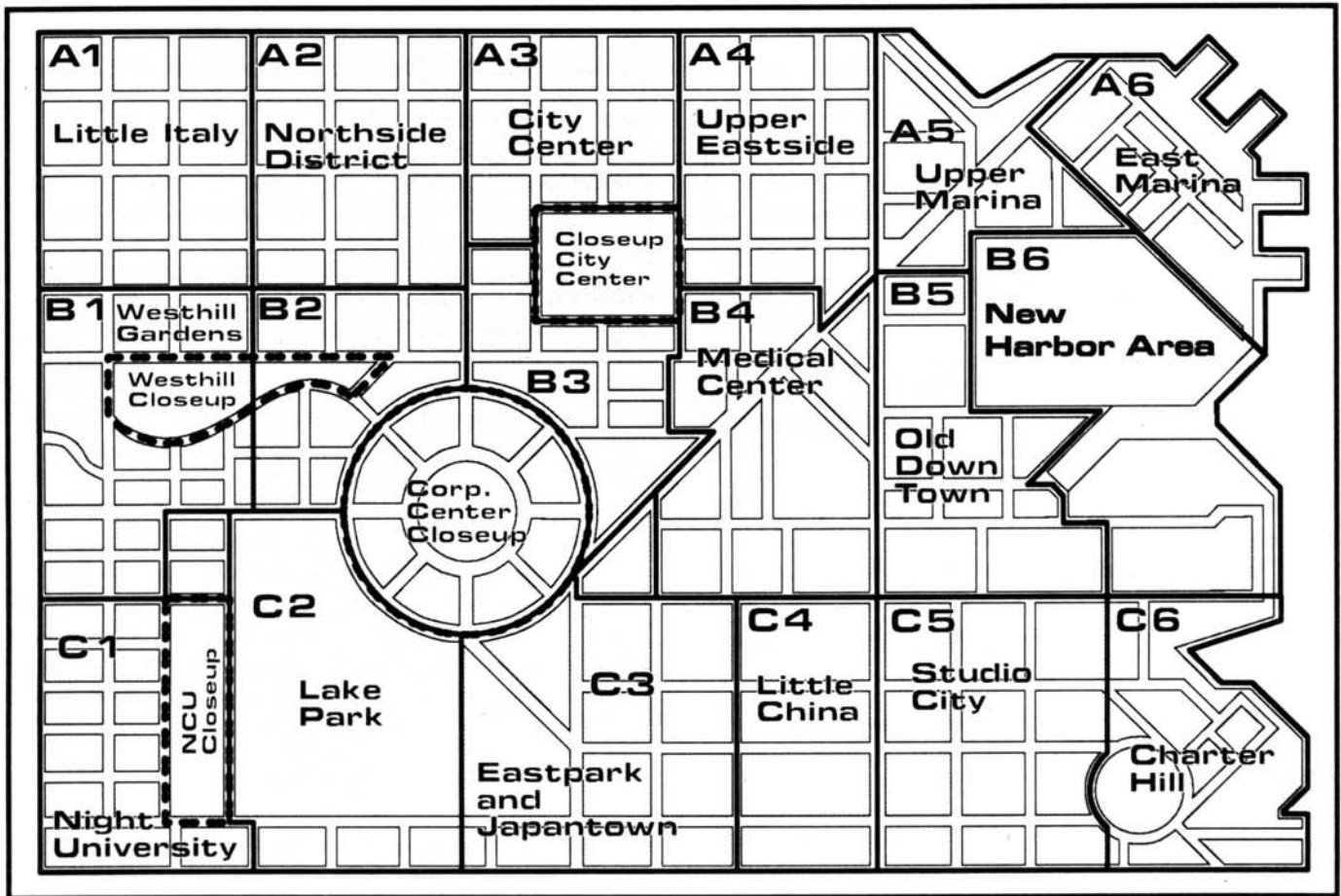

Little Italy (pg 57)
Traditional Italian neighborhood and stronghold of the colorful old Mafia Lords of Night City.

Northside District (pg 62)
Aging industrial neighborhood with many interesting inhabitants.

City Center (pg 68)
Governmental nexus and hub of the City government. See your taxes at work!

Upper Eastside (pg 75)
Commercial and business zone with increasing gang action and hot clubs.

Upper Marina (pg 82)
The old industrial and pier area. Home to the new Ferry Building, the Yacht

Club and a new 16 point combat parcouse .

West Hill (pg 90)
Elegant, self-contained community catering to the wealthy and powerful.

Corporate Center (pg 95)
Where the real power lies in Night City; home to the towering citadels of the megacorps and powerdealers.

Bank Block (pg 110)
Financial center of the City, and source of the Corporate cash.

Med Center (pg 114)
The largest concentration of medical -related businesses in the City. Also home to Trauma Team and other knife artists.

Old Downtown (pg 120)
The core of the original township of Del Coronado; a picturesque mesh of older slums and equally colorful boosters.

New Harbor Area (pg 125)
Home of the Mallplex; multi-level shopping plaza and mini-arcology, and its neighbor, McCartney Stadium, home of the Superbowl winning Rangers.

Night City Univ. (pg 136)
Academic fortress and bastion of higher learning, focussed in a lively counterculture.

Lake Park (pg 142)
Bioengineered plants and animals are only two of the attractions of this spacious central park.

Japantown (pg 146)
Exciting Japanese cultural center and link to the Pacific Rim.

Little China (pg 151)
An oldstyle Chinatown with many fine restaurants and curio shops.

Studio City (pg 160)
Visit Colonial Studios, an old-time film studio, where director Francesco Cippolina's classic films were made.

Charter Hill (pg 166)
Enjoy gambling in style in the luxurious Hacienda Hotel/Casino. Or take the kids to visit the Aquarium.

KEY

 Dataterm

 Remote Camera

LITTLE ITALY

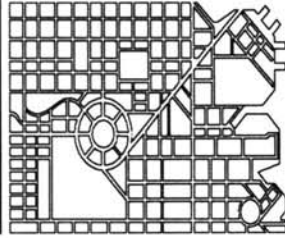

D A T A T A T E R M

It's known as Little Italy—a grimy, low rent district of the City, nudging up against the towers of the Corporate Center. Its roots run deep into local history; it was from Little Italy's assorted small storefronts and backroom vice dens that the Mob of 2005 launched its bid to wrest control of the City from developer Richard Night.

From 2005 to 2009, the Mob ruled the streets of Night City. From the small-time enforcers who controlled crime at the Street level, to the Capos who perched vulture-like in Richard Night's confiscated skyscrapers, the Cosa Nostra was everywhere, twisting Night's dream city into a nightmare landscape of violent crime.

Then the Corporations moved in. In an incredibly bloody, two year war of attrition, the forces of Arasaka and its allies decimated the Mobs, driving them back to ratholes in the western City. The City was liberated by a new set of tyrants and the Mob's power was broken for the time being.

But the Mob of 2020 has learned its lessons well; it's smaller and more cautious than before, keeping its activities well in the shadows where the Corporations don't look too hard. It has formed a tentative peace with the Yakuza mobs in Japantown, and has already begun to expand its power base towards City Hall. The Mob is patient; its sense of history is long and deep. And it is willing to wait for the right moment to rise again.

A1#1 Julius Electronics:

One of a small chain of electronics retailers featuring a spread of electronics from microchips to high quality finished merchandise. Julius is a good, standard source for the technician needing anything or everything for that special job at hand.

Security Level:1

A1#2 Cybertemps:

A local agency for temporary office help, specializing in office operations technicians, receptionists, language processors,

data entry techs, and office managers. Cybertemps can provide an office full of workers—and all the equipment they'll need to be productive.

Security Level:1

A1#3 Continental Detective Agency, Night City Branch:

This is one of the oldest such firms, with over a hundred years of experience. Today's Continental Ops assist corporate and private clients with all phases of investigative and security work. Continental has offices in most major cities throughout the world, and is even planning to put one on the Crystal Palace Orbital station.

Security Level:2

A1#4 Guido's Fashion Trim:

Not just a barber shop, Guido's has all the services needed for modern personal fashion grooming. This establishment is slanted toward services for male clientele. It is frequented by the now resurgent Mob, and is a good source for middle-class gangster gossip.

Security Level:1

A1#5 Night City Police Department, Precinct #2 HQ (and associated structures)

The NCPD is housed in a no-nonsense structure, which had bullet-proof glass and additional security systems installed in 2000 in response to the Mob move-in. The building layout is very straight forward, with no frills or decorations to mar the strict functionality of the place. The armory is well-guarded, and the motor pool is in an underground garage inaccessible to the public. The evidence warehouse occupies the core of the building from the basement to the second floor from the top. Its walls are built of reinforced masonry, and are shielded against electromagnetic fields. The warehouse can only be entered from the basement. NCPD is very serious about protecting their evidence.

Besides the regular administrative and laboratory facilities, the NCPD also has a bunkhouse and a cafeteria / recreation hall; these are the two buildings on the southwest corner of the block.

The building on the north side of the block contains the **Marksman**, a paid-access shooting range. The NCPD has permanent privileges here, but the public is also welcome to come to practice. The range is secretly owned by Arasaka; they surreptitiously check shooters' accuracy, and keep them on file for prospective employment if they're good.

Wedged between the range and the NCPD cafeteria is **The Urban Ranger**, a military surplus store. The NCPD often come here to pick up extra equipment and/or uniforms. Needless to say, security is good, although there's not much call for it. Firearms are not sold here, or so they say.

Security Level:3

LITTLE ITALY

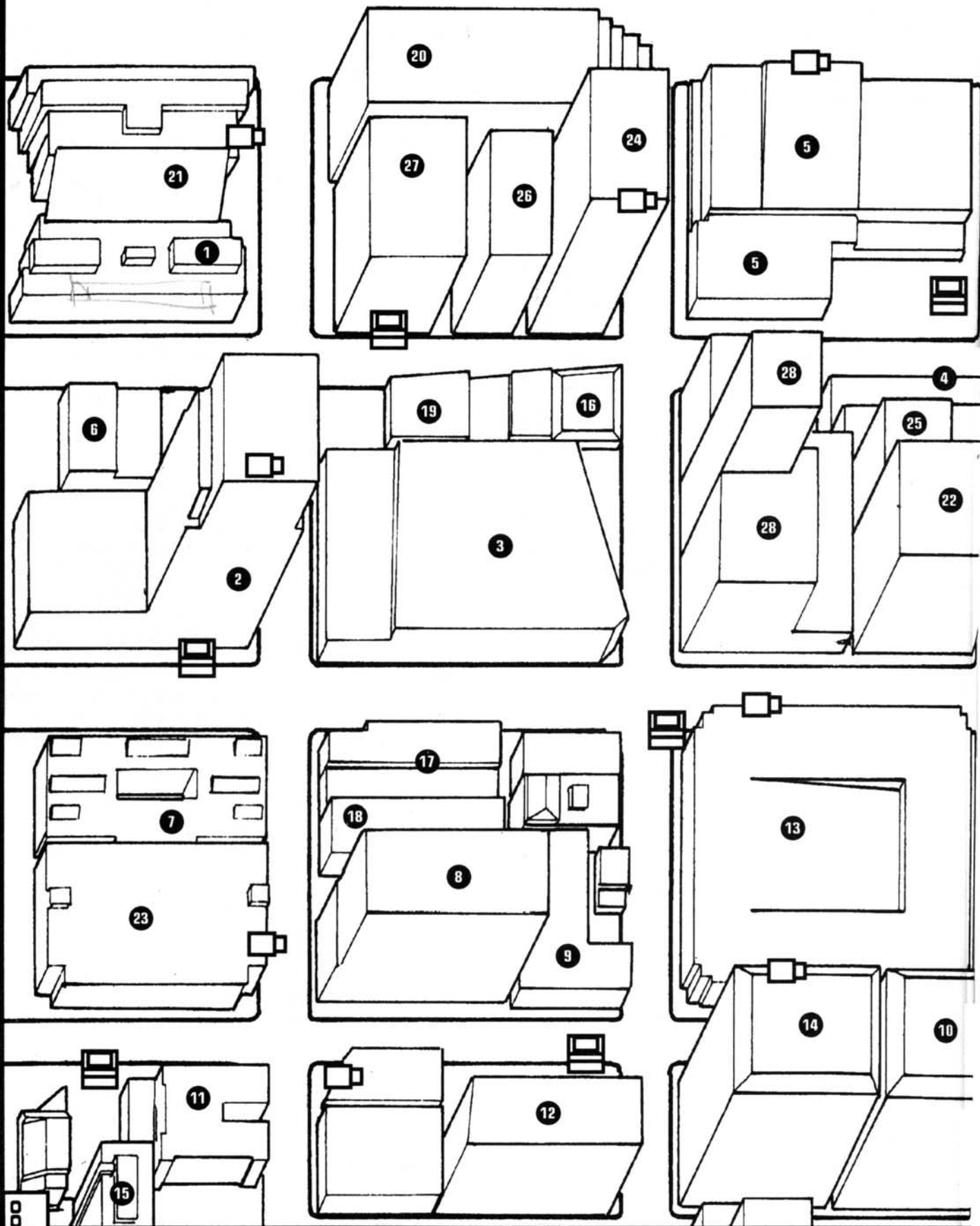

A1#6 Franciscin's Cafe:

A popular meeting place for the business lunch and Mover dinner set. This is a good place to dine with reasonable privacy if you have the euro (and corporate paraphernalia) to match the decor.

Security Level:1

A1#7 The Clinic:

Asurgery parlor. Very competent and resourceful, with prices at 200% of the 2020 rulebook costs for body change operations. The Clinic has access to all prosthetic technology available in Night City, and their doctors are the best, with enhanced results and a virtually nonexistent failure rate. (Refs should interpret this for their campaigns.)

Security Level:1

A1#8 Southwest Pacific Rim Trust Co.:

This is a full-service bank distinguished by ties to the new money from Indochinese profiteers of the Second Corporate War.

Security Level:2

A1#9 Billi G. Productions:

A concert promoter, Billi G. is the Ms. Rock of Night City. Both an agent and an impresario, Billi has the clout to arrange the best rates and working conditions in town, and her clients benefit accordingly. Two bands represented by her are *Good Rhythmic Noise* and *Synthetic Skin*, currently on the *Billboard* Top 10.

Security Level:1

A1#10 Protective Lighting:

This security systems company specializes in hardware and computer-controlled robotic installations. Their security machinery defends many important establishments throughout the town. Protective Lighting has even contributed to the famous defenses at Playland-By-The-Beach, a well-known amusement park in Pacifica.

Security Level:2

A1#11 Warder's Travel Agency:

Travel agencies are much the same as fifty or sixty years ago—a place to get travel tickets away from the airport or bus station. With modern use of the Net, Warder's can book you onto any ride or into any hotel room on, or off-world, at a 5% markup on normal ticket prices.

Security Level:1

A1#12 Stafford Metro Productions:

Movie producers. This is the business office (only) of a film production company that runs recording crews at various Nor/SoCalifornia studio locations, primarily for TV productions. Stafford also produces items for the Theater/Home Video market.

Security Level:1

A1#13 KJBR Studios:

This broadcast station serves Night City via TV and radio. KJBR is a standard on receivers all around Night City and its environs, 24 hours a day, providing a variety of popular programming. It's best known personality is *Rockaby Rozalyn*, one of Night City's leading DJ's.

Security Level:1

A1#14 Tokyo East Luxury Apartments:

This is a high-rent building for corporate executive personnel. Accommodations at this facility are suitably luxurious, and the security is the best.

Security Level:2

A1#15 Wilson and Company:

This relatively small investment firm has cyberlink seats on all the world's stock markets. The firm provides investment counselling, as well as information about activities in the Night City financial community.

Security Level:1

A1#16 Beppo's Trattoria:

Beppo's restaurant was an important dining spot *before* the Mob showed up. Beppo maneuvered the situation so that his restaurant became the neutral ground, open to all mob business, and off limits to violence (and the police). Beppo serves a mean plate of spaghetti marinara, and a meatball sandwich to die for.

Security Level:0

A1#17 Social Services Agency:

This building once housed the local state-funded services for Night City. When the California economy collapsed in 1997, all the state-funded services: welfare, unemployment, etc., went with it. After the collapse nobody knew what to do with this building. The civil authorities wanted to reopen it under some sort of corporate sponsorship but the corporations declined the honor.

When the Mob reentered the city, they bought the building and renovated it for a different type of social service—a middle-class brothel. Since prostitution was legalized in the early 2000's, the brothel is an excellent source of legal income for the Mob.

Security Level:1

A1#18 Artists' Supplies by Cagliari:

Real artists go to San Francisco or Los Angeles, but there are some diehard creative types in Night City, supported by the connoisseurship of the corporate nouveau riche, and the dollars of their ad departments. Mona Lisa Cagliari's shop has a great selection of materials for all modern artistic medias, with reasonable prices.

Security Level:1

A1#19 Chrome Ring Gym #46:

This athletic club is nominally a branch of the well-known nation-wide chain. It is also the headquarters of the enforcement arm of the Mob, where solos gather to gossip, work out, and receive orders.

Security Level:2

A1#20 Tamalpias Crimson Winery:

This is a front business used by Mob accountants to launder illicit funds. In addition, the winery actually ferments grapes and markets an annual vintage.

Security Level:1

A1#21 Chrome Age Loan Company:

This pawn shop is where you go to meet the local loan shark. Corporate types sometimes patronize Mob loansharks to cover business shortfalls, or to make up the difference between a preferred lifestyle and nasty reality.

Security Level:1

A1#22 Doctor Bill's Sanitarium:

Local ripperdoc Dr. William Galen selected this as the site for his clinic. Besides conventional cyberwear implantation, Galen is also available for street trade in optional surgery and "weapon trauma recovery services" (he gets lots and lots of Mob business). There is a pad on the roof for aerial "deliveries".

Security Level:1

A1#23 Black's Shirt Shop:

A conventional haberdashery, mostly catering to Mob members, and also serving as a Mob money launderer. Black's features traditional and modern fashions, plus extreme versions of the same.

Security Level:1

A1#24 Balboa Aeronautics:

This is nominally a designer and manufacturer of aircraft, but the premises also serve as offices for many illicit Mob enterprises. Most Mob netrunners use Balboa's back room as a base of operations. There is a largish mainframe computer supporting the runners, with some fearsome ice and a rather nice artificial reality in the local Net construct.

Security Level:2

A1#25 Da Vinci Somatic Artistry:

This is a fancifully named bodysculpting parlor. Da Vinci does a fair trade, but its reported gross is often enhanced by money laundering. A good place to get illegal bodomods or new, unlicensed faces and prints (if you've already fixed it up with Boss Skiv).

Security Level:1

A1#26 Empty Building:

This building has stood empty for the last year. The contractor who owns it is planning to renovate it into a hotel. The Mob

is also trying to buy the building, and is stalling the contractor's building loan to stop him.

Security Level: 0

A1#27 Arbathy Townhouses:

This building houses a series of upscale condominiums. Many upper-level mobsters live here, with the occasional well-to-do outsider thrown in for cover.

Security Level: 2

A1#28 The Falcone Building:

This massive (and very intimidating) structure holds some three dozen smaller establishments, concentrating on manufacturing and distribution. It is believed that the entire basement level is a giant drug lab, run and operated by the Mob.

Security Level:1

PERSONALITIES



Don "The Boss" Skiv (NCPD file video, June 2020)

The Boss- The local "Capo di tutti Cappi" is an up and coming fixer-turned-Mob corporate manager, who has made a name for himself the length of the Coast. Bruce Skiv (also known as "The Boss") can be found either at Balboa's, at the Chrome Ring, or at Beppo's. Every morning starts with a shave at Guido's, of course.

INT 9, REF 8, TECH 6, COOL 10, ATTR 8, LUCK 9, MA 7, BODY 6, EMP 7

SKILLS: Intimidate 10, Pistol 7, Oratory 5, Education 5, Stock Market 3, Specific Know(Mob) 8, Leadership 5

CYBERNETICS: Shift-Tacts, neural processor, pain editor, Sandevistian speedware.

Julia "Patty Hurst" Jones- Julia Jones is a woman playing an

extremely dangerous game; a lieutenant in the Mob, working the rackets and rising in the Organization, she is at the same time the leader and guiding force of Bay Area Rapid Terror, the deadly nihilist gang operating throughout the California Free States. Julia has secretly hidden the BART's main headquarters in the basement of the building that also houses Balboa Aeronautics.

INT 6, REF 7, TECH 7, COOL 8, ATTR 9, LUCK 10, MA 6, BODY 7, EMP 4,

SKILLS: Melee Weapon 7, Fast Talk 5, Seduction 3, Leadership 3, Pistol 3, SMG 3, Disguise 4, Shadow 2, Stealth 3, Specific Know(Mob) 2, Interrogation 3

CYBERNETICS: None

A NOTE ON THE MOB



Some people feel that the difference between the Megacorps and organized crime is simply one of business methods

and areas of operation, rather than any particular elevation of moral tone. Nonetheless, it is the public position of most Corps that organized crime is one of the greatest evils and should be eliminated by all means (a strong law & order campaign is also an effective way of eliminating competition and regaining control over business costs).

When the Corps won their war to destroy the Mob ten years ago, that resilient organization simply reinvested its resources elsewhere and bided its time. Now, the Mob is attempting to regain its old influence, yet is being careful not to compete with the biggest corporations; the ones who could instigate another round of persecution against the allied criminals.

The Mob has lost much of its old ethnic base, and new recruitment is often multicultural. There is also competition with the *Yakuza* and other ethnic gangs from the Asian Far East. Traditional Mobsters are into quasi-white collar crimes: vice, extortion, and racketeering, and work to keep a monopoly on these activities wherever they operate. There is also a system of mostly legitimate businesses that serve as conduits for laundering illegal money (and as sources of profit in their own right).

ENCOUNTERS

- 1- It's a meeting between the Mob and another powerful group. The meeting is taking place at some eating place or night spot, and Mob solos plus solos from the other party(ies) are guarding the front entrance. GM Option: the PCs are recognized (mistakenly?) as likely enemies of those inside.
- 2- Spontaneous rock concert in the street. A couple of

beginning bands (Ref Option: Make one of them a name band) have set up their amps and are serenading the people with their music. This will most likely happen at noon, at quitting time, or in the evening. D10 minutes remain before the cops come to break up the traffic jam.

3-All the screamsheet boxes in town start flashing their 'Extra Edition' lights. This probably just means a new, scandalous turn in the latest Corpwar, but it could also mean the printing of a vital clue needed by the PCs.

4-The Bay Area Rapid Terror are perpetrating their latest violence right now, in the same block with the PCs. Use your imagination, just back it up with enough cyborged gang members to make it a good fight.

5-Happy Hooly (or any of his many zonked-out brothers and sisters) sets up a stand and starts giving away drugs. This lasts D10 minutes in the crowded business district. Even odds whether it's the police or the Mob that shuts down this operation.

6-What a mess! Some kind of garbage spill happens. Maybe the sewers overflow, maybe the toxic dump tank in an office building leaks (or ruptures!), maybe a garbage truck flips over (or is bombed by somebody). It's dirty, probably poisonous, and it happens as close to the PCs as you want.

7-Giant moving vans and cargo helicopters descend on a building to install a new corporate office. Traffic messed up for 10D10 minutes.

8-It's almost another mob scene. Everybody is crowding around a stand where some corporate Suit is giving away free advice on the stock market. This could be where the PCs find an important clue for their mystery.

9-The panhandlers have gotten together and set up a roadblock. They are charging toll to get through their gate, which is set up on an important street. D10 minutes for the police to respond.

10-Urban Road Race! Two or more wise guys are having a traffic race, messing up the flow of cars for D6 blocks, until the police get them (make a D10 roll less than the D6 result above to succeed), or they vanish into the general confusion. Much traffic snarling, car crashes, deaths . . .

CONTACTS

1. **Nunzio Scallioné**- A Mob enforcer who hates corporations more than anything else in the world. He will offer the players Mob aid if he knows that they are involved in any kind of confrontation with the Corps.
2. **Martha Harris**- A secretary with Balboa, she is an excellent source of Mob information, and she knows how to keep her mouth shut.
3. **Edward Kilmartin**- An Irish beat cop on the streets of Little Italy. He knows where all the Mob businesses are, but he isn't talking. He believes the Mob to be a lesser evil than the Corporations.
4. **Lynn Skiv**- Teenage niece of the local Mob boss. Spirited and a troublemaker; believing her uncle will always come to bail her out of any jam. She could be real trouble for anyone she decided to attach herself to.
5. **Vinnie Ciccione**- An Arasaka agent working undercover in the Mob. It is his job to ascertain just how much of a threat the Mob is, and whether Arasaka needs to deal with it.

NORTH SIDE

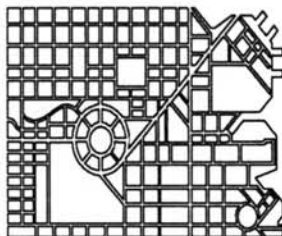

D A T A T E R M

Warning: If you live in Northside, you're dealing up front and personal with gangs. Home to many successful businesses in the last few years, a constant gang presence still threatens the area's welfare, and makes this one of the city's worst areas for gang violence. The gangs are involved in a constant turf war, after being pushed out of the Corporate Zone to the south and the civic complexes to the east. The Northside District is responsible for a full forty percent of the gang-related fatalities in the downtown area.

Bes Isis put it best during her report on the infamous *2nd Street Massacre*, "The civic authorities don't care...this district isn't a source of heavy income for the city... The corporations don't concern themselves with matters below their mighty concerns and cash flows...and that leaves the citizens and shopkeepers."

A2#1 The Widmark:

This classic flophouse is the home turf of the *Black Death*. The rents are cheap and the rooms are infested with all types of vermin, human and otherwise. Stay here at your own risk. A constant stream of John and Jane Doe's are pulled from these rooms with their throats slit for as little as four euro and change. Though right across from the police station, the local cops view these murders as scum killing scum and only come over to pick up the pieces.

Security Level:0

A2#2 Meratis Warehouse:

On the surface, this is a warehouse used for the storage and distribution of dried fruits by the Maratis Company, a fruit processor based in nearby Pacifica. There have been numerous reports that the building also houses a source of

black market weaponry used to supply the city's gangs. There have been two recent raids by the N.C.P.D. (both have turned up nothing).

Security Level:1

A2#3 Fax-Press:

These two buildings house the local offices of Fax-Press. The company produces several popular magazines distributed nationwide, mostly via electronic media. Titles include the bestsellers *SOLO OF FORTUNE* and *NETWORK*. The building has an elite solo team to provide 24 hour security (normal operating hours), and a large construct in the local Net space to accommodate the company's information market. Netrunners are welcome to enter the construct (which resembles a tropical resort hotel on a Hawaiian beach), as long as they sign the register and are willing to share with the company any "information" they may have come across.

Security Level:2

A2#4 Holy Angels Church:

Holy Angels Church is a Roman Catholic church offering traditional Latin Mass M-F at 7 a.m., Sunday at 8 a.m. and reformed Mass in English (Spanish speaking deacons available for translation.) at 8:30 Mon-Sat and 10 a.m. Sunday. The church is a three story stone structure, initially endowed by a terminally ill heiress with a guilty conscience.

Unstable world conditions and the reforms of Vatican III in 2014 have brought many alienated Catholics back to the comforting tradition of a conservative liturgy, combined with a more liberal, socially responsive church. With the acceptance of limited pre-conception birth control by the Pope in 2014, the way was open for many to reclaim their faith and for Third World Countries to re-embrace the church while solving their overwhelming population problems.

The church is staffed by two priests; Father Kevin, a rugged fifty year old Irishman born in Belfast, who came to the church late in life, and Father Paul (from Nigeria, where the church has been a growing concern for some time). Father Paul's wife, Lucy, is a lay sister of immigrant Italian parents, who grew up in Night City. They have two daughters.

Sisters Mary Grace, Elizabeth, Ruth and Theresa also live on the premises (all living quarters are on the third floor), running the soup kitchen and catechism classes. All four of the sisters are veterans of Third World stands much worse than Night City. Scars from the removal (when she gave up the world twelve years ago) of Sister Elizabeth's street tattoos are still visible. In addition to the Sisters, there are 12 deacons (community members who hold a position in the church) including Daniel O'Flaherty, owner of the tavern across the street.

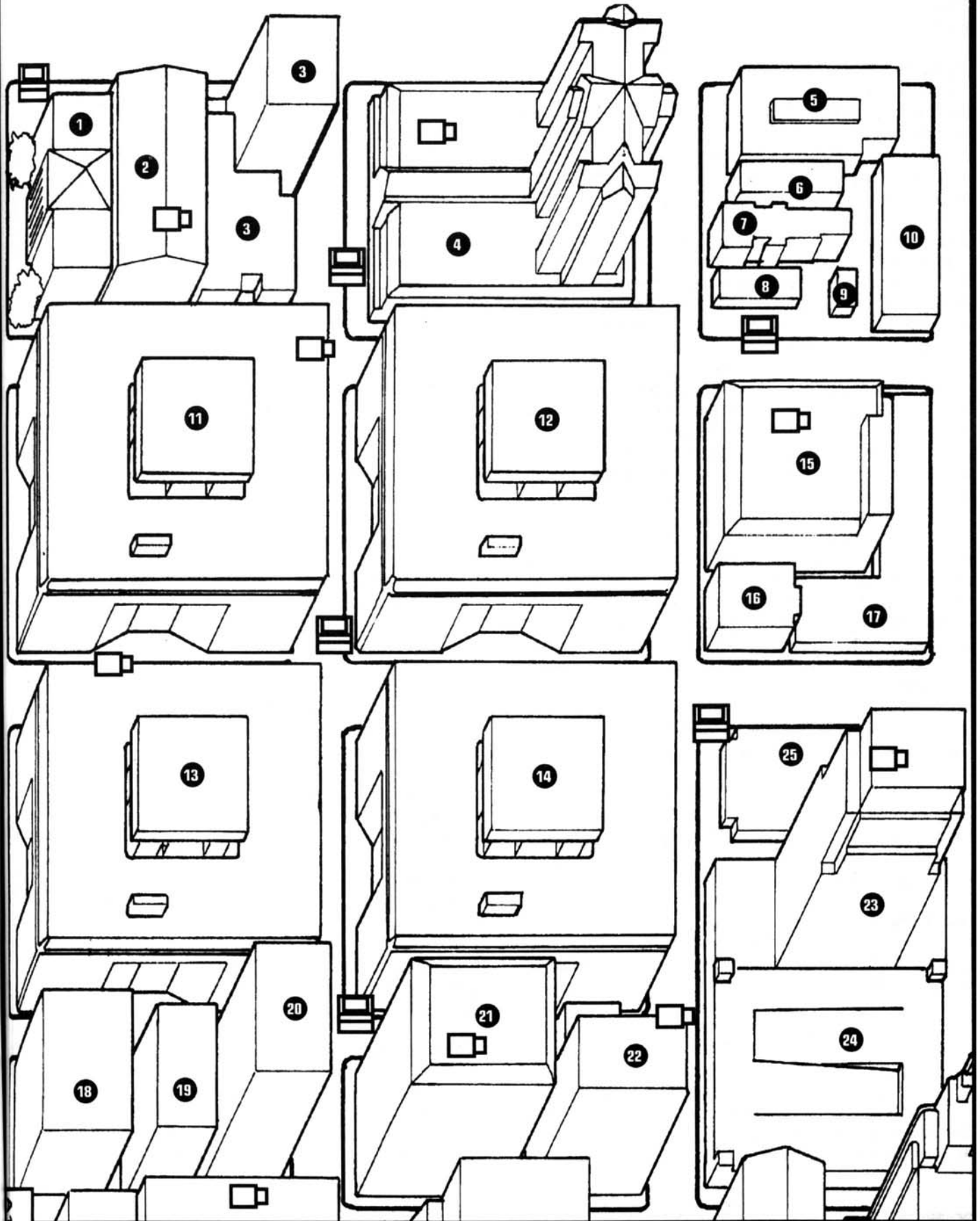

The church originally housed a small parochial school, which has since been transformed into a soup kitchen and homeless shelter. The homeless shelter can accommodate up to 250 people, and is open 24 hours a day. The only entry requirement is that all weapons be turned over to Father Kevin for safekeeping (including cyberware ammunition). Confiscated weapons are kept in a locked metal storage closet in Father Kevin's study on the third floor. Shelter space is filled up starting on the first floor and expanding into the second floor.

Free meals are available twice a day from 8-9 am and from 5 to 6 p.m. Diners are not required to go to Mass (but it makes the Sisters happy). Feeding all these people isn't cheap and Holy Angel's is always just scraping by. Father Kevin is always on the lookout for a wealthy family or corporation that might be creatively convinced to donate. Additional income comes from dinners, bake sales and street fairs on church holidays, patrolled by the deacons, church-goers and many of the more loyal patrons of the Holy Angels shelter (this is one fun place on St. Patrick's Day, featuring popular snake races which draw out-of-town tourists). Free childcare is also offered, with parents participating on a rotating basis.

All the stained glass windows are barred. At midnight, all doors are closed and IR and movement sensors around the church are activated (the doors have steel cores and reinforced hinges). There is always one member of the staff on duty inside with a panic button linked to the third floor. In case of emergencies there is always enough food and fresh water for twenty people for one month stored on the third floor. Tasers and dart weapons are standard issue for church staff when walking in the community. Deacons are also responsible for, among other things, the safety of parishioners coming into the City.

Father Kevin has invoked the sanctuary of the Church before the law on a few occasions (when trying to diffuse a tense gang situation). Whether the police desisted out of fear of God or Father Kevin is unknown.

Security Level:1

A2#5 The Range:

This large cement building looks much like an oversized bunker from the Second World War. Its walls are soundproofed and very thick. The Range is one of California's most famous indoor shooting galleries. It is run by Elaric Fail, a solo and vet of the Central American Wars. Elaric offers courses in shooting anything that can be shot; from the new high-tech compound bows to the largest of assault rifles. Courses at the Range are very expensive, but well worth the price. It has been said that the Range is second only to Arasaka in training people to handle combat firearms. Elaric also has started a free small

arms workshop for the citizens of the district, to counter victimization by gangs.

Security Level:2

A2#6 O'Flaherty's Tavern:

O'Flaherty's Tavern serves good Irish whiskey and hearty Irish home cooking seven days a week, 12 p.m.-4 a.m. officially (and to the Night City Irish emigre community at any time). It is a dark and quiet place with private, high-backed wood booths, a salvaged long bar (real oakwood!), and vid boards always set to soccer and rugby matches. If you want to fit in, don't ask for your beer cold. It's helpful if you speak Gaelic, but not necessary.

The tavern is patronized by the largely Irish and Italian attendees of Holy Angels Catholic Church across the street, and is a good lunch spot for local businesses. The beer and corned beef also draws in teachers and students from the Range (this is its own kind of security).

Police believe that owner Daniel O'Flaherty harbors local countrymen in trouble in the rooms upstairs, and suspect the bar itself of being a stop on the underground railroad for I.R.A. members. Deals for weapons destined for the Northern Irish Pacification Zone take place in the back booths, under cover of coppery-haired little girls going to the community room for step-dancing classes (complete with Uilleann bag pipes and harps). Personal questions aren't too appreciated; a heavily armed man at the bar could be a local Northside tech, or an I.R.A. gunner on the run. You never know.

Security consists of mini-cameras inside and out (including the restrooms), small laser mounts on the roof, obvious and remote alarms, electrified locks, motion sensor-tripped flood lights, a submachinegun under the cash register, and Joe and Pete, two four-and-a-half foot tall, bioengineered Irish wolfhounds. The owner and his daughter, Bridget, live upstairs.

Security Level:2

A2#7 The Taira Apts:

This was once a nice middle-class apartment block until the street punks moved in and scared all the families out. Now the punks infest the place. It's a sore point with the neighbors, and people point to it as a prime example of how the neighborhood is going to hell.

Security Level:0

A2#8 Corrigan's Market:

This is a small streetcorner market run by an elderly Asian woman whose husband was killed in a robbery a few years back. The punks in the area leave her alone; they suspect she has Yakuza connections. Interestingly enough, the gang members involved in her husband's murder died

under mysterious (and horrible) circumstances about a week after the crime.

Security Level:0

A2#9 The Taco Hut:

This small stand sells everything *except* tacos. If you know the right people, it is said that the "Hut" can provide anything from drugs to automatic weapons. The small stand has been a nexus of gang violence ever since it was put up in 2018. Many fixers frequent the Hut, but never after dark.

Security Level:0

A2#10 The Shooting Gallery:

This building is part of The Range. Like its neighboring building, it seems like nothing more than a solid slab of cement. Unlike the other building, however, this one lacks doors or windows, and the only way to gain entry is through an underground tunnel that runs between the Range and the Gallery. In this building heavy weapons are stored, and classes on their use are also held here.

Security Level:2

A2#11, 12 Deveron Showroom:

These two buildings were once owned by a larger corporation that tried to settle in this area. The corporation was dissolved in 2016 and the buildings were sold to individual businesses. Now these two buildings are showrooms for AV's and fan-powered vehicles. Building 11 showcases variations of the AV-4 and AV-7. Building 12 showcases new fan cars, with all the standard variants. The ceilings on both buildings are equipped with lifts to take the AV's from the showroom to the roof if needed. After several instances of gang violence in the showrooms, the dealer entered into a security contract with Arasaka, making these two buildings the best defended in the Northside district, but security ignores anything not threatening the buildings themselves.

Security Level:3

A2#13,14 The Ron Walker Showroom:

With two buildings housing one of California's biggest auto showrooms, this is where all the lower level corporates go to buy their new cars. Ron Walker carries all makes and styles, from the newest designs from Japan to solid domestic models. The showrooms are multi-leveled, with each level housing a different manufacturer. Walker has entered into a Arasaka security contract similar to that of the Deveron showrooms.

Security Level:3

A2#15 The Sandorf Hotel:

This building is officially condemned, but is occupied anyway. The Sandorf is owned and operated by a coalition of smaller gangs in the district, who keep the place

standing to keep a ceiling over their heads. The building is also a contested turf area, with drive-by firebombings happening every few days.

Security Level:0

A2#16 The Pit:

Once a low-rent housing unit, the Pit stood empty for nearly five years. Finally, the gangs moved in. The entire structure is now the home turf of the Slaughterhouse, one of the most dangerous and powerful gangs in the city. There has been only one attempt to oust them (by a realtor who was selling the building), but the private security force he employed quit after suffering heavy casualties in an attempt to "reason" with the gang. The entire building is run-down and covered with graffiti. The gang tends to lay low during the day and always avoids the Arasaka security team in the nearby AV dealership (who just want an excuse). The cops have yet to enter the picture.

Security Level:0

A2#17 The Uptown Mall:

This building was renovated by a contractor and turned into an indoor mall. Unfortunately for him, the mall attracted more gangs than it did regular shoppers. Now the entire building is one giant gang hangout. Almost a dozen gangs claim small sections of the mall as turf; accordingly, the space is now filled with businesses equipped to better serve the new clientele. Within the mall one can find weapons shops carrying anything from pistols to illegal automatic weapons, black market drugs, joy girls, and generally the worst wares Night City has to offer. The Mall is a very dangerous place to be after dark. The gangs are very territorial, and often kill at the slightest offense. Occasionally, just to make a point, the Slaughterhouse comes across the sidewalk to do some damage to the lesser gangs.

Security Level: 0

A2#18 Night City Technical Exchange:

This tower houses the offices of the N.C.T.E. Operated by a coalition of powerful techies throughout the City, the Exchange is a centerpoint for new technologies being developed in the Night City area (it is rumored that the Exchange can find any item of technology that exists, and if it doesn't exist, can usually create it). Techies are welcome to join the Exchange for a mere 200 eb per year, and at least one week per year work time in the Exchange offices. The Exchange is a powerful organization, with members in almost all the major corporations.

Security Level:3

A2#19 Everything And More:

This middle-class department store has just that—everything and more. Everything and More has departments for cyberwear, clothing, nomadic living, chipware; you name

it. Prices are reasonable, and the service is good. The store hires private security to guard against gang violence, so the area is relatively safe.

Security Level:1

A2#20 The Renwald Plaza:

This building is a collection of small industrial businesses, most of them in various stages of going under. Of all the businesses, only three are on steady ground. **Mexal**, a designer of custom cybereyes, occupies the top two floors. **Reclon**, an independent chemical research lab, occupies the basement. **Psycol** is a therapy house for registered cyberpsychos occupying the rather heavily armored fourth floor.

Security Level:2

A2#21 Dynalar Technologies:

This large steel and glass building houses the west coast regional offices and manufacturing plant for Dynalar Technologies, a cyberlimb design and production company. Dynalar has plants in several major cities in the United States, with its main headquarters in Dallas. Dynalar does have a ground level sales floor and demonstration area open to the public.

Security Level:2

A2#22 Security Specialists Inc:

This business specializes in small, often individual, security contracts. When you can't afford Arasaka, Security Specialists is a wise second choice. They handle everything from alarm systems to fully armed, well-trained guards on station 24-hours a day. Many small local businesses come to them for their security needs. Affordable and very reliable.

Security Level:2

A2#23 Recording Systems:

This up and coming recording studio has a reputation for taking chances, recording and distributing albums for relatively unknown artists whose stuff they like. This open door policy has made RS a rising star in the recording industry, and many of its new discoveries have gone on to become international stars. The company is now accepting tryouts for new bands and solo acts. If they like your sound, they'll almost certainly write a contract. There have been rumors that Recording Systems is owned by DMS, but both companies deny it.

Security Level:1

A2#24 Parking Garage:

The multi-leveled carport for the area. Security is good during the day, but don't leave your car overnight if you're fond of it.

Security Level:1

A2#25 Fury Sound Audio Electronics:

Run by ex-rocker Mike "Fury" Crosanti, this is a high-level retail shop devoted to sound. Here you can buy everything from cyberaudio to car speakers. Mike's staff is well versed in all fields of audio; if it makes, records, or modifies sound, they know about it and probably sell it.

Security Level:1

PERSONALITIES

Janet Demaine- Janet is the Vice President in charge of acquisitions at Recording Systems. She is bright and cheerful, and is always willing to give an ear to any struggling young band. If she likes the sound of your music, you're almost guaranteed to get a recording contract. She is responsible for launching many young stars in the business today.

INT 7, REF 8, TECH 5, COOL 10, ATTR 10, LUCK 9, MA 5, BODY 6, EMP 9

SKILLS: Human Perception 6, Music Know 10, Wardrobe & Style 6, Seduction 5, Fast Talk 8, History 5, Dance 4, Streetwise 3, Personal Grooming 3

Dillon Murphy - Dillon is a soft-spoken, twenty-one year old solo who already has a reputation on the Street for a cool head and a fast .44. He speaks with a thick Irish accent and bears a resemblance to a certain Rory McGuire, an I.R.A. gunner from Belfast who escaped from a maximum security prison a few years ago. Behind his back, he is known as the "White Knight of Night City" because of a chivalrous streak that causes him to protect women and children - sometimes without pay! He also has a soft spot for pretty girls, most preferably redheads with little or no cyberware and lots of freckles.

INT 7, REF10, TECH 5, COOL 10, ATTR 9, LUCK 10, MA 6, BODY 10, EMP 9

SKILLS: Handgun 10, Brawl 9, Melee Weapon 8, Human Perception 6, Awareness 7, Dodge 6, Fast Talk & Persuasion 7, Play Celtic Harp 3 Gaelic 5, Stealth 6, Dance 2, Seduction 2, Demolition 4, SMG 5, Drive 2, Combat Sense 6

CYBERWARE: Chipped for smart handgun; bone lace.

Father Kevin- To no one's surprise, Father Kevin of Holy Angels Church was a solo in his younger days and saw action in a dozen or more countries. When he grew sick of wholesale destruction and human intolerance, he came to the conclusion that only charity and divine grace could save humanity. He and his church will provide sanctuary

and mediate disputes for anyone that will ask (and is willing to turn over their weapons). Father Kevin's record for peacefully settling gang or corporation problems is exceptional.

INT 6, REF 10, TECH 4, COOL 10,
ATTR 5 LUCK 8 MA 7 BODY 7 EMP 9

SKILLS:

Handgun 10, Martial Arts(Akido) 8, Persuasion 8, Dodge 7, Human Perception 8, Specific Know(Church Doctrine) 10, Melee Weapon 7, Leadership 7

ENCOUNTERS

1. A Tech heading to the N.C.T.E. is being harassed by four members of the Slaughterhouse, and they mean to kill him. If the players help the tech he will introduce them (if any are interested) to the higher execs in the Exchange.
2. Members of a small booster gang are torching a car, just for laughs.
3. Firefight between two cops and three gang members, the players could tip the balance either way.
4. Find a dead body in the back alley. Ref's option as to importance of person or potential for looting.
5. The Inquisitors have nailed a sole booster gang member

to a nearby wall, with a sign reading "Repent sinners" hung around his neck.

6. Gang War- Three lesser gangs are being massacred by the Slaughterhouse. Look the other way and hope they don't notice you?

7. Rumble- Two lesser gangs having some fun. They won't bother you if you don't bother them.

8-9 The streets are quiet, for now.

10. A booster gang is tearing apart a parked car. Nothing too dangerous, unless it's yours.

CONTACTS

1. **Ed Fillet**- Works at the Taco Hut. Know him and you can get anything. Maybe even a taco.
2. **Lisa Harris**- One of the best salesmen at the Deveron Showroom. She hears a lot of what goes on in the corporate sector.
3. **Millie O'Keefe**- A barmaid at O'Flaherty's, she is bright and cheerful, and knows just about anything that happens in the neighborhood.
4. **Killigre**- A lieutenant with The Slaughterhouse. If you're careful this guy can be of great aid.
5. **Liz Borden**- A name given to a slightly psychotic joy girl working with one of the gangs in the Mall. She (in her more lucid moments) is a good source of information.

DATATERM DISPLAY SYSTEM

Topic: Local Hangouts

UP

DN

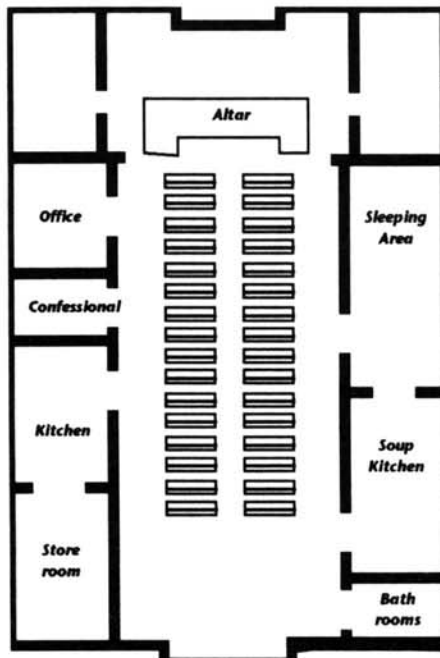

Holy Angels

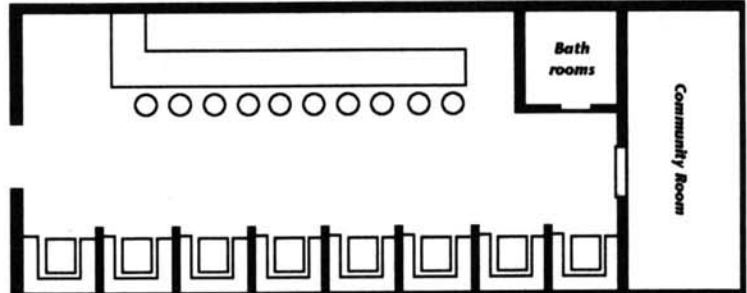

O'Flaherty's

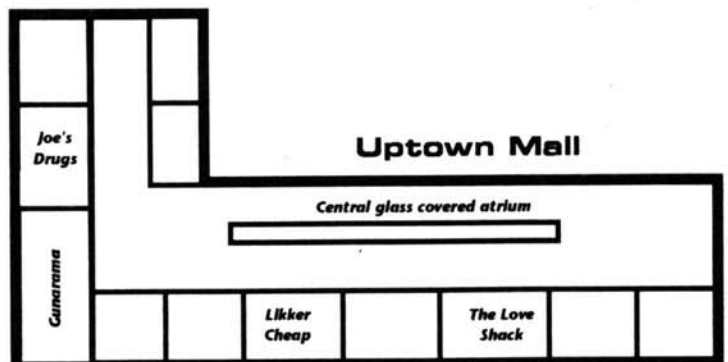

Uptown Mall

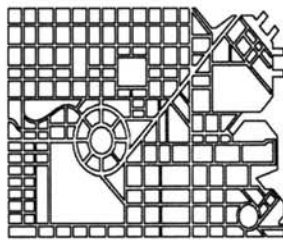
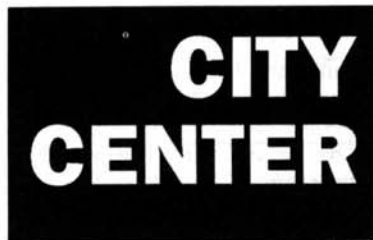

D A T A T A T E R M

The City Center—governmental nexus and hub of the City. From its stately modern buildings and halls filled with bustling officials, originate the decisions that shape Night City's municipal destiny.

Theoretically, Night City is actually what is known as a *Corporate Controlled New City Democratic Mayorality*; a satrapy in which the ten largest Corporations get to place their own board members on the City Council. The Mayor is ostensibly chosen from an open field of candidates who are elected by popular vote; however, it's commonly accepted that Night City's *IdentiCard™* voter-registration software has been so heavily compromised by Corporate netrunners that a real election is all but impossible.

Although it's true that the corps own the city in all but name, the mayor, formally a corporate lackey, is now taking steps to regain municipal powers lost in the last decade. This is making him very unpopular with the corporations.

A3#1 Night City City Hall:

City Hall is done entirely in wood, and is styled to imitate the colonial government houses of the East Coast. Recent advances in wood technology keep this building looking clean and glossy with minimal maintenance costs. The City Hall is always bustling with lobbyists, special interest groups, corps, execs, and even a few government employees. Occasionally, something even gets done there.

Security Level:3

A3#2 Night City Justice Court:

The City Court is never a pleasant place to go, but a lot of cyberpunks seem to end up visiting it at one time or another. The entire building is done in Brutalist style, from the giant pillars ringing the exterior of the building to the four-meter black steel interior doors set in the cold, smooth stone walls. Everything in this building is oversized, designed expressly to intimidate anyone who crosses the threshold through the six-meter front doorway (with portcullis!). Inside, sounds echo as in a giant tomb, and in the foyer stands a large, automated security drone. It looks like a truncated cone equipped with

multiple sensors and weapons, and nobody really knows whether or not it's a stationary emplacement. No one wants to find out. It was a gift to the city from Arasaka, donated in 2009, two days before the Corporations hit the Mob.

Civil concerns are handled on the lower floors, where the architecture is a little more friendly. This is where a person goes to file birth certificates, transfer titles, etc. But they make sure you pass through the criminal section *before* you get there.
Security Level:3

A3#3 Night City Museum:

Clean, modern and inviting, the museum's labyrinthine layout is designed to make exploring the building as much fun as discovering the past. It is remarkably well-stocked, as Richard Night was quite an art collector in his early years. There are many priceless antiques and original works by master painters, though the more valuable a given item is, the more likely it is to be found underground, where the security is notoriously tight. The building is also popular for clandestine meetings, as surveillance is quite difficult for outside parties, and the museum security system is not built for eavesdropping.
Security Level:1 (3 on lower levels)

A3#4 Burroughs Municipal Library:

The library is an aggregate of buildings in several architectural styles, and is one of the very few parts of the City Center that shows a lack of foresight and planning. Despite this handicap it's very well organized, and has an extensive collection. By far the most impressive asset are the CD-ROM stacks, which have digital copies of every major newspaper and magazine since the turn of the millennium. This can be accessed only through the library's rental terminals, which can browse and print out copies (with a .50eb per page charge). Extensive computer security hardware and software ensure that the stored data is untampered with.

Security Level:1

A3#5 Marcini's:

Marcini's is a large, quiet and elegant department store, where Corpzoners send their spouses to buy items for the home. Almost anything can be found here, along with designer labels and heart-stopping prices. Shopping at Marcini's is a status symbol in Night City (and many other cities around the world).

Marcini's is most famous for their extensive lingerie collection, which generates a surprising fraction of their income (particularly among Corpzoner mistresses). They also have a counter-espionage department where many defensive systems can be purchased. It's against Marcini's policy to sell anything that can be used for espionage; everything here is strictly defensive or preventative. Security is friendly but strict, and there is even a private taxi service (between shoppers' homes and the store).

Security Level:2

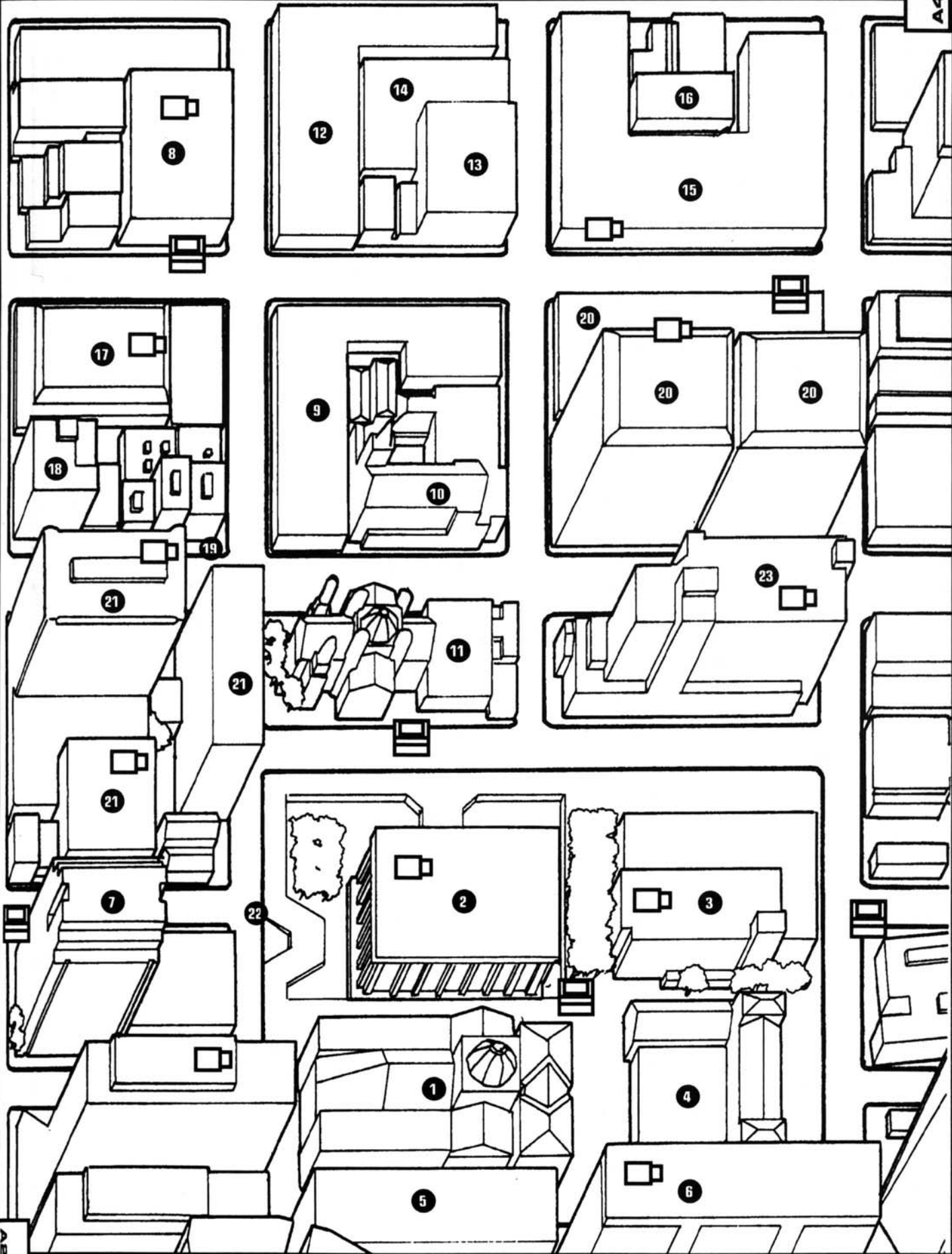



A3#6 Grandmill:

Grandmill is the inevitable consequence of a society where jaded execs make mountains of money. The entire building is stocked with startlingly expensive and very unusual items for the self-indulgent... sort of a *DAK* or *Sharper Image* run amok. The hyper-modern decor, all sparkling white and mirrored with pointillist lighting, focuses the shopper's attention on the merchandise. Most of the stuff is not much more than stylized gizmos, but some of the items are truly novel and useful. Regardless, if it's wierd, these people have it in stock.

There's no organization in the store; half the fun of shopping here is finding things you didn't know existed. Grandmill also has a voice-activated and self-motivated computer system ("You seem lost. May I help you find something, sir?") to help shoppers locate a specific item.

Several of the floors in the middle of the building have been ripped out. Here shoppers can find the specialty vehicle department, where items like minisubs, helicopters, and yachts lie suspended in acrylic over the heads of the customers below. The vehicles are not entirely encased, and shoppers are welcome to enter them. Should someone purchase one of these, a freight elevator at the east end of the building can carry it to the roof, where a waiting cargo chopper will deliver it from Grandmill's helipad to wherever the customer desires.
Security Level:2

A3#7 Burleson Tower (and associated structures):

Burleson Construction Company was in charge of a lot of the construction in downtown Night City, and went bankrupt shortly after Mob businesses took over. The Mob left the building standing and the name unchanged as a monument to their victory.

Poor maintenance has resulted in the slow deterioration of this building, which has finally ended up as a hotel. The rates are high, for despite the condition of the building, it's convenient to the CityCenter, CorporateCenter, and financial district. There are also a number of joygirls working the hotel, and there's a massage parlor operating on the third floor.

The top three floors of the building are occupied by **Totentanz**, a poorly-supervised club where a lot of boostergang members go to work up some adrenaline before getting laid. The music is loud, the drinks strong, and the patrons rowdy to an extreme. The local ambulance companies no longer make runs here, because too many of the casualties of this club couldn't pay their bills. Late at night, groups of boostergangers will make trips to Medicross Preservation (on High Street near Sterling) to finance their next round of drinks.

The NCPD lets Totentanz stay open for two reasons: one; it kills the punks, and two; the gangs would get very upset if the place got closed down.

The two-story building east of the tower used to be a general store. It went out of business several years ago, and has remained deserted ever since. Lord only knows what goes on inside there now. Rumor has it that the City plans to buy the building for a municipal annex.

Security Level:0

A3#8 Zenger's Electronics:

Zenger's is in the business of buying and selling cases and carloads of commercial silicon. If you need a shipment of electronics, or information on other people's shipments, Zenger's is a good place to start. Wholesaler and jobber, Zenger's supplies bulk quantities of materials to retailers like *Julius'* in Little Italy.

Security Level:1

A3#9 Wing Chang, "Sustenance of the Emperors" (and associated structures):

Wing Chang is the single most expensive restaurant in the city, running \$200 per person, flat rate. The entrance is a covered turnabout at the north end of the block, where valets take your car to the parking garage to the north. The restaurant itself is long and rather narrow, but each table occupies a separate soundproofed room. The decor is ornate and authentic. It is not at all touristy, and very luxurious.

There is no menu; you are simply served a Chinese banquet. But what a banquet! A seemingly endless variety of authentic Chinese cooking, artfully executed and served in copious quantity. The all-Chinese staff has a knack for knowing exactly how and when to serve things, which is hardly surprising since most of the employees have been doing this all their lives.

Certain corporations have taken out a contract with Wing Chang; for a membership fee, (presumably a staggering amount), the corporation's top execs can eat there whenever they want. This is a favorite place for the power business luncheon, although the budding young exec must remember that the waiting list is about three months long.

Security Level:2

A3#10 The Holy Church of God:

Right next to Wing Chang is the Holy Church of God. This ornate, fundamentalist church has survived the departure of the largely religious mobsters quite well; many corporate execs go here to ease their conscience. The bell tower also serves as a broadcast antenna for KNOW, the church's religious radio station, which pretends to be part of a national chain of Christian stations. The station manager (Dieter Scheumann) is able to generate a lot of revenue by broadcasting a variety of "charity" programs under the pretense of Christian network programming - "Just send your donations to P.O. Box...". If anyone ever catches on, the station (and therefore the church) will be in a lot of hot water. Or should we say fire?

Reverend Paul Night (no relation to the founder of Night City) heads the church. He is an honest, caring man, and his wife is a person of some importance in several area charities. They are always willing to help street kids, and therefore the kids will protect them from being hassled. The Nights don't condone this, as violence is usually involved, but that's the way it is. Needless to say, Paul and Mary Night are unaware of KNOW's false programming.

Security Level:1

A3#11 La Croix:

Trendy magazines consider this the best restaurant in Night City. More respectable sources consider it banally gimmicked. Its owner, Jaqueline duBenalle, took over the mortgage on the building from the bank, and, since the church occupying the building was having financial difficulties, foreclosed immediately. Within one month, Ms. duBenalle had opened her restaurant, having left most of the traditional religious trappings in place. The food and service are excellent, though too 'fashionable' for many people. They even serve French-style raw seafood, which they call *Siouçais*.

Restaurants like this tend to prosper in urban areas, where a sizable portion of the populace believes whatever the media feeds them. La Croix is no exception; it's always packed with Beaver wage slaves having affairs, edgerunner wannabes, and movers trying to impress people. Jaqueline herself is almost always on the premises during the dinner hour, socializing with the guests, and dressed in one of her many provocative outfits. She claims to be French, though her features belie this. (Actually, her father is Algerian-French, and her mother French-Vietnamese.)

Security Level:1

A3#12 The "West Block":

The north and west sides of this block are comprised of a continuous series of older three-story buildings housing a variety of small shops, nightclubs, bars, and restaurants. Most of these shops have a life-span of about two years, although the **Metropolitan Barbecue and Grill** (an excellent and inexpensive steak house and bar) has been around since the 1990's.

Security Level:0

A3#13 Fantasy Unlimited:

The building on the southeast corner of the block houses the offices of Fantasy Unlimited, an unusual service company founded by Alice Forge in 2003. Fantasy Unlimited has slowly clawed its way from an out-of-house operation to a unique business in its own niche, providing clients with whatever they desire. Fantasy is not a production company, but rather the ultimate networkers. They know where to find the necessary equipment and expertise; they get good rates with their vulpine negotiations team, and pull down a tidy profit making their clients' dreams come true (if only for a night).

Alice Forge, a pale, raven-haired woman with an unusual sort of good looks, was raised in a disciplinarian corporate household. Her frustrated and unfulfilling childhood inspired Fantasy Unlimited, and her ruthless business acumen insured its eventual success. She has had several intimate friends, but few could abide her formidable temper.

Security Level:1

A3#14 Puddleforge's:

On the east side of the block (just north of Fantasy Unlimited) is a large, well-stocked, used book store where copious amounts of remaindered *Cyberpunk 1.0* games can be bought for a song and burned as fuel.

Security Level:0

A3#15 Revere Courier Service:

Revere Courier Service (RCS) dominates this block with their sprawling shipping offices. RCS is a vertical monopoly, providing corporations with every type of shipping desired. They have armored cars for cash or asset transfers, cycle couriers for crosstown deliveries, and their own fleet of jets for same-day delivery around the world. RCS built their reputation on emergency deliveries, and has now expanded into the standard shipping business. Most people do not yet consider this newcomer to be as reliable as UPS or United Express, so RCS is starting out somewhat slowly.

Security Level:1

A3#16 The Del Coronado Bay Journal:

These are the offices and print facilities of a small, old fashioned newspaper. While screamsheets have driven most newspapers to the edge of extinction, some are still fighting for survival. The Bay Journal is one of them. A very reliable source for non-biased news.

Security Level:0

A3#17 Meridian Square:

The north side of this block is dominated by Meridian Square, an older indoor shopping mall. To the east is a parking lot with ramps leading to an underground garage. Streetkids often come here to rollerblade down the ramps and across the smooth, empty lot. Meridian Square has been having rough times since 2011, when the **New Harbor Mallplex** was finally opened. Over the last two years there has been a gradual increase in the number of vacant stores, despite repeated redecoration and other incentives. In fact, the only thing keeping Meridian Square afloat is the fact that they house a large number of local specialty companies who can't afford New Harbor Mallplexes' rent, yet offer hard-to-find, unusual, handmade, or imported merchandise. This place gets real busy during Christmas and the tourist season.

Security Level:1

A3#18 FutSure:

The FutSure building rises from the southwest corner of the block; an unbroken expanse of gold reflective glass clean and

modern enough to cast Meridian Square and the other local buildings in a bad light. This locally-owned stock brokerage rents office space to a wide variety of financial and real estate concerns. Despite the company's small size, they have a lot of brokers, all of whom deal with their clients one-on-one. Anybody with money will be welcomed here.

Security Level:2

A3#19 "The Hole":

This is an assortment of smaller brick buildings on the block, each of which sports a fast-food franchise on the ground floor and small apartments on the floors above. Black Queen gang members can often be seen here, hanging out, chowing down, and surreptitiously dealing drugs to execs who come down here on their lunch hour. So far, the gang has not caused enough of a disturbance to attract the serious attention of the NCPD.

Security Level:0

A3#20 Merrill, Asukaga & Finch Business Center:

Merrill, Asukaga & Finch owns this pair of high-rise office buildings, and rents office space to non-competitive corporations (airlines and such). The exterior of the buildings is done in a sort of steel mesh (chrome to the west, gun-barrel blue to the east), which gives the appearance of an impenetrable fortress, yet still reflects light dazzlingly. Security is very tight in the buildings, and submachinegun-toting guards can be seen patrolling the sidewalks around the block. Although MA&F is a high-power investment firm, they tend to primarily service corporations. Many folks don't care for their expensive, impersonal approach, and instead go to FutSure down the street.

The parking garage to the north is large and clean, and the high rates ensure that anyone who can afford to park there will be able to find an empty slot.

Security Level:3

A3#21 The Demitrov, Koski, Pang, & Lo Law Complex:

Starting with one tower on the east side of the block, Demitrov, Koski, Pang, & Lo, an international law firm, has eventually taken over every other building here. They are currently undergoing some rather chaotic reorganization, as their original building is being converted to a hotel of sorts, filled with suites for their lobbyists to entertain government employees and apartments to house their clients and visitors. In the meantime, offices in the other skyscraper are being pressed into service as suites, and the displaced office workers have been moved to the assorted smaller buildings on the south side of the block. Since they were unsuited to this use, they are also being renovated around the employees. Productivity and morale has dropped during this time, and confidence in DKP&L is wavering. Only time will tell if this has been a costly mistake for the firm.

Security Level:2

A3 #22 NCART City Center Station:

On the south side of 5th street, wedged between the cold glass highrises of Demitrov, Koski, Pang, & Lo, wide concrete stairs lead down to the NCART station. There have been sporadic attempts by the City to keep the stairs clean and the brass railings polished, but the fumes, dust and trash integral to a subway line keeps them gritty.

The platform itself is a typical concrete slab, with a few molded concrete benches scattered about. There is a shoeshine stand tended by an ancient Hispanic man, a small overpriced barber shop, and a newsstand with screamsheets, books, etc.

The Transit Police keep the platform clear of beggars and dorphers, but there are a large number of young boys and girls here at all hours of the day, plying their trade. Rumor has it that some are so skilled they can administer their services on a crowded maglev car with no one else being the wiser. There are also those who make aggressive passes at prospective clients as a cover to pick pockets.

The juvie gangers refer to this station as "the Zoo." This is their most popular hangout, because the security is loose and the clients less depraved than those found in the Plaza Center station (aka "the Jungle"), yet the money is every bit as good. Despite the fact that most of the kids are hooked on one or more illegal drugs, they know the letter of the law and can avoid doing anything technically illegal when trying to turn a trick. That, and the fact that their customer base is made of rich taxpayers, prevents the Transit Police from running them off, although NCART has mounted a few sting operations.

Security Level:0

A3#23 Bay Area Savings & Loan Building:

Bay Area S&L stock has been way down since 2009, when the Corporate takeover caused a lot of their outstanding loans to go default. Since then, they've been struggling to regain their feet, and the local business community suspects them of some shaky dealings. The top half of the building is rented by **Administrative & Clerical Services, Inc.**, which in turn subleases office space and secretarial services to a large number of high-powered small business concerns.

The BASL building is starting to show its age; since BASL has been unable to afford any renovation, work which should have been started two or three years ago has gone wanting. If ACS moves out, it will leave BASL in very dire straits indeed.

Security Level:1

PERSONALITIES

Mbole Ebunike (aka Judson Freeman)- The Mayor was reelected as a result of the support he received from the corporations; support he received because he was groomed to be a well-behaved corporate puppet. Although he was

nothing but a toady for his first term (2012-2016), he has recently become rather intransigent. Tired of being a puppet, (and like a child who finally learns the meaning of 'no'), he's trying to rebuild his self-esteem by vetoing anything that crosses his desk. The Mayor has also recently become quite active in the burgeoning Pan Neo-African political party; hence the name change from Judson Freeman to Mbole

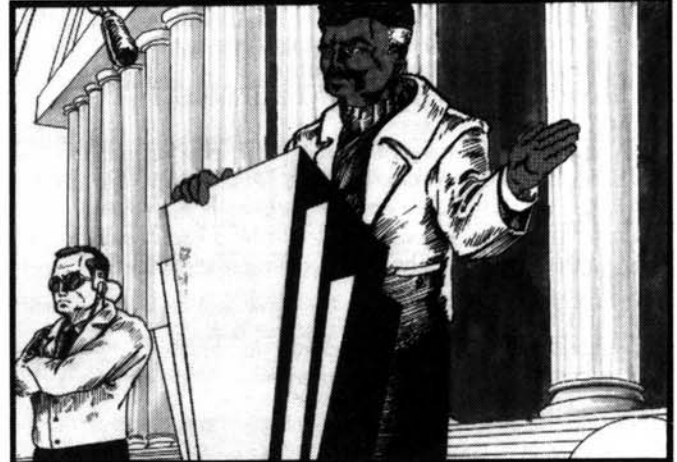

Press Conference, May 19, 2019. Mayor Ebunike(R), Garvin Haakensen(L)

Ebunike. Whatever his name, Mbole's getting to be very unpopular these days, and therefore doesn't spend too much time in his office, preferring to remain unavailable. Even when he's in his office, his door is usually locked, leaving his hapless secretary to deal with irate visitors.

INT 10, REF 5, TECH 7, COOL 7, ATTR 6, LUCK 7, MA 5, BODY 7, EMP 7

SKILLS: Leadership 8, Awareness 5, Human Perception 6, Education 4, Library Search 3, Social 5, Persuasion 3, Wardrobe & Style 2, History 4, Politics 5, Oratory 2

CYBERNETICS: Cyberaudio with bug detector and voice stress analyzer.

Garvin Haakensen- In stark contrast, the Assistant Mayor can always be found in his office. Garvin plays Machiavellian politics, and has his crosshairs on the Mayor's seat (for starters). He has contacts with all the special interest groups, as well as the corporations and organized crime (Or, to be more specific, they all have contacts with him). So far he has been able to juggle all this without anyone being the wiser, and, given the Mayor's recent change in personality, he has been approached for all sorts of favors, which he will eventually call in.

INT 9, REF 6, TECH 5, COOL 7, ATTR 9, LUCK 8, MA 6, BODY 6, EMP 7

NIGHT CITY

SECTION A3

SKILLS: Leadership 4, Notice 5, Education 6, Persuasion 10, Oratory 10, Handgun 3, Forgery 5, Drive 3

CYBERNETICS: Cyberarm with Realskin™ and a popup 9mm gun.

ENCOUNTERS

- 1: The mayor is having a rare press conference on the steps of City Hall. Any questions? (day only)
- 2: Spot the Asst. Mayor talking with a known hired gun. What's he up to?
- 3: A very dangerous gang of the referee's choice has decided to carve it's initials in every building on the block, and on anyone who gets in their way. (night only)
- 4-6: Just those damned tourists with the holo-cams again.
- 7: A joy girl offers to sell her wares, or information if the price is right.
- 8: Bump into an irate corporate.
- 9: Brenda McAllan (roving reporter for Network 54) is conducting man on the street interviews. Hope no one is looking for your face.

10: An impromptu protest is set up against the corrupt nature of the government. Good luck on getting out before the cops get here...

CONTACTS

1. **Edna Wilston**- Edna works as a file clerk in City Hall. She knows all the dirt and will talk to the right person.
2. **Greg Calters**- He handles all the arrest records for City Hall. His one weakness is for tall blonde women. He can't resist any request one makes.
3. **Melinda**- A young joy girl, working the streets until she gets enough cash to start a small antique shop. She is a favorite of the Assistant Mayor and knows much.
4. **Stacey Makida**- The head Librarian. If you want to know anything about the City's past, ask her.
5. **Fred Tallson**- A small time reporter with big time ambitions. He currently works at the *Bay Journal*.

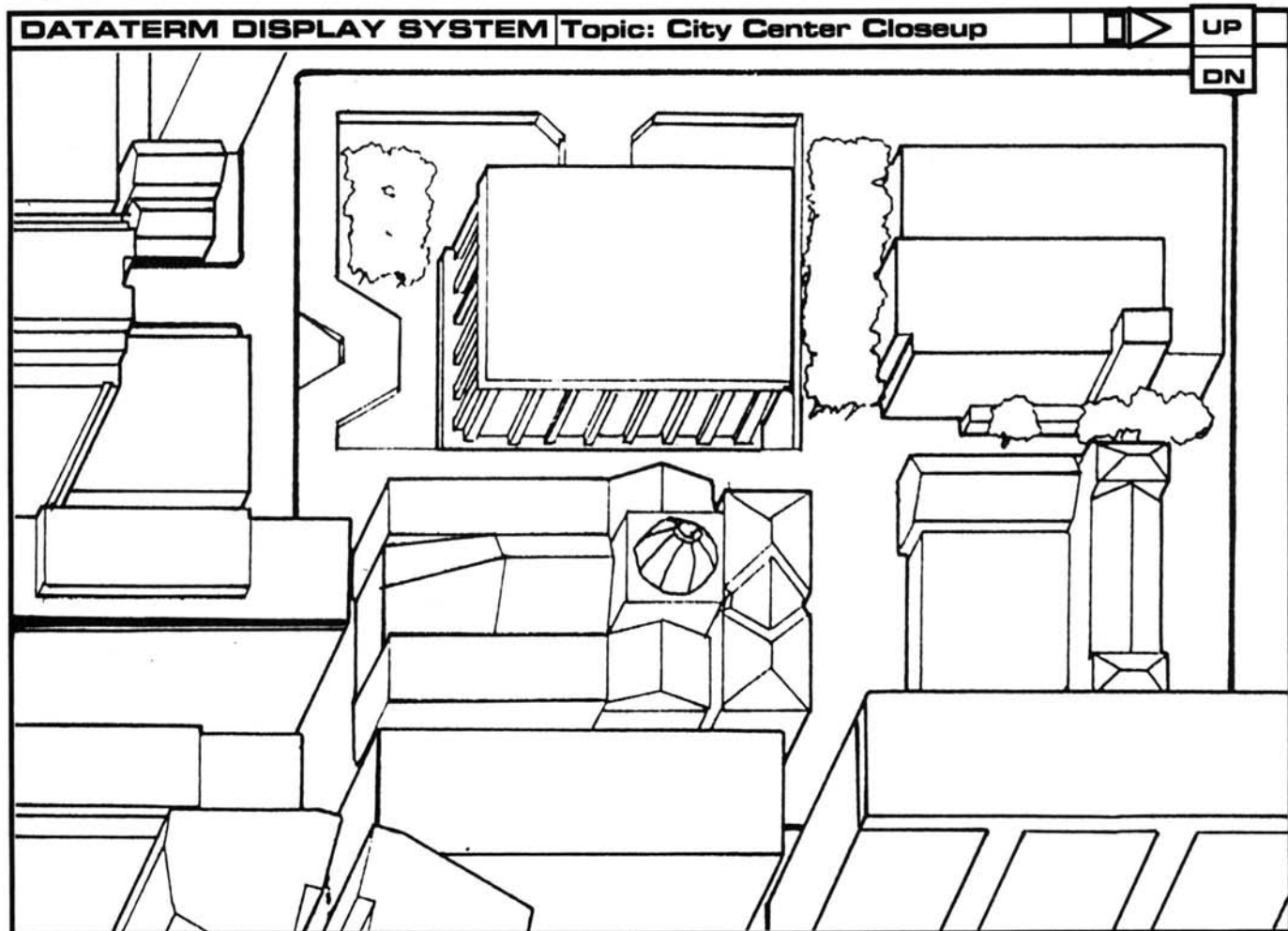

UPPER EAST SIDE

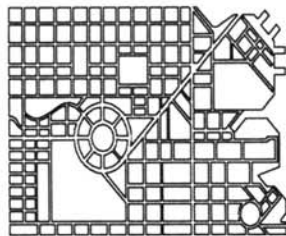

D A T A T E R M

Upper Eastside, one of the commercial sections of Night City, has suddenly found itself in the trenches of the war against urban decay. Here you'll find the oil-and-water mix of heavy metal and soft velvet: hard rockers who'll crush your skull and soft corps who'll crush your life.

Upper Eastside, thanks to its proximity to the City Center and the police, was long considered a safe area. Most felt that the presence of the rich corporations would keep the streets in showcase style. Slowly, though, other businesses moved in, taking advantage of the convenient central location to offer their wares to boostergangsters around the city; the Slammer and Metalstrom to name a few of the most notorious.

The first businesses were essentially nighttime concerns, so the problem was easily ignored by the Corps, who had long since commuted to their suburban castles. But other businesses rapidly followed suit; places like **Metal Heaven** and **Kitty Liquor**, until one day the Corpzoners woke up to see boostergangsters walking down the streets, shouting, drinking, and generally spoiling the lunch hour.

The atmosphere of this area has gotten harsher, and the decay threatens to continue. Meanwhile, the boosters are here to stay, and the corps want them out... now. All is not quiet on the Eastern Front.

A4#1 Allworld Insurance:

This multi-level structure is the Region 8 headquarters of Allworld Insurance, a company that specializes in industrial coverage. The architect intended the building to look strong and old-fashioned, to reflect the company's stolidity and reliability. Instead, the building just looks squat and ugly. The upper story is an aviation pad for the company's pair of AV-4's, used to reach a claim scene within minutes. Once at the claim scene, an appointed agent of the company will investigate and write a preliminary report, which will be followed up by junior investigators who do the tedious research no one else wants to do.

The north end of the block is a large (10m high) enclosure built of very thick reinforced concrete. This structure houses the physical evidence gathered by Allworld investigators for further inspection by forensic engineers. Short of very heavy explosives, the only entry from the street is the long ramp from the south. This entry has two checkpoints sealed by heavy steel doors (ain't no one gonna tamper with Allworld's evidence). The concrete walls are covered roof to gutter with wildstyle graffiti and urban murals. There is also a dataterm in the lobby of the Allworld building.

Security Level: 2

A4#2 Aquadynamics:

These converted warehouses are actually the main research laboratories for Aquadynamics, a firm specializing in fluid technology and synthetic foods derived from a plankton base. The outer walls have been rebuilt from the original corrugated steel to concrete and bulletproof plexi, so as to prevent industrial espionage and potential toxic chemical leakage.

There are no luxury accommodations in these buildings; this is a purely industrial site. Given the number of hydroponics tanks and other research equipment, any firefight in this area will be rather messy. The lack of exterior lighting makes this a popular hangout after dark.

Security Level: 1

A4#3 The Slammer:

The Slammer started out many years ago as a small speedmetal/punk rock club. Over the years, the constant standing-room-only crowds have generated so much income that The Slammer has expanded to cover the entire south and east sides of this block. Currently owned by Suds Joliet (see Personalities section), a former Booster and Rocker, this bar and arena is favored by boostergangs, posers, chromers, 'dorphanes, the occasional solo, and any other brave souls who love hardcore punk rock.

Although many people come to drink or meet with prospective contacts, the main attraction of this bar is the Arena, and thankfully so. Were it not for the vicarious pleasure offered by the Arena, there'd be constant brawls in this club.

The interior of The Slammer is close, due to both the large number of small tables, and the number of patrons. It's a miracle if you can walk to the bar without bumping half a dozen people and getting in the same number of shouting matches or brief scuffles. Pickpockets are common here, though novices don't last long.

The structure on the east side of the block is called the **Arena**, and is built out of several layers of cinder blocks. It's used to settle disputes between gangs (free of charge, but there's a waiting list). These battles usually take place

UPPER EAST SIDE

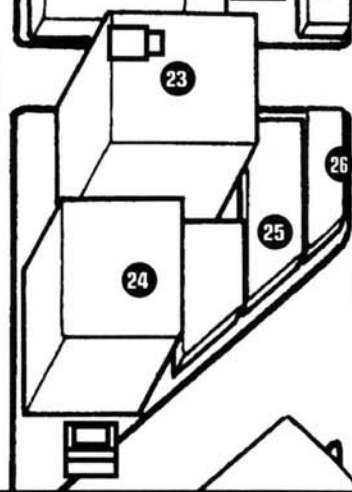
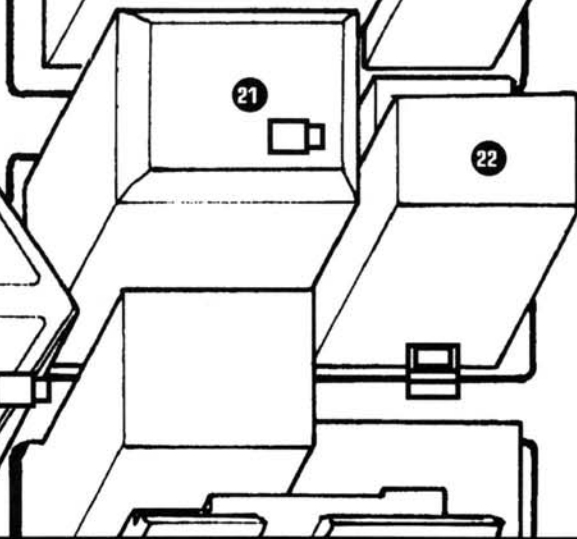
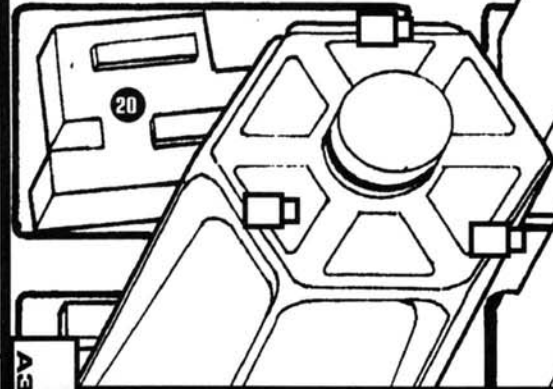
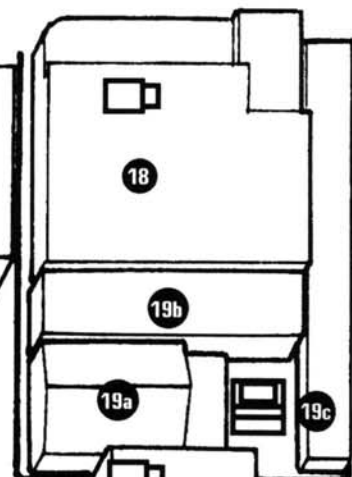
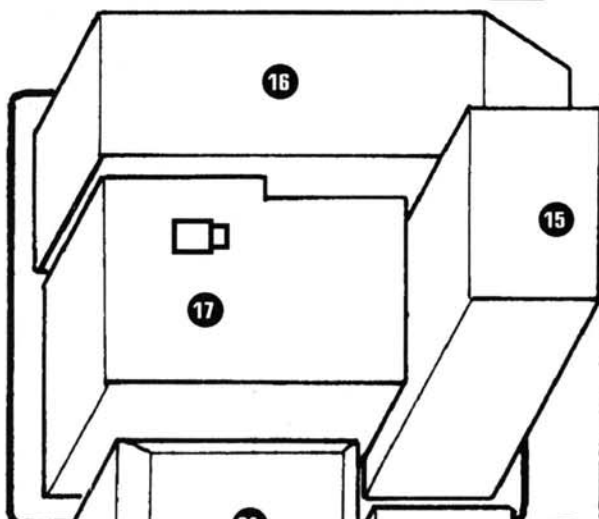
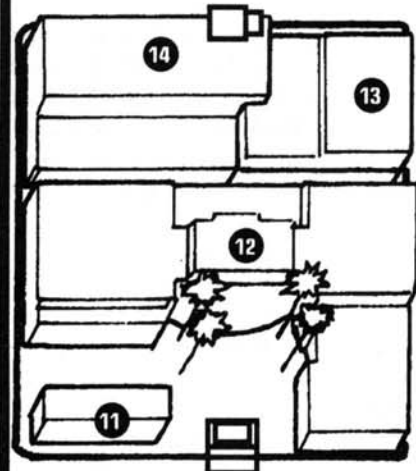
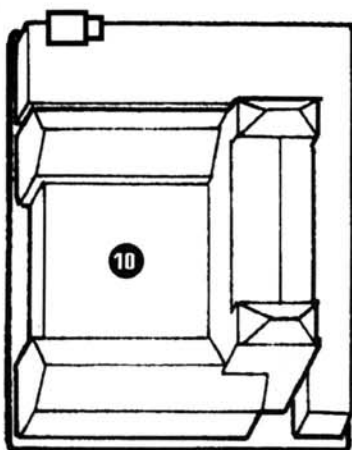
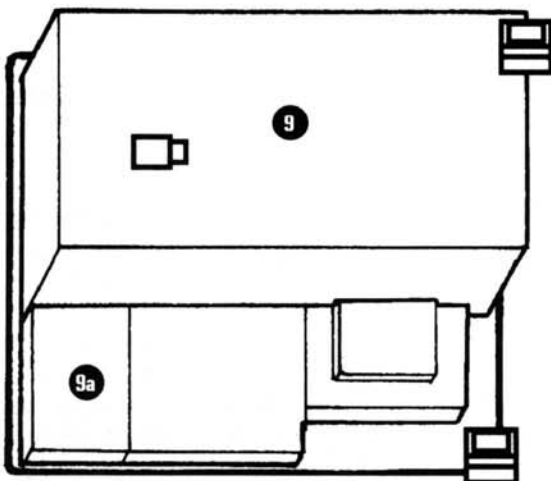
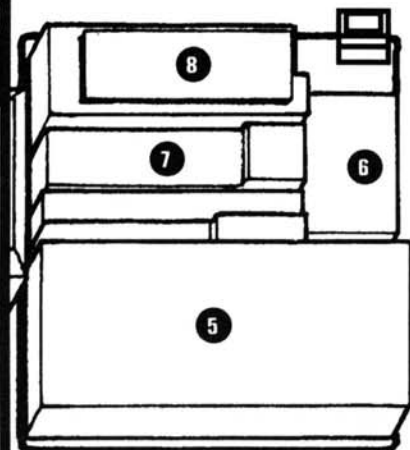
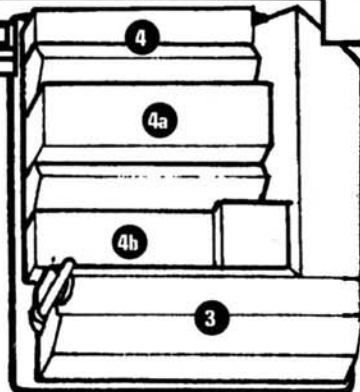
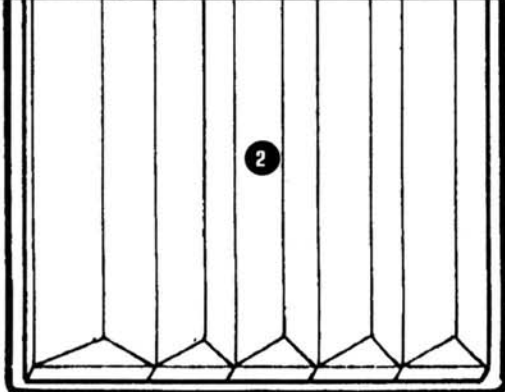
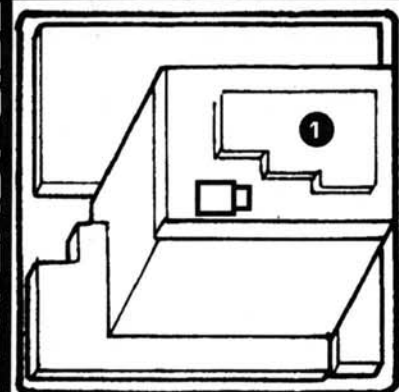

A3
B4

between two or three of a gang's best fighters, but wars of up to ten or fifteen people on a side have been known to happen. Under an unwritten code of the Street, a gang who accepts a challenge must abide by the "decision" rendered by the outcome of the battle.

Between the Arena and the club proper are betting booths (run by the club) and a medical center staffed by a renegade cybersurgeon known as Vaso. There are also glass walkways above the Arena where those who can afford the ticket price can stand and watch the battles below. Those of a rougher edge often engage in intercourse while watching a battle.

The gang presence in this area, coupled with the nearby NCPD station and security guards, makes walking these streets about as enjoyable as bird-watching in a DMZ.

Security Level: 1

A4#4 Barstow Enterprises:

BE is a trucking firm that bases their operations out of these buildings. On most days ten to twenty trucks make pickups and deliveries here. The garage and loading dock are unfortunately located right next to the entrance to The Slammer. Although somewhat tolerant of the rowdy punks that patronize The Slammer, many of the truckers are not discreet in voicing their opinions, which has led to altercations in the past. Some of the trucks sport little pedestrian symbols on the driver's door.

The northernmost building in this complex is the office, which contains BE's dispatch system, financial records, etc. The three buildings providing a buffer zone between the office and The Slammer are all warehouses, containing merchandise of little worth to boosters. For example, the largest building (A4#4a) is a large refrigerated warehouse with wholesale amounts of liver paté, caviar, cream cheese with raspberries, and other foodstuffs gang members wouldn't be caught dead eating. The other warehouses contain merchandise for area markets, large heavy items like refrigerators, and other items of little interest to the true cyberpunk.

Security Level: 1

A4#5 Metalstrom:

Metalstrom is large 'club' catering to the hardest (and loudest) of chromatic rock tastes. It was designed in an attempt to blend the best of both rock bar and concert hall, and the resulting ambience is quite unsettling. Fortunately, most of the patrons are too brain-dead to notice, so the place is a success.

The decor borders on the indestructible. Bars and mirrors are polished steel (dented with abuse), and chairs and tables are made of resilient plastic. After much experimentation (and financial outlay), the owner of the club (a canny corporate

who hates music) decided to purchase 'breakaway' furniture. The chair and tables fall apart when overstressed, which makes brawls inside Metalstrom look like a Hollywood western. The Chromers naturally credit their brawny physiques. Although the club doesn't open until 4:00 PM, workers arrive here every morning at 9:00 AM to reassemble the furniture.

Bands which make regular appearances include *Armed Havoc*, *Blood and Ice*, and the *Destructors*. Most of the juves who attend this club are armed, as the Chromers enjoy their violence almost as much as their music. Although the reputation of the bar precedes itself, many still come to fight, drink and dance.

Due to the extremely territorial nature of Chromers, many fights have started over who has the right to control the area surrounding Metalstrom. Finally, in a mass battle with single representatives from each gang inside the Slammer's arena, it was decided that the *Back Alley Brawlers*, a guardian vigilante gang, would control the block. Although the police don't spend much time patrolling this area, it's pretty well-behaved; it's well known that members of the Brawlers deal out street justice to those violating the local code of conduct (as posted around the block by the Brawlers).

Security Level: 1

A4#6 Kitty Liquor:

When the Metalstrom opened in 2010, Mark MacGerald saw a fabulous opportunity for money making and purchased the fabric store next door. After a short period of greasing the right palms, he wound up with a liquor distribution license and opened his discount warehouse, which immediately became popular with those patrons of Metalstrom who didn't want to pay six euro for a Smash. Not wishing the wrath of a rich corp, he managed to convince the owner of Metalstrom to allow him to supply their liquor needs as well (with a radical discount) so no one lost money in the process.

MacGerald openly sells liquor in defiance of local laws, selling at all times of day and to minors. The constant crowd of liquor-emboldened gangs make the City Council reluctant to order his arrest. Riots have been threatened if Kitty Liquor gets closed, and the council doesn't want to see this area go up in smoke. They still have vague hopes of cleaning it up.

Security Level: 0

A4#7 Warehouses:

Although the main offices of *Mitifer*, the art importers, are located in one of the corporate towers, they also own these two warehouses that are used to store the acquired pieces while awaiting passage through customs. The buildings are thoroughly sealed to protect against (interior) vandalism. *Mitifer* has been trying to unload the buildings, but due to the proximity of Metalstrom, Metal Heaven, and Kitty Liquor (all of whom attract lowlifes), no one is willing to meet their price.

If Mitifer ever lowers its price, expect another gang-oriented business to open up there soon after.

Security Level:0

A4#8 Metal Heaven:

Billed as the audiophile's nirvana, this building houses supplies for every music need. On the first floor, there's a full line of domestic, imported, and garage discs, albeit at inflated prices. If you can't find the album, they'll order it for you, and they're rumored to be able to find any music ever recorded. Their rep is so good that, in spite of the chromers, corps will come here regularly to pick up their classical TiCDs. Metal Heaven also has a trio of ceremet robo-dobermans to ensure these well-paying customers don't get hassled.

Downstairs there's a small recording studio, which they rent out at outrageous rates. The quality is good, but not excellent, and they'll produce and package your album for you.

But it's the upstairs that deserves the most attention. Have you ever dreamed of a twelve-string bass with active pickups, fretless neck, fully-programmable drum machine, parametric equalizer and nine other optional effects, hand-carved and painted with the pigment of a rare Australian plant that causes the instrument to glow under certain lighting conditions? Now, for the right price, *it can be yours*. This music store specializes in custom instruments, though they carry all major brands as well. With specialist technicians on hand at all times, they can take your dream and turn it into an instrument you can play.

There's also a badly-abused dataterm on the northeast corner of this block.

Security Level:1

A4#9 DeskMate Corp:

This block is taken up by the DeskMate Corporation's main offices. A company whose main assembly line is but a part of this complex, DeskMate specializes in low-cost ultra-compact (and cheaply built) laser printers. The corporation maintains its offices, laboratories, and assembly areas within a draconian security system, which includes several on-line netranners, various warning devices and cameras, plenty of steel gates, and a hired private security force who don't appreciate their 6.25eb an hour jobs enough to die for them.

A small donut shop sublets the southwest part of this building. Heavily frequented by corps by day and chromers by night, it is rumored that you can buy 'special' donuts here if you know the code. NCPD Narcotics agents have been unable to prove this either way. There is also a small dataterm on the southeast corner of this block, and a better-equipped one in the main lobby.

Security Level:1

A4#10 Windemere's:

Known city-wide as the *Giant's Chair*, the buildings that compose this block are actually a world-respected art gallery flanked north and east by private apartments and the studios in which art restoration is done for the gallery. Due to the expensive art objects that are often shown and stored here, security is extremely heavy, with live-in armed guards in fortified kiosks and vehicles making sure all "undesirables," especially boosters on their way to The Slammer, are kept away from the premises. Although there is an agreement between the gangs and the security forces, about once a month the security is tested by drunken juvegangsters, who are lucky to escape with their lives (let alone all their body parts).

Security Level:3

A4#11 NNews:

Reminiscent of an old-time newsstand, the NNews building is really a souped-up dataterm. It has ten stations from which one may access any published material from the local screamsheets to international magazines. There is also a small autovendor at the east end, run by a marginally intelligent AI program. Don't even think about stealing a can of Smash; the autovendor has been known to chop the hands off would-be thieves. Or so they say.

Security Level:0

A4#12 Café Chrome:

So you've always thought you were one of the beautiful people, but were somehow shuffled out of the deck? Everyone knows that the Café is the place to be, so that's where you go to party in hopes that someone will recognize your true edgerunner nature and sweep you away from it all. During the day, many Corps come to enjoy the informal 50's decor and discuss their various business interests. The nights are dominated by the juvegang, young adult and rocker crowds who come to the Café to party, and possibly get a glimpse of their favorite stars while enjoying the atmosphere.

Security doesn't seem like much, but given the famous people who often come here to party, don't let yourself get too complacent. In addition to the cameras and the bouncers, fans wishing to mob their favorite stars will also have to deal with whatever security the stars have brought with them. Café Chrome relies on this, but when all else fails, steel doors have been rigged to drop (no, not shut nicely, DROP) in all doorways, sealing each room. The occupants therein are on their own until Café Chrome manages to hire an Arasaka team to swing by.

The exterior is another matter, and frequently gangs will hang out here to prey on the weaker teeny-boppers, or just to climb the palms and spit on the Corps.

The southeastern building in this compound is a valet parking garage. Stealing a car from here would be extremely

difficult at best. Café Chrome is entered through the foyer in the center; the restaurant and kitchen are to the west, and the bar and dance floor are to the east. While there are back doors to the place, they are rigged with fire alarms. And speaking of fires—better hope the steel doors don't drop if one breaks out...

Security Level:1

A4#13 All-RX Drugs:

This building contains a branch of a nationwide commercial low-end drug store. These folks have started delivering prescriptions to outpatients from the various hospitals in the Medical Center (section B-4). With the recent addition of a pharmacy for prescriptions, it is rumored that several pharmacists are using the lab area to create designer drugs which they sell on their own time. These drugs are supposedly distributed by GutterRat, an almost mythical fixer who allegedly frequents this area. The store stocks nothing valuable, as they have had a lot of theft problems. The security is tough enough to handle street people and derelicts, but not much more.

Security Level:0

A4#14 Systems Original:

This is a computer software firm which manufactures networking software similar to that used in the Net. Once on-line, a user needs only move their representative icon to the destination desired and they will be able to access the necessary data. The actual shipping and storage of the software packages is done from a warehouse in Pacifica. At night, steel portcullises (SDP 60) drop in front of the doors and windows.

Security Level:0

A4#15 CalBank Building

This bank building is also home to several international law firms as well as CTC (a corporate insurance company) and **Manfred's**, an expensive German restaurant which specializes in dishes prepared with Japanese Kobe veal. The lobby is open-air (to illustrate CalBanks "open door" policy), but automatic APEX machineguns sweep the area at night. Security is on the second floor, and may be buzzed by intercom to acquire passage.

Security Level:1

A4#16 Delany Transport Plaza:

This building is dedicated to the leasing and sale of any and every transportation device available. The ground floors are occupied by **AutoToys International**, who specialize in imported automobiles. They will also customize, to your specifications, any existing vehicle you may own. AutoToys leases the rest of the building to other firms, from whom one can obtain bulk shipping, locomotives, 787s, and anything else.

Security Level:2

A4#17 Parkinson's Place:

When Larsen Parkinson began selling customized electronics integrated into furnishings, he never imagined the response he would receive. Within months, his operations had expanded from his garage to a vast industrial park, and then to a chain of stores that specialized in these custom furnishings. This branch of Parkinson's also carries an extensive selection of personal items for home and recreation.

Security Level:1

A4#18 CiNemaXUS:

This is an old-fashioned theater as well as a braindance arcade. It has fallen on hard times in recent years, with the presence of more and more punks on the streets at night, heading to *Metalstrom*, *Metal Heaven*, or the *Slammer*. The presence of this riffraff is driving the corporate clientele of this theater elsewhere, and daytime crowds alone are not enough to meet the bills. There are rumors that the theater will start catering to the streetpunks, thereby compounding the deterioration of this area.

Security Level:1

A4#19. Global Foods:

Originally a department store, this multilevel food emporium caters to any taste imaginable. The owner, Raymond Krok, has a standing challenge for someone to come up with a dish that the restaurant section cannot prepare. Although there have been many takers, no one has yet to win the prize of a month-long, all expenses paid trip to anywhere in the world.

One of the more entertaining occurrences happens when an uninformed booster walks into this corporate diner and deliberately orders something particularly disgusting. Much to his surprise, the dish is prepared, and the building security will assist the hapless diner in eating his entire meal. They also won't let him leave to get his stomach pumped until he pays.

The restaurant proper is very stylish, carefully decorated in culturally neutral style, and crowded every day between 10:30 am and 3:00 pm. In the middle of the block is the kitchen, where food is stored and prepared. The east end of the block is dominated by a series of take-out stalls, where busy people can grab a bite on the run. The types of food available change often, but variety can be counted upon.

The open area is occupied by a dataterm, and (at times), a booster puking his guts out while corporates stand around and place bets on his constitution.

Security Level:2

A4#20 Modern Office:

This is a typical office furniture store, although the products run heavy on the glitz end of the spectrum. From the brushed steel logo to the canted arrangement of the building, this store is designed to snare the young corporate trying hard to

buy an image as a cyberpunk. Much more effort goes into making the furniture stylish, as opposed to, say, functional. Needless to say, the store is quite profitable.

Security Level:1

A4#21 The Advocet:

This place bills itself as being a luxury hotel, and with good reason. With terminals in each room as well as a gym, spa, casino, shopping arcade and nightclub/lounge, the owners feel their customers, mainly businessmen, will spend their money inside the hotel and keep the profits up. If extralegal activities (drugs, illegal braidances or the like) are desired by visiting businessmen, the hotel concierge can arrange the desired "service." Since this "service" is offered to in-house guests only, police attention has not been focused in this direction. . .yet. All this results in a lot of rich, though questionable characters renting the upper penthouse suites. Rock stars are common here.

The Advocet and the Havenford are generally booked full the entire year due to their proximity to the Night City Convention Center.

Security Level:2

A4#22 The Havenford Hotel:

This hotel also advertises itself as a "luxury" hotel, but is really no better than the average Howard Johnson's. On the other hand, it has much better rates than the Advocet. The Havenford focuses on their business clientele which rotate through the rooms at weekly intervals. The rooms are functional and there is a dataterm in each hallway.

Security Level:1

A4#23 EuroBank 1:

The other building on this block is the offices of EuroBank 1, a banking and commodities brokerage, specializing in international finance. Although situated away from the Corporate Center, many corporate representatives arrange for their commodity services to be handled here.

Security Level:2

A4#24 Night City Fire Station #1:

This fire station (one of two serving the Night City area) is equipped with the most sophisticated fire and rescue equipment available. Utilizing both a ground and an air fleet, the fire division stationed here prides itself on being the best firefighting team in the Free State of Northern California.

The smaller building to the east houses the garage for fire vehicles. Very loud sirens ensure that no one will remain on the sidewalk when an alarm is called. Two indelible stains attest that there are still some deaf people in Night City.

In addition to the dining and living areas, the upper floors of the larger building are used by the firefighters to simulate and

practice rescue situations. Because of the large number of firefighters needed, the city has begun a recruitment drive in the armed forces, suggesting that with the amount of dangerous work firemen get involved in, firefighting would be a logical career choice for someone used to assault-style situations.

Security Level:1

A4#25 Long Last Books:

This bookstore is owned by a couple who, in resistance to the publishing combines, only sell books by independent companies, as well as rare, out of print, banned, or hard-to-find books. Although they charge exorbitant rates, their stock is genuine, and though it may take them ten years or more to find something, they never stop looking. This store's defiance of social norms has brought them immunity from the gangs, but not from the corps.

Security Level:0

A4#26 StreeTemps:

Although it does not advertise itself as such (and in fact does not advertise itself at all), this is a well-known agency used to hire down-on-their-luck cyberpunks for run-of-the-mill, though nonetheless questionable, activities. Those who use StreeTemps still prefer working the Street itself for larger operations. StreeTemps does not require any information on what the actual service will be, just what skills are required. Ignorance thus becomes a pat legal defense. They are allowed to remain in business because they are secretly a branch of the NCPD, and keep an eye out for problem areas and potential cyberpsychos.

Security Level:1

PERSONALITIES

Suds Joliet- Suds Joliet owns and operates the Slammer. A former singer in the 90's metalpunk band *Stormrider*, he decided to open his own bar to showcase new acts. Upon realizing the bar/arena could also be used to settle disputes between gangs, he opened it up to that idea and has profited by running betting booths as well. He does not enter the fights himself, but has been known to sing for bands that need a substitute.

INT 7, REF 5, TECH 7, COOL 8, ATTR 5, LUCK 10, MA 6, BODY 6, EMP 5

SKILLS: Charismatic Leadership 7, Wardrobe & Style 6, Intimidate 6, Streetwise 8, Human Perception 5, Leadership 3, Perform 5, Brawling 3,

CYBERWARE: Toxin Binders, Audio Vox

P.L. Ellison- Originally a beat writer for *Rockerboy Magazine*, P.L. now has his own half hour show, *Style and Substance*, which

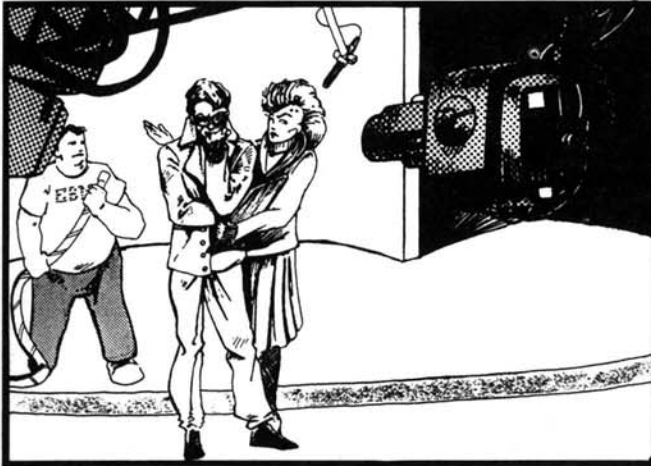

P.L. Ellison on the Set of *Style and Substance*. Sept. 2, 2020

he broadcasts live from the Café Chrome every Wednesday night. Although he usually has a set script for the show, it is not uncommon for him to deviate from the night's agenda if the opportunity to interview/harass a celebrity arises.

INT 6, REF 7, TECH 5, COOL 8, ATTR 7, LUCK 5, MA 6, BODY 6, EMP 8

SKILLS: Credibility 4, Personal Grooming 4, Wardrobe & Style 7, Human Perception 5, Interview 4, Streetwise 3

CYBERNETICS: None.

DATATERM™
FYI
 For Your Information™

LOCAL COLOR

There is a large chromer population in this area, but they are mostly held in check by the Back Alley Brawlers, a vigilante gang who have control of the territory. Although there are reports of citizen molestation, they are, more often than not, reported to the Brawlers; who dispense their own justice to those offenders. The Brawlers have posted a "code of conduct" on the walls of ganger buildings which simply states, "If you're going to do it, make sure we don't find out."

There are also a lot of boosters, punks, etc. here. They don't tend to fight with each other too often, as the corporate security takes the opportunity to open fire. They figure that as long as they're going to incur the wrath of corporate security, they may as well bash on some upper-class dweebs.

ENCOUNTERS

1. The NCPD is on the prowl. Most likely it's a squad car or a few on foot, but occasionally the NCPD sweeps the streets to clear them of undesirables.
2. Any of several gangs heading to or from Metalstrom or Kitty Liquor. How they react depends on their mood. You can never tell with drunk punks.
3. The Slammer's on overload, and the war has spilled into the streets. Scraps of two or more gangs having a running battle. Expect the NCPD soon.
4. A group of young, bored, upper-class yahoos looking for entertainment to meet their jaded tastes.
5. Corps heading to Café Chrome for some tense negotiations. Their bodyguards will not take kindly to your presence.
6. A flying bottle heralds the arrival of some punks who want to heckle and intimidate you.
7. Security Guards chasing someone.
8. The Back Alley Brawlers take unwanted interest in your activities.
9. A small caravan and a large crowd herald someone famous (or infamous) arriving at The Advocet.
10. An accident (possibly between a Barstow truck and a new AutoToys car) locks up an intersection.

CONTACTS

1. **Ziv Ellis**- A maid at the Advocet, she has passkeys to all the rooms. For enough money, she will sell you the key you need.
2. **Michael Stewart**- A trucker from Barstow, he hates street punks, and likes to use his heavily armored rig to squash them.
3. **Kamina Wazashi**- One of Allworld's best insurance investigators, she is always first on the scene of a claim. She is also an excellent source of any non-confidential information, particularly about local fires, accidents, etc.
4. **Wilgan Adrven**- A security guard at Aquadynamics, he likes his job, and will not betray the company. However, if the company is under any threat he will act to defend it.
5. **Martin Scall**- Barkeep at Metalstrom, he keeps a close eye on problems involving patrons. He will, on occasion, help arrange meetings between people he likes.

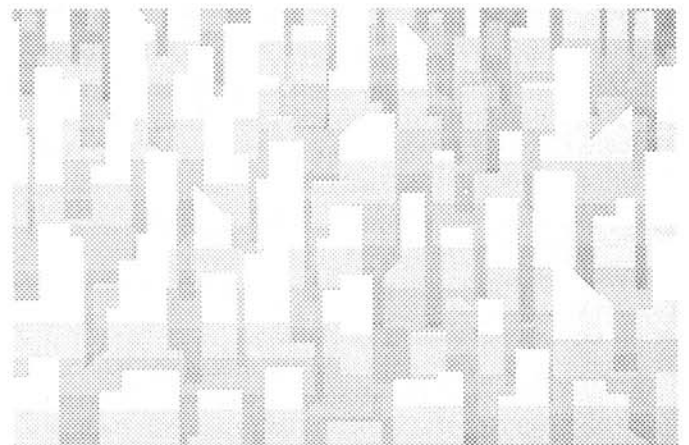

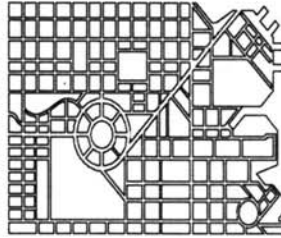
**UPPER
MARINA**

D A T A T E R M

Before the 2000's, this was the home of numerous local private yachts and a sizable fishing fleet. Now, the Upper Marina has become a seedy industrial district characterized by low rents and a few businesses requiring large amounts of space.

A modern **Ferry Building** mounted on piers stands at water's edge; providing regular ferry service to the cross-bay suburb of Westbrook, while across a marina green of dying grass squats the recently renovated home of the **Night City Yacht Club**, favored by those Corpzoners and Mover wanna-bes that still fancy themselves masters of the raging sea (when the local pirates aren't about). From the edge of its old and marginally maintained docks, you can watch sailboats cleaving the steaming, polluted waters of Del Coronado Bay, an echo of happier times.

A5#1 C. Donut Express Co:

This is a trucking company equipped with long-haul semis, local delivery vans, and armored cars. The Night City facility combines a truckyard with a trans-shipment warehouse to transfer shipments between local and long-haul trucks. This is a good place for nomads to pick up jobs as convoy outriders; they hire at all hours and don't ask too many questions.

Security Level: 1**A5#2 Big Blue Foods:**

This is a factory for food processing. Food from the fields is combined with processed soy powder, yeast products, spices and chemical additives to make typical Night City provender. Frozen, canned, and room-temperature stored foods are all manufactured here. Most of what you buy in the local All Food co-op is "constructed" in a Big Blue factory or in facilities very much like this one.

Security Level: 1**A5#3 Osborne-Spielberg Publishing:**

This building combines office and warehouse space. Books, tapes, and other media are stored for regional distribution, and the offices house the corporate headquarters and editorial

offices. Actual media production (printing, etc.) is done elsewhere.

Security Level: 1**A5#4 Chrome Cross:**

This firm supplies the high-tech gear used by the medics at local knife parlors to install cyberwear and heal wounds. CC is a big firm with a long catalogue containing everything a medtech could conceivably need. They have a fast delivery system to send supplies to the sites of medical emergencies throughout the area.

Security Level: 1**A5#5 Night City Today!**

This is the home of Night City's most popular mainstream screamsheet. Locally produced editorial content is added to a nationally distributed news product for piping to screamboxes all across town. *Night City Today!* is the kind of rag that depends on lurid headlines for circulation, rather than on hard-hitting journalism.

Security Level: 1**A5#6 Servospiff:**

This is a reputable supplier of security-coded work fashions to large and small corps throughout the Free States of California and nationwide. Servospiff's highly regarded security precautions keep the registered designs out of the hands of unauthorized would-be purchasers.

Security Level: 1**A5#7 Mustang Arms Co:**

Largely a NorCal regional headquarters and warehousing point, the actual combat hardware is produced in gigantic automated factories elsewhere. Mustang specializes in shoulder arms, with supplemental lines of pistols and cyberlimb weapons.

Security Level: 2**A5#8 Acme Distributors:**

Acme Distributors does a legitimate business in goods transfer, but there are a lot of odd goods which come in through the back door, "hot" off the street.

Security Level: 1**A5#9 Cleanroom:**

These people clean corporate offices, doing things like waxing floors and desktops, taking out the trash, etc. All service personnel are bonded, as they have access to the innermost areas of powerful companies.

Security Level: 1**A5#10 24 Hour Cafe:**

This is one of a durable breed of "joints" serving food to the neverending stream of workers and wanderers who pass through the maritime area. Very popular among the smugglers

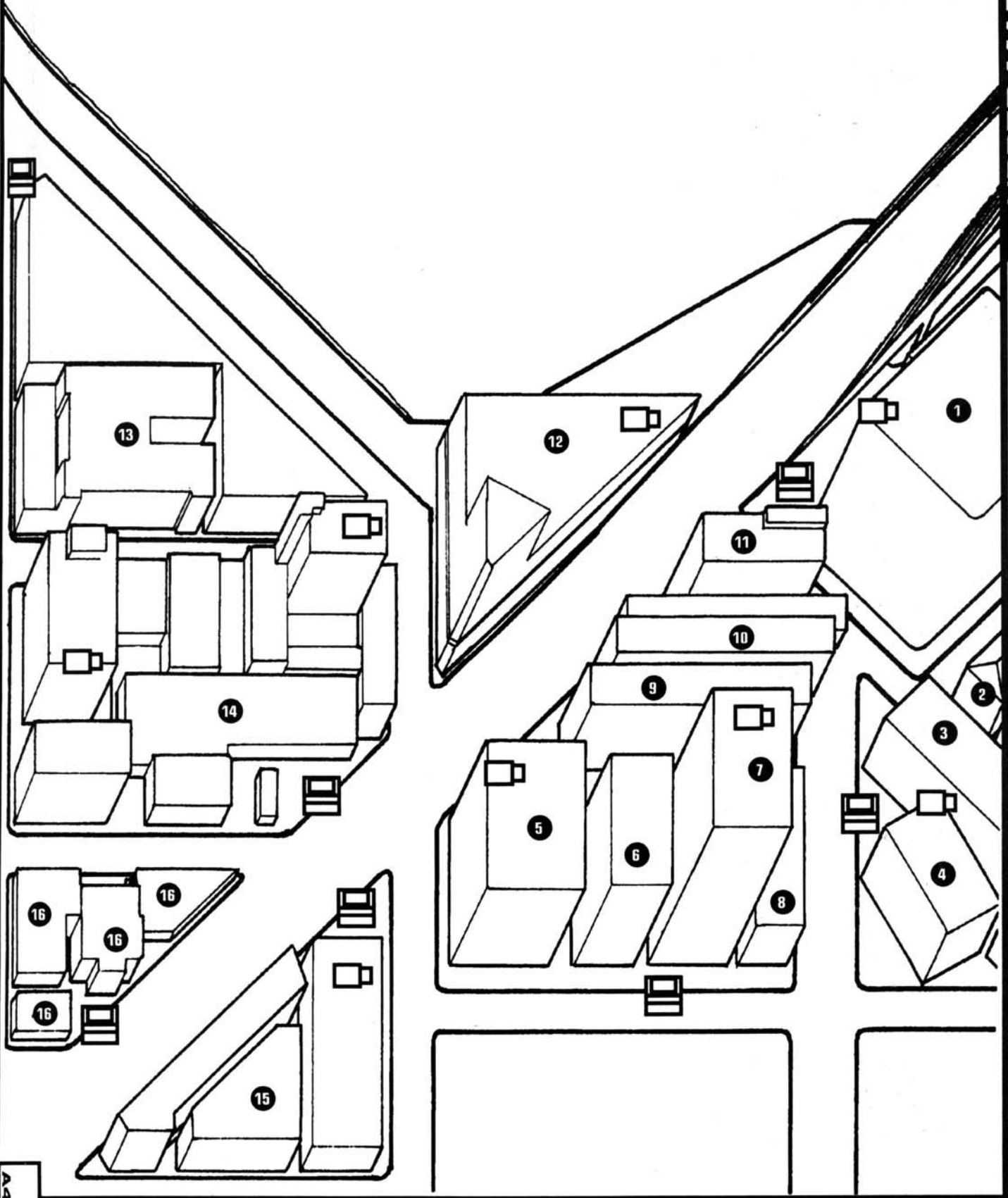



and other dockside denizens of the area, thanks to its "home-cooked style" meals.

Security Level:0

A5#11 SensuTours:

Ostensibly a travel agency, SensuTours is really a front for Interpol, the EEC's police/secret service. SensuTours rarely sells travel packages, and is amazingly inefficient when dealing with real customers.

Security Level:2

A5#12 Harbormaster's Office:

The Harbormaster is in charge of the Port of Night City, including the maritime district extending to San Morro Bay to the south. The Harbormaster handles shipping movements, assignment of facilities, etc. while his agents, the Harbor Police, have jurisdiction over this area. This often puts them up against the NCPD, whom they consider hopelessly corrupt.

Security Level:2

A5#13 American Bar:

A watering place catering to mercenary soldier-type solos as well as toughs and laborers from the waterfront. The bar is licenced by the Harbormaster's Office, but it is often under the surveillance of the NCPD and the CIA.

Security Level:1

A5#14 Department of Motor Vehicles:

This building is the Night City DMV. All traffic fines are paid here. The DMV also handles all registration and traffic clearances for both ground and air vehicles.

Security Level:2

A5#15 Medicross Preservation:

A slightly legal "body bank" that collects a good portion of Night City's unnamed and unidentified corpses. Then the bodies are dissected and used for donor parts for such illustrious hospitals as the Medical Center. Medicross also pays for intact body parts: 500eb for an arm, 600eb for a leg, 700eb for vital organs, 200eb for secondary organs, and 800eb for eyes. Prices are reduced drastically for diseased or damaged parts. Some dorphers have been known to hawk parts of their bodies to afford a fix.

Security Level:1

PERSONALITIES

Harbormaster Mahan Jones— Capt. Mahan Jones is a cop who also happens to be a Government official. Jones has made the Harbor Authority and its associated Harbor Police into a separate government in "his" part of town. He considers the civic bureaucracy of Night City irredeemably corrupted



Harbor Police after major operation, Nov. 30, 2018. Capt. Mahan Jones (C)

by corps and the Mob. Jones tolerates no corruption within his own organization.

The Harbor Police are in charge of law and order in the dockside area (most of which is south of the main part of the City). There are infrequent conflicts when the NCPD have been bought off for a caper, and the unbribed (and extremely unbribable) Harbor Police move in.

INT 7, REF 5, TECH 8, COOL 9, ATTR 7, LUCK 9, MA 6, BODY 8, EMP 5

SKILLS: Streetwise 9, Handgun 5, Rifle 4, Sailing 4, Brawling 3, Administration 7, Wardrobe & Style 4, Awareness 2

CYBERNETICS: Cybereye with lowlight and camera.

ENCOUNTERS

1: A parade/convoy of U.S. Army troops rolls up from South of the city and rumbles over the Bridge to an embarkation point at North Oak.

2: A fixer approaches the party offering a best buy in recently stolen merchandise. Determine what's wrong with the deal,

and then let the characters use their street skills to see if they can find out what it is. Maybe they can figure out how to make some money...

3: Word on the Street is that a small fishing boat is going to tie up at the finger piers carrying illegal drugs under a layer of somewhat stale fish.

4: The Chrome Angels are here, setting up an ambush against an enemy gang. This is a Guardian-type outfit; they won't bother the PCs if they're cool. The GM can make it really hard for the players to keep their characters cool.

5: Of course traffic is stopped. Traffic will stop for no reason at all, and this time two huge trailer rigs are parked in the street while the drivers argue about who has the right to load cargo from a particular shipper.

6: Did you notice that the bridge drops traffic directly into the traffic grid of Night City? It's rush hour and there is no way to move faster than a slow walk in traffic on any street remotely connected with the bridge. Rush hour occurs three times a day and lasts four hours.

7: An agent on the corner is recruiting parties of Cyberpunks to move small, valuable commodities from Night City to various parts of the world. If the characters want a job, she is hard to get. If they don't want to be bothered, she is persistent.

8-10: Nuthin' hap'nen....

CONTACTS

Horsehead Harry- A shop steward for the union at C. Donut's. Hates the corps and will help anyone willing to blacken a corporate eye.

Rikki Sampson- She runs the swing shift at the American Bar. A good person to know if you want the scoop on any "corrupt" Night City institutions.

Lt. Robert James- One of the Harbor Police. He will give you help only if he deems it necessary for the greater good. He cannot be bought.

Alex Andersen- Works for Chrome Cross. He can get parts cheap for a friend.

Synthia Harrison- The top regional salesperson for Mustang Arms. She might give you a deal if you buy in bulk...

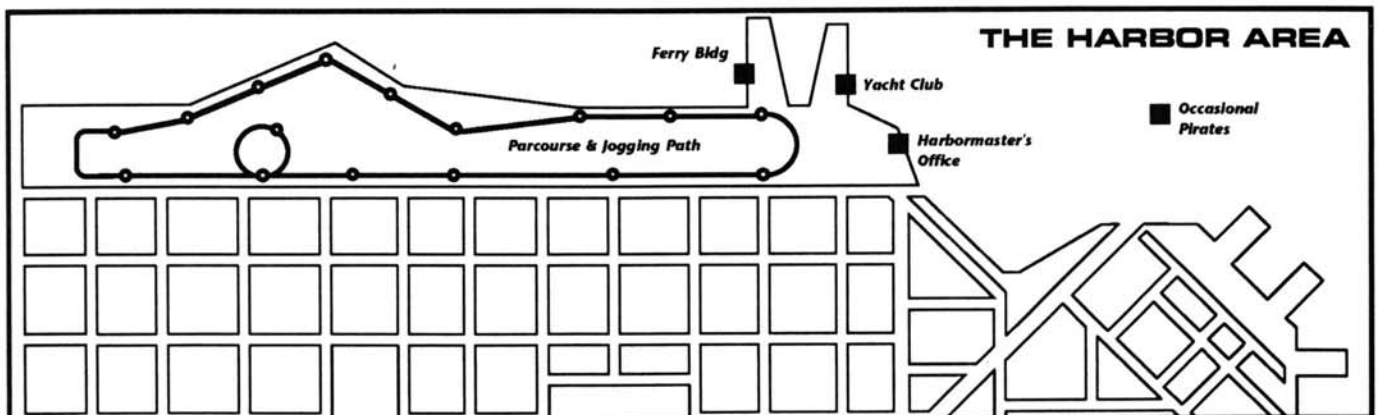

EAST MARINA

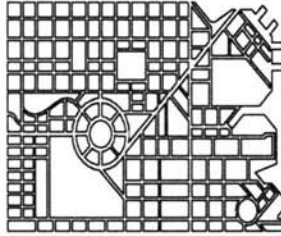

D A T A T E R M

The East Marina was the original home of most of Night City's commerce and shipping through the mid-20th century. The original township of Del Coronado (on which Night City was built) included a number of finger-style piers suitable for unloading the obsolete break-bulk freighters of the nineteenth and twentieth centuries. However, shipping traffic in 2020 is usually in bulk or modular cargo vessels; as a result, most incoming shipping is loaded and unloaded at the newer container port in San Morro Bay to the south.

Nonetheless, the whole area still retains a certain maritime air, thanks to the many smugglers and small-time dockworkers in the locale. The East Marina's many small docks and hangouts are also home to the local **pirates**: small groups of nomads who occasionally raid smuggling ships in their heavily armed, high-powered speedboats. It has been said that anyone can find anything in the East Marina, as long as they look hard enough and are willing to pay the price to its shadowy denizens.

A6#1 Joe's Diner:

This is a traditional, human-staffed 'fast food' joint, part of the quarter's quaint atmosphere. In addition to the tourists, local working people frequent this eatery seeking their workday provender. Gang elements are excluded by the regular patrons, who wish to eat undisturbed, and are quite willing to rip your head off to make sure things stay that way.

Security Level:0

A6#2 Pier Three Paradise:

This is a typical renovation of the cavernous warehouse associated with this obsolete finger pier. This conversion features a big rent-a-space flop parlor, an "exotic" schlock chain restaurant catering to low/middle level corporates, and an all-night bar.

Security Level:1

A6#3 Wierd Stuff:

Weird Stuff is the ultimate expression of techie heaven. The owners appear to have bought every odd lot of leftover spare parts on the Pacific seaboard. Techs can often find replacement parts or equipment at a suitable reduction in Difficulty (at the ruling of the Referee) due to the vast collection of unorganized miscellany assembled here. Pirates and smugglers often unload their electronic booty here.

Security Level:1

A6#4 Universal Export:

This is a consulting firm specializing in sea freight tariffs and standard shipping routes. UE is also rumored to be a front for the British Provisional Government's notorious Army Intelligence Active Service (ARMINTAC), particularly its branches dealing in covert anti-IRA operations in the United States.

Security Level:1

A6#5 United Express:

This small-package courier service guarantees delivery of "anything smaller than a breadbox" anywhere in human space within 24-30 hours. Their familiar rocket-red AV's ply business and industrial routes all over the world and even into orbit.

Security Level:1

A6#6 ILLW Hiring Hall:

While labor unions are in something of a decline in the *Cyberpunk* era, the ILLW still controls the longshoremen and technical crews who load and unload the ships stopping at Night City. The ILLW is the last bastion of the organized labor movement in this area.

Security Level:0

A6#7 Stallion Slough Shipyard:

This is the local office of Night City's only major shipyard. The main facility, located a few miles to the south, can build hulls up to 5,000 tons standard displacement. Stallion Slough's Night City facility is a rat's nest of small docks, cubbyholes and berths where the local pirate fleet occasionally hides its larger vessels.

Security Level:2

A6#8 Baltic Real Estate Co:

Baltic is a specialist realtor, dealing exclusively with commercial real estate in the Maritime area. Baltic deals in factory and warehouse space, although some office suites are also handled.

Security Level:1

A6#9 Lucky Barber Shop

A unisex clip joint, frequented by Korean and Chinese gangsters. In the wake of the Second Corporate War, a number of Taiwanese, Indonesian and Phillipine pirate tong members have relocated to the NorCal region and are joining

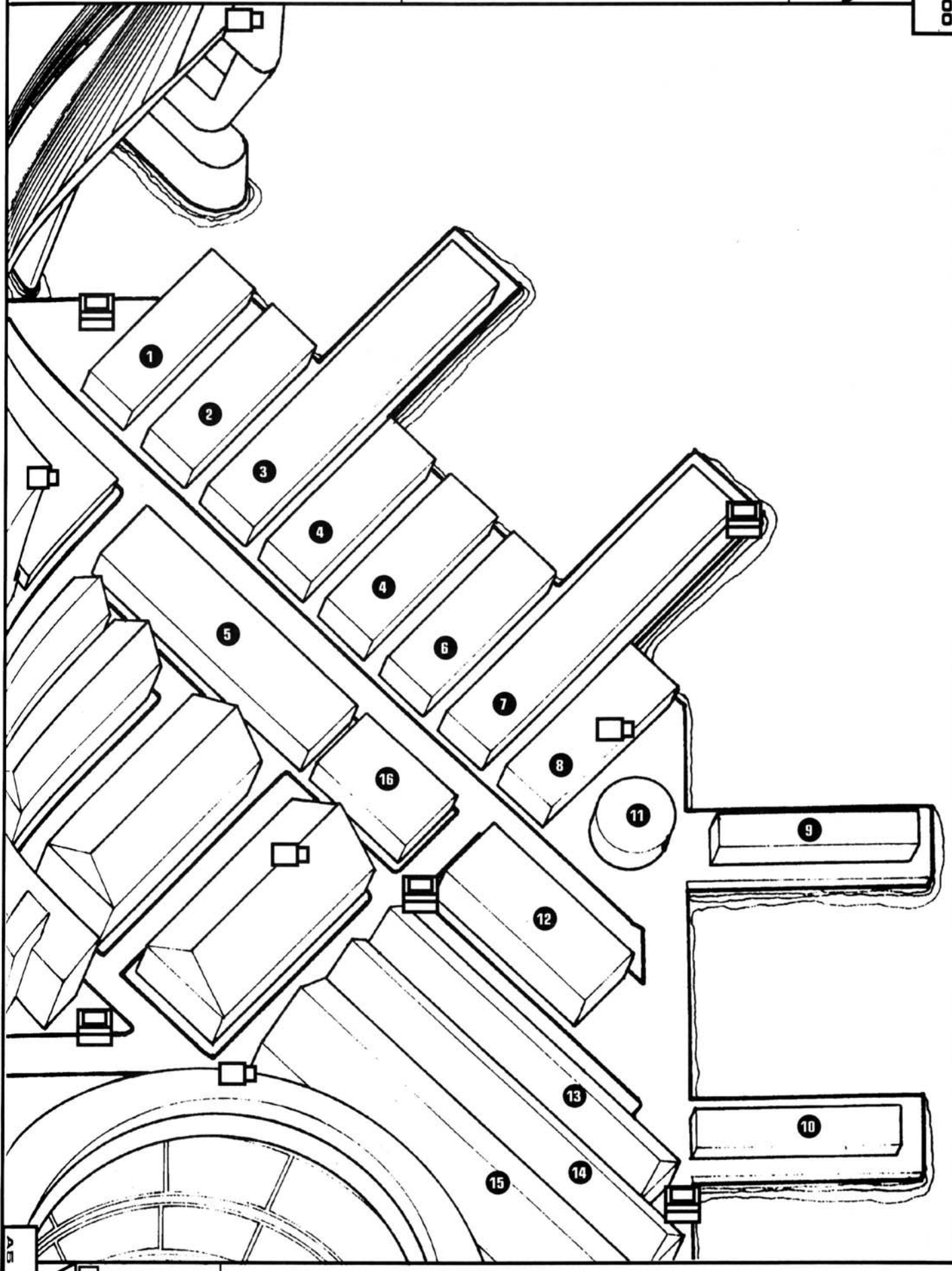



the local pirate groups. A good place for Nomads to pick up work, or ex-Navy to make contacts.

Security Level:0

A6#10 Eastern Star Novelty Co.

Yet another front organization, this almost legitimate (it makes money) importer of exotic toys from all around the world is also the West Coast station for the Chinese secret service. Separate from the consular contacts with the business world, Eastern Star is a hub of espionage and other devilry in the coastal region.

Security Level:2

A6#11 Prudhoe Pride Oil Co.

Oil is almost as big a business as ever; the reserves are good for at least thirty more years, and there's a lot of money to be made now that the Arabs are out of business (especially in plastics). PPO has refineries and storage tanks in the San Morro Bay area.

Security Level:1

A6#12 Reunification Hall and Social Club

This is a facility where small and large groups rent rooms to hold meetings. The Night City Recreation Department rents this hall a lot for various youth functions. Concerts are held occasionally.

Security Level:0

A6#13 Arcade Arcade

This is also a youth facility, although on an individual use basis. It is a typical arcade, occupying the second floor of its building, with visual-mechanical interfaces, as well as games played only by braindance. The well-patronized fast food bar is a popular feature of Arcade Arcade.

Security Level:0

A6#14 Good Night Rooms and Coffins

This is a flophouse on the first floor of the Arcade building; a suitable address for the streetscum who doesn't have a van to live in. Good Night features stand-up rooms with and without bath, as well as coffin-sized sleeping bag spaces.

Security Level:0

A6#15 Blue Light Special Sales

Local rockers know that equipment from Blue Light is right up there with the best. Axes, consoles, amps, process computers, and a full line of musician's cyberware are featured at the full-service warehouse and sales center occupying the entire first floor of this building.

Security Level:1

A6#16 Decker, Tanaka & Rogers

One of the giants in the shipping business, D,T&R is famous

for its modern shipping fleet. This building is the office for the Night City area. The loading facilities are in South Night City. D,T&R are always looking for escorts on freighters heading for the Pacific Rim. They will provide food and lodging in return for protection from pirates. An excellent way to leave the country.

Security Level: 1

PERSONALITIES

Mountain Joe, labor organizer- Joe is a dedicated foe of the corporate system. The expression of his outrage is through the "old-fashioned" labor union movement. He is a competent organizer, capable of making many dedicated low-level corps aware of their downtrodden condition.

INT 6, REF 4, TECH 6, COOL 8, ATTR 5, LUCK 8, MA 7, BODY 7, EMP 8

SKILLS: Public Speaking 7, Brawling 4, Handgun 3, Awareness 5, System Knowledge(Corporate) 3, Oratory 6, Fast Talk 6, Education 3

Captain Comet- United Express dispatcher. Comet, the night man at U.E., is usually good for a job for special friends of his who are in need, but the PCs have to make him their friend. They can figure out how. He's also a good source of news in the shipping biz.

INT 5, REF 7, TECH 7, COOL 6, ATTR 7, LUCK 9, MA 9, BODY 5, EMP 6

SKILLS: Streetwise 6, System Knowledge(Shipping Biz) 10, Fast Talk 7, Handgun 1, Gamble 2, Awareness 4.

ENCOUNTERS

1: There is a labor dispute brewing. Solos from one of the remaining unions are getting ready to defend a picket line from some Corporate solos, who are lining up and getting ready for something.

2: A gang is in the act of hijacking a large truck loaded with some kind of goods. Is either the trucking company, or the gang, one which the PCs are watching?

3: A group of Corporates, suits and all, are walking/cruising furtively down the street, looking for an address. Which seedy gang or Secret Service are they trying to find?

4: There's a big concert at Reunification Hall. Traffic is a mess, and a lot of the cops are there, rather than on the street.

5: Gang rumble in progress. Make the gangs important to the adventure at hand, or make a selection of your favorite Night City skuzzies; sometimes gangs will come down to this area just to have it out.

6: Obvious foreigners (wrong clothes, strange foreign language, etc.) walking/cruising furtively down the street looking for an address. Are they trying to find the Corporates from encounter #3?

7: Another spontaneous rock concert. Over here nobody cares, and traffic is dead for 5D10 minutes. If the PCs investigate, they might find a needed bit of information.

8: A Harbor Police wagon pulls up and disgorges a squad or two of cops who raid a building.

9: Out of nowhere, a gun battle starts between two groups, neither of which seems to be a gang or any kind of police.

10: There is a show of force in the area by the N. C. police, who are patrolling the waterfront in numbers, inside APCs.

CONTACTS

1. **"John Smith"**- The manager of Eastern Star Novelty. He hears all and is a great source of information—once he trusts the players.

2. **"Elizbeth"**- One of the more lucid and sociable of the *Wild Things* (the local gang), she is willing to sell out the gang if the price is right...

3. **Nina Santiago-** A waitress at Joe's, she has her ear to the ground and knows much about the surrounding streets. She is also an incurable romantic, and is a sucker for love.

4. **Billy "The Packrat" Osgood-** The catalog chief at Weird Stuff. If you're on his good side, there's nothing he can't dig up for you.

5. **Gina Josephson-** An active player in the video-juvie gangs, Gina spends her days in Arcade Arcade. She has an uncanny knowledge of the movements of almost all gangs in the city. No one knows where she lives, and her price is high, but with her on your side your chances of out-maneuvering any gang have just increased drastically (70%).

WEST HILL

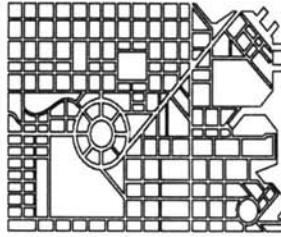

D A T A T E R M

Not all of Night City is decaying slums, corporate towers and roving boostergangs. Elegant living is the order of the day at West Hill Gardens, as is sophisticated shopping at the boutiques in Pinewood Bazaar. West Hill Gardens takes its name from the luxurious pine trees and shrubbery blanketing the grounds around the executive apartments. Pinewood Bazaar is an underground shopping center, illuminated in the daytime by glass domes set in the pine garden. Together the apartments and bazaar make an integrated community, complete with fitness center and an Episcopalian church, that provides the best in urban living to a pampered corpzoner few.

A mere five-minute subway ride away from the corporate plaza, West Hill Gardens is the residential community choice of young urban professionals. Apartment rents start at 2,800eb monthly and go up from there.

All of West Hill is patrolled by corporate security forces. Legally, West Hill Gardens and Pinewood Bazaar are private property. Whatever gang toughs or other undesirables find their way there are immediately detained for trespassing, disciplined, and dumped back in the south end of town.

B1#1 West Hill Gardens:

West Hill Gardens consists of executive class apartments on the gentle slope of West Hill. Underground parking leaves the grounds free for gardens and covered benches. West Hill has incorporated many state of the art services to protect the residents and make their lives easier. Residents enter their building using personal electronic security cards. Contract

housekeeping services are available, as are fully automated laundry facilities. Each of the apartment buildings connects with Pinewood Bazaar through underground walkways.

Security Level:2

B1#2 Pinewood Spa:

The spa features all the exercise facilities favored by today's executives. The management has just installed new Braindance Bodytoner booths, in which the patrons immerse themselves in the latest Braindances while their bodies are electronically exercised. For the more traditional there is an old-fashioned weight machine room, handball courts, and a multi-purpose sport gymnasium. On the roof is an oval jogging track and swimming pool.

Security Level:1

B1#3 West Hill Church of God:

This quaint Episcopalian Church was here even before West Hill Gardens was built. It continues to serve the spiritual needs of the residents in this modern millennium.

Security Level:0

B1#4 Pinewood Bazaar:

Light from the glass domes spills down to illuminate the shops and boutiques in this subterranean shopping center. Pinewood Bazaar features many upscale boutiques that cater to the tastes of urban professionals. Among them are **BodyWorks** bodysculpters; a pair of art galleries: one featuring modern Korean and Vietnamese works, and the other reproductions of the classics; bookstores; clothing shops; jewelry shops; and **Merrillians**, a fully automated supermarket where customers can shop from a computerized catalogue, or even place delivery orders over the Net.

There is even a six screen theater in the bazaar, and **Manhattan's**, a bar, keeps hours until late into the night. The bazaar features two fine restaurants, the **Thai House** and **Little Italy**, as well as several fast food shops. Construction has recently been completed on **HoloPlex**, a braindance theater. HoloPlex features over a hundred individual braindance cubicles where the customer sits in a comfortable reclining chair to experience his choice from among dozens of current releases. The underground walkway exits into the mall as well as onto the street, where there are both a dataterm and a screamsheet box.

Security Level:2

B1#5 Tijuana Cafe:

Light dishes from Mexico, served under a peasant-style thatched roof. Chef Casteda is not only a master of Mexican cuisine; his study of custom and history brings an authentic native atmosphere to the Tijuana Cafe. Try the hand-made tortillas with anything, and don't forget to order the sopias for dessert.

Security Level:1

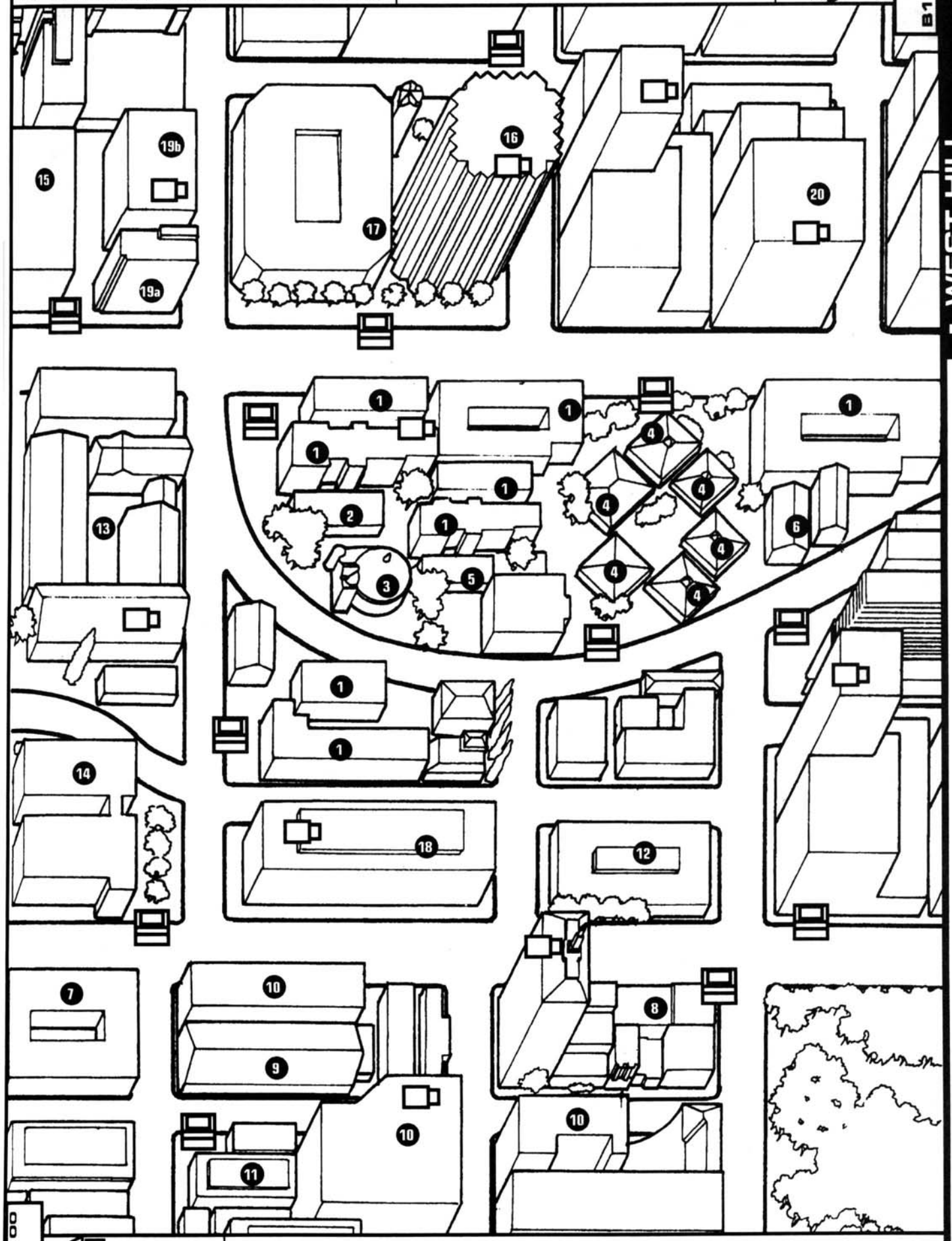

NIGHT CITY

SECTION B1

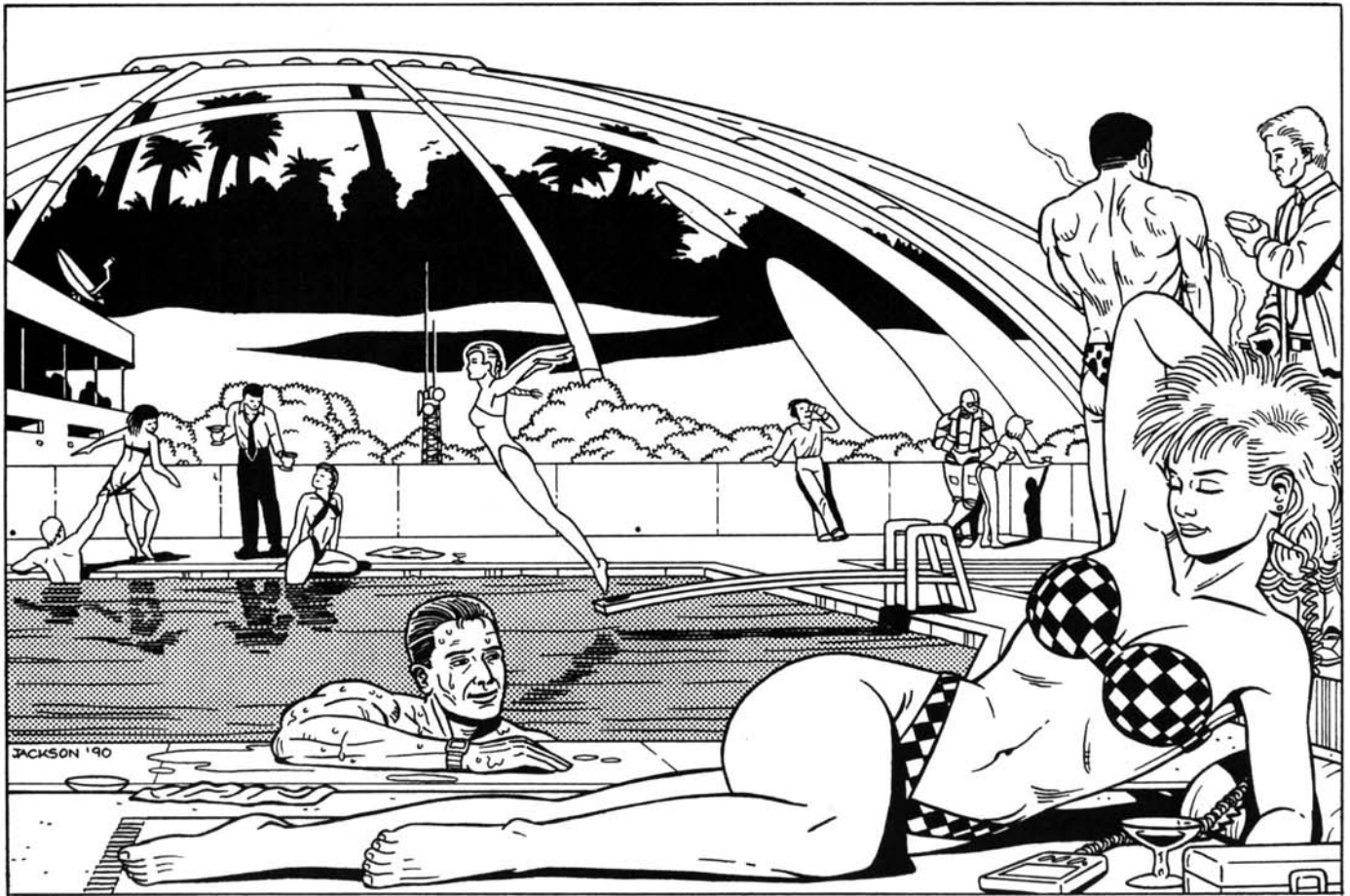

B1#6 Nino Tea House:

Japanese fare with an Okinawan accent. Nino's features full-course meals of everything from rustic pig's ear sashimi to more traditional fare. Or try the sushi bar for a light meal and saki.

Security Level:0

B1#7 Serengeti Gallery:

Just inside the door a pride of wild lions lazily sun themselves in the branches of a tree. In other corners giraffes and rhinoceroses graze, as monkeys chatter above their heads. While the plants are real, the animals are only holographs. Serengeti Gallery specializes in African wildlife holography. Perhaps the most startling is the leopard holograph that looks for all the world like a wild cat draped across the coffee table—a definite conversation starter in any living room. The holographs all come with recorded animal sounds that can be set to play when someone nears.

Security Level:1

B1#8 Park Shops:

Numerous service businesses, mainly coffee shops and a copy store, fill this block. The **Krishna Coffee-shop** at the northwest corner is renowned for the artists and poets that frequent it. Here one can find the best literary and artistic talents of Night City arguing the finer points of style among

themselves. A dataterm and a screamsheet box stand at the northeast corner.

Security Level:1

B1#9 Apartments:

A mixture of students, artists, and professionals rent in these buildings.

Security Level:1

B1#10 Warehouses and Art Studios:

Some of these warehouses have been converted to artist's studios, while still others house small businesses. Some of the larger corporations store their goods here. The area also includes an outlet of *Silverhand Studios*, as well as numerous small art galleries dotting the ground floors of buildings.

Security Level:1

B1#11 Shops:

The **Rainbow Art Supply** store, a taco stand, and a convenience store grace this side of the block, evidence of the bare minimum artists require to create their works.

Security Level:0

B1#12 West Hill Library:

This is the West Hill branch of the main library.

Security Level:0

B1#13 Petrochem Fine Arts Museum:

Generous corporate sponsorship has allowed Night City to build this recently completed fine arts museum to complement the downtown City Museum. Built in the style of an Italian Renaissance square, the entire museum is open to a central courtyard which can be entered only through the gatehouse. The four main buildings are organized into *Ancient Art*, *Classical*, *Contemporary*, and *Sculpture*. The smaller building north of the entrance gatehouse contains the administrative offices and functionary rooms for special events and guests.

Petrochem supplies security personnel to staff the gatehouse and maintain security within the museum. Many valuable works of art are on display here. Besides thieves, security must protect the patrons and artwork from gang violence and vandalism.

Security Level:2

B1#14 NCU Fine Arts Campus:

Built alongside the museum, the Night City University Fine Arts campus works with the Petrochem Fine Art Museum in educating the students and maintaining the museum's impressive collection. Here students can work in the many studios and workshops, and study art history with actual samples next door in the museum.

A contingent of NCU Campus Police maintains order on the Fine Arts campus. The University also operates shuttle buses between here and the main campus in the interest of student safety.

Security Level:2

B1#15 Assorted Businesses:

These high-rise office buildings house numerous small and medium sized businesses. Among them are the **GHP Architectural Firm**, **Stohlman & Stohlman Accounting**, **Pegasus Graphics**, **World Wide Engineering**, **Night City Newspaper Agency**, **Gueller & Stravinsky Law Offices**, **Pacific Security Services**, **Union Publishers**, **Coastal Real Estate**, and many others. Interspersed among the ground floors are many cafes, convenience stores, restaurants, book stores, a kung fu studio, and other retail shops.

Security Level:1

B1#16 Night-Marriot Hotel:

The glossy black tower of the Night-Marriot Hotel stands over its companion convention center at the top of West Hill, where it is visible to the southern edge of Lake Park. Discreetly tucked away in the lobby are a dataterm and a screamsheet box. Numerous small shops decorate the hotel's ground level concourse.

On the uppermost floor, the **Kilimanjaro Peak** restaurant commands a majestic view of the city from atop the tower. Dine on the finest African cuisine available anywhere in the city, with representative dishes from every part of the Dark Continent.

Security Level:2

B1#17 Convention Center:

Adjacent to the Marriot is the Night-Marriot Convention Center. The below-ground garage is spacious enough to handle the convention center's demanding parking needs. Inside the convention center has the space to handle large trade shows and concerts, or it can be partitioned to house simultaneous smaller events. A dataterm and screamsheet box are in the entrance foyer.

Security Level:1

B1#18 Apartments, Artists' Studios, Galleries:

Nestled between the University and the executive-class apartments to the north, this transition neighborhood is home to students, artists, and small businesses of all sorts. Much of the warehouse space is in use as artists' studios and galleries. Small coffee houses and boutiques along the park give this a Greenwich Village atmosphere.

Come here anytime in the weekend to see artists' works displayed along the sidewalk. For several blocks the artists set up their artwork in what amounts to a giant outdoor gallery. Tollaré used to paint in a studio here before he was widely known, and even today you can sometimes find other well-known artists such as Harold Pickman and J. T. Harris displaying their work here on the weekends.

This area has had some trouble with the Bozos, a poser gang whose members have undergone plastic surgery and facial tattoos to make themselves look like carbon-copy clowns. They hang around in identical orange fright wigs, dingy polka dot suits and floppy feet, harassing people as they pass by. The Bozos like destructive practical jokes; one of their favorites is pouring a bucket of paint (or blood) on an artist's sidewalk display. Fortunately their garish costumes make them easy to spot in a crowd, giving the artists opportunity to drive them off. Occasionally the Voodoo Boys come up this way for a dose of culture, in which case everybody packs up and leaves the street.

Security Level:0

B1#19 Honda Avis Rentals:

This is the Night City local office of the international chain, reorganized in 2002 in a corporate merger between the Japanese automaking zaibatsu and the failing U.S. rental firm. Honda-Avis ("We're Still Number One"), specializes in it's own brand of inexpensive, electric-driven Metrocars®. The offices are simple, spare and furnished in Late Japanese Functional. There are usually two to six people on site at any one time, and vehicles are stored in the large parking structure to the north of the main offices.

Security Level:1

B1#20 Parking Garage:

Your basic parking facility.

Security Level: 0

PERSONALITIES

Harold Pickman- A local street artist. Harold comes from a family with a long standing artistic tradition. He also keeps his eyes and ears open when on the streets. Because of this he is an excellent source of information if approached properly. He will be willing to part with most of his information if he can sell one of his more expensive paintings.

INT 8, REF 9, TECH 4, COOL 7, ATTR 5, LUCK 6, MA 7, BODY 5, EMP 8

SKILLS: Paint 8, Area Knowledge(B1) 9, Forgery 8, Stealth 4, Wardrobe & Style 3, Teach 4

CYBERNETICS: None



MEET THE BOZOS

Most of the gang influence in this part of the city comes from two sources. One is the Bozos, a posergang that is located in the artists' quarter. The Bozos revel in the destruction of public and private property, and they practice a very deadly form of slapstick.

The other gang is the Voodoo Boys, who come up from the University district on occasion, and are known to be major bad news.

ENCOUNTERS

1. A Corporate on his day off spots the players, and reports them to the police as undesirables.
2. A Fixer mistakes the players as a contact. She then tries to sell them information on a top secret Arasaka project.
- 3-6. All quiet
7. The Bozos have decided to try their newest joke out on the unsuspecting players.
8. The Voodoo boys are heading this way...
9. There is a firearms expo at the convention center. There might be some new items of interest.
10. The police need witnesses to the fatal shooting of a local artist. You don't happen to know anything about this do you?

CONTACTS

Melinda Estoria- A bored corporate wife with infidelity on her mind. She will bankroll any illicit activities that look "exciting" to her.

Ed Hill- Head janitor at the Pinewood Bazaar. With a sufficient cut he can make sure that the alarms are "malfunctioning" on a particular night. Not a bad man but he needs to feed his wife and kids.

Tamiko Yagata- A waitress at the Nino tea house, she hears a lot of interesting things in the course of a night. And for a high price she will tell you what you want to know.

"The Ferret"- An illicit information gatherer whose cover is a night watchman at the Convention Center.

Thain Western- Another artist on the row. In reality, he is an infamous netrunner with a price on his head. He will come out of hiding only if the stakes are high enough.

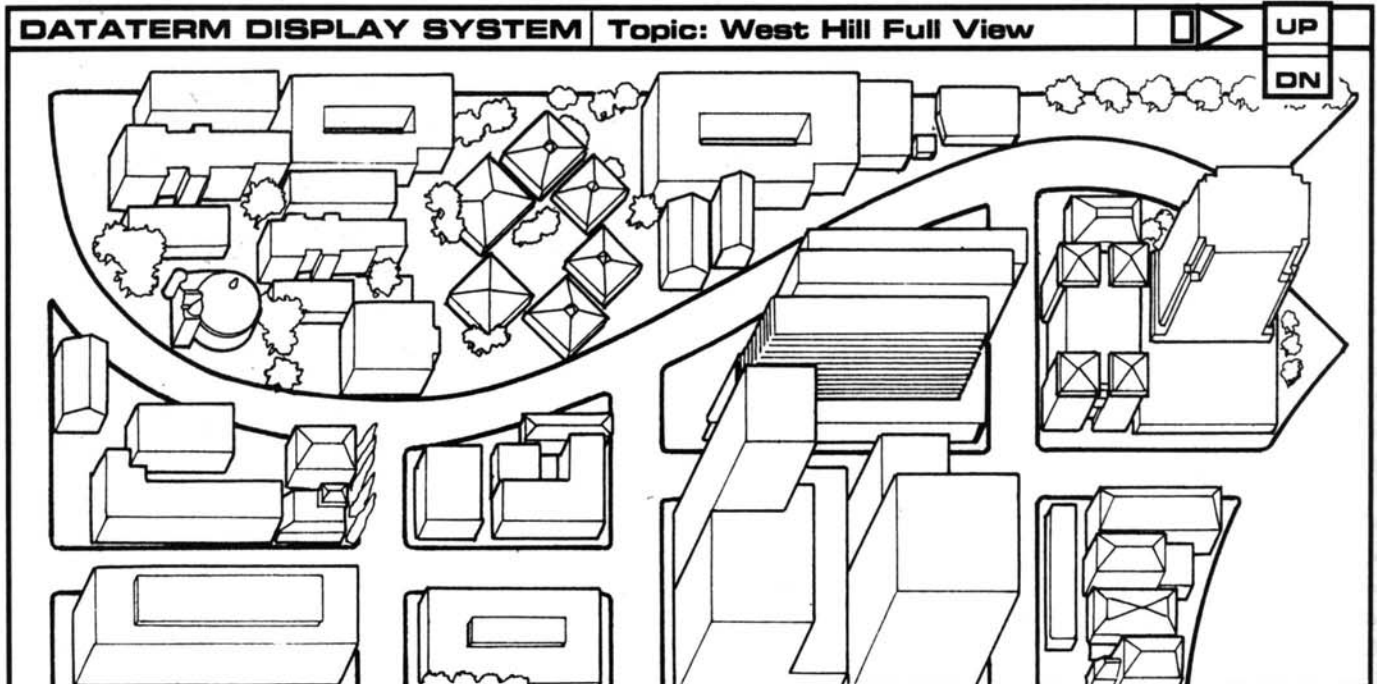

SECTION B2: THE CORPORATE CENTER

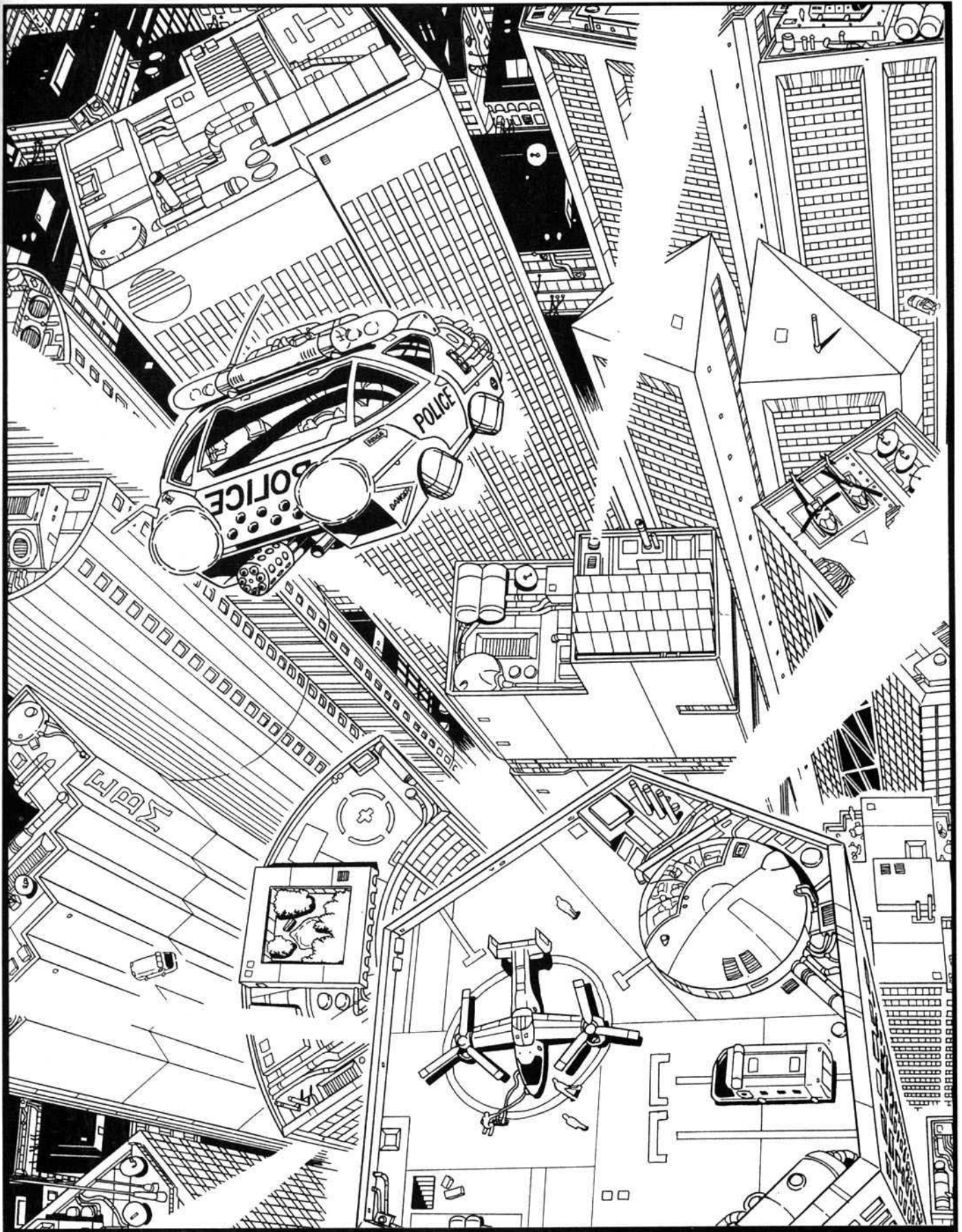

CORP. CENTER

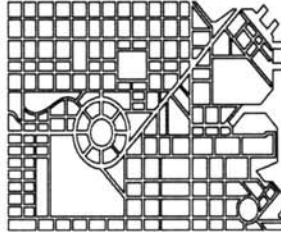

D A T A T E R M

Like any modern metropolis, Night City is always in a state of flux. Over the years, most neighborhoods and districts wend their way through a tortuous cycle, alternating between fashion and disrepair. But one area stands as an exception. It is all landscaped plazas and sculpted architecture. There are no cracks in the sidewalks, the streetlights always work, and there is always a police officer around if you need him, although he may not draw his salary from City Hall. From these wide, orderly streets rise the skyscrapers, lofty and serene over the chaos that is most of the urban ground level, spearing daggerlike through the grey smog above.

This is the Corporate Center, true locus of power in the city.

Most of the major office towers are located in the Corporate Plaza, a circular area encompassed by Plaza Drive. The Corps spare no expense in the area's upkeep. This is reflected in the relative safety and elegance of the district. Persons who look or act out of place are liable to be stopped and questioned by corporate or city police. Those who can't adequately justify their presence will most likely find themselves quietly but quickly escorted out of the area. The blocks surrounding the Plaza are not quite so tightly controlled as the Plaza itself, but they have a high corporate ambience, and are upscale enough to warrant a considerable, though discreet, police presence.

The area is active twenty-four hours a day, although noticeably

more so during business hours, when most of the workforce is active and the majority of the area's restaurants, boutiques and shopping courts are open. Vehicular traffic varies from very heavy, during commute hours, to light or moderate in the middle of the night. The Corporate Plaza is extensively serviced by city transit and there are three large transit stations arranged around the circle of Plaza Drive, serving both bus and maglev subway. These are *North Plaza* at Meridian and Plaza Drive; *14th Street* at Plaza and 14th; *Williams Street* at Plaza and Williams, and *Plaza West* at Plaza and 14th. There are also bus stops at one block intervals along all bus routes.

In the Plaza itself, one is likely to find corporate executives and service personnel, shoppers, city and corporate police/security. At night, the percentage of shoppers and executives decreases, and the percentage of police, security and service personnel increases. At night the police pay special attention to the area bordering the park and the transit stations. The population and composition of the areas peripheral to the plaza varies depending on whether the blocks are commercial, or residential.

West Plaza Businesses

B2#1 The International Cafe and L'Etranger:

A chic businessman's cafe and fern bar, the International is a popular lunch hour watering hole for many of the corporate area's mover set. Next door is the L'Etranger bar, a slick night spot decorated in a continental European theme, and favored by late-working corps and white collar security personnel. Order in the building is maintained by Malcolm, L'Etranger's tuxedo-wearing bouncer. Ever since negotiations between a corp representative and two rival solos deteriorated into a firefight inside the building, Malcolm has been kept on hand at all times. A man of few words, his discretion is matched only by his size, martial competence and marksmanship. The upper floors of this building are apartments frequented by area service and retail personnel.

Security Level: 1

B2#2 The Balinger Building:

This is a typical small-business building, with fifteen floors of nine-to-five private sector micro-businesses. The largest among them are **Parkman Domestic Realty, World Insurance, Wrigley & Wrigley Inc., Financial Consultants**, and the offices of **Ben Feinberg, C.P.A.** Feinberg is a notable character, as he is accountant to many Night City celebrities, including the Mayor, several local actors and musicians, and a number of wealthy executives from EBM and Net 54.

Security Level: 2

B2#3 700 9th St.:

This is another small, all-purpose office building. The most notable tenants are **Plaza Realty**, handling much of the office

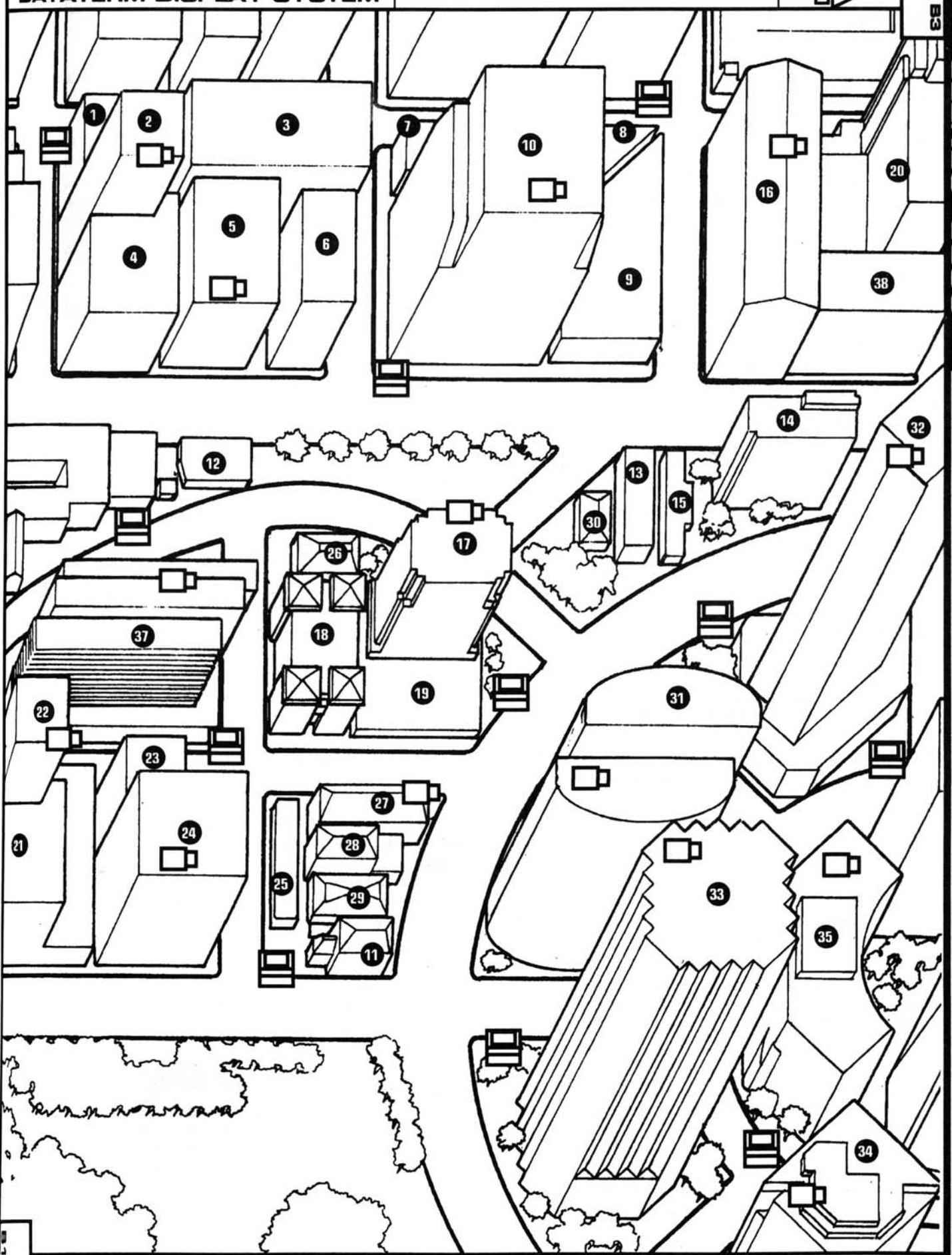

space and commercial leasing in the corporate area, and the **Sunset Bar and Grill**, a popular restaurant and bar catering primarily to the residential population. The only time things are rough at the Sunset is when popular bands are playing at the *Rainbow Nights* club on the next block. Then the normally peaceful clientele is displaced by concert-goers, gang-members and such. On those nights, Sunset owner Barney Chan, a wily Hong Kong emigré, is likely to add some security in the form of members of his son's martially adept street gang, the *Hong Kong Musketeers*.

Security Level: 1

B2#4 Dean Warner, Inc.:

This is a typical small, mildly successful financial investment operation. Its clientele includes middle class investors who want good service, but can't afford consulting or brokering on the level of Merrill, Asukaga and Finch, or other large firms.

Security Level: 1

B2#5 Modern Office Technologies and Robbie's Monster Subs:

MOT sells, leases and distributes office equipment and supplies to small and medium sized local companies. This is their head office. They have warehouses and smaller showrooms throughout the city.

The basement of the MOT building is occupied by **Robbie's Monster Subs**, a fast-moving, greasy sandwich joint frequented by the lower echelon corporate lunch and dinner crowd. Robbie's is open 24 hours a day, and when the *Rainbow Nights* club has a good show on, the midnight crowd there can get a little freaky. Robbie, an ex-sumo wrestler from Hawaii, maintains order himself on those nights. His 300 pound bulk can come over the counter fist-first with surprising speed when properly aroused.

Security Level: 1

B2#6 Pacifica Bank:

A West Coast mini-bank, not favored by the corporate crowd. Clientele is mostly service personnel and immigrant labor. This building is the Night City head office.

Security Level: 1

B2#7 Xian Electronic Exchange:

This is a typical downtown electronics store, selling discounted, imported Chinese, Japanese and Korean personal and home electronics and cyberware.

Security Level: 1

B2#8 Rael's Bodysculpting and Tattoo:

This is a somewhat seedy, small-scale cosmetic bodyshop and outpatient cyberware installation joint. It is operated by Rael Sanchez, CMT (Cosmetic Medical Technician). Most of the business comes from the crowd attracted to the adjacent *Rainbow Nights* dance club. The right connections and an appropriate sum of money will get you admitted to the back

of the studio, after hours, when Rael sheds his CMT certification and operates a profitable ripperdoc business. Any illegal cybertech installed.

Security Level: 1

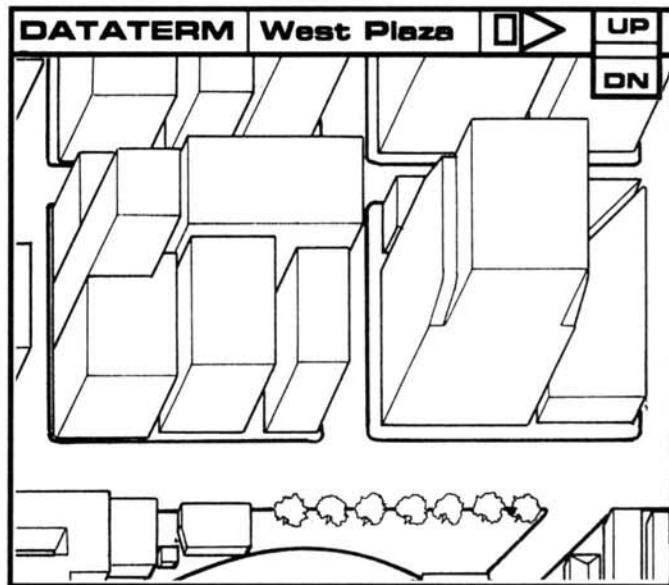

B2#9 The Rainbow Nights Dance Club:

The *Rainbow Nights* Dance Club is a fairly large 24-hour club, with a huge dance floor. Most of their acts are local small-timers, with crowds being consistently large, but generally tractable. Once or twice a month, however, they get a big headliner. When that happens, the neighborhood chokes up with a huge number of boosters, chromers, and just plain rowdy kids. The crime rate in the area goes up on these nights, and the City and Corporations deploy extra police.

The club occupies the entirety of a large, low building covering almost half the block. There is a main entrance out front, and a smaller, secure entrance on the back alley. There are fire exits all around which can be opened from the inside only. The roof is bare. Inside is an enormous dance floor with a stage at one end, and a bar at the other. There are offices located in the large backstage area.

Security is tight at all times, and doubly so when they have a big act. Don't expect to get in without a ticket or a hell of a fight.

Security Level: 1

B2#10 Marshall's Department store:

A large, classy, downtown department store, Marshall's has twenty floors of shopping area topped by thirteen floors of stock-rooms and offices. It runs towards the expensive and stylish, with departments such as designer clothes, electronics and personal cybermetics, imported home accessories, and so on. It is difficult to get through the front door if you look

suspiciously un-monied. Plainclothes store security is tight.
Security Level:2

B2#11 The Corporate Showing:

A small, select art theatre that shows old films. Often used by the corporate set for clandestine meetings. Admission is 17.50eb per showing, and the seats are very comfortable.

Security Level:2

B2#12 Kuramoto Galleries

A large, exclusive art gallery, catering to Night City's wealthier residents. The gallery showcases modern and classical art of all varieties, and often hosts invitation-only auctions. Security is provided by an on-site team of German solos. Yamiko Kuramoto, an aging, wealthy dowager-daughter of the Kuramoto family runs this gallery. The family also operates galleries in New York, Tokyo and Bonn.

Security Level:1

B2#13 Mac Donovan's:

More fast food like you had it back home.

Security Level:0

B2#14 10th St. Center:

A mini-mall with several small businesses inside. Included are **Nadine's**, a fashionable boutique; **R. Bush and Sons- Jewelers**; **Color Zone**, a youth-oriented clothing store; **Major Music**, a pop-oriented music store, and **Zeke's**, a cheap fast food restaurant. Clientele is mostly teenaged throughout this mall, with the exception of the jewelry store.

Security Level:1

B2#15 Night City Tourism Office:

This building is the official Night City tourist information center. Here, visitors from abroad, as well as around the country can learn what hotels are appropriate for various budgets, what neighborhoods and areas are recommended for sightseeing or avoidance, where the tourist attractions are, and what areas are scenic or have historical significance. Shopping guides (2eb) are also available, as are chipped package tours of the city and surrounding areas (10eb).

Security Level:0

B2#16 The Regal Hotel:

This is a typical, downtown businessman's hotel. It is aimed at the middle management and lesser corporate level: classy without being prohibitively expensive or extremely luxurious. The clientele is largely undistinguished and overworked.

Security Level:1

B2#17 The Chatworth Tower:

This building is luxury town-houses and apartments. The Chatworth is not quite as slick and expensive as they come, but it is fairly close. The twenty-five floor tower has apartments and town-houses ranging from studios to the enormous pent-house, which is owned by multi-millionaire securities

broker Nolan Taggia and occupies the entire top floor. Most of the units are in the two or three bedroom range, and are rented out to, or owned by, moderately wealthy retirees and well-off travelling businessmen who need a convenient place near the center of commerce. Security at the Chatworth is composed of a contingent of armed guards leased from a local corporate security firm. They are effective without being top-notch. There are usually ten guards on duty at any given time, and a hot-line to the police station.

Security Level:2

B2#18 The Town Center:

This is another small, urban mall. It is somewhat larger than the 10th St. Center, and is targeted towards a more mature clientele. Businesses include expensive boutiques and gift stores, a book store, a music store, jewelers, clothing stores, a computer and cyber-tech store, and an upscale cosmetic bodyshop. There are also a couple of small restaurants and cafes. Patrons include residents of the nearby luxury condo towers, hotel guests, tourists and corporate employees.

Security Level:1

B2#19 The Cavalier:

This is an expensive clothing store targeting well-off area residents, corporate executives and rich tourists. The store sells high-quality imported suits, coats, furs, peripherals, and luxury household items. Extremely classy, and impossible to get into if you don't obviously have the money to spend. By the way; if you have to ask for a price, it's too expensive.

Security Level:2

B2#20 The Kuroshita Hotel and Convention Center:

This is an expensive, stylish business hotel favored by Japanese corps, tourists and solos. The Kuroshita is known for discretion and elegance. Security is in-house, consisting of uniformed officers and plainclothes solos, all armed. The Kuroshita is also a popular spot for business and trade conventions. There is a 50% chance that the hotel will be hosting a convention at any given time.

Security Level:2

Parkside Residential Towers**B2#21 Plaza East Tower:**

This is an upscale residential tower with a view of the park. Small units cost upwards of half a million dollars each to buy, or 5000eb per month to lease. Large units, and the penthouse suites, can cost millions of dollars to buy, and tens of thousands to rent. The residents of the Plaza East Tower are largely wealthy retirees, and older, well financed corporate executives. Security is extremely tight, with access beyond the building lobby restricted to residents and invited guests. Mail and other deliveries are turned over to hotel employees in the secure subterranean vehicular area before being distributed to residents. Security personnel are contracted

from a local high-end corporate security firm. All guards are armed, and dressed in police-style uniforms.

Security Level:3

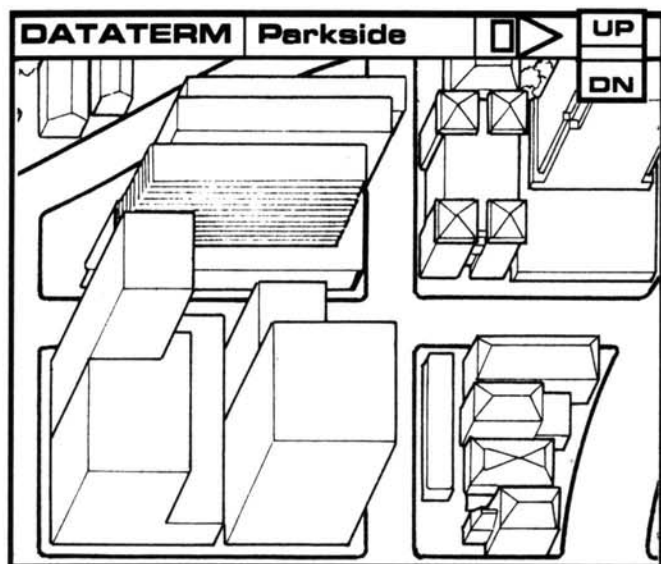

B2#22 700, 14th St:

This is another luxury town-house building. It is similar to the Plaza East Tower in all respects, save that it is slightly more expensive due to its unobscured view of the park. Residents are of a similar composition, with a slightly higher proportion of wealthy young corpzoner couples.

Security Level:2

B2#23 Plaza West Tower:

This is the lowest priced tower on the block, as it is shorter than the other buildings, and has no view of the park. It still costs upwards of 300,000 euro dollars to buy a unit here, or 3000eb per month to rent. Plaza West is popular with wealthy businessmen and couples who want a place near the Corporate Center, and rich foreign corps and solos who want a permanent place in Night City. Its security is less strict than the other towers, though still tight. All guards are provided by an in-house agency.

Security Level:2

B2#24 The Parkview Tower:

This is the grand-daddy of them all; the most luxurious, expensive and secure residential tower in the city. It is twice as expensive as the next door Plaza East Tower. Security consists of armed plainclothes agents contracted from Arasaka, and is accordingly tight. Residents vary among local millionaires and billionaires, foreign arms merchants, dictators, corporate heads, celebrities, and Night City corporate VIPs.

Parkview has its own infirmary and a tactical rescue go-team on call at all times. The building is forty-five stories tall, has secure underground vehicular areas, and heliports and AV-4 pads on the roof.

There are fine restaurants, shops and markets inside the building and open to the public, but the residential areas and infirmary are as secure as the insides of the more paranoid corporations. The penthouse is owned by eccentric arms merchant and filthy-rich billionaire Omar Khadabhi. He is rarely seen in the building, spending much of his time on his three-hundred foot yacht, and in his other houses around the world. He comes and goes by private, heavily-armed Osprey tilt-rotor aircraft.

Security Level:4

The Consular Block

B2#25 World Travel Agency:

A large travel agency and tour planning office, offering booking and ticketing for all sorts of travel and vacations. Typical are such things as safaris, cruises, orbital flights, and long range commuter flights.

Security Level:0

B2#26 The European Economic Community Consular Building:

This building contains consular offices for all the EEC nations, as well as a combined EEC diplomatic mission. Passport, diplomatic, immigration and visa services are available, as well as currency exchange and aid for distressed EEC national tourists. The building also contains an Interpol office and an armed security detachment of twenty-five troops from EEC nations. The Consul Generals and higher placed consular officials live in the Plaza West tower. All other personnel live in the consulate itself. The consulate is a locus for the activities of many Eurocorps and eurosolos.

Security Level:2

B2#27 The Soviet Consulate:

This building is the local consular headquarters for the Neo-Soviet Union. Services provided are the same as the EEC consulate, but all Soviet consular personnel live in the consulate building. Security is a detachment of twenty Soviet troops. The Soviet consul-general is a stout, good natured man named Sergei Mosiusnik. He is fond of touring the local bars and restaurants with other consular employees along for fun, and two or three nervous plainclothes troops for security. Mosiusnik is something of a neighborhood card. His actions are frowned upon by the consular political officer, who is also the consular KGB representative. There is little the rep can do however, as Sergei is a blood relation of the President back in Moscow.

Security Level:2

B2#28 The Chinese Consulate:

Providing the same services as most other consulates, but in a somewhat lower key than either the Soviet or EEC offices. All personnel live in the building. Security is a detail of fifteen plainclothes Chinese diplomatic police. The Chinese consul-general is seldom seen outside the building.

Security Level:2

CORPORATE PLAZA

Because all of its buildings serve a similar function, the Corporate Plaza Area is described separately from the rest of sections B2 and B3. Detailed information on most of the corporations covered here can be found in the "Welcome to Night City" section of your *Cyberpunk* game.

B2#31 Raven Microcybernetics:

This building is the worldwide head office of the Raven Microcybernetics Corporation, premier American manufacturer of cybernetic prosthetics, cyberenhancements, wetware, and cybernetic biomedical equipment. The actual industrial manufacturing plants are disbursed around the globe, with most of the Night City facilities located in the industrial parks on the outskirts of town and across the bay. There is a small manufacturing area in the upper floors of the building, to complement the large R&D section. The building itself is a mirrored, 70 story structure with a split level, divided circle architecture. (See map.) There are AV-4 pads and heliports on the upper roof. The lower roof contains a small, landscaped park for employees. There is no giant logo on the building, only a modest sign over the main entrance. All elevators and stairwells are internal. There is a subterranean parking lot, but the loading docks are open air, under a fenced off, cantilevered section of the back of the building.

The RMC building contains no public facilities as such, although the bottom several floors are leased as office space to four other small cybernetic and technology companies, most of which do contract work for RMC itself. These companies are **Klein Cyberoptics**, **Interface Engineering, Inc.**, **Advanced Cyberpolymer Research Inc.**, and **Logan Engineering, Inc.** Company facilities include a general cafeteria, a surgery-capable infirmary, a company-owned general store, and sleeping quarters.

The common areas of the leased floors are public, although most of the small companies control access to their own areas. Access to all other sections of the building except the parking lot is strictly controlled. All areas are patrolled 24 hours a day.

Security Level:4

B2#29 The Mexican Consulate:

Similar in services to all of the other consulates. High-ranking officials, including the consul-general, live at the Chatworth Tower. Security is eighteen Mexican soldiers in plainclothes.

Security Level:2

B2#30 Child Creche:

Since the late 1990's, the problem of traveling with small children has been a major concern of Corporate families. Taking the risk of lugging several toddlers through a City rife with random firefights and potential kidnapers is something most parents want to avoid at all costs. What to do?

Enter Child Creche. For only 50eb per day, you can place your child in a secure cryotank, inspected weekly by licenced, credentialled members of Trauma Team®. The child is interfaced into any number of possible braindance tapes, making what would normally be a boring family trip into an exciting and memorable adventure.

Security Level:1

B2#37 Red Cab:

The largest private transport company in Night City is Red Cab, Inc, with its fleet of well-maintained, well-armed urban groundcars. Red Cab units can be summoned by either dataterm or phone. The main dispatch office and garage are located in the parking structure on the corner. Red Cab also maintains a fleet of four AV-4's, used for corporate clients. However, Red Cab is no threat to its main competition (Aerocab) in this regard.

Security Level:1

B2#38 Night City Towing and Storage:

These buildings house the offices of the public towing facility for Night City. Any cars towed are placed in the large parking structure to the south. Fines for towed cars are 200-300eb for the towing fee. All cars not claimed after 24 hours are considered property of the towing company, and are usually hauled off to a wrecking yard in South Night City, where they are sold as scrap. Especially nice vehicles are held and sold at an auto auction once every six months. Security is very tight, since few people in Night City enjoy paying the outrageous fines and bullets are cheaper.

Security Level:2

B2#32 Microtech Center:

This building is the regional headquarters for Microtech International, makers of fine mainframe and specialized computer systems. Microtech is a young, up and coming corporation, and the Center is a relatively recent addition to the Plaza. The tower is ninety-four stories tall, with typical architecture, surfaced in black glass and white synthetic marble. The company logo and name are prominently displayed in large, backlit, red letters on the two widest exterior walls of the top several stories. There is a heliport and AV-4 pad on the roof, and a restricted subterranean parking garage and loading dock. All elevators and stairwells are internal.

The lower ten floors of the building are open to the public. There are showrooms and demo areas for Microtech products, a cafeteria, a regular restaurant, a "history of computing" museum, a small emergency medical center, a boutique and a gift shop. The businesses are all

Access to the parking area, loading dock, and all the floors above the tenth is tightly controlled. Keyed express elevators run from the vehicle areas to the eleventh floor and above, with no

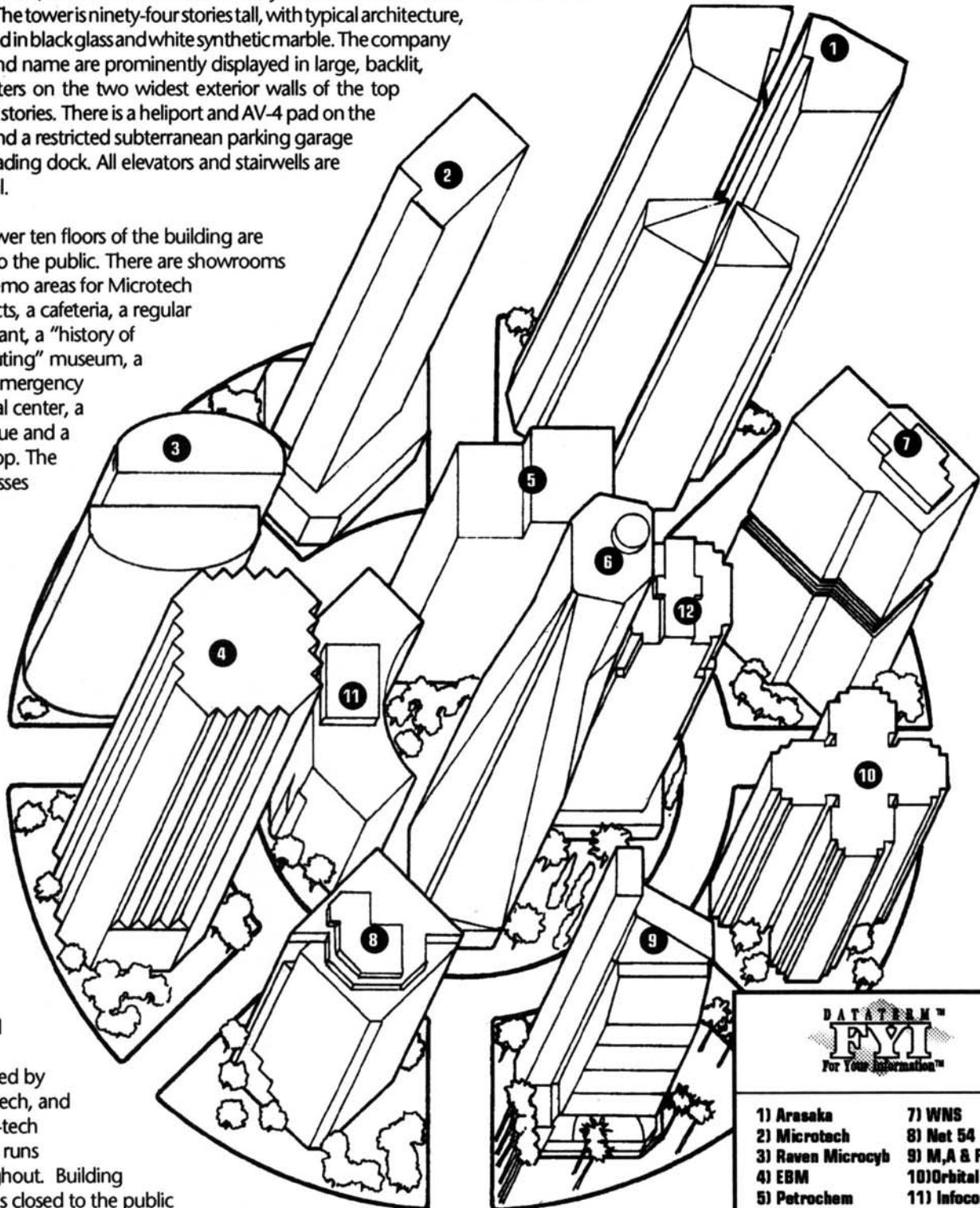

owned and operated by Microtech, and a high-tech theme runs throughout. Building facilities closed to the public include a cafeteria, gymnasium, surgery-capable trauma center, and recreation center.



- | | |
|-------------------|---------------------|
| 1) Arasaka | 7) WNS |
| 2) Microtech | 8) Net 54 |
| 3) Raven Microcyb | 9) M, A & F |
| 4) EBM | 10) Orbital Air |
| 5) Petrochem | 11) Infocomp |
| 6) Plaza Tower | 12) West City Tower |

intermediary stops. The roof and parking areas are continuously monitored. Company security patrols all areas 24 hours a day.
Security Level:3

B3#13 Arasaka Plaza & Tower:

This is the main office of the Arasaka America division of the Arasaka Corporation, replacing the previous building destroyed in 2013. At 130 stories, it is the tallest building in Night City, and is clearly visible from most areas in clear weather. It is almost two separate buildings, with the twin towers being structurally connected only below the 20th floor. Above that, the narrow (20m) gap between the towers is bridged regularly by closed tunnels with exposed walkways on top. Above the 90th floor, the tunnels have no exposed walkways or windows. The towers are featurelessly surfaced in black glass and steel, imparting a rather sinister look. The logo and name are on a black marble plaque that stands by the walkway to the main entrance. There are heliports and AV-4 pads on both tower roofs, and a restricted subterranean parking and loading area. Each tower has its own internal elevators and stairways.

Only the ground floor reception area of the Arasaka tower is open to the public. There are no public facilities in the building. Private company facilities include general and executive cafeterias, a surgical/trauma center, a company store and equipment center, a recreation center and sleeping quarters and barracks.

All building access is tightly controlled. Armed security troops patrol the roof, grounds, parking area, and building interiors 24 hours a day. No unauthorized vehicles are permitted on the roof, or in the subterranean areas. Authorization can be given only if one has an appointment, appears on a traffic/commercial manifest or schedule, or is cleared by someone within the company. Similar conditions apply to persons who wish to proceed beyond the reception area. The Arasaka Plaza, a small park surrounding the building, is open to the public, but company security patrols at all times.

Security Level:4

B2#33 Euro Business Machines, International:

This building is the main office for the U.S. division of the powerful and renowned Hamburg-based EBM corporation. EBM manufactures all manner of computer systems and high-tech hardware, and is the largest of the high-tech corporations. The architecture is striking, with the cross section of the building resembling a jagged sided square with truncated corners. The exterior is equally interesting, with a latticework of black, tubular girders crossing over the recessed, mirrored windows. At either side of all four flattened corners, glasswalled exterior elevators travel in the first groove formed by the angular walls. There are also interior elevators and stairways. The white EBM logo is prominently displayed on the top stories of all four of the walls formed by the flattened corners.

There is a combination heliport/AV-4 pad on the roof. There is a subterranean parking lot and loading area and ten underground manufacturing levels below that. (The underground levels are in addition to the 112 aboveground stories.)

EBM prides itself on its public relations and paternal image, and consequently, there are many public service areas in the building. There is a grand reception area on the ground floor, in the center of a mall-like indoor pavilion. From there, with proper authorization, one may use the interior elevators, which go to the corporate floors and subterranean levels. The exterior glass elevators service only the first eight pavilion floors, the 9th through 15th floor (which are subcontracted out as office space to other businesses), and the rooftop restaurant and observation deck on the 112th floor. They will stop at the intervening EBM floors only if one has the appropriate cardkey. The pavilion itself is composed of wide walkways circling the insides of the first eight floors. The fourth side of this enormous, open space is dominated by a huge marble-walled cylinder, encasing the interior elevators, stairwells, building service ducts, and the structural core.

There are thirty-six businesses in the pavilion, including restaurants, cafes, bookstores, boutiques, clothing stores, gift stores, and EBM showrooms and display areas. The rooftop restaurant is exclusive and expensive, but the observation deck is not. There are also employee cafeterias, recreation centers, and surgical and medical facilities not open to the public.

The EBM building is the most accessible of all the high-tech corp offices. The greater part of the parking area is open to the public, although the executive lots and loading docks are off limits to unauthorized vehicles, and the entire area is patrolled. The first fifteen floors of the building, including the open pavilion and subcontracted floors are publicly accessible, as are the rooftop restaurant and observation deck. Access to the roof itself, the EBM floors, and the subterranean floors are restricted to employees and authorized personnel. There are guided tours of the non-proprietary areas of the manufacturing section. All persons entering the building at any point are subject to discreet metal detector and explosive sniffer tests. All areas are patrolled 24 hours a day.

Security Level:4

B3#14 Petrochem International:

As Night City isn't a big oil port or refining area, Petrochem maintains only a relatively small 50-story office here. It primarily services the petroleum by-products, high-tech, and advanced polymer research divisions of the company. The building itself is squat and unremarkable, surfaced in black glass and grey stone. The roof has an AV-4 pad and a heliport. There is a subterranean parking lot and loading dock. All elevator shafts and stairwells are internal.

The reception area of the Petrochem building is open to the public, but there are no public services in the building other than a small museum and gift shop/public relations department. The company facilities, including a cafeteria, small gymnasium and company store are generally off limits to the public.

All access beyond the first floor is controlled, and all areas are patrolled 24 hours a day. Because of the sensitive nature of Petrochem's R&D, armed staff security is quite high in the building, and computer security is third only to that of Arasaka and Infocomp. There is a detachment of corporate troops on call at all times.

Security Level:3

B2#34 Network News 54, Night City:

Forty-three stories of canned heat, the Net 54 office building is always visible, despite its relatively stunted size. Searchlights on each of the four rooftop corners help this, as does the continuous air traffic to and from the building, the mirrored walls, and the scintillating, red neon "54" plastered in fifty-foot digits near the top of each side of the building. The roof is entirely covered with AV-4 pads and heliports for the roving news teams. There is a subterranean parking lot and loading dock. All the stairways and elevators are internal.

The reception area of the Net 54 building is open to the public, and there are several facilities for public use, including a huge gift shop and boutique, screening rooms, an infirmary, a restaurant, and a cafeteria. The cafeteria actually tends to be more popular than the restaurant because Net 54's stars sometimes eat there during filming breaks. This draws large numbers of tourists. Since many of Net 54's shows are taped live before studio audiences, several of the sound stages are open to the public. Tickets are usually required for admittance to these areas, and security is always heavy. There are also guided tours of non-proprietary recording and production facilities. Facilities off-limits to the public include a surgery/trauma center, a rec-center, a second cafeteria, the vehicular areas, several lounges, and housing for news teams.

Access to non-public areas is tightly controlled; security patrols and monitors all areas 24 hours a day. All persons who leave the reception/hospitality area will be asked to produce a show ticket or valid guest pass. Persons who stray from the well-designated audience areas are subject to arrest.

Security Level:3

B3#15 Plaza Business Tower:

Ninety-six stories of assorted businesses, the Plaza Business Tower is the corporate answer to the suburban mall. Spiralling downtown land prices forced developers to go vertical, and this building is the result. A testament to modern merchandising, this building is as glitzy and eye catching as they come. The exterior is of mirrored glass, polished white marble and stainless steel. There are internal elevators and stairs, but exterior glass elevators also travel in herds up and down both sides. The entire affair is capped on the top of

the walls of each side with huge black letters reading "The Plaza." At night, these are backlit in red. There is a rotating restaurant on the roof, overlooking the numerous heliports and AV-4 pads on other buildings. The enormous underground parking lot and loading area also serves the West City Tower next door.

The Plaza Business Tower is, by nature, one giant public facility. It contains hundreds of businesses and outlets, including restaurants, clothing stores, fitness centers, computer stores, high-tech stores, arms merchants, architects, flight schools, out-patient cyberclinics, body-shops, and even an auto dealership. A complete list of the businesses in the tower would be impractical here, but if you need a particular type of merchant or contractor, chances are there is one in the Plaza Business Tower. Including a public emergency medical center. There are a few facilities reserved for employees of businesses in the tower, and employees of the tower's ownership company itself, but they are by far the exception, not the rule.

Access to most of the Plaza Business Tower is, of course, unlimited. All common areas are accessible 24 hours a day, though most of the businesses are closed at night. Service areas are secured against unauthorized personnel, and the loading dock and roof landing area are off-limits without clearance. The businesses in the tower maintain their own security measures, and several of them are quite well protected. There are some areas of the tower that are privately leased and off limits to the public, but these areas are well patrolled and secured, and generally not accessible from the common areas without authorization or a key. As a rule, the tower is more exclusive and secure at the upper levels, where the higher end services, businesses and offices are located. There is a security center on the ground floor, and the entire tower is patrolled 24 hours a day by contracted security. City police can also usually be found in the building.

Security Level:2

B3#16 West City Tower:

The West City Tower is similar in many ways to the Plaza Business Tower. It tends more toward office space, and less toward consumer-oriented businesses, but it has a good number of retail outlets, public services and public contractors. It is a slightly older building than the Plaza Business Tower, and not quite so slick. The exterior is grey granite and black glass with no large logo or sign. All elevators and stairwells are internal, and there are the standard heliport and AV-4 pad on the roof. The West City Tower shares an enormous subterranean parking lot and loading area with the adjacent Plaza Business Tower.

Like its larger neighbor, the West City Tower is largely offices. It contains much the same composition of businesses as the Plaza Tower, although proportionately more of the building is occupied by private office space for contractors, security services, investment/financial firms and so on. Like the Plaza

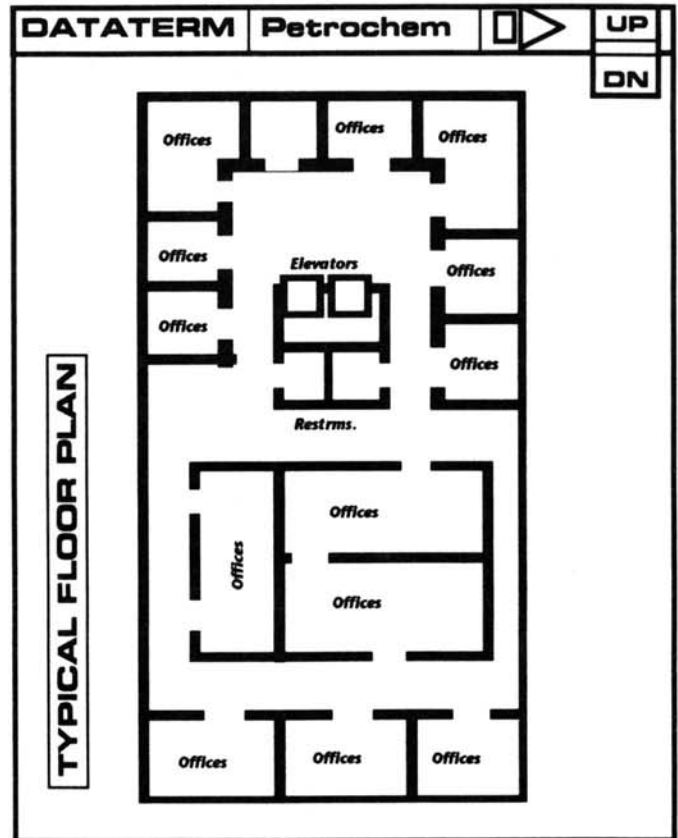
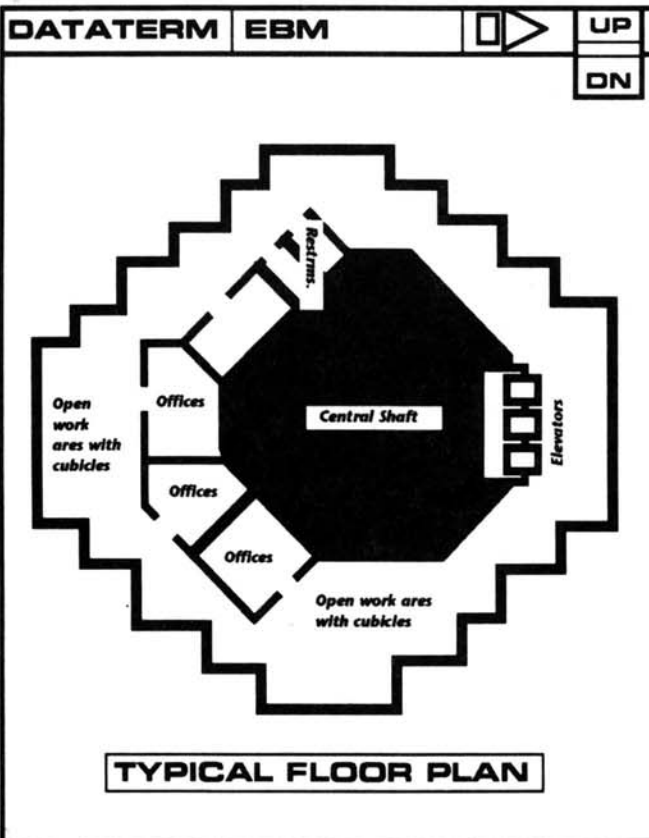
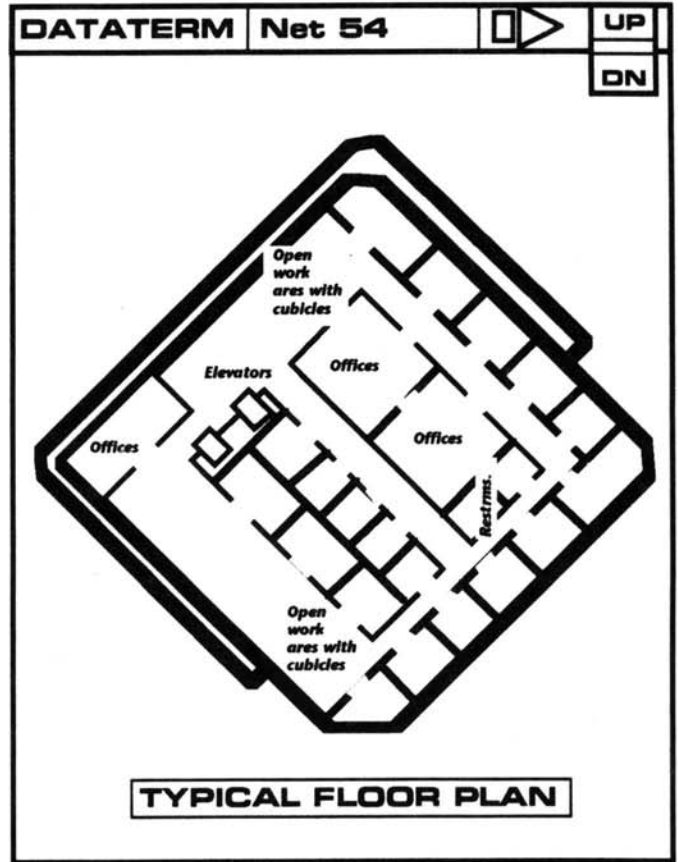
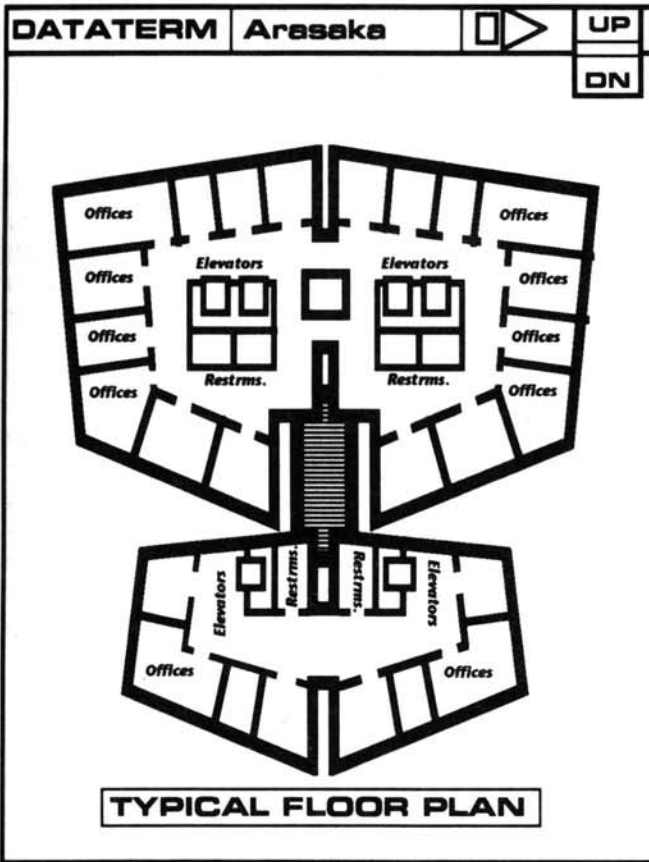

Tower, there is a general medical facility. Unlike the Plaza tower, there is also a private tenants-only cafeteria and recreational facility.

Access to the West City Tower is, again, almost the same as its neighbor. The only difference is that, with the relative increase in office space and decrease in retail space, proportionately more of West City is restricted to the public. The bulk of the building is, however, freely accessible 24 hours a day.
Security Level:2

B2#35 The Infocomp Building:

Infocomp is a think-tank, analysis, fact finding, and detective firm. Subtlety and restraint are its trademarks. Consequently, it is not surprising that the Infocomp building, while large in the absolute sense at 40 stories, is the smallest and least imposing of the Corporate Plaza towers. The exterior is a muted, elegant, grey synthetic marble with smoked windows. There is no logo on the building, only a small sign by the main entrance. There are several AV-4 pads and heliports on the roof, and the usual subterranean parking lot beneath the building. The loading area is below ground with the parking lot, but it is relatively small as little bulk material other than office supplies goes in or out of the Infocomp building. All elevators and stairwells are internal.

The only public facility in the Infocomp building is a huge research library on computer memory. Much of the information contained in it is sensitive, and not accessible through normal computer information nets. An appointment is necessary to access their computer library, as it can only be done from on-site terminals. The charge for library time fluctuates from 100 to 5000 eurobucks per hour depending on the information to be accessed, and the equipment needed. No copying or removal of sensitive material is allowed, other than in handwritten notes. Security is tight, and all users are monitored. Persons wishing access to especially sensitive information are subject to background check. Employee facilities include a surgical/trauma center, cafeteria, gymnasium and rec center.

Access is tightly controlled throughout the Infocomp building. Only the main reception area is open to the general public, as library use requires an appointment. All areas are patrolled 24 hours a day. Computer security and ICE is especially prevalent around their system, with only Arasaka being a tougher computer nut to crack.
Security Level:4

B3#17 World News Service, Night City:

The WNS building, like Infocomp, is largely functional and restrained in design. WNS does not need to advertise itself through gaudiness, and maintains a certain amount of pride in its Old-World conservative air. The WNS tower is 63 stories tall, and surfaced in white stone with black windows. A

windowless section circling the center floors of the building encompasses the recording and video studio floors. There is a relatively small, white-lit WNS logo on the upper left corner of each exterior wall. There are the usual AV-4 pads and heliports on the roof, plus parking and loading areas underground. All elevators and stairs are internal.

There are no public facilities in the WNS building except a small news-stand and company shop, where the latest news faxes and newsdeck downloads can be purchased with a morning cup of coffee. Employee facilities include screening rooms, a rec center, cafeteria, studios that can be checked out for personal use, and a surgical/trauma center.

Access to the WNS building is tightly controlled. Only the reception area and news-shop are open to the general public. There are guided tours of the non-sensitive areas, but they are escorted by security as well as tour guides. All areas are patrolled 24 hours a day.

Note: WNS does not do its own broadcasting, but contracts to the highest bidder. In Night City, most of the broadcast rights are, predictably, in the hands of Net 54. Consequently, there is a fair amount of courier work and secure transmission between the two buildings.

Security Level:3

B3#18 Orbital Air, Night City:

The Orbital Air tower is the regional office for this mighty aerospace transport and development corporation. In keeping with its cutting edge image, the OA tower is a sight to behold. It is composed of four linked lobes, all surfaced in gleaming, mirrored glass. The OA logo glows in letters of shifting, neon colors from the top of each lobe's outward facing wall. There are AV-4 pads and heliports on top of each lobe, and the usual subterranean parking lot and loading facility. The loading facility is rather small, as there is little bulk transport to or from the building, other than office, computer and cafeteria supplies. There are both external glass elevators and regular internal ones. All stairwells are internal.

Public facilities in the OA tower include an aerospace technology and history museum, a restaurant with an aerospace theme, and a ticketing agency. Employee facilities include a rec center, surgical/trauma center, cafeteria, and rooming facilities for OA aircraft crews who spend time in the city between flights.

Access to the non-public areas of the building is fairly tightly controlled, but staff security is only noticeably severe around the tower's R&D department and computer rooms. The OA hangars and buildings near the airport, where most of the hands-on tech work and all of the aircraft are located, are a more likely infiltration target.

Security Level:3

B3#19 Merrill, Asukaga & Finch, Night City:

As befits a corporation whose sole reason for existence is the handling and application of large sums of money, the MA&F tower is a masterpiece of subdued majesty. At only 55 floors (and a relatively small cross section), it is one of the smaller buildings in the Corporate Plaza, but it is also one of the most eye-catching and elegant. The building is surfaced with glass overlying a steel frame. The interior floors of the building are built as open, plant-festooned terraces within the glass walls, giving the effect of an enormous greenhouse. There is a good amount of open space between the floor terraces and the exterior walls, with contact made only through steel structural supports. Only at the lobby and top floors do the walls and interior floors structurally merge. The exterior walls are transparent from both inside and outside the building. There is no logo on the building, and no aircraft facility on the roof. There is a subterranean loading dock and parking area. The elevators and stairs are external, and located in a glass-sheathed shaft at one end of the building.

The MA&F building has several public facilities in the lower three floors. There are bank offices, boutiques, a bar, restaurant and a small indoor park which occupies the entire third floor. There is also the public reception area for MA&F itself. Private employee facilities include a cafeteria, non-surgical infirmary and a rec center.

Access to the MA&F tower is restricted only above the third floor. Security is fairly tight throughout most of the building, but heavy only in the executive office areas, computer areas and the vault level, all of which are on the upper floors. The glass exterior walls will withstand hits from most small arms. The parking lot is public, but the executive section and the loading area are controlled. All areas are patrolled 24 hours a day.

Security Level:3

PERSONALITIES

Yoru Tomobiki- Yoru Tomobiki supervises the Arasaka Corporation's security contracts in the Night City Area. As he is personally responsible, and accountable, for the success and perpetuation of those contracts, Tomobiki goes to great pains to see that the troops and equipment at his installations are always in top-notch form. He makes regular surprise inspections and drills his men mercilessly. Any troops caught slacking are dismissed. Tomobiki's fanaticism extends to vendettas. When security is breached at a site protected by an Arasaka contract under his command, Tomobiki will frequently assemble a black ops team and personally lead it on a mission to find and kill the transgressors. Since he is also in charge of Night City black operations for the Arasaka Corporation, he is quite good at this. A dangerous man to make an enemy of.



Yoru Tomobiki (from office video records), 12/21/18

INT 8, REF 10, TECH 3, COOL 10, ATTR 7, LUCK 1, MA 7, BODY 6, EMP 6/3

SKILLS: Combat Sense 6, Interrogation 5, Intimidate 3, Streetwise 4, Awareness 8, Hide/Evade 3, English Language 6, Shadow/Track 5, Handgun 5, Rifle 6, Sub-Machinegun 3, Stealth 5, Karate 6(3), Dodge/Escape 4, Driving 2, Melee 3, Acrobatics 3.

CYBERWARE: neural processor, interface plugs, chipware socket, Kerezikov boosterware, image enhancement, targeting scope, smartgun link, vehicle link.

Dr. Jasmine Lai Ket- A brilliant student in a troubled part of the world, Lin "Jasmine" Lai Ket fled war-torn Southeast Asia and her native Thailand for Germany, where she pursued studies in computer engineering and computer cognition. By the age of 26, Lai Ket had her Ph.D. and was considered one of the world's bright young stars in the field of artificial intelligence engineering. EBM snapped her up as soon as she hit the market, offering her unlimited funds and resources, and the freedom to pursue her research however she saw fit...on the condition that all of her research and developments remain proprietary to EBM. Lai Ket accepted, and has worked in her labs at the Night City EBM tower ever since, producing several major breakthroughs.

Jasmine Lai Ket's skills have made her the envy of several other corporations, and no less than eight extraction attempts have been made on her in the five years she has been working for EBM. Aside from being extremely intelligent, Jasmine is also extremely beautiful, and it has been hazarded that some of the extraction attempts have been motivated by more than just her research potentials. As a result, she is under discrete 24-hour guard by three rotating teams of crack EBM commandos.

INT 10, REF 5, TECH 10, COOL 8, ATTR 10, LUCK 6, MA 3, BODY 4, EMP 8/7

SKILLS: Jury rig 4, Wardrobe and Style 5, Social 5, Programmer 8, Education and General Knowledge 7, Expert Computer Engineer 5, Expert in AIs 9, English 6, Mathematics 5, Physics 4, Cybertech 2.

CYBERWARE: basic processor, interface plugs, chipware sockets, cybermodem and dataterm links.

William Joseph (Billy Joe) Brentwood- To most of the people he meets, Billy Joe Brentwood is the congenial, backslapping, loudmouthed executive in charge of the Dallas-based Petrochem's Night City office...spinner of good natured fish stories and tall tales of a rowdy youth in Texas. Those a little closer know the truth. Behind the high profile, free-spending exterior is a ruthless, ambitious executive who cares little whom he cuts down on his way to the top, as long as he doesn't besmirch his public image. Brentwood is rumored to have his fingers in many pies, including local and national politics. His lifestyle has made him no stranger to scandal. He is a favorite target of blackmailers and investigative reporters, but many of the people trying to coerce him, or expose his more shady side have turned up face down in the harbor, or have disappeared completely.

INT 8, REF 4, TECH 3, COOL 9, ATTR 5, LUCK 8, MA 5, BODY 9, EMP 9/5

SKILLS: Resources 7, Personal Grooming 3, Wardrobe and Style 6, Oratory 4, Human Perception 5, Social 5, Persuasion and Fast Talk 6, Education and General Knowledge 3, Handgun 4, Expert Executive 3, Gambling 4.

CYBERWARE: basic processor, Kerenzikov boosterware, interface plugs, chipware sockets, smartweapon link, Mr. Studd™, basic eye module with Times Square marquis, chrome cyberarm with popup 9mm smartgun (10 rds), basic cyberaudio with radiolink.

Fiona Hayes- Where one finds scandal, graft or corruption, one can also be fairly sure of finding Net 54 star Fiona Hayes. She's in the habit of turning up where she is most definitely unwanted, usually accompanied by a hand picked, seasoned camera crew and a battery of tough questions. Her investigations have uncovered political and corporate crime, scandal and conspiracy. Many a once-powerful person lives in jail or retired shame due to a Fiona Hayes investigation. Naturally, Fiona's journalistic exploits have made her a marked woman, and she sometimes lives like a fugitive for months at a time to avoid assassination by the targets of her investigations. She'll turn up only when her report is complete and her evidence solid, cornering her mark with a camera crew somewhere nice and public. Even if the only response is a "no-comment",

the report she logs is usually enough to snowball matters to their conclusion. Her current target is Billy Joe Brentwood, and don't think he doesn't know it.

INT9, REF 5, TECH 3, COOL 9, ATTR 8, LUCK 8, MA 5, BODY 7, EMP 10/8

SKILLS: Credibility 8, Personal Grooming 4, Wardrobe and Style 6, Oratory 4, Human Perception 7, Interview 5, Social 3, Persuasion and Fast Talk 4, Education and General Knowledge 4, Streetwise 5, Expert Journalism 5, Aikido 4(2), Pistol 1, Library Search 4.

CYBERWARE: shift-tacts, neural processor, chipware socket, interface plugs, basic eye module, image enhancement, Low Lite™, micro-video optic, basic hearing module, digital recording link, wide band radio scanner, sound editing, voice stress analyzer, phone splice, radio link.

Franklin M'bolu- As Orbital Air expands its exploration of the commercial possibilities of space, it relies on technology both developed in-house, and bought and licensed from corporations around the world. Much of the technology used by OA is purchased or contracted from U.S. corporations or U.S. subsidiaries of international corporations. Franklin M'bolu of Kenya is the hard bargaining man responsible for managing OA's contracts and purchases in the U.S. As such, M'bolu is responsible for shipping and itemizing large amounts of proprietary technology. He is rumored in some circles to supplement his income by dealing some of this technology and information on the black markets.

INT 7, REF 7, TECH 2, COOL 8, ATTR 4, LUCK 6, MA 8, BODY 10, EMP 6/5

SKILLS: Resources: 7, Wardrobe and Style 5, Leadership, 4, Accounting 6, Education and General Knowledge 2, Expert Black Marketeer 4, Persuasion and Fast Talk (Bargaining) 5, Stock Market 3, Boxing 4.

CYBERWARE: basic processor, Kerenzikov booster, chipware sockets, sunglass implants.



Corp Center Gangs

While gangs are regularly seen in the area surrounding the plaza, it's no one's turf. And while some wild gangs may actually enter the Center to do some damage, it is very unlikely that any of them will leave alive; so only the real nut cases try.

ENCOUNTERS

1. A very well protected corporate asks the party if they are interested in a very well-paying job. All they have to do is off a V.P. at Arasaka.
2. The center is so packed that traffic moves only at a crawl. And anyone moving on foot has a problem with moving faster than a slow jog.
3. Encounter a diplomat and his retinue. Nationality is random.
4. A high ranking corporate is on the move with her security team. If the players have easily detectable weapons there is a 50-50 chance that they will be stopped.
- 5-7. Other than the normal hussle and bustle nothing is going on.
8. An AV-4 has been flying overhead for a while now. Is it looking for someone?
9. A very high priced joy girl asks the party for protection. It seems she has some dirt on a high ranking corporate exec. And now he wants her silenced...
10. A small squad of corporate security (4 solos) stops the players for "routine" questioning.

CONTACTS

1. **Willie Maxwell**- A corporate "wage slave" who also happens to be one of the city's best netrunners. He works for the corporation to get Net time. If contacted he will help out as long as the current project is "legal".
2. **Clive Richards**- Clive works for a high class limo service. He has had many high powered passengers in the back of his car, and has heard more than his fair share of gossip.
3. **Lisa Parker**- One of the many "lunch-carriers" in the Corporate Center, who makes her living delivering lunches to corporate workers too busy to go out to eat. With her identity card she can get past the lobby security of any of the corps that "subscribe" to her service.
4. **Masters Hanson**- A security captain with one of the giant Corporations in the city. Masters is also a member of the Inquisitors.
5. **Mina Steward**- Mina is a secretary at one of the big corporations. She is also sleeping with her boss; an executive V.P. If she leaks any info (Ref's choice), and he finds out, she will need protection.

DATATERM DISPLAY SYSTEM | Topic: NCART Train Layout

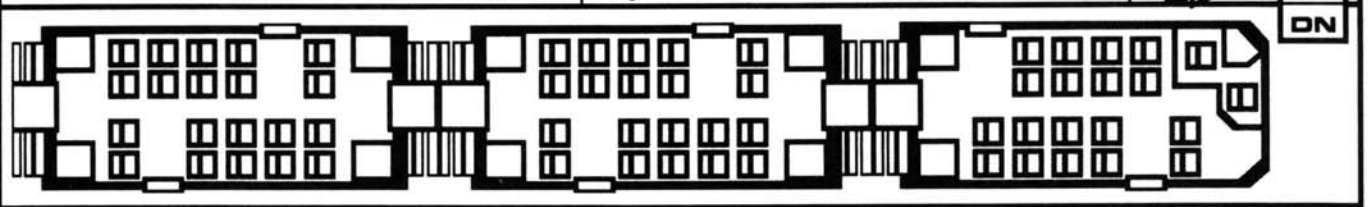

DATATERM WNS

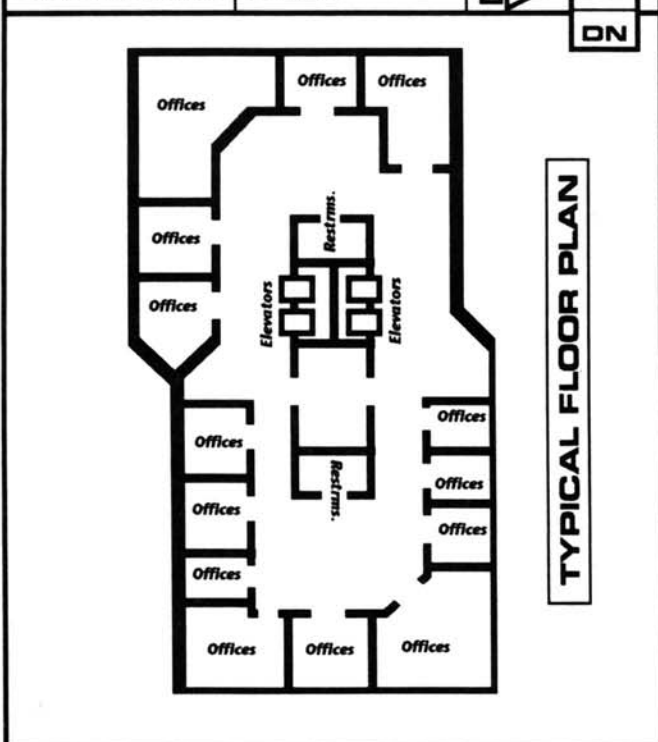

DATATERM Orbital Air

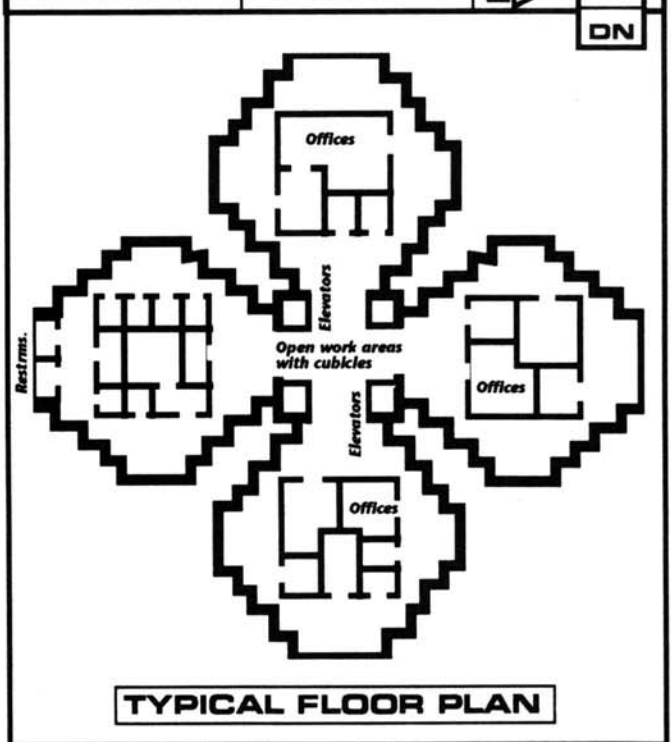

BANK BLOCK

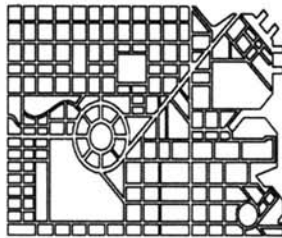

D A T A T E R M

The Bank Block is the financial heart of the City. For while it's true that the corporations run the city; they couldn't do it without the aid of the banks.

It has been said that if the corporate center is the "brain" that runs the city, then the Bank Block must be the "heart". It pumps the stuff that keeps the brain functioning: cash.

Befitting the "heart" of the City, the streets are always clean here, just as the corporations would have it. The Bank Block is a fitting testament to life in 2020: the world is a nice clean place as long as you have the cash to keep the scum away.

B3#1 1st CitiBank Tower:

This tower, the largest bank building in Night City, is the national and local head office for 1st CitiBank. 1st CitiBank is one of the largest American banks, and one of the few holding its own against European and Japanese competitors. The tower is a fairly standard looking affair, with a black granite and glass exterior, and the usual rooftop aircraft and subterranean vehicular facilities.

Inside, the bank is richly and stylishly appointed. Public access is limited to the parking lot and the teller and customer service areas on the ground floor. All other areas are strictly controlled. The vault is in the center of the second floor. Security is, naturally, extremely tight, with thirty uniformed officers patrolling the building 24 hours a day. The computer is also well protected against Net-trespassing. Nathan Robinson, the bank's CEO and founder, is a resident of the Parkview Tower. He travels the short distance to work every morning by helicopter from the residential tower's roof.

Security Level:3

B3#2 The Fujiwara Bank Building:

A typical, successful Japanese bank. The building is well secured at all times. Business is relatively heavy. The tower also contains Fujiwara Realty and Fujiwara Investment Inc.

offices. Customers are American, European and Japanese from all walks of life.

Security Level:2

B3#3 The Night City Stock Exchange and Trade Center Building: This building contains trading areas for all of the world's major securities, stock and commodities markets, as well as brokerage offices for several firms. Included for each market are computer marketing and telecommunications areas, which handle part of the business automatically, and trading pits where deals are made in the good, old-fashioned push-and-shove manner. Depending on the market or particular commodity, deals are either processed strictly through computer, or by humans in the pit. Proper identification is required to get to the electronic sales areas or the pits. The building is active 24 hours a day, as there is always a market open somewhere. Security at the exchange is provided by a detachment of city police. Computer security is *extremely* heavy, to prevent tampering with world markets.

Security Level:3

B3#4 The Militech Corporation:

This building is the Night City office of the prosperous, worldwide Militech corporation. The Night City building is relatively small, as it handles purely bureaucratic business. Security is provided by Militech corporate soldiers, and is very tight. See the *Megacorps 2020* section in *Cyberpunk 2020* for more information on Militech.

Security Level:3

B3#5 The West Plaza Executive Tower:

A typical executive office space building, home to several small companies and businesses. Law offices are prevalent, with the largest being the headquarters of the prestigious **Howard, Fine and Howard, Attorneys at Law**. Howard, Fine and Howard maintains a large staff of excellent legal and paralegal personnel, with experts in corporate law, international law, space law, entertainment law, warfare and military justice, and federal and local law. They are the best, but they are expensive. Their clients include celebrities, heads of state, politicians, small nations, the filthy-rich, and so on. As one might expect, security around their part of the building is stiff. Appointments are required.

Security Level:2

B3#6 The Federal Building:

This building was built before California became a Free State. The federal government still maintains a small presence in Night City, mostly as an Embassy or Consul.

Security Level:1

B3#7 The Japanese Consulate:

This is the largest consular building in Night City. It houses not only the consulate proper, but also the main American office of the Japanese trade ministry, which oversees all

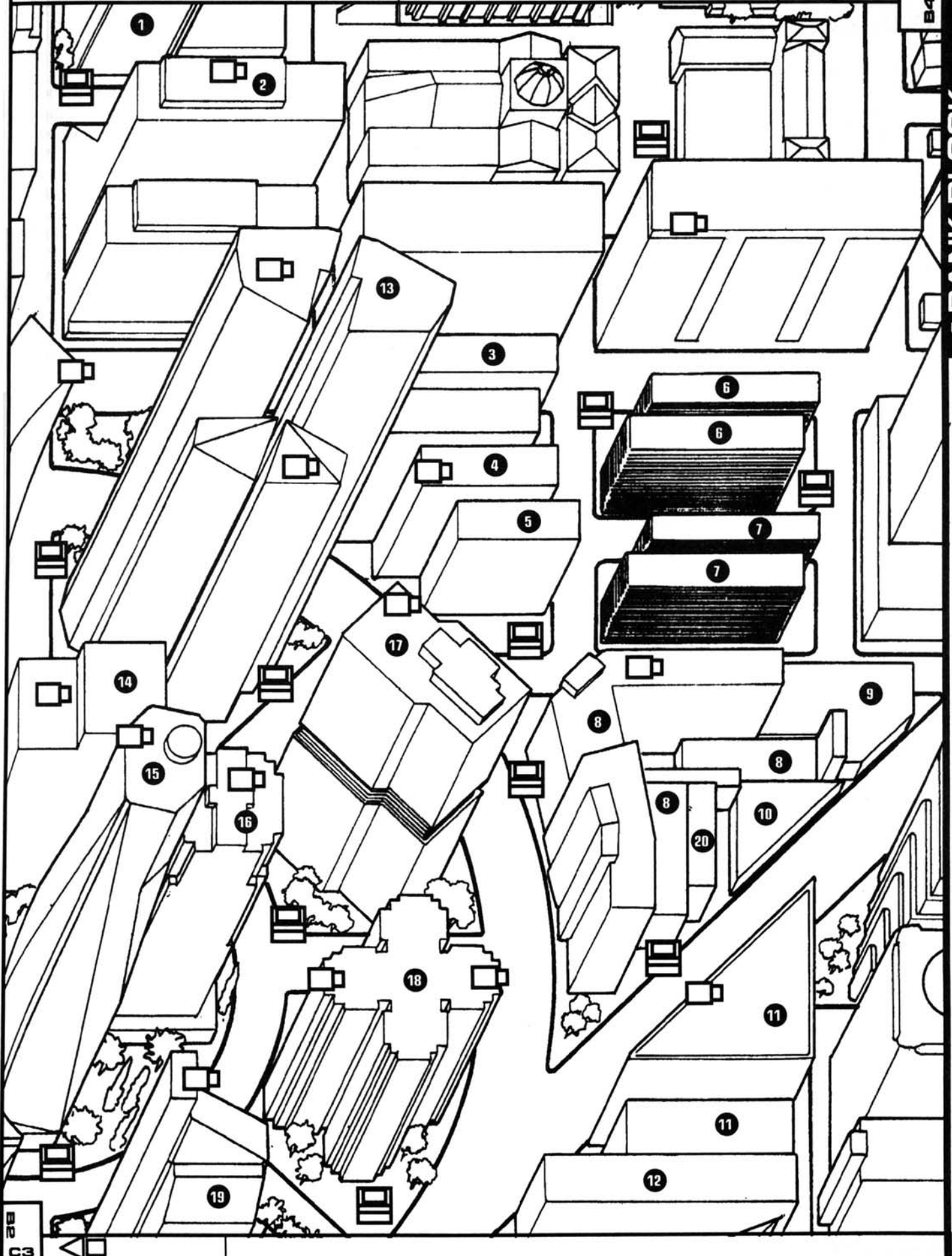

BANK BLOCK

matters of import and export to and from the United States. All personnel, including a security detachment of 100 diplomatic police, live in apartments in the consulate. The living quarters of the higher ranking officials are quite lavish, and security is tight throughout. Naturally, the Japanese consulate offers the same services as its smaller counterparts on the opposite side of the plaza. It also serves as a way-station for travelling Japanese politicians, plus Japanese solos and businessmen who, for some reason or another, feel insecure outside of a diplomatically protected environment.

The consul-general, Juzo Inoue, is samurai businessman through and through. He has a long standing reputation as a tough, wily and inscrutable man. Unlike most Japanese government officials, he was not a career politician, but made his name in business. His days as the ruthless director of an industrial combine earned him many enemies at home and abroad. He is under constant guard by loyal retainers, and rarely leaves the compound. Claims of *yakuza* and Arasaka connections have never been substantiated.

Security Level:2

B3#8 The Ashcroft Hotel:

This is Night City's largest, most expensive, and most exclusive hotel. It is run by the wealthy Ashcroft-Hammersmith family from England, and favored by wealthy European corporates, tourists, celebrities and solos. The hotel is the ultimate in luxury and service; rooms and suites renting from 300 to 5000 eurodollars per night. There are several fine restaurants and expensive shops in the hotel, as well. Security is provided by plainclothes operatives contracted from Dieter-Kauffman AG, one of the finest German security firms, and is guaranteed in writing. Reservations are a necessity. The on-site representative of the family, and manager of the hotel is Winifred Ashcroft-Hammersmith. As she is reclusive and eccentric, her daughter Julia does much of the actual work.

Security Level:3

B3#9 Ashcroft and Hammersmith, Ltd.:

A large, extremely expensive store connected to the hotel, and dealing in fine clothes, luxury items, personal security items, and so on.

Security Level:3

B3#10 Plaza Medical Services:

The only part of this block not owned by the Ashcroft-Hammersmith combine, this building has a private doctor's office and surgery ward, private dental and cybernetic services, and private body customization shop. It is tolerated in its proximity to the hotel because the services are expensive and top of the line, and the clientele is largely rich and powerful. No credit accepted.

Security Level:2

B3#11 The Night City Medical Center:

This is the closest thing Night City has to a medical school and research hospital. While not in the business of accepting charity cases, this hospital does treat patients who subscribe to most of the available health insurance plans, and it accepts emergency and Trauma Team cases. It offers these services because it is Night City's largest hospital, and because it is also annexed to Night City's most prestigious medical research school. Security throughout most of the hospital is reasonably light, with notably strict areas confined to the VIP wards, emergency room, and the biomedical research areas. There is an armed security team on call at all times. Hot areas of research at the medical school are bioengineered enhancement and augmentation, and biological nanotechnology (biological computers, memory systems, and biological/cytological micro-robotics).

Security Level:2

B3#12 Night City Technical College:

This is a typical, urban technical college, of the variety that advertises itself on late-night video. Here, the aspiring student can earn a valuable associate degree in computer tech or programming, secretarial services, security and law enforcement, basic cybertech, auto or aircraft repair, emergency medical technician certification, professional game design, and so on.

Security Level:1

B3#20 Safe Child:

Established in 2019 for the upscale Corpzoner parent, Safe Child provides EuroTheatre-trained nannies and on-site child psychotechs for an exciting play environment in a secure setting (24 hour Arasaka Security with on call Tactical Squad support). High quality pre-pack food is usually served, and fresh food is available at slightly higher fees, making this a particularly unique and healthy daycare alternative.

Security Level:2

PERSONALITIES

Yarakimi(Kimi) Inoue- The daughter of the Japanese consul general for Night City, Yarakimi is a regular on the Night City club scene. She has a horrible reputation for getting into all sorts of trouble, usually ending up with Daddy hiring an Arasaka security team to get her out of it. She is never without an attractive male escort, usually a rockerboy.

Although only seventeen, Yarakimi has a list of old lovers as long as your arm, and while daddy has threatened time and again to send her back to Japan, she never settles down. On paper, she should be attending NCU, but her class work is usually ignored. She is beautiful and spoiled, and very used to getting her own way. Once attached to an available man, she pledges her undying love for him (until someone better comes along).

INT 6, REF 7, TECH 3, COOL 8, ATTR 10, LUCK 7, MA 4, BODY 6, EMP 6

SKILLS: Dance 8, Wardrobe & Style 8, Personal Grooming 7, Seduction 6, Driving 2, Forgery 4, Social 1

CYBERWARE: None

ENCOUNTERS

1. A Network 54 Av-4 is parked outside the Medical Center. Could there be a famous patient inside?
2. A very stupid gang is trying to spraypaint their names on the Stock Exchange. Better get out of there before the cops mow anyone down between them and the gang.
- 3-6. Other than the average suits, nothing unusual.
7. Car accident evolves into a fire. Three minutes to get in some target practice before the cops arrive.
8. A fender bender. Traffic stopped for 20 minutes. Hope you don't have to be somewhere.
9. A corporate security team making a sweep of the streets,

50-50 chance the players will be hassled.

10. A hit. The players are standing near a corporate when bullets start flying. There is only one assassin, and the corporate will owe you a favor if you save his neck.

CONTACTS

Tina Allen- A night clerk at the Ashcroft Hotel. It is her job to keep track of the comings and goings at night.
Alvin Hart- an orderly at Night City General. He is a very useful person to know if you need to find medical records.

Lucinda Hatherford- A well-paid netrunner on the Stock Exchange. She claims to know the System better than anyone else alive, even Rache Bartmoss.

Kaminia Kanzaki- A maid at the Japanese consul. She has the ear of the consul-general and can sometimes sway his opinion.

Walt Williams- A famous novelist staying at the Ashcroft. He is working on an exposé of one of the Corporations, and may need to hire a bodyguard.

DATATERM DISPLAY SYSTEM Topic: Overview Maps

UP

DN

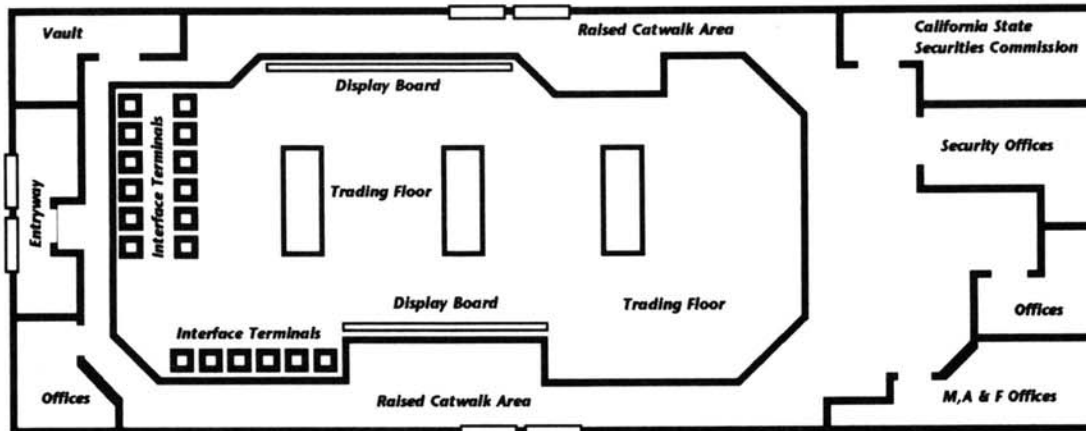

Night City Stock Exchange Trading Floor

Night City Medical Center

Treatment Floors

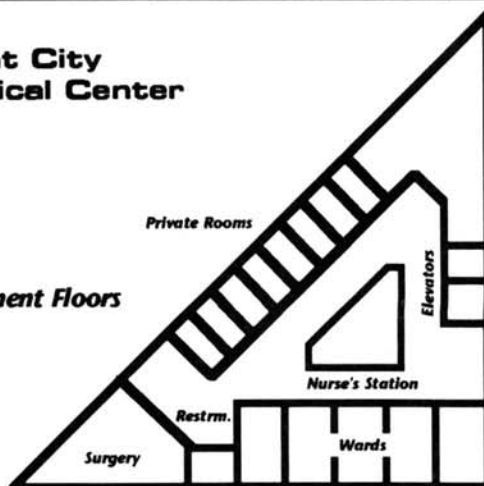

Lobby/Reception

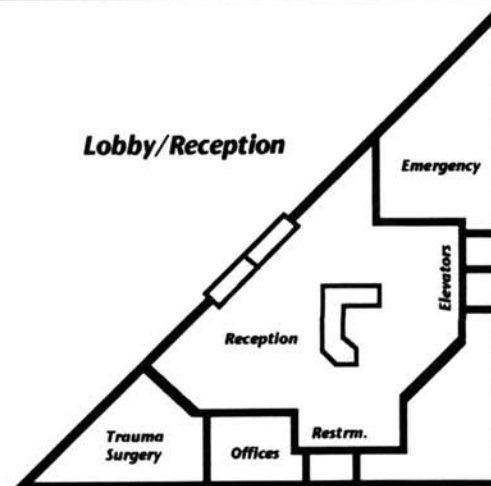

MED CENTER

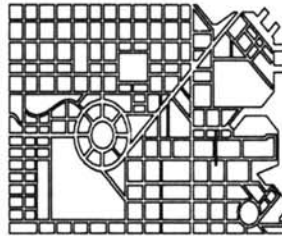

D A T A T E R M

This section of town is known as the Medical Center, thanks to the concentration of health-oriented businesses found here. This area is one most crowded in the city. Filled with offices, the two-building Convention Center, the Transit Center, Crisis Medical Center, etc., the human traffic in this area is of such a volume that the city has started constructing a vast skyway which will interlink this block and the rest of the city to allow a greater volume of traffic.

This upscale environment was designed right from the start; the first zoning ordinances gave special consideration to Trauma Team and Crisis Medical, among others. This has also kept this area of town clean even through the worst years, as the security around here is tight. Lately, though, with the development of the Transit Center and the labor troubles at the Post Office, concern has been voiced that even this area will begin to fall to the gangs. Alarmed by this possibility, and seeing what has been happening to Medical Block, security has been redoubled.

B4#1 Municipal Criminal Justice Complex:

Towering over most of the city's buildings, the dark blue mirrored glass of this Corporate-funded monolith perfectly complements the cold, clean look PR officials desire for the local judicial system. Inside its grand tower and subterranean passages is one of the most efficient examples of the modern justice system at work. Housed here you will find the Night City Police Precinct #1, the city arraignment courts, jail cells, braindance rehabilitation areas, a police academy, and simulators for the officers, as well as the normal offices, file rooms, and vehicle and weapons training and maintenance areas required by a police force.

Regular visitors (both workers and inmates) call this edifice 'The Muckjuck' (from MuCJuC), but this does not belittle its

impressiveness in anyone's eyes. Sort of like joking about A-bombs.

Security Level:4

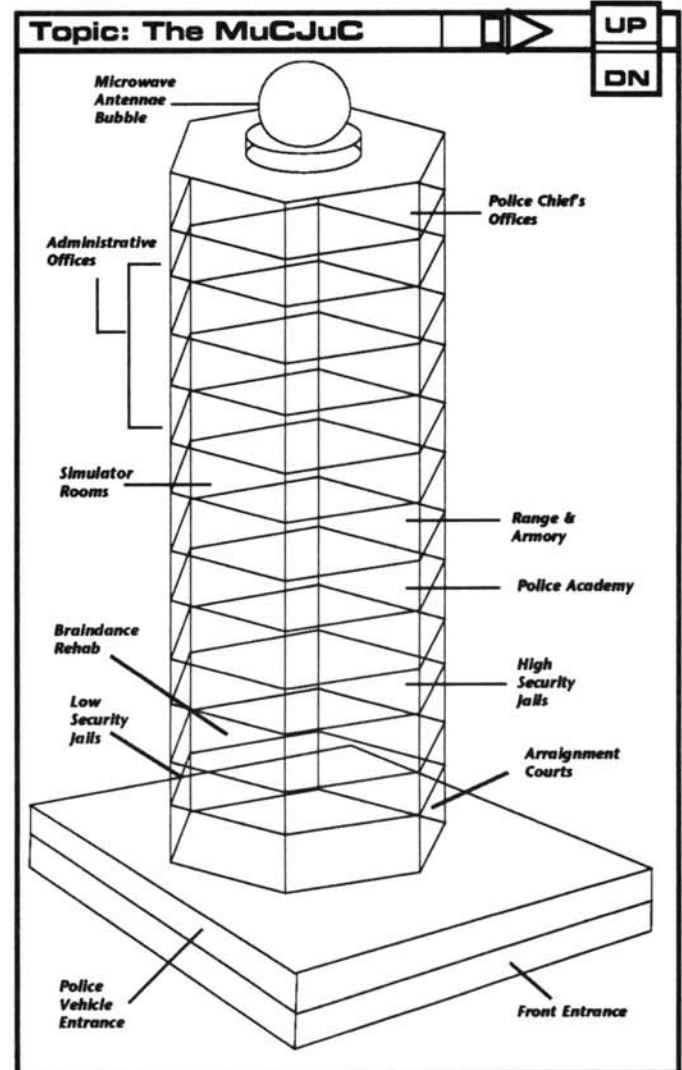

B4#2 Eurasiabank Plaza:

This corporate office structure contains the North American headquarters of this financial institution. With direct lines to all of the world's stock exchanges and brokerage houses, these offices control much of the money that is processed in the Western Hemisphere. Although it is not widely known, the United States Federal Reserve has heavily invested in the European commodities market through this bank, in order to help the economy recover from the isolationist years. This knowledge is, of course, sealed under secrecy agreements.

Security Level:3

B4#3 The Post Office

Although the main means of communication in the 21st century are electronic (dataterms, faxmail), or by courier

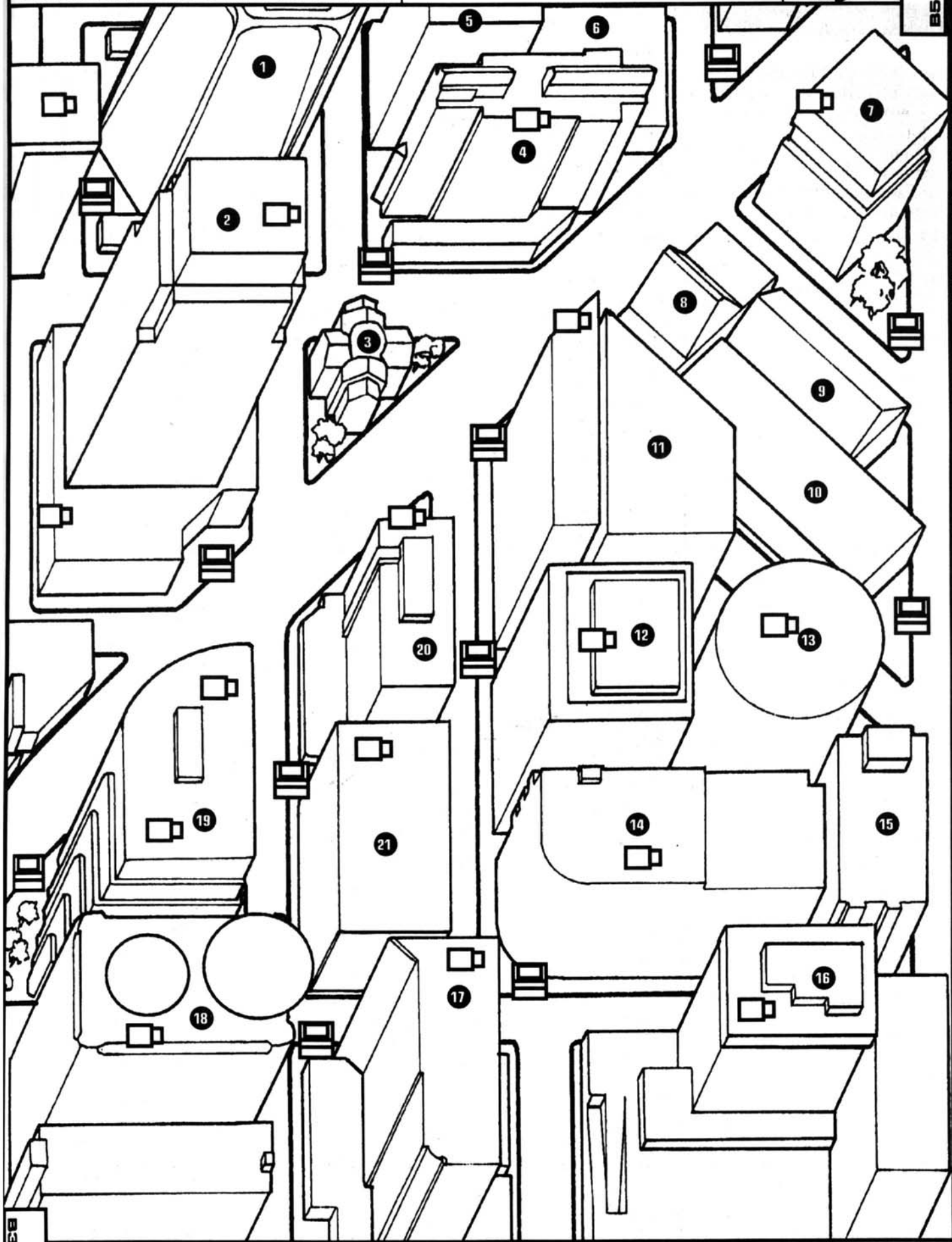

services (United Express, etc.) there are still limited holdouts who feel a letter isn't a letter unless it has a Class F stamp on it. Thus, even in 2020, there's a Post Office.

But not the *United States Postal Service*. With the Collapse, most services of the United States Government were eliminated or drastically reduced. One of the first to go was the U.S. Mail. With its antiquated delivery vans and dark-ages computer tracking, the old monopoly was no match for a host of smaller, more sophisticated private organizations. As a result, most mail services throughout the U.S. are now provided by these private service vendors.

Night City's postal service is provided by the largest mail delivery corporation in the country, **Federal Express Mail Service** (a wholly-owned subsidiary of the Federal Express shipping giant). FEMS' bright blue mail kiosks can be found on street corners throughout the City (65% chance). Stamps (.95eb) and envelopes, as well as other shipping supplies, are dispensed by vending machines on top of the mail drop box. Deliveries are at 10.00 am and 3.00 pm, with pickups at 12.00 pm and 6.00pm.

This building houses the central clearing house and dispatchers area for FEMS' fleet of delivery AV's. The actual AV's are stored on pads throughout the city, and follow daily routes that pass through this main terminal.

Security Level:1

B4#4 The Central:

This hotel is definitely luxury, but has none of the bells and whistles of most other lodgings. The furnishings are excellent, the rooms spacious, and the price high, but beyond that, everything is strictly utilitarian. No tassled drapes, no gold-plated swan-shaped faucets... no vanities or fetishes will be accommodated here. There is, of course a huge waiting list, made up primarily of professionals who don't want distractions.

Security Level:2

B4#5 The MacMillan Building:

This office complex is known as "Shrink Tower" to much of the city because of the large number of psychologists/psychiatrists who populate this building. There are also several doctors whose private practices specialize in "white collar" injuries. Occasionally a real nut case is brought in to help one of the tenants research a thesis. They don't get loose... at least not often.

Security Level:2

B4#6 The Grand Illusion:

The Grand Illusion is one of the hottest rock clubs on the West Coast. Known for its three bars and hot dance floor, many 'big name' artists got their start in this club and pay homage to it by appearing under assumed names.

Unbeknownst to most, Johnny Silverhand and Kerry Eurodyne bought the club in 2012. They did not announce it publicly. Driven by memories and using their influence, they have begun an open mike night on Thursdays which is regularly attended by an executive of Universal Records, the label under which both men record.

The Grand Illusion exists for one purpose only: Music. While patrons are encouraged to party, the security here is very strict. All weapons must be checked at the door, and everyone is scanned. When leaving, patrons have their weapons returned, even if they are illegal. It's all a part of the trust that the club uses to get cyberpunks to part with their weapons. The ex-*Samurai* bandmen are working their way towards the dream of a nonviolent future.

Security Level:1

B4#7 Bay Bridge Residential Hotel:

The majority of this building is occupied by a residential hotel unit, where visitors can rent fully functional apartments by the week or month. The standard of furnishings is excellent, though by no means opulent. The security is decent, although most tenants bring along a few extra gadgets.

Half of the lobby is occupied by **Mark 24**, a major-chain convenience store, open 24 hours. Ammo can be bought here if you know the right passwords (few people do).

There is also an express elevator to the **Night Owl**, the bar located on top of the building. This bar is one of the only bars in the city which never closes. The crowd it attracts is of the no-nonsense, mind-your-own-business type. No dancing, quiet music, pool tables, light meals, that sort of thing. Besides its never-ending business hours, the Night Owl is also one of the few places in the city where you can still obtain real(!) beer, and they carry over one thousand in stock (or on special order if you become a regular at the bar).

Security Level:1

B4#8 The Afterlife:

This converted mortuary has three different areas, "The Antechamber," "The Crypt," and "Hades", which are all inhabited by hard-drinking, hard-fighting solos who come here to enjoy the atmosphere and the camaraderie. As one delves deeper into the Afterlife, each successive chamber becomes darker and more dangerous, with Hades being filled with the combat veterans who hire out for the highest prices.

The Afterlife might best be described as a cross between a country-western bar and a motorcycle guild hall. The sound system plays a variety of martial music and gothic rock, and the closest thing to dancing is the occasional brawl. But this is a pro's club, no one needs to prove themselves; their presence here is proof enough. Any brawls are strictly for fun; no one wants to smear each other, but they do play hard.

Although many people come to the Afterlife to hire solos, a larger proportion post messages on a marquee which circulates proposals throughout the bar. Those who do enter the bar do so at their own risk, and have paid the price in the past.
Security Level:1

B4#9 Amerline Depot:

This is the central nervous system of Ameriline (a national system of heavily armed charter busses). The Airport Shuttle also uses this depot as a base of operations in Night City.

Not wishing the terminal to become the stereotypical home of drug addicts and prostitutes, Ameriline hired a private security force to maintain the area and keep it free of "undesirables." Despite these efforts, there has been a resurgence of crime (due to a contract dispute with the bus line's contract security).

Security Level:1

B4#10 Garage:

This is where the buses load and unload. It's a simple concrete slab with a steel raincover overhead. The northwest end contains garage and maintenance facilities. This is where most of the illegal activity occurs.

Security Level:0

B4#11 The Night City Convention Center:

Known as NC³, the Center is used by organizations who wish to hold their business gatherings on the Central Coast. Renowned for its vast auditoriums and halls (to say nothing of its bar and restaurant) the Center is consistently booked full with conventions ranging from the Grand Order of Opossums to the West Coast Gun Show to the World Book Association's annual display of up and coming (i.e., media-hyped) authors.

Security Level:2

B4#12 Trauma Team Tower:

This building houses the main corporate offices as well as the local operations center for Trauma Team, Inc. The operations center contains a dispatch office, armory, maintenance yard, supply depot and launch area for the many AV's used by the Patient Retrieval Teams™.

Security Level:3

B4#13 Barbican Building:

This black edifice contains the main offices of **Argus Inc.**, a company specializing in netrunner software. Argus, which is owned by Livewire (see *Cyberpunk 2020*, pg. 212), has been focusing lately on developing applications for the many local medical facilities. Well regarded among the netrunner community, Argus programs are considered to be some of the most reliable commercial products on the market.

The **Short Circuit** is a bar set on top of the Argus offices. Favored by many of the city's netrunners and techies, it is

highly useful for people looking for help in those areas. The bar's other interesting feature is its rotating floor, which allows patrons to see a panoramic view of the City below. Although there has been a lot of corporate interest in the bar, Livewire has forbidden recruiting there because he's had problems with corporations and no longer trusts them (or the people who associate with them).

Rough, street-hired bouncers make sure no one exceeds the dress code. In addition to normal booths, there are booths with interface jacks which allow netrunners access to an area in Netspace where the bar is represented. Whether online or not, many netrunners use the bar as a gathering place to exchange news and services.

Security Level:2

B4#14 Crisis Medical Center:

This hospital has one of the most advanced modern-day Trauma Centers in the world. Many of the surgeons employed at the Center have combat surgery experience from any one of the Central American conflicts and are very efficient at quickly repairing any damage done to the body, though the repair may not necessarily be "pretty". Although work is done here without questions, many of the critical cases are only transferred to the City Medical Center if their insurance will cover the extended care.

Security Level:1

B4#15 The Jellicol Inn:

This is another hotel catering to business travelers in town attending various conventions. Although the accommodations are somewhat spartan, many business people enjoy staying at this theme inn, which requires that all personnel attire themselves as cats. This seemingly stupid idea is successful as many travellers appreciate any diversion from the normally oppressive atmosphere in which they work. Although constantly booked, the hotel keeps one wing of rooms open (at inflated rates) to those people whose relatives are hospitalized in the nearby medical centers.

Security Level:1

B4#16 Medical Technologies:

This corporation is dedicated to the replacement of body parts. The main building is dedicated to replacement meat: artificial growth of new, and the storage of "donated" body parts. The second (eastern) building is a new addition to the Medical Technologies Corporation, and holds a new cybernetic research and development group. An underground tunnel runs between the main building and Crisis Medical center. There is also a landing pad for ambulances on top of the main building.

Security Level:1

B4#17 Uniform Group Health Building:

A local HMO occupies the majority of this building. Most

NIGHT CITY

SECTION B4

local corporations have contracts here. The top ten floors of this building are leased to small businesses, mostly specialist practitioners. The local Arasaka office provides security in exchange for health care benefits.

Security Level:2

B4#18 WorldSat Communications Center:

This building is more than just a corporate office building, it's also the heart of communications for many international corporations. In addition to the vast cellular network which they control, the executives of this corporation also have interests in the L-5 stations, where they provide some of the communications satellites linking them to both the Terran and Lunar communities. Every so often, some paranoid in the Corporate Center accuses WorldSat of beaming microwaves at their offices.

Security Level:3

B4#19 Hotel Hamilton:

This modern hotel is very popular with visiting business executives due to the design and security of the building. Although it has some smaller rooms, most are two or three room suites, with full entertainment centers, miniature dataterms and business centers. There are also several convention areas for limited interest meetings.

Security Level:2

B4#20 U(F)C Health Sciences Center:

This is a branch of the University of Free California Medical School, where med students go for their two years of schooling. Some internship is done here, as well. The one-story block that juts out from the west side of the building contains a 24-hour emergency clinic run by the students and interns. They do just fine on stab wounds, broken bones, and gunshots, but the serious cases are referred to Crisis Medical. They will not turn anyone away (they want the practice), but if someone can't pay the fee, the practitioners will cut back on expensive supplies like, say, anaesthetic. At four in the morning, this place is often packed with screaming boosters getting amputations and the like. It's not uncommon to get additional injuries here, especially when a wounded chromer thinks he's been waiting in line too long.

Security Level:1

B4#21 Madre María Children's Hospital:

This building specializes in obstetrics and pediatrics, although gynecology is also practiced. Surprisingly, this hospital is one of the leaders in natural childbirth.

Security Level:1

PERSONALITIES

Ares- Ares is the living example of a man who has been through Hell and come back to tell about it. With an extensive military background, he surfaced in Night City years ago as a high priced solo. In 2010, after a particularly difficult mission

which drove him over the edge, he opted for body plating, which in turn ripped away any vestige of humanity remaining. After several well publicized "weeks of terror" Ares was captured alive by the police in a spectacular firefight which cost the lives of over thirty police officers and civilians. Although vehemently protested against by both police and public, and only after much personality reconditioning, Ares was put in charge of the Night City Cyberpsycho (or 'borg) Squad. His daring tactics and actions have earned him much notoriety, and his face appears almost nightly across many of the city's screamsheets.

INT 6, REF 10, TECH 7, COOL 9, ATTR 7, LUCK 5, MA 8, BODY 10, EMP 3

SKILLS: Combat Sense 8, Strength Feat 5, Interrogation 8, Intimidate 9, Resist Torture 5, Education 3, Drive 3, Handgun 10, Melee 10, Rifle 6, SMG 7, Combat Leadership 7, Dodge 6, Demolitions 5, Expert (combat tactics) 7

CYBERNETICS: Full body plating, Cyberarm with BigRipp (see *Interface*, vol. 1) Cyberaudio w/ampl. hearing, Phone Link, Radio Splice. Cybereye w/IR, Anti Dazzle.



Jack Masters (shot via cybercam) June 4th, 2019

Jack Masters - Although he looks like a drugged-out has-been 'dorpher, forty year-old Masters is actually president of Universal Recording. Most people in the recording industry think he's loco in his method of discovering new bands: getting drunk and partying with the crowd while the band plays. However, this method has netted him seven of the last ten "mega-groups" of the decade, so his opinions, though eccentric, are well respected.

INT 9, REF 4, TECH 6, COOL 7, ATTR 7, LUCK 9, MA 4, BODY 6, EMP 8

SKILLS: Wardrobe & Style 4, Oratory 7, Streetwise 4,

Human Perception 6, Fast Talk 4, Notice 7, Education 7, Expert (Music Trends) 9, Brawling 2, System Know (Music Biz)10

CYBERWARE: Cyberaudio with amplified hearing.

ENCOUNTERS

1. Hassled by some streetdregs from the Depot.
2. A solo, possibly just from a cyborging operation or from a bad day at The Afterlife, is living a little too close the The Edge. But you probably don't notice before you offend him.
3. Police escorting a notorious felon to the Muckjuck.
4. Pickpocket, con man, or purse snatcher. But such a nice boy.
5. Gang of rowdies headed for The Grand Illusion. Maybe the players are the type they rock against.
6. A solo of some interest to the party, heading to the Afterlife.
7. Undesirables heading to or from the Bus Station, looking for easy prey.
8. Drunken conventioners (aka 'easy prey') figure you've "got the goods."

9. NCPD undercover cop propositions you. Vice, Narc, who knows?

10. A firefight involving corporate security and a perceived threat. Could be anything, given the way these corporate torpedoes behave.

CONTACTS

1. **Allen Cooper**- Works at the Afterlife, is a usual contact for solo's looking for work.
2. **Evie Lark**- A waitress at the Grand Illusion, she is also an undercover agent for the NCPD, working on breaking Arasaka control over a local gang. It's a very dangerous assignment, and she may need help in the near future.
3. **Edgar Hall**- Works as an intern at the UFCLA Med. Center, he keeps a close watch on the commings and goings of patients.
4. **"Eunice"**- A joy girl working the bus station. She is a wealth of street information about the area.
5. **Richard Wilson**- Desk Sergeant at the Muckjuck, he has a 15 year knowledge of the Night City criminal system.

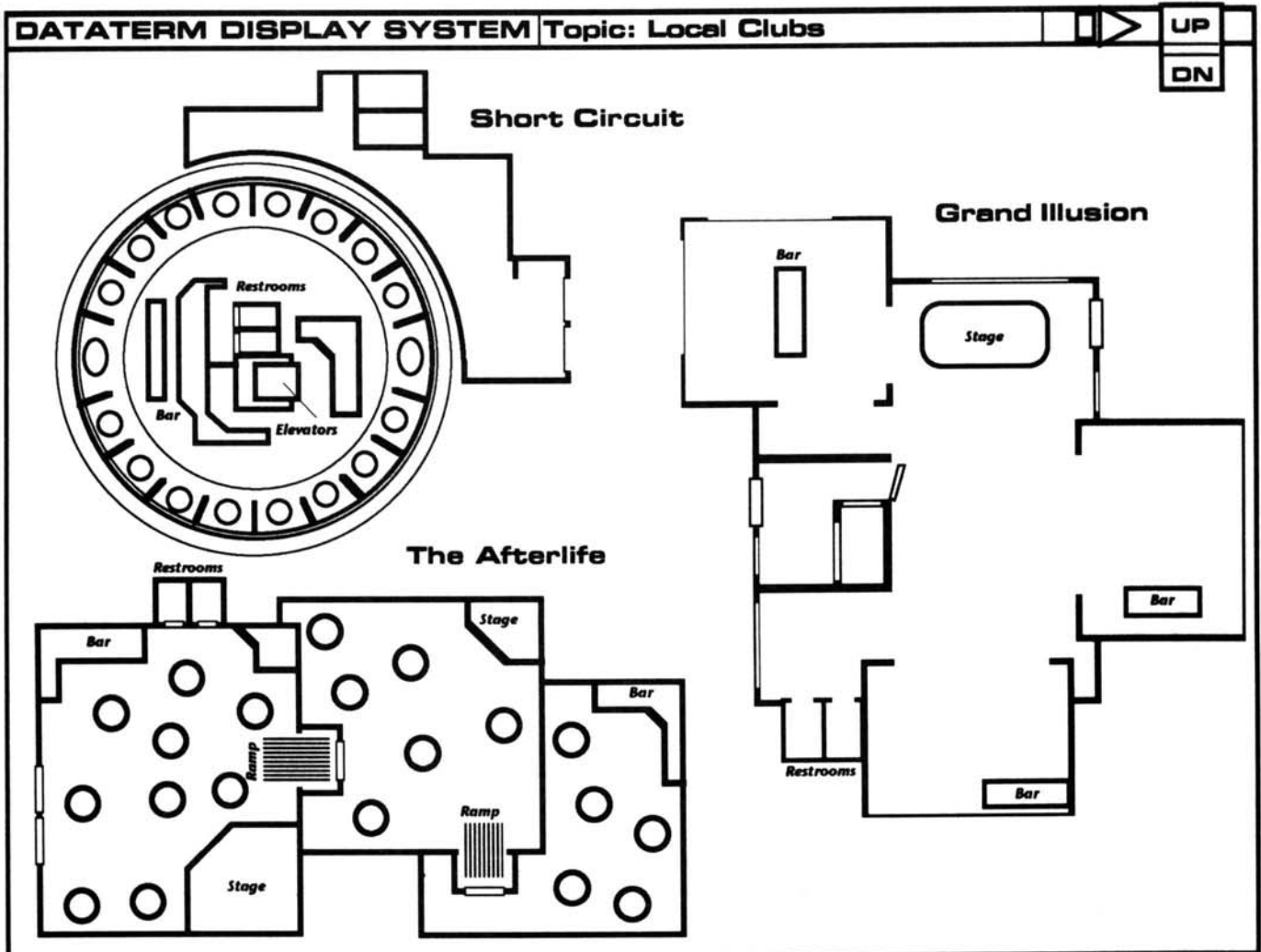

OLD DOWN- TOWN

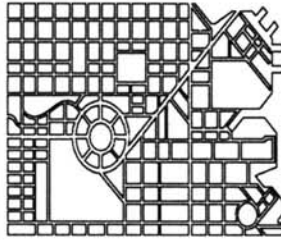

D A T A T E R M

Originally the center of the township of Del Coronado, the Old Downtown area has since fallen to urban decay. Only the solid presence of City Medical has prevented this area from turning into a slum. Gangs are common, and night time is dangerous, especially when the Rangers are playing a home game.

There's no real identity to this area. It's kinda close to Charter Hill, it's at the fringes of the Medical Center, and it's kind of near the Bridge. It's not really anything except dominated by the stadium, and the term 'Old Downtown' isn't used anymore. The urban struggle is starting to escalate here, as the gradual decrepitation has reached City Medical and the Municipal Building.

Expect to see a lot more shooting here in the next few months.

B5#1 Hari Kiri Sushi Bar:

This expensive sushi bar imports only the highest quality fish from around the world. Reservations *with orders* must be made a week in advance, so the fish you are served will be fresh (often mere hours old to ensure quality). The service is discrete but excellent, and has garnered the highest honors from reviewers throughout the world. There is a modest security force on hand, due to the number of boosters who want to "get some sushi and not pay." There are those who think the establishment's name implies they'll serve you misprepared pufferfish if you cause trouble. Although there have been several questionable characters who have died in the last few years, nothing has ever been proven.

Security Level:1

B5#2 Camden Court:

These high-priced apartments are favored by solos, and the price reflects the amount of security in the complex. With two online netrunners, reinforced guard posts replete with miniguns and enough sensory equipment to build a supercomputer, the solos who live here feel they can "relax," and usually will carry only one or two small weapons while visiting others in the complex. The security force are all tenants, and as up-and-

coming solos, they have a great stake in keeping the area secure (which has resulted in some unfortunate "accidents" involving saki-sloshed patrons from next door). Because of the number of ranking police officers who live in this complex, incident reports are covered up very quickly.

Security Level:3

B5#3 REO Meatwagon:

These three annexed and partially renovated buildings house the Night City rival of Trauma Team, Inc. Although they have extensive clientele of their own (mostly at the lower end of the economic scale: to wit, the gangs), REO is infamous for ambushing Trauma Teams on their way to pick up clients. This action, known as "meat jumping," though illegal, is extremely difficult to prove in court, and increasing numbers of incidents have begun an escalation in violence between the two companies. The main offices of REO Meatwagon are similar to those of Trauma Team in that they house the entire operation within one building. Due to the increased threat, REO Meatwagon has started to hire extra solos to protect the grounds in case of direct action by Trauma Team. There are also usually quite a few gangers hanging out around here, who will be only too glad to join a fracas.

Security Level:2

B5#4 Ranger Sports:

Named for the local football team, Ranger Sports provides sporting goods, martial arts supplies, fan paraphernalia, and tickets for the various sporting events in the area. Tickets for other events (music, art, etc.) can also be purchased here, but don't expect the counter help to be knowledgeable. They also sell liquor on the side, especially when there's an event in the stadium. The NCPD has yet to catch them in the act.

Security Level:1

B5#5 Tong Laundrys (sic):

This laundry service provides linen and uniforms to most of the local hospitals and security firms. This is an old building, mostly boarded up, usually too hot, and well, 'fragrant' for most people's tastes. They don't care what goes on right outside their doors, so punks roughhouse on the fire escapes or on the roof. One area gang (Maelstrom) is notorious for 'laundering' miscreants; a discipline applied by throwing them off the roof.

Security Level:0

B5#6 Savannah Medical Supply Warehouse:

This freight warehouse is the processing center for most medical supplies which pass into Night City. Early in 2013, REO Meatwagon tried to forcibly prevent Trauma Team from receiving supplies, but this blockade was thwarted by city police who were called in after a shipment to Crisis Medical Center was mistakenly waylaid.

Being a building full of drugs is not a way to ensure a crime-free existence in Night City, which is why every window is solidly bricked up, and the rooftop door is welded shut. It is an ugly,

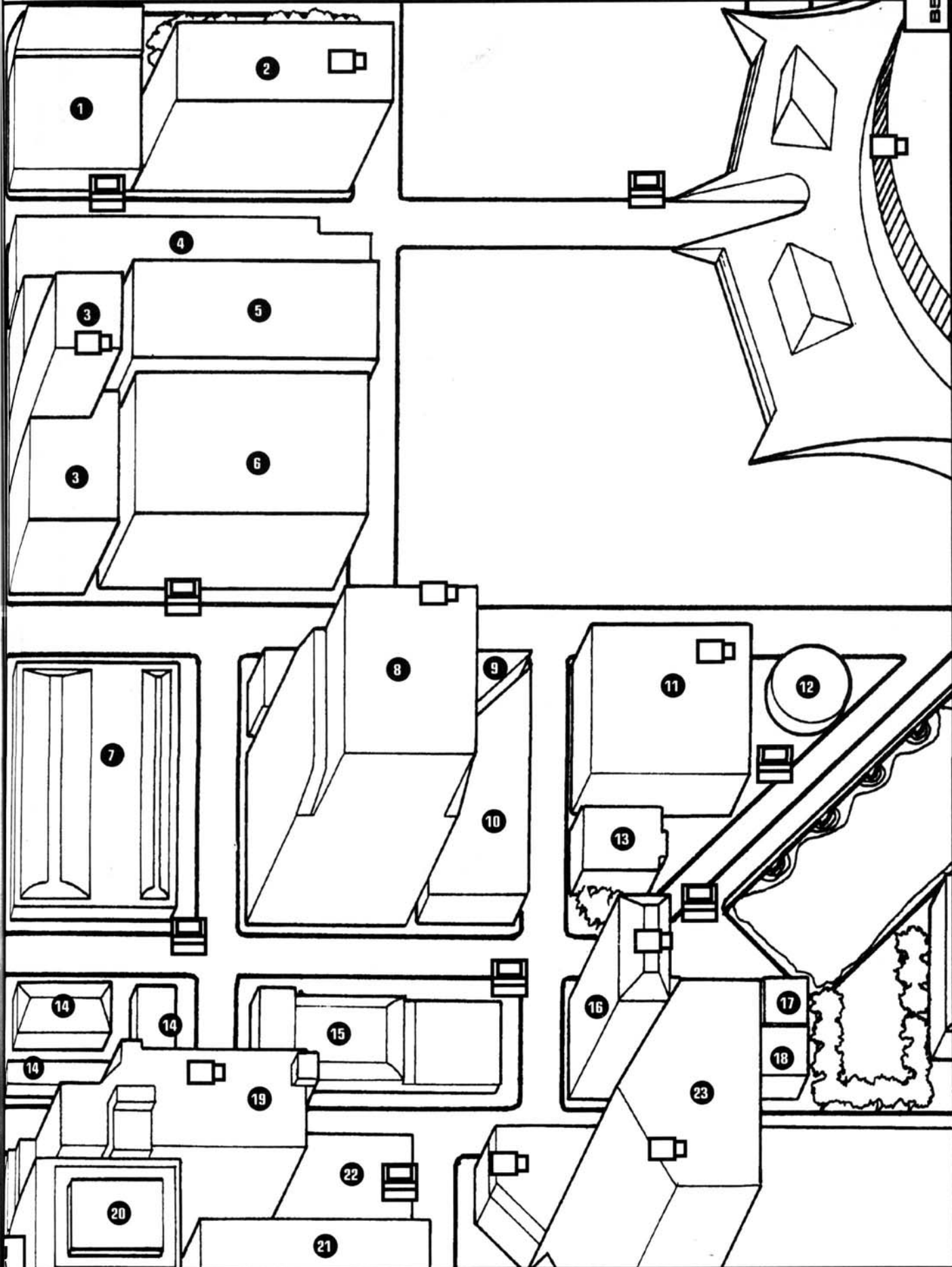



dirty building, covered with drug graffiti. Punks abound on the roof here, as well; 'alley-jumping' from building to building on this block is a popular recreation.

A renegade ripperdoc, Dr. Bob, has his offices and operating room in the basement of the warehouse. He was granted permission to use this area after arranging for some "enhancements" for the owner's son.

Security Level:1

B5#7 Rose, Dahlia, & Flora's Creations:

This is a large and well-stocked greenhouse and flower shop. The greenhouses are in the interior, well-protected against vandals. Not so the exterior. Graffiti is starting to cover these walls, too. RD&F has most every exotic plant known. It is owned & operated by a trio of elderly women who will argue among themselves for hours about your floral arrangement if you let them. But boy, can they deliver. If you really need to impress a date, come here. Just ignore the trash the boosters will throw at you.

Security Level:0

B5#8 Meadowcreek Pines:

If the name isn't enough to get you to avoid this low rent apartment complex, the design will be. It has very little security, poorly lit interior hallways, and few amenities in the apartments.

Some residents are just a step above streetscum, but most of these families are blue collar workers. Everyone keeps what few valuables they have in their apartments, a fact well recognized by the boostergangs which plague the area. Shootings here are common. There is also a small and cheesy country-western bar on the ground floor.

Security Level:0

B5#9 Golden State Pawn:

Formerly the site of a respectable department store, this dive is filled with every fenceable item known to man. One guess how it gets here. Clothes, jewelry, guns, CDs, books, programs, it's all on the inventory. You've just got to find it.

Security Level:1

B5#10 Guevarra's:

This Mexican restaurant is owned and operated by two ex-CIA agents. Unbeknownst to most, the two have also set up a weapons smuggling network which operates out of the back alley. It is from here that many of the fixers in the city get their weapons. The food is good, and it's a good place to run into old spies and government agents.

Security Level:2

B5#11 MaxiMarket:

A 24-hour supermarket, MaxiMarket claims they have

everything you want. If they don't, just ask and the manager will personally order your item (what they don't tell you is that it usually takes two weeks to get here). The several video games guarantee the constant presence of at least a few drunken juvie gangers.

Security Level: 1

B5#12 Derelict tank:

This rusty green storage tank sits on a plot of land deeded to someone in Hong Kong. With no one interested in buying the property, it has remained largely untouched. (The stadium parking lot was brazenly poured over a portion of the area). The tank itself still contains almost a foot of scummy, partially congealed oil, and has become a popular arena for ritual gang combat with all the spectators pounding on the sides of the tank. Losing your balance is a serious consideration here, because even a small amount of oil in your lungs can suffocate you.

Security Level: 0

B5#13 My Bakery:

When Giuseppe Bartolini bought this store, he chose it not for location, but because it was within walking distance of the water (Giuseppe, having spent the first seven years of his life on the Italian coast, likes to toss scraps to the seagulls). Popular with rich and poor people alike, the line to get in occasionally circumnavigates the outside of the store. When the MaxiMarket moved in next door, there was some concern that Bartolini would be forced out of business, but thanks to the support of several wealthy corporate customers, this possibility soon faded into oblivion. Aside from the normal baked goods, you can also buy several varieties of homemade pasta here. The gangs tend to leave the business alone, because Giuseppe occasionally feeds them.

Security Level: 1

B5#14 Soul Foods News Kiosk:

How the owner of these buildings, with only a poorly-stocked health food store and a moldering news kiosk manages to stay in business is a mystery to the locals in this area. Although the owner maintains that business couldn't be better, few are seen patronizing his stores. His actual income comes from a telephone escort service which he runs through a double blind connection in the kiosk.

Security Level: 1

B5#15 Counter Intelligence Associates:

This building, shaped like a stylized classic Barasan VS-7 (a car made popular by the 3-D Bond flicks in the early 2000's), contains the area's experts in industrial espionage. They advertise themselves as practitioners of countersurveillance, but their reps can be hired as 'consultants' to assist with other, less ethical operations. Any spy gadget can be bought here. Infrared driving assemblies to foil oil sprayers, bug detectors, gas bombs hidden in ballpoint pens, you name it, and if they don't have it, they'll make it. They can even redo your car.

They will not deign to give you a catalog or quote prices unless you're a corp of some resource. They don't even *have* a catalog of their offensive hardware, and will not admit that any such stuff exists. And, to avoid compromising their clients, consulting reps will never associate in any way with their clients' competitors.

Security Level: 2

B5#16 Bayview Condos:

This used to be a small, but nice set of condos. Because the area has degenerated quite a bit since these were erected, they have been converted to lower-income rental housing. Just east of the tower is a basketball court where a bunch of juvie gangers hang out at all hours of the day. The swimming pool was filled in and paved over to accommodate the next two buildings. There is no security here. Now you know why the rent is so cheap.

Security Level: 0

B5#17 Bay Hardware:

Coming from a long line of Canadian lumberjacks, Francis Shaeffer opened this hardware store in 2011 and has been doing respectable business with the people in the area ever since. Purchases of hammers and the like have been rising steadily.

Security Level: 1

B5#18 (Formerly) Barley's:

When Barley's department store went out of business, the landowner sought to rent the building to someone else, noting the property's strategic location near the Mall. Sadly, she asked too much, and by the time she lowered her price, the streetscum had broken all the windows and moved in. Now gutted, smelly, filled with garbage and huge (mutant?) cockroaches, the building has become the home of *Maelstrom*, a notorious booster gang.

Security Level: 0

B5#19 Municipal Works Building:

A leftover from harder times, this building is home to all the various city utilities, commissions, etc., etc. Although the Night City government has been on the rebound, it has never been profitable to move this sludgepit of bureaucracy, and so they have remained in an aging building in an area going to the dogs.

Security Level: 1

B5#20 West City Bank:

This financial institution was created through the merger of several large West Coast corporate banks who felt that consolidation would strengthen their position through the isolationist years. Although the initial plan was aimed at corporate clients, West City soon found their niche with personal accounts. They now handle the financial transactions for approximately 32% of the Northern Californian Free State population.

Security Level: 2

B5#21 EH&M Legal Center:

The offices of the corporate lawyers, Eiki, Hubbard and Maramba are located here. Instead of developing themselves into a strong legal house, they have sought to broaden their base by training other firms' lawyers. Many junior executives are apprenticed to the firm, with the understanding that their practice will be limited to the corporation to which they owe their allegiance. Due to this expansive practice, it is not unheard of for firm members to be arguing on different sides of the same case. Conflicting loyalties (between the parent corp and EH&M) are also not unheard of, but EH&M takes care of these very quietly.

Security Level: 1

B5#22 Stock Exchange:

This multilevel roman-style edifice is an adjunct to the Night City branch of the World Stock Exchange. After the isolationist period ended, this exchange was quickly opened. Many of the seats here are foreign-owned, but there has been a strong resurgence of American investors in recent years. Security is amazingly tight, but even so, most investors prefer to stay away, given the state of the neighborhood.

Security Level: 3

B5#23 Night City Medical Center:

This hospital is the most modern on the West Coast, and the prices show it. Although they do have some overflow clientele from Crisis Medical, most of their patients are in need of expensive treatments requiring extensive stays. At 6000 eb/day for a non-private room, you can guess why only the very rich can afford to stay here. The aforementioned non-private rooms are very rare at the Center, and the private rooms at the top of the tower are truly comparable to a luxury suite at almost any hotel in the city. Obviously, most people choose out-patient status.

Security Level: 2

PERSONALITIES

Dr. Bob- One of the few surgeons in the city who didn't get his training from the military. Dr. Bob does a lot of cybernetic implants for booster gangs, but he won't do facial reconstruction for posers. He maintains that this is not a bias against posers, but rather a limitation in his training. However, several poser gangs who were rejected by him have reportedly started a contest in which the first person who brings in Dr. Bob's hands will get the body job of their choice; the job to be paid for by all posers involved.

INT 10, REF 9, TECH 6, COOL 7, ATTR 5, LUCK 6, MA 6, BODY 5, EMP 8

SKILLS: Medical Tech 9, Human Perception 3, Fast Talk 6, Accounting 4, Diagnose Illness 7, Expert(Medical Procedures) 4, First Aid 9, Pharmaceuticals 8

Francisco- A former member of the CIA, Francisco spent the better part of twenty years fomenting revolution in Central and South American countries. At the end of the second Central American Conflict, Francisco left the CIA and married a fellow agent whom he'd met while fighting in Columbia. As a wedding gift, he presented his bride with the papers to Guevarra's, a Mexican restaurant. Although he's retired from action, Francisco will sometimes informally train a street urchin in the ways of urban combat.

INT 8, REF 10, TECH 7, COOL 8, ATTR 6, LUCK 5, MA 6, BODY 7, EMP 4

SKILLS: Combat Sense 9, Endurance 7, Interrogation 6, Intimidate 4, Resist Torture 7, Education 5, Expert(Espionage) 6, Spanish 4, System Knowledge(CIA) 7, Handgun 7, Stealth 4, Forgery 8, Photo & Film 5, Teaching 6

CYBERNETICS: Cybereye with targeting scope and lowlight. Cyberaudio with radio splice, phone link.

ENCOUNTERS

1. A juvie gang is out wilding. They won't be much bother unless you're in their path.
2. A juvie gang has cornered a hapless victim. Might be a mugging, a rape, or, if near Tong Laundrys, a 'laundering.'
3. Gunrunners going to or from Guevarra's.
4. Nonviolent crime in commission; auto theft, breaking & entering, etc.
5. Vigilantes on the street - do you look criminal?
6. Paranoid businessman and entourage heading to Counter Intelligence Associates.
7. Major drug transaction under way.
8. Policemen or residents' patrol getting the worst of a fight with a gang.
9. Heavy traffic and a lot of parties after a game at the stadium. Everyone brought their own Smash.
10. A gang has taken a predatory interest in your group.

CONTACTS

Alex Walker- A busboy at Guevarra's, he can arrange an arms deal with Francisco if you need it.

Kira Ysmain- Kira is a launderer at Tong's. She has several siblings in local gangs and a fairly good knowledge of gang activity in the area.

Rudy Hamilton- Works as a stock handler at City Medical's pharmacy. He does all the inventory and is a good source of cheap drugs.

Bola Riker- An engineer for the Municipal Works, he handles civic utilities in the corporate sector.

Tillie Lake- On-site manager of Bayview Condos, she's trying to hire some muscle. She's also willing to exchange living space for on-site security. Good if players need both a job and a place to stay.

NEW HARBOR

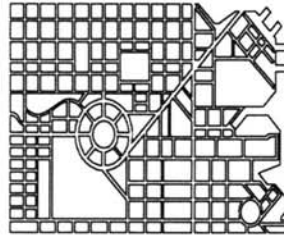

D A T A T E R M

This is not so much an area, as a pair of leviathan constructions, separated by a small canal. The Stadium is a favorite stomping ground of all sorts of violent people, and the Mallplex is the favorite stomping ground of violent people who suppress it well.

B6 # 1. McCartney Stadium

This 75,000 seat stadium is home of the Night City Rangers, a National Football League team which has shown tenacious dominance in recent years (nations may balkanise and states may go independent, but football leagues are forever).

Many columnists refer to the Rangers as "the best team money could buy." In addition, the Deathdealers (a combat-soccer team), The Heat (basketball) and the Slammers, a professional baseball team, also play here. When the stadium is not being used for sporting events many large concerts and entertainment events are held here.

The entire Night City sports system was the result of heavy corporate investment, deemed to be necessary for the image of Night City as a heaven on earth (besides, even corpzoners like Monday Night Football). Fortunately for all involved, the teams (recruited with corporate money) have all become popular enough to be self-supporting.

Although the internal security is reasonable, once outside the stadium you are on your own and massive gang attacks are not unheard of.

Security Level:2

TEAMS & STAR PLAYERS

Night City Rangers (Football)

This is the premier team playing in Night City. Resplendent in their black and red uniforms, the Rangers have taken the Super Bowl twice in row, and are now angling for a "threepeat" of 2019's sterling performance. Lead by the almost machinelike

precision of quarterback Joe Montenegro, the Rangers look like the strong contenders for the title.

Joe Montenegro (Quarterback)- Softspoken and shy, with a throwing arm described by sportswriter Mace Roberts of *Night City Today* as "the greased railway express", Montenegro is the lynchpin of a team built on its passing offense. His uncanny accuracy has often raised accusations that "Mountain Joe's" piercing blue eyes are actually cybernetic implants, but so far the NFL holds these rumors unfounded.

Cyrus "The Grim Reaper" McKormick (Fullback)-To quote Mace Roberts, "Like Death, he's big, black and all powerful." An apt description one of the NFL's most feared backs, the Reaper played hardball with the infamous Steel Slaughter boostergang before going cyberpsycho in 2018. After cyberstrip and psych-probing, the huge athlete was signed by the Ranger's EBM recruiting team and has had a stellar (and bloody) career ever since.

Flint "Buck" Dillon (Receiver)- His lightning fast reflexes and incredible speed have earned this former UFC Berkeley student the sobriquet of the "Rocketjock". However, he's known to teammates and fans by his childhood nickname of Buck. With degrees in Political Science and History, Dillon is an unlikely candidate for an athletic career, and his shambling, "jocklike" nature seems to be a careful disguise for a keen and insightful mind. Recent investments in his Merrill, Asukaga & Finch portfolio seem to bear this out.

Night City Slammers (Baseball)

The Slammers are the home baseball team; not as good as the Rangers, but still showing strong, thanks to the hitting power of their volatile star José Rosé. Weaker on the defense and with an abysmal outfield, the Slammers are also hampered by their blue and white striped uniforms (described by one sportswriter as "convict-stripe modern").

José Rosé (Batter)- With a love of fast cars, faster women and large handguns, this young superstar's career is always teetering on the edge of suspension or worse. With a hitting record, his prowess at the plate is only matched by his string of injuries and scandals. You can as often find him at a fixer's placing bets as you can on the field; a dangerous combination.

The Night City Heat (Basketball)

The Heat is Night City's answer to the LA Megaplex's Lakers, and a fierce rivalry exists between the two teams (after-game rumbles are not uncommon). A good, tight team, with the added threat of center Yosh Koriyama to boot.

NEW HARBOR

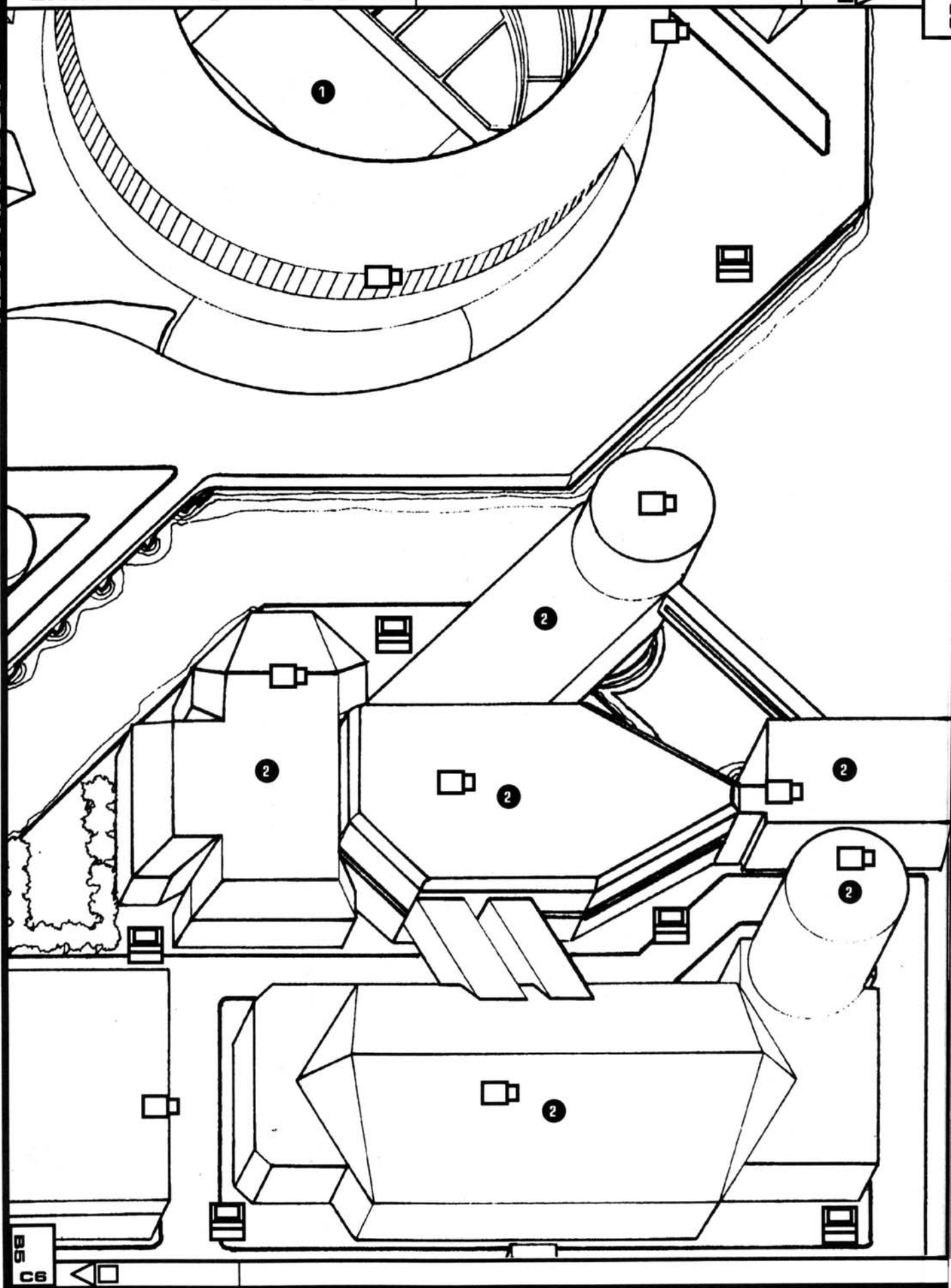

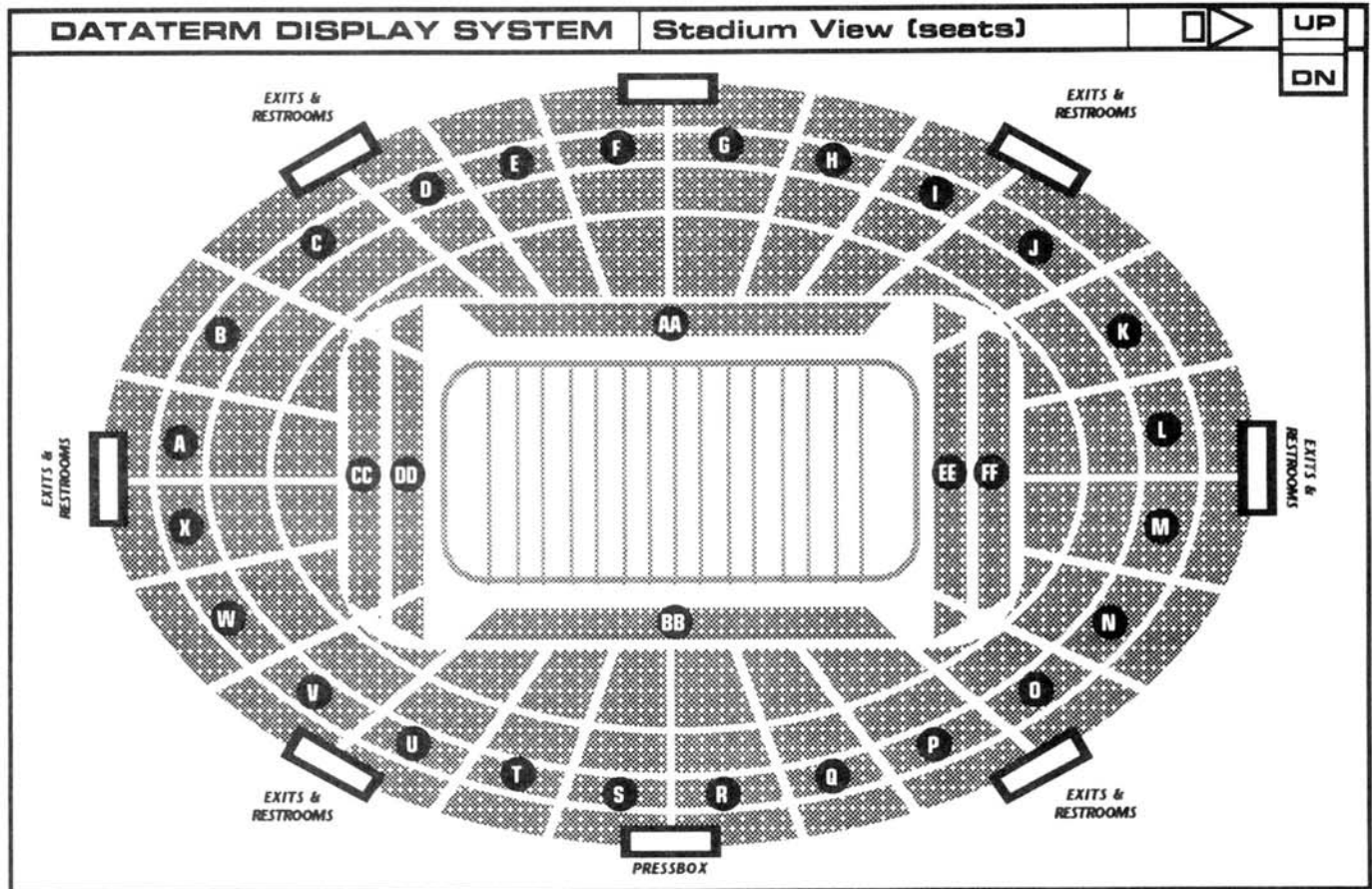

Yoshiuki "The Yosh" Koriyama- Dubbed "the Japanese import" by Night City columnists, the Yosh is an eight foot-two center originally from Shinjuku-ku, Tokyo. Some speculate that Koriyama is actually a Japanese gene-tailoring experiment gone pro, but there is little to support this rumor.

The Night City Deathdealers (Combat Soccer)

If violence is the favorite sport of Night City, then the Deathdealers are probably its favorite team. Specializing in combat soccer (using spiked boots, headgear and balls), the Dealers are one of the most popular teams on the World Sports Network sat channels. There are no stars on this team; most players don't survive long enough to get a following.

36 # 2. New Harbor Mallplex

(aka New Harbor Shopping Redevelopment & Residential Complex)

Like many urban mallplexes in the United States, the New Harbor Mallplex began life as a heavily secured shopping mall set around a core, or magnet store (in this case, the national Shop-Mart chain) and was constructed on the ruins of a previous shopping center vacated during the Collapse. By 2011, the Mall held almost a two dozen varied stores, as well as a small business office tower added in 2012. It was only a

minor step for the Mall's corporate owners to add in several levels of residential conapts and suites for its employees, culminating in the final micro-arcology of today.

Make no mistake; the New Harbor Mallplex is huge; almost five thousand people live packed into its labyrinthine corridors. Its residential areas now extend deep into the muddy bay bottom surrounding eastern Night City, as well as in two towering levels above the three level public-access shopping mall. The Mallplex has its own food stores, rec-complexes, fire stations, power generators, private police force and broadcast stations. It is a city within a City; self contained and increasingly isolated from the outside by its fortress mentality.

Each level and area of the Mallplex is dedicated to a specific purpose; no space is wasted. Security is amazingly complex and tight, with every square inch covered by cameras and sensors. Mallplex cops are the next best thing to Nazi stormtroopers. Passcards are required just to get from the public areas to the residential sectors; a lost or stolen card carries a 1000 eb fine or potential eviction from the Mallplex.

The Mallplex is broken into eight areas; Living Areas Alpha, Beta and Gamma (containing conapts, schools and services), the Business Tower (with rental space for businesses usually connected to the Mall in some way), the Administration

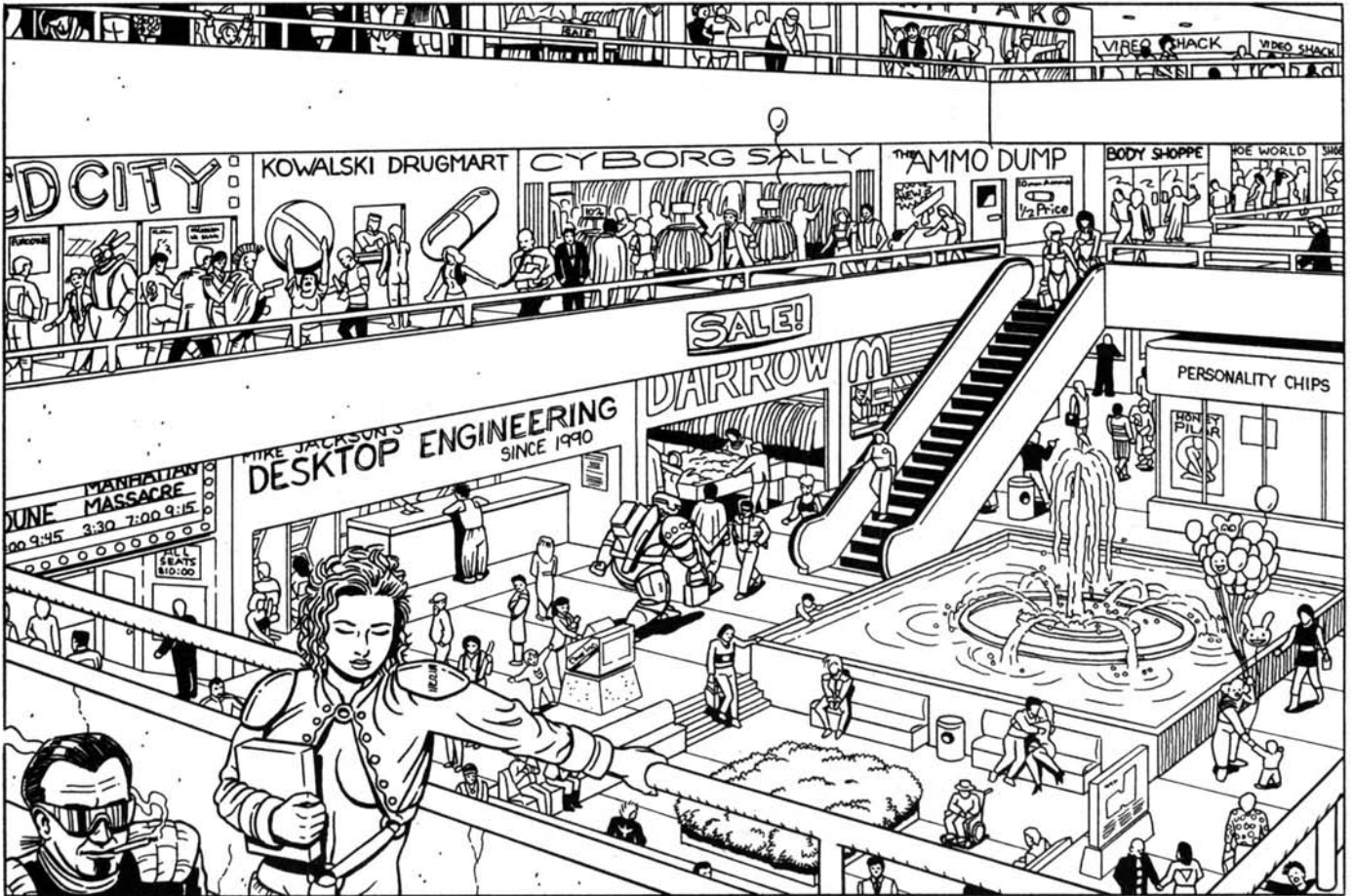

Complex (with Police, Fire and Administrative Services), the Magnet Store (Shop-Mart) and the Main Shopping Concourse (what most people see of the Mall):

Mallplex Living Area Alpha

Also known as the Executive's Tower, this building holds 500 luxury apartments designated for Mallplex Administrators and staff. Most Mallplexers don't have a passcard for this area; you must be an Administrator or other honcho in order to get into this section.

Security Level: 1

Mallplex Living Area Beta

This module contains 3,500 one-bedroom living conapts, arranged around a central light shaft. The two ground level floors contain a school (K to 9th), a badly stocked library, an enclosed schoolyard and the entryway to an underground parking structure.

Security Level: 1

Mallplex Living Area Gamma

This immense module contains 1,000 two-bedroom living conapts. There are two light wells at either end of the living area. The two ground levels contain a high school, a 100 bed mini-hospital, a Mall-only radio/TV station (KMALL), a large recreation and gym area, and a post office.

Security Level: 2

Mallplex Business Tower

Joined to the main Mall-plex by a large walk-bridge over the canal, the business tower holds seven floors of assorted offices, including two law firms, seven consulting firms, a tax attorney's office, five doctors and a dental clinic. The top two floors are occupied by **Ebertech**, a software firm specializing in braindance videogame design, and the creators of the hit *Starwarrior Commander* chip now sweeping the arcades of America.

Security Level: 1

Administration Complex

This section contains the main offices for the Mall Administration. The two ground floors contain a three vehicle Fire Department, and a well-armed, rabidly additudinal Mall Police Department.

Security Level: 3

Shop-Mart

This is the magnet store for the New Harbor Mall complex. The upper two levels are an immense discount store, featuring housewares, cheap furniture, tools, books & CD's, inexpensive personal electronics, everyday clothing for mallplexers on a budget, cosmetics, a drug store, a soda fountain and small cafeteria. The lower, ground level, is a large supermarket divided into three sections: *Lifestyles* (with

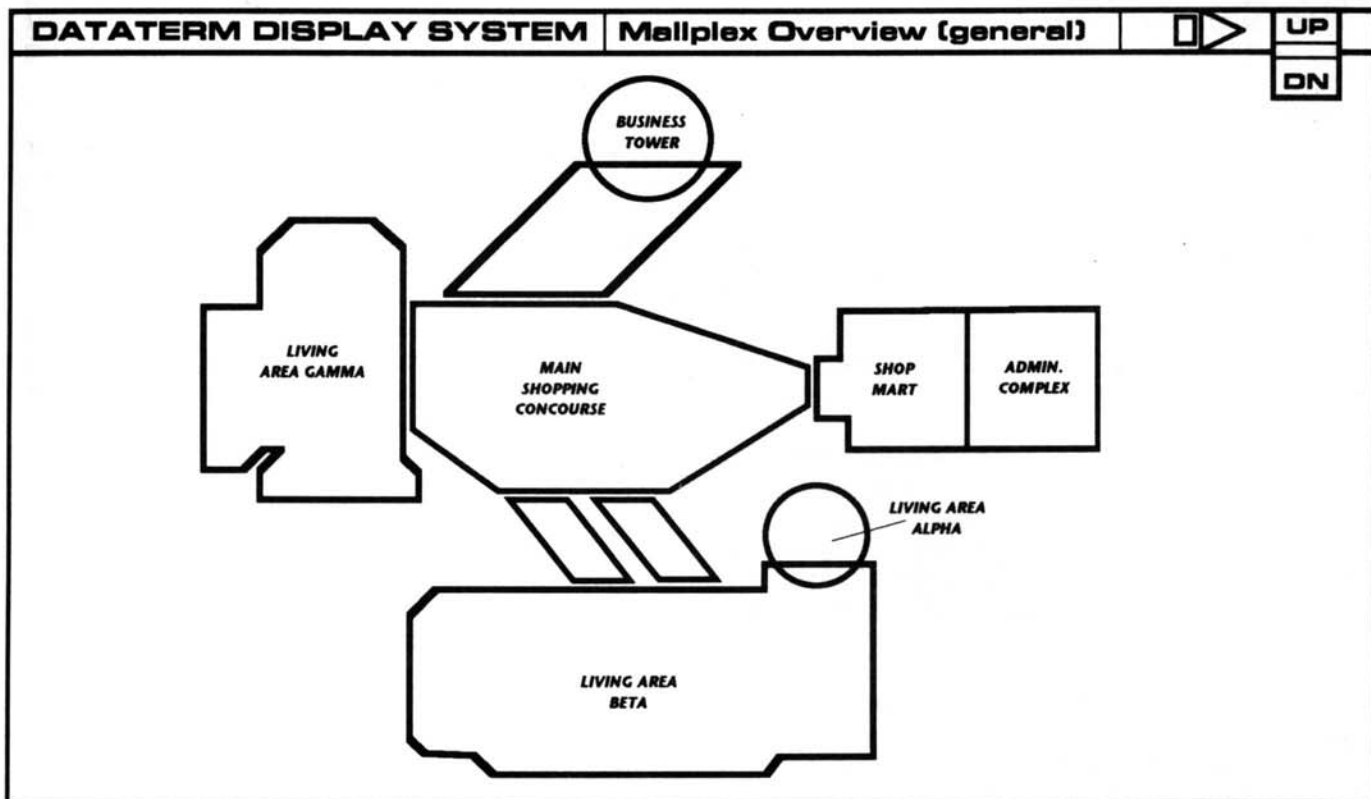

expensive pre-pack for upscale mallplexers and beavers), *American Values* (cheaper pre-pack and bulk foods for what used to be called the "blue collar" class), and *Generics* (kibble, human-chow, soy-meat-in-a-can and other bulk foods one step above dog food).

Security Level: 1

Main Shopping Concourse (Level 1)

This section contains the shopping mall part of the Mallplex. As businesses are constantly changing, collapsing or starting up, the following entries are listed from the most recent tenant survey as of May 12, 2020. Those interested in spaces listed for Lease may contact New Harbor Mallplex Administration at LDL 652.9828. 9829 or via cellphone at (416) 553-5256.

Security Level (for the entire Shopping Concourse):1

SHOPS

A. If personal computers are your thing, be sure to check out Mike Jackson's **Desktop Engineering**. The best in town for fixing those small machines, including Microtech's new *Mobile 19* cyberdeck. The prices are reasonable and the service is good.

B. The **Civic Theatre** shows all the current hits, and at 7eb a seat, how can you go wrong? A great place to meet a contact, or just catch the latest *Airborne Ranger* installment.

C. **Darrow** is the place to go if you want to be a well dressed juvie-ganger. Decent clothing at reasonable prices, with a fanatical following among Night City's teenage set.

D. If you're looking for inexpensive fashionware in the newest styles, **Parts N' Programms** has it all. Need any chipped boosterware? They'll beat any price in town (all prices 5% lower than listed in the *Cyberpunk 2020* rulebook).

E. "This space for lease."

F. **Dignity** is an international clothing chain started by cadet members of British royalty in 2002. Originally, its fashion concepts were aimed toward the upper strata of society, but recent trends have seen the introduction of a new line of moderately (750-2500eb) priced garments for the middle class as well.

G. **Bastion Swimwear** bills itself as the innovative leader of the swimwear industry. This season, they are releasing an entire new line of suits made from endangered animal pelts. The suggestion that this is high fashion repulses many, but the industry usually follows the trends set by this company.

H. "If it's fashion you want, **MaxiWear** will provide." This major ad campaign ruled public billboards throughout early 2019, as this new company tried to force its way into a crowded leisureware market. Most of MaxiWear's outfits are designed to be interchangeable; however, the quality of the product is often suspect.

I. **Destry Fashions** is a high-priced men's clothier specializing in formal evening attire, including the exclusive *Takanaka*

NIGHT CITY

SECTION B6

Corporate Shogun line of tuxedos. Rentals are also available. This is where Corpzoner kids go to rent or buy a Prom tux.

J. Maxwell's Shoes specializes in handmade bootery; a luxury in the 2000's. Even at the age of 89, owner Jess Maxwell still handcrafts each shoe to the specifications of the buyer. His waiting list (especially among the Powerbrokers of Night City) is so long that he has started searching for an apprentice.

K. Jensen's specializes in jackets and boots for musicians. This one of a kind store caters to such big names as Johnny Silverhand, Harmonic Distortion, and Jessé Moore (when she isn't boycotting the leather industry).

L. When price is no object, **Rapture Fashion Concepts** is the place to go. Staffed by twenty tailors and designers, each individual is given personal attention in creating their own definitive clothing style. Although they usually will not comment on customers' tastes, Rapture's tailors will give advice as to trends on the cutting edge of fashion. Many Night City media personalities regularly visit this store.

M. Action Jackets bills itself as the ultimate in clothing accessories and armorjackets. With a digitally controlled tailoring module right on site for the best fit, this store is especially favored by solos who find the kevleather (SP=16) selection to be a major plus when they want to buy

fashionable clothing, but don't want to go entirely unprotected, or need a stylish holster to fit underneath that *Takanaka E*X*E*C** silk jacket.

N. Lingerie Heaven is a good old-fashioned lingerie shop, carrying everything from classic merry widows to the daring edge of sensual style. Many young corporate women shop here; it's a status symbol among the Plaza set.

O. Ambiends is dedicated to home entertainment complexes, including braindance consoles and the like. Their prices are considered to be on the low end, though many of the top quality brands are kept in stock for the more discriminating customer.

P. Data Inc. is one of a few stores which carries netrunning programs, and is favored by many novices. Data Inc. also secretly registers its customers on a database which it sells to corporations looking for potential employees (or threats).

Q. If you need new cybernetics, **Docs R Us** can take you through all stages of a cybernetic implant. For one fee, they will arrange the purchase of the limb or implant, arrange the surgery, and take care of all of the required paperwork. For an added insurance fee (5%) the company will arrange for therapy as well (as needed). Prices depend on the type of implant (1.5 times the cost listed in the rulebook), but

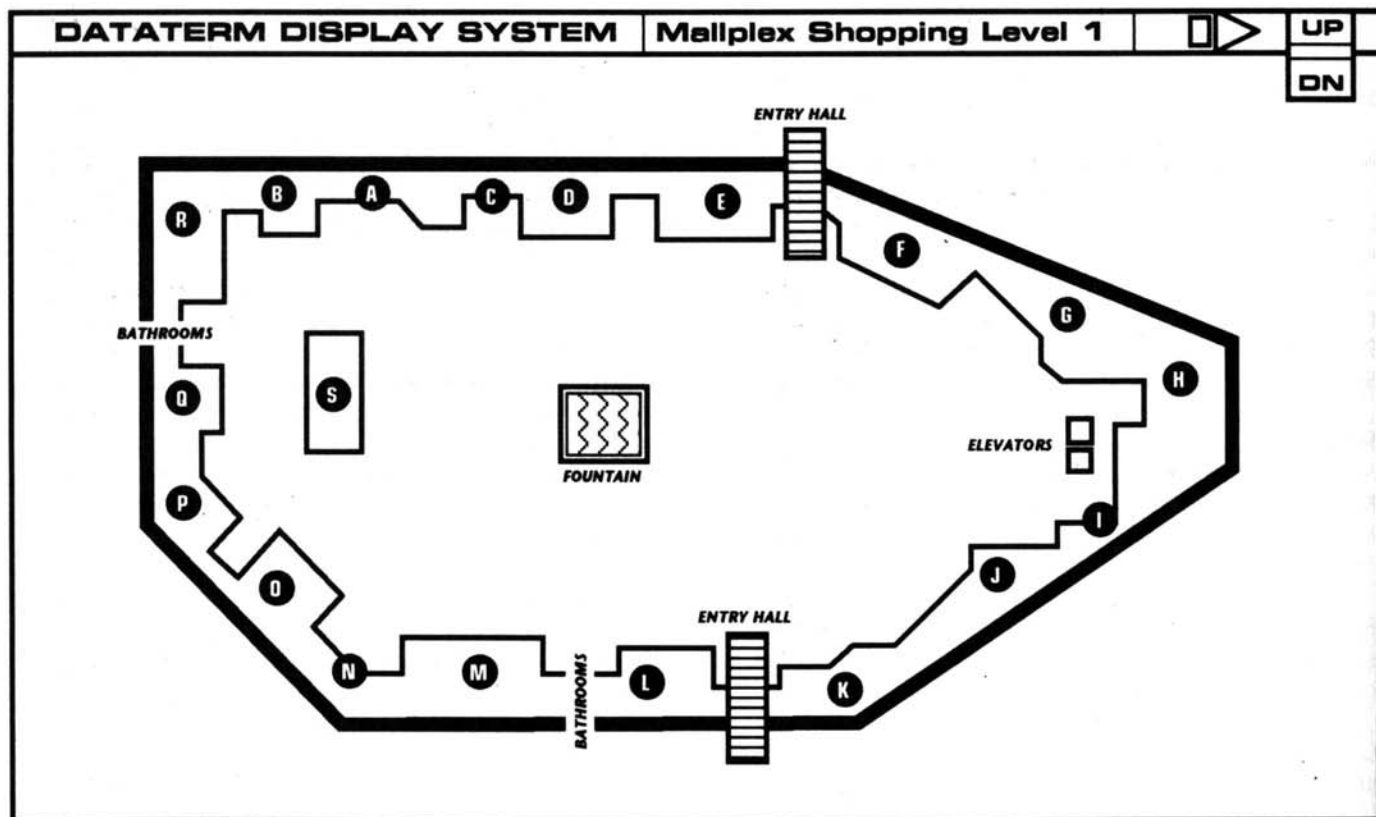

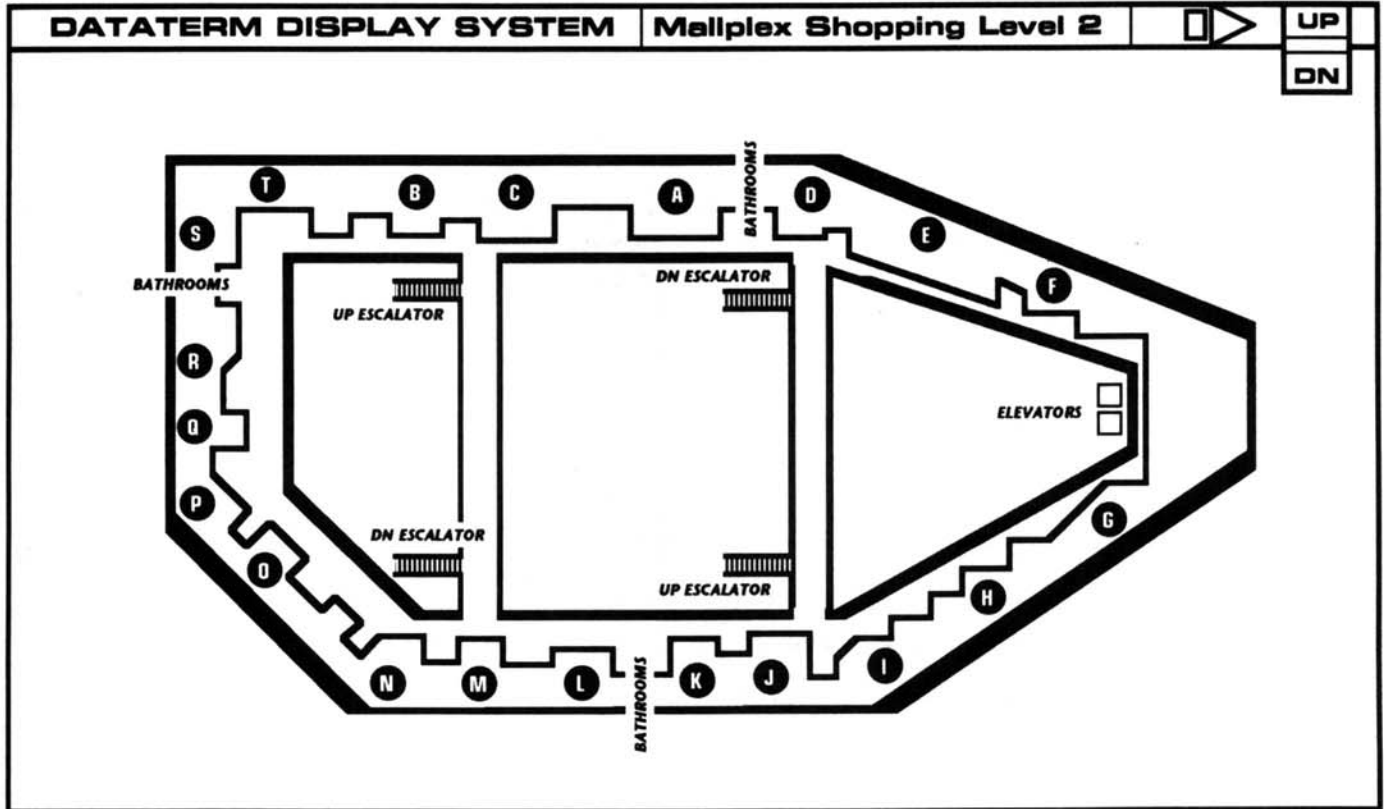

the service is excellent. The recovery time is halved due to the care taken during the entire procedure. Note: Docs R Us will not handle illegal implants.

R. Okay, it's a bit disconcerting to see the window display of **Underwater**, but this 20 foot hologram of an ocean reef *does* drag in a lot of business. This shop carries various diving gear, as well as offering classes in both scuba and the newer fuba (fluid underwater breathing apparatus). Classes meet at the shop on Tuesday and Thursday nights, and on the Marina (for dive trips to the Trench) on weekends.

S. **Madame Estelle's** is a high-classed escort service catering to either sex, providing biosculpted escorts with perfect grace and charm. Madame Estelle's is not a brothel; the escorts are forbidden by contract to become involved in romantic or sexual relations with the client, and a well trained staff of solo help makes sure that clients stick to the agreement.

Main Shopping Concourse (Level 2)

A. Having trouble finding a well-tailored evening gown or business dress that can stand up the rigors of a cyberlimb? **Cyborg Sally** is for you.

B. **C.D. City** has all the latest release at prices even a dorpher' can afford. All the wannabe rockers hang out here.

C. In the 20th century, they told you to give the gift that kept on giving. Now, that gift comes in prepackaged boxes with a personalized greeting card from **Slayer's**, produced on it's laser printer-card maker. Choose from a vast selection of personalized gifts (gift books, china, art objects, etc.), in a variety of price ranges. Slayers will also pay up to 25eb for any marketable slogan which they use on their line of in-house greeting cards.

D. **Baskin Books** specializes in technical textbooks, but also carries a wide selection of tech manuals from all the major publishers. This is the place for techies to go to get that new specsheet or technician's guide. Although Baskin is an independent bookstore, there is a rumor that the *Signtor* book conglomerate is looking to take them over.

E. **Home Fax Office** is a nationwide chain of stores which specialize in personal Data Kiosks. Designed to your specifications, the company will put together a dream desk that will fit into your briefcase (or your money back).

F. **Dem Bones Games** is owned by Dr. D, a junior executive in the *RandHaus* book conglomerate. The store offers chess, Pente, Monopoly, Dungeons & Dragons and other classic games in its extensive inventory. Although he maintains that the store is just a tax shelter, Dr. D can usually be seen there on weekends, guiding the younger kids through a roleplaying game he calls "The Field Trip."

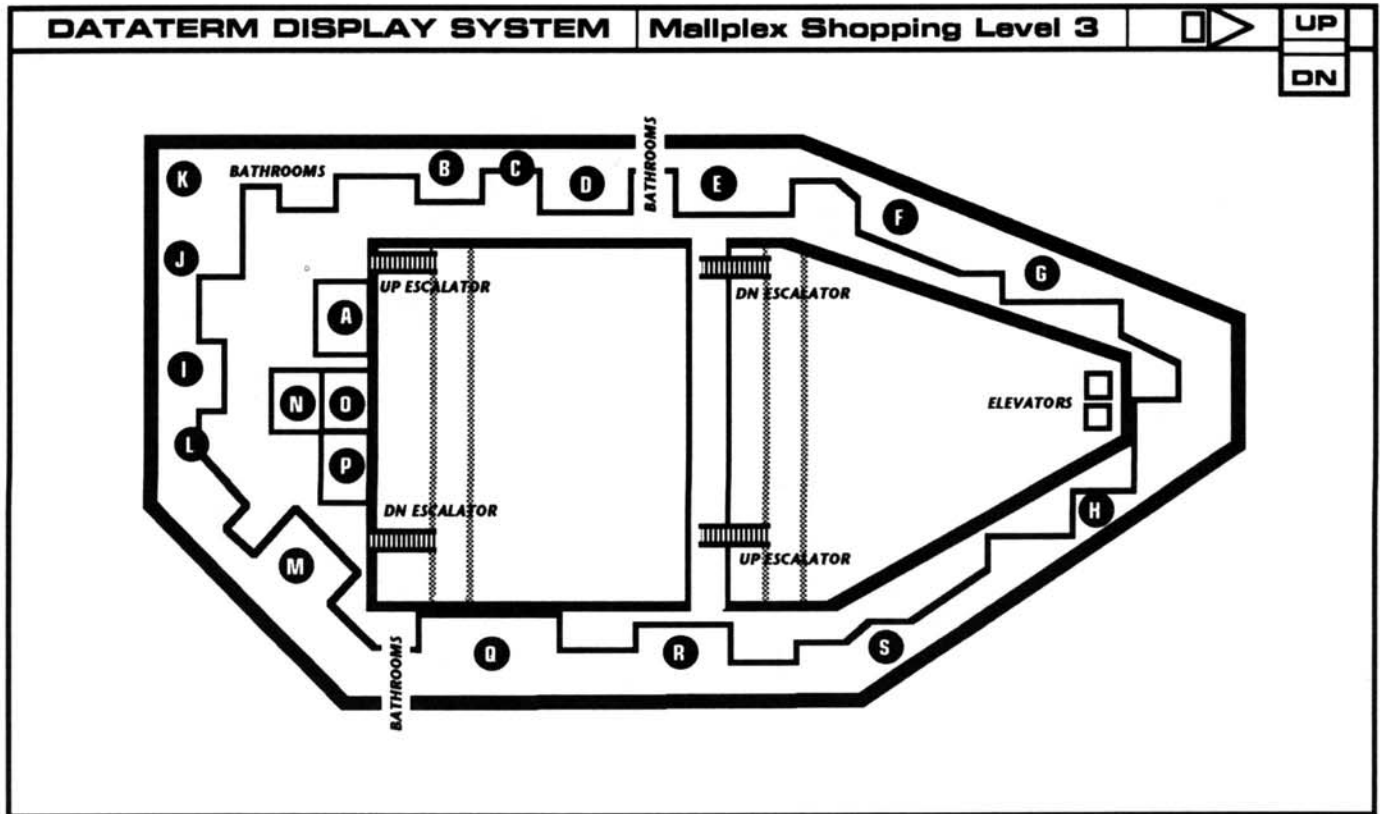

G. Music Machine: this combination instrument retailer/music store is one of the most popular with the juvie crowd, which hangs around the store in hopes of meeting a major recording star. They still haven't figured out that most recording stars avoid this store, unless contracted to do an autograph signing session.

H&I. Software Inc. and its neighboring store, **Ratchet Computers**, are privately owned by a pair of elderly men who refer to themselves as S.J. and S.W. Although the selection of software is limited in compatibility to what is sold in the computer store, many punks who frequent these stores agree that the low prices are the best they've seen.

J. New World Pets: tired of that grey tabby which sits around the conapt shredding everything in sight? Now, you too can own the latest rage in home pets: genetically altered five foot long rabbits. If that's a little big for you, how about our new miniature St. Bernard? We guarantee you'll find something for your tastes, or we'll make it for you (certain combinations are not possible for home living. See your sales rep).

K. Microcoox: originally specializing in microwave cooking utensils, this store now stocks prepack meals in their own self heating containers (just pop the tab, and the meal heats in one minute, using its own internal chemical heat source). Owner Martin Marks, a former waverider with *Scott-Hawaii*, suggests these meals (at 2-22eb apiece) are the next generation in food to go.

L. "The score of a lifetime has just hit and if you don't cash in within thirty minutes, the deal dies on the vine? See us! Your business is our business." **The Money Place** will loan, on a sliding interest scale, up to three million euro at only two percent interest per hour. In addition, financial counselors will provide sound investment advice for a modest fee (insider information is extra). This company has also acquired a rep for collecting equity for bad loans.

M. The **Outdoor Sports Emporium** is a store dedicated to keeping the idle rich entertained via new and unusual ways. Though they carry accessories for such classics as tennis and volleyball, the store's main emphasis is on variations of old sports or entirely new activities such as the 1,000,000 eb entertainment plaza; providing such diversions as *Mancatcher* (you supply the humans) or *Big Game Wars* (animal-shaped armored vehicles which "attack" each other by remote control).

N. With an emphasis on the early twentieth century, **Allhouse Antiques** has those rare items which will make your conapt the envy of all visitors. The store gained recent fan notice by providing many of the items used in the new braindance hit, *Kelley Lang: Gun Moll of the Thirties*, starring Sherri Glass.

O. Vitamensch: owned and operated by Riley Roberts, this store has dedicated itself to the promotion of "better living through nature." The store was going out of business until a recent NorCal FDA report named Vitamensch's all natural

vitamin tablets (50eb per 100 tabs) as a major factor in reducing health risks from Night City's carcinogenic smog.

P. You only have a minute for lunch before hopping that downtown tube to the meeting, but you need some type of nutrition. Now, **Pizza To Go** offers its new service in malls throughout the world; preprepared pizza which only needs to be reheated in one of our Pizzawaves™. In less than a minute, you'll be on the tube with a slice of piping hot pizza in hand. For 50eb extra, you can get the real specialty of the house; the *Hotslice*—cheese, pepperoni and mushrooms, dusted with a powerful hallucinogenic and sold under the counter. A juvieganger fave.

Q. "This space for lease."

R. **Mirrorshades**- A high priced optical and glasses supply shop. Where do you think all the shades' in Night City come from anyway?

S. **Other Lives** is a shop catering entirely to braindance vids. There are no dangerous or blackmarket vids in the shop, and the owners is one of the city's biggest proponent of "safe" braindances.

T. "This space for lease."

Main Shopping Concourse (Level 3)

A. **Hanson's Pets** is a simple, conventional pet store. Nothing fancier than a Komoto Dragon.

B. With the high cost of living, **Homehelpers** is doing more business than it ever has. This establishment matches incomes to available housing to help the underclass find a home. For a fee of course.

C. "Skinlight...When you want to be the light in his dark future!" A high level cosmetic body shop, **SkinLight** features the latest in light tatoos, including Image Fashionware's Bodyline styles.

D. **Gelberts World Information** sells only one product—information, gathered from around the world by a staff of seven full time "Information Gatherers". For one fee (price depending on difficulty of information to obtain), Gelberts will provide data and background on any subject desired, with a money back guarantee if they can't answer your question.

E. When your gun is in need of repair, look no further than **Ed's Firearm Repair Shoppe**. Ed can repair any firearm, from the old Colt .45 to the Arasaka Minami 10. His prices are reasonable (2% of gun cost) and the quality of work is excellent.

F. **Morgan's** is the full service weapons store for the discerning shopper. Within its walls one can find just about any assault weapon available to the general public (all prices as listed in the rulebook). If Morgan doesn't have the gun you're looking for odds are (45%) he knows someone who does.

G. Looking for a fun time? Look for **Playthings**, the retail outlet for the popular **Party Time** entertainment service. For a price Playthings will find you a "romantic partner" with the same unique tastes as yours. Imagine computer dating with questions like "How many things can you think of to do with peanut butter?".

H. "This space for lease."

I. **The Food Court**: This is a small dining area surrounded by a number of unusual fast food outlets. The Food Court isn't much as a culinary experience, but it's just right for harried Beaver moms and mallie juvebrats with only a few euro to blow. The eating area is filled with small, uncomfortable plastic chairs and tables, and meals are served on bright plastic trays.

J. "This space for lease."

K. **SoSushiMe** is the product of two lawyers in the early twenty-first century who came up with the idea of marketing prepackaged sushi in seaweed cartons to save unnecessary waste. Now, with over 2000 locations in existence, this franchise has become one of the most popular eating establishments in the corporate world.

L. **Hot Dingo**: after failing in the corporate world, Dingo Oliver started this franchise with a new marketing concept—hot dogs made from unusual ingredients. Some of the more popular delicacies include the sushidog, the synth-fleshdog, and the ever-popular tofudog.

M. A family run business, **Merril's Cookie Place** offers fresh baked cookies and awesome cinnamon rolls to those who have a sweet tooth left after sampling the gourmet offerings of the court.

N. **Harmony Grits** started out as a bakery specializing in goods made out of nonprocessed flour. Now, after many owner changes, it offers soups and salads with these baked goods.

O. When Olivia Brandenburg inherited the Brandenburg vinegar fortune, she immediately branched out into other venues where her product could gain better exposure. The **Fish and Chips Parlor** showcases the companies products, liberally poured over bland, greasy, fried mud-fish.

P. Specializing in frozen delights, the **Slushee Place** is tops with many of the younger Mall patrons. With a continuous influx of new products, most recently ice cream-filled

NIGHT CITY

SECTION B6

croissants, the store is trying to gain a foothold into the adult market as well.

Q. One of the most expensive stores in the Mallplex, **Allison's** is the exclusive domain of the Corporate rich. There are armed guards posted at all entryways, with orders to keep the "streetscum" out of the establishment. Allison's sells imported goods, if it's decadent and expensive, they probably have it in stock.

R. This area houses **Mall Security and Management**. Any complaints must be submitted in writing, please.

S. **Gregory's** is a simple men's clothing store. They carry everything from old-fashioned cottons to the newest in artificial leathers from Biotechnica.

ENCOUNTERS

1. Abdul the Butcher has many knives for sale. If you're not interested, watch your back. (quick-tempered solo, with combat sense 2)
2. Jerico Davies, technician extraordinaire, will fix any item for a price. (Techie with scrounge 6)
3. Giant spotted frog? Perfect for your living room.
4. Cookies for sale? (contain a powerful narcotic which will addict you on a D10 roll of 4 or less)
5. So you want a watch? Step right this way. (Solo, combat sense 7, arranging arms deals.)
6. Feel the warmth of this real muskrat jacket. (McCracken

Bones, ripperdoc, offering biosurgery)

7. Want a houseplant? Bioengineered to protect your belongings (just don't forget to feed it).

8. Take a look at this wind-up stapler... (Fixer, connections 3)

9. Motorcycle parts for sale. Give to the cause. (Levin, a Nomad group trying to make a quick buck)

10. Sure, I have something for cold sores... (Fixer, level 6 connections, possible drug deal)

CONTACTS

Melinda Upton- A typical teenaged mallplex-bunny, Melinda knows every inch of the place. If you want to hide in the Mall till after closing, ask her.

"Max"-After the security guards roused him several times from the halls, they gave him a job. Now Max sweeps the floors and watches people. If you want to know if a person has entered the Mallplex in the last five hours, ask him (75% chance that he will know).

Pat Riley- An ambitious security guard. If you approach him with proof that someone in the Mallplex is breaking the law, he'll check it out.

Kim Takashi- Another mallplex bunny, Kim keeps her ear to the ground. If something funny's going on at the Mallplex, odds are she knows about it.

Fred Gregory- One time techie, now a night janitor, he knows how to disable all the cameras linked to the Mallplex Security Center. For a price.

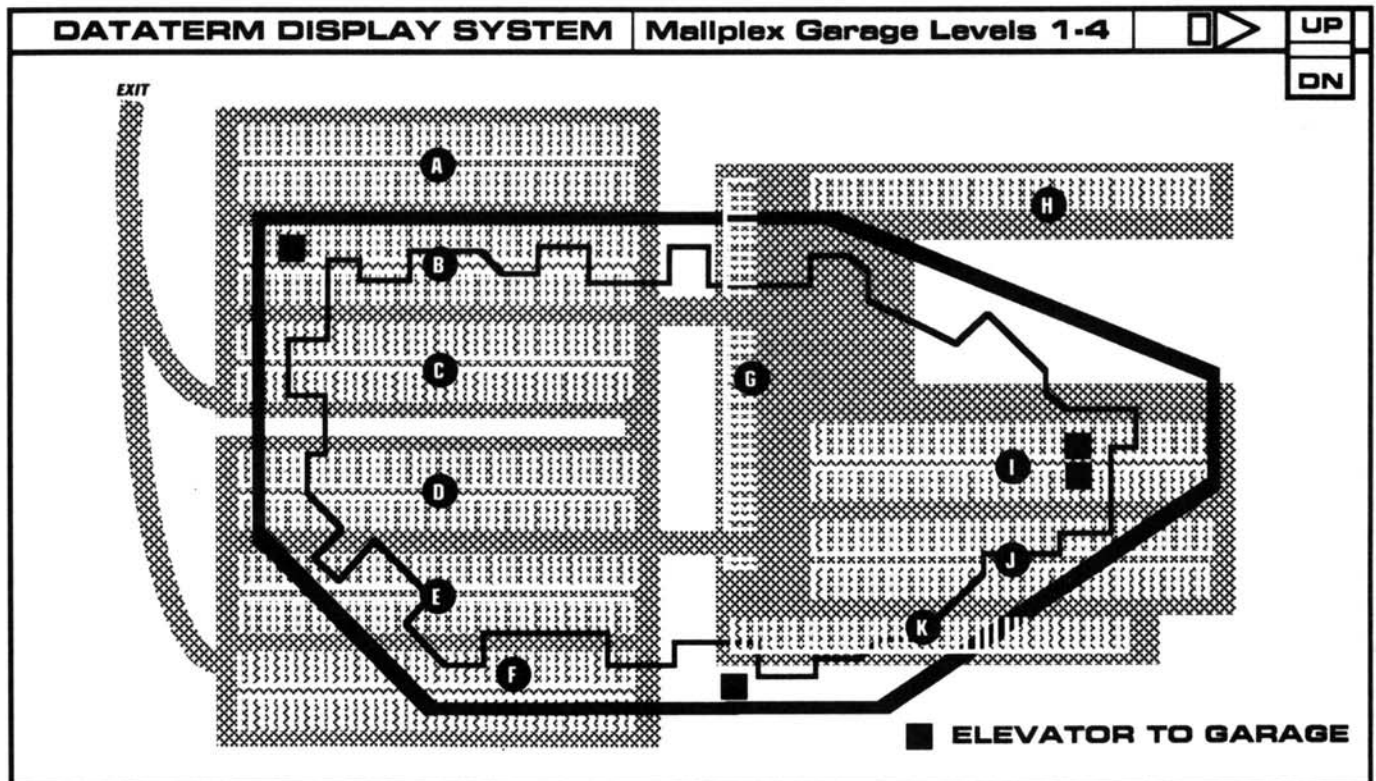

DATATERM DISPLAY SYSTEM

Mallplex Elevation View



UP

DN

NEW HARBOR MALLPLEX

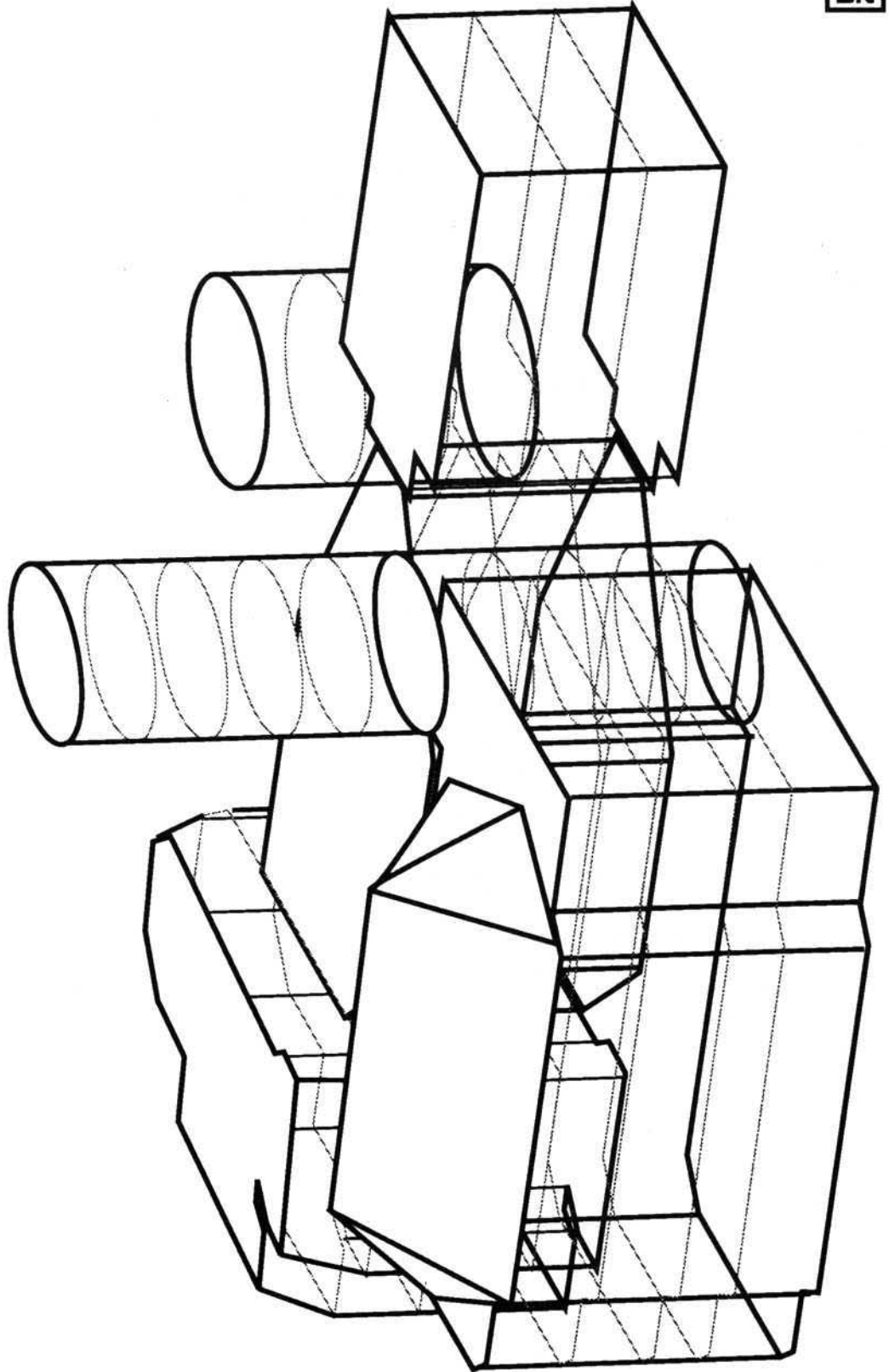

NIGHT CITY U.

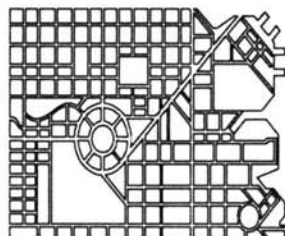

D A T A T E R M

Night City University began as Richard Night University, and was built in 1994 to be the academic center of his model city. He placed the campus on the western edge of beautiful Lake Park to balance the thriving corporate sector on the opposite side. Together they form the city's Yin and Yang of commerce and higher learning. On warm days, the campus end of the park teems with students studying or enjoying the sun.

The original university took up only the lower half of the current NCU campus. After the corporate takeover in 2009, the campus was expanded to its present size and renamed Night City University. Most of the humanities functions were moved to the newly constructed northern half of the campus, while the science departments stayed in the grouping of older buildings in the southern end.

Today, Night City University has over 15,000 students, many of whom commute to classes on busses that run at 20 minute intervals between the campus and the maglev station at the western edge of the corporate sector. The university is best known for its high quality engineering curriculum, but can still offer a sound education in the humanities.

When you visit the NCU campus, you needn't worry about the gang problem that plagues so much of the city, because the campus police keep stern control over the undesirables in their territory. Their glossy black protective gear and no-nonsense attitude has earned them the moniker "The Mad Maxes" among the students. While they may jibe their protectors, it isn't uncommon to hear a student yell for a "Max" when he gets into trouble. While the main objective of the campus police is campus security, students can enter into an optional protection agreement with the university in which the campus police will come to the aid of any student living in the nearby blocks outside of the campus.

C1#1 NCU Administration:

The Administration Building is constructed with the modern plastics and alloys favored by Richard Night, while the architectural design draws strongly on classical roots. The suggestion of marble columns in the entranceway, with the open rotunda beyond, gives the administrative building a sense of ancient wisdom impressed upon the modern world. This dramatic entrance, sequestered in a private setting by the jutting East and West wings, makes the visitor feel as though he has stepped out of Night City and into a realm of higher learning.

Within the east wing are many of the administrative offices, including the President's and the Dean's. Student registration is in the western wing, along with guidance and counseling offices. Part of the main building contains an amphitheater used for guest lectures and official functions.

Security Level:3

C1#2 Thompson Hall:

Thompson Hall continues the campus' particular style with more modern plastics and alloys. Within are the foreign language departments. The department offices are on the upper floor, while the lower two are filled with classrooms and language labs.

Security Level:3

C1#3 Science Labs:

On the lower two floors are the physics, chemistry, biology, psychology, and geology laboratories. Above them are general purpose classrooms used by all the science departments. The top floor houses science department offices. Interconnecting hallways run through all of the adjacent buildings numbered 3 through 6, making what looks like separate structures from the outside into one large building on the inside.

Security Level:3

C1#4 Science Tower:

The Science Tower is the heart of the Night City University Engineering School. Its reflective silvered windows can be seen from one corner of the campus to the other. The Tower contains classrooms for Engineering, Physics, Astronomy and Astrophysics. Three elevators service the upper floors, the top of which holds the Engineering Department offices.

The first two floors are filled with multi-curriculum study cubicles, in which students can review the prepared coursework for their classes. The cubicles can download the coursework to students for study later. Many cubicles are equipped to allow students with the necessary neural interface wiring to plug in directly. Fax printers can print out hardcopy for those who prefer it that way. The study cubicles take the place of much of the classroom study in old-style universities, which frees up the professors for personal instruction time with individual students.

Security Level:3

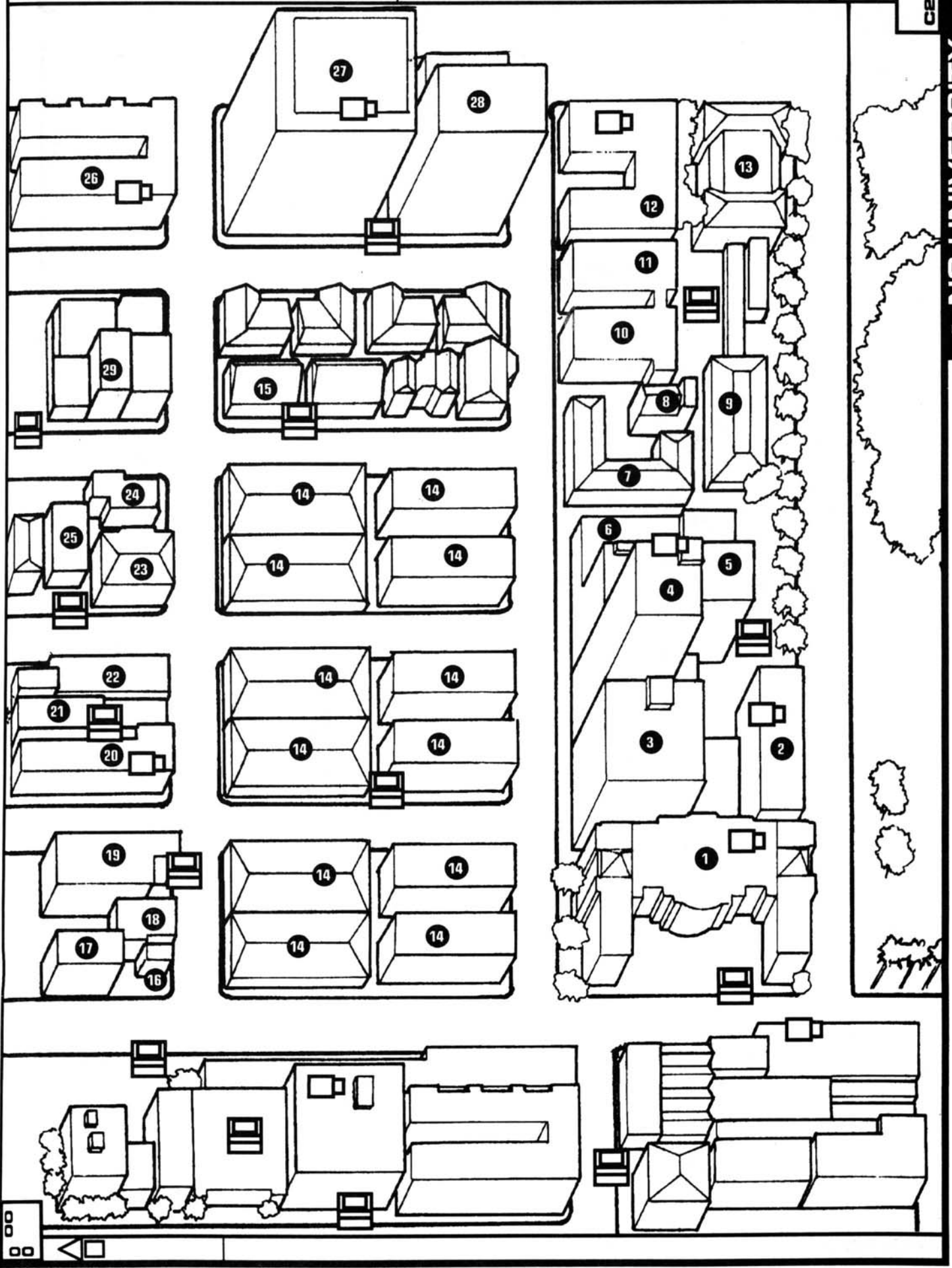

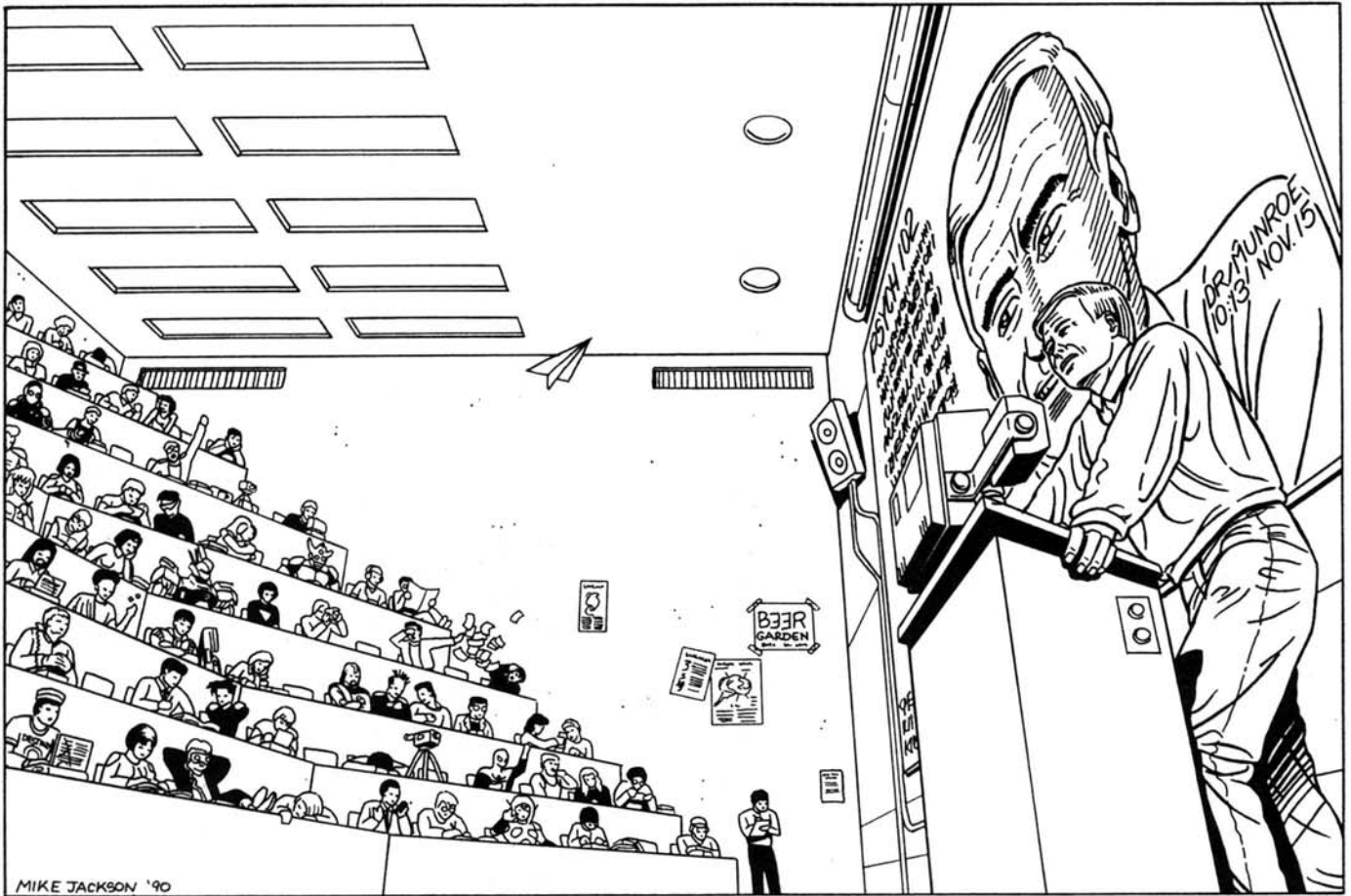

C1#5 Knute Hall:

Knute Hall houses the computer science classrooms and labs. In the basement is the university mainframe in its environment room, and an array of computer terminals in the surrounding laboratories. The upper floors house the computer-bio labs from which have emerged some of the leading developments in neuralchip interfaces. On the top floor is the Computer Science department office. Night City University has been able to attract leading scholars in the computer field. Notable among them are Professor Kang Park, pioneering researcher in the field of neuralchip interfacing, and Professor Alice Bloom, who was influential in the creation and standardization of the world Net.

Security Level:3

C1#6 Robinson Hall:

The northern portion of Robinson Hall contains the Mathematics department and classes. The taller southern half houses more Mathematics rooms on the lower floors, and Biological Science classrooms on the upper floors.

Security Level:3

C1#7 Brooks Library:

The ground floor contains printed books, microfiche copies of periodicals, and hundreds of thousands of fully computerized publications, all referenced by a modern computer catalogue

system which can locate physical books and download or print out selected passages for the student (using technology similar to a screamsheet). For a small fee, students can link into the library files from home and download the information to their own terminals. The underground level of the library is a vast student study area arranged into group study cells and multi-curriculum study cubicles.

Security Level:3

C1#8 Clinic:

The clinic handles minor health problems and medical emergencies.

Security Level:3

C1#9 Student Union:

The ground floor features a central atrium and a student lounge. Student government offices and student meeting rooms take up the northern end of the building. At the southern end is the University bookstore. Inside the lobby are a cluster of phone/dataterms, and a couple of screamsheet boxes just outside. Down the stairs are the student and faculty cafeterias, the **Ratskeller** bar with music video entertainment and weekend parties, NCU Pastry shop, Pizza By-the-Slice, a food co-op, and a NCU music co-op where the students can buy music recordings at co-op prices.

Security Level:3

C1#10 Howard Wong Building:

The School of Business takes up the whole of this building and makes use of extra class space in the Tower of Science. The building was recently renamed in honor of Howard Wong after his estate made a sizeable donation to the university.

Security Level:3

C1#11 Social Sciences Building:

This building houses the Social Sciences department and classrooms.

Security Level:3

C1#12 Humanities Building:

The English and Journalism departments are in the Southeast portion of this building. The rest is given over to the Humanities, including History, Philosophy, Anthropology, and Religious Studies. All of the department offices can be found on the second floor. Many of the classes for these departments are conducted in the Science Tower.

Security Level:3

C1#13 Schumaker Hall of Performing Arts:

The Dance, Music, Theater, and Video Communications departments share Schumaker Hall. In the southern end is the main theater and theater classrooms. In the center of the building is the music recital hall, and to the north are the dance classrooms and film and video studios.

Security Level:3

**EDUCATION IN THE MODERN AGE**

Unlike his parents, 2020's student doesn't even have to

crack a book to study his history lesson. He can call up the university library and download all the History 101 texts to his personal computer, then read them at his leisure. The wealthy don't even have to do that; they can buy the course on a chip and plug the knowledge straight into their craniums.

With today's neural chips anybody can be a trivia king, but real intelligence — true cognitive excellence — still has to be taught the old-fashioned way. Chips can cram the periodic table into your head or make whiz-bang calculations, but that's all they're good for, rote memory and superfast calculating. As the saying goes, a buttonhead's only as smart as his programmer. Some of the new Artificial Intelligence programs can make associative decisions very close to true thought. However, such "cognitive" AIs don't fit on anything smaller than a giant corporate mainframe costing more than most universities.

Continued next column

Continued from previous column

All of this has changed the way people learn. With information so easy to obtain, modern education no longer emphasizes rote memorization, but rather the management and analysis of information. Students are taught to sift the important information from the unimportant, and to synthesize conclusions from the result.

The universities that can afford it, like NCU, make frequent use of computers in the classroom. Students still gather with teachers for group discussions, but they spend much of their class time in the multi-curriculum study cubicles absorbing their lessons.

C1#14 Apartments:

These are privately owned residential apartment buildings rented entirely by students. The three identical blocks to the west of the university were built during the expansion phase to house new students. The uppermost block is of older construction apartment houses.

Security Level:2

C1#15 Lombardy Groceries:

Lombardy's Groceries is a small neighborhood grocery store. Out front is a phone/dataterm next to a screamsheet box.

Security Level:0

**STUDENT HOUSING**

Like most modern apartment complexes, all of the student housing facilities require electronic passkeys to enter the building. Once inside, further passkeys are needed to operate the elevators or enter an apartment.

Inside, student apartments range from high-tech playlands of the wealthy to thrift shop-decorated homes of the less well-to-do. Most students have some sort of personal computer on which they write papers and program assignments, download from the library database, and even access the Net. The difference between machines lies in the availability of money to buy giant color screens and gigachip programs.

Most apartments also have at least one entertainment center, with components ranging from the parents' aging CD and DAT players to the new Music Video Chip players equipped with braindance-style headsets. Cable TV is still a favorite among the college set. With over 2000 channels to choose from it's actually possible to

Continued next column

Continued from previous column

find something interesting to watch at most times. Artwork and fashion from the 1990's is the new vogue among students. They decorate their apartments with memorabilia like old cola ads and antique electronics pieces.

Grace Street Businesses

These businesses cater to the university students, offering them the services and products they need and want. In the evenings these streets are busy with young people. The smaller buildings are the original houses converted for business use, while the larger buildings are more recent constructions.

The *Voodoo Boys* also call this stretch of real estate home. They're a nasty bunch of boosters that gets as much fun out of terrorizing people with bloody chicken parts as they do extorting money from the shop owners. They prefer to use machetes on their victims and enemies, amputating body parts of the minor offenders and hacking others to death. It's easy to spot a Voodoo Boy in a crowd. They wear feathers, teeth and other trappings, and all have a distinctive bone through the nose.

The Voodoo Boys and Campus Security are extremely antagonistic. They also clash whenever the Voodoo Boys go after a student with extended security coverage. Security personnel never come into this neighborhood alone, while on university property, it's considered open season on the Voodoo Boys.

C1#16 Don's Hot Nuts:

Don painted this converted house bright green to give it a stand-out appearance. Now he and his wife stand outside his business and hand out free nut and candy samples to passing students. Don is a landlord of local renown, owning some of the dingier properties south of the campus.

Security Level:0

C1#17 Clothes in Modern:

The best in pre-owned clothes and accessories can be found inside, as well as the newest fashions. The upper floor is an apartment.

Security Level:1

C1#18 MacDonnells':

Fast food just like you had it back home.

Security Level:0

C1#19 Carriage Street Book and Coffee House:

The lower level is a fully stocked and eclectic bookstore. On the interior balcony overhanging the back of the store is the *Afterwords* coffee house, where patrons can sit and enjoy coffee, light drinks and sandwiches as they read their new

purchases. A dataterm can be found in front as well as a screamsheet box.

Security Level:1

C1#20 Newgate Prison/ Paragon:

Downstairs is *Newgate Prison*, a serious college drinking establishment made up to look like a famous London prison. The wooden benches and tables are bolted to the concrete floor, which is dotted with drains so that all the proprietors need to do is hose down the room at the end of the night. On Thursdays the bartenders pour pitchers of beer for only two dollars each and the line to get in can wind around the corner and partway down the street.

Upstairs is the *Paragon* bar, featuring a large dance floor and live bands most nights. Many local groups play here, most of them not very good, although occasionally a talented band passes through. Drinks are about half again as expensive as downstairs, so serious drinkers fill up at Newgate and just keep themselves topped off up here.

Security Level:1

C1#21 Market Drugs:

Market Drugs is a neighborhood drug store with a licensed pharmacist. Out front is a screamsheet box and dataterm.

Security Level:1

C1#22 Hababas:

Still a favorite of the local rowdies, Hababas once was a respectable biker bar, but is now the preferred hangout of the Voodoo Boys boostergang. The front plate window, perpetually broken, now has a permanent plywood support sheet attached to it. Inside, the furniture is thick and hard to break, and the two hefty bouncers discourage armed conflicts inside the bar. Students who fancy themselves toughs, or are looking for a rough time, frequent this bar.

Security Level:0

C1#23 Biograph Theater:

The Biograph is a charming 1970's era two-screen theater. One side is art films and other sophisticated fare for the educated college audience. The other side features pornographic movies, the revenues from which support the art theater side.

Security Level:0

C1#24 Metro Cafe:

The interior is decorated with a modern European flair. Best on the menu is their monstrous one-pound hamburger, made with a full pound of soya-beef and a choice of extravagant toppings. Mounted against the wall in the rear-most booths are braindance boxes playing the latest DMS releases. If he knows the right people, a customer can experience limited release artistic braindances, and (rumor has it) even restricted underground productions.

Security Level:0

C1#25 Fashion Cuts:

Fashion Cuts is tucked away behind the Biograph and Metro Cafe. From the street, the only evidence of its presence is the neon Fashion Cuts logo on the building's side. Their hair artists are skilled in all the latest styles, from magnetic spikes to true neon interweaving.

Security Level:0

C1#26 Stuart Hospital:

The best medical care money can buy. Stuart Hospital is a private, full-service multi-bed hospital with complete emergency medical facilities. They run a complete financial check on new patents and do not treat credit risks.

Security Level:2

C1#27 Byrd Student Co-op Housing:

Night City University houses many of its resident students in this converted hotel.

Security Level:2

C1#28 The Ritz:

This is a privately-owned apartment building inhabited mostly by students.

Security Level:1

C1#29 Apartments:

All of the buildings on this block have been converted to apartments which are rented to students.

Security Level:1

PERSONALITIES

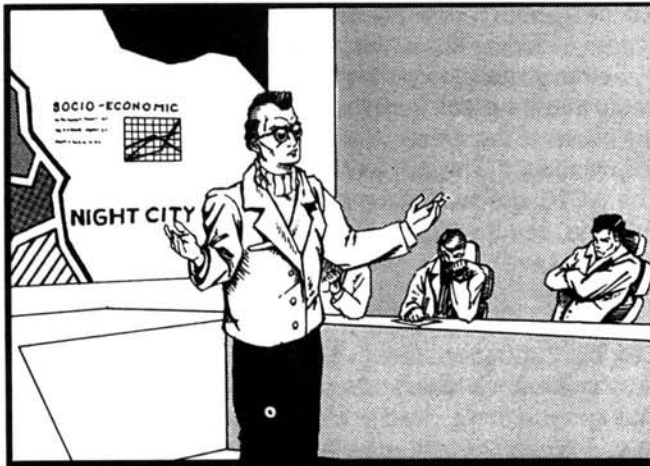

Dr. Michaels (from Pacifica schoolboard meeting, May 2004)

Dr. Edward Michaels, Ph.D. Dean of Night City University. Anyone who wants anything from the University will eventually meet with this man. He is balding and in his late fifties, but

still runs every morning to keep in shape. Dr. Michaels is a very open and honest man, he made his reputation for excellence in the academic circles during his term on the Pacifica school board. He always tries to keep the corporations out of the University's decision-making processes. Michaels also believes that everyone at the university should be treated equally; while many of his colleagues believe that total corporate sponsorship is the way to go.

INT 10, REF 4, TECH 5, COOL 8, ATTR 6, LUCK 4, MA 5, BODY 6, EMP 9

SKILLS: Education 9, System Knowledge (University) 10, Chemistry 9, Physics 6, Biology 5, History 4, Botany 2, Leadership 1, Mathematics 6, Geology 1

CYBERNETICS: Cyberaudio with digital recorder link.

ENCOUNTERS

1: The Voodoo Boys are causing trouble again. Do you really want to get involved?

2: The bulletin board reads "Netrunner wanted for research on cutting edge technologies." Sound interesting?

3: A well-dressed young woman is being assaulted by members of the Voodoo Boys. What the players don't know is that she is a corporate's daughter, and helping her will carry a big cash reward.

4-6: Business as usual.

7: A young student asks if she can examine the cyberware one of the players is sporting. She is an aspiring Tech and hasn't yet seen that model.

8: Schools out for the day. Traffic moves at a crawl.

9: Run across another victim of the Voodoo Boys. You know, something should really be done about them.

10: An anti-corporate protest is on its way to the park.

CONTACTS

Samantha Yurrid- A promising biochemistry student, she may soon attract the Corporations' attention.

Hilda Gustav- A student netrunner. She knows all the BBS' where student runners hang out, and would make a great ally in the Net.

Arthur Edwards- A member of the NCU Student Council, Arthur is a big supporter of the free market system, and a secret member of the *Corporate Raiders* posegang.

Karen Liston- Works in Admissions, and has access to all of the school records.

Michael Hill- The head of Campus Police. He is also covertly on Arasaka's payroll, reporting any potential talent (or troublemakers) to them.

LAKE PARK

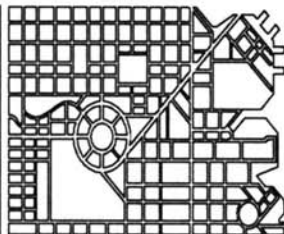

D A T A T E R M

Designed by Richard Night to be the playground of his model city, the City government officially dedicated Lake Park to his memory. The grandstand that was built in 2014 to commemorate his death still bears a bronze plaque with his name on it; one of the few items of metal in the Park not yet pried off it's fixture and sold by an ambitious punker.

Most of the only natural plant life in Night City grows in the Park. The Park itself is totally man-made, from the lake to the patches of trees, with specially bio-engineered foliage contributed as a gift by the Biotechnica Corporation.

By day the city owns the park; custodians keep it clean, and young mothers bring their children to play in a "natural" environment. But night is a different story. When the sun goes down, the "residents" emerge from the filth in which they have been hiding, and stalk the silent greenswards. The park is a very dangerous place at night, and there have been many disappearances. The bodies are never found. Ever.

And some of the residents look suspiciously well-fed.

C2#1 The Lake:

The lake has a built-in filtration system, which the Park Department runs once a day. With the water cleaned daily the lake can be used for swimming and other water sports on hot days. There is however a 15% chance on any given day that the filtration system will be out of order. On these days the lake smells like raw sewage, and the park is almost deserted.

Security Level:NA

C2#2 Isadore Island:

No one has any idea how this island got its name—it's just called that. Once a week, when the sun goes down, the *Gilligan's* have their weekly meeting here. During the day one can usually find juvegangers making out in the woods.

Security Level:NA

C2#3 The Picnic Grounds:

This island is connected to the rest of the park by a small bridge, and is used as a picnic and cooking spot. There are gas-powered grills at locations all over the island. The gas is turned off at night.

Security Level:NA

C2#4 Night City Fire Station #2:

This block houses the second of two downtown Night City fire stations; Station Two is responsible for everything west of the Corporate Center. The NCFD is electronically hooked into the police emergency network. This, in addition to three AV-4's specifically designed as fire-fighting units give the fire department a response time of mere minutes in the case of smaller fires. The snag in the system comes when the department needs to roll out the old-fashioned tanker trucks. The traffic is usually so bad that a building is often burnt to the ground before the bigger trucks can reach it. In response to this problem, the Fire Department is now working on a project to replace the older tanker trucks with a modified version of the AV-8 specifically designed for use as a fire-fighting vehicle.

The station itself includes sleeping and eating quarters for 20 men, who work a three day on and four day off rotating shift. On site are three AV's, four light trucks, three hook and ladders, and five tankers. In the case of a large fire in the downtown area, the lake can be used as a water supply.

Security Level:2

C2#5 The Night City Transit Corporation:

This entire block is devoted to the offices and headquarters of the Transit Corporation. This civic organization is responsible for the smooth running of the entire Night City mass transit system, including all buslines, NCART and the inter-continental Planetran station. From here the authorities can monitor the entire transit system, from the maglev trains in the tunnels to the busses in the streets. If anything goes wrong, the NCTC knows about it. The staff is well trained and does a good job. The NCTC also has total police power over its busses and subways, and is willing to use it.

Security Level:3

C2#6 Combat Cabb™

Combat Cabb specialises in ground vehicle transport, with cabs armored like tanks and armed like AV-9s. Their mottoes, "We get you there, dead or alive", and "Leave the Combat to us," typify the attitude of its freebooting drivers. Now world famous, thanks to DMS's long running comedy-drama, the Combat Cabb company began as a four hack operation in early 2011. Its colorful staff of cyberwar vets, recovered cyberpsychosis cases and expatriate Corporates, led by retired solo and mercenary Harrick McGivenay, soon became a popular local legend. In 2013, author G. Stafford drafted a slightly fictionalized account of CC's adventures

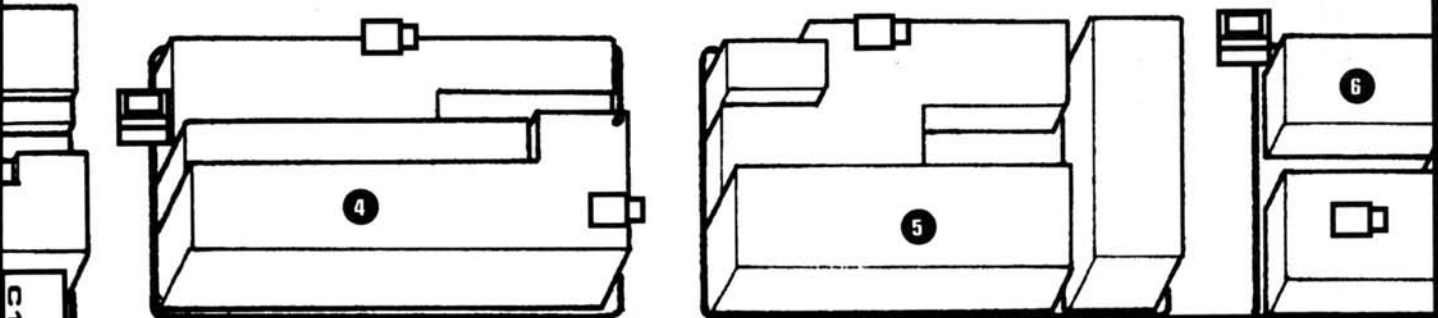
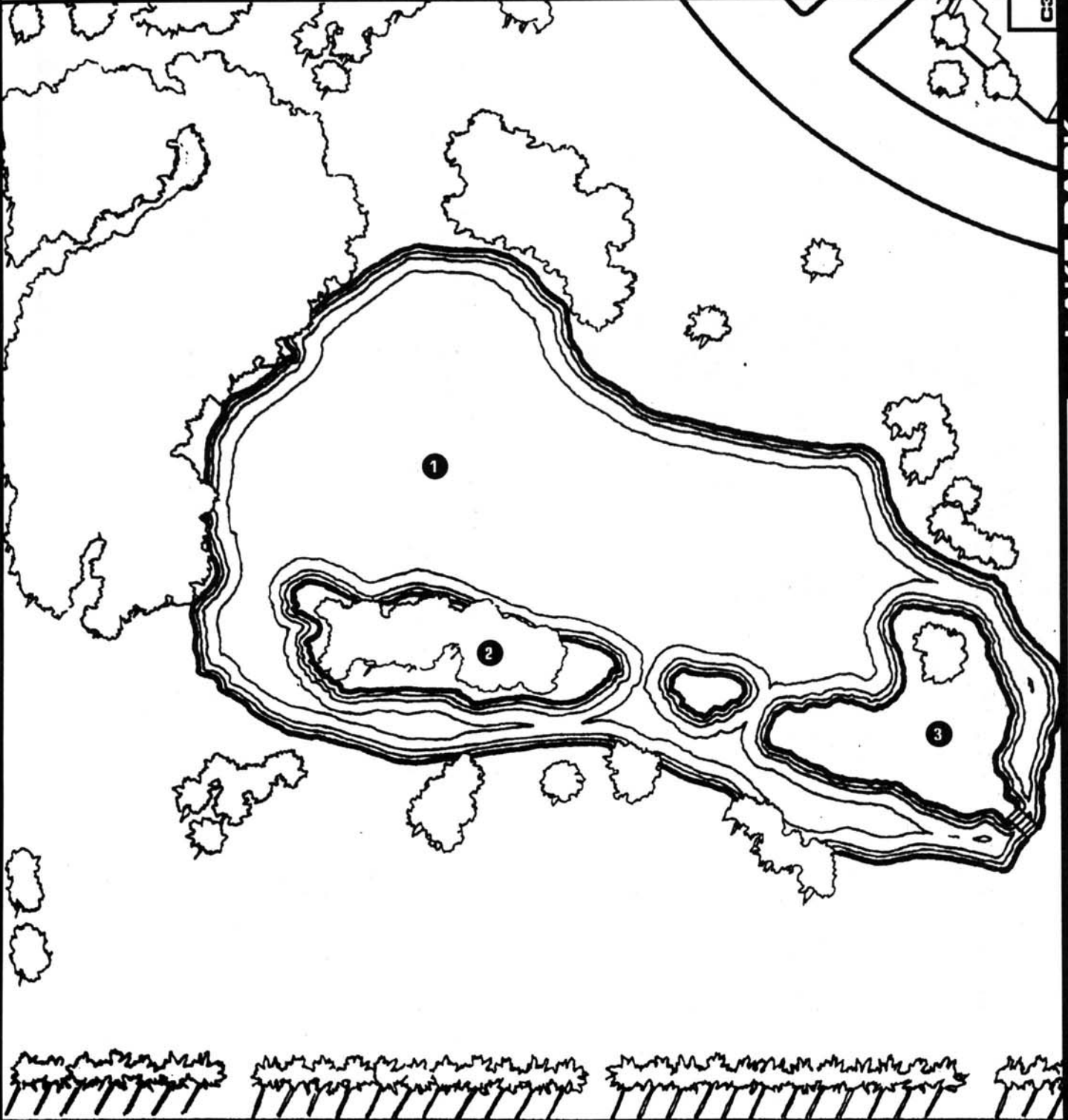



during the Mob Wars and the Metal Wars after; the book was later produced as a movie by director Francesco Cippolina, then taken to video in 2017 by Diverse Media Systems. For the last three years, hundreds of millions have been glued each Thursday night to their vid-screens, faithfully following the adventures of Harrick (portrayed by screen hunk Patrick Lewis-Lyndell), his partner/lover Emmanuelle Moore (toughest cabbie in the City), and the rest of Combat Cabb's lovable cast, making the series one of the highest-rated vid-shows in history.

True to its rough-and-ready background, the Combat Cabb offices are situated in two heavily-armored, almost bunkerlike buildings. The northernmost building contains the main garage and dispatch offices. The second building contains a well-guarded munitions bunker, repair facilities, and six "special-cabs" (read: heavily armed fan panzers purchased at government auction after the Central American Conflicts). These are used for only the most extreme fares, or to bail out "Com-Cabbies" trapped in the lower reaches of the Zone. Four small buildings grouped around a central courtyard serve as housing, lunchroom, break area and rec-area for CC's rather extended family.

Security Level:2

PERSONALITIES

Erika Annabelle- Erika is the head of the NCTC, and the youngest woman ever to hold a position in the Night City government. Only twenty-four, she now looks well over thirty; there are many who say that her job is second only to the police chief for the amount of stress involved. She is personally responsible to the mayor for any accident involving the Transit Corporation. If there is any one person who knows how all Night City operates, it's her.

INT 10, REF 6, TECH 7, COOL 9, ATTR 8, LUCK 7, MA 6, BODY 6, EMP 6

SKILLS: Personal Grooming 7, System Knowledge(Public Transport systems) 10, History(Night City) 7, Streetwise 6, Electronics 4, Leadership 4, Dance 3

CYBERNETICS: Chipware socket.

Kilven Wilkon- The leader of the largest homeless pack in the City, and an excellent source of information for going's on in the Park area. Kilven is a rather likeable man, and has moderated several disputes between gangs who frequent the park. For this reason, the homeless who reside in the park are kept generally safe from gang activity. In some

cases the local gangs will even protect the Pack from outside gangs that enter the park.

Kilven was at one time was a highly respected corporate lawyer, until he took on one case too big. Now he and his family are homeless. He is trying to form other small packs into a nomad family, and is having a remarkable success in this area. It should also be noted that Kilven has powerful friends he can call on. A Network 54 reporter and two different solo's will often come to his aid if he contacts them.

INT 8, REF 6, TECH 6, COOL 9, ATTR 7, LUCK 5,
MA 7, BODY 8, EMP 10

SKILLS: Leadership 9, Melee Weapon 5, Human Perception 6, Streetwise 8, Education 6, Law 7, First Aid 4

CYBERNETICS: None.

ENCOUNTERS

1. The Blood Razors are attacking a homeless pack; there is a small booster gang defending the pack but the Razors are slaughtering them.

2. A single member of the Blood Razors has ambushed a homeless family. The father has been knocked out, leaving the mother and young son at the Booster's mercy. And he doesn't have any.

3. Fires in the park. All the homeless packs are having a meeting. A 50% chance the police will come in and disperse the "riot". With live ammunition.

4. A homeless man asks the players if any of them are a doctor. His wife is having complications in her childbirth. If the players help the Pack may "take them in".

5. The Players spot a homeless girl being dragged into the undergrowth by several gang members from the infamous Breakfast Klub.

6-8. Congratulations! You've just discovered that there really are cannibal gangs in the Park! You're jumped by four of the Breakfast Klub and asked to dinner.

9. One member of the Pack has asked the players if they will help defend them from a gang attack. If the players will help, the Pack will "take them in"

10. Several Arasaka security troops are killing homeless, "on orders."



THE PACK

With a one room conapt going for 1500eb a month, the homeless problem in Night City has reached epidemic proportions (there's never been an official census of the homeless population in the City, but estimates place it at around ten to fifteen thousand). The Street is impossibly crowded, and often there are ten or twenty people fighting to sleep in the same dumpster. Worse, the gangs prey on the homeless, the cops beat them and drive them out of the more livable sections of the City, and corporate security often uses them for target practice (or worse). In Night City, the only real refuge for these victims is the Park; a place with little or no police and plenty of bio-engineered foliage to huddle under at night.

Much like a nomad Elder, Kilven Wilkson has banded these various groups of terrorized Park dwellers together into a large organization nicknamed the "Pack". The Pack operates much like any other nomad family, with a rough chain of command based on seniority, communal food sharing and group defense. Unlike other nomad bands, the Pack doesn't have any vehicles; if they did, you can bet they'd be living in them.

No one knows exactly how large the Pack really is, but thanks to its numbers and Kilven's street savvy, it is becoming a political force to be reckoned with. In addition, the Pack has negotiated loose alliances with some of the gangs in the Park Area. Even a booster gang can appreciate having a thousand-plus people willing to help out in the next big turf war.

The Pack also will "take in" outsiders who have helped them out in some way. Even important and famous people have been adopted by The Pack; rocker Johnny Silverhand, for his Pack-benefit concerts, solo Andrew Scythe of the Hacienda, for defending The Pack against the Bay Area Rapid Terror, and media Jacob Davies, a Net 54 reporter who conned the police into helping the Pack during a gang attack. As a result, the Pack has some powerful friends.

JAPAN TOWN

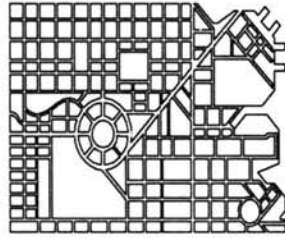

D A T A T E R M

The streets never rest in this section of Night City, whether it's the scum that surfaces from the Park at night, or the glitzy corporates visiting the Bodukkan to see the newest from the Nakagowa Kabuki troupe. In a city that never sleeps, Japantown (or J-town) provides the antidote for the late night blues. If you're a high level corporate, or streetscum looking for a score, this is where you find what you're looking for. The corporate security keeps the J-Town streets clean and pleasant, but the Park belongs to the night.

J-town is especially important to Night City for two reasons. First, it's the cultural center for Night City's sizable Japanese community, and in a city where the most powerful corporation is Arasaka Security, that's saying a lot. Second, Japantown is home base for most of the *yakuza* (Japanese gangster) families operating throughout the Free State of NorCal; it's centrally located, has limited police interference, and outsiders tend to stick out like a sore thumb.

C3#1 The Lake Park Bandstand:

The park bandstand is a piece of Night City history, built to commemorate the death of Richard Knight. Destroyed during the Homeless Riots of 2014, and rebuilt soon after, it was used by Johnny Silverhand during his famous free benefit concert to bring attention to brutal methods the NCPD used to quell the riots. The Bandstand stood pretty well neglected for the next few years, only to enter the headlines once again when the Cyberpsycho Squad from the Muckjuck ran a mass murderer known as "The Claw" to ground here in 2019. After that, the Bandstand got a fresh coat of paint, and is now used by public officials and the occasional rockerboy for small events.

Security Level:NA

C3#2 The Gazebo:

This small wooden structure has almost as much of a history as the Bandstand. Rumor has it that Richard Night built it himself, and that he planned to propose to his lover in it on the completion of his city. Even if this romantic tale is true, he (unfortunately) never got the chance.

The Gazebo is also where "The Claw" left most of his victim's bodies; he was on his way there when he was killed by C-SWAT. It's now used by anyone who can think of something interesting to do there (which isn't much). Rumor has it that the City is planning to tear it down.

Security Level:NA

C3#3 The Garden:

Even in the hard, dark streets of Night City there is a lover's lane, and the Garden is it. This small mini-park, with its fountain and roses, is the one spot in Night City where the old-fashioned late-night stroll with one's lover is still possible, thanks to the constant patrolling of the *Gold Eagles*, a Japantown-based guardian gang who have selected the Garden as their turf. Why the Eagles perform this public service is unclear (rumor has it that the gangleader's sister was murdered there); but no matter what the time, if anyone wants stroll in the garden, they can be assured of being safe thanks to this gang's vigilant presence.

Security Level:NA

C3#4 The Bodukkan Center for the Performing Arts:

This is one of the most prestigious performing arts centers on the West Coast. Its original funding came from a combination of Arasaka grants and matching funds donated from the considerable fortunes of Night City's leading *yakuza* (gangster) families. The Bodukkan features two full stages for plays or operas, and a larger main stage that is usually used to accommodate the Bodukkan Center's premiere attraction: the Nakagowa Kabuki Troupe.

The Nakagowa Kabuki Troupe is widely hailed as one of the greatest Kabuki performing troupes in the history of the artform. Some Troupe members are so dedicated as to have been bio-sculpted to match their time-honored and classical roles as demons, princes, or princesses. These actors are *never* out of character, and when they make public appearances they always appear in their roles. There has been some discussion in the media to the effect that the Troupe is basically a professional posergang, but this has always been scoffed at by true Kabuki aficionados.

When the Troupe is not performing, the large stage is used for first-run movies or Broadway plays from the East Coast. The Bodukkan is world-famous for its posh luxury; Japanese visitors like to think of it as a little gem of culture set among the *gaijin* barbarians.

Security Level:2

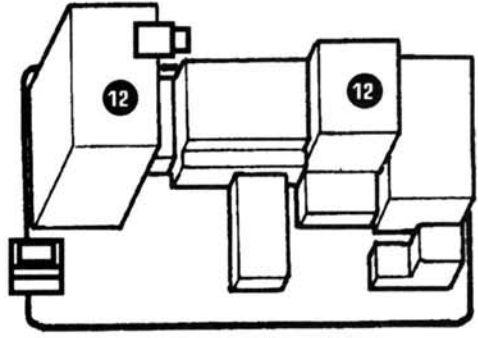
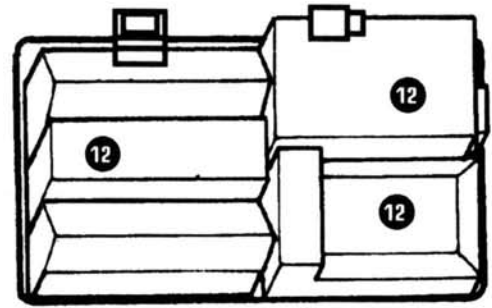
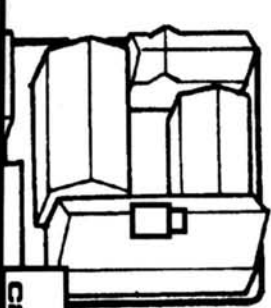
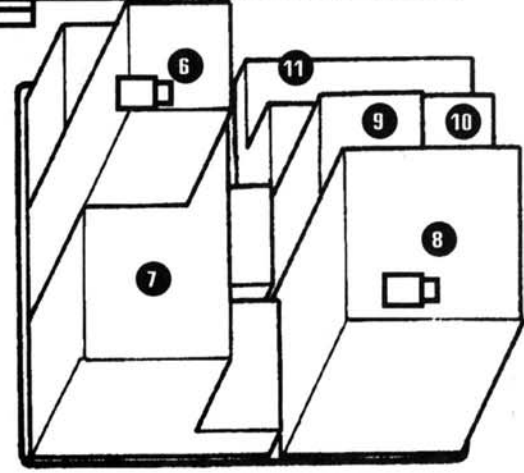
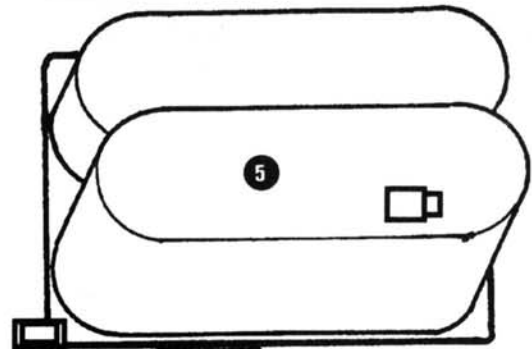
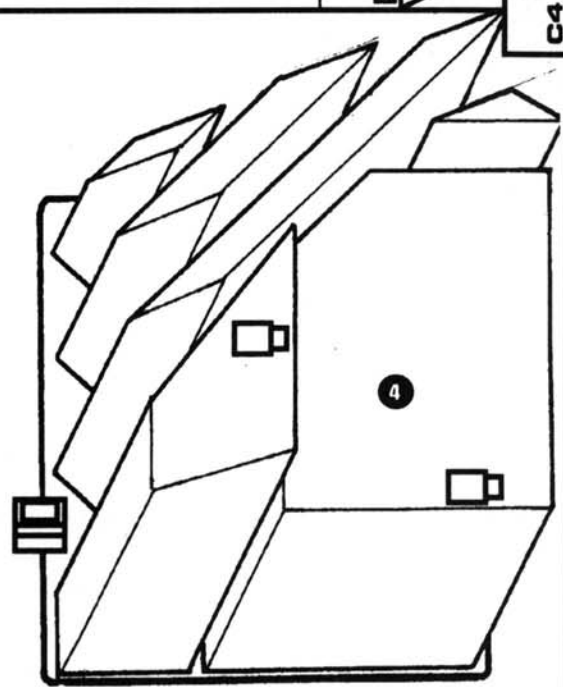
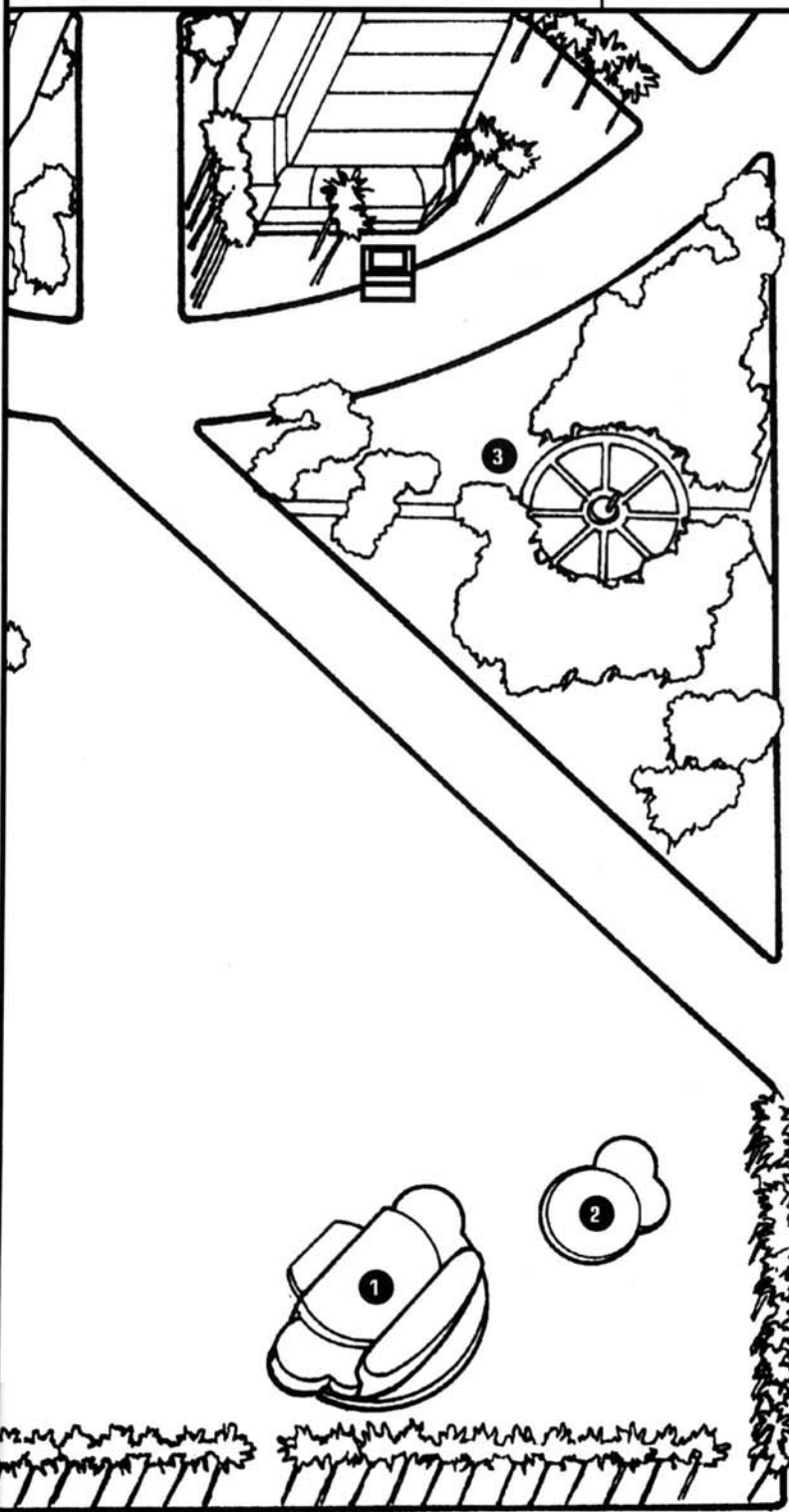

C3#5 The Japan Trade Center:

These buildings are the heart of the Japanese community in Night City. Within these walls, high-level executives from most of the Japanese corporations operating within the United States meet monthly to discuss economic strategy and future acquisitions. This informal group represents some of the most powerful economic forces at work within 2020 America, and the topics of its meetings are kept quite secret. **Security Level:2**

C3#6 The Tokagawa Tower:

The bottom floor of this building is home to many small businesses, most of which are nothing out of the ordinary; lawyers, an acupuncture clinic, and several small Japanese bookstores. The top floor of the Tower is occupied by the local *yakuza* boss, Hichigo Kanzaki, his family and retainers.

The most noteworthy establishment takes up the middle three floors of the building. This is the **Japanese Cultural Heritage Museum**. Made possible by a grant from Arasaka, the J.C.H.M. is a tour of the heritage of the Japanese people, from ancient times to the present. Well worth the 2eb entrance charge.

Security Level:1 (Level 3 on top floor)

C3#7 Nichiban Mall:

This long building houses the Nichiban Mall. Only about one third of the mall is above ground, the rest sinks straight into the earth. The mall is built along the lines of the classic Japanese "underground malls" of the late 20th century. Once inside, there is absolutely no way to tell that you are even in America, (except for all the tourists). The clean, spare architecture features Japanese accents and tiny girls in crisp, pressed uniforms stand as "greeters" at every entrance. The shops are either food chains popular in Japan, or small household convenience shops catering to an exclusively Japanese population. All signs are in Japanese, and any *gaijin* (foreigner) wandering about will have a hard time getting directions.

Security Level:1

C3#8 The Nakagumi Business Plaza:

This hollow-core building is home to many small businesses. Most are unnoteworthy, being small shops, vidstores, book sellers, a couple of noodle-takeout lunch spots and the assorted flotsam and jetsam a place like this collects.

The Plaza has only four notable establishments. The first is the **Kanchi**, a small but expensive Japanese restaurant, serving what many edgerunners claim is the best Japanese *teppan* cuisine in town. Word on J-town streets is that the large booth in the back is reserved exclusively for the local *oyabun* (gangster chieftain) and his retinue, but that, of course, is only a rumor.

The **Hasagumi** is a total-body beauty parlor, offering everything from haircuts to making arrangements for bio-

sculpting. Wives of Arasaka execs and local *yakuza* come here. It's a great place to hear gossip (if you happen to speak Japanese).

The **XYZ Piano Bar** is a well-known J-town fixture, featuring a dimly lit, smoke-wreathed bar, attractive bargirls (who will sit in your lap if you buy them a watered-down drink), real wood panelling and leather booths. The XYZ also specializes in *karaoke* singing: automated music players synched with open microphones provided for its guests. Patrons are welcomed—no, urged by prodding from the bar girls and other patrons, to come up to the mike and sing renditions of popular songs (in either Japanese or English) accompanied by taped musical arrangements. A hologram system combined with a sophisticated rear projection TV screen allows the singer to even participate in canned music videos.

Besides being notable for its *karaoke* bar, the XYZ is also known as a popular *yakuza* watering hole. On any weekend night, you can find scores of heavily built men with tatoos peeking from under suit cuffs, wearing wraparound shades, nursing their scotches-over-ice, fondling the bargirls, and discussing underworld business in whispered Japanese. For a solo or fixer of Japanese descent, the XYZ is a great place to pick up leads, look for jobs, or just soak up a little atmosphere.

Cherry Blossom Memories is one of the most interesting places in the southern side of the City; it is a braintance arcade with a twist—all the 'dances here are reenactments from Japanese history. For an exorbitant fee (50eb.) you can be a ninja working for the Tokagowa Shogunate, an Imperial princess, a brave Samurai *ronin*, or the current favorite, a fighter pilot making a daring raid on Pearl Harbor.

Security Level:2

C3#9 The Imperial Bank:

This is a prestigious institution with home offices based in Japan. One of the largest Japanese-owned lending institutions, it has a reputation as an "everyman bank"; a bank for the people. Most of the residents of Night City's Japantown have accounts here. It has never been robbed, and many believe this is because the bank has an Arasaka security contract; a very expensive security contract.

Security Level:3

C3#10 Hotel Yamagumi:

This is a small and rather unassuming hotel nudged between the plaza and Michiko's. The only remarkable thing about this hotel is the comfort. Many say that the best place to stay in the city for the cash. An interesting note: City records show that this hotel is owned by Arasaka. No one really knows why.

As it happens, a legendary knife artist with the improbable nickname of "Savage Doc" maintains a three-room suite in the Yamaguchi. Although his actual ripperdoc studio is

located in a residential district to the south, Doc can usually be found at the hotel during the day, taking appointments for the night's work.

Security Level:1

C3#11 Michiko's:

If you are a modern "fashion victim", this is the shop for you. The entire shop is dedicated to women's fashions; from tops that show vid-images to good old-fashioned mini-skirts, Michiko's has it all. Mostly popular with late-teen corpzoners and younger movers, Michiko's features the Night City exclusive on the entire *Eji of Japan* collection.

Security Level:1

C3#12 Japanese Neighborhoods:

These are apartments and homes for the large Japanese community in Night City. Local private security is good and the streets are clean.

Security Level:1

PERSONALITIES



Shinobu Nakagowa in performance (Feb. 12, 2019)

"Shinobu" Nakagowa-"Shinobu" is one of the most publically active of the entire Nakagowa Kabuki Troupe, playing all the group's female lead roles. Bio-sculpted into "her" role, Nakagowa always appears in public dressed in kimono and moving with the grace of a feudal princess.

Traditionally, all women's roles in Kabuki theatre are played by men, so no one knows if Shinobu is female or a young man 'sculpted to look female. If Shinobu is male, no one will probably ever know; "she" never speaks, lending credence to rumors that her vocal cords have been cut. Shinobu always walks and acts with a feminine grace that seems to come naturally.

Shinobu leads an active life within the City, appearing at charity benefits, giving donations to whatever cause seems most needy at the moment. She is a favorite of the media and

the entire city is charmed by her. The most popular player in the Troupe, and by far the most friendly, she has been known to mingle with the audience after performances (something the other members have never done).

INT 9, REF 10, TECH 3, COOL 8, ATTR 9, LUCK 8, MA 4, BODY 5, EMP 10

SKILLS: Poise and Grace 10, Personal Grooming 9, Wardrobe & Style 4, Social 6, Preform 10, Human Perception 5, Melee Weapon(thrown poison hairpin) 3, Dance 9

CYBERNETICS: None.

Hichigo Kanzaki—The local *yakuza* clan head or *oyabun*, he is an aging but still powerful man in his sixties. Impeccably dressed in a severe grey suit, he is never without his bodyguard of six enforcers. Among his retinue are his son Shin (slated to inherit control of the clan when Hichigo retires), his beautiful daughter Yasumé, and his wife Hitome.

Hichigo is a man of habit; he moves in a predictable orbit from his luxurious penthouse home to his main headquarters in the back of the XYZ Piano Bar. He is considered to be a leading pillar of the community, and takes his civic responsibilities as seriously as he does his underworld duties. When something goes wrong in J-town, this is the man to see about fixing it. Whether it takes guns or money, Kanzaki-sama always takes care of his own.

INT 8, REF 6, TECH 2, COOL 9, ATTR 4, LUCK 5, MA 4, BODY 8, EMP 5

SKILLS: Wardrobe & Style 8, Social(Japanese Custom) 7, Human Perception 7, Brawling 10, Handgun 9, Submachinegun 8, Intimidation 10, Combat Sense +10.

CYBERNETICS: Cyberoptics with IR, Times Square, radio-splice.

ENCOUNTERS

1. A group of four boosters is dragging a girl into the park to have some fun. She is going to be killed if the players don't put a stop to it.
2. Three dorphers want some cash to get their fix. To get it they are selling small, cute grey kittens.
3. A small fire is burning in the park, and a group of posers roasting things that resemble small, grey rats. Kittens from encounter #2?
4. Spot a famous face in line to a performance at the Bodukkan.
5. Gang fight near the Garden. Three members of the Gold Eagles are ripping up six members of the Blood Razors. Serious kung-fu sword action.

NIGHT CITY

SECTION C3

6-8. A group of six to seven *yakuza* escorting the local *oyabun* to (or from) his car (a BMW 901 8s). The Street is momentarily choked with expensive cars and tattooed guys in suits and sunglasses.

9. Gunfire coming from the residential district. The local *yakusa* seem to be having a disagreement; do you really want to get involved?

10. All is quiet.

CONTACTS

Michiko Yashida- The owner of Michiko's. In actuality this "teenager" is over thirty years old. She uses hormone treatments and the occasional bio-sculpt job to remain looking just over seventeen, claiming it helps her "keep better track of the youth market."

"Bill"- A pal of Savage Doc's, he can set up an appointment at any time during the day or night. He works at the Hotel Yamigumi as a bellboy.

Kimki Yasaka- An usherette at the Boudakkan. She has the keys to the entire place. She is also dating a corp from Arasaka.

"The Knife" A Yakuza hitman now operating in the

Night City Area. A master of disguise; no one knows what The Knife looks like, or even what sex this assassin really is. You can leave a message at the dataterm outside the Imperial Bank, under the access code *katana*.

Mamoru Shintani- Leader of the Gold Eagles, this guardian is one of the best of his kind in the city. Specializing in monokatana combat, the Golden Eagles patrol the Garden as part of an honor debt related to the death of Shintani-san's younger sister.

Kenshiro Saeba A young solo who served in the Central American Conflicts, Kenshiro once worked as a private investigator in Little Italy, where he picked up the nickname "The Night Hunter". However, when he cracked a kidnapping case involving Yasume Kanzaki and a rival Mob boss, he was forced to pull up stakes and hide out in J-town.

Much to his heir Shin's fury, *Oyabun* Kanzaki is quite fond of Ken and treats him almost as a second son. A hellacious hand with a gun (Skill 10) and a good man to have backing you in a fight.

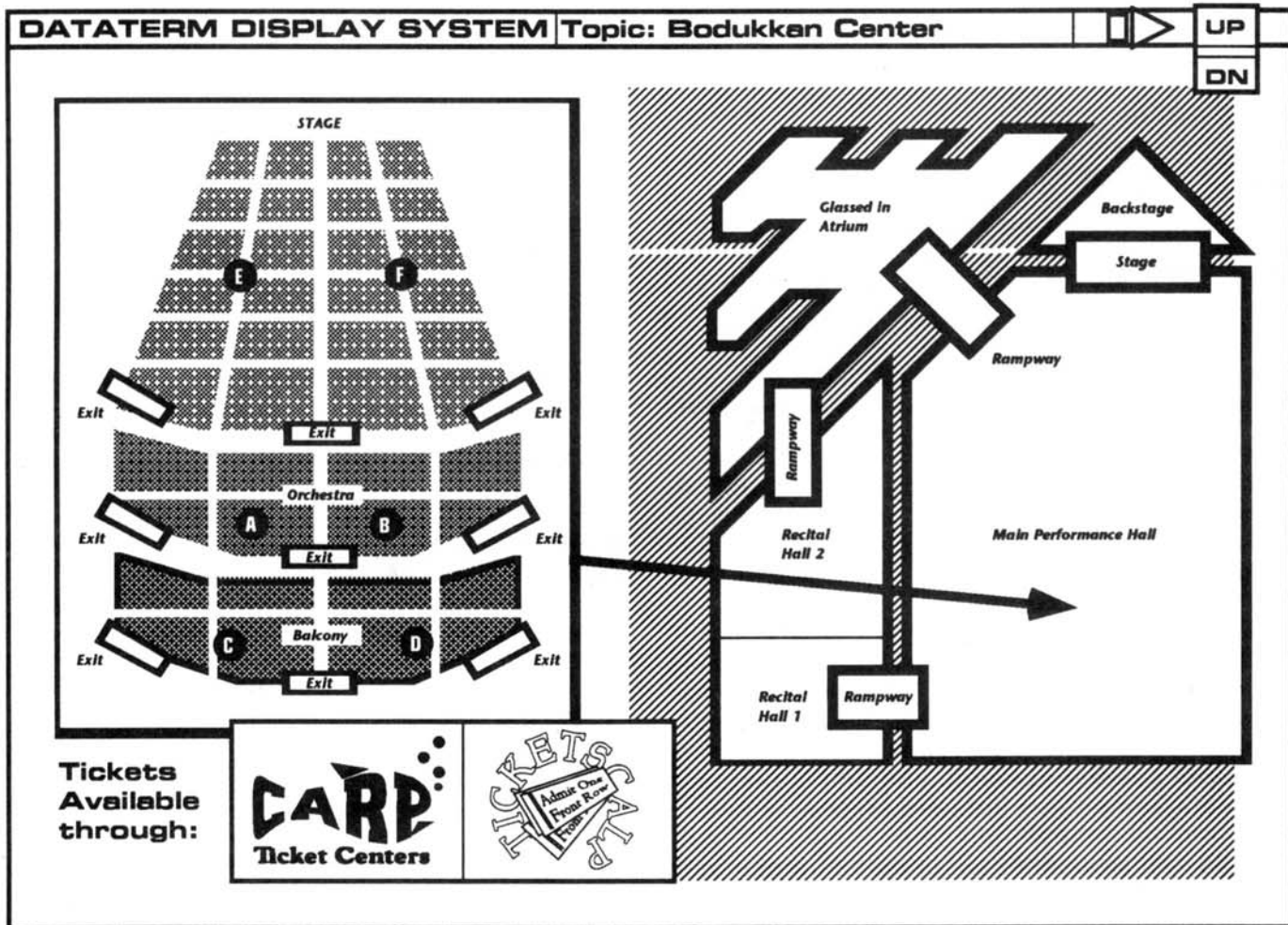

LITTLE CHINA

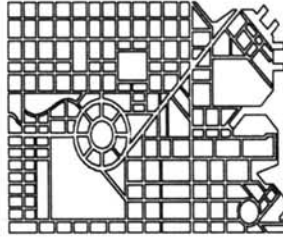

D A T A T E R M

Little China is a neighborhood of light commercial properties, retail shops, and apartment complexes to the eastward, between the central City and it's eastern waterfront. Some of the oldest buildings in Night City can be found in this part of town, many dating back to before the inception of Richard Night's original urban plan. With the completion of the urban plan, the area known as Chinatown has been pushed steadily southward by encroaching development. Many of these small shops and buildings have been marked for demolition and urban renewal, but have been ignored until recently, thanks to larger concerns like the Collapse and the Mob War.

Not having the obvious clout of the Night City Japanese community, the local Chinese leaders drew the line here, realizing they would soon end up in the middle of the Combat Zone (and certain destruction). Developers have found entering the area tough going, with local street tongs sabotaging equipment and terrorizing workers. In addition, a recent influx of cash from Southeast Asia has made it possible to keep the neighborhood firmly in local hands.

Most of these blocks have been cordoned off for pedestrian traffic only, except for 22nd Street which runs directly through the middle of this district. Small shops, restaurants, and open air markets abound in this district.

No matter what the neighborhood's history, the most dominant building in this area is unarguably the massive **Night City Police Headquarters**. Built in 2018 of reinforced concrete and mirrored (SP 100) armorglas, this facility is an imposing twenty floors of urban fortification. It is here that

much of Night City's police operations are based, as well as its newly designed **Criminal Court Division**. The building deserves special consideration, inasmuch as this is where all serious weapons crimes and felony violators (aka "player characters") will be taken if captured.

C4#1 Night City Police Headquarters, aka "Southside Central-Precinct #3"

While most criminal cases in Night City are handled out of the Municipal Criminal Justice Complex, the City soon realized that there was neither enough room to handle the large number of police operations needed to pacify the Combat Zone, or a place with enough security to handle a two-ton rampaging cyberspycho. The result was the Night City Police Headquarters, a maximum security facility equal to any Federal Prison in the United States, constructed on the site of the original Southside Police Precinct #3.

There are six elevator shafts in this building. Four are normal elevators that provide service to the first through ninth floors, the fourteenth floor and rooftop, while two of these elevators are small six by six foot affairs. One is used to transport criminals from the first floor booking to the jails, high security and the Criminal Court Division and has no way to reach any but those floors. The other elevator is used by Special Police Operations to reach the rooftop heli-pad or to go to any floor in the building for internal security purposes.

The sub-basement was originally designed as a fallout shelter, but is now used as quarters and training area for Special Police Operations. It contains the armory and weapon repair section, a seventy-foot firearm range, and four evidence storage vaults. The upper basement is completely committed to underground parking of police cruisers, officer's personal vehicles, and assorted police ground vehicles. Light technical and repair facilities for refueling and maintenance are also found here. Any police vehicles damaged (or vehicles impounded) during an arrest are taken here for processing, storage, or repair.

The first floor contains the entry mezzanine, booking offices, and a small commissary. The second through eighth floors houses department offices, holding cubicles, and interview rooms. Each floor contains a specific criminal division, i.e. Corporate/Fraud, Theft, Homicide, Vice, Narco, and Internal Affairs.

Home to the new **Criminal Court Division**, the redesigned ninth and tenth floors are devoted entirely to judicial and sentencing sections. Totally streamlined and automated, it is here that alleged criminals are tried and if found guilty, sentenced for their acts. The eleventh floor contains the Forensics department, computer operations, and file rooms. Locker rooms, a gym and weight room, showers, and facilities to house thirty-six officers in six bunk rooms are located on

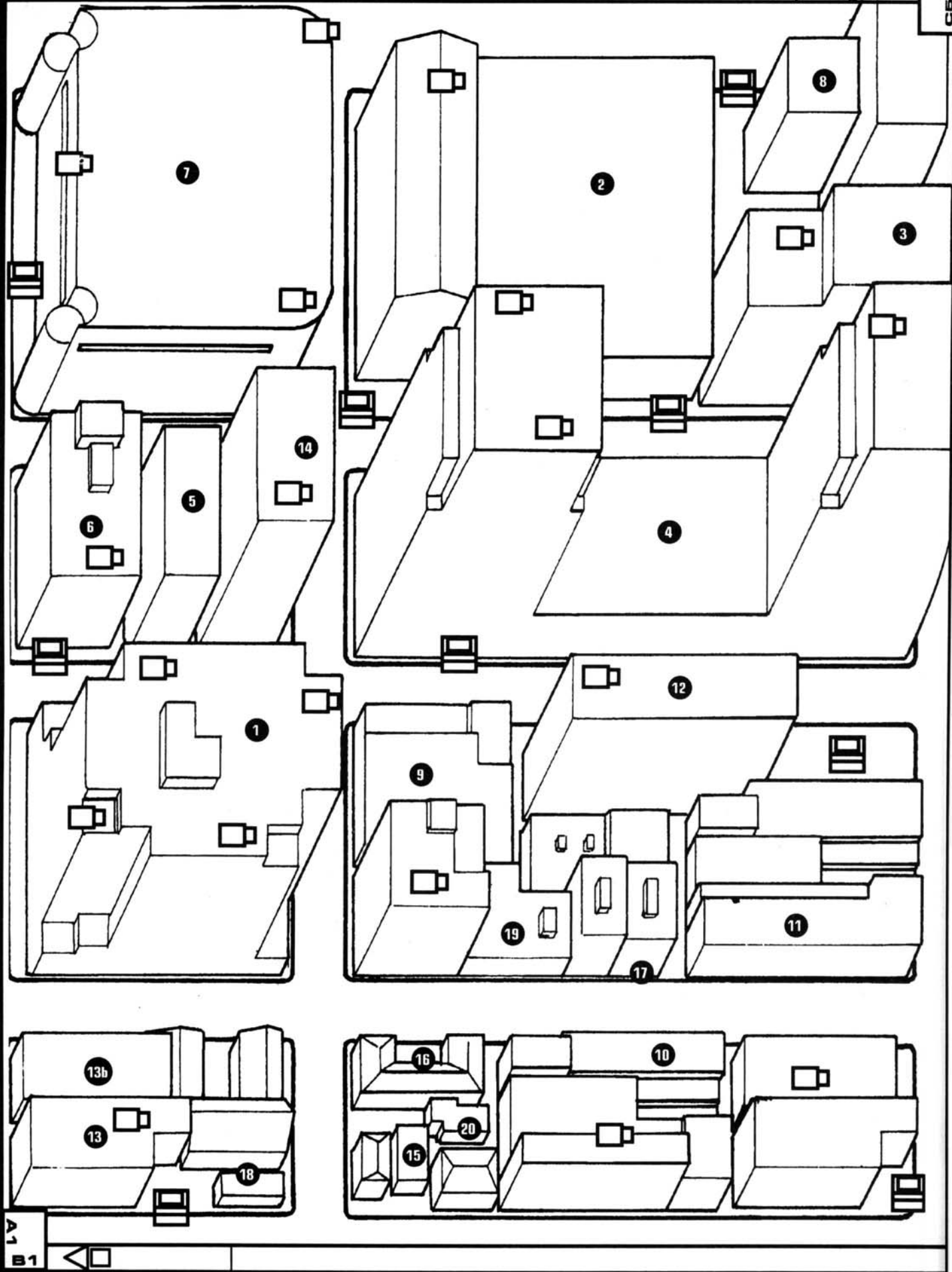

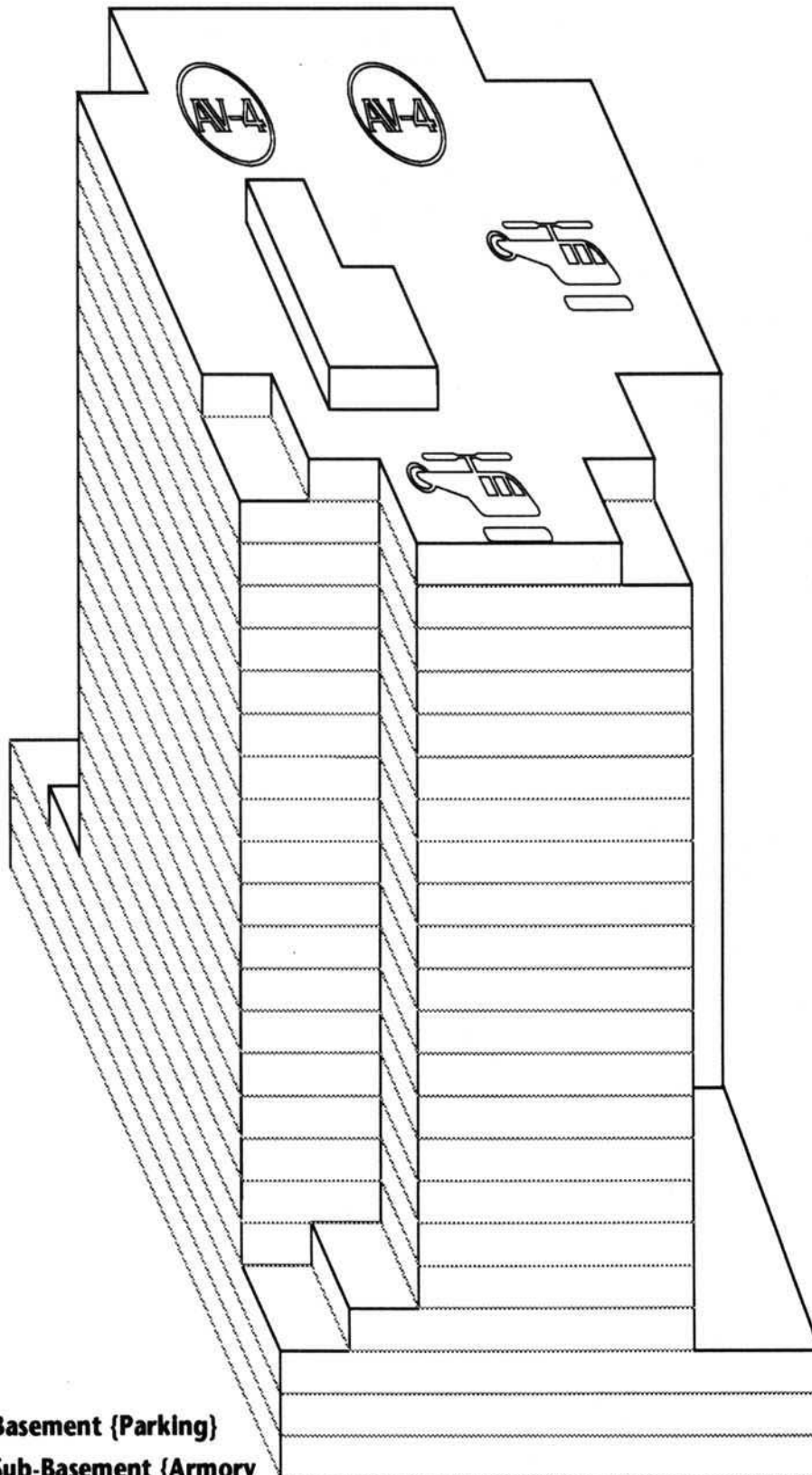

Basement (Parking)
Sub-Basement (Armory
and Training Area)

- 20 {Tactical COMM
- 19 {Cell Monitoring
- 18 {High Security
- 17 {Holding Cells
- 16 {
- 15 {Jail
- 14 {Cells
- 13 {
- 12 {Living Area
- 11 {Forensics, Computer Ops.
- 10 {Crimnal Court
- 9 {Division
- 8 {Department offices
- 7 { (Corporate, Theft,
- 6 {Homicide, Vice,
- 5 {Narco, and Internal
- 4 {Affairs), holding
- 3 {cubicles, and
- 2 {Interview rooms,
- 1 {Entrance, Booking
- {offices and
- {commissary

the 12th floor. Preshift briefings are also held here in two conference rooms.

The thirteenth through sixteenth floors contain the jails, with a total capacity of two hundred forty inmates. The sixteenth floor houses all female prisoners and food preparation, while the seventeenth and eighteenth floors each hold thirty-six single-occupancy, high-security cubicles per floor. These cells are used for cyberpsychosis cases, terrorists and politically high-risk prisoners, plus convicted felons awaiting transportation to State prisons. All these cells are monitored by hidden videocams monitored from consoles on the 19th floor. The twentieth floor is devoted to the Police Tactical COMM center and air tactical control.

The top of the roof is designated for air operations to and from the building, and includes a large radome, a hangar storage facility, and a small control tower for flight direction of police aircraft and any civilian aircraft wishing to legally takeoff or land at any civilian air-pad within a ten block radius. The rooftop and landing pads were reinforced in 2018 for AV-4 use, and can handle four aircraft, including the current complement of two Bell Spy Eye 18 turbo-helicopters equipped with a high intensity searchlight with active infrared mode and a single chin-turreted 15mm chaingun.
Security Level:4

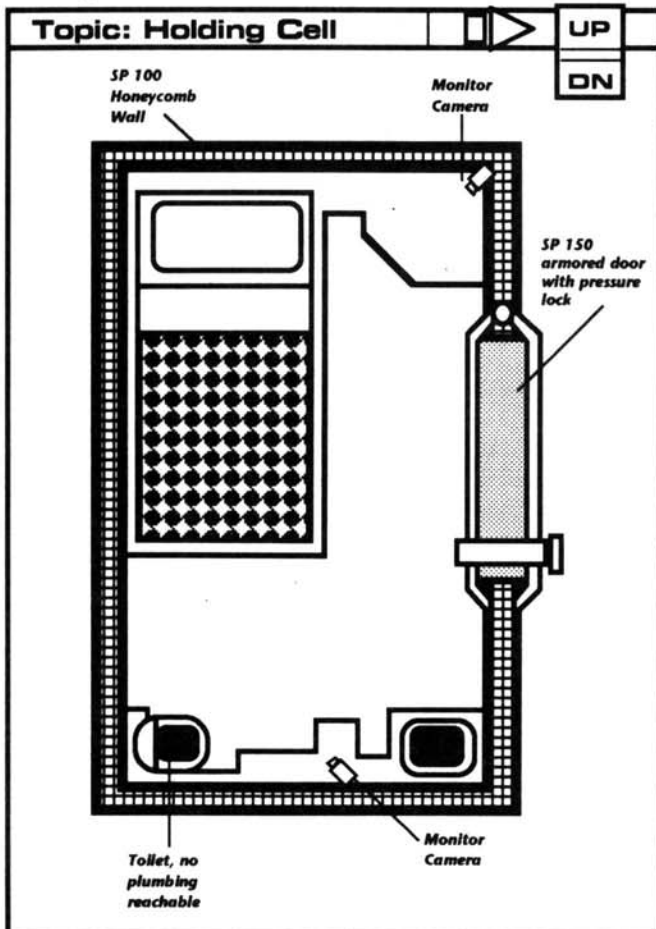

DIGITAL JUSTICE

All of the courts in the new **Criminal Court Division** are run via computer conferencing.

Defendants have access to their defense attorney via two-way video. The judge monitors the entire trial as it occurs and rules on decisions pertaining to the case. The jury is given the evidence that is pertinent to the case, hears the testimony of witnesses, and delivers their verdict. If found "not guilty", the defendant is released after twenty-four hours. If found "guilty" then the convicted criminal is put into maximum security holding to wait for the next AV-4 from Penal Security. When six convicted criminals are in holding, a call is made for pick up. Six convicts at a time are lightly tranquilized, ankle and handcuffed and transported to one of several state penal processing centers.

Once at the center, the convicts are processed by sentence. Some are sent to prisons or mental hospitals; others receive aversion implants, and some are processed and sent to the state's maximum security euthanasia center at San Quentin Prison, where they will await their one and only attempt for appeal. If that appeal fails, then within 48 hours the sentence will be carried out.

C4#2 The Piper Memorial Sports Arena and Club Atlantis:

This indoor sports coliseum has seating for fourteen hundred people. Professional wrestling, boxing matches, and other blood sports are a major attraction. Channel 54 has exclusive video rights to cover events for broadcast. The arena itself was originally constructed in 1999, and named after a professional wrestler who, unknowingly, thwarted a terrorist attempt to hijack an airliner and crash dive into the White House to assassinate the President of the United States. Piper foiled the terrorists, but died of gunshot wounds received during this heroic act.

The Arena covers only the lower two floors; the rest of the twin towers of this building are taken up by assorted offices and business suites. The entire top three floors of the Sports Arena is the home of **Club Atlantis**, a favorite hangout for upwardly-mobile corpzoners and streetronin between assignments. This expensive establishment is decorated in a disorienting style reminiscent of M.C. Escher's "House of Stairs": a series of cantilevered stairs, angled mirrors, special effects lighting and robotic mannequins placed strategically on walls and ceilings create the optical illusion of bar patrons moving against the laws of physics and gravity. The bar itself serves a complete selection of liquors, beers, and cocktails. It also has a multilevel dance floor and a small performance stage.

Security Level:2

**C4#3 Office building:**

This building has twelve floors of medium office suites with two sub-levels of underground parking. The third through sixth floors are available for rent as office space. (1000 square feet at 1400eb per month). Because of a recent slump in commercial property sales in Night City, many commercial realtors are ready to make incentive deals to secure even a twelve-month lease.

Security Level:1

C4#4 25 Highcourt Plaza Hotel:

Twenty-eight stories of expensive, very chic hotel, with twin towers of silvered glass and four observation elevators rising from the central atrium/lobby, the Highcourt's interior decor is rendered in an understated 1920's Art Deco style. The east wing includes an indoor pool, health spa, and beauty and fitness center, while the west wing features a small convention center (capacity 200 people), a travel bureau and the three-star French restaurant *Le Fontainebleau*.

The third through twenty-fourth floors consist of double occupancy rooms with baths. The twenty-fifth through twenty-seventh floors have sixteen suites complete with kitchen, full bath, and interfacing capacity. The twenty-eighth floor consists of two huge penthouse apartments reserved for visiting heads of state, captains of industry, and millionaire rockerboys and their entourages.

Valet parking is provided by the hotel in their two levels of underground parking as well as rental car and limousine service for those guests needing transportation around Night City. The west wing's rooftop is specially equipped with a landing pad capable of handling the heaviest corporate helo or tilt-wing business aircraft.

Hotel security consists of two armed hotel detectives and four eight-hour shifts of eight roving plainclothes security personnel, plus two people monitoring video display cameras. Equipped with electric stun guns and handheld communications gear, the security can handle most common situations in the hotel (i.e.; drunks, loud parties, and nonpaying patrons). If anything more dangerous occurs, or hotel property or guests are in danger, they will not hesitate to call law enforcement authorities immediately.

Security Level:2

C4#5 Multilevel Parking Garage:

A six-story parking facility with a capacity to park five hundred automobiles, parking meters are provided for every parking space at 1eb per hour. Run by the local *Allpark* company, this building does not have any security, and vehicles without security systems are prime targets for a break-in by a local boostergang known as the *Lords of Discipline* (a small juviegang whose most prevalent affectation is Neo-Nazi uniforms) The Lord's crimes range from simple muggings

to grand theft auto. A real bunch of losers, this gang is small, relatively unarmed and easy to intimidate with a show of bravado or simple firepower.

Security Level:1

C4#6 Night City First National Bank:

One of the oldest buildings in Night City, first constructed during the initial stages of the City's development when the quality of life was a higher concern to city planners than making the bottom line. The architect's goal was to design a workplace that would promote a sense of space and equilibrium for the workers. The planned parks and open air market/restaurants were never realized after the death of the city's founder.

Many older patrons of this bank still prefer to do their business the old-fashioned personal way, and this is reflected in the service. The bank is equipped with an underground drive-through computerized teller system as well as an old-fashioned, walk-in, full-service banking establishment with human tellers and loan officers waiting to help you open an account. Once an account is established, any and all banking activities may be transacted by interfacing or by debit card.

Security Level:2

C4#7 Night City Transit Center

This building is the central hub for the entire Night City transit system, as well as the maintenance yards for the Night City Transit Corporation. The busses are parked in a large garage yard to the south, and brought here during the day to work their routes. The western side of the center is used for taxi and car unloading, while buses pass through two covered loops on the north and south sides. The eastern side of the building contains a covered concrete garage pad for emergency repairs and alternate busses.

The first belowground level contains the Transit Center NCART stop, which is a transfer station between the A and C maglev lines. All corporate (read: "beaverville") trains also stop here. The second level is the terminal for the intercontinental *Planetran* maglev, although NCART trains can be routed to a lower siding for repairs.

Security Level:2

C4#8 Crestview Place:

Built by the Notori Corporation in 2007 and designed by master architect Jon Kurokawa, this elegant fourteen-story structure houses eighty-four security condo apartments. Easy access to downtown and the proximity of shops and restaurants nearby are just a few of the advantages of purchasing a condominium here.

Security in this building is tight to the level of paranoia with special identification cards provided by a local firm, Benten Security Company. This company is a false front for Arasaka Corporate Security and is used by them for on-the-job

training of licensed corporate armed and unarmed security personnel. One floor is also owned by the Arasaka group for use as a safe house or as a location for visiting Corporate officials. Cyberpunks planning a break-in against this building may find themselves in a tight and lethal situation.

This building has an underground garage with one hundred twenty-eight reserved parking spaces, and thirty-two spaces for guests, maintenance and security personnel. The roof is equipped with an airpad for small civilian commuter tilting aircraft and helos. There is a small hangar building atop the roof with four spaces for condo owners with commuter aircraft. NOTE: The landing pad was recently reinforced so that it is possible to land an AV-4 here for short periods of time without structurally damaging the roof.

Security Level: 4

C4#9 Chen's Oriental Gardens:

This establishment's high standard of Asian cuisine and spacious dining area make it a favorite with many in Night City. Cantonese, Mandarin and Thai are just a few of the styles found on the menu. The decor is reminiscent of a Chinese emperor's garden complete with Koi fish ponds, canary cages and lighting designed to promote a relaxed, opulent setting for fine dining. The service is polite, fast and efficient considering the use of human waiters. Fourstars.

Security Level:1

C4#10 Wu Chii Lee and Son's Apothecary & Yeh Ching Yah School of Martial Arts:

A large well-lit shop with many curious-looking preserved and pickled animals, Chinese acupuncture charts and literally hundreds of drawers along one wall. At the back of the store is a small, cramped service counter. Dr. Lee can help you with any prescription or Chinese herbal-medicinal cure. He does not sell 'dorps or other illegal drugs.

Dr. Lee is known by the people of the neighborhood as a *Feng Shiu* or geomancer; a combination priest/doctor/psychiatrist who also tells fortunes. He can be a very useful source of information about the area, if you can curry his favor.

The second story is a gymnasium and martial arts *dojo* run by Dr. Lee's son, Bryan. The Yeh Ching Yah School offers many different Asian fighting styles as well as a complete fitness center. Showers and locker space are available for members only.

Security Level:0

C4#11 Ling Po Imports:

Since 1997, Ling Po Imports, Ltd. has been an importer for a wide range of luxury, exotic and collectable items from all parts of the Orient. Expensive china, porcelain, and all manner of Oriental art objects are also sold. Prices on many of the items in their galleries are prohibitively high, but Ling Po guarantees authenticity and provides an accurate history

or provenance with all works of art they sell. The four-story building housing this importer dates back to the late 1940's and is one of the oldest still standing in Night City. Renovated several times by the owner, Daniel Ling Po, this thriving venture is a model for the community at large.

Security Level:2

C4#12 Red Door Inn:

This hotel on the edge of the Little China District is one of many cubicle hotels owned and operated by the Red Door Inn Hotel chain. For a very small amount of money (12eb/day plus water charge) anyone may rent a room cubicle. These modular plastic cubicles are 1.5m wide, 3m deep, 2.5m high, and come in four pastel colors. They are equipped with a small bed that folds up into a molded recess, a very small sink, and a security wall locker. Disposable linens and ice are available as well as a selection of food and beverages from vending machines on every floor. These efficient, affordable, clean security cubicles are the cutting edge of modern, low maintenance accommodations.

As you walk into the lobby you can check the availability of a room on the automated vacancy board. Rooms are color coded by decor and numbered. Rooms coded in black are either out of order or occupied. Press your selection, pay for the room by either magnetic credcard or inserting cash and proceed to your cubicle. You now have three minutes to confirm your selection by entering your thumbprint on the identipad lock on your cubicle's door. The elevator's CPU is not always cooperative (25%) when taking someone to his correct floor—nothing really serious, but confirming your occupancy may get a little hectic.

Security Level:1

C4#13 Renta-Robo:

The AI-operated Renta-Robo® chain can be found in its familiar grey and white stations throughout the City. There are no human salespeople, instead an AI vendor takes your debit card number, signs out a car, and uses its robotic driving mechanism to bring it from the central garage to the specific RR office. Renta-Robo's offices are basically faceless waiting rooms, with one wall entirely taken up by a video-display board, a dedicated dataterm, and a courtesy phone for calling a human operator if something goes wrong (which rarely happens). Vehicles are stored in the small parking structure adjacent to the main building.

Security Level:1

C4#14 Aerocab:

Aerocab is primarily an airtaxi, specializing in short flights to local areas in the Night City region. Airtaxis of this sort are a relatively new phenomenon, possible only as corporate AV-fleets and government obsolescence made aerodyne vehicle available at lower prices. Aerocab was one of the first to break into this lucrative market, and gained a very strong foothold by sharing the costs of AV-landing stages and rooftop platforms

with various landlords throughout Night City. At prices of 10eb per mile, plus a 25eb pick-up fee, Aerocab is primarily a luxury for Movers in a hurry, or cyberpunks on the run from a botched job.

Aerocab's taxi force consists of approximately ten reconditioned AV-4's, 3 aerogyros and a three new AV-7 vehicles. Its few ground units are mostly used to take customers into areas where a flying vehicle would find landing too dangerous. AeroCab units can be called by phone, dataterm, or from most buildings in the Corporate Center. The Aerocab building is primarily designed as a dispatcher location; maintenance and storage of its vehicles are on Aerocab's many private landing stages throughout the City.

Security Level:1

C4#15 Ling Husan's New China Pharmacy:

An active supplier to the heavy drug markets of Night City, Mr. Ling covers his activity with this pharmacy operation. Oddly enough, Mr. Ling is an excellent pharmacist, and he does almost as much business in legal drugs as he does supplying the various gangs with their fixes. All illegal transactions are done through the local dataterm, using the code ALCHMST. Once logged on, a person will find prices and instructions for ordering various goods.

Security Level:0

C4#16 The Hong Kong Market:

An average Chinese market, with fresh vegetables and other culinary necessities for cooking truly great Chinese food. The market is popular with both Edgezoners and Movers, and it is not uncommon to see an EBM executive walking down the aisles dodging small, shouting children. The market is run by Malcolm Allister and his Chinese wife, Tsuan Lee. The couple inherited the market from Tsuan Lee's mother, who ran the shop until she died in 2018. Security is provided by Malcolm's Militech Crusher, a gun he favored when working for that company.

Security Level:0

C4#17 Madame Lin's Massage Parlor:

Madame Lin is well known for her massages and her girls. For a mere 40eb per hour, you can experience the "Heavenly Delight" of an "authentic" Oriental massage. While the insides of the establishment might not quite reach the expectations of the advertisements, the girls give it their best shot. Many girls in the local Ling Po crime organization get their start here; the local training ground, so to speak. There are also rumors that Madame Lin is involved quite actively in the Pacific Rim slaver circuit, but such rumors are unsubstantiated.

Security Level:1

C4#18 The Toy Box:

The Toy Box is run by an ancient man named Hing Chin, who locals say is well over one hundred years old. The store itself

has been located at the same corner ever since Night City was known as Del Coronado. Mr. Chin has sold toys to three generations of children in Little China, and will keep selling them until death finally catches up with him. He carries toys from all over the world, all of the finest quality.

Security Level:0

C4#19 The Silver Dragon:

A high quality Chinese restaurant, catering exclusively to the population of Little China. Any outsiders will be turned away, with excuses like "no more tables" or "just closing". If potential patrons bully themselves into the Silver Dragon, they will soon regret their presumption. The meal will taste delicious at the time, but after about an hour, all characters who ate the meal will be struck with the most awful stomach cramps. Note: Punks had better think twice about any retribution against the Silver Dragon, since the management has ties to the local Tong. Close ties.

Security Level:1

C4#20 Old China:

A basic odds and ends shop. Old China carries everything from plastic Buddha temples to four foot tall, hand carved ivory images of the goddess Kali. A basic tourist shop, with prices to match.

Security Level:1



THE CHINESE RESTAURANT METHOD

Like most "Chinatowns" throughout the United States, Night City's Little China is a web of

interconnected family lines, shared businesses and rabid private entrepreneurship. With space at a premium, a single three-story building may contain as many as *fourteen* different shops (most of which are pretty much the same). When populating your personal Little China, you may find the following system useful for crowding every single available space with some kind of free enterprise experiment. Roll D10 to discover how many smaller shops are in a single building, then roll a second D10 and consult the chart below to find the types of shops.

1. Tattoo parlor.
2. Small Market.
- 3-5. Knick Knack Store.
6. Butcher.
7. Restaurant.
8. Illicit Activity; gambling den, brothel, drug den, etc.
9. Front for the Ling Po organization.
10. Shop selling religious paraphernalia.

PERSONALITIES



Dr. Wu Chii Lee (C), and son (L) at New Year's Parade (Net 54)

Dr. Wu Chii Lee- In his neighborhood, Dr. Lee is a healer, priest, fortune teller and herbal pharmacist to his people. Lee is also well known and respected by his peers for having his finger on the pulse of Little China. Information flows like a stream through his hands, often directed by him to where it will do the most good. To most people, he seems to be a simple herbalist who speaks only his native Cantonese. But if faced with an interesting problem, or shown proper respect, this facade is quickly done away with and he can be of great help.

INT 9, TECH 4, REF 8, COOL 7, LUCK 8, ATTR 4, EMP 10, MA 4, BODY 5

SKILLS: Med. Tech 8, Pharmacology 10, Teach 4, Human Perception 7, Street Deal 5, Martial Arts 6, Streetwise 3, Culture 3, Persuasion 3, Awareness 3, General Knowledge 3, Drive 6, Complex Language(Chinese) 7

CYBERNETICS: None.

Sensei Bryan Duncan Lee- Born in 1986, Bryan is the son of Wu Chii Lee and his wife, Susan Anthony-Lee, a Berkeley-educated professor of Asian studies at NCU. As a young boy, Bryan showed phenomenal promise as an amateur martial artist, competing successfully in several major tournaments. On his way to the 2017 Olympic tryouts, an automobile crash killed Bryan's mother and robbed him of his sight. Three years passed before his sight could be restored via cyberoptic implants. Since then, he has been teaching martial arts above his father's shop and doing odd solo work for people in the district.

INT 7, TECH 6, REF 10/12, COOL 9 LUCK 7, ATTR 7, EMP 8, MA 8, BODY 8

SKILLS: Athletics 7, Martial Arts 9, Martial Art Melee Weapon 5, Teach 8, Stealth 5, Awareness 7, Pistol 4, Pharmacology 2, Culture 2, Complex Language (Chinese) 4, General Knowledge 3, Wardrobe and Style 4, Streetwise 3, Drive Motorcycle 3

CYBERNETICS: Cyberoptic with thermographic, anti-dazzle, targeting scope, low light enhancement. Neural processor with reflex boost.

David Ling Po- Born in Hong Kong, David Ling Po emigrated with his family to the United States in 2014. A graduate, (Summa Cum Laude) of Stanford University, in every respect Ling Po appears to be a model businessman and pillar of the community. But behind his mask of respectability, Ling Po is head of the *Weng Fang Tong*, the largest and most powerful Chinese criminal organization in the western United States. The *Weng Fang* controls all gambling, loan sharking, and prostitution in Little China. Almost all the boostergangs operating in the area are on Ling Po's payroll and he uses them as enforcers for his various dealings. Operating from the top floor of his export business, he monitors the district through the use of numerous hirelings, each equipped with a telescopic video microcamera replacing one eye. Their information is sent via scrambled signal to Mr. Po.

INT 8, TECH 6, REF 7, COOL 9, LUCK 9, ATTR 8, EMP 4, MA 6, BODY 7

SKILLS: Gamble 4, Streetwise 6, Drive 2, Streetdeal 8, Human Perception 3, Thief 4, Persuasion/Lie 4, Pistol 4, Awareness 6, Intimidate 6, Specific Knowledge(Art) 9, Seduction 2, Martial Arts 2, Culture 3, Complex Language (Chinese) 5

CYBERNETICS: Interface Plugs. Memoryware. Cyberhand.

ENCOUNTERS

1: A joygirl offers to sell her wares. This may be a good start towards learning about the extent of the Ling Po operation.

2: A small skirmish has broken out between members of the *Weng Fang Tong* and group of boosters from the Combat Zone. The boosters are outnumbered but they have some pretty heavy firepower. Take sides; it's time to dance.

3: An irate storekeeper accuses one of the players of stealing a duck that was hanging in a nearby window.

4: A small boy tries to steal the wallet of one of the players on a crowded street.

5: A young girl asks the players if they will protect her frail father from the Tong, which has threatened his life for non-payment of "protection" money.

6: A street magician sets up shop on a nearby corner. The foot traffic slows to a halt.

7-9: The foot traffic is so heavy that no one can move at more than a slow walk.

10: Come nightfall, the people of Little China will be having a large celebration. There will be fireworks, dancing dragons, and all the mayhem you would expect from such a gathering. Watch your back.

CONTACTS

Lin Chi Nan- A joygirl working for Ling Po, she was purchased from her parents while still a child. Her good looks have been marred by beatings.

Sang Hoi Wan- A street performer in direct contact with Wu Chii Lee. He will send the players to Mr. Lee if things get hot.

Tani Chow- Apparently just another joygirl, "Tani Chow" is really Helen Leigh Atkins, a student at the university whom Ling Po took a liking to (unfortunately for her). When she spurned Po, he had her kidnapped, injected with an addictive drug, brainwiped and biosculpted to look Chinese. A Chinese language chip completed the job, and, after toying with her for a few weeks, he put her on the streets to make money for his organization. "Tani" is now a mental wreck and an addict. If helped, she could get over her condition with major psychological aid. Her parents, a prominent EBM family, have offered a reward of 50,000eb for her return.

Sam Chin- A street urchin, Sam knows all the back alleys of Little China, and can ditch anyone if he has a twenty-foot lead. Ling Po wants him dead for bringing the cops in to bust a smuggling ring.

Wan Kin- An old man often found sitting on the streetcorners of Little China. He seems to know everything and everyone. If asked politely he may give a well needed clue to the players.

STUDIO CITY

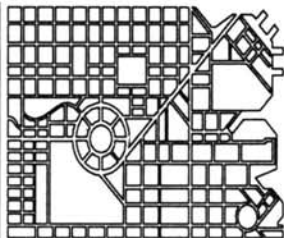

D A T A T E R M

This is the home of Colonial Studios, an older flatscreen movie studio which achieved some fame in the years just after the Collapse. Founded by avant-garde director Franscesco Cippolina and his partner Greg Lukasian, Colonial produced the now-classic films *Smile of the Lady Xanadu*, *Destiny Over Damascus* (with its memorable tribute to Orson Welles' *Third Man*), and *Messiah of the Endless Sea*, before decending into trashy obscurity with drive-in double-bills like *Killer Mechanoids From the Amazon Planet* and *Demon in a D-Cup*.

Many inhabitants of the City view the production facility as a waste of space, and others believe Colonial should move out of the City proper. But Colonial is not planning on moving. They have a 50 year lease from the city and they plan to keep the land; especially Cippolina's daughter and heir Magretta, who hopes to one day restore the studio to its former glory.

This intransigence upsets most of the larger local corporations, as many of them have plans for developing the area. Some executives at the studio believe that the corps are behind some of their "accidents" of late. The corps deny this with lines like "that sort of action went out with the weekly matinee showing of *Flash Gordon*."

Colonial Studios

Formerly a major production facility, a rash of financial setbacks and a tragic fire made it necessary to sell this property as a corporate cost-cutting measure. A foreign investment group led by Magretta Cippolina has recently purchased the studio and is interested in making it the "state of the art" facility in the holographic and braindance entertainment industry. Renovation and repair of the present facilities are underway and are due for completion in May of 2022. Even

with construction still going on, several new productions are shooting on location.

Security consists of uniformed studio guards and two-man walking patrols of the environs of the studio property. The studio is surrounded by fourteen-foot chainlink fence with entrances at Twenty-First and Sterling Avenue. The security fence is equipped with weight and vibration sensors. Anyone attempting to climb or cut this fence stands an excellent chance of being hit with progressively larger electrical shocks at three second intervals, while uniformed guards respond to the location of the trespass.

C5#1 Main Business Offices:

These three buildings house the business offices of Colonial Studios. The building fronting Sterling Avenue is architecturally reminiscent of the big studios of the 1940's, but the remaining offices are purely functional in style. Personnel, payroll, legal, and production duties are all carried out in these office spaces.

Security Level:2

C5#2 Studio A:

This large building houses most of the television production facilities for Colonial. There are at present two game shows and a daytime melodrama being shot here for syndicated broadcast by several major networks.

Security Level:2

C5#3 Studio B:

This soundstage is being renovated to accommodate holographic and interfacing technology.

Security Level:2

C5#4 Studio C:

This location is nothing now but a gutted shell of a building. A fire, started by an unknown arsonist, destroyed this studio soundstage and killed two security guards who were trapped in the flames. At the present time this structure is awaiting demolition and will be used by the owners in a future project. There is a temporary wooden construction wall around this building. To enter the damaged structure would be very unwise as it is in danger of collapsing.

NOTE: The basement of this building was not damaged by the fire itself, only by water. Without the notice of the studio, a group of "undergrounders" have moved into this basement by digging tunnels into it from a nearby closed-down sewer. With some forty members, these homeless individuals have set up shop producing unlicensed filter masks and pollution protection clothing for their fellow undergrounders.

Security Level:0

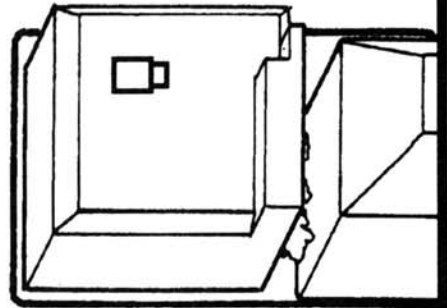
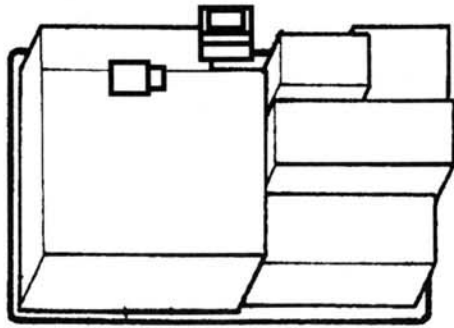
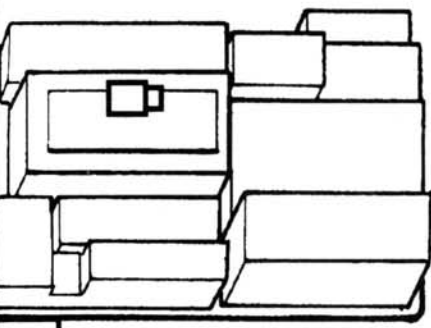
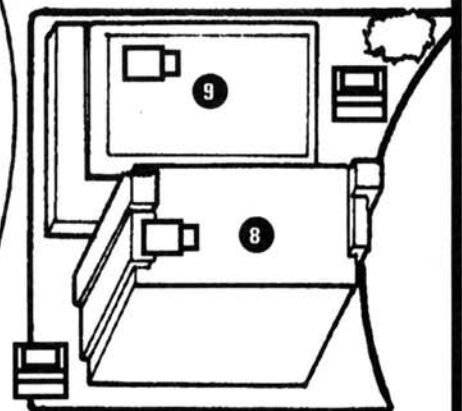
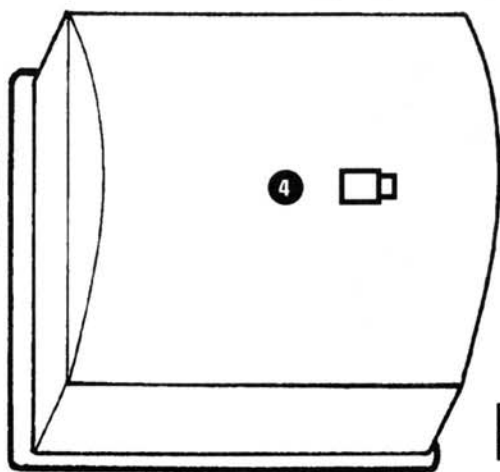
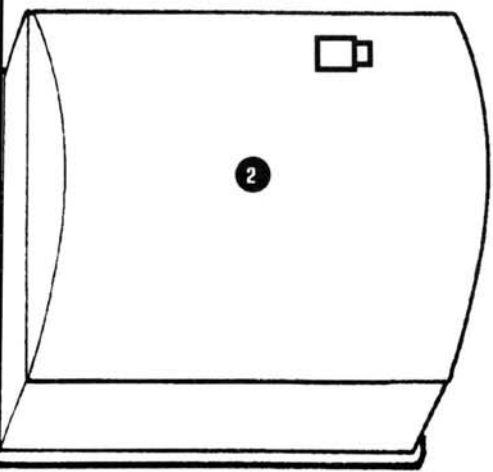
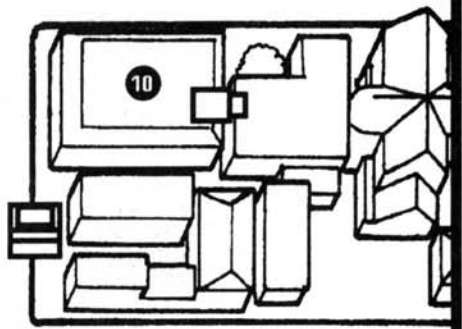
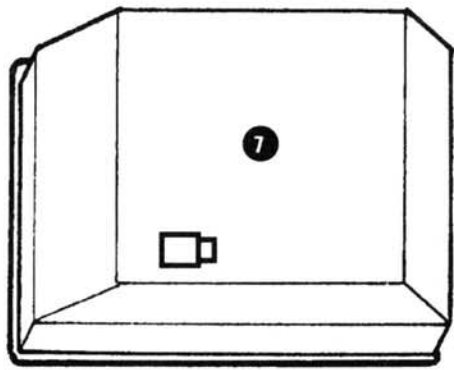
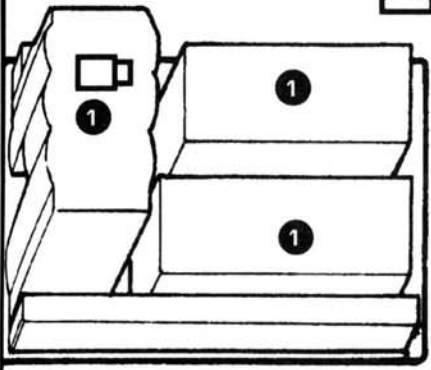
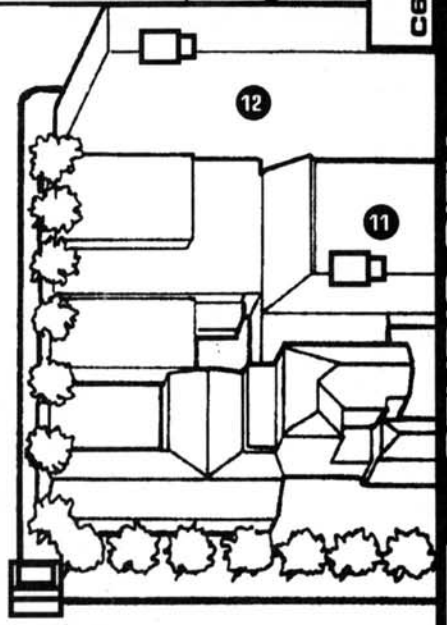
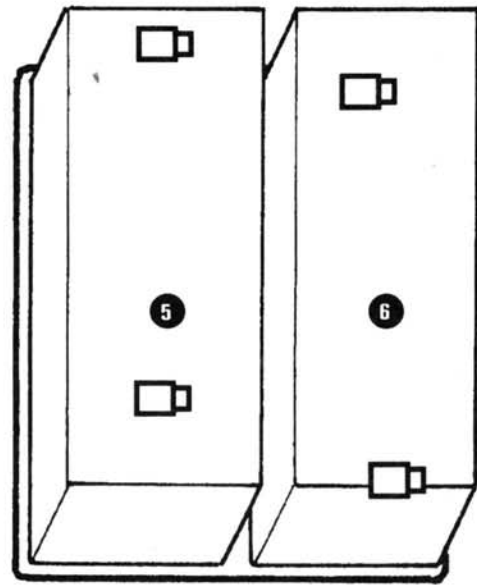
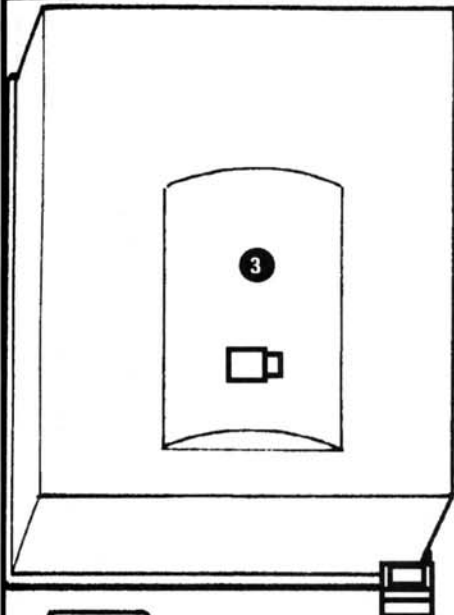



C5#5 Warehouse A:

This is a warehouse for props, electrical equipment, boom cranes, studio vehicles, and all manner of gear and paraphernalia used in the production of television and film.

Security Level:2

C5#6 Warehouse B:

This building houses wardrobe and technical services. Furnishings, scenery, props, and weapons are created here for use on sets in other soundstages on the studio lot. Make up and special FX are designed here and tested before used in production.

Security Level:2

C5#7 Post Production Building:

This facility handles all technical post-production work such as editing, sound mixing, and computer generated special effects. Braintance programs are also edited in this building. "State of the art" neural response translation equipment is presently being set up for full-scale production of alternate reality interface chips.

Security Level:2

C5#8 The offices of Z-KNT (QFM 104):

The four floors of this office building hold the business, production, and transmitting facilities of one of Night City's most successful and progressive radio stations.

Zee-Night's format of high power rock and its late night interview/talk radio concept has kept it in the forefront of the audio industry for three consecutive years. Many rockers who've gone on to great fame were first heard on *Zee-Night's* spotlight show for new local talent. The show is hosted by ex-rockergirl Renee Reynard, whose knowledge of the inner workings of the music industry and low dulcet voice are perfect for the station's "insider" format.

Security Level:1

C5#9 United Non-denominational Churches of God(s):

Religion is very important to many people in Night City, but the realities of life in this twenty-first century urban sprawl have created many problems. Crimes committed against churches and their parishioners have forced many non-secular groups to form religious co-op's. One such cooperative is the U.N.C.G. Using old shopping centers as a base, the shops and chain stores are leased, renovated, and redecorated to the specific needs and tastes of each religious order. Over forty recognized religions are found here as well as two dozen non-denominational services scheduled in several open chapels at this location. An open soup kitchen for the homeless capable of serving six hundred people is also an integral part of this facility.

There are also many businesses who join the co-op for profit: **New Age Cryonics, Inc.**, **Final Rest Euthanasia Centers**, and several national funeral franchises such as **Carter and Sons Internment**.

Security Level:0

C5#10 Malorian Firearms, Inc:

"Distinctive firearms for distinctive people" is the motto found above the entrance of this establishment. Owned and operated by Eran Malour, a well-known gunsmith in Night City, Malorian's custom weapons are known for their accuracy and durability in tight situations. Customers include well-known solos like Morgan Blackhand, high-level bodyguards, and celebrities like Johnny Silverhand (for whom Malour designed the now world-famous Malorian Arms 3516).

The shop has a 1000 square foot showroom, a data center, and an indoor pistol range. The extensive basement of this building houses a fully-automated robotic machine and tooling facility. If a client requires a specific custom weapon or the Malorian version of any factory handgun, submachinegun, shotgun, or rifle, the weapon specifications are taken from a data file with over eighteen hundred firearm designs in its catalog. The robotic factory can machine most desired weapons from scratch in as little as two hours. Some best selling items are the Malorian version of the M 12 Beretta SMG in 10mm, or the "Vindicator", a three-round capacity, 30mm grenade launcher that is a favorite of many Night City solos. Custom weapons made of high quality steel, alloy or polymers can also be ordered based on customer preferences.

While the customer is waiting for his order, a complete weapons record check is made via Malorian's direct link to NCPD and INTERPOL databases. Known felons, clients suspected to be prone to cyberpsychosis, or clients with a history of mental problems automatically have their orders politely and firmly refused. If the legal status of the person is in question, the police are contacted immediately via computer net without the customer's knowledge. The customer can then be stalled until police arrive.

Security Level:3

C5#11 Libertine Lanes:

An anachronism from the original town of Del Comonado, this old bowling alley still stands as a reminder of simpler times. Featuring thirty-two lanes constructed of real wood (!), a small bar and a holo-game parlor, the lanes are often used as a favored hangout of juviegangs living in nearby conapts. Libertine Lanes is also the scene of frequent gang fights. Dorphers usually sell their wares openly until their juve lookouts warn them of approaching cops:

Security Level:0

C5#12 Brookhaven Co-op:

Brookhaven is a good example of low-cost apartment housing for low-income families throughout Night City. Built by corrupt, cost-cutting city contractors from substandard materials, Brookhaven can barely stand up to city building codes. The only thing that is in any way superior in construction at Brookhaven Co-op is the plumbing. A mistake in a computerized order sent the best plumbing materials to be installed and by the time the mistake was detected, the building was finished.

The apartment units have one bedroom, a kitchen, and a bath. This building is run as a co-op, so the tenants keep it clean, and provide some security in the form of neighborhood watches.

Security Level:0

PERSONALITIES

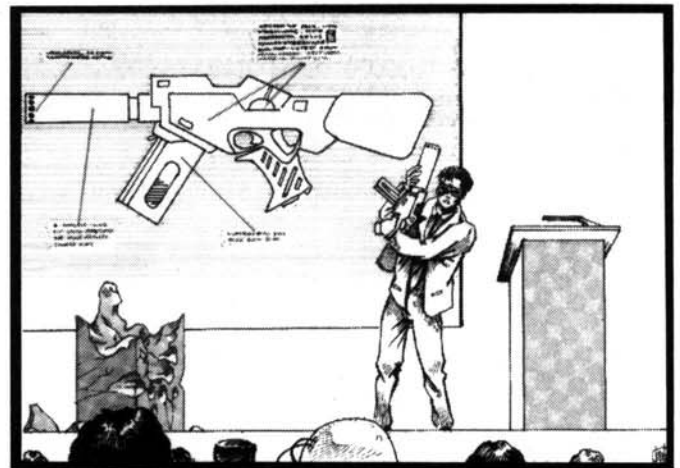

Eran Malour (podium) demonstrating new assault cannon, Oct. 18, 2020.

Eran Malour- Thirty-two years old and a decorated veteran of the brushfire wars of South America, Eran Malour decided he had seen enough. After eight years in the Marines, Malour returned to the United States, and using his veteran's benefits, started up his own business. A skilled armorer, he began building custom weapons for his friends and soon gathered a following among many solos in Night City.

In 2016, Malour convinced some of his best customers to invest in plans to expand his business. He purchased a small robotic factory that had been rendered obsolete by recent innovations in zero-gee manufacturing. He then modified the factory with his own specifications to design, produce and modify any firearm to the wants and needs of the customer.

INT 8, TECH 9, REF 9/11, COOL 7, ATTR 6, LUCK 4, MA 6, BODY 8, EMP 5

SKILLS: Basic tech 8, Cyber tech 4, Specific Knowledge (gunsmithing) 7, Interface 3, Pistol 6, Rifle 5, Driving 3,

Motorcycle 3, General Knowledge 5, Stealth 3, Complex Language (Japanese) 3, Streetwise 2, Simple Language (Spanish) 2

CYBERNETICS: Cyberoptics with targeting, low light enhancement and anti-dazzle. Interface plugs, weapon smartlink, reflex boost. Cyberaudio with phone link and ECM scrambler. Cyberarm with 30mm grenade launcher

Detective Louis Brandt- Detective Brandt is the model of an overworked law enforcement officer. In the eleven years working as a policeman, he has seen just about everything possible in his field. Presently he is attached to the Homicide Division at Southside. Because of his successful arrest record, Brandt tends to get the worst cases: serial killers, cyberpsychosis cases, and streetgang murders are often dropped into his lap.

On his off hours, Detective Brandt spends much of his time collecting videos of television police shows and old detective movies. He is known for using catch phrases and affectations of these old cop shows in his work, but his superiors overlook this eccentricity as it seems to help him do his job.

INT 9, TECH 6, REF 9, COOL 9, ATTR 6, LUCK 7, MA 8, BODY 7, EMP 7

SKILLS: Authority 7, Intimidate 4, Notice 4, Spec. Knowledge (Police Forensics) 7, Pistol 6, Rifle 5, Melee Weapons 2, Drive 3, Persuasion 3, Interview 7, Interrogation 3, Streetwise 4, Shadow 4, Ditch 2, Disguise 4, Wardrobe and Style 2

CYBERNETICS: Cyberoptics with micro/telescopes, low light enhancement, targeting. Interface Plugs. Chipware: simple language (Spanish), complex language (Chinese)

Magretta Cippolina— Daughter of once-famous movie mogul Franscesco Cippolina, this strong willed, raven-haired beauty is determined to restore her father's old studio to its former glory. To do this, she has entered into a partnership with a small eurocorp that has had moderate success in the art-film and braindance arena. The tiny corporation is heavily leveraged and desperately needs a successful project in the next few months.

Magretta is an obvious film buff, and can often be found haunting the small art theatres around the University and Charter Hill Districts. She is generally reserved, but can become quite vivacious and animated when she meets a fellow filmophile.

INT 9, TECH 8, REF 5, COOL 6, ATTR 10, LUCK 7, MA 8, BODY 6, EMP 8

SKILLS: Resources 2, Notice 4, Spec. Knowledge (Film History) 8, Handgun 6, Drive 6, Persuasion 4, Wardrobe and Style 9, Seduction 9.

CYBERNETICS: Cyberoptics with colorshift, microvideo, interface plugs, simple language chip (English: Magretta is Italian and doesn't really know English).

Renee Reynard- Renee Reynard was once a top draw on the European rocker scene. Her last album, *All These Foxes*, sold four million chips in just seven weeks. But a hard-driving singing style and life in the fast lane put too much strain on her vocal cords and resulted in the loss of her voice. Surgery did not fully correct the problem and she retired from the music scene after a short-lived career.

A year passed, with Renee surfacing in Night City as the late night host of Z-KNT radio. Her knowledge of music and the industry surrounding it gives her the edge over her competitors. While the restorative surgery did not return her singing voice, the husky, whisky-throated quality of her speech, along with her subtle French accent has proved to be irresistible to the listeners.

INT 7, TECH 4, REF 8, COOL 7, ATTR 10, LUCK 7, MA 6, BODY 6, EMP 7

SKILLS: Credibility 4, Streetwise 2, Persuade 1, Charismatic Leadership 3, Seduce 5, Compose 3 Sing 4, Athletics 5, Play Instrument 4, Pistol 5, Interview 3, Simple Language (French) 8, Wardrobe and style 6

CYBERNETICS: Memoryware. Interface Plugs. Cyberarm with microtape recorder. Cyberaudio with wearman and phonelink

ENCOUNTERS

1-2: Nothing much going on in this part of town...

3-4: You see Margretta Cippolina and several worried executives surveying recent damage to a studio building. There's probably a job there for a punk with a little initiative.

5: Spot some members of a boostergang getting ready to cut the fence going into Colonial.

6-7: Alarms are ringing in the distance. Someone's broken into Colonial again...

8: Some real nasty types from the Zone have worked their way through the residential district to do some damage in the big city. They've decided to start with the players. Bad mistake on their part.

9: Spot members of a gang trying to torch a local building. Looks like some Chromers have decided to have a bonfire; a real big one.

10: Two gangs (referee's choice) are having a turf battle away from prying eyes. Unfortunately the players have walked right into it.

CONTACTS

Alvin Whitacker- A talent scout for Colonial, he can be found wandering the clubs looking for talent. It is said that his idea of talent is any girl with a well built body and cheap morals. Do you want to be a star?

Maxi West- Another talent scout. Maxi is in charge of finding new bands to showcase the Colonial music video production. She frequents all the major clubs.

Tim Ward- A security guard at Colonial. He and Maxi are friends, and he often refers her to bands he likes.

Alice Kimberly- One of the production directors at the studio. She knows how to get things done. If you want anything at the studio, ask her.

"Will"- A local streetscum who knows the area well. He even knows whose running the current operation to drive Colonial out of town.

DATATERM DISPLAY SYSTEM Topic: Soundstage Layout

UP

ON

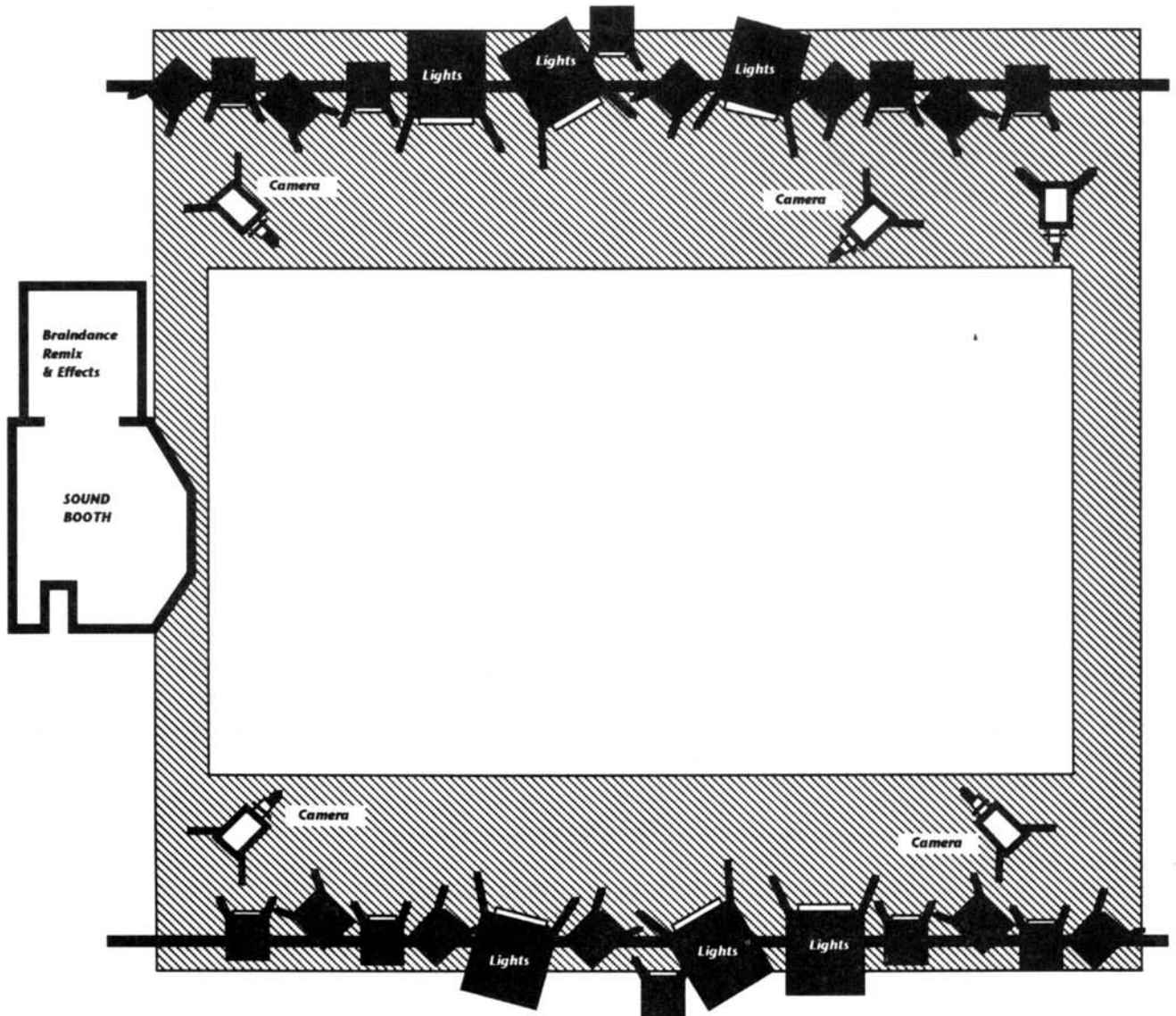

CHARTER HILL

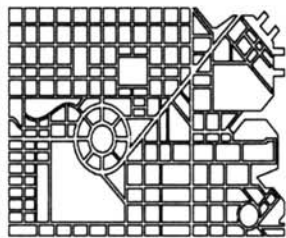

D A T A T E R M

Charter Hill is a small section of the city between the crowded streets of Little China and the sludge-slicked waters of Del Coronado Bay. Charter Hill was originally zoned as a residential area, and was much like the larger area to the south (or the "Combat Zone", as it would later be named.).

This area of Night City was one of the hardest hit in 2005, and was nearly destroyed in the Mob War of 2009-2011. After the Corps had cleaned up the city, the Charter Hill area remained pretty well undeveloped and ignored in the larger scheme of things.

What saved Charter Hill was the intervention of the European company **Hydrosubsidium**. This development, and the glamor and money of the neighboring **Hacienda**, re-established Charter Hill as one of the more pleasant sections of the city. After five years of development and reconstruction, Charter Hill is now known as having one of the lowest crime rates on Del Coronado Bay. Considering that Charter Hill is no-man's land as far as the gangs are concerned, it's often used as a neutral meeting point to resolve problems (both the Hilton and the Hacienda see heavy use in this way).

Both the **Stars** theatre and the **Richard Night Memorial Aquarium** bring a fair amount of upper class traffic to the area, and it is said that only the richest of powerdealers can afford a lengthy stay at the **Hacienda**.

C6#1 Hydrosubsidium:

This company got its start with its release of an affordable and efficient fluid breathing system (called the Gilbear lung). After several sales of the system to different European and American salvage companies the Hydrosubsidium became complacent, believing it could survive on the sales of one product alone. After several near-bankruptcies the company was forced to branch out into other underwater technologies.

Eight years after the invention of the Gilbear system, the Hydrosubsidium had three innovative underwater techno-

logies on the market: the **Poseidon Fluid Breathing Suit**, capable of reaching depths up to 1000 ft. below sea level; the **Sinclair** submersible, (infamous for making the "rape of the Titanic" possible) and the **Davidson rebreather**. After sales of the rebreather to several navies, the company had the income to enter into full scale production of many of their ground-breaking inventions. If any significant advancement is made in the realm of aquatic technology it is a good bet that the Hydrosubsidium is behind it.

Although Hydrosubsidium could be called a major corporation, and probably should be ranked among the giants like Arasaka and Zetatech, it prefers to keep a low profile. The company has recently opened a research facility on nearby San Morro Bay, and is known to be conducting operations of a secretive nature in the Del Coronado Trench to the west.

While the outsides of Hydrosubsidium look like a simple warehouse, the inside is an oceanographer's dream. The administration building, (the only building that visitors are allowed inside) is decorated with maps and charts of the ocean dating back to the time of Columbus. In the center of the main lobby, a 3D hologram map of the bottom of Del Coronado Bay is displayed. The staff is friendly and will try to answer any question concerning the company or the seas in general; they will not, however, release any information on the current project in the Trench, or let anyone examine the equipment in the project building.

Security Level:3

C6#2 Warehouses:

These buildings are general warehouse space, and contain various goods. The only thing of interest in them is a small section rented to the Hacienda casino under a cover business; this is where Andrew Scythe keeps all the back-up equipment for the Hacienda's security force when not in use.

Security Level:2

C6#3 The Night City Hilton:

This residence hotel has remained relatively unchanged since the Mob War; it primarily caters to mid-line corporate types, and sees a fair business in the high seasons. The rates are average, and the service is good. Rumored to be the hideout of several well-known solos, it's a good place to rest up between missions.

Security Level:2

C6#3b Parking:

This lot is shared by the Hacienda and the Hilton, and is patrolled by Hacienda security. It is very secure.

Security Level:2

C6#4 The Richard Night Memorial Aquarium:

This aquarium was built by the citizens of Night City right after the cleanup of the Mob by the Corps. The aquarium is kept open by grants from the various corporations (for a substantial write-off).

Security Level:1

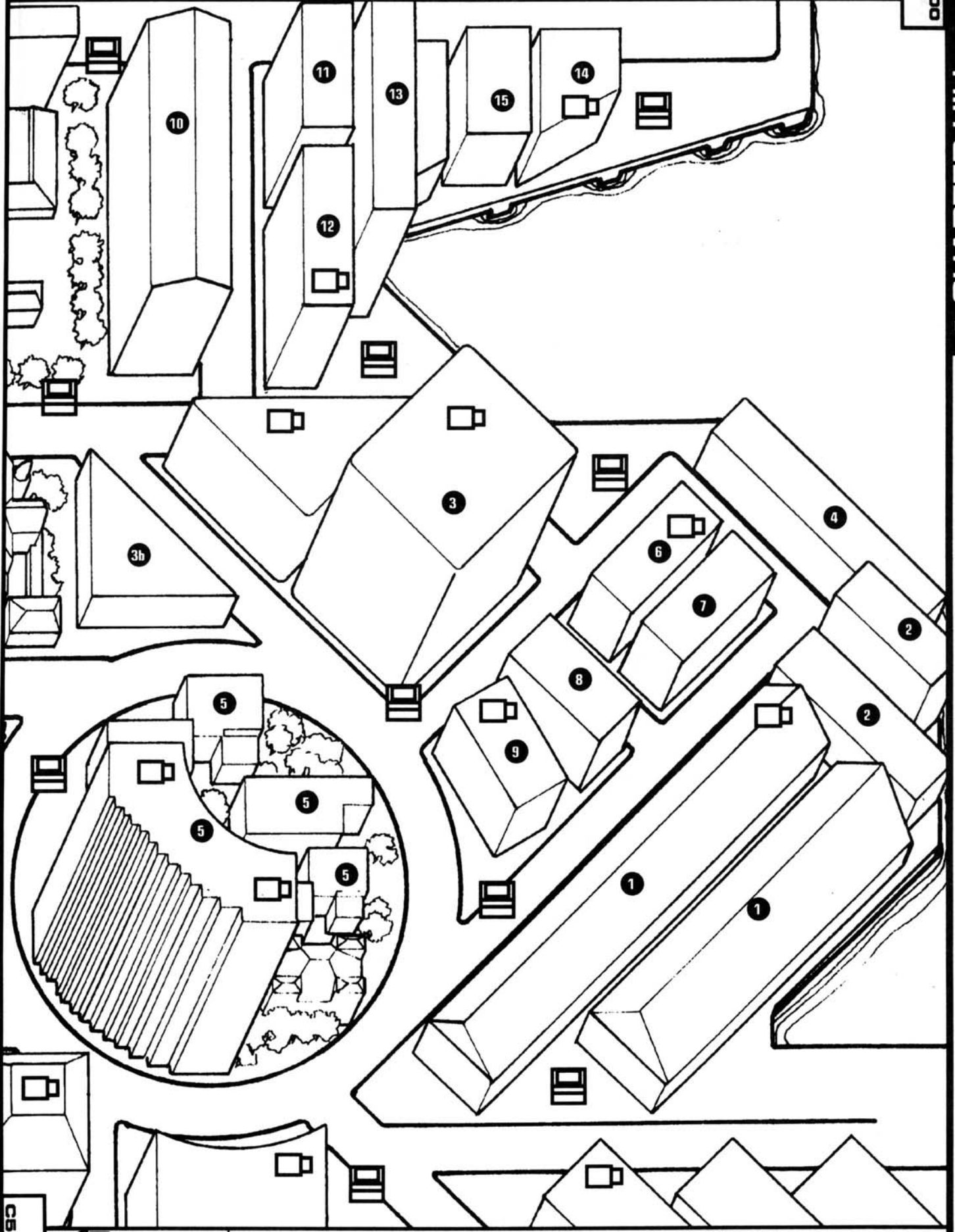

NIGHT CITY

SECTION C6

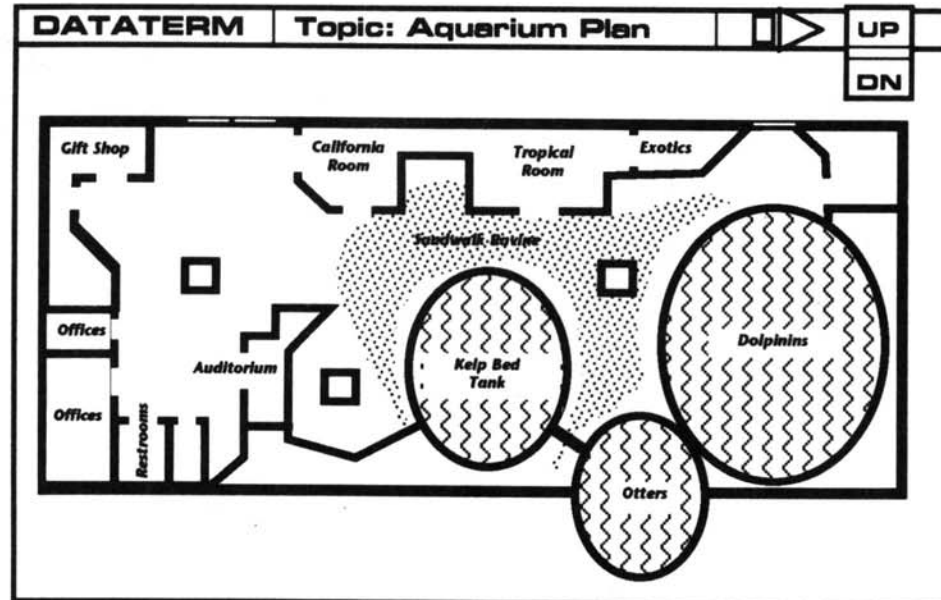

C6#5 The Hacienda:

Right after the Cleanup, land in the Charter Hill area was going cheap, and Isabel Vargas saw an opportunity. She bought a run-down apartment block, demolished it, and built the Hacienda. The Hacienda is Night City's only true hotel-casino, and it is famous the world 'round. Only the

richest of the rich can afford to stay there, and it is said that millions change hands on the gaming floor daily.

In the early days the casino was literally besieged by gangs, so Isabel hired noted solo Andrew Scythe to run her security force. He built the security force into a small army of well trained men. Now the Hacienda is one of the most well-protected spots in the entire city, and everyone knows it.

Most of the Hacienda's clientele are high level Corps and wealthy Powerdealers flying in from Europe just to spend the weekend there. While it is one of the most expensive

places to stay in Night City, those who've spent money there have never regretted it. The hospitality of the Hacienda is legendary, its gardens enchanting, the atmosphere intoxicating, the food wondrous, and the security force sees to it that nothing disturbs this. There is both a dress and behavior code enforced; if a guest wishes to indulge in illegal

activity, he or she had best do it in the privacy of their own suite. Even the hostesses are hand-picked by Isabel (for grace and charm as well as beauty).

C6#9 Casa De Sevilla:

This restaurant is run as a subsidiary of the Hacienda and serves the best Spanish food in the city. It's very expensive and well worth it. All of the meats and cheeses are fresh, and the service is first rate. There is also an underground tunnel connecting the two establishments, for use in shuttling food and people from one building to another.
Security Level:2

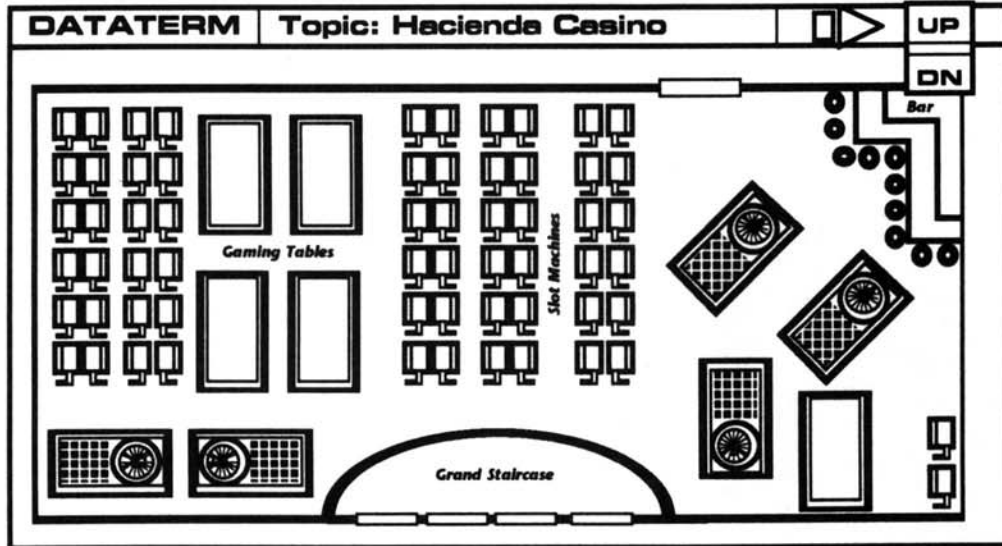

C6#10 The Concord Apts.:

These apartments are home to many mid-level corporate types. Located by the Mallplex; in a low crime area, the apartments are in high demand. Though it is not on public record, both the Concord and the Darkwood are owned by the Hydrosubsidium, and are a source of extra income and home to many of their researchers.
Security Level:2

Isabel is famous for her beauty and wit; one of the last great Spanish ladies. While rumored that Isabel and Andrew are lovers, both deny it.

Security Level:4

C6#6 The Matsouka Gallery:

This gallery is run by an Asian family, and specializes in Japanese and Chinese works of art.

Security Level:1

C6#7 Shaito Imports:

Run by the same family that operates the Matsouka gallery, this establishment deals with the import and sales of many far Eastern goods.

Security Level:1

C6#8 The Stars Theatre:

This theatre was built early in the post-fall period of Night City, and remained empty for quite some time. Finally, one of the upper-level managers of the Hacienda bought it and renovated it to his personal tastes.

The Stars only shows movies at night, and mainly old movies at that. The most remarkable feature of the Stars is its roof, made entirely of polarized glass. While the roof is covered during the day, at night it is uncovered to reveal the entire night sky during showings. (Of course this is a projection of what the stars should look like, as the lights from the city make it impossible to see the actual stars under normal circumstances; imagine a planetarium combined with a theatre.)

Security Level:1

C6#11 The Darkwood Apts.:

Much like the Concord, the Darkwood is home to many families that work in other areas of the city. The top three floors belong to the Hydrosubsidium, and it keeps two research rooms hidden in apartments on these floors.

Security Level:2

C6#12 The Hydro-Technics Building:

These are the main offices of the Night City branch of the Hydrosubsidium, and this is where most of the theoretical research is done. While the buildings on the waterfront are generally believed to be the main offices of the company, this building is the actual heart of the American branch.

Security Level:3

C6#13 The Wyman Building:

Simply an industrial building with many different companies occupying various spaces within it. There are several front companies strictly for use in laundering cash.

Security Level:1

C6#14 The Marina:

Another slightly upscale restaurant, the Marina serves fresh seafood at reasonable prices. It mainly caters to the techs, low level Movers, and visiting Beavers out for a night on the town.

Security Level:1

NIGHT CITY

SECTION C6

C6#15 The Synop-Tel Building:

A small company researching advances in telecommunications, Synop-Tel manages to stay in business by licencing new inventions and technological advances to larger corporations.

Security Level:1

PERSONALITIES



Isabel Vargas (I) and Andrew Scythe(R). At the opening of the Hacienda, May 20, 2015

Isabel Vargas- One of the last truly romantic Spanish ladies; Isabel is famous for her charm, wit, and beauty (all natural; she has never had cosmetic surgery). She is kind and compassionate and will give aid to someone if she believes it necessary. She leaves the more unpleasant aspects of running the business to Andrew.

INT 9, REF 8, TECH 6, COOL 10, ATTR 10, LUCK 8, MA 7, BODY 5, EMP 10

SKILLS: Poise & Grace 10, Personal Grooming 10, Education 7, Wardrobe & Style 10, Social 8, Human Perception 5, Gambling 6, Seduction 4, Accounting 6, Spanish 10

CYBERWARE: None

Andrew Scythe- Famous for his skill in arms and leadership of security forces, Andrew is a very dangerous man. Several companies have tried to hire him away from Isabel but he has refused to leave the Hacienda (this has given birth to the rumors that he and Isabel are lovers). Very capable and very harsh with offenders, he is the reason gangs citywide have declared Charter Hill neutral turf.

INT 8, REF 10, TECH 6, COOL 9, ATTR 8, LUCK 7, MA 7, BODY 8, EMP 7/6

SKILLS: Combat Sense 10, Notice 10, Handgun 9,

Brawl 4, Melee Weapon 3, Martial Arts(Karate) 5, Rifle 5, Athletics 4, SMG 6, Stealth 5, Leadership 9, Expert(Tactics) 8

CYBERNETICS: Speedware. Cyberarm with *Streetmaster* popup gun.

DATA TERM™
NYI
For Your Information™

THE HACIENDA SPECIAL

While Charter Hill does have the regular Night City bus routes it also has the Hacienda Special, which is a special charter that runs from the airport and back every three hours. It's used to pick up influential guests and is very well armed and armored.

ENCOUNTERS

- 1: A small group of corps(5) heading towards the Hacienda for a bit of gambling
2. The players spot a known fixer scrounging about a warehouse space.
3. Looks like the Hacienda security force (5 solos) is making another sweep to keep the gangs off the streets.
4. Oops... two gangs are having a sit-down to discuss a disputed area of turf. They are lightly armed, but don't like strangers sticking their noses into gang business.
5. The players encounter a security team from the Hacienda (3 solos), who are tracking a man who robbed a patron. They will be grateful for any information.
6. The players find a small cache of notes, possibly having to do with the current adventure.
7. The players spot a familiar face in line at the Stars Theatre.
8. Gunshots coming from the south.
9. The players spot a V.I.P. going into the Hacienda, possibly for an illicit meeting.
10. The streets are as silent as the grave...

CONTACTS

Bill Johnson- A hardworking busboy at the Casa de Seville, he knows all the regular patrons.

Miki Samson- An attractive blackjack dealer at the Hacienda, she hears all and tells little. But Mr. Right may get an earful.

Erik Wells- The ticket clerk at the Stars. He always has his ears open, and the right amount of cash will open his mouth.

Davis Bradshaw- One of the Hacienda's security officers. A good man to have as a friend, a nightmare to have as an enemy.

Irene Stallis- A secretary at the Hydrosubsidium, she knows all about the secret operations in the Trench. If she opens her mouth, she may need serious help very soon.

COMBAT ZONE

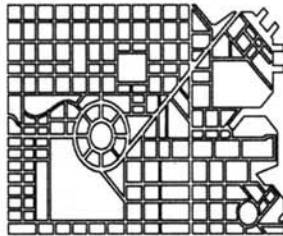

D A T A T E R M

The Combat Zone. Every modern American city has one; Night City is no exception. A burned-out sprawl of tenements, abandoned factories, boarded up offices and trashed shopping malls, occupied only by the desperate, the devious and the dead. During the light of day, the Zone sleeps under its industrial strength pall of smog. But at night, the Zone comes alive, for it is only then that it's most feared residents venture out of their sweltering sewer holes and rat-infested hovels to howl and prowl.

Night City's Combat Zone lies somewhere south of the central City as shown on most Chamber of Commerce maps. For the first few miles, this region is mostly made up of residential areas; blocks and blocks of nearly identical tract housing interspersed with small businesses. Further south, lies the area actually known as the Combat Zone, with its blocks and blocks of burnt out wasteland. There is no clear definition between the residential area and the combat zone; things just tend to degrade gradually, getting worse and worse until the neighborhood is finally at the level of a postholocaust hellhole.

It should be noted the Zone seems to be growing yearly, and what was once marginally valuable housing one year is often now another pile of junk in the Zone a year later. There has been much discussion on whether or not Night City should wall off its Zone, much as has been done in Detroit (with its ubiquitous twenty foot concrete abutments established in the late 90's). So far, no agency either civil or corporate, has been willing to take the initiative to begin such a massive undertaking.

The Combat Zone is never safe. Sure you can get in and out again, maybe even twice, but even the high-rollers at the Hacienda wouldn't give you odds on it. Entire security

teams have disappeared in the Zone, and not even the police are willing to go down there anymore. About the only professional organization that will enter the Zone, is Trauma Team™, and even then only with state of the art firepower backing them up.

The only information most people can get about life in the Zone comes from those who have "come back to tell the tale" (so to speak). People who are tough enough to survive the Zone don't really care about small talk, so much of this information is gathered in bits and pieces. It is pretty well accepted that there is some form of hierarchy among the combat gangs, with the Blood Razors currently on top. It is also rumored that something called "RazorBall" is played at an abandoned ice-skating rink, once a month, and has a great turnout among the gangs.

The Zone is where Cyberpunks go to play. It's a place where there are no streetlamps to mar the shadows, no monitor cameras to watch illegal deals, and no cops to interfere. Of all the mean streets of the 21st century, the Zone is the meanest. Firefights are a way of life. Drugs are a way of choice. Brutal, sudden death is a constant option.

Because the Zone is such a nebulous region, no exact maps exist within your dataterm database. The Zone's entry is instead updated by running reports from Combat Cabb hacks, random fixers selling information, and the occasional solo with something interesting to report related to a job.

Referee's Do It Yourself Combat Zone.

We know you're going to be basing a lot of your action in the Zone. But if your players can look in this book and know all the facts, it's not going to be any fun at all. So here's everything you'll need to construct your own Combat Zone hellholes. Select any of the following maps as a location for your action. For each building/block, roll 1D10 for Type, and 1D10 for condition. If a gang is present, roll on the Gang Table for type, then add 1D10+1 for number.

Building Type (1D10)

- 1 Church
- 2 Mini-mall
- 3-4 Apartment Block
- 5-6 Bar or club
- 7-8 Factory
- 9 Small Storefront
- 10 Offices

Building Condition (1D10)

- 1-2 Abandoned, empty
- 3-4 Burned out, still standing
- 5-6 Decaying, filled with squatters
- 7-8 Decaying, filled with gangs
- 9 Partial rubble, run down
- 10 Renovated by Movers

Gang Encounter (roll 1D10)

see Gangs, pgs. 54-55 for descriptions

- 1 Warrior Heart
- 2 Steel Slaughter Slammers
- 3 Pirahnas
- 4 Second Comming
- 5 Blood & Tears
- 6 Golden Knights
- 7 Fangs of Justice
- 8 Western Stars
- 9 Death in the Afternoon
- 10 Blood Razors

NIGHT CITY

SECTION D



Random Objects in Area (roll 1D6)

- 1 Abandoned car
- 2 Dataterm (slightly fragged)
- 3 Videoboard
- 4 TV monitor camera
- 5 Parked car, in lockdown mode
- 6 Screamsheet box

Random Hangouts (roll 1D10)

- | | |
|-------------------------|---------------------|
| 1 Combat-Sport arena | 2 Sleazy bar |
| 3 Sleazy "coffin" hotel | 4 Drug dealer's |
| 5 Weapon dealer's | 6 Gang clubhouse |
| 7 Dance club | 8 Street drag strip |
| 9 Junkyard | 10 Sewer |

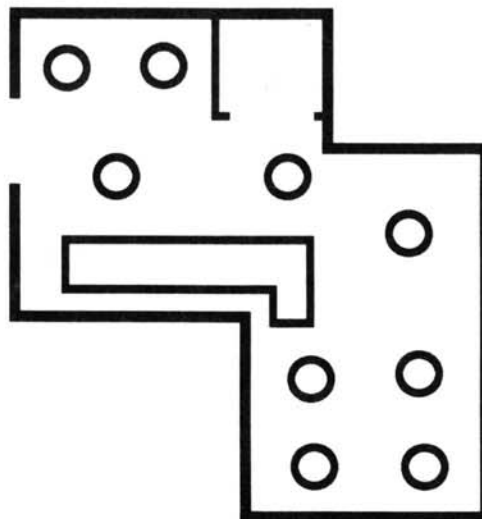
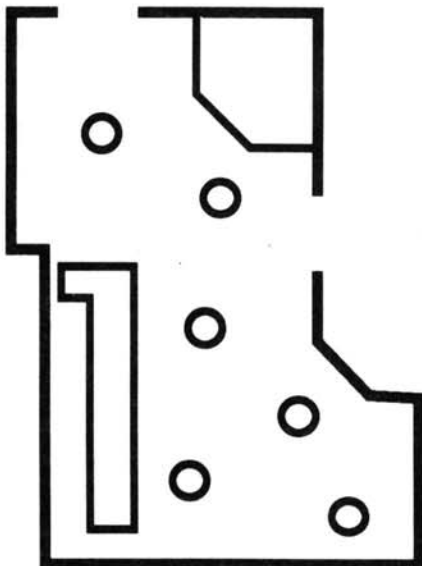

Assorted Sleazy Dives

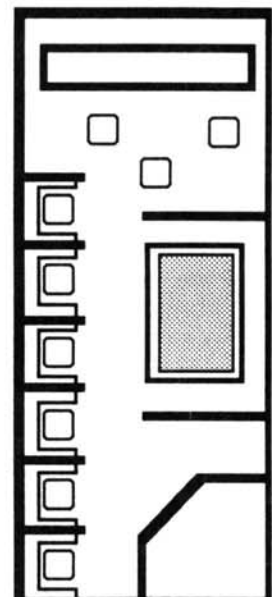

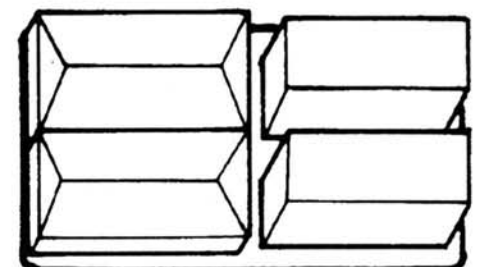
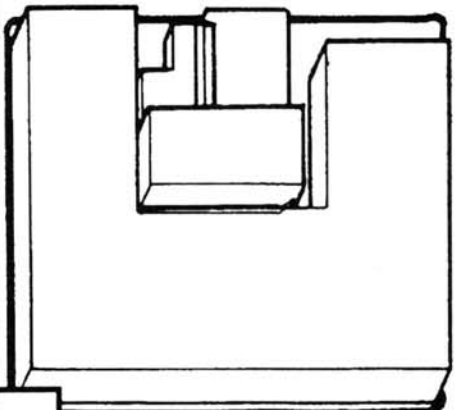
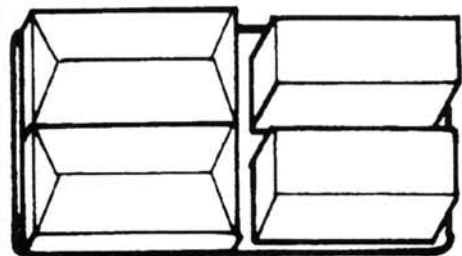
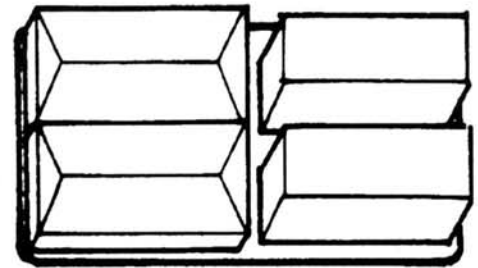
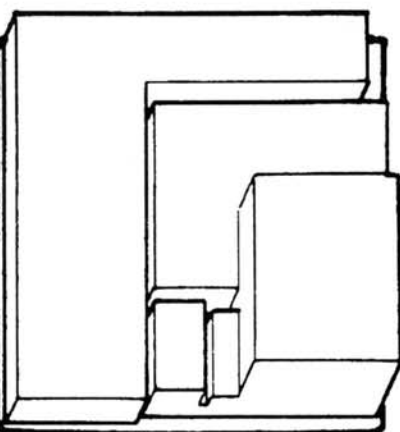
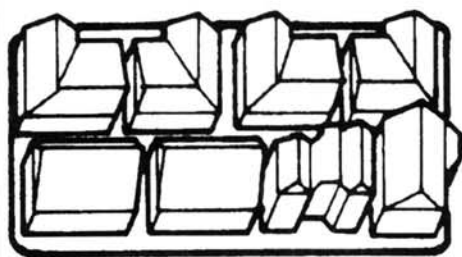
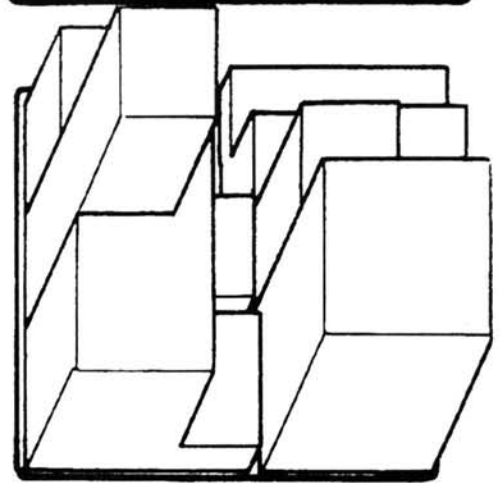
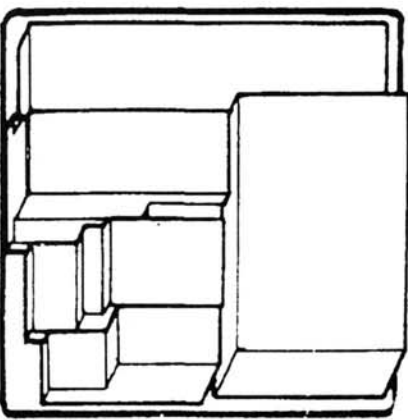
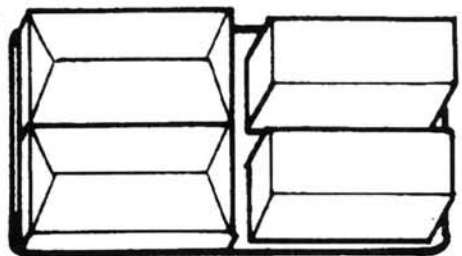
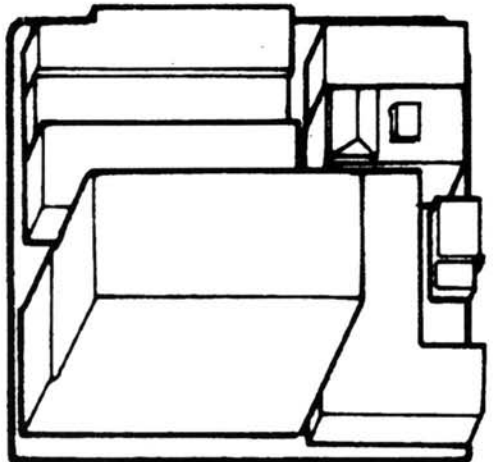
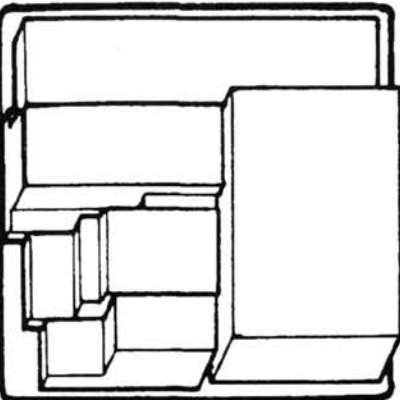
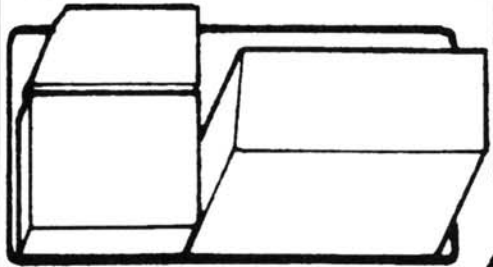
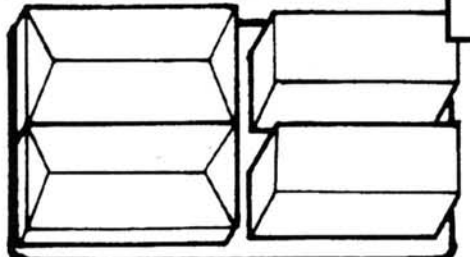
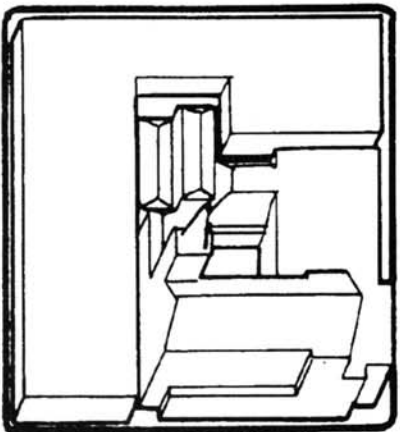
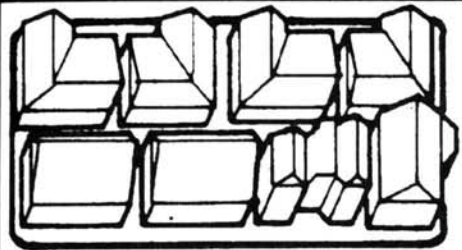



COMBAT ZONE

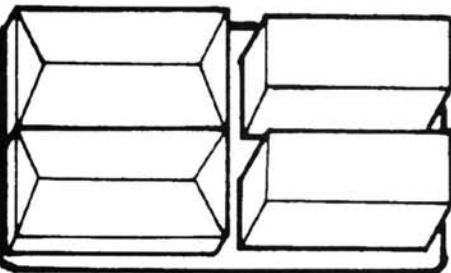
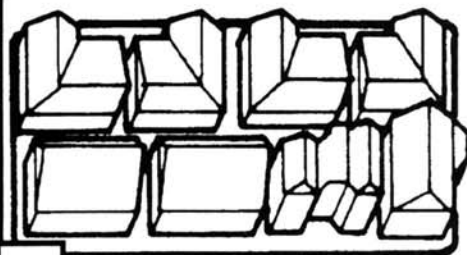
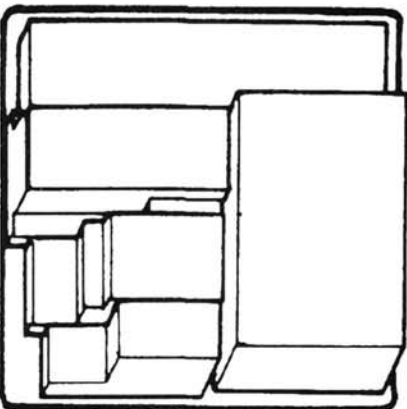
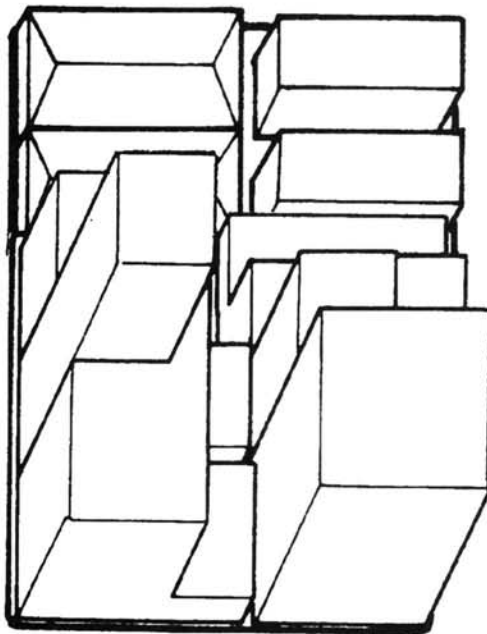
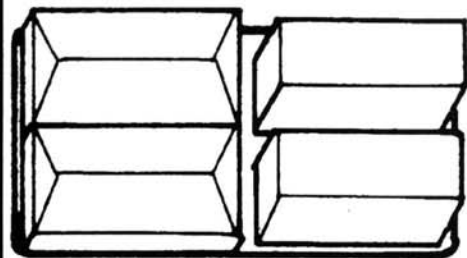
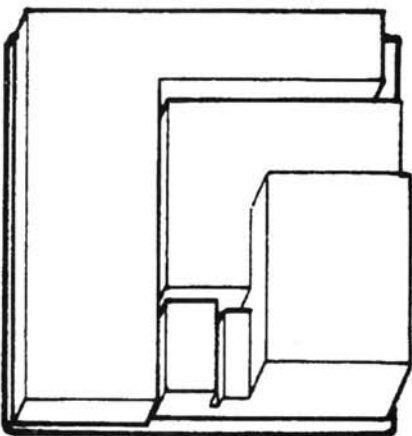
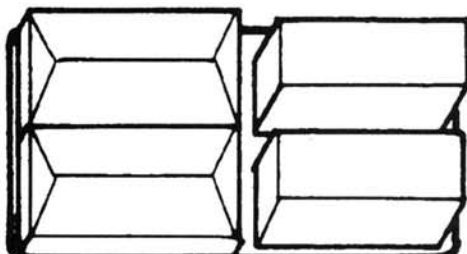
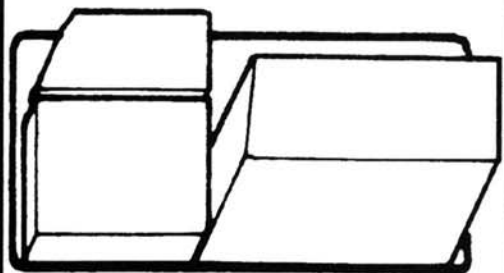
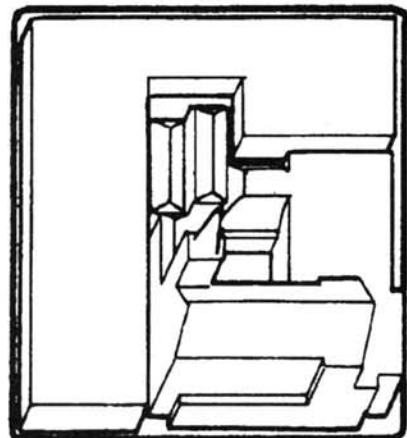
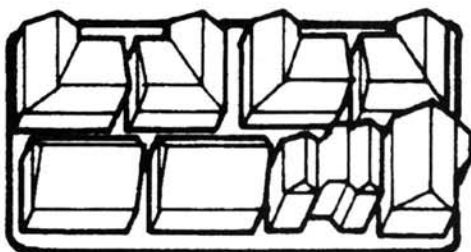
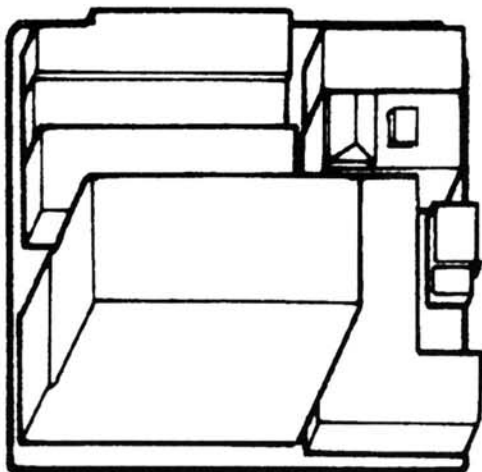
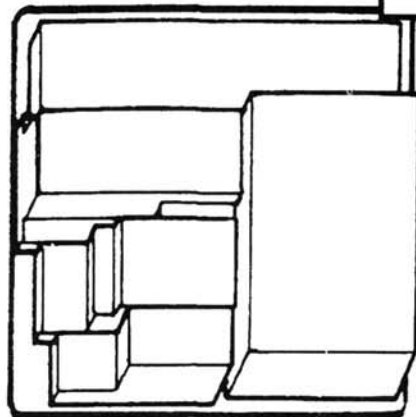
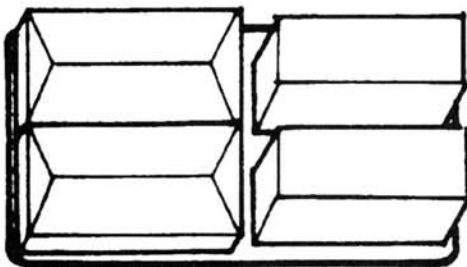
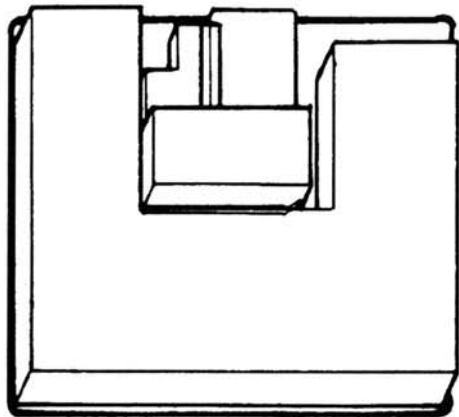

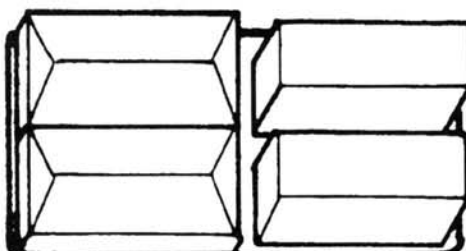
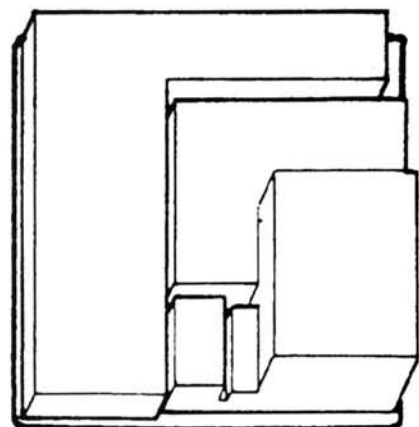
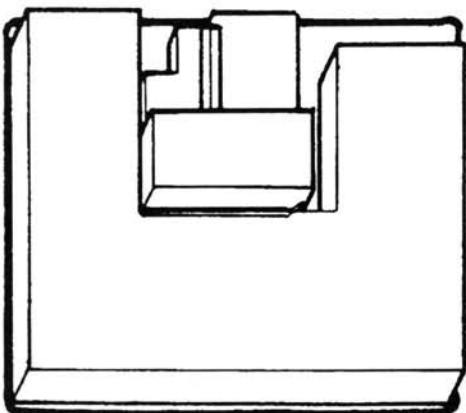
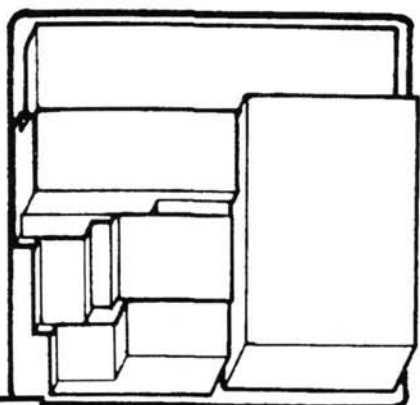
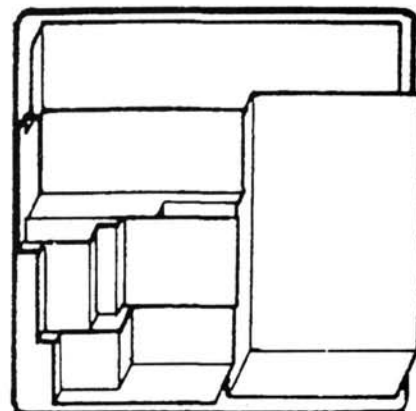
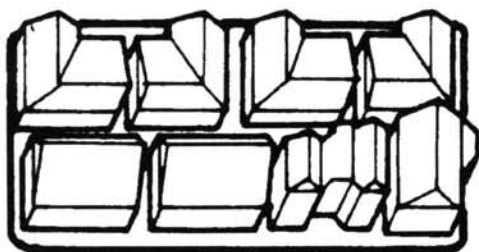
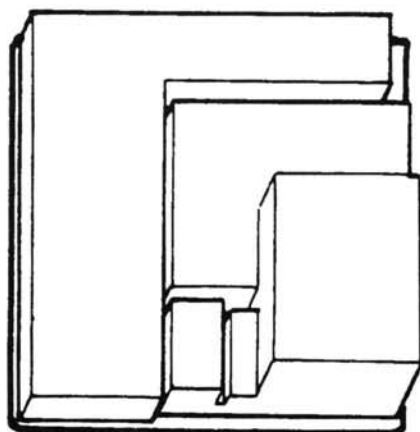
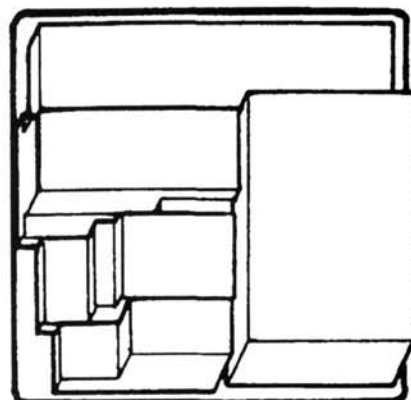
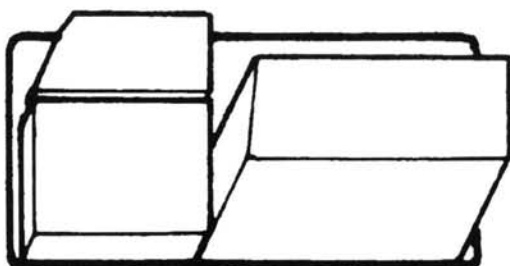
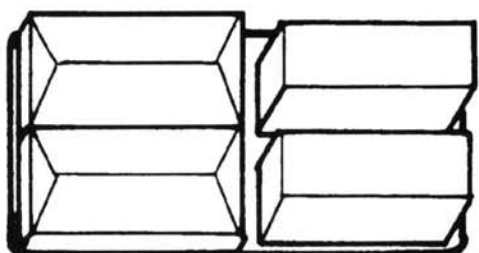
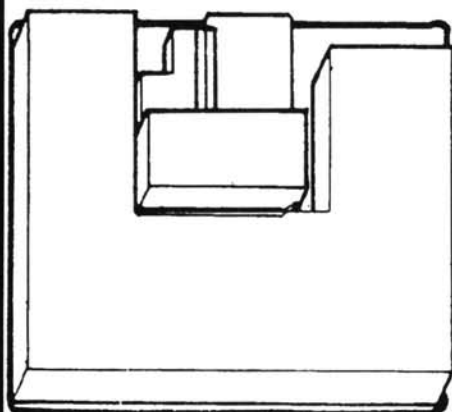
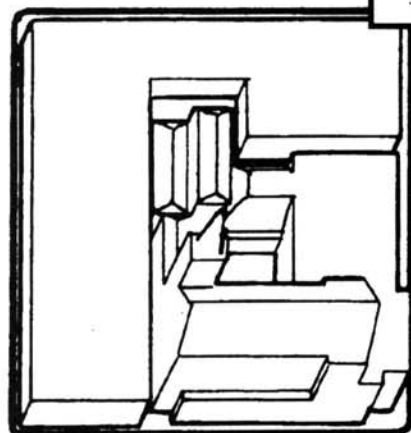
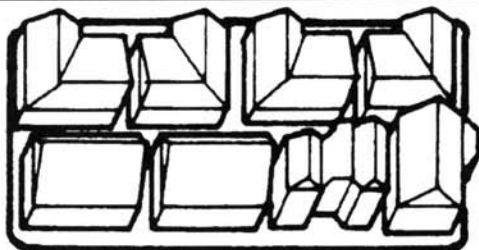
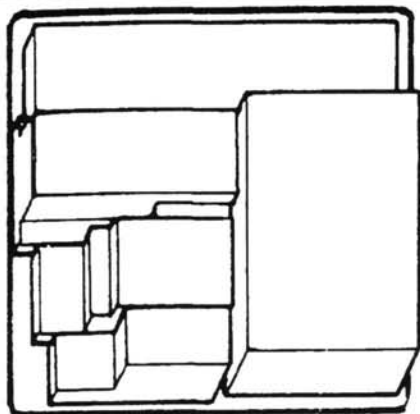

THE SUB-URBAN SPRAWL

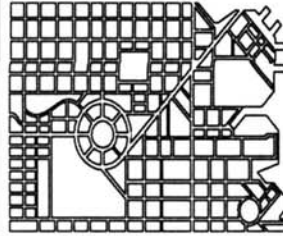

D A T A T E R M

Sections E1 thru J1: South Night City, Heywood, Westbrook, Rancho Coronado, NorthOak & Pacifica

There are six "suburbs" surrounding metropolitan Night City: South Night City (an industrial port area), Pacifica (a beach city on the coast), Rancho Coronado (ultimate beaverville), Heywood (light industry and residential suburbs), North Oak (sister city to Night City, and the home of the NorCal Military Base) and Westbrook (Land of the Rich and Powerful). All of these suburbs are within twenty minutes (by maglev) of the City.

E: SOUTH NIGHT CITY

This area is basically an heavily industrialized port city with one of the last oil refinery terminals in the area, a container shipping port, the Night City Municipal Sewage Treatment Plant and miles and miles of cheap, shabby housing constructed at the turn of the century by Mob-controlled contractors.

South Night City is a dangerous place. If you're not taken in a dark alley by one of the many gangs that roam the urban sprawl, it is quite likely you'll be shot by some trigger happy local mistaking you for a member of one the aforementioned gangs. It's always a good idea to travel here during the day. At night the fireworks start, and usually the ambulances don't come till the morning. Security here varies by location; some places are literal fortresses, with heavy firepower protecting them, while others just seal themselves in behind thick doors.

E1#1 Night City Municipal Sewage Plant

This is where most of Night City's sewage and waste processing goes on. The plant, run by corrupt city officials through a system of cronyism that would make a Chicago democrat blush, is well-known for its regular sewage backfills and toxic emergencies.

E1#2 San Morro Bay Cargo & Container Port

This is the main loading and unloading terminal for cargo-container vessels entering the central California area. From here, fruit, vegetables, processed foods and manufactured goods flow out of both Nor and SoCal in a steady stream, while imported goods flow back in. The Cargo Port is rarely used for smuggling, as the U.S. Customs Tax Service and the N.C. Harbor Police are generally incorruptible and extremely well armed.

E1#3 Petrochem Refinery Terminal

An older style refinery, with three extended docks for tankers to load and unload cargo. Most of the refinery products manufactured here are used in plastics making, not fuels. However, the refineries dozens of tanks, miles of pipes, and four towering stacks (illuminated by blue gas-flame burnoffs) are a dominating presence in the area.

F: WESTBROOK

Westbrook is a fortress, built on a naturally occurring set of hills overlooking Night City from across the bay and North Oak below. Many of the Corporate rich live here, and they make sure that nothing disturbs them. An Arasaka services contract makes sure of it. All Westbrook residences have specially coded identity cards, and there at least three check points on the road into the hills, and several surface to air missile sites to make sure all air traffic has the proper access codes.

All traffic is heavily monitored. It takes an Nearly Impossible difficulty roll to bypass the security of any one location, and you must go through at least three checkpoints before reaching the living compound. Forget about going overland, Apex systems dot the countryside, and even the walking paths are guarded. The computer system is programed by security to allow card holders to pass safely by. The cards are keyed to specific bio-monitors, they become useless if separated from the issued holder by a space of more than 10 feet. If you drop your card while jogging you'd better be able to run real fast—the guns cut in after a 10 second delay. Needless to say, most residents keep a very close eye on their cards.

Almost all corporations in Night City are represented in Westbrook; Arasaka, EBM, Petrochem and all the rest. Eran Mallor has a home here, as does Isabel Vargas and many other prominent Night City personalities. Admission to Westbrook is only limited in one way, you've got to be able to afford it. In short, only very rich people can afford to live here.

Westbrook is also a very safe place for corporations to place high extraction risk employees. There has only been one extraction attempt in the history of Westbrook, and that left three AV-4's destroyed and 24 Militech soldiers dead. That was the first and last attempted extraction at Westbrook. Many say that this incident was what had started the long running rivalry between the Night City branches of Arasaka and Militech.

WESTBROOK

NORTH OAK

16-828 Interchange

NorCal Military Base

Del Coronado Bay

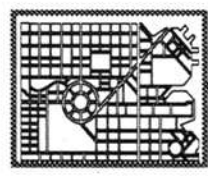

Del Coronado Bridge

828-928 North Interchange



SOUTH NIGHT CITY

6 Airport

San Morro Bay

128-828 Interchange

HEYWOOD

PACIFICA

RANCHO CORONADO

828-828 South Interchange



828 to 15

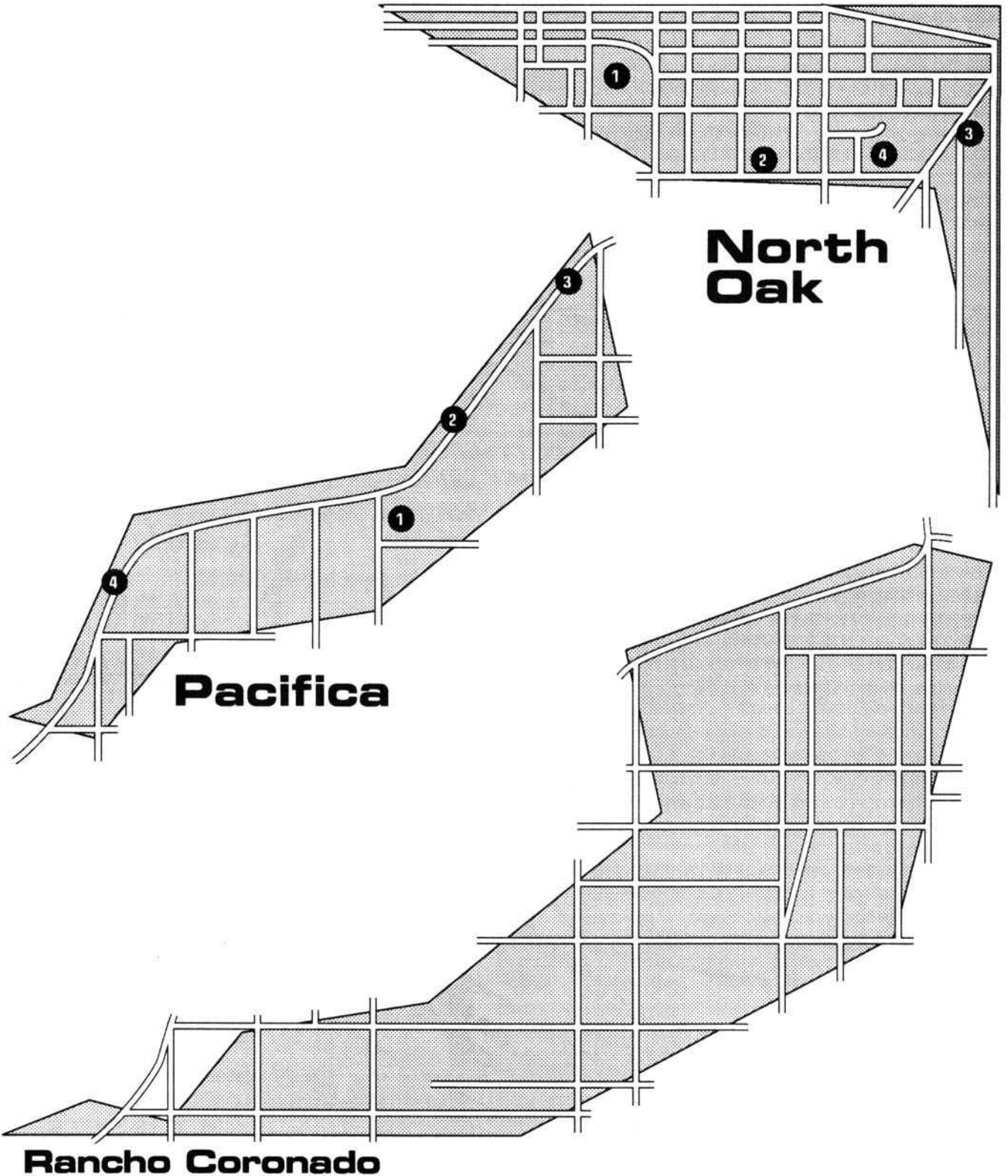

F1 #1 Executive Estates:

The most exclusive corporate-owned suburb in the area, EE caters to only the highest ranking Corpzoners and their assistants. Although it's been nicknamed a "beaverville", the name doesn't really apply to this stately sweep of million dollar homes, lush gardens and parks, huge greenbelts and golf courses, and private AV-pads. EE dwellers are among the very richest people of the Night City Area, and have the security and power to make sure they stay undisturbed. A private, Arasaka-sponsored maglev line passes through the edge of Executive Estates, and is shared with the more mundane rich people in the Westbrook area; however, you must have an EE passcard in order to exit at the Estates station.

G: PACIFICA

Home of Playland by the Sea™, Pacifica is an upper class residential area nestled between the cliffs of the Pacific Ocean and Rancho Coronado. Protected by a Militech security contract, Pacifica is a fairly safe place. The newly renovated **Playland** is a hit among the amusement park crowd from San Francisco, and brings a fair amount of tourist traffic up from the south. On the cliffs at Pacifica are the expensive home/condos of the **Coastview** development, offering a view of both the open sea, and for some a view of the bright lights of Playland™ itself. The entire area has the more relaxed attitude of SoCal and prides itself in being the only place in the Night City Area where one can truly relax.

The security in Pacifica isn't nearly as draconian as Westbrook. There are some people that hang out at Playland that wouldn't be let past the security gates at Coastview, but when dealing with Coastview, the security plays for keeps. While a booster can party down on the beach (with only a warning from security to keep the noise down), if he tries to cause trouble in Coastview, the Militech troops will think nothing of cutting him down. The response time for complaints from Coastview is very good.

Pacifica is also known for having the best seafood in the Night City area. Almost all the restaurants have made the top ten lists in their respective fields. Pacifica is also home to several galleries and museums as well as a small and fairly prestigious art college.

G1#1 WestWind Estates

A small beaverville located about two miles from the ocean, WestWind advertises a beachfront view (possible with a telescope). Home to many of the younger corporate techies and engineers, WestWind prides itself on its liberal, enlightened environment, with local art festivals, bookstores and many community events.

There's a dark side to this picture. As originally planned by it's Microtech investors in 2006, WestWind was to be a haven of liberalism in a world of right-wing fascists. Once the Gang of Four's reign collapsed, WestWind's progressive leaders became entrenched, and their liberal agenda became dogma. The once enlightened community now has many of the elements of an Orwellian nightmare; local leaders shunning those of differing

political views, "social counselors" acting as thought police, and neighbors informing on each other's "politically incorrect" activities. Don't eat meat, read George Will, or argue about Marxist political theory if you know what's good for you.

G1#2 Coastview

An expensive complex of individual beachhouses and recreation centers, protected by a somewhat draconian security contract. When edgerunners get tired of the fast life in the City and want a quiet but trendy place to settle in, this is where they go; such local lights as Johnny Silverhand and Bes Isis maintain beachfront homes in this development.

G1#3 Playland By the Sea

Originally a run down amusement park on the edge of the Pacific, Playland was bought in 2007 by the Tower of Dark corporation, an investment cartel from Southern California who hoped to build a new park using the latest in braindance and interface technology. The Park has grown from this humble beginning to a major NorCal amusement center, featuring live-roleplaying adventures, group braindance entertainments, parks, exhibits, and the most amazing carnival rides the advanced technology of the 21st century can offer.

G1#4 Pacifica Arcology

On the towering beachside cliffs four miles south of the center of Pacifica stands the fortresslike sprawl of the Pacifica Arcology. Built by foreign investors fleeing the collapse of Hong Kong in 1999, the Arcology is a mega-building ten times the size of the New Harbor Mallplex, housing almost 100,000 people in its seven square miles. Self-contained and aloof, the Pacifica Arcology members are rarely seen and don't often associate with other Pacifica locals.

H: NORTH OAK

The home of the NorCal Military Base, NorthOak is Night City's closest neighboring city. Smaller than Night City, NorthOak's towering structures and ship-superstructures can be seen across the bay from the East Marina. NorthOak is a military city, most of its shops sell to military servicemen or their families, and the majority of it's population is in some way or another associated with this huge military complex.

In the light of vast post-war funding cutbacks and the rise of the Free States, the Pentagon fell back to the concept of core bases; large, well-defended installations which would protect a regional area, and support units from all four branches of the military. NorCal Military Base was established as part of the deal which allowed Northern California it's titular independence from the Union as a Free State. The State government doesn't mind; it keeps the SoCal scum from coming north and raiding for water.

NorCal Military homeports Navy ships (the carrier *John F. Kennedy* and cruisers *Ticonderoga* and *Washington*, plus assorted support frigates and destroyers), a small Air Force squadron of F-36 *Jaguar*

fighters, and a U.S. Army armored battallion with its own AV-7 and AV-4 support vehicles.

The city of NorthOak is almost entirely federally owned and operated. The "Mayor" is the commander of the base, and of the twelve man city council, eleven are now, or have been in the military. NorthOak is no longer even considered a Californian city—M.P.'s patrol the streets instead of police, and all justice is handled in a military court under a military version of the Uniform Justice Code. The crime rate is a mere percentage of Night City's, thanks to the fact that the military runs NorthOak with an iron fist, acting as judge, jury, and executioner in all criminal cases. If you live in NorthOak, you'd better be prepared to follow the federal lead. Firing squads have come back into fashion.

Living on NorthOak's wide, oak-shaded streets can be quite agreeable. The homes are pleasant, pastel-colored bungaloes with identical numbered curbs. Schools are excellent and the Base Hospital, Theatre, Officers and Enlistedman's Clubs and the Base Exchange shopping mall will provide almost anything you might want. If you like life in or around uniforms, this is the place for you.

H1#1 The Oaks

The Oaks occupies a unique position among beaverilles; adjacent to the massive Military presence of the city itself, the Oaks have become a suburb for retired military officers and enlisted, as well as a few civilian personnel associated in some way with the Base (Base Exchange clerks, secretaries, contractors, teachers, etc.). Like the rest of the "city", the Oaks are under the same military control and have an orderly, well-regimented flavor to them.

H1#2 Headquarters, CINC-NORPAC

Headquarters, Commander in Chief, Northern Pacific Task Force 384. Basically, the Navy headquarters for the seven ship task group operating out of Del Coronado Bay.

H1#3 157th TACTICAL AIR SQDRN/ NORCAL ADC (Air Defense Command)

Headquarters and ops building for the F-36 fighter squadron operating out of the Night City region. The 157th patrols south to San Luis Obispo and north to San Francisco Bay.

H1#4 223rd ARMORED BATTALLION HDQTRS.

The local Army battallion, with about 100 tanks on ready status, plus support troops and vehicles. The 223rd was brought into play during the Separation War between Nor and SoCal in 2013, primarily to keep hostilities from escalating out of hand, and has remained here ever since.

I: RANCHO CORONADO

The Ultimate Beaverville, with all that the name implies. South of

Night City, on Highway 126, Rancho Coronado extends for miles, consisting almost entirely of tract housing, interspersed with small, trendy mini-malls. While the security here doesn't have incredible amounts of firepower, what they lack in bullets, they make up for in viciousness. "RC-beaver" security is famous for its pit bull tenacity, making the area a very safe place to raise a family. In Rancho Coronado, you'll find subdivisions packed full of Arasaka, Petrochem, Biotechnica, WNS and EBM employees, all neatly slotted into rows of identical small three-bedroom homes that reach towards the horizon... Rancho Coronado makes most edgerunners break out into a cold sweat just thinking about it.

Most of Rancho Coronado is walled by a twelve foot concrete barrier with an electrified, barbed wire fence extending another three feet above that. There are five main entrances around the perimeter of the RC development; two off of Highway 126, one leading to Del Coronado Bay, and two off of Highway 828 towards Heywood.

J: HEYWOOD

A light industrial area that lies on the east of Del Coronado bay, between Rancho Coronado and NorthOak. Heywood has a little of everything, some housing, a little retail shopping, a few parks, and the well known **Apple Corporate Valley** subdivision, a primarily Biotechnica-dominated beaverville in South Heywood.

But most of Heywood's rolling hills are dotted with large, sprawling factories. Among these many industrial complexes, one can find an Arasaka arms factory, several Biotechnica research stations, two EBM storage and research stations, and many others. They dot the hills, some underground, some above, some small, some sprawling over acres.

J1#1 Arasaka Weapon Assembly Facility A-452

A small weapon assembly plant, (mostly automated), warehouse and firing range.

J1#2 Biotechnica Mono-clonal Research Station

A medium sized lab building, with a staff of about 200 scientists, techs and security. Research is done here on many small Biotechnica cloning projects.

J1#3 EBM Remote Assembly Facility

A large automated factory which produces EBM's larger mainframes, as well as a shipping and storage section for product.

J1#4 Militech Armored Assault Group Training & Live Fire Range

A 200 acre simulation range for testing AV's and ground assault vehicles under fire conditions. There is a small "town" built in the center of the range; this is used to practice urban assault tactics.

Heywood

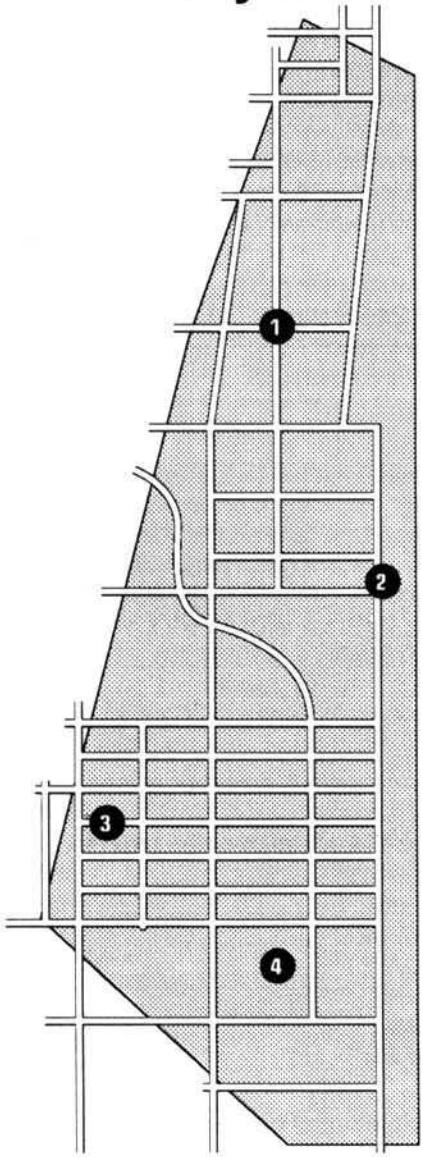

**South
Night City**

Westbrook

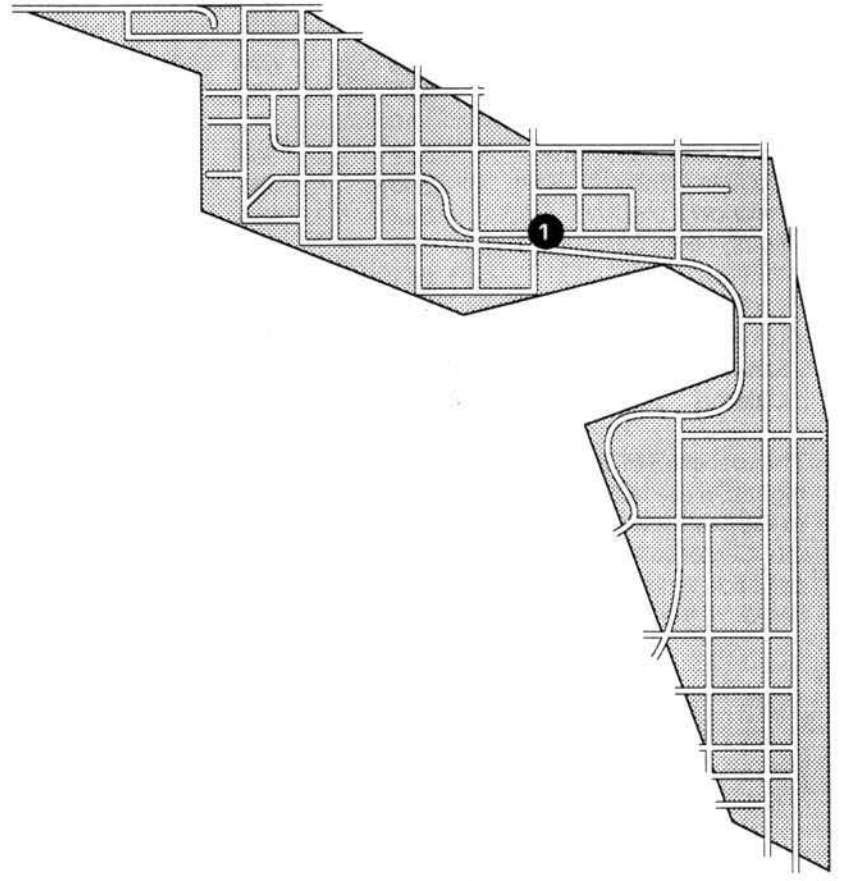

DATATERM UTILITIES

Phone Number Locator UP
DN

Phone Numbers gives you a percentage chance to locate a specific number, based on whether it's a business, unlisted, etc. To determine a phone number:

- Public office or retail business 95%
- Private office or manufacturing business 80%
- Corporate Exec's Private Line 20%
- Private Phone Number, listed 95%
- Important person's private line 20%
- Very Important person's private line 10%

The dataterm also lists Prefix Codes as below. To determine an actual phone number, determine the prefix by location, then roll 4D6 for the last digits.

Location	Prefix	Area Code
Northside, Little Italy	551	666
City Center, Upper Eastside	552	666
Corporate Center	553	666
Charter Hill, New Harbor	554	666
Upper & East Marina	555	666
East Park & Japantown	556	666
Little China, Med Center	557	666
Studio City, Old Downtown	558	666
Lake Park & University	559	666
Combat Zone	666	666
Heywood	662	666
South Night City	667	666
Pacifica	665	666
Pacifica Arcology	664	666
Los Angeles		213
San Francisco		415
Oakland		515

The cost of a 3 minute call is the difference between the highest of the two prefixes and the lowest, rounded up to the nearest whole penny. For example, from Corporate Center to Arco Pacifica would be 664-553=\$1.11 per each 3 minute period. Calls between area codes are based on the per-minute table below.

		CALLING FROM			
		213	415	515	666
CALLING TO	213	Local	3.00	300	2.50
	415	3.00	Local	1.00	1.75
	515	3.00	1.00	Local	1.75
	666	2.50	1.75	1.75	Local

General Database UP
DN

General Information asks questions about the data you want to know about (is it well known? Is it published somewhere? Is it secret?) then adds up the values for each question to give you a percentage chance that the dataterm knows the facts you need. Your base chance of finding out any fact is 95%. Add all percentages listed below that pertain to the information for a total chance of finding the information:

- 1) Has this information been published?
 - More than once? (+5% for each publication)
- 2) Is this public knowledge? (+10%)
- 3) Is this:
 - Corporate information? -30%
 - Underworld information? -50%
 - Military information? -40%
 - Government information? -30%
 - Foreign information? -20%
- 4) Is this information related to a known public figure?
 - How important or well known is the person?
 - Not very important (guy on the street) -60%
 - Marginally important (local personality minor media, official) -10%
 - Important (City/State official, media personality) -5%
 - Very Important (world leader or megacorporate head) +10%
- 5) Is the information secret, covert or related to something illegal? -70%
- 6) How long ago did this information take place?
 - Within a week -10%
 - Within a month -20%
 - Within 6 months -30%
 - Within a year -40%
 - Within 5 years -50%
 - Within 10 years -60%
 - Within a decade -70%
- 7) Where did this information originate?
 - Locally +10%
 - In the same state +5%
 - In the same country -10%
 - In a major country -20%
 - In a minor or obscure country -40%

DATATERM DISPLAY SYSTEM Topic: **NET Access**



UP

DN

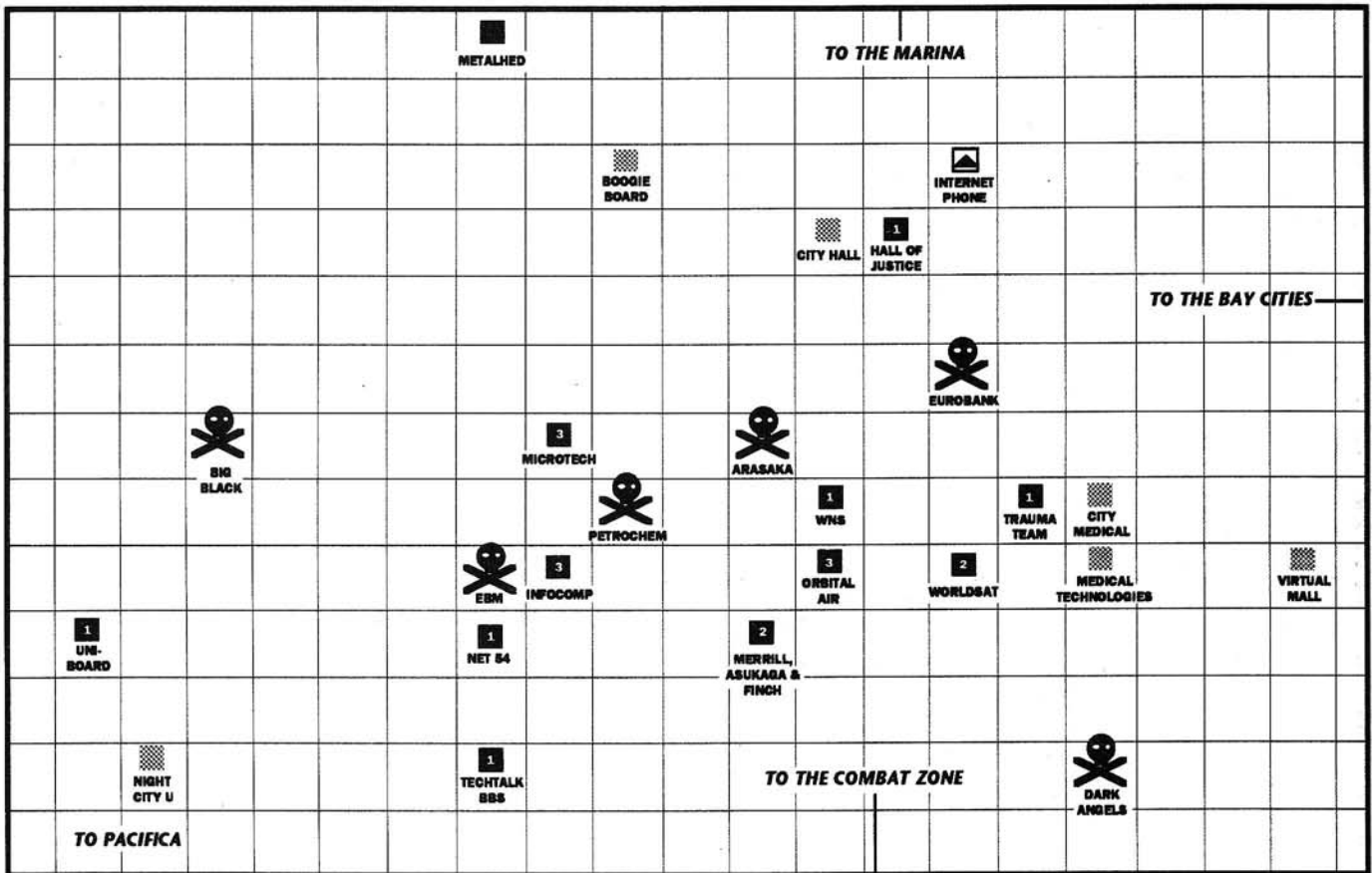

NAME	DESCRIPTION	SYSOP?	AI?
Arasaka	Corporate Information Database	Y	Y
Big Black	Netrunner Board (medium level hackers, 'runners)	Y	N
Boogie Board	Weefle-runner Board (mostly kids)	Y	N
City Hall	City Records, Permits and Licencing Database	N	Y
City Medical	Hospital Records	N	N
Dark Angels	Heavy Duty Netrunner board (Maximum level cowboys)	Y	N
EBM	Corporate Information Database	Y	Y
Eurobank	Financial Records and Cash Transfer	N	Y
Hall of Justice	Criminal Records, Police APBs, etc.	Y	N
InfoComp	General High Security Information Database	Y	Y
Internet Phone	Phone LDL link and Terminal Entrance	N	N
Medical Technologies	Hospital Records, Medical Research	N	N
Merrill, Asukaga & Finch	Stock & Commodities Transactions	Y	N
MetalHed	Chromatic Rocker BBS with Virtual Videos	Y	N
Microtech	Corporate Information Database	N	Y
Net 54	News & Broadcast Media Information Database	Y	N
Night City U	Educational Database, Research Projects	N	N
Orbital Air	Corporate Information Database	Y	N
Petrochem	Corporate Information Database	Y	Y
Techtalk	Technical Information Exchange	Y	Y
Trauma Team	Medical Records, Trauma Team Calls	N	N
Uniboard	Student Hackers, Professorial Papers, Open Forum	N	N
Virtual Mall	Shopping and Ordering Service in Virtual Form	N	Y
WNS	News & Broadcast Media Information Database	Y	N
Worldsat	Corporate Information Database	Y	Y

DATATERM DISPLAY SYSTEM**Topic: Message Mail****UP****DN**

Message Mail allows you to leave a message on a dataterm; this message is stored in all dataterms in the City and can only be accessed if the recipient has a secret 7 letter/number code which you have previously agreed on. You can also post **General Messages** to the Message Mail as well. These messages can be accessed by any dataterm without a seven letter code.

To use Message Mail, you keyboard in your message (no longer than 50 words), and assign it a seven letter/number code (such as HOTSTUF or NETRUN2). The message cannot be retrieved unless the exact code is entered.

If two exact codes are entered into the dataterm, the term accepts the first and tells the second to select a new code. To retrieve a message, you must place a phone debit card with your ID on it into the dataterm, and use the right code word in combination with that ID. Messages are erased after 48 hours.

Most people use several dataterm "blind drops"; they have one code they give to all friends; this drop lists all the codes for other message areas.

Hardcopy gives you a fax-flimsy of whatever you want, at a cost of .50eb per page.

DATATERM DISPLAY SYSTEM**Topic: Top of the News****UP****DN**

Top of the News gives you the top 5 screamsheet headlines for a four hour time period, in order of importance:
1) INTERNATIONAL 2) NATIONAL 3) STATE 4) LOCAL 5) GOSSIP

Following is a list of mix and match headlines for you to cut and paste. These can be used to create your own screamsheets for your adventures.

Arasaka
Senator
President
Mayor
Corporations
City Council
Cyberpsycho
Killer
Slayer
Tragic
Investigators

Offers
Threatens
Continues
Warns
Compromises
Murders
Killed
Dies
Praises
Announces
Reveals

Corporations
City
Compromise
Warning
Plan
Scandal
Woman
Man
Accident
Hope
Danger

Headlines are updated regularly: In most cases, International, National and State are updated once per day. Local is updated hourly. Gossip is updated as it comes in; often a hot story will get minute by minute updates.

Night City! Awhooooooo!

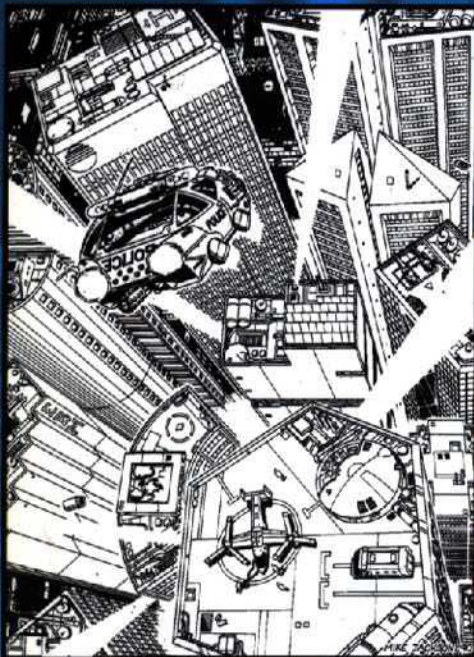

You can hear them moving up fast; faster than your meek legs can carry you. There's a snick as they pop the rippers and move in for the kill; you flatten against the alley wall, and brace your Minami against the slick, slimy stone. It's now or never, you think, slamming back the bolt and offering up a prayer to whatever dark and nameless gods might be listening.

Maybe if you'd known this was Blood Razor turf, you woulda been smart enough to stay clear after dark. Maybe there was another way to get crosstown and infiltrate Arasaka's Japantown base, but you didn't know it. Maybe if you'd stopped to download some info from a dataterm before you walked right into the sharp end, you wouldn't be here now, waiting to become a booster's latest mutilation victim...

But you're never gonna know. Not now. You're not getting a second chance.

Because this is NIGHT CITY.



NIGHT CITY. A monster sourcebook containing over 180 jam-packed pages of information on the definitive **CYBERPUNK®** setting! Hit the **CONTROLLED URBAN ZONES** with 3D maps and detailed, building by building descriptions to match. Each section also includes comprehensive overviews of **FLOOR PLANS, PERSONALITIES, ENCOUNTERS** and **CONTACTS.** The **FLASHMAPS** Section puts you "on the spot" at the hottest restaurants, clubs, and theaters, as well as **SCHEDULES, TRANSIT MAPS** and **AREA VIEWS.** The **ARTICLES** Section interfaces you with background on **SECURITY, PEOPLE OF THE CITY, GANGS & TURFMAPS,** plus a **U.S. 2020** overview! But that's not all— **NIGHT CITY** also comes with a full-color, 2'x3' 3D map of downtown Night City, your backdrop for adventure!

So, if you're looking for the ultimate dark future urban environment, take a trip to **NIGHT CITY.** Because you may not live to get another chance.



A CITY SOURCEBOOK FOR

CYBERPUNK®

**R. TALSORIAN
GAMES, INC.**

Published by R. Talsorian Games
P.O. Box 7356, Berkeley, CA 94707
Copyright 1991 By R. Talsorian Games Inc.
Cyberpunk and Night City are trademarks of
R. Talsorian Games Inc. all rights reserved

CP 3501
ISBN # 0-937-279-11-0