

CHROME #1

#2

cyberpunk style guides 1 & 2



CYBERPUNK®

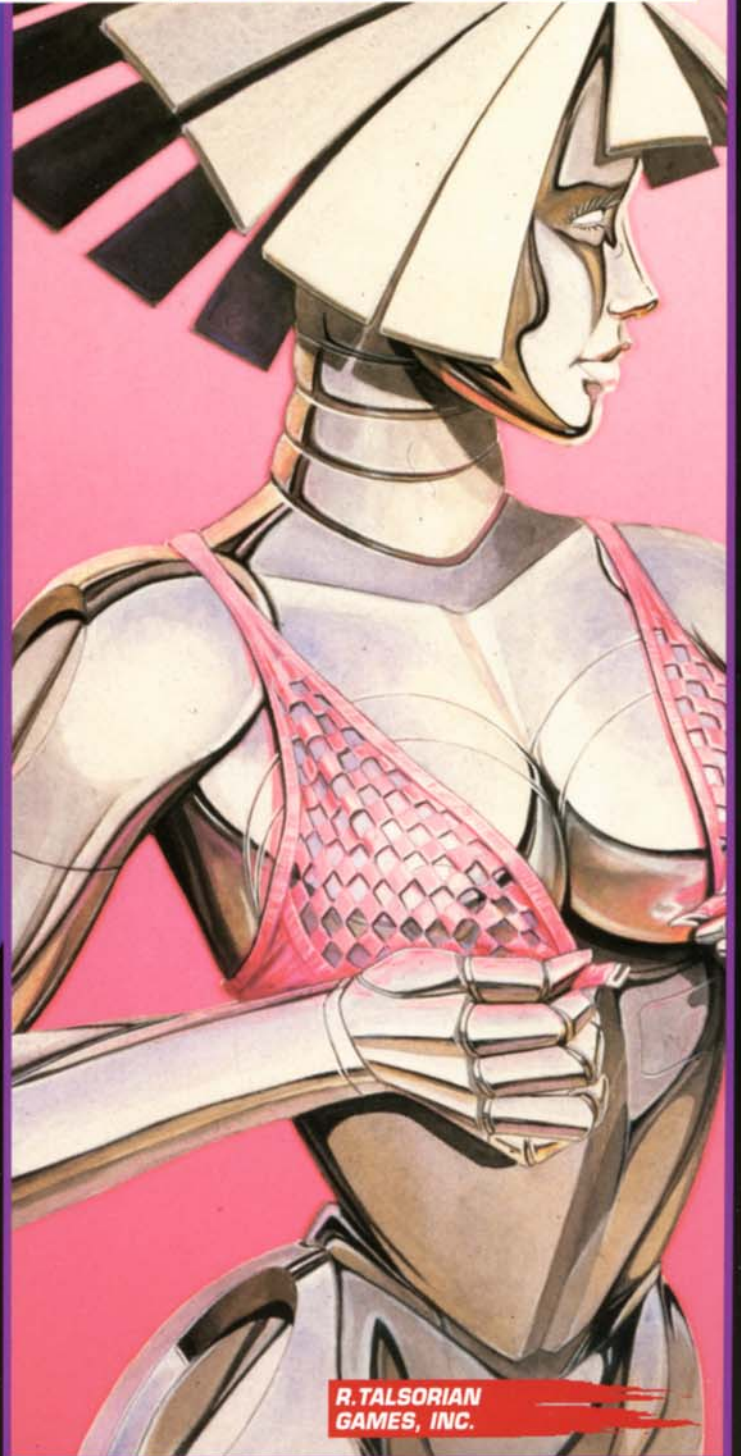

R. TALSORIAN
GAMES, INC.

CHROME

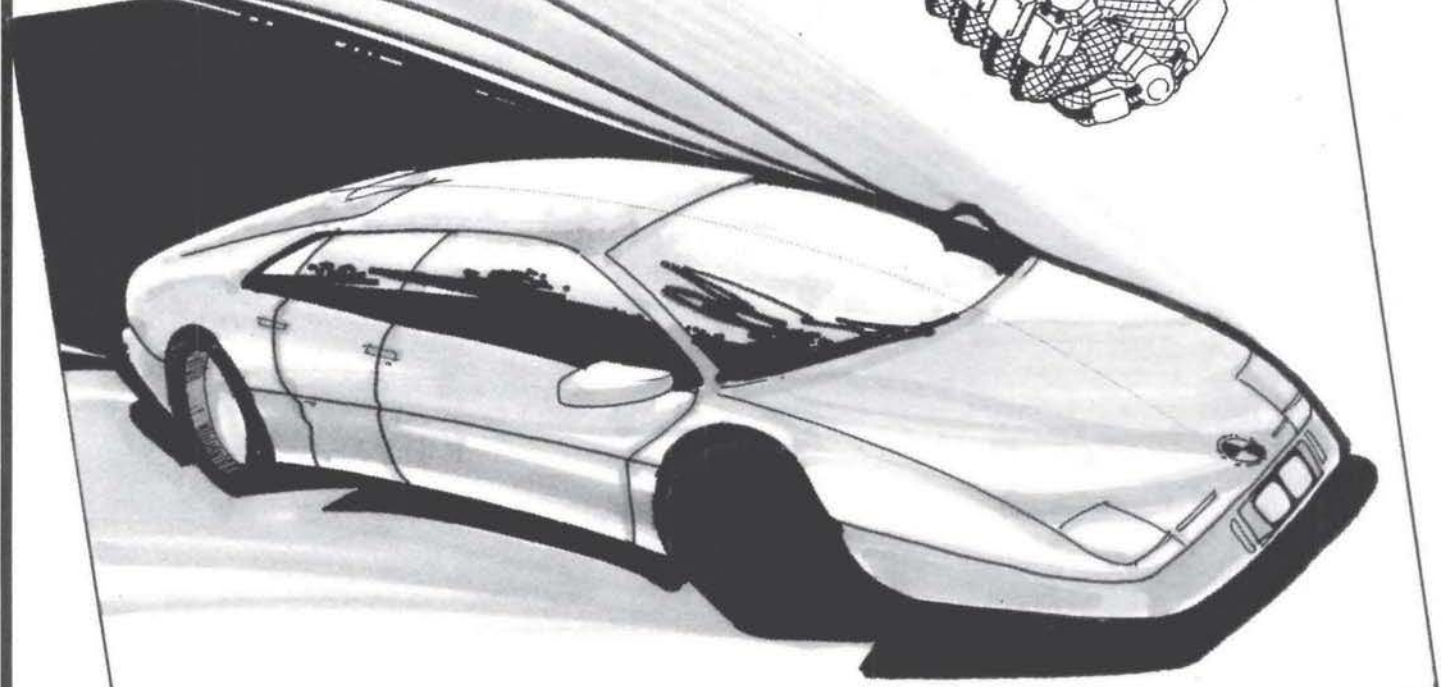
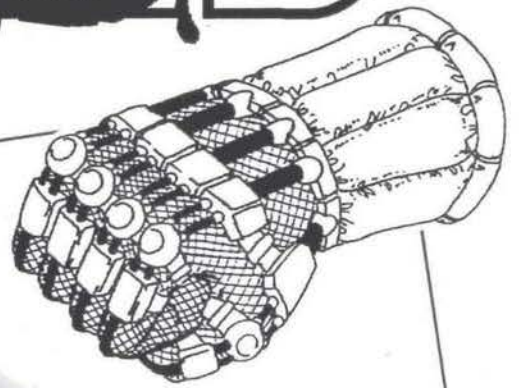

THE DIGITAL STYLEGUIDE AND
TECHBOOK FOR

CYBERPUNK

2-0-2-0

INTRODUCTION

IF YOU'RE *CYBERPUNK*, YOU'RE GONNA LOVE THIS BOOK.

I KNOW I DO. IT'S GOT ALL THOSE THINGS I NEED WHEN I DO A *CYBERPUNK*® RUN; GADGETS, GEAR, NIFTY LOCATIONS AND SLICK NEW TOYS. IN SHORT, THE NON-ESSENTIAL NECESSITIES—CHROME— FOR A GOOD *CYBERPUNK*® GAME.

THE **PERSONAL ELECTRONICS** SECTION STARTS YOU OFF WITH A BANG; LOTS OF GADGETS THAT PLAYERS ALWAYS IGNORE UNTIL THAT MOMENT WHEN ONLY A LEFT-HANDED WRENCH WILL DO THE JOB. THE **VEHICLE** SECTION'S SET UP TO GIVE A REFEREE AN OVERVIEW OF A WIDE VARIETY OF 2020 MOVEWARE; NOW YOU'LL KNOW WHAT A NOMAD RIDES AND WHAT A BOOSTERGANG CAN MUSTER AGAINST A POLICE BARRICADE.

CHECK OUT THE **HOUSING SECTION** FOR IDEAS ON LIVING CONDITIONS IN 2020. WHETHER YOU NEED A LUXURY PENTHOUSE WHERE THE PC'S CAN MEET THEIR CORP CONNECTION, OR A SLEAZY COFFIN-HOTEL AS THE BACKDROP TO A DRUG DEAL, YOU'LL FIND IT HERE. JUST FOR FUN, WE'VE ALSO ADDED **EXECUTIVE SERVICES**; THE PEOPLE WHO GET THINGS DONE FOR YOUR *CYBERPUNKS* (AND INCIDENTLY PROVIDE THEM WITH ALL KINDS OF ADVENTURE HOOKS!) LASTLY, THE **COLOR FASHION SECTION** GIVES YOU THE LOWDOWN ON WHO WEARS WHAT AND WHAT'S TRULY SUPERCHILLED THIS YEAR.

OF COURSE, WE'VE ADDED LOTS AND LOTS OF FUN AND DEADLY **WEAPONS** FOR YOUR SOLOS TO PLAY WITH, AS WELL AS NEW **CYBERWARE** AND **CHIPWARE** FOR EVERYONE. THERE'S EVEN SOME NEW (AND NASTY) **SOFTWARE** FOR THE NETRUNNERS. SO WHATEVER YOUR *CYBERPUNK*® GAME' IS LIKE, YOU'LL FIND AT LEAST TWO DOZEN THINGS HERE THAT YOU'LL WANT TO USE.

CHECK IT OUT. LIKE I SAID, YOU'RE GONNA LOVE THIS BOOK.



**R. TALSORIAN
GAMES, INC.**

PUBLISHED BY R. TALSORIAN GAMES
P.O. BOX 7356, BERKELEY, CA. 94707
COPYRIGHT ©1991 BY R. TALSORIAN GAMES, INC.
CYBERPUNK® & *CHROMEBOOK*™ ARE TRADEMARKS OF
R. TALSORIAN GAMES, INC. ALL RIGHTS RESERVED.

CONTENTS

ELECTRONICS & MISCELLANEOUS	3-16
VEHICLES	17-29
CYBERWARE	30-40
WEAPONS	41-55
FASHION	56-64
EXECUTIVE SERVICES	65-71
CHIPWARE	72-76
HOUSING	77-89
SOFTWARE	90-92
PRICE LIST & INDEX	93-96

CONTRIBUTORS

**C=CYBERWEAR G=GADGETS S=SERVICES
H=HOUSING V=VEHICLES VR=VARIOUS
SW=SOFTWARE CH=CHIPWEAR W=WEAPONS
F=FASHION**

COLIN FISK (S)
DAVE HARMER (G+C)
MIKE MASARATI (V)
MIKE PONDSMITH (VR+SW+W)
DEREK QUINTANAR (VR+SW)
MIKE ROTOR (C+G+SW)
JOHN SMITH (W)
KEVIN STEIN (H)
WILLIAM TRACY (C)
KARL WU (F)
ANDREW STRASSMANN (C)
BEN WRIGHT (C+G)
JEFF HEXTER (C+G)
GLENN GODDARD (G)
MARCUS PRESENT (C)

ARTISTS

JUSTIN CHIN
SHON HOWELL
SCOTT RUGGELS
KARL WU (COLOR)

SANDY COLLORA
MIKE PONDSMITH
BEN WRIGHT

LAYOUT & PRODUCTION

DESIGN BY TED TALSORIAN
LAYOUT: DIANA GOLDMAN, D. QUINTANAR
CUTOUTS BY MIKE MACDONALD
COVER BY MIKE EBERT, © 1990.
COVER DESIGN MIKE POND SMITH & MATT ANACLETO

EDITING

DEREK QUINTANAR, SENIOR EDITOR
WILL MOSS
COLIN FISK
MIKE POND SMITH

DEDICATED TO E4 MIKE FIERCE AND
THE MEN & WOMEN OF THE 602ND
MAINTENANCE COMPANY, U.S.
ARMY. ALWAYS *CYBERPUNK*.

ELECTRONICS

& Miscellaneous Techware

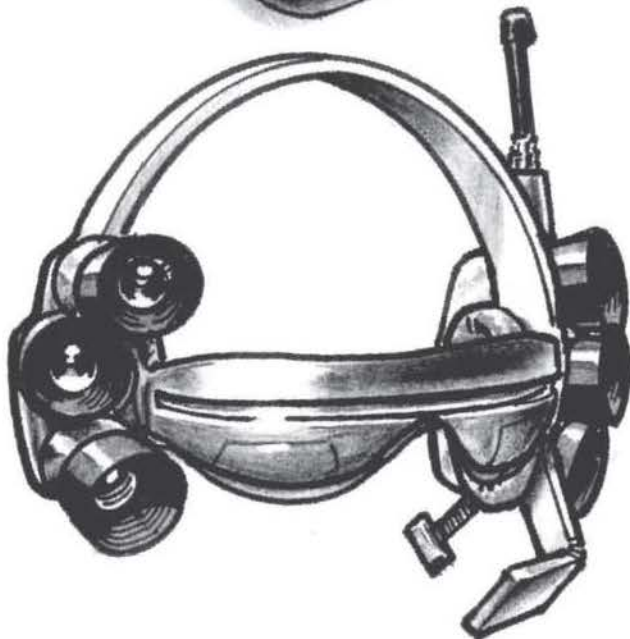

"Whether it's communications, security, information services or just plain entertainment, this year's Chromebook offers numerous personal equipment entries for the discerning cybernaut. If you're a Netrunner, make sure you interface with our new Utility Sneaksuit or Deck Security systems. For the Rockers, Telectronic's compact Digital Studio may be just what you've needed. There's digital weapon links and speedgear for the Solos, and Cybercam links for the Medias. And of course, Worldsats integrated Office Commo system for the well-heeled Corporate..."

—The Chromebook download for January, 2020

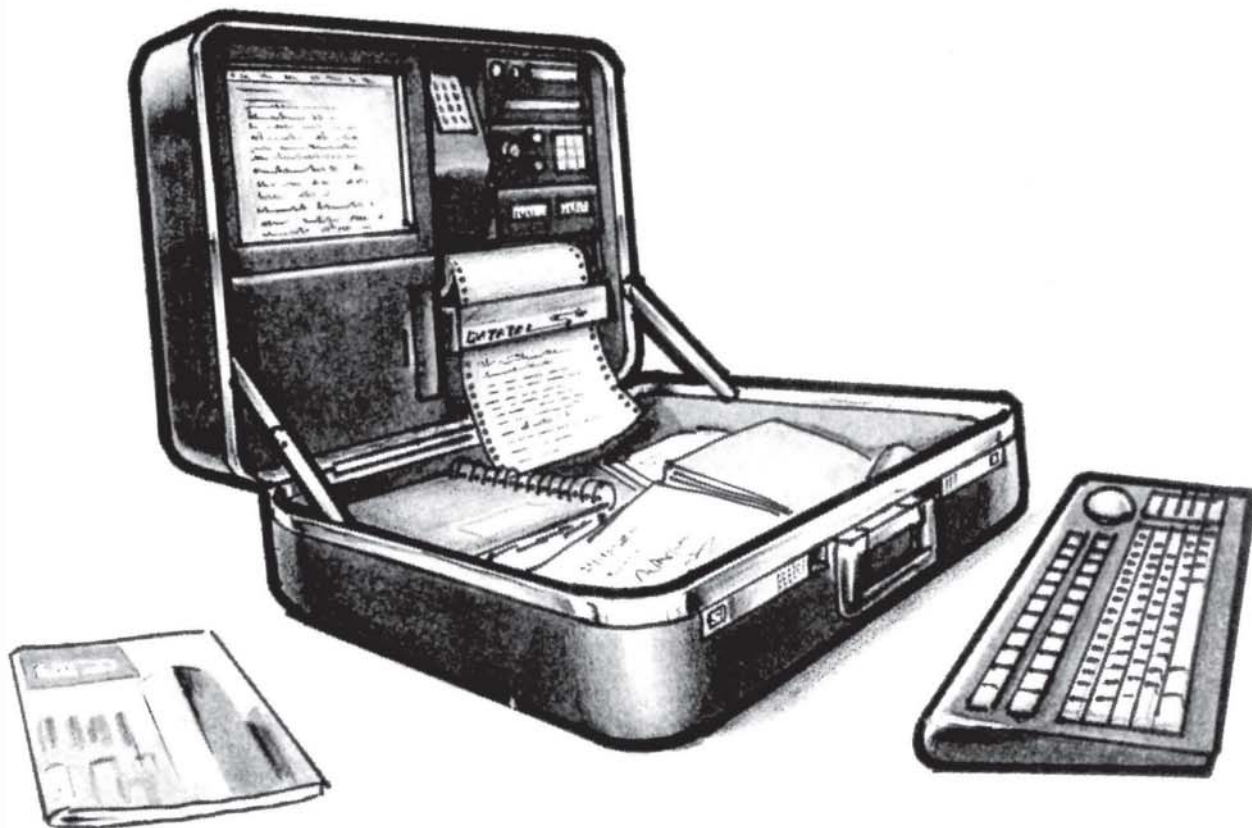

Advanced Communications Suitcase 8000eb.

Keep in contact with your business!

Datatel's new Advanced Communications Suitcase has the equipment required to let you stay in touch anywhere in the world, or in orbit. This sophisticated system begins with a 48 MHz personal computer (See Laptop Computer, 'Punk 2020 equipment section.) with on-line memory and drive, linked to a plug-in portable Cybermodem (speed +2, 20MU, data walls +4, vidboard, chip reader). The system also includes a standard cellular phone, mini-fax, and optional short-wave capability (add 800eb. for short-wave radio).



TRITECH Line Tap Detector 60eb.

Who's listening to your phone?

Tritech's inexpensive line tap detector measures changes in line impedance to inform you when anyone is listening in on your conversations. Green, yellow, and red lights tell you when the line is clear, monitored from an extension, or tapped. This device will not detect surveillance of cellular phones or fiber-optic networks.



TRITECH Linozap™ 350 eb.

Line Tapped? Now clear it!

Simply press the button on the unit and 50 Kv of electricity will fuse the circuits of any listening devices attached to the line. An isolated transformer protects your own phone from damage. Be totally sure your line is secure.

Warning: willful destruction of private property is a crime, and interfering with a legal tap is a felony. The Manufacturer does not condone any illegal activity or illegal usage of this device. Manufacturer assumes no liability for damage to phone lines from use of this product.

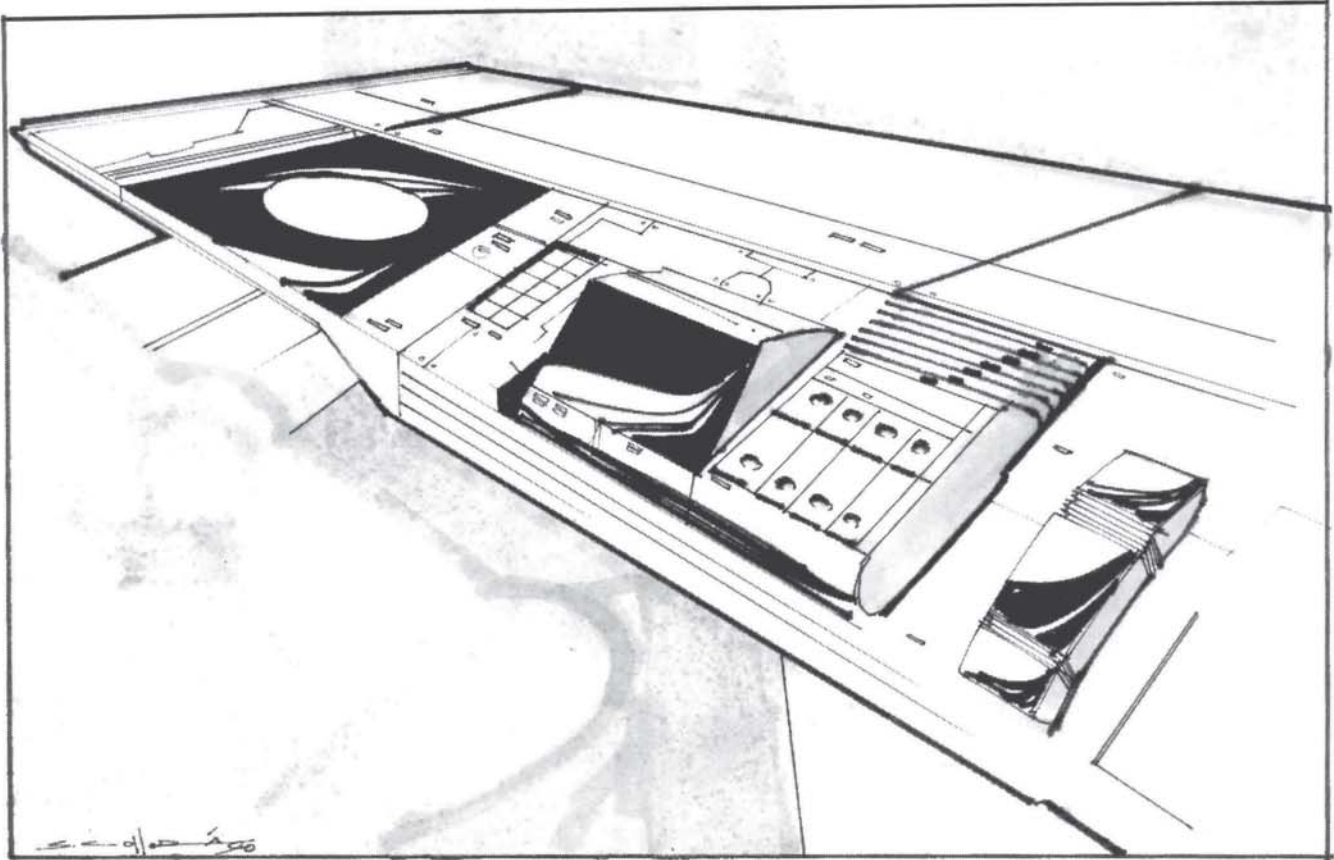

Office Communications Suite
The Ultimate In Corporate communications!

1000eb.

Worldsat's integrated Cellular Phone/Fax/Message Machine system allows the enterprising executive to handle and manage his communications easily and efficiently. The answering machine keeps you from missing those important calls with a beeperless remote, and has a remote fax alarm as well. A built-in switching device selects between fax and voice transmissions automatically, preventing the annoyance of hearing the fax tone when you pick up the phone. The cellular capability can be carried on a standard cellular account, providing access anywhere service is available. And the printed transmission report logs all fax calls with error checking, all voice calls including number called and connection time, and all incoming calls, whether fax or voice. The system can also include a video intercom for a low extra cost. Office vid system 1100eb. extra.



Cab Hailer

150eb.

Never be without a ride again!

Checker Systems Incorporated announces its new cellular Cab Hailer. Only 7cm x 5cm x 1cm, it is lightweight, convenient, and practical. Accepted in 36 member countries, the Cab Hailer automatically calls the nearest available cab to your location, ensuring prompt service. Simply plug the unit into any DataTerm outlet (found in airports and major hotels), and the local call numbers and frequencies are loaded into its memory. When you need a cab, simply lift the safety and press the call button. The closest vacant cab will promptly arrive (1D6 minutes) to carry you to your destination. Never worry about fumbling for change, either, as the Cab Hailer automatically processes billing for the fare, including the tip (itemized statement is sent to you each month). Additional activation charges: 10eb./month plus fares.

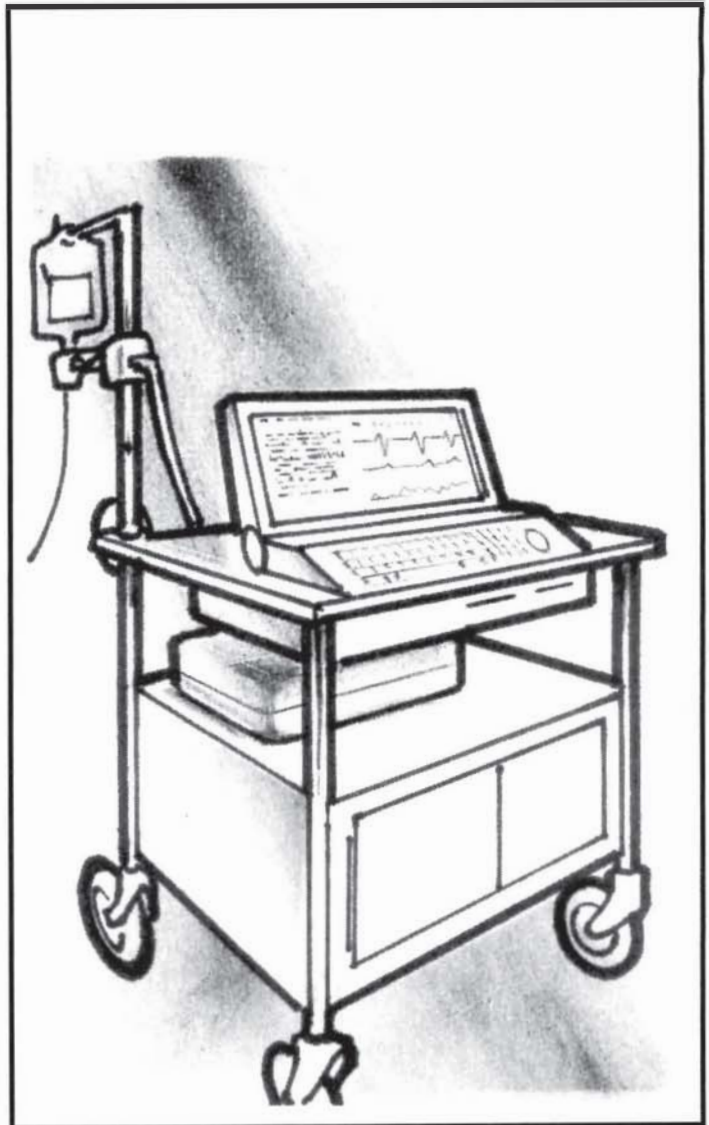
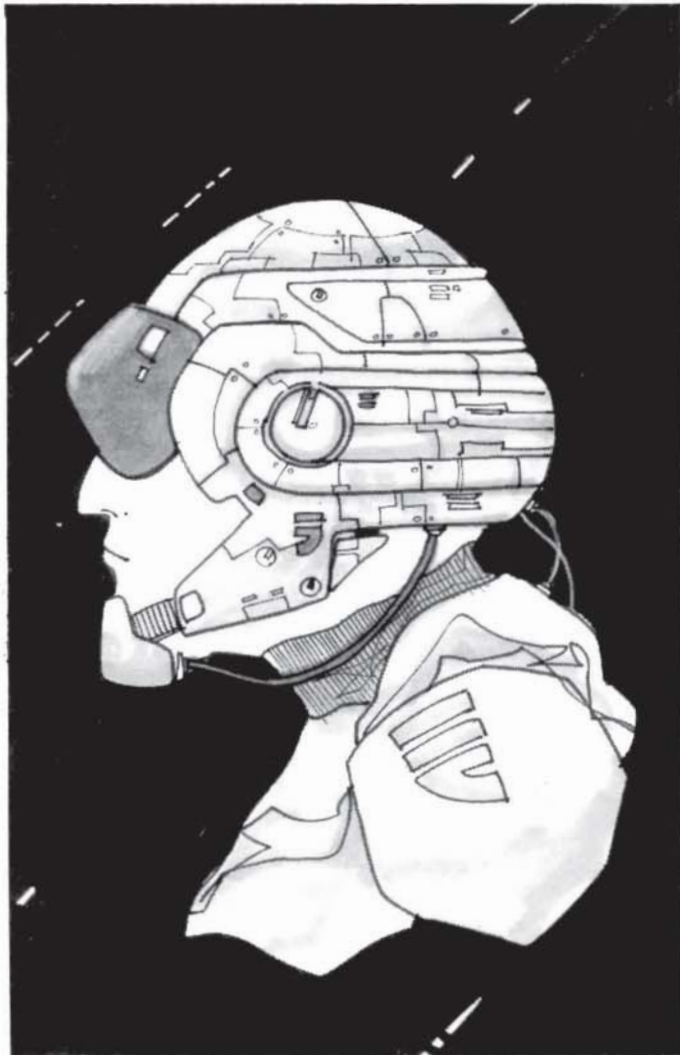

Microtech
HEADGEAR™ CYBERMODEM TECH

HEADGEAR™
Cybermodem Helmet
4100eb.

Elegance in form and function!

This injection-molded, impact-proof helmet (SP 16) houses a sophisticated cyberdeck complete with reflex-translators, neural interface jacks, and utility program drives. HEADGEAR™ also contains a heads-up info display and radio link. Weight 4-4.75kg. See your Microtech dealer for further details. (Portable deck, MU 10, Speed +2, Data Walls +2).

BODYWEIGHT
 Life Preservation Systems

Life/Support®
500eb.

No long-runner should be without one!

The latest support option from Bodyweight. When this package is connected to a cyberdeck, a biomonitor watches the user's condition, controlling an IV drip for feeding and a catheter to take care of bodily functions. Such a system is relatively small (about the size of a PC monitor), and can keep the body going for approx. 72 hours of constant work within the Net. Weight 1.3-2kg.

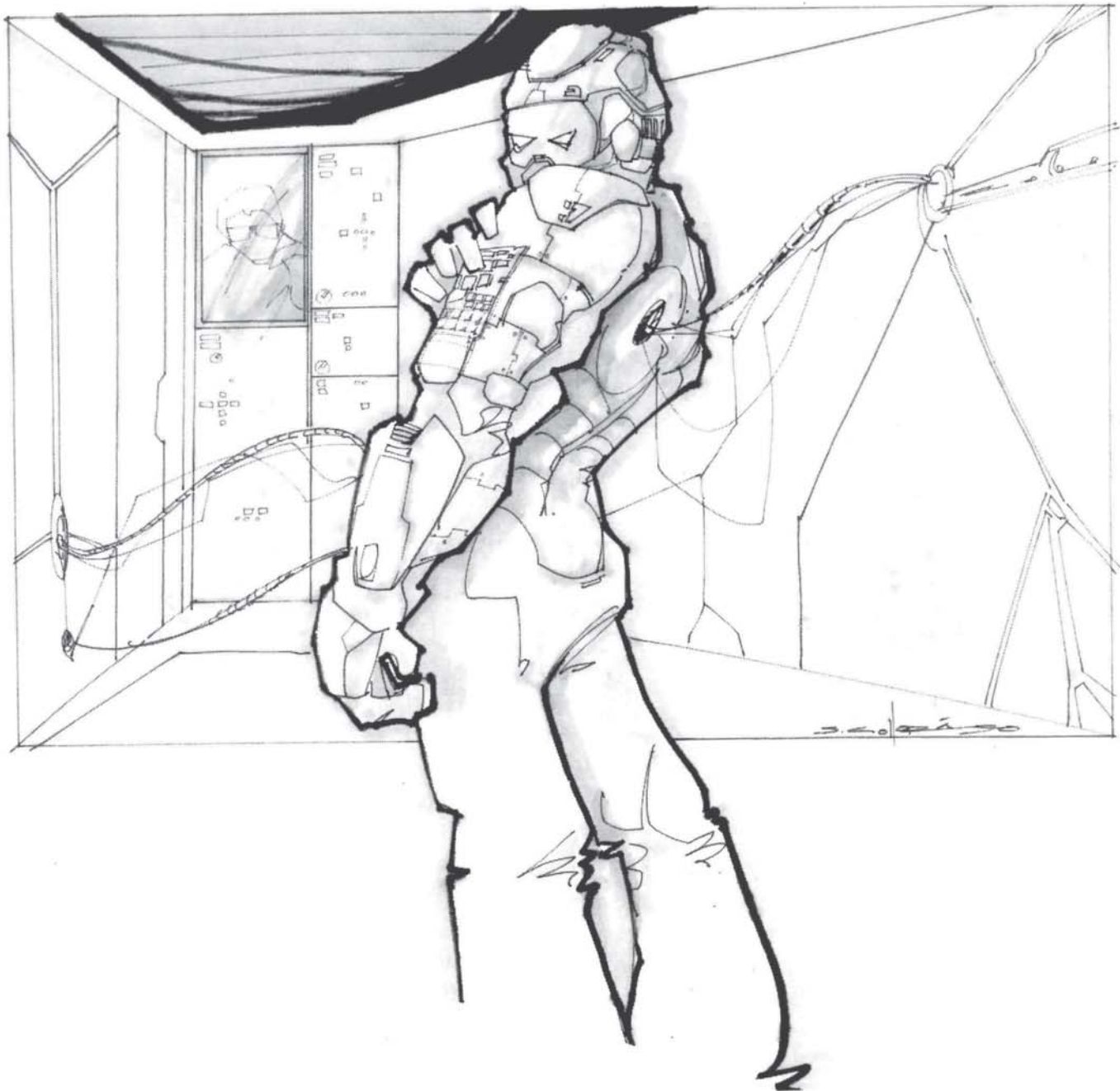

Net-Runner™ Cybermodem Utility Suit

6300eb. (Portable deck, MU 20, Speed +1, Data Walls +3),

7800eb. (Cellular deck and IR Sneaksuit options)

Walking simplicity with compact power!

A fully-functional, netrunning cybermodem system in a ready-for-action configuration. The collar houses the deck's reflex-translators and neural interface jacks. Control surfaces, a 20MU memory bank, and a keypad are located on armpacks, and utility/interface programs are loaded into a belt-mounted processor. All systems are connected by fiberoptic cables which run through the multi-ply kevlar bodysuit (SP 12, available in many styles, colors, and fabrics; including light-absorbent, IR-reducing sneaksuit weave). A biomonitor and wide-band radio commlink are included in the package. Very popular with assault-programmers and commandos. Weight 3.25kg.

Smartlock Door Security System 250eb./level

If you know security, you know Smartlock™. Stop those midnight entries, and keep tabs on your guard forces! A Smartlock can be installed on any door, safe, or terminal, requiring that the user actually plug into the lock via an interface cable and communicate the correct combination code (or other data required) in order for the lock to open. An additional option for 220eb. requires that a guard jack in at certain preset times or a police alarm sounds.



Mini-printer 125eb.

Equal in size to the pocket computers or portable cyberdecks it's linked to. Uses 500 foot register paper (1 eb per roll) and a tiny laser printer head.

Paper Shredder 500eb

Secure your trash!

Prevent loss of valuable corporate secrets through improper waste disposal. This Arasaka-designed paper and disc shredder destroys both hardcopy information and computer discs at an economical price. Advanced safety features prevent injury to the operator.

Auto Punchout 330eb.

What you're reading may save your life!

Worried that somebody's slipped a Brainwipe into your bank file, ready to fry you the next time you check your balance? (If you're not worried, you should be.) Then MinFac's new Auto Punchout is the hardware for you. These analysis plugs instantly disconnect you when it detects any current stronger than a data signal. Bad news for Netrunners, though—the extra circuitry that signals must pass through slows the user's Netrunning Initiative Roll by -5.



EBM Carfaxx© 2002 500eb.

EBM's new portable cellular fax machine combines the convenience of cellular with the business power of fax, giving you mobile fax transmission from your car. Perfect for the traveling businessman, this fax machine is fully compatible with all standard fax devices. When your car is your office, give it full office potential with the EBM fax machine. Can be linked to DataTerms and most vehicle short-wave systems.



Sonar Scanner 50eb. **Never get stuck in the dark.**

Telectronics' Ranger is a hand-held sonar sensor with dual functions. First, it accurately measures distance to, and the dimensions of, the nearest solid obstruction. Second, it serves as a motion detector within a 120m. radius. Weight .2kg.

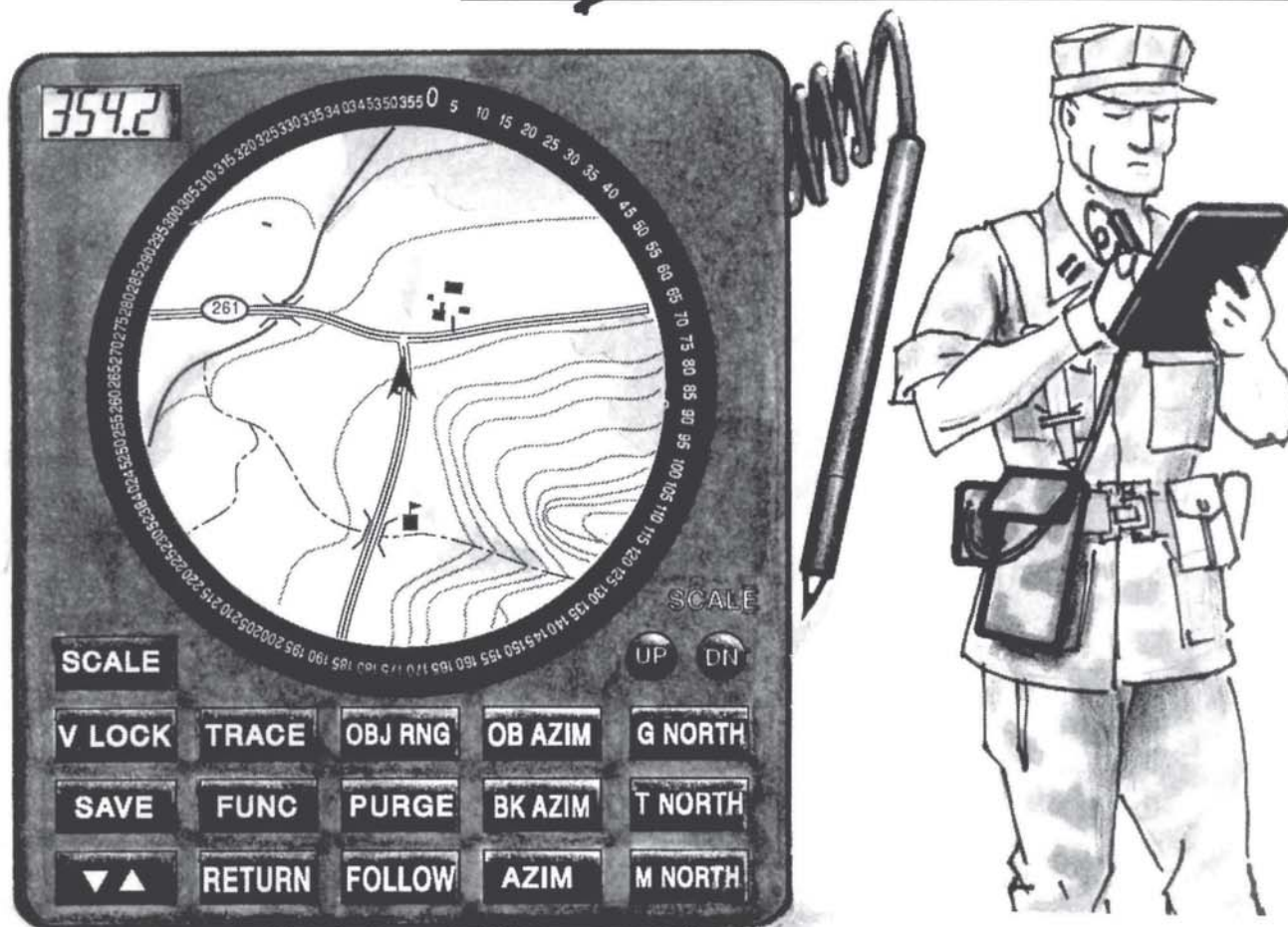

DataTel's Mapmaker®

500eb.

It's late, it's dark, do you know where you are? DataTel does.

The Mapmaker serves as a portable inertial tracking computer, pre-programmable with the exterior dimensions of an area as well as specified mapping symbols. It will mark progress through unknown terrain, showing position in relation to the starting and current positions. The path, and any noted surrounding area, are recorded in its memory. On traceback mode, the Mapmaker provides warning via audio signal, visual, or both when the return course deviates from its entries. Weight 1 kg. Note: for 400eb. more, a Navstar satellite link system can plot your true Earth position to within 10m.

Netrunner Flip Switch 135eb

Never let your guard down!

The Flip Switch system allows the netrunner to 'flip' from his perceived position in the Net to reality and back at a thought. A good way to check up on things when you're 'running' during a crisis situation. When 'flipped' into reality, the netrunner's signal remains where he was, and he is still vulnerable to attack by ICE within the Net. The reality view is projected onto a 2m x2m "window" in the Net, giving the view the Netrunner would normally see out of his own eyes.

Deck Security System 400eb (thumbprint)

1000eb (retina)

Keep your deck to yourself!

This Cyberdeck Security System consists of a thumbprint scanner which is connected to the deck's CPU. Unless a pre-programmed print is used, the deck will not operate. A secondary monitor checks blood flow, so that a dismembered thumb cannot be used. The more advanced version uses a retina scanner (if the subject has cyberoptics, it checks the serial number of the optic).

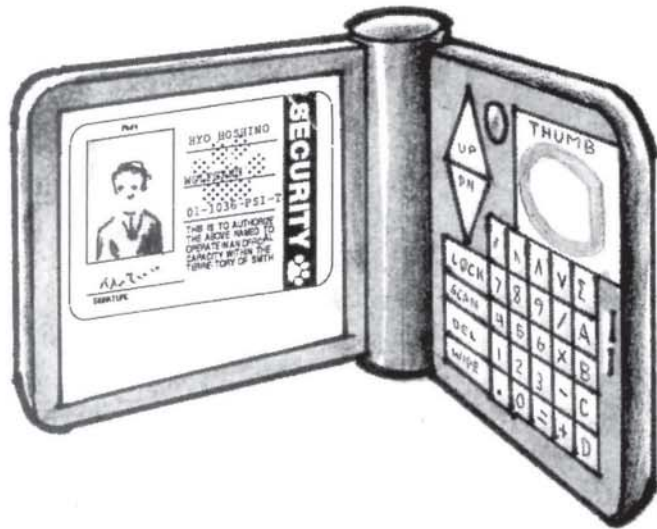

DataTel

Image Wallet 100eb. ***Information at a moment's notice!***

From DataTel, a completely self-contained electronic documentation carrier. The Image Wallet is the wave of the future: by pressing the owner's thumbprint on the cover, documents' images will be flashed on the surface of the wallet one at a time (the owner may specify specific documents). Registration cards, ID, and other types can then be optically scanned. Weight: .1kg.



WorldSat COMMUNICATIONS

Newsviewer 100eb.

Always be on top of information in today's world.

The Newsviewer is WorldSat's portable dataterm download device, aka, the "Newsdeck". News preferences can be audited by logging on by thumbprint. The system will then review stories in the order desired, working from a menu of story headlines. It can also be set to alert the user to breaking stories (monitoring the mediacorp broadcast bands for their distinctive "alert" codes). Weight : 0.1kg, rental fees 2eb.an hr.



DPI Smartsticks

800eb.

Bringing drums into the silicon age.

This new cybernetic instrument brings the drums into the silicon age. Smartsticks consist of two hand-held, drumstick-style tactile reactors, cables which lead from the sticks to an on-belt synthesizer package, and interface cables to link the synth-pack to the player's plugs. The result is a +1 on *Play Drums* skill, but with the added advantage of being a synthesizer: any percussion sound can be programmed and accessed by striking a 'stick' on a solid surface (drums, walls, heads). The synth-pack is radio-linked for amps or speakers. Dealer's prices may vary.

**Sleep Inducer
85eb.**



Everyone needs their rest; some just need it quicker!

Tritech's Sleep Inducer, aka, "The Russian Sleep," consists of a small device with electrodes which are placed on each eyelid and the nape of the neck. A small current then passes through the brain putting a person directly into deep sleep. Users can get a full night's sleep in two or three hours. If not turned off via the integral timer, the user will eventually be awakened by hunger. Weight under 0.5kg.

Fireproof Clothing

Fireproofing and high fashion !

Salamander Line— New from Savagery Fashions, the first line of fashionable fireproof clothing! Overcoats, jackets, pants, and hats that cannot burn. Make your style equal safety with Savagery's Salamander Line! Base Costs: Multiply by Style, as on CYBERPUNK 2020, pg. 58

Coat	110eb
Jacket.....	100eb
Shirt, hat	65eb
Skirt, pants	75eb
Overcoat	250eb

Game Effects: This wardrobe acts as SP 20 protection against all FIRE damage only.

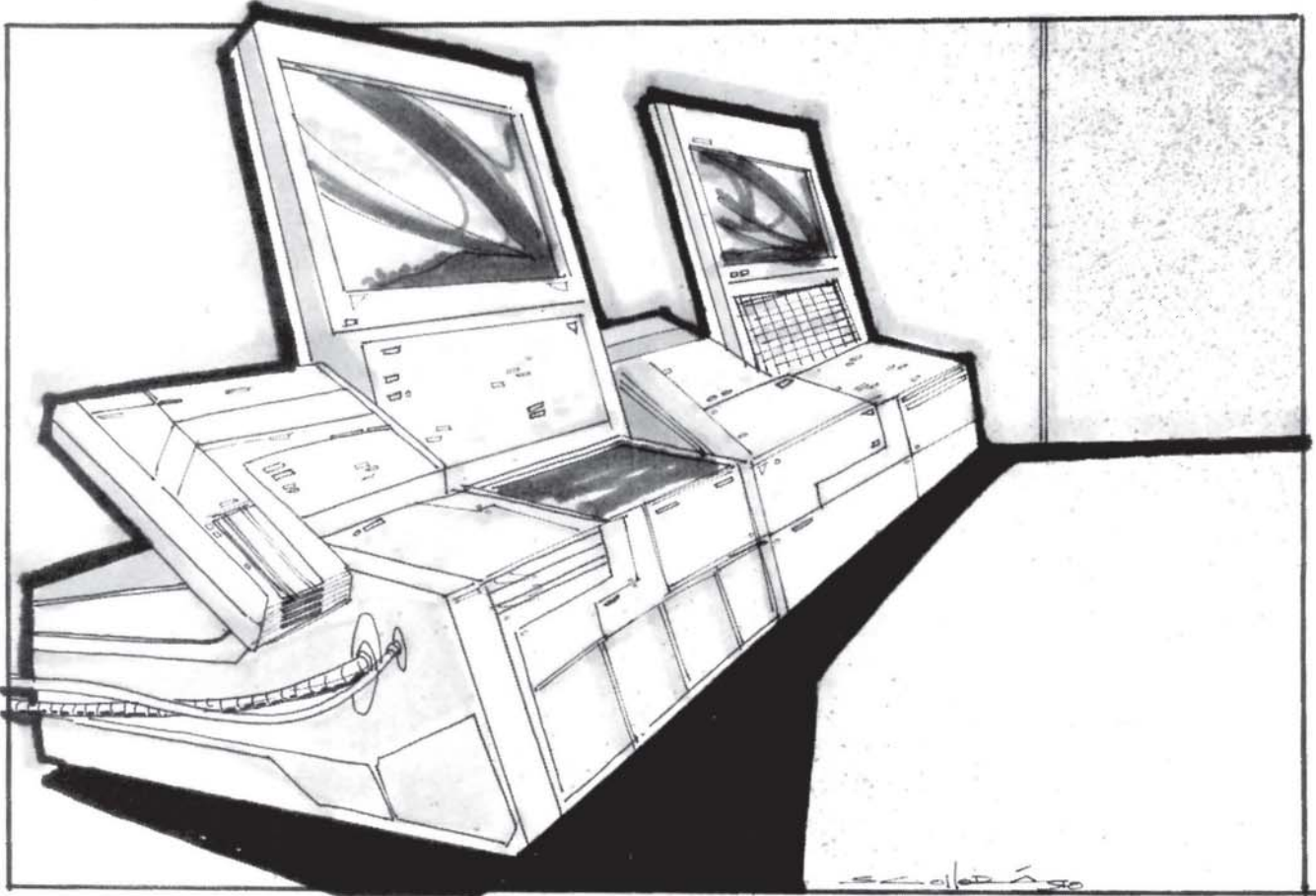

Digital Recording Studio

12,000eb

Record your own audio chips!

Telectronics' professional quality digital chip recorder records up to ten chips simultaneously. Wide-band frequency capability gives the T-2020 a full 20 to 65 thousand Hz recording at 0.00001% THD. A sixteen channel multi-tracking SMPTE mixer provides the solo musician the ability to sound like a full band. The T-2020 is approved by the World Musicians Exchange, and was used by Sarah O'Connor to produce her recent Top Ten hit *Loving at the Speed of Light*. Fully SmartMIDI compatible, the T-2020 uses state of the art mixing circuitry to balance the sound, and recording sampling technology to assure that duplicated copies will be 99.999% error free!

Digital Weapon Uplink 500eb.

Techtronica's advanced smartgun model, the Digital Uplink Diagnostic (aka DUD Smartchipping) monitors the status of your smartgun and feeds readouts to your TimesSquare Marquee cyberoptic. Information includes rounds fired, barrel temperature, and the maintenance state of the weapon's action. In case of a jam, this option will automatically tell the user the problem, adding +2 to his TECH roll to unjam the gun.

DUD Smartgun Controller 720eb.

Your gun's never out of reach!

A DUD option, the package consists of a vocalizer chip, voice-recognition processor, and mini-pickup mike. The weapon can give its user data via cyberaudio rather than TimesSquare, plus the owner can program the smartgun to be *voice-activated* (no cable needed!). Example: If a solo's weapon has been dropped, and it's pointing at the target (1 in 6 chance), he can order it to fire!



MICROCYBERNETICS

Cybercam EX-1 1200eb.

No media should be without one.

A headset-style multi-format newscam, the Cybercam EX-1 has interface connections allowing for visual synch with cyber-optics and audio, as well as graphics, logos, and on site editing of tapes and livefootage! Recommended by Net 54 techs, and produced by Raven Microcyb on a Nikkon America design. Weight 2.2kg.



ID Badgemaker 500eb. Make your own ID badges!

Perfect for the small corporation or club, the Danshi ID Badgemaker produces professional quality solid-plastic, keycard, and photo-ID badges. Upgrade your security for a low, economical price, and protect your employees. One easy to use, simple unit lets your security worry about security, not administrative duties. An additional 200eb. will allow Tennerec LTD's CookieCutter™ smartgun cut-out system (*Solo of Fortune*, pg. 22) to be interfaced with Danshi ID's.



CYBERMATRIX

Speedholster 100eb. There are two types of people in 2020, the quick and the dead.

Speed Draw® holsters—Be your own John Wayne with CYBERMATRIX'S new spring-loaded reflex holsters. Available in many configurations including hip, shoulder rig, leg, and back rigs. Plus, the ever-popular *Handlauncher* will give your enemies a little surprise from up your sleeve! (Adds an extra +1 to Initiative when you declare a fast draw.)

Detcord High Explosive 900eb./pack

Need to make entry quick ?

Detcord— Used primarily for hostage-rescue situations, detcord is a rapid-opening system, containing explosive charges in strip form. It can be used to blow precision holes through doors, steel, and brickwork, and is detonated by a wire-controlled button in each 10m package.

Game Effects: cuts through up to SP40 armor like a cutting torch in 1 turn.

Temperfoam Furniture 80-140eb per piece

For the Mallplex conapt or just for fun!

Foam furniture which shapes itself to the individual user. It has a feel similar to a firm and stable gel. Weight varies.

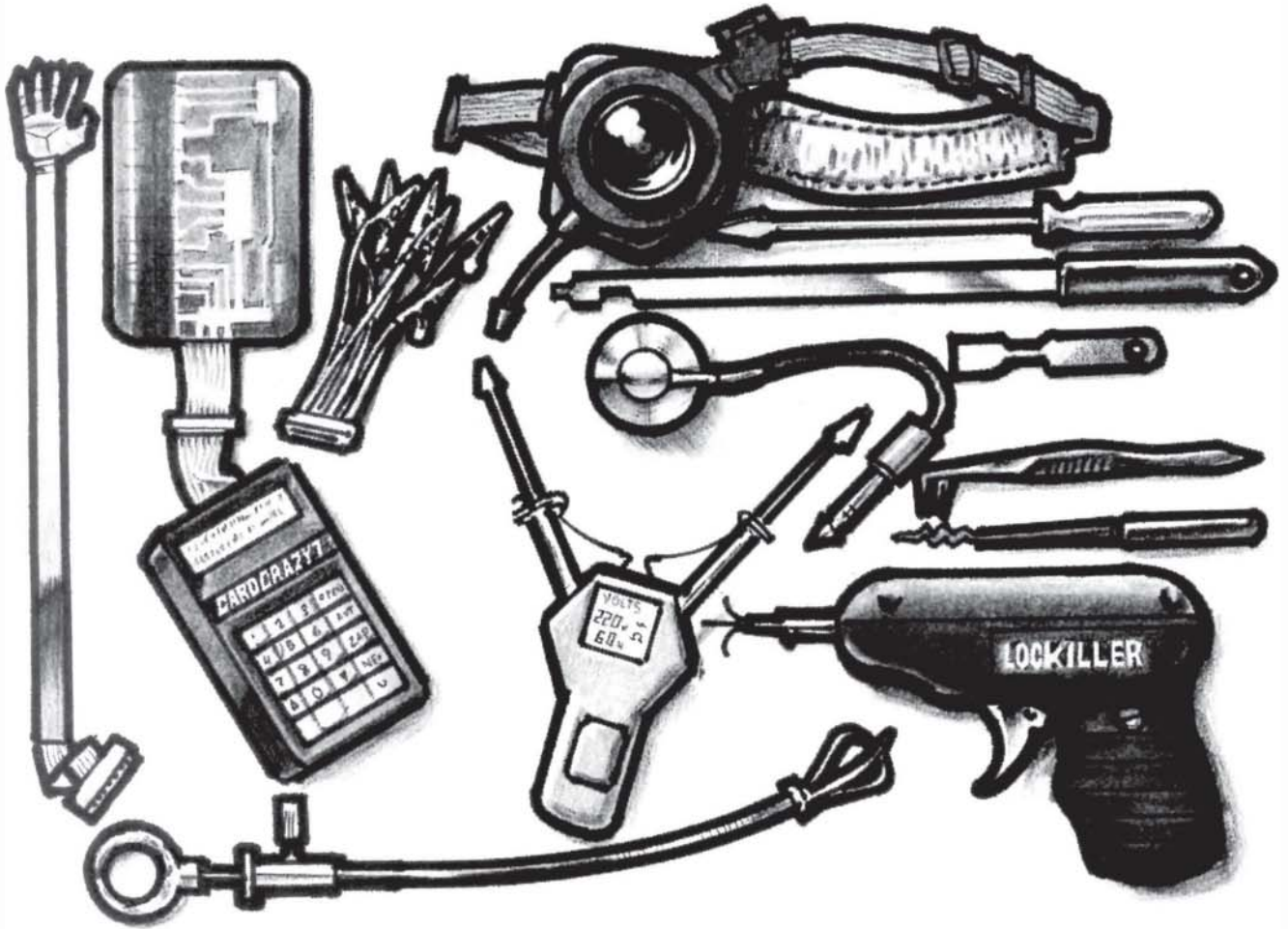

Advanced Alarm Removal Kit

290eb.

This package contains state-of-the-art intrusion devices, including insertable circuit breakers, a bypass analyzer, logic probes, microwave reflectors, ultrasound absorption plates, and micro-manipulator tools. Using the kit adds +1 to all TECH rolls made vs. card/voco-locks, security scanners, and movement sensors. Weight 3kg.

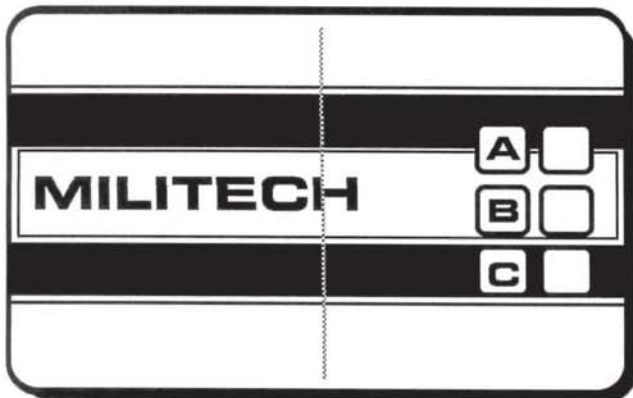

**Personal Body Alarm
400eb.**

plus 300eb./month. and ammo and medical fees upon extraction.

Never be caught alone again!

Originally developed for prison guards and perfected by Militech, the personal body alarm is now available to the public. Similar to a Trauma Team Card, this unit works upon manual activation. Simply break the card, and the nearest contracted security squad arrives to evacuate you from the vicinity of the danger. Ammunition and medical fees are a nominal extra.

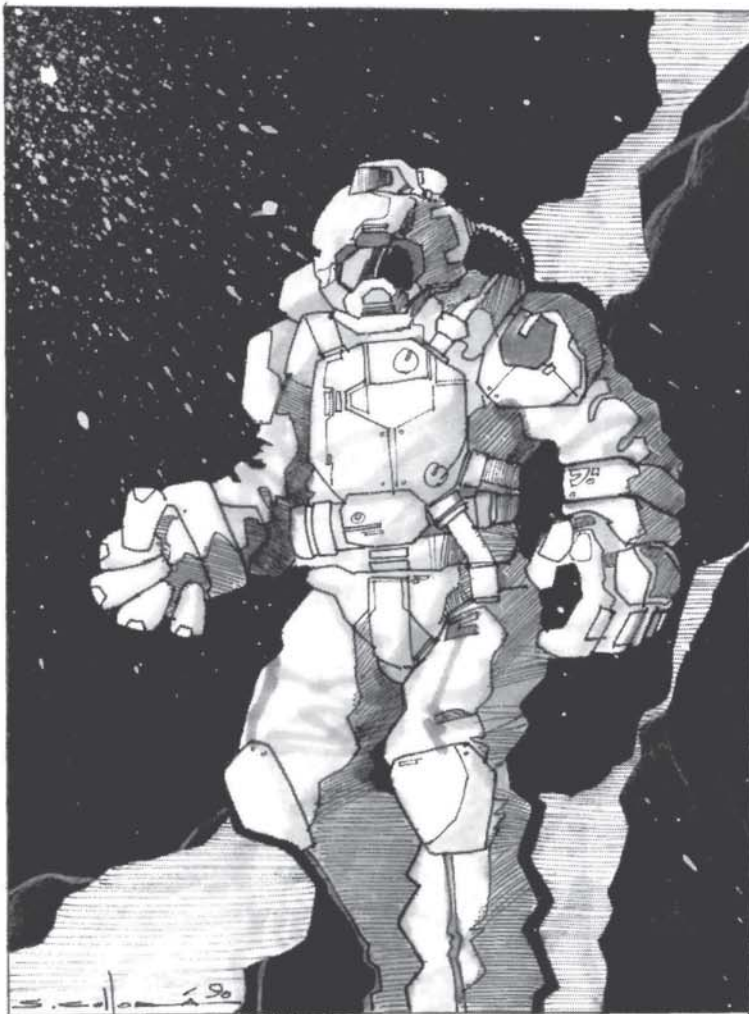

Diving Suit 6000eb,

plus 100eb for a 30min. tank of L.B.M.
(up to 4 tanks can be carried during a dive)

The suit that set the world record!

On July 13, 2011, Bryan LeShawn dove to 12,645ft. in the deepest independent suit dive ever recorded. His edge? The Poseidon Fluid Breathing Suit. The liquid breathing medium equalizes the pressure in the lungs, preventing the former problems of extra deep dives. Dive where no man has ever gone. Explore sunken galleons unknown. Walk the decks of the *Titanic*. The Poseidon Suit can take you deeper than any other diving method around, and is produced exclusively by the Hydrosubsidiium. Maximum recommended depth is 10,000ft.

Note: there is a 20% chance that a person cannot tolerate the liquid breathing medium, and therefore cannot use the suit. Also, a diver will be at -2 to his Body Type stat for an hour after the dive while his respiratory system readjusts.

GIBSON



BATTLEGEAR®

IR Combat Cloak 450eb.

A must for night missions!

A loose-fitting, mackintosh-style garment from Gibson Battlegear which absorbs IR emissions until the wearer can safely bleed the heat off. Then the cloak bleeds the heat in a random pattern so it does not appear to come from a human source. (-5 to Awareness/Notice when using IR.) Weight 2kg (EV2).





Slosh Bag 65eb.

A 'sleeping bag' style bath for use in 0-G situations. The user puts on a respirator, gets into the bag, seals up; and fills it with water through a special valve. After draining into your station's recycling tanks, rinse with disinfectant included. Weight: 2kg.

Power Grid® Solar-Electric Panel 100eb

Power without plugs!

Got to run something, but don't have access to the juice? Power Grid Inc.'s new solar panel is just the thing. Set the Grid® in a sunny window, plug any 110 household appliance into it and it'll provide current for free. Or link several together with the built in adapters. Each panel powers one 110 volt device, and you can plug the total grid into a central extension cord (25eb.) to power a whole conapt for free!

Medieval Armor 3500eb

Own your own suit of armor!

Have your own personalized suit of authentic reproduction armor made to fit out of modern steel (SP 14, EV 6). A great addition to your living room, or for wearing to parties in the Combat Zone! Two models are available, *Standard* for regular use, and *Maximillian* for those who want to cut a swath of steel style (10,600eb.).

Travel Kit 150eb ***Keeps you prepared for any trip!***

The Complete Travel Kit contains all you'll need for an overnight stay. Lightweight, convenient and economical, the kit contains a sleeping bag, inflatable pad, first aid kit, nylon carrybag, flashlight, toiletries, and 6 disposable sets of pajamas; just what you need to stay sharp when away from home. The entire package only weighs 5 kilos. 10 extra sets pajamas 10eb.

Flavored Cigarettes ***NEW! From Biotechnica!***

Sample Biotechnica's newest creation, with real, genetically engineered, tobacco. Biotechnica's special line of flavored cigarettes promises enduring smoking pleasure. 2eb./pack, 15eb./carton.

The Following Flavors Are Available:

REAL MAN—Jalapeño	TRAILMASTER—Smoked Beef
SWISS ALPS—Chocolate	FIELDS OF GREEN—Strawberry
ITALIANO—Pizza	HAIGHT STREET—Hashish

Shower-in-a-Can 3eb.

Have you ever had to spend the night in a cramped 'cube outside a busy airport because your plane was delayed? Ever been peeved by the lack of available showers under such conditions? Shower-in-a-Can is the answer. Just spray yourself with the patented, 100% safe disinfectant/deodorant foam, wipe it off, and you're ready to go!

Bar-in-a-Briefcase 100eb. ***Party on the Road!***

The Bar-In-A-Briefcase has everything that you want for a party away from the crowds. Two liters of assorted liquors and mixers, plus a menu display and mixing instruments let you give an executive-style party for up to ten people. Great for the traveling businessman, or a private party for two.

Vehicles

NEW DESIGNS 2020

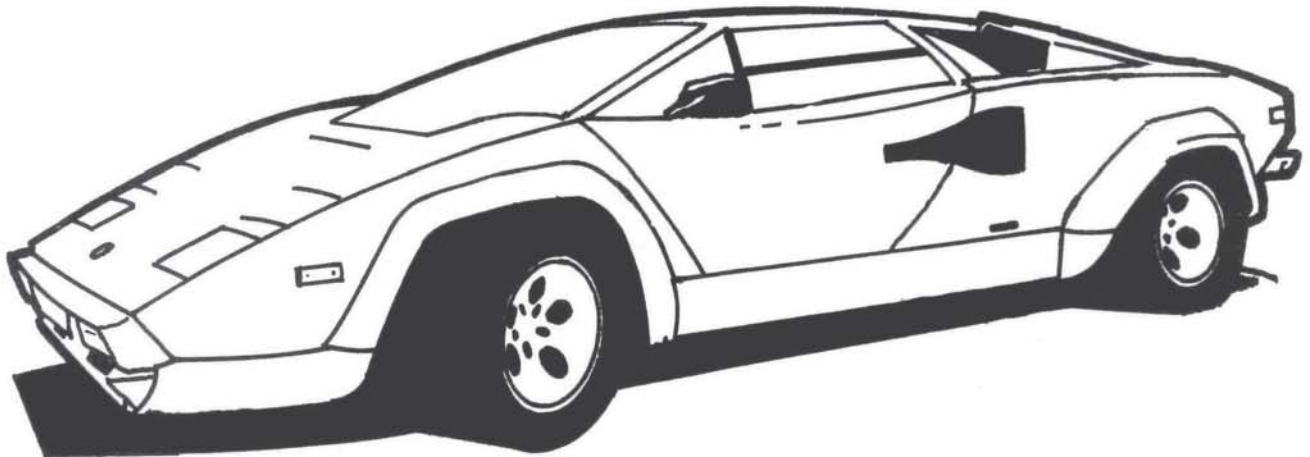

CHOOH₂-powered Countech replica. 53,000eb.

"You have to get there somehow, even in the far future. But you can have a lot of choices about how you get there. These days, we have sleek cyberbikes and streethogs for the Nomads. High powered roadsters for the Corps and Solos. Combat Aerodynes, helicopters and assault vehicles for Cops, Medias and combat professionals. And finally, Postholocaust highway horrors like the dreaded Punknaught, scorge of the freeway and terror of the open road. It's all there— you just have to have the guts and the euro to claim it..."

***—Mister Ice
Head of Design, Technix Inc.***

CASCADE

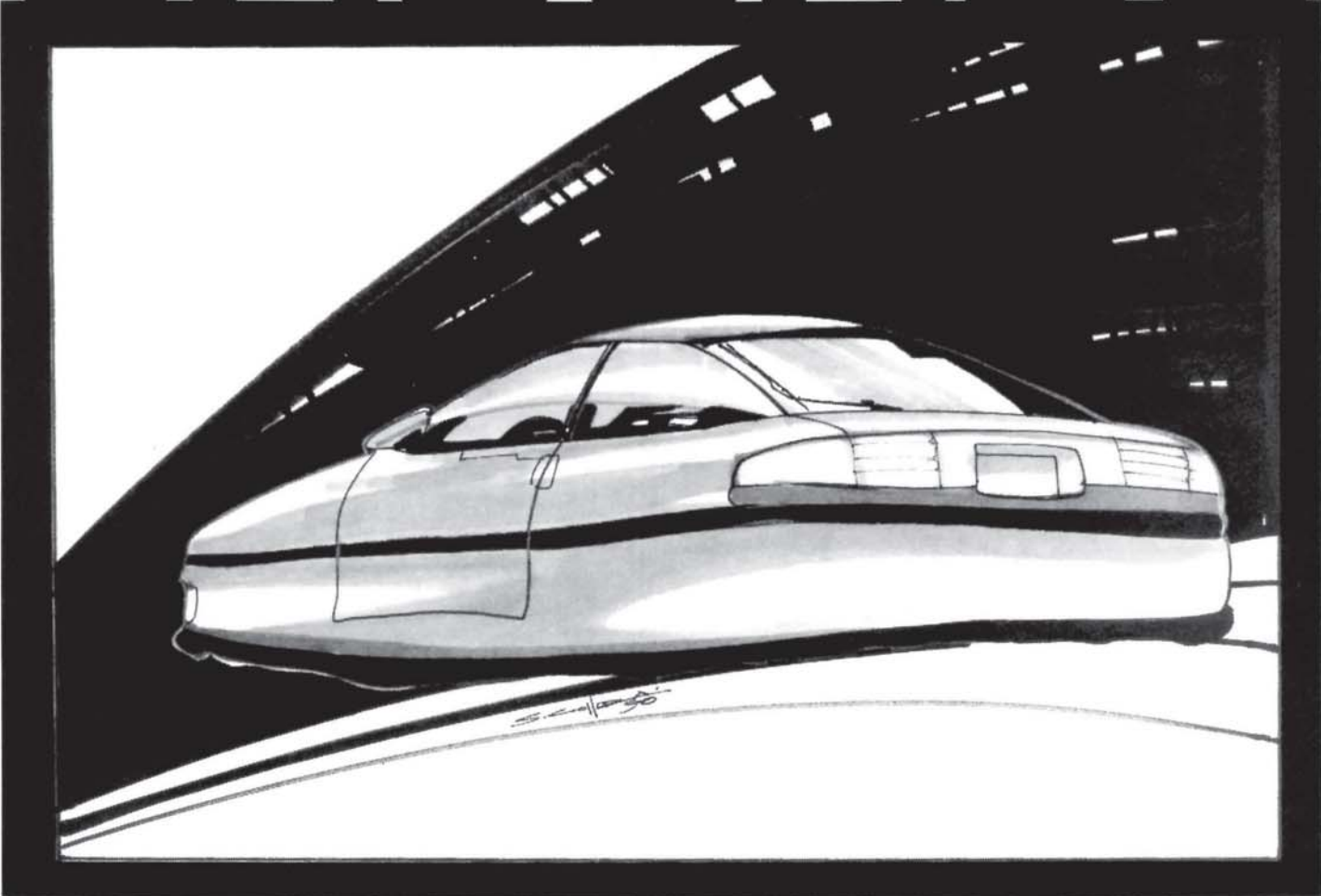

The Bensen Cascade

58,000eb.

Racetested for optimum performance, this new model from Bensen carries the tradition of the ultra-fast sport hover into a new decade. The '20 Cascade is the epitome of newtech: its electronics, avionics, powerplant, and luxury are all tomorrow's models today. Gutwrenching acceleration on the straights, bloodcurdling handling in the turns terrifies the uninitiated; only a master (Drive Skill of 8 or greater required) can control the Cascade. Worldspanning access via cellular link keeps you in touch, and the fastest multiprocessors keeps control a thought away with standard interface plugs. Only Night City's best is good enough. Are you?

Comes in two colors: black as usual, and new for 2020, chrome.

Game Stats: Top speed 260 mph; can leap up to 3m off the ground but requires a control roll (DIFFICULT) to avoid scraping ground on landing. Full onboard computer systems, including limited autopilot (straight line with no more than 10 turns) and interface controls. SDP: 40 SP:12.

BMW 9018s

BMW 9018s

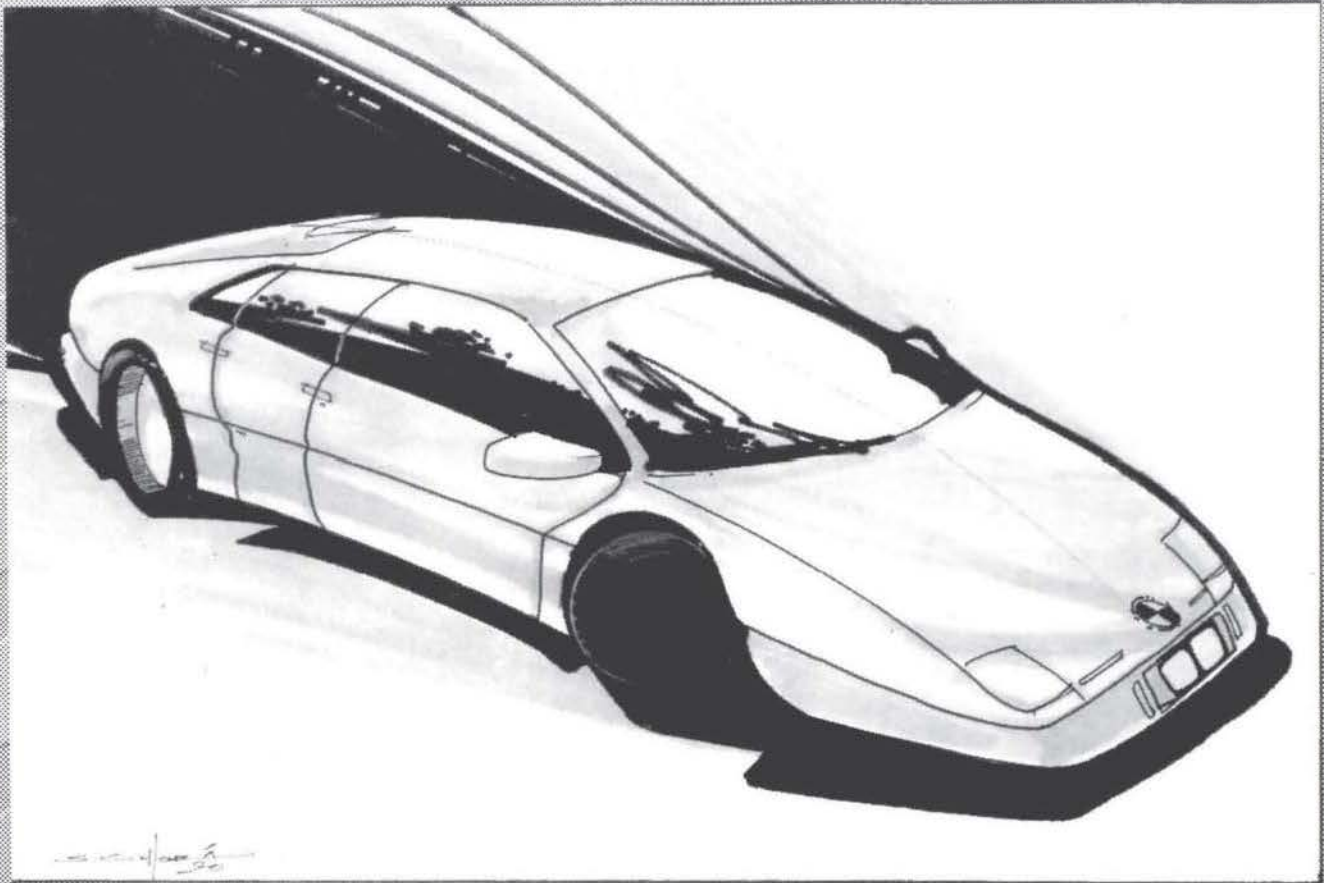

BMW 9018s

The BMW 9018s

100,000eb.

Only the most elegant performance sedan ever engineered. Built for style, built for comfort. Space for six, every luxury. Handmade. Nothing more need be said.

Game notes: Top speed is 210 mph. SDP=90, full armor SP=24. Full cybernetic controls for the driver. It doesn't have options, they ask you what you want, then they build it: car fax and phone, multi-channel TV/VCR, laptop computer, limited microwave relay link, wet bar and snack case, deluxe SegAtari cybergame system, endangered fur upholstery, quad-surround stereo, SilentTalk anti-surveillance system; you name it.

THUNDERGOD

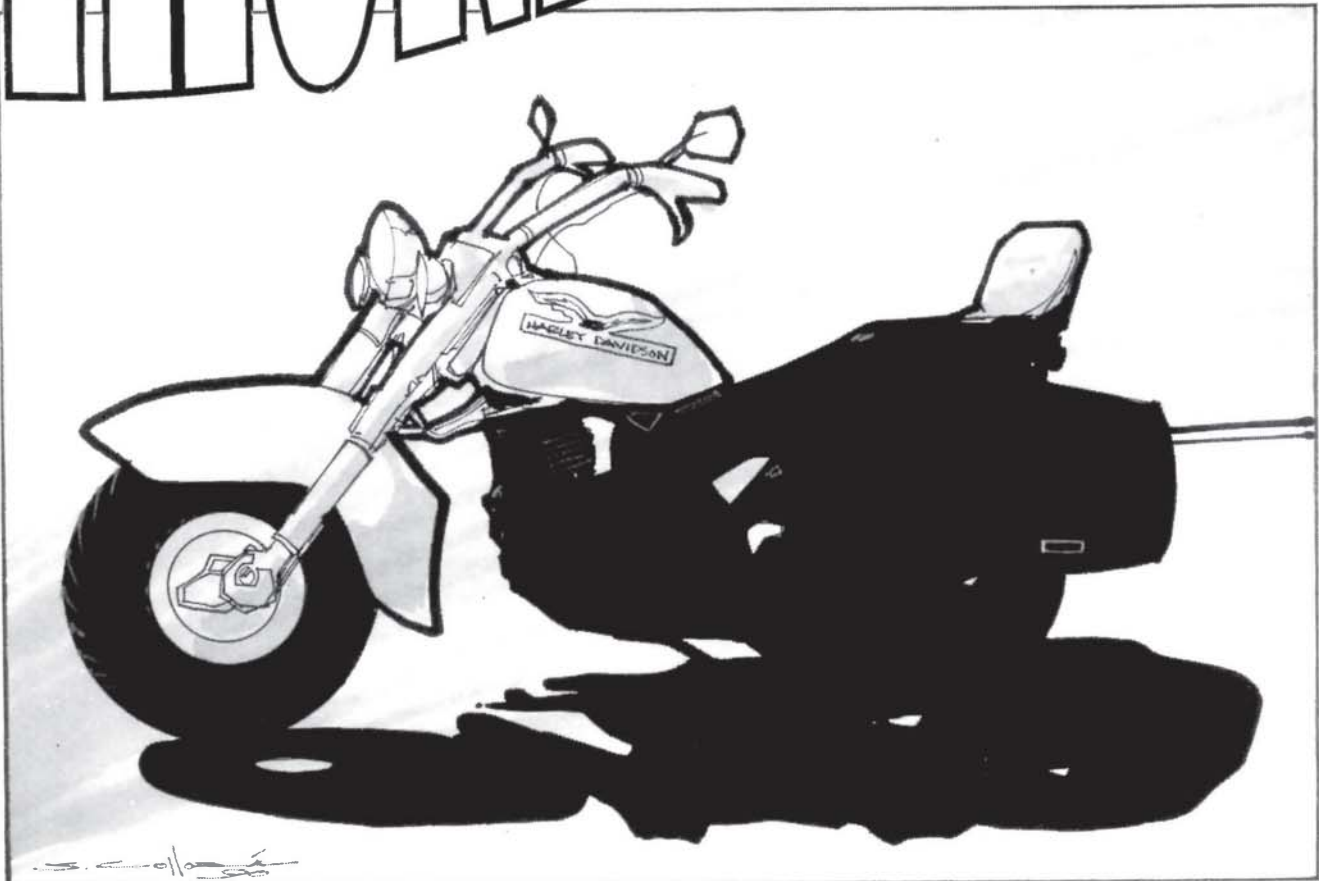

Harley-Davidson Thundergod

5040eb.

Not only newest bike from Harley, but the best ever! The horsepower of a sportscar (perched on two wheels via fully computerized suspension) turns this motorcycle into a rocket. The chassis is sturdy enough for long hauls with only cursory maintenance, and the onboard electronics are modular for easy repairs and upgrades. Two people can ride comfortably, and their outfit won't slow the bike down. Tough enough, fast enough—bike enough for today's road.

Game Notes: the Thundergod is a hog for a new decade, a favorite with many Nomad packs. It is fully cyber-capable, and will run on CHOOH2 or hydro fuels. CB is standard equipment, and there is lots of room to add extra electronic goodies—the Thundergod was designed for a custom electronics suite. Base price for the bike is 4640eb; add 950eb for cybernetic controls. The frame is SDP35, unarmored. *Cruising range is 600km.*

Shiva

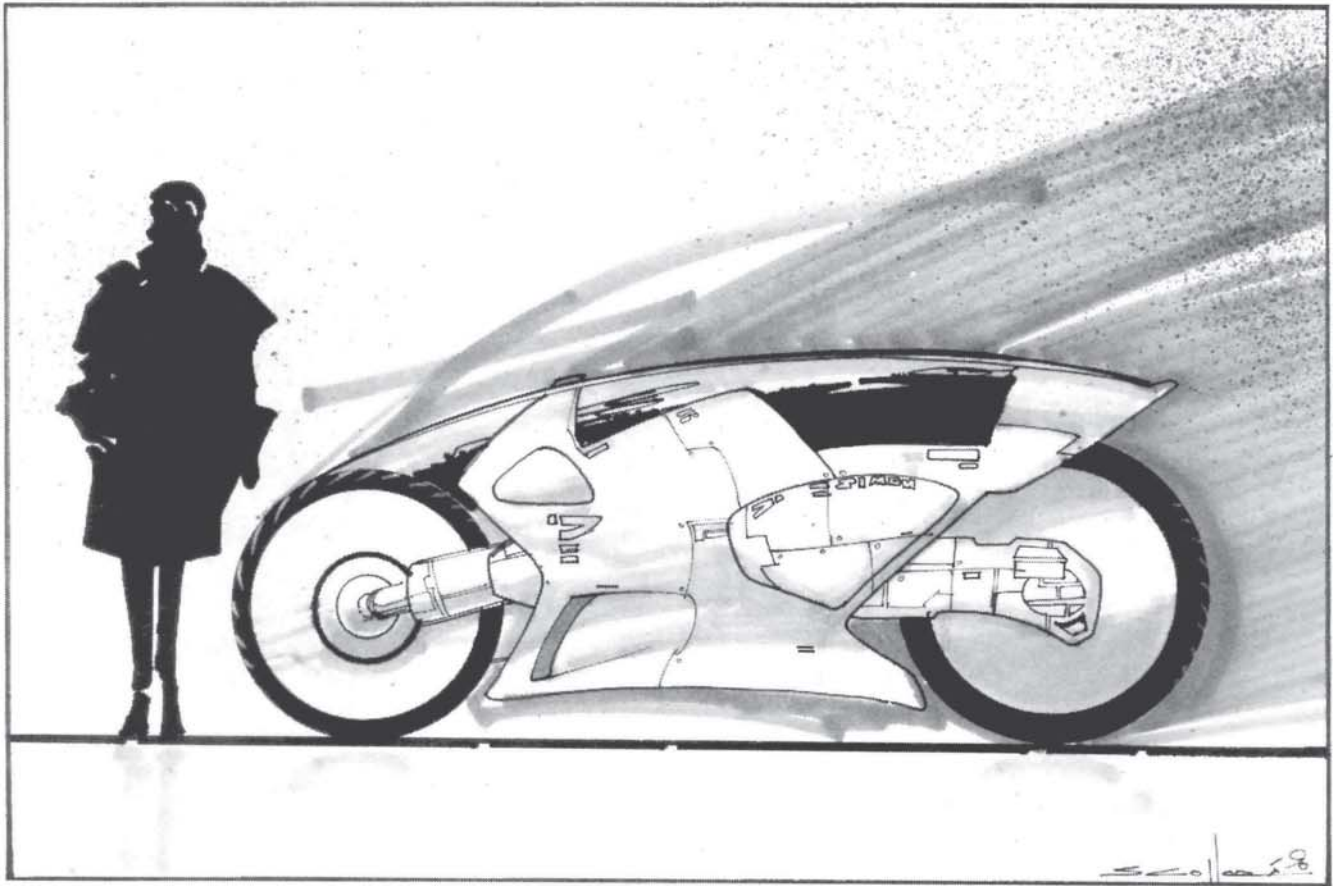

Shiva

Kundalini Roadworks Shiva®

8000eb.

The Shiva is the first high-performance motorcycle entry from Kundalini. Following in the tracks of their highly successful personal and utility vehicles, the Shiva promises spectacular performance for the E-buck. Rated at over 260kph on racetracks, its cyber-assisted suspension will keep you upright on rough surfaces at close to its theoretical maximum. Its acceleration is comparable to other speedbikes, and its handling belongs on a racetrack, not the street. But there it is; fast as a laser, blacker than night.

Game Notes: the Shiva is indeed highly maneuverable (reduce DIFF for all maneuvers by 5 pts), and fast as well. Just don't take off too fast with a passenger on the back. Top speed on city streets is 250kph! It can pull almost a G with a skilled rider, expect it to make almost any corner. Interface plugs can be added easily. Range is 400km. SDP=32.

Pedicab

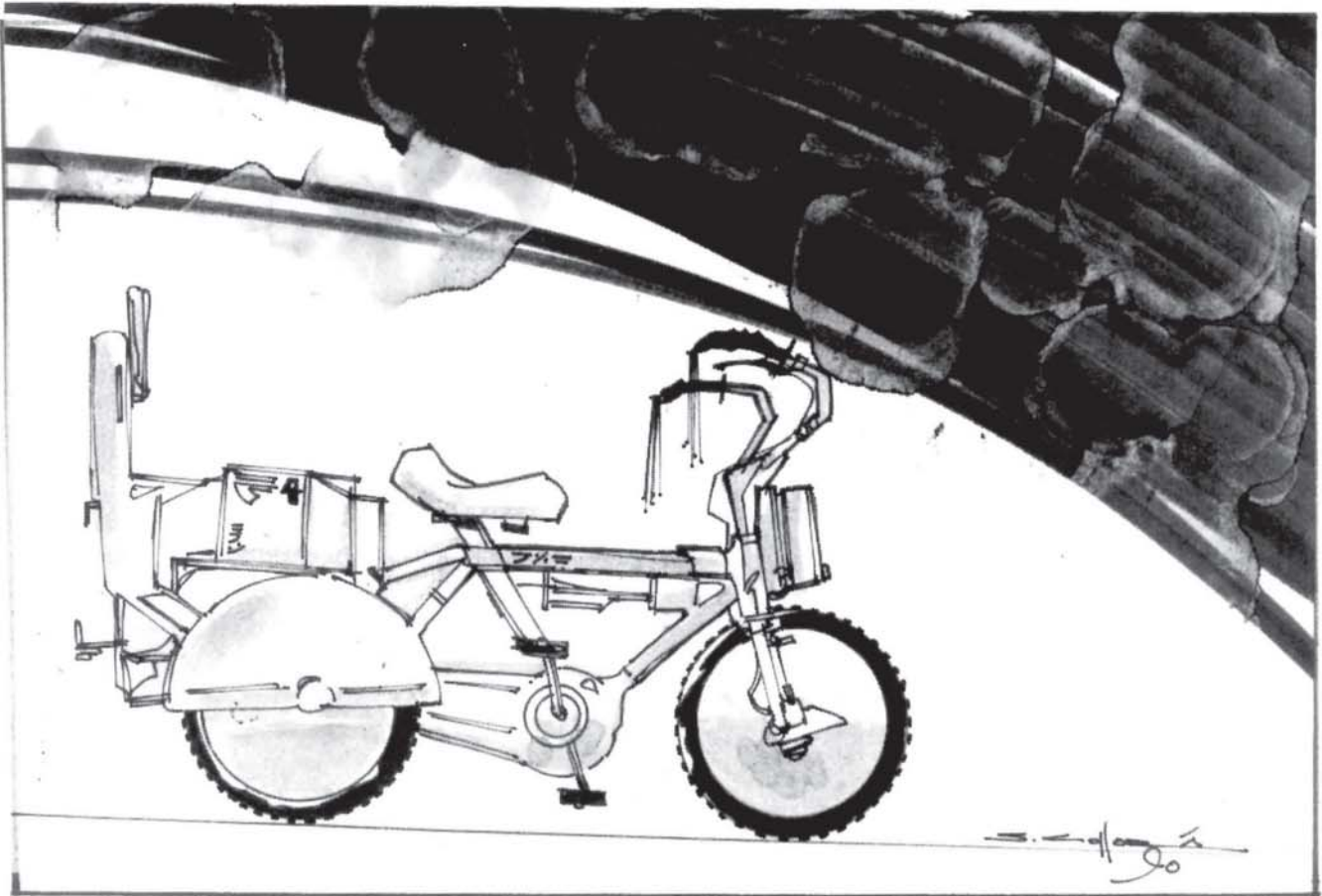

Pedicab

1200eb

They're everywhere, and they'll take you anywhere. One man pedalling away replaces an expensive motor, and for fuel; he eats. The typical pedicab seats two with a minimum of cargo. The fare is usually 1.5eb. per mile. Heavy people pay extra. Top speed is 25 mph on level ground, down to fifteen if fully loaded. Speed is somewhat higher downhill, but make sure the brakes are working properly before you let the driver coast down a big hill. Pedicab drivers are wonderful sources of information, if properly tipped. And if properly motivated (gunfire usually does the trick), Pedicab drivers can occasionally get up to thirty mph.

Game stats: SDP=15, but gunfire has a 75% chance of doing only cosmetic damage as there isn't a lot on a pedicab that can stop a bullet. Or protect the passengers.

New American Autoworks®

Ambunaught

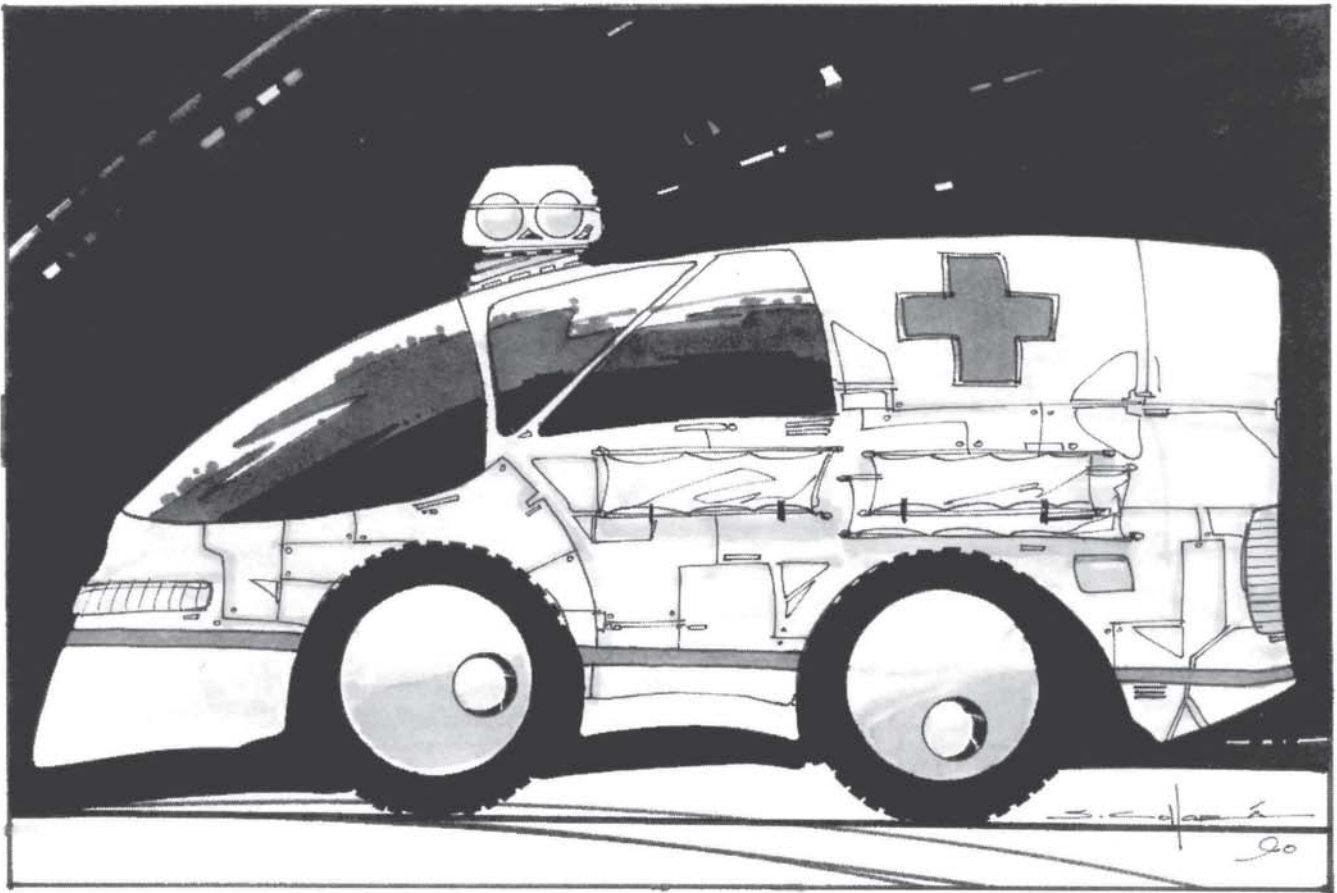

New American Autoworks Ambunaught. 76,000 eb.

Paramedic crews are exposed to the worst situations, often expected to rescue people from active firefights, or to brave fire-and-explosion-prone areas. The NAA Ambunaught is the answer to their prayers. The Ambunaught has the smoothest ride possible on four wheel drive, capable of crossing the roughest ground any city has to offer. The outer shell can resist fire from all small-arms and light AT weapons. The Ambunaught is also environment sealed and completely fireproof. Space is available for up to 4 patients on stretchers and two working paramedics. Would you ride in anything less ?

Game notes: The Ambunaught is really well armored, capable of resisting fire from most small arms, although it does have some chinks. Next year's model is supposed to float, too. Its sealed environment capability is 16 man/hours of life support. They are resistant to heat and have a non-flammable exterior. It also has a full roll cage and can easily survive up to two tons dropped on it. Top speed is 72 mph. on flat ground, 30 mph on rough. SDP= 120, SP=40.

RIOT-VIII

ARASAKA

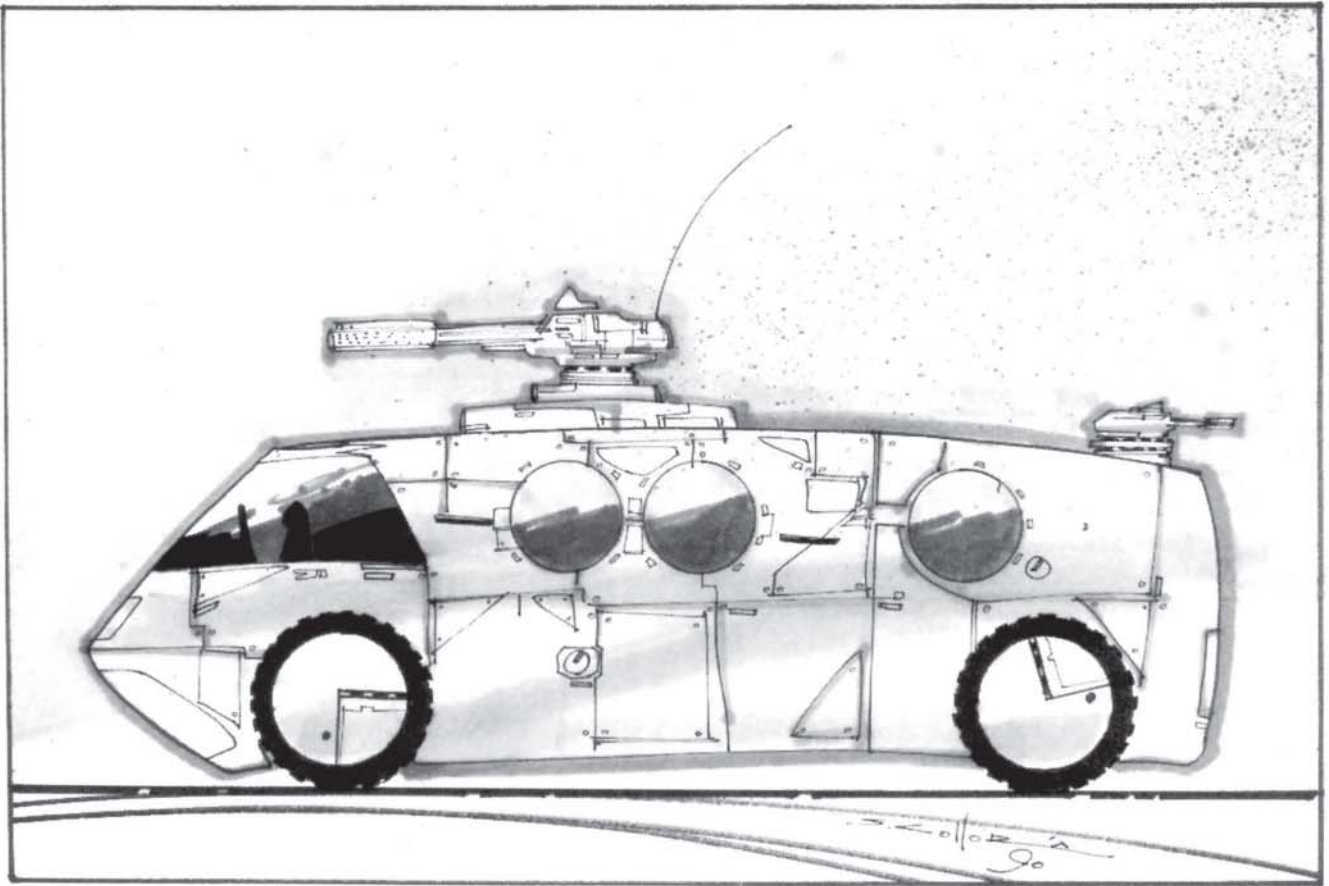

Arasaka Riot-VIII

250,000eb.

When the great unwashed come knocking at your door, you'll want to have a Riot-VIII waiting for them. The Riot-VIII is a state of the art crowd control/suppression vehicle. Enhancements over the old generation of riot control vehicles include: fully fire-resistant hull designed to shrug off Molotov cocktails; water cannon with 10 minutes of spray and a new steam function (pat. pend.) that will break up the most determined riot with only minor scalds and burns; fully cybered control system including a satellite uplink that allows the board of directors to handle a situation with that personal touch. And this new generation of crowd control vehicles is capable of operating in the most rugged of urban environments for days if necessary. Riot at your downtown facility? Call 1-800-ARASAKA now and our representative can have vehicles in operation within 120 minutes or less. You have our word. We'll be there.

Game Notes: Top speed is 120mph. SDP=200, SP=30. Crew of two, and up to 8 riot police. Troops carried are not fully enclosed, but are under 75% cover. The watercannon is turreted- 360° traverse. Water cannon range=30m; 10m for live steam. There is also a grenade launcher on the cab roof; 180°. arc carries 18 standard grenades, 300m range. The watercannon's effects are up to the individual Referee, keep them an unknown factor; unknown, but potentially extremely painful.

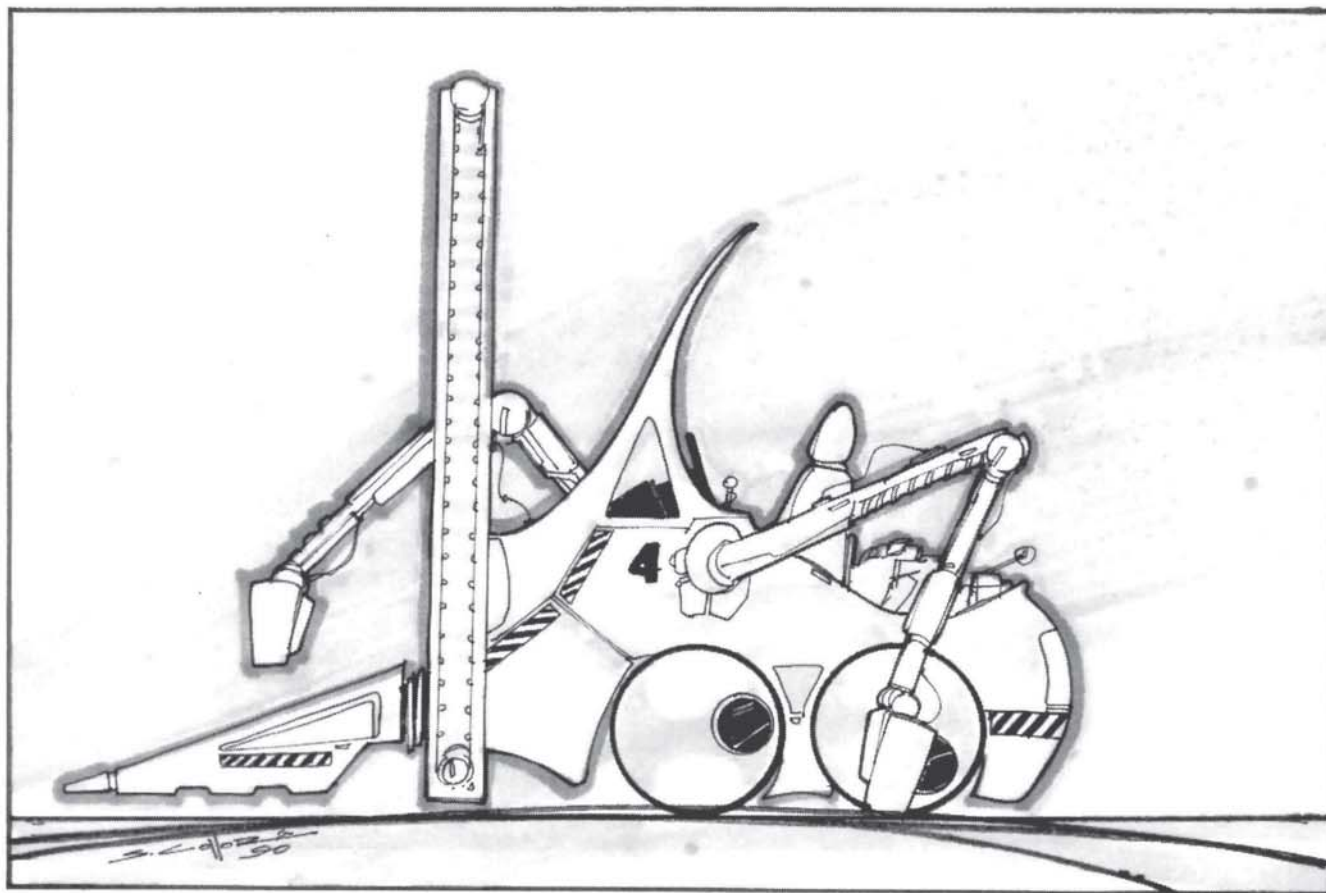

The GM/Hyundai Worker Bee

5,000eb

Cargo transport in a secure installation is at best a routine task. Free skilled workers for more important tasks by letting the Worker Bee take over most of your warehouse duties. Each Worker Bee is a semi-autonomous robot slaved to a controlling program in your mainframe. The Bee can carry up to two metric tons of cargo; half that on the main forklifts (the rest on the cargo bed), and the secondary arms can lift 400kg. Packages as small as an egg or as large as a crated Bell-15 Autogyro are easily manipulated. Onboard computers reduce the drain on precious mainframe time. They work twenty-four hours a day, never go on strike, work in the dark, and are engineered for maximum reliability.

GameNotes: The Worker Bee is typical of the remote vehicles controlled by computer systems. They are found in those industrial facilities *Cyberpunk* PC's are so fond of breaking into. They have an SDP of 60 and their tough construction is worth an SP of 20. They move at a maximum speed of 25 mph, much less when not on a smooth surface. There is a limited control station on board, just watch out for the arms—the working programs assume nobody is on board.

BELL AERONAUTICS

SPY EYE



Bell Spy-Eye 18

206,000eb.

This ultra-modern helicopter is designed for the news-team that needs mobility, but can't afford an AV. The Spy-Eye is almost as fast as an AV-4, but at half the price. A Spy-Eye can give your team the edge it needs to beat the competition to the story, with full onboard computers and scanners that make the chopper a video lab in the sky, first on the scene, and first on the air. In dangerous situations you will find that the Spy-Eye is as safe as a police chopper. Although unarmed, this chopper is well-armed and maneuverable enough to get out of harm's way while filming. Satellite uplinks are a standard feature. Options include onboard Cybermodem and IR baffling to defeat AA missiles and other IR scanners (-30% vs missile hit %). The Spy-Eye is capable of operations at night, in bad weather, or through a cloud of smoke while going for that dramatic footage.

Game Notes: the Spy-Eye seats four in the relative safety (SDP= 65, SP=12). The sensor net is of high quality. The airframe comparatively is pretty cheap, but the electronics are first-rate. Stations tend to use these as backups, stringers, and expendables, so the state-of-the-art equipment goes on AV's. Airspeed is 280mph, and maneuverability is high compared to other choppers (-2 from all maneuver rolls).

SIKORSKY-MITSUBISHI

DRAGON

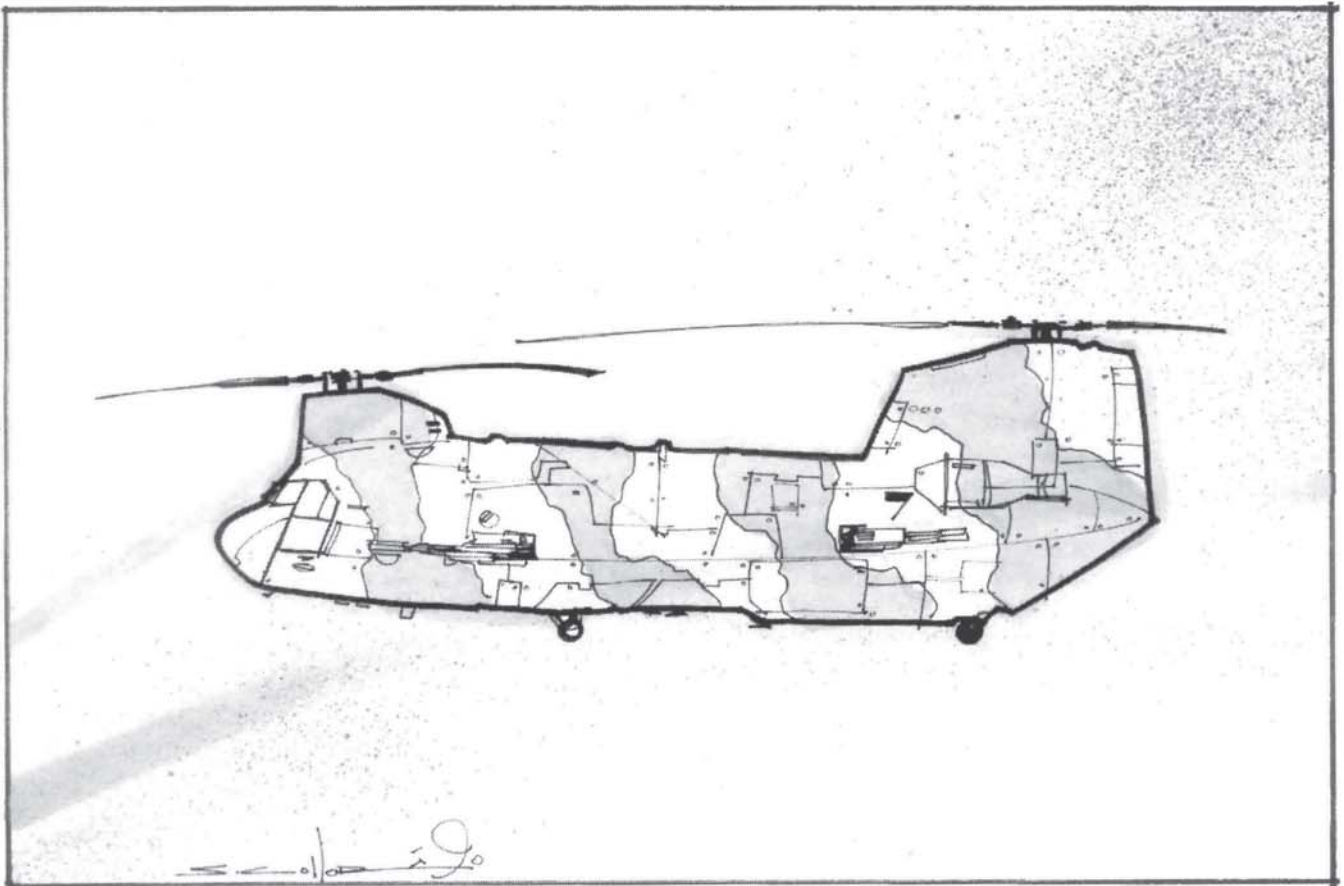
**Sikorsky-Mitsubishi Dragon****2.5 million eb.**

Following a design philosophy dating back 40 years, the SM-Dragon brings thirty troops and devastating firepower to the battlefield. And brings it quickly. This huge helicopter travels at 350mph when fully loaded ! A salvo from a Dragon can cool off the hottest LZ. Rockets, miniguns, grenades, and machineguns add up to the deadliest helicopter in the world.

Game Notes: the Dragon is the most dangerous thing most Cyberpunk players will ever see. Use it as you would a real dragon—to kill big things and frighten small children. The Dragon's top speed unloaded is 420mph. It is armored to an SP of 90 and has 400SDP. Hard To Kill. Its armament is colossal (choose any 8 heavy weapons from the *Solo of Fortune* and *Cyberpunk* books to arm it). Use it for destroying whole city blocks.

AV-9

Combat Assault Aerodyne

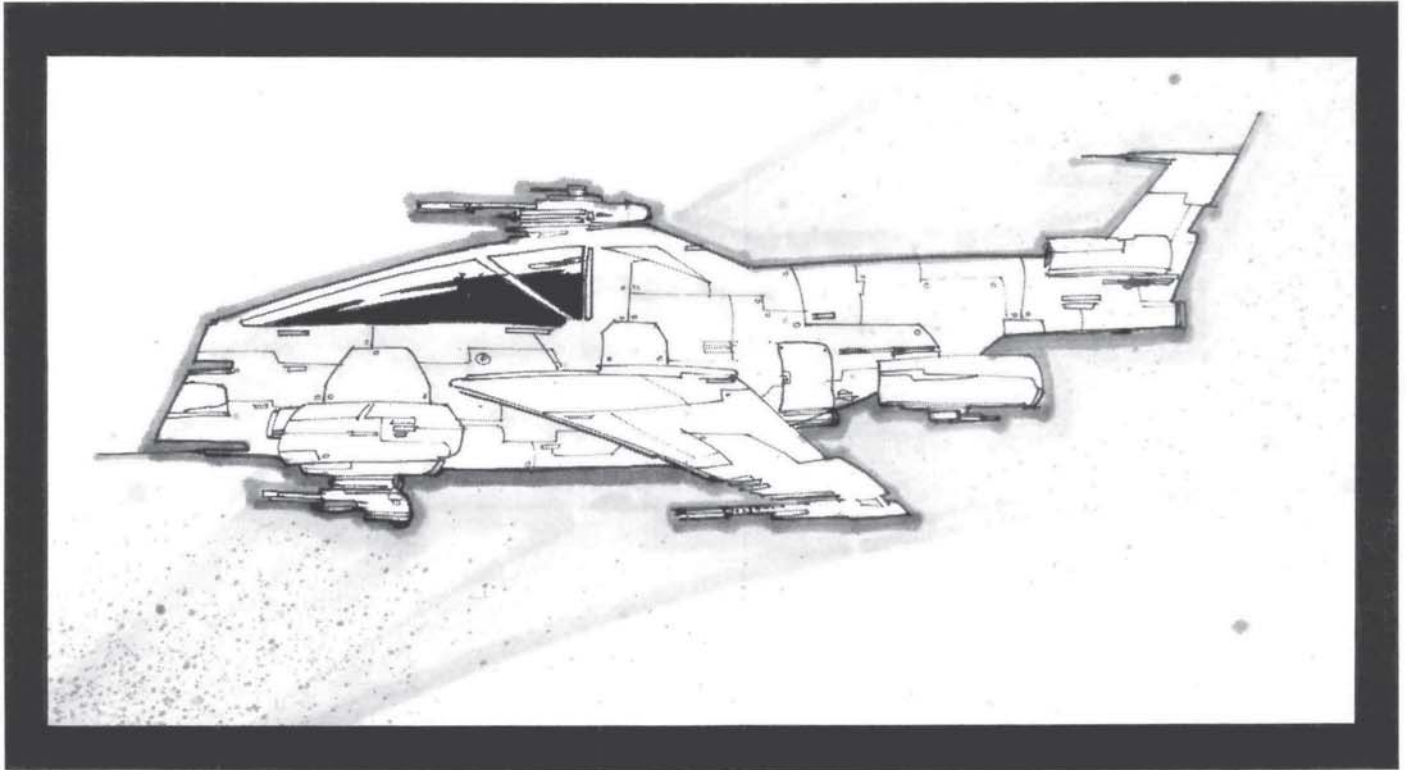

The AV-9

1.3 million eb.

The big brother to the well known AV-4 is about to make itself known ! Imagine a modular-design AV where the base unit is a combat-capable vehicle. Visualize a command center with space for you and your staff to observe a battlefield with the AV-8's ultramodern sensors. Imagine the devastating firepower of a chaingun, two grenade launchers and up to four (!) outboard rocket pods. See a troop transport with space for ten of your best, delivering them where you need them, when you need them. See all this in one package, then call your salesrep before the other guy does.

Game notes: The AV-9 has a slot for a module which can contain either troop space, ordinance, or an airborne command post. It takes 10 minutes for a field crew to replace modules with full equipment. Weapons are also modular, except for two grenade launcher turrets (180 degrees each). Two heavy weapon hardpoints are fitted to the belly with power, sensor and ammo feeds into the gunship module (not usable with other modules). The outboard stabilizers may have single MG turrets and one pylon beneath each stabilizer. You get quad-fire capability by placing one rocket pod on each stabilizer, and using the belly mounts for rapid-fire launchers feeding from ammo stored in the module.

Top speed is 400mph, operational radius is 400 miles. SDP: 180, armor: SP 45 All AV-9 modes have all-weather capability, and active & passive IR sensors. A trained squad can dismount (via ropes) in 10 seconds without the vehicle ever touching ground. Weapons suite: Grenade launchers use standard grenades in a turreted launcher with a 750m range, ROF=2 and 30 rounds ammo of up to two different types (selectable each turn). Rocket pods are equivalent to the Militech RPG-A, but have an ROF of 8! They fire straight ahead with a firing angle of +/-15° off the flight path. Normal tactics are to "walk" the rockets ahead of the vehicle as it makes its strafing run. They carry either 24 (outboard pods) or 72 rounds (belly mounts, gunship only). MG's are cyberlinked MMG's firing 5.56 mm ammo, use stats for the AKR 20. Ammo=200 rounds (or 500 in the Gunship module).

PUNKNAUGHT!

Maximum violence, Maximum speed!

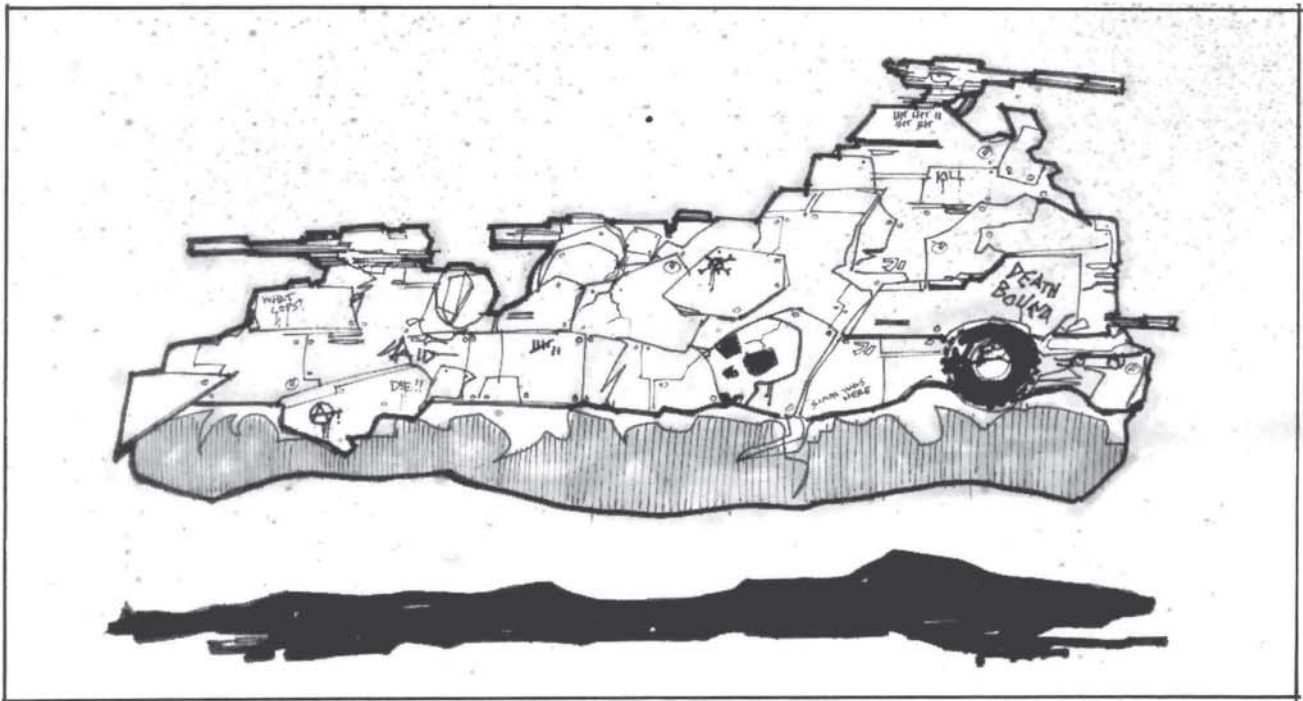

The Dreaded Punknaught!

Unknown

Every riot cop's nightmare. Take the engines from three or four downed AV's, weld them into an amalgamation of buses, flatbed trailers, and assorted junk, tack on all the weapons you can scrounge and send it charging into a police line—watch the cops scatter!! A typical Punknaught is capable of hovering a meter or two off the ground and with enough of a start can make fifty kph. They can carry twenty or thirty passengers and a crew of about a dozen. Each Punknaught is unique, and bears its own name.

Punknaughts have been built and used in London, Chicago, New York (twice), Night City, Osaka, and Manila to name the most notorious instances. They are built by gangs to smash police lines, break martial law, and engage in sheer destruction and ultraviolence. A Punknaught is a tenuous combination of machine; few gangs can support one for long, though many try. Typical armament is homemade rockets and light machineguns. Heavier guns weigh too much and eat power for servos and controls.

Game Notes: A punknaught is the streetgang's answer to the Sikorsky-Mitsubishi Dragon—if they can build one. Construction takes from a week to a month, and uses lots of scrap metal and welding torches. As a general rule, each AV engine can lift one bus or flatbed trailer in the assembly. Tradeoffs can be made for weight to allow more than the absolute minimum of armor, and no more than two gun mounts per unit (one engine's lift capacity) without serious weight problems. Lots of people can crowd on; boostergangs love these things, and love to party with them. Each 'unit' has an SDP of 60 to 80. Most areas are unarmored; controls, engines, and (hopefully) ammo and fuel are the exception, with an SP of 20 as average. Exact design (weapons available, number of engines) is up to the referee and not the designers! These things are very dramatic, and just the building can make opportunities for many adventures. Rumors exist of more advanced versions being built, but these have been ruthlessly suppressed.

Cyberware

NEW ENHANCEMENTS ON THE CYBER EDGE

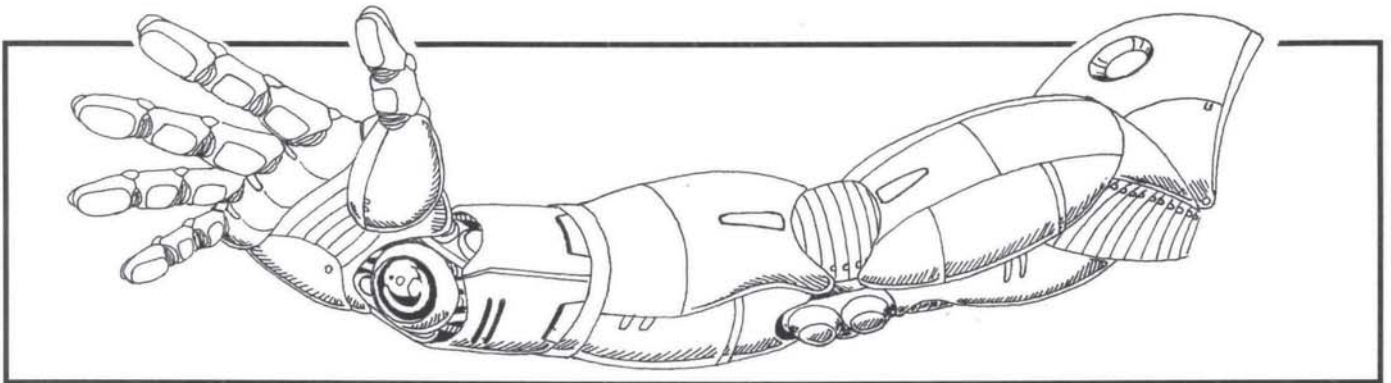

"You can't be a Cyberpunk without Cyberwear. It's what sets you apart from all those other toesuckers walkin' the Street. You know — victims..."

—Ripperjack

"The new stuff on the Street is' supa-chilled. You got optional hands, plug-in guts, skate feet now. Stuff in a couple o' rockets and cover da face with the maximum Optishield, and yo be ready, chombatta. You go make tread marks all over da tough guy's backs."

*—Lord Molo
Leader of the Boogiemem*

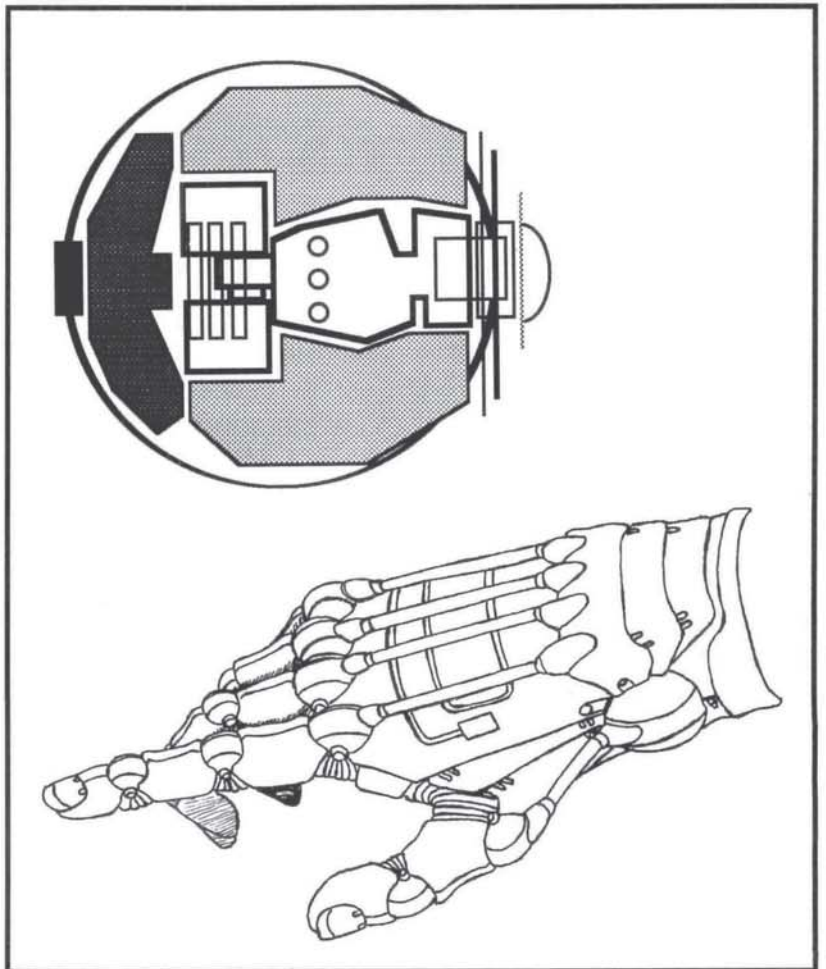

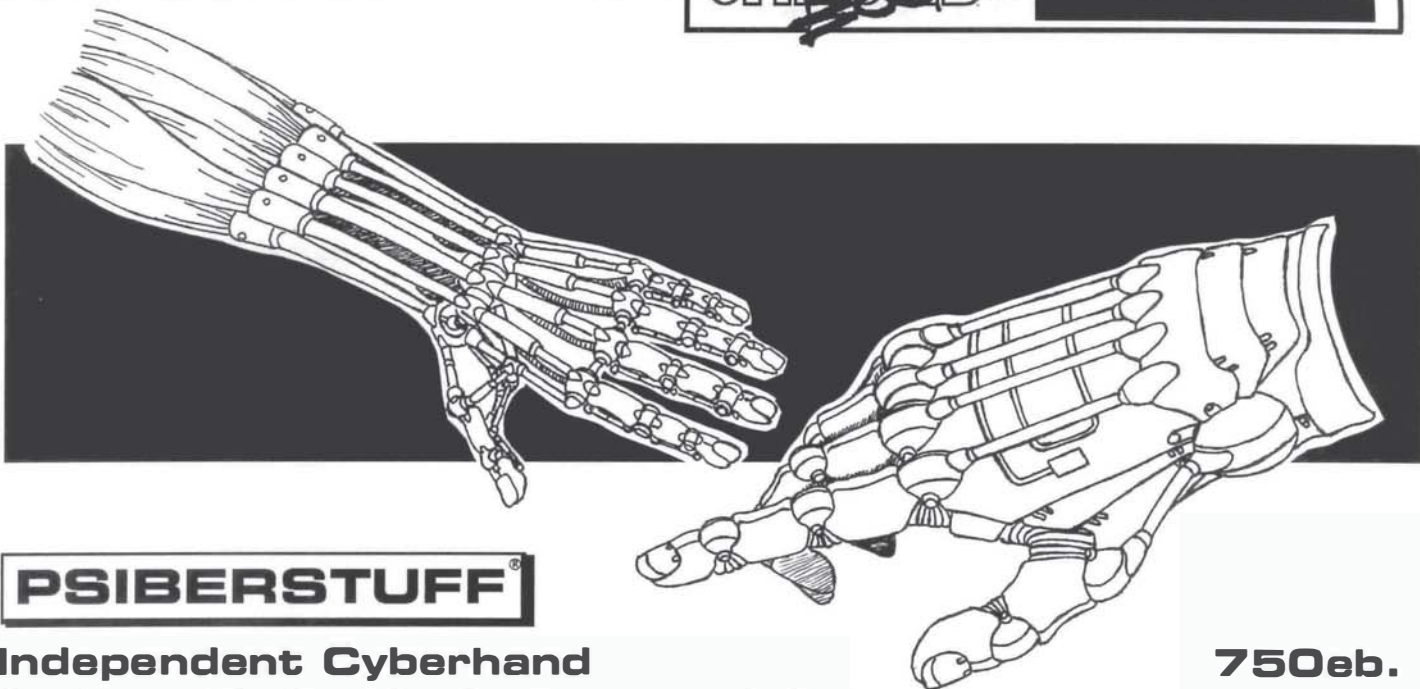

PSIBERSTUFF®

Independent Cyberhand

750eb.

For those who've lost a hand, not an arm and a leg!

From Psiberstuff—This new cyberhand has a 1D10 crushing strength (it doesn't have the actuators of an entire arm backing it up), and can hold 4 optional fingers (or 1 option installed in the hand as a whole). The hand takes 7pts.(structural damage) to cripple and 10 points to destroy. RealSkinn™, Superchrome®, or armor coatings are 100eb. each. HC=1D6.



OptiShields® 300eb.

Ultimate in style and function !

For maximum effect! Kiroshi Opticals has introduced their new Shields for those who KNOW that style is everything. The bulletproof mirrorshades are built into housings in the forehead and orbital ridge. These mirrored lenses enclose the eyesockets and have a SP of 8 (1-3 on d10 for a headshot to hit the lenses). The eyes are permanently protected from all irritant gasses and the Anti-dazzle feature is standard. HC=1D6+2 .





Dynalar Technologies

DIGITS® Cyberfingers

A new line of cybernetic fingers from Dynalar Technologies! Compatible with any standard cyberhand or cyberarm; easily installed in the privacy of your own home.

a) Dartgun **100eb.**
Compressed-air dart (3m range) similar to cyberoptic weapon from CP 2020. HC=2.

b) Lockpick **50eb.**
A concealed and "handy" breaking and entering tool. HC=.5.

c) Light Pen **45eb.**
Used to write on computer screens and graphics tablets. HC=.5.

d) Mini Light **25eb.**
A narrow beam 25m in length. Batteries are replaceable (1 eb); last 12hrs. HC=.5.

e) Finger Bomb **150eb.**
To be detached and thrown, it inflicts 2D6+3 damage to all targets in a 3m diameter. Caution: Black market cyberware in some states. HC=2.

f) Scissors/Wirecutters **50eb.**
A pair of cutters is built into the middle and index fingers. They inflict 1D6/3 if used as weapons. HC=1.

g) Mace Sprayer **150eb.**
Holds 2 bursts of incapacitating mist (-4 to REF and Awareness skill for 1 D6 combat rounds). An Average difficulty roll to hit the facial area if target is surprised; a Very Difficult roll if not. HC=2

Dynalar has all these and more—act now and we'll buy back your used cyberfingers at 30eb. each!

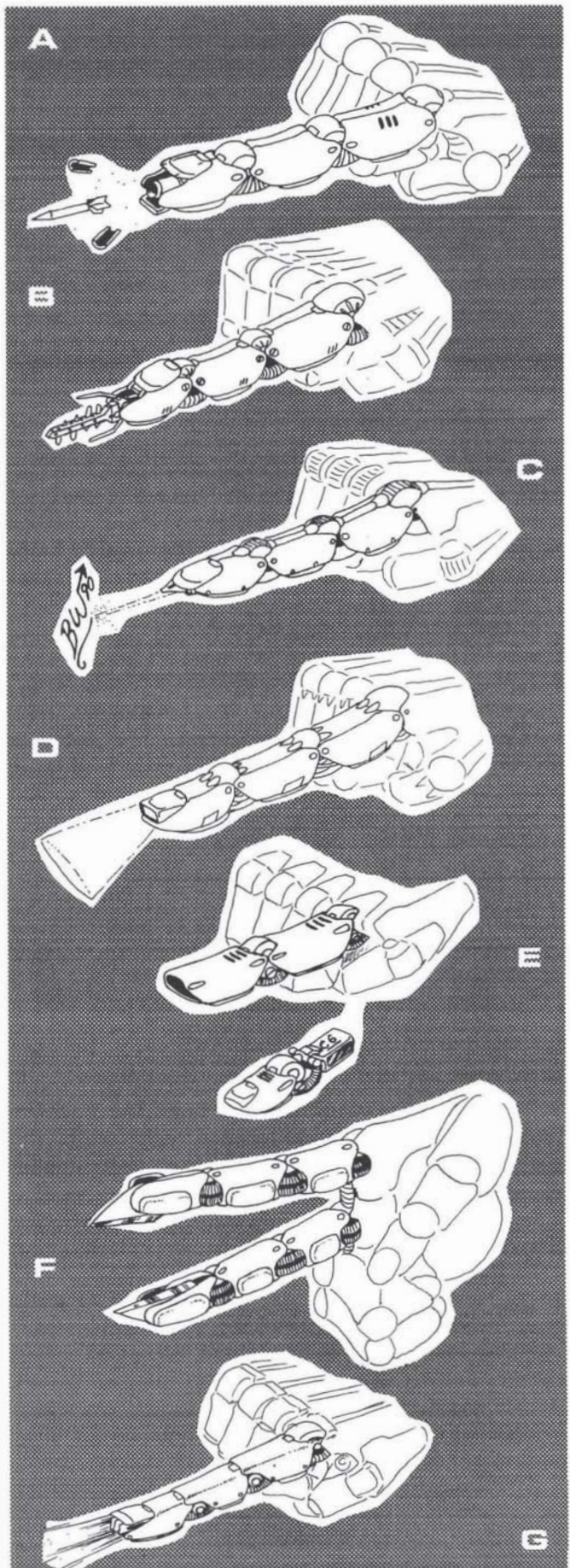

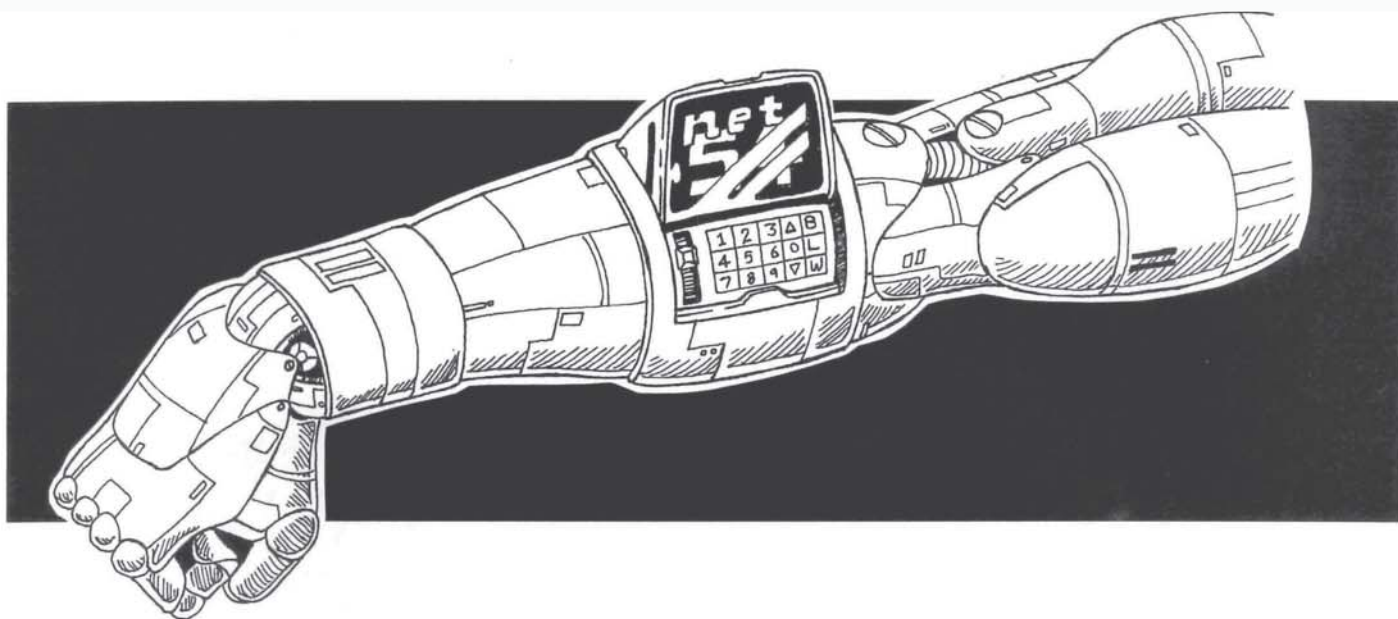

Watch-Man®

180eb.

Cyberarm option from *Psiberstuff*. This miniature TV can be installed into any cyberarm, giving the user a 7.5cm x 5cm screen to watch when he needs to get the news, replay video chips, or is just bored. HC=1.

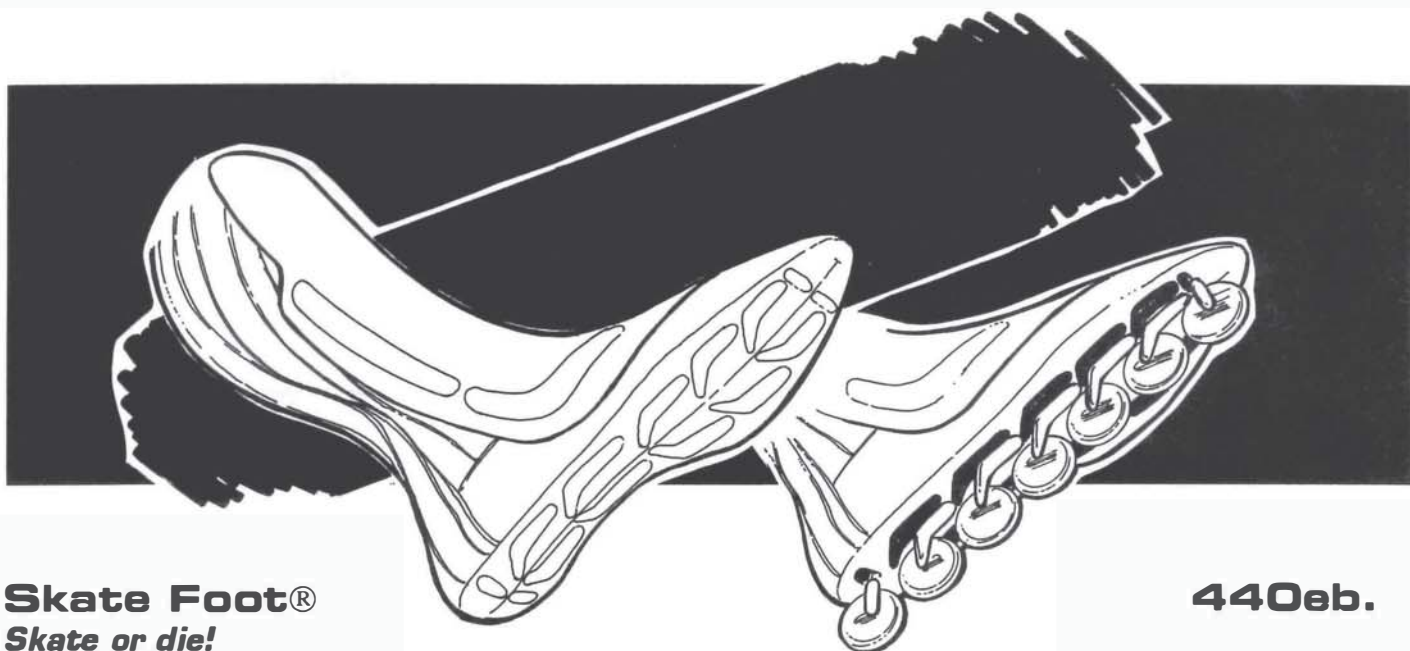

Skate Foot®

440eb.

Skate or die!

This motorized foot module (for installation in cyberlimbs only) is fitted with four chain-driven, super-grip wheels which fold up behind the heel when not in use. Once activated, micro-hydraulic servos slide the wheels down beneath the feet and... ZOOM!! Beat the rush hour traffic by reaching speeds of close to 35mph (an effective MA of 20+ !) in under half a minute (but beware of road rash). HC=1 D6. NOTE: subject needs *Skating* or *Athletics* skill for effective use.

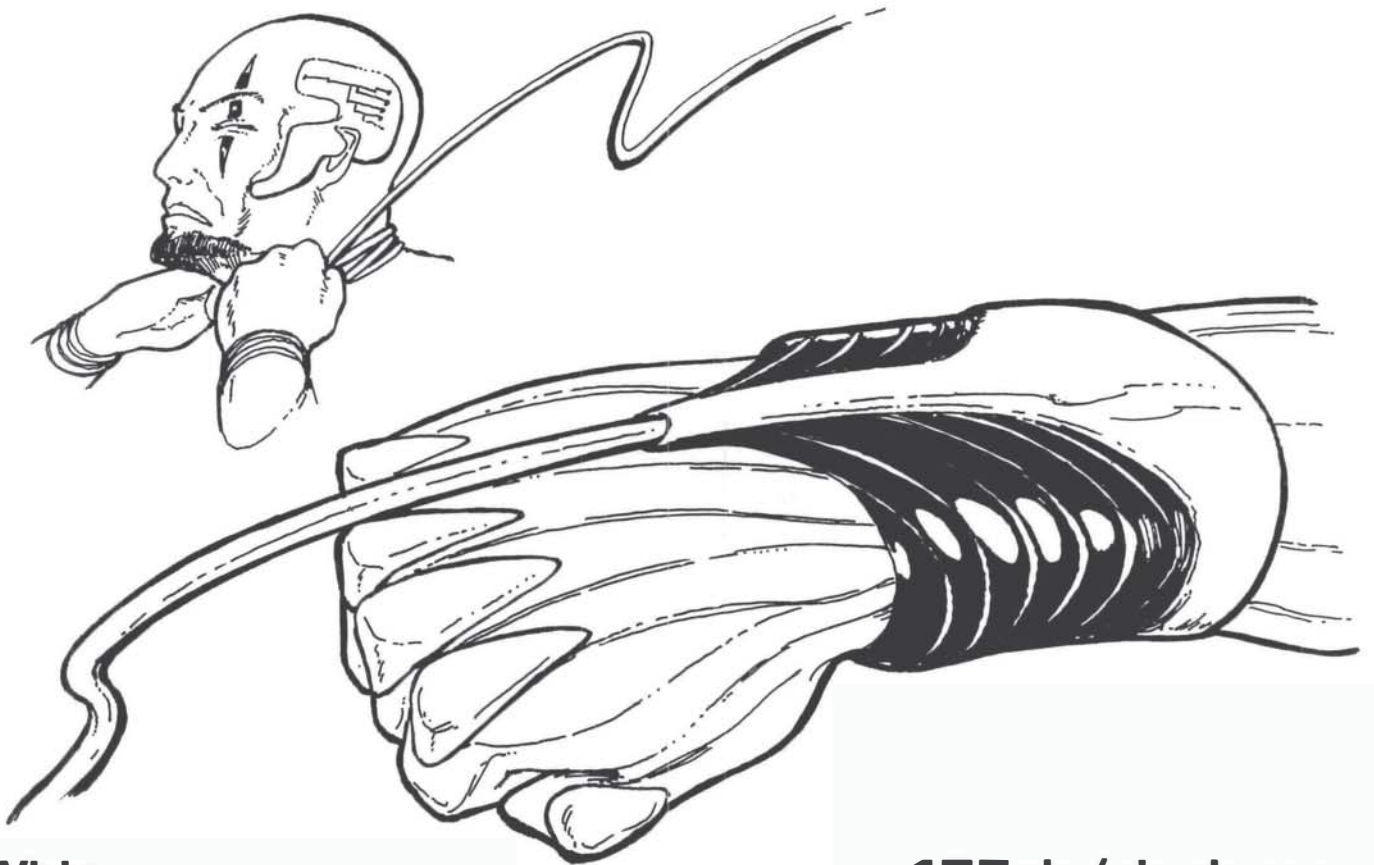

Whip

475eb./single arm

Always keep your enemy within reach !

Cyberarm option. A 2.2m long alloy tentacle that can either whip for 1D6/2 damage, strangle for 1D6 damage per combat round (target must make Difficult BOD or REF roll to escape), or act as a short-range grapple. HC=2D6.

LimbLink™

100eb.

Cyberarm option. Using a "smart"-monocle on a cable connected to the cyberarm's limb-control interface, this turns any cyberlimb pop-up gun into a Smartgun (+1). You do not need a separate neural processor module for this link. HC=1.

Magnetic feet/hands

60eb./pair of limbs

Small electrostatic adhesive surfaces are placed in the soles or palms of cyberlimbs. These are for use in Low Earth Orbit, allowing the subject to walk on walls and ceilings. HC=0.

Gas Jet

275eb.

The last word in chemical warfare.

A pressurized cannister of gas (any type) with a 6 use capacity is installed in a cyberlimb (normally the arm). Range is 2m. Effects depend on the type of gas used (sleep, blister, nerve, poison, etc.). HC=1D6+3.

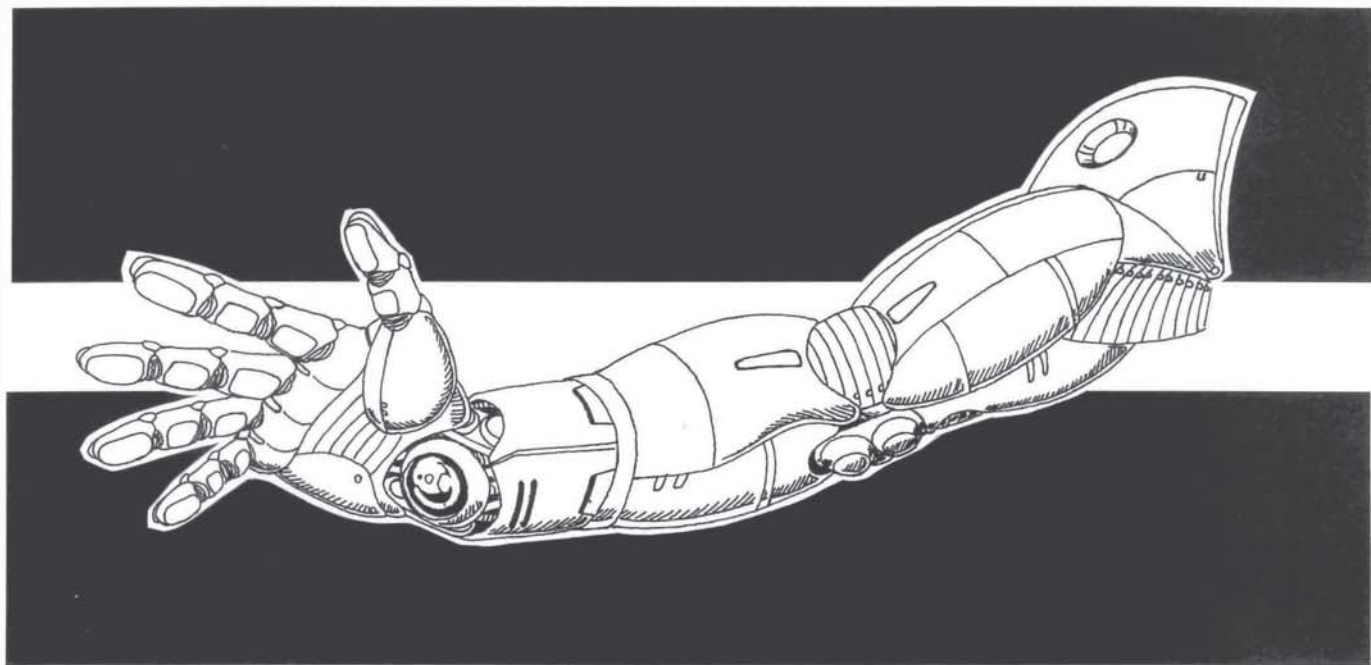

Flashbulb™

250eb.

Make 'em "see the light"—for the last time.

A 20,000 candlepower strobe installed in the palm. It effects a 4m diam. cone with a 6m range. Target must make a Difficult REF roll (add *Dodge* skill) to shield eyes. Failure means an Impossible COOL roll (add *Resist Torture* skill) to avoid convulsions or psychomotor paralysis for 1D6 min. Surprise attack increases REF roll to Very Difficult. Cyberoptics or goggles with anti-dazzle make a person immune to this type of attack. HC=1D6/2.

Wet Drive

320eb.

+175eb./extra memory

Computer crash? Never lose critical data again. Forgetful secretary? No longer. Intruding Netrunners? No problem.

Installed at the base of the skull, CYBERMATRIX's new silicon solid-state storage allows the user to store 1MU of file-only memory in the head (the Read-Write Memory is loaded and downloaded through interface plugs). A code-lock can be applied, if necessary, and the data will be loaded or downloaded only after the access code is entered. The user cannot access the information, but it's a very secure place to store hot data. Order soon, and get an extra 1MU of storage for only 175eb. HC=1D6.

Voice Pattern

350eb.

An AudioVox option (of dubious legality) which, when used in conjunction with cyberaudio, Wearman, or interfaced to a sound system or audio tape/chipplayer, allows the user to exactly emulate the voice pattern of another person.

Game Notes: this allows the player to pass for someone else in conversations and fool voiceprint scanners. HC=2.

Forked Tongue

350eb.

Now anyone can be a smooth talker.

Employing ultrasonics, this A-Vox option (also dubiously legal) makes a listener subliminally susceptible to suggestions (+1 to use of *Persuasion/Seduction* skills). HC=2

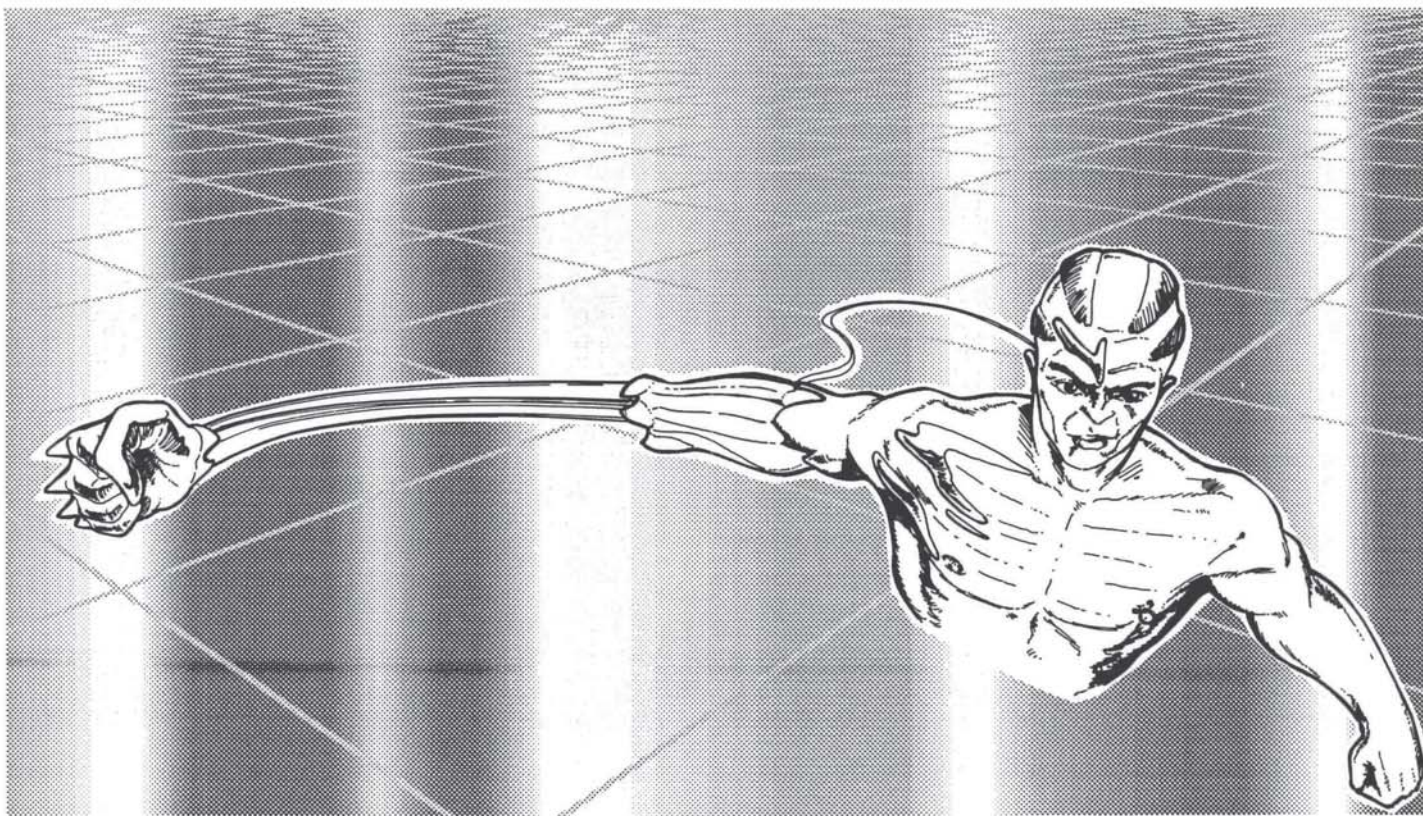

Mace Hand

300eb.

A very heavy hitter! The Mace Hand is a high-density, weighted club which can be smashed into a target, delivering 2D6+1 damage (1D10-2 when used as a fist). Furthermore, the Mace can be extended on 1 meter of heavy cable, allowing a longer range and flexibility of attack (1/2 damage gets through a parry). A must for devoted combat gangs! HC=3.

Game Notes: The Mace Hand is not well articulated; there is a permanent -2 REF penalty for any actions attempted with that hand.

Icer™

200eb.

Cyberarm option. A CO₂ fire extinguisher built into the forearm. Range is only 2m. If used as a weapon, target must make a Difficult REF roll to avoid being blinded for 1D6/2 combat rounds. HC=1D6/2.

Cutting Torch

100eb.

Cyberhand option. Equivalent to a blowtorch with a 10cm flame, 2.5 minute duration. Does 1D6+2 damage if used in combat. Can cut through metal, plastic or wood up to SP 20. HC=1D6/2+1.

Derringer

220eb.

Cyberhand option. 2-shot pistol built into cyberhand, with stats equal to 5mm BudgetArms C-13 (P•1•P•E•1D6(5mm)•2•2•ST•50m). HC=1D6.



MICROCYBERNETICS

Rebreathers

700eb.

Tired of having to buy a breath? No longer!

Living in the Big City? Why wait for consumption or cancer to get you tomorrow when you can have Raven Microcyb's new organware today? With their new Rebreathers, the lungs are cyber-enhanced with synthetic filters and O₂ superchargers. A breath can be held up to 15 minutes! RM's Rebreathers can be adjusted by a doctor to filter out toxic gasses 55% of the time (but not surface irritants like mace or mustard gas). HC=1D6+1.

BODYWEIGHT

Life Preservation Systems

Decentralized Heart **1300eb.**
Reduce vulnerability, increase survivability!

Don't put your heart on the line. Replace it with synthetic implants that disperse the chambers, main arteries, and main veins to three areas within the torso. This cuts down on the critical damage done by a single wound. With this implant, a player adds 2 to Death Saves caused by torso injuries. HC=1D6+4.

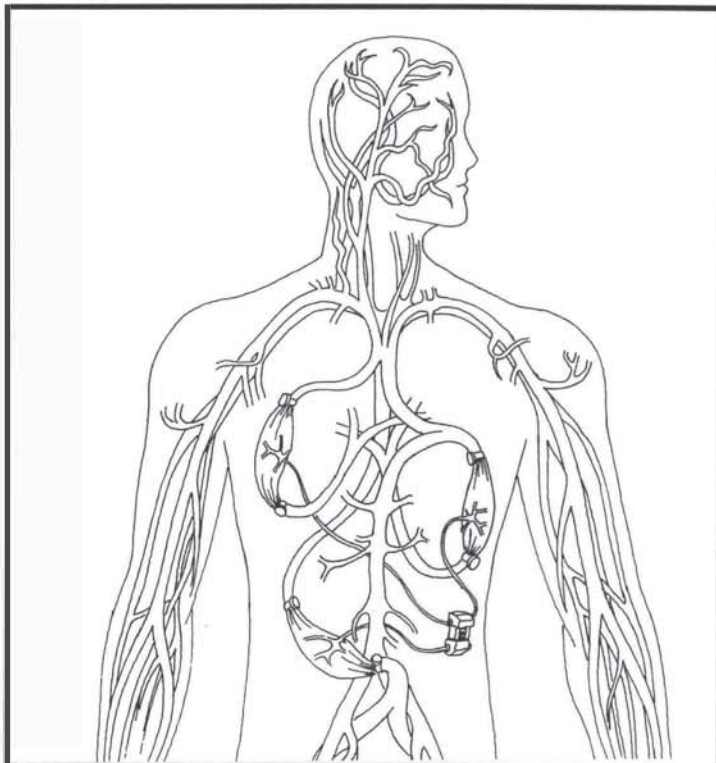

PACESETTER® Sport Heart **900eb.**

Bodyweight now offers a new sporting heart for the physically oriented. This rapid-action turbopump implant is capable of increasing circulation many times over, effectively boosting physical performance. This will temporarily boost Movement Allowance and Body stats by 1 when the heart is kicked into "overdrive." (Game effect: this alters run/leap/lift and all BOD skill rolls except BTM and Death Saves. Death Saves are at -1 due to cardiovascular overpressure.) HC=1D6.

Surgeon General's Warning: use of such organware for more than *four minutes* can cause torn ligaments, muscle damage, and hyperventilation (At the time limit, roll a D10, if roll is under your normal BOD stat, no effect. Subtract 1 from your BOD for every minute over 4 you use the implant. If the roll goes over your stat, take 1D6 damage and *halve* your BOD stat for the next 4 minutes!).

T-MAXX "Cyberliver" **450eb.**

No more DUI's!

You can party longer with the T-MAXX Cybernetic Blood Filter. Micropore Filter units equipped with the new T-mx2 electrochemical diffusion process can filter out up to 98% of blood alcohol, and even remove most cardio-vascular transported poisons. This unit protects you from the adverse effects of drugs such as Smash, 'Dorphs, even Purple Pause. Enjoy the party without the side effects. (The character gets a +4 to all stat rolls involving the effects and addictiveness of drugs and ingested poisons, plus 90% effectiveness in neutralizing all types of alcohol.) The new, deluxe T-MAXX II (850eb) is equipped with a convenient fluid rerouting system, to let you enjoy a night off. HC=1D6.

PACESETTER 2000™ Overdrive Heart **985eb.**
More power, more action, greater endurance!

Pacesetter 2000™—"I couldn't have made my 83rd home run without the Pacesetter 2000! That extra pulse of power really made my season!" Baseball superstar Ray Isaac and other world-famous athletes agree—the Bodyweight Pacesetter 2000 is the *ultimate* in high-performance organware. This sophisticated heart's "overdrive" boosts Movement Allowance and Body stats by +2 when activated. *Power On!!!* HC=1D6 (Effects and penalties are the same as the original Pacesetter, except that the safe use time is only *two minutes*.)

TimesSquare Plus™ **500eb**

Never forget. Always where you need it. Information to make you a maximum cyborg!
NEW From ZETATECH! Just recently declassified, the new TimesSquare Plus™ cyberoptics upgrade integrates your cybereye with a cognitive-reflex processor and a DataTerm link or chipware plugs. Special chipware allows visual recognition, identification, and information retrieval. Full integration with the Farley File™ database allows you to access needed information easily and quickly, displaying the records on your Times Square Plus marquee. This upgrade can also be used with the new Video Imager cybereye. (See the Chipware Section, pg. 76 of this catalog for further information.) Takes 3 options. HC=2. Half price if done as an upgrade.

Wearman Mark II **200eb.**

Nobody wants to go 'borg for a sound system!

Do you long for the luxury of cybernetic stereo, but can't have one because the doc says your body won't handle full cyberaudio? Advanced Audio Systems comes through again with the newest generation of audio entertainment! The Mark II Wearman implant can be installed at any clinic in an hour and a half—micro speakers are housed in the bone of the skull next to the ears, and a laser-optic reading surface is located beneath the ear. Simply place the microdisk into the synthi-skin pocket and rock on!! HC=0.

Tazer Grip **180eb.**

Cyberarm option. Miniature electrical contacts in the thumb, first, and middle fingers deliver a multi-Kilovolt static charge to the target. Effects are equal to the hand-held taser ('Punk 2020, pg.53). HC=2D6-2.

E-Monitor **185eb.**

If you make a mistake in space, odds are, you won't live to make another.

Going LEO? Worried about the vac sneaking up on you? The Cyber-Sniffer™ brand e-monitor is the ultimate environment tool for the highrider of tomorrow. The Sniffer has a built-in barometer to check air pressure and can be programmed to observe and report on physical symptoms caused by changes in pressure or atmosphere composition (it will monitor levels of CO₂, oxygen, C-monoxide, and nitrogen with 90% accuracy). The information is displayed via subdermal LEDs on your arm or leg. An excellent way to know when the air is going bad or cabin pressure is too low. Along with all these features, electromagnetic hardening is standard. HC=1.

Mag-Duct™ Spots **220eb.**

For the fashion minded !

For those who are appearance conscious, but still need an interface, DSI's sub-dermal magnetic induction plug allows full interface ability while retaining your "unspoiled" appearance. Implanted just below the skin (with only two metalized "spots" showing), a wristband and cable jack allow you to plug into your cyber device, reading the signals by mag-field induction. (No cybermodems; -1 to interfacing controls with all other devices.) The manufacturer suggests using low-impedance cables with this installation. HC=1D6/2.

Gyro-Stabilizer **1000eb.**

Raven Microcyb's gyro-implants give the cyber-man of today perfect balance! Using an automatically triggered gyroscope and balancing fluid reservoirs mounted in the skull, the subject will not suffer from dizziness due to a sudden change in orientation. This provides a +2 on Space Sickness die rolls (*Near Orbit*, pg.12), and an automatic +1 Skill in 0-G Maneuver (*Near Orbit*, pg.13). The owner will also have a +1 bonus to any *Athletic* skill maneuver involving extended balance. HC=1D6.

Dodgeball™ 440eb.

You'll be one step ahead of them!

This cyberoptic option from Kiroshi Optics consists of a logic processor keyed to predict movements of the human body according to established patterns of body language. The device will enhance the user's close-combat capabilities, allowing him/her to predict an opponent's offensive or defensive actions. This increases the user's Brawling, Martial Arts, or Melee Weapons skill by +1. The user must observe his opponent for 3 regular turns (30 sec.) in order to 'work in' his moves. Uses 1 option space. HC=1.

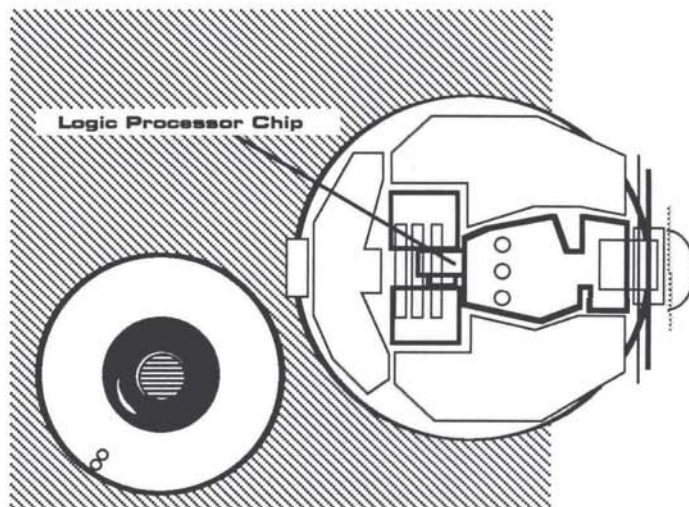

Video Cam/Transmitter 330eb.

Never miss the picture, with Kiroshi.

Cyberoptic option. Sends whatever image the subject sees as a constant live feed to a remote monitor. Range is 1 mile. Takes 4 options. HC=1.

Lifesaver™ Skinweave 4,500eb.

Reading this ad could save your life !

An enhanced version of the *Enhanced Antibody treatment* (2020 pg. 75), Lifesaver also incorporates a limited form of skinweave similar to SpraySkin. It seals torn blood vessels and counters the more extreme effects of shock. The patient therefore advances Death Levels once every four minutes instead of once every minute. Critical wounds do not advance to Mortal as long as the patient isn't exposed to rough treatment, and the healing rate is +1 point/day. Each time the subject sustains a wound higher than Critical, he/she needs a maintenance treatment costing 1000eb. HC=(1D6/2)+1.



Video Imager 350eb.

For images only you need to see.

An advanced form of TimesSquare, this option allows the user to receive vid images (via telecommunications transmission or interface plugs) that are displayed internally. Takes 2 options. HC=2.

Anti-Plague Nanotech 1,750eb.

Improved antigens and mutated T-cells provide increased immunity against serious diseases. A number of pharmaceutical companies provide updates to maintain parity with the latest biowar developments. The user gets +3 to BOD rolls vs. contracting diseases or vs. the effects of biowar agents. HC=.5.

Cyberoptic Teargas Sprayer 200eb.

Why carry mace? Just look him in the eye.

A one-shot burst of gas with a 1m range, blinding target for 1D6 turns. Cyberoptics are affected. It requires a Very Difficult roll to hit the facial area, dropping to an Average roll if surprise is achieved. A failed roll may affect the user! (Referee's choice) Takes 2 options. HC=2.

Frequency Changer 100eb.

This circuit switcher gives the user an option of up to 6 channels on his radio splice. HC=0.



Gang Jazzler

600eb.

"Shocking" newtech from CYBERMATRIX!

The installation consists of small, highly conductive needles housed in insulated forefinger sheaths. These are wired to a powerful minibattery. This battery, located in the forearm, has enough of a charge for 3 lethal surges (if the victim fails a BOD roll of 20, he is immobilized 1D10+1 minutes; if he's hit in the head or torso and rolls less than 15, he's dead. He may add his *Endurance* skill to this roll). Soft body armor up to SP 3 can be penetrated. Contact (a solid combat grapple) with cyberware has a 10% chance of completely shorting out non-insulated cybertech. Gang Jazzlers are black market cyberware in most judicial regions. HC=2D6+3.

WEAPONS

ADVANCED COMBAT TECHNOLOGY 2020



Goncz-Taurus Autopistol (pg. 44)

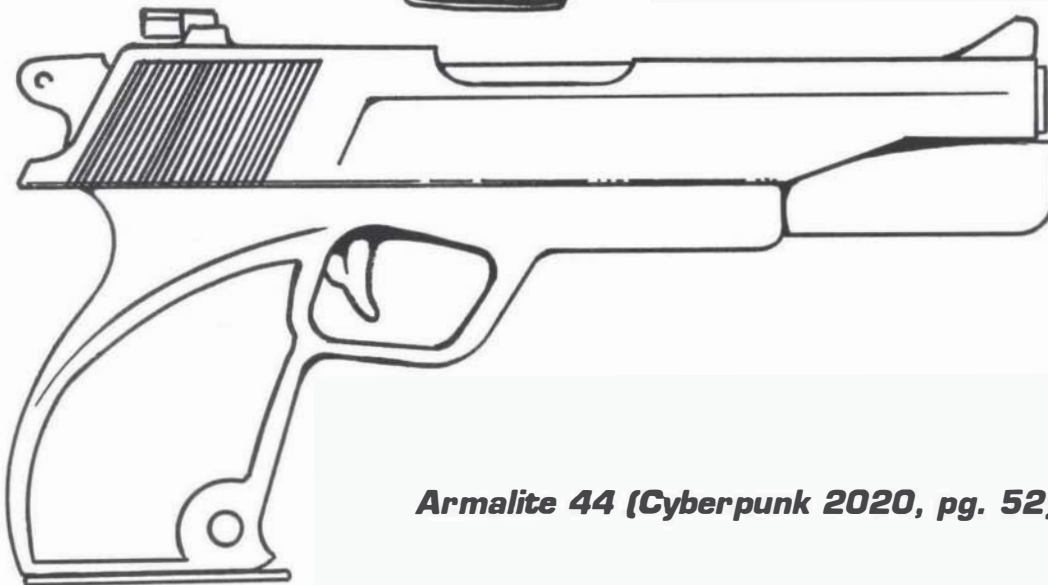

Armalite 44 (Cyberpunk 2020, pg. 52)

"On the Street, there's no room for excuses; for hardware that doesn't work or equipment that doesn't perform. You can't demand a refund with a bullet in the brain, and a lawsuit's pretty problematical when you've been parted out to the local body bank. You want the best weapons euro can buy, because the alternative is the costliest of all— your life."

*—Morgan Blackhand
The Enforcer's Handbook, 2017*

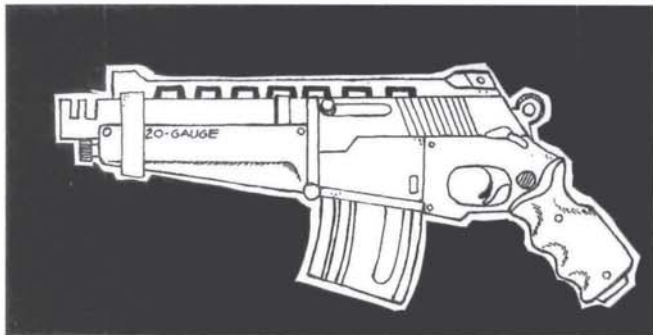

Militech Crusher SSG 450eb.

SHT -1/-3 J C 3D6/1D6+2(20 Gauge) 6 2 ST

This pistol-sized shotgun was developed during the 2nd Central American Conflict for close combat and roomsweeping duties. The Crusher is a handy weapon in 20ga., with its box-type magazine and 10in. barrel, but not very accurate.

Game Notes: due to "whippet" styling — stockless, short barrel; the weapon is -1 to 12m, -3 to 25m, and ineffective beyond that. The damages correspond to the two ranges.

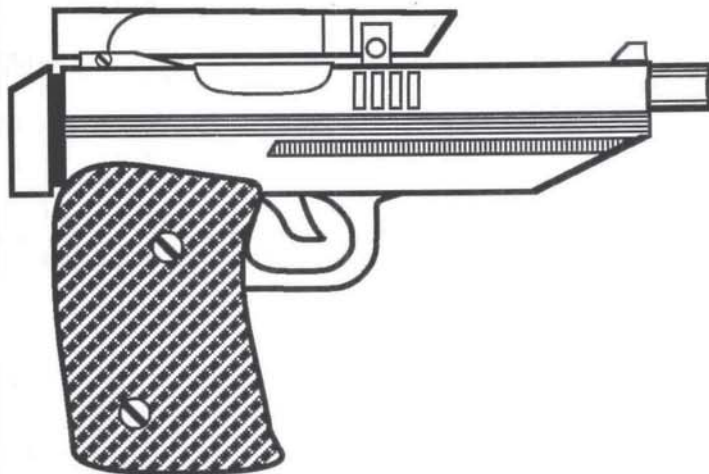

Budgetarms Laser-Niner 675eb.

P 1 J/L P 2D6+1(9mm) 15/35 1/3/20 ST*

A quality auto/machine pistol, sleek in design, which fires 9mm caseless rounds. Made to security specifications, it is built for combat, employing an integral lasersight and 3 round burst/full-auto firing mode. It has a 15-shot magazine, but for assault ops it can be fitted with a 35-rnd. "snail" clip (concealment rating goes up to "L" when the snail clip is loaded).

Game Notes: normal WA rating drops to 0 if Smartlinked, due to integration of existing laser sight.

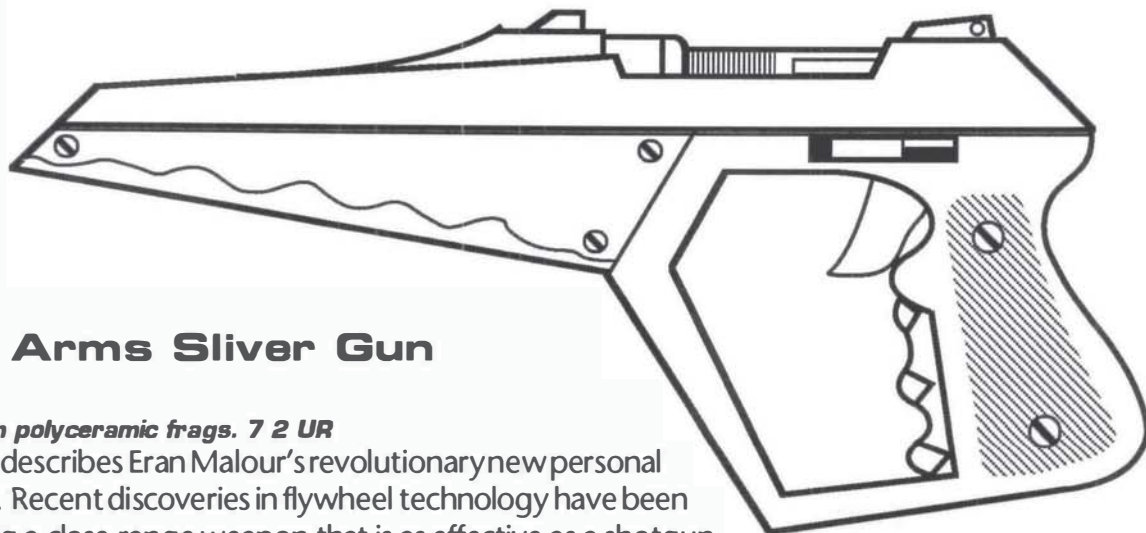

Malorian Arms Sliver Gun 375eb.

P 0 J P 2cm x 2cm polyceramic frags. 7 2 UR

Quiet and deadly describes Eran Malour's revolutionary new personal defence weapon. Recent discoveries in flywheel technology have been utilized in creating a close range weapon that is as effective as a shotgun but no louder than an electric toothbrush. The sliver gun uses a squeeze cocking action to activate the four inch flywheel. When triggered, the wheel presses against a polyceramic block creating a multitude of sharp fragments traveling well in excess of 1200 feet per second! The internal power cell can spin the flywheel up to eighteen minutes before replacement (cost per cell: 7eb.). The sliver gun is also available in a accessory cyberarm version (HC=1D6+2).

Game Notes: Cyberarm version retails at 550eb. (2D6 Fragments/hit, each 1D6/2 damage; treat as knife for armor penetration) HC=1D6+2

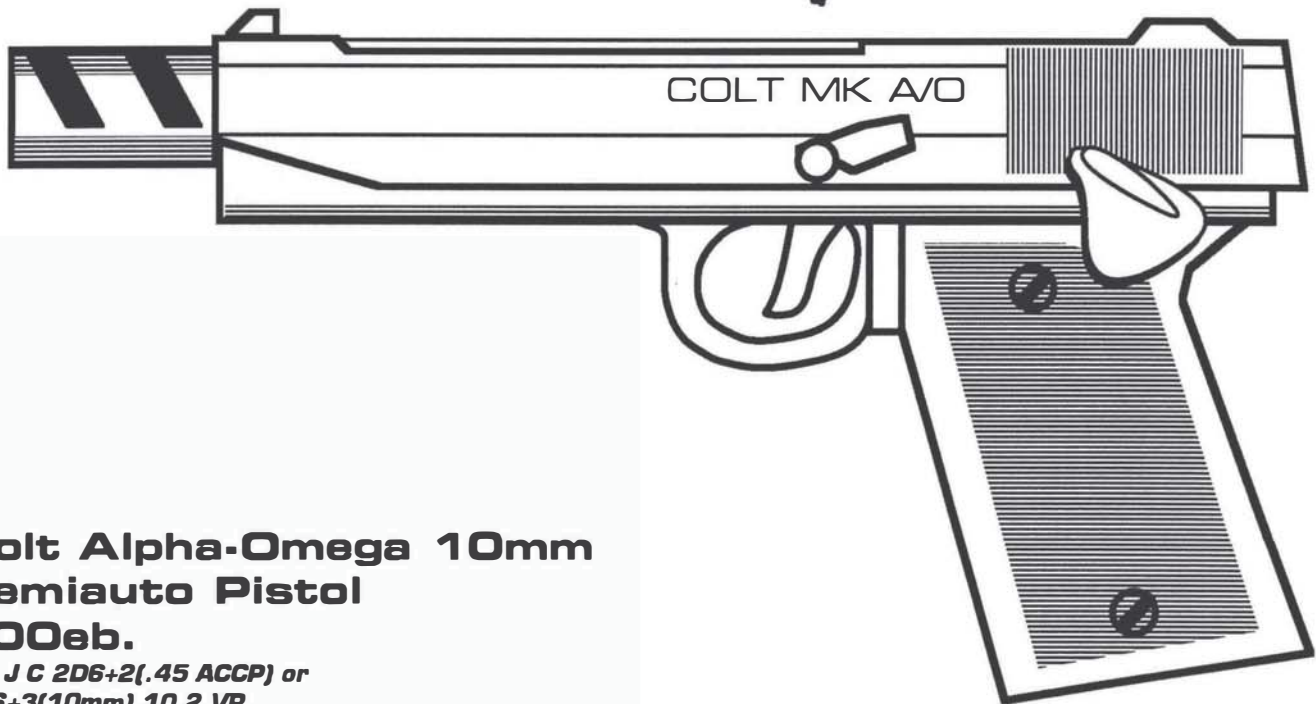

**Colt Alpha-Omega 10mm
Semiauto Pistol
500eb.**

*P 2 J C 2D6+2(.45 ACCP) or
2D6+3(10mm) 10 2 VR*

For over a century, Colt Firearms has been producing, and improving, the definitive semiautomatic pistol. From the M1911a1 .45 Colt to the present Alpha-Omega, Colt has strived for excellence. The Alpha-Omega is a semiauto, double action pistol. It has a ten round magazine in the shooter's choice of .45 ACCP or 10mm caseless. The pistol comes with a barrel compensator and shooter's interface as standard factory options. It may also be ordered with a Nikon COT sight system (*Solo of Fortune*) for an additional 3900eb.

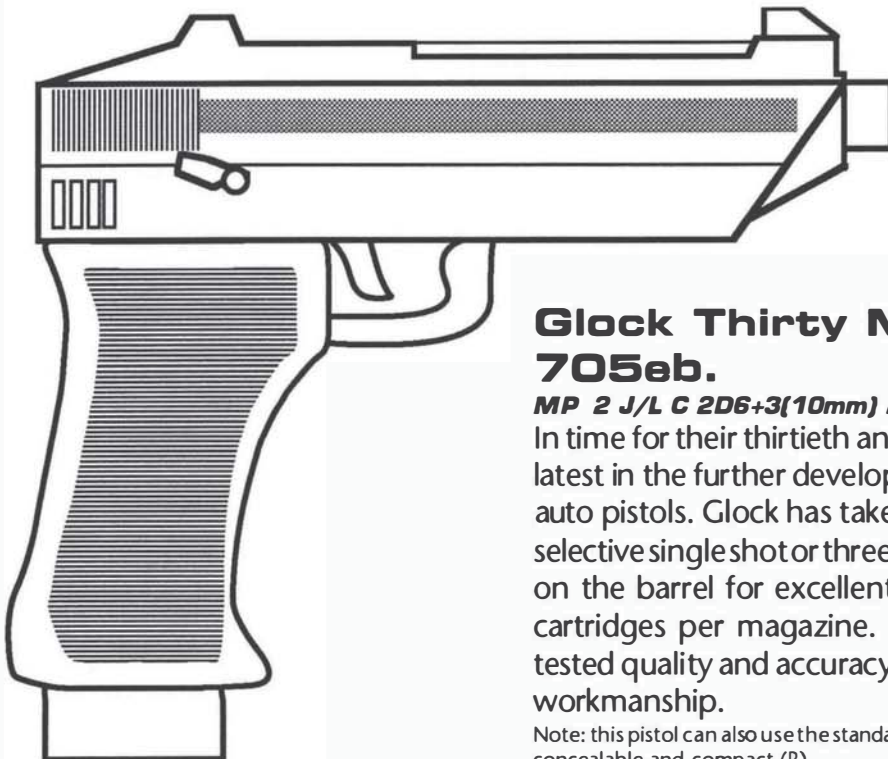

**Glock Thirty Machine Pistol
705eb.**

MP 2 J/L C 2D6+3(10mm) 20/30 1/3 VR

In time for their thirtieth anniversary, Glock Int. introduces the latest in the further development of their famous line of semi-auto pistols. Glock has taken their 10mm Glock-20, given it a selective single shot or three-round burst capability, gasporting on the barrel for excellent controllability, and thirty 10mm cartridges per magazine. These features, plus Glock's time tested quality and accuracy, creates a fine example of Austrian workmanship.

Note: this pistol can also use the standard 20 rnd pistol magazine making it slightly more concealable and compact (P).



Setsuko-Arasaka "PMS" Advanced Sub-Machine Gun 1150eb.

SMG 1 LP 106+2(7mm) 40 20 ST

For the wanna-be technoninja, Setsuko-Arasaka (a division of the parent company) is now producing their Police/Military/Security SMG in the United States at their new automated plant in Night City, California. Designed for low-profile corporate security and paramilitary forces where discretion is valued over raw firepower, the weapon fires a sub-sonic, caseless 7mm bullet paired with a built-in Sonex suppressor. Early models of this weapon gained the reputation of being fussy about ammo and rumors that the weapon interface caused peripheral vision hallucinations. These problems were due to subcontractors substituting inferior or non-spec parts. The new PMS has been put through exhaustive testing to overcome all earlier problems with this weapon.

Note: non-smartlinked version is 200eb. less.

Goncz-Taurus Pistol 200-275eb.

P O J E 2D6+1(9mm)15 2 ST

300-400eb. (Selective-fire version)

MP -1 J C 9mm 15/30 2/10 ST

Standard officers-issue weapon in the Pan-Americas, and for many years illegally smuggled into the southwestern United States; this pistol has been made famous by that notorious nomad gang, the *Bat People*, and their leader, "The Brian." Don't be fooled by cheap Mexican or underground knock-offs! The G-T Pistol is manufactured by Taurus Brazilia De Brazil to their exacting standards and imported by De Santos Ltd. Two versions of this weapon are available: the 9mm semiautomatic, and the machine pistol version with a selective fire capability. A sturdy and reliable pistol at a very competitive price, with the choice of fifteen or thirty round magazines available. Dealer's prices may vary.

Malorian Arms Heavy Flechette Pistol 595eb.

P 1 J C 1D6+1(4mm AP Flechette Proj.) 25 2 ST Disposable magazines are 14eb.

Firing a single 150 grain, 4mm dart at over 1700 feet per second, the Malorian Arms heavy flechette pistol is second to none in flechette handgun technology. Using a liquified gas combustion system, this semiautomatic pistol packs a rifle-round wallop in a handgun-sized package. The rechargeable liquid propellant reservoir can fire over two hundred rounds before needing a refill (30eb). The large magazine capacity make this weapon a favorite with firepower freaks everywhere. Eran Malour has specifically designed his new flechette gun with the "enhanced" customer in mind. The weapon comes chipped from the factory; safety interlocked and encoded to the owner, so use by anyone else is impossible. This feature is a definite plus to anyone needing a strong



home defense weapon but who worries that their children might hurt themselves with an accidental discharge.

Note: Dense metallic bolt has double the AP effect (armor is $\times 1/4$). User must wear a special "safety-chipped" wristband, or have the safety chip in a wrist socket.

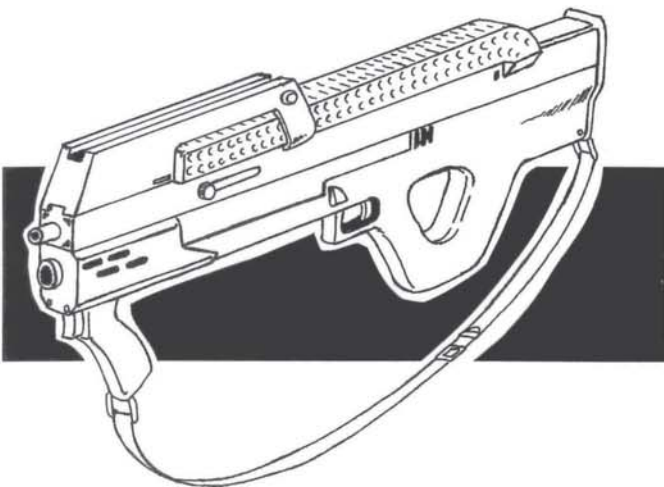

Militech M-31a1 Advanced Infantry Combat Weapon 1695eb.

RIF 2 N R 4D6(4.5mm) 150 30 ST/VR

Two years ago, the Provisional United States government proposed a new competition to select an advanced infantry combat weapon. The armed services committee felt that the military had a fine weapon already, and decided to create an impossible set of design parameters to purposely set this weapon program back at least ten years. The first and only

entrant in the competition was the M-31a1. Militech had developed a new grenade launcher firing a projectile no larger than a 10 gauge three-inch shotgun shell, but with performance almost equal to the original M-79's 40mm grenade. Malorian Firearms had recently patented a new weapon system called "liquid propellant action" but didn't have the capital to develop anything more than a working prototype. Eran Malour offered the license to Militech and in just eighteen months, the M-31 advanced infantry combat weapon was in production. The M-31a1 is an over and under configuration with a 4.5mm caliber assault weapon atop a pump-action mini-grenade launcher. The liquid propellant action functions more like an old style gasoline motor in that a propellant and oxidizer are mixed in a firing chamber, then electrically fired by pulling the trigger, launching a 4.5mm copper jacketed bullet (50 grains), and cycling the action to feed the next round into the chamber. One of the requirements of the government contract was a magazine capacity of at least 100 rounds. The M31a1 magazine holds 150 projectiles and the propellant necessary to fire them. Paired with the *grenade launcher*, this design has proven to be an efficient and deadly combination.

Note: see pg.46 for stats on mini-grenade launcher.

Militech Mini-Grenade Launcher 255eb.

MGL(pump) -1 L C Mini-Grenade/10 Gauge 4 2 ST
475eb.

MGL(drum) ON P Mini-Grenade/10 Gauge 16 2 ST

Militech has developed a new grenade projectile sixty percent smaller in size (25mm x 90mm), but having the same range and effect as the standard 40mm grenade. Two styles of launcher are sold by Militech. The first is a pump-action, shotgun-style launcher with a tube magazine holding four rounds. This version is the one normally mated onto Militech's M-31a1 Advanced Infantry Combat Weapon (see pg. 45), or the Militech 10 Submachinegun (pg.51). The second design (shown here) has a large rotary drum with a sixteen round capacity, constructed on a modified Militech 10 frame. This weapon's settings allow a shooter to select between the ammo types that have been loaded. For example, the shooter could

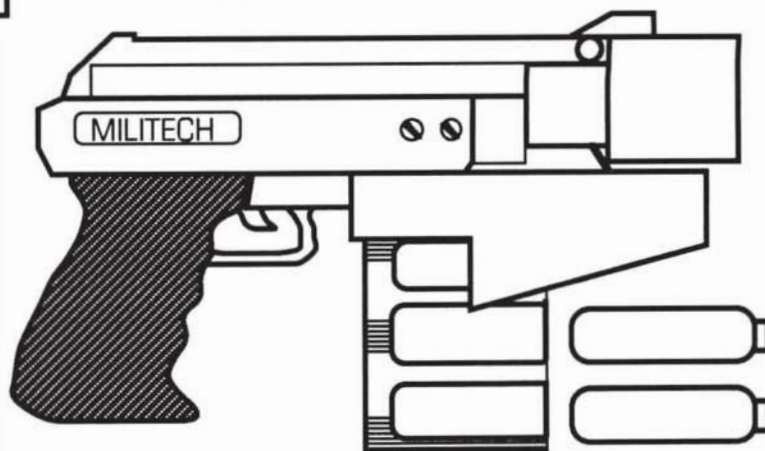

fire a tear gas shell, select an HE round, fire the HE, and then select a multiple flechette round, all without reloading! The weapon automatically rotates the drum to place the specified type of round into the chamber. Both weapons can also use 10 gauge shotgun ammunition.

Note: ROF drops to 1 if the shooter is selecting new ammo types between firings.

Mini-grenade munitions: HEP 5D6 (damage is 1/2 real, 1/2 stun-only; armor has no effect and is damaged 2 lvls.), Fragmentation 2D6+1 (5m diam.), Antipersonnel Flechette 1D6 (2D6 hits/shot), Smoke or Tear Gas (5m diam., see *Cyberpunk 2020* for effects.)

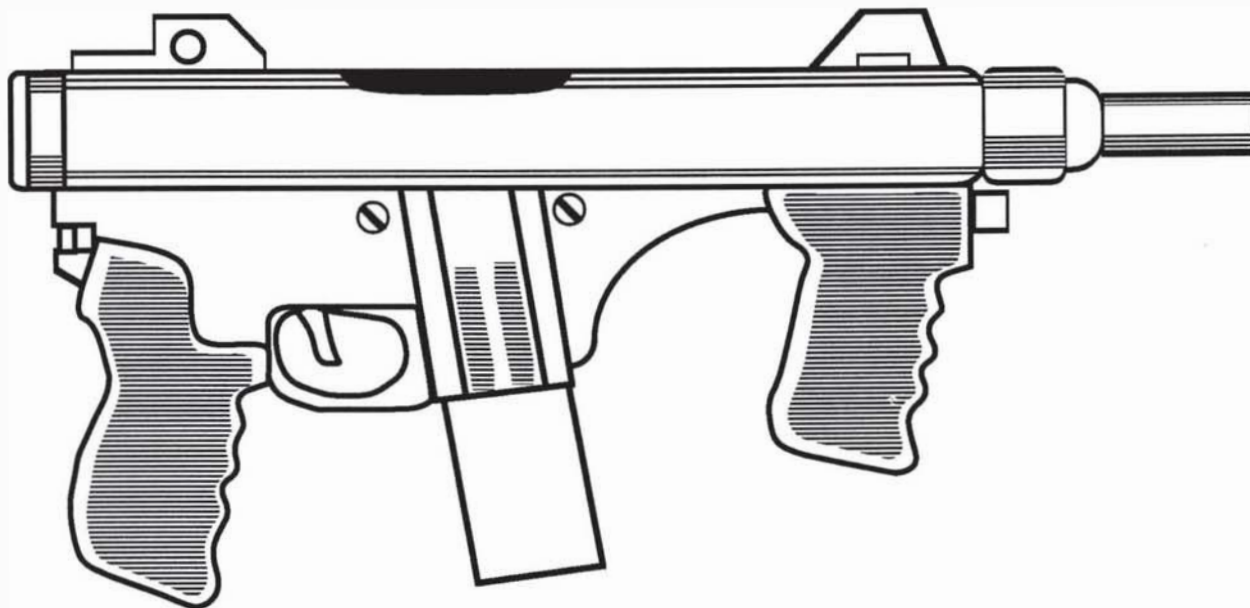

Beretta M-24 Advanced Sub-machine Gun 1250eb.

SMG 2 L P 2D6+1(9mm) 50 25 VR

The NEW standard-issue SMG for Interpol. Beretta Euroarms has set new standards in weapon technology with their M-24 sub-machine gun. Using the time-proven M-12 SMG as the basis for this new weapon, they incorporate features such as an integral smart link, large magazine capacity, and a recoil compensator. This makes a total weapon package that will fill the needs of any solo.

Note: non-smartlinked version may be had for 300eb. less

EMP Grenade

Cost: @ 200-400eb?

GRN O P R High Energy/ Electronic 1 1 varies

Are you a fifty kilo weakling? The metal dweeb next door won't tone down his chip box? Is your action being electromuscled by some borgboy in a bad thousand-yen suit? Put that chipped beef on toast with this "soon to be patented" Veg-o-matic Electromagpulse Grenade. Manually or remotely detonated, this munition will produce an electromagnetic pulse with a very limited range (approx. 10m dia.) that will scramble electrons, wipe chip memory, and teach any chromedome how to do the Dying Cockroach. If you're interested in this or any other electronic marvels, lay a query line at Night City's *Boogie Board* for the "The Great Neeso".

Note: We received a single EMP Grenade for testing along with payment for this ad. The instructions claim that when detonated, the grenade does not explode, but fuses its internal mechanism five seconds after arming. We tested the grenade among a group of volunteers from the shipping dept. and found that the more heavily augmented a person was, the longer it took for the effects to wear off. We estimate that internal cyberware came back on line in about four minutes and cyberlimb functions were regained in about ten minutes. Even a person with no cyberwear whatsoever will have orientation loss for about ten seconds. MRAM chips are totally lost unless shielded against EMP but our shipping manager's augmentation was unaffected, due in part to its L-5 origins.

DCR Rifle Grenades

@50eb./round for frags and others

100eb. for Anti-Tank

RGRN -1 N P varies 1 1/2turns VR

RGRN O N P Anti-Tank 1 1/2turns ST

With the addition of a 22mm muzzle adaptor (200eb), any rifle may fire the DCR line of rifle grenades. The use of a bullet trap design developed in the 1970's allows the shooter to fire conventional ammunition and also launch a rifle grenade up to 150 meters away! These small finned projectiles carry a warhead capable of doing as much damage as a standard grenade. It packs the same punch, but at a tenth the cost of a grenade launcher.

Note: the muzzle fitting for launching grenades can be installed on any paramilitary rifle by a competent tech for about 50eb.

FEN Dz 22 "Saucer Grenades"

65eb.

GRN 1 P P HE/Frag 1 1 ST

Introduced at the Paris Weapons Exposition by Fabrique Europa Nationale. These hand grenades have a liquid explosive filler in a aerodynamically saucer-shaped (4.5" dia. x 0.6" thick) grenade body (+2 to *Athletics* skill). Arming the grenade is achieved by turning the trigger button clockwise. Pressing the same button will allow a six second delay before detonation occurs. One hundred-sixty hardened steel pellets create a zone of fragmentation fifteen meters in diameter (Damage 2D6+3). This grenade has a rubber edge to allow the user to carom it off objects. Because of the way one throws the grenade, colorful nicknames such as "Frisbee O' Death" and "Perforation-Puck" are often used to describe this product.

FEN Dz 25 "Det Card™"

120eb.

GRN 1 P P HE 1 1 ST

Another nifty new design from those clever folks at Fabrique Europa Nationale. The Det Card is a credit-card sized wafer of C-4, stabilized with a plastic shell, and ignited by a tiny detonator chip imbedded in the card. Simply snap the card in half, place it where desired, and it will explode in twenty seconds. Just right for noisy B&E jobs. Available in Trauma Team™, Euro-Worldbank, and WNS press card formats.

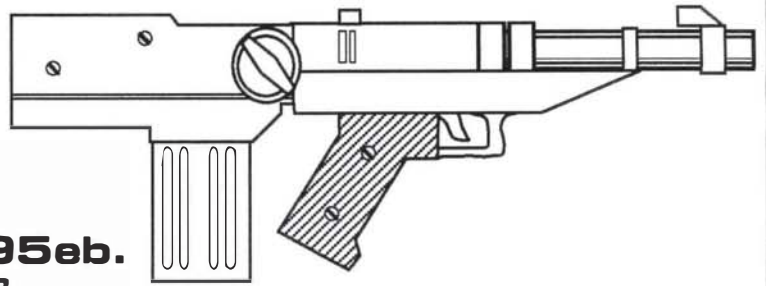

Malorian Arms Sub-Flechette Gun 795eb.

SMG(F) 2 J C 10mm (multi Flechette) 10/30 3/35 VR

Malorian Arms has beaten the competition to the punch with their new flechette sub-gun. A bullpup - configured weapon using a rotary bolt system similar to the proven M-95/G-11 operating system. This weapon uses the new 10mm caseless flechette round containing six steel penetrators capable of defeating any ballistic cloth (Kevlar) body armor in present use. Equipped from the factory with three round burst/full-auto capability, and an integral compensator. Ammunition magazines come in ten and thirty round capacities.

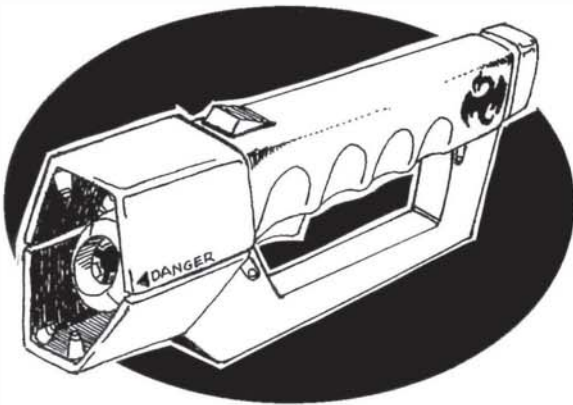

Kendachi Dragon 660eb.

EX O J P varies 4 1 ST

This hand-held flamer provides destruction at your fingertips. The ignition must be activated 1 combat rnd. before firing. Creates a 4m flame, doing 2D6 spread over 2 random body areas 1st round, 1D6 to 1 area 2nd rnd. Only hard armor, or soft armors of SP 15+ will protect the target. All soft armors will be damaged 2 lvs. instead of 1.

GPz-78 Mini-Grenade 40eb.

GRN O P P HE/Frag 1 1 VR

A very small hand thrown grenade (1.5" diam.) using a HDX explosive filler. Because of its size this grenade is very concealable but its blast effect is limited to only three meters (Damage 1d6+2). Licenced to Gremyenko of Moscow by DutchArms LTD.

Militech Military/Police Shotgun 300eb.

SHT O/-1 N/L C 4D6(12 Ga.) 8 2 ST

A gas operated, semi-auto shotgun with an eight round detachable box magazine and folding stock. A hard-working weapon for the hard-working corporate MP. May be ordered in either twelve or ten gauge (six round capacity, no folding stock).

Note: 10 gauge ammo does 4D6+3 damage, 12 gauge is 4D6. Second Acc. and Conceal. ratings are for stock folded.

Biotech-Askari Motion Restraints 60eb./bomb, 25eb./release tube

EX O P P Special 1 1 UR

A fine, gossamer-web polymer material dispensed by hand-thrown bomb. It allows slow, steady movements, but clamps down instantly on quick or violent motion. 1m radius effect; a Very Difficult REF (use Dodge/Escape skill), or Near Impossible BOD (use Strength Feat skill) roll to get free. The release catalyst comes in a 10-use squirt tube; otherwise, wait 30-40min for chemical breakdown.

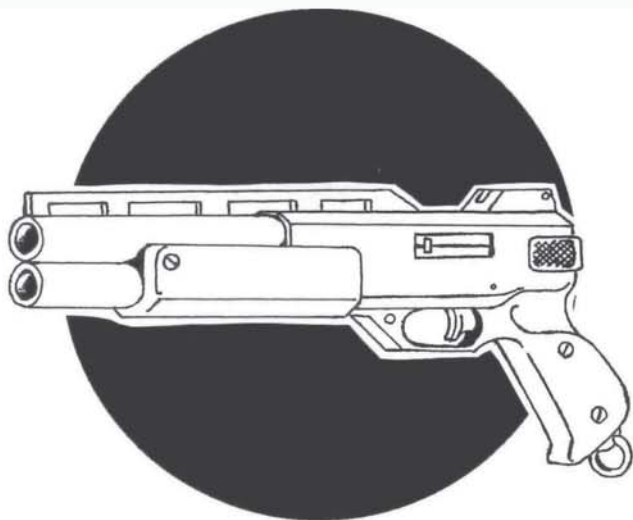

**Stundart Pistol
109eb.**

P -1 J C Stun /-1 Save(.45 cal low-V dart) 2 2 VR

A new addition to our catalog comes from Pursuit Security Incorporated. For the solo needing a non-lethal alternative, the stundart gun is an excellent choice. This weapon is an over-and-under double-barrel breakopen configuration. The stundart ammunition itself consists of a special low velocity (400 fps) .45 caliber plastic cartridge. The projectile is a pronged copper-jacketed capacitor capable of storing a charge of up to 70,000 volts! The dart-like projections allow the round to deliver its charge through heavy clothing, fur, and even some ballistic cloth armors (penetration of soft armor up to 5SP is possible). Incapacitation is instantaneous and lasts up to one hour.

Note: This weapon is unsafe to fire with any regular ammunition (90% chance of misfire, 2D6+1 damage to shooter's arm). Projectiles are sold four to a package and have an expiration date for use.

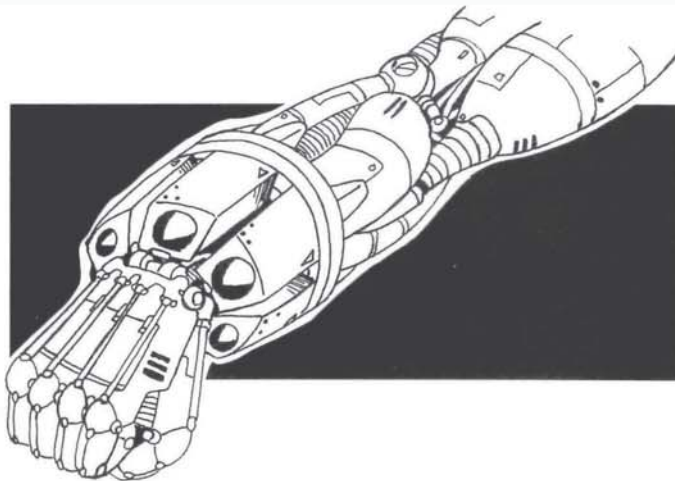

**Rostovic Wrist Racate
380eb.**

for launcher, rockets are sold in packages of six at 200eb.

MRL 0 N P 5D6(30mm HE) 6 3 ST/P

From our friends in the Eastern bloc comes a new weapon, the "Wrist Racate". This pseudo-cyberweapon consists of a cylindrical mini-rocket pod that rotates around a forearm fitting. It is capable of firing six 30mm HE rockets either singularly or in volley. Backblast is not a problem as each rocket is cold-launched by compressed air until ignition occurs about five meters from the launcher. Effective against personnel or structures (Damage 5d6, 3m diam.), the Racate can also be used in an indirect artillery support role. If looks are secondary to firepower, then this is the personal weapon for you. The Wrist Racate must be worn over a cyberarm or battleglove; it is too heavy and awkward for a normal arm.

**Techtronica Black-Zap
Glove
90eb.**

EX 0 P C Stun 6 1 ST

An electrified mesh glove with effects equal to a taser, powered by an armband battery pack. The Black-Zap can be use with either a grab a punch attack.

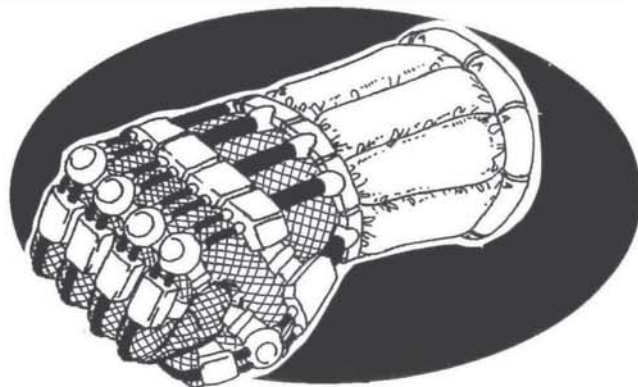



**Darra-Polytechnic
M-9 Assault Rifle 300eb.**

RIF O N P 4D6+2(5.5mm) 40 25 ST

The first assault rifle using a caseless cartridge built entirely in the Hindu-Chinese Confederation. Designed to use the 5.5mm caseless (Chinese), this weapon's lineage is clearly Kalashnikov. Ballistic qualities are similar to the early Soviet 5.45mm used in the AK-74 assault rifle. Two things are readily apparent when you first pick up this weapon. The first is the lack of interfacing for the shooter. This weapon is designed for military forces in the Third World who don't fit their soldiers with chips and plugs. Second is the old-fashioned configuration in an age where bullpups are the style. Side-folding stock and a 1.2x optical sight are standard options on the weapon. Because of the large numbers of these guns exported out of the Hong Kong trade zone, and their very low cost; the M-9 has become a common sight in the Third World and on the streets.

Note: this gun normally uses special hollow-nosed ammo (armor SP is x2; any damage that penetrates is x1.5), standard ball ammo would do 4D6 damage.

**Militech Mini-Gat
Machine Carbine
695eb.**

SMG O L P 1D6 (.22 caseless/5mm) 120 40 ST

The .22cal caseless (5mm) has never been taken seriously as a defensive round until now. The Mini-Gat is a 5mm five barrel gatling gun capable of emptying its helical magazine in under five seconds flat! Don't be satisfied with some machine pistol's dink thirty round clip when a Mini-Gat carries one-hundred and twenty rounds! It's electronically fired, operating from a rechargeable battery in the magazine. Famous bounty hunter/solo Crista Margaret, when asked about the Mini-Gat's firepower states, "I call it my garden hose— it makes planting all too easy."

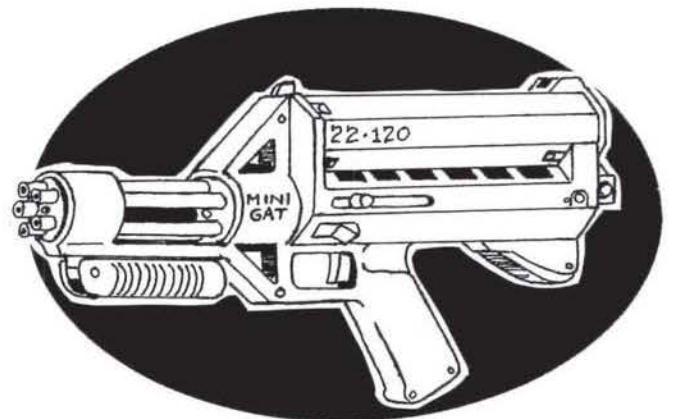

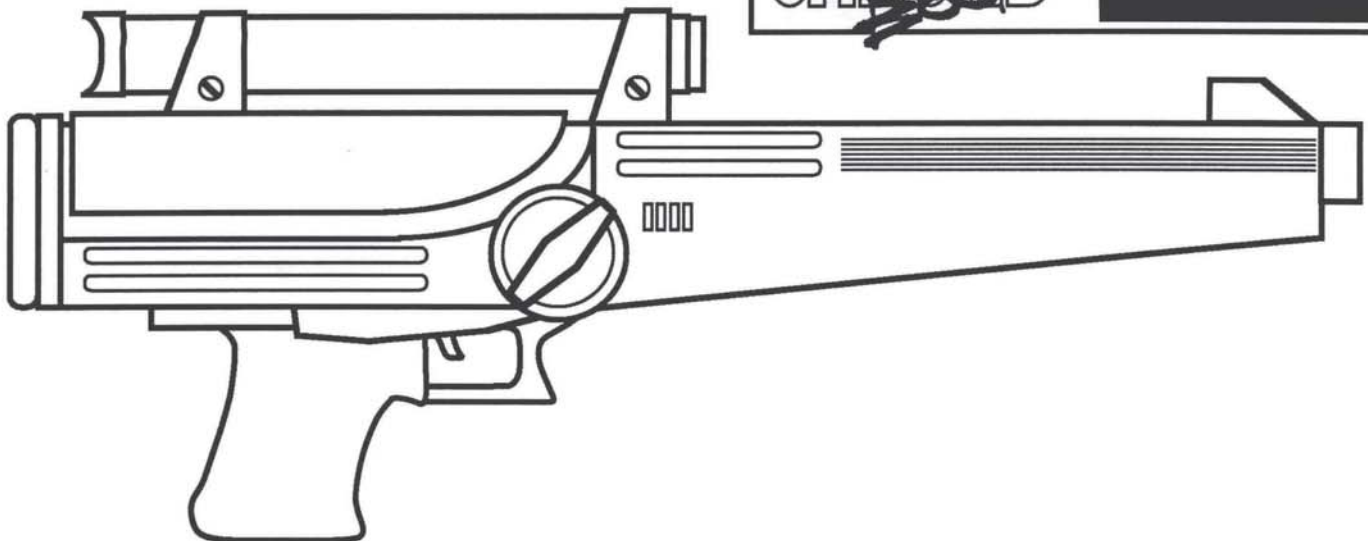

Heckler & Koch G-6 Advanced Squad Automatic 2050eb.

LMG 1 N P 5D6(6mm) 100 30 VR

In 2018, H&K decided to build a squad heavy weapon based upon the G-11/12 rotating bolt system. By scaling up the basic G-11 rifle by 50%, the desired weapon completed initial testing and was designated the G-6 squad automatic weapon. The caseless 6mm round is accurate out to 900 meters and the 100 grain bullet has a steel core to defeat body armor (SP halved). A gunner normally carries eight 100-round magazines. This light machinegun has full interface for the chipped soldier, and an integral 2x scope with cyberoptic triangulation and passive IR capability.

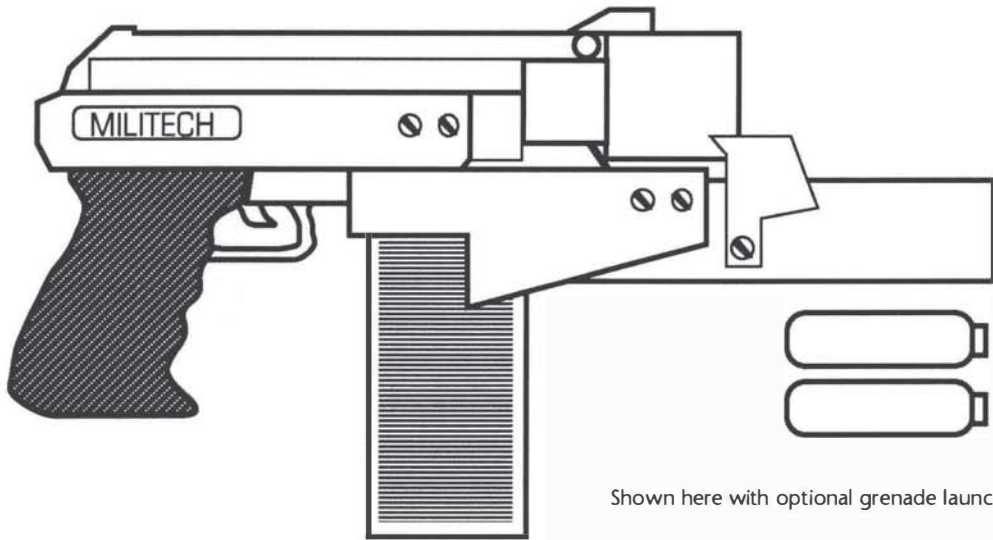

Shown here with optional grenade launcher (see pg. 46)

Militech-10 Submachine Gun 455eb.

*SMG 1 J E 2D6+3(10mm),
or 2D6+2 (.45 ACP) 30 20 ST*

Want value for your Eurobuck? Look no further than your nearest Militech dealer. The Militech Ten uses composite plastics and the most modern computer machining techniques to create a submachine gun that is light, accurate, and a pleasure to shoot. Available in two calibers: 10mm PlasticCase and the venerable .45 ACP. Factory accessories include sound suppressor, scope mounts, grenade launcher and interchangeable caliber kits allowing a wide choice of firepower. And Militech doesn't forget the fashion conscious with a choice of eight designer colors (red, blue, green, black, silver, cammo, gold, grey).

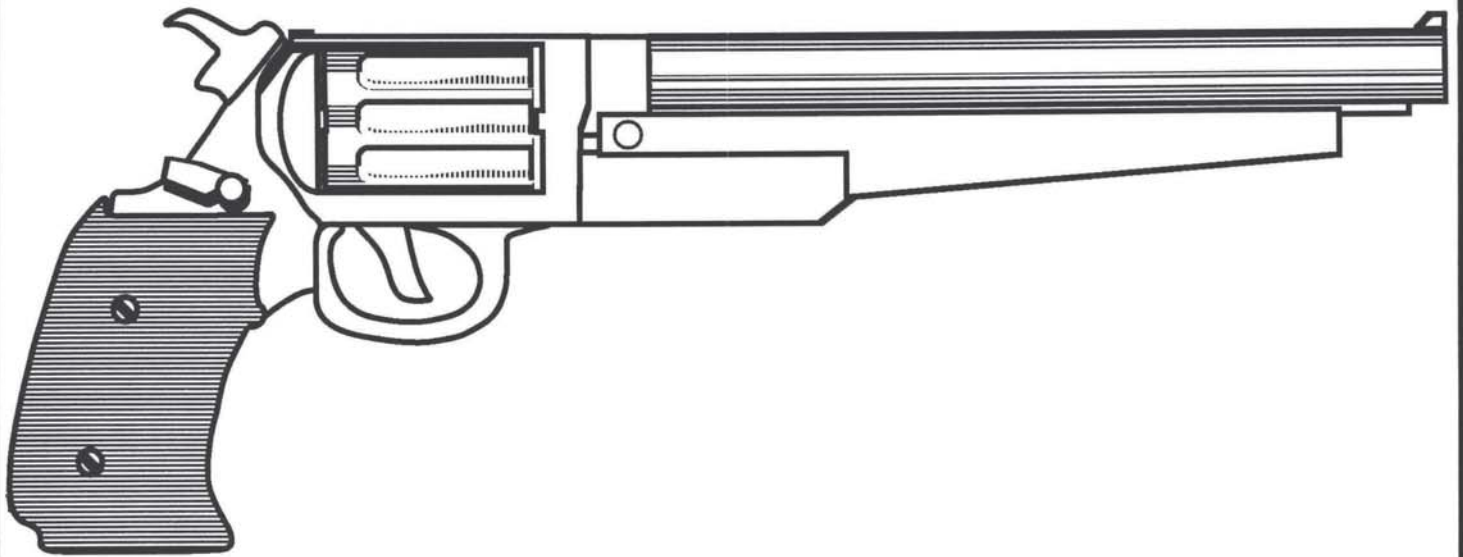

**Federated Arms 454 DA "Super Chief"
375eb.**

P 0 J P 4D6+3(.454 Casull) 5 1 VR

Originally conceived with handgun hunters in mind, the Super Chief is a double action revolver finished in stainless steel and chambered for the .454 Casull, a cutdown big-game cartridge specifically designed for large animals. A big success with people who like the challenge of handgun hunting, this weapon has also proven itself as a real manstopper when the situation warrants. It's also a very popular Nomad weapon.

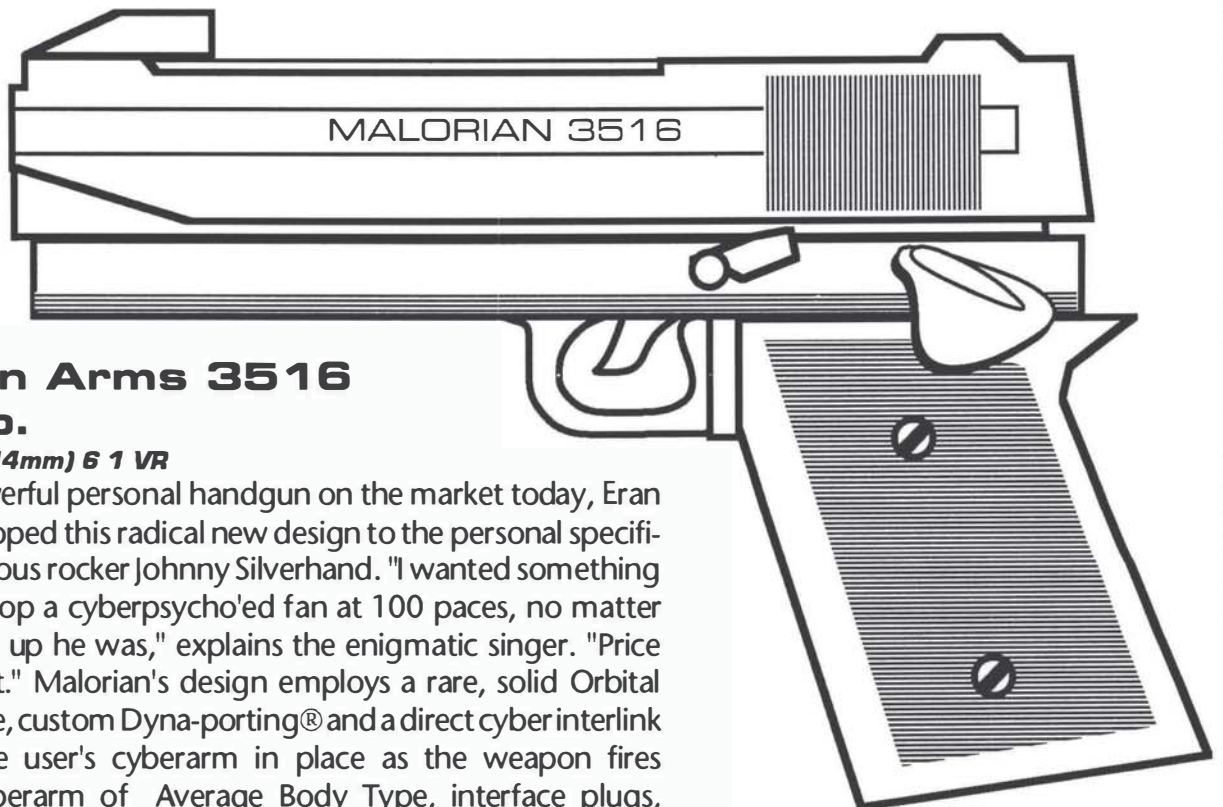

**Malorian Arms 3516
4525eb.**

P -1 J R 6D6 (14mm) 6 1 VR

The most powerful personal handgun on the market today, Eran Malour developed this radical new design to the personal specifications of famous rocker Johnny Silverhand. "I wanted something that would drop a cyberpsycho'ed fan at 100 paces, no matter how metallised up he was," explains the enigmatic singer. "Price was no object." Malorian's design employs a rare, solid Orbital titanium frame, custom Dyna-porting® and a direct cyber interlink that locks the user's cyberarm in place as the weapon fires (required: cyberarm of Average Body Type, interface plugs, smartgun link). By special order only.

APEX Mobile Point Defense System 10,000eb.

LMG X N P 2D6+4(9mm CL) 400 40 ST

Got a perimeter to defend? An airfield to protect? Just want to get some sleep at night without worrying about streetgangs trashing your house? You want APEX. Based on the Phalanx automated weapons systems of the U.S.Navy, the APEX Point Defense System is a movable light machinegun, capable of defending a secure area by itself, or under the direction of a remote operator. Most Corporate aerodyne pads and rooftops are defended by larger and more expensive versions of the APEX, however, this little beauty puts maximum point defense control in the hands of even the smallest business or homeowner. And it only weighs twenty kg., allowing it to be carried to new locations easily!

The upper part of the APEX dome houses four computer-controlled motion sensors with an effective range of 200 meters. When a target moves across the sensor's 360° field of fire, the central mini-gun tracks the target, adjusts for movement, and fires. Sensors can be set for a specific target size, from that of a small rodent, up to a large vehicle. A hand held controller allows the operator to activate the APEX from as far away as a 1000 meters; the controller can also be used to activate individual APEX units by location (each one is assigned a number and frequency), or to deactivate specific units allowing the operator to enter at will.

The APEX unit is self powered, with a battery life of 50 hours (this may be extended by linking a solar panel to the unit). The internal drum magazine holds 400 rounds of 9mm Caseless Long ammunition (the same as used in the innovative Militech High Power-15 SAW [Solo of Fortune, pg, 50]). An automatic shut off will disable the weapon in the event of a jam, signalling the operator through the remote control. The APEX has a SDP of 20, and an SP rating of 5.

Range	+150	75	35	15
% To Hit	10	20	30	40

To determine hits, roll percentage for each target in range, then roll 1D10 for number of hits on each. Add 10% to hit percentage if target is moving at half speed or less.

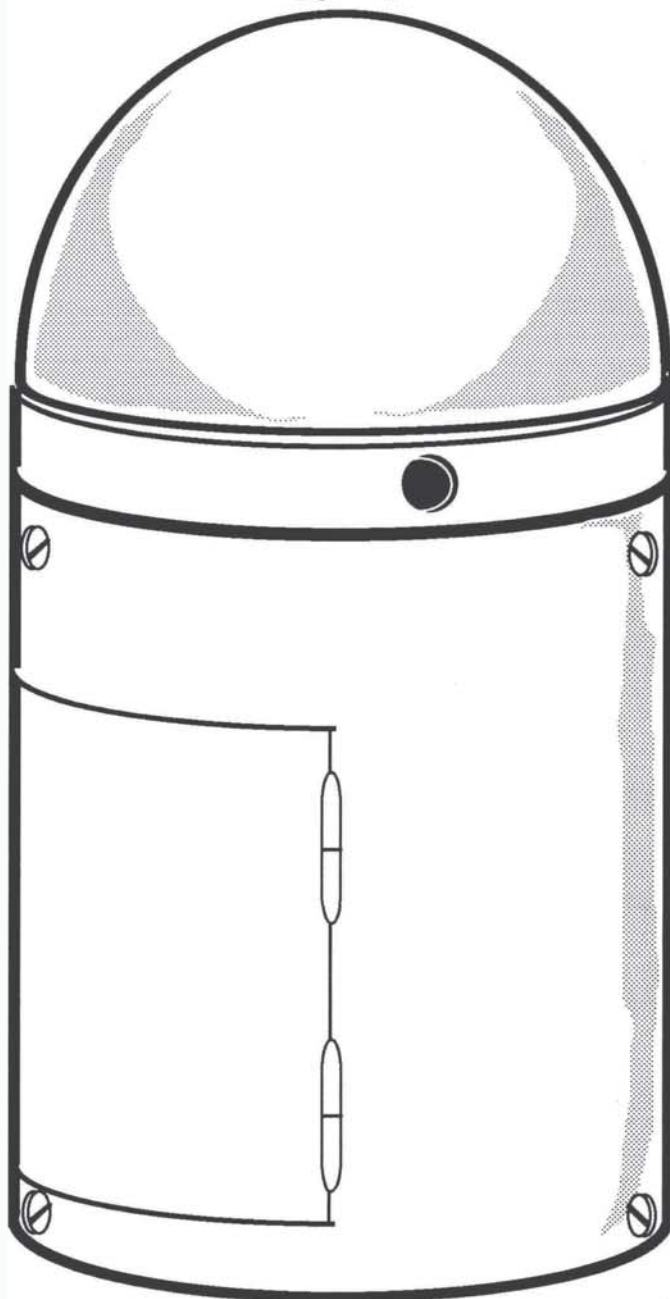
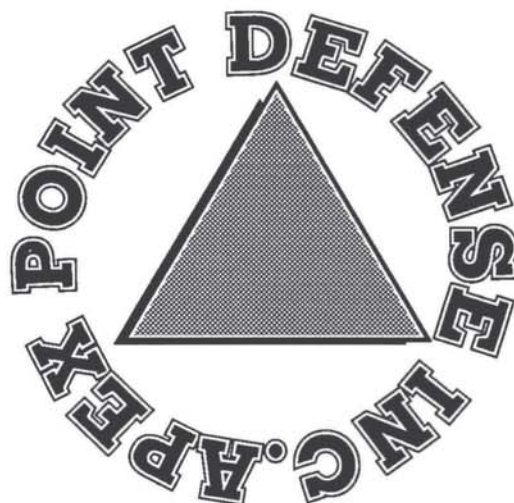

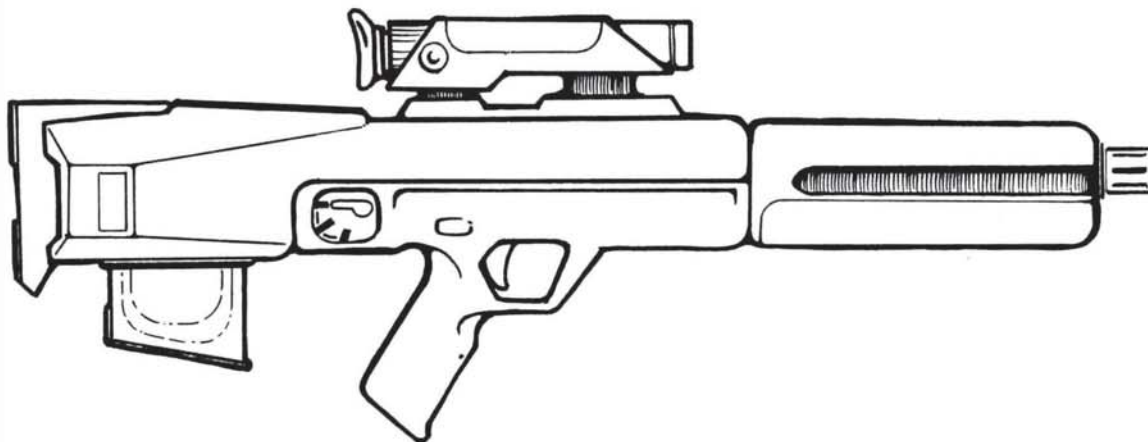

Federated Arms Light Assault 15
400eb./700eb. if "smart" rigged

RIF O N C 5D6(7mm caseless) 30 3/25 VR*

Federated's bid for the plastic-frame, bullpup configured, caseless market pioneered by H&K's G-11/12 and Sternmeyer's M-95A. As with all Federated products, this is a durable light rifle, with good accuracy and a low price. The LA-15 comes already rigged with smartgun interface plugs; the built-in optical sight is a welcome backup when the weapon is used by non-chipped troops. With its durability, adaptable sighting systems, and inexpensive price tag, you can expect the LA-15 to give Darra Polytechnic's M-9 (pg. 50) a run for the money in the Third World arena.

*Weapon is optimized for 3-rnd. burst; Acc. is 1 when firing in that mode.

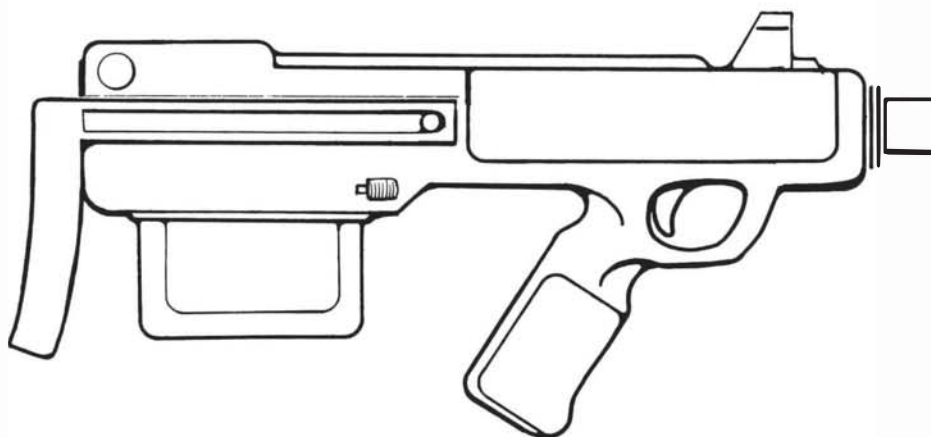

Stein & Wasserman Model F "Cyborg Assault"
Weapon System
1650eb.

RIF O L P 13mm Mixed 8 1 VR

The hot weapon for psycho-squads everywhere; the Cyborg Assault is the Rolls-Royce of close-in shoulder arms designed to stop the heavily enhanced. This bullpup rifle fires a wide selection of rounds (see below) and is muzzle-adapted for DCR rifle grenades (pg. 47) as well! The unique eight-shot box magazine with rotary feed can be loaded with all ammo types at once, and the selector switch allows the shooter to pick the load type by its number position in the magazine! A must-have for any C-SWAT team!

The low-pressure rounds have a 100m range, and the following assortment of ammo is available: HEP (high-expl. cratering) 4D6+2 Damage is 1/2 real, 1/2 stun-only; armor has no effect, and is damaged 2 lvls. API (AP Incendiary) 4D6+3 Armor SP is 1/2; 1st rnd. after hit target takes 1D6 extra, 2nd rnd. after, 1/2D6 extra. Armor does not stop this extra damage! Acid Shell (glass-lined container) damage and effects equal to Nelspot "Wombat" (Punk 2020, pg. 97), except duration is 4 combat rnds.

**Kendachi
Mono-Two
650/700eb.**

*MEL 1 J/N P/R 2D6/4D6
-- VR*

An improved version of the original Kendachi Monoblade, favored by corporate samurai everywhere. A thicker blade cross section reinforced with Orbital crystal strengthens the weapon against parries (shatters on a 2 or less on 1D10), and bad cuts (no breaking on a fumble). For an additional 50eb, you can have a miniscule laser implanted in the hilt; while it has no effect on combat, the laser refracts with the crystalline blade, giving it the flaring neon glow of a movie "light saber". Blade tints include red, blue, white, green, violet, orange and rainbow. Sold only in traditional two blade sets.

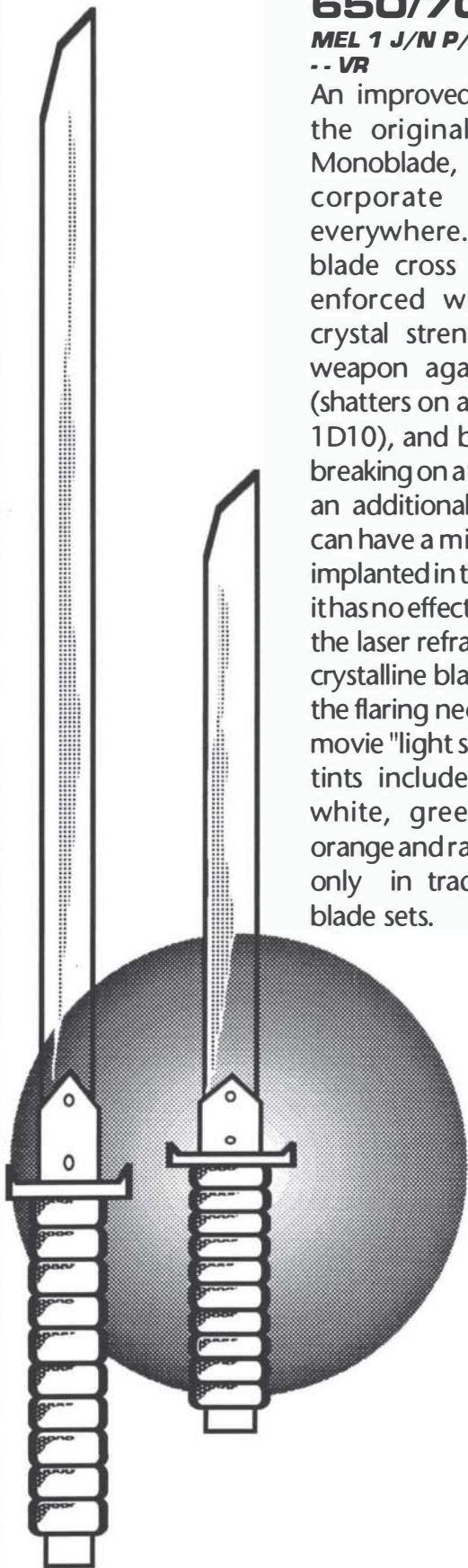

**Kendachi
M-33
Powersword
860eb.**

MEL 0 L R 4D6 -- ST

Combining elements of the popular Kendachi monoline with a powered handle, the Powersword vibrates its molecular crystal blade 2000 times per minute. Combined with a microscopically serrated edge, this weapon literally chews its way through anything it encounters, including armor (soft armor SP at 1/4, hard armors at 1/2), metal, flesh and bone. The blade activates when the handle is gripped, but takes 1 combat turn. to "warm up." Although the current model is quite heavy (3kg) and fragile (breaks on a fumble, shatters on a parry check of 5 or less on 1D10), Kendachi is currently testing a new model for release in 2022.

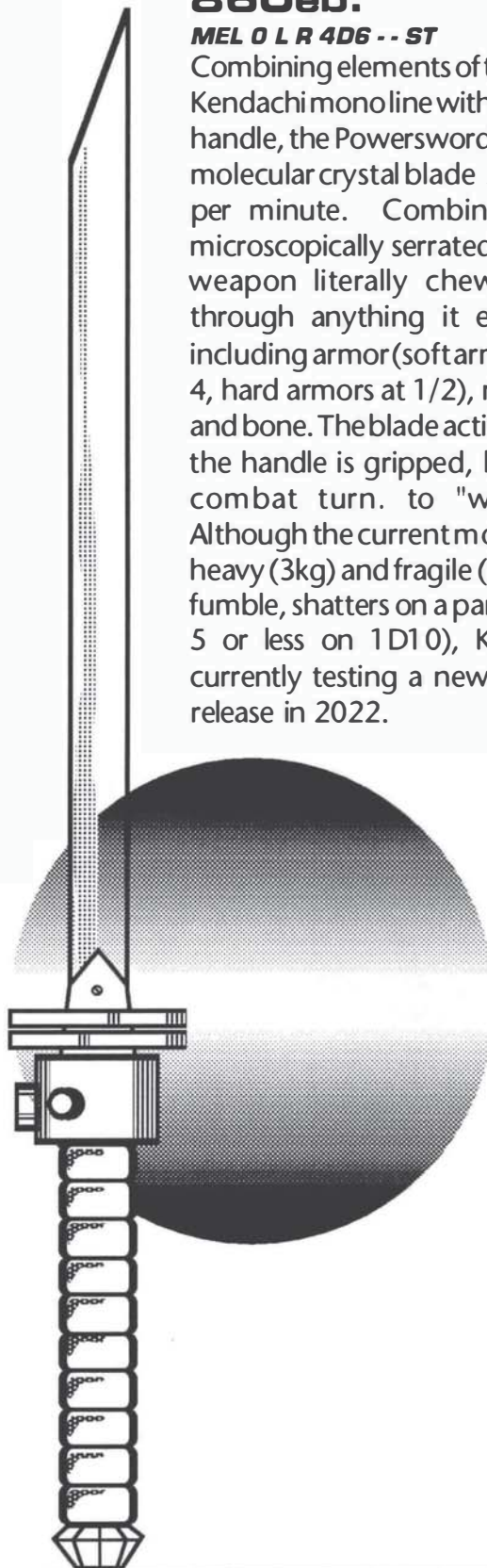

Fashion nono

Style Substance Elegance

"Frack! It doesn't matter what it looks like. What's the SP?"

—Ripperjack

"There's nothing as unforgivable as leaving a bad looking corpse..."

—Dr. Halman Thompson, DMS News

"Style not matter? Hey, the difference between a 20eb. handmedown and a 2000eb. Eji original is worth a clean million on the Street. When you look like you're the Man, people treat you like the Man. And that means respect."

—Phil "Nacho" Hernandez, Fixer



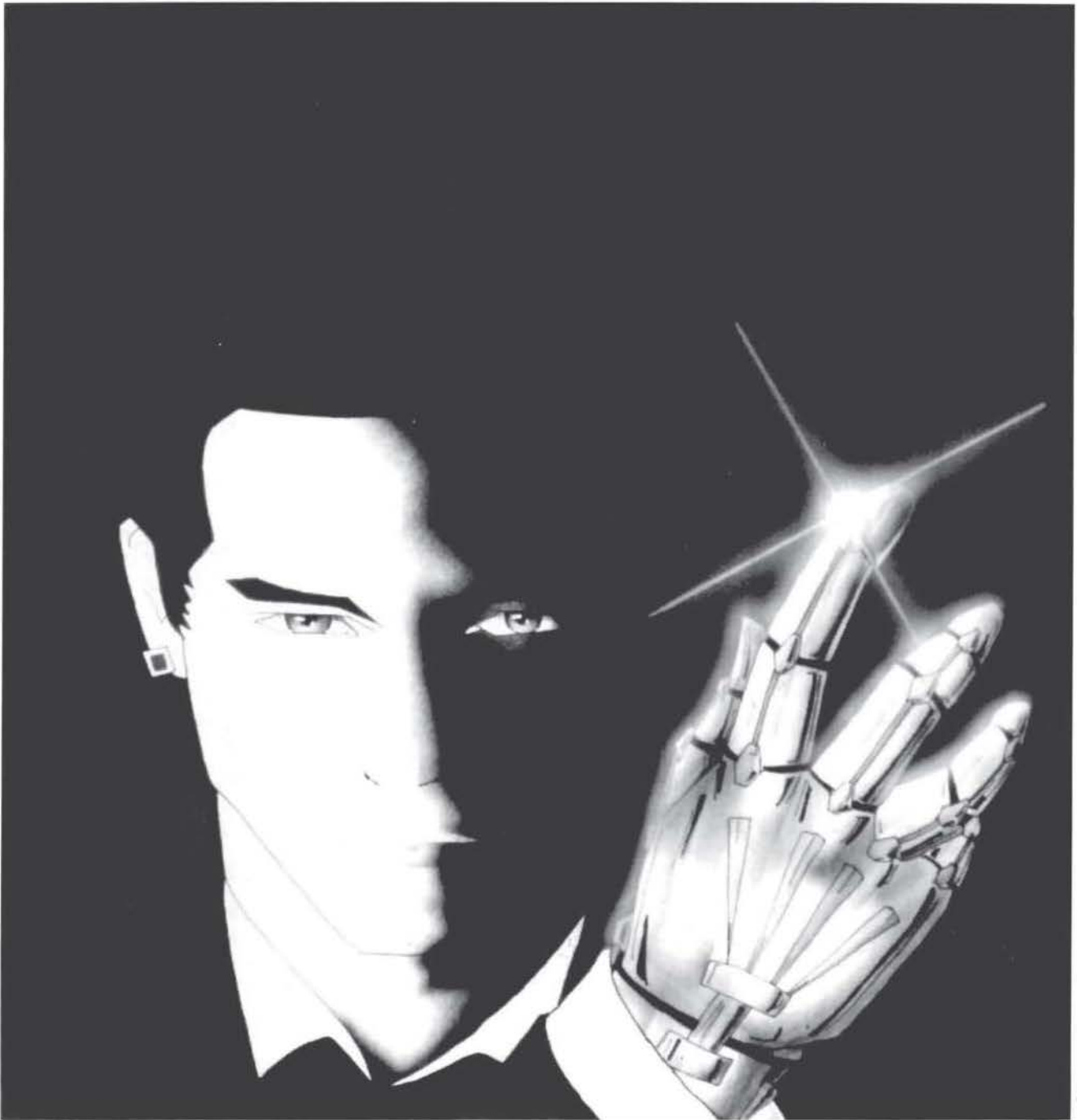

Psiberstuff

Slaves to Fashion: *Cryochilled* is a term used to describe the growing faction of individuals who believe that cyber-replacement of functioning appendages is the ultimate in self-expression. Today's cybernetics are as much a child of the designer's stylus as they are of the engineer's tools. Psiberstuff leads the pack with innovative looks and technology. Form and function no longer remain mutually exclusive. Pictured: Orbital Crystal Cyberarm for 7,000eb (SDP=60). Also available: Nu-Tek holographic "Wearman" option for the above (see pg. 58 for details).



Nu-Tek

Nu visions:

It's not enough to watch vids anymore. Make the scene—and be seen. The Wearman series from Nu-Tek is making its mark on our streets. On jackets (300eb.), skirts (200eb.), and many other types of clothing, video has never been more popular. Everybody's got their 10 minutes in the limelight, and now, everybody can watch themselves while they bask.

I love my Nu-Tek video jacket! I can pick up all my favorite videos, no matter what comsat they're beamed from! And the built-in chip reader lets me play my own recorded videos, or just replay the same image over and over!

—A Mallplex Juvieganger

Uniware

The Corporate look:

If you've noticed that things are looking better in the world today, it's not the governments of the world you have to thank. Many of the more public-oriented companies have started switching their uniforms over to ones designed by Uniware. Durable, functional and stylish, image-conscious corps no longer have to worry about having their great-looking staff wearing any old rag while on the job.

Uniware's given our Corp a whole new look: professional, competent and forward looking. From the new tunics for our Security people, down to the one piece minidress combo for our Secretarial Pool, everything Uniware makes is perfectly coordinated. And Company Logos are even included!

***—Shelly Yeats
Personnel Mgr., NET 54***

Item	Price
Vest	25eb
Pants	35eb
Boots	30eb
Skirt	35eb
Blouse/shirt	20eb
Dress	50eb
Torso Armor (SP 10, torso) ..	60eb
Legpads (SP 10, legs)	60eb
Utility Belt	15eb
Jumpsuit	75eb
Armorjacket (SP 14)	200eb
Armor Trenchcoat (SP 18)	300eb



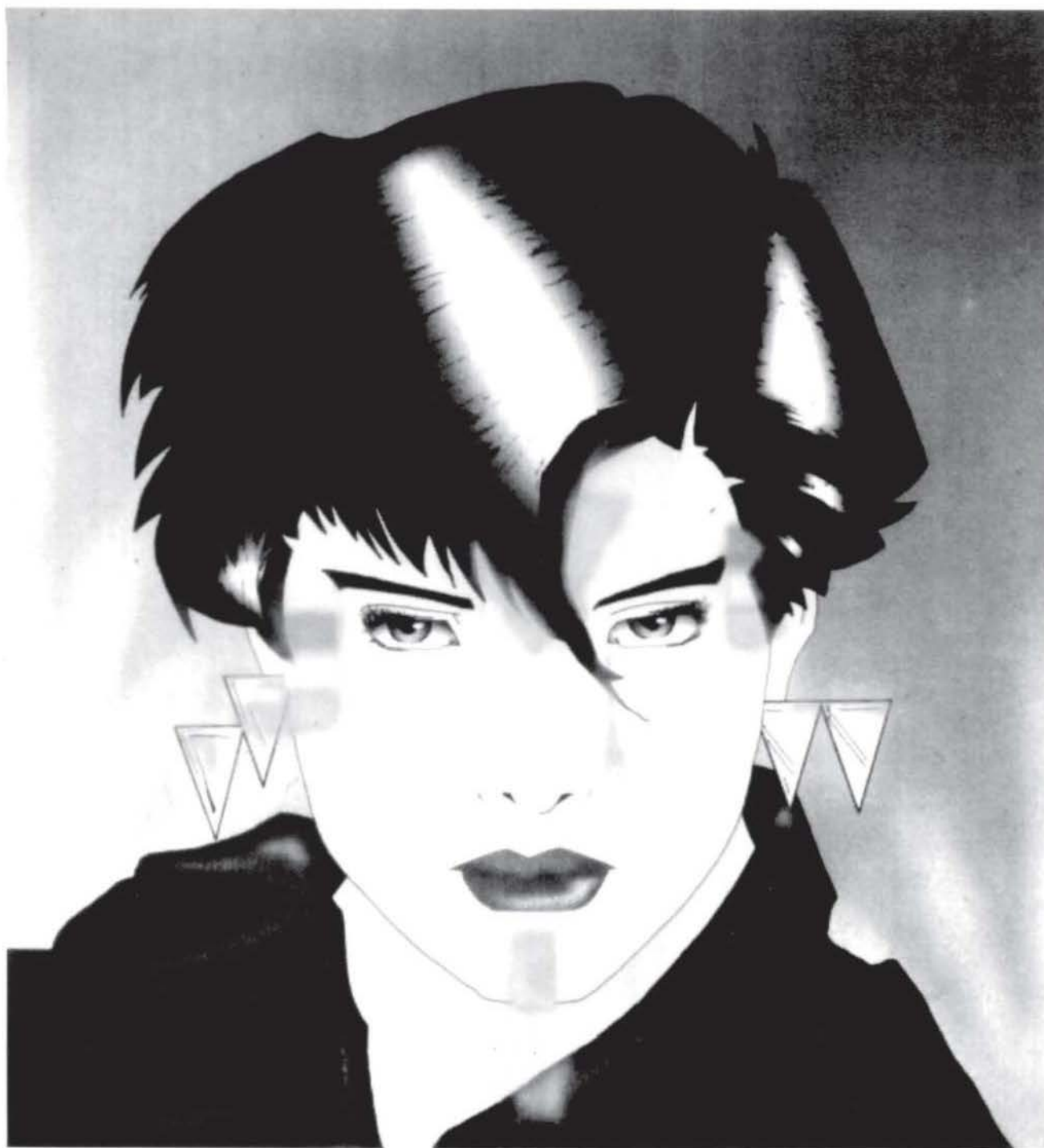

Image Fashionware

Artful style: With hi-tech art, your body becomes the canvas. Above, Vidstar Chantel makes the point with her trademark teardrop from Image Fashionware's *Bodyline* tattoo collection. In the past, cosmetic surgery could make anyone blandly perfect. Now, with *Bodyline*, you can be—uniquely perfect. Available: Trademarks & Logos (100eb), Stars & Shapes (50eb), Heat Sensitive Color Changers (120eb).



ICON America

Classic appeal:

Some things never change. When some things look this good — they never should. Leather has always looked HOT!! This jacket (300eb.), and skirt (100eb.) from ICON America are no exception.

I love what leather does for me. Smooth, sleek, in animal patterns and colors. Ostrich, snakeskin, tegu lizardskin; no matter where it comes from, it always looks good. And with the new tank-grown skins Biotechnica's coming out with, who knows what kind of leather they'll make next!

—*Sherrri Glass*
WEN Braindance Star

Item	Price
Bomber Jacket	300eb
Tunic	220eb
Pants	250eb
Miniskirt	100eb
Long skirt	200eb
Gun Belt	60eb
"Gunfighter" Hat	100eb
Long Duster	500eb
Boots	150eb
Halfboots	100eb

It's true; you don't have to look good to be a street solo. But dressing down has its limits. You're not going to get the big jobs: extracting major corporates, guarding big-name vidstars, or covering media security on the important parties. For that kind of work, you have to look the part. The eurosolos I know have always been partial to Gibson when they're on the job; it's tough, durable, and has a lot of flair. For a young solo on the way up, you can't do much better; it's the enforcer's equivalent of the 500eb grey flannel suit.

—Morgan Blackhand
The Enforcer's Handbook

Gibson Battlegear **Street lethal 2020:**

Substance AND style. You've got to look good doing what you do; a professional but casual image. On one hand, protection is fine, as long as you don't let them think you're scared. On the other hand, style counts for nada if you're dead. Gibson Battlegear firmly addresses the issue by mixing armored acid-washed jeans (30eb, SP 16), a cotton T-shirt (10eb, SP 10), and a reinforced denim jacket (150eb, SP 14) with pieces of Metalgear-style hard armor (SP 25, prices var.) where it's needed most.





Tanaka's Exec Line gives me what I demand from a fine clothier. Real-silk shirts; cotton lightweights for summer. The suits are actually Italian wool, not synthetic, and cut with authority and attention to detail.

—Ulf Grünwalder
EBM Board Member

In Nihon, we make some of the best vehicles, computers and cyberware in the world. But the epitomé of the samurai spirit is embodied in the work of Takanaka's Executive clothing. Spare and exact, it shows us that the true master of business must not only follow the Way of the Sword, but also the Way of Art.

—Seki Arasaka
Arasaka Advertising Division Head

Item	Price
Jacket	800eb
Vest	500eb
Pants	700eb
Top Coat	1000eb
Full Armored Topcoat (SP 16)	2000eb
Matching Briefcase	600eb
Monogram Shirt	200eb
Tie	100eb
Cravat	100
Scarf	75eb
Cologne	150eb
Sword case	300eb
Cape	900eb
Opera Cloak (Armored SP 16)	1200eb

Takanaka *Exec* Line
Power in simplicity:

In our world of 2020, we sometimes forget— less is more. Understated power screams in every fiber of Takanaka's new *Exec* line. No gimmicks, no fancy syntha-cloth, nothing extraneous. There's no need for any of it. Anyone who can see knows that it's the person in these clothes that counts.

T A N A K A
* EXEC *
THERE IS NOTHING FINER



This summer's collection from Eji of Japan is the highlight of the season. Loose tunics with soft collars, daring armor-capes with the trademarked light panels Eji used in his Night City and Cyberpunk collections; it's all there for the Edgerunner on the go. And the best part—it's an affordable fashion option even for the kids in the Mallplexes.

—Action in Fashion Magazine, May 2020

Eji of Japan

Hi-tech flair:

If you dress like a Suit, no deck, (not even a Matrix-8) will make people think you're anything but a loser with an expensive toy. The look is it, and Eji of Japan seems to capture IT in their look. Designer jeans (50eb.), and a lamb's wool sweater (60eb.), topped off with the armored cloak with light panels (SP 14, 500eb.). It's a picture of confidence and taste.

EXECUTIVE SERVICES

"When was the last time you saw Saburo Arasaka doing his own laundry?"

—Spider Murphy

"Yeah, yeah, I hear the Solos down in Security talking all the time about the 'Edge'. They think you strap on a few cyberbits and you're set, neh? Up here in Management, we don't need metal. We need the people edge... Investigators unconnected with the Company for black ops work. Someone to sweep your conapt for hidden bugs. A tough courier service to get something cross-town so you don't have to dodge the Zone. Maybe even a little 'companionship' for a valued client...That's the real Edge."

*—Dave Whindam
Biotechnica*

Baskin

Habit
The Personal Service



Undercover Inc.
"Always Discrete"

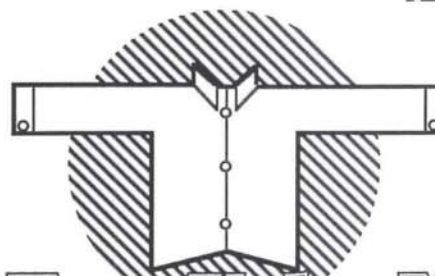

ExecUclean

Bodycure

"For A Lovelier You."

Williams

Management

Apartment Services

Williams Management Inc. is the largest executive conapt management service in the world today. With offices in every major city, Williams will procure a conapt for today's business executive who is interested in relocating to another city, country, orbital, or just across town.

Williams Management incorporates its fee within the purchase or rental price of any unit under their contract. These fees (ten percent of purchase price or fifteen percent per monthly rental charge) are actually on the low side considering Williams Management has strict guidelines on all properties they manage and sell. Since Williams Inc. only works with their own properties, the aforementioned fee is already calculated into the price so that potential buyers/renters needn't worry about additional costs.

Williams Management incorporates its fee within the purchase or rental price of any unit under their contract. These fees (ten percent of purchase price

Complex Services Contract: The Complex Services Contract, or CSC, is a standard option available to those living in the larger, 500+ unit conapt buildings now dominating the City scene. For a basic fee (usually between 500 and 2000 euro per month), Williams Management will take care of those little details (maid service, pet care, video-cable feeds, food services, etc.) which are a bothersome part of a modern lifestyle.

Game Notes: Williams Management is one of the best ways to create a landlord service for Corps and other upscale players. Apartments are about 2-3000 eb. per month. If you wish, use the Corporate Flat on pg. 83 as a model for a standard conapt managed by Williams Apartment Services. Most of the following services in this section, with the exception of Party Time Inc., SyCust, and the International Companion Network, can be offered through a Williams CSC.

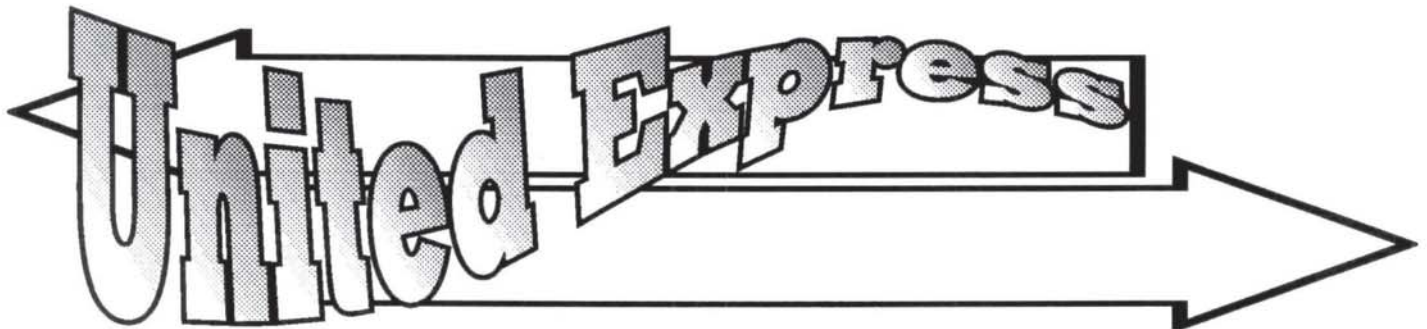

Worldwide Delivery & Courier Services

Whether it's not having to take the time to pick up groceries at the local market, or not being forced to personally hand over a contract to that unpleasant customer who insists that electronic devices are the curse of modern business; one of the most valuable services for the modern executive is a good courier. Of the thirty-seven multinational delivery companies, only United Express is large enough to have offices in all major cities and Orbitals, *and* carry an insurance policy which will cover any costs incurred through late delivery or damage to objects or documents being transported.

United Express has a set rate for common business items, such as contracts, models and prototypes. Said prices range from 25 to 650 eurodollars, depending on the speed, secrecy, special conditions and distance which you wish the package to be delivered. If the service involves a purchase, the delivery bill is usually 10 percent of the purchase price, with a 25 euro minimum charge to the recipient (remember, most delivery services give a thirty percent commission to their couriers in lieu of salary, so tipping a courier is unnecessary).



Whether you're having dinner for two—or two hundred, there is only one catering service to consider: Continental. While many other services offer a variety of food in a wide range of prices, only Continental has no surcharges for items which need to be imported. When you contract us, the only charge is a scaled fee with regard to the number of guests; we absorb any additional costs which may be incurred in the process of creating, serving, or the cleaning up of your meal.

Continental charges 200eb per dinner guest, up to 15. If there are more than 15 guests, the per-guest charge is reduced to 150 eurodollars. Included in this price is food preparation, dining set-up, service and clean-up. Continental has branches in most major cities, with some of the larger conapts employing a

smaller scale operation exclusively for its residents. It is recommended that you make reservations with Continental at least one week in advance, though emergency service can often be provided on one day's notice.

Do you want to go out, but don't have a clue of what to do? Let us make the decision for you. At Party Time Inc., we arrange for your evening's entertainment with a twist. The special part about this service lies in the mystery of where you're going and what you're going to do. And if you don't enjoy yourself, we guarantee a full refund.

Party Time Inc. is an entertainment service which charges a fee of 500 eurodollars per evening, or a flat monthly fee of 3000 eurodollars, plus an evening fee of 50eb. People subscribing to this service are given a comprehensive psychosocial evaluation to better understand their personalities so that Party Time may plan an evening's entertainment to their satisfaction. Interested subscribers who do not wish to undergo this evaluation forfeit the money back guarantee.

Game Notes: Think of this as a built-in adventure generator. No matter what else they're doing, Party Time guarantees that once a month your players be doing something interesting! Including maybe working for Party Time!





CLEAN SWEEP

Tired of that nagging suspicion that someone doesn't trust you? Afraid that you're giving away corporate secrets while you sleep? Now you can do something about it! Clean Sweep Enterprises offers the finest in data and electronic protection services. After we clean your conapt of any unwanted surveillance devices, we will come back on a monthly basis to recheck our work for one year, all for one low fee.

Clean Sweep Enterprises charges a yearly fee of 7000 eurodollars to keep your conapt clean of unauthorized surveillance devices. This cost includes an initial visit, eleven additional visits to do a routine sweep, and the rental fee of a Databox™. Should you wish to discover the identity of the person/organization who is trying to keep tabs on you, you will receive a referral to Baskin Undercover Inc., a private detective service under the same corporate ownership as Clean Sweep.

Just out— the Databox™: The Databox is an anti-surveillance device marketed by Gateway Securities, the parent corporation of Clean Sweep and Baskin Undercover. Containing its own five year power source, the Databox™ is a self supporting, EMP-shielded computer which monitors all frequencies of radio, microwave, laser, x-ray and ultraviolet radiation for unusual broadcasts. After its initial programming, only the owner can change, or add frequencies which the Databox™ will ignore. After all, what good is a device which warns you that you've successfully cooked a meal?

Game Notes: Clean Sweep's chance of finding bugs is based on the person installing the bug: Amateur (90%), Pro (60%), Master (30%).



Game Notes: ExecUclean can also repair damaged armor clothing at a rate of 20% of the initial purchase price of the garment, restoring it to full SP.

Although laundromats still exist in the world of 2020, no executive would be caught dead sitting around in a pair of old jeans, fishing for quarters when the machine buzzer sounds. In today's world the new concept in drycleaning is ExecUclean Inc. With ExecUclean, there is no need to go hunting around the city for a laundering service; we have drycleaning offices in most large corporate plazas and conapts, and guarantee clean clothing within one hour, or you receive a thirty percent discount.

ExecUclean costs range from 15 eurodollars for a shirt and tie, 25 for a set of pants, 40 for a jacket, and an entire suit will cost about 100 euros to have it cleaned and pressed. There is a nominal 15 eurodollar charge for pick up and delivery should you wish us to retrieve your laundry for you.

Baskin

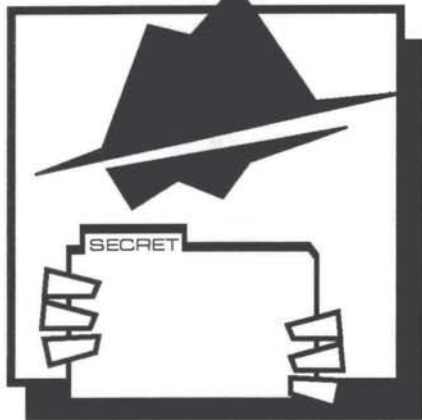

Undercover Inc. "Always Discrete"

Whether it's a simple information search or a complex counterespionage action, there is only one place you can go for guaranteed confidentiality. At Baskin Undercover Inc., we get your job done quickly and efficiently without sacrificing quality.

Baskin Undercover Inc. charges 200 eurodollars an hour plus expenses for basic investigative services including research, shadowing, phone/computer traces, confidential interviews and discrete, trial-admissible recording of meetings. Extra charges include an additional 100 eurodollar per hour charge if an operative is involved in a dangerous situation, an extra hourly fee of 150 eurodollars per extra operative needed and a flat charge of 5000eb if the subject being investigated is a target for extraction.

Baskin Undercover is a legal, private investigative service with a license to operate on six continents and the Orbital colonies. Advisory: If it is discovered that the duties to be performed by our service are not of a legal nature, we will terminate our contract immediately and pass on all information to the proper authorities.

Game Notes: Baskin is a good way for players to pursue an investigation while they're busy elsewhere. While it's up to the Referee to determine just how much Baskin finds out for the players, here are some guidelines: Basic Information (75%). In Depth Information (50%). Secret Information (20%).

By the time you get home from work you usually don't have the energy, or it's much too late to safely take your miniature pit bull for a walk in the park. That's when you call Pet Minders. Just like a regular babysitting service, PetMinders' sole concern is caring for the pet you keep for comfort or status. Whether it's this year's "in" pet, the African Wolf Spider (or any other exotic animal you may keep) your pet will pose no problem for our staff of well-trained, highly educated professional zoologists.

PetMinders charges a basic monthly fee between 50 and 5000 eurodollars, depending on the complexity of the care your animal requires and the amount of time you wish us to spend with your pet. This service includes at least 2 extended visits a week by our in-home caregivers, daily feeding (we pay for the food) and the weekly cleaning of your pet's waste facilities.



Game Notes: Besides providing pet care, PetMinders also locates rare and exotic pets for it's more exclusive clients. Whether these are stolen or just black market is unclear (and no one asks). Prices are anywhere from 1,000eb to a million, based on rarity (and Ref decision). PetMinders also does a booming underground business in endangered animal products and exotic animal meats.

Not as cute as you thought, neh?



SHOPPING SERVICE

When you're always on the go, you don't have time for grocery shopping. Allfood cooperatives have the solution to your problem. Simply place your order in the morning, along with the time you wish your food to be delivered and we'll take care of your weekly shopping needs.

Allfood cooperatives charge a nominal delivery fee of 10 eurodollars per delivery, plus an additional 25 eurodollar monthly membership fee. Included in this fee is the Allfood guarantee of the finest quality goods, plus membership discounts on items and services offered by other members of the Holt Coalition, an international conglomerate run by Maxcene Holt, consisting of Allfood Inc., PetMinders, Bodycure™, CompuShop, and Mark 24 convenience stores.

Game Notes: Sure, there are supermarkets in 2020, but who wants to waste game time shopping for food? All Food is a perfect dodge around this problem. It also exposes the players to all kinds of food-related adventure hooks, like poisonings, toxic emergencies, and the chance to discover firsthand if Soylent Green really is made from people.

**International
Companion Network**

When your profession demands high fashion one minute and practical kevlar the next, there is no better personnel service than the International Companion Network. Our skilled professionals have the looks to garner

the attention you want at a business party and the brains to make sure you get home after rejecting the competition's offer. When you need to look good while feeling safe, there is only one company to call: ICN.

The International Companion Network loans its personnel by the hour, day, week or month. Charges range from 75 eurodollars an hour, 750 a day, 4000 per week and our monthly charge is 10,000 euro. All of our professionals are trained in both social and protective skills, though we do offer specialists in certain areas of personal defense. If such a specialization is required, reservations must be made at least one week in advance.

Game Notes: Rent-A-Solo. Rent-A-Mistress. Rent-A-Hunk. This provides the players to ability to hire any of the above, or perhaps take part-time jobs as same.

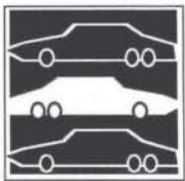

**Executive
Transportation
Service**

When you're not cruising around in the corporate limo, what other way is there to travel the city streets in style? At ETS, we offer a low cost, executive transportation alternative. Our employees are courteous and unobtrusive, discretely chauffeuring you to your destination in safety and style.

Executive Transportation Service charges 150eb an hour for the rental of an armored limousine, 500 euro per hour for an AV-4 and 850eb for hourly rental of a V-22B Osprey. The rental charge includes the vehicle and one ETS pilot/chauffeur (optional with proof of rentor licence). A deposit equal to four hours rental is required, unless your credit status is Diamond or higher.

Game Notes: So where does the party get an AV-4 to make that big extraction? Guess.

SYCUST

BODYWEAR & CUSTOMIZATION

Tired of the same old glittering chrome peeking out from under your sleeve? Want to make a statement with your new eyes in

something other than an unusual color? SyCust offers the finest in cybernetic customization for today's executive. Cybernetic customization possibilities are endless, but listed are some of the more popular options:

Tattooing: ever the popular method of expression, today's cybernetics, including eyes, can have a customized design etched onto the surface with no cost to your humanity. Our costs range from 20 eb for a simple design, up to 5000 eb for a complex design which may require anesthesia due to the length of time it will take to complete the customization. This charge can be reduced by 2000 eb by bringing in the piece of cyberware before it becomes a part of your body.

Unusual colorization: a classic option which involves covering the cybernetic in a two or three molecule layer of our special, non-scratch coating. The cost of this option is 25 eurodollars per cubic inch covered, with the exception of eyes, which cost 50eb per optical unit. Once again a nominal 2000 euro charge is added if surgery is required.

Limblite™: An innovative patented design, limblite™ involves the installation of a neural processor and a transparent plastic sheath which contains a light-sensitive fluid controlled by the processor. With this new option, you can change the color of your cybernetic limb by just thinking about it. The cost is high, 750 eurodollars, plus the 1000 euro charge for the installation of the neural processor. (HC 1d6-1 for the processor, 1-2 for the limblite™) If you already have a neural processor, a controlling chip can be purchased for only 700 eb.

Game Notes: Where do the players go to get the really flashy cyberoptions they dream up? This is the place! For four times the normal cost of the 2020 list cybernetic replacement, SyCust will build or modify the cyberoption as desired (subject to Referee discretion).

Habit

The Personal Service

At Habit, we not only teach you the basics, we refine you into the perfect executive. In addition to basic decorum, our specialists teach you how to act when dealing with all the different people you might come into contact with, including corporate owners.

Since it would be ungainly (as well as unrefined) to sit in a classroom to learn about manners, we assign each student a private tutor who comes to your home twice a week for lessons. Our course lasts six months, but it guarantees results, or we'll continue the lessons until you get it right for no extra charge. Our fee is 5000 eurodollars per course and includes the lessons, several catered parties to practice your new ways with other students, plus follow up sessions should they be needed.

Game Notes: For each 6 month course, add +2 to Social Skill, up to 2 courses.



Bodycure

"For A Lovelier You."

Do you want to change the way you look, but don't want to undergo radical facial/bodily reconstruction? Now there is another option: Bodycure™. At our exclusive salons, trained professionals will change the way you look and feel about yourself in a matter of hours, or your money back.

Bodycure™ is more than a makeover and a haircut, it is a total body rejuvenation process involving massage, hair restoration and shaping, manicure, acupuncture and an environment guaranteed to help you relax. A single bodycure™ takes 3 hours and costs 450 eb, though discounts are given if you purchase coupons for ten visits (4000 eb). Bodycure™ requires that you make appointments at least twenty-four hours in advance.

Game Notes: Each Session increases your Attractiveness by +2 for 1D6 days. You may only have one session at a time.

Pictured: Neural Interface Processor Installed and Closeup



CHIPWEAR

Mindwear For the Future Edge

Security & Operative Chips

If you're holding the line on the Street, you need every edge you can get. Now access the latest in cyberchips and dataware from Digital Dimensions, the leader in paramilitary and police operations chipware since 2010!

M.O. Chips

A must for Cops and Bounty Hunters!

For 3 years, an East Coast police department (in collaboration with Digital Dimensions) has been working on what has been termed the most important development in criminology ever conceived. With the advent of the MRAM chip, criminal psychology experts have (aided by Microtech's AI division), developed several experimental "M.O.chips" of the city's 10 MostWanted list. These chips plug into any standard chipware-processor socket and function basically as a memory chip. The chip contains a partial personality construct of the criminal, including all data police records have on the criminal's M.O., his contacts and character traits. This enables the investigator to better understand the criminal, and aid in speedier capture or termination. **Black Market Value: 1200eb.**

GameNotes: Recently, some of these chips have unofficially "appeared" on the black market. An M.O. chip will enable the chipped character to ask the referee one yes/no question, per successful INT roll (INT + 1D10 vs 15), about the criminal or his actions. One dangerous thing about M.O. chips is that the character must make a roll against his Empathy (EMP + 1D10 >= 10) when he first uses the chip. If he fails, his personality will shift to that of the criminal's (this is best done by good roleplaying, but if necessary, the character may have to become an NPC). The character will remain in this condition until the chip is removed (which he will not want to happen); if the character receives regular therapy, an EMP roll (EMP + 1D10 >= 12) may be made once per week. If successful, the character regains his personality.

Courier Chips (special CPM chip)

Worried about the safety of electronic data transmission?

Program our special Courier Chip with the data you want delivered and enter a ten character alphanumeric code; the chip will imprint the data (via processor) on a portion of the courier's brain. Then remove and erase the chip. The courier will be unable to remember any of the data until the alphanumeric code is spoken out loud to him. He will then recite the information verbally. While delivering the message, the courier will be in a trance-like state, and will not be able to remember afterwards any part of the data delivered. (Very Difficult to Near Impossible Interrogation skill check will get the information out of the courier, if psychological and chemical methods are used. This will not work if the courier has already delivered the message.) **Cost: 600eb**

Security Chips

Worried about people stealing your personal skill chips, or electronically retrieving erased info from your programmable chips? Use our new security chips. This special line comes in two types. One type, when erased, stays erased, the best

hacker can't bring it back. The other type is made of memory silicon that can be melted after being removed from the user's chip slot. (An IMPOSSIBLE Computer tech skill roll will recover material from the first type of chip; information on the second type cannot be recovered.) **Cost: 50eb/Type I + base price of chip, 75eb/Type II + base price**

Digi-Tone ID

This chip, when used with cyberaudio, or interfaced to a recorder or modem, can pick up and recognize a digital tone phone signal, allowing the listener to know what number has just been dialed. The actual number can be displayed via TimesSquare or Skinwatch modification. **Cost: 70eb.**

Special Operative Chip

Be prepared !

—Find yourself being dropped into the sharp end at the last minute? Have no fear, we've got just what you need. Our special operative chips are created to cover a number of hotspots around the world. These special chips provide a basic understanding of the local language and culture. In addition, the chip provides the user with knowledge of the basic geography of the land (including the detailed location of important cities and geological features). Chip provides *Language +1*, *Specific Knowledge*[geography] +1, and your choice of *Wilderness Survival +1*, or *Specific Know.*[police practices] +1, or *Culture +1*, or *Specific Know.*[military organization] +1 for the country in question. **Cost: 900eb.**

Poser Impersonation Chip

Live an idolized life !

Just looking like JFK doesn't mean you know all about him, or how to act like him. Poser chips solve the problems; these chips provide all the information you need to exactly match your role model. Special feedback circuits even allow you to sound much like him. For an extra 200eb, biofeedback circuits will allow you to copy nervous gestures and habits that your role model displayed. Chips for a number of Poser gang favorites are available. (The chip gives the Poser *Specific Knowledge* [subject person] +2, and *Perform* +1). **Cost: 900-1100eb**

GameNotes: The above chip can be designed for a person still living, allowing him to be kidnapped and impersonated by someone that has been 'sculpted' to look like him. However, it would take major euro to fund the investigations and surveillance needed to program the chip correctly.

Storage, Entertainment and Information Chips

Even if you're not one of the cyberelite, you can still get some leverage from the technological edge. Interface with these new entries from *DataEdge*, *Parts N' Programs*, and *SegAtari*.

PhotoMemory RAM Chip

Make the moment last !

A biochip capable of recording base cognitive patterns and emotions, effectively giving the user a selective photographic memory. Playback is not like being there, rather it emulates the process of remembering certain events or facts. (Make an Average INT roll to get a specific memory, the chip adding +2 Every 6hrs. over 24 raises the difficulty lvl. by one.) One RAM chip can hold approximately 24hrs worth of full memory. The chips are very expensive, but re-recordable. **Cost 1600eb., depending on the dealer.**

Memory Compression

More skills in a smaller package.

A new technology using pizo-electric crystals has allowed our researchers to come up with a higher rate of storage compression on skill chips. This has allowed us to place up to **three** skills on one chip, with very little quality loss. (Up to three skills can be placed on one chip, but the skill bonuses cannot exceed a total of +3. For example, the chip could contain three skills at +1 level each. The skills must be all Memory or all Reflex skills; the two types cannot be mixed on one chip. Since the skills are on one chip, they only count as one towards the maximum number of skill chips that can be run at one time.) **Cost is normal price/level for the skills, plus 200-400eb. for Memory Compression.**

Programmable Chipware

Save time and money !

Tired of wasting valuable company time on training new employees? Use our new prog-chips and Chip Programming Module (CPM). Simple job routines and company policies can be programmed into the chip via the CPM's keyboard and drive. (While the CPM/MRAM chips can provide basic knowledge on a specific procedure, they will not provide an actual skill level.) **Cost 50eb./chip, or 400eb./10 chips and 1000eb. for the CPM**

Mind Games®

The newest in recreational cybernetics: SegAtari Mind Games. Play 300 of today's most popular video games in that most unspoiled of environments—your mind. Usable with any standard chipware processor, the SegAtari 99-type Mind Game Chips make your mind the playing field. Try our most popular games: *Cyber Ninja*, *Mutant Death Race*, *Hackman 3* and *Brazil Invaders!* As if that isn't enough, you and your friends can interface (via any basic cables between your plugs) and play against each other! Buy it now! **Cost: 40eb. per gamechip**

Business Trip Chip—

Avoid those foreign faux pas!

As an executive, you may find yourself assigned to a foreign country that may be as alien to you as outer space. But stay chilled—we've got just what you need. Via Memory Compression, we've built business chips for a number of foreign countries, providing a basic understanding of the language, and information on the native culture and customs. So far we have chips for Japan, most of United Europe and the U.S., and hope to include the Sovs and certain African states as well. (This chip will provide its user with *Language* +1, *Culture* +1, and a choice of *Wardrobe/Style* +1, or *Business Law* +1, as applicable to the inhabitants of the country.) **Cost 800eb.**

Tourism Chip

Act like a Local! Or just look like one!

Visiting a foreign country can sometimes prove very embarrassing, especially if you don't know the language or customs. Thanks to help from expert tour guides, special chips similar to our business models have been created for a number of oft-travelled countries. Customs, law, and points of interest are among the knowledge included. (The chip contains *Language* +1, *Culture* +1, and *General Knowledge* +1 for the country specified.) **Cost 750eb.**

New Skill: Culture. This specific knowledge skill provides the user with basic knowledge concerning the culture of a foreign country and its people. Without this EMP based skill, a character will have a +2 on other EMP skill rolls when dealing with a NPC from another country.

Space Chip

Visiting space ? Don't leave Earth without it.

A busy executive never knows where the Corp will send him, and someday he might be sent out of this world. Utilizing Memory Compression and the latest biofeedback breakthroughs, we have created a chip that will help anyone visiting Near Orbit habitats and provide basic knowledge on how to survive Up There. (The chip provides the following skills: *Space Survival* +2 and *Highrider Culture* +1.) **Cost 900eb.**

Maximum Lover Chip

Sure, you've got a Mister Studd. But it takes more than hardware to really interface right with a lover. Our new chip can tell you what to do (65K *Kama Sutra* database integral), when to do it, and what to say while you're doing it (thanks to a 154 line database, accessible via any cyberaudio or Times Square). Don't be tagged as an insensitive metal man! No matter what your Empathy rating, jack into *Maximum Lover* and be the man of her dreams (Add +2 to any Seduction check). **Cost: 1300eb.**

Biofeedback Chips

Take command of the future with the new twist in chipware technology. Don't settle for a chip that just transmits data, or teaches the body certain physical skills. These new designs from *BioTec* Σ send and receive messages directly to and from the brain! *BioTec* Σ; the future in APTR!

Stress Chip

Are you plagued by tension headaches from office stress? Does close gunfire make you overly nervous? We've got a chip for you. This special biofeedback chip sends a message to your brain creating calmness and serenity, removing tension stress. (Not only does this chip provide relief from migraines and hypertension, but while chipped in, the user has a +1 bonus to his COOL for the purposes of combat morale. He also has a +1 to his EMP stat while using human interactive skills.) **Cost 350eb.**

Adrenaline/Endorphin Surge

If you want to ignore the pain of the bullet wound in your side, or just ignore exhaustion while working overnight on a business report, this is the chip for you! Signals are sent to the brain, blanking pain and exhaustion symptoms; plus 3 times every 24 hours you can signal for a spurt of adrenaline to give you the edge. **Cost 800eb.**

Game Notes: Pain/Exhaustion effects: with the chip in, food and sleep can be ignored for 48 hours straight. Skill penalties due to wounds can be ignored, except for head wounds. Once the time is up, or the chip removed, you must sleep 2 hrs. for every 1 hr. over normal rest times you have gone. During this period your stats are halved. Adrenaline effects: the user's BOD stat is increased by 1 for purposes of BTM, Stun/Shock saves, and skill rolls. This effect lasts 1 min. per use.)

Increased Neural Feedback Option

Utilizing the new biofeedback chip-tech, we have come up with new APTR chips. These new chips take half the learning time that the old chips took, but the increased neural feedback burns the chip out rapidly (within 24 hours of use). Currently, these new chips are only economical if you need the ability quicker than the old type would allow. ("Chipping in" is 1/2 the normal time needed, but the chip becomes useless after 24hrs. of use.) **Cost equal to a normal APTR chip plus 400eb.**

Ambidexterity Chip

Never be caught "short handed" again.

A biochip which augments the user's motor control, rerouting control energies across the body, and consequently making the user ambidextrous. Anyone using an ambidexterity chip can use two single-handed tools or weapons at the same time, thus receiving—under some

conditions—twice the normal amount of actions. However, because this chipware does not grant the user any ability to independently focus the eyes, actions performed with both hands must be directed at a single objective. **Cost: 800eb.**

Game Notes: If the character has twin cyberoptics, a second chip may be added for 250eb. that will allow independent action for each arm.

Death Trance

Great party trick!

This rare APTR chip will, when studded in, allow you to put yourself in a death-like trance at any time (recovery from the trance is on a timer function). This trance includes lowering and almost total stoppage of heartbeat, respiration, circulation, and EEG activity (life functions can be detected on a *Medtech* roll of 25+). The trance takes 1-3 minutes to enter, and so cannot be used for most first aid purposes. This chip is useful for long trips in cramped quarters or extended periods of waiting. **Cost: 1000eb.**

Redundancy Loop

When you don't want to be perfect, just good enough.

You have to play tennis with the boss, but you've never played before. *No problem, you say; just chip in a Tennis APTR.* But what if the chip is so good, you actually win? That's where our new Redundancy Loop comes in. We can program a APTR chip so that at the right moment you'll err slightly, allowing the boss to win without it looking like you threw the game. We currently have chips for tennis, racquetball and golf (more are on the way). (Chips with Redundancy Loops will screw up at a crucial moment. At that moment the Ref should secretly make a skill check roll at the same time the player makes his. The lowest roll will be used to determine the success of the skill check.) **Cost: 50-75% of a normal skill chip.**

"Fish N' Chips"

A dietary biochip which serves as an appetite control device, set to reduce the level at which the user will feel full, thus keeping their weight down. Popular with fashion models and people suffering from eating disorders. **Cost: 85eb.**

Visual Recognition Chips

Cost: 100eb./level to +3 (Police chips are 200eb./lvl.)

For use with TimesSquare Plus™ (pg. 38), these new database chips from *Direct Dataware* can get you the most out of any direct visual stimulation cybersystem. And at a cost that's a bargain for any Corporate employer! [All V.R. chipware rolls are INT+chip+1D10+(any applicable *Specif. Knowledge*)]

Techie Chip

For IDing circuits, parts, tools, manufacturers, serial #'s, etc. Chip is only valid to date of manufacture.

Task Difficulty:

- Easy Task-visual identification of tools, manufacturer's logos with address and phone, circuit diagrams.
- Average Task-visually identify circuit diagram and purpose from printed circuit boards.
- Difficult Task-identify manufacturer from product visual.
- Very Difficult Task-identify manufacture date, location, etc. from serial number.

Corporate Officer Chip

The Corporate Officer chip allows recognition of Corp officers, documents, and other operations, giving limited biographies on certain personnel. Prices as above; quarterly updates are available at 50eb, 100eb and 150eb (based on level). These chips are only available to corporate employees.

Task Difficulty:

- Easy-employee's name and position
- Average-the above, plus spouse's name, children, home address, etc.
- Difficult-the above, plus employment history, transfers, co-workers, special projects involved in, etc.
- Very Difficult-full biography, life events, etc.

Police

Visual ID's on criminals and licenses. References for auto tag hot sheets and APB's, etc. Plus daily/weekly crime SitReps. These chips will pull felons' records, vehicle hot sheets, etc. at the listed difficulty levels. Misdemeanors require different chipping. European criminals are listed by INTERPOL weekly. Cost 200eb./lvl. up to +3. Daily/weekly updates are a one-time fee equal to 2.5x normal price, plus update terminal for 10,000eb.

Task Difficulty:

- Easy-identify stolen plates, wanted person via driver's licence, CIA/FBI Ten Most Wanted on sight.
- Average-visually ID local suspects, NCIC top 100 list.
- Difficult-visually ID internationally wanted criminals from passport/ID card or rap sheet.
- Very Difficult-identify nationally and internationally known/wanted criminals on sight, even with simple disguises.

Military

Uniform and unit recognition. Weapon/Vehicle specs from silhouette ID's. Prices as standard. Chips should be replaced

annually. Those older than two years can be bought for 1/2 price.

Task Difficulty:

- Easy-nationality, name of force.
- Average-the above, plus rank or general object specification.
- Difficult-full technical specifications, unit standings.
- Very Difficult-complete unit history, vehicle/weapon manufacturer's background.

Rocker

With this chip you can identify certain instruments, recognize songs (when interfaced with cyberaudio), and display specific sheet music to your cyberoptic. Music company execs and talent scouts can be IDed if their images are preprogrammed into the chip. Talent scout and executive images need to be updated each year (50eb). Cost 100eb./level up to +3.

Task Difficulty:

- Easy-identify instrument (class and use), display pre-stored sheet music.
- Average-identify name and company of major music corp execs.
- Difficult-audio song recognition with HUD of sheet music.
- Very Difficult- visual ID of record company scouts.

Secretarial

With this chip, you can put a full reference file for all of your employer's clients, contacts and associates on the tip of your mind! Files faces, cross references names, indexes birthdays, personal data, previous appointments, letters on file (recorded with optional camera implant), and a 100,000 number phone file.

Task Difficulty:

- Easy-identify person by face, with reference to name & position.
- Average- above, plus spouse's name, children, home address, etc.
- Difficult- the above, plus any correspondence, memos and phone call records within the last two years.
- Very Difficult- the above, plus personal facts, biography, birthdates of family members, presents and gifts given or received in name of your employer (very important in the Asian Theatre).



Housing

LIVING FACILITIES FOR
THE CYBER AGE

SLEEPDCAUBE

"You gotta remember; since the late 20th Century, having a place to live isn't a given. These days, you're lucky to find a sheltered alley or dumpster. You just can't assume you'll be able to rent a conapt anywhere you want, even if you have the euro to front the action. You gotta plan ahead..."

—Ripperjack

"I got a bike, I got a Drifter RV. I got a gun to keep 'em both. Don't nobody call me homeless."

—Nomad Santiago

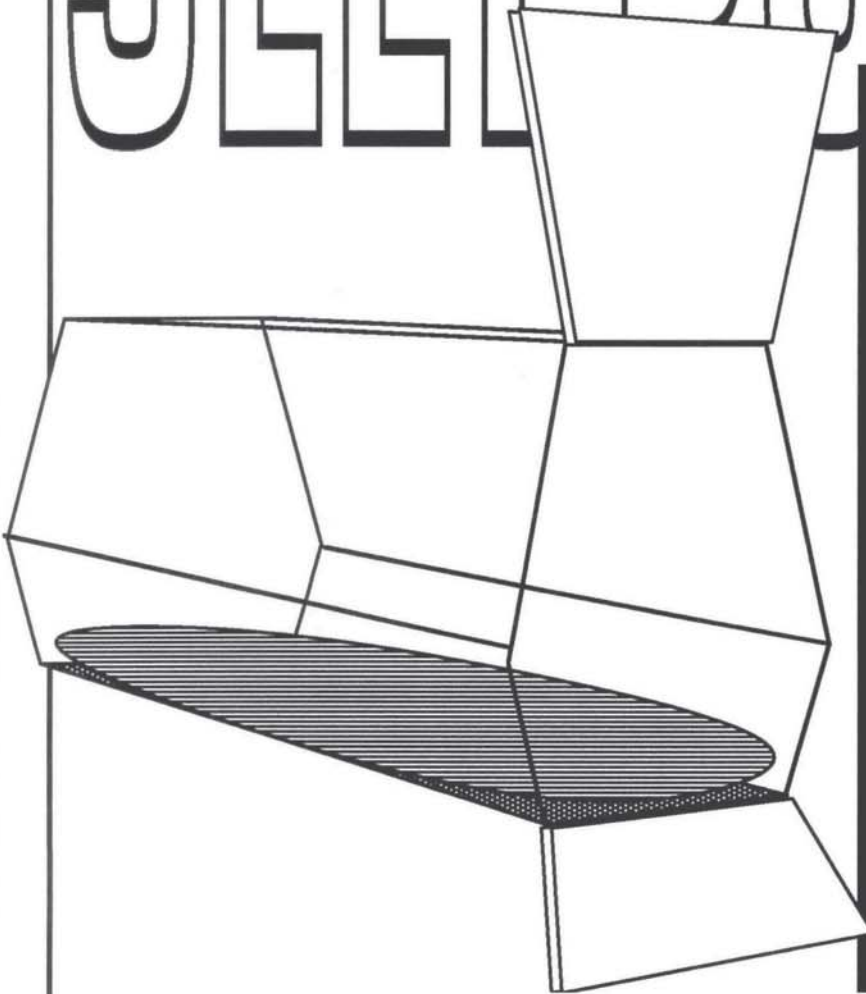

Sleep Facility

ARASAKA ARASAKA ARASAKA

Comfort. Privacy. Security.

The Arasaka Sleep Facility provides all three at a reasonable cost. The ASF network is a series of sleeping establishments set up in nearly every city of the globe. Each building is equipped with hundreds of sleep cubicles, spacious enough to hold the largest man in comfort, yet inexpensive enough to fit that budget on the run.

Each Arasaka Sleep Facility has a resident lounge, where guests can get to know each other in a relaxed environment far away from the hustle and bustle of the city. In addition to that priceless commodity, there are also entertainment centers which provide access to over 180 channels, both public and cable, from around the world.

Many of the major ASF buildings near Lev Train stops, giving nearly immediate access to the city for those quick "getaway" journeys, or just a relaxing romp through the urban marketplace. Who can tell what can be found just around the corner? Maybe a new friend from another cubicle might know!

What you'll get for your 40eb.:

- A clean and comfortable sleep cubicle, satisfaction guaranteed.
- Full use of all Arasaka Sleeping Facility's lounge and entertainment centers.
- The chance to meet new and interesting people.

For small additional fees, the following services are also available:

- Electrical outlet. Only 10eb. per hour of use.
- In-cubicle television. Only a 50eb. deposit and a 5eb. fee.
- In-cubicle radio. Only a 25eb. deposit and a 2.5eb. fee.
- Private telephone. Only a 10eb. initial fee and 0.75eb. per minute.
- Heavy-duty lock. Only a 100eb. deposit and a 10eb. fee.
- Privacy option. Only a 1000eb. deposit and a 100eb. fee.

Comfort. Privacy. Security. Arasaka Sleep Facilities provide all these and more. Stay at one on your next trip and hide away from your troubles.

Inside A Sleep Facility: Sleep facilities (The Cubes) are large, box-like buildings, unattractive and depressing. They are pestholes of filth and degradation, catering to the misplaced, mistreated, or mistrusted of the world.

The only windows are on the first floor, where the lobby, main operator, entertainment facilities, and resident lounge are located. Each main operator handles requests from the tenants (which are typically ignored), as well as admits new guests and takes care of the money. He sits inside an armored room with SP 14 walls, with a 12 gauge shotgun nearby. There is also an emergency button to call the police or fire department, but these calls are also typically ignored.

A standard ASF has 800 cubicles broken down into 80 cubicles per floor, making the building around 11 floors. The extra floor of space is used for storage. The cubicles themselves are broken down in groups of four, stacked two by two. Larger facilities can have as many as 1,000 cubicles, and the largest, located in Tokyo, has 2,000.

Washrooms are located at the end of each hall and provide enough sinks, toilets, and electrical outlets for half the number of cubicles in the hall.

The train facilities are usually located at a platform adjoining the ASF, or sometimes inside the ASF, either running through an enclosed first floor terminal or through a sublevel.

Sleepcubes are 2m x 1.5 x 1.5m, providing just enough space for a man to sleep in relative comfort. The beds are slabs of soft plastic, permanently affixed to the floor and usually stained by unmentionable things

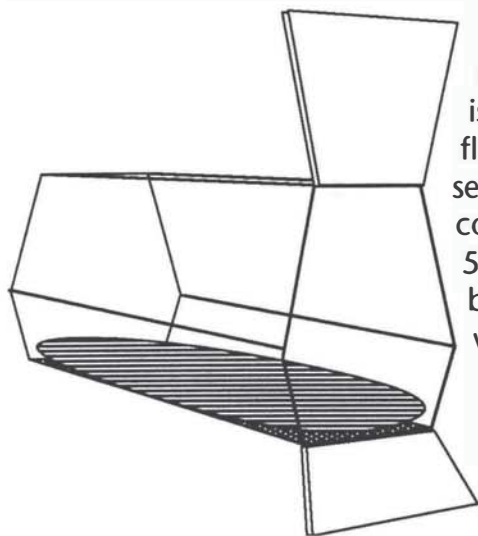

spanning all colors of the rainbow. Lighting is provided by two fluorescent tubes set into the upper corners. There is a 50% chance that both lights are working.

The door is much like a torpedo tube hatch, and the lock is little more than a bar

slid across the entry. (Difficulty to open = 6). The door is SP 14, and the walls are SP 20.

The television option provides a small set built securely into the ceiling of the cubicle. Reception and maintenance are poor in an ASF, and only a fraction (around 20%) of the 180 promised stations come in. Radios usually work better, giving nearly full access to all stations, at least in the immediate area.

Anyone trying to get inside the radio or television automatically sets off an alarm at the main operator's desk and immediately forfeits the deposit. Getting to the equipment is a Task Difficulty 10 vs the *Basic Tech* skill.

Price: 40eb/night + options.

What Goes on at an ASF: Everything from drug deals to sex games happens at a sleep facility. ASFs are a good place to pick up new contacts and a better place to get killed. Most of the action at a facility runs toward petty theft and similar crimes, but occasionally a travelling ripperdoc takes up shop in a cubicle, adding to the number of stains on the bed.

The chance to find some piece of equipment such as a gun or similar piece of hardware is Difficulty 8 against the *Streetwise* skill. Searching for a chump to do a crime runs between Task Difficulty 6 to 12 against the *Streetwise* skill, depending on the severity. Ripperdocs are naturally wary, and finding one is Difficulty 12 against the *Streetwise* skill.

Gambling is the most common form of entertainment at a sleep facility, especially since the televisions and radios usually don't work. Prostitution is the second most common form of entertainment. No roll is needed for either.

The heavy-duty lock (DIFF 18) is a must for any rational resident at an ASF. When a character checks into a facility, the Referee should secretly make an Intimidation check (DIFF 8). Success means the character's cubicle goes unmolested for one week. For every point below the needed roll, a thief tries to break into the character's cubicle. An equal roll means one attempt is tried. The Referee determines when this happens (whether or not the character is home). No more than five attempts can happen in a week.

The privacy option is little more than a bribe, and the actual price may vary.

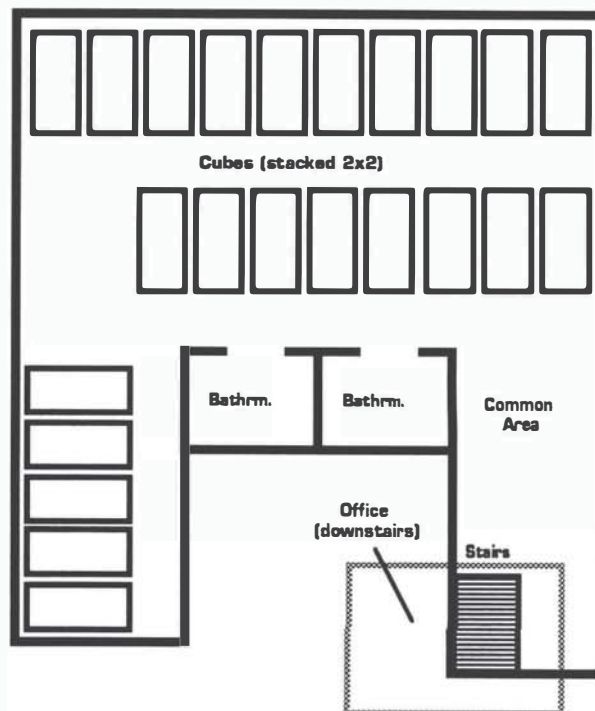

Security Services, Inc.

Professional Apartments

As a valued member of your company, you know that the right conapt is more than just a contract perk—it's a necessity. Security Services, the leading supplier of housing to the Corporate market, understands your requirements, and knows how to meet them by providing only what you expect: the best.

In designing these deluxe spaces, Security Services addresses the three greatest needs of all professionals. The first requirement is *style*. A fine conapt should reflect its owner's impeccable taste. Therefore, Security Services uses only the top floorplan and furniture designers, including such legendaries as Laubenstein, Bradstreet, and the ever-popular Nagano.

The next requirement is *communication*. How quickly can you be reached from work? Using the most advanced paging equipment, Security Services ensures that you can be contacted anytime, guaranteeing that you can make that "Big Deal" at a moment's notice. We offer a "hands-off" ten line phonesystem with hold, call-waiting, and conference calling, including a full-page, legal-quality Fax link for those "must-have" documents. Naturally, our sat/cable television and radio modules are second to none, receiving broadcasts from around the world with crystalline clarity.

The last and most important requirement of the high-pressure, high-opportunity world of the 21st Century is *security*. Whether it's protecting your work or protecting your life, we feel Security Services should be your choice. Store your important work in

a personal safe, hidden anywhere in your flat, with combination and location known only by you and our security experts. Protect your hard earned possessions with an ultrasonic security net, ensuring that anything larger than a small pet will set off an alarm. And with our off-line central alarm system, computer tampering and break-ins are impossible!

At Security Services, we believe the best security has that personal touch, which is why we provide all our apartment complexes with a team of expert security guards, armed and ready to defend *your* life and property. They'll check all visitors for identification and weapons, and call you for confirmation of your guests. There's also an in-house video camera system as an extra precaution.

Security Services also provides other invaluable services, such as valet parking for your automobile, maid service, and regular food deliveries by the meal, or by the week. We even provide pet care.

Only Security Services offers the Corporate Client so much:

- Your choice of three floor plans by the hottest designers today.
- Your choice of ten major furnishings, plus three major kitchen appliances.
- An advanced telecommunications system for those important conferences.
- Television and radio with satellite link-up to anywhere in the world.
- Your own private safe placed in a strategic location of your choice.
- Ultrasonic security; the best available.
- Trained, on-site security personnel and video security equipment.

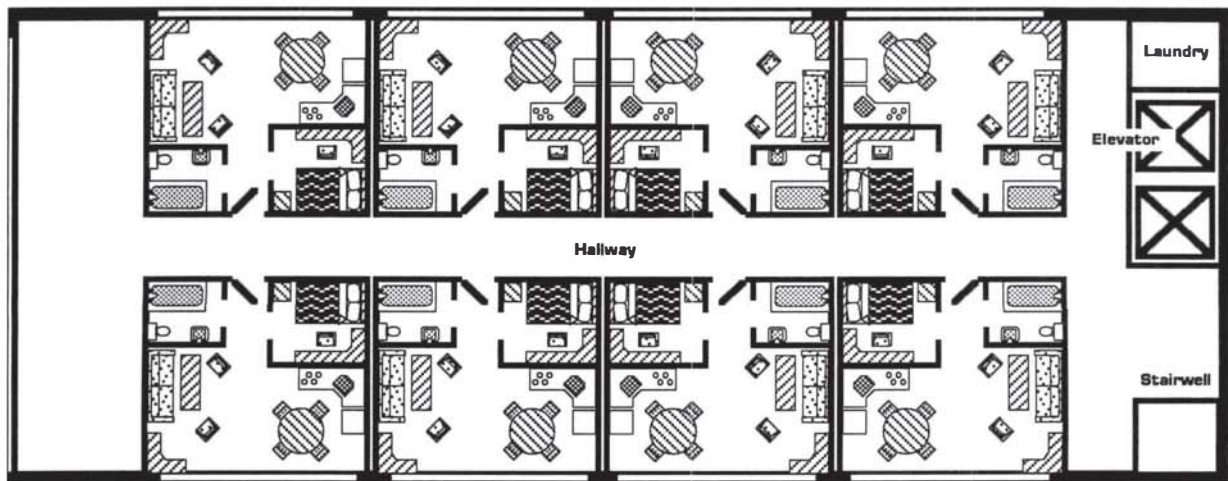
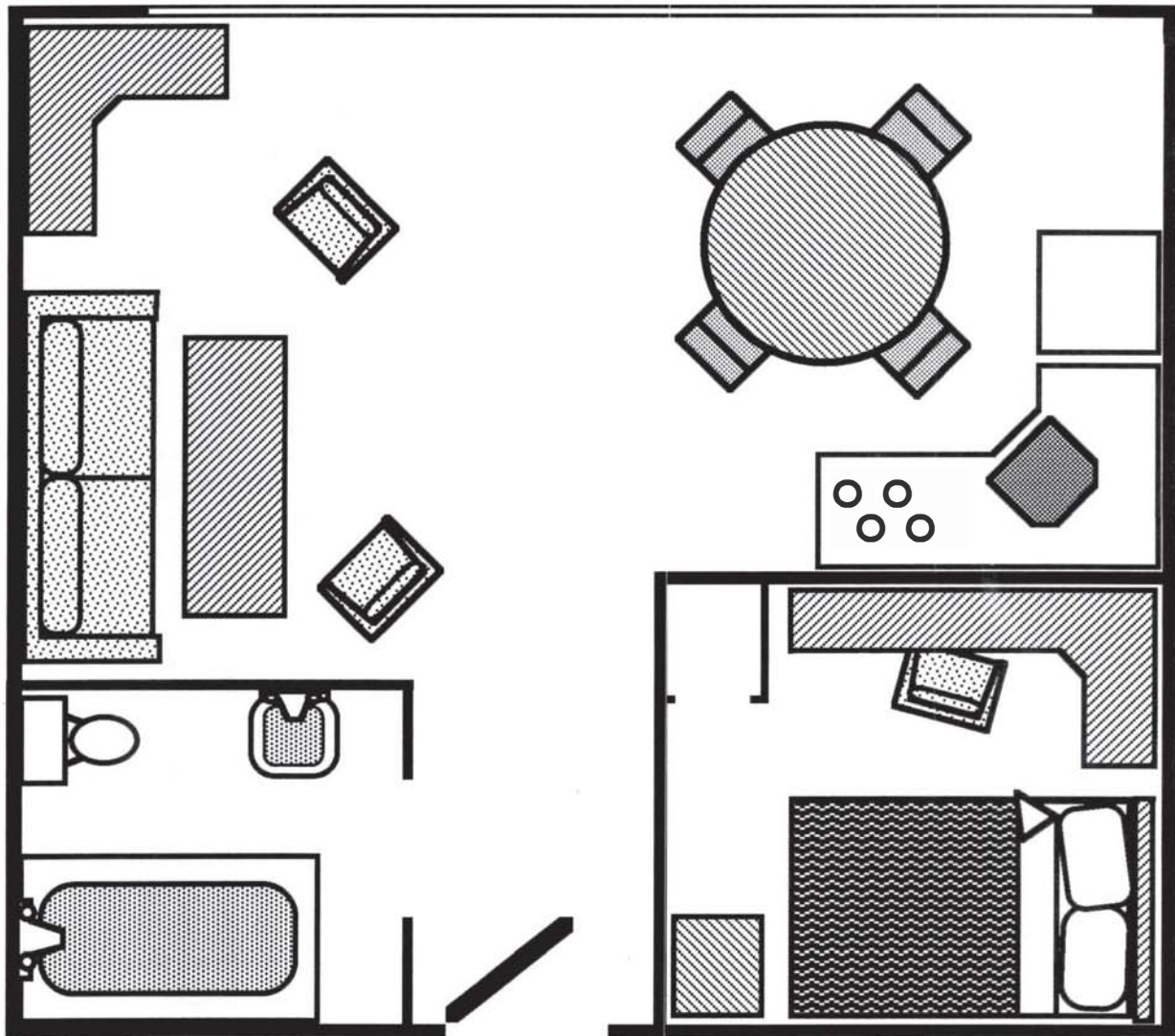

**CORP APARTMENT
& Typical Building Floor Plan**

CHROME HOUSING

Sound impressive? There's more. For small additional fees, you can get more furniture and even a fireplace for those romantic interludes. Food service can be upgraded to include exotic dishes from around the world. We can add pressure sensors to the floor and infra-red detectors to the walls for even tighter security. You can also store documents in our main building safe for extra protection. Don't see something you want? Tell us and we'll get it. There's no limit to the lengths we'll go to please you, the Corporate client

Live up to your company's high standards (and your own) by moving into a flat built by Security Services today. Think of everything we provide, then look at any other apartment around. We dare you to find better. Style, Communications, and Security. Security Services flats have all the necessary qualities for a healthier, more productive, corporate life.

Remember; when your Lifetime Contract comes up for negotiation, you deserve something more than just a Trauma Team account. As a valued employee, your Corporation has the option to offer you the best in management housing. When they ask you what you want, tell them Security Services.

Rental: 2500eb. per month

Notes on the Corporate Flat: In the 2000's, many Corporations hire housing services to provide living space for their most important employees. A corporate flat is usually offered to an employee for three reasons: the company needs a place where they can reach their worker; the company needs a place where they can spy on their worker, or the employee asks for it as a contract "perk" (living space being so hard to find in 2020). In any case, there will be some type of listening devices placed in the flat and the phone lines will be tapped (Detection Difficulty=18).

Extra furniture can be rented for a 20-50eb. fee. An upgraded food service is also available for 100eb. per week or an extra 20eb. per meal. Extra pressure and IR sensors cost 2,000eb. Using heavy security safe is a 100eb. per 10 pages of documents stored.

The ultrasonic sensor creates an invisible net of sound that sets off an alarm if broken. The net effectively fills the entire room and anything larger than a cat sets off the alarm. Characters with cyberaudio in the ultrasonic range are able to hear and pick out the emitters' locations. The chance to find a sensor is Difficulty 10 against Awareness.

The infra-red sensor beams are set up at shin level at the door and in the middle of all windows. Anything crossing a beam sets off an alarm. (IR-detecting cyberoptics can see the beams). Pressure sensors activate if when more than 2 kg are placed on them, and are located at doors and windows (Difficult to detect). Both ultrasonic and IR sensors have SPs of 6 and audible alarms.

When an alarm sounds, the guards call the Chief of Housing enroute to the conapt. One guard always mans the phones, while (1D6/2)+1 guards answer the alarm call. They are typically armed with pistols or shotguns; and wearing armored jackets.

The personal safe can be hidden in anything or placed anywhere, even inside an appliance or the ceiling. The safe's total volume is about one cubic foot. It is SP 24 and effectively impossible to remove unless inside something like an appliance. The building safe is located in the guard's room on the main floor and is SP 34.

The security measures have no central computer link, so they cannot be tampered with by Netrunners. Netrunners may, however, use the telephone and satellite links.

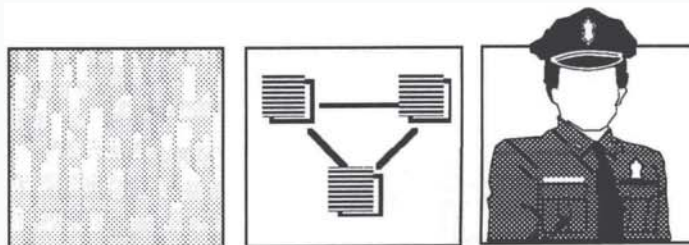

Security Services

STYLE • COMMUNICATIONS • SECURITY

Harris & Company

Luxury Penthouses and Conapts

Luxury Penthouses and Conapts

When there is no substitute. . .

. . . it must be designed by the craftsmen at Harris and Company, faithfully serving the world's aristocratic, professional, and entrepreneurial communities for over twenty years. Creating such masterpieces as the Network News 54 Broadcast Tower and the Orbital Air Space Center, as well as refurbishing historic Comisky Park, Harris and Company is the unprecedented master of urban design, catering only to the most exclusive clientele.

Harris and Company is proud to unveil their most recent creation, set among the venerable spires of beautiful San Francisco: Triumph Tower. Triumph is the finest skysrise built, a symphony of steel, glass, and gold, with authentic wood accents (a daring innovation by our master designer, Pat Stephens). Inside and out, Triumph Tower shatters all previous concepts of luxury and taste. Critic Otto Cornejo of *Big Time Magazine* describes it as "Superlative!"

Offices, lofts, and residences will be available soon, but we at Harris and Company wish to extend this special invitation so you may attend the exclusive auction of Triumph Tower's pride, the **Masterpiece**. The Masterpiece is the only penthouse suite in the Tower, and is as unique and priceless as a Warhol Monroe. We need not go into detail of what wonders the Masterpiece holds for its final owner. Harris and Company's reputation says enough.

Contact your local broker for bidding dates and instructions. Don't pass up this opportunity to live in a work of art.

Opening bidding price: 800,000eb.

Notes on the Masterpiece: A perfect example of a high class apartment suite (suitable for ranking Corporates) the Masterpiece is accented with gold and wood; the frame is constructed from more mundane materials. The Masterpiece takes up two floors, the lower holding the kitchen, main living room, entertainment room, and various guest and washrooms, while the upper contains the master bedroom, workout room, and the master bath. The roof is also a helipad.

Everything that could possibly be crammed into a single dwelling can be found in the Masterpiece, and of course, everything is top of the line. All televisions, stereos, computers, and telecommunications are accessible from every room with the touch of a button.

The walls, doors, and floors of the Masterpiece are lined with honeycombed alloys and reactive armor, creating an effective SP of 40. The glass in the penthouse is lined with similar honeycombed (and microfilament) metals sandwiched between sheets of transparent polymers, SP 25.

Telecommunications is the most well-developed system in the Masterpiece. The penthouse has a link to the Harris and Company satellite, giving unlimited access to any other communications network in the world. This system includes a scrambler for privacy and a spectrum sweep option to search for specific broadcasts. The number of people that can conference call is virtually infinite.

The computer is almost as sophisticated. Used by the

normal executive or aristocrat, it can analyze the stock market or give the best guess of who to bet on in the next polo match. Accessed by a Netrunner, the computer is an awesome tool for espionage.

The computer comes with *Data* and *Code Gate Level III*, *Poison Flatline*, *Pit Bull*, *Aardvark*, *Dragon*, and *Zombie* (though this last is kept secret from the general public). The 'runner can hook up his own cybermodem through the Masterpiece computer, using it as a "carrier" for protection.

A persona duplication program called *Doppelganger* creates a data "scarecrow" that is targeted by black programs instead of the netrunner. In order for the Netrunner to be effected, the Masterpiece computer's defenses must be defeated first, the *Scarecrow's* second, (it has the same Net combat statistics as the 'runner), and finally the netrunner himself. Programs that wait for users like *Pit Bull* or *Hellhound* cannot track a user through the Masterpiece computer, since the *Scarecrow* is not a true image of the 'runner (although operating through a *Scarecrow* costs the Netrunner 1 point of INT for purposes of Net combat).

On the outside, the Masterpiece is protected by a radar net covering a two kilometer area, detecting anything with a surface area of greater than 2 square meters. There is also a close range motion sensor that detects anything moving along the perimeter of the penthouse. The radar and motion detector domes are SDP 30 and 10 each.

Inside, there is another set of motion sensors, as well as an ultrasonic and infrared network. Alarms on the inside or the outside alert guards on the first and twentieth floors (the Tower is 22 floors tall). The guards are highly trained and equipped with heavy weapons and SP 24 hardshell armor. If desired, the guards can enter immediately to deal with any threat; otherwise they will seal off the floor and wait for the Masterpiece's owner to let them in.

The alarm also lowers steel shutters (SP 40), to close off the windows. It takes a strength of 12 or better to lift these. If the radar detects an incoming intruder, the Masterpiece computer accesses its programs to

determine if the object is friendly or hostile (determined by the owner and a huge list of default settings). Hostile intruders on the rooftop and garden levels can be attacked by the six Apex minigun turrets (pg. 53) set on the perimeter of the penthouse.

In the event of an intrusion through the elevator or the garden/spa area, a close-range motion sensor will activate an electrical defense system that shocks up to six targets at a time with a multi-kilovolt electrical arc (1 to 8 D6 damage; the exact number is determined by the Masterpiece's owner). Like the miniguns, this system can be keyed to exclude certain individuals or vehicles.

Both internal and external security are operational at all times, and there is a backup generator in the Masterpiece's lower level in case of a power shortage. The generator also runs the computer and the elevator.

The computer controls access to everything in the penthouse, and everything is activated either by keypad or voice. The owner presets any guests in the computer's memory, in order to prevent false alarms. The defences can also be switched off by the owner's voice.

For an additional fee, the owner may also include a code-key in any of his cybergear. Scanners in the penthouse read the key and determine if it is the correct code. If it isn't, the alarms go off. Eye code-keys cost 200eb., finger or limb code-keys cost 100eb. Of course, removing the code-keyed piece of cyber-equipment from the owner will give an intruder access to the entire penthouse.

There are many options available on the penthouse. Harris and Company can provide a cook to live in one of the servant's quarters on a lower level of the Tower. Food can be delivered from anywhere in the world. Security can be increased or changed at a moment's notice.

This is the Masterpiece. Anything is possible.

MASTERPIECE

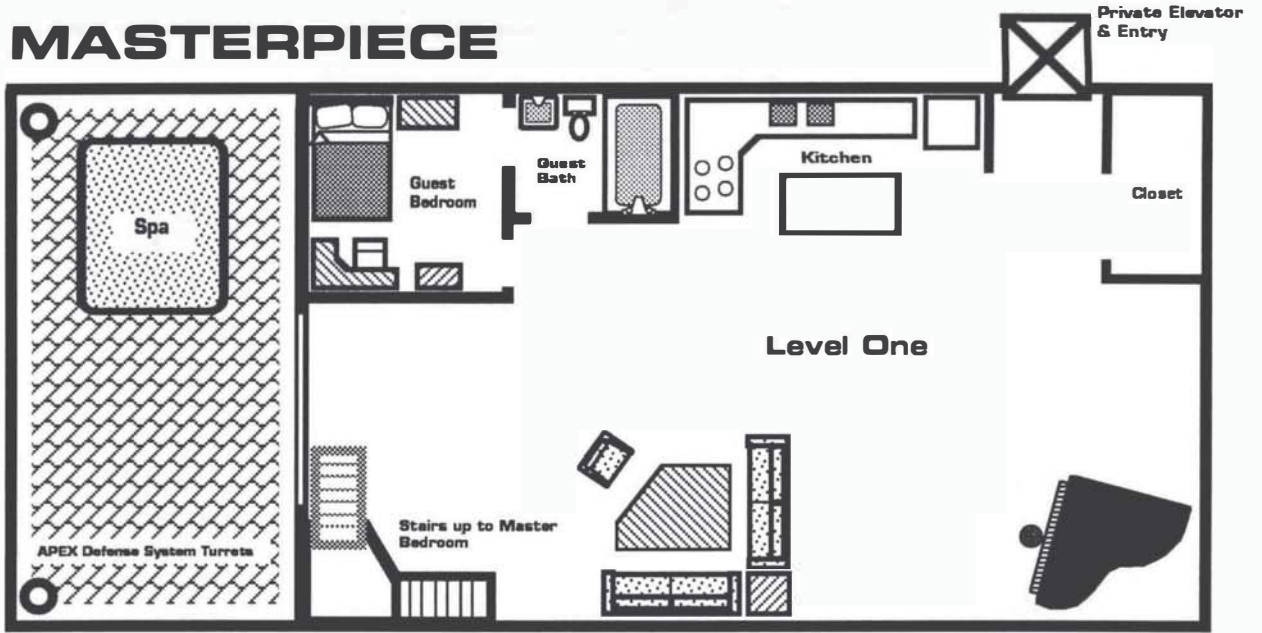

Level Two

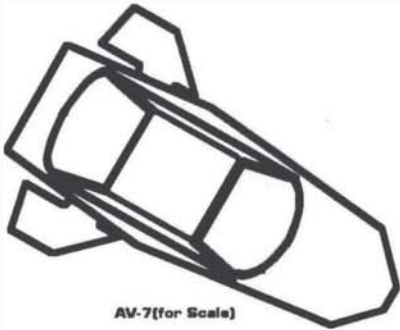
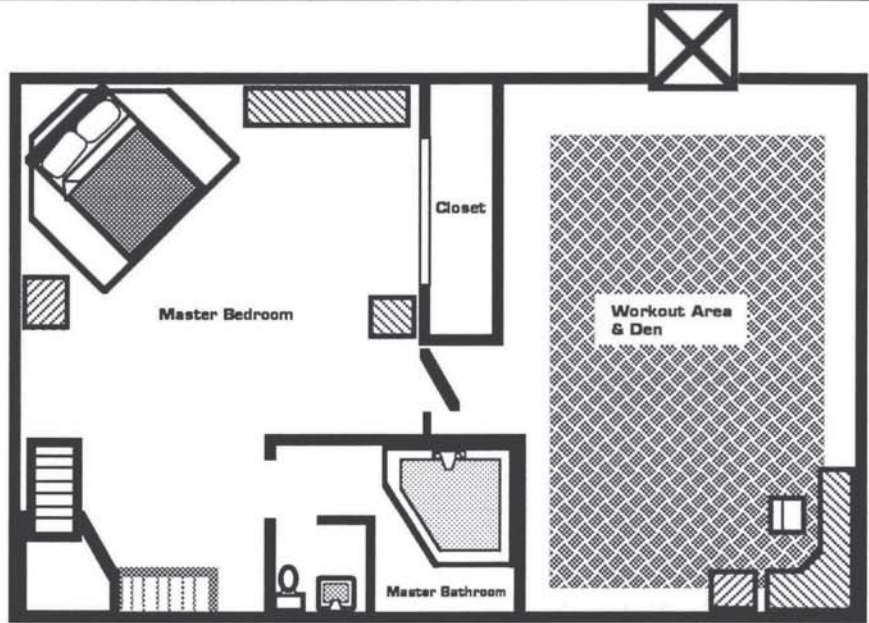

Roof Level

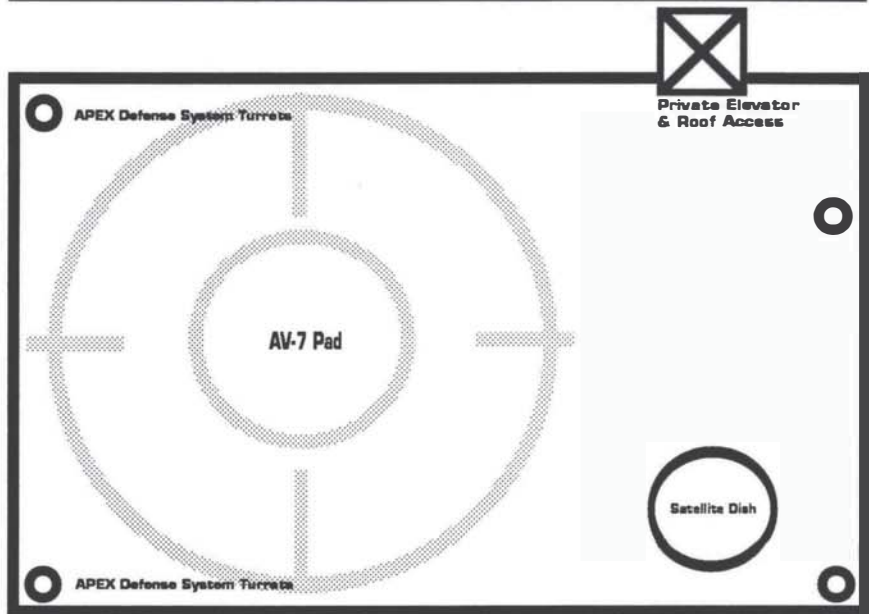



Silverhand Studios

"The difference between artists and normal people is that they leave their windows open when it rains.

— excerpt from *Zen and the Motorcycle Maintenance of Art*

In the days of the Renaissance, artists could get together to discuss their work, free from the pressures of business and the influence of those in power. Today, the mega-corps dictate what the masses see; they control and twist the work of the artist until it suits their overlord mentality: banal and sterile.

Now's your chance to interface the New Renaissance and join a revolutionary artist's community. I've bought warehouses in all sections of the city and converted them into low rent, low profile lofts especially for you, the visionary of the Edge. Whether you're a realtext writer, violence painter, rocker or virtual image creator, my plan is to promote the general welfare of talent; to make sure that talent can grow and develop free from the menace of little minds and Corporate control.

You can do anything you want in your loft. Paint it black, erect monuments to your gods, hang from the rafters and sing like a loon. Hold concerts and poetry readings and orgies. It doesn't matter to me. Just don't wreck the room for the next artist who will live there; that's a 'facer kind of attitude.

Remember; the future belongs to the minds that are free. Don't have it done to you. Be the actor, not the audience.

Johnny Silverhand

Rent: 600eb. per month.

About Silverhand Studios: Silverhand Studios is a private operation run by Johnny Silverhand, rockerboy and popular insurgent. A radical to the end, he wants to give artists a place to do their own thing, free from the manipulations of outsiders. To do this, Johnny has bought warehouses in many major cities and converted them into living spaces. Almost any shape and size studio can be found, some with plumbing and electricity, some without.

The average loft is a high-ceilinged room on the second floor of a warehouse with a dramatic skylight and a huge row of windows against one wall. The first level is usually completely empty, offering the artists a large gathering space. Depending on the warehouse, the structure may be wooden beams or corrugated steel.

In general, there are as many as twelve lofts per warehouse, and washrooms have been installed as needed. Cooking is electric and each room has a complete stove. All the housing is clean and vermin free.

The warehouses become communities, where the artists often get together to drink espresso, eat scones, and talk art. They all know how stereotypical this is, and find it ironically funny. Being among colleagues in such close proximity is conducive to learning, and each year one lives at an artist's community, one gains +1 to his respective artistic skills, up to +3.

There's a sense of secrecy to the communities; the general consensus is that the corporations could move in and take over or destroy the "work" at any moment. This make everyone a bit paranoid.

Cheap supplies (at discounts up to 70%) can be

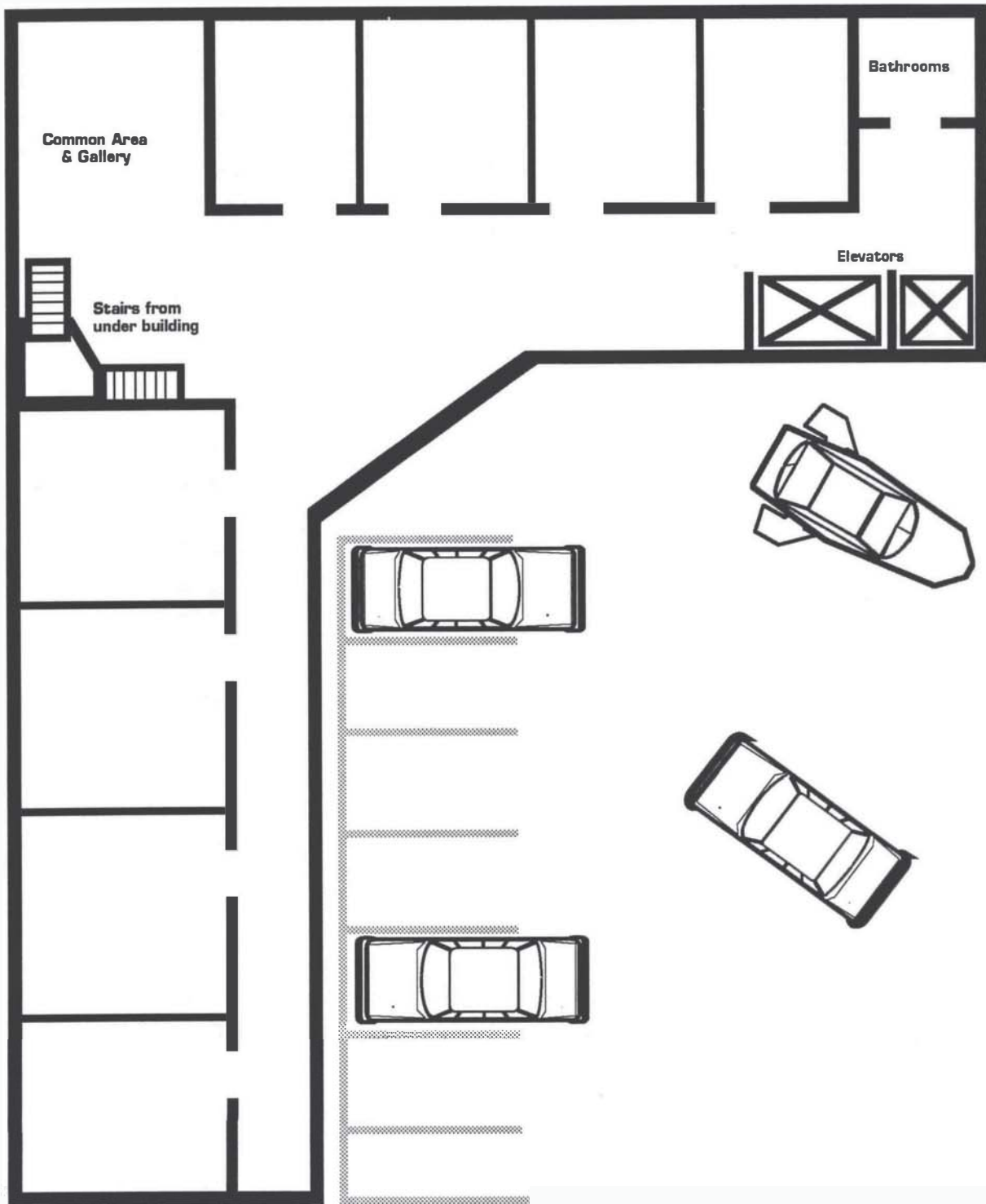

**SILVERHAND
STUDIOS**

obtained by the warehouse's "landlord," who is actually a contact to Johnny's creative agent. All the artists in a given community know how to get in nearly immediate contact with the landlord, (usually an out-of-work solo) who can also provide protection and an occasional hiding place for a particularly "sought after" artist. If an artist's life is in real jeopardy, he or she will be given the location of a warehouse in another city, and asked to leave.

The landlord can also find jobs for the artists so they can eat and pay rent. Silverhand isn't running a

charity, and he figures having to pay rent, as cheap as it is, keeps an artist from losing that *hungry* edge. There is, however, great leeway when it comes to payment, and artists in a studio often chip in and help pay for each other's expenses.

In addition to those duties, the landlord also tells Johnny when a particular artist is showing great promise. When this happens, Silverhand occasionally arranges for an art dealer to "drop by" the warehouse and look over the artist's work to determine if it has merit.

The Drifter

Mobile Environment

The return of a legend. . .

The legend is the open road, and now you can become part of it. Experience the thrill of travel in your own recreational vehicle from New American Motor.

Adventure is yours when you hit the web of concrete spanning the states. New American Motor's *Drifter* is the flagship of our RV line, providing the best in comfort, maintenance, and affordability. For comfort, the Drifter has two full beds, a comfortable couch, and a state-of-the-art video/audio system. There's also a complete cooking range with microwave and disposal.

Maintenance for the Drifter is simple. Using New American Motor's patented diagnostic computer and modular replacement system, even the most mechanically inexperienced person can fix the rare *malfunction*. The Drifter also has an auxiliary electric motor for those short intra-city hops.

The Drifter is the most competitively priced RV on the market. New American Motors offers the lowest finance rates (22.5%) and the highest cash back incentives.

Contact your New American Motors dealer for details today—and become part of a legend.

Price: 24,995eb.

About the Drifter: The Drifter is a large recreational vehicle with a twelve foot clearance. It holds three people comfortably. The beds are bunks, one atop the other, and the couch is long enough to sleep on. There is some storage space underneath the beds and the couch.

The kitchen area has a stove with four electric burners. The microwave is smaller than home

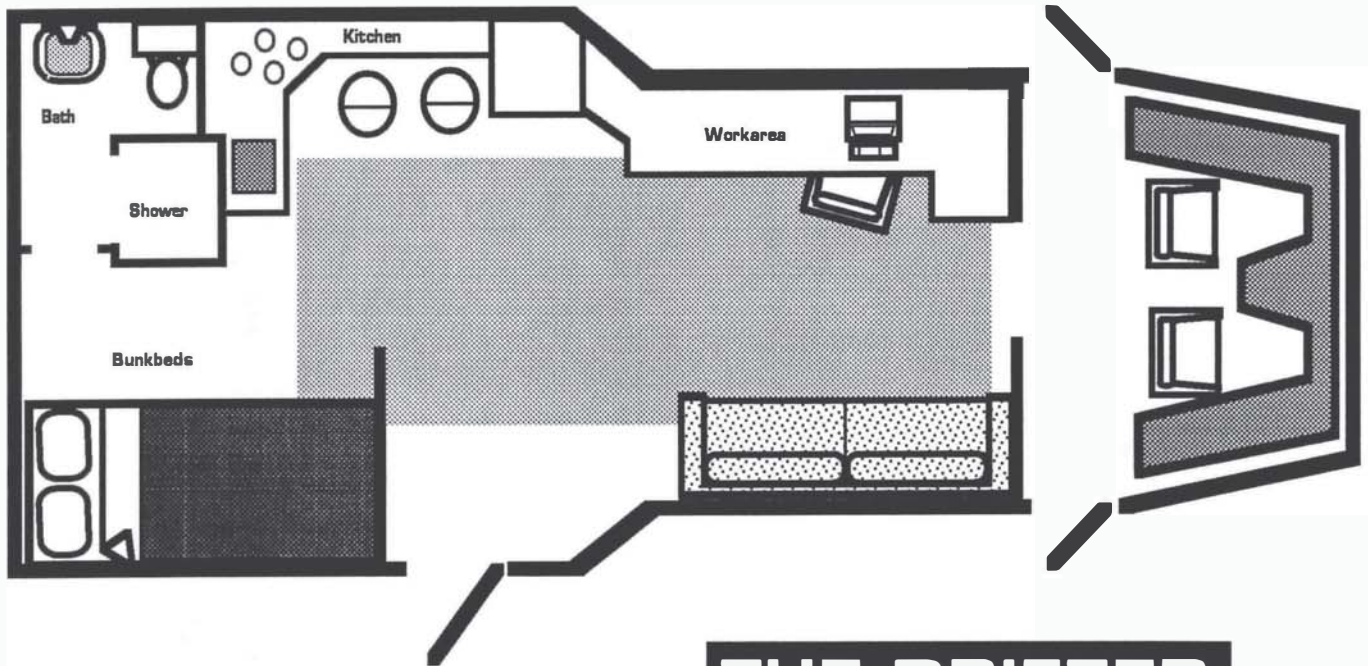

THE DRIFTER

models. The refrigerator holds about a week's worth of food and drink. There is a large water reservoir for two weeks of normal drinking, cooking, and washroom use.

The Drifter's gas tank holds 60 gallons of fuel, and the vehicle will also run on CHOOH_2 . However, the gas mileage drops from 25 to 15 kpg when alternate fuels are used.

The auxiliary electric motor's battery has a charge good for about 320km. It takes six hours to recharge off a house outlet, and three hours off a higher output outlet, such as found in factories or special recharge facilities. All of the Drifter's electrical needs come from this battery, and excessive use of the video equipment or cooking range will drain it at a rate of @4km per hour of use.

The visual/audio equipment is a reliable television and stereo system running off a small solar collector mounted on the roof. The collector may be retracted in bad weather.

The Drifter has an SDP of 80, with an SP of 10. All glass has an SP of 10, and the tires have an SDP of 40.

The diagnostics system gives general repair information, such as "the engine needs oil" or "the carburetor needs adjustment". It does not give specific multiple system information, such as "the dirty spark plugs are causing emission problems which have affected the catalytic converter". The modular repair system gives a +1 on all Basic Tech repair rolls. The vehicle holds enough repair modules for ten simple jobs.

People use vehicles like the Drifter for a number of different purposes. Nomads use them to travel, since they are reasonably comfortable and affordable. Others use them as intelligence vans, installing optical and listening equipment for spying and counter-insurgency work. Ripperdocs often use them as mobile black-market cybertech hospitals.

SOFTWARE

DIGITAL DEMONS, DOWNLOADED DREAMS

"Net's gotten more dangerous since when me and Rache Bartmoss did the first pioneering... In those days, you could scream out to the Fringe of Netspace— frack!; way past Pacifica and out into the Orbital Loop without encountering a single ICON. It was wide open then; not even a Netwatch.

No more, choomba. You gotta watch your back every nanosec. You got cowboys zippin outa Fortresses the size of the the frackin' Death Star, loaded for the hunt with Soukillers, Mindbenders—you name it."

—Spider Murphy





Wolf

Class: *Disguised Anti-IC*
Strength: 4 **MU:** 6
 1500 eb.

This program is a *Killer IV* disguised as a *Watchdog* program. If triggered, the netrunner gets a Difficult ID roll (use *System Knowledge* and *Programming* skills, plus half your *Interface* ability) to detect its hidden ability. If the 'runner fails the roll, he is fooled by the program, and the *Wolf* gets a +1 to its initiative and attack rolls. *Speedtrap* will not detect *Wolf*, but *Smarteye* will. If you have *SeeYa* or *Hidden Virtue* running at the time of the encounter, they will ID the program as disguised, but not tell you its true nature.

ICON: To all appearances, it is identical to the *Watchdog* icon, except that it will flash entirely red as it attacks.



Guard-Dog

Class: *Detection/Alarm*
Strength: 4 **MU:** 5
 720eb.

A modified version of the original *Bloodhound* program, *Guard-Dog* was designed with *Invisibility* sub-coding. *Guard-Dog* alerts its owners if anybody is using a workstation or other in-system entrypoint, and indicates which station is active (it cannot be fooled by *Invisibility*). *Guard-Dog* does not watch the LDL inputs to a system, and can be eliminated by the standard *Killer* software, if the netrunner detects it.

ICON: *Guard-Dog* is invisible except for a flicker at the periphery of vision. If detected, *Guard-Dog* appears as a standard *Bloodhound*.



Bulldog

Class: *Detection/Alarm*
Strength: 6 **MU:** 6
 660eb.

A software upgrade of the *Watchdog* alarm, *Bulldog* (aka, *Watchdog v.II*) was designed with higher-powered probe systems than its foreunner. Like the normal *Watchdog*, *Bulldog* alerts its owners to illegal entries in the system. This program can be fooled with *Invisibility* or *Replicator*, and can be eliminated with *Killer*.

ICON: A short, burly humanoid in metal armor. Sharpened



Smarteye

Class: *Detection/Alarm*
Strength: 3 **MU:** 4
 620eb.

Smarteye is a more precise (but weaker) form of *Speedtrap*. Unlike its predecessor, which only warns of programs within a certain radius, *Smarteye* will allow you to take a closer look. This program functions exactly like *Speedtrap*, but when an offensive program is detected, the 'runner may choose to identify exactly what the program is. If he does so, and the program is self-mobile or is monitored by another netrunner, it gets a detection roll ('Punk 2020, pg. 143) to recognize that it is being probed.

ICON: A spinning crystal ball; when a program is ID'd, the ball stops and the appropriate icon appears within.



Termite

Class: *Intrusion*
Strength: 1 **MU:** 2
 160eb.

One of the earliest and most enduring programs, *Termite* is a favorite of really green weefle-runners because of its simplicity and low cost. Although not a very powerful program, it is quiet and easy to find. *Termite* only works on data walls.

ICON: A brown, fist-sized insect of fractal construction with bright blue eyes. It emits low-pitched bleeps as it burrows into the wall.



Psychodrome

Class: *Anti-personnel*
Strength: 4(5) **MU:** 11
 14,000eb.

This program employs a radical new approach to electronic counter-intrusion. *Psychodrome* does not attack the netrunner's body, but rather his mind: via its *Bloodhound* subroutine, it uses a direct sensory feed (like that of braindance) to fill the netrunner's mind with scenes/sounds of shock

and horror. If successful, the immediate effect is unconsciousness for 1D6 hours, plus a lasting side-effect. When a 'runner has been hit by *Psychodrome*, he must make an Average COOL roll once per day, or he cannot face returning to the net. When the netrunner makes the roll, he has overcome his trauma (until the next time he encounters the *Psychodrome*). The program is usually disguised as a code gate, memory unit, or other innocuous system location (sysop's choice). If keyed to the psych traits of a specific netrunner, its strength is 5 instead of 4.

ICON: If the attack is successful, the program places the netrunner in a virtual room of faceted, mirrored walls from which the sights and sounds of torture, death, and madness are projected at odd speeds and angles in rapid succession.



Vampyre II

Class: Demon/Anti-IC
Strength: 6 **MU:** 7
2300eb.

Vampyre is an extremely powerful variant on the *Demon* series of compiler programs, credited to the notorious Waycon Kidd. Very expensive and rare, *Vampyre* dismantles any target program it attacks, adding the "victim's" abilities to itself. The only type of programs *Vampyre* cannot absorb are other *Demons* and programs involving virtual realities (such as *Psychodrome*).

When *Vampyre* attacks a program, it rewrites the program into itself as one-time code, so that every program "eaten" by a *Vampyre* (up to a total of 6) can then be used by that *Vampyre* once, and then it is erased. This constant re-writing of code lines and activation of subroutines does put a strain on the program's logic systems, however: every time you activate one of the absorbed programs you must roll a D10 greater than the current number of programs stored. Failure means that the *Vampyre* has "crashed," purging all its stored programs, and rendering it useless until the 'runner leaves the net, removes the *Vampyre* from his deck, and reinstalls it.

ICON: A cadaverous figure in grey robes, with golden orbs for eyes, and a snarling mouth baring golden fangs. When it attacks, it transforms into a misty grey cloud, shot through with sparkling red lights. This cloud then covers and dissolves the other program's *icon*.



Bunnies

Class: Anti-IC, Vampyre-specific
Strength: 4 **MU:** 3
440eb.

Bunnies is a program designed by Wilson Wake, an enterprising 'runner who wanted to kill a *Vampyre* but didn't want to spring for *Assassin* software. When activated, *Bunnies* simply replicates itself, offering the *Vampyre* dozens of tasty subroutines to absorb. Since a *Vampyre* can only absorb 6 programs before automatically crashing, this program is very effective, if very specialized. The strength of the program represents the potential for initiating it before the *Vampyre* absorbs some other program.

ICON: A rapidly-multiplying bunch of burnished gunmetal-colored bubbles. Each bubble has a set of the classic "rabbit ears" antennae identifying its front end.



Fatal Attractor

Class: Anti-personnel
Strength: 7 **MU:** 7
10,750eb.

A particularly nasty version of *Hellhound* credited to the infamous Waycon Kidd. Legend has it, the Kidd ended up as the loser in a romantic triangle, and used this duplicate of his ex-girlfriend to eliminate his netrunning rival.

The *Fatal Attractor* operates much like a *Hellhound*; it lurks around Data Fortresses waiting to pounce on intruders. However, instead of immediately attacking, it appears as a very attractive female netrunner who offers to help the intruder break into the system. The *Fatal Attractor* will cheerfully accompany the 'runner for 1D6+1 turns, then attack as a *Hellhound*.

ICON: An attractive young woman in a skintight bodysuit. Legend has it that the *ICON* is derived from the Waycon Kidd's old girlfriend; a System Knowledge check at DIFFICULT will be required for the target netrunner to recognize her—The Kidd installed a subroutine into the program that changes its hair, eye and skin color randomly; the *Attractor* can only be recognized by her face.

Prices

Electronics & Miscellaneous Equipment

Advanced Communications Suitcase	8000eb/800eb options
Alarm Removal Kit	290eb
Auto Punchout.....	330eb
Bar-in-a-Briefcase	100eb
Complete Travel Kit	150eb
Cab Hailer	150eb+10eb/month
Canned Shower	3eb
Car faxx	500eb
Cybermodem Helmet	4100eb
Cybermodem Utility Suit	6300eb/7800eb
Cyberdeck Security System	400eb/1000eb
Cybercam EX-1	1200eb
Detcord Explosive	900/pack
Digital Recording Studio	12,000eb
Digital Weapon Uplink	500eb
Fireproof Clothing	varies by garment
Flavored Cigarettes	2eb/15eb
Fluid Diving Suit	6000eb+100eb/extras
Flip Switch	135eb
Image Wallet	100eb
ID Badge Maker	500eb
IR Cloak	400eb
Line Tap Detector	60eb
Linozap	350eb
Mapmaker	500eb/400eb extras
Mini Printer.....	125eb
Newsviewer	100eb + rental fees
Netrunner Life Support Equipment	500eb
Office Communication Suite	1000eb/1100eb options
Paper Shredder	500eb
Personal Body Alarm	400eb+300eb/month
DUD Smartgun Controller	720eb
Replica Armor	3500eb/10,600eb
Solar Electric Panel	100eb
Sonar Scanner.....	50eb
Sleep Inducer	85eb
Slosh Bag	65eb
Smartlock Security System	250eb/level
Smartsticks	800eb
Speedholsters	100eb
Temperfoam Furniture.....	80eb-140eb/piece

Vehicles

Arasaka Riot VIII	250,000eb
AV-9	1.3million eb
Bensen Cascade	58,000eb
Bell Spy-Eye 18	206,000eb
BMW 9018s	100,000eb
Harley-D. Thundergod	5040eb+950eb/extras
Hundai Worker Bee	5000eb
Kundalini Roadworks Shiva	8000eb
Mitsubishi Dragon	2.5million eb
NAA Ambunaught	76,000eb
Pedicab.....	1200eb
Punknaught	???

Cyberware

I=implant,B=bioware,BW=bodyweapon,O=cyberoptics, A=cyberaudio,L=cyberlimb, CW=cyberlimb weapon,N=neuralware

Anti-Plague(B).....	1750eb
Cyberliver(I).....	450eb/850eb
Cyberhand(L)	750eb+100eb/options
Cutting Torch(L)	100eb
Decentralized Heart(I)	1300eb
Dodgeball(O)	440eb
Digits(L)	25eb-150eb
Derringer(L)	220eb
E-Monitor(I)	185eb
Frequency Changer(A)	100eb
Forked Tongue(I)	350
Flashbulb(CW)	250eb
Gyro-Stabilizer(I)	1000eb
Gang Jazzler(BW)	600eb
Gas Jet(CW)	275eb
Icer(L)	200eb
Lifesaver(B)	4500eb+1000eb/extras
Limb Link(L).....	100eb
Magnetic Feet/Hands(L)	60eb/pair
Mace Hand(L)	300eb
Mag-Duct Spots(N)	220eb
OptiShields(I)	300eb
Pacesetter Heart(I)	900eb
Pacesetter 2000 Heart(I)	985eb
Rebreathers(I)	700eb
Skate Foot(L).....	440eb
Tazer Grip(CW)	180eb
Tear Gas Sprayer(O).....	200eb
Times Square Plus(O)	500eb
Voice Pattern(I)	350eb
Video Cam/Transmitter(O)	330eb
Video Imager(O)	350eb
Wet Drive(I)	320eb+175eb/extras
Whip(CW)	475eb/single arm
Watch-Man(L)	180eb
Wearman Mk. II(I).....	200eb

Weapons

APEX Mobile Point Defense System	10,000eb
Beretta M-24	950eb/1250eb
Bio.-Askari Motion Restraints	60eb+25eb/extras
Budgetarms Laser-Niner	675eb
Colt Alpha-Omega	500eb
Darra-Polytechnic M-9	300eb
DCR Rifle Grenades	50eb/100eb
EMP Grenade	200-400?
FEN Dz 22 Saucer	65eb
FEN Dz 25 "Det Card"	120eb
Federated Arms Light Assault 15	400eb/700eb
Federated Arms Super Chief	375eb
Gremyenko GPz-78.....	40eb
Goncz-Tarus Pistol.....	300eb-400eb/dealer
Glock 30	705eb
H & K G6	2050eb
Kendachi Dragon	660eb

Kendachi Mono-Two	650-700eb
Kendachi M-33 Powersword	860eb
Malorian Arms Hvy. Flechette Pistol	595eb
Malorian Arms Sub-Flechette Gun	795eb
Malorian Arms Sliver Gun	375eb
Malorian Arms 3516	4525eb/special order
Militech Mini-Gat	695eb
Militech Crusher SSG	450eb
Militech M/P Shotgun	300eb
Militech 10	455eb
Militech M-31a1 AICW	1695eb
Militech Mini GL	255eb/475eb
Pursuit Security Stundart Pistol	109eb
Rostovic Wrist Racate	380eb
Setsuko-Arasaka PMS	950eb/1150eb
Stein & Wasserman Model F	650eb
Techtronica Black-Zap	90eb

Fashion

Bodyline Tatoos from Image	
Fashionware	50-120eb
Exec line from Takanaka	75-2000eb
Gibson Battlegear	10-150eb
Leather Series from ICON America	60-500eb
Psiberstuff Fashion Cyberwear	7000eb
Streetware from Eji of Japan	50-500eb
Wearman Series from Nu-Tek	100-300eb
Uniforms from Uniware	15-300eb

Executive Services

Allfood Inc.	25eb/month+10eb/extras
Baskin Undercover Inc.	200eb/hour+150eb/extras
Bodycure.	450eb/visit
Clean Sweep Enterprises	7000eb/year
Continental	150eb-200eb/person
ExecUclean	15eb-100eb/garment
Executive Transportation Service	150eb-850eb/hour
Habit	5000eb/course
International Companion Network ...	75eb/hr.-10,000eb/mon.
Party Time Inc.	500eb/day-3000eb/month
PetMinders	50eb-5000eb/month
SyCust	25eb-5000eb/job
United Express	25eb-650eb/package
Williams Management CS Contract	10-15% rent/month

Chipware

A=APTR chip, M=MRAM chip

Adrenaline/Endorphin Surge(A)	800eb
Ambidexterity(A)	800eb+250eb/option
Business Trip Chip(M)	800eb
Courier Chip(M)	600eb
DeathTrance(A)	1000eb
Digi-Tone ID(M)	70eb
"Fish N' Chips"(M)	85eb
Increased Neural Feedback	standard price+400eb
Maximum Lover Chip	1300eb
Memory Compression	standard price+200eb-400eb
Mind Games(M)	40eb
M.O. Chip(M)	1200eb
PhotoMemory RAM(M)	1600eb

Poser Impersonation(M)	900eb-1100eb
Programmable Chipware	50eb+1000eb/extras
Redundancy Loop(A)	50-75% off standard prices
Security Chips	standard price+50eb-75eb
Space Chip(M)	900eb
Special Operative Chip(M)	900eb
Stress Reducer(A)	350eb
Tourism(M)	750eb
Visual Recognition Chipware(M)—Techie	100eb/level
V.R.C.—Corporate	50eb-150eb
V.R.C.—Military	100eb/level
V.R.C.—Police	200eb/level+10,000eb/extras
V.R.C.—Rocker	100eb/level
V.R.C.—Secretarial	100eb/level

Housing

Arasaka Sleep Facilities	40eb/night+10eb-1000eb/options
Harris & Company Masterpiece Penthouse	800,000eb+options
Security Services Corporate Flat	2500eb/mon.+extras
Silverhand Studios	600eb/month
The Drifter RV	24,995eb

Software

Bulldog(Detect/Alarm)	660eb
Bunnies(Anti-IC)	440eb
Fatal Attractor	10,750eb
Guard-Dog(Detect/Alarm)	720eb
Psychodrome(Anti-Personnel)	14,000eb
Smarteye(Detect/Alarm)	620eb
Termite(Intrusion)	160eb
Vampyre(Demon/Anti-IC)	2300eb
Wolf(Anti-IC)	1500eb

Index

Electronics & Miscellaneous Equipment

Advanced Communications Suitcase.....	4
Alarm Removal Kit	14
Auto Punchouts	8
Bar-in-a-Briefcase	16
Cab Hailer	5
Canned Shower	16
Carfax	8
Complete Travel Kit	16
Cybermodem Helmet	6
Cybermodem Utility Suit	7
Cyberdeck Security System	9
Cybercam EX-1	13
Detcord Explosive	13
Digital Recording Studio	12
Digital Weapon Uplink	12
Fireproof Clothing	13
Flavored Cigarettes	16
Fluid Diving Suit	15
Flip Switch	9
ID Badge Maker	13
Image Wallet	10
IR Cloak	15
Line Tap Detector	4
Linozap	4
Mapmaker	9
Mini Printer	8
Newsviewer	10
Netrunner Life Support Equipment	6
Office Communication Suite	5
Paper Shredder	8
Personal Body Alarm	14
DUD Smartgun Controller	12
Replica Armor	16
Sleep Inducer	11
Slosh Bag	16
Smartlocks	8
Smartsticks	11
Solar Electric Panel	16
Sonar Scanner	8
Speed Holsters	13
Temperfoam Furniture	11

Vehicles

Arasaka Riot VIII	24
AV-9	28
Bensen Cascade	18
Bell Spy-Eye 18	26
BMW 9018s	19
Harley-D. Thundergod	20
Hundai Worker Bee	25
Kundalini Roadworks Shiva	21
Mitsubishi Dragon	27
NAA Ambunaught	23
Pedicab	22
Punknaught	29

Cyberware

I=implant, B=bioware, BW=bodyweapon, O=cyberoptics, A=cyberaudio, L=cyberlimb, CW=cyberlimb weapon, N=neuralware

Anti-Plague(B)	39
Cutting Torch(L)	36
Cyberliver(I)	37
Cyberhand(L)	31
Decentralized Heart(I)	37
Derringer(L)	36
Digits(L)	32
Dodgeball(O)	39
E-Monitor(I)	38
Flashbulb(CW)	35
Forked Tongue(I)	35
Frequency Changer(A)	39
Gang Jazzler(BW)	40
Gas Jet(CW)	34
Gyro-Stabilizer(I)	38
Icer(L)	36
Lifesaver(B)	39
Limb Link(L)	34
Magnetic Feet/Hands(L)	34
Mace Hand(L)	36
Mag-Duct Spots(N)	38
Optishields(I)	31
Pacesetter Heart(I)	37
Pacesetter 2000 Heart(I)	37
Rebreathers(I)	36
Skate Foot(L)	33
Tazer Grip(CW)	38
Tear Gas Sprayer(O)	39
Times Square Plus(O)	38
Video Cam/Transmitter(O)	39
Video Imager(O)	39
Voice Pattern(I)	35
Watch-Man(L)	33
Wearman Mk. II(I)	38
Wet Drive(I)	35
Whip(CW)	34

Weapons

APEX Mobile Point Defense System	53
Beretta M-24	46
Bio.-Askari Motion Restraints	48
Budgetarms Laser-Niner	42
Colt Alpha-Omega	43
Darra-Polytechnic M-9	50
DCR Rifle Grenades	47
EMP Grenade	47
FEN Dz 22 Saucer	47
FEN Dz 25 "Det Card"	47
Federated Arms Super Chief	52
Federated Arms Light Assault 15	54
Glock 30	43
Goncz-Tarus Pistol	44
Gremyenko GPz-78	40
H & K G6	51
Kendachi Dragon	48

Kendachi Mono-Two	55
Kendachi M-33 Powersword	55
Malorian Arms Hvy. Flechette Pistol	45
Malorian Arms Sub-Flechette Gun	795
Malorian Arms Sliver Gun	42
Malorian Arms 3516	52
Militech Mini-Gat	50
Militech Crusher SSG	42
Militech M/P Shotgun	48
Militech 10	51
Militech M-31a1 AICW	45
Militech Micro GL	46
Pursuit Security Stundart Pistol	49
Rostovic Wrist Racate	49
Setsuko-Arasaka PMS	44
Stein & Wasserman Model F	54
Techtronica Black-Zap	49

Fashion

Bodyline Tatoos from Image	
Fashionware	60
Exec line from Takanaka	63
Gibson Battlegear	62
Leather Series from ICON America	61
Psiberstuff Fashion Cyberwear	57
Streetware from Eji of Japan	64
Uniforms from Uniware	59
Wearman Series from Nu-Tek	58

Executive Services

Allfood Inc.	70
Baskin Undercover Inc.	69
Bodycure	71
Clean Sweep Enterprises	68
Continental	67
ExecUcleaN	68
Executive Transportation Service	70
Habit	71
International Companion Network	70
Party Time Inc.	67
PetMinders	69
SyCust	71
United Express	66
Williams Management CS Contract	66

Chipware

A=APT-R chip, M=MRAM chip

Adrenaline/Endorphin Surge(A)	75
Ambidexterity(A)	75
Business Trip Chip(M)	74
Courier Chip(M)	73
DeathTrance(A)	75
Digi-Tone ID(M)	73
"Fish N' Chips"(M)	75
Increased Neural Feedback	75
Maximum Lover Chip	74
Memory Compression	74
Mind Games(M)	74
M.O. Chip(M)	73

PhotoMemory RAM(M)	74
Poser Impersonation(M)	73
Programmable Chipware	74
Redundancy Loop(A)	75
Security Chips	73
Space Chip(M)	74
Special Operative Chip(M)	73
Stress Reducer(A)	75
Tourism(M)	74
Visual Recognition Chipware(M)—Tehchie	76
V.R.C.—Corporate	76
V.R.C.—Military	76
V.R.C.—Police	76
V.R.C.—Rocker	76
V.R.C.—Secretarial	76

Housing

Arasaka Sleep Facilities	78
Harris & Company Apex Penthouse	83
Security Services Corporate Flat	80
Silverhand Studios	86
The Drifter RV	88

Software

Bulldog (Detect/Alarm)	91
Bunnies (Anti-IC)	92
Fatal Attractor	92
Guard-Dog (Detect/Alarm)	91
Psychodrome (Anti-Personnel)	91
Smarteye (Detect/Alarm)	91
Termite (Intrusion)	91
Vampyre (Demon/Anti-IC)	92
Wolf (Anti-IC)	91

CHROME 2

The Cyberpunk Style Guide Vol. 2



R. TALSORIAN
GAMES, INC.

CYBERPUNK®

STAFF

CONTRIBUTING WRITERS

Ben Wright
Mike Roter
Scott Taylor
Marcus Pregent
Craig Sheeley
Mike MacDonald
Ross Winn
Mike Pondsmith
Colin Tipton
Michael Todd

CONTRIBUTING EDITORS

Derek Quintanar
David Ackerman
Mike Pondsmith
Mike MacDonald
Lisa Pondsmith

ARTISTS

Ben Wright
Gloria Yuh Jenkins
Harrison Fong
Tim Eldred

COVER

Mike Ebert

ART DIRECTION

Matthew Anacleto

GRAPHICS

Mike Pondsmith
David Ackerman
Matthew Anacleto

**R. TALSORIAN
GAMES, INC.**

Published by R. Talsorian Games
P.O. Box 7356
Berkeley, CA 94707

Copyright 1992 by R. Talsorian Games Inc.
Cyberpunk® and Chromebook 2 are trademarks
of R. Talsorian Games Inc. All Rights Reserved.

CONTENTS

CYBERWARE 3

EQUIPMENT 10

WEAPONS 35

TEAMS 51

FULL BODY REPLACEMENT 63

VEHICLES 86

EXOTICS 101

INDEX 111



**MILITECH URBAN
MISSILE LAUNCHER PG. 41**



FED-BOEING FALCON PG. 96

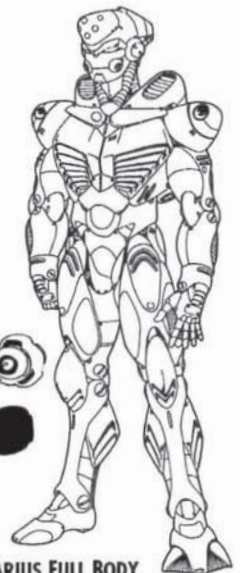

**AQUARIUS FULL BODY
CONVERSION PG. 67**

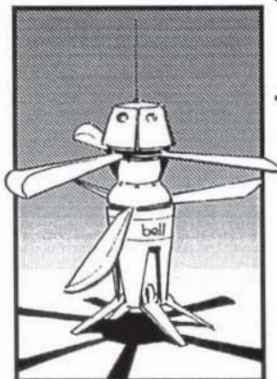

**BELL REMOTE
ROTOCRAFT PG. 31**

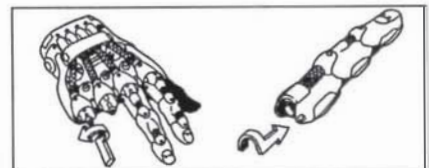

DYNALAR QUICK CHANGE MOUNTS PG. 4

CYBERWARE

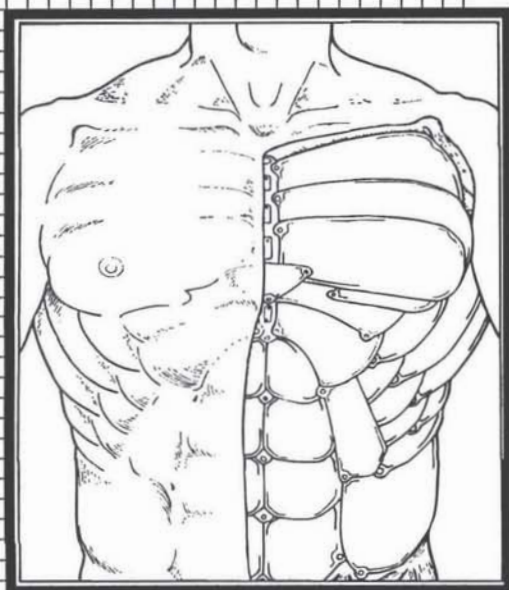
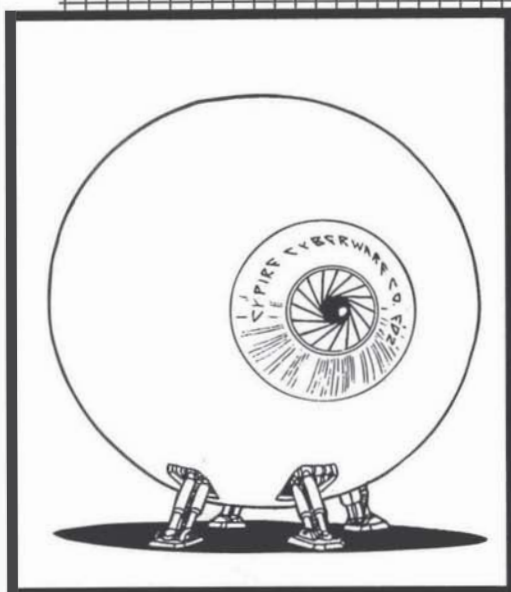

"Court the Chrome, become one with it. You need it, and it needs you. You will become stronger in the bonding."

—**Quess**

"Once you're sure you've got the Chrome on the inside then you can take care of the exterior. If you don't have the interior instinct, don't bother with the trappings."

—**Akira Takahashi**

"The quintessential 'punk needs quintessential warez. It's a necessity, chombatta."

—**Gil Myxx**

"Hey, Cyberware's just like factory options for humanity, y'know? Heh."

—**Blitz**

CYBERWARE

DYNALAR TECHNOLOGIES "DIGITS" CYBERFINGERS



The latest line of cyberfingers from the minds at Dynalar Technologies. Compatible with any standard cybernetic hand or arm; easily installed in the privacy of your own home.

QUICK CHANGE MOUNT

150EB

A handy click-and-turn mount installed at the knuckle of the cyberhand. Any Dynalar cyberfinger can be modified for use with a quick change mount for 20eb. HC=1

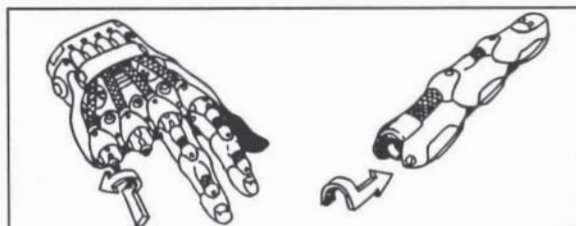

CHANGE MOUNT ▲

VIDCAM

400EB

Designed in conjunction with Kiroshi Optics, this cyberfinger contains a miniature video camera designed to transmit its input to a Kiroshi Video Imager (*Chromebook 1*, pg.39). This cyberfinger is ideal for peering around corners unobtrusively. HC=2 The vidcam can have one of the following options.

Passive IR200eb

Teleoptics (10x)225eb

Lowlite 100eb

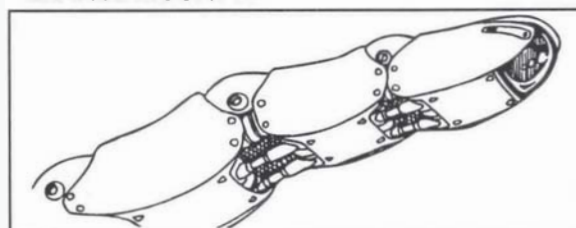

VIDCAM ▲

SELF-PROPELLED GRENADE

200EB

The first joint of the cyberfinger is a self-propelled grenade (7m range). 2D6 damage to all targets in a 2m diameter. Replacement grenades cost 25eb. each. Caution: Black market cyberware in most judicial regions. HC=2

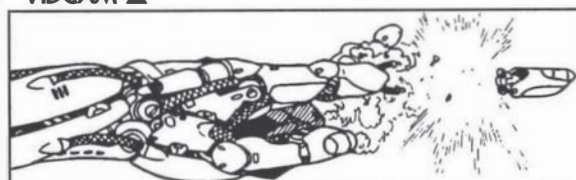

GRENADE ▲

AIR HYPO

200EB

Miniature "Bones McCoy". Drug container plugs into a socket below the knuckle. Enough compressed air for 4 injections. Replacement air containers are 3eb. each. See CP2020, pg. 112 for available drugs. HC=1

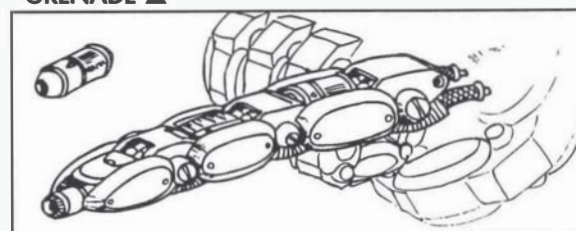

HYPO ▲

TRACKING DEVICE

300EB

Another cyberfinger designed in conjunction with Kiroshi Optics. This cyberfinger contains a tracking device with a range of 3km. It transmits the direction and distance to a TimesSquare display. This cyberfinger holds 2 magnetized tracer bugs that it can launch at targets up to 3m away. Extra bugs are 10eb each. HC=0.5

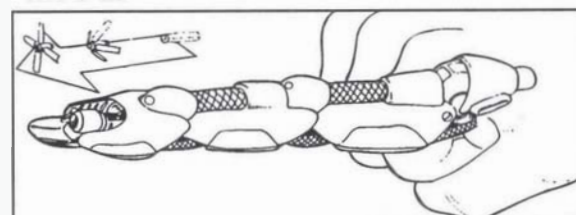

TRACKER ▲

LIGHTER

25EB

A miniature flame lighter. It has fuel enough for 2 hours of continuous use. Extra fuel 1eb/refill. HC=2



LIGHTER ▲

KIROSHI OPTISHIELD OPTIONS

There's no need for cyberoptics with Kiroshi's new OptiShield options. This line of options are exactly the same as the standard cyberoptic upgrades (2 options per OptiShield).



- Times Square 250eb
- TimesSquare Plus 500eb
- Teleoptics 150eb
- Lowlite 200eb
- Infrared 250eb
- Time/day display
(uses no options) 100eb

Game notes: See CP2020, pg.67 for descriptions; HC is at 1/2 normal. See Chromebook 1, pg.38 for TimesSquare Plus, pg. 31 for OptiShields.

WINCH 500EB

Cyberarm option. A winch is installed in the arm. The winch has a hook and a 15m cable which is driven by a powerful motor. The winch's motor is capable of pulling up to 1 ton. Uses all option spaces. HC=1D6+3.

Game notes: Of course, the user wouldn't be capable of pulling a ton without anchoring himself in some way. Muscle/bone lace or a linear frame is required to gain full use of this cyberoption. You can operate at only 33-50% of capacity without them. If the limits are exceeded, the character takes 1D6 damage and his BOD is reduced by 1 for 1D6 days due to muscle/ligament strain.

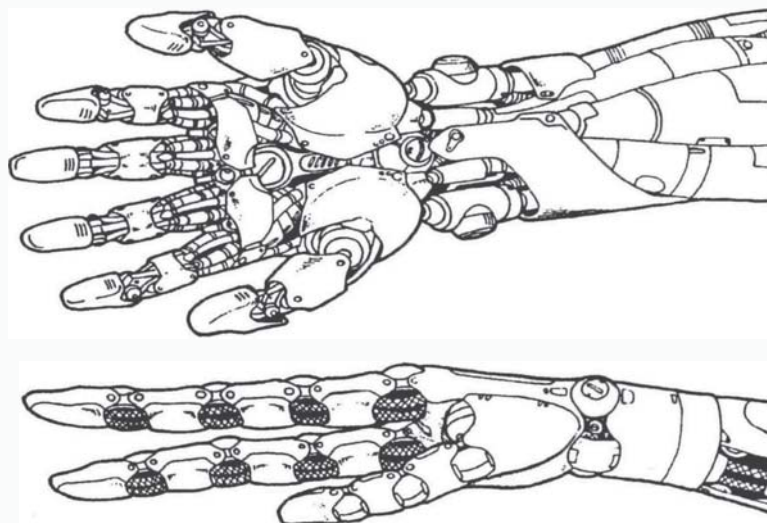

CYTECH CUSTOM CYBERHANDS 900EB

The latest line of cyberhands from Cytech includes three, four, and six-fingered hands, as well as cyberhands with joints that can bend in either direction. Do you think your cyberarm is too drab and ordinary? Cytech can help you rise above the crowd.

Game notes: The primary game effect these cyberhands have is in the realm of cyberfinger capacity. Double-jointedness gives +1 to Dodge/Escape skill attempts when escaping from bindings. Cytech offers a service to customize cyberhands, including plating the hand with precious metals and configuring the joints and fingers to specifications. The HC is unchanged. Special effects are up to the Referee.

ANCHORING CYBERFEET 400EB

This cyberleg option (uses 2 spaces) has anchoring spikes with fold-out hooks. The spikes can penetrate anything with an SP of 12 or less. These cyberfeet can be used to adhere to a surface or to avoid being knocked down. The anchor spike detaches when you wish to move again. This device can be used 4 times before the spikes must be replaced. Cost: 120eb. HC=3

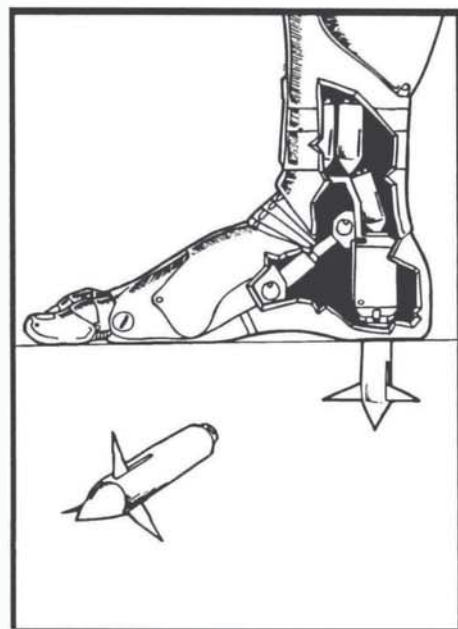

CYBERWARE

QUICKDRAW ARMHOLSTER 200EB

This cyberarm option consists of a concealed, spring-loaded holster installed in the forearm. The holster launches anything the size of a light pistol (P class concealment) or a knife into the hand of the cyberarm (adds an extra +2 to Initiative when a fast draw is declared). Uses 1 option space. HC=0

KILL DISPLAY 100EB

Sure you've got a lot of kills, but those street punks still keep hasslin' ya. What do you do? Maybe you should advertise your expertise some to get the boosters off your back. Similar to a skinwatch, a Kill Display shows in prominent glowing letters and numbers "KILLS: xxx" (any three-digit number you enter with a special key). The display can be any size from 2" X 2" up to 6" X 6" and placed anywhere. The actual number displayed is on the honor system, but if they have any doubts as to the veracity of the total, why don't they ask you, eh? HC=1, Surgery: N

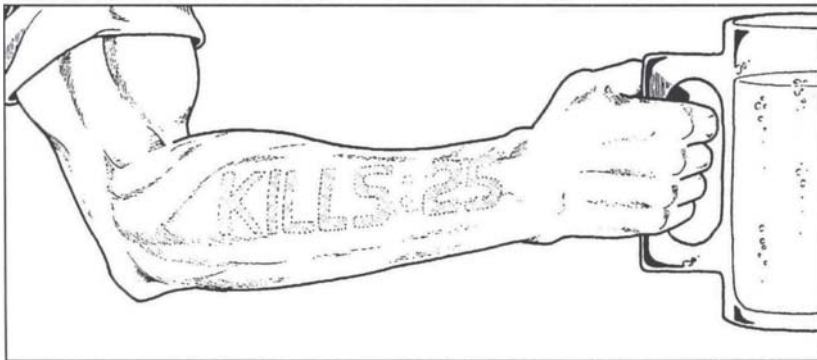

COLOR GLAND CONTROL 250EB

There's a little gland in the back of your eye that generally works only once in your life; changing your eye color from blue (the color ALL human babies' eyes are) to your adult

color six to eight weeks after birth. With the color gland control unit (a small electrical unit which stimulates the gland's functioning), you can change the color of your eyes to almost every color in the spectrum without having to have cyberoptics. The shift takes 1D6 minutes to affect and the colors must be pre-programmed in. HC=1, Surgery: M

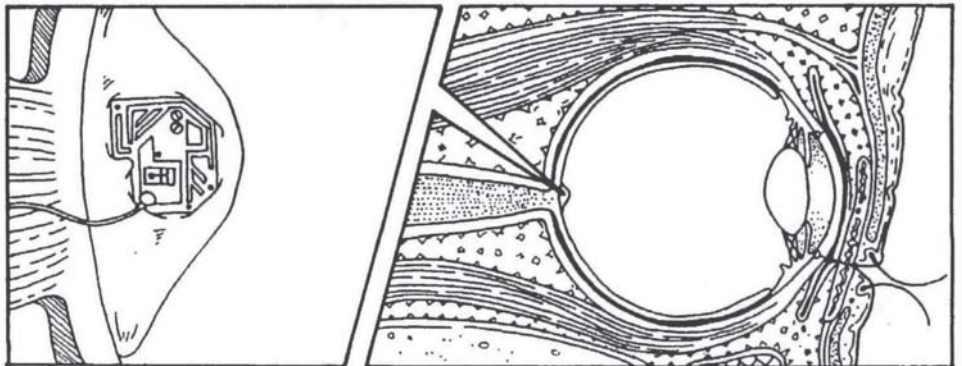

TRI-DART LAUNCHER 300EB

CYBER Three dart launchers are installed between the knuckles of the cyberhand. Each launcher contains 1 dart that will inflict 1D6/2 damage (armor is at 1/3). All three darts may be fired simultaneously or separately. They are silent, and can be poisoned or drugged. HC=1D6/2

WETDRIVE ACCESS LINK 200EB

This co-processor will allow the owner of a Wetdrive memory unit to mentally link to the wetdrive memory without external interface cables, calling up information as desired. The information is not "known" as with MRAM chips, but has to be called up exactly like a computer. A character is essentially "studded in" when accessing and as such, is relatively helpless. HC=1D6/2, Surgery: M



GRADIATED SUBDERMAL ARMOR (TORSO)

Adapted from the old version (*CP 2020*), and slightly altered to give those who prefer discretion the opportunity to be discreet about their personal

enhancements, subdermal armor can come in a variety of SP ratings and thicknesses. All require CRITICAL surgery. The Attractiveness loss is permanent and cannot be remedied with plastic surgery. The reflex penalty has been known to be removed by using high-tech orbital materials. (Approx. 8x cost for each -1 REF you want to remove at GM's call.)

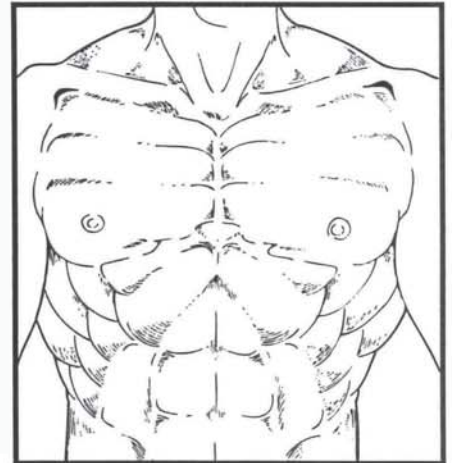

Chest (Exterior View)

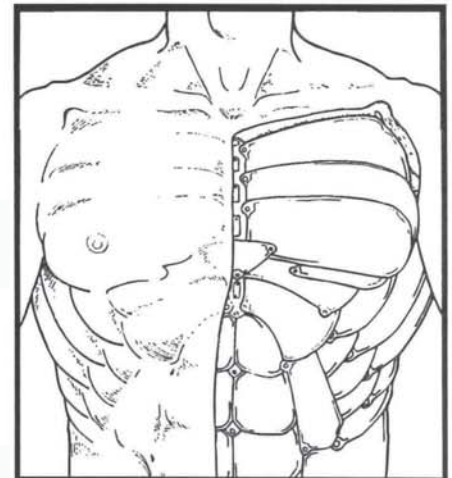

Chest (Surgical View)

SP	HC	COST	DIFFICULTY TO SPOT	ATTR LOSS	REF LOSS
6	1D6/3	350	Impossible (35+)	None	None
8	1D6/2	500	Impossible (32)	None	None
10	1D6/2+1	650	Impossible (30)	None	None
12	1D6	800	Very difficult (25)	None	None
14	1D6+2	1000	Very difficult (25)	None	None
16	1D6+3	1100	Difficult (20)	None	None
18	2D6	1200	Difficult (20)	-1(50%)	None
20	2D6+2	1450	Average (15)	-1	-1
22	3D6	1750	Easy (10)	-2	-2



SUBDERMAL ARMOR (SKULL)

Hey, your skull doesn't have any moving parts, at least not in the important places, like right over your brain! So why not get subdermal plating on your main cranium? It protects like a helmet in every way (there's a 1-4 on 1D10 chance any head attack hits an unprotected part—like your face or neck; subject to Ref's ruling). Requires MA surgery.

Game Notes: Subdermal armor on your *face* and *neck* also sounds like a great idea; right? Not so. Average skin thickness on your face is less than half an inch. Adding a 1/4 inch thick rigid kevlar weave to your torso and skull is possible, but not on your face.

SP	HC	COST	CHANCE TO SPOT	ATTR LOSS
4	1D6/3	300	Impossible (35)	None
6	1D6/2	550	Impossible (30)	None
8	1D6	750	Very difficult (25)	None
10	1D6+2	1000	Difficult (20)	None
12	1D6+3	1200	Average (15)	-1(50%)*
14	2D6	1400	Easy (10)	-1

*Chance of loss

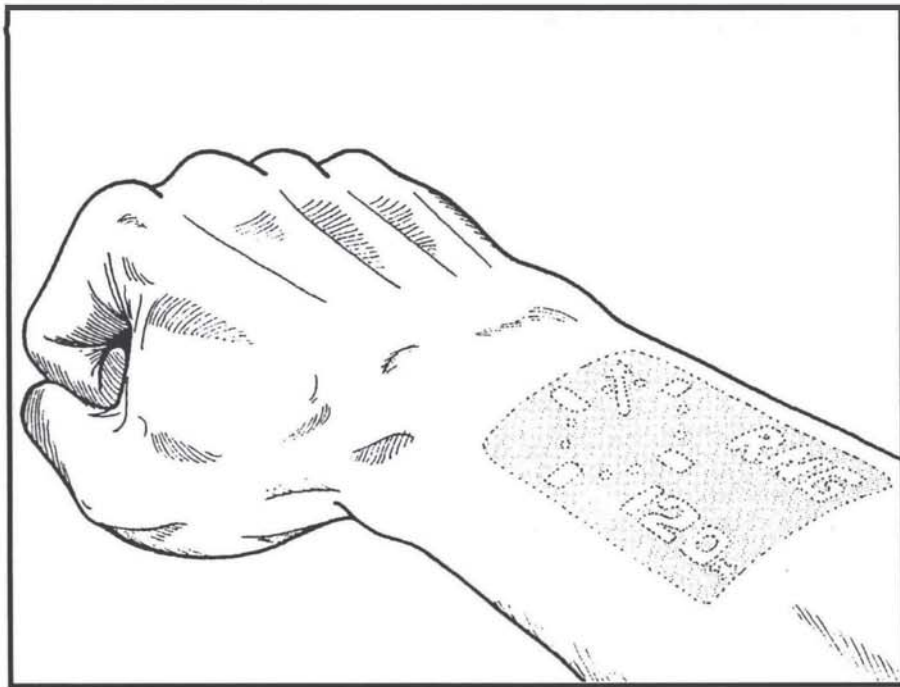

SUBDERMAL VIEWSCREEN

250EB

For those without the benefit of a standard Times Square Marquee, or any other of the multitude of readout options, a small glowing LCD screen is inserted under the flesh of an easily accesible area, usually a forearm. It can be read in bright glowing letters that pan by, showing up to five lines of type at one time. This unit will not work with Times Square Plus or the Video Imager. HC=1D6/2, Surgery: M

ZETATECH BODYCOMP 1,750EB

PERSONAL COMPUTING TAKEN TO THE LOGICAL EXTREME!



The BodyComp is the latest in microcomputing; a computer so small it can be implanted in the human body, yet as powerful as an E-Book! A unit the size of a large lighter is implanted in the torso, and links are run to the user's Neural Processor by nanomachines. Power is supplied by a pair of microfne blood turbines, implanted in the pulmonary and femoral arteries.

The BodyComp has functions and capabilities equal to a E-Book. (No chipslot, but it can read from the player's Chipware socket or a chip player plugged into an Interface Plug.) It requires Times Square Plus (or Video Imager) and Cyberaudio to operate (it can be plugged into a Kiroshi Optics HUD, but without audio). Hardened systems are available, but this option cannot be retrofitted. BodyComps can be outfitted with all CompuMods and other modifications, but the sensors are separate; they can be installed in a cyberlimb (usually taking up about 1/3 of an option space each) or carried separately and jacked in with a special cable and multi-processor (50eb). For an additional 125eb, the unit can be hooked up to a character's Wet Drive, allowing for extra memory (and an easy way to see what you're carrying).

Game notes: If the unit is not EMP hardened, a hit by a microwaver will usually (70% chance) wipe the BodyComp's memory (but not an attached Wet Drive) and will inflict an additional 1D6-2 damage in feedback and burns. HC: 1D6+4, Surgery: MA

NANOOPTICAL UPGRADE

1500EB

For those of you loathe to replace your natural orbs, you can have specialized Nanosurgeons rebuild your retinas and optic nerves for a song! These nanosurgeons work ONLY on natural eyes. They give the character capacity for Infrared and Ultraviolet spectrum pickup and allow +2 to night vision.

Game Notes: Reduces darkness penalties; see CP2020, pg.32) The process takes 1 week and the character is blind for 5D10 hours after the treatment (blindness begins 2D6 hours after injection) due to the fact that the nanosurgeons are taking your retina apart and rebuilding a partially fiber-optic coated LCD latticework into it. HC=1D6/2, Surgery: N

RETRACTABLE VAMPIRES

Created on request by Sycust several times, the resulting patents were transferred to a subsidiary mass-pro uction cyberware company, Cyphire Cyberware. The entire upper and lower jaw must be removed/rebuilt with new spring housings inside. Extended bite versions are also available, modifying the jaws to open wide enough to stick a baseball in comfortably. All retractible teeth are between 3/4" and 1" long. **Note:** extended bite=knife for AP effects.

- Retractable vampires or shark-grin: Cost: 500eb, HC=2D6+2, Surgery: MA
- Extended Canines (1D6/2+1 dam. due to deeper bite): Cost 1000eb, HC=3D6+2, Surgery: CR
- Sharkgrin Special Extended (1D6 dam.): Cost: 1400eb, HC=4D6, Surgery: CR

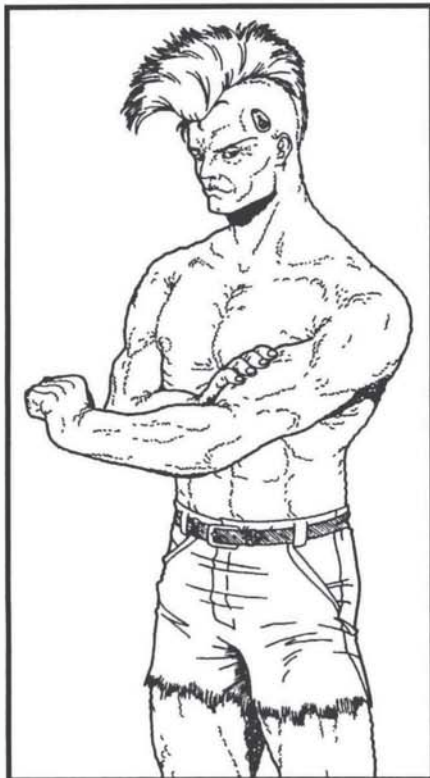

TOTAL BODY PLATING 6,800EB

This is a fully-armored exoskeletal "shell," with no internal reconstruction. The entire body is covered in a damage-resistant, hybrid ceramic material which is porous so that the body can breathe. The **entire** body receives SP20 armor (and is gas/flash-resistant due to filters), but suffers a -3 to REF. -1 to Stealth. Nanotechnological micromachines heal penetration damage to the armor at the rate of 1 point per day. Total body plating is very obvious, making the cyborg look like a metallic or plastic person (visual features and effects vary). Appearance reduced by 1/2; can be regained by body sculpt/design. Because of the nanotech support mechanisms, this form of 'plating can **only** be done to the **entire body**. HC=8D6, Surgery: 2xCR; yearly maintenance 680 eb.

REMOTE EYE 1 500EB

A strange and particularly disturbing idea created by the Cyphire Cyberwear company. Upon internal command, the eye *detaches* and can be placed in a small mount with magnetic and velcro feet (standard equipment that comes with the eye). It then transmits back to the user as if he/she were seeing from that position! You must have a receiver set or Video Imager in your other eye. Only ONE option space is open for the Remote Eye. Transmission range is 100 meters. HC=3D6 per eye, Surgery: MA

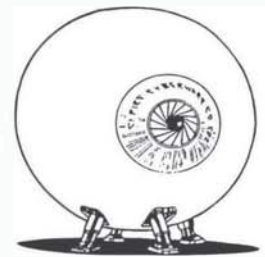

UPGRADED SKINWEAVE

Skinweave of lighter or tougher stopping powers is available almost everywhere standard skinweave is found. Below are costs and HC for differing armor values. Also listed is the Awareness difficulty to notice the skinweave. Attractiveness loss cannot be remedied with bodysculpting, because the woven skin looks and feels like tough rubber or plastic.

Skinweave can be upgraded to different levels at the full cost of the new level. (e.g., you have 8SP and want 12SP, you pay full 12SP price) Remember, skinweave cannot be downgraded or removed without undergoing a treatment equal in price and time to the original treatment, so choose carefully!

SP	HC	Cost	SPOTTING CHECK	ATTR LOSS
6	1D6	1000	Impossible (35+)	none
8	1D6+1	1250	Impossible (30)	none
10	1D6+3	1600	Very diff. (25)	none
12	2D6	2000	Difficult (20)	-1(50%)*
14	2D6+2	2400	Difficult (20)	-1
16	2D6+4	2750	Average (15)	-2

*Chance of loss

EQUIPMENT

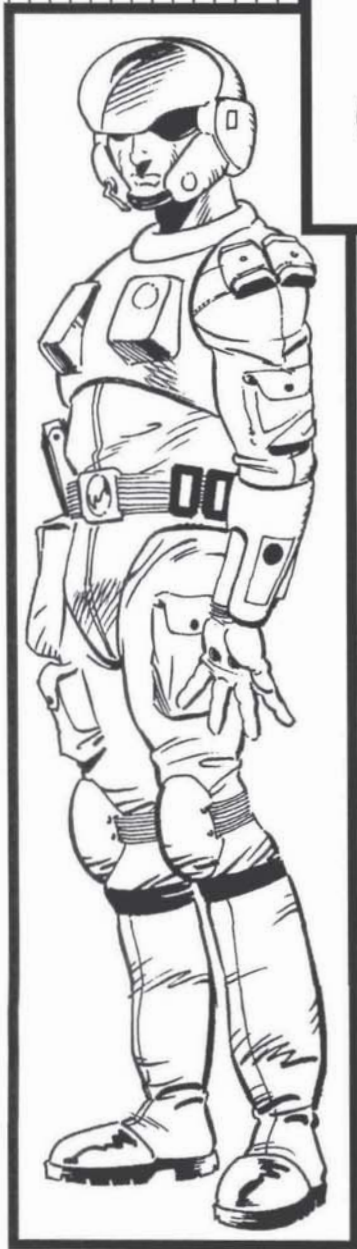

“Whatever you need, you can find it here. The latest Chromebook has all the necessities for the street. There’s crucial programs for the Netrunners. For all the Rockerboys and girls there’s rhythm boxes and programmable axes. The deadliest of weapons are available for the Solos. New Campods for the Medias, and streetlethal corpwear for the executive with an attitude. If you’re a Cyberpunk, then you need Chrome. If you have the Edge on the inside, then you need the meanest Edge that euro can buy on the outside.”

**—The Chromebook,
downloaded for June, 2020**

“Hey, can you spare some euro for a fellow ‘punk who’s down on his luck?”

**-The Bogie, leader of the
Bogarts poser gang**

BIOTECHNICA NUTRISUPPLEMENT 1 OEB

This nutrient-rich drink produced by Biotechnica will provide alternative sustenance for those who don't have time to bother with food. The Nutrisupplement will not only provide all essential vitamins, it will also negate hunger. Just drink one bottle of Nutrisupplement a day and you won't need any other sustenance. Comes in a variety of flavors. Weight 0.5kg.

Game notes: The Nutrisupplement can only be used for a week at a time, because it does not sufficiently meet all of the body's requirements. After that time, the character will lose 1 point of BOD every week.

BIOTECHNICA**NYMPH PERFUME 200EB**

Finally a perfume that goes beyond the aesthetic. Our new Nymph perfume contains special pheromones that will stimulate the sexual centers of the brain. Any member of the opposite sex that inhales your scent will instantly become attracted to you. Available in fragrances for men and women. Nymph perfume is the closest that Biotechnica has come to a love potion.

Game notes: +2 to the use of Persuasion/Seduction skills against members of the opposite sex.

GEOTECH**ENVIROSCANNER 400EB**

This compact, hand-held unit is capable of detecting and indentifying the level and direction of radioactive and biological contamination within 7m. The Enviroscanner also provides a constant reading of the purity of the oxygen in the area. The scanner has an auditory warning system, so there's no need to constantly monitor it. The scanner has an AC adapter and a rechargeable 12 hour battery. Weight 1kg.

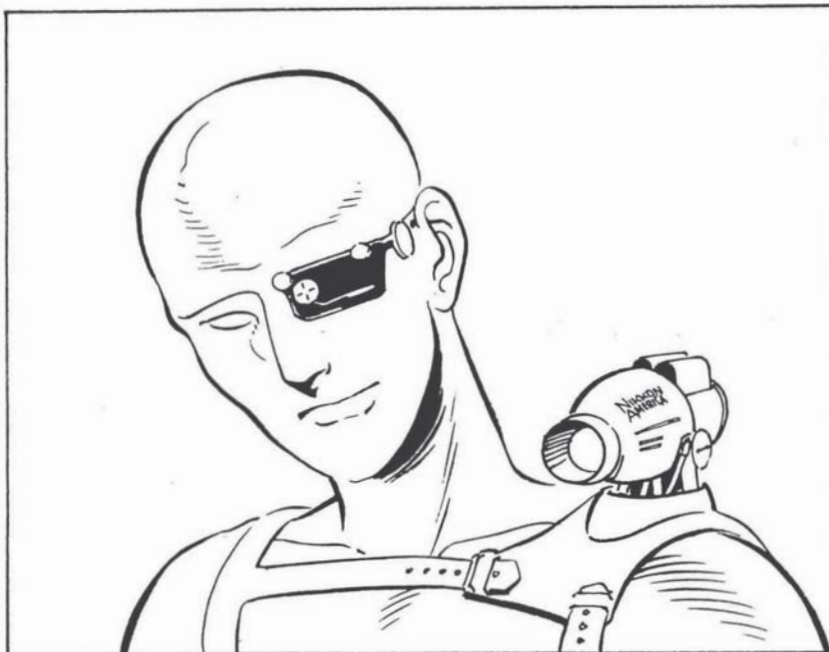
NIKON AMERICA CAMPOD 1,000EB

Nikon's new Campod isn't the old head-mounted variety; it mounts on the user's shoulder. The user wears a cordless viewfinder monocle that displays the Campod's input. If the user turns his head then the Campod will automatically follow his view. It may also be left in a fixed position while the user looks elsewhere. Since the viewfinder is cordless, the Campod may be detached from its shoulder harness and left somewhere or used to look around corners. The Campod is ideal for field reporters on the trail of a hot story. It has a rechargeable battery with a life of 12 hours. Weight 2kg.

Game notes: The cordless viewfinder has a range of 15m. The Campod is made to take quite a beating, so it has an SP of 8.

EQUIPMENT



SECSYSTEMS PROTECTION FIELD 750EB

Rockers! Tired of being mobbed by overzealous fans? Try SecSystem's Protection Field on for size. The Field consists of a thin, lightweight harness that is worn under your clothing. The device emits a high-voltage static field in a 2m diameter. If anyone comes within range they will receive a mildly discouraging shock (no damage, make Average COOL to approach again). If they come within 0.5m they will receive something much more considerable (1D6/3 damage, Difficult COOL roll). The Protection Field does not affect the wearer. (The same cannot be said for any electronic devices he might be using at the time. Effects are at GM's discretion.) The batteries hold enough power for 5 hours of continuous use. Replacement batteries are 6eb each. Weight 1.5kg

MEAD ELECTRONIC NOTEBOOK 860EB

This souped-up lapcomp has 6MegB RAM, a 30MB hard drive, a full page color display, an internal cellular fax machine, a digital dictating machine, and an external hand scanner for copying documents or pictures into memory. It is very durable (SP=4), and has an AC adapter and a rechargeable 12 hour battery. Weight 2.5kg.

DATATEL 2350A VIDPHONE 150EB

More than just a phone, the Vidphone sends visual images as well. This model Vidphone has a call screening feature, a focus and zoom control, a built-in fax, and an answering machine. **Game notes:** Vidphones come in a variety of sizes; they can be as small as a laptop, or they can fill a whole wall (400eb).



MICROTECH VIRTUAL REALITY BBS 10,000EB

Tired of tying up the memory in your own deck for a virtual reality? Now you have an alternative. Microtech's VR-BBS is a cybermodem specifically designed for use as a Virtual Reality generator. This cyberdeck has a specialized Creator program that makes it easier to generate a virtual reality. When using the specialized programs treat the realism multipliers as being 1 level less. Weight 8kg.

Game notes: (MU40, Speed +1, Data Walls +3, only 10MU can be used for active running, the rest is VR storage.)

FROSTECH PORTABLE CRYOGENIC CASE 250EB

The Frostech CryoCase is a 2'x 2'x 1' case that is ideal for moving and preserving organs and tissue. Perfect for body bank couriers or Trauma Team members, the CryoCase can maintain and preserve human tissue for up to 12 hours. It has a 24 hour rechargeable battery, and may also plug into any standard outlet. The CryoCase is highly durable and damage resistant. Weight 2kg. **Game notes:** SDP=5, SP=10

PORTABLE ELECTROPACK 100EB

This is a hand-held power pack that can provide 6 hours of power for any 110 volt device. The recharge pack itself is rechargeable. It reaches full charge in 2 hours. Now you can make any of your appliances fully portable. Weight 2kg.

KIROSHI OPTICS REMOTE CYBERCAM 20 350EB

Perfect for surveillance or security, the remote CyberCam is designed to work in tandem with Kiroshi's Video Imager cyberware (*Chromebook 1*, pg.39). The CyberCam sends its video image directly to the Video Imager. This is perfect for being in two places at once. The CyberCam is about the size of a fist and has a range of 2km. It can be plugged into any standard outlet and also has a rechargeable battery with a 24 hour life. Weight 1kg.

SECSYSTEMS DETENTION COLLAR 260EB

No need to worry about troublesome prisoners with SecSystem's Detention Collar. This highly durable collar locks into place around the prisoner's neck. You hold the remote for the collar which can cause it to deliver a considerable shock (1D6/2 damage). Or it can deliver a dose of a paralysis or relaxant drug (Difficult BOD check to avoid effects, unmoving/unconscious for 1D10 minutes otherwise). If the prisoner moves beyond the range of the remote (10m) the collar automatically delivers the shock and/or the drug. The collar has a rechargeable battery with a 48 hour life; 5 drug doses can be injected. Weight 0.5kg.

DDI PRAYERWARE 120EB

Because God can't wait and you shouldn't have to! Times and technologies change. Like everything else,

Religion has been forced to adapt. In the old days, people had time to spare to visit places of worship. Today's rushed lifestyles leave little time for the pleasures of spiritual renewal. Now, Digital Divinity Incorporated brings the House of God to you. Each wallet-sized PrayerWare unit instantly connects its user to an ordained minister of the user's faith.

The small video screen allows for personalized religious guidance. DDI's patented PrayerWare is approved by the World Interfaith Council.

"Once, when I was pinned down in this alley, I used my PrayerWare to call my priest for spiritual help. And help me he did—'specially when he showed up with the Holy Fathers of the Perpetual Railgun to save my heathen soul. Religion sure can be a comfort to a believin' man.

—Ripperjack

SECSYSTEMS MAGLOCK 300EB (+80EB FOR CAMERA)

If you find yourself spending the night in an unsafe place, then you need SecSystem's new Maglock. This durable, portable magnetic clamp lock is usable with any door. As an option, it can have a fiberoptic camera that allows you to see what's on the other side of the door. The fiberoptic camera can run off solar power or a rechargeable 12 hour battery. There won't be any nasty surprises with the SecSystems Maglock. Weight 1kg.

Game notes: SP=15, Difficulty level to break through =25+

EQUIPMENT

COMPUTERS & PERIPHERALS

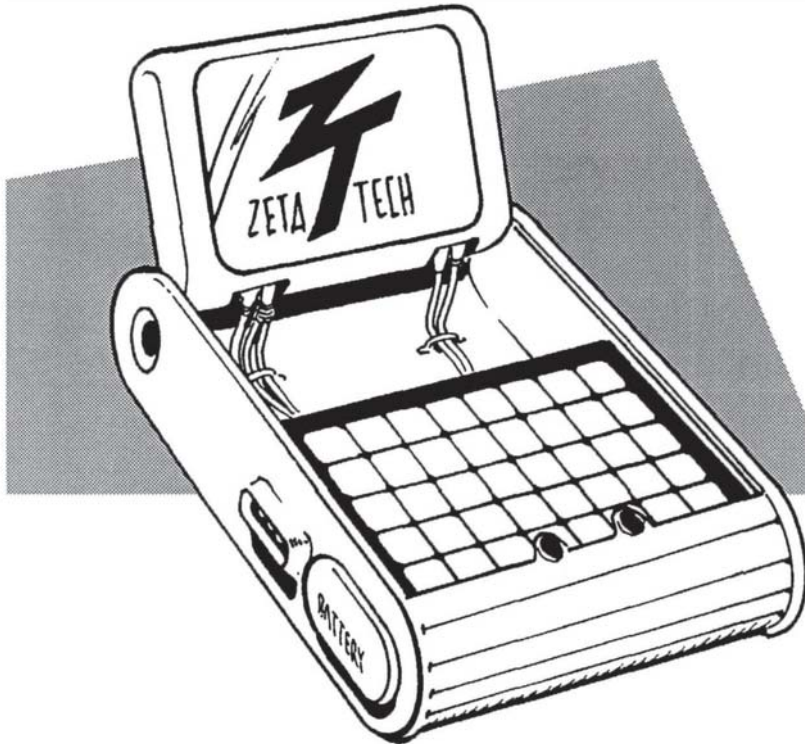

ZETATECH "E-BOOK" MICROCOMP 100EB

Maximum data, minimum bulk!

As important as a wallet, as common as a wristwatch, Zetatech's E-Book series (and hundreds of other models from a host of competitors) can be found almost everywhere in 2020. The E-Book is a 15.4cm by 7.6cm by 1.3cm pocket computer with a keypad and one chipslot, housed in a hardened ceramic housing (designer colors are available). Able to function for 5 hours before its batteries need to be replaced, this entirely portable system uses a liquid crystal processor (a CPU with an effective INT of 1) boasting 12MU of programmable memory. The liquid crystal CPU can run one program at a time, but netrunning is impossible with an E-Book. The chipslot can accept digital audio chips as well as standard datachips, and it can even process video (although the screen is a bit small for this.) A cybernetic version is available for a 40% increase in price (140eb), and adds +2 to any INT/TECH skill roll. Capable of accepting a multitude of attachments, many custom versions can be found on the street, functioning as bug detectors, encryption units, biomonitors and codebreakers. Perfect for the edgerunner on the go!

EBM "PCX"

MINICOMP 900EB

Still the most powerful, still the most popular!

This common portable system is housed in a lightweight impact-resistant plastic casing (available in several colors) with a folding handle for easy transport, and the entire package measures 5.1 cm by 35.6cm by 51 cm and weighs one kilogram. It can run off house current or an internal 2-hour rechargeable battery. The processing core of the PCX is a multitasking superchip (treat as a CPU with an INT of 2) driving a 25 Memory Unit storage bank. The superchip can run two programs at a time, but this unit cannot be used for netrunning. The unit's dual datachip ports can accept and play any kind of digital chip, allowing the PCX to double as an audio/video player. The touch-sensitive keyboard and high-definition screen can be folded away for transport, or removed to be replaced with other peripherals. EBM also markets a factory-standard cybernetic-interface version of the PCX, available for a 40% increase in price (Cyber-PCX is 1200eb and adds +1 to any INT or TECH skill rolls that can be computer-assisted). Arguably the most popular laptop model computer in the 21st century, EBM's PCX series still has some competition from similar products marketed by Microtech, ARC, Mitsubishi and others. Just about every home has a minicomputer like this one, and many a sweatshop and underground weapons factory have made use of these babies as well!

EQUIPMENT

MICROTECH IIKL-4 WORKSTATION 1200EB

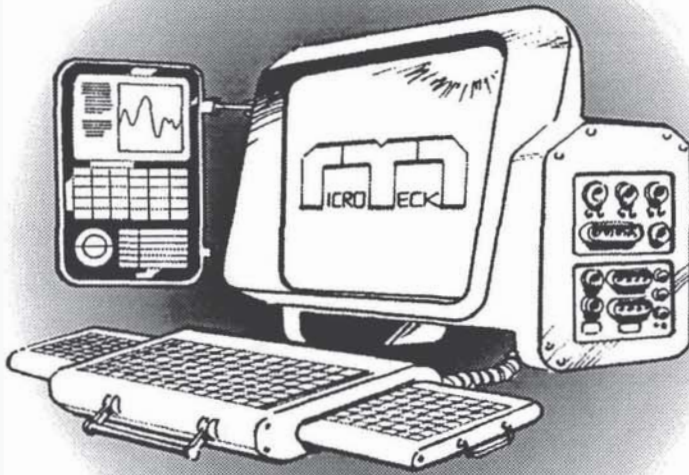

Mainframe power on your desktop!

Considered by some to be the most versatile personal computer on the market today, the IIKL uses an advanced optical 90689 multiprocessing chip (treat as INT 3) as its processing core, making it one of the most powerful personal computers on the market today. With 40MU and the ability to run up to three programs simultaneously (No, you can't use this one as a cybermodem either, poser.), the IIKL is popular for high power CADaM and illustration. With two chipslots, ports for Two SCSI-4 chains and on-board protocols that can read and write data for audio, video, and braindance chips, the IIKL is also popular

with underground recording studios, as it can control the entire studio through its MIDI port, and encode on up to 20 chipreaders at once! The IIKL comes with a 2'x2' video board, full stereo output and an extended keyboard. A cybernetically controlled version is also available (+40% to cost), as are a wide number of peripherals. **Note:** the IIKL is about the size of a modern desktop computer...it's portable, but only in a large case. Very common in pirate radio stations, underground studios and publishers.

TELECTRONICS "BLACK BOOK" MICROCOMP 250EB

The portable police processor that puts perps in their place!
Designed as a compact computer system for urban patrol officers, the Black Book is the size and shape of a common pocket computer, and can be found on the hip of almost every 2020 cop (sometimes it is built into the dash of a patrol car). The Black Book has all the capabilities of a standard microcomp (see Zetatech's E-Book, page 14), and is packed with police modifications. It has a cellular communications link for immediate access to police Net-based databases. Its left side has a slot for reading the magnetic strips of driver and weapon licenses, and the front end has a heat-sensitive optical scanner for fingerprint identification. The small videoscreen can be used to call up criminal records, and a tiny laser-printer can be used to run off a ticket or summons in seconds. Although the Black Book comes chipped for interface, it has a small keypad as backup. Housed in a nearly-indestructible kevlar frame, the Black Book can withstand a hit from a .357 Magnum (SP15) and is also shielded against microwaves and EMP!

LANGUAGE

PROCESSORS

Bring your system into the 4th generation!

Microtech is now offering aftermarket retrofits for any and all computer systems, allowing them full voice recognition and language comprehension ability. Take your unit to your nearest Parts N' Programs, and for 40% of your computer's original cost, you can do away with keyboards and protocols entirely! **Note:** Microtech markets its own versions of the PCX and E-Book with these processors already included (cost is only 20% more than normal). The processors can also be bought separately and installed in 1D6/2+2 hours on an electronics roll of 25.

EQUIPMENT

WORLD SAT COMMUNICATIONS

FLOPSCREEN™

**400EB
PER
SQ.
FOOT**

MOLECULAR

memory for versatile video!

WorldSat takes advantage of recent advantage in memory plastics and fiber-optics to bring you the Flopscreen. The

Flopscreen operates exactly like a videoboard when unfolded, but it can be rolled up and stowed in a pocket, or what have

you. It has small adhesive surfaces on the back which allow it to be stuck onto a wall or floor (or

ceiling) for display when connected to a computer. The Flopscreen can

even be used while hanging on a rack or piled in a heap, although image distortion will occur.

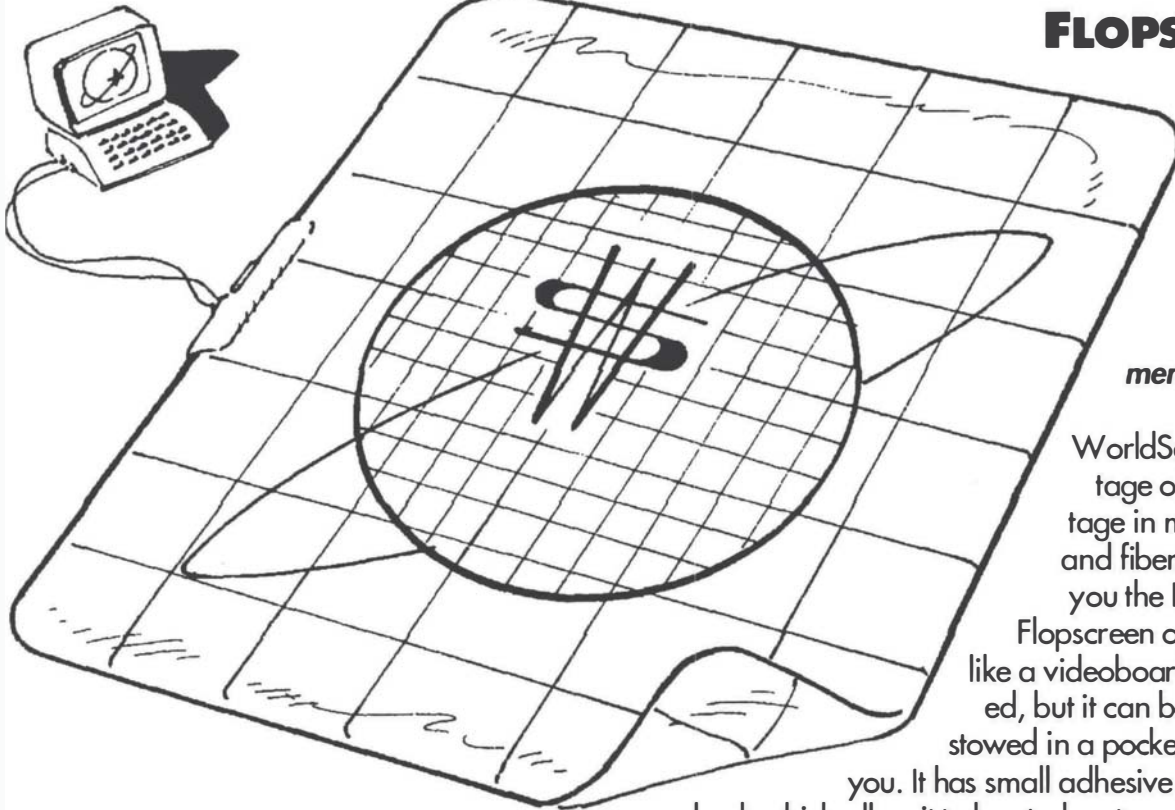

DIRECT DATAWARE EXPERT SERIES COMPUTER

SKILL PROGRAMS

These programs come prepackaged in small plastic boxes, complete with an instruction booklet and software stored on standard datachips (1 MU per chip, each skill level uses one MU). Because of their MU size, the programs must be stored on a computer's memory unit to be usable. These skill programs will add to the user's INT skills, but they take time to run (one second per level of skill), unlike MRAM skillchips. Skill programs available include *Accounting, Anthropology, Botany, Chemistry, Corporate Policy, Diagnose Illness, Expert* (subjects vary), *Geology, History, Language, Library Search, Mathematics, Physics, System Knowledge, and Zoology*. **Note:** Desktop computers can also run Netrunner Utility programs (which function and cost as described in the *Cyberpunk* rulebook), Visual Recognition Chips (*Chromebook 1*, pg. 76), and can even store small virtual realities! Base 200eb for Level 4, +100eb per added +1 up to Level 8.

DATATEL "TREASURER" DATAWATCH 55EB

Elegantly styled, finished in gloss black, the Treasurer is an environment-proof 26-function digital watch (calendar, world time, stopwatch, lunar phases, thermometer, pressure gauge...) which contains a high-density storage microchip (1 MU). Capable of being connected via fiber-optic cable to any computer, the Treasurer can be used to store sensitive data in a very safe spot. Note that this datawatch cannot run skill or utility programs, because it has no processor.

TRITECH DATASHIELDING (20% COST OF COMPUTER)

Makes electronic warfare a thing of the past!

Tritech now offers datashielding as an aftermarket option for your computer system. By replacing the housing of your unit with a lead and hybrid alloy frame, and hardening sensitive electronics, your computer can be made immune to the effects of EMP, Microwaves, and Tempest equipment. This service can be performed at your local Parts N' Programs (or in 1D6+2 hours on an electronics roll of 25).

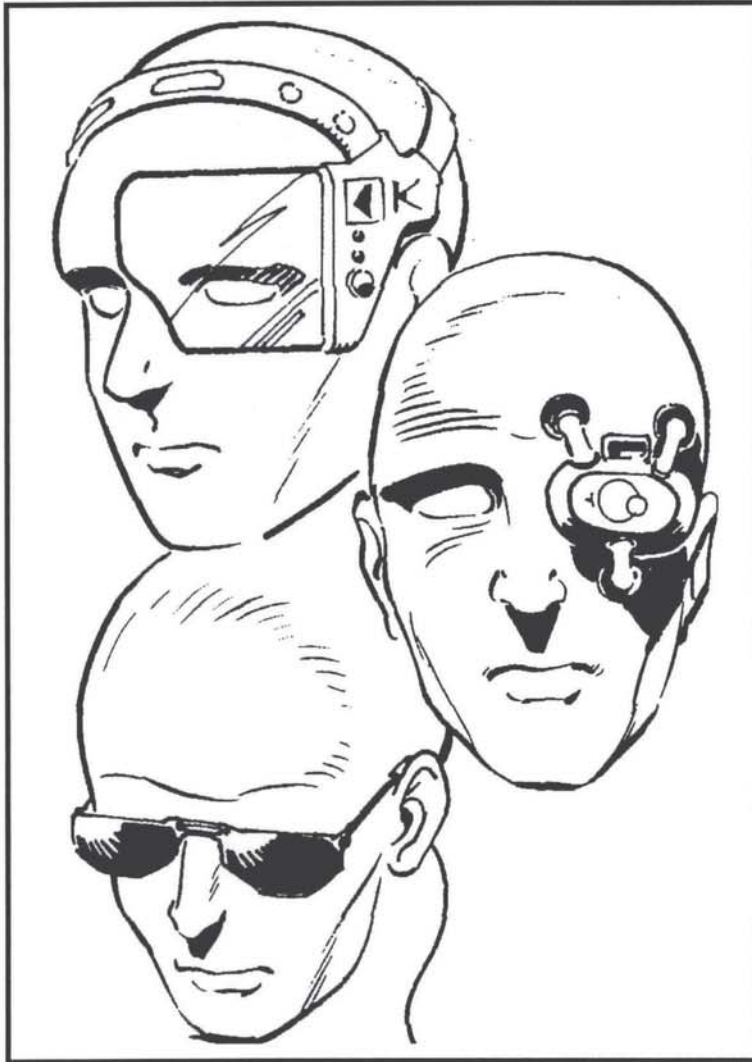

KIROSHI OPTICS HEADS-UP DISPLAY (150EB FOR GOGGLES, 200EB FOR MONOCLE)

Kiroshi's Heads-Up Displays can be connected to any computer system for totally accessible visual readouts. Both the headset and monocle models display a color image in the user's field of vision, but do not obscure the outside world. This allows full access to computing power without requiring the user to look away from what he is doing. Endorsed by Trauma Team medics (who connect heads-up monocles to their medscanner units) as "a life saver." Also useful for technicians, surgeons, assembly line workers, and many others who need to have access to visual information while keeping track of their task. The display reduces Awareness skill checks by -3. A special version of the Heads-Up Display is available for corporate security operatives (and on the black market) for 300eb: a heads-up display which looks exactly like a pair of mirrorshades. Connected to a pocket computer by a tiny wire from the earpiece, these will pass casual inspection (Awareness vs 20 to spot wire).

DATATEL MODEM UNITS

(OPTICAL FIBER LINK 200EB, CELLULAR LINK 1200EB)

For the ultimate in universal access, Datatel's modems are what you need! By adding on a cable jack or cellular transmitter, your computer can connect with the Net and access databases, bulletin boards, the DataTerm network, Infocomp services, and an almost infinite selection of electronic media. Pay-per-view videos, electronic publishing, games, online rocker jams, and across-the-world shareware are all yours for the taking with this aftermarket add-on. **Note:** even if your computer is chipped for interface, you still cannot perform netrunning with this unit. Buy a cybermodem already!

EQUIPMENT



ZETATECH COMPUMODS™

STERIODS FOR YOUR COMPUTER!

Now you can modify your computer to suit your lifestyle! Worried that the junior manager in the next office has bugged your desk? You need a CompuMod. Does your genetically-tailored pet seem sick? You need a CompuMod. Is that pesky electronic lock holding up your black op? CompuMod. These computer modification packages are interchangeable, cheap, and completely legal in most states! Usable with most laptop or pocket computers.

Voice Stress Analyzer Package (200eb): This package includes a 3MU program and a tiny microphone add-on. Adds +2 to *Human Perception* and *Interrogation* after appropriate sampling of the unstressed voice.

Lie Detector Package (400eb): This package includes a 3MU program, a sensor pad, and a tiny needle probe. Attach the sensor and probe to the informant's arm, and red or green lights will go off. This heart rate and blood flow analyzer has 65% reliability. Use of the Voice Stress Analyzer in conjunction raises the reliability to 75%.

Bug Detector Package (200eb): This package consists of a 2MU program and a signal scanner add-on. It will detect and locate line taps and bugs (if they are transmitting) in a 6m radius with 80% reliability.

Bug Jammer Package (200eb): This package consists of a 1MU program and a transmitter add-on. Broadcasting electronic noise over a wide band of frequencies, it overrides any signals a bug may be sending. Operates within 10m radius; 80% reliability.

Radar Detector Package (150eb): This package consists of a 2MU program and a signal scanner add-on. This package will emit a beep if it detects any radar signal, and locates the source. It is 60% reliable.

Signal Tracker Package (300eb): This package consists of a 2MU program and a signal scanner add-on. The highly sensitive handheld scanner will search out signals sent from line taps and bugs (if they are transmitting), following them to the listening source with 80% reliability.

Medscanner Package (250eb): Consisting of a 5MU database and a compact array of sensor add-ons; this package gives readouts for body temperature, heart rate, blood pressure, respiration, and blood sugar levels. The chipped database adds +1 to your *Diagnose* skill.

Techscanner Package (250eb): Including a 5MU database and an assortment of circuit tester and computer-linkage jacks, this package can be hooked up to the diagnostic systems of most vehicles, appliances and personal electronics to determine possible problems and troubleshoot break-downs. Reliability is 60%. On a successful roll, the difficulty of the task is reduced by -3. (You know what's wrong; you just have to fix it.)

Drug Analyzer Package (75eb): This package includes a 4MU database and an intelligent multi-analysis sensor port. It will determine the purity of a drug with a known composition, or identify the molecular makeup and possible effects of an unknown substance that is similar to a drug already in its database. Reliability is 75%. Popular with cops—they add it to their Black Book microcomps.

Credit Transactor Package (250eb): Consisting of a 1MU program and a special chipslot, this unit can be used to make electronic money transactions to and from bank accounts. (A modem of some kind is needed to do this.) Although technically you must have a legitimate business license to have one of these, a fixers can usually manage to get ahold of one for his pocket computer (*Streetwise* or *Streetdeal* vs 22).



HYBRID™ WEARABLE COMPUTER 1000EB/1400EB CHIPPED

Blurring the line between body and machine!

Mitsubishi and Raven Microcyb takes portability to the ultimate level with their new Hybrid™ line of wearable computer systems. The standard model functions as a portable computer (see EBM PCX, page 14), but is worn over the shoulders and around the waist. The 25MU memory storage is housed on the shoulders, along with the battery pack and backup solar cells. A specially-arranged keyboard is arrayed around the waist along with a flip-down display screen, keeping the user's hands free when the keyboard isn't being used. This section can be removed and replaced with heads-up displays and voice-recognition or cybernetic operating systems for total hands-free operation. This remarkable 2.1 kg system is housed in a lightweight impact-proof plastic casing (available

in several stylish color schemes), and is popular with reporters, medics, and warehouse inventory personnel. There are many models tailored for specific applications, such as an over-the-shoulder unit with a barcode optical scanner on the forearm (used for inventory purposes) and a flip-down mirror for using the liquid-crystal display screen. Another special version is the Hybrid MedicWear, which does away with the waist component and instead uses a language processor core and a set of heads-up display goggles with headphones, a vocal pickup mike and a digital video recorder. An armpack contains a track-ball and body sensors, while the back unit houses a satellite link for communication with hospitals. The MedicWear costs 2,500eb, and functions as a Medscanner as well as a portable computer.

MEDICGEAR COMBAT

MEDICAL ARMOR 3400EB

Lifesaving protection!

Utilizing the latest in computer, medical, and armor technology, MedicGear by Body-weight Systems is designed to assist medics everywhere. Endorsed by Trauma Team, Inc. and the Night City Search and Rescue service! MedicGear starts with SP20 hard-shell armor, then starts loading on the goodies. Incorporated into the structure is a Hybrid MedicWear computer, with a few additional functions. Sensors and software are added that allow it to function as drug analyzer and a techscanner (see appropriate CompuMods), giving you the ability to see just what he's on, and what cyberware he's got! A drug injector is built into an extending stalk on the left arm (5 doses each of 10 different drugs are stored in the wrist/forearm assembly. A pack on the waist includes various pressure bandages and other supplies, as well as a mask and small cannister of oxygen (about 30 minutes worth). A sprayskin applier is mounted on the right wrist, and a dermal stapler is also available. For extreme cases, the palms of the gloves can be electrified, allowing them to be used as a resuscitator (they can also be used as a taser, at -2 to hit). Enough charge is carried for 3 attempts. A number of storage pouches and cargo containers are available to allow the medic to further customize his load. Finally, an anesthetic gun can be mounted alongside the right wrist (or on the right hip), allowing you to knock out especially unruly patients! (Treat as p-1135, CP 2020, pg.52, but 1/2 range, 8 shots, and ACC 0. Usually loaded with anesthetic/sleep darts.) Medic gear has an EV of -3. It adds a +2 to all "on-the-spot" medical rolls, due to the wealth of information and tools available.

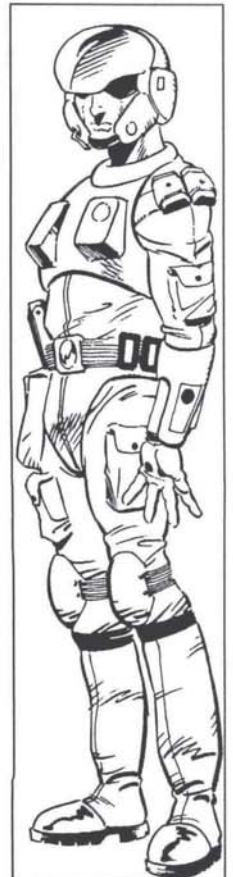

SECURITY SCANNERS & EQUIPMENT

TELECTRONICS TATTLETALE® VOICE STRESS ANALYZER 200EB

Your very own pocket-size snitch!

This hand-held unit registers minute changes in vocal patterns and tones and cross-references them with preset parameters. Once the unit has sampled the subject's voice while he/she is telling the truth or is un-stressed, it will recognize variations in vocal modulation. The unit is the size of a pack of cigarettes, and uses a small screen to display the vocal deviations, thereby adding +1 to the user's *Human Perception* and *Interrogation* skills. An interfaced version (250eb) can display through Times Square Marquee, so that the user would not need to have the unit out in the open as long as it was chipped into his/her plug (works best with wrist plugs).

CCI BRL-3014

WINDOW TREMBLER 120EB

Handiest vibrator ever. (NOT!)

Tired of people listening in on your conversation through the windows? Sick and tired of people using laser-mikes to record everything you say? No problem. The window trembler (by the nice folks at Communications Control Incorporated), is a small device that when stuck on a window (using the re-usable adhesive patch on the back), will set up a microscopic vibration in the glass (or plexiglass, or armoracry...) that effectively scrambles the vibrations that a laser microphone uses to "hear" you. So you can speak with candor over dinner, thanks to CCI!

ARASAKA "KOMAKU" LASER MIKES 250EB (350 FOR FIXED VERSION)

Can't get in to drop a microbug? Have they got a window? No problem. With the new Komaku laser-transduction microphone system, you can hear them as plain as day! The Komaku bounces an ultraclear low power laser beam off of the window, picking up the vibrations made by any conversation. A powerful CPU then translates these vibrations back into human speech. The Komaku is so accurate that you can tell accents, tone, and even shadings in speech patterns. Three versions are available. The first is stylized to resemble an indeterminate polymer one-shot, and has a range of 50m. The second is capable of being mounted on a wall or ledge, has a 4 hour recorder built in, and has a range of 75m. The third is mountable in a cyberarm (1d6+2HC, 400eb, 60m range). Its input can be routed to cyberaudio and/or internal or external recorders.

The Komaku can be used to make *Human Perception* rolls on any conversation that are overheard with it, due to the powerful processor (these are at a -5, due to the lack of visual cues). Komaku mikes are usually a *DIFF Streetwise* (or *Streetdeal*) roll to acquire (AVG Resource roll), due to their utility. Corps don't like people listening in.

BUG DETECTOR 200EB

Forget Big Brother — everyone's watching you!

Communications Control Incorporated's handheld bug scanner will detect line taps and bugs (if they are actively transmitting) in a 6m radius with 80% reliability, telling the user if they are "hot" or "cold" with varying-pitched tones. It is the size of a pack of cigarettes.

BUG JAMMER 200EB

Kills bugs dead!

This handheld transmitter from the friendly folks at Communications Control Incorporated broadcasts random electronic noise over a wide band of frequencies, overriding any signals a bug may be sending (it will also garble any radio broadcasts other than tight-beam transmissions). It operates within a 10m radius with 80% reliability, and is the size of a cigarette pack.

OMEGA™ PHONE TAP BY TRITECH **1400EB**

The last word in surveillance equipment!

The Omega is the top of the line in phone surveillance equipment (besides owning the phone company, of course). When plugged into the phone switching box for a building, it can monitor up to 10 lines simultaneously and record up to 24 hours of conversations onto a standard datachip (8 hours of video phone or data transmission). The Omega can even listen in on and record conversations in any room containing a phone! Best yet, because the unit is self-powered and does not draw any power from the line in use, it is more difficult to detect than other run of the mill line taps. Omega...even when your target is expecting surveillance, he can't hide from the Omega!

The Omega really is all it seems to be, and more. The thing can even shunt a copy of every conversation off to another line (like yours) when the datachip is full, or fire off a burst transmission (compressed data at high speed, takes 1 minute of phone time) to any dedicated receiver. When the lines are checked with a line tap detector, roll a D10. On a 1-6, the line tap detector has failed to find the Omega. Of course, anyone going downstairs to check the phone switching box will find it (it's about the size of a Walkman), but who's ever that physical?

ARASAKA OMNITEC RADAR DETECTOR **250EB**

Use their own sensors against them!

This sophisticated system emits a warning tone whenever a radar beam is detected. Considering the specificity of radar transmissions, this function is completely reliable. This unit can also be used to locate the source of the radar by triangulation; when the direction of the beam is ascertained, the tone changes to a rapid chirping (this function has a 60% chance of success). The unit has a 100m range and is the size of a pack of cigarettes.

TELECTRONICS "SCOUT" **SIGNAL TRACKER 300EB**

They can hear, but they can't hide!

This is a specially-tuned, highly sensitive handheld radio transceiver which can search out signals sent from line taps and bugs (if they are actively transmitting), and then follow them to their listening source with 80% reliability. A digital, compass-style pointer indicates the direction of the listening source, and a tone indicates whether you are "hot or cold." It is the size and shape of a handheld radio (like a "walkie-talkie").

EQUIPMENT



ARASAKA **JETSETTER** **EXECUTIVE** **BRIEFCASE** **2000EB**

Carry out your business with style and security!

A lavishly styled, superior-quality attache case for the security-minded corporate. Built from composite materials stronger than steel (SDP=10, SP=30), the JetSetter disguises its toughness with an exterior of real leather! A maximum level (difficulty 30) Smartlock keeps your documents safe, and the patented AcidErase™ security assurance system prevents your work from falling into the wrong hands. For an extra 200eb, a silent alarm and NachtJager gas trap can be installed (Very Difficult BOD roll or unconscious for 6D10+10 min).

EQUIPMENT

WORLD SAT COMMUNICATIONS

LINEAR BEAM COMMLINK

200EB

WorldSat offers this tight beam radio linkage system for all brands and types of radio communications gear. Once installed in your radio, this will allow untappable, eavesdrop-proof communication for up to one mile, as long as both parties are within line of sight of each other and are not blocked by any object thicker than one foot. With a Linear Beam Link at each end of a conversation, no-one else can tap in or eavesdrop, ensuring secure communications for your black op! **Note:** installation requires a Difficult Electronics task and takes about a half an hour. This service can be performed at any Radio Shack or other electronics shop.

.....

ARASAKA ECM COMM-SCRAMBLER

100EB

Radio Silence? Never again!

In an age where information is power, private communications are as important as armor! Arasaka's ECM module, when attached to any radio or telephone unit, scrambles all communicated messages according to a preset pattern. Only another comm-scrambled radio or phone set to the same combination can then understand the message. Arasaka guarantees that their Scrambler package will stump any decryption system on the market today for at least 300 seconds. Since the scrambler only consists of a small assortment of microchips and a small control panel, the entire unit is very small (capable of fitting inside most handheld radios or phones) and requires a Difficult Electronics roll to install in one hour.

.....

TRITECH "MUMBLER" WHITE NOISE GENERATOR **3500EB**

It's sonic camouflage!

Gone are the days when a whispered conversation around a table in a crowded, noisy dance club was the only way to ensure that you are not overheard. Trittech now offers the Mumbler, for total privacy in any environment. This "white noise" generator is a sophisticated electronic broadcaster, about the size of a paperback book. It emits random noise at a level which is barely audible to human ears but will confound listening devices with 90% reliability. Anything within a 3-meter radius of the Mumbler will be "camouflaged" by the white noise, thereby allowing private conversation and defeating eavesdropping.

.....

TELECTRONICS SCANMAN™

FULL IDENTITY SCANNER

2100EB

Know your enemy!

This pan-spectrum scanning system employs ultrasound, thermographics, magnetic resonance, and optical sensors to fully analyze, digitize, and categorize all identifying physical features for total identity parameters. The ScanMan™ can assess as well as recognize the features of whatever person it is turned upon, allowing for positive identification. This unit has three main functions: first, it can be programmed to recognize a certain person's features, and when used in this way it will be able to recognize the person even if they have undergone body sculpting (33% chance). Second, it can be used to scan a subject and then compare collected information with a database (either chipped for a small number of suspects, or connected to a microcomp or mainframe for access to full institutional records). However, it is only effective if the subject already has a ScanMan™ record to be accessed. The ScanMan™ can be operated with its own separate scanning devices, or as an analysis package for detection equipment already in place (such as Arasaka's Scanway Gates). It is currently in use with several police departments, the CIA, Interpol, and many powerful corporations.



ARASAKA "SCANWAY" SCANNER GATES (2,800EB, 5400EB FOR DELUXE MODEL)

Arasaka knows that dealing with the public can be difficult. One never knows what a customer or visitor may be hiding beneath their clothes (or in their cyberlimbs!). Protect your premises with an Arasaka Scanway. Placed in a doorway, the frame of a Scanway will scan anyone who walks through it. Three models are available: a weapons detector, a cyberware detector, and a chemicals and explosives detector. All function with 95% reliability, and a deluxe model Scanway (which can be set to scan for any, or all, of the three anomalies) is available. The total package consists of a 7' tall, 3-4' wide (adjustable) frame (500eb. large screen optional) packed with sophisticated sensor systems and a small terminal with controls for programming scan parameters and monitoring scans. Scanway frames are available in an assortment of colors and styles, allowing them to blend in with your decor or stand out (black and yellow Danger-Striping® is our most popular pattern for this purpose). Along with being displayed on the terminal's screen, the results of the scans can be custom-programmed — an obvious or silent alarm could be set off, the police could be called, a remote weapon could be initiated; it's all up to you!

**If you have
a door, you need
a Scanway!**

EQUIPMENT

CYBERDECKS & NET-STUFF

RAVEN MICROCYB NET-VISION™ IG-ALGORITHM GLASSES 900EB

Now you too can own a pair of Net-Vision™ glasses, originally designed by Raven Microcybernetics for Netwatch. This mirrorshades-style eyewear uses a cellular 'trod link which allows you to have a Net's-eye-view of your realspace location! (25% chance of losing contact when in a moving vehicle; not all places have cellular connections to their systems.) Drawing information from the Net's own Ihara-Grubb Transformation Algorithms, these glasses show the wearer how their surroundings appear in the Net.



Now you can see what you've been missing!

Electronic surveillance of ICE and other computer security can now be done from the safety of realspace, without the danger of actually jacking in. Remember, though, that you will still have an icon representing you in the Net (unless chipped for Invisibility; add 300eb), and you won't be able to penetrate Code Gates or Data Walls. **Notes:** with these glasses, the wearer can see Net icons and determine Net locations, but even if you are inside the Arasaka tower, you won't see the inside of their Data Fortress; the Data Walls and Code Gates keep your perceptions "outside." Remember, you are not a Netrunner, only an observer.

DECKMATE + YOUR CYBERDECK = YOUR COMPLETE COMMUNICATIONS SOLUTION



DECKMATE

100EB

Expand your electronic horizons!

Although they are very advanced systems, almost all off-the-shelf cybermodems are dedicated computers which exclusively support the capability to perform netrunning. The hard-working engineers at Zetatech have solved this limitation with the DeckMate! The addition of this plug-in option gives your deck the processing power of a pocket computer, allowing your cybermodem to perform all the functions of a multi-purpose micro-computer. The DeckMate incorporates an INT 1 liquid-crystal processor core (capable of performing one task at a time), a small keypad and LCD screen (for use without interface plugs), and a datachip port which can run audio, video or information media. The DeckMate has no memory of its own, instead it uses the deck's memory, but it allows your deck to perform all the functions of a Zetatech E-Book, including the use of CompuMods or other computer options.

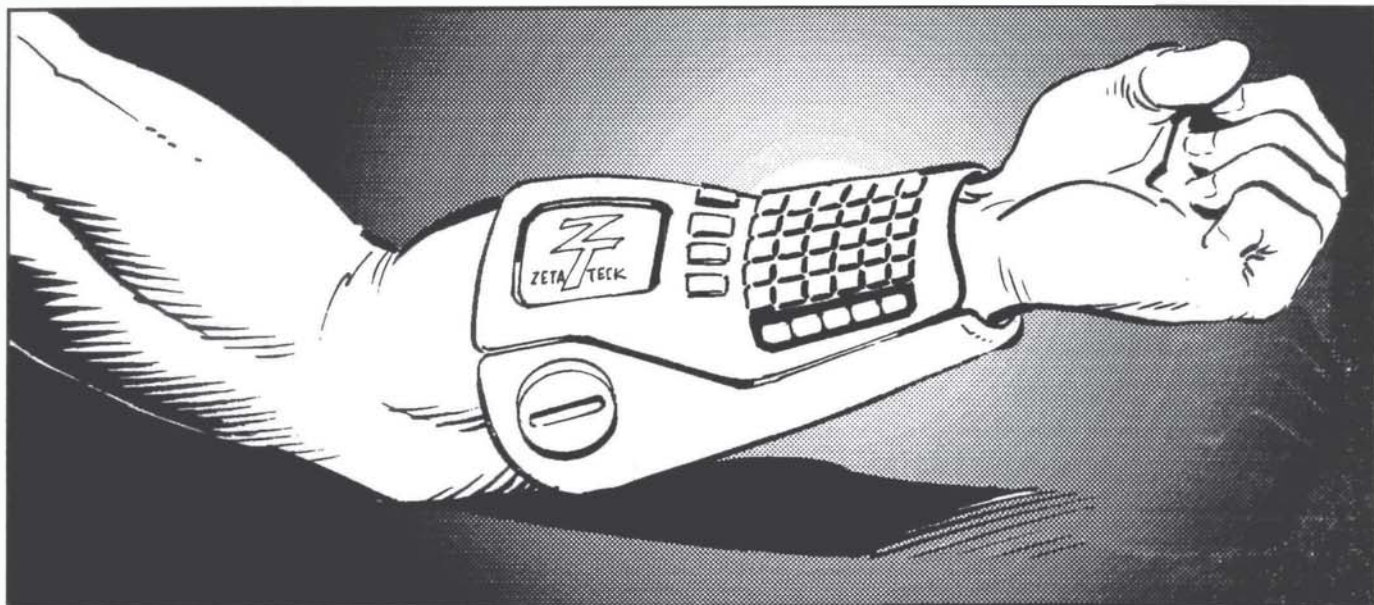

ZETATECH D2-3000 ARMDECK 5,000EB

The only universal system for hands-on integration.

Zetatech proudly presents the D2-3000 "Armdeck," the only true all-purpose cybernetic computer system on the market. Incorporating a gigabit superconductive microprocessor and a cybernetic operating system, the Armdeck can perform a variety of functions for the edgerunner who's on the move! Housed in an impact-resistant molyporcelain shell, the Armdeck has adjustable straps which allow it to be worn comfortably on the user's forearm. It's profile is so slim that it can even fit comfortably beneath the wearer's sleeve (Difficulty 18 to spot it)! It incorporates all the functions of a state-of-the-art micro-computer and a portable cybermodem, supporting a wide range of applications, from quick calculations to electronic intrusion! **Game notes:** for computer functions, see Zetatech E-Book (page 14). Cybermodem has 15MU, Speed +2, Data Walls +4, and includes Flip Switch option.

MUSIC-TECH & INSTRUMENTATION

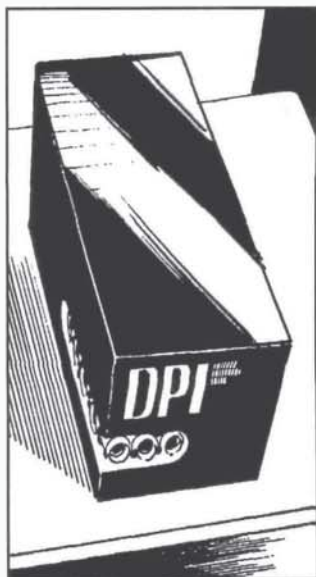

DPI "BLACK BOX" BACKUP SYNTHAMP

800EB

Jam with the legends!

Digital Products Incorporated's Black Box is a highly sophisticated programmable vocal synthesizer. Specific voices are available on datachips for 10eb each, containing the completely digitized vocal patterns of many famous performers. The digitizations are so precise that they are indistinguishable from the real thing without painstaking analysis (even a Voice Stress Analyzer couldn't tell the difference). Once loaded with a selected voice, the Black Box can be programmed to sing pre-programmed lyrics along with a pre-programmed selection of music. The vocal synthesizing is so complete that a Black Box would make the same mistakes that the original artist would. Imagine; you can have anyone from the Beatles to Kerry Eurodyne as your backing singers! **Game notes:** A Black Box is the size of a shoebox, and must be connected to a synthesizer and speakers in order to function.

EQUIPMENT

DPI BODY RHYTHM™ DANCE BRACELETS (400EB PER PAIR, PLUS 250EB FOR AMP)

Music in motion!

These neural-interface bracelets are chipped to translate muscle-activity impulses into musical patterns. The type of sound which the bracelets will synthesize must be pre-programmed beforehand, giving the bracelets the ability to sound like any one instrument; anything from a violin to a xylophone. The musical patterns are then broadcast via radiolink to a mini-amp (max range 1.5m) which then pumps the music out through a separate speaker system. With these bracelets, the user's body language actually creates the music! Many have likened a Body Rhythm performance to a hypnotic dance which borders on a new language. **Notes:** with a set of DPI's Body Rhythm™ dance bracelets, the performer can use either his/her Play Instrument (Synthesizer) or Dance skill, whichever is highest! To use the Bracelets, one must have wrist-located interface plugs.

WASHBURN SOUNDMACHINE GUITAR 1,000EB

Who needs a band when you have the Washburn Soundmachine? The Soundmachine has an internal rhythm box (with the full range of drums, cymbals and bass notes) and has a 100 beat loopable memory. It also has a memory for the notes played on the guitar; you can play a riff of up to 100 notes and the Soundmachine will loop it. Weight 3.5kg. **Game notes:** +1 to use of the *Perform* skill when not playing with a band.

"Okay, so I thought this was a joke—in fact, when my input slammed me a Washburn for my birth/incept date, I had to stop myself from laughing. But it grew on me...late nights on the tour, I found I could use it to work out new ideas, or get in a few hours of practice. "

—Jack Entropy



CHAMELEON CLOTHING AND STEALTH ARMOR



MILITECH M96 "GHOSTSUIT"

CHAMELEON CLOTHING 5300EB

Winner of the #2 spot on *Solo of Fortune* magazine's **Top Ten Most Useful Newtech Tools of 2020!** The Ghostsuit is a full-body coverall made of materials incorporating liquid crystal technology and a multi-faceted fiber-optic digitization system. Stealthier than a Sneaksuit, and smarter than Mirage Gear, the Ghostsuit actually blends into its surroundings. There are no preset restrictions; the Ghostsuit uses its computerized liquid crystal system to formulate the perfect camouflage for any situation. Just pull on the Ghostsuit, chip into the operator's interface via your plugs, don the visor and you're ready to vanish. The suit's liquid crystal exterior is composed of a matrix of cameras and projectors which cover the body. Through the interface, the wearer chooses the angle to which their camouflage will apply (i.e., the front of the suit will look like what is behind you; the right side will look like what's on your left; the back of the suit will look like what you're laying on). Then the suit's on-board computer carries out the user's wish. The effect is that the wearer is "painted" with the chosen background.

Game notes: Movement causes a lag in processing time, resulting in a blur effect (the normal bonus is -4 to any observers's *Awareness*, but only -2 if you're moving — all bonuses increase by -1/10 meters of distance between the wearer and the observer). The Ghostsuit cannot make you invisible, rather, your background is mapped onto your body. Therefore, you cannot emulate more than one background at once, and you can't fool two or more observers who have different points of view. Militech recommends that for best results, press up against (or lie down on) a surface, flattening against it so that you do not disturb the contours of your background. In such a case, multiple observers may be fooled. The Ghostsuit has an EV of -1 and provides 10SP of armor. For every two levels of protection the armor is damaged, there is a +1 penalty on the *Awareness* modifier. The hood features a set of eye-covering lenses for total protection. A fully-enclosed SP16 Combat Helmet (EV 0) can also be bought for an additional 600eb.

EQUIPMENT

GIBSON BATTLEGEAR "SNEAK SUIT"

560EB

Make the shadows your home!

Gibson Battlegear's sneak suit — the most popular brand of stealth garb in the world. This tight, black, light absorbent bodysuit (composed of PhotoCarbon™) sports a hood and an ultra-light trifilament weave for lightly armored protection. It also reduces the wearer's infrared signature, giving an overall -4 to an observer's Awareness rolls (visual or infrared) to spot anyone wearing a sneak suit in darkness, shadows or low-light conditions (this bonus compounds by -1/10 meters of distance between the wearer and the observer). The sneak suit has an EV of 0, and provides 1OSP of armor. The hood features a set of eye-covering lenses for total protection. An SP16 Flak Vest (EV -1) with webgear and assorted pockets is available for 375eb, and a fully-enclosed SP18 Combat Helmet (EV 0) can also be bought for 185eb. Gibson also manufactures a space sneak-suit in cooperation with Mitsubishi/Koryidanshu; the Light Maneuver Sneak-Suit, a rubberized SP8 coverall with a 40 minute air supply (2,500eb, EV -2). Sonar-baffling diving suits made with the help of the Hydrosubsidium are also available (3,500eb, EV-2). Manufacturers Warning: Gibson Battlegear recommends that the Sneak Suit not be exposed to daylight for more than 10 consecutive minutes, as the photocarbon will overheat and melt. Be aware that lasers and other heat-based weapons will have a similar effect (any hit doing 20 points or more of damage will overheat the suit, making it inoperative).

.....

MILITECH M73 "MIRAGE GEAR"

ENVIRONMENTAL ASSIMILATION SYSTEM

1050EB

Adaptability is survivability.

Militech's new Mirage Gear revolutionizes the science of camouflage. Employing liquid crystal technology, the Environmental Assimilation System allows you to match your camouflage to your surroundings. The system consists of a full-body coverall whose patterning and coloration can be selected by the wearer. The Mirage Gear's internal memory stores 24 different camouflage patterns (desert, urban, snow, etc) as well as flat black and olive drab coloration, selectable by the wearer via a keypad on the inner wrist. Observers are at -2 Awareness if the wearer remains still, -1 if they're moving (this bonus compounds by -1/10 meters of distance between the wearer and the observer). Mirage Gear has an SP of 12, weighs 1.5kg, and has an EV of -1 (the hood includes an eye-covering visor for total protection). An SP24 Combat Helmet (EV -1) with transparent face shield can be bought for 140eb, and an SP18 Flak Vest (EV -1) with utility harness is available for 275eb.

.....

ARMORED STOCKINGS 110EB/PAIR

New—from Fashiondrome®

Because Beauty Never Goes Out of Style

The armored stocking, new for 2020 from Fashiondrome, the ultimate in elegant form and useful functionality. These stockings, made from new Nylon23, Militech's revolutionary new armor polymer, provides useful protection, with a minimum of bulky encumbrance. These stockings are just as silky and elegant as others on the market, but the new Nylon23 will stop the penetration of any thing up to a .38cal bullet. Now your legs can be well protected, even with the tiniest of mini-skirts. The stockings come in blue, basic black, white, red and beige. Styles include plain, fishnet, lace and circuit-board designs.

Game notes: 6SP protection on each leg. EV: 0. Garter or panty-hose styles both available.

HOLOGRAPHY

HOLOSCREEN

HOLOGRAPHIC VIEWERS (2X BASIC PRICE)

A window on a new dimension.

At last, 3-D enters the mainstream. Supplanting the older generation of holographic generators (see Holo Generator, *Cyberpunk 2020* pg.59), whose screens could only supply simulated 3-D images, the new Holo-screens have unmatched clarity and resolution. Making use of KodaGraphix and other similar imaging technologies, holographic viewers allow high-quality projection of 3-D images. Many different models are available, such as videoboards, video/audio tape players, pocket TVs (note that only about 4% of TV broadcasts are in 3-D), computers, cyberoptic video imagers and cybermodem screen options. Holo-screens can only show 3-D images if they were recorded in 3-D, but they are fully capable of playing 2-D images as well.



DATATEL HOLOTANKS (500EB, 1000EB, 5000EB)

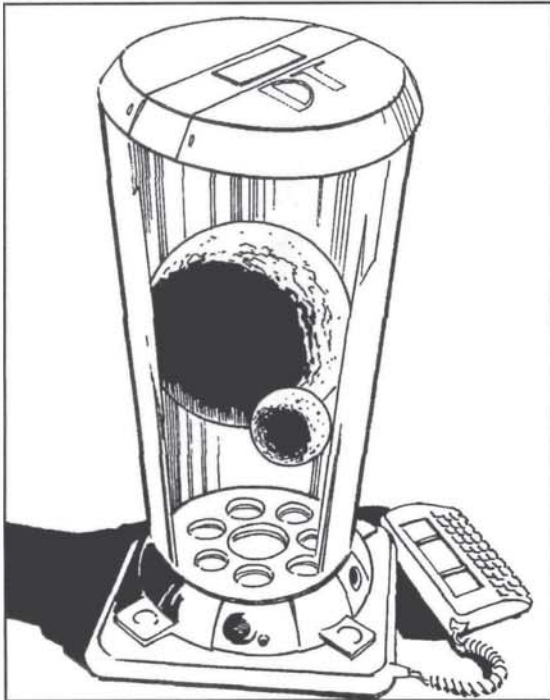

The holotank reestablishes the art of visual modelling. Consisting of a clear cylinder capped at both ends with super high-definition laser projectors, a Holotank is filled with a highly-reflective, non-toxic gas into which a hologram is projected. The hologram can be static or animated, and its positioning can be manipulated by a remote keypad. Walk around the tank, and you can see all sides of the image (also called a "model"). To film a model, three holographic cameras are necessary; the image to be recorded must be in the middle of the three cameras. This makes holotanks inefficient for TV shows or other highly active models — usually individual, static images are best for holotanks (however holotanks are often used when one person will be speaking or dancing). Three models of holotanks are available: the tabletop model measures 12" diameter & 18" tall, the desktop model is 24" diameter & 36" tall, and the display size holotank is 4' diameter & 7' tall. Holotanks are most popular for computer modelling purposes, but are also seeing use as programmable fashion mannequins for clothing stores (as well as walk-in models which serve as instant clothing "try-on" booths), holographic video games, visual tele-

conferencing, battlefield strategic analysis, weather prediction, and for air traffic control displays.

EQUIPMENT

EASTMAN KODAGRAPHIX

HOLOGRAPHIC CAMERAS (2X BASIC PRICE)

Give your images more depth!

Eastman-Kodak's new holographic imaging technology allows you to create flatscreen images with realistic depth. Using advanced laser-rangefinding systems, regular photography or film procedure with Kodagraphix yields flat pictures with a simulated 3rd dimension. All camera types are available as holographic models, including headsets, multiformat news cameras, pocket units and cyberarm options; they have the same statistics, but cost 100% more than normal versions.

.....

EASTMAN ARTS MINDSCAPE®

CYBERHOLO ART IMAGER

600EB

Bringing art into the 3rd dimension!

Eastman-Kodak's Arts division removes the middleman with Mindscape®. This advanced holographic imager employs the latest in cybernetic and hologram technology to render the pad and the palette obsolete. With Mindscape®, anyone can be an artist—just stud into the unit with a set of interface plugs, and let your imagination do the work. Whatever you can visualize, Mindscape® can model in 5792-color 3-D!

Game notes: this unit will indeed draw pictures from your mind's eye, but it takes more control than its makers would have you believe. Stream of consciousness and train of thought must be under strict control to maintain an image for recording to memory, so the Mindscape® merely adds +1 to Paint or Draw skill (but your picture is in 3D).

.....

REMOTES & DRONES

REMOTE CONTROL SYSTEMS

There are several remote control systems for remote vehicles, all requiring the use of either the new skill Remote Systems Operation (REF/INT average based) or the Netrunner special ability Interface. This is modified by the remote's Control Modifier for tricky, delicate, or combat maneuvers (as well as the control systems modifier). The most basic design is a manual version, which costs 300eb and has a control modifier of -2. A more advanced control system uses a virtual reality heads-up-display helmet with a dataglove and keypad. This system costs 500eb and has a control modifier of -1. The most advanced control system available for remotes is a cybernetic control deck (CCD) which the operator simply chips into in order to control the remote; a CCD costs 800eb and has a control modifier of 0 or +1 depending on quality. These three units are available either in stationary panel style or compact portable versions—the cost is the same, but control range is sacrificed for portability: a stationary unit with repeaters can have up to a 100km range, while many portable versions have a mere 15km, tops.

"Netrunners moan all the time about how they can't stand with the Solos when combat comes. I never needed more than a couple assassin remotes or a handy Robo-Cab™ to level any opposition."

—Rache Bartmoss

BELL "BUMBLEBEE"**REMOTE ROTOCRAFT 4,000EB**

The classic remote vehicle; a design that has been in service since the 1980's. The Bumblebee is the latest refinement of the "peanut" rotorwing—the light, ceramic body consists of two bulbs, with two counter-rotating blades spinning around the central body between the bulbs. A meter tall and weighing 35kg, it can easily be launched from the deck of any ship (or from the trunk of your car). Its lower bulb, which sports the landing skids, can be fitted with a variety of cameras, sensor systems and other electronics (such systems are doubled in cost). Some have even been armed (with capacitor lasers, micro-missiles, SMGs), but this is a rare occurrence; anything bigger than an SMG is too big, heavy and has too much recoil. The ultimate multi-purpose remote. **Game notes:** Control Modifier -2, SDP=25, SP=6, maximum speed 120mph, operational range 250 miles.

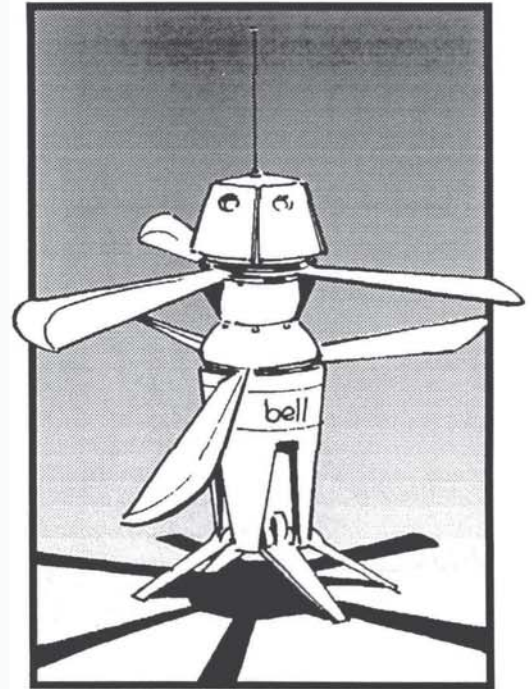
**MITSUBISHI "ROVER" WHEELED REMOTE 9,000EB**

The driverless jeep! Rover's primary purpose is perimeter patrol and other security tasks. It has a small CHOOH-powered combustion engine driving its 6 independent-suspension wheels, and its body is sturdy enough to take the punishment of any job. It normally patrols an area autonomously, following a pre-programmed route, alerting an operator when a security anomaly is detected. It is lightly armored, equipped with a small turret for sensors or weapons, and can run for six hours. Rover is 4 feet long, 2 feet wide, and 2 feet tall—weighing 60kg, it is too big to be used indoors, and forget about kicking it over! The turret sports a audio-visual, light-intensification and IR sensor suite, and there are two spaces which can be used for more sensors or weapons systems (each space can hold a rifle-sized weapon). Rover has very limited threat engagement and isn't too smart, but it's reliable and loyal. **Game notes:** Control Modifier -3, SDP=35, SP=20, maximum speed 45mph; its Awareness, Targeting & Initiative rolls are at 10+1D10.

MILITECH RPV-400 LIGHT COMBAT TILTROTOR REMOTE

Designed to be a light, easily-deployed unit. Capable of carrying a wide variety of munitions and options, mounted on 4 wing and one centerline hard point. Integral weaponry consists of a 2-barrel 12.7mm rapid-fire machine gun, firing from a dual box feed mechanism. Each box holds 1500 rounds; usually one is loaded with LAPHE (light AP/HE), while the other is loaded with anti-personnel fragmenting rounds (treat as DP ammo), and a flare chaff launcher which can fire 10 flares or chaff pods (-30% to be hit by radar homing or heat seeking missiles. only a 60% chance of deployment when under self control). The RPV-400 is capable of remote operation, using the new VRSU-23 control helmet (or cybernetically), and can also control itself, thanks to a pre-programmed set of responses and orders (orders can be loaded in before mission, or they can be selected from a pre-programmed list). **Game notes:** Control Modifier +2, SDP 65, SP25, Maximum Speed 210mph, Operational Radius 450 miles. 12.7mm Chaingun: HVY•+2•N•P•12.7mm/4D10+2• 1500x2•150•STD, Range 1km. Note: armor is 1/2 vs. LAPHE ammo, but penetrating damage is not reduced.

PRICE: 150,000EB

EQUIPMENT

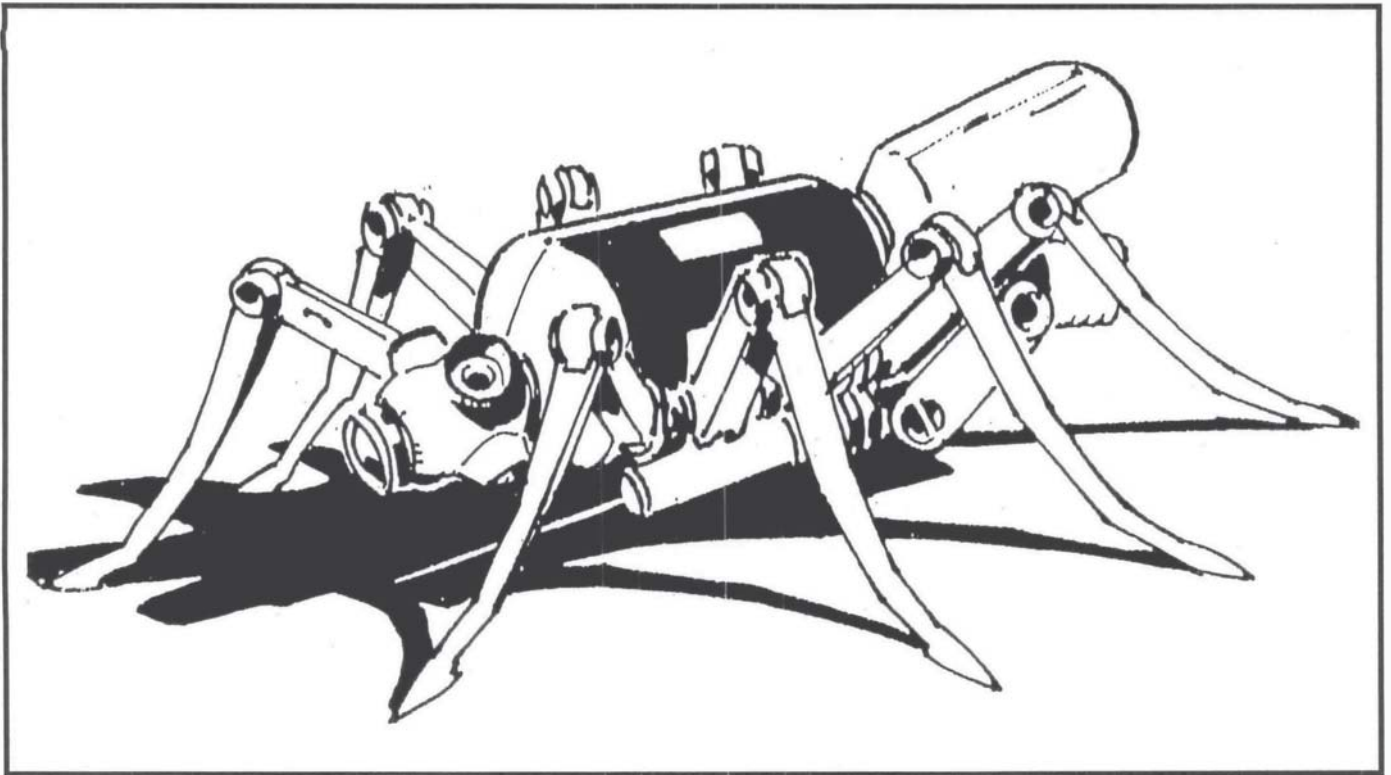

ARASAKA RDAK SPY &

ASSASSIN REMOTE

12,000EB

An advanced synthesis of robotics and state-of-the-art remote technology, the Remotely Deployed Arachnoid Killer is Arasaka's premier entry in the field of remote weaponry. Designed for stealthy urban reconnaissance, sabotage and assassinations, RDAKs (also known on the streets as "Spiders") have eight thin, highly maneuverable legs which can also function as crude manipulators. Its small body (about the size of a paperback book) has a multipositionable "head" which is packed with audiovisual, low-light, and thermal microsensors as well as a set of small wirecutter "teeth." The abdomen unit has a space for including a single pistol-size weapon system such as a handgun, needler, squirtgun, capacitor laser, etc. (Note: all handgun-type weapons will have 1/2 normal magazine capacity and 1/2 basic range. Capacitor lasers will be 1-shot. All weapons are Acc 0.) RDAKs are very sophisticated, but also quite durable for their size; for example, a Spider can easily withstand a fall down a flight of stairs or from a 2nd story window without harm. Each RDAK has a 5-dose hypodermic "stinger" built into it, and the ends of its legs are tipped with molecular adhesive which allows it to climb walls and walk on ceilings. Available in a variety of colors and camouflage patterns. Their ceretronic systems (the combined silicon microcircuitry and vat-grown organic neural tissue that functions as a "brain") are less vulnerable to a Microwaver than most cyberware: 1-3/

"Killer bugs. I hate those things. They can hide under a piece of paper, waiting to blow yer face off. Or watch you from the corner of the ceiling with their beady lil' eyes till your back is turned..."

—Ripperjack

no effect; 4-5/motor malfunction—runs in random circles for 1D10 combat (10sec.) turns; 6/total breakdown—it just sits, twitches, and smolders. On 4-6, if it has a ranged weapon, there's a 25% chance it will fire once at random. An EMP grenade or MagField generator has normal effect. **Game notes:** Control Modifier -1, SDP 10, SP10, MA 12, battery time: 5 hours, control range: 300m. Remember, Arasaka normally only sells these little beauties to friendly corporate entities.

CONSUMER ELECTRONICS

AUTOTANNER™ 200EB

The greatest invention since lotion. Wanted to get a tan, but couldn't get to the parlor? Ever since the holes in the ozone made it hazardous to get extended exposure, people have wanted new ways to get that bronzed look. Well now, thanks to the design staff at RelCo, you can get that look any time you want. Simply touch the chemical injector to your skin and voila! Instant tan. Be the envy of all your neighbors and get the Autotanner™ today. 30-day money back guarantee if not completely satisfied. Your look means a lot to us.

Game notes: Device gives the player a +1 to ATT for a period of 1D6 days.

PHONE

UPGRADES

(COST VARIES)

The following items and services are designed to make your cellular phone work for you.

VOICEMAIL 20EB/MONTH

Another way to avoid the ring. Now, they can leave a message on your private voicemail service. Any number of messages can be recorded. The Phone Company maintains the equipment, all you pay for is the service.

FAX INTERFACE 75EB

This device allows the attachment of a fax machine directly to your cellular. Fax in that proposal while heading to the airport. Why wait to use a stationary fax machine, when you can carry yours along for the trip? Very handy.

DIGITAL RECORDER 75EB

Allows one to record that special conversation for later. Record up to 2hrs before replacing the chip. Extra chips are available for a mere 10eb each. Note: Some areas consider this device a form of "bug" and is illegal. We do not condone the practice of breaking the law.



ECM SCRAMBLER 50EB

Allows for private phone calls to another likewise equipped unit.

VIDEO OPTION 150EB

2"x2" screen and a mini digital camera to allow you to see, and be seen by, whomever you are speaking to. Not available for microcellular models.

EMERGENCY AUTODIALER 25EB

A memory for emergency numbers. Allows one-touch dialing of Police, Fire Dept, and either Trauma Team or REO Meatwagon rescue services. 6 preset numbers.

CONFERENCE CALLING 5EB/MONTH

Owner can call 2 separate lines and have all talking to one another. For each additional 5eb/month you spend, you can have 1 more line added.

SPLIT LINE 50EB

Owner has 2 separate numbers for the same phone. Each line is billed separately. Like having 2 phones in one.

CYBERMODEM INTERFACE 500EB

Turns any plain cyberdeck into a cellular model. Never again will your netrunner need to buy an overpriced cellular job, when for hundreds less, he/she can buy a phone with Zetatech's new Cyberbaud 7 cellular deck upgrade.

Note: Due to extra circuitry, a -1 penalty to the netrunner's interface skill is applied.

PRIVACY PLUS™ 300EB

For the discreet businessman. Privacy Plus™ provides the caller with ECM, a built-in bug detector, and a display of the number calling you. This display flashes each time the phone rings. For an additional 50eb, a memory of up to 20 numbers can be installed and will list the name of the person calling, as well as the number.

EQUIPMENT

RUSH® VIRTUAL ENTERTAINMENT SYSTEM 500EB

SegAtari has just recently dropped the price of its home Virtual Reality unit, Rush®. Using a combination of Virtual and Braindance technology, Rush® is the ultimate home video game experience. Already gaining notoriety, Rush® is setting the industry standard for home entertainment. Over 300 games have been released so far and the list just keeps growing. Check out *Brainburner*, it's a wild ride! A guaranteed favorite!

Game notes: Interface plugs and basic processor required for use.

: RUSH® VR UNIT UPGRADES

• These items allow you to improve the system you purchased (smuggled, stole, whatever) to maximize game play and enjoyment.

• TOTAL ENVIRONMENT™

• The Total Environment™ allows far more realistic sensations than the basic Rush® unit. When chipped into a Total Environment™/Rush® system, you are given complete freedom of movement for maximum enjoyment. Comes with 16 games designed specifically for the To-

tal Environment™ unit. If you like excitement, Total Environment™ is for you! **1000eb**

MULTI-PLAYER ADAPTOR

Allows up to 4 other Rush® players to join in. With multiple adaptors, you could have an unlimited number of players. (Software permitting). **100eb.**



VIDEO WALL™ 3500EB

New from Telectronics Ltd comes

the masterpiece of visual stimulation: The Video Wall. Transforms any size wall into a 2-D or 3-D movie screen. Great for watching the classics! A must for either the movie buff or the person with money to burn. Hooks up to any standard video machine or game system with ease. Try *Rush® Kung Fu Fighter VI* on this baby! **WOW!!!!!!**

Note: Requires at least a 6'x6' space of wall to be effective.

: SEGATARI VIRTUAL VILLAINS 150EB

• Battle the greatest villains of all time with SegAtari's Virtual Villains. This Rush® system game chip contains a virtual reality with photorealistic portrayal of a medieval castle. It's there that you have a showdown with the greatest of evils. The game deck has a massive collection of historical and fictional villains. You and up to nine of your friends can do battle with the likes of Hitler, Genghis Khan, and Captain Hook! There is also a large assortment of weapons, both modern and archaic. Live the game with Seg-Atari!

"Karkong the Impaler. Worst of the lot. Makes Atilla the Hun look like a poser. I don't know how many Virtual games I've lost to that frackin' SOB. I don't even wanna know. It's humiliating to get your butt kicked by a virtual algorithm."

—Rache Bartmoss

SCHOLAR™ HOME LEARNING SYSTEM 750EB

The Scholar™ Home Learning System has recently been added to SegAtari's long list of breakthrough hardware. By use of Virtual/Braindance Technology, you can learn languages, history, mathematics, just about anything. And in your own home! No more are you required to take long, boring classes. No more lectures. All you need to do is jack in to the Scholar™ upgrade package for your Rush® home virtual reality unit.

Game note: Any skill requiring hands-on experience requires you to have a Total Environment upgrade. Maximum skill level learnable is +2. Cannot be used to improve skills already known. Skill is learned at a rate of +1 per 6-hour lesson; plus 1 day of practice per lesson.

WEAPONS

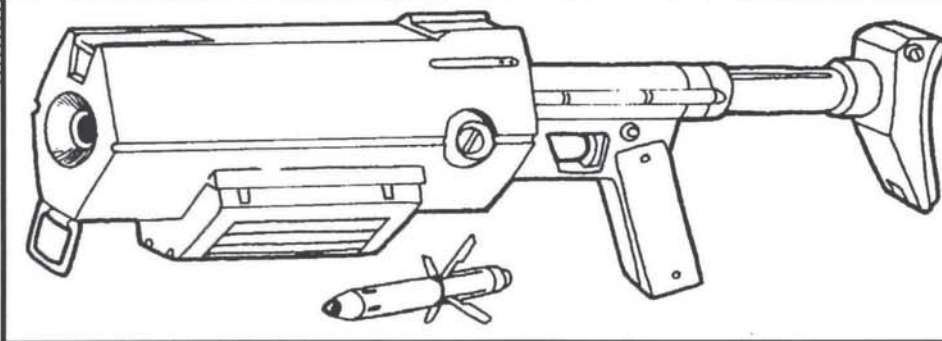
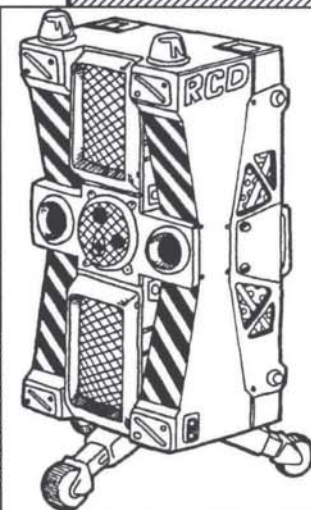
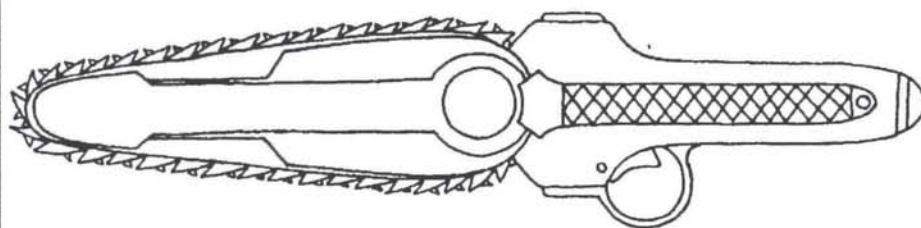

“Let’s not kid ourselves. As Solos, we use guns to kill. They may have other uses, but that is no concern of ours. So, with that in mind, you must agree that we need a wide variety of weapons for a wide variety of situations. And you must also agree that the best weapons are the ones that kill with the most efficiency and speed.”

-Jake Takada

WEAPONS

TSUNAMI ARMS RAMJET RIFLE 1,230EB

RIF +3 N P 8.5MM RAMJET 9 3
VR 800M

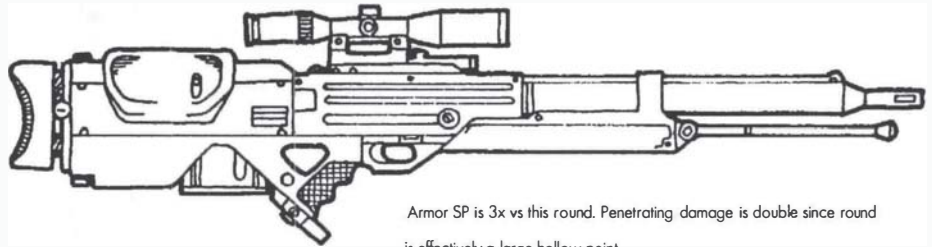

Armor SP is 3x vs this round. Penetrating damage is double since round is effectively a large hollow point.

"Tsunami Arms - Better Than The Best." The top-secret Japanese weapons design firm once again lives up to its motto with their Ramjet Rifle, a remarkable new weapon which is fitted well to the roles of sniper, counter-sniper and light anti-armor weapons system. What makes this rifle special is the bullets it fires—not a normal slug, flechette or gyrojet, these 8.5mm projectiles are small ramjet engines! Fired from the rifle at a velocity of 3,200 feet per second, the supersonic bullets have a conical aperture in their nose into which the incoming air is compressed. This jet of hot air ignites the solid fuel in the center of the bullet; the exhaust blasts out of the back, accelerating the round until it runs out of fuel. This results in a constant increase of the velocity and energy of the shell until it reaches its maximum range, making the Ramjet Rifle a harder hitter the further away it is from its target. The gun is a semiautomatic, caseless ammo-firing bullpup made of lightweight polymers, boasting an adjustable grip and stock as well as an adjustable bipod and a free-floating heavy barrel. For superior accuracy at long ranges, the Ramjet Rifle comes equipped with a 4x telescopic laser-reflex smartgun interlock, which paints the target with a laser and then uses microprocessor-controlled liquid lenses to determine the range and the proper elevation to hit the target at that range by moving the aimpoint, causing the shooter to bring it to the correct angle. **Game Notes:** the 8.5mm Ramjet rounds do 5D6+3 at Close range, 6D6+1 at Medium range, 7D6 at long range and 7D6+3 at Extreme range.

POLYMER ONE-SHOT CANNON 90EB

"So like, he came at me, and like, I pulled the trigger and — ewww—lunch meat.."

—Random
mall brat

RIF -2 L C 4D6+2 (13MM)
1 1 UR 100M

Heavy firepower in a disposable package! This plastic blaster from Kang Tao is the ultimate last-chance weapon—after all, you're not going to need more than one explosive 13mm bullet to get

the toughest pursuer off your tail! To keep costs down, the "One-Cannon" is made from inexpensive materials, and the shell is filled with stable explosive materials. **Game Notes:** The 13mm shell is a low-velocity HEP (High-Explosive Plastic, cratering) round which does 4D6+2. Damage is 1/2 real, 1/2 stun only - armor has no effect and is damaged 2 lvls. The gun is so poorly made that if it jams, it breaks—if a 1 is rolled, the weapon explodes, doing 2D6 to the firer's arm!

MILITECH CYBORG RIFLE 800EB



RIF +1 N P 7D6+3AP (.300WM) 30 2 ST 500M

They say that if you want good weapons, you buy Militech. The Cyborg Rifle is no exception. Made for 'borg fighting, the Cyborg Rifle can be relied on to drop a metalhead at any range. A massive bullpup, this rifle was designed around the .300 Winchester Magnum hunting cartridge, which is normally used for hunting big game. The .300WM was chosen for its versatility under a variety of conditions, ranges and targets. Militech is fully licensed to use this round, since they bought out most of the Winchester holdings many years ago! An assortment of .300WM ammunition has been produced for the Cyborg Rifle; among these is a teflon-coated armor-piercing bullet, which has proven to be sufficiently effective against most Body Plating. To enhance controllability, the barrel of the rifle is surrounded by a hydro-pneumatic recoil sleeve. Even so, this weapon is most often used by combat 'borgs themselves, as most unaugmented soldiers find its bulk taxing (loaded weight is 7.5kg).

STEIN & WASSERMAN "TRI-STAR" REVOLVER 375EB

P O J C 2D6 (#000) 6 1 ST 50M

S & W designed this special-load revolver as a "compact yet practical multi-munitions delivery system." What this means (in plain English) is that the Tri-Star is a big, double-action revolver-style handgun which fires .410 shotgun ammo. Although it is capable of firing shotshells (2D6/1D6+2/1D6) and slugs (3D6+1 AP), the Tri-Star is best known for loading Triplex shells which pack three #000 buckshot pellets. When using this load, treat each shot as a "3-round burst," rolling 1D6/2 to see how many buckshot hit and then rolling each hit randomly (2D6 damage each). Stein & Wasserman also markets a 100eb lasersight which is specially made for Tri-Stars packing the #000 Triplex: the sight projects a red dot which marks the point of aim, and a surrounding circle which marks the area into which the three pellets will spread. Because of the visually distinct style of these sights, the Tri-Star has seen a great deal of use in media entertainment.

"I like this gun. It's a little old fashioned, but it has a certain kind of charm. And S&W knows how to make a good revolver too.

"Yeah, I really like it. Thanks for letting me blow your head off so I could keep it."

—conversation in the Aftermath night club, six seconds after a firefight.

PURSUIT SECURITY INCORPORATED WEBGUN 250EB

RIF +1 N C ENTANGLE 1 1 ST 30M

P.S.I. continues its popular line of non-lethal weapons systems with their Webgun, the "long-range mantrap."

This single-shot weapon has a shock-absorbing stock, a pistolgrip and forend-grip arrangement, and an optical sight. The "Webber's" conical muzzle has four blast-directing "barrels," each of which propels an elliptical weight, attached to a spiderweb-like nylon net. Fired by a single cartridge, the net is pulled open by the radiating trajectories of the weights, ensnaring the target in a fast-moving, hard-pulling tangle. In police tests it has been 95% effective in rendering a person helpless. **Notes:** The web is large enough to encompass any size assailant. The victim must make Near Impossible BOD and REF checks to escape. Failure of both rolls means the target is captured; 1/2 REF for Initiative and actions, and a non-moving target for attacks. A single failure means the target will escape in 10-(BOD or REF) minutes (whichever is shorter). While stretchy and tough, the material can easily be cut by any decent blade the victim has in hand.

For an additional 100eb, the Webber can be outfitted with a carbosteel wire net and the integral taser mount to charge it. P.S.I. assumes no responsibility for the safety of those caught by the device. If web is equipped with taser charging, use Taser rules (CP2020, pg.97)

Also available is the **FEN Dz-55 Det-Web (450eb/net):** Designed as a new anti-Borg net-projectile for the P.S.I. Webgun, the Det-Web replaces the net's nylon strands with strips of Detcord. These directional explosive charges in strip form can make instantaneous, precision cuts through just about anything (burns through up to SP40 armor like a cutting torch in 1 combat round) when detonated. In effect, anything caught in a Detweb will take a 40-point AP hit to every body location, which will all but shred anything but the most monstrous of combat Borgs. Accuracy and range for the carbosteel net and the Det-Web are 0 • 25m.

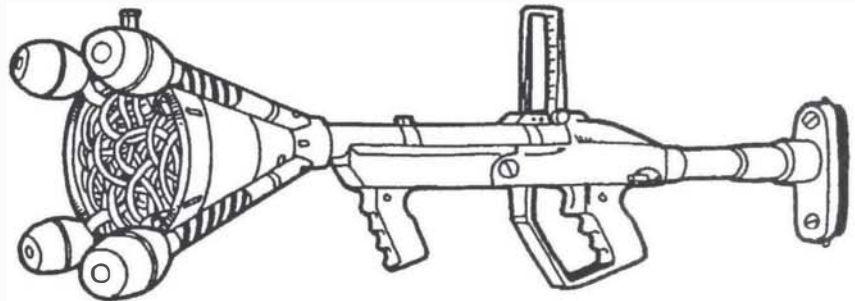

WEAPONS

RHINEMETALL EMG-85

KINETIC ENERGY RAILGUN 11,370EB

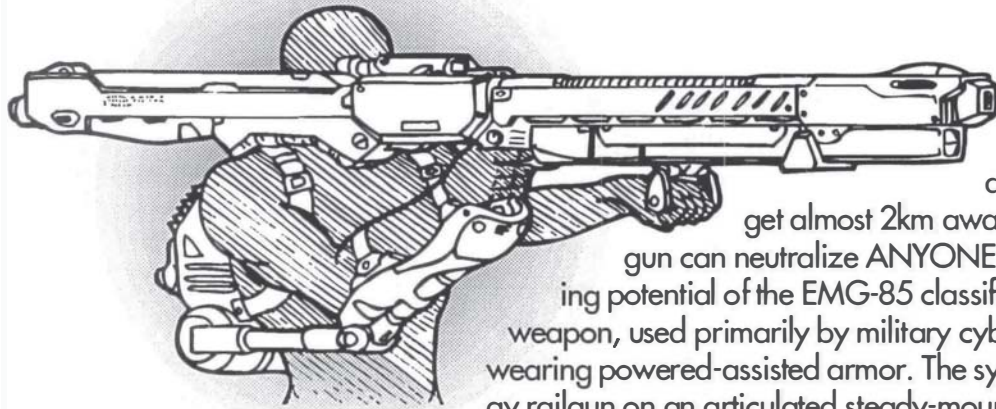

HVY +3 NR 5D10+10
(EAP) 5 1/2 ST 1,500M

The ultimate weapon in the war on cyberpsychosis. Delivering a nickel-ferrous slug at hypersonic velocity to a target almost 2km away, the new Rhinemetall Rail-

gun can neutralize ANYONE! The appalling multi-level killing potential of the EMG-85 classifies it as a special-purpose weapon, used primarily by military cyborgs and C-SWAT troops wearing powered-assisted armor. The system consists of a kinetic energy railgun on an articulated steady-mount harness with a computer-

ized fire-control system. This electro-magnetic gun (or EMG) uses superconducting technology to launch a special 15-gram Mylar-coated metal projectile at 8,000 feet per second! This projectile is not only utterly lethal to the human body, but it can also punch through all but the toughest vehicular armor plating. The fire-control system acts as a sophisticated smartgun, allowing for rapid target acquisition and engagement. The weapon has a built-in magazine with 5 superconductor power loops and a 5-round projectile pack (weight 1 kg.). The ammo unit (plus power charging) costs 1200eb. Militech hopes to have a competing model, the XR-1 Mag-Pulse Gun in 12/5mm Sabot (with removable ammo/power pack) out in 18 months.

Game Notes: Due to the sheer weight and recoil, a minimum BOD of 11 is required to fire the gun without a linear frame or powered armor. The gyro-stabilized mount-harness negates all modifiers for movement, but has an EV of -1 and negates the use of a Smartlink. The Extra-AP effect of the ammo is 1/4 to armor, but only 1/2 to penetrating damage. Short range extends out to approx. 375m, and maximum range is 3000m, similar to most HMGs and light cannon. Weapon weight: 35kg (77 pounds) fully loaded. The weapon requires 1 combat round to realign the magnets before a second shot can be fired. Interface plugs and a Smartgun Link can be used by themselves instead of the harness, but shooter's MA is at -1; EV is -2, and the minimum BOD requirement becomes 12.

Only found with authorized C-SWAT teams, military armories, and sometimes mounted on vehicles, the EMG-85 is incredibly rare, expensive, and illegal. Black-Market purchases should only be available with a Near Impossible Streetdeal roll. (And a critical success at that!)

LUIGI FRANCHI "KING BUCK" MULTI-MAGNUM 800EB

SHG -1 NP 6D6/5D6/4D6 (10-GAUGE) 4 2/4 VR

The Italian-made King Buck is a four-barreled pepperbox-style shotgun, made for hunting big game. It has four separate barrels and chambers, and they can be fired one at a time, or (if you want to be really gross) you can fire all four at once! This magnum shotgun fires 10-Gauge 3" Magnum shells, and can load buckshot and slugs. A huge, unusual and exceptionally heavy weapon (7 kilos), which is considered a collector's item.

"You'll love this. A large gun but simple to operate. One pull of the trigger, and BOOM, his head falls off. A very fine instrument. We make excellent instruments in Italy, yes?"

—Giovanni Stratelibre, Eurosolo

UNDERBARREL CAPACITOR LASERS/ MICROWAVERS 950/500EB

U-B CAPACITOR LASER RIF +2 * R 3D6 2 2 UR 25M

U-B MICROWAVER EX 0 * P 1D6 4 2 ST 20M

Advanced weapons from the genius at Tsunami Arms, these capacitor weapons negate the need for bulky power units by using advanced superconducting capacitor packs instead. Accuracy and hitting power in a ceramic and polymer tube that will fit under your weapon's barrel! You can even plug them into a hip power pack, giving you more shots. They are designed for sub-machine guns and rifles (medium SMG or larger).

The power pack costs 250eb, weighs 4kg, and doubles the number of shots (it also adds 5m to the microwaver range). The capacitor lasers mount in an underbarrel position, and look like older laser sights (DIFF Awareness to spot the difference). Note: the laser is an advanced version of the cyberarm weapon (CP2020, pg.82)

"By my second or third op, I was slinging all kinds of hardware under the muzzle; flashlights to spot, lasers to pinpoint... Now I've settled on a combination that works for me; a Militech grenade launcher and a Tsunami microwaver in tandem. I call it Shake and Bake."

—Morgan Blackhand

TECHTRONICA M40 "PULSE RIFLE" 3,500EB

RIF 0 N R EMP 6 1/2 ST 50M

Techntronica's milspec Electro-Magnetic Pulse cannon is quickly proving itself to be the ultimate electronics-killer. Utilizing new breakthroughs in multi-band electromagnetic beam propagation systems, the M40 is a rugged weapon designed to disrupt, defeat and otherwise destroy electronics and computer systems of all kinds. This stubby, rifle-shaped weapon (which uses liquid metal storage cells), is fully insulated against its own effects—which are devastating! At Close range, the weapon can permanently fry electronics of all kinds (from computers to cyberware), and incapacitate people for hours.

Game Notes: This a tight-beam weapon, affecting one target per shot (body locations are irrelevant), and because of its charging cycle it can only fire once every other turn.

Warning: a Point-Blank shot can be lethal to the human nervous system. At Point Blank range it has a 50% chance that it will ruin electronics even through shielding, and people must make a Death Save at -3 (if they succeed, they will be unconscious for 2D6x30min). At Close range, any unshielded electronics or cyberware are immediately disabled (but can be repaired) and people must make a Stun Save at -5 or pass out of 1D6x10 minutes. At Medium range, any unshielded electronics or cyberware are disabled for 1D6/2 hours, and people must make a Stun Save at -3 or pass out for 2D6 minutes. At Long range, any unshielded electronics or cyberware have a 70% chance of being disabled for 2D10 minutes, and people must make a Stun Save at -1 or pass out of 1D6 minutes. At Extreme range, any unshielded electronics or cyberware have a 30% chance of being disabled for 1D10 turns, and people must make a Stun Save or pass out for 1D6 combat turns.

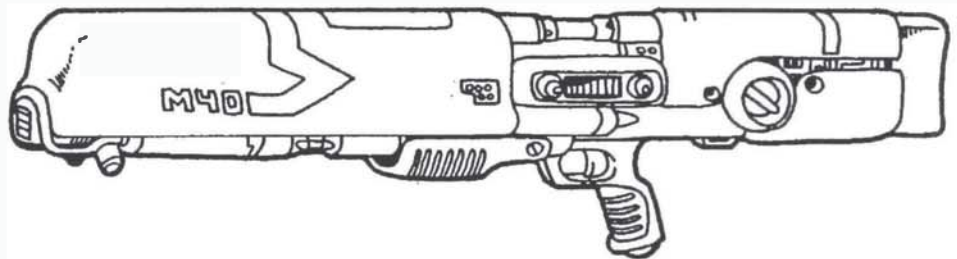

WEAPONS

NOVA .338 CITYGUN 460EB

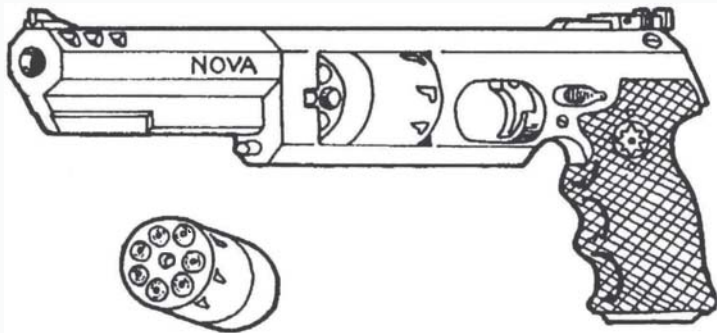

P +1 J P 3D6 (.338) 7 3 VR 50M

The double-action Citygun is Nova Arms' attempt to bring the revolver up to date. Rather than employing a traditional cylinder, it uses Nova's patented "Ammo Cassettes." These are disposable cylinders composed of superstrong composite ceramics, preloaded with seven .338 Nova cartridges. To reload, one simply drops out the empty cassette and slaps in a fresh one, thus doing away with clumsy re-

loading of individual rounds. The Citygun is packed with modern features, sporting a nonreflective matte-black finish, a octagonal barrel which has an underbarrel universal scope-mount, an adjustable trigger, and twin triple-porting on the barrel, which serves as a sophisticated muzzle compensator (the compensator aids in quick recovery for follow-up shots, increasing the ROF to 3). Nova also includes two spare ammo cassettes with every Citygun. Durable, reliable, and capable of placing seven high-velocity slugs in a two-inch pattern as fast as you can pull the trigger, the Citygun is indisputably the most advanced wheelgun on the market today. **Note:** .338 Nova—This rimmed, brass-cased cartridge fires a 98-grain bullet at 1695 fps. This places Nova's new cartridge around the .357 Magnum, making it an ideal mid-range load. Ammo is available for 15eb (per box of 50 rounds), and disposable

COLT-MAUSER M2X CANNON 3,050EB

HVY 0 N R 4D10+6 (20MM EHI) 8 1 ST 600M

The undeservingly world-famous Barrett-Arasaka "Light 20" has a 20mm bore diameter but fires sabot subcaliber penetrators of depleted uranium; it's a cheap cop-out, a "20mm" rifle any wimp can fire. The Colt and Mauser arms companies have recently joined forces to produce the M-2x, a true 20mm rifle! This massively powerful semiautomatic is fired over the shoulder, much like a WWII bazooka, and uses the same 20mm shells as those in the Vulcan guns on aircraft like the F-36. The magazine housing is built into the shoulder brace, bullpup-style, and the long-travel recoil absorbing rod goes over the firer's shoulder. Despite composite construction and hydraulic shock-absorption systems, the M-2 requires an Average BOD roll (difficulty 15) to avoid taking 1D6/3 in bruise damage to the firing arm (a critical failure also results in the gun being dropped). A 4x telescopic sight in the carrying handle is standard equipment, and the M-2 weighs 23kg fully loaded.

EHI: Extra High Impact ammo (for rounds in the 20-30mm range)—armor is at 1/4, penetrating damage is not reduced. If the damage is stopped, but exceeds 1/2 the armor's SP, the target takes 1/4 damage from sheer kinetic impact. Brittle cover (i.e., cinderblock walls) will shatter if the cover's SP is exceeded by the shell's damage.

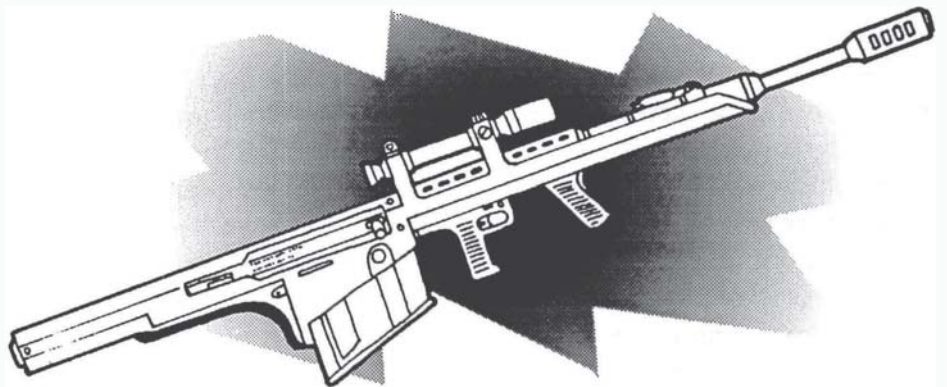

MILITECH AM-3 "ANTI-MATTER RIFLE" 6,000EB

HVY 0/+1 NR 6D10+12 (30MMEHI) 5 1 ST 1600M

The return of the Anti-Tank Rifle! Militech's 30mm recoilless rifle is the only man-portable weapons system capable of taking on a main battle tank. More commonly, this high-power cannon is used to smash combat borgs, powered armor, and sensitive targets such as bunkers, radar stations and armored fighting vehicles. It fires Militech's patented 30mm rocket-propelled depleted-uranium shells to avoid the crushing recoil that ac-

"Okay, so it doesn't really use anti-matter. We just call it that because it uses depleted uranium. "

— Marlo (Militech Rep)

"Right. I say you call it that because you can use it to knock the frackin' Starship Enterprise outa orbit. "

— Axeman (Freelancer)

companies a standard 30mm cartridge (these are the same shells used in Militech's aircraft-mounted gatling cannon). Nonetheless, this rifle is by no means recoilless, and it is made of high-strength ceramics in order to withstand the tremendous pressures and reduce overall weight. Equipped with a hydro-pneumatic recoil absorption system, an advanced muzzle brake, and a telescoping shock-absorbing stock and bipod, the AM-3's recoil is still punishing: it requires an Average BOD roll (difficulty 15) to avoid taking 1D6/2 in bruise damage to the firing arm (a critical failure also results in the gun being dropped). Warning: do not try firing this thing standing up unless you have a linear frame of at least Beta class, or you will be knocked down and the bruise damage doubled! Equipped with a Cyberoptic Triangulation smartgun interlock and a 2-10x telescopic sighting system with low-light and thermal imaging

capabilities, this rifle has incredible range potential. Strictly a military weapon, this gun is incredibly illegal. What's more, the Depleted Uranium rounds (which are rated Extra High Impact, see Colt-Mausser M-2x) cost 100eb each! Because the round is low-velocity with rocket boost, there is a "safe zone" of 160m in which the weapon has Acc 0 and does 1/3 damage; it does 1/2 damage, Acc +1 between 160-800m, and full damage, Acc 0 after that.

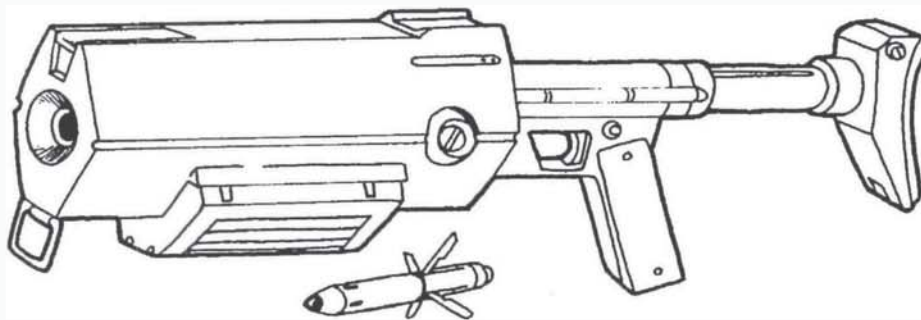

MILITECH URBAN MISSILE LAUNCHER 900EB

HVY +2 LP 4D6 (MICROMISSILE) 12 2 ST 200M
MM-POD: HVY +1 * P 4D6 (MICROMISSILE) 1 1 ST 200M

The most advanced urban weapon ever to hit the streets! This magazine-fed weapon, which resembles an oversized SMG, fires the same self-guided heat-seeking explosive-tipped rocket-propelled projectiles as the cyberarm Micromissile Launcher. However, its large box magazine allows for high firepower and rapid reloading. With an Urban Missile Launcher, the average corporate solo becomes a fearsome hunter-killer! Also available from Militech is the Micro-Missile Pod, a muzzle-loading 1-shot micromissile launcher designed to be mounted on any shoulder firearm, from a carbine to a machinegun (this unit costs 200eb, and can be mounted on any weapon for 50eb). **Notes:** see Micromissiles, pg. 49, for rules on using these weapons.

WEAPONS

MILITECH PDU-3 MULTI-PURPOSE PERIMETER DEFENSE UNIT 150EB PER UNIT

HVY 0 P P 2d6+5 1 1 ST (2.5M
BLAST RADIUS)

These small devices are one of the most compact sensor-deterrent units on the market today. The PDU-3 is a unit about 3" square by .75" thick, with a sensor, controls, and a small panel for insertion of a single microcell (to power the sensor and controls). Designed to be used as a part of a perimeter, or to be sown to dissuade pursuit, these units contain a small, but potent, explosive charge. The casing is made of a light ceramic that shatters into long, sharp shards, providing a fragmentation effect. The PDU-3 can be set to fire from a variety of triggers, and can be set for almost any time delay. While the unit will accept input from most military sensors, it is equipped with a PIR (Passive Infra-Red) motion sensor, a magnetic door contact (about the same size as a matchstick), and a tripwire. Each unit has a small amount of charge-activated molecular glue on it's back, allowing for solid adhesion with almost any surface. The PDU is state of the art in man-portable area denial weaponry! Versions adapted to throw gas are usually bursting types with a similar radius.

TSUNAMI ARMS "AIRHAMMER" 5.3 MM AIR PISTOL 325-400EB

P+1 J SPECIAL (5.3MM AIRJET/VARIES) 5/7 2 ST

An unusual design for an unusual purpose. Tsunami was asked by Crystal Palace Security to design a weapon that would penetrate the light armor (like skinweave) commonly encountered on the Palace, while still avoiding the problems of hull penetration and threats to bystanders. The answer was the AirHammer, which fires a 5.3x19mm cartridge, using a compressed gas cannister for propulsion. The low velocity of the air gun limits penetration, and reduces recoil. A simple switch on the bottom of the barrel controls how much gas is used. The gun has three settings: "Target," "Combat," and "Overload." A variety of rounds are available for this weapon, but the most common is a fragmenting flechette made by Kendachi that has minimal penetration versus solid surfaces but excellent stopping power. Other rounds include flechette, gas, gel, and practice rounds. The AirHammer is available in two versions: the first has a 5-round cylinder, a laser sight, and mounts a 10-shot gun camera as integral equipment. HighRider solos prefer this weapon, as it gives positive proof that the user was unable to close with the victim. The second version (the Mark 2) has a seven-round cylinder and an integral smartgun rig. This is usually issued to Security personnel and bodyguards.

The AirHammer is Very Difficult (25) to find on Earth, but Average (15) at any Spacer facility (although they may not sell one to a Groundhog). "Target" is used when performance is not necessary, and only delivers 1/2 damage. "Combat" is the normal setting for the weapon, and no modifiers are applied. When the pistol is set for "Overload," its reliability drops to UR. It also does +3 damage. The gun's air reservoir holds 15 units of air—each target shot uses 1/2 a unit, each combat 1, and overload uses 3. Replacing the cylinder is a 1 turn (10sec) operation, and requires a REF roll vs 15 (to keep from dropping something). This roll can be skipped by taking an extra turn. The Z-G Recoil Modifier is +1 so the base REF roll to maintain position in Z-G while firing this weapon is 16+.

MUNITIONS LIST

Kendachi Fragmentation Flechette—does 1 d6+2 damage, uses special ceramic darts.

Flechette—1D6+2 AP. Uses bioplastic or ceramic darts. Shreds soft armor (reduces SP by 1/4), but shatters against solid surfaces.

JellSlugs—2D6+2 damage (see rubber bullets, pg. 47). The gel rounds splat against walls or hard armors.

Gas—Throws out a 2m gas cloud when it impacts a solid surface (usually sleep gas, but any gas is usable). Persistence is 2 rounds.

Practice—1D6-1 damage, uses a plastic slug.

TECHTRONICA MODEL 009 VOLT PISTOL 950EB

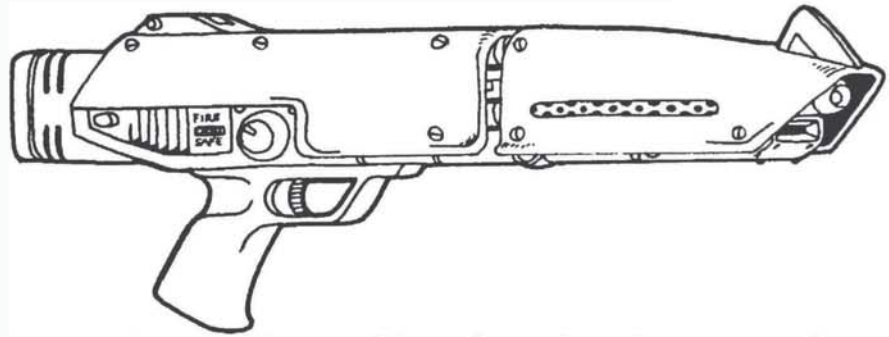

P +1J R 3D6 6 1 ST 25M

A dynamic new weapon from the masters of electronic warfare! Inside the sleek metallic frame of the Volt Pistol is a low-intensity laser projector, which ionizes the air when fired. Then the 009's high-capacitance liquid metal batteries release an electrical charge along that path, resulting in an artificially-generated, directed "lightning bolt." (damage is 1/2 real, 1/2 stun) Since this is an electrical discharge weapon, any cyberlimb hit by a Volt Pistol will be shorted out for 1D6+3 turns (if a critical success is rolled, the limb is permanently shorted out and must be repaired) unless shielded (20% chance). Even if the target is hit in a meat part, adjacent cyberware is treated as if hit by a microwaver with a +1 on the effect roll (a critical TO HIT success means any effects are permanent until repaired). Of course, most armor is not grounded against electrical impulse (this is 50% the cost of the armor, and negates the gun's effects), so normal armor offers no protection against the blast! Utilizing advanced technology, the Volt Pistol is comparable in size to a large SMG, and is powered by an energy pack (reloads cost 25eb) which attaches to the rear of the weapon.

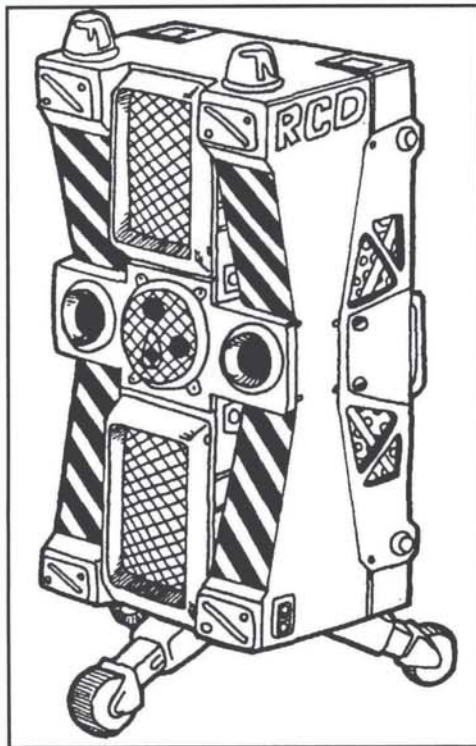

ARASAKA "NAUSEATOR" RIOT CONTROL DEVICE™ 1900EB

EX 0 N P SPECIAL 10 1 ST

The latest in large-scale crowd control. Police forces take note: the "Nauseator" (as it was dubbed at last year's LawTech convention), has proven itself as an effective way to cool down an otherwise ugly situation without unnecessary bloodshed. No need to hose down a field with expensive 30mm ammo. Just dose 'em with ultrasound and watch those poor souls puke their guts out. The mess is certainly less than that of blood on the streets.

- All targets within range must make a Very Difficult BOD check to avoid the disorientation, headaches and nausea/vomiting.
- If check was made: Debilitation (-4 to all actions for 1D6 rounds)
- If check failed by 1-3: Incapacitation (REF and MA reduced to 1 for 1D6+1 rounds)
- If save failed by 4+: Serious Incapacitation (unconscious for 1D6 minutes)

Target must be hit for a minimum of 2 consecutive rounds before being subdued. Range is a shotgun pattern 15m deep and 25m wide.

The following cyberaudio options increase the BOD check one level: Amplified Hearing, Increased Hearing Range. These options make you immune to the effects: Sound Editing, Level Damper. Special headsets or ear-plugs reduce the BOD check by one level. Note: the device is a field generator (0.6m wide x 1.7m tall), not a hand-held weapon.

WEAPONS

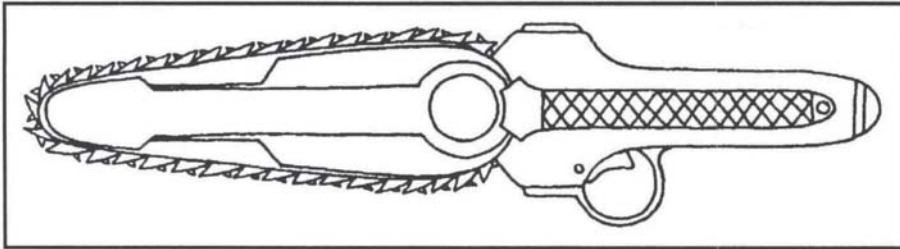

IMI "CHAINKNIFE" 120EB

M +0 J P 2D6+1 NA NA VR

Designed and manufactured in Israel, the ChainKnife has seen a great deal of use with Mossad agents. Shaped somewhat like a survival knife, this is a battery-powered (2 hours) hand-held combat saw (similar to the Buzzsaw cyber-option; *Solo of Fortune*, pg32) which can chew through armor like cheesecloth (1/2 SP, soft armors are reduced 2 pts/hit)!

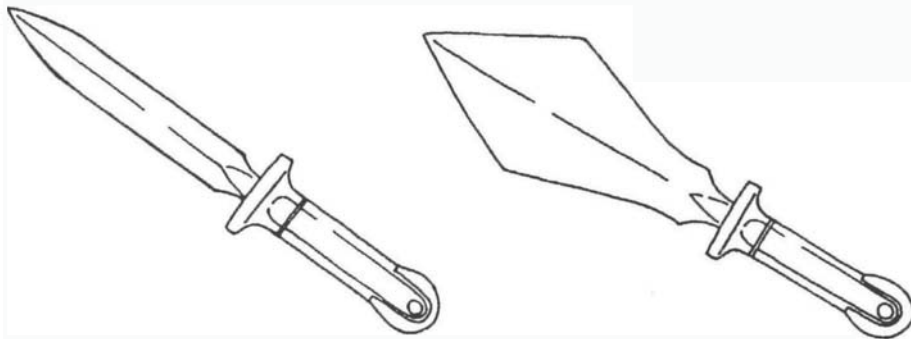

SLAMDANCE INC. SPAWNBLADE 450EB

M0(+1 THROWN) J P 1D6+BOD/1D6+4 NA NA ST

With the Spawnblade, SlamDance Inc. puts the "combat" back into the combat knife! To the naked eye, the Spawnblade just looks much like any combat knife that has been balanced for throwing (1D6+BOD modifier damage). The differences manifest only in combat: once the safety is disabled, the Spawnblade's memory-metal blade has the ability to "fan out" its cutting edges. On any combat hit that does more than 4 points of damage (including BOD bonuses to damage, but before BTM) and gets past your opponent's armor, the Spawnblade can be triggered. The blade spreads into a razor-sharp 50° spatula—inside your opponent's body! This does an additional 1D6+3 (armor won't help). Once opened, the Spawnblade can only be safely removed with a Medtech roll of 20; any other means of removal will cause the victim another 1D6/2 damage. The Spawnblade comes with a safety sheath in a choice of ten designer colors.

KENDACHI MONOWHIP 350EB

M 0 J P 2D6 NA NA ST 1-3M

Following in the tradition of the popular cyberweapon, Kendachi's Monowhip houses a spool of mono-filament wire in an ergonomically-designed handle. The wire has a small weight at one end for balance and swing, and can be extended up to 4m in length or reeled in at the push of a switch. The Monowhip can therefore be used as a garotte, cutter, or razor-sharp grapple. The monomolecular wire will cut through almost any organic material as well as most plastics, doing 2D6 damage (double damage on a critical success). **Note:** Monoweapons, unless noted otherwise, allow only 1/3 armor protection vs. both hard and soft armors.

KENDACHI MONOWIRE 60EB PER METER

String it at neck level, and watch your pursuit go to pieces; string it at ankle level, and watch intruders lose their footing! Available in varying lengths, Kendachi's monomolecular wires are capped with synthetic bulbs at either end for safe handling. The ultimate trap element, and ideal for slicing your cheese, too. **Note:** Monowire does 3D6/cut damage, while reducing armor values to 1/3rd.

TASER WALLET 65EB

New from Pursuit Security Inc. comes their complete line of personal object protection devices. Thieves got you down? Try our little toys. Each wallet,

billfold, and purse is rigged with a 1000-volt charge that activates when removed more than 2m from the transmitter chip hidden on your person. The unwary pickpocket is unable to hold onto the object for more than a few seconds. Discreet and non-lethal, these are designed to discourage so called "five-finger discounts" of your personal belongings.

Note: Beyond 2m the thief must make a Very Difficult BOD roll each round to hold onto the stolen item. An Average COOL check is recommended to avoid crying out.

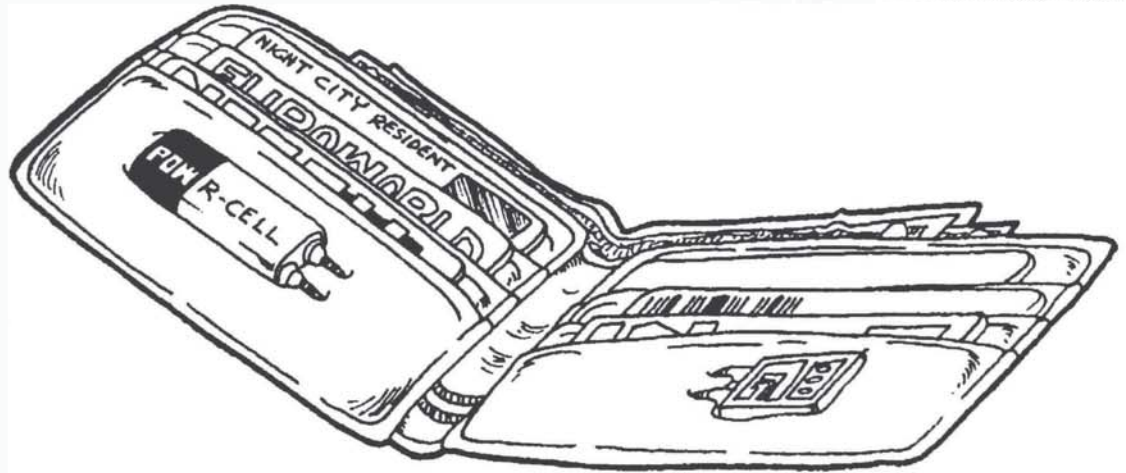

MYSTIC TECHNOLOGIES SPRING KNIFE 125EB

MEL O P C 1D6 NA NA ST 1M/5M

On first inspection this knife appears to be the standard survival variety, but in fact its blade can be released and launched via a high-powered spring. The blade has a range of 5m and inflicts 1D6 points of damage. The knife takes 2 rounds to reload.

DRUG-A-THUG™ 150EB

EX O P C CHEMICAL 5 1 VR

The latest thing to hit the streets of 2020 is the Petrochem Drug-a-Thug™. This handy-dandy little device delivers a solid dose of any paralyzing or sleep-inducing drug that the wielder chooses. Compact, it is capable of fitting into most pockets and purses. Only slightly larger than a touch taser, the Drug-a-Thug™ is perfect for those who wish to be discreetly armed.

Any target struck must make a Very Difficult BOD check (plus Resist Drugs skill) to avoid its effects. Reloads cost from 10-20eb per dose. Capable of being loaded with any drug. The device will not penetrate armor.

TASER II™ 100EB

EX O P C STUN 4 2 VR

The newest in personal protection for the non-violent person. This little friend is capable of delivering a 15,000 volt charge to a touched target. Reach out and say hello to that perp with the modern answer to crime. The new Taser II™, brought to you by the people at Militech. Because we care about your safety.

Note: Target must make a Stun Save with an additional -1 to avoid its effects. See taser rules in CP2020, pg.97 for more details.

SKUNKER™ 70EB

EX -1 P E GAS 4 1 VR

Armament for the non-violent person. Delivers up to 4 doses of non-lethal gas (Purchaser's choice) to a target 2m away. One target only, but enough to discourage any allies he/she may have. At 6 inches long and 1 inch around, it fits in any purse or jacket pocket. Comes in 6 designer colors. For 5-10eb more, the gas can be mixed with odiferous chemicals creating additional effect equal to Stench Bomb (see entry).

Note: See gas rules CP2020, pg 100 for details.

AMMUNITION

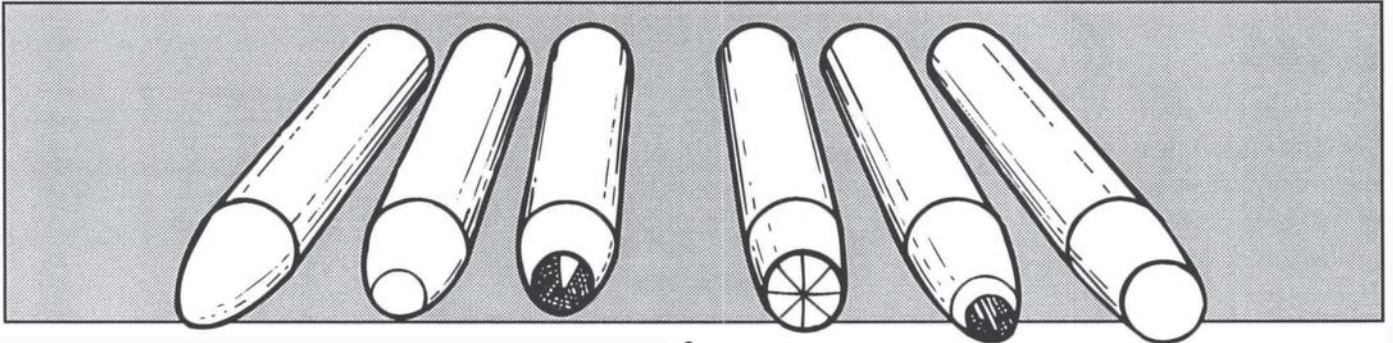

DUAL-PURPOSE ROUNDS (4X BASIC COST)

Gone are the days when you might accidentally bring AP bullets to a nudist colony, or normal ammo to a Body Armor manufacturer's convention. Dual-Purpose ammo gives you the best ballistics for the best situation; DP rounds consist of a dense, sub-caliber penetrator core of tungsten steel wrapped in a sheath of soft, quickly-mushrooming lead. When these rounds hit armor, the lead sheath strips away while the penetrator continues through to your target. However, when these rounds hit flesh, the lead squashes out to cause a massive wound cavity. In any situation, Dual-Purpose rounds leave little to be desired. **Notes:** when DP rounds hit an armored target, they treat it as 1/2SP but do 1/2 damage to flesh. If the target is unarmored, they do 1.5x normal damage.

API - ARMOR-PIERCING INCENDIARY (4X COST)

In the old days, guns were called "heaters." That name applies once again, thanks to the remarkable new API rounds. These cartridges fire metal-jacketed, sharp-nosed slugs which cut through most armor with ease, but these slugs pack a surprise: each bullet is composed of a solid chemical compound which combusts in reaction to high-pressure impacts. The overall effect is a bullet which, upon impact, becomes incredibly hot, searing the insides of its target! Just try not to get into a firefight in a paper factory... **Notes:** API ammo acts as normal AP ammo (armor SP is halved but so is damage vs. flesh), but if the bullet penetrates its target's armor, it does an extra 1D6 damage the first turn, and 1D6/2 damage the second turn. API rounds may ignite any flammables they hit (50% chance). Cannot be fired from guns with ElectroThermal Enhancement

Minimum bullet size is 10mm for pistols, 7mm for rifles.

KENDACHI FRAGMENTATION FLECHETTES (5X COST)

This ammunition, manufactured by the Kendachi Corporation, consists of a synthetic-cased or caseless cartridge which fires a subcaliber alloy flechette. These sabotaged, fin-stabilized arrows travel at impressive speeds (up to 4,000 feet per second), giving them superior armor penetration ability. They are also injected with a near-microscopic filling of a C6-style plastic explosive, and are chemically time-delayed to detonate a microsecond after impact. Using this design, the needle-like projectiles are able to successfully penetrate armor without suffering from overpenetration. The classic problem with flechettes is this: being of very small diameter and traveling at extremely high velocity, a flechette may pass directly through the target and leave only a tiny (and ineffective) hole in the body. To overcome this, Kendachi's fragmentation flechettes pack just enough explosive to break themselves apart once they enter the body, thereby creating a devastating wound cavity. **Notes:** Kendachi's Fragmentation Flechette ammo is available for any weapon at 5x the cost of regular rounds; they treat soft armor as 1/2SP and do normal damage to flesh. Beware — these rounds are Rare availability and very illegal. Usually found with orbital weapons. Cannot be fired from weapons with ElectroThermal Enhancement.

WEAPONS

LESS-THAN-LETHAL™ AMMUNITION (COST VARIES)

Many ammunition manufacturers have produced a variety of Less-Than-Lethal ammunition as well as utility rounds for shotguns. They can not be called non-lethal, as many are very dangerous if not used at the proper ranges. These are just a few of the types available to the public.

RUBBER BULLETS 1/3 NORMAL PRICE BOX OF 50
Damage is Stun only beyond 3m. Below that range, 1/2 is real, 1/2 is Stun.

STINGER SHOTGUN SHELLS, 12 GAUGE 15EB BOX OF 25
Damage is Stun only beyond 3m. Damage is 4d6 under that range.

STINGER SHOTGUN SHELLS, 10 GAUGE 20EB BOX OF 25
Damage is Stun only beyond 9m. Damage is 5d6 under that range.

GAS SHOTGUN SHELLS 20EB/25EB BOX OF 25
Damage is by gas type used. Area of effect is 2m circle.

FLARE SHOTGUN SHELLS 25EB/30EB BOX OF 25
Lights up an area of 30m diam. Causes 2d6+2 and 1d6/2 per round fire damage if fired as a regular shell.

SMOKE SHOTGUN SHELLS 15EB/20EB BOX OF 25
No damage, but obscures a 3m circle with dense smoke.

FLASH SHOTGUN SHELLS 30EB/35EB BOX OF 25
Act as a flashbang grenade in a shotgun pattern 25m deep by 3m wide. (see Flashbang Grenade)

**"Non-lethal
ammo only?
Geez, Morgan.
You're really a
killjoy, y'know
that?"**
—Ripper jack

PROPELLED / HAND GRENADE TYPES

URBAN TECHNOLOGIES SLASHER 75EB EACH

Another lethal toy from the madmen at Urban Technologies! They've come up with an antipersonnel shell (available in 12 or 10 ga., 25mm, 30mm, and 40mm shells) that strings monowire between two specially-weighted slugs. As the slugs travel, they spread apart, pulling the monowire taut and slicing everything that passes between them in half!

The Slasher delivers a single attack if it hits, doing 4d6 damage at 1/3 armor SP. The only difference is the length of the monowire...the 12/10ga has a 1m wire, while larger shells have longer wires (25mm= 2m, 30mm= 2.5m, 40mm= 3m wire). The shell can attack any target in that area, similar to a shotgun blast.

SPLATHELL (1 OEB PLUS COST OF SPLATBALLS)

One of the most unique riot control weapons to ever come down the pike, the SplatShell is a sub-munitions dispenser of a different sort. Loading 20 16mm splatball rounds into a special sabot (for 30mm/40mm launched grenades), the SplatShell can spray a 10 meter area with your favorite splatballs...virtually guaranteeing a hit! The SplatShell is treated just like a shotgun blast, but all pattern sizes are doubled (2m at Close range, etc.), and any target will be hit with 1d6 splat balls...which can be of any type, but must be selected ahead of time. Munitions can be mixed... Referee's discretion as to which types hit whom.

Shotgun is -3 WA, with LNG range of 10m. If round hits leg, 50% chance of a leg wrap; separate damage to each leg and immobilizing the target. Grenade version is -2WA, with LNG range of 50m. 75% chance of torso (arms) leg (both) or head wrap (will have 50% chance of breaking neck). Rounds cost 150eb each.

WEAPONS

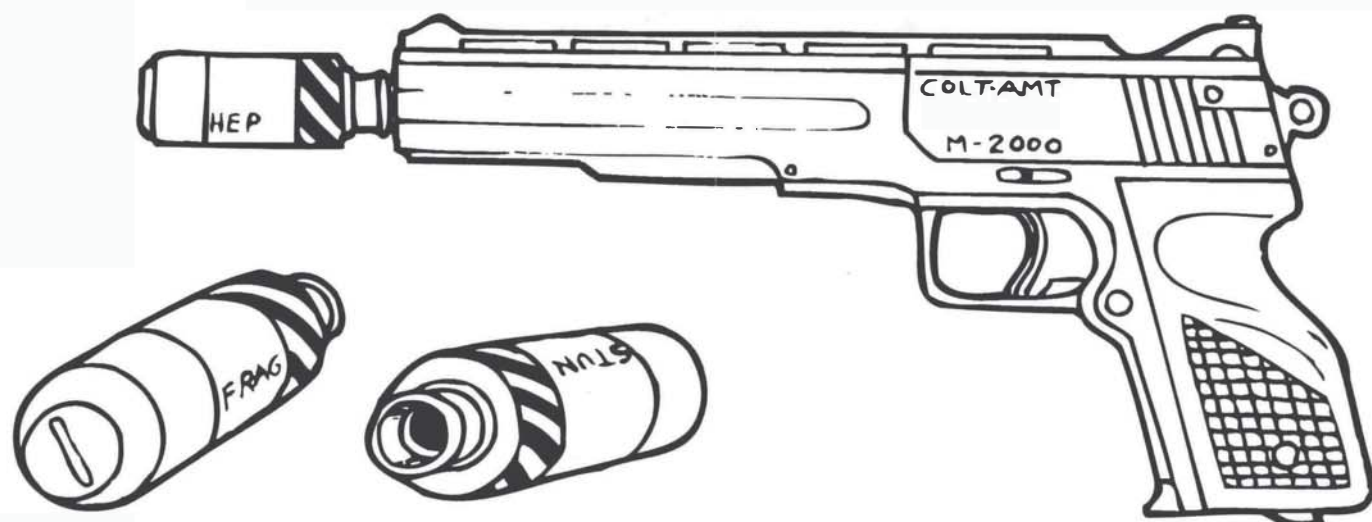

MILITECH 25MM PISTOL-GRENADES 15-30EB EACH

These are similar to DCR's rifle-fired grenades, but they are designed to be fired from pistol-caliber weapons. Any pistol or submachinegun's barrel can be fitted with a Militech-produced muzzle adaptor (200eb) in the appropriate caliber by a weaponsmith or techie (for about 50eb). The adaptor's bullet trap design allows the shooter to fire a conventional round to launch the pistol grenade up to 100m away. These small, barrel-shaped (25x50mm) projectiles carry warheads with capabilities equal to standard 25mm Mini-Grenades. **Note:** Pistol-Grenades cannot be launched by weapons of less power than 9mm, and 9mm through .45-caliber weapons will only have an Extreme Range of 30m! .357, 10mm and other, more powerful rounds will have an Extreme Range of 100m. Bullet trap launcher cannot be used on guns with ElectroThermal Enhancement.

GRENADE TYPE	LONG RANGE 9MM/.45	LONG RANGE .357/10MM+	BLAST RADIUS/DAM	COST EA.
HEP (Cratering) - Damage is 1/2 real, 1/2 stun only; armor has no effect and is damaged 2 levels.	15m	50m	- /5D6	30eb
INCENDIARY - 4D6 first turn, 2D6 second turn, 1D6 third turn; flammables in 1m radius burn. Soft armors reduced two levels/hit.	15m	50m	1M/ 4-2-1D6	30EB
OFFENSIVE FRAG - High-explosive fragmentation; very messy in closed areas.	15m	50m	3M/5D6	25EB
DEFENSIVE FRAG - Reduced explosive; safer for use in tight confines (like rooms, hallways, etc).	15m	50m	3M/2D6+1	20EB
SMOKE/TEAR GAS - See CP rules for clouds; Tear Gas causes tearing & -2 REF, Smoke can't be seen thru.	15m	50m	3M/VARIES	20EB
CONCUSSION - 3D6 damage is stun only, armor protects at only 1/3 effectiveness.	15m	50m	4M/3D6	15EB
FLASH BOMB - 1/2 Stun Save per person with -4 to REF & Awareness for 5 turns.	15m	50m	5M/-4REF/AWA	15EB

WEAPONS

MICROMISSILES 50EB EACH

75EB FOR ANTI-ARMOR, 200EB FOR HEP

CYBERLIMB LAUNCHER (900EB):

HVY +2 * P 4D6 4 2 UR 200M

These miniature missiles are explosive-tipped rocket-propelled rounds with heat-seeking guidance and steering vents. They can be programmed to track objects by their specific IR signature (vehicle engines and human body heat are the most common choices), and explode on impact. The missiles are self-guided, and once locked onto a target they can follow it through one direction change of 90 degrees or less, giving them the ability to track around corners and obstacles (with a 3 in 10 chance of losing the target). Attacks are resolved in the following manner: first, the firer makes an attack roll, adding the Missile's +2 accuracy and ignoring cover and line of sight modifiers. If the attack roll is greater than the difficulty for the listed range, then the missile has hits its target. If the attack fails, then the firer rolls 1D10: on a 4-10, the Micromissile corrects its path and a second attack roll, just like the first, can be made. A failed roll means that the micromissile was distracted and struck something or someone else at random, with no possibility to hit the target (use the Grenade Table on page 89 of *Cyberpunk 2020* to determine where the missile went). However, if your first shot misses your target, you may always fire at him again with your next shot(s) — even if he's under complete cover! Micromissiles have a minimum range of 10 meters, and they must be aimed at a partially exposed target — if they are fired blindly they will fail to initialize a target and will fly in straight paths like normal projectiles. Micromissiles normally do 4D6 damage in a 2m radius, but Anti-Armor Micromissiles (which treat the target's armor as 1/2SP, 1m radius) are available for a 50% increase in price. Missiles can be fitted with HEP warheads for 4x normal price. (4D6+4 damage, no radius; effects equal to S&W Model F)

SCATTER GRENADE 70EB

GRN O P C SPECIAL 1 1 VR

This grenade closely resembles a standard frag grenade. It has a 6 second delay after the pin is pulled. When the grenade discharges, it fills a 5m radius with smoke and harmless particles. The cloud is not only impenetrable to normal sight, it also makes IR and thermal imaging useless.

The cloud lasts for 5 rounds in calm winds.

STENCH BOMB 20EB

Best weapon to clear a room with. Few, if any, can stand the putrid odor that emits from the bomb after activation. The cloud covers a 5x5m area and sticks to any surface. Surfaces must be cleaned to remove the odor.

Note: All those in area of effect not in protective gear (gas mask, nasal filters, etc.) must make a Very Difficult COOL or BOD check or leave the area.

FLASHBANG GRENADE 40EB

GRN O P P 4D10 (STUN) 1 1 VR

The perfect weapon for those delicate jobs requiring that the target be returned alive. Put two or three of these babies in their laps and watch 'em drop. No one can stand up to a concussion blast as well as three 1,000,000-candle-power flashes delivered in under a second. Even the most borged-out loon gets bounced around when a flashbang goes off in his lap. Minimal damage is accrued to surroundings and no permanent structural damage is incurred. The only thing you need to worry about is the bill from the glass men.

The flash effect is similar to that of Flashbulb (*Chrome Book*, pg.35). Soft armor has NO EFFECT against the stun damage; hard armor is at 1/4. Total time out is 1D10 minutes. Flash affects anyone who looks at the blast. Concussion effects all in 5m diam. circle. Glass is shattered up to 10m away if in an enclosed area, like a building.

SPRAYPAINT GRENADE 20EB

Good for the 'punk with a sense of humor. Upon any sharp impact the grenade will "detonate," sending paint all over a 3m area. Paint comes in 15 vibrant colors.

Note: Can blind a target for 1D6/3 minutes if caught dead center of "blast".

WEAPON MODIFICATIONS

NINE-ELEVEN CHIP 175EB : SECURITY CHIPPING 250EB

Now you can rely on the cops.

How likely is it that the police will even know about, let alone respond to, a firefight which you happen to get mixed up in? With the Nine-Eleven chip, it's a sure thing! This modification to your handgun (which does not require a smartgun interlock) installs a small, high-power cellular phone-link which calls the local police (or anyone else you choose) the instant you pull the trigger. Law enforcement agents (or whoever you have selected) are almost guaranteed to respond within 1D10+2 minutes. GMs' discretion on how likely the cops are to respond. **Note:** do not expect any help if you use this item in the Combat Zone.

Keep your gun out of the wrong hands.

This aftermarket chipping for your smartgun establishes a coded lock on the weapon's firing mechanism. In order to use the weapon, you must first jack into your weapon and then "think" the correct password or combination to the gun's on-board computer. Only after the correct code has been given will the weapon operate. A Very Difficult (25) Electronic Security roll is required to break the lock.

GUN-CAM 100EB

This modification to your handgun (which does not require a smartgun interlock) mounts a tiny digital camera aimed parallel with the barrel. Whenever your gun fires, it takes a picture, giving you instant evidence for your self-defense plea. Its internal memory can hold 10 "shots" to aid in your defense, downloadable to any computer or display system. **Note:** many states now require that registered guns have Gun-Cams.

ELECTROTHERMAL AMMO ENHANCEMENT (50% OF WEAPON'S BASE COST)

Overcome the laws of physics! The maximum speed a bullet can be accelerated with gunpowder (around 6,500 feet per second) and the pressure spike created by a gunpowder gas explosion have always limited the capabilities of firearms technology—until now. Take your firearms beyond the limitations of the last century with ElectroThermal Enhancement. By modifying the breechlock, adding a micro-battery pack, insulating the weapon and using high-tech ammunition, a firearm's muzzle energy can be doubled! (Without blowing apart, too!) ElectroThermal (ET) ammunition has the same cartridge dimensions as regular cased loads, but instead of a primer and powder, ET guns employ an electrical pulse and a liquid working fluid. This liquid can be anything from methanol to water, but it must be primed with around 100,000 amps. This energy pulse causes the liquid to combust, changing state to plasma, which pushes the bullet down the barrel at incredible velocities. ET guns can also modulate barrel pressure with a throttle, controlling the energy in the priming process with a safe time/pressure trace. As an example, a 5.56mm bullet has a muzzle energy of 1330 foot-pounds, while an ET 5.56mm has a muzzle energy of 2764 ft-lbs! ET enhancement insulates the gun against electrical surges, modifies it to accept a 100-shot battery (10eb each), and replaces the hammer with an electrode: the result is that the gun does 50% more damage! the procedure can be performed by many arms factories and some gunsmiths (**Poor** availability, Weaponsmith vs. 25), usually costs a couple of hundred euro, and adds .5kg to the weapon — note that only weapons which use **cased** ammo can take advantage of ET enhancement (this generally means 20th-century guns). ET ammo costs 2x normal, and can be combined with some of the other ammo types (AP, etc).

TEAMS

lifetime
escort
service

LES



ORION

AUTOJOKS

"Hire some help?
Hell no! I can
handle those
Arasaka goons myself!"

—**epitaph of an
unknown Solo.**

"No, I won't cut our
price in half. Do
you want only
half of a daughter in exchange?"

—**Orion Contract
Agent**

SAFETY IN NUMBERS

For those times in life when a single street ronin isn't enough, or the giants of Lazarus and Arasaka just aren't *subtle* enough, only a small team of dedicated professionals will do.

Teams can provide a discrete "escort" for a safe (and enjoyable) night on the town, to secure, expedited, shipments anywhere in the world! For employment opportunities or assistance, these organizations may just save your life. Well worth the Euro at any price!

TEAMS



SPHERE...

IF IT

NEEDS

TO GET THERE;

ANYWHERE.

Sphere Courier is the world's finest transportation company. From LEO to Lyon, Tycho to Topeka, secure, prompt delivery is our specialty. Other companies may compete, but none can compare. Worried about your shipment? Sleep tight— call SPHERE.

We move any size package, from a data chip to a mainframe. Our staff will help with planning, threat determination, packing, and handle all security while in transport. Our overland trucks use state of the art ECM suites, anti-personnel weapons and real human pilots to ensure against hijackers. Our aircraft are all rated at Mach 2 or better, and are under full human control. Codelock Safeboxes™ protect all but the largest of our cargoes with armor to SP40. Self-destruct is standard. A typical SPHERE operation includes a netrunner or expert system to check for spooks, a driver/pilot, an ECM tech and a security guard. On larger vehicles a weapon operator may also be required. Crews differ slightly on air cargo and LEO flights but operational capabilities remain constant.

While there is no standardized rate system

(threat, size, distance and mode of transport all affect the cost of service), it is however, safe to assume costs will fall within three basic price ranges. **Low threat** cargo costs about 50eb per kilo, overland. **Air Cargo** starts at about 120eb per kilo and **LEO** at 300eb (down) and 1500eb (up), per kilo. **Threat level increases** cost by 2-50 times. Delivery distances greater than 6000 kilometers double the price (except for LEO travel).

SPHERE has offices in every major city and arcology in the world (define major city as anything over 100,000 ppl.), with its headquarters in Capetown, Azania. Feeder service is available in all other locations at no extra charge, just call OSPHERE-CAAZ and one of our representatives will consult with you free.

SPHERE. Expensive. Cocky. But the best. How do we know we're this good? Our customers keep coming back.

Background Notes: SPHERE became a reality in 2004 when several antiquated courier services (DHL, Roadway, etc.) were co-opted by famed

TEAMS

corporate raider, Peter X. In one of the most widely televised corporate eliminations in history, sixteen major stockholders were assassinated at the 2005 World Cup Soccer semifinals. (The event was sponsored by Federated Transport, a progenitor of SPHERE. In 2010, the company was sold to the employees for an undisclosed sum.)

This is not the only scandal associated with SPHERE's checkered past. The company is still trying to live down its nickname, *The Blackball Express*, coined by a pirate vidchannel after a highly publicized incident where a mid-level EBM manager tried to mail himself to Haiti (after he was blackballed and targeted for "retirement"). The executive was delivered; he was even still alive, and almost made it across the street before he was retired (earning the corporation the sobriquet *Blackball Express*. The Company's logo, a black sphere, was not a help here).

SPHERE DRIVER/REPRESENTATIVE

INT 6 REF 8 TECH 6 COOL 6
ATR 5 LUCK 6 MA 5 BOD 7 EMP 8

SKILLS: Family+3, Awareness+5, Melee+2, Rifle (or SMG)+3, Drive+6, Pilot (varies)+2, Pilot(also varies)+2, Basic tech+4, Wilderness (or Urban) Survival+2, Brawling+4, Athletics+4, Education+3, Math (or Business Sense)+2

EQUIPMENT: Sternmeyer S-10 w/50rmds, Lt. Armorjack, Notebook Computer, Personal Commlink (as in C-TEAM), Delivery Vehicle (varies). Cyberware: Neural Processor with Vehicle-link, Dataterm-link, Plug set; +1 Kerenzikov; Chipsocket; Cyb-optics with IE, TE, AD, LL.



It's a dangerous world out there. Everyone has enemies, and no one has the time to watch them all. Today's security problems call for tough solutions. For thousands of people, Lifetime Escort Services provides the solutions for their day-to-day security needs. And we can help YOU.

Our bodyguards and security teams cover nearly the full gamut of armed force. From a sophisticated lady or gentleman companion (who won't raise an eyebrow at that luncheon meeting); to a full-time staff of uniformed bodyguards, capable and obvious, LES gives you all the options for personal security and peace of mind.

And you can count on us to be discrete. A single escort can be disguised as a romantic involvement, a long time friend, a personal secretaries or chauffeur. Or, if you prefer, an obvious and heavily armed personal Cyborg Attendant can be provided. (Why does every nineteen year-old netrunner in the world think that it's really cool to have your own full-on 'borg as a doorstop?)

Most security needs are met by the aforementioned options: the single escort (the most common); the three man team: escort, driver, ECM specialist, and the security squad (coordinator, driver, ECM specialist, technician, three escorts and a netrunner). Daily rates run about 150eb/day average for a single escort, with experts running from 400-20,000eb. A three man team will start at 4000EB a day. A car will cost between 75eb (for a basic sedan with no extras, like the T-C Omega; CP2020, pg.171) to about 500eb (for a limousine, or a low-end APC). AV-4's start at about 800eb per day. A fully equipped security team with armored vehicle (usually an armored van; SP20, SDP200, tires SP20, SDP20, glass also armored to SP20. The

TEAMS

van seats ten and is equipped with all-around firing ports and a top hatch with weapon mount.) Starts at 2000eb per day for an average unit. As with all services, highly trained experts with big reputations will cost a lot extra (4-20 times). Some discounts may apply for larger groups but most local escort services top out at forty operatives. Weekly rates for the three options are 900eb, 2400eb, and 12000eb. An easy formula for weekly services is buy six days, get the seventh one free. The easy monthly formula is half-off the fourth week. This sets monthly rates at 3200eb, 8800eb, and 42,000eb. Use the same formula for long term vehicle rental. These rates assume you pay for all room and board. There is also usually a slight surcharge on AV fuel and maintenance (long term rentals or excessive use only).

Local talent is critically important in security work and as a nationwide franchise specializing in the use of local operatives, LES has the edge over other out-of town security forces (if your high-power, imported Meat Boys don't know what local trouble looks like, it makes their job that much harder). For discretionary assignments, operatives can also easily be brought in from offices outside your region.

Conveniently accessed via Data Term, through our franchised storefront operations, or our high tech Regional Clearing Exchange Offices—your local office is always nearby.

Reliable, bonded and discrete. Lifetime Escort Service. Count on us.

AVERAGE ESCORT (SOLO)

INT 5 REF 7 TECH 5 COOL 6
ATR 4 MA 6 BOD 7 EMP 5

SKILLS: Combat Sense+5 Awareness+3, SMG+3, Handgun+4, Social+3, Human Perception+4, Intimidate+5, Elec.Security+3, Personal Grooming+3, Wardrobe & Style+2, Driving+4, MA (judo)+4, Melee+4, Streetwise+5, Fast Talk+3, Education+2, First Aid+2, Hide/Evade+3

CYBERWARE: Nasal Filters, Rippers, Cyberoptic w/TimeSquare Plus and Vis. Rec. chipware is good idea; maybe some Fashionware. Remember, the bodyguard/escort is a people person; having low/no empathy is usually a bad idea

EQUIPMENT: Colt Alpha/Omega with silencer and laser sight in shoulder rig w/3 mags, HK MP-2013 with laser sight in breakaway holster w/5 magazines, Monoknife, Tonfa, Gibson Armortrench (SP14, EV 1), Eji action jeans, Arasaka-Nike TacTrainers.

WHEN YOU
NEED MORE
THAN A MAN TO
GET THE JOB
DONE...



When you need more than a man to do the job, C-TEAM gives you more than a man. At C-TEAM we supply top-of-the-line cybermercs for a price you can afford. A team of six men will give all the flexibility and force options of most units twice the size.

Our standard six man team consists of a Team Leader (with over five years of experience, guaranteed!), a commo/ECM expert, three line infantrymen (cross trained or chipped in a specialty you choose) and a heavy weapons expert/certified demolitions tech. Most special equipment is included. However, due to recent de-

TEAMS

mand, air-mobile teams have a slight surcharge. Many other types of cyber teams are also available. Air Cav, ground support aircraft, full-plated bodyguard teams, even custom operatives made to order. C-TEAM does it all.

C-TEAM was founded in 2015 by Len Carrington, a highly decorated officer in the U.S. Air Force who has served in cyber-augmented forces since the Pittman 2 project in 1999. An expert in small unit tactics and counter-insurgency with over thirty successful missions in the Central American Conflicts, Carrington saw a definite need for the kind of tough soldier that the big corporations would not employ. C-TEAM was his solution; it's probably yours, too!

To contact C-TEAM, just dial CTEAM-2NEB on your local dataterm, or feel free to visit our

training center in Omaha, Nebraska. Offices or representatives are located in most American cities; no matter how remote your location, we can have a team on duty in 48 hours (some charges may apply, custom teams are exempt). Periodically, supply exceeds demand, so make your reservations early.

A standard six man team starts at only 1000eb per day or 3500eb weekly with extra weeks as low as 3000eb. Monthly rates can start at 12,000eb and only 11,000eb per extra month. Air-mobile units start at 12,500 per week plus fuel with a standard AV-4; a pilot and a technician are also included. Monthly rates start at 45,000eb flat rate, fuel extra. Supply and Transport charges may apply. All rates subject to availability. For custom teams or larger units please call for a quote.

STANDARD C-TEAM LEADER (SOLO)

INT 6 REF 10 TECH 5 COOL 6
ATR ? LUCK 5 MA 6 BOD 9 EMP 2

SKILLS: Combat Sense+5, Aware+5, Handgun+3, SMG+4, Brawling (or MA)+3, Melee+2, Weap. tech+3, Athletics+4, Rifle+4, Stealth+3, Cyber tech+2, Exp: tactics+4, Intimidate+2, Leader+3, Wild. Survival+2, Heavy Weapons+1

Equipment: Assault rifle w/15 mags, tactical computer, Sidearm w/5 mags, portable braindance unit, etc.

CYBERWARE: Neural Processor with Boosterware+2, Pain Ed., Weap. Link, Plug set x2; Chipsocket; Muscle/Bone Lace or Graft. Muscle; Nanosurg.; Cyb-optic x2 with IE, TA, AD, IL; Cyb-audio with RL, SC, SE, EH, LD; Cyb-arm x2 with THK, RJ, MSR, ARM, RPH (right) and THK, RJ, MSR, ARM, GRP (left); Cyb-leg x2 with THK, RJ, ARM, GRPF; Body Plating: SKUL, FACE, TORS

HVY WEAPON/DEMO TROOPER (SOLO)

INT 6 REF 11 TECH 7 COOL 8
ATR ? LUCK 7 MA 5 BOD 11 EMP 3

SKILLS: Combat Sense+4, Aware +5, Handgun+2, Rifle+6, Hvy. wpn.+5, Demo.+4, Brawl (or MA)+3, Weap. tech+4, Athletics+3, SMG+2, stealth+1, Exp: combat engineer+3, Oper. Hvy. Machine +2

EQUIP: Any SAW w/800 rnds, or Grenade Launcher w/25 rnds, SMG w/7 mags, demolitions kit, long range multichannel encrypted radiodetonator, etc. Σ-series linear frame, Metalgear.

CYBERWARE: Neural Processor with Boosterware+2, Pain Ed., Weap. Link, Plug set x2; Chipsocket; Nasal Filters, Independ. Air, Adren. Boost; Muscle/Bone Lace; Nanosurg.; Cyb-optic x2 with IE, TA, AD, IR; Cyb-audio with RL, SC, SE, RD, LD; (optional) Cyb-arm with MSR, ARM, MML

TEAMS

"Meatboys are fine for some things...like getting perforated. If you want survivability, choose the Metal."

Anonymous C-Team Squad Leader

COMMO/ECM TROOPER (SOLO)

INT 7 INT 10 INT 7 COOL 6
ATR ? LUCK 7 MA 6 BOD 8 EMP 4

SKILLS: Jury Rig+5, Aware+5, Basic tech+5, Cyber tech+2, Teach+3, Educ.+3, Electronics+4, Weap. tech+1, Elect. security+4, ECM+5, Exp: commo+3, Exp: cryptology +3, Math+3, Remote Sys. Op.+3

EQUIPMENT: Assault rifle w/10 mags, tactical computer with crypto software, electronic maintenance tools, drone-control terminal (optional), cybernetic repair kit(optional), weapon tool kit(optional)

CYBERWARE: As Team Leader without the Cyb-leg mods, adding a special radio-uplink/ECM unit in all leg spaces, instead. No THK, RJ in Cyb-arms. Radio/Cellular Booster Station (Interface #2, pg.19): full radio-phone station, sat-capable; the equivalent of an Army backpack radio. 160 hours operation on a charge; has power-tap extension, signal-boosting fins; can be attached to portable antenna. Comes with standard channel-jumping encryption. Uses all spaces in one standard cyberleg; 2950eb. An equivalent electronic counter-measures emitter is mounted in the other leg; 2650eb

COMMON TROOPER (SOLO)

INT 5 REF 9 TECH 5 COOL 5
ATR? MA 5 LUCK 5 BOD 8 EMP3/4

SKILLS: standard Solo career package with all at +4

Equipment: Assault rifle w/20 mags, 1 RAW, 4 frag grenades, 3 smoke/gas grenades, etc.

CYBERWARE: Same as team leader without the Cyb-limb options: THK, RJ; x2 Wolverers instead of GRP/RPH; and no Muscle/Bone Lace or Grafted Muscle; Body Plating: SKUL and TORS only. All members carry a personal commlink (with global positioning, beeper), bayonet/utility tool (M-9), E-tool, field gear/supplies for 2 weeks, and a weapon cleaning kit. Armor is usually issued only to non-plated personnel.

"I assure you Mr. Henderson, one squad will be more than enough for this operation. You want the building standing when it's over, correct?"

Leonard Barton—C-Team contact Agent

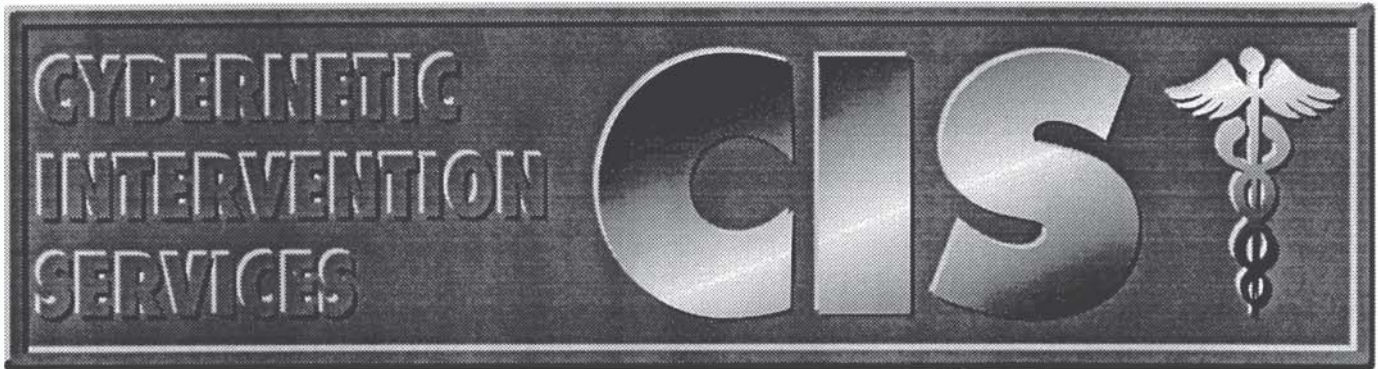

Cyberpsychosis. A word that strikes fear into the hearts of families across America. Each year, thousands succumb to its ravages. Until now.

When your friend or loved one finally goes over the Edge, we can prevent the final solution. Cybernetic Intervention Services is one of the most experienced innovators in the field of restorative intervention techniques. As a wholly owned subsidiary of C-TEAM International, we have more experience with C-Psychos than anyone in the world. And if we don't beat MaxTac, you get a full refund.

Capture is our first objective, but our services don't end there. Our state-of-the-art Cyberpsychosis Rehabilitation Center in Omaha, Nebraska, is one of the finest in America. Upon recovery, your friend or loved one will be immediately jacked into the finest virtual world available. While their mind is being healed by one of our certified therapists, a team of surgeons will remove the patient's cyberware and replace it with real biological parts. Only the patient's Neural Processor and coprocessors (if any) will remain (CIS does not remove neuralware, internal organs, nanotech of any kind, or anything that may cause harm to the client. CIS does not accept any liability for cortex bombs or tailored binary toxins). For a small additional fee, we can also install a T-Maxx "cyber liver" to limit the patients' use of controlled substances. After a nine-week stay in our virtual therapy and regen facility, we will deliver him or her to you anywhere in the U.S.A

CIS is automatically available in any city with a C-TEAM office, and can be on station anywhere in the world in 24 hours. Our teams are fully-equipped with a tactical vehicle (usually an AV-4) and state of the art weapons and restraint equipment (EMP gre-

nades, Static field nets, Gauss projectors and other non-lethal equipment).

So when a loved one calls out to you from the depths of cybernetic addiction, call us. Cybernetic Intervention Services. We Care, Because You Care. Call us at CTEAM-2NEB for a quote.

Game Background: A Standard CIS contract calls for a *minimum* charge of 250,000eb in the Continental U.S.A. There is an extra charge of 50,000eb outside the Continental U.S. If you don't have a verifiable credit rating, then pay up-front. If you don't have the cash for a full rehabilitation, the client can be captured and delivered to you (inside the U.S.) for only 100,000eb. How you control them once they wake up is not CIS's problem. If the rehabilitation requires an extraction, then the cost triples. The phrase, "at what price friendship" comes to mind...

CIS automatically co-opts the offending hardware once a capture has been made. An astute customer should ask for credit to the account for all cyberware removed (or the company will take it anyway). There are no refunds; as a matter of fact, the only thing that C-Team offers refunds for is a missed target. As the contract reads, "If, for any reason we fail to locate our client, or the client is located and subdued by any other party, CIS agrees to refund the full amount within 24 hours."

Each eight man team has the same makeup as a standard C-TEAM, with a variety of chipped skills, and the extra equipment below:

EMP GRENADE (CHROMEBOOK 1, PG.47)

GRN O P R ELECT. 1 1 VARIES

These grenades are usually deployed as a rifle grenade, or a limpet-type round. The Intervention Team

"WE CARE, BECAUSE YOU CARE."

TEAMS

is very cautious about using these, as they are almost as heavily-augmented as the client.

BIOTECH-ASKARI MOTION RESTRAINT BOMBS (CHROMEBOOK 1, PG.48)

EX 0 P P SPECIAL 1 1 UR

Every line trooper on a Team carries 3 or 4 of these. The bigger 'borgs rip right out, but they're good for subduing lesser psychos with a minimum of fuss.

SHARPWIRE NET UNDER-BARREL MOUNT (INTERFACE #1, PG.26)

EX +2 N P NET 1 1 STD 10M RANGE 450EB/NET

A one-use cannister mounted under an assault rifle; it launches a macro-filament wire net. If target fails Dodge skill roll (or Athletics at -1), MA is reduced to 0. If an attempt to escape is made using force, divide target's BOD by 2 (round up); apply this as damage (1/2 armor, don't reduce penetrating damage) as filament cuts in. If target uses cutting weapon to escape, it will take 12-REF in combat rounds.

PURSUIT SECURITY, INC. WEBGUN (SEE WEAPONS SECTION, PG.37)

TECHTRONICA M-40 PULSE RIFLE (SEE WEAPONS SECTION, PG.39)

GAUSS FIELD PROJECTOR EX +2 N R MAG. FIELD 10 1 ST 10,000EB

This weapon projects a magnetic field strong enough to disrupt the electrical signals of the brain. It is quite large (200kg), and is usually mounted on a vehicle or set up in a trap. The shots are charges lasting about 30 seconds. The disorientation lasts for (BOD-2)x10 minutes. If the target can make a Strength Feat or Dodge/Escape skill roll of 25+, he can throw himself out of the field during the first second of the shot (the chances of that are minimal).

WARNING: THE GAUSS FIELD UNIT WORKS ON EVERYBODY—BE CAREFUL

ORION

America: held hostage. Terrorists, psychopaths, disgruntled employees, and the gangboy streetscum; they all hunt us relentlessly. You forget to check the door lock one night and your children disappear. You trust the security at an expensive hotel, and the maid kidnaps your top particle physicist. Who can you call, when the spectre of corporate kidnapping and terrorist extortion threatens your family or business?

Call us. ORION—the Hunters. We use the most talented people in the extraction business to do the job right in any kind of "hostage-rescue" situation.

Founder Orion Hunter is a decorated veteran of SOG Panama and has served in over twenty successful extraction and hostage-rescue missions. Shortly after Hunter's retirement, MA&F

Corporate Director Howard Merrill was trapped in his home by a group of the infamous "Iron Sights" street gang. Assembling a dedicated team of experienced solos, Hunter swiftly accomplished the rescue with minimal loss of life. That team has become the core group that has evolved into ORION's elite cadre of experts; a team that we can put to work for YOU.

In the rare event that ORION cannot handle the type of operation that you need (or you prefer to utilize your own corporate extraction teams), we can still help. We maintain a worldwide database of operatives and can construct any type of specialized team for you. Air assault—no problem. Underground hideout—it's handled. At ORION we never say die. ORION (and its sister companies; C-TEAM

TEAMS

and Cybernetic Intervention Services) have offices across America. We can be anywhere, ready to go in twenty-four hours, guaranteed. Contact us; ask one of our efficient consultants to take down all of your information and compile a mission prospectus.

Once the victim is located, we move swiftly to the planning phase of our contract. We keep you involved at each step. Even though our mission planners are the best in the world, only you will be able to tell us about the client. How will they react? Are they expecting rescue? How can we prove to them that we are on their side?

All missions are accomplished with state-of-the-art weapons and equipment. An aerodyne with on-board trauma unit is standard. When the mission is complete, we can deliver the target directly to you, anywhere in the world. Most operations are completed in less than 72 hours. Your associate or loved one will be returned to you safe and sound. We guarantee it.

Initial investigation is only 10,000eb. Low-threat rescues, like gang abductions and white slavery, start at only 20,000eb (Continental U.S.) and 30,000eb (Western Hemisphere). Some missions cost more, but all are tax-deductible.

Game Notes: Although Orion's "hostage recovery" pitch *sounds* altruistic, the flip side is that they also specialize in corporate *kidnapping* as well (this is as bold as a company specializing in extraction can be and still operate legally). Why go to this kind of trouble when the big corporations, like Arasaka, have their own black ops teams? It's simple; Arasaka won't take outside clients. No one in Corporate America wants to admit that they actually perform extractions on a regular basis. They certainly aren't going to risk their reputations for a third party.

Deniability and secrecy are very important in high-level extraction, and most Corporations work outside through services like this one. The best operatives are freelance and they don't work cheap. They live in the shadows, work through double cutouts, and stay invisible. Most of the time the Corporations consider them a necessary evil, but paranoia rules. A full biosculpt after every mission does wonders for your survival.

If you really want to extract a "Top Man," you had better have deep pockets; these operations cost between 1.5 and 2 million eb depending on the tar-

get and the threat. Terms will be dictated in extreme secrecy and through many levels of cutouts. You won't see these people or talk to them. You won't pay them until delivery. You'll probably only talk to their fixer's fixer. You'll pay them in gold or other stable non-currency.

They won't even leave a footprint in the sand.

TEAM LEADER (SOLO)

INT 9	REF 10	COOL 9
TECH 6	ATR 8	LUCK 6
MA 8	BOD 10	EMP 5

Skills: Combat Sense+7, Awareness+6, Handgun+4, MA (Aikido)+6, Melee+4, Weap. Tech+3, Rifle+3, Athletics+6, SMG+5, Stealth+7, Exp: Extraction+4, Streetwise+5, Exp: Tactics+4, Leader+6, Elect. Security+4, Endurance+4, Social+3, Wardrobe/Style+3, Grooming+3, Dodge/Escapes+4, Hide/Evade+7, Education+4, Math+2, Corporate Policy+4, Business Sense+3 [*Corp. Policy and Busin. Sense* skill are in *Solo of Fortune*, pg.31]

Cyberware: Neural Processor w/Vehicle, Smartgun, Dataterm links; Speedware +3, Tactile and Olfac. boosts, Pain Ed., Plug Set x2; Chipsocket; Skinweave and Lifesaver weave, Musc./Bone Lace, Tox. Binders, Nanosurg.

Equipment: Notebook computer, cellular phone, Arasaka WSA smartpistol w/silencer and 3 extra mags, Smartgoggles w/Targeting and Lowlight; Commlink, Tanaka Suit w/ matching briefcase, Kendachi Sword Cane, low impedance interfacecables, Metalgear, Militech Smart "Bulldog" CAW w/ 5 mags(saboted slug)

TEAMS

"They kidnapped my wife. By the time I called Orion and got her back, she needed a full body rebuild. So I hired Orion to get the terrorists out of a Mossád prison. And hand them over to my wife and her bodyguards..."

—An EBM Manager

MEDTECH

INT 8 REF 8 COOL 8 TECH 10
ATTR 5 LUCK 6 MA 9 BOD 8 EMP 6

SKILLS: Medical Tech+8, Aware.+6, Diagnose+8, Education+6, Cryotank Ops+8, Library Search+6, Pharmaceuticals+5, Zoology+3, Cyber tech+6, First Aid+5, Biology+6, Exp: Loyalty Devices+6*, SMG+3 (chip), Melee+3 (chip), Exp: Surgery+4 (chip), Stealth+3 (chip), Basic tech+4(chip)* This skill specializes in the devices implanted to prevent disloyalty/extraction

CYBERWARE: Neural Processor with all links except Cybermodem, Tactile Boost, Plug Set x2; Chipsocket; Skinweave, Tox. Binders, Nanosurg.; Cyb-hand w/Medical Module (Interface#2)

EQUIPMENT: Malorian Smart SMG w/5 mags, Commlink, MedicGear combat med armor, Smartgoggles (IE,AD,ME,TH options), portable trauma unit and cryotank (in get-away vehicle), interface cables

BASIC OPERATIVE (SOLO)

INT 7 REF 10 COOL 8 TECH 7
ATTR 7 LUCK 6 MA 8 BOD 10 EMP 5

SKILLS: Combat Sense+5, Awareness+6, Athletics+5, Handgun+3, SMG+4, Rifle+6, MA (Thai)+5, Melee+4, Weap. tech+5, Stealth+6, Endurance+3, Basic tech+3, Streetwise+4, Grooming+2, Wardrobe+2 Education+2, Math+2

CYBERWARE: Neural Processor with Weap. Link, Plug Set x1; Chipsocket; Graft. Muscle; Rippers x2

EQUIPMENT: Metalgear, commlink, Smarted FedArms Lt. Assault-15 w/10 mags AP ammo, 4 Dazzle, 4 Frag, 4 Sonic, 2 EMP grenades

NETRUNNER

INT 10 REF 9 COOL 8 TECH 9
ATTR 7 LUCK 7 MA 6 BOD 7 EMP 6

SKILLS: Interface+8, Aware.+8, Sys.Know.+8, Composition+6 Program+9, Basic Tech+5, Electronics+5, Cyber Tech+5, Cyberdeck Design+7, Education+6, Math+6, Elect. Security+6, SMG+3 (chip), Stealth+4 (chip), Grooming+3, Wardrobe+3 (chip), Exp: Computer Systems (mainframes)+4 (chip)

CYBERWARE: Neural Processor with all links, Plug Set x3, Pain Ed., Tactile Boost, Speedware +3

EQUIPMENT: Cybermodem Utility Suit with custom cellular combat deck, armor t-shirt, metalgear (legs), backup custom portable deck, Viper SMG w/5 mags

AUTOBOOKS



"Why do all the Meat Boys get the credit? Sure, they got smartguns, but they haven't got the right smarts. They can pull trigger on a guy, or even a bunch of guys. They don't have any real power. I do; I can make you wish you were dead. I mean, we're sitting here in this nice cafe, havin' tea. In about three minutes, I can make your car, your wife, your Cred-Card... disappear. Pfft, gone, see ya'. We can do anything and you can't even touch us. Sure, you can do me, but the Joks will know and we look after our own." She ends the diatribe to light a cigarette.

"The Net is a wild place, a wilderspace/ So much can happen in the 'face/ The speed of it, the light of it/ My brain disintegrates bit by bit/ IN...THE...NET..."

"IN THE NET", THE SINNTHETIKS FROM THEIR DISK CHAINSAW INTERFACE, ©2018, INTERROGATION RECORDS.

You really didn't think your boss was serious. You are sitting across the table from a skinny girl, about sixteen year sold. Her techhair is iridescent green and she wears this ugly blue armorjack with a picture of Gibson on it. Her six plugs make a neat row across her forehead. Your boss needs a shrink. This kid doesn't stand a chance of breaking the other guy. She probably watches too much vid. But hey, you're sitting here, so let the kid feed you her pitch....

"So this run, you got a shopping list or you just want I should crash the system. Hey! You listening?" You turn your datacase around, showing her the screen. She blinks a couple of times as she looks at it, then you hit the erase macro. "This is gonna take some time, The files are ease but that 'frame has pretty thick ICE. I'm gonna'

TEAMS

need 15K up front for software. The balance will run you, let's say 145K on delivery."

Yeah. Right. You smile. "No deal," you say. "The price is 100K on delivery, take it and that's that. The time frame is sixteen hours. Seventeen and the deal's off."

She looks for a moment at you with eyes that seem inhuman, then she speaks. "Check. Sixteen hours, but the price just became 150K. Time is money. Without a day to plan, this is gonna' be a stone bitch." She gets up and sticks out her hand, you nod and smile, shaking it. "By the way, this whole meeting has been recorded," she says. "Try to stiff us and you get to become a deniable asset, on national television." As she walks away, you smile to yourself. The boss gave you a budget of 200K; if she pulls it off you are going to have a great vacation.

Meeting an AUTOJOKS rep is probably the toughest part of a desperate executive's life. These people don't advertise. They don't take out ads on the DataTerm. According to most fixers they're a myth. The truth is—no one wants to know the truth. That a syndicate of subzero netcriminals are hiring themselves out to the highest bidder...too freaky. But if you know the right kind of people (and ask obtuse enough

questions) you might get a call in the middle of night. A call not logged on your (or anyone else's) monthly bill. A call that will get the job done, for the right price (Ref's call).

Not quite a gang and not quite a mafia: AUTOJOKS.

The network sprang up a year ago, or maybe two. Some young kid was nervous about his first run. They say he asked an older Netrunner, some guy he once worked joeboy for, to keep an eye out. When the kid disappeared—so did the client.

An idea was born. Things are getting pretty tight now. Watching over each other in a kind of voyeuristic way. This isn't all "hearts and flowers;" everyone gets a cut. Older runners sometimes coordinate several contracts with the same company, cutting costs. Most AUTOJOKS sleep soundly. Sometimes being alone can really stink. Now, they never have to be.

Not all netrunners are AUTOJOKS. Most don't want to be that connected to other people. Some are asked and some just find their way. A side note: a new vid show that glorifies netcrime is getting decent ratings on 54. It's called AUTOJOKS; poser gangs are popping up already.

No camouflage like publicity.

A TYPICAL AUTOJOK (YEAH, RIGHT)

INT 10 REF 7 TECH 9
COOL 7 ATR 5 LUCK 7
MA 5 BOD 5 EMP 7-4

SKILLS: Interface+6, Aware.+6, Basic tech+4, Educ.+4, Sys. Know.+7, Cyberdeck Des.+7, Composition+5, Electronics+6, Programming+6, Math+4, Library Search+6, Streetwise+4, Wardrobe and Style+4, Culture+2, Elect. Security+3, MA (Tai Chi)+4(chip), Handgun+4 (chip), Melee+2 (chip), PhotoRAM chip, Stress chip, "Fish n' Chips" chip [Culture skill is in *Solo of Fortune*, pg.31]

CYBERWARE: Neural Processor with all links except Smartgun, Kerenzikov +2, Tactile Boost, Plug set x3, Pain Ed. (option); Chipsocket; Digit. Recorder, Contracept. Impl., various Fashionware (usually Techhair); Cyb-optics x2 with ME, IE, TS Plus, Vid. Imager. Some have Cyb-legs x2 (orbital crystal) with ARM, custom CMD, LCD, HOL, TOLF (right), STDF (left)

EQUIPMENT: A ton of programs, Eji Armorjack SP14, Chanel handbag, Arasaka WSA pistol (in leg holster), spare magazines (in bag), CredCard, three complete passports and two driver licences, Frag grenade, a great deal of random junk.

FULL BODY REPLACEMENT

TOTAL CONVERSION FOR THE TOTAL CYBERPUNK

“There I was, trapped on the third floor of the burning apt-block—thick smoke and fire everywhere... I couldn’t tell *which* way was out. A blazing section of ceiling had fallen on the last fireman who tried to rescue me. I figured I was burnt toast for sure, ready to flatline. Suddenly, the burning wall to my left exploded as a metallic form charged through it. Emergency lights flashed on its shoulders, and it marched straight through the inferno surrounding me. No foolin, choomba, this thing just scooped me up like a mother collecting her kid. Before I knew what was happening, it leapt out the window and we hurtled to the ground. When I came to, it told me that her name was Samantha.”

—*Johnny Silverhand.*

“Full Conversion—because sometimes meat just can’t cut it.”

—*Advertisement*

Borg is a four letter word. As early as 2005, various military forces were experimenting with fully cybernetic body conversions. It was during these early experiments that “Cyberpsychosis” was first identified and diagnosed. In 2020, “full borgs,” as they are colloquially referred to, are becoming an increasingly common sight. Construction workers, fighter pilots, space explorers and even firemen are opting to supplant their human bodies with mechanical replacements which will help them do their jobs better. The full potential of this technology has yet to be realized, but becoming a full borg is far from a standard procedure.

Such a conversion is the ultimate step in cybernetic enhancement. By supplanting a skeletal system with a metal endoskeleton interlaced with a myomar fiber musculature, incorporating fully cybernetic limbs and covering the entire body with armor, you can become the “classic” cyborg of science fiction. A full borg can lift and throw a small car, tear down brick walls with his bare hands, and walk through machinegun fire. His body has effectively been fully replaced, giving him all the equivalent abilities and structural damages of cyberlimbs and more. He is reinforced and armored, with a full body SP of 25. His cybernetic nervous system and interlaced synthetic muscle fibers give him incredible reflexes and movement speed. Heavier combat models also utilize electromagnetic pistons, commonly referred to as “Hydraulics,” which are stronger and faster. A combat borg is almost unstoppable, capable of withstanding massed machinegun fire and light anti-tank weapons. Full borg conversions are still rare (and frequently illegal) new-tech. One reason for this is that by the time the

FULL BODY REPLACEMENT

arduous and expensive process is over, much of the intangible "humanness" of the person is lost, sometimes creating a cold, merciless, machinelike personality. Physically speaking, the character becomes so "unhuman" that he takes Structural Damage Points rather than wound damage.

There is some hope for those who undergo full conversion... because full body replacement is performed all at once, there is less trauma to the individual. If a person were to get all the components of a full borg separately, she/he would suffer a massive loss of humanity (usually over 100 HC!) This is because there would be several operations, repeated physical and psychological trauma, and a sort of "slow chipping away at the body and soul" of the patient. A full borg conversion, however, is an all-in-one procedure which is less like an operation performed on the body and more like a transplant. In such a case, the patient's brain, a portion of the spinal cord, and the few organs which cannot be replaced (collectively known as the "Biosystem") are transplanted into a "robotic" body. Most of the functions performed by internal organs (such as a digestive tract, lungs and heart) are taken up by cybernetic analogs. For instance, the lungs are replaced with a high-efficiency filtration and oxygenation system; for this reason, a full borg is immune to any kind of gas. In fact, a full borg has a pressurized air storage cell which it "charges" twice a day, eliminating the need to breathe almost entirely. The

case is similar for eating and drinking, although for psychological reasons all full borgs are capable of regular eating (it is unavoidable that most full borgs cannot engage in sexual activity or have children). For psychological reasons, a full borg must sleep and is not normally able to turn off his sense of touch — thus they are susceptible to pain (but many have built-in Pain Editors). Being mechanical in nature, a full borg body cannot heal damage without repairs. Full body conversion imparts improved physical capabilities (supplanting the patient's original REF, ATT, MA & BOD with new ones based upon the functions of the body). Additionally, full borg bodies have many option spaces which can accept any of the standard cyberlimb options and many new systems.

Although full borgs enjoy massively increased physical abilities and the capability to totally customize the body, they have some serious disadvantages as well. Aside from the obvious humanity costs, full borgs (sometimes referred to as "Metalheads") suffer from a strong social stigma against them. Many people are fearful of their potential for cyberpsychosis, while others are jealous of a Metalhead's physical capabilities and perceived wealth. (Full borgs have many more job opportunities than normals because of their bodies, which are quite simply...superior.) Although opinions vary, most full borgs find themselves the victims of discrimination and prejudice—this has resulted in a sort of brother-

hood among borgs, which is not always understood by others (some see it as a secret club or conspiracy, leading to more fear and hatred). For obvious reasons, every city's C-SWAT division requires all full borgs to register (see page 64 of *Cyberpunk 2020* "Registered Cybers"), and often corporate sponsorship is also needed for complete legitimization.

Corporate sponsorship is, in fact, the most common route for attaining a full body conversion. Many corporations will offer a contract for full conversion to those who satisfy the extensive screening and testing procedures (which are structured to determine psychological profile and stability—usually a minimum EMP of 8 is required to pass these tests). A corporation will offer an employee a full body conversion on a 10- to 25-year basis, during which time the employee will be able to perform at fantastic levels, thereby making the corp a lot of money. Once the contracted time has expired, the employee has the option to keep the body or have it downgraded to a "naturalized" body (one that is more human in appearance/function). There have been rumors that the best borgs can have their brains transplanted to clone bodies after their term of service. Corporate (or Military) sponsorship can be chosen as an option in character creation similar to selling out (see *Cyberpunk 2020* pg. 83-4), but there is only a 20% chance that you'll be given a full borg body. (No luck can be

FULL BODY REPLACEMENT

added to this roll, so don't skimp on your stats, because if you don't get the body, you're stuck with your original one. You only get a basic body, and all options must still be paid for.) Although most borgs are corporate or military creations, there have been a few cases of "street" Borgs—most of these jobs have been sloppy and unreliable (as well as being psychotic and short-lived). Once in a blue moon, a custom borg does show up, but they are incredibly rare and expensive. In

any event, whether you have sponsorship or get a custom body, the transplant operation has a Surgery Code of 2x CRITICAL (see *Cyberpunk 2020* p.70 for more on surgery).

There are rumors on the street of exotic experiments focusing on full body conversions, and they aren't pretty. Interchangeable braincases are a reality (though rare), but there are supposed to be projects involving inserting such braincases into tanks and fighter planes, and there are even rumors of

human brains in robohound bodies. Even more speculative and exotic is the rumor that Microtech can electronically transfer a mind from a human body into a borg housing an implanted clone brain. These rumors are unconfirmed, but many experts say it is possible. The implications are enormous...

Note: We suggest you use the Therapy rules from the Exotics Section (pgs.101-102) with these conversions. HC for high Stats or special Options is marked by asterisks: *N*

TOTAL-BODY CYBERWARE:

To illustrate the point of how a Full Borg is made, a list has been provided showing the relative costs (in Humanity and Eurodollars) for the component parts of a total cyborg

INDIVIDUAL COMPONENTS	HC	COST
Neural Processor (required)	1D6	1000eb
Interface Plugs (assumed)	1D6	200eb
Cyberoptics (no options)	2D6/2D6	500eb/500eb
Cyberaudio (no options)	2D6	500eb
-HEADWARE TOTAL-	-8D6-	-2,700EB-
Cyberarms (basic)	2D6/2D6	3000eb/3000eb
Hands (standard)	0/0	150eb/150eb
Arm Armor (SP25)	0/0	250eb/250eb
Cyberlegs (basic)	2D6/2D6	2000eb/2000eb
Feet (standard)	0/0	200eb/200eb
Leg Armor (SP25)	0/0	250eb/250eb
-CYBERLIMBS TOTAL-	-8D6-	-11,700EB-
Cowl (skull SP25)	1D6	200eb
Faceplate (face SP25)	4D6	400eb
Torso Plate (torso SP25)	3D6	2000eb
-BODY PLATING TOTAL-	-8D6-	-2,600EB-
BODY REPLACEMENT*		
(H30/T40/SP25)	8D6 (was 5D6)	20,000eb (was 8,000eb)
-REPLACEMENT TOTAL-	-8D6-	-20,000EB-
TOTALLED SEPARATE COSTS	-32D6-	-37,000EB-

The list above covers all the basic components required to make a full borg. The "Body Replacement"* is not a standard cybernetic item — it is only available as part of a full borg conversion. However, for reference's sake, it has been itemized in the complete list. Compare these costs to the Alpha body which represents a basic full borg conversion.

FULL BODY REPLACEMENT

ALPHA CLASS

INTERNATIONAL ELECTRIC CYBERNETICS
FULL CYBERNETIC CONVERSION

40,000EB

IEC, as one of the largest and most successful manufacturers of cybernetics in the world, offers many full conversion packages. Their "Alpha Class" is considered to be the industry standard, and as such can be regarded as one of many "generic" designs. Similar models are also offered by Raven Microcyb, Cybermatrix Inc, Militech Cybernetics International, Dynalar Technologies, and Noveltech Ltd. Composed of durable, ultra-light polyceramics, foamed alloys and other hybrid materials, an Alpha Class body is designed to bear a strong resemblance to the human form. It is anthropomorphically structured to integrate with standard human ergonomics with little or no difficulty. Following this design concept, an Alpha Class stands about 6'6" tall, weighs approximately 350lbs, and is built like a linebacker or world-class bodybuilder.

Once a patient's brain is transplanted into the head and the few required biosystems are wired into

the body, all the physical functions (oxygenation, digestion, blood circulation, etc.) of the body are performed by cybernetic components. The internal systems of an Alpha Class body consist of a cybernetic nervous system, an alloy endoskeleton actuated by a myomar fiber musculature, and a covering of an ultra-light plating of woven carbon-beryllium fibers in a plastic base. The Alpha Class body's physical abilities are easily equivalent to the human maximum, with strength and lifting power being even higher. Because the cybernetic reconstruction is so complete, an Alpha Class body takes Structural Damage Points rather than wound damage.

Although an Alpha Class (or similar model) body comes essentially "stripped," (except for Interface Plugs, of course) it has many option spaces to accept subsystems for customization. Most custom-built or otherwise non-corporate/military bodies will be similar to an Alpha Class, with assorted options built-in to serve the patient's (or creator's) own purposes. Similarly, when an individual manages to get together enough money to buy himself a full body conversion, he will usually get an Alpha Class body with a customized suite of options (such as improved physical capabilities, sensors and weapons systems, aesthetics and stylization, etc).

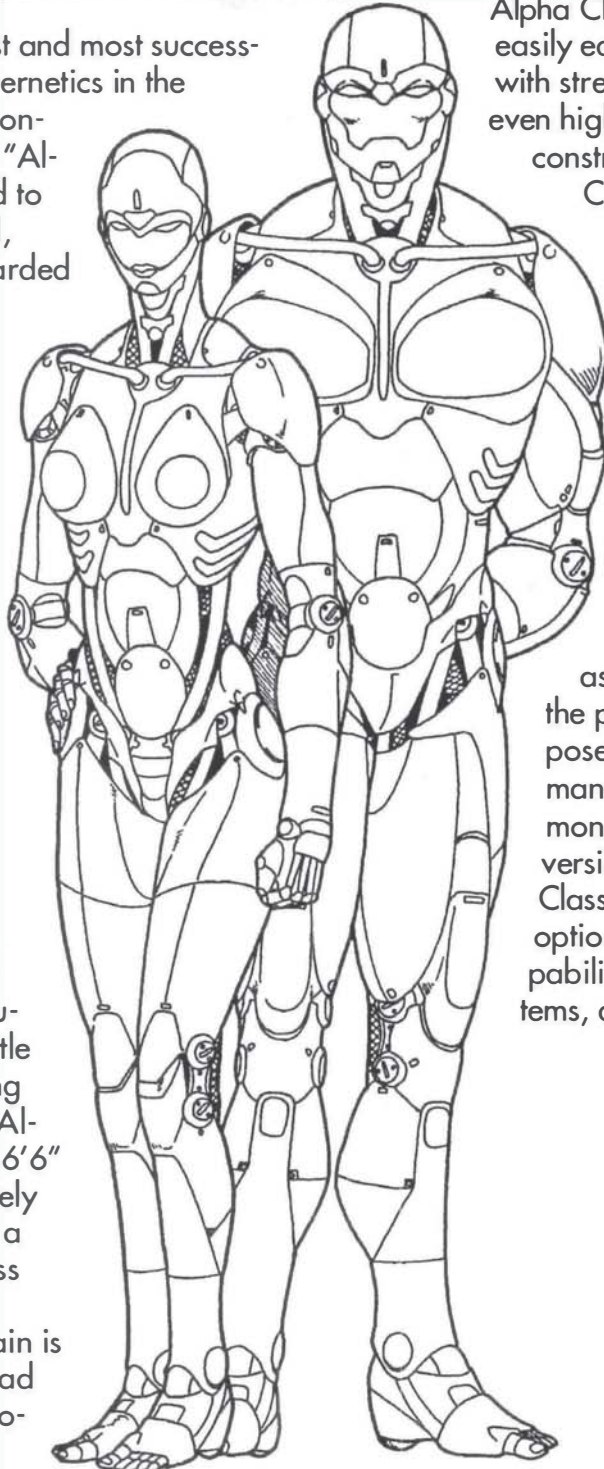

FULL BODY REPLACEMENT

ALPHA CLASS PHYSICAL STATS

REFLEX: 10
 ATTRACTIVENESS: NA
 MOVEMENT ALLOWANCE: 10
 M/turn: 30m MPH: 20mph
 Jump (up): 6m (broad): 8m

Body: 12
 Lift: 480kg Throw: 120m
 Damage Mod: +4

HAND-TO-HAND:

Punch: 1D6+4 Kick: 2D6+4

OPTION PACKAGES

Sensor Options: None installed
 Weapon Subsystems: None installed
 Other Options: None installed

PHYSICAL STRUCTURE

HEAD

SP: 25
 SDP: 20 (disabled), 30 (destroyed)
 Options (Optic): 4 & 4
 Options (Audio): 6

RIGHT ARM W/ HAND	TORSO	LEFT ARM W/ HAND
SP: 25	SP: 25	SP: 25
SDP: 20/30	SDP: 30/40	SDP: 20/30
Options: 3	Options: 4	Options: 3

RIGHT LEG W/ FOOT	LEFT LEG W/ FOOT
SP: 25	SP: 25
SDP: 20/30	SDP: 20/30
Options: 2	Options: 2

TOTAL PACKAGE COSTS

Eurodollars: 40,000
 Humanity Cost: 16D6

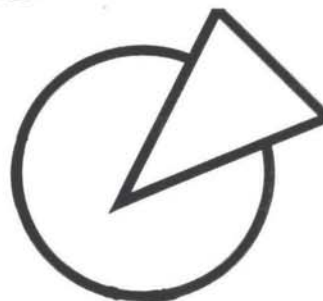
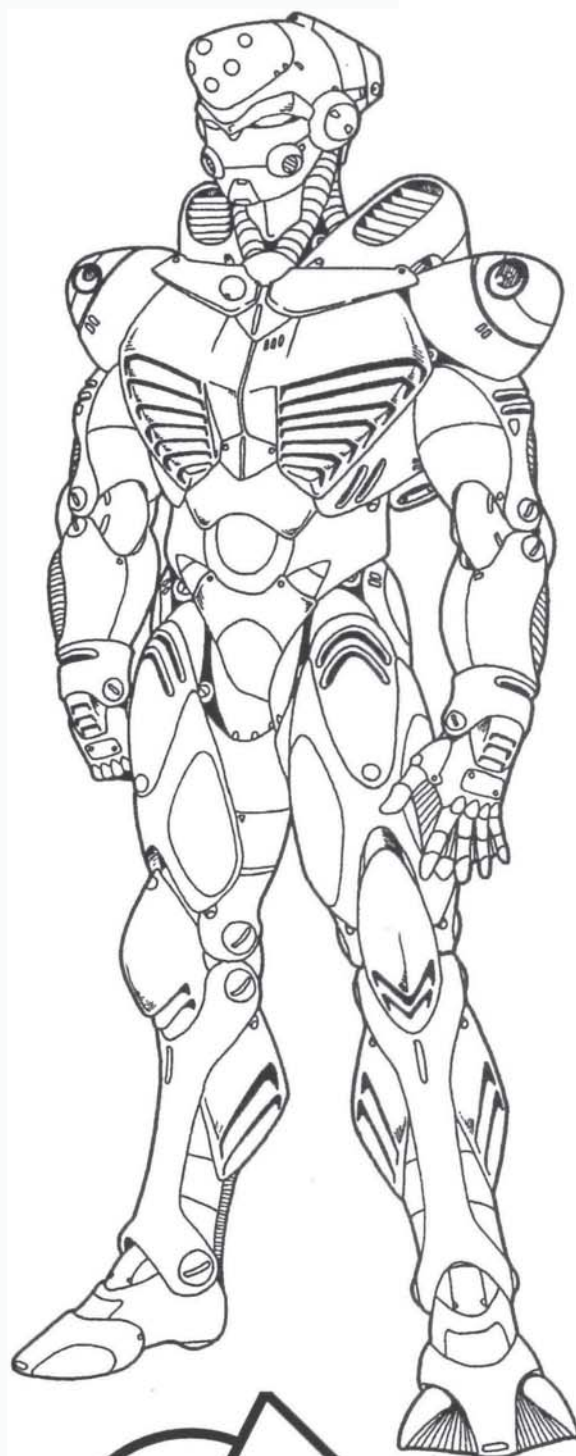

DYNALAR

AQUARIUS

DYNALAR TECHNOLOGIES
 SUB-MARINE FULL CONVERSION

50,000EB

The only way to dive deeper than Bryan LeShawn (who dove to a record 12,645 feet on July 13, 2011) is with Dynalar Technologies' "Aquarius" full body conversion. Designed for use in underwater environments (both fresh and salt water), Aquarius is superior to any diving system. It is ideal for undersea exploration, mining, aquaculture, construc-

FULL BODY REPLACEMENT

Don't let your frail, organic frame keep you from exploring a bold new frontier. See another world—with your body as your vessel... Aquarius
—Advertisement

tion, and covert operations. Endorsed by the Cousteau Society, the U.S. Navy SEALs, the Hydrosubsidium and OTEC; Aquarius can operate underwater for up to 16 hours, and at depths of up to 16,000 feet! Remember, it was an Aquarius cyborg that explored the Marianas Trench!

The Aquarius is built using corrosion-proof materials, and is waterproofed to protect all internal systems. The body is carefully weighted for neutral buoyancy (its density is equal to that of water), allowing easier maneuvering. Rather than using the standard oxygen cell, Aquarius employs a solid oxygen battery which must be recharged approximately every 16 hours. Its motive system forgoes standard myomar technologies, instead using a high-speed hydraulic system, which has fewer difficulties than myomars when submerged, and boasts a higher strength factor. Supplementing its normal locomotion, Aquarius has a set of miniaturized "caterpillar" drives for high-speed propulsion. These electromagnetic engines (manufactured by the Hydrosubsidium) charge and propel water through their lengths, granting high speed and energy efficiency with minimal audio signature or pollution.

To better function in the alien environment of the deepest waters, Aquarius has several specialized sensor systems. In addition to the standard audio-visual array, a powerful head-mounted Sonar system allows accurate ranging and detection out to 1 km. Built into multipositionable housings in the shoulders are two 1,000,000-candela spotlights, capable of penetrating the murky depths up to 100m (depending on conditions). Communications is provided by a long-range, ULF multichannel radio link (range 50km) so that contact can be maintained with the surface and other units. For defense, Aquarius takes after the Electric Eel, being capable of charging its hull with a high-voltage electric current; no need to worry about shark attacks!

AQUARIUS PHYSICAL STATS

REFLEX: 10 (- TO REFLEXES WHEN SUBMERGED GM*CALL)
ATTRACTIVENESS: NA
MOVEMENT ALLOWANCE: 10 (1/2 MA WHEN SUBMERGED)
M/turn:30m/15m MPH:20mph/10mph
Jump (up):6m/3m (broad):8m/4m
Body: 15 *6*
Lift: 600kg Throw:150/15m underwater
Damage Mod: +8

HAND-TO-HAND:

Punch:1D6+8 Kick:2D6+8

PHYSICAL STRUCTURE

HEAD

SP: 25
SDP: 20 (disabled), 30 (destroyed)
Options (Optic): 4 & 4
Options (Audio): 4

RIGHT ARM W/ HAND	TORSO	LEFT ARM W/ HAND
SP: 25	SP: 25	SP: 25
SDP: 20/30	SDP: 30/40	SDP: 20/30
Options: 2	Options: 2	Options: 2

RIGHT LEG W/ FOOT	LEFT LEG W/ FOOT
SP: 25	SP: 25
SDP: 20/30	SDP: 20/30
Options: 2	Options: 2

OPTION PACKAGES

SENSOR OPTIONS:

Sonar - 1km range. Note that if a full power Sonar pulse ("Ping") is directed at a human at close range (20m), the person must make a Stun Save at -2 or be deafened & disoriented for 1D6+3 full combat turns. This only works underwater. *2*

Spotlights - 100m range, varies depending on conditions. Note that when used at close ranges, can function in the same way as a Dazzle grenade (blinds for 4 turns). This only works above water. *2*

WEAPON SUBSYSTEMS:

Electrified Hull - A contact weapon which will do 1D6+2 in electrical burn damage and also requires a Stun Save at -3. This electrifies the entire surface of the borg. *1*

OTHER OPTIONS:

Caterpillar Drive - Maximum speed is 30mph (MA 15) underwater. Being electrically powered, these have no maximum range or duration. These only work underwater! *2*

Long-Range Radio - Range 50km, with 10 channels. *2*

TOTAL PACKAGE COSTS

EURODOLLARS: 50,000
HUMANITY COST: 18D6+2 (16D6+14)

COPERNICUS

CYBERMATRIX INCORPORATED
SPACE-USE FULL CONVERSION

60,000EB

There is no environment more hostile than the cold vacuum of space. Radiation constantly bombards those who venture outside of man's fragile artificial habitats, and many have fallen prey to the unique accidents of an orbital environment. Cybermatrix Incorporated offers the Copernicus body conversion to make you a native inhabitant of the final frontier. From EVA construction to deep-space exploration, Copernicus is the ideal body conversion.

As a standard feature, this body is fully protected against radiation, EMP and Microwaves with fully-shielded materials and hardened electronics; cosmic rays and electromagnetic storms are no threat to Copernicus. In addition, all exposed surfaces are highly reflective so as not to absorb heat from the glaring light of the sun's unobstructed rays. For added reliability, Copernicus' reaction time has been increased beyond the normal human threshold, making it possible to avoid or avert those zero-G accidents which can occur in a split-second. Because of the unique nature of Full Borg biosystems, minimal reconstruction was required to make this body fully vacuum-proofed; a 12-hour stint of EVA is standard for this cybersystem (after which time the borg must return to a human-friendly environment to recharge air). An internal gyroscope gives excellent balance and level-headedness, despite the lack of any kind of "up" or "down."

By no means a helpless observer, Copernicus can do much more than simply survive in space: 36 micro-verniers are clustered across the body in retractable housings, enabling this Full Borg to perform maneuvers without needing to push off against any surfaces (this effectively adds +2 to Zero-G Maneuver skill). A central fuel storage pod, which is loaded into a receptacle in the borg's lower back, allows enough fuel for 12

FULL BODY REPLACEMENT

hours of EVA maneuvering. In addition to these maneuver rockets, Copernicus has one main thruster nozzle built into the back of the upper body: this compact rocket-propulsion system (usable only in zero-G) can grant acceleration of 5 meters per second squared (or an ever increasing speed of about 10mph per second). Its replaceable solid fuel supply has enough fuel for 20 seconds of burn, giving Copernicus the ability to get up to 200mph if it's really necessary. Just in

case, a 20m grapple-line with an Electro-Stick Pad (fired by a spring-launcher) is housed in the left

arm, for secure tethering to metal surfaces. For reliable traction and stability inside orbital habitats, electromagnets are built into the palms of the hands and the soles of the feet.

Copernicus' audiovisual sensor suite is also specially adapted for space. Most notable is the radar sensor module, whose receiver antenna is

housed in the chest, with the signal emitter housed in the forehead. This high-power sensor has a 2km range, giving the Full Borg an unparalleled

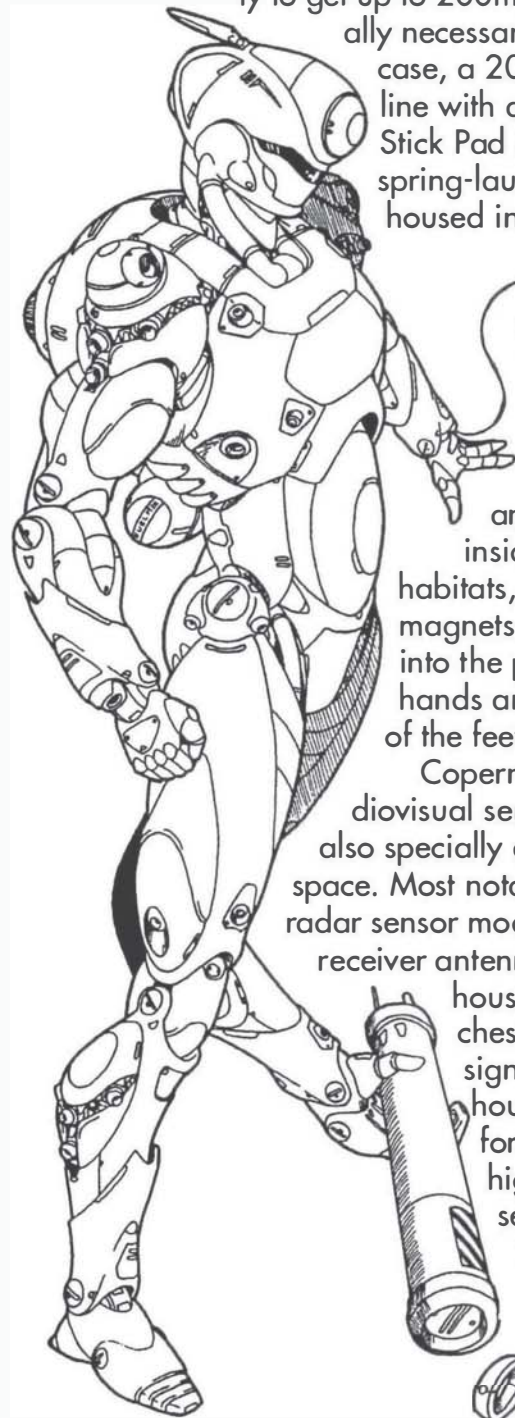

FULL BODY REPLACEMENT

leed awareness of his environment. A radio link is spliced into the audio systems, and both optics are fully protected from bright lights with integral flare-compensation capability. A radio beacon with a 100km range is also standard, in case the borg gets separated from his station. To enhance visibility in the blackness of space, two 1,000,000-candela spotlights are built into multipositionable housings in the shoulders.

In addition to, all these necessities, Copernicus is packed with additional features which make this Full Borg the equal of any Space Suit or Work Module. Although this body's legs can perform all the normal functions that those of the human body can, they can also act as a supplementary set of arms. Copernicus' legs are literally double-jointed, and the feet can unfold into rudimentary hands, the toes extending into finger-like digits which can manipulate objects. These dual-purpose limbs can act just like arms, but at a -3 penalty to reflexes due to their inferior dexterity. Another utility is the 3-shot Goop Ball launcher in the right arm, whose spring-launcher has a 10m range. Goop Balls are ping pong sized plastic spheres filled with a fluid which can harden to patch holes up to 2 inches wide in structures. For convenience, the left hand has several tools useful in zero-G, allowing many small repairs to be done without any additional equipment.

COPERNICUS PHYSICAL STATS

REFLEX: 11 *2*
 ATTRACTIVENESS: NA
 MOVEMENT ALLOWANCE: 10
 M/turn: 30m MPH: 20mph
 Jump (up): 6m (broad): 8m

BODY: 12
 Lift: 480kg Throw: 120m
 Damage Mod: +4

HAND-TO-HAND:
 Punch: 1D6+4 Kick: 2D6+4

PHYSICAL STRUCTURE

HEAD
 SP: 25
 SDP: 20 (disabled), 30 (destroyed)
 Options (Optic): 3 & 3
 Options (Audio): 4

RIGHT ARM W/ HAND	TORSO	LEFT ARM W/ HAND
SP: 25	SP: 25	SP: 25
SDP: 20/30	SDP: 30/40	SDP: 20/30
Options: 2	Options: 0	Options: 1

RIGHT LEG W/ FOOT	LEFT LEG W/ FOOT
SP: 25	SP: 25
SDP: 20/30	SDP: 20/30
Options: 0	Options: 0

OPTION PACKAGES

SENSOR OPTIONS:

Radar Sensor: 2km range. *1*
 Radio Beacon: 100km range. *1*
 Flare Compensation: Works just like Anti-Dazzle. *1*
 Spotlights: 500m range.

Note that when used at close ranges, can function in the same way as a Dazzle grenade (blinds for 4 turns). *2*

WEAPON SUBSYSTEMS: NONE INSTALLED

OTHER OPTIONS:

Toolhand - contains a power-screwdriver, a vac-solderer, a micro-probe, and a small wirecutter. *2*

Dual-Purpose Limbs - these can act just like arms, but at a -3 penalty to reflexes due to their inferior dexterity. *2*

Goop Ball Launcher - 10m range, 3 shots, each shot can patch a 2" hole. *1*

Gyroscope (+2 on Space Sickness rolls, +1 on Zero-G Maneuver skill, +2 on any roll REF involving balance). *1*

Maneuver Verniers and Back Thruster: this system adds +2 to Zero-G Maneuver skill, and allows acceleration up to 5m/sec², or a 10mph (5MA) increase in speed each second. There are 20 seconds of burn for the thruster, and 12 hours of maneuvering for the verniers. Refueling pods cost 50eb each. *2*

Grapple line: 20m range, -1 accuracy. *1*

Magnetic hands & feet. *0*

Electromagnetic Shielding—Hardened circuitry and heat-reflective surface. *1*

TOTAL PACKAGE COSTS

EURODOLLARS: 60,000
 HUMANITY COST: 19D6 (16D6+17)



CYBERMATRIX

ECLIPSE

MILITECH CYBERNETICS INTERNATIONAL
COVERT OPERATIONS FULL CONVERSION

65,000 EB

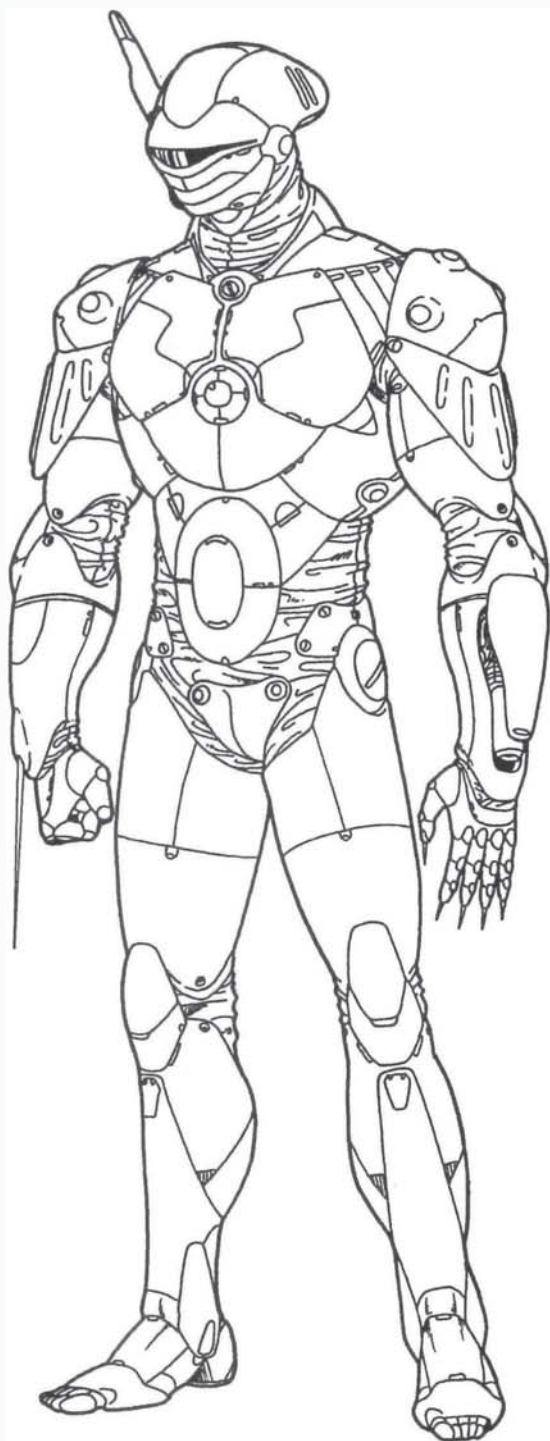

FULL BODY REPLACEMENT

In normal circumstances it takes six highly trained men to form an effective black ops cell. In such cases, you have versatility and firepower, but six men can only be so stealthy. Now, Eclipse offers maximum versatility, firepower and stealth in one compact package. Ideal for assassinations, intrusion, sabotage, kidnapping and information collection. A mix of advanced cybernetics, high-tech weaponry and stealth technology, the Eclipse Cyber System puts any ninja to shame.

As a superior black ops full conversion, the Eclipse uses jump-wired cybernetic reflexes to excel in its field. These reflexes feed directly into the high efficiency Myomar musculature, for increased speed, and a custom integrated gyro-stabilization unit, for near-perfect balance in any situation. Eclipse also comes standard with a pain editor, a pair of independently focusing optics and an on-board ambidexterity sub-processor. Eclipse's physical capabilities guarantee the greatest level of lethality.

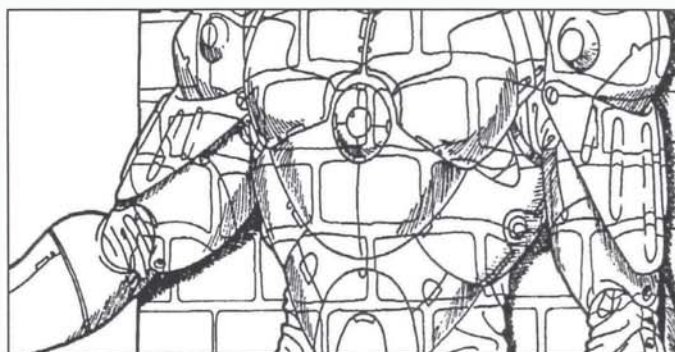

Eclipse chameleon system in action

What would a black ops 'borg be without stealth technology? The Eclipse's exterior incorporates a chameleon system, which employs liquid crystal technology and a multi-faceted fiber-optic digitization system. The visual effects of Eclipse's "skin" are complemented by a negative-noise sound canceller, which uses a complex sound array and fuzzy-logic processors to cancel out any noises made by the cyborg. Its stealth capabilities are supplemented by a high power ECM generator and IR Thermal Dam. Eclipse's foot modules have sound absorbing pads on their soles, which are covered in a tacky rubberized material for increased traction, and the toes can extend and curl around objects to aid in climbing.

FULL BODY REPLACEMENT

The Eclipse's optical array includes Thermal imaging, Lowlite enhancement, an auto-step feature, and an integrated heads-up display with targeting system. The audio package is equally impressive, featuring amplified audio pickups, a decibel leveling system, and a scrambled multifrequency radio with the ability to lock on to homing tracers. As a backup, the Eclipse has a sensor boom capable of looking around corners.

Eclipse's sensory and physical abilities are backed up by a formidable selection of subtle yet effective weapons. The fingers of one hand contain retractable hypodermic needles (See *Venomhand*, *Corpbook 1*, pg. 70). The other hand is a modular unit which comes standard with a dartgun, a lockpick, a finger bomb, and a gas sprayer. The left arm is equipped with a silenced 10mm pop-up auto-loader and the right arm with a retractable 12" monoblade. Secret spaces in the legs are perfect for additional gear.

ECLIPSE PHYSICAL STATS

REFLEX: 13 *6*
 ATTRACTIVENESS: NA
 MOVEMENT ALLOWANCE: 13 *6*
 M/turn: 39m MPH: 26mph
 Jump (up): 6m (broad): 10m

BODY: 12
 Lift: 480kg Throw: 120m
 Damage Mod: +4

HAND-TO-HAND:

Punch: 1D6+4 Kick: 2D6+4

PHYSICAL STRUCTURE

HEAD

SP: 25
 SDP: 20 (disabled), 30 (destroyed)
 Options (Optic): 0 & 0 (3 in boom)
 Options (Audio): 1 (2 in boom)

RIGHT ARM W/ HAND	TORSO	LEFT ARM W/ HAND
SP: 25	SP: 25	SP: 25
SDP: 20/30	SDP: 30/40	SDP: 20/30
Options: 2	Options: 0	Options: 2

RIGHT LEG W/ FOOT	LEFT LEG W/ FOOT
SP: 25	SP: 25
SDP: 20/30	SDP: 20/30
Options: 1	Options: 1

OPTION PACKAGES

SENSOR OPTIONS:

Audios: Amplified Hearing (+2 to audio Awareness rolls), Level

Damper (prevents deafening), Radio w/ Scrambler (1km range) and Homing Tracer (4 bugs included). *4*

Optics: Thermographic Sensor, Targeting Scope (+1 to Smart-guns), Low-Lite (night vision), AntiDazzle (prevents blinding) and Times Square Plus (Heads-Up Display) *6*

Sensory Boom ("Rabbit Ear"): Normal A-V systems, can look around corners. *3*

WEAPON SUBSYSTEMS:

Retractable Monoblade - This does 2d6+7 damage, including BOD, 1/3 to armor. *2*

Silenced pop-up gun (P +2 na na 2d6+3(10mm) 10 2 VR 50m) w/LimbLink- Any Awareness roll to hear it fire is at -10. *2*

Modular Cyberhand; Dartgun, Gas Sprayer, Finger-Bomb and Lockpick fingers (see *ChromeBook 1*, pg. 32). *1*

Venomhand (4 drug-injecting needles, 1d6-1 damage if used in a slash) for more detail, see *Corpbook 1*, pg. 70. *2*

OTHER OPTIONS:

Secret Spaces - There is one in each leg (2" x 6" x 2"). *1*

Gyro-Balancer - This adds +1 to all rolls involving balance. See *Chromebook 1*, pg. 38. *1*

Grip Foot - This adds +2 to all Climbing rolls. *2*

Stealth Foot - This adds +1 to Stealth rolls. *1*

Pain Editor- This negates heat, cold, and pain on command. *2*

Chameleon Covering - This is a built-in digital camouflage system which makes the cyborg blend into its surroundings, granting -4 to Awareness. (See *Militech Ghostsuit*, Page 27). *0*

ECM Generator - This on-board electronics scrambler will jam any Radar or Sonar sensor, motion detectors, and any form of radio communications (except for tight-beam transmissions). Its sphere of influence is adjustable, ranging from 5-100m. *2*

Sound Cancellor - This system incorporates an array of sensitive audio pickups, noise generators and a matrix of fuzzy-logic microprocessors. This unit can analyze the sounds being made by the cyborg (such as footsteps, hands touching things, etc) and instantly emit the "opposite" of that sound; this anti-noise effectively cancels out the original sound, resulting in virtually no sound at all (this causes a -3 modifier to any listener's Awareness rolls). *2*

IR Thermal Dam - This system absorbs IR emissions until they can be safely bled off; this is done in a random pattern, so that it does not appear to come from a humanoid source. This translates into a -5 to any IR-based Awareness rolls. *2*

TOTAL PACKAGE COSTS

EURODOLLARS: 65,000
 HUMANITY COST: 21D6+3 (16D6+33)

ENFORCER

MILITECH CYBERNETICS INTERNATIONAL
POLICE & SECURITY FULL CONVERSION

55,000 EB

Militech knows that cops are on the run in our cities. That's why they've created the Enforcer, a full body cybernetics package designed especially for the Police and Security community. Militech's own contracted police services proudly include several Enforcers in each of their precincts, and Militech security divisions are often supplemented by Enforcers to better guarantee the safety of your premises. Now available for any police group, public or private, the Enforcer is sure to become a familiar sight where you live.

With streetgangs and organized crime becoming better armed all the time, the Enforcer package is well-armed, capable of withstanding almost any small arms fire. Since the scene on the street (or during a security breach) can change in an instant, the Enforcer's nervous system is hardwired for superior response time, and no perpetrator can outrun this cyborg, since its ground speed matches that of most electrically-powered vehicles! Of course, any good cop knows that intimidation is the better part of crime prevention, and to that end the Enforcer is built on a large, heavy-duty chassis which can soak up a good deal of damage, but also scare the most "chilled" of intruders into surrendering.

FULL BODY REPLACEMENT

The Enforcer's audiovisual systems are configured to aid officers of the law no matter what department they're with, from street patrol, to investigations, to the Psycho Squad. This full body conversion's cyberoptics feature a targeting system, a video recorder (for filming evidence), a thermographic sensor (to check suspicious types for hidden weapons and cyberware), as well as low-light and flare compensation capability. The audio system includes a radio link, a recorder (for taking statements), and a voice stress analyzer (to see if those statements are true). The left forearm also stores a Black Book micro-computer (see Electronics section) for instant access to police databases.

When the time comes to get serious, the Enforcer conversion is more than ready. First, there are light bars mounted on the cyborg's shoulders to ensure that you legally identify yourself, but we all know that it takes more than lights to stop a Black Lace addict. That's why each of the Enforcer's legs has a storage space: the right leg houses a pop-out weapon holster, while the left leg has space for three hand grenades (Stun and Gas bombs are good choices). For hand-to-hand combat and subduing antsy criminals, both hands have built-in tasers. Once the job is done, the striptape dispenser in the right arm keeps the catch under wraps.

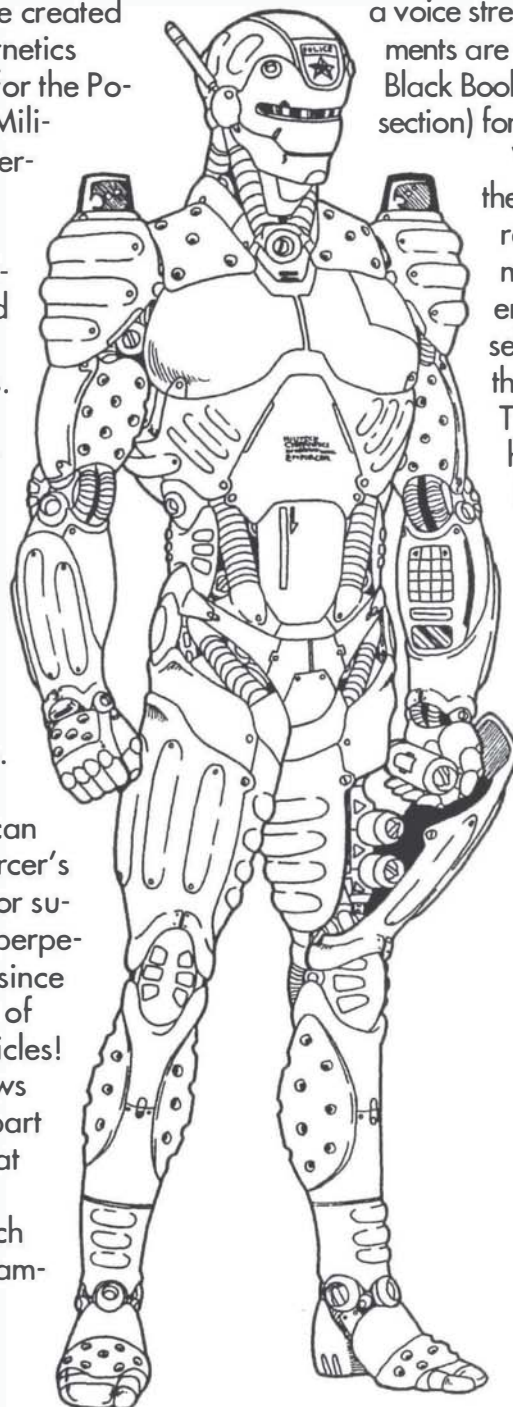

M

FULL BODY REPLACEMENT

ENFORCER PHYSICAL STATS

REFLEX: 12 *4*
 ATTRACTIVENESS: NA
 MOVEMENT ALLOWANCE: 15 *10*
 M/turn: 45m MPH: 40mph
 Jump (up): 6m (broad): 11m

Body: 12
 Lift: 480kg Throw: 120m
 Damage Mod: +4

HAND-TO-HAND:

Punch: 1D6+4 Kick: 2D6+4

PHYSICAL STRUCTURE

HEAD

SP: 30
 SDP: 25 (disabled), 35 (destroyed)
 Options (Optic): 1 & 1
 Options (Audio): 3

RIGHT ARM W/ HAND	TORSO	LEFT ARM W/ HAND
SP: 30	SP: 30	SP: 30
SDP: 25/35	SDP: 35/45	SDP: 25/35
Options: 1	Options: 4	Options: 1

RIGHT LEG W/ FOOT	LEFT LEG W/ FOOT
SP: 30	SP: 30
SDP: 25/35	SDP: 25/35
Options: 1	Options: 1

OPTION PACKAGES

SENSOR OPTIONS:

Cyberoptics: Targeting Scope (adds +1 to Smartguns only), Video recorder (can record up to 20 minutes of video), Thermograph Sensor, Lowlite and Antidazzle. *4*

Cyberaudio: Voice Stress Analyzer (+2 to Human Perception & Interrogation), Radio Link (1km range) and Digital Recording Link (can record up to 2 hours). *3*

WEAPON SUBSYSTEMS:

Leg Holster - This can hold a Heavy Pistol, Medium SMG or a folding shotgun, as well as one spare clip of ammo (weapons not included). *1*

Grenade Storage - This space can hold three hand grenades or bombs of any type. *1*

Taser Grips - Each hand can be treated as having a built-in Taser. *2*

OTHER OPTIONS:

Black Book Micro-Computer - built into the left arm. See the Equipment section for specifications and details. *1*

Striptape Dispenser - 12 one-use lengths of plastic tape which serve as temporary handcuffs (Very Difficult to break), this dispenser is reloadable. *1*

Light Bars - These cannot be used as blinders, just as signals. *1*

TOTAL PACKAGE COSTS

EURODOLLARS: 55,000
 HUMANITY COST: 21D6-2 (16D6+28)

BRIMSTONE

DYNALAR TECHNOLOGIES
 FIRE-FIGHTER FULL CONVERSION

47,000 EB

Throughout time, fire has been man's greatest tool as well as his greatest enemy. Firefighting, an art that has evolved for centuries, now reaches its pinnacle with Dynalar's Brimstone full body conversion. Immune to the hazards of smoke inhalation, burns and rapidly-changing pressures, Brimstone can do the work of an entire company of regular firemen. Originally deployed in London, Brimstone cyborgs are now a regular sight in many major cities throughout the world.

As a necessity, the Brimstone package is fully fireproofed and insulated, making it capable of enduring the searing heat of almost any blazing inferno. It is also protected by extra-thick layers of laminate armor, allowing it to survive such catastrophes as collapsing ceilings, falling rubble and explosive backdrafts. The musculature of the Brimstone system mixes thickened myomar fibers with magnetic piston actuators, giving it the strength it needs to break through doors and walls to reach trapped civilians. An improved response time in the cybernetic nervous system also makes sure that Brimstone can react quickly to the crisis situations it was designed for, and an automatic pain editing feature keeps the cyborg from feeling the searing heat that may surround him.

Since the intense heat of blazing fires will scramble IR and thermal imagers, and smoke will obscure any other visual sensors, the Brimstone conversion includes a low-power radar sensor.

FULL BODY REPLACEMENT

BRIMSTONE PHYSICAL STATS

REFLEX: 11 *2*
 ATTRACTIVENESS: NA
 MOVEMENT ALLOWANCE: 10
 M/turn: 30m MPH: 20mph
 Jump (up): 6m (broad): 8m

Body: 14 *4*
 Lift: 560kg Throw: 140m
 Damage Mod: +6

HAND-TO-HAND:

Punch: 1D6+6 Kick: 2D6+6

PHYSICAL STRUCTURE

Head

SP: 30
 SDP: 20 (disabled), 30 (destroyed)
 Options (Optic): 4 & 4
 Options (Audio): 6

RIGHT ARM w/ HAND	TORSO	LEFT ARM w/ HAND
SP: 30	SP: 30	SP: 30
SDP: 20/30	SDP: 30/40	SDP: 20/30
Options: 3	Options: 4	Options: 3

RIGHT LEG w/ FOOT	LEFT LEG w/ FOOT
SP: 30	SP: 30
SDP: 20/30	SDP: 20/30
Options: 2	Options: 2

OPTION PACKAGES

Sensor Options:

Radar Sensor - 100m range, very reliable. *2*

Audio Systems: Radio link with 1km range, Amplified Hearing (+2 to audio Awareness rolls), Level Damper (prevents deafening), Sound Editor (selective sound sensor, adds +1 to audio Awareness rolls). *3*

WEAPON SUBSYSTEMS: NONE INSTALLED

OTHER OPTIONS:

Waterhose System - A high-pressure pump in the back draws in water from a firehose, which can be attached to a sleeve in the back. A duct leads through to the arm, which has an adjustable nozzle in the wrist. The water can reach up to 50m, and has very high pressure (Very Difficult BOD roll to withstand it). *2*

CO2 Fire Extinguisher - 5m range, fueled by a replaceable 10-turn cannister. If used as a weapon, target must make a Difficult REF roll to avoid being blinded for 1D6/2 turns. *1*

Pain Editor - This system tunes out heat, cold and pain. *2*

Light Bars - These cannot be used to blind, just as signals. *1*

TOTAL PACKAGE COSTS

EURODOLLARS: 47,000
 HUMANITY COST: 19D6 (16D6+17)

The signal emitter is housed in the chest, with the receiver mounted in the forehead, allowing the cyborg to navigate through the thickest smoke without difficulty. This conversion's audio package includes a radio link, so that communications can be maintained with the command structure and other firefighters. Amplified hearing range, sound editing, and acoustic level dampers make it possible to hear the calls of trapped victims through the loudest explosions and blazes.

For active anti-blaze and rescue duty, the Brimstone cybersystem has a CO² fire extinguisher built into its left arm, and the right arm has a tubular conductor

for water drawn in through a high-pressure pump in the back. To complete the package, dual revolving-style emergency light bars (in yellow and white) are mounted on the shoulders, accompanied by a siren to let bystanders know that the authorities have arrived.

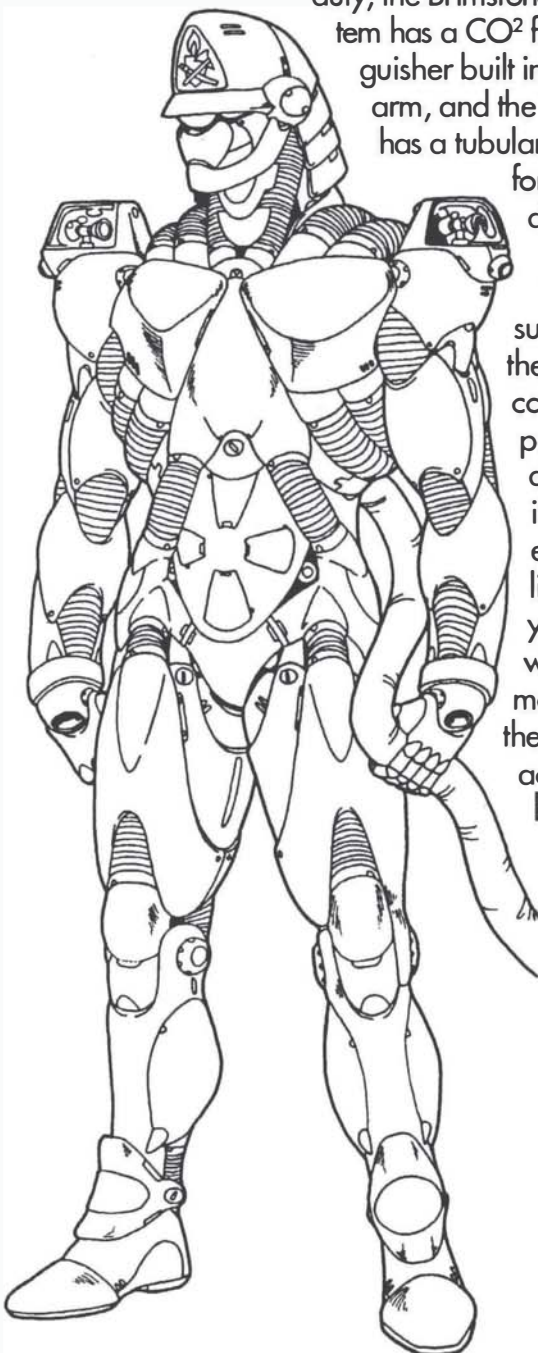

FULL BODY REPLACEMENT

G E M I N I

RAVEN MICROCYBERNETICS
HUMANOID FULL CONVERSION

55,000 EB

Full Body Conversions have a multitude of advantages: superhuman strength, speed, and durability, heightened reflexes, the ability to alter the body at will and even an increased lifespan. However, being a Full Borg sets you apart. Society brands you as a "Metalhead," and people treat you like a machine—even a tool. The sad truth is that if you look like a robot, no matter how you behave, people will tend to treat you like a robot. So, if you want the advantages of a full conversion without the societal baggage, Gemini is the package for you.

The Gemini cybersystem is a full-body conversion that simulates the human body in both form and function. Its chassis is designed in a similar manner to the human skeletal structure, and its myomar muscle system is arranged to physically mimic the human musculature. With this carefully-tailored layout, the Gemini cleverly imitates the anatomy of a normal person without sacrificing the superior capabilities for which full body conversions are so well-known. To complete the effect, Gemini's entire surface is covered with ExoDerm®, a synthetic surface which looks and feels like almost exactly like human skin (assorted skin tones, textures and hairstyles are available).

The Gemini's capability to pass for a normal human is impressive. Its built-in "Pinocchio" sub-processor automatically maintains body temperature (through the use of a heating system integrated into the ExoDerm®), expands and contracts the upper torso to create the illusion of breathing, and even

blinks the eyes occasionally. What's more, the entire body is composed of lightweight carbon-carbon synthetics and other composite materials, resulting in a mere 10-pound deviation from the average weight for a similar-size person. However, it should be kept in mind that ExoDerm® can be cut, punctured, and burnt as easily as real skin. (Although it does not bleed!)

It is a Nearly Impossible (Diff 30) Awareness roll to determine that a Gemini is a Full Borg through any of the five senses. However, a Thermograph sensor, a highly sensitive Radar scanner, a Scanman™ (see Scanman, in Equipment section, page 23) or similar material-sensitive detectors

will reveal the Gemini's true nature. The apparent Body Type can be chosen (Average, Strong or Very Strong) without affecting the true strength of the Borg. However, the actual BOD cannot be boosted, nor can additional SDP or SP be added (the ExoDerm® already integrates a high-density "skinweave"); if the ExoDerm® becomes damaged, it must be "patched" by a competent Cybertechician.

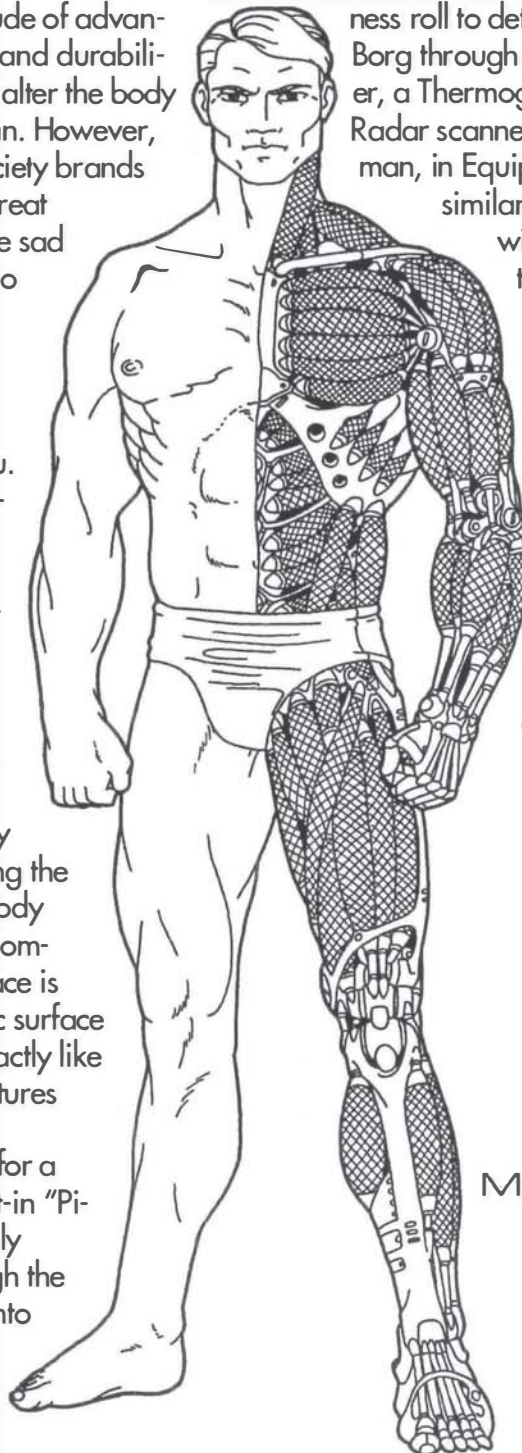

As an option, Gemini can be equipped with an added "disguise" feature, wherein tiny microsurfaces can be used to change the cyborg's facial features, and a chemskin-type modification to the Exo-Derm® allows the skin tone to be altered at will. This is a popular option for infiltration and espionage, roles to which the Gemini cybersystem is well-suited.

GEMINI PHYSICAL STATS

REFLEX: 10
 ATTRACTIVENESS: 2-10 (THIS CAN BE CHOSEN BY THE PURCHASER)
 MOVEMENT ALLOWANCE: 10
 M/turn: 30m MPH: 20mph
 Jump (up): 6m (broad): 8m
 BODY: 12
 Lift: 480kg Throw: 120m
 Damage Mod: +4
 HAND-TO-HAND:
 Punch: 1D6+4 Kick: 2D6+4

PHYSICAL STRUCTURE

HEAD
 SP: 25
 SDP: 20 (disabled), 30 (destroyed)
 Options (Optic): 4 & 4
 Options (Audio): 6

RIGHT ARM W/ HAND	TORSO	LEFT ARM W/ HAND
SP: 25	SP: 25	SP: 25
SDP: 20/30	SDP: 30/40	SDP: 20/30
Options: 1	Options: 2	Options: 1

RIGHT LEG W/ FOOT	LEFT LEG W/ FOOT
SP: 25	SP: 25
SDP: 20/30	SDP: 20/30
Options: 1	Options: 1

OPTION PACKAGES

SENSOR OPTIONS: NONE INSTALLED
 WEAPON SUBSYSTEMS: NONE INSTALLED

OTHER OPTIONS:

Sexual Implant - Treat as a Mr. Studd or Midnight Lady. Can't pass for a human being without one of these! (HC2)

"Disguise" Option - This allows the cyborg to alter its skin tone and facial features, effectively adding +5 to any Disguise roll. This is not a standard feature, but can be purchased for 1000eb (HC2)

TOTAL PACKAGE COSTS

EURODOLLARS: 55,000
 HUMANITY COST: 16D6+2 (+2 FOR DISGUISE FEATURE)

FULL BODY REPLACEMENT

W I N G M A N

INTERNATIONAL ELECTRIC CYBERNETICS
 FIGHTER PILOT FULL CONVERSION

54,000 EB

For decades, modern fighter planes have had the ability to outperform their pilots. The G-forces caused by acceleration and high-speed maneuvers have been the cause of many pilot fatalities. It stands to reason that when the machine outperforms the flesh, you get rid of the flesh. IEC, with the Wingman full body conversion, has finally enabled pilots to take their fighter to the limit. Designed to withstand even the fifteen G's pumped out by the F-36 Fire-shark cyberfighter, Wingman takes air combat to new, undreamt-of heights.

Wingman's responses are as fast as a computer—they have to be. With AI-guided missiles and hypervelocity projectiles filling the air, every microsecond counts. Along with a "greased" nervous system, the Wingman body has six interface plugs, allowing for maximum interface with any cybernetically-controlled aircraft. To further aid in dogfighting and maneuvering, an advanced gyro-stabilizer is built into the skull, preventing any dizziness due to sudden changes in orientation; very little can disturb the concentration of a Wingman. Employing specially buffered biosystems and a high-performance, high-stress blood pump, Wingman can effectively ignore the problems normally associated with acceleration. Blackouts and red-outs become a thing of the past.

All the reflexes in the world won't help in an air war if you can't sense your environment effectively. To this end, Wingman's visual sensor suite includes everything a fighter pilot could want: flare compensation, telescopic systems, high-resolution visual enhancement and a visual marquee for heads-up information. There comes a time, however, when you have to leave your plane behind. For such contingencies, this full-body conversion includes an on-board parachute. A weapon holster and multi-purpose blade are also included for when you reach the ground, and a locator beacon ensures that the rescue team will be able to find you. Remember: any cyborg body you can walk away in is a good one.

FULL BODY REPLACEMENT

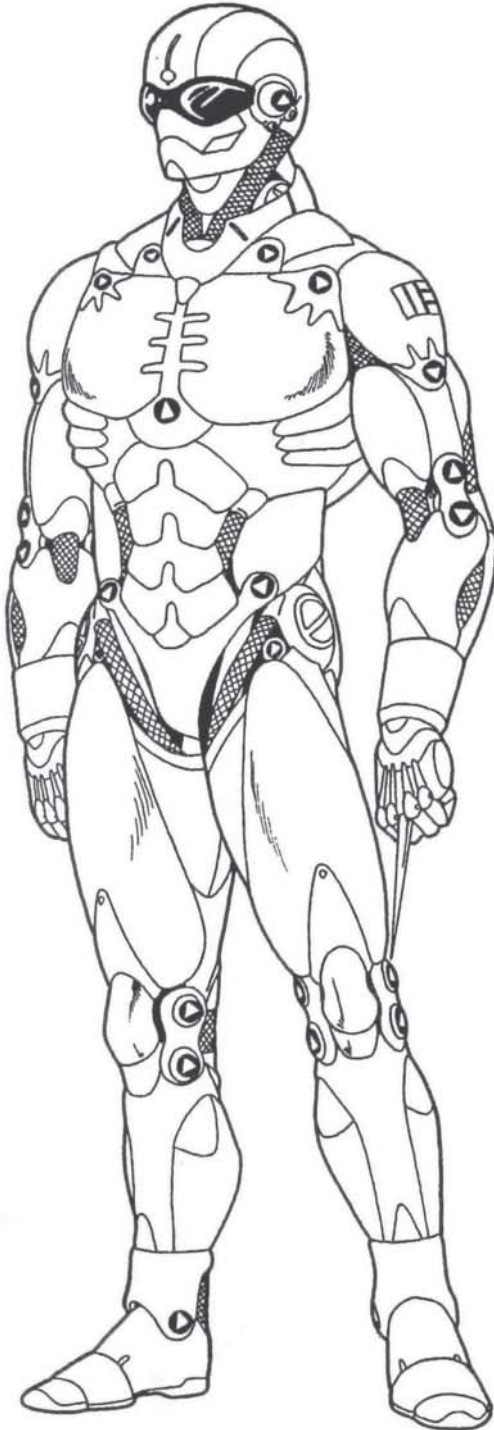

WINGMAN PHYSICAL STATS

REFLEX: 15 *10*
 ATTRACTIVENESS: NA
 MOVEMENT ALLOWANCE: 10
 M/turn: 30m MPH: 20mph
 Jump (up): 6m (broad): 8m

Body: 12
 Lift: 480kg Throw: 120m
 Damage Mod: +4

HAND-TO-HAND:

Punch: 1D6+4 Kick: 2D6+4

PHYSICAL STRUCTURE

HEAD

SP: 25
 SDP: 20 (disabled), 30 (destroyed)
 Options (Optic): 0 & 0
 Options (Audio): 5

RIGHT ARM w/ HAND	TORSO	LEFT ARM w/ HAND
SP: 25	SP: 25	SP: 25
SDP: 20/30	SDP: 30/40	SDP: 20/30
Options: 2	Options: 3	Options: 3

RIGHT LEG w/ FOOT	LEFT LEG w/ FOOT
SP: 25	SP: 25
SDP: 20/30	SDP: 20/30
Options: 1	Options: 2

OPTION PACKAGES

SENSOR OPTIONS:

Locator Beacon - a radio signal unit with a 100km range, because you want to protect your investment. *1*

Visual Systems: Teleoptics (20x magnifications), Image Enhancement (+2 to visual Awareness rolls), AntiDazzle, Times Square Plus. *4*

WEAPON SUBSYSTEMS:

Survival Blade - A wrist blade which extends between the knuckles, doing 1D6+7 damage (BOD included). *2*

Leg Holster - This can hold a Heavy Pistol, Light SMG or a Folding Shotgun, as well as one spare clip of ammo (weapons not included). *1*

OTHER OPTIONS:

Parachute - This internally-stored back unit compresses the 'chute into a tiny package, and blasts it out with gas pressure: cannot work under 200 feet. *2*

Gyroscope - (+2 on Sickness rolls, +1 to high-G maneuvers, +2 on any REF roll involving balance). *1*

Two extra sets of Interface Plugs, making three pairs total. *2*

TOTAL PACKAGE COSTS

EURODOLLARS: 54,000
 HUMANITY COST: 20D6 (16D6+23)

SAMSON

NOVELTECH LIMITED
INDUSTRIAL-USE FULL CONVERSION

50,000 EB

Imagine a perfect worker: tireless, incredibly strong, and capable of surviving almost any accident. This is the Samson full body conversion. Designed for construction, loading, and "hazmat" duty (dealing with hazardous materials and environments), Samson is as effective as an entire crew of union hardhats! Samson is equally at home hundreds of stories above the ground as a welder on high steel, or hundreds of feet below the surface of the Earth in a mining tunnel. Samson's other areas of expertise include logging, oil drilling, toxic waste disposal and any other industrial application you can think of.

Like his namesake, this full body conversion is unparalleled in strength. Using a mix of super-dense myomar fibers and high-powered magnetic pistons, Samson is brawny enough to load and unload almost any cargo, reshuffle steel girders, and demolish old tenements with his bare hands. This full conversion is also tough enough to withstand the many accidents which plague construction sites, and can be relied upon to rescue any co-worker who is so unlucky.

Since he has to work with his hands, Samson's own are packed with every tool he could ever need. He can cut wires, twist in screws, test circuits, manipulate microserves, tighten (or loosen) any bolt, drill a hole through a 2" steel plate, and link up with any electronic device's diagnostic systems. On top of this impressive array of equip-

FULL BODY REPLACEMENT

ment, Samson's right arm has an industrial-strength arc-welder and cutting torch which is powerful enough to work on battleship armor plating. Since it wouldn't do for any cyborg to be blinded by his own torch, Samson's optics have auto-stepdown flare compensation as a standard feature.

In order to do the job better, Samson has an interactive heads-up display which can access assorted databases and information systems through the cyborg's interface plugs, or from special chipware (such as Techie Visual Recognition Chips). This display is often used in concert with a cyber-chipped micro-computer (which stores blueprints, diagrams, etc.) worn around the waist on a belt, and it also ties directly into the tech-scanner which is built into the left forearm.

This device can be hooked up (through connectors in Samson's fingers) to the diagnostic systems of most vehicles, appliances and personal electronics to determine possible problems and troubleshoot breakdowns.

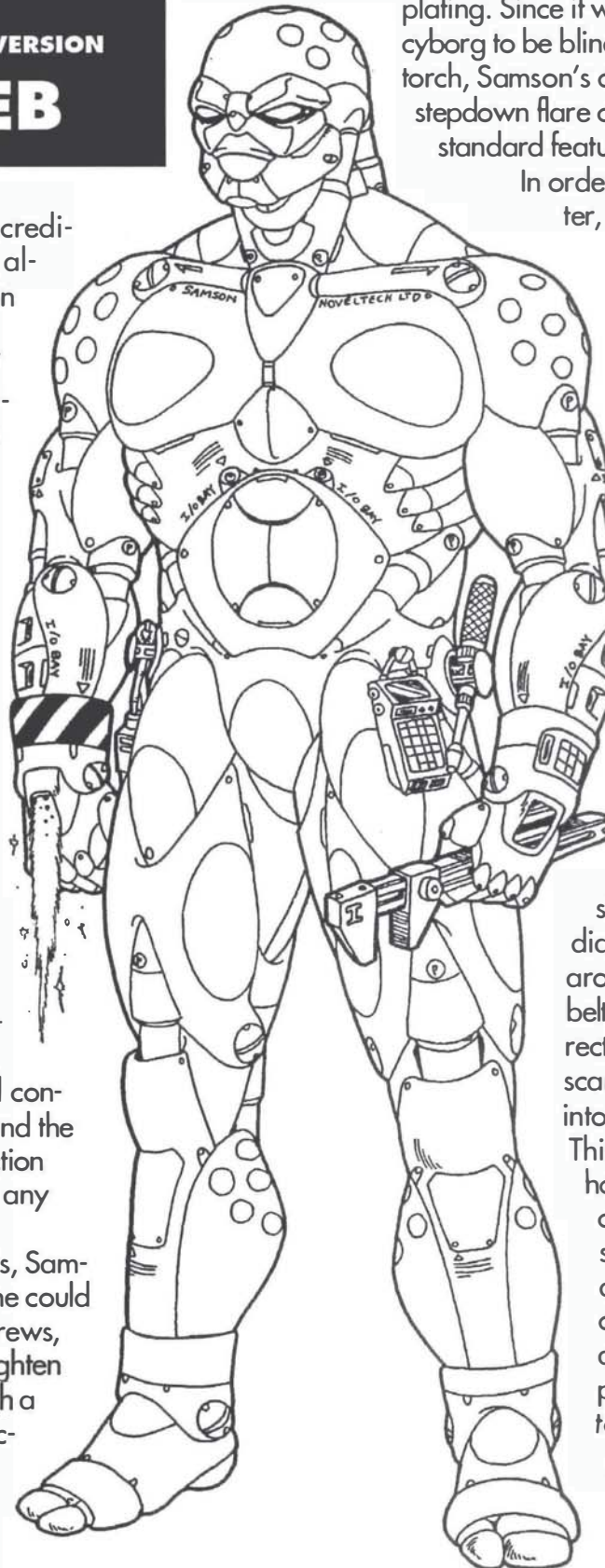

FULL BODY REPLACEMENT

Being more than human, Samson truly shines in the field of hazardous material handling and hostile environment duty. Already immune to the effects of toxic gasses, this body also has a special lead-lined biosystem housing which protects Samson's organic components from radiation poisoning. Further enhancing Samson's Hazmat capabilities is a built-in radmeter which can detect radiation in a 10m radius, determine its intensity and extrapolate the dangers of continued exposure. He just has remember to get "cleaned" of radioactivity before going to the bar after work!

SAMSON PHYSICAL STATS

REFLEX: 10
 ATTRACTIVENESS: NA
 MOVEMENT ALLOWANCE: 1 0
 M/turn: 30m MPH: 20mph
 Jump (up): 6m (broad): 8m

Body: 18 *12*
 Lift: 720kg Throw: 180m
 Damage Mod: +8

HAND-TO-HAND:

Punch: 1D6+8 Kick: 2D6+8

PHYSICAL STRUCTURE

HEAD
 SP: 25
 SDP: 20 (disabled), 30 (destroyed)
 Options (Optic): 1 & 3
 Options (Audio): 6

RIGHT ARM W/ TOOLHAND	TORSO	LEFT ARM W/ TOOLHAND
SP: 25	SP: 25	SP: 25
SDP: 20/30	SDP: 30/40	SDP: 20/30
Options: 2	Options: 3	Options: 2

RIGHT LEG W/ FOOT	LEFT LEG W/ FOOT
SP: 25	SP: 25
SDP: 20/30	SDP: 20/30
Options: 2	Options: 2

OPTION PACKAGES

Sensor Options:

Times Square Plus - This interactive heads-up display can integrate with databases through interface plugs and chipware. It is usually used in concert with a plug-in micro-computer (which stores blueprints, diagrams, etc) worn around the waist on a belt. *2*

Anti-Dazzle - Both optics are equipped with stepdown flare compensation, so that the glaring light from the arc-welder won't blind the cyborg. *1*

Radiation Detector - Very useful for Hazmat duty, this unit is built into the torso and has a 10m range. Data is displayed on the Times Square Plus. *2*

WEAPON SUBSYSTEMS: NONE INSTALLED

OTHER OPTIONS:

Arc-Welder - Built into the right arm, his super-high-powered thermite lance has a foot-long flame which can weld together anything you want, and can burn through up to SP50 in one turn. It does 4D6+2, halving the SP of any armor, if used as a weapon. *2*

Techscanner - Built into the left arm, this microcomputer has various I/O connectors and probes to connect with assorted electronic systems. It adds +3 to any TECH rolls by running diagnostics, identifying and examining malfunctioning components, and displaying schematics on the Times Square Plus. *1*

Toolhand (right) - Wirecutters, power screwdriver, micro tools, wrench. *2*

Toolhand (left) - Mini-drill, I/O Connector (for Techscanner), probe (for Techscanner), socket wrench. *2*

Radiation Shielding - This protects the biosystem from suffering from any harmful side-effects due to exposure to radioactive material. Handy for Hazmat duty. *1*

TOTAL PACKAGE COSTS

EURODOLLARS: 50,000
 HUMANITY COST: 20D6+1 (16D6+25)

D R A G O O N

INTERNATIONAL ELECTRIC CYBERNETICS
 MILITARY-USE FULL CONVERSION

120,000 EB

The modern battlefield sees many impressive weapons—remote-controlled drones, STOVL stealth fighters, minitanks, combat bikes, anti-tank vehicles, power-assisted infantry armor, and AV-type ground attack craft. However, the ultimate multi-role land-deployed combat unit is the "Dragoon" cybersystem. IEC, holders of the U.S. military cybernetics contract, designed the Dragoon to be the most deadly weapon any army could have. Variants of the Dragoon have, predictably, sold well overseas. Being a strictly military weapon, the Dragoon is absolutely impossible to buy on the open market, and even the most powerful of corporations have a hard time getting ahold of these (except for IEC, that is). Measuring over 8 feet in height, and weighing in at

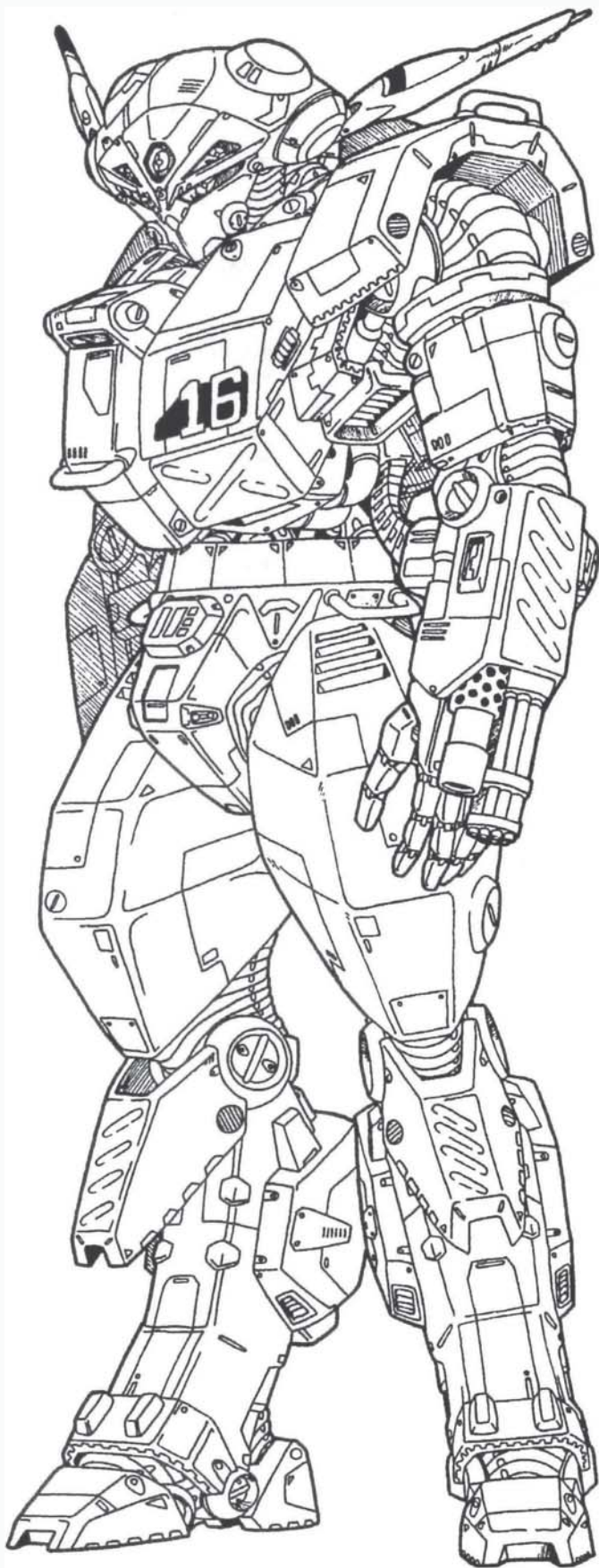

FULL BODY REPLACEMENT

“Personally, they give me the creeps. It’s like standing next to a 7 foot, steel-encased, cannon-toting, basket case. Give me your good, old-fashioned, armed nuclear weapon any day.”

—Infantry Sgt. James R. Teal

620 pounds, the Dragoon is arguably the most powerful full conversion in existence.

The Dragoon’s advantage over all other land-based combat units is its humanoid form. It is capable of taking maximum advantage of terrain, it can enter buildings, hold territory and perform every part of a military operation, from guerilla warfare to anti-aircraft artillery. Its performance levels give it equal speed (and superior all-terrain capability) to a 4x4 combat car, while it can go where no car ever could: treetops, maintenance tunnels, even vehicle cockpits. Combined with this unbeatable mobility is the Dragoon’s inherent toughness: its armor plating consists of a monocrystalline ceramic composite with an ablative layer of heat-displacing ceramics and foamed metal (full SP vs lasers, etc), while its critical system redundancies and raw ability to soak damage make it the rough equivalent of an AFV. In this respect, the Dragoon can easily function as a perimeter patrol and defense unit, as well as an anti-site fast-attack system. It is also a fearsome opponent to troops and vehicles.

FULL BODY REPLACEMENT

As a military weapon, Dragoon has many subsystems which are vital on the battlefield as standard features. It has a wide array of detection, acquisition and designation systems, backup sensors, environmental scanners and communications gear which maximize its chances of getting that most precious of commodities: current data on your foe. However, the Dragoon is not a dedicated design; rather, its modular construction allows it to custom-tailor its equipment to suit almost any role. All four of its limbs are interchangeable, allowing it to mount almost any type of weaponry, from a suppressed SMG for special ops to a heavy machinegun or railcannon for anti-vehicular combat. The Dragoon is also fully protected against nuclear, biological, chemical and electronic warfare, giving it greatly enhanced staying power in an extended engagement.

The most immediately obvious problem with such a full body conversion package is the almost guaranteed development of devastating cyberpsychosis. It is true that a human brain, implanted in such a body, cannot easily cope with so many new senses and capabilities. IEC overcame this problem: the Dragoon, being a restricted, combat-use body, comes with an interchangeable biopod. This biopod, which houses the cyborg's biosystems, normally inhabits an "off-duty body," usually an Alpha Class. The Dragoon is only fitted with the biopod, and the human mind within, when it is actively performing missions. To ensure reliable performance from the Dragoon, a Behavioral Inhibitor Program in the cyborg's on-board computer (operating in concert with a chemical injection system loaded with psychoactives) restrict the Borg's thought processes, turning it into a loyal soldier. Battle-proven in the Brushfire Wars of 2018, the Dragoon's prowess and dependability are assured.

Note: The Behavioral Inhibitor Program and its battery of psychoactives do, indeed, keep the cyborg from going cyberpsycho (in the conventional sense). Basically, anyone whose biopod is in this body will act like a robot, unimaginative and literal minded. The borg's commanding officer says "Do this," and the Dragoon says "Yes, sir..." and does it. Because Dragoons are so straightforward-thinking, they are given very spe-

cific orders with carefully-laid out parameters. They are also easy to trick, so truly sensitive work is still left to more human operatives. A common mission would be to send a Dragoon into a sector which has been cleared of friendly forces and have it kill anyone it finds, then return. Those soldiers who have been the "minds" of Dragoons are not comfortable with the experience, likening it to being in a dream (or nightmare).

DRAGOON PHYSICAL STATS

REFLEX: 1 5 *10*
 ATTRACTIVENESS: NA
 MOVEMENT ALLOWANCE: 25 *30*
 M/turn: 75m MPH: 50mph
 Jump (up): 6m (broad): 19m
 BODY: 20 *16*
 Lift: 800kg Throw: 200m
 Damage Mod: +8

HAND-TO-HAND:

Hand to Hand Damage is 3D6+8 per punch, 6D6+8 kick.

PHYSICAL STRUCTURE

HEAD
 SP: 40
 SDP: 40 (disabled), 50 (destroyed)
 Options (Optic): 0
 Options (Audio): 0

RIGHT ARM w/o HAND	TORSO	LEFT ARM w/o HAND
SP: 40	SP: 40	SP: 40
SDP: 40/50	SDP: 50/60	SDP: 40/50
Options: 4	Options: 0	Options: 4

RIGHT LEG w/ FOOT	LEFT LEG w/ FOOT
SP: 40	SP: 40
SDP: 40/50	SDP: 40/50
Options: 2	Options: 2

OPTION PACKAGES

Sensor Options:

- Front Optic Mount with 5 cyberoptics: *23*
- (Night-Vision Optic) Lowlight, Image Enhancement, Anti-Dazzle, Targeting Scope.
 - (Thermal Optic) Thermographics, Image Enhancement, Anti-Dazzle, Targeting Scope.
 - (Long-Range Optic) Teleoptics, Image Enhancement, Anti-Dazzle, Targeting Scope.
 - (IR-Vision Optic) Infrared, Image Enhancement, Anti-Dazzle, Targeting Scope.
 - (Heads-Up Display Optic) Times Square Plus, Anti-Dazzle.

Cyberaudio: Amplified Hearing (+2 Awareness) with Level Damper and Enhanced Hearing Range, Long-Range Radio (25km) with 6 frequencies and Scrambler, Radar Detector (automatically detects Radar beam, 40% chance of fixing source). *5*

Twin Sensory Booms: *6*

(Right) Optic with Video Transmitter (transmits what the optic is seeing, live), Audio with Audio Transmitter (transmits what the mike is hearing, live). *2*

(Left) Optic with Video Imager (can show video images from recordings, transmissions and through Interface Plugs), Audio with Tight Beam Transmitter (unjammable within line of sight). *3*

"Sniffer" - Built into the head, consisting of an Olfactory Booster (which adds +2 to smell Awareness rolls, and has a 50% chance of picking up a scent and adding +2 to Shadow/Track skill) and a Chemical Analyzer (which can analyze chemical traces in the air and break them down into their components). Data is displayed on the Times Square Plus. *4*

Sonar Scanner - Built into the skull, this ultrasound sensor accurately measures distance to, and dimensions of, the nearest solid object. It also serves as a motion sensor with a 120m radius. Data is displayed on the Times Square Plus. *2*

Radar Sensor - This 1km range sensor has its emitter in the skull, and its receiver in the chest area. Data is displayed on the Times Square Plus. *2*

Radiation Detector - Built into the torso, this unit has a 10m range. Data is displayed on the Times Square Plus. *2*

WEAPON SUBSYSTEMS:

None installed, but all four limbs have Quick-Change Mounts, allowing the Dragoon to suit its weapon suite to its mission; anything from a .22 pistol to a grenade launcher or railcannon can be mounted. *8*

OTHER OPTIONS:

Interchangeable Biopod - This allows the cyborg's biosystems to inhabit different bodies for different purposes. The Dragoon body is only inhabited by a biopod when it is active, and a Behavioral Inhibitor Program keeps the semi-cyberpsycho borg from getting out of line. *3D6*

Chipware Socket - If a Dragoon cyborg needs any extra skills in the battlefield, it's able to use them without filling up its Interface Plugs. *1*

Pain Editor - Cuts out heat, cold and pain on command. A must for a combat borg! *2*

Ambidexterity Sub-Processor - This allows Dragoon to use either arm with equal effectiveness, and at the same time. *1*

Combat Crystal - This system allows 5 or more Dragoons to coordinate their actions; making sure that their vision covers 360°, covering each other, and generally using teamwork. This does not promote much individual action, but it grants maximum

FULL BODY REPLACEMENT

efficiency. When used, it adds +1 to Initiative and Attack rolls, +2 to Awareness and Defense rolls. *4*

Chronometer - Dragoon has a built-in timekeeping unit with stopwatch and alternate time-zone functions, displayed on the Times Square Plus. *0*

IR Thermal Dam - This system absorbs IR emissions until they can be safely bled off; this is done in a random pattern, so that it does not appear to come from a humanoid source. This translates into a -5 to any IR-based Awareness rolls. *2*

Black Box Recorder - This is a built-in Brainsdance recorder, recording on chip everything the 'Borg experiences during its mission. It is used for post-mission analysis and debriefing, and it records what happened to those borgs who didn't make it. *1*

Environmental Assimilation System - Dragoon's exterior patterning and coloration can be selected. Internal memory stores 24 different camouflage patterns (desert, urban, snow, etc) as well as flat black and olive drab coloration, selectable by the 'Borg. Observers are at -2 Awareness if the wearer remains still, -1 if they're moving (This bonus compounds for each 10 meters of distance between the wearer and the observer). See Militech Mirage Gear, Equipment section, page 28. *2*

Autoinjector - This is a small, refillable drug injector which can dose the brain with psychoactive drugs. Black Lace derivatives are a common choice. *1*

Ammo Hopper - This is a back-mounted ammo container with an electrically-powered belt feed. It can be modified to carry almost any type of ammo, and holds 20x the weapon's standard magazine capacity. *2*

Locator Beacon - a radio signal unit with a 100km range, because you want to protect your investment. *1*

IFF Transponder - This emits a coded, Identify Friend-or-Foe signal so that friendly patrols, smart mines, and air support won't mistake a Dragoon for the enemy. *0*

Satellite Link - This high-powered microwave communication system (which uses "rabbit ears" as antennae) allows communication with friendly satellites, giving instant access to battlefield data, intelligence, and updated orders. It also has a Global Positioning System which can pinpoint Dragoon's True Earth location to within 5m. *3*

Micro-Computer - An on-board fuzzy-logic subprocessor with capabilities equivalent to a pocket computer (see EBM PCX, Equipment section page 14). *2*

Shielding - Dragoon is fully protected against electromagnetic pulse, electrical surges and microwave attacks. *6*

TOTAL PACKAGE COSTS

EURODOLLARS: 120,000

HUMANITY COST: 42D6+3 (19D6+141)

OPTIONS FOR FULL BODY CONVERSIONS:

Full Borgs, by their very nature, have the advantage of being able to accept a wider variety of options than any enhanced human. These cyborgs can use any Cyberware mentioned in any of the rules: most Bioware and Organware would be superfluous, but all Cyberlimb, Optic and Audio Options, as well as other systems, are perfectly acceptable. The only limitations come from the potential humanity costs, and the number of option spaces the cyborg has. As a rule, all option components cost the minimum HC. Ex: Rippers (3D6) would cost 3 Humanity points. Any options added at the same time as the full body package (ie, it is included in the body at the time that the person's biosystems are implanted into it) have their minimized HC costs added together and broken into dice plus modifiers. Example: six 2-point options would total 12HC, so they would become 2D6HC. Options which are built into the body at a later time simply cost minimum HC, but they are not broken into dice values.

Stylization (Price varies): Most full body conversions are "standard" models, with no unique features to set them apart from another body of the same series. Since individuality is the essence of being cyberpunk, customization is a common occurrence among Full Borgs. Some are sculpted to look sleek and graceful, others are made more fearsome looking. Such stylization varies in cost, depending upon what the effect is. However, certain choices can affect skill rolls: a monstrous appearance might add +2 (or more) to Intimidation, while a smooth "sexy robot" appearance might actually give you a chance at a Seduction roll. Attractiveness really cannot be changed; Personal Grooming skill is a moot point, while Wardrobe and Style skill can simply be used as its own "Stat." [What, you thought Metalheads didn't wear clothes?]

Increased SP (2000eb, HCO): Monocrystalline matrices, latticed plating, chitin-ceramics, carbon polyalloys and other hybrid materials can all be employed to increase the overall Stopping Power of the cyborg's armor plating. Each +5 increase in the overall SP of the body (+5 to arms, legs, head and torso) costs 2000eb, adding 10lbs for +5SP, 25lbs for +10SP and 50lbs for +15. An overall SP of 40 is the maximum. SP must be applied to the body as a whole not just to specific parts.

Increased SDP (1500eb, HCO): Reinforced joints, denser myomars, metallic matrix materials and redundant construction can all contribute to increasing a cyborg's Structural Damage Points. Each +5 increase in the overall SDP of the body (+5 to arms, legs, head and torso) costs 1500eb,

adds 55 pounds, and may increase overall size slightly. Remember that the maximum is +20SDP.

Increased Stats (Cost varies, HC2): By hardwiring faster response times, replacing myomars with magnetic-powered hydraulics, and supercharging micromotors, the Borg's physical stats can be increased. Reflexes cost 2000eb per +1 (Maximum 15), MA costs 1500eb per +1 (1MA equals 3mpt/2mph, Maximum 25), and Body costs 1000eb per +1 (Maximum 20). Humanity cost is 2 per +1 increase in any stat.

Shielding (2000eb, HC6): Placed internally, this "hardened" sheathing protects the cyborg from the effects of electromagnetic pulse, electrical surges, and microwave attacks. A very useful item, since one shot from a Techtronica M40 Pulse Rifle at close range is enough to turn the toughest Metalhead into the equivalent of a broken toaster.

Quick-Change Mounts (200eb, HC2): All Full Borgs (except the Gemini) may purchase Quick-Change mounts for any or all of their limbs, as well as for their hands and feet. If an arm does not have a hand installed, that space may be used for some other option, and it becomes possible to install Rifles (2 spaces) and Heavy Weapons (3 spaces) in the limb. Keep in mind that your Humanity index will change depending upon what limb you have mounted. Don't even think about getting a Quick-Change Head, you poser.

Interchangeable Biopod (20,000eb, 18D6): This drastic option for full-body conversions allows the purchaser to effectively have an assortment of interchangeable bodies! When the transplant operation is performed, the patient's biosystem (the brain and the few organs which cannot be replaced) is not built into a cybernetic body; rather, the biosystem is placed in a compact life-support module. This Biopod (which is about two cubic feet in size) can then be interfaced with any cyborg body which has been fitted with the correct receptacle, thereby allowing the Biopod to be switched from body to body, depending on what

FULL BODY REPLACEMENT

duty it intends to perform. However, it can only be put in a cyborg body which was designed to accept an Interchangeable Biopod (these bodies cost the same amount as normal ones, but cannot be used by anything but a Biopod). When the Biopod is removed, it is often jacked into a braindance recording in order to provide stimulus for the brain while it waits for the next body to be prepped for installation. Those cyborgs who can afford it often buy human-looking bodies for everyday life, and also buy other bodies for their "work." Theoretically, it would be possible to place such a Biopod inside a specially-modified vehicle (or other non-humanoid body), thus granting the brain unmatched versatility. However, the alien nature of these bodies would probably incur catastrophic humanity loss. An Interchangeable Biopod can only be bought at the time of the subject's transplant operation, and the Humanity Cost is 18D6 (rather than 16D6 for the basic Full Body Conversion); the humanity index will vary depending upon which body the Biopod is using. This is determined by the total HC of the body, less 16D6.

Longevity Module (15,000eb, HC1): This module, which can be installed in any full body conversion system, consists of an advanced medical computer (which functions like a Medscanner and Biomonitor), a chemical synthesizer, and a vast supply of free-roaming nanosurgeons. Once installed in the body of a cyborg, the Longevity Module monitors the status of the Borg's biosystems (ie, the brain and its few support organs) and maintains upkeep of their health. The nanosurgeons isolate local brain degeneration and stimulate deteriorating cells to regenerate. The medical computer diagnoses any illnesses or dysfunctions in the biosystems and synthesizes chemicals and catalyst enzymes to heal any problems. Although this system has not been on the market long enough to prove its full capabilities, it makes the cyborg all but immune to disease and will theoretically triple its lifespan (this based on computer projections). This is a popular choice among those who have a Gemini body.

VEHICLES

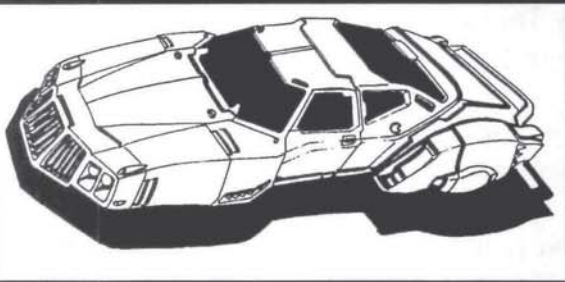
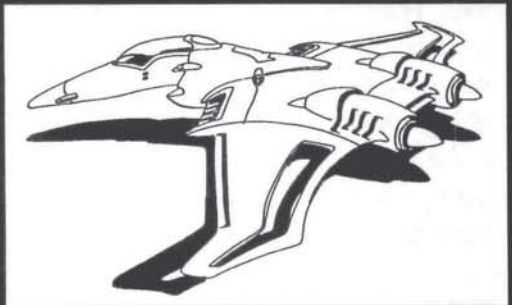

"Ares combat bike . . . A Nomad's dream. Rock 'n roll, babe!"

-Donya West, Demo-racer and Braindance Star

"A Punk's ride is an extension of his attitude. And we all know attitude is everything."

-Gil Myxx

"Who cares what it looks like; how fast is it?"

-Jake Takada

AERODYNES

Aerodynes (vectored thrust vehicles) are airframes without lifting surfaces (wings or rotors) that can fly by virtue of vectoring jet engine thrust to counteract gravity. They are true Vertical Take-Off and Landing (VTOL) aircraft.

Aerodynes are a familiar sight in the *Cyberpunk 2.0.2.0* universe, largely represented by the ugly, bulbous AV-4. There are drawbacks to their versatility: if an aerodyne is flipped on its side or back, it loses all lift and plummets until it can point its jets at the ground again. Aerodynes also use jet engines which produce lots of heat; heat that attracts IR-homing missiles in combat (including most SAMs). Finally, jet engines can't use alcohol fuel (the octane is far too low) and must use Avgas or Kerosene, expensive petroleum derivatives. Avgas is available at airports and other aerodyne/helicopter ports, and costs $(2D6 \times 10) + 50$ eb per gallon (70-170 eb/gallon).

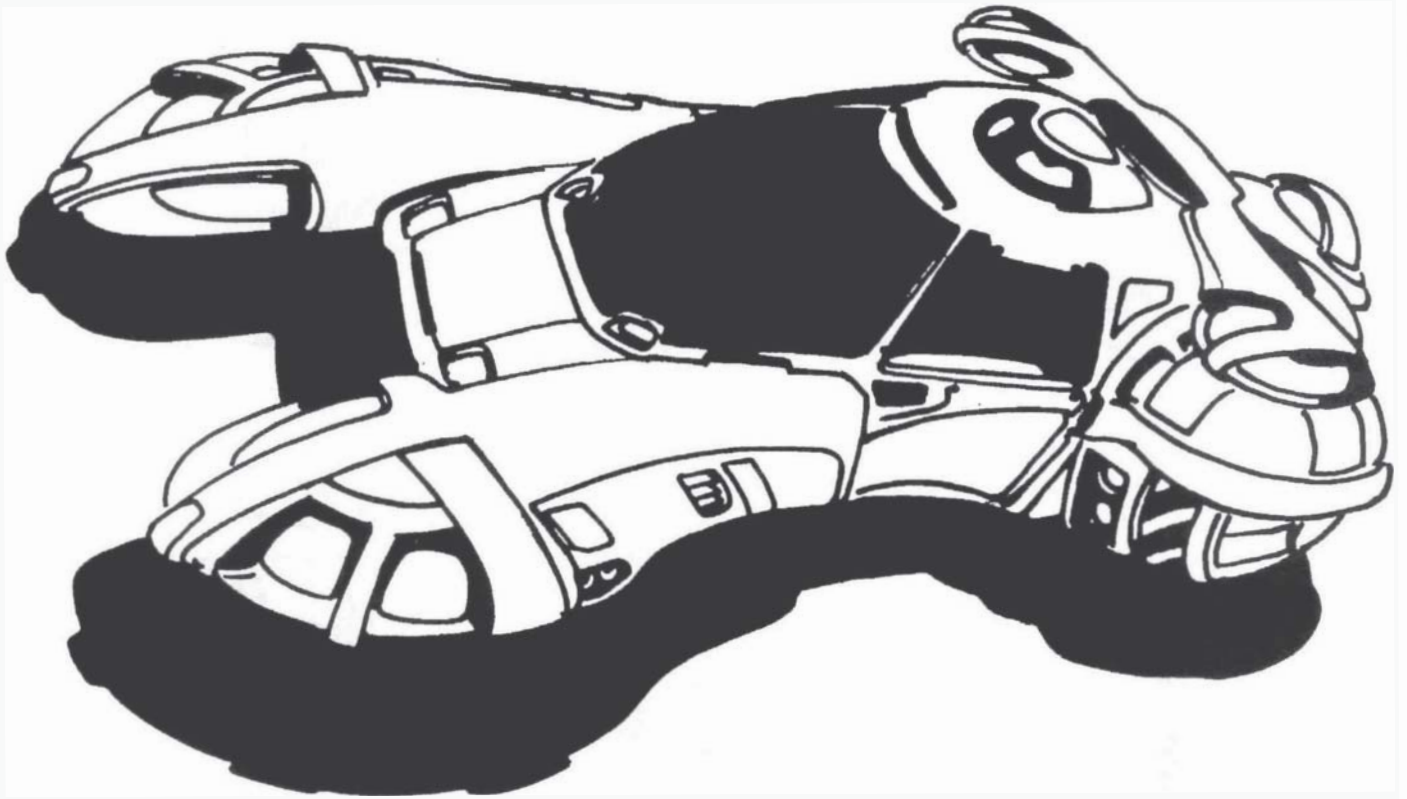

AV-3 "AEROCOP"

The AV-3 "Aerocop" (as it is known) is a familiar sight in any metropolitan area in the world. It is the standard for police departments the world over, with good armor, good performance, and versatility. The Aerocop functions just like a normal police car, except that it can fly as well as "roll".

The turret machinegun mount owes its existence to the AV-3's design concept as a military scouting vehicle. Rejected in favor of the all-purpose AV-4 and the assault AV-6, the AV-3 was then sold to police departments the world over. Some departments dismount the turret; others keep it, and even vary the weaponry from the standard machinegun to heavy machineguns, light autocannons and missiles. The AV-3 is possibly unique in that it has retained ground wheels for surface maneuvering, another legacy of military requirements that it be able to go to ground and operate in surface mode. This comes in very handy for police operating in areas where tall surface clutter precludes flight.

Maneuver Speed: 250 mph
Acc/Dec: 50 mph per phase
Top Speed: 350 mph
Fuel Efficiency: 1 mpg
Passengers: 5
Fuel Capacity: 300 gallons avgas
SDP: 50
Maneuverability: +1 to all rolls
SP: 20
Cost: 500,000 eb

Special Equipment: Radio, computer link to police headquarters, crash webbing (counts as 15 SP for passengers in crashes and collisions), ejection seats for front passengers (passengers then drift to ground on individual parachutes), secure back seat (20 SP armorplastic barrier between front and back seat), spotlight, police strobe lights, loudspeaker.

Game Notes: The AV-3 has a Maneuvering Speed of 60 mph, a Top Speed of 150 mph, Maneuverability of +0 to all rolls and Acc/Dec 10 mph per phase when on the ground.

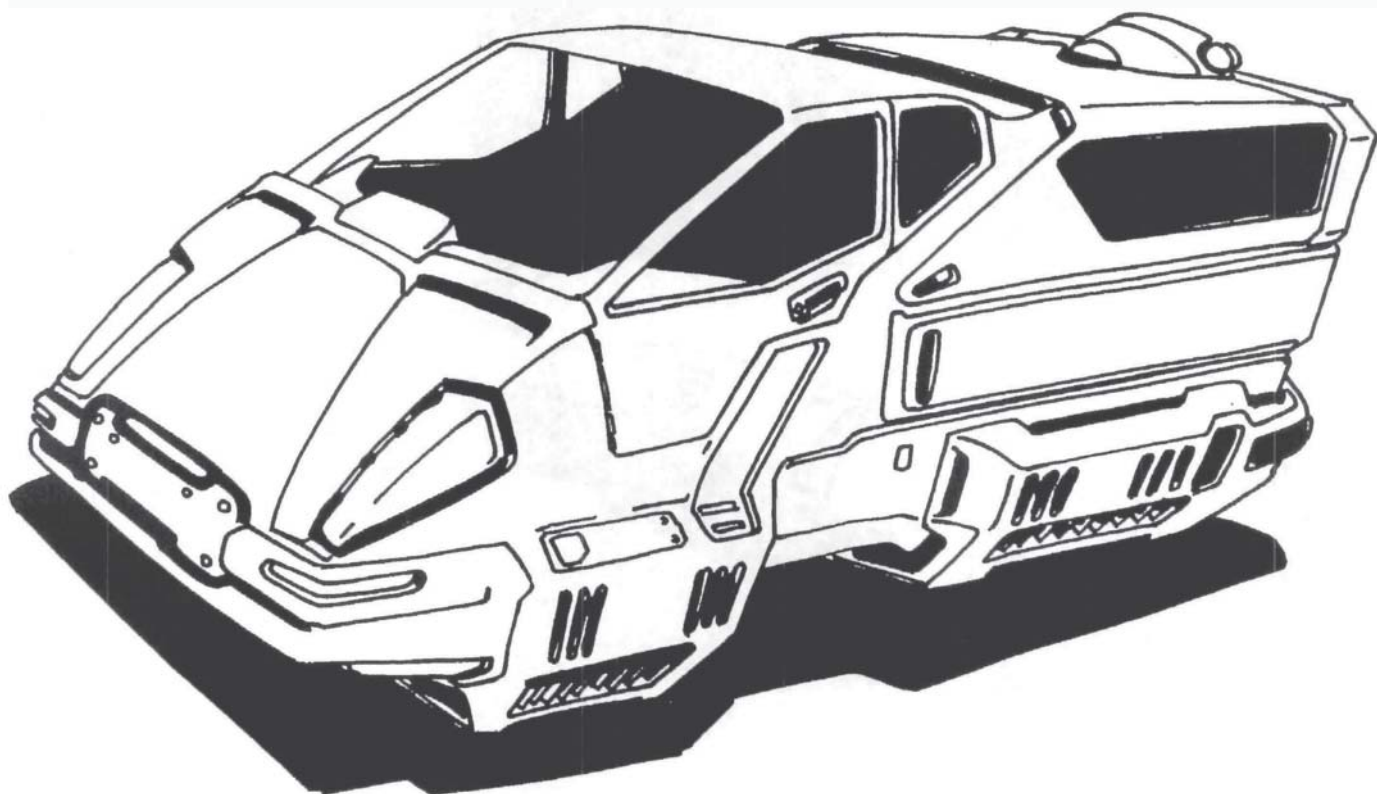

THE FAMILY FLIER

For years, the AV series has been the epitome of fast transport, a vehicle that can take off and land without the need of a runway and flit to its destination at aircraft speeds, avoiding ground clutter and traffic congestion. But it's always been beyond the reach of any but the most filthy rich.

No longer! VMW now introduces its new export model of their popular EEC military airjeep, the Family Flier. Priced to sell, the Family Flier is available to the middle-class family, at reasonable interest rates (10% APR). It's easy to fly, cheap to maintain, and has one of the highest fuel milage rates of any aerodyne on the market. The Family Flier: Safe, fast, inexpensive, convenient. Head on down to your VMW dealership today and take to the skies!

Maneuver Speed: 75 mph
Acc/Dec: 25 mph per phase

Top Speed: 150 mph
Fuel Efficiency: > 2 mpg
Passengers: 6
Fuel Capacity: 100 gallons avgas
SDP: 50
Maneuverability: -2 to all rolls
SP: 15
Cost: 50,000eb

Special Equipment: Crash bags for passengers (counts as SP20 for resisting crash and collision damage to passengers)..

Game Notes: The Family Flier is underpowered (thus its slow speed, sluggish maneuverability and high fuel efficiency). It can hold up to six people (including the driver) and another 100 kilograms of cargo in a cargo bay

THE NISSAN FORD FANMASTER

Can't afford avgas? Why not try a cheaper and more low tech alternative? The FanMaster is a common sight both in the city and outside city limits (especially in areas where roads are limited or non-existent). Its large cargo capacity, reliability and durability make this hovertruck the perfect vehicle for the outdoorsperson on the go, or for an intercity trip with the furniture.

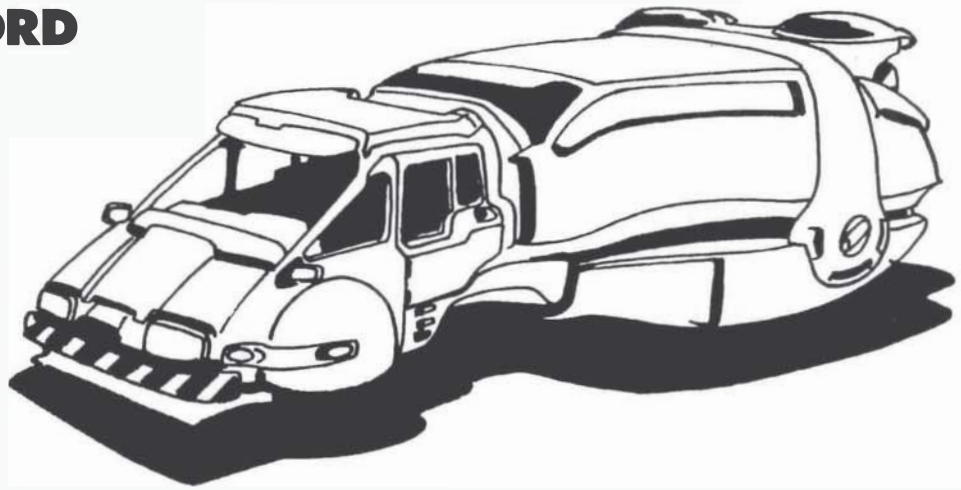

Built to military suspension specifications, if you can get there on a hoverfan, the FanMaster will get you there! It's even fully amphibious!

Maneuver Speed: 25 mph

Fuel Efficiency: 20 mph

Fuel Capacity: 25 gallons CHOOH2

Cost: 20,000 eb

Acc/Dec: 12 mph per phase

Passengers: 3

Maneuverability: -2 to all rolls

Top Speed: 100 mph

SDP: 75

SP: 15

Special Equipment: The FanMaster can carry 750 kg of cargo in the back bed. Enclosed rear vans are available (add 2,000 eb to cost) for in-city vans and runabouts.

Game Notes: The FanMaster is also a fully amphibious, hoverfan vehicle (although it can't fly). As long as it is not carrying more than 250 kg of cargo, it can drive right into water and float. Its low-power fan blade system allows it to drive at 5 mph speed (Acc/Dec 1 mph per phase) overwater. Its maneuvering is terrible, though: -3 to all maneuvering rolls while in water.

THE MACH

The AV series is popular. It's reliable. It's useful. It's everywhere. And every vehicle in the series looks like it was designed by a truck-builder. An AV looks about as fast as a gum eraser, and has the same sex appeal. You can get

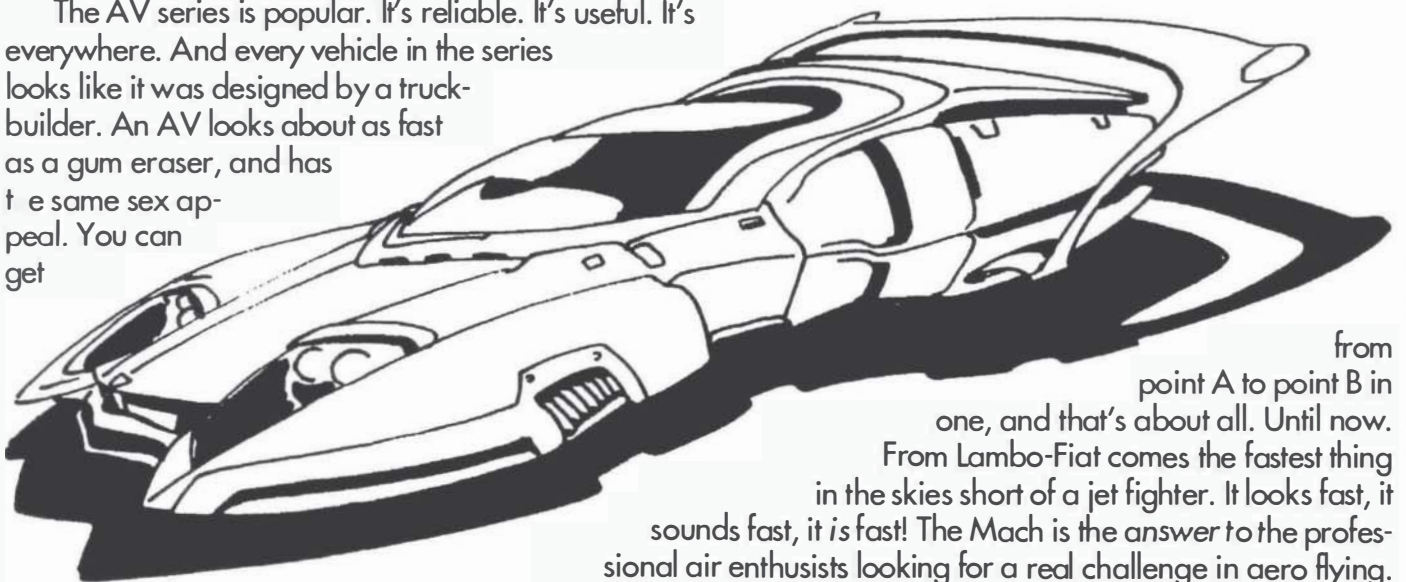

from point A to point B in one, and that's about all. Until now. From Lambo-Fiat comes the fastest thing in the skies short of a jet fighter. It looks fast, it sounds fast, it *is* fast! The Mach is the answer to the professional air enthusiasts looking for a real challenge in aero flying. And it's the sexiest vehicle in the air or on the ground. Available in black with red interior or red with black interior.

VEHICLES

Maneuver Speed: 200 mph

Fuel Efficiency: 1 mpg

SDP: 40

Cost: 650,000 eb

Acc/Dec: 150 mph per phase

Passengers: 2

Maneuverability: +2 to all rolls

Top Speed: 500 mph

Fuel Capacity: 300 gallons avgas

SP: 10

Special Equipment: Autopilot and computer navigation systems can fly the car to any destination, as long as the destination is programmed into the computer and satellite navigation systems can be accessed. The autopilot makes all maneuvers at skill Pilot (Vector Thrust) 5. The Mach comes equipped with top quality compact audio and video entertainment systems.

Game Notes: The Mach is a very unforgiving aircraft. Unless the pilot has a Pilot (Vector Thrust) skill of 5+, the Mach's maneuverability drops from +2 to all rolls to -5 to all rolls.

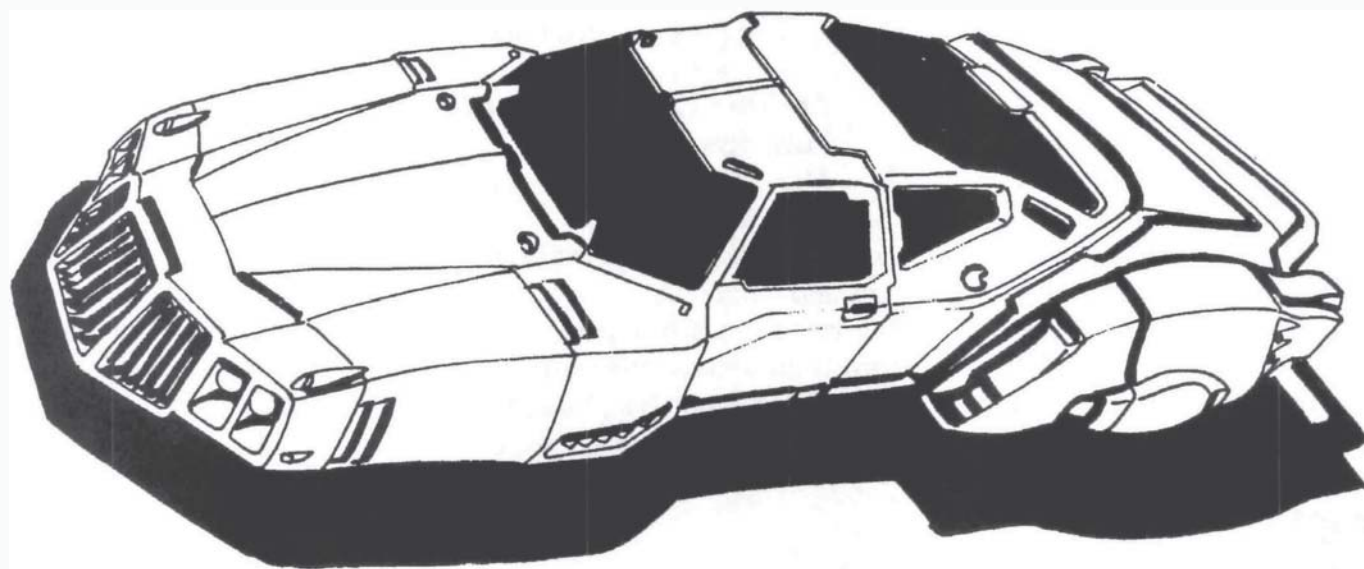

THE SWAN

For the executive on the go, who doesn't want to bother with the pressures of traffic, road repairs, and obscene interest payments, the aircraft and automotive manufacturers of Scandinavia offer the Swan. Performance, high speed, maneuverability, reliability and safety combined with a look that says "You're a success."

The Swan is equipped with the latest in autopilot and computer navigation systems, as well as the top of the line in safety and control equipment. The Swan. Elegance, dependability, and performance.

Maneuver Speed: 100 mph

Acc/Dec: 50 mph per phase

Top Speed: 200 mph

Fuel Efficiency: 1.5 mpg

Passengers: 3

SDP: 65

Fuel Capacity: 300 gal. avgas

Maneuverability: -1 to maneuver rolls

SP: 20

Cost: 200,000 eb

Special Equipment: Crash bags and restraint equipment for passengers (counts as SP 40 to passengers in case of crash or collision). Autopilot and computer navigation systems can literally fly the Swan to any destination, as long as the destination is programmed into the computer and satellite navigation systems can be accessed. The autopilot makes all maneuvers at skill Pilot (Vector Thrust) 5. If the Swan suffers control loss, compensator systems add +5 to Pilot die rolls to regain control. The Swan can carry 100 kg of cargo if the third passenger is not carried.

GROUND CARS

Most ground cars are simple devices very much like those available in the late 20th Century. They almost always have digital readouts and heads-up displays projected onto the windshields, and all-wheel drive/steering. And they almost always run on CHOOH₂ alcohol fuel, or electrical storage/flywheel systems.

THE CROWDER

The New American Motors Crowder is one of the most popular electric citycars in North America, and is even made by license overseas (Japan being the country with the next largest quantity of Crowders). The Crowder's popularity over its closest rival, the Honda Metrocar, comes from its electrical power system. Electricity is available almost anywhere, at a lower cost than CHOOH₂. A Metrocar fillup with CHOOH₂ costs about 15 eb, while a Crowder recharge costs only 10 eb in most cities where electricity is readily available.

For the Green citizen, the Crowder is the only alternative. Make your impact on the environment! Send a message to polluters, and save on fuel costs at the same time.

Maneuver Speed: 20
mph
Acc/Dec: 3 mph per
phase

Top Speed: 40 mph

Fuel Efficiency: 1 hour per power unit

Passengers: 2

Fuel Capacity: 5 power units

SDP: 25

Maneuverability: -1 on all rolls

SP: 10

Cost: 3,000 eb

Game Notes: The Crowder takes 1 hour per power unit to charge when connected to at least a 220-volt power output. A regular 110-volt house power plug charges the battery in 10 hours.

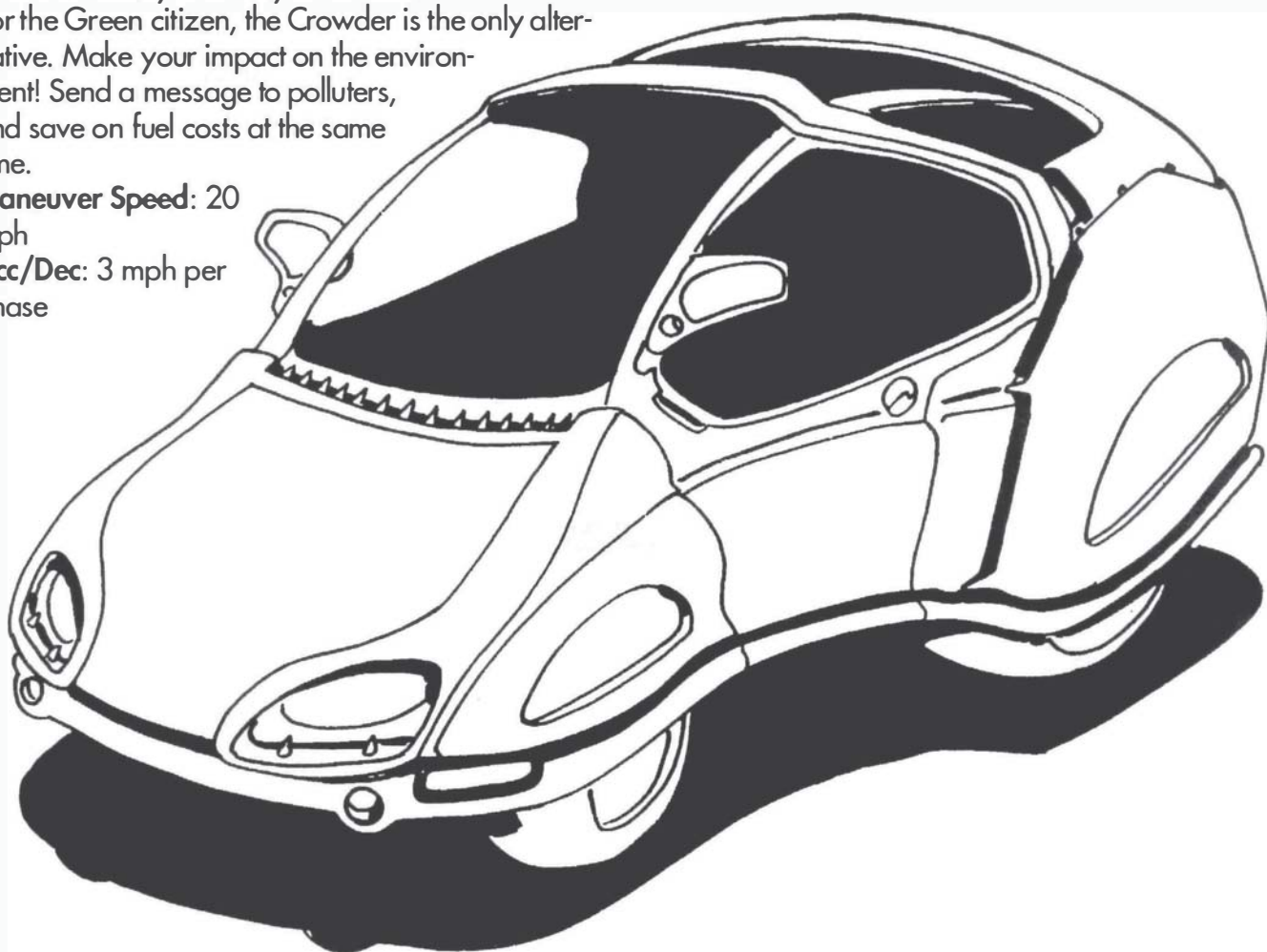

VEHICLES

THE MAX INTERCEPTOR

Used by intercity police the world over! Faster than anything but an aero, tougher than anything but a tank, with the acceleration to make it count and the endurance to maintain long-range high-speed chases, the Max Interceptor is now available to the public. Official chase car of the United States Highway Marshals.

Maneuver Speed: 50 mph

Acc/Dec: 12 mph per phase

Top Speed: 180 mph

Fuel Efficiency: 20 mpg

Passengers: 4

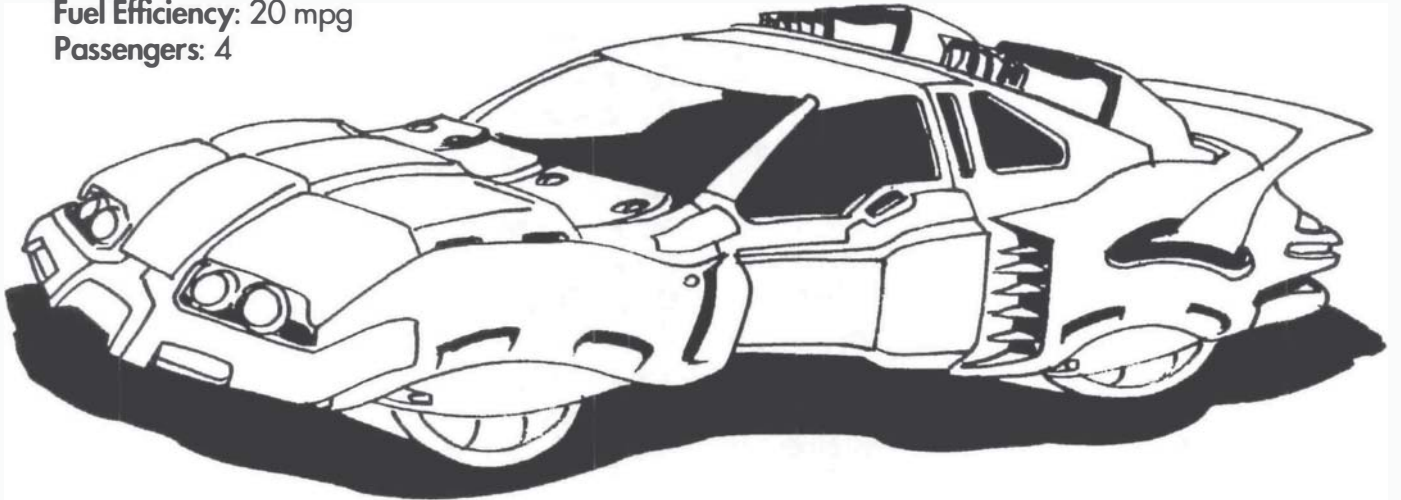

Fuel Capacity: 40 gallons CHOOH2
Cost: 40,000 eb

SDP: 60

Maneuverability: +1 on all rolls

SP: 15

Special Equipment: Police radio, satellite uplink for onboard computer, fire extinguisher, crash webbing (counts as 15 SP for passengers in crashes and collisions), secure back seat (20 SP armorplastic barrier between front and back seat), spotlight, police strobe lights, loudspeaker. **Game notes:** Sometimes this car is armed with a machinegun turret like the AV-3 "Aerocop."

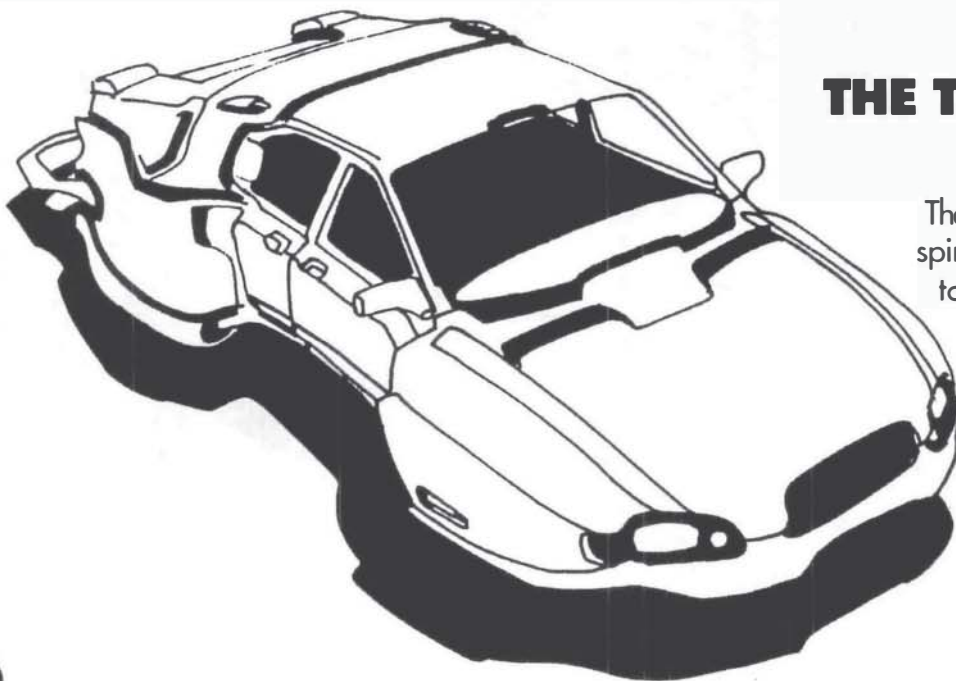

THE TOYO-CHEVROLET '17 CHEVY

The '17 Chevy is possibly the least inspired automobile in the history of automobiles. It is virtually a copy of every selling feature seen on every rival passenger sedan on the market. Intended as a marketing ploy, the imitation instead made the '17 Chevy nearly invisible; it has no distinct look that sets it apart from *any* of its competitors.

Maneuver Speed: 30 mph

Acc/Dec: 3 mph per phase

Top Speed: 90 mph
Fuel Efficiency: 30 mpg
Passengers: 4
Fuel Capacity: 10 gallons CHOOH2
SDP: 50
Maneuverability: +0 to all rolls
SP: 10
Cost: 10,000 eb

Game Notes: The '17 Chevy (and its competitors) can haul 150 kg of cargo in addition to its passengers. If not carrying cargo, it can haul up to 5 passengers (provided that the three in the back are very friendly with one another).

MOTORCYCLES

Ever popular with the younger crowd, in the year 2020 sometimes a good cycle is all the transport you can afford. Still, a cycle isn't a bad option — it gets great gas mileage, is easy to maintain, and looks cool. And, after all, isn't image what life is all about?

THE ASHIGARU

The Mitsuzuki Ashigaru is just the thing for the city rider. Classic lines, clean handling, and the bonus of electrical power make the Ashigaru the perfect city transport, with enough speed to get you where you're going and enough acceleration to get you out of trouble, fast.

Maneuver Speed: 30 mph
Acc/Dec: 4 mph per phase
Top Speed: 70 mph
Fuel Efficiency: 1 hour per power unit
Passengers: 1
Fuel Capacity: 8 power units
SDP: 20
Maneuverability: +1 on all rolls
SP: 0
Cost: 1,750 eb
Special Equipment:
 The Ashigaru can carry 25 kg of cargo in its cargo boot.

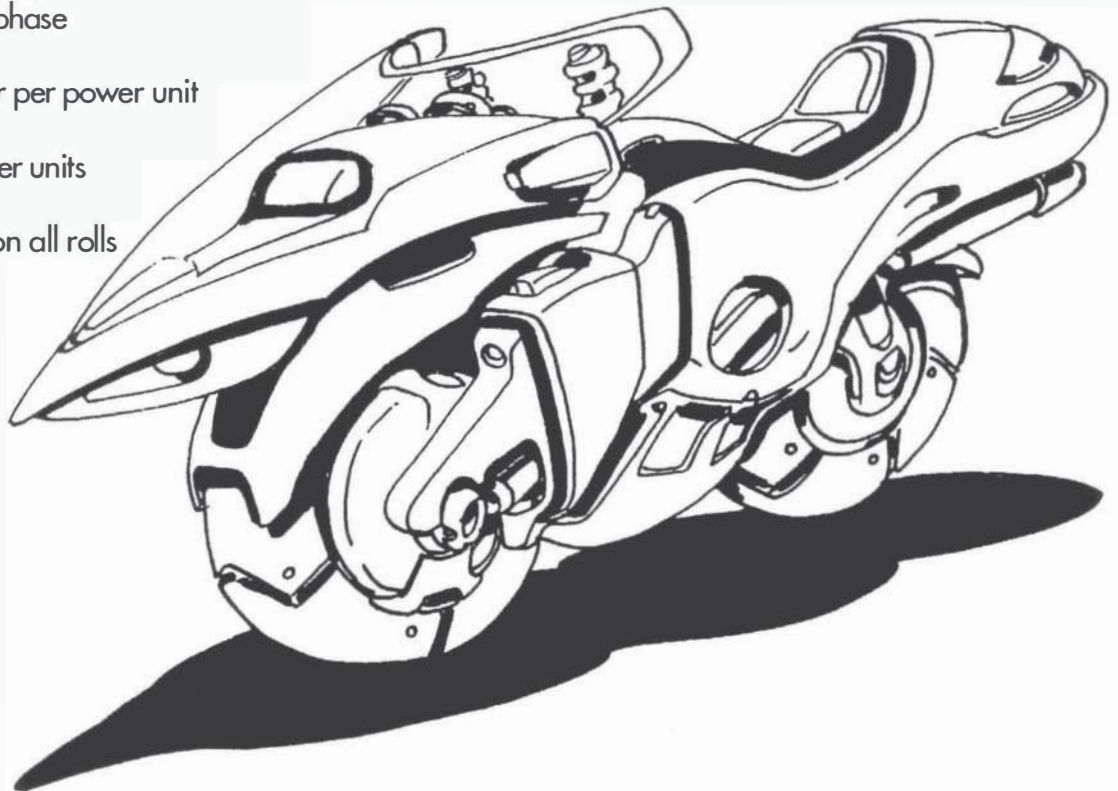

VEHICLES

THE BERMUDA

Bermuda, home to the most dangerous triangle on the high seas. Only fitting that it lend its name to the most dangerous triangle on the roads. The Delta Motors Bermuda is a new concept on the roads—a tricycle instead of a bike. Faster, more maneuverable, steadier, longer-ranged and just plain more comfortable to ride. Enter the Triangle. The Bermuda awaits.

Maneuver Speed: 45 mph

Acc/Dec: 4 mph per phase

Top Speed: 155 mph

Fuel Efficiency: 60 mpg

Passengers: 1

Fuel Capacity: 5 gallon CHOOH₂

SDP: 40

Maneuverability: +2 all rolls

SP: 0

Cost: 3,000 eb

Special Equipment: CB radio. The Bermuda can be fitted with a special seat to allow carrying 100 kg of cargo, or another passenger. This modification costs an additional 200 eb.

Game Notes: The Bermuda functions as well off-road as it does on pavement.

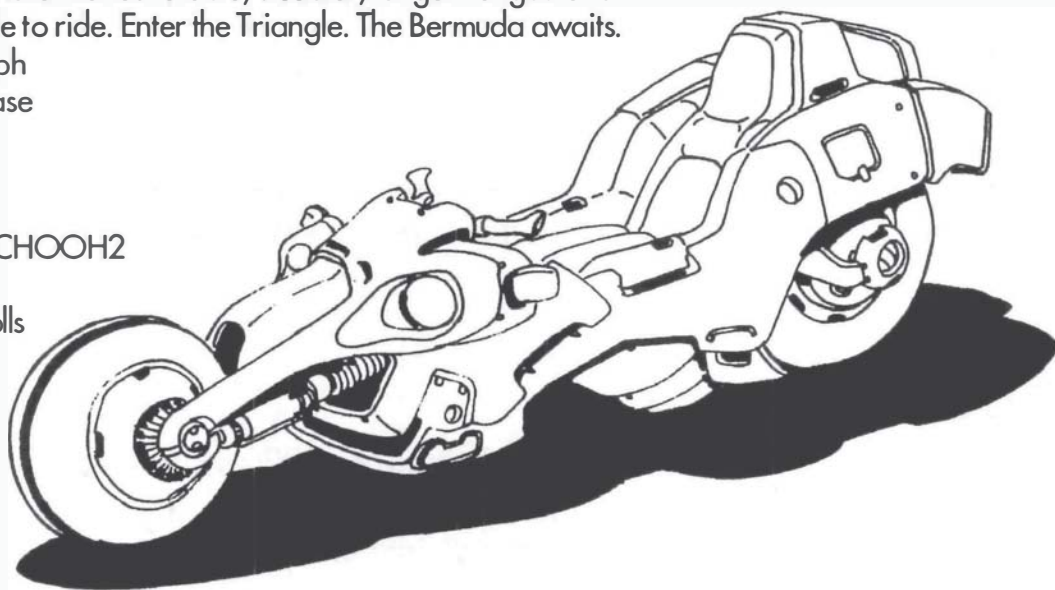

THE DARKWING

The Darkwing is Harley's latest entry into the off-road cycle market. It's not as fast as a Shiva, nor does it haul as much as a Thundergod. It doesn't *have* to be that fast, or haul that much. Because the Darkwing will go anywhere you can take it. It'll go places a tank can't get to, and brave country that will have any other bike in pieces. So if you have to access the inaccessible, get on the Darkwing and go!

From Harley. Bikes built for Americans, by Americans.

Maneuver Speed: 30 mph

Acc/Dec: 3 mph per phase

Top Speed: 100 mph

Fuel Efficiency: 75 mpg

Passengers: 1

Fuel Capacity: 5 gallon CHOOH₂

SDP: 35

Maneuverability: +3 when off-road

SP: 5

Cost: 4,500 eb

Special Equipment: CB radio, halogen headlights. Can be outfitted for cybernetic use at a cost of an additional 1,000 eb.

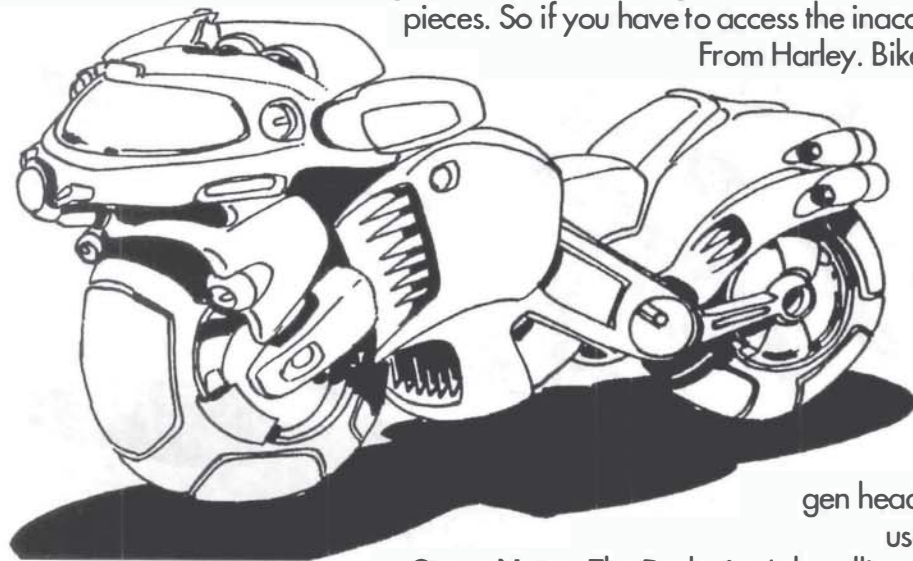

Game Notes: The Darkwing's handling is only fair on pavement. Off-road, in

dirt, sand, mud and other similar conditions, all maneuvering rolls are +3 with the Darkwing. Darkwings have been used by military organizations, and are armed with fixed-forward SAW light machineguns (treat as a Ronin Light Assault rifle with #Shots as 150) and a rear-firing smoke projector.

AIRCRAFT AND MINI-JETS

Most aircraft are limited to airports in order to support their long takeoff and landing requirements. There are a number of VTOL aircraft that don't have this problem. Ospreys and their tilt-jet cousins operate from building roofs, helipads and other restricted areas. They can't go places that an aerodyne can, but they can usually go farther.

Unfortunately for the prospect of Everyman owning a tilt-plane, the high power requirements of this method of flight require jets or jet-engine power, meaning that these aircraft (again) use some variant of Avgas for fuel.

Some of the vehicles listed below (Wasp & Comet), belong to a special category known as **minijets**. Since even governments find it difficult to stockpile enough jet fuel to operate the fuel-gobbling monsters of old, most corporate armies don't use full-sized jet fighters. Instead, smaller is better—small jets can carry lethal weaponry, are more maneuverable, and use less fuel.

GD F-36 COMET

General Dynamics introduces the Comet. Faster than the Wasp, more maneuverable than the Wasp, better than the Wasp. Ride the wave of the future; leave the insects behind and rocket to the skies!

Maneuver Speed: 625 mph

Acc/Dec: 15 mph per phase

Top Speed: 1,400 mph

Fuel Efficiency: 1 mpg

Passengers: 1

Fuel Capacity: 500 gallons avgas

SDP: 175

Maneuverability: +10 to all rolls

SP: 20

Cost: 45,000,000 eb

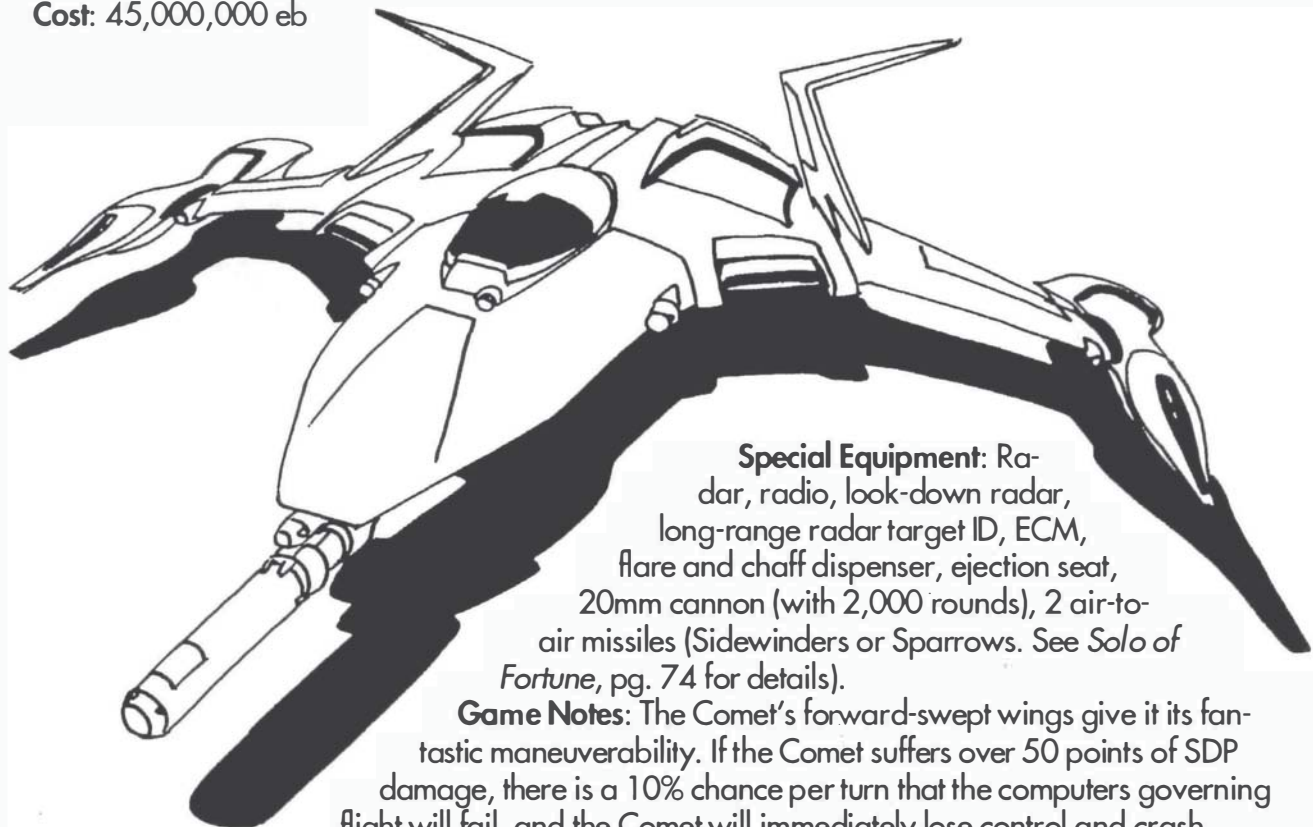

Special Equipment: Radar, radio, look-down radar, long-range radar target ID, ECM, flare and chaff dispenser, ejection seat, 20mm cannon (with 2,000 rounds), 2 air-to-air missiles (Sidewinders or Sparrows. See *Solo of Fortune*, pg. 74 for details).

Game Notes: The Comet's forward-swept wings give it its fantastic maneuverability. If the Comet suffers over 50 points of SDP damage, there is a 10% chance per turn that the computers governing flight will fail, and the Comet will immediately lose control and crash.

VEHICLES

MDD F-33 WASP

The F-33 Wasp is MacDonald-Douglass' current market leader in fast interceptors. Weighing in at a mere 6,800 kg, the Wasp can reach Mach 1.8, has an extended range of 1,000 miles, and carries four air-to-air missiles as well as the internal gun.

Maneuver Speed: 550 mph

Acc/Dec: 15 mph per phase

Top Speed: 1,250 mph

Fuel Efficiency: 1.5 mpg **Passengers:** 1

Fuel Capacity: 670 gallons avgas

SDP: 250 **SP:** 20

Maneuverability: +3 to all rolls

Cost: 35,000,000eb

Special Equipment: Radar, radio, ECM, chaff and flare dispenser, look-down radar, long-range radar target ID, ejection seat, 30mm cannon (with 1,000 rounds), 4 air-to-air missiles (either Sidewinders or Sparrows, or a mix of both).

Game Notes: The Sparrow missile is a radar-guided missile, doing 6D10 damage, with a 90% hit probability. Effected by chaff and ECM jamming. (See *Solo*, pg. 74, for Sidewinder and cannon details)

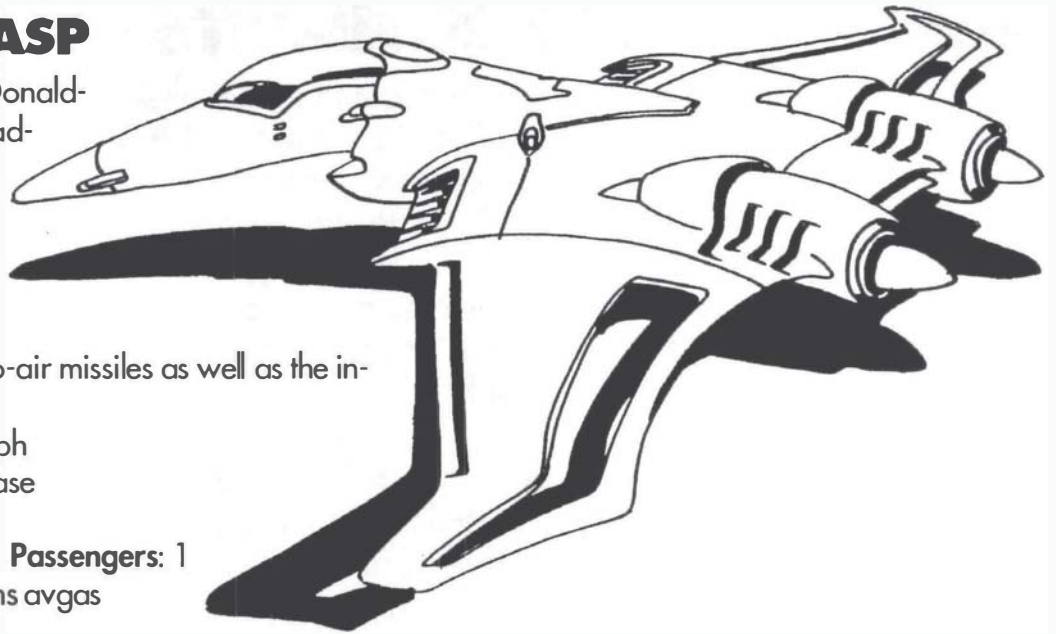

THE FED-BOEING FALCON

Swooping from the sky like its namesake, the Falcon stoops to deliver its cargo rather than slashing its prey. Fed-Boeing is proud to supply the world with this fine transport, continuing the line of top-quality Fed-Boeing aircraft.

Maneuver Speed: 100 mph

Acc/Dec: 10 mph per phase

Top Speed: 300 mph

Fuel Efficiency: 5 mpg

Passengers: 10

Fuel Capacity: 150-gallon avgas

SDP: 100

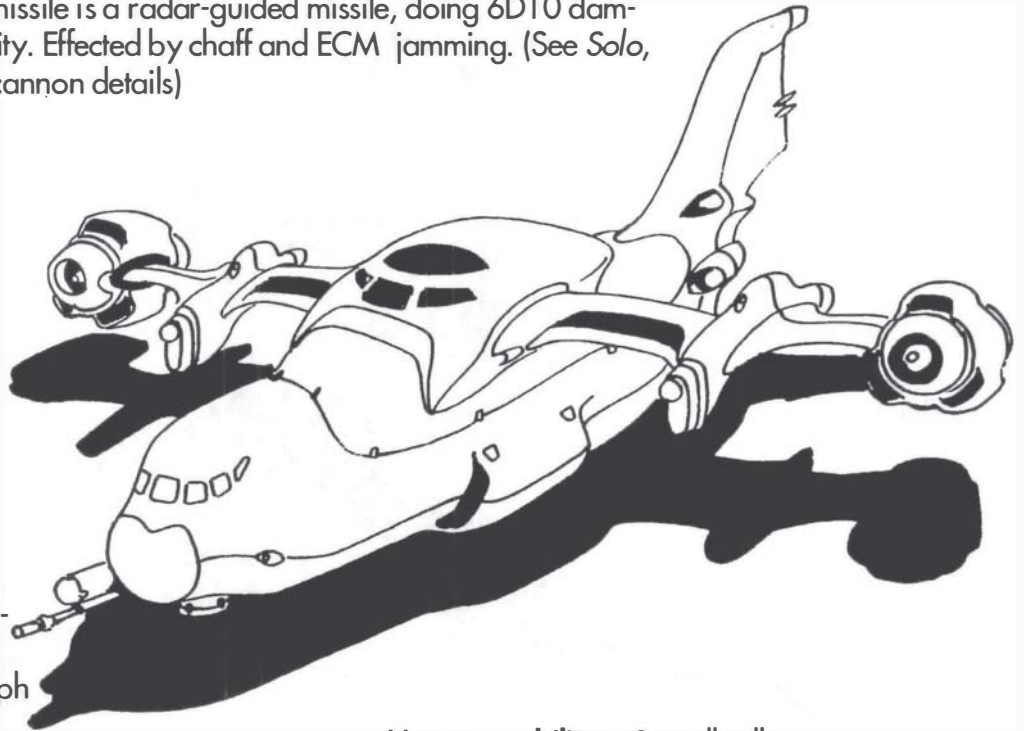

Maneuverability: +0 to all rolls

SP: 10

Cost: 1,250,000 eb

Special Equipment: Radar, long-range radio.

Game Notes: The Falcon needs at least 30 meters of open space to land or take off.

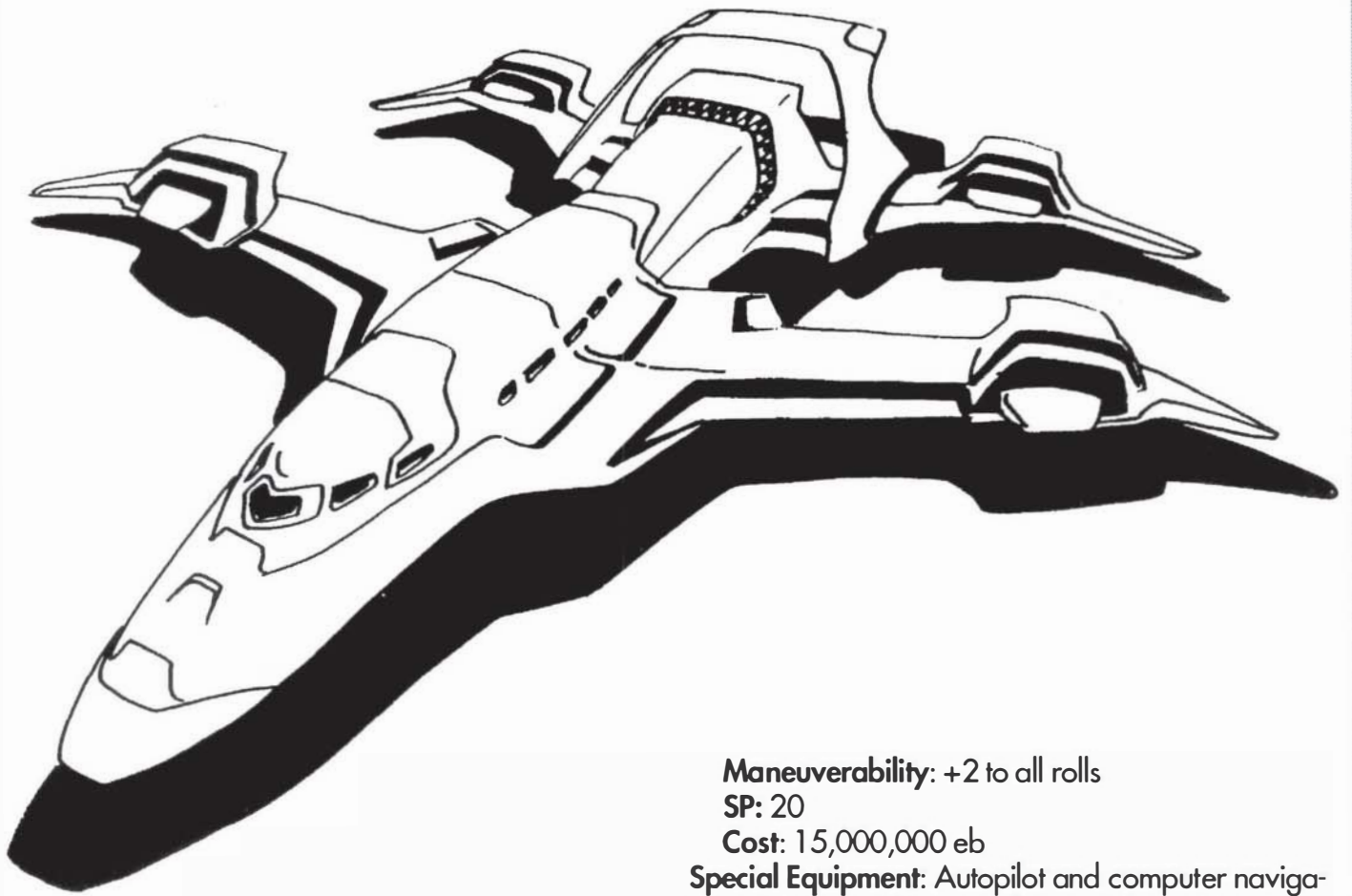

GD HUMMINGBIRD

Airships are too slow. Aerodynes don't have the range. Passenger scramjets just too expensive — after all, you're just going across the country, not LEO. So what can get you there when you absolutely, positively have to be there in a few hours?

The Hummingbird can. Combining the virtues of winged speed with tilt-wing vectored thrust, the Hummingbird can land on a helipad, and take off from one* as well. Fast, agile, comfortable ... That's the Hummingbird.

*With catapult assist.

Maneuver Speed: 300 mph
Acc/Dec: 10 mph per phase
Top Speed: 600 mph
Fuel Efficiency: 0.75 mpg
Passengers: 10
Fuel Capacity: 1,000 gallons avgas
SDP: 100

Maneuverability: +2 to all rolls

SP: 20

Cost: 15,000,000 eb

Special Equipment: Autopilot and computer navigation systems can fly the craft to any destination, as long as the destination is programmed into the computer and satellite navigation systems can be accessed. The autopilot makes all maneuvers at skill Pilot (Vector Thrust) 5. Mini-computer (see the Laptop computer in *Cyberpunk 2020*), a wet-bar, complete environment control, cellular visiphone, satellite uplink, telefax, radio, television, document shredder, fire extinguisher, radar, thermographic sensors, radar detector, laser detector and on-board ECM systems (see *Solo of Fortune* for details).

Game Notes: The Hummingbird is a tilt-wing, not a tilt-engine design. It is actually a very short Short Take-Off and Landing (STOL) aircraft. Landing it without a runway is a Difficult task; the airplane's size requires a minimum of a 20 meter radius to land it without harming the wing-mounted engines. The Hummingbird requires a 150 by 40 meter runway, or a catapult assist to take off. A crazed pilot could take off from a skyscraper roof, by taxiing over the edge and plummeting to gain speed! This is a Very Difficult task, and requires at least 100 meters of fall to build up speed.

VEHICLES

LOCKHEED-CESSNA PINTO

There's a target on the ground. The jet fighters whizz past at 400+ miles per hour, firing. Missed! Not enough fire to take it out; the jet went by too fast. Call in the gunships! Oops, they're not fast enough to make it to the target zone in time. When a jet is too fast, and a helicopter is too slow, and an AV is too vulnerable, you have to turn to the old standby: The prop plane.

The Pinto is a STOL weapons platform. It has the speed to get to the target area, the rough-landing capability to lurk on the ground behind the lines, waiting for action, and the loiter time to hover around the battlefield.

The Pinto. It's not another one-trick pony.

Maneuver Speed: 200 mph

Acc/Dec: 5 mph per phase

Top Speed: 450 mph

Fuel Efficiency: 3 mpg

Passengers: 4

Fuel Capacity: 500 gallons avgas

SDP: 150

Maneuverability: +2 to all rolls

SP: 20

Cost: 10,500,000 eb

Special Equipment: Radio, radar, thermographic vision, painting laser rangefinder, ejection seats, chaff and flare dispenser, ECM, two 20mm cannons fixed forward (each has 2,000 rounds. See *Solo*, pg. 74). The Pinto can carry 1,400 kg of ordnance.

Game Notes: The laser rangefinder can guide Hellfire missiles (*Solo*, pg. 74) and other laser-guided munitions. It also gives a +3 to cannon fire at Long and Extreme ranges. Ordnance weights: Hellfire missile 45 kg, 7-shot rocket pod 250 kg, 19-shot rocket pod 650 kg, Sidewinder missile 85 kg, bombs as per weight (115, 230, 340 or 455 kg). Bombs do explosive damage equal to 1D10 per kilogram of bomb weight with a radius of 1 meter per 10 kg, rounded down, of bomb weight. There is a further blast radius of 1 meter per 5 kg, rounded down, of bomb weight, where the bomb does 1D10 damage per 5 kg of bomb weight.

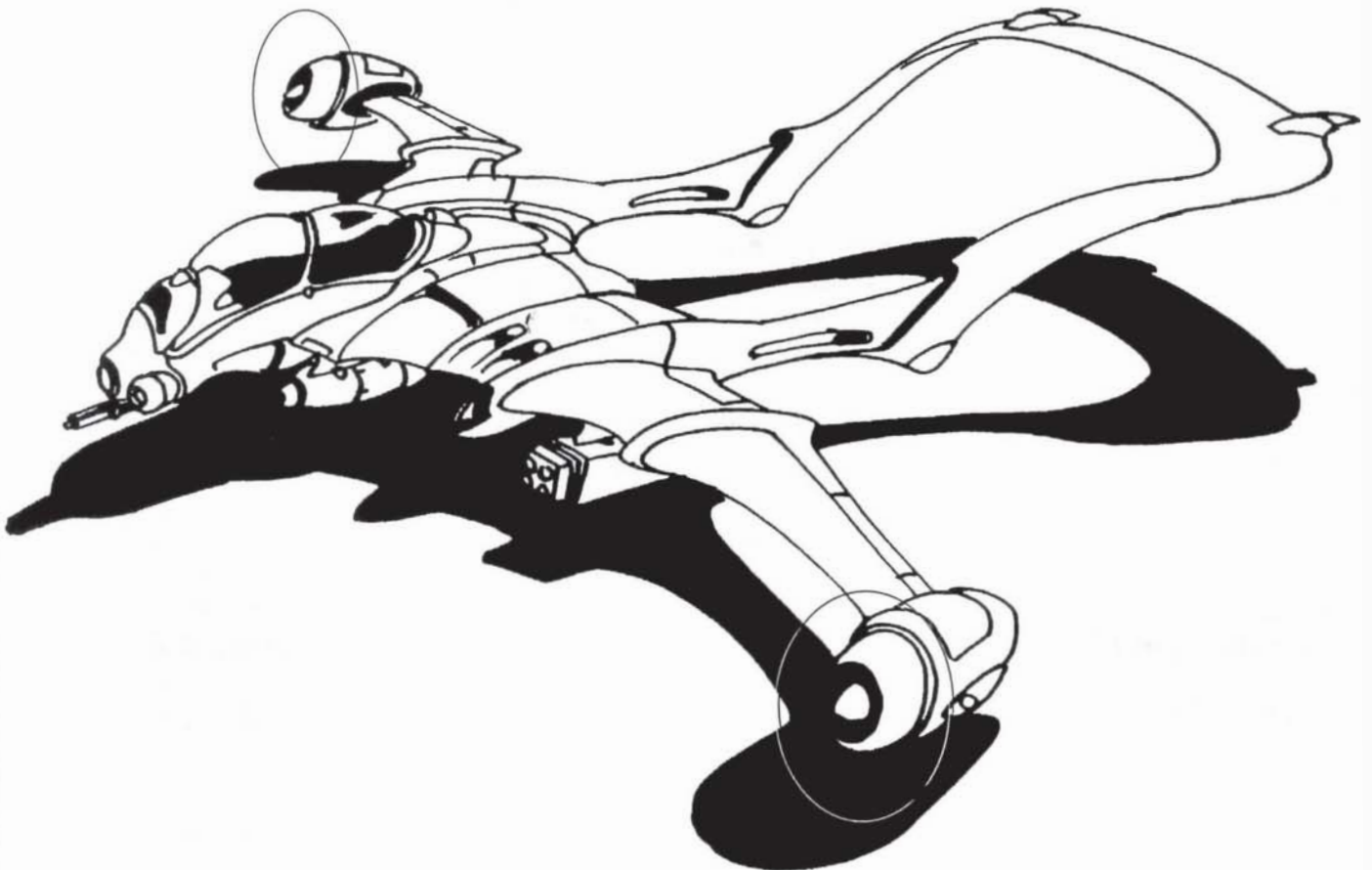

AIRSHIPS

With the price of aviation fuel so high, the jetliners that roamed the skies of the 20th Century are gone. In their place are the slower, quieter, more dignified lighter-than-air airships. Filled with helium, fueled by CHOOH_2 , these mammoth fliers drift across the world, conveying people and cargo without effort. And since they've got so much more cubic space when compared to airliners, they can afford luxuries for the passengers. You may not get there as fast on an airship, but you'll enjoy the ride!

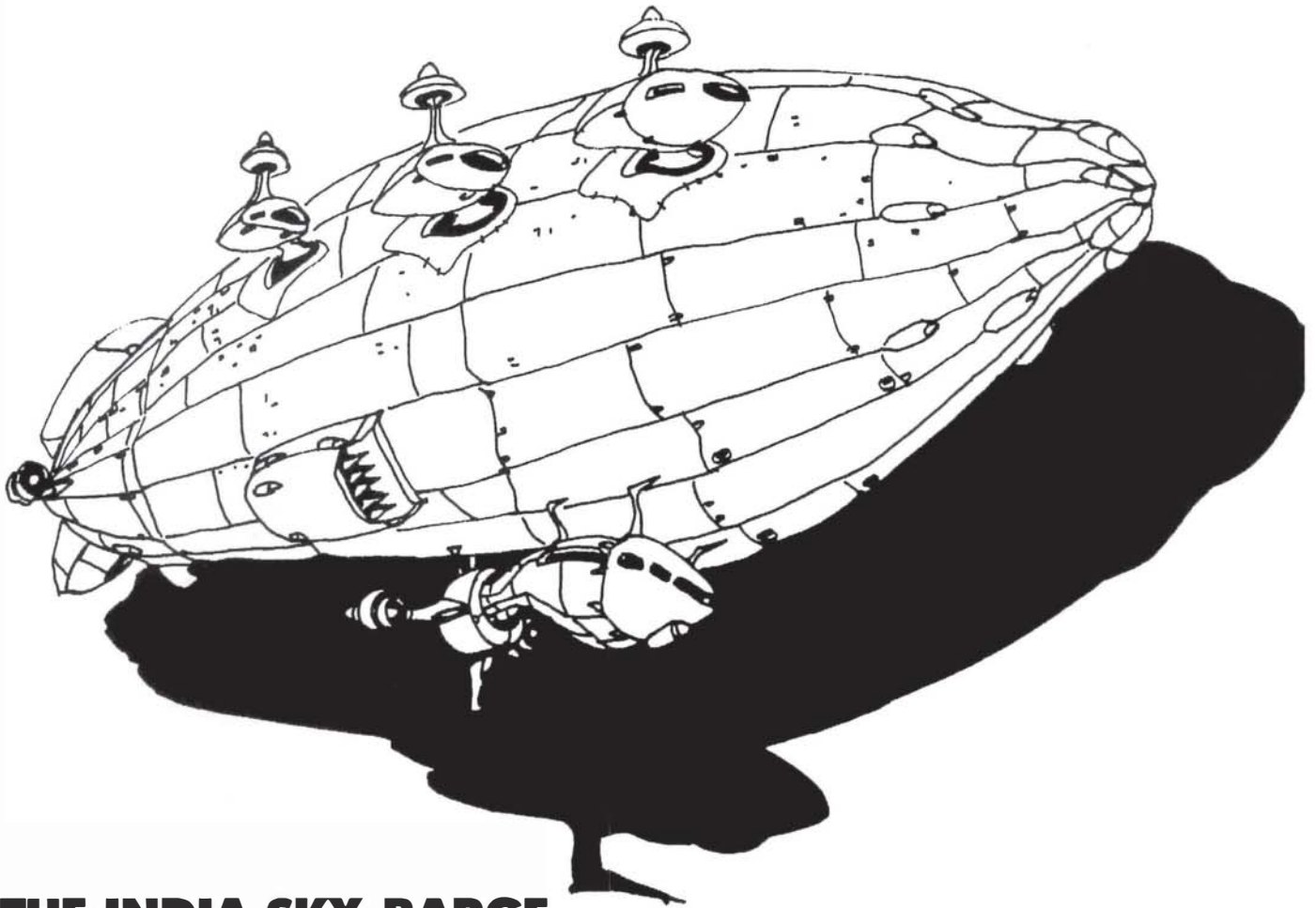

THE INDIA SKY-BARGE

Cargo-hauler *par excellence*. With the Sky-Barge, you can fly over the countryside, without having to brave the anarchy of the unsupervised country or endure the poor road system running from city to city. Rated at over 150 metric tons, the Sky-Barge is the cheap answer to moving goods.

Maneuver Speed: 30 mph

Acc/Dec: 1 mph per phase

Top Speed: 60 mph

Fuel Efficiency: 0.33 mpg

Passengers: 6

Fuel Capacity: 3,000 gallons CHOOH_2

SDP: 750

Maneuverability: -3 to all rolls

SP: 0

Cost: 10,000,000eb

Special Equipment: Radio, radar. The Sky-Barge can haul up to 150 metric tons at full speed. It can haul up to 250 tons at a top speed of 45 mph.

VEHICLES

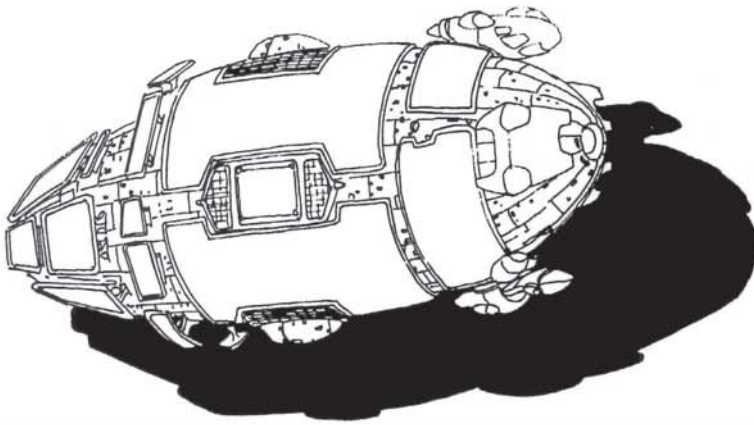

THE "MADISON AVENUE" ADVERTBLIMP

Madison Avenue, once the hub of North American advertising. This remote-controlled LTA vehicle is a tribute to that stretch of street. A flying billboard, the "Mad Ave," as it's known, is the perfect attention-getter. Its video screens are fully programmable from any computer that can run the software (software

included with purchase), and the blimp can be set for pre-programmed routes or directly guided with a joystick and video monitor.

Maneuver Speed: 15 mph

Fuel Efficiency: 1 mpg

Fuel Capacity: 500 gallons CHOOH₂

Cost: 2,500,000 eb

Acc/Dec: 1 mph per phase

Passengers: 2

Maneuverability: -3 to all rolls

Top Speed: 35 mph

SDP: 500

SP: 0

Special Equipment: Video cameras, spotlights, 6 meter by 12 meter electronic projection screens.

Game Notes: In a pinch, two people can squeeze into the emergency cockpit and fly the vessel.



THE SKY QUEEN CRUISE-LINER

The Dayton Sky-Queen, regal ruler of the North American skies. Comfort, safety and convenience in trans-continental transport. Fly the floating skies with the Sky-Queen!

Maneuver Speed: 40 mph

Fuel Efficiency: 0.25 mpg

Fuel Capacity: 8,000 gallons CHOOH₂

Cost: 20,000,000 eb

Acc/Dec: 1 mph per phase

Passengers: 170

Maneuverability: -1 to all rolls

Top Speed: 100 mph

SDP: 1,000

SP: 0

Special Equipment: Radio, radar, ECM, flare and chaff dispenser, sleeping accommodations for 150, 3 bars, 2 restaurants, crew compartment for 20, 37.5 metric tons cargo capacity, 6 Sidewinder AA missiles (Solo, pg. 74).

Game Notes: The Sky-Queen usually cruises at 60 mph, taking approximately one full day to go from coast to coast. The high SDP rating reflects the difficulty of downing the compartmented, self-sealing gasbag.

EXOTICS

Exotic: Foreign; having the charm of fascination or the unfamiliar; strangely beautiful; enticing. **Slang:** A human biosculpted with nonhuman elements: fur, long fangs, tails, etc.

In the world of 2020, practically anything is available—for a price. With sophisticated plastic surgery techniques, a person can have his or her appearance changed to nearly any specification. Bodysculpting is popular, relatively inexpensive and available on a “while you wait” basis.

So what do the wealthy do to show that they’re wealthy? Once upon a time, plastic surgery was a symbol of the filthy rich. Now it’s *passé*. A new line of bodysculpting is available for those with the euro. Why bother being one of the beautiful people when you don’t have to be “people” at all?

Biotechnica is proud to unveil its new line of Bioexotics™. With nanosurgery, cloning, gene matching and grafting, there’s nothing you can’t become!

Disclaimer: *Biotechnica accepts no responsibility for the misuse of its exotic technology. For best results, a full psychological therapy program should be implemented before, during and after exotic biosculpting. Only Biotechnica-licensed clinics guarantee official implantation and exotic sculpting procedures.*

THERAPY PROGRAMS

Biotechnica-licensed clinics and hospitals also provide therapy programs to ease the transition from mere human to your new form. (Game Note: Other hospitals also provide therapy for recovery from accident and cybernetic implantation.) Therapy costs money and time, but it’s worth it in the end!

Therapy is a regimen (referred to as “tor re” by patients) designed to assist the patient in recovering use of damaged muscles and nerves. In game terms, therapy lowers the humanity loss from any injury/implant as the patient is helped to understand what has happened and how to use his/her new parts; and is given practice in using them.

There are three levels of therapy: Outpatient, where the patient attends therapy sessions at the clinic/hospital; Inpatient, where the patient lives in the hospital and practices every day under medical supervision; and Intensive Care Therapy, where the patient not only lives in the facility but has his/her nervous system and psyche probed each day for “fine-tuning” (in essence, a trained psychological team rebuilds the patient’s personality into one that minimizes identity loss. By the time they’re done, the psych team knows more about the person than the person does, so you’d better trust these people with all of your innermost secrets).

The time needed for successful therapy is based on the complexity of the operations performed. Add up the surgery codes as follows:

4 Negligible = 1 Minor

2 Minor = 1 Major

2 Major = 1 Critical

The time needed for each kind of therapy is listed below. The surgeries add together, so the therapy time for multiple surgeries is determined by the surgery total. For instance, a patient who experienced 1 Major surgery and 3 Minor surgeries would treat therapy time as if he had had 1 Critical and one Minor surgery (1 Major + (3 Minors/2))=22 weeks of outpatient therapy or 11 weeks of inpatient/IC therapy.

EXOTICS

THERAPY

Surgery	Out	Inpatient/ICT
Negligible	2 weeks	1 week
Minor	6 weeks	3 weeks
Major	8 weeks	4 weeks
Critical	16 weeks	8 weeks

THERAPY COSTS AND EFFECTS

Therapy	Cost/Week	Time Required	HPT
Outpatient	1,000 eb	14 hours/week	25%
Inpatient	5,000 eb	168 hours/week*	33%
ICT	10,000 eb	168 hours/week*	50%

* In these sorts of therapy, you live in the facility 24

hours a day and they don't want to let you out...
 † Humanity Points Regained

SURGERY ADDENDA AND NOTES

When a person is undergoing surgery, the surgeons will work on only one area of the body at a time (divided up into head, torso, abdomen, arms and legs). All work in that area will be done at the same time—for instance, installing a cyberhand on one arm and putting rippers in the other hand will be done simultaneously. The operation costs are all still separate, of course. (What, you expect otherwise? Not on your bankbook, chum!)

EXOTIC CYBERWARE

(COSTS DO NOT INCLUDE SURGERY AND HOSPITALIZATION FOR RECOVERY.)

ITEM	SURGERY	HL	COST	NOTES
MINOR FACIAL MODIFICATIONS	M	1d6/2	1,000 EB	
MAJOR FACIAL MODIFICATIONS	M	1d6	2,000 EB	
MUZZLE, SHORT	M	1d6	2,000 EB	
MUZZLE, LONG	MA	2d6	2,500 EB	A
MANDIBLES, EXTENDED	MA	3d6	4,000 EB	B
NATURAL FANGS (DO 1D6 IN COMBAT)	N	2d6	500 EB	C
NATURAL CLAWS (DO 1D6 IN COMBAT)	N	1d6+1	1,000 EB (PER LIMB)	D
RETRACTABLE CLAWS (DO 1D6 IN COMBAT)	M	2d6	1,000 EB (PER LIMB)	
SCRATCHERS	N	1d6	500 EB (PER LIMB)	E
RIPPERS	M	2d6	750 EB (PER LIMB)	E
TAIL	MA	2d6	1,500 EB	F
COMBAT TAIL	MA	3d6	2,500 EB	G
DIGITIGRADE LEGS	CR	6d6	4,000 EB	H
FUR/SCALES/SKINCHANGE	N	3d6	10,000 EB	I
HEAVY SCALES	N	3d6	12,000 EB	J
EXOSKELETON	CR	4d6	20,000 EB	K
FRAME ALTERATION	CR	2d6	8,000 EB	L
BEHAVIOR CHIP	N	1d6/2	1,000 EB	M
NEW BIOTECH:				
ARMORWEAVE	N	1d6	4,000 EB	N
SPEED GRAFTS	MA	1d6	750 EB	O

EXPLANATION OF "NOTES" (ABOVE)

- A: Like a dog's or horse's muzzle.
- B: Mandibles are semi-prehensile grasping "jaws" extended from the facial bone structure. They are usually sharp and strong, and can inflict 1D6 damage in grappling combat.
- C: Only when the person with fangs has grappled its opponent.
- D: Grown from the bones via nanotech. -3 to manipulation skill rolls (anything requiring use of fingertips—typing, delicate tool use, writing).
- E: Low HC loss is due to implantation in a good hospital environment.
- F: Mobile but weak—can only exert about 3 lbs. of force.
- G: A heavily-muscled tail, usually tipped with spikes, spines or a bony knob. Does 1D6 + Body Damage Modifier in hand-to-hand combat. Some combat tails have poison stingers added, doing damage like a knife and injecting appropriate drugs/toxins. A stinger tail costs 500eb more than a regular combat tail.

EXOTICS

- H: Dog-legs, jack-legs, etc. Animal-style hind legs, with a short foot and 3 joints instead of 2. This option replaces both legs. If acquired without a tail, the recipient is at -2 MA and -1 REF whenever on his/her feet. If acquired with a tail, digitigrade legs increase MA by 1.
- I: This changes the bearer's skin to the desired texture. There is a 10% chance of developing cancer from the genetic implant. The cancer can be cured, but the skinchange will have to be removed and curing the cancer will take 1-6 months and cost 2,000-12,000 eb. (roll 1d6 for months and multiply by 2,000eb for cost)
- J: This is actually Skinchange with Skinweave thrown in, for SP 12 protection. Same cancer risk as Skinchange.
- K: A rigid exoskeleton provides SP 18 protection, but reduces MA and REF by 2! Same cancer risk as Skinchange.
- L: Frame alteration can make the patient shorter, taller, fatter, thinner, etc., up to 25% change from patient's actual body size.
- M: Behavior chips are personality modifiers. Some rigidly lock a person into a single set of pre-programmed behavior (these are largely used by correction authorities to control prisoners), others simply provide a strong urge to act in certain ways when presented with certain stimuli. These chips can alter moods—want to be the life of the party? Simply slip in a chip and you're fun-loving for the rest of the night! (Or until the chip comes out.) Want to be the board-room terror? Slip in the Dominator chip and bully your partners into submission. Want to be a real Romeo? The Maximum Lover chip just gives the techniques. Use the Romance chip and feel the emotional high. Any emotion you want, any state of mind you crave, Behavioral chips can provide. The high price is for precise adjustment to your neural system (thus the visit to the clinic).
Warning: These chips can become addictive. Prisoner-correction chips can't be removed without special equipment; the others can be slipped in or out like a regular chip. But you might not want to take it out! The chip produces constant emotion patterns that many people find hard to give up—they know the second the chip comes out, they return to normal thought chaos. Removing a chip requires a Cool/Will roll vs. +15 difficulty. If you fail, you fight having the chip removed by anybody. Each time you fail, you can try again in five minutes, but the next test is against +5 more each time you fail (maximum difficulty +30). If you spend over 48 hours under the influence of a Behavior Chip, you're mentally addicted. Once the chip is removed, the person has to roll under his/her Cool each hour to avoid fits of depression, shaking, and anxiety, overlaid by a compulsion to acquire the chip again.
- Behavior Chips are legal, but using them on someone against their will is not. In addition, the person for whom the chip is made (they are, after all, individualized) signs a waiver when the chip is made. This waiver exempts the chip-producer from any legal obligations arising from use of the chip.
- The stronger Behavior Chips that lock the subject into specific actions for specific stimuli cost 2,000eb, and are illegal for use by anyone except correctional and mental health institutions. (Sure. We all know that corporations would never do something illegal and use these. Right.)
- N: ArmorWeave is an addition to SkinWeave and Muscle/Bone Lace. It is a subcutaneous endoskeletal "carapace" woven into the subject's skin layers, linking the floating ribs with the pelvis and allowing cybernetically-strengthened people to use their full lifting power without breaking their backs! It adds +1 to BOD, increases the subjects SkinWeave armor factor to SP 18 and permanently subtracts 1 from REF and MA. The subject must already have SkinWeave and Muscle/Bone Lace to buy ArmorWeave.
- O: Speed Grafts improve the subject's MA by +2.

EXOTICS

MINOR EXOTIC PACKAGE DEALS

So you don't want to go all the way down the evolutionary scale? Take too much time, too much money, too scary? Well, there's no reason to change yourself too far. Almost any Biotechnica-licensed walk-in clinic can handle a minor exotic change. Here are some of the favorites:

Me-yow! Feeling catty? The KatNip™ package includes pointed ears, whiskers, proper synthskin to mimic fur patterns, cat claws, bio-contacts for that cat-eyed look, and voice-box modifications for those who truly want to yowl! Here, kitty, kitty, kitty...

Game Statistics: Minor Facial Modification (slit-eyes, pointed ears, whiskers, modified hairstyle), Scratchers, Tail, Synthskin. 3,400eb total. Surgeries: 1 Major, 1 Minor, 2 Negligible (2,200eb). HC=4 1/2D6.

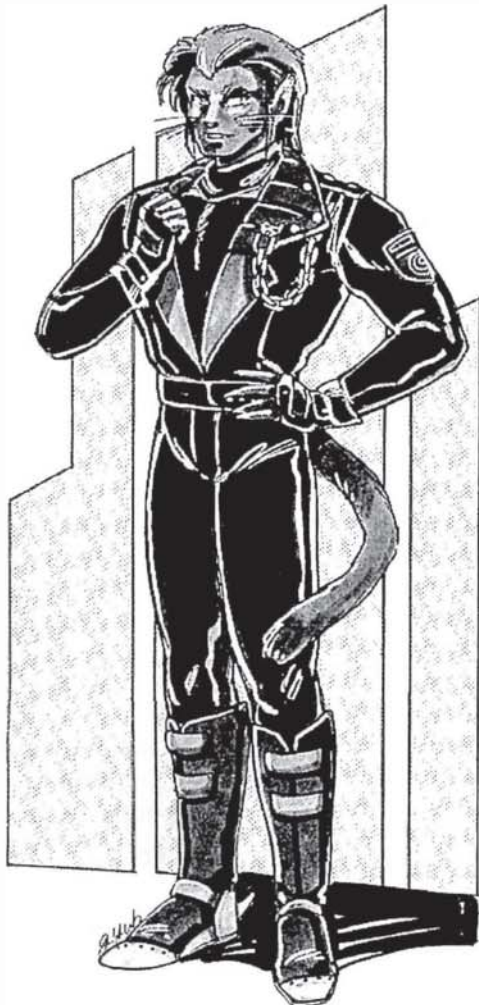

Hickory, dickory, dock: If you just don't like cats, why not be a mouse? An anthropomorphism made popular by a certain unnamed mouse (you know who; our lawyers won't let us say his name), and countless animation and graphic works, the mouse is always popular at parties. For those really interested in deception, psychological studies indicate that people are less threatened by mice than by any other exotic. What better way to conceal your true nature... until they find that you're the mouse that roars! (Other rodent forms— chipmunks, minks and ferrets, rats, etc. are also possible with this package.)

Game Statistics: Minor Facial Modification (ears enlarged, face somewhat pointed, button nose, overlarge eyes), Synthskin. 1,400eb total. Surgeries: 1 Minor, 1 Negligible (700eb). HC=1 1/2D6

EXOTICS



Hiss-s-s-s-s: Mammals not appealing? Are you cold, calculating; reptilian and proud of it? Are you accused of speaking with a forked tongue? Want to be the best french-kisser in your circle? Serpentize yourself. There's nothing so seductive as the original tempter!

Game Statistics: Minor Facial Modification (eyes, removal of outside ears, long tongue, olfactory boost, nose reduced to slits), Natural Fangs, Synthskin. 2,000eb total. Surgeries: 1 Minor, 3 Negligible (1,100eb) HC=4D6

Fantasy Packages: No, not that kind of fantasy! If you're looking into exotics, you're beyond that anyway. This is "classic" fantasy, as made famous by obscure 60's writers, and the time-honored art of role-playing games that now forms the basis for braindance and netgames. Be someone who walked out of a novel, or even the Elfines™ series!

Do the Bunny Hop! Be your own good luck charm! And what could be a better lover than a bunny? (Everyone knows about rabbits', uh, activities.) And girls, remember, men world-wide have been conditioned for over half a century to regard the "bunny" as the epitome of feminine sexuality. Okay, so they won't think you're likely to win any Nobel prizes, but you'll be popular!

Game Statistics: Minor Facial Surgery (bunny ears, optional button nose and whiskers; some like buck teeth). Bunny Tail (not nearly as traumatic a process as the listed tail; Minor surgery, HC=2 points, costs 250eb) 1,250eb total. Surgeries: 2 Minor (500eb). HC=1D6.

Elf: Minor Facial Modification (pointed ears, up-turned eyebrows, thin face). 1,000eb total. 1 Minor Surgery (500eb). HC=1/2D6. Popular options include enhanced cyberears.

Dwarf or Halfling: Minor Facial Modification (broader features), Frame Alteration (shorter, stockier). MA is -2 because of shorter legs. 9,000eb total. Surgeries: 1 Critical, 1 Minor (3,000eb). HC=2 1/2D6. Popular options include grafted muscle or bone and muscle lace. Skinweave is also popular.

EXOTICS



Ork/Goblin: Major Facial Modification (broad features, squint eyes, big nose), Natural Fangs, Frame Alteration (wider, longer arms), Synthiskin (green, brown, black, etc.). 10,900eb. Surgeries: 1 Critical, 1 Minor, 2 Negligible (3,400eb). HC=6D6. Popular options include red shift-tacts or enhanced cybereyes, grafted muscle, scratchers, dermal armor and skinweave.

Troll/Ogre: Minor Facial Modification, Natural Fangs, Frame Alteration (taller), grafted muscle, muscle and bone lace. 12,000eb total. Surgeries: 1 Critical, 1 Major, 1 Minor, 2 Negligible (4,900eb). HC=7D6.

Fishman: Gills, Synthiskin, Webbing (minor alterations to hands and feet; equivalent to Minor Facial Modifications), Custom Contacts (to keep water out of the eyes and facilitate easier vision along the blue-green spectrum). 2,000eb total. Surgeries: 1 Major, 1 Minor, 2 Negligible (2,400eb). HC=4 1/2D6.

GRAFTABLES

They are available for that discerning patron who doesn't want the whole look, but just parts of it! This is a very popular line for many people who calculate their appearance to startle, to amaze, to intrigue. The sample given here is the package adopted by Zark Nartanq, the famous dirty-combat star of the *Urban Nightmare* vids.

Game Statistics: Natural Fangs, Wolverers, Combat Tail with stinger, SkinWeave, Bone & Muscle Lace, ArmorWeave, Speed Grafts. 12,350eb total. Surgeries: 2 Major, 1 Minor, 4 Negligible (4,300eb). HC=12 1/2d6+1.

MAJOR EXOTIC PACKAGES

THE BEAR NECESSITIES

The bear can be an effective form. It shares the dual advantages of being cuddly and *big*. (Even in this age of high-tech toys and games, the old teddy bear is a comforting constant.) Perfect for that easy-going personality; but when you need to get tough, people listen!

Game Statistics: Major Facial Modification, Muzzle (short), Natural Fangs, Retractable Claws, Fur Skinchange, Frame Alteration (taller, bigger), Grafted Muscle. 24,500eb total. Surgeries: 1 Critical, 1 Major, 3 Minor, 2 Negligible (5,900eb). HC=13d6.



THE SUPERMAN

Some people like to think of themselves as evolution in action, preferring to step up the evolutionary chain instead of down. Thanks to gene-splicing nanotech, cloning, chemical enhancement and bionics, you can be an Übermensch, the future of humanity!

Game Statistics: Grafted Muscle and/or Bone/ Muscle Lace, Speed Grafts, Neural Processor, Kerenzikov Boost +2, Pain Editor, Biomonitor, Skin-Weave, Lifesaver weave, Toxin Binders, Nanosurgeons, Pacesetter 2000 Heart, Rebreather Lungs, NanoOptical rebuild (see Cyberware section, pg. 8). 19,735eb total. Surgeries: 1 Critical, 3 Major, 1 Minor, 8 Negligible (8,900eb). HC=1 3D6.



HOLD THAT TIGER!

For the truly feline, nothing less than the BigKatt™ package will do. After *this* transformation, you can stalk with the tigers, run with the lions, chase with the cheetahs, or prowl with the pumas! Exotic, erotic, seductive, mysterious—become the newest predator in the concrete jungle.

Game Statistics: Major Facial Modification, Muzzle (short), Natural Fangs, Retractable Claws (or Rippers), Tail, Digitigrade Legs, Skinchange (fur). 21,000eb total. Surgeries: 1 Critical, 1 Major, 3 Minor, 1 Negligible (5,700eb). HC=1 9D6. Popular options include enhanced cybereyes, enhanced cyberears, grafted muscles, boosted reflexes.

EXOTICS

BUG OUT!

Why not take a step sideways on the evolutionary scale? For those who are looking for a rare and truly exotic look, take a lesson from some of the most satisfied lifeforms on the planet—the insects! We can make you look like something that crawled out of Franz Kafka's imagination, or a creation from another planet, or just a bit "buggy." For the closet aliens among us.

Slightly Buggy: This creates a bug-headed human. Major Facial Modification (bug-eyes, plating the face with bony chitin, adding antennae, etc.), slightly scaly Synthiskin, Custom Cybereyes. 3,400eb total. Surgeries: 1 Major, 1 Minor, 1 Negligible (2,200eb). HC=6d6.

Bughouse: Major Facial Modification (as above), Mandibles, Frame Alteration (to change the body shape, hands and feet), Custom Cybereyes, Exoskeleton, Scratchers. 35,500eb total. Surgeries: 2 Critical, 2 Major, 1 Minor, 1 Negligible (8,700eb). HC: 15d6. Extremely

popular options include enhanced vision in the cybereyes, boosted reflexes, enhanced olfactory sense and cyberears. Some "Bughouse" patients even have Cybersnakes (or worse) installed in oversized head housings.

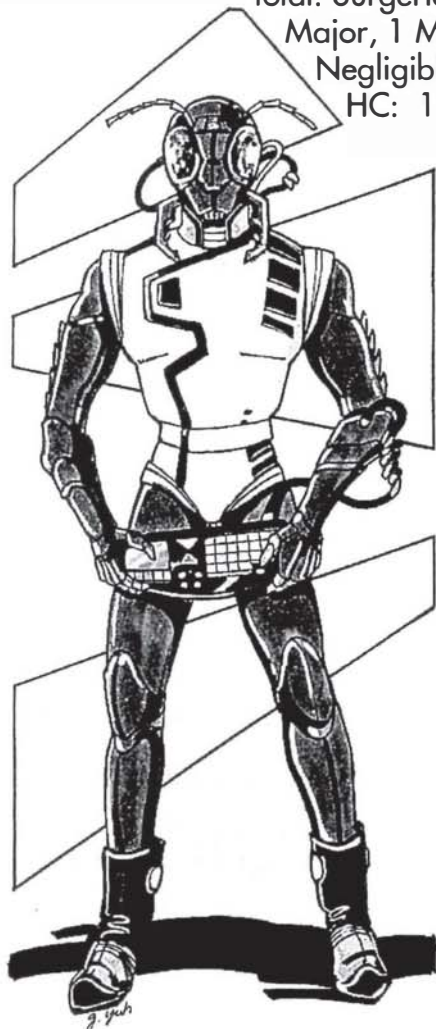

AQUAFORMS

Almost seventy percent of the Earth's surface is covered by water. And almost all of Earth's population is ill-equipped to deal with it. Break out of the evolutionary track, return to our watery origins, and merge with the liquid of life once again. **Note:** custom designed gills for exotics have two times the duration of standard cybergills.

Merman: The classic aquaform. Not too useful out of the water, but while you're in the water, you're in your element.

Game Statistics: Gills, Skinchange, double Frame Alteration (rebuilding the legs into a "fish-tail"), Custom Contacts (for underwater vision), Sonar. 18,900eb total. Surgeries: 2 Critical, 1 Major, 1 Minor, 2 Negligible (12,900eb). HC=10 1/2D6.

Sharkman: Popular with lawyers, this resembles nothing so much as a two-legged shark. It's also a functioning aquaform, with full underwater capability; useful as well as being decorative (and intimidating).

Game Statistics: Gills, Sonar, Skinchange, Skinweave, Muzzle (long), Natural Fangs, Major Facial/Frame Modification (includes dorsal fin and webbed hands/feet as well as shaping face into shark's). 17,700eb total. Surgeries: 2 Major, 2 Minor, 3 Negligible (4,600eb). HC=12D6.



EXOTICS

THE FAITHFUL DOG

Man's best friend has touched the hearts of mankind for untold centuries. The cat walks by herself, but the dog has long been heralded for his steadfastness, his empathy, his friendliness. Maybe you want to cash in on this marvelous reputation (and the emotional content attached to it), or maybe you just really like dogs.

But remember, there's a darker side to the canine story. The Big Bad Wolf has long been a bogeyman; the fox and the coyote are classic tricksters, and there are few animals with a worse reputation than the pit-bull, the Tasmanian Devil of the canine world. Who says being a dog means you're harmless, happy-go-lucky and always faithful? Whether you want to be your own best friend or the fox in the henhouse, the LupaForm™ package is for you!

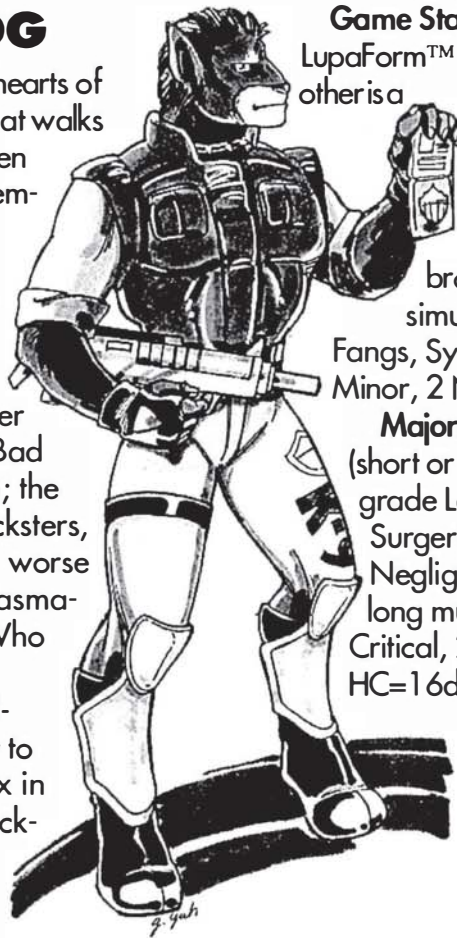

Game Statistics: There are two versions of the LupaForm™ package. One is relatively minor, the other is a full-form modification. The package elements can be mixed and matched to order.

Minor: Minor Facial Modification (pointed ears, dog-nose, big brown eyes; pugs and bull-dogs can be simulated with this procedure), Natural Fangs, Synthskin. 1,900eb total. Surgeries: 1 Minor, 2 Negligible (900eb). HC=3 1/2D6.

Major: Major Facial Modification, Muzzle (short or long), Natural Fangs, Tail, Digitigrade Legs, Fur Skinchange. 20,000eb total. Surgeries: 1 Critical, 1 Major, 2 Minor, 2 Negligible (5,400eb). HC=15D6. (With long muzzle, 21,000eb total., Surgeries: 1 Critical, 2 Major, 1 Minor, 2 Negligible., HC=16d6.)

Popular Options: Enhanced cyberears, enhanced olfactories, grafted muscle (for the bull-dog bullies and big muscle dogs.)

HERE THERE BE DRAGONS

Voted the most intimidating exotic form on public display, the Dragon-Man is perfect for those wanting to deliver a message on sight. An armored colossus, nothing stands in the way of a Dragon-Man. So you can't spit fire. Big deal. Who needs fire when you have an H&K MP in your fist? This form means that you likely won't need to use it!

Tempted, but afraid to scare off the girls? Don't worry! Independent research has found that Dragon-Men rate on a sexuality scale alongside and sometimes even higher than the felines! There's something about an inhuman tower of strength and teeth that sends a guilty thrill deep into the human psyche. After all, everyone loves dinosaurs!

The Thunder Lizards walk the Earth again. Join their ranks as the *Humanisaurus Rex!*

Game Statistics: Major Facial Modification, Muzzle (short), Natural Fangs, Tail, Scale Skinchange. 16,000eb total. Surgeries: 1 Major, 2 Minor, 2 Negligible (2,900eb). HC=9d6. Popular options include heavy scales, natural claws (or retractables), combat tail, enhanced olfactory sense, thermograph eyes, and grafted muscles. Some like digitigrade legs for the dinosaurian look.



EXOTICS

PLAYBEING

They are the true life of any party. The "erotic exotic" is always a welcome and popular guest. And what makes a playbeing different from a normal exotic? Those "special extras under the hood," so to speak. Lose your inhibitions. Become a master (or mistress) of the arts of physical pleasure. Who needs drugs or pleasure-center wireheading? Please yourself and others at the same time, with just a few "enhancements."

Disclaimer: *The rumors of persons being converted to exotic playbeings against their will by Biotechnica are false; as can easily be seen below, Biotechnica requires a legal waiver indicating intent and protecting against unfounded legal action before allowing any person to purchase a playbeing accessory package for installation. Any proven incidents of playbeing "manufacture" are due to unscrupulous agencies not related to Biotechnica.*

Warning: *Biotechnica refuses to install the playbeing package in any person without a signed waiver indicating that the applicant wishes to become a playbeing and absolves Biotechnica of all legal responsibility for any psychological aberrations or problems arising from the playbeing package.*

Game Statistics: The playbeing package is usually added to an existing exotic conversion, but can be purchased without exotic conversions. Playbeings usually have their ATT scores raised to a minimum of 10, up to a maximum of 12. The package includes a "Mr. Studd/Midnight Lady™" implant, Tactile Boost (hardwired into the sexual implant), Chipware socket with the Maximum Lover chip and a Behavior chip—specific behavioral slant is chosen by the user to correspond to his/her emotional patterns and wishes, in any case the chip stimulates the libido; plus a Contraceptive Implant. 3,000eb total. Surgeries: 1 Major, 4 Negligible (2,300eb). HC=3 1/2d6. Optionally, the pleasure impulses from sexual activity can be tied into the Tactile Boost for an additional 150eb. This can lead to addiction to such activity, as well as nervous or physical overload.



INDEX

CYBERWARE 3

Anchoring Cyberfeet	5
Color Gland Control	6
Cytech Custom Cyberhands	5
Dynalar Cyberfingers	4
Gradiated Subdermal Armor (torso)	7
Kill Display	6
Kiroshi OptiShield	5
NanoOptical upgrade	8
QuickDraw Armholster	6
Remote Eye	9
Retractable Vampires	9
Subdermal Armor (skull)	7
Subdermal Viewscreen	8
Total Body Plating	9
Tri-dart Launcher	6
Upgraded Skinweave	9
Wetdrive Access Link	6
Winch	5
Zetatech BodyComp	8

EQUIPMENT 10

Arasaka "Komaku" Laser Mikes	20
Arasaka "Scanway" Scanner Gates	23
Arasaka ECM Comm-Scrambler	22
Arasaka JetSetter Executive Briefcase	21
Arasaka OmniTec Radar Detector	21
Arasaka RDAK Spy & Assassin Remote	32
Armored Stockings	28
Autotanner™	33
Bell "Bumblebee" Remote Rotocraft	31
Bug Detector	20
Bug Jammer	20
CCI BRI-3014 Window Trembler	20
DataTel 2350AVidphone	12
DataTel Holotanks	29
Datatel "Treasurer" Datawatch	16
Datatel Modem Units	17
DDI PrayerWare	13
DeckMate	24
Direct Dataware EXPERT Series Programs	16
DPI "Black Box" Backup Synthamp	25
DPI Body Rhythm™ Dance Bracelets	26
Eastman Arts Mindscape®	
Cyberholo Art Imager	30
Eastman KodaGraphix	
Holographic Cameras	30
EBM "PCX" Minicomputer	14
Frostech Portable Cryogenic Case	13

Geotech EnviroScanner	11
Gibson Battlegear "Sneak Suit"	28
Holoscreen holographic viewers	29
Hybrid™ Wearable Computer	19
Kiroshi Optics Heads-Up Display	17
Kiroshi Optics Remote CyberCam 20	13
Language Processor	15
Mead Electronic Notebook	12
MedicGear Combat Medical Armor	19
Microtech IIKL-4 WorkStation	15
Microtech Virtual Reality BBS	12
Militech M73 "Mirage Gear"	
Environmental Assimilation System	28
Militech M96 "Ghostsuit"	27
Millitech RPV-400 Light	
Combat Tiltrotor Remote	31
Mitsubishi "Rover" Wheeled Remote	31
Multi-Player Adaptor	34
Nikkon America Campod	11
Nutrisupplement	11
Nymph Perfume	11
OMEGA™ phone tap by Trittech	21
Portable Electropack	13
Raven Microcyb Net-Vision™	
IG-Algorithm Glasses	24
Remote Control Systems	30
Scholar™ Home Learning System	34
SecSystems Detention Collar	13
SecSystems Maglock	13
SecSystems Protection Field	12
SegAtari Virtual Villains	34
Soundmachine Guitar	26
Teletronics "Black Book" Microcomp	15
Teletronics "Scout" Signal Tracker	21
Teletronics ScanMan™	
Full Identity Scanner	22
Teletronics TattleTale®	
Voice Stress Analyzer	20
Total Environment™	34
Trittech "Mumbler" White Noise Generator	22
Trittech Datashielding	17
Video Wall™	34
Virtual Reality Entertainment System	34
VR Unit Upgrades	34
WorldSat Communications Flopscreen™	16
WorldSat Communications	
Linear Beam Commlink	22
Zetatech "E-Book" Microcomp	14
Zetatech CompuMods™	18

INDEX

Zetatech D2-3000 Armdeck 25

WEAPONS 35

API - Armor-Piercing Incendiary	46
Arasaka "Nauseator" Riot Control Device™	43
Colt-Mauser M2x Cannon	40
Drug-a-Thug™	45
Dual-Purpose rounds	46
ElectroThermal Ammo Enhancement	50
Flare Shotgun Shells	47
Flash Shotgun Shells	47
Flashbang Grenade	49
Gas Shotgun Shells	47
Gun-Cam	50
IMI "ChainKnife"	44
Kendachi Fragmentation Flechettes	46
Kendachi Monowhip	44
Kendachi Monowire	44
Luigi Franchi "King Buck" Multi-Magnum	38
Micromissiles	49
Militech 25mm Pistol-Grenades	48
Militech AM-3 "Anti-Matter Rifle"	41
Militech Cyborg Rifle	36
Militech PDU-3 Multi-Purpose	
Perimeter Defense Unit	42
Militech Urban Missile Launcher	41
Mystic Technologies Spring Knife	45
Nine-Eleven Chip	50
Nova 338 Citygun	40
Polymer One-Shot Cannon	36
Pursuit Security Incorporated Webgun	37
Rhinemetall EMG-85 Kinetic Energy Railgun	38
Rubber Bullets	47
Scatter Grenade	49
Security Chipping	50
Skunker™	45
SlamDance Inc. Spawnblade	44
Smoke Shotgun Shells	47
SplatShell	47
Spraypaint Grenade	49
Stein & Wasserman "Tri-Star" Revolver	37
Stench Bomb	49
Stinger Shotgun Shells, 10 Gauge	47
Stinger Shotgun Shells, 12 Gauge	47
Taser II™	45
Taser Wallet	45
Techtronica M40 "Pulse Rifle"	39
Techtronica Model 009 Volt Pistol	43
Tsunami Arms	
"AirHammer" 5.3 mm Air pistol	42
Tsunami Arms Ramjet Rifle	36
UnderBarrel Capacitor	
Lasers/Microwavers	39
Urban Technologies Slasher	47

TEAMS 51

Autojok	61
C-Team	54

Cybernetic Intervention Services	57
Lifetime Escort Services	53
Orion	58
Sphere	52

FULL BODY REPLACEMENT 63

Alpha Class	66
Aquarius	67
Brimstone	74
Copernicus	69
Dragoon	80
Eclipse	71
Enforcer	73
Gemini	76
Options for Full Body Conversions	84
Samson	79
Wingman	77

VEHICLES 86

AV-3 "Aerocop"	87
Ashigaru	93
Bermuda	94
GD F-36 Comet	95
Crowder	91
Darkwing	94
Family Flier	88
Fed-Boeing Falcon	96
GD Hummingbird	97
India Sky-Barge	99
Lockheed-Cessna Pinto	98
MDD F-33 Wasp	96
Mach	89
"Madison Avenue" Advertblimp	100
Max Interceptor	92
Nissan Ford FanMaster	89
Sky Queen Cruise-Liner	100
Swan	90
Toyo-Chevrolet '17 Chevy	92

EXOTICS 101

Aquaforms	108
Bear Necessities	106
Bug Out!	108
Bunny	105
Dwarf/Halfling	105
Elf	105
Faithful Dog	109
Fishman	106
Graftables	106
Hold That Tiger!	107
Katnip™	104
Ork/Goblin	106
Playbeings	110
Rodent	104
Snake	105
Superman	107
Therapy Costs and Effects	102
Troll/Ogre	106

CHROME #1 1/2 #2

cyberpunk style guides 1 & 2

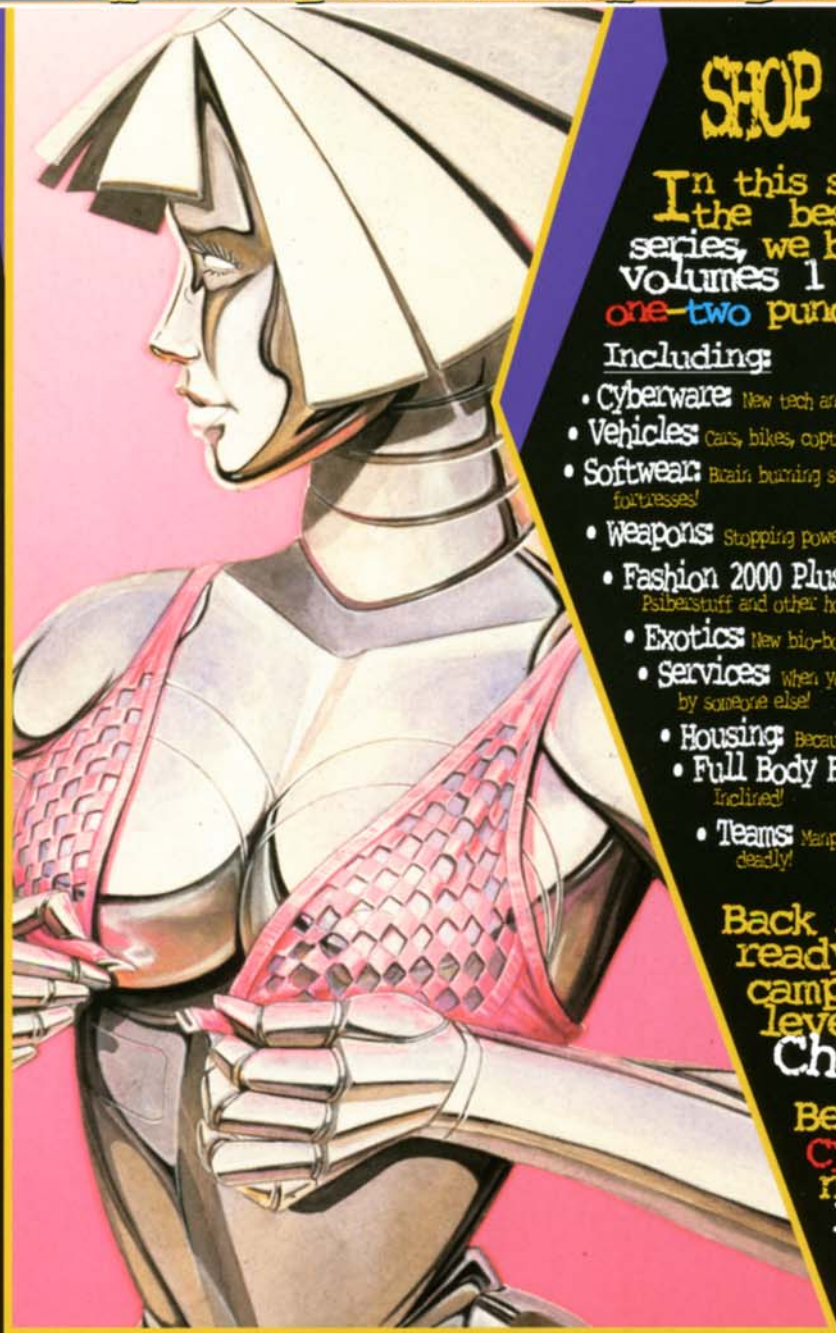

SHOP 'TIL THEY DROP!

In this second compilation of the bestselling Chromebook series, we bring together our hit volumes 1 and 2 for a serious one-two punch!

Including:

- **Cyberware** New tech and new metal to maximize your character!
- **Vehicles** Cars, bikes, copters, AVs and—Dragons?
- **Software** Brain burning superware for cracking the toughest Data fortresses!
- **Weapons** Stopping power and style in dozens of potent packages!
- **Fashion 2000 Plus** seductive styles and Lethal Looks from Eji, Psiberstuff and other hot designers!
- **Exotics** New bio-bodyware to uncage the animal in you!
- **Services** When you absolutely, positively have to get it done—by someone else!
- **Housing** Because there's more to life than a Rent-a-cube!
- **Full Body Borge** New Body Replacements for the Metal-Inclined!
- **Teams** Manpower for hire! No job too big! No contract too deadly!

Back in print and ready to boost your campaign to the next level; it's Chromebook 1/2.

Because in Cyberpunk, you can never be too rich—
or too far out on the Edge!



Copyright 2000 R. Talsorian Games All Rights Reserved. Cyberpunk® is R. Talsorian's trademarked name for its game of the dark future. Chromebook 4 is a trademark of R. Talsorian Games Inc. All Rights Reserved. All incidents, situations, and persons portrayed within are fictional and any similarity, without satiric intent, to characters living or dead is strictly coincidental.

RT3521 • ISBN# 1-891933-02-7

Visit us at www.talsorian.com

R. TALSORIAN
GAMES, INC.



A CYBERPUNK®
SOURCEBOOK