

# PROTECT & SERVE



THE LAW ENFORCEMENT  
SOURCEBOOK FOR

*CYBERPUNK*

R. TALSORIAN  
GAMES, INC.



# PROTECT & SERVE

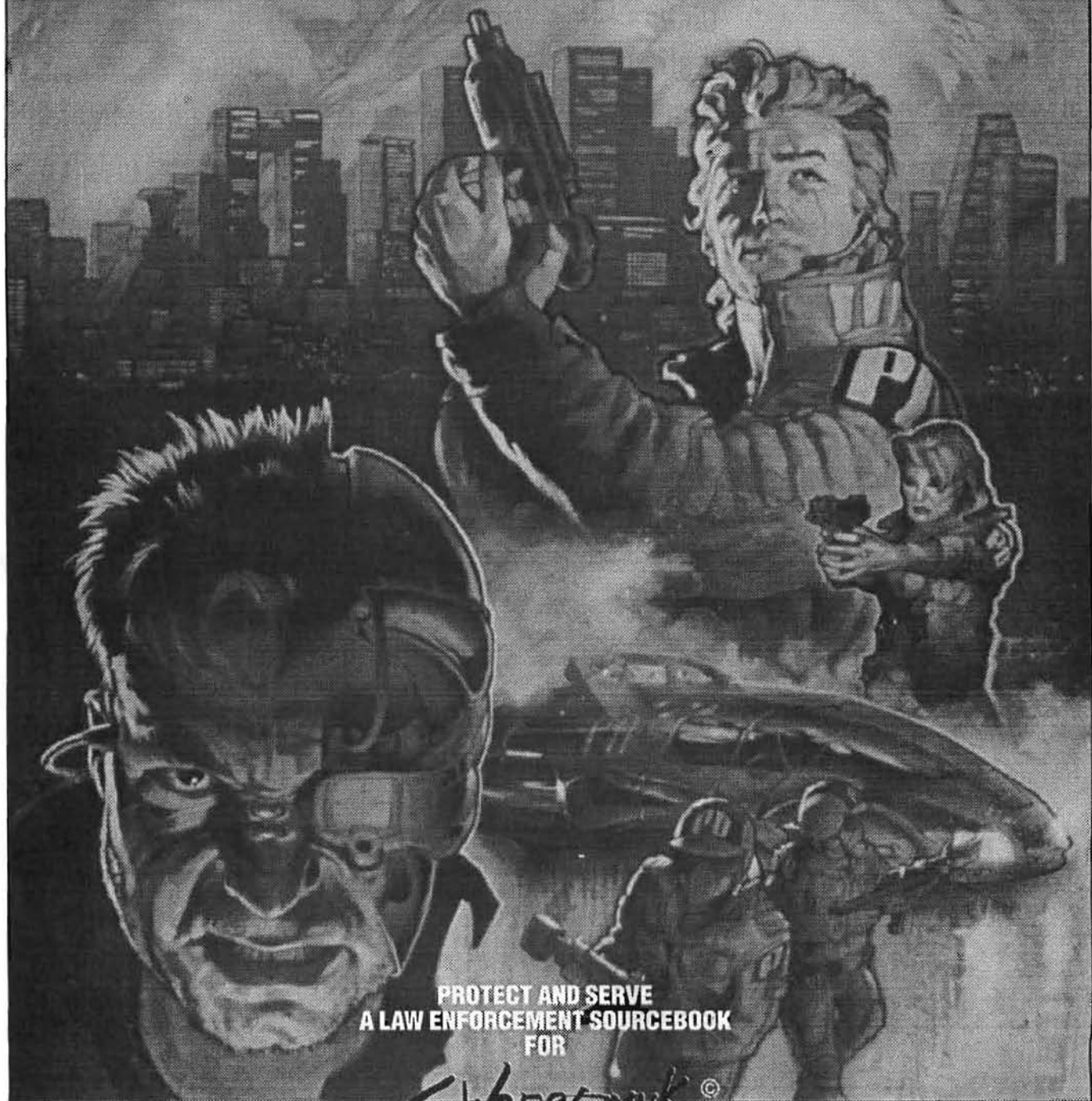

PROTECT AND SERVE  
A LAW ENFORCEMENT SOURCEBOOK  
FOR

CYBERPUNK®

# FORWARD

7 ft.

6 ft.

5 ft.

4 ft.

3 ft.

2 ft.

1 ft.

**B**efore you start accessing this book, let me tell you something about it. *To Protect and Serve* is a Law Enforcement Sourcebook for CYBERPUNK 2020, allowing you to run and play Cyberpunk games in the cop environment. A police-based game is probably a little different than any other game of CYBERPUNK you've played, but it offers a fantastic opportunity for roleplay and campaigning. If you don't plan on running this type of game, this book will still open your eyes to the worlds of crime and enforcement within the CYBERPUNK world.

When dealing with law enforcement, there is a great temptation to follow the rules to the letter. Referees reading this book should remember one important thing: Nothing is carved in stone! If you don't like, or agree, with something in here, change it! That's what you're there for.

I have to admit that I had a great time writing this project, from researching all the data to putting everything together. I've run a cop campaign in CYBERPUNK for some time and loved it; so did my players. If I can pass on a fraction of that fun to you, then it's all been worth the long nights, coffee and cigarettes.

And remember! Let's be careful out there...

Geoff Pass  
England.

#### AUTHOR'S ACKNOWLEDGEMENTS

This book is dedicated to Paul Strong, who got me into all this in the first place! Big thank yous must also go to the following:

Alex Bund (I owe you one!)

Heather Pass (Thanks again)

Derek Quintanar (For making it happen and being the best Editor I've worked with!)

Mike LaBossiere (For the Right Stuff)

Mark Galeotti (For advice and kind words)

Brian Perkins (For patience and help)

Alison Bentley Chief Superintendent Michael James

Jackie Christie

Derek Crossland (For saving the day!!!)

The Original Cops:

Alex Bund, Gerard Sydenham, Phil Sutton

And to the following Institutions and Organizations:

R. Talsorian Games

The New York Police Department

The British Library

Interpol

The National Institute of Justice

Bramshill Police College

The Police Research Foundation

The United States Embassy, London

New Scotland Yard and dozens of authors whose books were so helpful, but most of all: To every cop who has ever lived, and died, in the line of duty.

# CONTENTS

<b>INTRODUCTION</b> .....	<b>4</b>
<b>THE COP'S OATH</b> .....	<b>4</b>
<b>HITTING THE STREETS</b> .....	<b>7</b>
<b>GETTING THE BADGE</b> .....	<b>9</b>
<b>CASH, BOOSTS AND PROMOTION</b> .....	<b>14</b>
<b>COP HANDY TIPS</b> .....	<b>16</b>
<b>COP TERMINOLOGY</b> .....	<b>17</b>
<b>BY THE BOOK</b> .....	<b>18</b>
<b>OPERATIONAL PROCEDURES</b> .....	<b>18</b>
<b>DEPARTMENTAL STRUCTURE</b> .....	<b>21</b>
<b>DEPARTMENTAL SECTIONS</b> .....	<b>22</b>
<b>BACK UP</b> .....	<b>27</b>
<b>EQUIPMENT AND HARDWARE</b> .....	<b>32</b>
<b>GOOD GUYS &amp; BAD GUYS</b> .....	<b>42</b>
<b>NATIONAL RESOURCES</b> .....	<b>42</b>
<b>ORGANIZED CRIME</b> .....	<b>49</b>
<b>CORPORATIONS</b> .....	<b>54</b>
<b>GANGS</b> .....	<b>58</b>
<b>YOU'RE BUSTED</b> .....	<b>62</b>
<b>CRIME STATISTICS</b> .....	<b>62</b>
<b>CRIMES AND SENTENCING</b> .....	<b>62</b>
<b>IN THE MACHINE: THE LEGAL SYSTEM</b> .....	<b>67</b>
<b>GOING DOWN: PUNISHMENT IN 2020</b> .....	<b>70</b>
<b>JUST THE FACTS</b> .....	<b>73</b>
<b>RUNNING A LAW ENFORCEMENT CAMPAIGN</b> .....	<b>73</b>
<b>PERSONNEL FILES</b> .....	<b>74</b>
<b>SAMPLE PRECINCT</b> .....	<b>75</b>
<b>SCENARIO IDEAS</b> .....	<b>80</b>

# STAFF

Editors Derek Quintanar  
Janice Sellers

Written By Geoff Pass  
Mike LaBossiere

Art Director Matthew Anacleto

Layout Matthew Anacleto

Cover Bill Akin

Illustrations Karl Martin  
John Hurst  
James Balkovic  
Darrell Midgette  
Bob Giadrosich

Copyright© 1992 R. Talsorian Games  
All Rights Reserved. Cyberpunk® is R.  
Talsorian's trademark name for its  
adventure game of the dark future.  
*Protect & Serve* is a trademark of R.  
Talsorian Games Inc. All Rights  
Reserved. All incidents, situations, and  
persons portrayed within are fictional,  
and any similarity, *without satiric*  
intent, of characters living or dead is  
strictly coincidental.



# INTRODUCTION

7 ft.

6 ft.

5 ft.

4 ft.

3 ft.

2 ft.

1 ft.



## THE COP'S OATH

**As** a Law Enforcement Officer, my fundamental duty is to serve mankind; to safeguard lives and property; to protect the innocent against deception. I further swear to protect the weak against oppression or intimidation, the peaceful against violence and disorder; and to respect the Constitutional rights of all men to liberty, equality and justice.

I will keep my private life unsullied as an example to all; maintain courageous calm in the face of danger, scorn, or ridicule; develop self-restraint; and be constantly mindful of the welfare of others. Honest in thought and deed in both my personal and official life, I will be exemplary in obeying the laws of the land and regulations of my department. Whatever I see or hear of a confidential nature or that is confided to me in my official capacity will be kept ever secret unless revelation is necessary in the performance of my duty.

I will never act officiously or permit personal feelings, prejudices, animosities or friendships to influence my decisions. With no compromise for crime and with relentless prosecution of criminals, I will enforce the law courteously, without fear or favor, malice or ill will, never employing unnecessary force or violence and never accepting gratuities.

I recognize the badge of my office as a symbol of public faith, and I accept it as a public trust to be held so long as I am true to the ethics of the police service. I will constantly strive to achieve these objectives and ideals, dedicating myself before God to my chosen profession...law enforcement.

## KEEPING YOUR HEAD TOGETHER

The scene looked bad as the black Omega cruiser pulled in behind one of the six Trauma Team paramedic vans. The screaming siren died; the swirling lights died as well.

DeVris sat back in the sim-leather roll seat, narrowing his eyes as he drew deeply on a Russian Krilova. He let the smoke trickle through his nose, stubbing the cigarette out as he opened the door and stepped into chaos.

It was definitely bad.

Clear of the deceptive silence of the Omega's interior, DeVris could now hear the crackle of automatic weapons over garbled screams of "Ceasefire!" Unhooking the strap of his shoulder holster, he strode through the fray of police vehicles, paramedics and concerned citizens.

He knew it was big time when he caught the harsh glare of six floodlights focussed on a single apartment building. Backed away but covering the battle zone were at least twenty cops, most staying low as streams of lead spat out the windows of the top floor. Most of the police vehicles were pockmarked with bullet holes. Approaching the police line, he fought his way past the medias; all out for the story, they were playing wolf pack tactics in a feeble attempt to slip past the cops.

A hulking sergeant stood aside as DeVris approached, sparing a bemused look at his unexpectedly formal attire. Once inside the perimeter, he headed straight for the large rig with "NCPD Mobile Command 14" stencilled in white down the side, ducking as a stream of bullets swept the stationary vehicles. Some of the cops started shooting back. Two of the floods went out. Two more flickered on.

Dr. Crowley was crouched around the back of the mobile rig, coffee in one hand and loud-hailer in the other. He smiled at DeVris' approach. "How was the opera?"

DeVris lit another Krilova. Clouds of blue smoke billowed around him. "Bomb scare," he said shortly. "They had to close it down for two hours while disposal boys checked it out." DeVris did not sound happy. "Where's Sanchez?"

The police psychologist took another swig of coffee and shook his head. "No idea. He took off with some sticks to check out the rear of the building. That was about ten minutes ago."

"I guess I'll just hang around here then. Who's inside the can?" DeVris jerked his head towards the mobile HQ. "No one right now," the psychologist replied absently as he peered around the side of the rig at the now quiet apartment building. He turned back and popped the door to the

HQ. As the reinforced titanium doors slid open, a shadow of red light fell across him. "Wanna come in?" he said, big grin plastered over his face.

The interior of the mobile HQ vehicle was one large control center, packed with monitors, TV cams, external cameras, weapon systems, PA, vidcomm and communicators back to NCPD Central. DeVris followed Crowley in. "Who's holed up inside?" The psychologist picked up a phone set and began punching numbers on the keypad. "Ching and his boys," he replied. "They've declared war on their own Triad chief. They've got about fourteen hostages in there with them. We started with twenty-two."

DeVris picked up a bundle of computer printouts and cast an eye over them. "This the assimilation?" The psychologist nodded quickly, then spoke into the phone. "Is that Ching?...Well, get Ching on the line, dammit! This is Dr. Crowley...Listen to me, goon, get Ching on the horn now or I'll send in the National Guard!"

Glancing at a monitor, DeVris saw that the shooting had started up again. It seemed Ching had dumped the body of a hostage out of a top floor window. She fell screaming to the ground sixty feet below. DeVris shook his head. *Where the hell was Sanchez?*

"Where the frack am I going to get a freight jet at this time of night, Ching? Goddammit, I'm doing my best but you're gonna have to stop playing bouncy with the hostages." DeVris could see Crowley was losing it. He was about to make a suggestion when the door slid open and

a young Special Weapons trooper staggered in. He was soaked with blood; his AllStop Kevlar suit had about four holes punched in it, and he was making a mess of the white floor panels.

Another, less-trashed trooper followed the first one in. DeVris pulled his badge from his pocket and presented it to him. "Lieutenant DeVris, Tactical. Where's Captain Sanchez?"

The trooper looked dazed, as if he was having trouble comprehending what DeVris had just said. Then, in one sentence, he blurted it all out: "They've got heavy hardware man the Captain got his head blown off and before we could bug out the rest of us went down it's a real mess back there sir Charlie here took four from a support weapon or something Oh God I think I'm gonna puke..." With that, the trooper dropped to his knees and retched. DeVris stamped out his cigarette. Shaking his head, he grated, "So who the hell's in charge here?" "It looks like you are," Crowley answered as he hung up the phone.

"I knew this was gonna be bad," DeVris muttered. He turned back to Crowley "So what's your psychological evaluation?" The psychologist pondered for a moment, his brow furrowing. He shrugged. "These guys are far gone and blitzing all the way. If you don't take them down it's going to be Triad happy hour out there. They're nuts." DeVris paused for a moment before replying. "Okay, let's do it."

Five minutes later, Mobile HQ 14 was filled with cops. DeVris stood in the center, finishing his briefing. "...and I want all our wounded, and the

**"Where am I going to get a freight jet at this time of night, Ching? ...dammit, I'm doing my best, but you're gonna have to stop bouncing the hostages."**





wounded civilians, evac'd to hospital as fast as possible. We've only got eighteen men total until MaxTac or some form of backup arrives, so no heroics. Taylor, get your boys on covering fire—if they start shooting, shoot back at them. Reece, get your team geared up; you'll be going in when I give the word. Crowley, keep that communication line open—buy us some time. Ching must only have about ten hostages left; the next time he bounces someone off the sidewalk I want maximum firepower on that window! Shoot to kill."

The cops flooded out of the command rig. DeVris was left alone with Crowley and a cop who was manning the phones. He took two long swigs from a cold cup of coffee before he realized he'd dropped his cigarette butt in it five minutes earlier.

"Sir, it's the Chief!" the cop at the phones spoke nervously, handing a headset over to DeVris. "That's all I need," DeVries said, reaching for the mike. He keyed it, "DeVris. Tactical...Yes...No, I'm afraid Sanchez took a hit...No sir...That's right...I need backup here, sir...MaxTac for starters...Is that a good idea, sir?...Will do." DeVris passed the headset back to the cop and sighed.

Crowley pulled back the earpiece of his headset, "What's up?" DeVris shrugged. "Oh, nothing much. Garrison of MaxTac has signed himself out of NC General to hook up to Muther-1. He's our back up."

Crowley looked confused. "But he almost got iced at that riot on 28th St. a few hours ago! Took some real damage, they said." There was awe in his voice. DeVris nodded and lit another cigarette "Right. Lost three fingers and most of his left cheek in addition to the gunshot wounds. He's signed himself out saying it's only a concussion." He blew out smoke and turned to the cop manning the communications console. "Try and patch us in to Muther-1. I wanna talk to Garrison *before* he screams in."

DeVries turned back to the external monitor. Outside the command rig, Sergeant Reece and his squad of six men had geared up and were awaiting the word. Tension was high. The apartment block was drenched in white light and the shot-up police vehicles were providing cover for Taylor's boys. A pile of bodies had built up on the sidewalk outside the block. All was quiet except for the occasional scream from the top floor. Crowley started to say something; DeVries turned back towards him.

"They're arguing over their stash. It could be a good time..."

DeVris pulled up a headset and yelled into it. "Reece! Go!" Instantly a wall of bullets smashed into the apartment block's top floor, as Taylor and his men opened fire. Reece and his squad charged the doors. In a few moments they were in. Taylor's barrage continued.

DeVris' headset crackled as Reece's voice came through. "Okay, we're in. Proceeding up the stairwell. I don't think there's as many as..." DeVris ripped the headset away from his ears as it emitted a shrill scream of static. The rig shook with an almighty blast from the booby-trapped stairwell. A police vehicle was flipped and another caught fire. Reece's men were gone. The few survivors of Taylor's squad were now being cut to pieces by combined fire from the top floor as Ching's gang opened up.

"DeVris—this is Taylor! Reece has been torched and we're down to three men! We can't get to you without taking holes! Request assistance!" Taylor's voice sounded anxious, but not panicked.

---

**"Yo! What's the  
lowdown?" Garrison grinned,  
showing more teeth through his  
cheek.**

---

"Maintain your position, Taylor; we'll get to you." DeVris dropped the headset on the console and stubbed out his Krilova on the monitor screen in front of him. He turned to Crowley. "Could be a good time, huh?" Crowley shrugged and continued his attempts at picking up the line with Ching.

"Sir, I've got Lieutenant Garrison of MaxTac on hold," the cop at the comm desk said. DeVris pulled back on the headset and punched the green flashing button. A crackling picture appeared. It was Garrison in Muther-1. The flight helmet he wore obscured most of the damage to his cheek, but DeVris could still see teeth through the gaping wound; it was bleeding, too. He could see Garrison had come as soon as he could: He was still wearing his bloodstreaked hospital gown. "You okay, Garrison?" DeVris asked carefully.

"Yo! DeVris! What's the lowdown?" Garrison grinned, showing more of his teeth through his cheek.

"I've got over a dozen men down, including Sanchez. Ching is holed up in an apartment block with a several hostages. We're down to five men, including me. Are you *sure* you're okay?"

Garrison nodded. "Feelin' a bit green, but I'll make it. I'm locked and loaded and on my way in. You think you can hold for about ninety seconds?"

"We'll hold. Burn em' on my mark." DeVris turned to the cop. "Keep this line open." To Crowley, he said, "Tell Ching his transport's coming in now. Roof pick up. Conditional—he leaves the hostages where they are." He lit another cigarette. "Taylor. Go for the building now. Hostage rescue. Get them outta there; you've got just over 70 seconds."

"On our way."

"They're going for it!" Crowley yelled. DeVris turned back to Garrison. "Okay, come in fast and hit them. They'll be on the roof. You won't have time to lock on before they realize, so go to manual."

"They're on the roof. No hostages." Crowley called out. DeVris keyed his mike. "Taylor, what's your sitrep?"

"We're almost there. No resistance yet."

"All right. You've got 50 seconds. Let me know when you're on your way down or you'll be in Ground Zero!" Seconds counted down. DeVris watched his monitors. Garrison hooked up to his weapons links. The Triads on the roof were firing down at the crowd. They were taking hits.

"Okay, we're on our way down. There were only four of them." Taylor reported.

"I'm comin' in! This is going to be a Big Kahoma so keep your people back!" Garrison sounded gleeful.

"We're out!" Taylor reported. *Not bad*, thought DeVries, *only five seconds to spare*. The scream of the AV-9's jets sounded like a thousand banshees as it roared in. Garrison walked fire across the roof with his twin chain guns, while he adjusted for the belly-mounted rapid fire rocket launcher. The first rocket sheared off a corner of the roof. By this time Ching and his boys realized they'd been set up; they were fighting to get back into the building. The first of the multi-salvo of hi-explosive rockets took the roof clean off; the rest worked their way down floor by floor.

Over the comm, DeVris could hear Garrison's yells of "Yeah!" and "Get Some!" as he systematically demolished the entire building. The whole apartment block came down hard in a cloud of dust and fragments, with Muther-1 hovering over the devastated site like an avenging angel.

DeVris dropped back into his chair and tried to relax. The cop at the comm desk spoke up nervously. "Sir, you're wanted down near Med Tech—there's a firefight going on between Trauma Team and REO Meatwagon."

DeVris stubbed another cigarette out on the monitor screen and keyed his mike to Muther-1. "Garrison. Wait up, I'm hitching a ride." ■

**T**his chapter covers the basics of being a cop in 2020. Players who wish to make up cop characters are advised to go over this section carefully; all the information to get a cop character together is here. (You'll need the *Cyberpunk 2020* rulebook for a few things.)

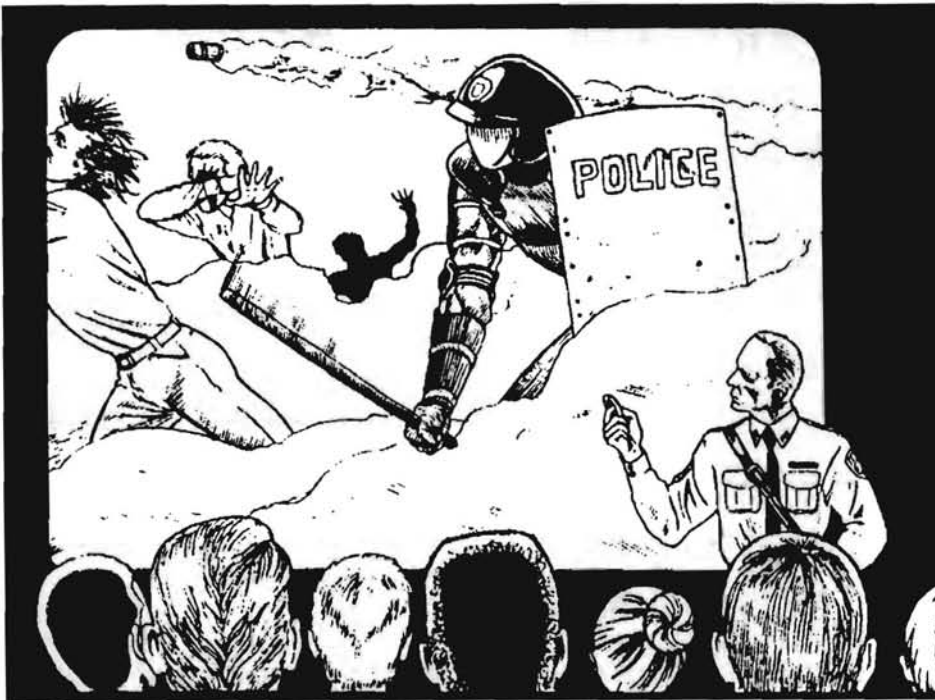

**NCPD Training Academy 06:00 hours.**  
**Audio Recording; Sgt. Instructor Korsky,**  
**On-Site Instructor:**

"Okay people, let's get on with it, this ain't no goddamn holiday camp. You raws wanna be cops, you gotta be good, and to be good, you gotta work for it. We're two weeks into your training and eighteen of your buddies have jacked out already, and they won't be the last. Unless, that is, you get off your butts and toe the line.

"Right, now that I've got your attention, here is your schedule for today. That's if Cadet Krueger wishes to hear what I have to say?

"Thank you. 06:30. You guys get to run the physical training course. It's 5 degrees outside, so what can I say, except stay frosty, Kids!"

"08:00. Clean up and report to Class 13. Doctor Crowley has a short film for you to watch. I think he said something about 'Ritual Killings in the 1990's', so take those sick bags, cadets. After that I want you at Parade Ground C by 10:05 for your first AV-6 G-Tolerance Familiarization Course. Yeah, I know it's only five minutes, Ling, but nobody said that life was fair!

"12:00. Chow down...come to think of it, maybe you'd better skip lunch!

"12:40. Report to the firing range for your Heavy Weapons instruction drill. Sgt. Magellan wants to introduce you to the effects of the Barrett-Arasaka Light 20mm Cannon on Kevlar at close range.

7 ft. ...  
 6 ft. ...  
 5 ft. ...  
 4 ft. ...  
 3 ft. ...  
 2 ft. ...  
 1 ft. ...

**HITTING THE STREETS**



# WHAT IT MEANS TO BE A COP IN 2020



Interview by C.J. O'Reilly

**“I got my badge back in 2015. Another rookie, fresh-faced and wide-eyed, ready to put the world to rights. I guess I’d always wanted to be a cop, ever since I was a little girl. Dad used to walk a beat back in the 90’s, when things were a bit different, but he died when I was still young. Mom said he was blasted through a shop-window by some crazy, doped up streetpunk.**

“Although Mom tried her hell-hardest to stop me from joining up with the NCPD, I had to do it. I guess I thought what was good enough for Dad was good enough for me. Anyway, it felt like the right move.

“The Academy spat me out, badge in hand, into the lowest ranks of the NCPD, cruising the streets in an armored patrol car. I can still remember my first call like it was yesterday. I lost my first partner then. It was 10:30 in the morning—ninety minutes into my first shift. My partner, Lloyd, was an old guy, 25 years on the force. He had stayed in the cruiser division all his life—said he liked it and it made him feel like he was helping people.

“Poor guy was dead by 11:00.

“We’d been called down to The Outer Limits; you know, the club down on 26th. Some crazy was trying to get inside, with a little help from his MAC-14. By the time

we got there, this freak was holed up in the john, using a waiter as body armor. Lloyd went in to deal with the guy, while I backed him up and called for support, just like they taught me at the Academy.

“The waiter was lying on the floor with half his skull blasted open, leaking blood and frag knows what else. I don’t think I even had a chance to look around, ‘cause the crazy appeared at that moment, SMG blazing. The slugs tore through Lloyd’s Kevlar and smashed him into the wall like a doll. I didn’t think—just squeezed off three rounds from my Avenger. I don’t remember much after that, except seeing the blood splattered on the wall, where Lloyd had been thrown into it.

“Two days later I met my new partner, Jim Hawkes. A real tough-guy, with a few years experience under his belt and a bad attitude to go with it. He gave me a hard

time at first, especially since his last rookie had gotten himself killed five days into the job. Boy, did he like reminding me about that!

“I don’t think I ate or slept for the first few weeks—there was too much to remember; like checking the car for bombs, watching each other’s backs, watching out for crazies—who’d even try to lift your piece, if you didn’t stay frosty.

“Now, I’ve got nothing against the Academy, but they don’t tell you what you really need to know—like how to tell if the gangs are ready for a burn (they just disappear). Suddenly they’re not hassling people on the streets, or hanging out at the bars. They just vanish, then all hell breaks loose as they hit their marks. Really scary stuff!

“Hawkes was okay, I guess, but I can’t say that I liked the guy. He was trigger happy, and with that Armalite .44 of his, most of the perps he shot were DOA when they hit Memorial. He acted like it was all out war between him and the punks, and he wasn’t too bothered about the rules, either. But there aren’t many who are.

“On Day 32 of my career, I caught my first slug—blasted by some crazy as I stepped out of the patrol car. Never did catch the creep. Back-up arrived real quick and the medics hauled me off to Memorial to pull the slug. It wasn’t too bad, but everyone made a fuss over me—even Hawkes!

“I guess it was then I realized I was doing the right job—trying to protect

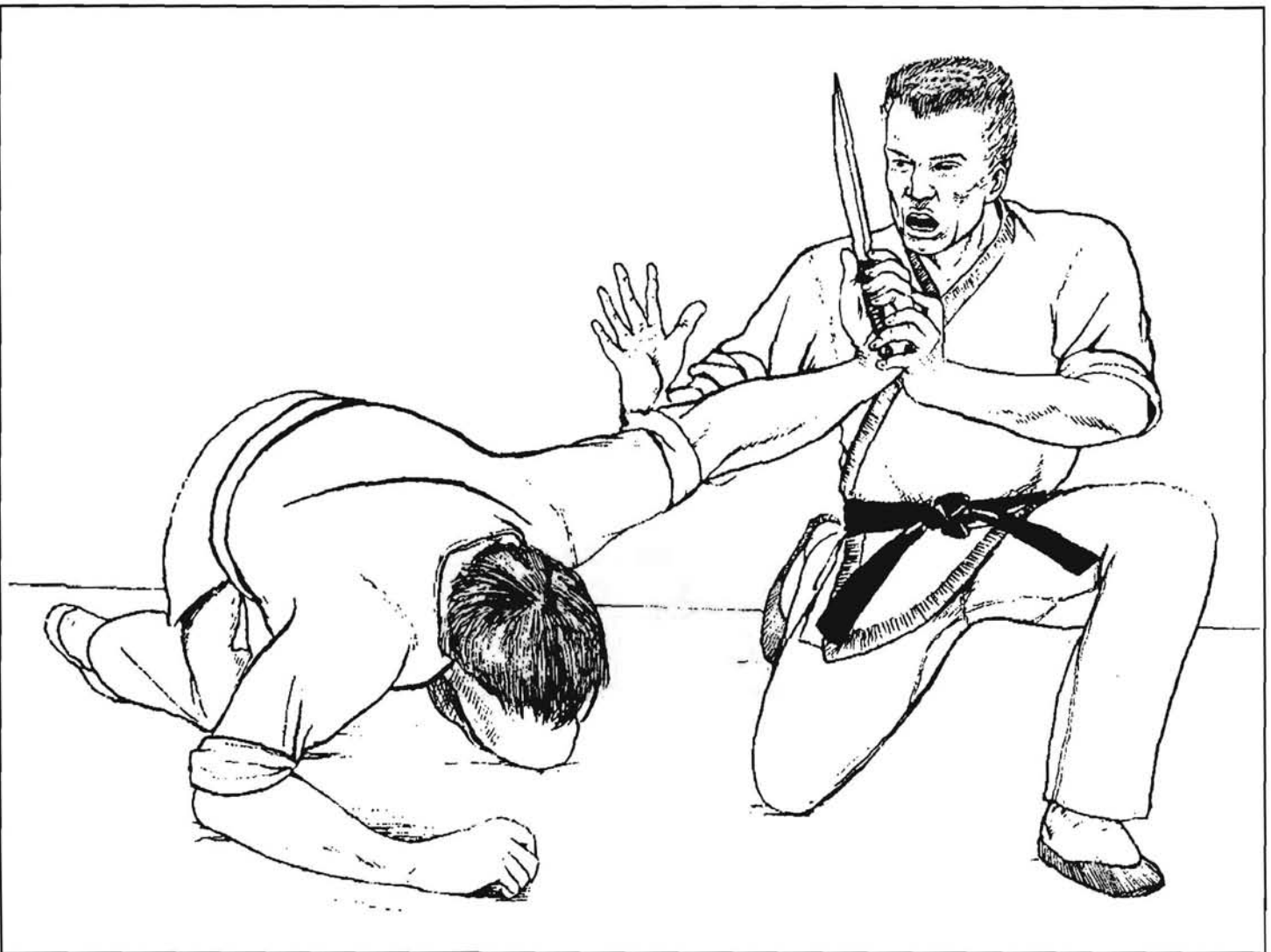

Sgt. Instructor Korsky demonstrates proper disarming hold on Cadet K. Nakata.

### THE BRIEFING

"That's all of you except Krueger, Ling and Kincaid. The Commandant wants to know what you intended to do with that silenced MPK-11 and the statue of his father in the parade area. Yeah, I figured that you wouldn't be involved, Kincaid, you never are..."

"14:00. Riot Training. Kit up and report to the riot simulator, and try to remember that you'll be up against live ammo again. I don't want any flatliners in this program; one a cadre is plenty enough this year.

"16:00. Tactical Vehicular Maneuvers Program. If you want to live through a high-speed pursuit, you gotta drive like you're in a goddamn warzone. I don't want to hear about any Sunday drivers in this group, okay?

"18:00. Chow time as normal, except for you three. The Commandant reckons he might be able to find something more worthwhile for you to do. Don't give me that, Krueger! Fer

Chrissakes—it was his father's statue!

"18:40. Basic Law part 2. Today's lecture—The Legal Rights of The Criminal Perpetrator. Should be a short lesson.

"19:40. Unarmed Combat Techniques. Since Sgt. Lucas is out of action for a while, I'll be taking the lesson today, and I wanna see you there, Ling. For those of you interested, Sgt. Lucas should be back in about two weeks, and MaxTac says they've nailed the cyberpsycho who almost iced him. Reports say he was in Rainbow Nights and wanted to dance.

"The current bodycount is seventeen.

"21:00. Time's your own, guys. Study up for next week's anti-terrorism exam, and I want lights out at 22:30 hours. Okay, you know the score people, so haul yourselves outta here. It's now 06:28 and you've got exactly two minutes to reach the Training Ground.

"So what are you waiting for, Christmas? Get your butts outta here! MOVE!"

### GETTING THE BADGE

Here is all the gen on how to cut it as a Cop. The character creation rules are similar to those in the *Cyberpunk Rulebook* and you'll need both books to work it out. There are six steps to creating a Cop.

- ① **You and the Ref figure out how you're going to start your character up.** Interface with Page 15 in the *Cyberpunk* rulebook and decide upon character points.
- ② **Run through pages 16-19 of the *Cyberpunk Rulebook*.** Generate Stats and Modifiers as as you would normally. All Cop characters must have the following Stat minimums:

Reflex 5    Cool 5    Bod 4    Int 4



people from the killers, psychos and rapists who call Night City their hunting ground. Dad would have been proud. I think I also grew up that day as well. I realised that if I didn't wake up soon, some perp would blow my brains out, and that'd be it. I mean, Patrol isn't a picnic—okay, so you get to know the people... Great; most are on the wrong side anyway, so none of them are going to be exactly pleased to see you. Still, I reckon somebody's gotta do it, otherwise this city's in a lotta trouble.

"Anyhow, as the weeks rolled on, I got used to street life. Hell, even Hawkes grew on me—yeah, so he was a dumbass packing a piece of man-portable artillery in his holster, but he was great backup in a tight spot. I may not have loved the guy, but he was a good friend, he was reliable, and those are what count the most.

"It's funny, but when you're cruising the streets in the dead of night, with the crazies out in force, and the acid rain pouring from the skies—you start to realise something. For all of the abuse that you get from people on the streets, they still need you. When some blood-soaked hooker runs out in front of you, with her pimp brandishing a blade close behind—you know that if you weren't there, she'd just be another stiff to scrape off the streets in the morning. Plus, when you get a solid collar, and you know the perp's going down for a long time, it makes it easier to sleep at night.

"It isn't always that way, though. Take this guy we nailed for flatlining some Corporate executive. Turns out the suit raped the guy's wife and got out of the rap by flashing Corporate Immunity around. I can see why the guy wasted him, but the perp broke the law, so he went down. He's doing seven at the moment—gets out in '24.

"Downtown in the alleys and coffin hotels, you know you've hit bottom; life doesn't get any worse than in the slums. There's a feeling you get down there, a good feeling—you know you're there to protect people. You don't get thanked for it; many even hate you for it. But then you don't join the NCPD and expect to get a pat on the back for wasting some booster street punk who tried to ice some old guy.

You join the force to stop the whole place from going crazy. The pay isn't great, but you're never alone. Maybe you're down and bleeding in some gutter—you're pretty bad, but you know the cavalry is on its way. There's nothing like the scream of the sirens in your ears when you're in a tight spot. We take care of each other. End of story.

"During my four years on patrol, I took seven hits, not bad really—Hawkes took fifteen during his six year service. The last time was the worst; he walked right into the middle of a Triad heist. I took a hit, but nothing compared to what they did to Hawkes; they'd blown chunks out of him before I could call backup. By the time he reached Memorial, he was clinically dead. Then the cybermedics moved in and turned him into a new man.

"It was around that time that I finally made Detective and transferred to Homicide. Last I heard of Hawkes, he'd been shipped off to MaxTac and the cyberpsycho squad, hunting down the cyberfreaks too far gone on their computer-assisted body boosts to live. Most of MaxTac are borderline cases anyway, so I guess Hawkes probably fits right in.

"My transfer to Homicide meant a better apartment and less Kevlar (for the most part). I missed being on the streets at first. I didn't miss the beat, just the people. The suits in Homicide are older and more detached. But I guess it goes with the turf. Homicide shows you the worst of life in the City. You need a strong stomach and nerves of steel if you're gonna last the duration. Our clean-up rate isn't great, and you never get used to seeing the bodies.

"Our last Lieutenant freaked out and had a breakdown, a real bad one. He just couldn't take it anymore—got pensioned off in the end. But then, we all get a little weird every so often; the rest of the team just pulls us through. If you don't keep the team in one piece, it'll fall apart around your ears.

"I still feel like an outsider in the unit. Still, I've got a great partner, Javez—he's half-Mex. Five years in the unit and he still has a sense of humor. We're good friends and good partners. What more is there to say?

- ③ **Move to the Cop Lifepath section (pgs. 10-13 of this book).** Work through your Lifepath with the Referee and sort out some history on your cop.

## LIFE EVENTS

Now you know who you are and you've got a grip on where you are going. Either roll 2D6+16 for your character's age, or pick any age you like between 18 and 45. For each year of your character's life past age 16, roll 1D10, reference that section of the Lifepath charts on pgs. 27-29 of the *CP 2020* book, and apply the results. After your character has joined the police, use the charts below. Each roll corresponds to an event during each year of your character's life. Keep rolling each year until you reach your starting age.

1-3 BIG PROBLEMS, BIG WINS

4-6 FRIENDS AND ENEMIES

7-8 ROMANTIC INVOLVEMENT

9-10 NOTHING HAPPENED THAT YEAR

## BIG PROBLEMS, BIG WINS

Life with the badge can be good and it can be hell. This year you cut it good or you got cut up. Roll 1D10: if it's even you got lucky, if it's odd you didn't.

### Disaster Strikes!

Roll 1D10

- 1 Financial loss or debt: Roll 1D10x100. You've lost this much Eb. If you can't pay it now, you have a debt to pay in cash—or blood.
- 2 You caught a slug! It was a bad one: Roll 1D10. 1-3= -1 to BOD Stat. 4-7= -1 to MA. 8-10= -1 to both. Either way, you've got a nasty scar.
- 3 Suspended and investigated by IAD: Pick up a Black Mark, and they're probably keeping a watchful eye on you now.
- 4 Betrayal: You have been backstabbed in some manner. Roll 1D10. 1-3, you're being blackmailed. 4-7, a secret was exposed. 8-10, you were betrayed by a close friend in either romance or career
- 5 Lover, friend or relative killed: You lost someone you really cared about. 1-5, they died accidentally. 6-8, they were murdered by unknown parties. 9-10,



**Deputy Chief James Teal hands gun and badge to cadet J. Davis at graduation ceremony.**

they were murdered and you know who did it. You just need the proof.

- 6 You shot an innocent: They didn't make it. Pick up a Black Mark. Suspended for six months.
- 7 Accident: You were in some kind of terrible accident. Roll 1D10. 1-4, you were terribly disfigured and must subtract -5 from your ATT. 5-6, you were hospitalized for 1D10 months that year. 7-8, you've lost 1D10 months of memory that year. 9-10, you constantly relive nightmares (8 in 10 chance each night) of the accident and wake up screaming.
- 8 Lose an Informant: He disappeared/got wasted/moved on.
- 9 Someone wanted you dead: Roll 1D10. 1-3, a criminal went after you personally. 4-6, an organised crime syndicate wanted you

out of the picture. 7-8, a Corp tried to take you down. 9-10, you don't know who they were or why they wanted you on a slab.

- 10 Lover, friend, relative busted! Roll 1D10. 1-4, it's only a misdemeanor. 5-7, it's a felony. 8-10, it's a federal crime.

#### **What Are You Gonna Do About It?**

Choose or roll one:

- 1-2 Clear your name.
- 3-4 Live it down and try to forget about it.
- 5-6 Hunt down those responsible and make them pay!
- 7-8 Attempt to cover it up.
- 9-10 Save, if possible, anyone else involved in the situation

#### **You Get Lucky**

Roll 1D10

- 1 Financial windfall. You got a work bonus, or a perp had a reward on him: Roll 1D10x100 for amount in Eurodollars.
- 2 Big collar, you're on the news!: +1 Rep and gain a commendation.
- 3 Martial Arts training: Begin a Martial Art at +2 or add +1 to an existing Martial Arts skill.
- 4 Served overseas: Pick up a foreign enforcement contact at +2.
- 5 Undercover Op: Totally successful, well done. Gain a commendation.
- 6 Gain an Informant: Choose or roll one.
- 7 Promotion: About time, too! Lose a black mark and shoot up one rank.



- 8 Selected for a special Task Force: +1 Rep.
- 9 Sent on firearms course: +2 to one weapon (Firearm) skill.
- 10 Beneficial transfer. You choose.

### FRIENDS AND ENEMIES

Life with the badge means two things. You make solid buddies, but your enemies are for life, and they're gonna be gunning for you. This year you met someone who isn't going to forget you fast. Good or bad? Let's see...

Roll 1D10. On a 1-5, it's a buddy; on a 6-10, it isn't.

#### Make A Friend

Roll 1D10 Even = Male, Odd = Female

Roll 1D10

- 1 Media
- 2 Corporate Exec
- 3 Gang Member
- 4 Nomad
- 5 LEDiv
- 6 Private Investigator
- 7 Criminal
- 8 Co-worker or boss
- 9 Government official
- 10 Military

#### Make An Enemy

Not too much of a surprise, really. Nobody loves the badge.

Roll 1D10

Even = Male, Odd = Female

Roll 1D10

- 1 Fellow Cop
- 2 Government Official
- 3 Organised Crime (GM chooses group)
- 4 Corporate Exec
- 5 Gang member
- 6 LEDiv

**“Why did I become a cop? Well, when push comes to shove, I like to be the one doing the pushing...you can push real hard with a Hurricane Assault Shotgun.”**

- 7 Informant or Friend
- 8 Independent Criminal
- 9 Lover/ex-lover
- 10 Media

#### The Cause

The enmity started when one of you (choose or roll one):

- 1 Caused the other to lose face or status.
- 2 Caused the loss of a lover, friend or relative.
- 3 Caused a physical disability: Roll 1D10. 1-2=lose eye, 3-4=lose arm, 5-6=badly scarred, 7-8=lose a leg, 9-10=lose 2 limbs.
- 4 Turned down other's offer of job or romantic involvement.
- 5 You just didn't like each other.
- 6 Was a romantic rival.
- 7 Foiled a plan of other's.
- 8 Busted him.
- 9 One of you was framed.
- 10 Rival at work.

#### Who's Fracked Off?

- 1-4 They hate you.

- 5-8 You hate them.
- 9-10 The feeling's mutual.

#### Whatcha' Gonna Do About It?

- 1-2 Concoct a murderous scheme to deal with him.
- 3-4 Avoid the scum.
- 5-6 Backstab him indirectly/Use your position to harass him.
- 7-8 Ignore the scum.
- 9-10 Rip into him verbally.

#### What Can He Throw Against You?

- 1-3 Just himself.
- 4-5 Him and a few friends.
- 6-8 His whole organization.
- 9-10 The whole organization, and he's got contacts everywhere!

### ROMANTIC INVOLVEMENT

#### How you met:

- 1-6 Off-duty romance
- 7 Other cop
- 8 Your partner(!)
- 9 A superior officer
- 10 A criminal gone good

#### How it Worked Out:

- 1-4 Happy love affair
- 5 Tragic love affair
- 6-7 Love affair with problems
- 8-10 Some small dates, nothing serious

#### Tragic Love Affair:

- 1 Lover killed in accident
- 2 Lover vanished
- 3 Lover a wanted criminal
- 4 Lover worked for Crime Syndicate (you never quit the Mob).



A remote surveillance system in operation.

④ **Generate Starting Skills (pg. 32-43, *Cyberpunk Rulebook*), using the Police Career Package below.**

- Awareness/Notice
- Handgun
- Human Perception
- Athletics
- Education
- Brawling
- Melee
- Interrogation
- Streetwise

Minimums must be purchased in the following skills:

- Streetwise 1
- Brawling 1
- Awareness 1
- First Aid 1
- Handgun 2
- Melee 1

Cop Special Ability: **Authority**. The ability to intimidate or control others through your position as a lawman. This attribute represents the Cop's ability to call on the forces of Law and the Government. Cops can use Authority to question suspects, arrest wrongdoers, and defend the innocent.

New Skill: REMOTE SYSTEMS OPERATIONS (2): The ability to operate all types of remote-controlled machines. This skill governs both maneuvering and combat activities of the remote machine. Computers do not use this skill, and instead treat the remote machine as an extension of their normal systems. This skill is based on an average of REF and INT. When operating remote devices engaged in certain activities, another skill will sometimes be used in place of the remote skill. However, this skill can only be used up to the level the character has in Remote System Operations. For example, a character with *Piloting 5* and *Remote System Operations 3* would be treated as having a *Piloting* skill of 3 if he tried to pilot a vehicle by using a robot to operate the controls.

⑤ **Get gear and equipment (see pgs. 47-61, *Cyberpunk Rulebook*).** As a cop, you are automatically issued a heavy handgun, body armor and some type of communications device (Referee's choice for each). An implanted location chip is imbedded in your skin. This is not a cyber implant, it just means that if you get in trouble, your cop buddies can

- |  |  |
|--|--|
| 5 Lover kidnapped by vengeful criminal/gang.                 | 8 Lover is jealous, and often "follows" while you do your job.           |
| 6 Lover left you for another cop.                            | 9 One of you is "messing around."  |
| 7 Lover committed suicide.                                   | 10 You have different beliefs on law enforcement, and bicker constantly. |
| 8 Lover killed in police action.                             |  |
| 9 Rival cut you out of the action.                           |  |
| 10 Lover serving jail time for some crime (possibly framed). |  |

**Mutual feelings**

- 1 They still love you
- 2 You still love them
- 3 You still love each other
- 4 You hate them
- 5 They hate you
- 6 You hate each other
- 7 You're friends
- 8 No feeling's either way; it's over
- 9 You like them; they hate you
- 10 They like you; you hate them

**Love Affair with Problems**

- 1 Lover's friends/family hate cops.
- 2 Lover has criminal ex who wants you dead.
- 3 Your friends/co-workers don't approve of your lover.
- 4 One of you has a romantic rival.
- 5 You are currently separated.
- 6 You think lover may be involved with criminal activities, but need proof.
- 7 If lover is a Cop—you are rivals for an upcoming promotion.  
If lover is not a Cop—lover thinks you should quit and find a "safe" job.



# Ranks

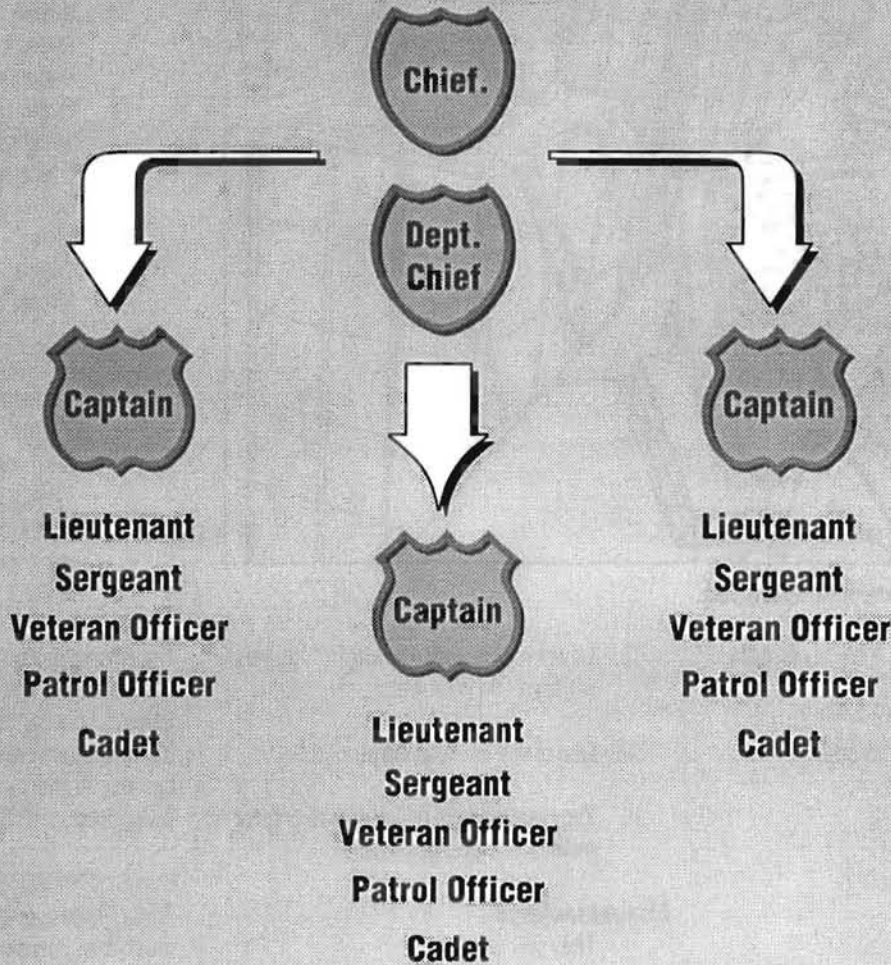

locate you. It will be removed when you leave the police department. Also, if you're a Patrol or Investigative cop, go to the section on Confidential Informants (pg.33) and pick/roll two off the list.

A *Cyberpunk* cop's salary is never great. But hey—you get to walk around with a gun and you're allowed to use it, and it's better than Jo's job. Cash is always (well mostly) paid directly into your account on the last day of every month. This is all computer calculated and additions are automatically made for overtime and other bonuses. There have been a few problems with errors on these computer payment systems, however EBM say they are designing a newer, more accurate system.

Any additional cyberware, gadgets, gear, etc., must be purchased from your salary (as either a patrol officer or cadet. Where you start is determined by the Referee at this time). Also work in your apartment details, and calculate overheads each month.

Not much of your paycheck left, is there?

- ⑥ **Sell out if you have to (see pg. 83, *Cyberpunk Rulebook*),** and tell the Ref the kind of game you're looking forward to. Make any aspirations of your character known to the Ref at this time.

## CASH, BOOSTS, RANKS AND PROMOTIONS

What can you expect as a Cop in 2020? Let's start with the important parts; what you get paid, your boosts (benefits), retirement, ranks and promotions.

### Standard Boosts

**Pension:** Your base pension is added to each year you work as a cop. Interest (05%) is calculated by the EBM Payment Computer and is added to a base of 200eb per month. Each year this figure is summed and added to your monthly pension, which you get to pick it up once you retire.

**Death Benefits:** If you die while on active duty, your designated next of kin receives 3 months pay and free cremation for your body.

**Medical:** Costs of injuries caused while on active duty are taken care of by the Police Department, and you stay on full pay while recovering. On the Street, you may also call for a Medical back-up (similar to Trauma Team).

### Promotion

To gain promotion you must be recommended by your immediate superior, although the Chief can promote whomever he wants. In addition, you

must also possess any and all requirements for the position you will be promoted to.

### Commendations

Commendations are awarded for Exceptional Merit in the execution of your job as a Law Enforcement Officer. If you are recommended for a Commendation it is passed up the chain of command to a relevant Deputy Chief. The Chief and his Deputies can also award Commendations on the spot.

You're likely to receive a commendation for bravery, making a big bust, doing well on something important, being in charge of something that went well, and any other positive moves in general that benefit the Department. A Commendation automatically wipes out 1 Black Mark.

### Black Marks

Black Marks are immediately entered into your file the moment they are awarded against you. If a cop collects five, he's out. That's it, gone. (see Black Marks in *Just the Facts*, pg. 74 `)

### Retirement

After you've served your 30 years in the police department you get to retire, hopefully with a nice fat pension to look after you. Until the time of your death, (or criminal prosecution), you can choose to remain a Licensed Terminator; in fact, many old cops become Bounty Hunters.

When you get into trouble, you can expect a fast and effective response from the cops. The police take care of their own—even when they're old and gray.

## RANKS

There are eight ranks of police officer—Cadet, Patrol Officer, Veteran Officer, Sergeant, Lieutenant, Captain, Dept. Chief and Chief. Each rank comes with its own pay scale; sometimes it's almost enough to live on. Cops live (and die) for their pensions. Promotion is good, because it means more cash and more boosts. Each rank described below details its promotion requirements along with cash and boosts.

### Academy Cadet

Payment for the Academy trainee is half the patrol officer rate: 600eb per month. The only boosts are the fact you get to see lots more daylight than most people. You get fit, learn how to handle yourself and take lots of tests. You also get shouted at all the time. If you're good, in the end, you get The Badge.

**“The gangs rule the streets, the Corps own them, the Triads and Yaks terrorize them; I guess it's our job to clean them up.”**

### Patrol Officer

Picks up 1,200eb a month. Officers can bunk at their precinct if they don't have their own place (this is generally thought of as uncool). Everyone else calls you *Bunkboy*. Think about it...

There aren't many other boosts beyond working four 8 hour shifts every three days. You're on the streets most of the time, wearing kevlar and packing something heavy while waiting for the shooting to start. You may get to drive something like a patrol unit, even an AV-4. It's not likely, though. You answer directly to your sergeant, and any veteran officers placed in charge of you.

### Veteran Officer

After a year "in" you automatically become a veteran officer. There's no cash bonus to this. It does mean you can request transfer to a special section (such as Special Weapons). This must be approved by your superior. If there's an available slot you'll be put on the list. Some Departments don't have lists, so you may make it straight away.

You are also up for promotion and may, if you wish, take the Detective's Assessment Course. This 3 day examination must be passed before transfer to certain sections is allowed. (See Departmental Sections for which Special Sections require this) The Detective's Test requires the cop to make the following successful task rolls:

Average Awareness      Average Streetwise  
Average Interview      Average Interrogation  
Average Human Perception  
Average Expert Knowledge: LAW

Only one DAC can be taken per year. Making Detective brings you an increase of +30% to your monthly cash.

When transferring, you are required to stay in your new section for at least six months. However, you're unlikely to be allowed to transfer again until a year has passed.

Veteran officers are a little more respected than patrol officers. They are often brought in to help train rookie cops and sometimes to lead them. You answer directly to your sergeant.

### Sergeant

REQUIREMENTS: Minimum of 2 years active service, proven expertise in given department. Potential.

A sergeant will pick up 3,000eb a month. He also picks up a large chunk of responsibility. You are almost always likely to be assigned a group of officers to command. If you work Beat, you supervise a large area of beats. If you work Admin, you're a desk sergeant sorting calls and complaints. If you're in Max-Tac you may get a vehicle command, etc.

As a Sergeant, you can assign veterans to be in charge of patrol officers. You can also place Black Marks and recommend Commendations and promotions. Many cops never make it past sergeant at all; it's a comfortable job—most of the time. You answer directly to your Lieutenant.

### Lieutenant

REQUIREMENTS: Minimum of 1 Commendation, no Black Marks at time of promotion. Proven ability in leadership. Minimum of 3 years active service and 1 year as sergeant.

You get this far, and you've made the big time. Lieutenants are often placed in charge of an entire section at a precinct. This means you're overseeing all cases, as well as your own workload. You're still active—by no means is this a desk jockey job; you just have to take on responsibility for all the people in your section. You also assign officers to cases and supervise them.

You pick up a check each month for 5,000eb. Not a bad wage.

As a Lieutenant, you assign Black Marks, and recommend Commendations and promotions. You also ensure the mental health and stability of your officers in addition to approving budget requirements. The job even comes with a car. But if things go bad, you take whatever was meant for the fan. You're also responsible for all your section liaison operations, and occasionally pick up some Media exposure. You're the man



they wanna talk to. "Hey, aren't you that guy I saw on the News?" Hmm...

You answer directly to your Divisional and Precinct Captains. It can be a real conflict of interests sometimes...

### Captain

**REQUIREMENTS:** Minimum of 2 Commendations. No Black Marks at time of promotion. Minimum of 4 years active service and at least 1 year as Lieutenant.

Captain is a big change in lifestyle. Cash is at 7,000eb a month and you get to be in charge of a whole Precinct or entire city Division!

Each Precinct comes with a large city district command in addition to loads of cops. You're responsible for everything that goes on with them in that district. The Chief talks to you lots—he shouts at you even more. You won't have enough cash to allocate on resources, and manpower is low. The streets are becoming more and more dangerous and everybody looks to you to sort it out. Deputy Chiefs are always sticking their nose in, and the last Captain probably either got himself wasted, quit due to nervous exhaustion, or is one of the Deputy Chiefs who is always telling you how easy he thinks your job is because he did it for years.

You still assign Black Marks, recommend Commendations and approve promotions. You get a better car, a driver, and loads of media exposure. You're starting to get involved in the political scene in the city, which means judges, lawyers, politicians and corps speak to you now. Everybody blames you for any bad karma in your precinct and you have to take it. You don't get to see much action, but if it's a real big, bad mother going down, you'll be first on the scene. You must also be aware of, and supervise, all liaisons within your precinct.

You're directly answerable to the Chief, Deputy Chiefs and the public. In return, you get to chew up your precinct Lieutenants when you're mad.

If you're a Division Captain, you're in charge of all your Division's sections in the entire city. You allocate your budget to the sections under your command; you even get to see some action. You supervise the activities of all the sections, recommending Black Marks and Commendations, while also approving promotions. You get a better car, a driver, and the media talk to you all the time.

You're also involved politically, although not much, and you usually catch the blame more than the praise. You are also responsible

**"I prefer the term civil unrest management.**

**Riot control sounds too...unfriendly"**

**—Deputy Chief M.M. Simmons**

for all section and divisional liaisons within your Division.

You're directly answerable to the Chief and the Deputy Chiefs.

### Deputy Chief

**REQUIREMENTS:** Must be a Captain and be hand-picked by the Chief. As Deputy Chief you pick up 8,000eb a month, a car with a driver, and a much easier job than a Captain's. You work directly for the Chief doing whatever he tells you to do. Lots of the time you play advisor to him; you may also be assigned the task of smoothing over public/media/corporate relations if it's needed. You may be placed at the head of a special task force. You'll get a fat budget and can pick your own team for it.

You assign Black Marks, approve Commendations and advise the Chief on strategy, planning and resource management. You get heavily involved in the political scene and regularly meet with judges, corporations and other big shots. You also keep an eye on all the police work going on within the city, while attempting to predict trouble spots and deal with them.

You're directly answerable to the Chief.

### Chief of Police

**REQUIREMENTS:** Must be hand-picked by the Mayor to serve each term of 4 years. You may be fired by the Mayor, at any time.

This is as far as it goes, unless you chase the political scene. Cash is at 9,000eb a month and there are lots of benefits (dental, Trauma Team, car, driver, etc.) to be had. You have a whole police force at your disposal; you receive the budget from the Mayor and assign it as you see fit, among Divisions, Precincts, Training

and a dozen other things. The Mayor is always on your phone, telling you what *must* be done. You've got a city full of criminals and it's your job to keep the peace. Everybody in the city looks to you for answers—and you'd better sound like you have them.

Politically, you're just a resource, but if you can turn it round in your favor you *could* make it on the Politics scene, even run for Mayor (don't expect to stay Chief when the Mayor finds out, though). You must also liaise with LEDiv regularly and ensure all *liaison between* your officers and other organizations and individuals goes smoothly.

You're directly answerable to the Mayor, and occasionally to LEDiv.

### HANDY COP TIPS

- Approach buildings from corners; then you can cover an entire building with just two cops.
- Don't use sirens if you believe the perp to be at the scene.
- Always watch your partner's back.
- If your weapon's almost empty, reload now.
- If the odds are stacked against you, then it's probably best to wait for back-up. There are no medals for getting yourself stupidly killed.
- Use your weapons to keep the cyberpsychos away from you, or they'll tear you limb from limb.
- Don't pull your gun unless you plan on using it. When you pull it, don't shoot once, shoot till the perp's down.
- Never underestimate the damage a gang can do.
- Don't accept gifts from civilians.
- Don't do drugs—it's not just your life, but your partner's, too.
- If you're unsure, back off.
- It doesn't matter how fast you can move, bullets move faster.
- If you're at a dead end in an investigation—think motive.

- A gun in the hand is worth two in the car.
- Don't call in for back-up unless you need it.
- Never cry wolf.
- Never rat on a buddy.
- Don't eat donuts: They're bad for you man.
- Don't get too personally involved.

## COP TERMINOLOGY

Agent Man=	LEDiv
Bag Man=	Fixer
Baked=	Burned
Banana Boys/Bunch=	MaxTac
Bird=	Aerial Assistance
Blitzed=	Drug Warp
Boney=	Corpse
Bust=	Arrest
Cold One=	Corpse
Creep=	Anyone else (besides the cops)
Crisped=	Burned
Dealer=	Fixer
Desk Jockey=	White collar guy
Dough Boy=	Money Man
Easy Rider=	Someone who travels a lot.
Flatbacker=	Hooker
Fried=	Insane
Geeked=	Killed
Going Down=	Going to Jail
Green=	Unwell
Grifter=	Con Artist

Headlining=	Wanted Man
Holding Down=	Drawing a weapon and aiming it.
Hustler=	Fixer
Iced=	Killed
Ice man=	No emotions
Inkman=	White collar guy
Jacket=	File
Jo/Joanna=	Nobody
Jumbo Bird=	Heavy aerial assist
Kid=	Anyone else
Loser=	Anyone else
Lost Boy/Girl=	Nobody
Lowlife=	Anyone else
Maggot=	Anyone else
Packing=	Carrying a weapon
Part Timer=	Corp Cop or Bounty Hunter
Pasta Boys=	Mafia
Paint Boys=	Yakuza
Pencil Neck=	White Collar guy
Perp=	Criminal
Pig=	Cop
Player=	Big time criminal
Punk=	Anyone else
Ripped=	Assaulted
Scum=	Anyone else
Slag=	Anyone else
Slime=	Anyone else
Smelly=	Corpse

Spiked=	Killed
Sprung=	Blown cover, or escaped custody with outside help
Sticks=	Beat Cops
Stiff=	Corpse
Suit=	Corporate Type, straight man
The Man=	Immediate Superior
Torched=	Burned
Tough Guy=	Muscle
Trashed=	Assaulted
Twisted=	Drug warp
Wasted=	Killed
Waxed=	Killed
Whacked=	Killed
Wise Guys=	Mafia
Worm=	Anyone else

## FAVORITE COP SAYINGS

Drop it!

Spread 'em!

Come out with your hands where I can see 'em!

You have 30 seconds to comply!

Freeze!

Dead or alive, buddy, it makes no difference to me!

Just the facts, ma'am.

Get on the ground! (prior to searches)

Do it now! (used as an accent to other verbal commands)

I think you should put the gun down now son, because you don't want to die, and I don't want to kill you. ■



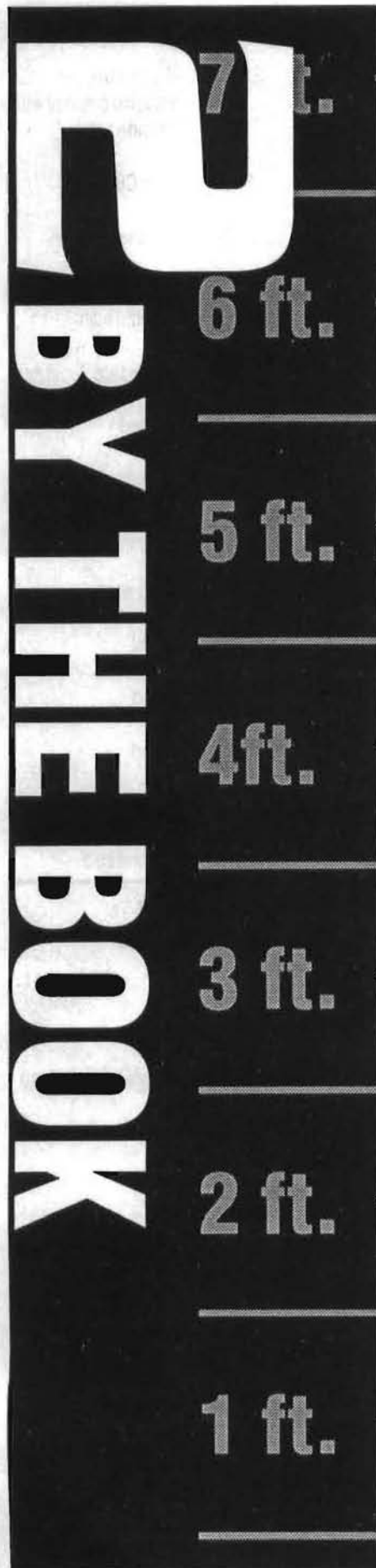

**T**his chapter examines the role of the Cop, providing data on the types of enforcement officers. This chapter also covers police equipment and resources, in addition to important facets of police organization, such as Confidential Informants, Procedures and the varying Divisions.

### OPERATIONAL PROCEDURES

The main difference between a cop and a perp is the fact a cop has to play by the rules. The perp doesn't. There are certain legal requirements an enforcement officer must adhere to in bringing a perp to justice. Failure to comply with these laws will make your bust resemble uncooked pasta...it won't stick.

### MAKING THE BUST

In the course of a cop's duty there will come many times when a bust must be made. There are certain restrictions placed upon an officer in determining who and how he may arrest.

They are as follows:

- ⊕ The officer must witness a given offense perpetrated by the individual before making the arrest (you gotta see 'em do it).
- or
- ⊕ The officer must have enough non-circumstantial evidence to ensure he can prove the individual has perpetrated, or conspired to perpetrate, an offense (you gotta be able to prove they did it, or were planning on doing it).
- ⊕ The officer cannot make a summary arrest upon the following types of perpetrators. He must obtain an Arrest Warrant first:

Corporate Executives with Corporate Immunity (see pg. 55)

Foreign Nationals with Diplomatic Immunity

Government Agents and/or Servants

- ⊕ When making an arrest, the perpetrator must be informed of the officer's legal right to arrest him. This is done by the officer displaying his badge and announcing his intent to arrest. The officer may then subdue the perpetrator with necessary force and arrange transportation to a police precinct, where the perp will be booked and charged with the stated crimes.
- ⊕ The arresting officer must inform the perpetrator as to why he is being arrested, stating the crimes he has committed. The officer must also ensure the perpetrator's safety from that point on.
- ⊕ Once officially charged and booked by the duty sergeant, the arrested individual must submit to a full sample test. It is the arresting officer's responsibility to ensure these samples are taken correctly. NOTE: A Biotechnica Bio-Sampler Scanning device is used to perform this test. This two ton machine takes a full holographic image of the perp, in addition to retinal scans, blood, DNA, fingerprint and hair samples. If the crime is Priority 3+, the information is relayed to the LEDiv central computer (where it becomes part of the permanent record if he is convicted). The entire process takes about seven minutes. Only minor discomfort is felt by the subject.

### USE OF FORCE

An officer is often required to make use of deadly force in the course of duty. Firearms and other weaponry are placed at the officer's disposal to achieve this. However, they may only be used

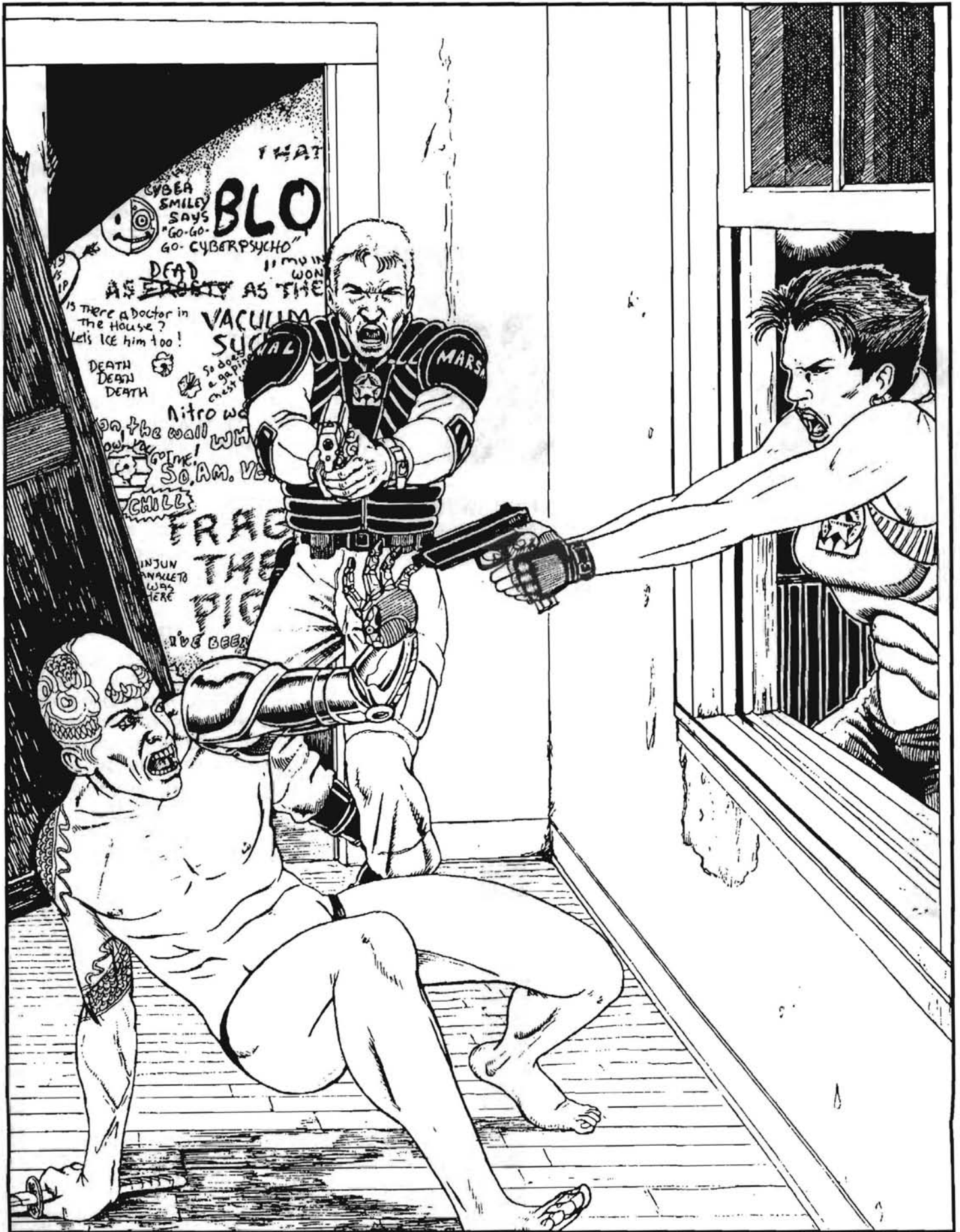





under specific circumstances. These are:

- When the officer witnesses a situation where the use of deadly force could mean the difference between life and death. The officer may use force when an individual's life is threatened (including his/her own), or when there is a danger of severe disabling injuries being caused.
- Force may be used against any individual who has been arrested and attempts to escape.
- Force may be used to control unruly or dangerous crowds (an example would be a riot).
- Force may be used if a perpetrator violently resists arrest.

## PAPERWORK

"I want your report on my desk first thing in the morning!"

Paperwork is the bane of every cop. Every official act requires a given amount of administration. While we do not specify the exact steps of each process, here are some approximate times required to process certain forms.

Arrest Report:	1 Hour
Use of Force Report:	1 Hour
Obtaining an Arrest Warrant:	2 Hours
Refusal of Bail Request:	2 Hours
Work-related Complaint Form:	2 Hours
Transfer Request:	3 Hours
Investigation Report:	6 Hours +
Resource Request:	1 Hour

## COP COMMUNICATION CODES

When an officer calls into Police Dispatch, and when Police Dispatch alerts other officers, a code system is used to describe various situations. Copy this and have your players get used to it.

- |   |               |    |                    |
|---|---------------|----|--------------------|
| 1 | EMERGENCY!    | 9  | Cannot Talk-HELP!  |
| 2 | Treason       | 10 | Aggravated Assault |
| 3 | Homicide-Mass | 11 | Assault            |
| 4 | Kidnapping    | 12 | Rape               |
| 5 | Cyberpsycho   | 13 | Arson              |
| 6 | Homicide      | 14 | Type A Trafficking |
| 7 | Riot          | 15 | Type B Trafficking |
| 8 | Armed Robbery | 16 | Type C Trafficking |
|   |               | 17 | Pursuit            |
|   |               | 18 | Robbery            |
|   |               | 19 | Burglary           |
|   |               | 20 | Auto Theft         |
|   |               | 21 | Grand Larceny      |
|   |               | 22 | Disorderly Conduct |
|   |               | 23 | Drunk              |
|   |               | 24 | Soliciting         |

## SEARCH

An enforcement officer is empowered to search and seize in any public or private area, or search and seize evidence from people, solely on the basis of "probable cause." Probable cause is defined as "Would a reasonable person suspect criminal activity was in progress, given the circumstances?" The officer must document the probable cause in a report. The report will be reviewed by the Court for "reasonability" of the search. Obviously, flagrant abuse of this right will ensure the cop's superiors will find out due to a flood of complaints, but a good cop can always "write it into evidence." Gone are the days of lengthy search warrant applications and having evidence thrown out on "technicalities." It's 2020, and tough times call for tough tactics...

The following procedures must be observed:

- The officer may enter private or commercial grounds to search once he has notified his direct superior. Normally, he just has to call into Police Dispatch on the radio.
- The officer may search an individual after informing him of the officer's belief that the individual has committed, or in some way has participated in the commission of, a crime.

## STIFFS

When an officer encounters a corpse, it is his/her responsibility to call in a Body Recovery Team (aka, "meatwagon"). Most police agencies have at least one Morgue vehicle delegated to this task; however, contracts with reputable body bank/medical recovery agencies are common.

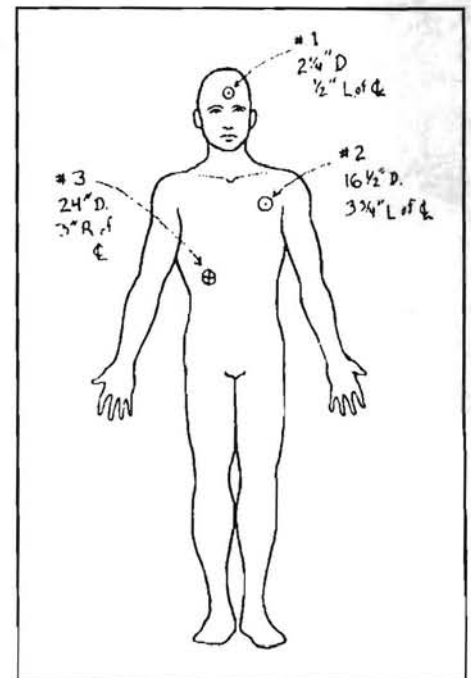



**"Mono-chopper, scatter gun, plastic one-shot, gas bomb; been watching the Militech Home Shopping Channel, humm?"**

Autopsies are performed on all crime scene corpses, in addition to all unidentified bodies. An autopsy on a body will be able to reveal any and all external and internal wounds, plus traces of foreign elements in the blood, skin and hair. It will also reveal details on stomach contents, and any medical illnesses or diseases possessed by the individual. Cause of death will also be noted. A full bioscan will also be performed in cases where identification has not been possible, in order to learn any details regarding the victim's background. An officer may request an autopsy on a body if he has sufficient cause to suspect foul play. Autopsy lag time runs from 8 hours (minimum) to about 5 days. An autopsy form is included in the Forms section of this book (pg. 94)

## DEPARTMENTAL STRUCTURE

Following is the basic structure of an average central police precinct. This chart can be referenced for chain of command, section placement, promotions, and transfer and allows the Ref and characters to grasp the general structure of their precinct.

### The Buck Stops Here!

#### —Departmental Chief

The Chief of Police (or just "Chief") is the head of law enforcement in any city. He or she is always an experienced officer, having risen through the ranks from beat cop all the way to the lofty position of Chief.

Each Chief serves a series of two to six year terms. The Mayor may select any available person from any recognised law enforcement agency. Normally, the Mayor will choose someone he knows from within the ranks of the city police. The Chief is answerable directly to the Mayor, who may fire the Chief on various grounds: incompetence, gross misconduct, etc. The Chief runs a knife edge of pandering to the Mayor, while ensuring that the city's cops get a fair break, along with the manpower, budget and resources they need. This is never easy.

### The Deputy Chief

The Chief may assign any number of Deputy Chiefs, whose job is to carry out the day-to-day responsibilities of running the Police Department. Deputies are often appointed to Administration, large precincts and even divisions. They must troubleshoot all potential prob-

lems arising in their fields of operation, and maintain lines of communication with the Chief, media, public and their own people.

### Division Level

Each precinct contains various personnel from the various police divisions. A division is the largest single body within the overall department; each division is in turn subdivided into sections. At this level, it is likely that a Captain will lead each division from Headquarters, or the largest precinct. At precinct level, single sections will be represented, not the division as a whole.

### Precinct Level

Each police precinct within a city is commanded by a Captain, answerable directly to the Chief or Deputy Chiefs. He is responsible for all law enforcement activity within his precinct, and oversees the performance of all the section heads under his command.

### Section Level

Each precinct will consist of various sections, normally headed by a Lieutenant. They are

# Departmental Structure

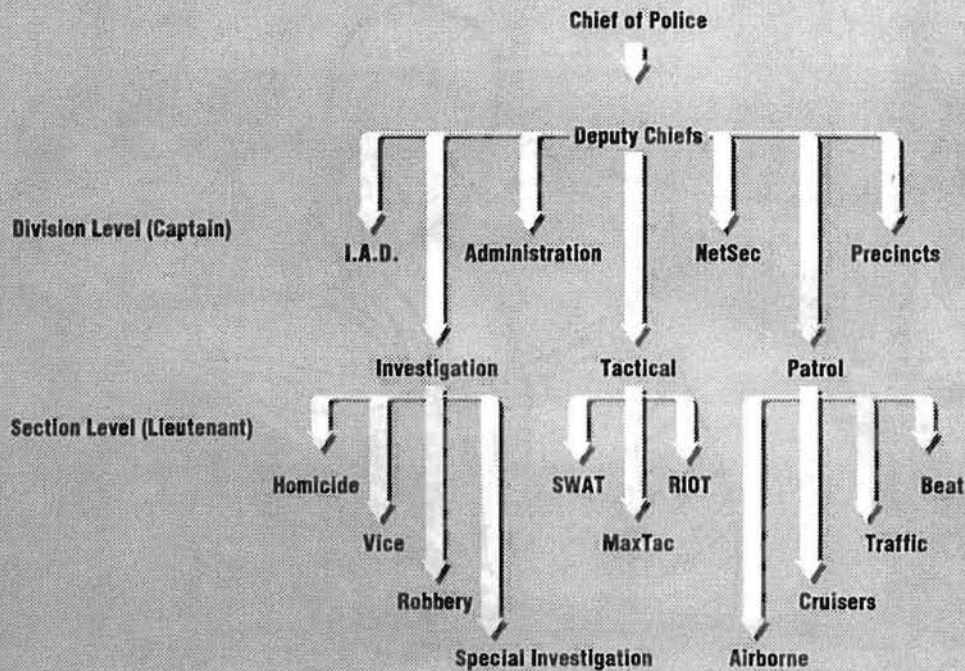

answerable directly to their Precinct Captain and their Divisional commander. For example, the SWAT Lieutenant of Precinct 5 is answerable to the Captain of Precinct 5 *and* to his Captain at Tactical Division.

## The Lowest of the Low

Beneath Section level are the sergeants, detectives and beat cops. They are answerable directly to their section heads and each are assigned to a specific precinct.

## DEPARTMENTAL SECTIONS

In this area, all police sections are discussed, even though some are not likely to be utilised a great deal within a *Cyberpunk* game. It is likely an officer would come into contact with all sections throughout his/her career; therefore, all are presented and examined.

Refs may wish to assign Cops to various sections throughout the course of a Law Enforcement campaign. Both Refs and players are advised to familiarize themselves with the sections they are likely to come into regular contact with.

Average Night City response times for each section are also included at the end of each description.

## RESPONSE TIMES:

VERY SLOW:	6 hours+ if at all.
SLOW:	Up to 3 hours
AVERAGE:	Up to 1 hour
FAST:	Up to 20 minutes
VERY FAST:	Up to 8 minutes

## PATROL DIVISION

Manpower and resources are constantly being poured into Patrol Division. This is due to the fact Patrol Div is the largest division within any police department. Patrol is the backbone of all police work. The main purpose of Patrol Div is to effectively distribute police officers in a way so as to reduce opportunities of civilian misconduct. It gets the cops onto the streets, in force.

Patrol Div consists almost entirely of uniformed officers. Their job: to patrol a given area and enforce the law. This means covering all minor incidents, in addition to anything serious that goes down in your zone.

### Beat Patrol

Beat cops have a hard time. It's their job to walk the streets, on foot, normally in pairs. They're always on the Street and they have to be alert to thousands of threats every patrol—gang

shootouts, corporate hits, riots, all sorts of illegal deals, psychos and outraged citizens (sometimes there is little difference between the latter two). Occasionally, they'll spot one of their own black and whites, or have to call in the heavy boys, but most of the time they're on their own. Day and night on the Street. It's not the best job in the world.

RESPONSE TIME: SLOW

### Average Beat Cop

INT: 6	REF: 7	TECH: 5
COOL: 6	EMP: 6/6	ATTR: 6
LUCK: 5	BODY: 7	MA: 6

**SKILLS:** Rifle 5, Streetwise 6, Handgun 6, Stealth 5, Dodge /Escape 4, Hide/Evade 4, Athletics 4, Awareness 6, Authority 3, Human Perception 6, Intimidate 4, Interrogation 5, Interview 5, Persuasion /Fast Talk 5, Brawling 4, Expert (Law) 5, Melee 5

**CYBERNETICS:** Usually none.



**EQUIPMENT:** Standard Issue Patrol Armor and Helmet, Sonar Scanner\*, Personal Body Alarm\*, 3 sets of Cuffs\*, First Aid Kit\*, Sonic Alarm\*, 'Burst' caster\*, Excalibur Nightstick, Armalite.44 Autopistol w/4 Magazines or CA-MAP Ordnance Weapon with ammunition varying dependent upon specific duty, Evidence Bags (3)

\* These items are standard issue for all uniformed police officers within the Night City Police Department.

### Traffic Patrol

Traffic is something of a lame job; it doesn't come with a great deal of pride. Traffic cops get vehicles (sometimes) and their roles are limited to enforcing the laws related to vehicles, while attempting to ensure the smooth day to day flow of traffic through the city. Nobody likes Traffic cops, not even other cops. A transfer to Traffic often means you've upset someone somewhere, and it's almost always a slow, monotonous job. People still shoot at you; many people think you're just another cop and give you just as much beef for it. Nobody wants to work for Traffic.

RESPONSE TIME: AVERAGE

### Average Traffic Cop

INT: 6 REF: 5 TECH: 6  
COOL: 5 EMP: 5/5 ATTR: 6  
LUCK: 5 BODY: 6 MA: 6

**SKILLS:** Handgun 4, Streetwise 3, Dodge/Escapes 5, Stealth 3, Athletics 5, Awareness 6, Authority 1, Human Perception 5, Basic Tech 5, Persuasion/Fast Talk 3, Expert (Traffic Control) 5, Motorcycle 6, Melee 4, Expert (Law) 5

**CYBERNETICS:** Usually none.

**EQUIPMENT:** Standard uniformed cop equipment, Flak Vest (SP = 15), Blue Knight Motorcycle, Traffic Helmet, Federated Arms x-9mm pistol w/3 Magazines

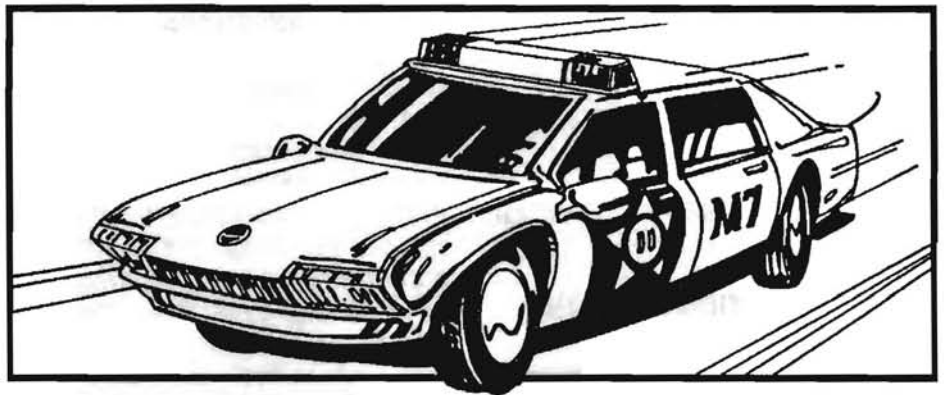

### Cruiser Patrol

Assignment to Cruisers is a step up from Traffic and Beat. Patrol Cruisers (aka Black and Whites) are the high-response police vehicles within the city. In most mega-urban *Cyberpunk* cities, cruisers are more common than beat cops—there's too much area to cover by walking. A Patrol unit consists of one cruiser and two Patrol officers who, like beat cops, are assigned a zone. However, they reap the benefits of the (comparative) luxury of a cruiser with full police features. This allows the officers to respond far quicker and more effectively to any situations arising within their patrol zone. Cruisers are also the immediate back up to Beat and Traffic should they call for assistance.

Each Cruiser is a Unit, and assigned a given patrol or other objective (such as escort). They are high profile, fast and reliable.

RESPONSE TIME: FAST

Average Cruiser Unit.

This type of unit consists of two Beat Cops with Drive skill of 7, in a BMW 600 Patrol vehicle (pg. 34).

### Airborne Patrol

Airborne provides all aerial patrol services for a given city, including AV-4 and AV-6 Operating Zones, Gyro Patrol and Surveillance.

Airborne, while equipped with state-of-the-art airware and formidable firepower, is basically a support branch. Should there be the need, Airborne can bring in chopper and AV support anywhere—FAST. The problem is they're always needed somewhere, and there aren't enough to go around. This can sometimes mean a lag time in response. Higher priority crimes are always dealt with first.

The bottom line with Airborne is: If you really need them, they'll be there—usually.

RESPONSE TIME: Average

Average Airborne Unit

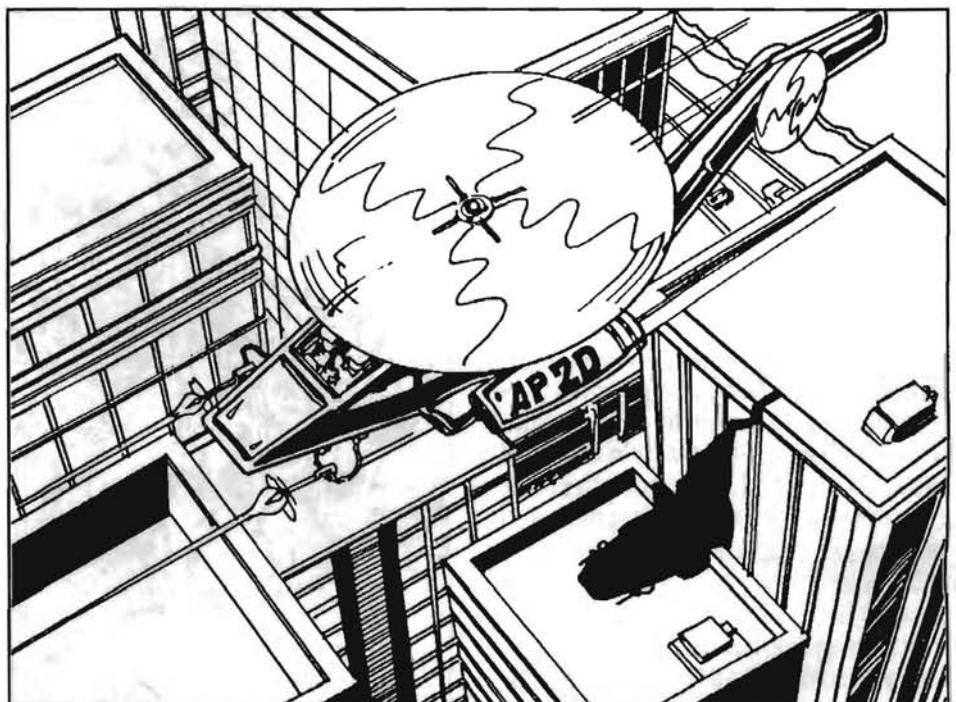

This unit consists of the following members:

- 1 Pilot:** Beat Cop with Pilot 5, Basic Tech 3
- 1 Officer:** Beat Cop with Authority 6, Awareness 7
- 2 Troopers:** Beat Cops
- 1 Medic:** Beat Cop with First Aid 6, Medical Tech 4

## INVESTIGATION DIVISION

**CRIMINAL INVESTIGATION IS NECESSARY WHEN LAWS FAIL TO DETER PERSONS FROM COMMITTING CRIMES, OR WHEN THE DETERRENT OF PATROLLING FAILS AND CRIMINALS HAVE NOT BEEN IMMEDIATELY APPREHENDED. ITS PURPOSE IS TO: IDENTIFY, LOCATE, ARREST AND ASSIST IN PROSECUTION.**

### SERGEANT INSTRUCTOR

**J.M. KORSKI, NCPD**

Investigation Division, while being a great deal smaller than Patrol Div, is a great deal more prestigious, as it carries out almost all ongoing criminal investigations within the city. Because of the nature of its operations, uniforms are rarely (if ever) worn and many other duty regulations are waived. Investigation officers are often assigned vehicles and special equipment. They are also far more likely to come into direct contact with the more violent criminals of the city, because of the nature of the work.

While Investigation does not have to patrol the streets, they have to *know* the streets better than your average beat cop. In many ways, Investigation is the best division to assign players to. They are allowed greater freedom in their work and in its execution. Most Investigation heads only care about results, but serious misconduct will still ensure IAD comes down hard on the players if they screw up.

### Vice

Vice is the section that gets all the dirty jobs. They are responsible for the continuing battle

against all controlled substances entering the city, and are generally concerned with Trafficking, Possession, Non-commercialized Vice, Gambling, Substance Abuse Laws, Weapon Laws and Extortion.

Almost all of these crimes occur at street level; Vice Cops know the street scene better than any other. They are excellent at undercover work and must perform it during most investigations, sometimes adopting a fake ID for months on end. The amount of drugs and other controlled substances entering the city is on the rise. Vice are there to try and curb it before it gets out of control.

It's not an easy job. The drug scene ensures Vice will come up against the craziest types who'll do anything rather than get busted. Organized Crime has a vested interest in most types of Vice; they too are a hard enemy.

RESPONSE TIME: FAST

#### Average Vice Cop

INT: 7	REF: 6	TECH: 5
COOL: 8	EMP: 6/5	ATTR: 7
LUCK: 5	BODY: 6	MA: 6

**SKILLS:** Awareness 7, Handgun 6, Athletics 6, Human Perception 7, Education 5, Brawling 6, Melee 5, Interrogation 6, Streetwise 8, Wardrobe/Style 6, Intimidate 5, Persuasion/Fast Talk 6, Disguise 5, Shadow/Track 6, Driving 5,



Personal Grooming 4, Expert (Narcotics) 5, Authority 5, Expert (Law) 7,

**CYBERNETICS:** Digital Camera, Amplified Hearing, Teleoptics, Voice Stress Analyzer, Adrenal Booster, Targeting Scope, Time Square

**EQUIPMENT:** Militech Arms Avenger, Sportscar (performance), High Fashion Clothing (Eji, Takanaka, etc), Two-way Radio, Kevlar T-Shirt (SP=10), Plastic Cuffs, Evidence Bags (6)

### Robbery

Robbery section is responsible for all serious theft and robbery investigations within the city. This section tends to receive good resources, because so much cash is at stake. Armed Robberies happen all the time; these are the guys who show up and track the robbers down. Big heists are on the increase, too, and Robbery section will often go undercover in attempts to infiltrate those groups who commit these crimes.

Robbery covers the following offenses: Armed Robbery, Robbery, Burglary, Auto Theft, Grand Larceny, Fraud, Counterfeiting, Embezzlement.

Robbery work means a great deal of admin paperwork; sifting through financial details on dozens of suspects, etc. It can also mean screaming onto the scene of an Armed Robbery with six or seven perps still in the bank, playing trigger with automatic weapons. This is a dangerous job. With so much Euro at stake, life becomes very cheap. Especially cop's lives.

RESPONSE TIME: VERY FAST

#### Average Robbery Cop

INT: 8	REF: 7	TECH: 7
COOL: 6	EMP: 5/5	ATTR: 5
LUCK: 5	BODY: 6	MA: 6

**SKILLS:** Awareness 4, Handgun 5, Athletics 5, Human Perception 7, Education 6, Brawling 5, Melee 4, Interrogation 6, Streetwise 6, Intimidate 5, Shadow/Track 4, Driving 5, Accounting 6, Maths 6, Expert (Law) 6

**CYBERNETICS:** Image Enhancement, Digital Camera, Chemical Analyzer, Times Square

**EQUIPMENT:** Sternmeyer Type 35 Heavy Pistol, Standard Automobile (unmarked), Plain Business Suit (non-designer label), Two-way Radio, 2 sets of Plastic Cuffs, Kevlar Armor Jacket (SP=18), Evidence Bags (6)

### Homicide

It's plain and simple: Homicide deals with murder. All types of murder. With city population explosions taking place every year, more and more people are getting killed. Murder is still a very popular crime. If a dead body turns up not in direct relation to another crime, Homicide moves in. Mass murders take place with frightening frequency and ferocity while Corps, crime syndicates and gangs all war among each other. Homicide gets to deal with it.

Crimes covered by Homicide include Mass Murder, Murder 1, Murder 2, Manslaughter, Corporate Murder and Aggravated Assault.

The officers working Homicide soon become really cold; they're seeing up to fifty dead bodies a day in various states of decay and dismemberment. They learn very fast how to distance themselves. The best Homicide officers may be more than a little way out, but if they're good, that's not a problem. There are too many psychos stalking the streets, too many lives getting snuffed out, too quickly. Homicide is there to locate and deal with all the murderers in the city.

RESPONSE TIME: AVERAGE

### Average Homicide Cop

INT: 6 REF: 7 TECH: 5  
COOL: 8 EMP: 6/4 ATTR: 5  
LUCK: 7 BODY: 7 MA: 7

**SKILLS:** Awareness 6, Handgun 8, Athletics 6, Human Perception 6, Education 4, Brawling 7, Melee 4, Interrogation 7, Streetwise 7, Intimidate 7, Shadow/Track 5, Driving 6, Rifle 5, SMG 6, Expert (Law) 7

**CYBERNETICS:** Targeting Scope, Motion Detector, Pain Editor, Smartgun Link

**EQUIPMENT:** Sternmeyer Type 35 Heavy Pistol, Standard Automobile (unmarked), Plain Business Suit (non-designer label), Two-way Radio, 2 sets of Plastic Cuffs, Kevlar Armor Jacket (SP=14), Evidence Bags (6)

### Special Investigation

S.IN. is a wild card unit common to many city's police departments in 2020. They are a task force of Investigation officers assigned to various cases within the city which have been granted special attention due to seriousness of the crime, media coverage, politics and Corporate pressure. S.IN. deals directly with the city's highest priorities, often liaising directly with LEDiv. Due to S.IN.'s nature, they are often granted access to large budgets and resources for investigations. They are also known to get results. Many other sections view S.IN. with a certain disdain, due to their tendency to take over certain investigations and make them their own.

S.IN. is often called in to deal with Mass Murders, Espionage, Corporate Activity, Organized Crime, Gangs, Major Kidnappings, Counterfeiting, Mass Internal Affairs Cases and Shocking Murders.

When a case becomes out of control, too dangerous, or just too damn difficult to crack, it's handed over to S.IN.

RESPONSE TIME: FAST

### Average S.IN Cop

INT: 8 REF: 7 TECH: 7  
COOL: 8 EMP: 5/5 ATTR: 5  
LUCK: 5 BODY: 7 MA: 6  
Humanity: 3.5

**SKILLS:** Awareness 7, Handgun 7, Athletics 6, Human Perception 7, Education 6, Brawling 6, Melee 5, Interrogation 8, Streetwise 7, Driving 6, SMG 5, Expert (Law) 8

**CYBERNETICS:** Image Enhancement, Digital Camera, Micro-Optics, Voice Stress Analyzer, Bug Detector

**EQUIPMENT:** Glock Thirty Machine Pistol, Unmarked Performance Vehicle (Armored),

2 sets of Plastic Cuffs, LapTop Computer, Kevlar Armor Jacket (SP=18), Evidence Bags (6)

### TACTICAL DIVISION

Tactical Division is there for when the talking stops (which is quite often in 2020). They're called into all sorts of hi-risk situations ranging from hostage rescue to dealing with a rampaging cyberpsycho. Trained in all types of Situational Response including Anti-Terrorist and Urban Clearance activities, Tactical is the bottom line—if they can't deal with it, there's a problem.

Apart from some ranking officers, TacDiv is a uniformed division, almost always geared up with hardcore armor, weapons and vehicles.

### S.W.A.T.

Special Weapons and Tactics Section (Also known in some cities as Emergency Response Unit or Special Response Team). These rapid-response units are always held on alert status, ready to react to any hi-risk situation where a large number of lives are placed at risk. SWAT is often called in to settle sieges, take down very dangerous suspects, provide security and seal off critical areas. All SWAT officers are trained in a wide array of weapons. Most carry heavy hardware and use their own fully combat-capable vehicles.

RESPONSE TIME: VERY FAST

Units consist of ten SWAT marksmen plus one officer.

### Typical SWAT Marksman

INT: 6 REF: 9 TECH: 6  
COOL: 7 EMP: 7/6 ATTR: 5  
LUCK: 5 BODY: 7 MA: 6

**SKILLS:** Dodge/Escapes 6, Weapon-smith 8, Athletics 5, Rifle 9, Shadow/Track 4, Stealth 7, Hide/Evade 7, Basic Tech 6, Awareness 7, Handgun 6, Authority 2, Streetwise 5, Karate 5, Expert (Law) 5, Melee 5

**CYBERNETICS:** Smartgun Link, Interface Plugs, Image Enhancement, Targeting Scope, Teleoptics, Infrared

**EQUIPMENT:** Digital Weapons Uplink, Hi-threat Battle Vest (SP =



25), Patrol Issue Combat Helmet, Stern.M-95B or FN-RAL or Militech Bulldog SG, Sonar Scanner

SWAT Officers are identical to the marksmen except for the following details: Authority 5 Streetwise 6 Awareness 9, Beretta M-24 Advanced SMG is carried along with a rifle. The SWAT marksmen use a BMW 910a Police Transport (pg. 35) as their primary vehicle.

### MAX-TAC

Max-Tac is still called C-SWAT by some departments; the official title in Night City currently is Cyborg Suppression Unit. Individual units are known as SPAR teams (Special Purpose Assault-Rescue). It is the bottom line in combat police officers. Specifically created to deal directly with the everpresent cyberpsycho threat, these officers are trained and equipped with the best resources money can buy. All officers are supremely fit and agile, and able to withstand a great deal of damage. Cyber-augmentation is common, if not mandatory. Max-Tac officers' enhanced abilities allow them to be the equal of any cyberpsycho. Weapons and armor of the most effective kind are placed at their disposal, as are combat vehicles, including fully equipped AV-9s.

Originally a division of SWAT, Max-Tac's actual role has expanded since its creation. While they are the only real force capable of dealing with the cyberpsycho threat effectively, they are occasionally also utilized as a higher form of SWAT. In any situation where SWAT fails, Max-Tac will arrive. Their job is almost always Hit Hard and Shoot to Kill. In many ways, they are as dangerous as those they are brought in to fight; many officers are teetering on the brink of cyberpsychosis themselves. NCPD sees this "fight fire with fire" strategy as effective (at least for now).

RESPONSE TIME: FAST

Max-Tac work in squads of six men plus one officer.

### Typical Max-Tac Operative

INT: 6 REF: 9 TECH: 5  
COOL: 7 EMP: 8/2 ATTR: 4  
LUCK: 3 BODY: 8(10) MA: 8

**SKILLS:** Authority 4, Brawling 8, Rifle 8, Athletics 6, SMG 6, Endurance 6, Handgun 8, Strength Feat 7, Heavy Weapons 7, Streetwise 5, Melee 8, Awareness 5,



Stealth 3, Dodge/Escape 5, Interrogation 5, Intimidate 8, Shadow/Track 4, Karate 8, Aikido 7, Expert (Law) 5

### CYBERNETICS:

Replacement Limb with Thickened Myomar, Reinforced Joints and Pop-up Micromissile Launcher, Torso Plate, Cybereye w/Infrared, Targeting Scope, Times Square, Smartgun Link, Muscle and Bone Lace, Wolver, Limblink, Decentralized Heart.

### EQUIPMENT:

Cyclone Squad Support Weapon or Remington Gyro-Sniper Rifle, Rostovic Wrist Racate, Militech Crusher SSG, Full Metal-Gear Armor (not always worn), Hurricane Shotgun, Federated Arms 454 DA 'Super Chief'. Max-Tac units use AV-9 transports for most situations, although several AV-9 gunships are also operating (such as 'Muther-1' commanded by the now famous Lt. Garrison).

A typical Max-Tac officer is set up as a normal Max-Tac operative except: Authority 7 Intimidate 9 Interrogation 7 Awareness 7,

### RIOT

Riot section is another Tactical force held on constant alert in order to deal with the vast number of civil disturbances taking place within the city. Equipped with armor equivalent to SWAT, they are issued non-lethal weapons and hard vehicles to take care of crowd control.

Trained in specific ways of dispersing large numbers of people, Riot can seal off entire blocks and disperse thousands. Riot's non-lethal weapons have been criticized (due to accidental deaths which have occasionally occurred). However, NCPD maintains the attitude of "If you don't want to get hurt, don't riot," and it seems to work for them.

RESPONSE TIME: FAST

Riot units consist of one officer plus 10 troopers.

### Typical Riot Trooper

INT: 6 REF: 7 TECH: 5  
COOL: 7 EMP: 6/6 ATTR: 6  
LUCK: 6 BODY: 8 MA: 8

**SKILLS:** Authority 4, Intimidate 7, Brawling 9, Dodge/Escape 5, Melee 7, Awareness 5, Athletics 6, Human Perception 3, Rifle 6, Persuasion/Fast Talk 4, SMG 4, Streetwise 6, Handgun 7, Aikido 6, Karate 6

**CYBERNETICS:** Usually none.

**EQUIPMENT:** Standard Issue Riot Armor and Helmet, Standard Issue Riot Shield, CA-MAP Ordnance Weapon, 6 chemical shells (Tear Gas), 4 standard shells, 4 taser shells, Excalibur Patrol Stick, Militech Military/ Police Shotgun w/4 Magazines

Note: One man per unit is issued with a Deluge CCW instead of a shotgun and acts as a support trooper. Riot officers are identical to the standard trooper except: Authority 6 Persuade/Fast Talk 6 Awareness 7, Armed with a Hurricane Assault Weapon; Vehicle: These units use the BMW 910a Police Transport

### NETSEC

Net Security Section provides an enforcement, monitoring, and information service on areas of the Net within a specific city. While NETSEC's main priority is to track down the most dangerous and daring criminal netrunners, they also provide all other sections with up-to-date information straight out of the Net. Not all municipalities have a NETSEC; many rely on the services of NETWATCH, the International Net Security organization.

Besides monitoring for illegal netrunning, NETSEC also performs its own information search runs—NETSEC runners often provide valuable information on suspects or corporations (which can lead to a conviction). This is rare, but cops will know a great deal more about their suspect after a Netrun details all his affairs...

NETSEC officers tend to be somewhat highly-strung, and are allowed into NCPD without Academy training. NETSEC monitors prospective operatives and recruits them, deputizing them in a similar way to CorpCops. These individuals then become officers within NETSEC with access to top level hardware, software and headware allowing them to become even more proficient in their chosen area of Netrunning.

RESPONSE TIME: AVERAGE

#### Typical Netsec Operative.

INT: 8 REF: 10 TECH: 9  
COOL: 6 EMP: 7/6 ATTR: 8  
LUCK: 8 BODY: 5 MA: 6

**SKILLS:** Interface 8, Awareness 8, Handgun 5, Basic Tech 6, Stealth 5, Education 7, Wardrobe/Style 9, Personal Grooming 8., Cy-



berTech 8, System Knowledge 8, Streetwise 7, Cyberdeck Design 8, Programming 9, Composition 7, Electronics 8., Persuasion/Fast Talk 6, Expert (Law) 2, Brawling 2, Melee 3,

**CYBERNETICS:** Interface Plugs, Wet Drive, Cybermodem Link, Chipware Socket, Adrenal Booster

**EQUIPMENT:** MirrorShades, 'Haight Street' Cigarettes, Malorian Arms Heavy Flechette Pistol, Police Issue Combat Deck, Eji of Japan clothing (loud and garish).

### INTERNAL AFFAIRS

Internal Affairs Division (IAD) is the bane of most police officers; its job is to investigate officers suspected of committing gross misconduct in the pursuance of their duties, or who are corrupt, dangerous, or perform other activities which either abuses their position, or endangers the Department as a whole. Experienced investigators, IAD officers are selected for their ability to sniff out when a cop is "bad."

IAD is not well liked by other divisions. They have the ability to turn an officer's life upside down on the mere *suspicion* of illicit involvement. An officer under investigation by

the IAD may be suspended, or worse, and there is always a stigma involved as your partner and buddies wonder if you really *are* a dirty cop.

RESPONSE TIME: VERY FAST (faster than you wish)

#### Average IAD Officer

INT: 9 REF: 7 TECH: 6  
COOL: 9 EMP: 7/7 ATTR: 7  
LUCK: 6 BODY: 6 MA: 7

**SKILLS:** Handgun 7, Social 6, Streetwise 8, Persuasion/Fast Talk 7, Authority 6, Education/Gen. Know 7, Interview 9, Library Search 8, Interrogation 8, Shadow/Track 8, Intimidate 7, Dodge/Escape 6, Expert (Law) 9, Melee 5, Awareness 7, Disguise 6, Rifle 5, Human Perception 7, Elec. Security 7, Forgery 5, Pick Lock 7, Aikido 4

**CYBERNETICS:** Usually none; sometimes Voice Stress Analyzer, or Digital Camera optic

**EQUIPMENT:** Glock Thirty Machine Pistol, Personal Body Alarm, Advanced Alarm Removal Kit, Newsviewer Security Scanner, Image Wallet, Laptop Computer, Kevlar Armor Jacket (SP=14), Mirrorshades, Evidence Bags (6)

### ADMINISTRATION DIVISION

Admin Div is manned mostly by non-cops: secretaries and other desk jockeys performing most of the administrative duties of the police department. While it is possible to transfer to Admin, nobody really wants to, unless they've had a real good scare or have been seriously wounded. Admin positions, unless very high up, hold little or no prestige among other officers.

### BACKUP AND RESOURCES

This section examines the types of backup an officer may have access to. For ease of reference, the backup types have been *broken down into* two sections: Immediate and Resource.

Backup can be called in two ways:

- If the officer requires immediate backup in the line of duty, all he has to do is call it in on



### Seconds are like hours when you're bleeding your life out onto the Street.

his communicator. Backup will then be dispatched to the officer at the earliest available opportunity, if not immediately.

- If the officer requires a resource-type backup he may attempt to reserve it in advance. For example, an officer wishes to go undercover. In this case the officer makes a request to his direct superior; in almost all cases there is likely to be a certain time lag between request and receipt of assistance.

## IMMEDIATE BACKUP

### Assistance

This can be called in anytime on communicators via the Police Dispatch System. There are innumerable cases when an officer, or officers, will encounter a situation they cannot deal with alone. They may be outgunned, they may be unable to continue pursuing a criminal, or one of a hundred other reasons. This is when an officer should request assistance.

Officers should be specific when requesting assistance, stating their name, badge num-

ber, location, type of assistance requested, type of situation encountered and speed of response required.

Example: "*Harris, 302, Back of Funes on 46th St., Vehicle Assistance, Gang Shootout, Now!*"

RESPONSE TIME: FAST

Example: "*Unit 302. Request Backup. 1500 block of 1st Street. Situation: [traffic stop, suspicious person, etc.] Additional information: [suspect description, vehicle number, etc.]*"

RESPONSE TIME: AVERAGE-FAST

### Officer Down

If, when calling for assistance, one or more officers have been seriously wounded, the officer requesting assistance can add "Officer Down" to their message. This will ensure a speedy response and will also serve the purpose of calling in a Paramedic team.

Example: "*302! Shots fired! Officer down! 1500 block of 1st!!*"

RESPONSE TIME: VERY FAST (if not faster!)

## PARAMEDICS

Should anyone become seriously wounded (civilian, officer, etc.), the officer on the scene can call in for Paramedics. This message will be dispatched directly to the rapid-reaction Paramedic Services working in coordination with the police.

Officers should state the severity of the situation and call for a specific number of paramedic units if more than one is required.

RESPONSE TIME: AVERAGE-FAST

Rapid Response Paramedic Unit: 3 man unit (2 paramedics and 1 driver) in New American Autoworks Ambunaught.

### Typical Paramedic

INT: 6	REF: 7	TECH: 7
COOL: 7	EMP: 6	ATTR: 5
LUCK: 5	BODY: 6	MA: 6

**SKILLS:** Awareness 4, Basic Tech 5, Diagnose 5, Handgun 4, Education 5, Cryotank



Operation 4, Pharmaceuticals 4, Brawling 4, First Aid 6, Medical Tech 5

**CYBERNETICS:** Sometimes; non-specific.

**EQUIPMENT:** Medical equipment detailed with other items under vehicle description.

#### Typical Paramedic/Driver

INT: 6 REF: 7 TECH: 6  
COOL: 7 EMP: 6/6 ATTR: 5  
LUCK: 4 BODY: 6 MA: 6

**SKILLS:** Awareness 5, Basic Tech 6, Driving 6, Handgun 6, SMG 5, First Aid 3, Education 4, Brawling 4, Streetwise 4,

**CYBERNETICS:** Low Lite, Thermograph optics, sometimes Interface Plugs and Vehicle Link

**EQUIPMENT:** Medical Issue Helmet (SP=20, Anti-Dazzle, Two-way radio) See vehicle description for cab equipment.

### MORGUE (AKA, THE MEATWAGON)

Should the situation be clearly too late for paramedics, the officer may call for a Morgue or Coroner's Vehicle. Similarly equipped as paramedics, the meatwagon is not armed and is designed purely to pick up dead bodies and take them away.

Officers are again advised to clearly state the number of meatwagons required. Note: One meatwagon holds five corpses. Body bags optional.

RESPONSE TIME: SLOW

Unit comprised of 2 orderlies driving a Mercedes Spacewagon 2000+.

#### Typical Orderly

INT: 5 REF: 4 TECH: 6  
COOL: 5 EMP: 5 ATTR: 4  
LUCK: 5 BODY: 6 MA: 5

**SKILLS:** Awareness 2, Education 4, Basic Tech 4, Medical Tech 3, Brawling 4, Driving 4

**CYBERNETICS:** Usually none.

**EQUIPMENT:** Medical Kit, Two-way Radio, White Jumpsuit (SP=0)

### FORENSICS TEAM

Upon reporting a crime scene, an officer may also call in a Forensics Team, especially if dealing with serious crimes. Forensics' task is to examine every feature of the crime scene closely, utilizing the latest hi-tech equipment and forensic science methods in order to gather evidence and information.

If an officer requires any type of blood or DNA check, etc., he'll also need a Forensics team. Alternatively, he may place the evidence in a sample bag and personally deliver it to the police department lab (where they will run the check). Lag time: 3 hours to 3 days.

RESPONSE TIME: AVERAGE

#### Typical Forensics Officer

INT: 8 REF: 7 TECH: 9  
COOL: 6 EMP: 7/7 ATTR: 6  
LUCK: 5 BODY: 6 MA: 6

**SKILLS:** Streetwise 4, Library Search 6, Physics 6, Human Perception 7, Interview 8, Zoology 4, Anthropology 5, Awareness 6, Basic Tech 6, Forgery 5, Biology 4, Chemistry 7, Photo/Film 6, Education 7, Expert (1 Field) 9, Pharmaceuticals 6, Escape/Dodge 4, Handgun 4, Authority 2, Expert (Law) 5, Brawling 2

**CYBERNETICS:** Sometimes. Might have Chipware Socket, Interface Plugs, Machine Link, DataTerm Link, Cyberoptic w/various options

**EQUIPMENT:** Laptop Computer (linked to vehicle computer), Cellular Phone, Poison Sniffer, Sonar Scanner, Cybercam EX-1 (linked to vehicle computer), Evidence Bags (several hundred in Minivan)

All other equipment housed in BMW 1010 Minivan.

#### Riot

Should an officer determine the need for a Riot Squad, he/she can contact the Police Dispatch System and request its presence. Number of Squads required should be communicated as soon as possible.

#### SWAT

Should an officer determine that there is a hi-risk situation and that use of SWAT would be the most effective and efficient resolution, a team may be called in via the Police Dispatch System.

#### Max-Tac

Max-Tac may also be requested when an overwhelming force threatens innocent lives, and officers on the scene are not able to (or are not equipped to), resolve the situation. Again, all that is required is a message to Police Dispatch.

Example: "*Get MaxTac here NOW!*"

#### All Points Bulletin

When a perp (Priority 3 crimes or higher) is likely to escape arrest by normal means, an officer may request an All Points Bulletin. The perp's details are made available to all authorities, and orders are placed for his immediate apprehension. APBs include all police precincts and transportation areas (such as airports and maglevs), in addition to circulating information to all Licensed Bounty Hunters.

RESPONSE TIME: SLOW-FAST

#### Roadblock

An officer in high speed pursuit, or an officer who knows his suspect plans on travelling a given route, may request a roadblock to be set up in order to stop him/her. Once the request is received by Police Dispatch, two police cruisers will be sent to block off the specified area.

RESPONSE TIME: AVERAGE

#### Name Check

An officer may request a Name Check in the course of an investigation. The name must be passed to Police Dispatch. A check will be made by NETSEC or Admin officers against police files, revealing any convictions or other information.

RESPONSE TIME: AVERAGE

#### Trace

An officer may request a Trace on any vehicle ID

plate or number in order to learn the name of the owner. The officer may also trace owners of phone or fax numbers, registered cyberware and/or registered weapons.

RESPONSE TIME: SLOW

## RESOURCE BACKUP

This type of Backup can be obtained by placing a request with your superior. The request *may* be immediately granted; however, in reality it is likely to take anything up to a week before a response is given. This situation varies greatly on the priority, and importance, of the crime and criminals under investigation.

## Psychologist



Investigating Officers may request the assistance of a police psychologist to aid them in building up a psychological profile of their suspect. This course of action happens mostly in murder investigations and other cases where the police have no idea who their suspect really is.

A police psychologist will assist with the investigation, has access to all evidence, and may interview witnesses and suspects in addition to performing psych tests on them.

### Typical Police Psychologist (Dr. J. Crowley)

INT: 9 REF: 5 TECH: 6  
COOL: 9 EMP: 8 ATTR: 7  
LUCK: 7 BODY: 6 MA: 6

**SKILLS:** Social 6, Personal Grooming 5, Wardrobe/Style 6, Interrogation 8, Inti-

**A Note on Criminal Profiles**—The more bizarre the crime, the easier it is to profile, while the more "normal" the perp's style, the harder it is. It is possible for a perp to leave psychological "fingerprints" all over a crime scene. A good profile will provide estimated race, age, education level, physical stats, and grooming. Sometimes it will cover marital status, military service, employment, residence (general location in relation to crime scene), and transportation as well.

The most common use of profiling is in homicide, sexual assault and arson cases. It cannot be taught by classroom work alone; years of investigative experience is needed for best results. Great strides are being made in the use of AIs for simulation, but such programs are closely monitored for emerging psychosis.

midate 9, Oratory 9, Interview 8, Human Perception 9, Anthropology 9, Persuade/Fast Talk 6, Education 9, Awareness 7, Expert: Psychos 9, History 6, Library Search 8, Drive 8, Teaching 8

**CYBERNETICS:** None

**EQUIPMENT:** Advanced Communications Suitcase, Image Wallet, Newsviver, Personal Body Alarm, Travel Kit, Shower-in-a-can, Takanaka 'Exec' line suit

### Surveillance

Many investigations require suspects to be placed under surveillance. This can range from domestic surveillance and bugging, to continuous 24-hour operations costing a great deal of manpower and resources. Surveillance can be vehicle, aerial, domestic, corporate and 24-hour. These requests are often turned down on political grounds.

### Surveillance Officer

INT: 8 REF: 6 TECH: 8  
COOL: 6 EMP: 6/5 ATTR: 5  
LUCK: 5 BODY: 6 MA: 6

**SKILLS:** Awareness 4, Handgun 4, Human Perception 2,

Athletics 5, Education 7, Brawling 4, Melee 2, Interrogation 2, Streetwise 4, Basic Tech 7, Photo/Film 6, Electronics 7, Elec. Security 7, Driving 6, System Knowledge (Power Grid) 7, Wardrobe/Style 5, Authority 2

**CYBERNETICS:** Audio/Video Tape Recorder, Radio Link, Enhanced Hearing Range, Voice Stress Analyzer

**EQUIPMENT:** Federated Arms X-22, Light Pistol, Shower-in-a-can, Travel Kit, Sleep Inducer, Binoculars, Advanced Alarm Removal Kit, Light Booster Goggles, Plain Clothes (several sets)

Standard surveillance vehicle is the Mercedes Spacewagon 2000+. See description for contents of Surveillance suite.

### Stores

Requests for special equipment, weapons, and vehicles all go through Stores. If an officer is in need of any of the above, he must have a chit signed by his superior and present his request at Stores. The officer and Stores sergeant both sign this chit. The issued equipment is then the responsibility of the officer, and is to be returned after use.

Stores allows officers greater freedom in their investigations, and ensures all personnel become proficient in a wide selection of equipment in the course of duty. Officers who habitually use, abuse or destroy equipment will be subject to disciplinary action. (See Personnel Files, pg. 74)

### NETSEC

If an officer determines that he requires the use of NETSEC and their abilities in his investigation, he must follow a procedure similar to that of the Stores. His immediate superior must agree with his estimation, and sign a form which NETSEC also signs (as does the investigating officer). NETSEC will then *perform the required* action and submit a report to the investigating officer.

### Witness Protection

Many cases hang on evidence given by witnesses to the crime. Lots of perps know this, so they pull out their heavy weapons and hunt the witnesses down before the trial. In the event an offi-

cer deems a witness to be endangered, he may file for Witness Protection. This system allows the investigating officer to place the witness in a police safehouse, protected by a minimum of two competent officers around the clock, until such time that there is no danger to the witness (normally at the time of the perp's conviction).

Witness Protection forms must be signed by the investigating officer's immediate supervisor (who assigns the guards) and a Deputy Chief (due to costs involved).

### Confidential Informants

The core of police work has always been on the streets. It is here that cops make contacts with Jo (and his input, Joanna). When a player creates a cop character, he may pick any two Informants from the list below. New informants can also be gained during the Lifepath procedure.

Informants may be gained and lost throughout the course of the game. They can provide solid or gunky lowdowns on loads of events on, and off, the Street. Sometimes they may need help from you. Maybe you pay them, or look the other way for them? Whatever the reason, he or she is your Informant, and is the link between you and the Street.

### C.I.'s can be any of the following:

- |   |   |
|---|---|
| <input type="checkbox"/> Vagrant            | <input type="checkbox"/> Student              |
| <input type="checkbox"/> Hooker             | <input type="checkbox"/> College Teacher      |
| <input type="checkbox"/> Street Vendor      | <input type="checkbox"/> Mercenary            |
| <input type="checkbox"/> Gang Member        | <input type="checkbox"/> Convict              |
| <input type="checkbox"/> Nomad              | <input type="checkbox"/> Prison Warden        |
| <input type="checkbox"/> Brainsdance Addict |   |
| <input type="checkbox"/> Retired Cop        | <input type="checkbox"/> Dealer               |
| <input type="checkbox"/> Corp Cop           | <input type="checkbox"/> Drug Addict          |
| <input type="checkbox"/> Bounty Hunter      | <input type="checkbox"/> Bartender            |
| <input type="checkbox"/> Store Owner        | <input type="checkbox"/> Ex-convict           |
| <input type="checkbox"/> Media              | <input type="checkbox"/> Organised Criminal   |
| <input type="checkbox"/> Indie Criminal     | <input type="checkbox"/> Private Investigator |
| <input type="checkbox"/> Street Crazy       | <input type="checkbox"/> Netrunner            |
| <input type="checkbox"/> Corporate Suit     | <input type="checkbox"/> Bouncer              |
| <input type="checkbox"/> Courier            | <input type="checkbox"/> Cabdriver            |
| <input type="checkbox"/> Trucker            | <input type="checkbox"/> Paramedic            |
| <input type="checkbox"/> Fixer              | <input type="checkbox"/> Techie               |
| <input type="checkbox"/> Rocker             | <input type="checkbox"/> Artist               |
| <input type="checkbox"/> A/I (!?)           | <input type="checkbox"/> Disc Jockey          |

## UNDERCOVER

### THE REASONS WHY...

Undercover operations are sanctioned for investigations which require enforcement officials to penetrate an organization in order to obtain the evidence required to prosecute it. In most cases, U-ops will only be authorized if there is no other course of action open to the investigating officers.

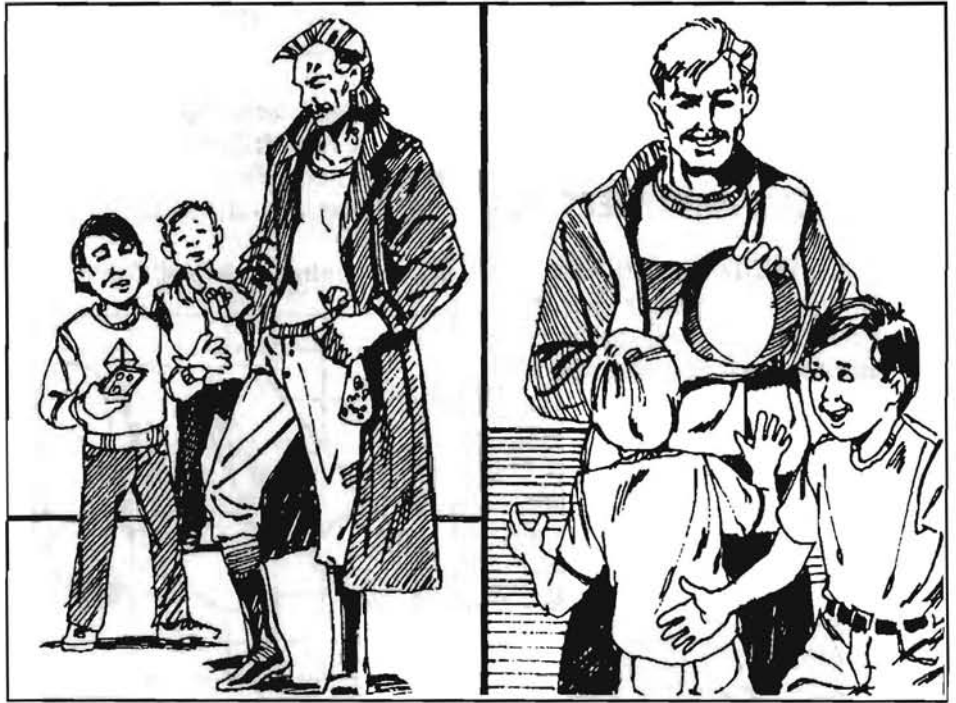

You play some antithetical roles in the Undercover game...

This is due to the considerable expense involved in these operations; many require large-scale backup, surveillance, the doctoring of official records, and injection of manpower into "cover" occupations. They are also dangerous.

U-ops most often take place when dealing with gangs, Organized Crime, and other activities that require "insiders" in order to get a handle on what's really going on. LEDiv often utilizes their large U-op wing to penetrate foreign espionage stations in the U.S., plus corporations, drug and other organized crime rings, as well as political bodies. A good undercover officer, if successful, can get enough info together to put away a lot of people for a long time. The pay's good, too. The full facial and physical surgery sometimes required can be something of a down, but hey! You don't wanna be a cop? Then throw away your badge and change your name to Jo.

### How to Go Undercover

If investigating officers determine a need to go undercover, they must put a request in to their divisional superior. The superior will assess the need, and if he deems the request reasonable, will get authorization from a Deputy Chief. This process can take anything from six hours to six weeks and is primarily dependant on who you know.

Once authorized, the investigating officers will be provided with a budget (every expenditure must be approved by their direct superior) for the Op. Undercover officers will either be supplied by another division, or the investigating officers will

go undercover themselves. Either way, they enter their "cover" as quickly as possible. From then on, the U-op team has to wing it, as they just can't call in for backup; they don't have access to their badge, etc. Forget about using your **Authority Special Ability**; depend on your *Streetwise Skill*.

Undercover requires a certain type of person. They must be confident in their cover for everything to work. If not, they'll blow it the moment the stress hits—and the stress *always* hits. If going undercover, the officers should have direct experience of the environment they are entering. Without this, they will stick out—and be dead. Organized criminals and other organizations are always on the lookout for infiltrators—it's never an easy ride.

### Dangers Involved

Many officers think going on a U-op is a good excuse not to have to wear uniform. Maybe so—but it's also a good way to get your head blown off.

If a cop blows his cover on a U-op, he's as good as dead. Sure, some make it, but they're the good ones. Most go down fast, as the infiltrated organization teaches them a quick lesson in counter-insurgency. Sometimes you even get back-up, but it can take a long time to arrive, because they don't want to be too nearby in case it blows your cover...

Many organizations may require the undercover officer to perform initiation rites (maybe that means you've gotta kill a cop!). U-ops are fraught with dangers. Only the experienced need apply. And there aren't many experienced around.



## Bonuses

You get paid time and a half for your trouble. You get to make a major bust (if you're lucky). If you're good at it, maybe LEDiv will want you for their own Undercover wing...

## GENERAL EQUIPMENT SECTION

### POLICE ISSUE WEAPONRY

The police officer of the 21st Century faces challenges that his 20th Century counterpart only saw on the movie screen. These challenges simply cannot be met by the old police .38, or even the 9mm. Fortunately for the 21st Century cop, he has at his disposal an array of effective armaments ranging from the non-lethal to the cyber-busting cannons of the Max-Tac division. The following is a selection of the available weapons currently in use by the NCPD and other police forces around the U.S.

Note that the majority of this technology is not available to the general 'Punk public, being restricted to police and para-military use only.

### CONSTITUTION ARMS MULTIPLE AMMUNITION PISTOL

CA-MAP P 0 J P Varies (12mm) 6 1 VR 50m (V) 525eb

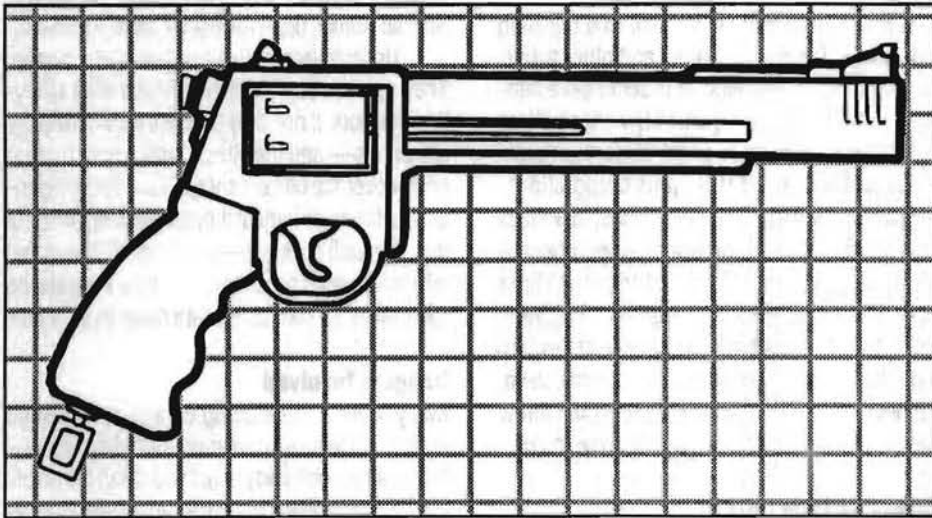

Designed by Constitution Arms to take advantage of advances in the field of ordnance technology, this revolver is designed to offer the user a choice between lethal and non-lethal response to a situation.

The standard model is equipped with a rapid selector switch (to select between rounds before firing) and a readout display under the rear sight, which informs the user of the round selected. Smart-chipped models give the user direct control over selection and round information is

provided directly to the user (requires Time Square Marquee).

### Constitution Arms Multiple Ammunition:

**Standard Round:** General purpose 12mm shells with a 50m effective range, and causing 4d6+1 damage. A box of 50 sells for 20eb.

**Hyper-Penetration Round:** Consists of a

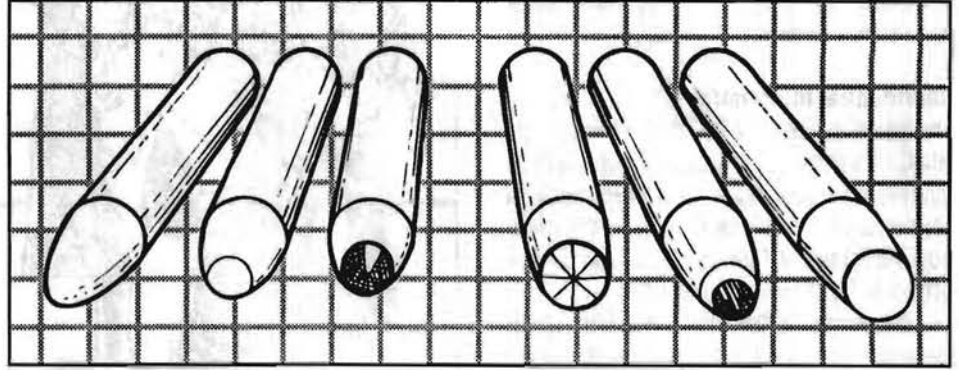

lead slug, surrounding a cadmium rod core with a higher than average propellant mass to provide an increase in velocity. If the round hits a soft target, it will mushroom like a standard round. However, upon impacting an armored target, the lead slug is halted, allowing the cadmium rod to

penetrate the armor. The round does 4d6+1 and is treated as armor-piercing or normal, whichever does the most favorable damage to the target. A box of 50 rounds sells for 60eb.

**Chemically Propelled Dart Round:** This round has a reduced propellant load to accommodate a small dart in its tip, capable of delivering toxins of various types. A CPD has a range of 45m and inflicts 1d6 damage plus any effects caused by the toxin payload. It is

considered AP vs. Soft Armors (i.e., leather, Kevlar-T, Lt. Armor jacket). Constitution Arms only sells sleep darts (officially). A box of 50 rounds sells for 40eb.

### Chemically Propelled Capsule Round:

Three types of CPC are available, each designed to release their payloads upon contact with a solid object, breaking the capsule within the slug

body. The three types are a paint round, used mostly for training, a sleep round favoured by many riot units around the world, and finally, an acid round (with a variety of uses, not against human targets; treat acid capsule as airgun load, 2 rounds duration). The round has a reduced propellant load, and thus only has a range of 45m. A box of 50 paint shells costs 25eb, while the sleep and acid rounds both sell for 40eb per 50 shells. It is also possible that other payloads could be used.

**Chemically Propelled Taser Round:** A relative breakthrough in taser technology. This shell avoids the problem of the taser's limited range by using a chemical propellant with the taser built into the projectile. Upon impact, the round causes 1d6 damage plus the usual taser effects. However, due to the low power of the weapon, all saves against the effects of the weapon are at +2. There is also a 1 in 10 chance that the impact will cause the taser to malfunction and fail to release its charge. A box of 50 of these rare rounds costs 80eb.

**Explosive Round:** Designed for the rapid 'lock-picking' that police so often have to carry out, this round is an effective anti-personnel weapon as well. The impact-activated warhead is formed of an experimental explosive with a far greater explosive yield than existing types. The range is 50m and the explosion causes 2d6 damage in a 1m blast diam. A box of 50 sells for 100eb.

**ARASAKA RESTRAINT CASTER**

P -1 J P Tangle (15mm) 4 1 ST 25m 200eb

Advances made by Arasaka in reactive polymers have made a popular weapon from generations of science-fiction stories a reality. This oversized pistol fires a low velocity capsule of reactive polymer which, upon contact with the atmosphere, assumes a semi-solid form and spreads into incredibly strong tendrils of polymer. These strands wrap around anything that they come into contact with. A human entangled by these strands will be effectively immobilized.

The tangles may be broken through, requiring a Very Difficult roll against Body Type (or against the strength of a linear frame or other cybernetics).

The polymer dissolves in around 20 minutes (plus or minus 1d10 minutes) or can be removed with a solvent.

Polymer shells cost 60eb for a case of 20, and a solvent spray costs an additional 10eb (10 uses).

**CONSTITUTION ARMS HURRICANE ASSAULT WEAPON**

SHT 0 N P 4d6 (00) 40 2/20 ST 70m 1000eb

The Hurricane is an automatic-action shotgun (12ga. magnum) that utilizes a dual reciprocating

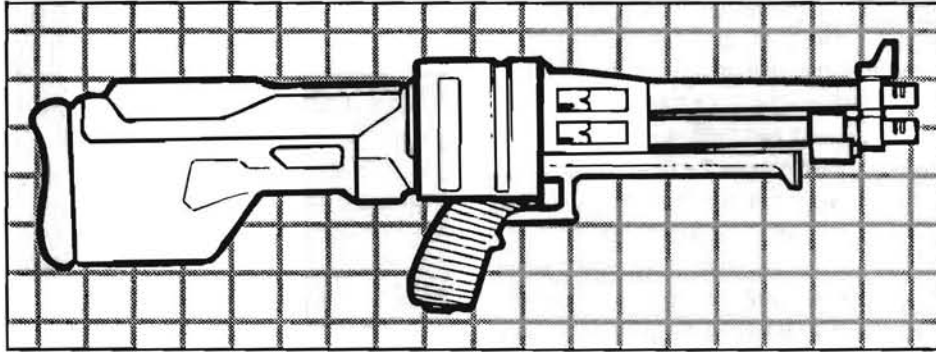

barrel action to minimize heat problems. The weapon is equipped with a forty-round saddle drum magazine, plus hydro-shock recoil compensation (mounted in the stock) that enables accurate autofire. The Hurricane was designed initially for urban police units requiring an effective weapon against street violence and crowd control that required extreme force. However, the use of this weapon has come to the attention of many Max-Tac units, who see the smart-chipped version as a perfect anti-cyberpsycho system. Note: Slugs do 4D6 AP, but damage is not halved after penetration.

**CONSTITUTION ARMS CYCLONE SQUAD SUPPORT WEAPON**

HVY +1 N P 6d6+2 (7.62mm) 100 35 VR 1200eb

One of the few weapons specifically designed for the type of mission so frequently given to the likes of Max-Tac. The weapon is chambered for 7.62mm caseless ammunition and has a 100 round drum magazine to feed it. The high rate-of-fire and stopping power of the 7.62mm round makes the Cyclone effective against any human or semi-human target. Military sales have been disappointing to CA, but the potential of the Cyclone has been discovered by the police force and so production will continue.

**REMINGTON GYRO SNIPER RIFLE**

RIF +2 N P 7d6API (18mm) 6 1 ST 600m 1000eb

A development of the gyrorocket system initially proposed by Militech in 2008, the Remington Gyro fires a rocket-propelled, gyro-stabilized shell. Through the use of advanced sensor technology, the shell homes in on the weapon's laser designator. The designator's integral rangefinding computer determines such factors as wind speed/direction, distance to target, and so forth, and then vectors the shell through use of its steering jets towards the intended target. Low Lite and Infrared capabilities are built in.

The incredible stopping power (and long range) of the Gyro has earned it the nickname "Zeus' Lightning" among the police and Max-Tac snipers.

Its ammunition is quite expensive, selling at 400eb for a case of 50 shells.

Note: because a rocket shell takes time to reach full velocity, the weapon does 3d6+2 and is 0 Acc. at 75m or less. Armor-Piercing Incendiary

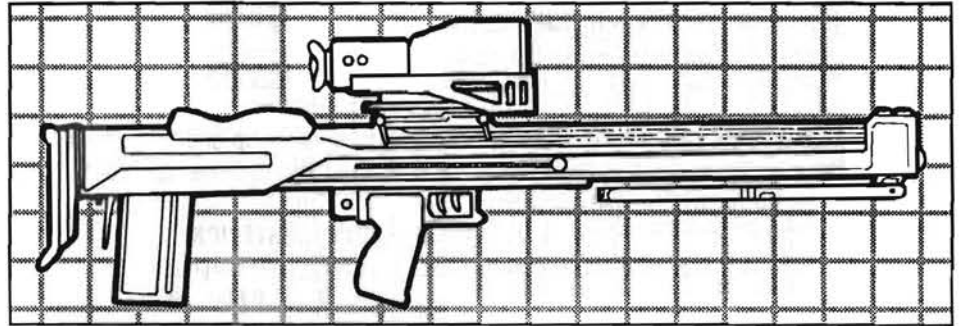

(API) ammo does an extra 1d6 damage for 2 rounds after hitting. Armor **does not** stop this extra damage.

**CONSTITUTION ARMS DELUGE CROWD CONTROL WEAPON**

HVY 0 N P 1-2pts+Drugs 400 35 ST 60m 800eb

The Deluge is essentially a machine-cannon that fires darts of ballistic polymer at an extreme rate of fire. Designed as a crowd-control weapon, it is capable of quelling a riot in a matter of minutes

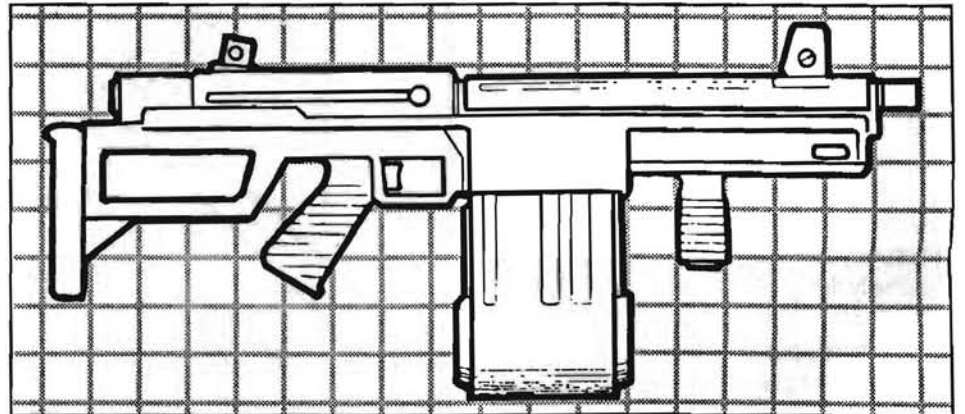



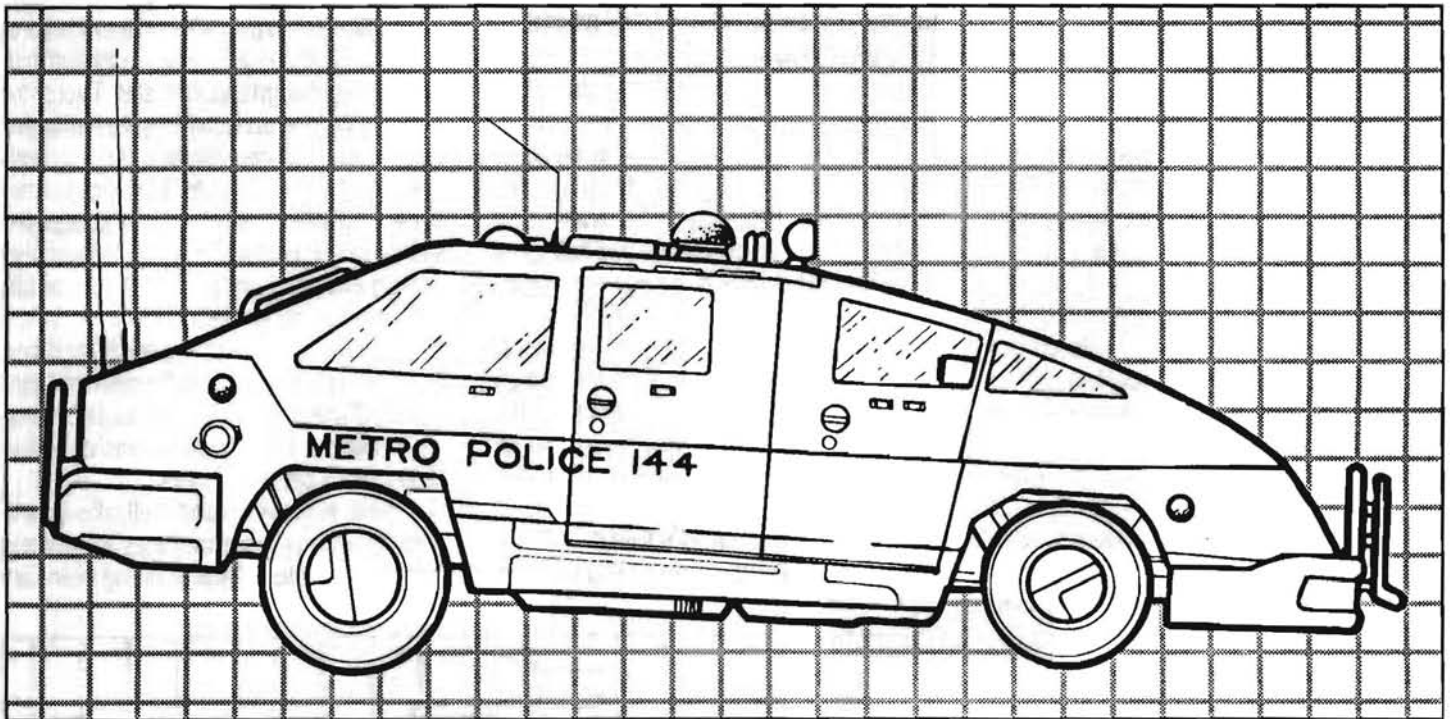

due to the sleep drug that each sliver is impregnated with. Because of this potentially non-lethal ability, the Deluge is most often seen mounted upon riot trucks and occasionally on other police vehicles. The magazine contains 400 sleep darts and a compressed air canister required to fire the weapon. A magazine sells for 125eb and they are only available in sleep dart format.

Recently, human rights groups (Yes, there are still one or two about!) have raised concerns over the Deluge due to its rate of fire, and the possibility of multiple hits upon one target causing an overdose on the sleep drug, or even the target being literally torn apart by the hail of darts. So far though, there have been no fatalities in Night City since this weapon was implemented.

#### STREETTECH 'BURST'

SHT Var P E 2d6+1(28ga.) 1 1 VR 3m 33eb

The latest in self-defense weapons from StreetTech. The Burst looks like a small flashlight. It is triggered by unlocking its built-in safety mechanism and thumbing the switch, which electronically detonates the weapon's propellant and fires its payload of pellets.

Designed to rapidly lose their destructive power, these pellets are ineffective beyond 3m (-1 accuracy at 0-1m, -2 at 1-2m, -3 at 2-3m). Originally designed as an emergency hideout weapon for police officers, StreetTech has recently re-packaged this design for public consumption, producing Burst models with design-

er key rings for the up-and-coming executive wanting that hidden defense (40eb each).

#### EXCALIBUR NIGHTSTICK

Taser-type MEL 0 J P Stun (Taser) 8 1 ST 1m 80eb  
Mace-type MEL 0 J P Mace Effect 6 1 ST 1m  
Basic-type MEL 0 J P 2d6+3 - - VR 1m

The melee weapon for the officer of the 21st century, this state-of-the-art nightstick is manufactured from industrial strength ceramics. In addition to its solid hitting power, the ENS is equipped with two hidden extras, ideal for suprising the creeps on the street. The business end of the weapon incorporates a taser or hidden mace-sprayer, while the side handle holds the trigger mechanism. Just right for those punks who won't lie down! The taser is rechargeable from any standard wall socket, while new mace canisters can be bought for 5eb a six-pack.

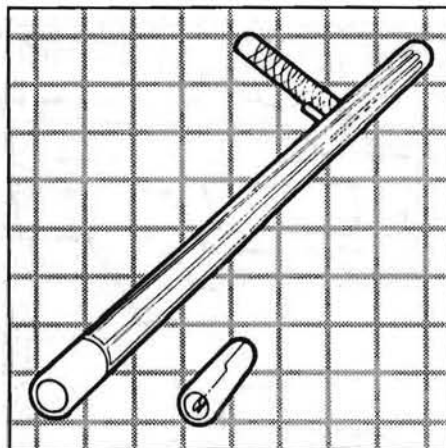

## POLICE VEHICLES

### BMW 600

Patrol Crusier 25,000eb

Based upon the tried-and-tested BMW 400 chassis, the 600 is the new police cruiser intended to provide officers with a fast and secure form of transport within the confines of any megaurban city.

Seating two officers in the front seats, the 600 has sufficient room in the rear to hold two perpetrators, in the high-tensile restraints provided, if necessary. The occupants of the vehicle are given maximum protection by the thick ballistic armor that cocoons the bodywork (SP=20, SDP=50), while the tires are protected by ceramic-core radial bands (SP=15).

Standard features on the BMW 600 include a multi-band radio, on-board police computer patched into the central precinct mainframe, sirens and high-intensity lights, as well as a loudspeaker system and remote searchlight. For those friday nights down in the warzones, gunports are provided in the front and side armor, allowing an unrestricted field of fire for the occupants.

Standard Police Cruiser Inventory: 2x Respirator units (15 minutes independent air supply), 2x Militech Military/Police Shotguns w/6 magazines, 6x magazines per officer for issued sidearm, 2x pairs Ion Cuffs, 4x pairs Plas-Cuffs 1x set of Binoculars, 2x Biotech/Askari Motion Restraint Bombs



**BMW 2020****Urban Patrol Vehicle 85,000eb**

The tiger of the urban jungle, the 2020 is a heavily armed and armored urban fighting vehicle. Designed to house just two crew, the vehicle contains a small containment facility, which at a squeeze can accommodate up to four prisoners (In some discomfort, but then they aren't there for the ride!).

Standard features include multi-band radio with a tight-beam transmitter/receiver, an on-board computer, automatic fire extinguishers, siren, lights, crashbags for emergency maneuvers, an infrared and lowlight viewer, and a 400m radar suite for those smoke-ridden battlefields and shopping malls.

The vehicle has a solid four-wheel drive system using new solid tires (SP=20), which support its heavily-armored frame with ease (SP=30, SDP=75). Included is a remote turret capable of holding most heavy weapons systems; common types tend to be the Deluge for crowd control actions, or for those cyberpsychos, the good ol' M-134 Minigun.

Top speed is 150kph on road, or 75kph off-road, a definite must for all of those tricky-to-catch creeps who like cross-country running.

**BMW 9-SERIES****Performance Interceptor 55,000eb**

Considered by many to be one of the fastest and meanest vehicles on the roads today. This nightmare on wheels can push at a terrifying 350kph on the roads, more than enough to take the life out of any speeder.

Designed for speed and duration, the 9-series has only two seats in its cab, the rear two being replaced by a pair of reserve fuel tanks, giving it double the effective range of most other performance vehicles. Features such as protective airbags, auto-fire extinguishers, crash cage, and an impressive 600m LowLight and Radar suite are fitted at the factory, and although no weaponry is included, space is provided for a few little 'extras' under the hood.

There are few vehicles that can stand against the sheer power of the Interceptor, and fewer are prepared to try!

Standard Interceptor Inventory: Interface Link, Computer SatMap with transponder, First Aid and survival kit, Weapons locker: your choice of 1 Hurricane Assault Shotgun, or 1 Militech Ronin Assault Rifle, or 1 Stein & Wasserman Model F "Cyborg Assault"; plus 2x Armalite .44 Pistols w/6 magazines per weapon

Popular vehicular weapons include the Barrett-Arasaka Light 20mm Cannon, or the Scorpion 16 Missile Launcher with an auto-feed mechanism (3 rounds) mounted in the front-left wing of the car.

**BMW 910a/910b Police Combat/Perpetrator Transport Vehicle 100,000eb**

This tried and tested vehicle comes in two major forms. The 910a is designed to transport officers into and out of a variety of hazardous environments, while the 910b is primarily used to transport prisoners in large numbers to holding areas and prison complexes. Both

vehicles have forward driver compartments equipped with two seats, multi-band radio, siren, lights, air bags, Infrared viewer, 100m radar and automated fire-extinguishers. Both are also fitted with six-wheel drive for steady maneuvering.

The police carrier can transport up to ten officers in full riot gear, or up to sixteen in an emergency. There are four fire ports on each side and a further two in the rear, providing all-round offensive capability.

The prison version is equipped to carry up to twelve prisoners, with seat restraints, if necessary, capable of holding even enhanced perpetrators. In addition, the rear section can also be flooded with a toxin that will cause unconsciousness within thirty seconds. Both vehicles have SP=30 and SDP=80. The tires have SP=15. Top speed is 140kph, or 70kph off-road.

**BLUE KNIGHT****Police Motorcycle 6000eb**

Produced by the Harley-Davidson company, the Blue Knight is the choice of the NCPD Traffic police. It comes equipped with multi-band radio, on-board computer, siren, lights and bullet-proof fuel tank and windscreen (SP=20).

While produced without weaponry, a light SMG can be mounted on the front of the bike (150eb to mount and fit remote trigger). The bike has SDP=36 and the tires have SP=15. Top speed is 240kph.

**BOEING CITYHAWK UAAV 800,000eb**

The Cityhawk Urban Airborne Assault Vehicle

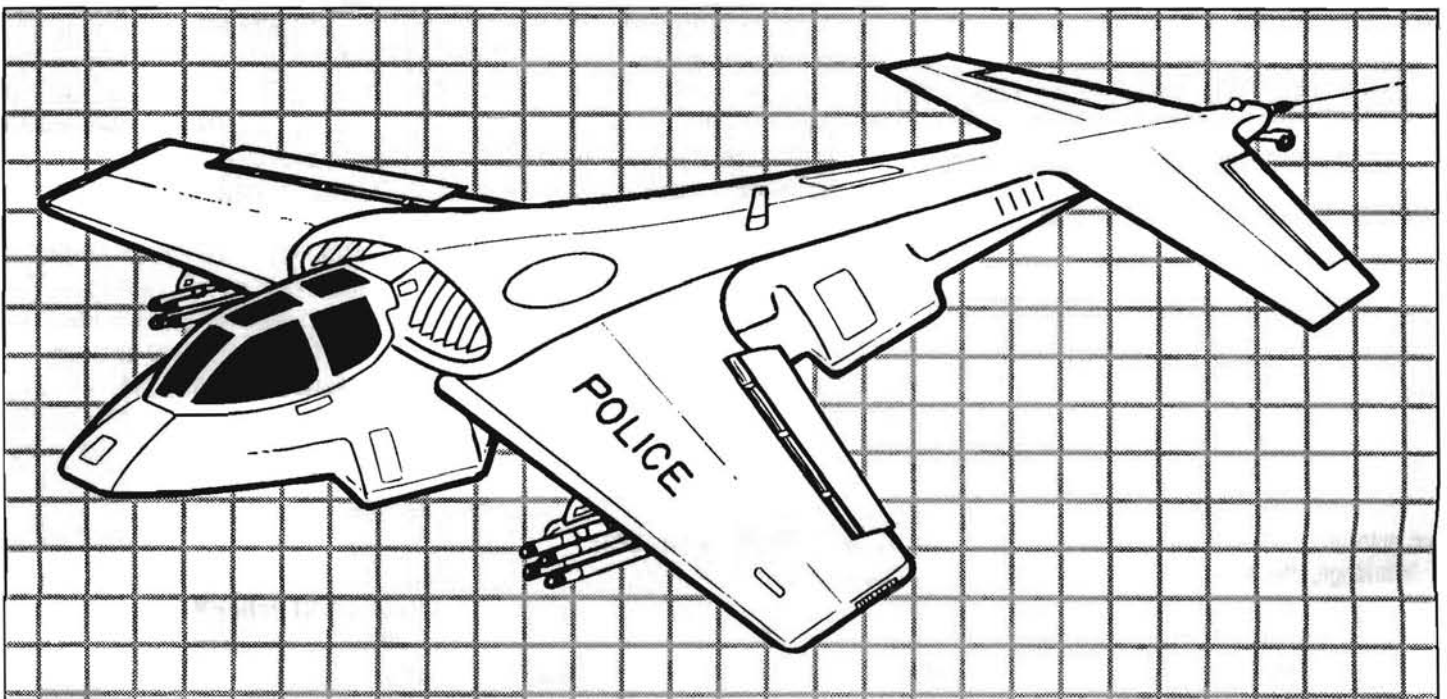

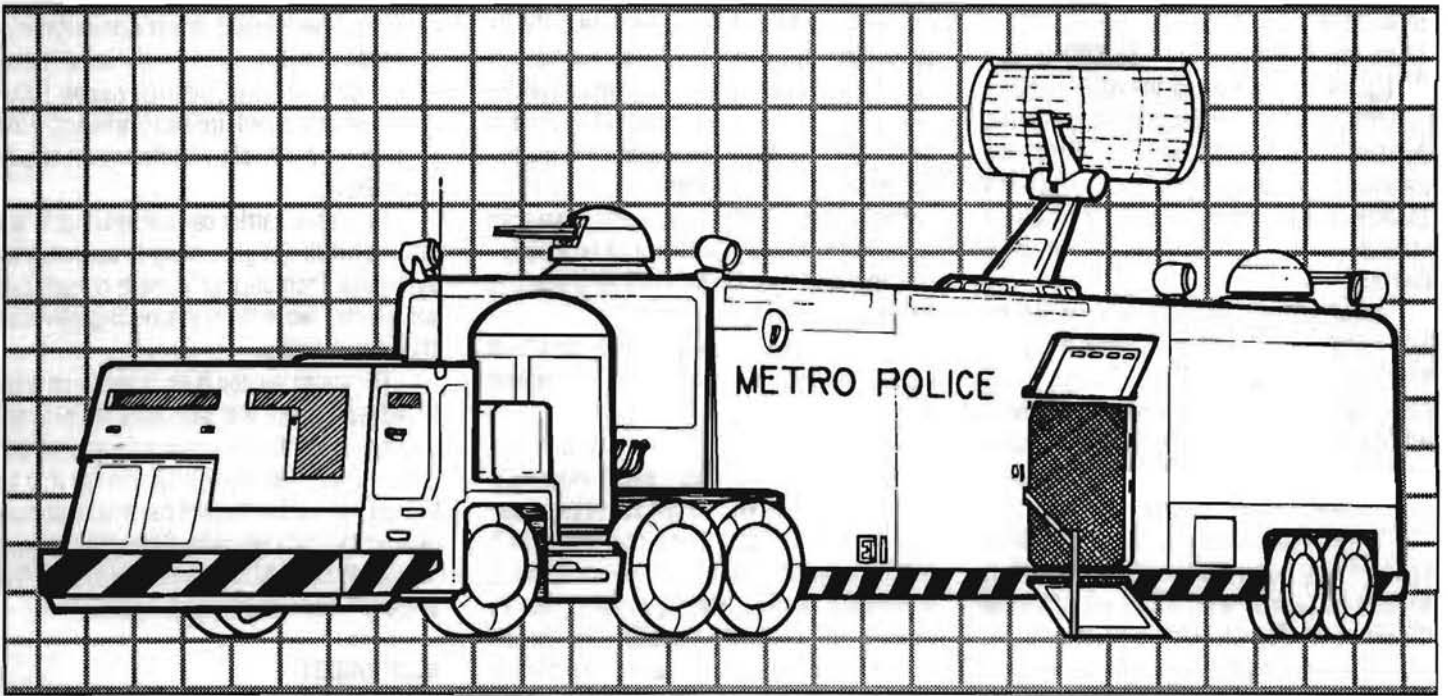

### MILITECH IVa Central Mobile Command and Control Center

is designed to maintain order in urban areas. The vehicle is similar in design to an AV, but is more closely related to VTOL aircraft. Standard equipment includes two ejection seats (pilot and gunner), a highly advanced sensor suite (Infrared, Lowlite, Image Enhancement, TeleOptics, and 100km Radar), ECM, flare launcher (20-round magazine), chaff dispenser (4 loads), onboard computer, multi-band and tight beam radio, and auto-fire extinguishers. The UAAV maneuvers exceptionally well (it was designed to fight between skyscrapers) and gives the operator a +2 bonus on his piloting skill rolls. A standard CityHawk is armed with one or two M-134 Miniguns (one in a chin turret and one in a tail mount), and has two launch pylons capable of holding Scorpion 16s or other rockets and missiles. SP=50, SDP=85. Top speed is 600kph.

### HUEY Police Helicopter 210,000eb

Intended as a low cost alternative to the AV or UAAV, the Huey PH comes standard with IR, LowLite, and telescopic video system as well as a 60km radar. Defensive systems include ECM, a chaff launcher (2 loads), and a flare launcher (6 rounds). Offensive capacity is limited to a chin-mounted M-134 Minigun or an auto-grenade launcher (ROF=6, 30rnds., 500m range, effects=hand grenade types). The PH can carry up to four people in addition to the pilot and gunner. Airspeed is 480kph. SP=20 and SDP=65

### BMW 1010 Minivan 23,000eb

The BMW Minivan is considered by many to be the workhorse of the police department. It is a four-wheel drive transport vehicle, designed to be used in a variety of police activities. Its primary use is as a portable lab and transport for the forensics teams, who require a fast and easy way to move their equipment from one crime scene to another. The Minivan can accommodate a total of four people, along with a large scientific computer and test equipment. The standard model is equipped with a multi-band radio, siren, lights, and a satlink antenna for transmitting data to the central police mainframe system.

The vehicle does possess a limited amount of armor, providing it with SP=15 and SDP=35. Top speed is 120kph, or 60kph over rough ground. The Minivan has no weapons, although space is provided for a single weapon mount on the roof (a Cyclone SSW is a popular fitting in the more hazardous areas).

Standard Inventory for a Forensics Team: 1x Armalite .44 Autopistol w/4 Magazines, Portable Forensics Lab (+1 to all related skill checks), Drug Analyzer, Mini-Computer (connected via satlink to Police Central computer), Ballistics Kit, Medical Examiner Kit

### MERCEDES SPACEWAGON 2000+ 32,000eb

One of the few common police vehicles not originating from the BMW company. The SpaceWagon is the standard unmarked truck used by the under-

cover units of the NCPD. It is a medium sized CHOOH2-burner with no exterior markings, designed to be inconspicuous and neutral in appearance. The interior of the vehicle is split into two areas. The cab area has smoked glass windows and can hold up to three people in limited discomfort. The rear section can hold only one person, the main bulk of it being filled by the advanced communication and surveillance suite. This rear section is sound-proofed and both rear-windows are smoked to provide maximum discretion for the occupant.

Aside from the surveillance version of the SpaceWagon, the NCPD utilize several other types, each with the modular rear-section used for a different purpose, such as the SpaceWagon Meatwagon units, which hold up to five bodies in the back of the vehicle.

The vehicle has very little armor (SP=5, SDP=25), and has standard tires. Top speed is 70kph, 30kph on rough ground.

Standard Inventory for a Surveillance Team: Jamming Transmitter, Movement Sensor, Police Mini-Computer, Radio, Scanner, 4x Linetaps, 1x H-7 Droid and sensor link, 2x Linozaps, 1x Pseudo-Dragon, 2x Airborne Surveillance Units, Electronics Kit, Power Grid Solar Electric Panel, 1x Movie and Still Camera suite w/LowLite, IR, and telephoto capability

### NEW AMERICAN AUTOWORKS

#### AMBUNAUGHT Police Paramedic Version 76,000eb

Based upon the standard Ambunaught design



(see *Chromebook*), the Police version is designed to extract the wounded from more hazardous environments, such as the streets of Night City. The Police Ambunaught is treated as a standard version except that it comes mounted with two 180° Grenade Launchers (equal to Militech drum-type GLs w/Tear Gas), or a remote turret-mounted Deluge Crowd Control Weapon. All armor for the vehicle is identical to the standard version.

Standard Inventory for a Police paramedic unit: Rear locker—Medscanner, 2x Surgical Kits, Cryotank, 4x Spray Skin Canisters, 12x Airhypos with painkiller loads, 4x Mastoid Communicators, 1x Tech Tool Kit, 4x Respirators, 1x Movement Sensor; Cab locker—2 Armalite .44 Auto Pistols w/2 magazines per weapon, 1 Militech Ronin Assault Rifle w/4 magazines, 1x Tool Kit, 2x Respirators.

### MILITECH IVa Central Mobile Command and Control Center 250,000eb

Considered by the Law Enforcement agencies of the world to be one of the most well designed and engineered tactical command vehicles available. The CMCCC system comprises an articulated tractor-trailer rig massing some forty tons in weight, protected by some of the best armor and armament systems on the market, and housing some of the most advanced surveillance and communication equipment available.

Capable of a top speed of 80kph (running on standard synthetic fuel), the CMCCC is a fast and reliable method of achieving tactical and strategic coordination of any force, in any situation.

The interior of the CMCCC is a high-tech command centre, designed using only the best technology and expertise from the labs of the Militech Corporation. Within this vehicle are the following systems:

1. Office Communications Suite with four additional miniscreen TVs, each linked to an external audio/video recorder unit, providing all-round vision of the area surrounding the vehicle. This unit is always manned by a Police Technical Officer.
2. Surveillance Communications Suite similar to that used by the Surveillance teams in the Mercedes SpaceWagon 2000+. This unit is manned by a Surveillance Officer when in the field.
3. Police Cyberdeck Interface linked via radio splice to the main Net, and by dedicated link to the Police Central CPU. This deck is similar to the Police Issue deck, and its memo-

ry is empty, allowing individual NETSEC officers to utilize their own personal programs when the system is needed.

4. Militech Multipurpose Weapons Console linked to the vehicle's weapon systems and security cameras. In addition, this console can be linked by radio to any remote weapons, and then used to direct fire from those weapons. This function has a maximum range of 5km. Using the console, all weapons can be voice-activated, fired manually, or set to fire upon any moving target by the weapons officer who mans this console at all times.
5. Command Console manned by the Chief Tactical Surveillance Officer. This console can be used to patch into all activities of the various other consoles and, if necessary, assume control of their functions.

The exterior of the trailer area is protected by fireproof armor (SP=30, SDP=200), while the tractor cab is armored to a lesser degree (SP=20, SDP=75).

The roof of the vehicle holds two APEX II turret systems (see Apex in *Chromebook*), one at the rear of the main body and one at the front. Both of these turrets have a 270° arc of fire, which stops them from crippling or destroying each other. Both turrets are linked to the Weapon Control Console inside the vehicle, through the security cameras mounted above the weapons.

Both flanks of the vehicle mount additional security cameras to provide 360° vision to those inside.

The roof section of the trailer is also fitted with four Power Grid improved solar panels, allowing the CMCCC to operate in the field independently from any fixed power supply, although links at the base of the fifth-wheel socket are included for power hook-ups when necessary. In addition, a series of internal batteries can be hooked up to provide thirty-six hours of power.

Each corner of the trailer is also fitted with powerful spotlights, which can illuminate an area 80m around the CMCCC.

A limited arms locker and some medical equipment is kept in the trailer section, but the content depends greatly upon the situation the vehicle is being used for.

### POLICE ROBOTS AND AI SYSTEMS

Modern police operations often involve the use of robots. While their most common use is for surveillance, the use of combat robots is not unheard of, and is in fact, growing more common.

### ROBOHOUNDS

The Robohound is a reasonably recent addition to the support services. Designed with diversity in mind, these hounds (a modular, computerized, robot system built of plastics/ceramics in a working animal shape) can perform a wide range of services. From providing guard duty at precincts, through

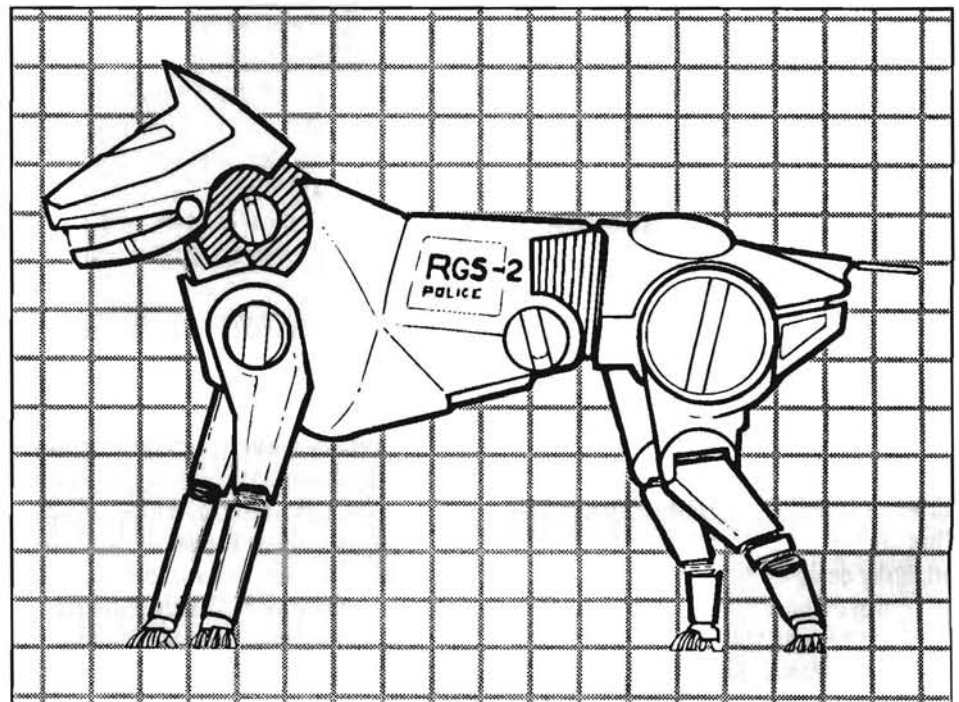



tracking perps, to large-scale crowd control. Unlike many of NCPD's toys, this one is actually useful. Most often used by Tactical Division, the RoboHound is an efficient and savage recruit.

### **The Lawtech Unlimited Police Model Robohound 3625eb**

Tri-Plastic frame; Great Dane Body: 10 REF: 10 MA: 20 ARMOR: 20 SP

Programs: Dog Behaviour, Kill System (Threaten, Attack, Patrol), Track: Specific, Target Restrain: Sharpwire System, Suppressive Fire: Mini-Rockets

Stealth Pad Feet, Chemical Bio sensors and sniffers, Infrared Vision, Increased Strength: +2D6 bite damage

CarboGlass Teeth: +2D6 Bite (for total damage=4d6AP), MicroRocket Launcher (ROF=5, 20rnds., 300m range) w/Nausea Gas (2m rad.) or Hi-Explosive Rounds (4d6 dam., 2m rad.), Sharpwire Net Launcher (+2Acc., 10m range; target must make Dodge roll to avoid entanglement; if target struggles, apply BOD/3 dice of AP damage; must use knife or other tool to escape in 12-REF combat turns)

For more on robohounds, see *Interface* magazine #1.

### **PSEUDO DRAGON**

#### **Aerial Surveillance Unit 800eb**

A battery-powered micro-copter equipped with a video camera and advanced boom microphone system. Size: 80cmL x 30cmW x 30cmT, Rotor dia. 150cm, Weight 5kg. Battery life is six hours (recharges from wall sockets) and top speed is 60kph. The unit is remote controlled from a hand-held or mounted unit which has a 30km range. If it loses contact with its controller, it will slowly descend until it touches a surface, then will shut down and emit a homing signal (same range as the control system). If contact is re-established, it will automatically re-start. The unit has SP=2, and SDP=4, target modifier=-2.

### **ORACLE**

#### **Airborne Surveillance Unit 1500eb**

This flying saucer-shaped device was originally designed for military use, but was adopted by the police of Night City. Size: 1.0m Dia. x 25cmT, Weight 6kg. It is kept airborne by an internal rotor system and maneuvers

using four compressed air nozzles. Its four micro-cameras are equipped with infrared, low-lite and telescopic capacity. Its four microphones are equipped with a broad reception range and have integral sound edit facilities. The unit's power pack has a duration of around 10 hours and can be recharged from a standard wall socket. The handheld or mounted controller has a range of 60km. The Oracle has the same out-of-contact program as the Pseudo Dragon.

For an additional 200eb above the base price, the unit can be equipped with an on-board computer which enables it to patrol an area on its own, recording information (up to 10 hours). It can also be programmed to signal a control station whenever certain conditions (pre-programmed) are met. The unit has SP=4, and SDP=8, target modifier=-1.

### **H-7 Hazardous Material Handling Robot 50,000eb**

The H-7 is designed to safely dispose of explosives, chemical agents and other hazardous materials. The unit's body is like that of a small tank (an armored vehicle body with treads or wheels). Size: 2mL x 0.8mT, Weight 600kg. In place of a turret, the H-7 has a vaguely humanoid, heavily-armored torso equipped with two manipulator arms and an array of smaller manipulators and tools for disarming explosives. The unit is equipped with heavily shielded cameras and microphones, all heavily enhanced. The cameras are equipped with infrared, low-lite and telescopic functions. The unit is also fitted with chemical sniffers and other detection equipment.

It is operated using a complex control panel usually situated in a vehicle (often the UPV). This panel may be equipped with an interface link (400eb extra) which gives an additional +2 bonus to operations. Transmission range is 20km and can be boosted with a more powerful transmitter if desired.

Bomb disarming procedure uses *Demolitions*, *Electronics* or *Mechanics* skill, whichever is appropriate, rather than *Remote Systems Operation* skill.

The H-7's lower body has SP=30 and SDP=45 (disabled)/55 (destroyed), while the upper body has SP=25 and SDP=35 (disabled)/40 (destroyed). Rendering the upper or lower body useless will disable the entire machine. The H-7's arms are treated as if they are equipped with hydraulic rams. Maximum ground speed is 50kph.

### **ADREK ROBOTICS Robot Patrol Unit ALPHA 75,000eb**

The RPU-A is designed to patrol low-threat areas, such as minimum to medium security containment facilities. It's also used as a crowd control unit in situations in which resistance is not expected to be too intense.

The standard unit looks somewhat like a trashcan on balloon tires. Size: 1.5mT x 45cm Dia., Weight 120kg. It is fitted with audio/visual sensors and a loud speaker unit. The unit has two manipulator arms, the right being equipped with a Militech Electronics Taser which runs off the robot's internal battery. The left arm is equipped with an Avante P-1135 Needlegun (with a 45 round magazine), while the torso contains a Nelspot 'Wombat' paintgun (for marking suspects) with a 60 round magazine. Sensors can be upgraded as per the cyberoptic/audio options, but at 20% less cost.

Each arm has SP=20 and SDP=20 (useless)/30 (destroyed). The central torso has SP=20 and SDP=40 (useless)/50 (destroyed). Rendering the central torso useless or destroyed disables the entire unit. Maximum speed is 50kph.

Remote-controlled by either a human or AI system, the standard range between control panel and unit is 80km, which may be enhanced by greater transmission power. If not under direct control, an RPU has a limited fallback routine: return to point of last contact, return to a pre-designated location, or shut down and emit homing signal. An interface link may be added at a 500eb cost, providing a +2 bonus to operation skills.

### **ADREK ROBOTICS**

#### **Robot Patrol Unit BETA 95,000eb**

The medium threat version of the RPU-A, the RPU-B is vaguely humanoid in configuration, and possesses senses equal to those of a human (enhancements are possible at the same cost as the RPU-A). Size: 2mT x 0.5m Dia., Weight 300kg.

The unit has two manipulator arms, fitted in an identical way to the RPU-A. In addition, the center torso holds an H&K MPK-9 (with 100 round drum). In addition, four external weapon mounts and links are also provided, two on the hips and two on the shoulders of the unit.

The units arms are SP=25 and SDP=25/35, while the torso has SP=25 and SDP=35/45. The legs have SP=25 and SDP=30/40. Crippling the central torso disables the unit.

Control and interface details are identical to those for the RPU-A. The unit can handle a slightly more sophisticated fallback routine, i.e. return to point of last contact and if contact not re-established, return to designated location. Maximum ground speed is 40kph.

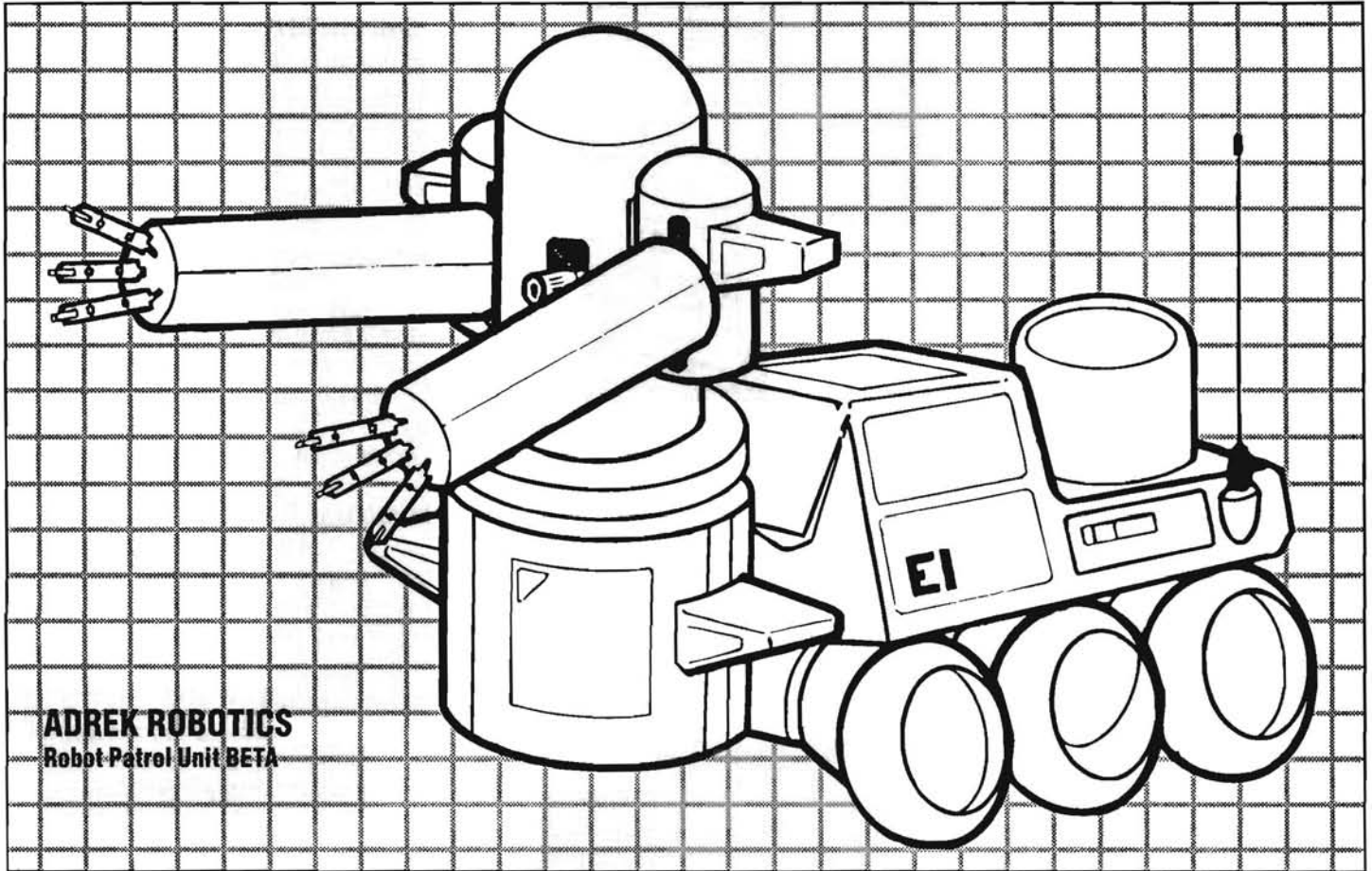

**ADREK ROBOTICS**  
Robot Patrol Unit BETA

### **ADREK ROBOTICS Robot Patrol Unit GAMMA 105,000eb**

The high-threat big brother to the RPU-A and RPU-B, designed for urban patrol and high-level crowd and prisoner control.

In configuration it is almost identical to the RPU-B, with both arms holding an H&K MP-2013 and a pair of implanted Rippers. The central torso contains an Arasaka RA-12 (with 100 round drum magazine) and an H&K MPK-11 (with 100 round magazine). It is also equipped with four weapon mounts and links in the same configuration as the RPU-B.

The unit's arms are SP=25 and SDP=30/40, its torso is SP=25 and SDP=40/50, and its legs SP=25 and SDP=35/45. Rendering the torso useless will disable the unit. Remote and interface capabilities are identical to those of the RPU-B. These units can operate semi-autonomously. Maximum ground speed is 30kph.

It is believed that Adrek Robotics has produced an experimental, fully-autonomous RPU, but it has yet to come onto the market.

### **REPEATER STATION 100eb**

Robots are often required to operate in situations in which radio and microwave transmissions

may be blocked or weakened. In such cases repeater units are often used. Commonly patrolled areas and many buildings have built-in repeaters. Repeaters can also be placed in an area. It is not uncommon for an RPU to carry several repeaters in case transmission-impairing areas are to be entered. A standard repeater weighs 0.33kg. Special models (shielded against detection, for example) cost extra.

### **MISCELLANEOUS EQUIPMENT**

#### **PATROL ARMOR 900eb**

Consisting of all-over flexi-armor (by Gibson Battlegear), the Patrol armor provides SP=18 for both legs, SP=20 for the torso and SP=15 for both arms. Optional alloy plates then cover the shoulders, elbows, knees and thighs, providing an extra SP=5 to arms and legs. [EV=+2/+3]

#### **MAXIMUM THREAT URBAN RIOT ARMOUR 1200eb**

Designed for use in urban disturbances where close combat is expected, the police riot armor provides SP=25 for the torso and arms, while the legs have SP=20. All limbs are also protected by alloy plates providing an additional SP=8. [EV=+3]

### **POLICE ISSUE PATROL HELMET 230eb (430eb w/option)**

Worn in conjunction with the Patrol armor, the helmet provides SP=25 protection. Built into the helmet is a two-way radio, a high-intensity beamlight, and an anti-dazzle visor. A targeting scope with infrared ability for "smart" weapons is optional.

### **POLICE ISSUE RIOT HELMET 650eb**

Identical to the Patrol helmet, except that the Riot helmet is environmentally sealed and has a built-in 10 minute air supply for use in hostile environments (riot gases, poison gases, smoke, etc.).

### **POLICE ISSUE TRAFFIC HELMET 170eb**

Lighter than the Patrol and Riot helmets, the Traffic police helmet provides SP=15, and has no Infrared or Targeting capabilities. However, it does have a built-in Digital Stillcam with 20 shot capability.

### **POLICE ISSUE PARAMEDIC HELMET 180eb**

Worn by the drivers of the Police Rapid-Response Paramedic units, these helmets provide SP=20, as well as an anti-dazzle visor and a two-way radio.



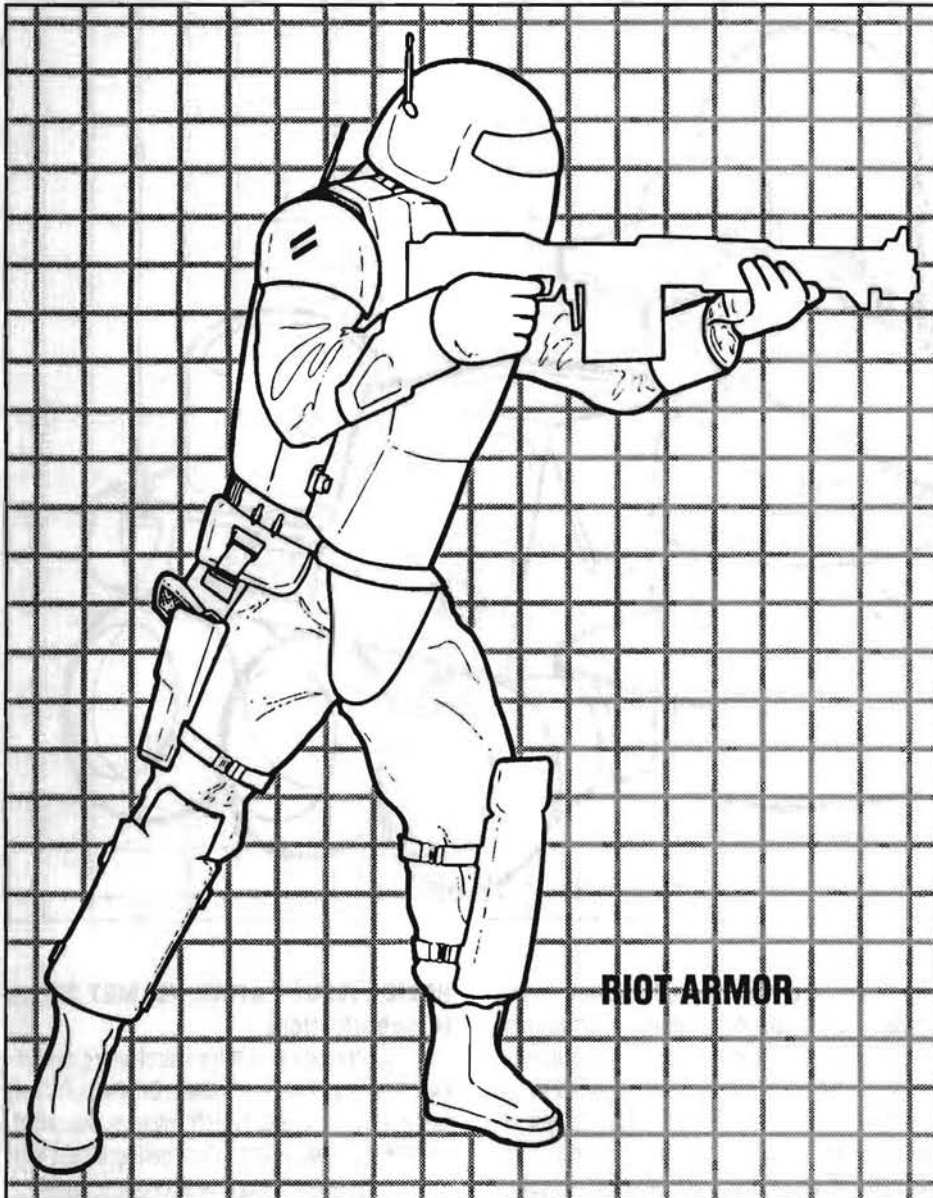

#### **POLICE ISSUE RIOT SHIELD 150eb (180eb w/option)**

Designed with the defense of riot police in mind, the Riot shield is a full-length plastic barrier (SP=15), intended to protect the officer from attack. The center of the shield has a built-in Militech Taser for contact subdual. The most interesting feature of the shield is the optional strobelight built into the face some six inches from the top. When activated, those directly in front of the light must make a REF save to shield their eyes; failure means a BOD save or become stunned for 1d6 combat turns, incapable of any but the most basic actions. The shield's battery has enough power for 10 pulses.

#### **POLICE ISSUE GENERAL PURPOSE SHIELD 80eb**

A smaller, round shield issued to officers, mostly on the beat patrols. These are shields provide SP=10.

#### **RETINA SCANNER 400eb**

The retina scanner consists of a cylinder with an eyepiece linked by cable to a belt unit which contains the system's microprocessor and memory chips. The unit can record a subject's retinal pattern and then use this as identification at a later date. The unit's memory can hold up to 250 retinal images. Police stations have versions linked to the central CPU to keep track of personnel and prisoners.

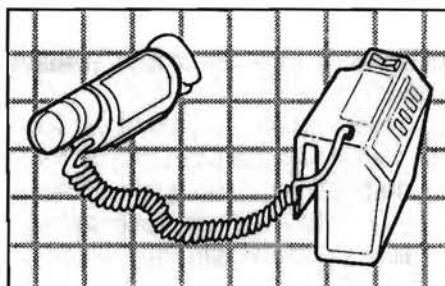

#### **HAND SCANNER 350eb**

A flat, plastic plate used for palm-print recognition systems, which identifies palm-prints against those in its 500 template memory. Just like the Retina Scanner, these are used in conjunction with the Central CPU to provide a secure personnel tracing system.

#### **DNA SCANNER 1000eb**

This is a cylindrical sampling device linked via cable to a microprocessor and analysis unit the size of a trunk. The unit records DNA patterns and uses them to identify individuals at a later date. It can be linked to the Central Precinct CPU for expanded memory capabilities.

#### **BLOOD TESTER 300eb**

This cylindrical device is used by police officers to analyze the blood of suspects for traces of illegal substances, or the amount of legal substances within their systems.

#### **CYBER SCANNER 500eb**

This device utilizes sonic/magnetic resonance scanning 'wands' linked to a microprocessor to detect the presence of implanted cyberware. The difficulty of a scan is dependent upon the type of cyberware being scanned. Things like neural processors or rippers are easy to find, but specially made cyberware (such as organically-made items) may be almost impossible to detect. Police precincts have larger, more sophisticated versions at their disposal.

#### **BALLISTICS KIT 600eb**

This field kit contains all of the equipment required for an on-site ballistics investigation. It allows a skilled user to identify type of weapon used, angle of attack, and so forth. The entire kit is contained in an armored suitcase (SP=15)

#### **MEDICAL EXAMINER'S EQUIPMENT PACK 700eb**

This unit provides a skilled user with all of the equipment necessary to carry out a preliminary examination of a body or biological substance, before removing it to a forensic lab.

#### **INVESTIGATION KIT 45,000eb**

This highly advanced kit contains forty specialized scanners, a command panel, and four Cyberform Spiders.

Each scan unit contains an infrared scanner, a pheromone sniffer, and a sound pickup. When planted by one of the Cyberform 'Spiders', the scanners are activated by a command pulse. This activation will give the user a three-dimensional



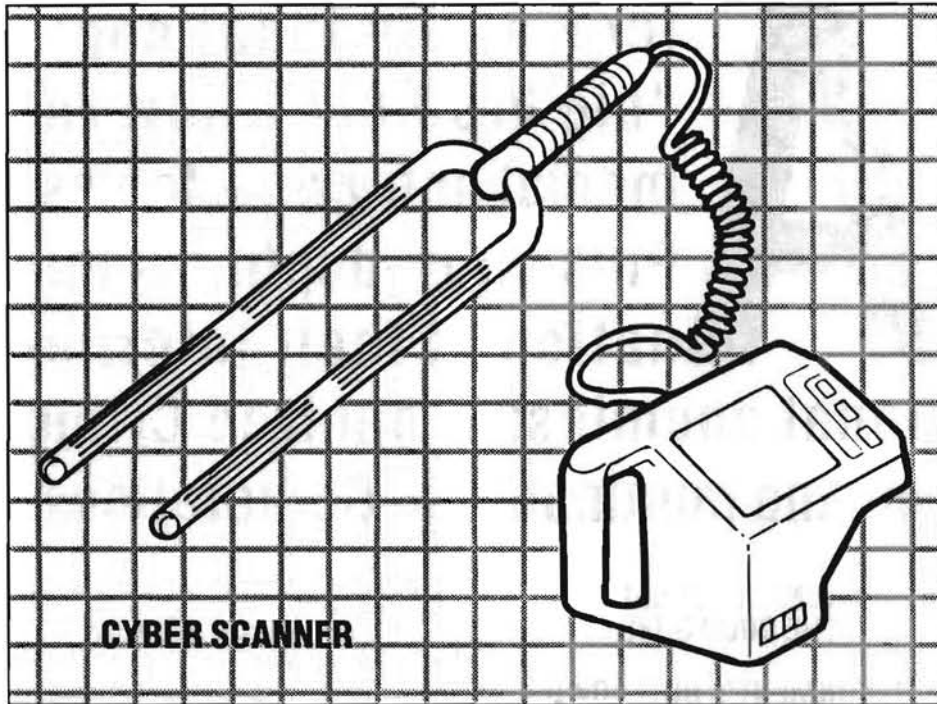

CYBER SCANNER

image of the area covered, including IR patterns, pheromone patterns and a sonar map of the area.

Each scanner has a 10m range, and correct use of them can provide a skilled user with an idea of the number of people who have used the room, how and where they moved, and so forth. Approximate identification of individuals is possible through their thermographic and pheromone patterns.

The Cyberform Spiders (courtesy of Adrek Robotics), are robotic bodies with partially organic brains (the ceretronic system) that are designed for two tasks. Firstly, they can plant the scanners anywhere (using their multiple legs to climb walls and ceilings), and secondly, their own scanners can pick up tissue samples, chemical traces, etc. Correct use of this system can provide an officer with a complete picture of a crime and the environment in which it took place.

#### INFORMATION LINKS 25eb

The appropriate identification/examination equipment can be linked into the police version of the Visual Recognition Chipware (*Chromebook*, pg. 76). A slight modification is required in the chipware, which can be done at the sales/service site.

#### PLAS-CUFFS 40eb

High-tensile strength plastic handcuffs designed to hold all but enhanced individuals (BOD check at 25+, use *Strength Feat* skill). Release is only possible through use of the computer key carried by the officer.

#### ION CUFFS 100eb

These cuffs are manufactured from conductive polymers, and are designed to restrain enhanced prisoners. To do this, they run a disabling current through the metallic elements of the arms that they are holding. The effect of this is that the subject loses all control of the bound limbs and cannot use them until released. The cuffs have no keys and can only be unlocked at the central precinct.

#### EVIDENCE BAGS 5 for 6eb

Small ziplock polythene bags used to pick up evidence for later examination, without smearing prints all over the item. A must for all good cops.

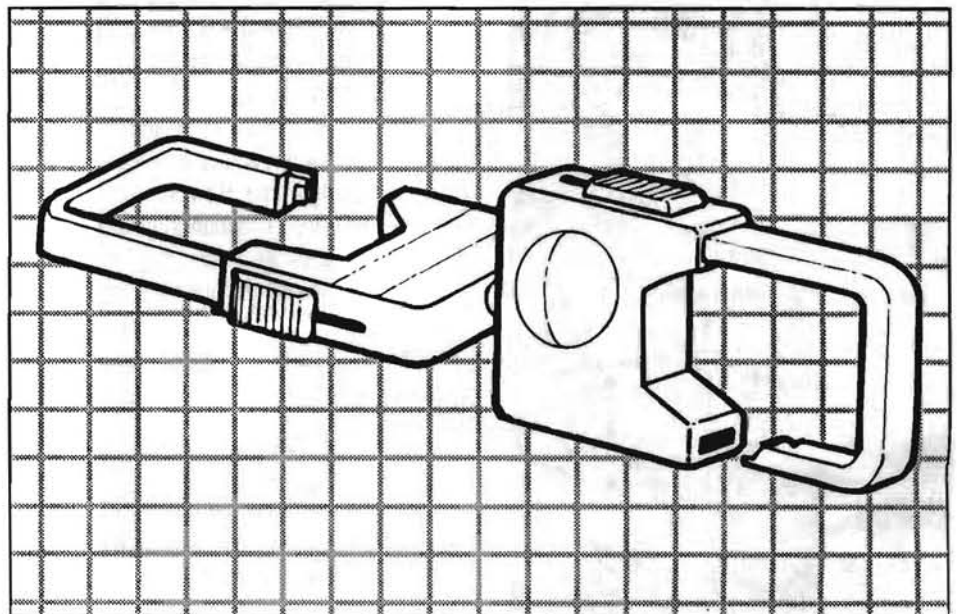

## CYBERWARE/COMPUTER SYSTEMS

### POLICE COMPUTER Eb Varles

This vehicle-mounted police computer is primarily an information processing and storage system. It contains information such as wanted lists, lists of stolen vehicles, lists of donut shops, and so forth. Police computers are generally linked via radio/microwave to a central police CPU which enables officers to acquire information they need and transmit data back. The police computer is also capable of running various programs. For example, some are equipped to process medical data; some are even designed to control the vehicles in emergencies. Price depends upon the complexity of the system.

### POLICE ISSUE NETSEC CYBERDECK

#### Eb Varles

This is the standard type of deck used by the Netrunners of NETSEC, although most of the runners modify their systems to their own personal needs. Zetatech 2000 Combat Assault Deck—Memory: 20MU, Speed: +4, Data Walls: +6, Low Impedance Cables, Auto Punchout, Flip Switch, Videoboard, Chip Reader, VoxBox, Deck Security System (retina).

#### SOFTWARE

The police use a variety of software systems in the line of duty, some legal and (occasionally) some illegal. The NETSEC runners each have a personal preference as to which software they do and don't use. In general, most current programs can be found amongst the cyberdecks of NETSEC, even ones that theoretically don't, or shouldn't, exist. ■

# Look at the local cop's "big brothers": governmental anti-crime forces. Plus an in-depth examination of their international enemies: Organized Crime and the Multinational Corporations.

## NATIONAL RESOURCES: THE GOOD GUYS

### GOVERNMENT'S OUTLOOK ON LAW ENFORCEMENT

The Government still retains a sizable dedication to national law enforcement, and has always been a solid supporter of the Uniform Civilian Justice Code. Although unforeseen political and budget difficulties were the cause of the initial FBI and CIA merger, it has turned out to be far more of a working venture than originally intended (or expected). Due to their success, LEDiv is now the pride and joy of the government, and personnel are recruited nationally from various agencies to form this prestigious side arm of the CIA.

The Government has a stake in ensuring LEDiv's continued success, as the only alternative to a strong police system would be Martial Law. With the events of the late 1990's still fresh in everyone's memories, the government knows that the martial law alternative will not win them any friends (and will cost them a big bundle of cash).

Since the Jacobi assassination, the Government is far more active in its struggles against Corporations and other nations than it is in suppressing crime. However, Government does its best to meet common crime with effective force; while not always a good deterrent, they try to put the problem down hard whenever they can.

#### LEDiv

The National Law Enforcement Division of the Central Intelligence Agency springs from an amalgamation of the Federal Bureau of Investigation (FBI) and the Drug Enforcement Agency (DEA) with the CIA. After the lifting of martial law, and the removal of restrictions on Federal law enforcement boundaries, it was hoped that a single enforcement

body could police the country on its own. Initially thought to be an expedient combining of similar resources to reduce costs, LEDiv has now become an excellent pool of law enforcement resources, outperforming the sum of its original parts.

The only stigma it now faces is local law enforcement's disdain for "agents from outta town." This antipathy has been enhanced due to LEDiv's greater powers of investigation beyond the limits of the local enforcement community. Sometimes the local cops don't ever find out much about what's really going on, but when LEDiv moves in, the cops know they mean business.

Most cities maintain a single LEDiv office which monitors criminal activity and investigates national threats and crimes. In addition, they liaise with (and sometimes monitor) the local law enforcement agencies. Unlike the police, LEDiv's activities are not guided by a city Mayor, but by the Director of the CIA, and ultimately the President.

LEDiv is active in most areas of investigation. They have enough manpower and resources at their disposal to make any Mayor cry. They also have full immunity and Presidential clearance in regard to carrying out their duties. While secrecy does not permit us to examine the CIA in any great detail, we *can* take a look at the general structure of LEDiv.

Ten bureaus make up LEDiv (despite constant media statements claiming there are actually twelve); we shall examine each one briefly.

#### RECORDS

LEDiv Records Bureau maintains files on all convicted criminals nationwide. These files include holophotos, DNA and finger-prints, retinal and voice scans. In addition, up-to-date criminal histories can be accessed through the CIA's central computer.



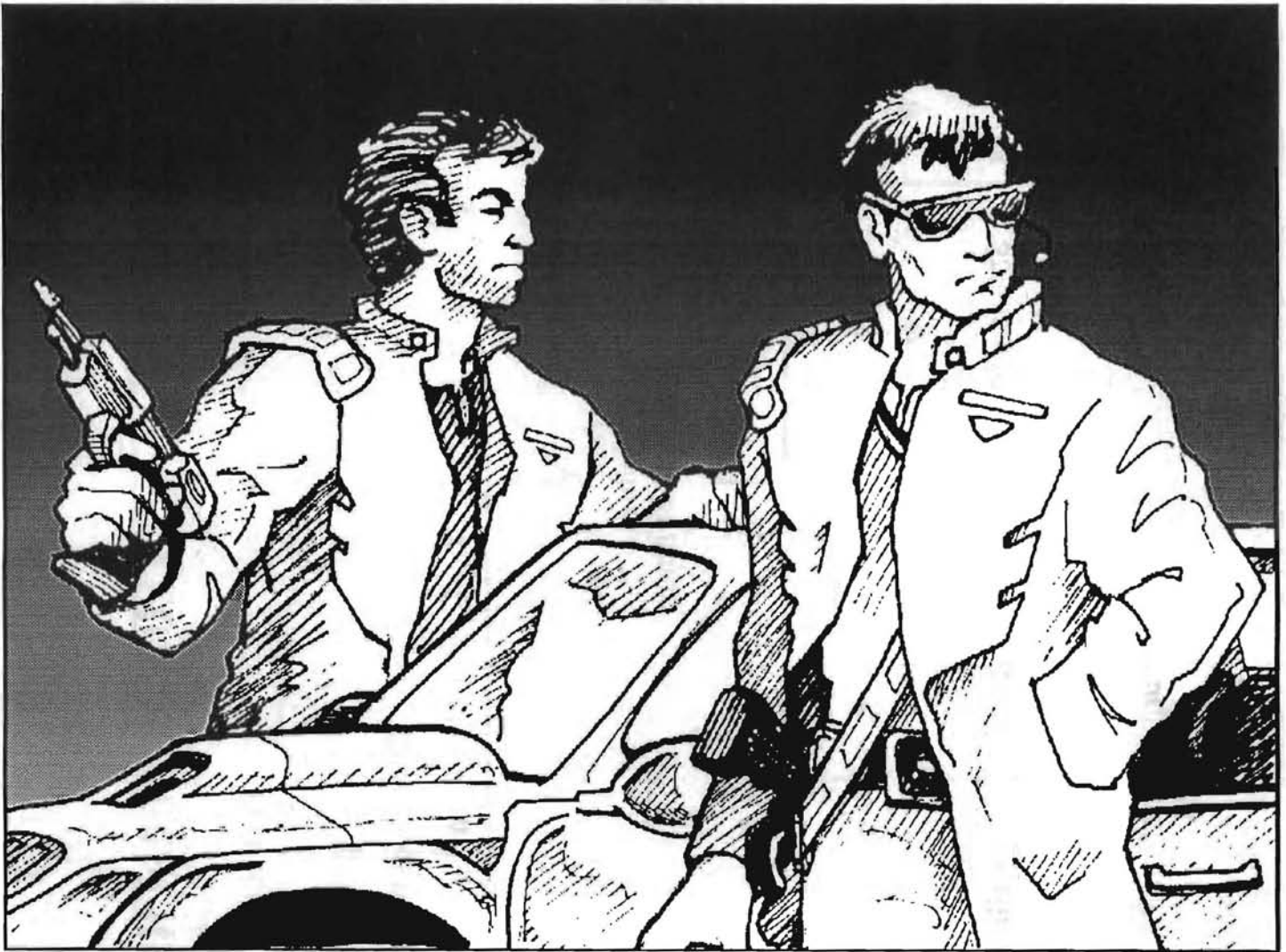

**LEDiv's Agents are often as ruthless as their criminal counterparts.**

New records of convicted criminals are constantly fed into the computer. Interpol and other agencies will sometimes share resources, allowing access to a full international database of known felons.

**SCIENCE AND TECHNICAL BUREAU**

This bureau provides all the laboratory and technical work for LEDiv. Various tech and analysis sections are combined in the STB, allowing it a full array of state-of-the-art sensing and scanning devices, as well as full analysis capabilities.

All LEDiv agents may call upon the services of STB in the course of their investigations. Those working for STB are among the most professional and dedicated members of their given scientific area. This bureau also provides a full psychological portrait and prediction program for agents pursuing unknown suspects.

**INTELLIGENCE**

The Intelligence Bureau's only goal is to gather

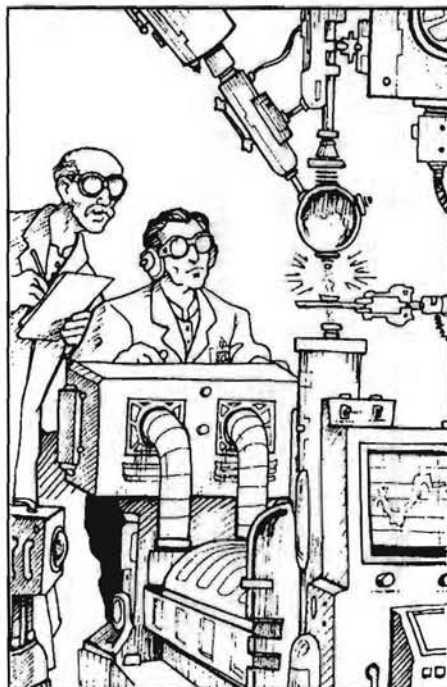

law enforcement-related data for use by agents. Intelligence also infiltrates various organizations in an effort to learn their strengths and weaknesses. Undercover operations are a specialty of Intelligence, and this Bureau is one of the more secretive areas within LEDiv.

**SPECIAL OPERATIONS**

This is the military arm of LEDiv. When real war needs to be waged against criminals, Special Ops are called in. Recruited from the military (usually the Special Forces), these soldiers are as good as they come. Trained in every manner of counter-insurgency technique, Special Ops teams wage small wars against powerful criminals nationwide. A typical Special Ops team will consist of four men, hand-picked for each assignment (all of them deniable). *Special Ops* is a classified bureau.

**SECRET SERVICE**

This bureau of highly-trained agents serves the



# LEDIV National Resources

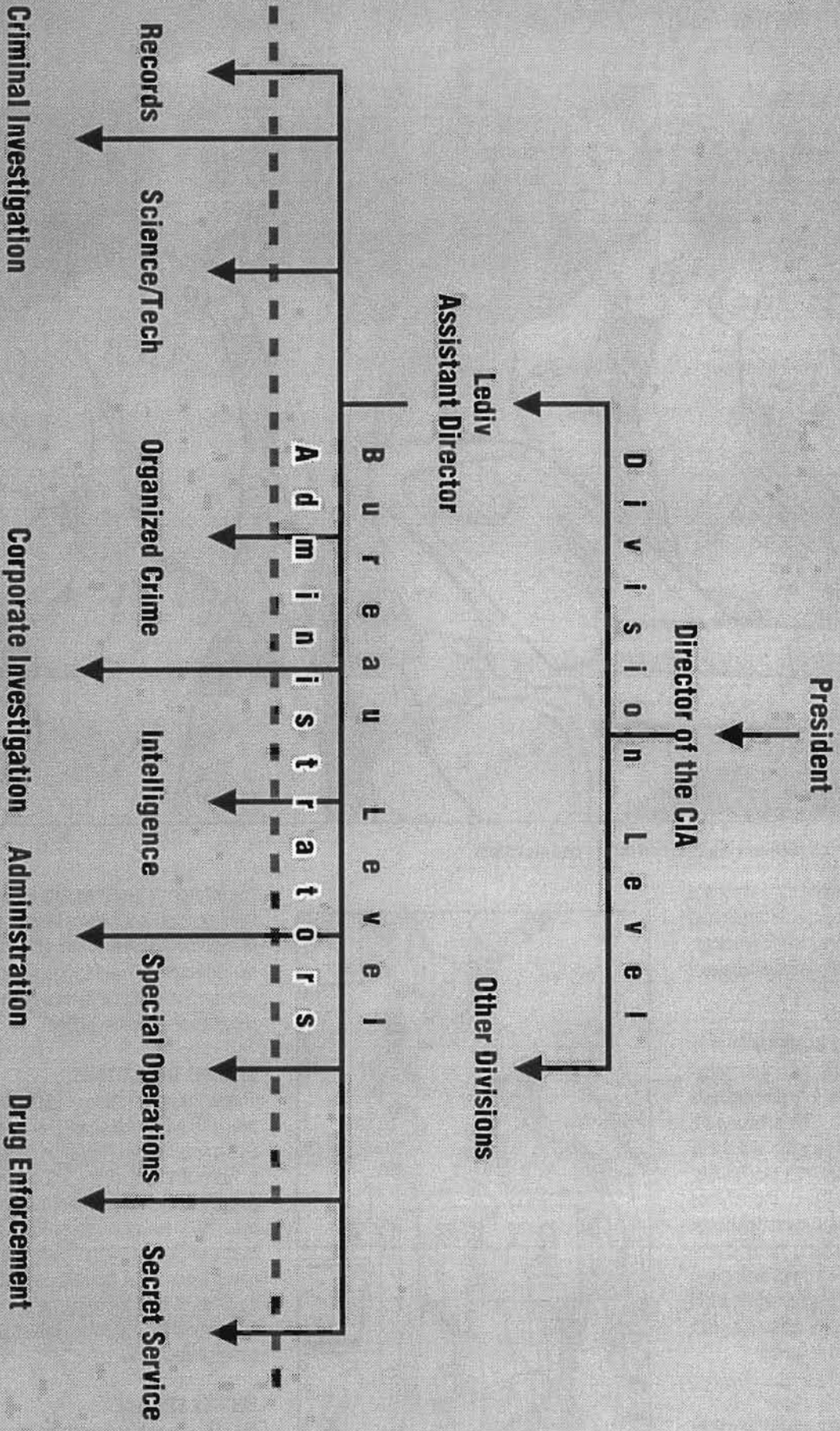

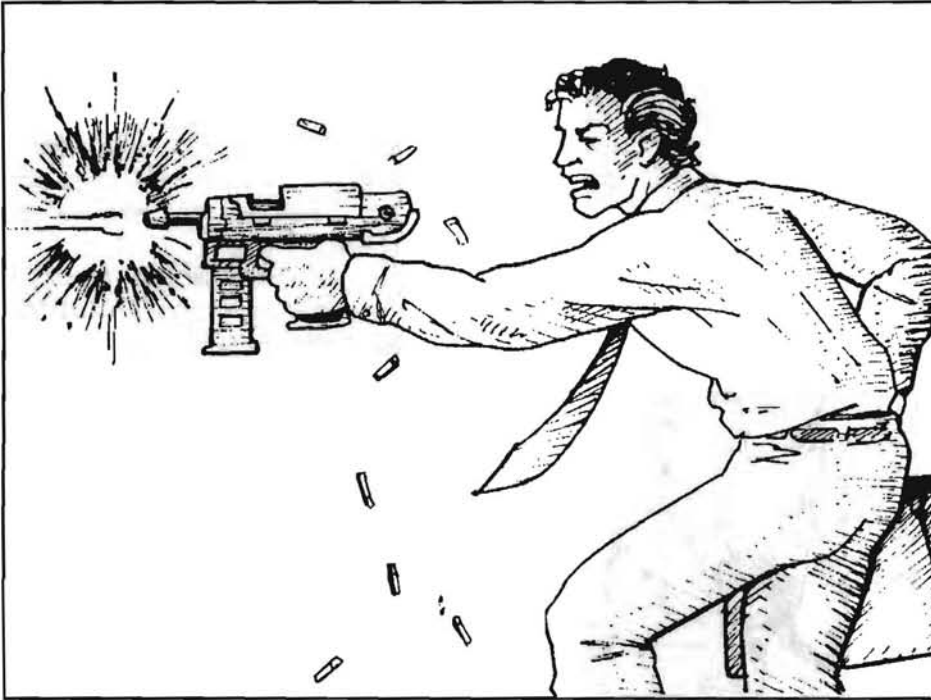

Sometimes an OCB op goes sour and you've got no other way out...

Presidential office directly, providing security and gathering data on threats to the Executive Branch. Each one of these deadly security agents is trained to ensure no assassin reaches the President, and is occasionally tasked with undercover operations within the borders of the USA.

### CORPORATE INVESTIGATION

CIB is a relatively new bureau, created to monitor the activities of the many multinational corporations operating on U.S. soil. After the corp-sponsored assassination of President Jacobi, there is still a great deal of fear and paranoia within the law enforcement community with regard to corps. CIB agents infiltrate these multinationals, gathering data and performing anti-corporate subversion in order to ensure they cannot, and will not, target the U.S. directly again.

### ORGANIZED CRIME

OCB was created to stem the rising tide of Organized Crime. Most OCB agents' identities are kept secret because of the governmental corruption Organized Crime brings. Small task forces from OCB are sometimes assigned to a city to bring down the head of a given criminal group. At this time, OCB concentrates most heavily on the Southeast Asian syndicates.

### CRIMINAL INVESTIGATION

These agents are the core of LEDiv, most often coming into direct contact with local Police. Criminal Investigation agents bring their valued

resources to bear on difficult cases, giving local agencies some aid in tracking down their most dangerous criminals.

Criminal Investigation offices are situated in each city, liaising directly with the enforcement community and maintaining close contact with each other. However, most cops resent the presence of LEDiv agents, especially when they take over the locals' current case...

### DRUG ENFORCEMENT

Formed from the hardcore of the original Drug Enforcement Administration, these agents are purely concerned with keeping controlled substances out of the cities. Many agents are ex-vice cops, and all have an excellent feel for the streets. Most of them are also experienced undercover operatives.

### ADMIN

Somebody has to push the papers and answer the phones. 'Nuff said.

### Typical LEDiv Operative

**ROLE: COP**  
 INT: 10 REF: 7 TECH: 6  
 COOL: 9 EMP: 7/6 ATTR: 6  
 LUCK: 7 MA: 7 BODY: 7

**SKILLS:** Authority 6, Resources (LEDiv) 3, Wardrobe and Style 6, Streetwise 5, Interrogation 8, Handgun 8,

Intimidate 7, SMG 7, Resist Torture/Drugs 5, Human Perception 6, Interview 8, Personal Grooming 8, Social 5, Persuasion/Fast Talk 5, Hide/Evade 6, Awareness 8, Education/Gen 7, Library Search 4, Athletics 5, Shadow/Track 5, Brawling 6, Driving 7, Elec. Security 7, Stealth 6, Pick Lock 6, Disguise 6, Expert (Law) 9, Karate 7

**CYBERNETICS:** Chipware Socket, LEDiv Procedures in MemChips, Interface Plugs, DataTerm Link, Smart Link, Vehicle Link, Cyberoptic, Targeting Scope, Image Enhancement, Time Square, sometimes a Video Cam/Transmitter and Wide Band Radio Scanner

**EQUIPMENT:** Sternmeyer Type 35 Auto-pistol, Sternmeyer SMG 21 in vehicle, 5 magazines per weapon @, Mirrorshades, Light Booster Goggles, Tracking Device and 12 Tracer Buttons, Advanced Communications Suitcase in vehicle, Cellular Phone, Line Tap Detector and Linozap, EBM Carfaxx and Laptop computer, Executive Line Suit: Armored SP = 13, Evidence Bags (12)

### HiWAY

In between the cities, along the old interstates, outside of anybody's jurisdiction, wait HiWay.

The name is general Nomad slang for the various legal agencies charged with law enforcement in the "great wide open." Texas Rangers, NorCal Highway Rangers, SoCal Highway Patrol, U.S. Marshals "riding the circuit"—all these make up HiWay.

Freeway law enforcement is a very different type of policing. Many of the men and women of HiWay are ex-bounty hunters, or city cops with nowhere to go, drawn to the idea of getting a very fast car, a selection of hi-powered weapons, and the power to mete justice on the long roads between the cities. HiWay officers (although not always the cream of law enforcement agencies),



perform this job well in a lawless wasteland. Marauder gangs, Exiled criminals and those who seek to harm others outside the cities must face the HiWay cops, who have the power to deal out instant justice.

But they're not the only ones. The U.S. Marshals Service operates within a regular system of "judicial districts," each encompassing the rural areas of several states within the current U.S. borders. As a result, the Old West concepts of circuit judges and lawmen riding a large territory have returned. Marshals are empowered to make extradition runs deep into the Free States, and can be sometimes be encountered on the open road in pursuit of such missions.

Laws vary between states and cities, but in general, one law stands throughout—anybody endangering the life of another without proper cause, or stealing a vehicle which does not belong to him/her is to be met with maximum force: **DEATH**. There's a good reason for this. In the wildlands of 2020's America, stealing a man's vehicle and stranding him is often tantamount to killing him.

The various HiWay systems are currently under review, due to the occasional horror stories circulating about lunatic HiWay cops killing everyone they meet on the road, etc. However, many state HiWay programs have always been underfunded, and it's unlikely you'll meet a HiWay officer on any trip of less than one hundred miles. You're far more likely to run into a nasty gang or a Corporation performing some illegal activity than you are a HiWay cop. But if you do: Tread softly.

#### Typical HiWay Cop

##### ROLE: COP

INT: 5    REF: 9    TECH: 6  
COOL: 8    EMP: 6/2    ATTR: 6  
LUCK: 5    MA: 7    BODY: 8

**SKILLS:** Authority 6, Strength Feat 6, Handgun 9, Awareness 8, SMG 7, Rifle 7, Melee 8, Brawling 7, Drive 8, Streetwise 5, Intimidate 7, Basic Tech 5, Interrogation 5, Expert (Interstate Roadnet) 7, Shadow/Track 3, Athletics 6, Dodge/Escape 6, Stealth 5, First Aid 3, Wilderness Survival 6, Expert (Law) 5, Karate 5

**CYBERNETICS:** Smartgun Link, Skin Weave (Sp = 12), Vehicle

Link, Rippers, Interface Plugs, Targeting Scope, Pain Editor, Anti-Dazzle Wearman, Ultraviolet Image Enhancement, Time Square, Teleoptics



**EQUIPMENT:** Colt Alpha-Omega 10mm Pistol in Speedholster w/5 Magazines, Beretta M-24 Advanced SMG w/4 Magazines, Full MetalGear armor and Salamander Line fireproof jumpsuit, Mirrorshades, Binoculars, Kendachi Monoblade, plus all other uniformed cop equipment except for armor and helmet

#### STATE EXECUTIONER'S OFFICE

The duties of the office of State Executioner tend to vary depending on the state, but gener-

ally fall into these categories: performance of legal executions by close-range pistol shot, pursuit of fugitives under sentence of death, supervision of the security of Death Row prisoners, and the direction/supervision of alternative state executions (should there be other methods allowed than the primary one mentioned above).

The State Executioner for the NorCal Free State is currently Susan Forrest, ex-NCPD Max-Tac. Being State Executioner is a pretty tough job. The pay's great, but the chances of getting iced by some crazy punk while you're chasing him are real big. So you've got to be good, and prepared to deal with every eventuality.

Susan Forrest was one of the most highly trained individuals within the structure of the Night City Police Department. Ex-MaxTac, she requested a transfer to her current position after being seriously wounded in a firefight. She doesn't have much time for punks, and takes great pride in her job, especially when tracking down an escapee.

She is paid well, and drives a Bensen Cascade hovercar, or AV-9 (depending upon her current activity). She wears the best of the Gibson Battlegear, along with a Salamander Fireproof jacket. Susan is a level-headed and rational woman, but getting on her bad side will be the last mistake many a punk will make. After all, you don't become the State Executioner by being a nice person.

#### CORPORATE COPS

With regular cops spread thinly enough over the city, Corporate Police are a necessary evil. With all sorts of manpower and resource problems within the police department, it is almost thankful the Corporations police themselves, taking a large slice of police work away from the city.

That's the good side.

The problem with Corporate cops is the fact that many of them are ex-city cops who've changed sides for better money and equipment. In some extreme cases, having disgraced themselves as real cops, bad apples go corporate, and are viewed by regular officers as little more than pumped-up security guards.

Corporate cops don't have to play by the same rules, either. They can shoot first and ask questions later (the company can normally cover up any problems when they occur). If Corp cops want to make a bust stick, they throw their suspects into holding cells until the regular cops can come and take them away. But since police to corporate response time tends to be sloooow (nobody really gives it a high priority), you could



# THE STATE EXECUTIONER FOR THE NORCAL FREE STATE: SUSAN FORREST

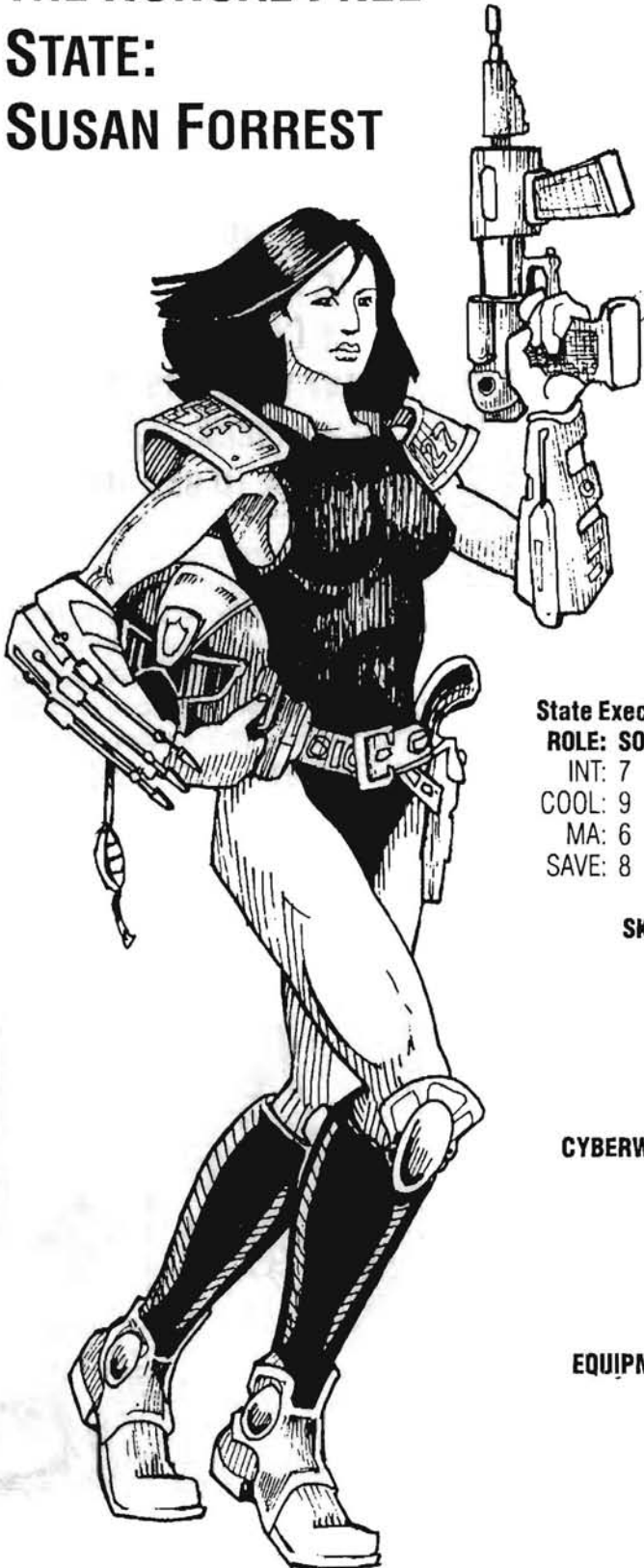

## State Executioner

### ROLE: SOLO

INT: 7 REF: 9 TECH: 6  
COOL: 9 ATTR: 7 LUCK: 7  
MA: 6 BODY: 8 EMP: 9/4  
SAVE: 8 BTM: -3

**SKILLS:** Combat Sense 6, Weaponsmith 6, Martial Arts (Karate) 7, Awareness 9, Handgun 10, Melee 8, SMG 8, Athletics 6, Stealth 9, Rifle 8, Pers. Grooming 5, Endurance 8, Swimming 6, Interrogation 9, Intimidate 9, Streetwise 7, Human Perception 8, Interview 6, Persuade/Fast Talk 7, Anthropology 3, Hide/Evade 7, Shadow/Track 9, Dodge/Escape 7, Driving 8, Basic Tech 6, Motorcycle 4, Disguise 5, First Aid 6

**CYBERWARE:** Sandevistan Speedware, Pain Editor, Vehicle and Smartgun Links, Interface Plugs, Chipware Socket (with chips relevant to current mission), Adrenal Booster, Motion Detector, A/V Tape Recorder, Biomonitor, Skin Weave (SP=12), Cyberoptics, Target Scope, Image Enhancement, Time Square, Anti-Dazzle, Low-lite, MicroVideo, Digital Camera

**EQUIPMENT:** Armalite .44 autopistol, Malorian Arms 3516 Pistol (Smartlinked) in vehicle, Militech-10 SMG (Smartlinked), Militech M-31a1 Rifle (Smartlinked), Kendachi M-33 Powersword, Advanced Communication Suitcase, Newsviewer, Digital Weapons Uplink, Speedholster (pistol), Personal Body Alarm, Travel Kit and Shower-in-a-can, Battleglove (with Micromissile Launcher), First Aid Kit, note: must be wearing Battleglove to use Malorian 3516

spend months in holding or just end up dumped in the landfill.

In some cities, the entire police department is made up of Corp cops; this sometimes creates an effect similar to that of a Police State. Anti-Corporate dissidents are subjected to terrible harassment (although this is rarely uncovered). Providing a company with its own independent law enforcement capabilities is not always a good idea.

In Night City, the Police Department has allowed each Corp a small police force of its own, whose jurisdiction ends at the Company Property line (see *Corporate Immunity* for definitions of Company Property). This is monitored by NCPD, which checks officer records and is allowed to register objections to applications before deputizing corp cops. This allows the NCPD a degree of control when dealing with Corp cops as they still, to a certain extent, hold the reins. It is far more tricky in practice, because there are so many political and financial considerations to take into account.

There is no doubt Corp cops receive better cash, benefits and equipment than City police. However, the real difference between City police and the Corporate security is their effectiveness. Fighting crime in general means nothing to these hired guns; they are created solely to keep unwanted individuals away from corporate premises, and to ensure the personal safety of the corporate employees. There are also documented cases of Corp cops moonlighting as Black Operations teams within their parent corporation; this is unavoidable when you place a paramilitary organization at the disposal of a multinational corporation.

#### Typical Corp Cop

INT: 5 REF: 7 TECH: 4  
COOL: 7 EMP: 7/4 ATTR: 5  
LUCK: 5 BODY: 7 MA: 6

**SKILLS:** Awareness 5, Handgun 6, Brawling 6, Aikido 5, Rifle 6, Athletics 5, SMG 5, First Aid 2, Intimidate 5, Interrogation 3, Wardrobe/Style 4, Expert (Law) 3, Melee 6

**CYBERNETICS:** Cyberarm, Cyberoptic, Times Square, Low Lite, Anti-Dazzle, VideoCam Transmitter, Grafted Muscle, Decentralized Heart

**EQUIPMENT:** High Fashion Clothing (Eji, Gibson, Armorline, etc), SpeedHolster with Armalite .44, Arasaka Minami 10 SMG, Cellular Phone, Pocket Computer, Mirror-Shades, Gibson All-Over Battle Gear (SP=18)

#### BOUNTY HUNTERS

In addition to Police, Corp Cops, LEDiv agents and HiWay, there is one other group of individuals who have the power of arrest and are issued with Terminator Licenses: Bounty Hunters.

Anyone with a clean criminal record and previous police, military or security experience can apply to become a licensed terminator. The city administration, in liaison with the police department, issues a number of these permits each year in an effort to assist the legitimate enforcement officers in the apprehension of dangerous criminals. At least that's what they say.

Bounty Hunters are a varied lot; sure, they're not supposed to have criminal records, but many do. They may not have been convicted of murder, but maybe aggravated assault, threatening behavior and drug offenses. This motley crew are issued licenses, and told which criminals the police want found via a limited-access FAX network. Full file details are provided, in addition to details on any related investigations. Bounties are posted for each

criminal, ranging from as low as 50eb into the thousands.

When an alert goes out, Bounty Hunters all over the city arm up with heavy weaponry, pull on their combat vests, and hit the streets to bag their man. The police often attempt to restrict the activities of bounty hunters, and there have been cases of hunters stealing criminals from arresting officers in order to pick up the bounty. Sometimes even killing other bounty hunters and enforcement personnel occurs (this is known as "bounty-jumping") if the stakes are

### WHEN THE ALERT GOES OUT, HUNTERS ALL OVER THE CITY ARM UP WITH HEAVY WEAPONS, PULL ON THEIR COMBAT VESTS, AND HEAD OUT TO BAG THE MAN.

high enough. Bounty Hunters have their uses, however, and usually work well with the police. If not, the department knows how to deal with the troublesome ones by revoking their licenses or other, less regulated means. But as long as bounty hunters keep on bringing in criminals, there will be a place for them inside (and outside) the law.



## A Typical Bounty Hunter

### ROLE: SOLO

INT: 6 REF: 7 TECH: 5  
 COOL: 8 EMP: 7/3 ATTR: 5  
 LUCK: 5 BODY: 8 MA: 6

**SKILLS:** Combat Sense 5, Awareness 6, Handgun 6, Brawling 6, Melee 5, Thai Boxing 6, Rifle 7, Athletics 6, SMG 6, Stealth 5, First Aid 3, Drive 6, Basic Tech 3, Shadow/Track 5, Persuasion/Fast Talk 6, Intimidate 6, Disguise 4, Wardrobe/Style 4, Expert (Law) 4

**CYBERNETICS:** Cyberlimb, Smartgun Link, Pain Editor, Subdermal Armor, Cyberoptic, Targeting Scope, Time Square, Low Lite, Dodgeball, Adrenal Booster, Flashbulb

**EQUIPMENT:** Tech Tool Kit, Breathing Mask, High Fashion Clothing, Pocket Computer, Cellular Phone, Movement Sensor, Medkit, Sleeping Bag, Bensen Cascade performance Speedholster with Fed.Arms 454 'Super Chief', Advanced Alarm Removal Kit, Militech Military Shotgun, Beretta M-24 SMG, all-over Gibson BattleGear SP=18

## PERPS: THE BAD GUYS

### ORGANIZED CRIME

#### THE BASICS

Organized Crime is BIG business in 2020, but then again, it always has been.

Organized crime is cause for great concern within the law enforcement community due to its very disturbing nature. In comparison to other crime, organized crime actions are planned and executed with extreme care, utilizing a network of professional and semi-professional criminals. In many cases, services and materials are supplied (in large quantity) which are not available through other, legal, sources. In order for these enterprises to become long term successes, the criminals must either corrupt officials or utilize violence to eliminate any and all competition,



securing their place in underworld society. In many cases, organized crime also filters off large amounts of money, undermining the legitimate economy. The wealth is then distributed to the criminal/underworld subculture, and is often sent abroad.

The government has placed heavy emphasis on neutralizing the threat of Organized Crime because of the grave danger it presents to individuals, communities, and the economy. Organized crime is often rooted very deeply within the communities it serves (and exploits), making removing it an almost impossible task. Pulling up these roots can cause a great deal of damage; the end result leaves the populace poorer, without services they had taken for granted, and resentful. However, studies have shown that uprooting organized crime communities is the most successful and satisfactory solution to the problem.

In this chapter, we will examine the faces of organized crime within the U.S. However, there are some features common to all types of organized crime which are listed here:

- The sole purpose of organized crime is to make money. This is their NUMBER ONE objective—anything which affects this becomes a problem. Interruption of cash flow is also the best way to draw organized criminals into the open.
- Criminal organizations are generally made up of individuals who live in, or come from, the same ethnic community.

- Criminal organizations, due to their size and the need to live within their community, may be more popular within their own area than without. This can cause difficulties when attempting to secure aid from the local populace.
- Organized crime's goals tend to be long-term. Not only are organized criminals (usually) more careful than individual perps, but they are always planning to expand their "field of operations." This means they prefer to diversify and not tie themselves to a single area of exploitation.
- Organized criminals are resourceful. They have financial support in addition to manpower. This makes them very dangerous.
- Almost all organized crime syndicates are run by a single leader or small group (although a single gang may be subservient to another gang head and so on).
- Many organized criminals may call upon "part-timers" for aid. These can range from truck drivers to store owners and street docs. This is one of the reasons organized crime is so popular within a community—it can provide work and money to those that need it.
- Organized crime will seek to subvert power wherever possible. This is achieved through corruption, intimidation, violence, or a combination of all three.



■ Organized crime will often hide behind legitimate fronts, such as stores, restaurants and even corporations. There is no differentiation between the crime and the front protecting it, making the job of discovery and apprehension even more difficult.

## DEALING WITH ORGANIZED CRIME

Since the 1930's, the responsibility for "uprooting" organized crime fell to the Federal Bureau of Investigation. This was natural, because many of the crimes committed by organized criminals were federal crimes. Today, the LEDiv office of each city will have a Special Agent in Charge of Organized Crime (from the O.C. Bureau) to coordinate anti-organized crime efforts, liaising with local law enforcement agencies.

Due to the corrupting nature of organized criminal activity, OCB agents may act above and beyond the rights bestowed upon them by the Mayor of any city. They are responsible only to their own supervisors, who in turn are responsible directly to the Bureau chiefs. This allows the OCB a certain flexibility when dealing with organized crime. This has also been a bone of contention with civil government officials, who have always resisted these measures, stating the OCB is "out of control."

OCB agents may, at their discretion, set up a Task Force within a city to combat organized crime. The Agent in Charge must coordinate this personally, and choose his team from among the existing ranks of local law enforcement officers. Many are selected right out of the academy due to their lack of potential corruptibility.

We'll now examine four major types of Organized Criminals that remain a continual problem within the cities of 2020.

### The Yakuza

The word *Yakuza* translates into "Good for Nothing." It originates from a Japanese gambling game called *Sammai Karuta* or "Three Card." This game is very similar to Blackjack, but the idea is to get 19 points instead of 21. Thus drawing an Eight (Ya), Nine (Ku) and Three (Za) you get 20 which (not being 19) was "good for nothing." The Yakuza originated in Japan, but has now spread worldwide as successfully as most Japanese corporations. (In fact, there are some who say there is little difference, if any, between the two...)

It has always been commonly held by the Yakuza that there are only two paths they may follow: prison or death. They are among the most violent of all organized criminals and perhaps the



most widespread. With a membership larger than the Mafia (who are less visible these days), the Yakuza are also one of the most dangerous and difficult types of organized criminals to successfully apprehend.

The Yakuza have always been based in the Osaka region of Japan. Efforts by the Japanese National Police Agency (their FBI) to crack the Yakuza have always failed; the reason for this is commonly thought to be the extent of Yakuza infiltration in local police departments. It may also have something to do with the amount of Yakuza-influenced pressure the many Osaka corporations heap onto the overworked police force. The NPA maintains an International Index on the Yakuza which may be accessed by other country's enforcement agencies in their attempts to shut them down.

Based upon the ancient Japanese principles of *Giri Ninjo* (strong obligations), the Yakuza operate today in the same manner they have done for countless years. The leader of a Yakuza clan is the *Oyabun*, and is granted his power by the Osaka Clan chiefs personally. These chiefs are a loose alliance of Yakuza heads who oversee Yakuza operations worldwide. However, they have been known to wage war among themselves on occasion. An *Oyabun's* clan is made up of a number of Gangs, each commanded by a Captain appointed by the *Oyabun*. A Captain then appoints Lieutenants as he sees fit to supervise various areas of gang activity. Each Captain of a member gang must pay regular tribute to the *Oyabun*, lest he be replaced with someone else who can pay. In

turn, the *Oyabun* pays annual tribute to the Osaka Clan chiefs; the same rules apply.

The Yakuza (or "Yaks") primarily recruit in two ways:

They rely heavily on the Japanese *Bosozuka*, or hot rod and motorcycle gangs. Many foolish, daredevil young men involved in these bloodthirsty gangs end up being recruited by the Yaks. The *Bosozuka* are also used for indirect intimidation by the clans, as these roving, often-boosted mobs know the cities just as well as (and sometimes better than) other, non-affiliated gangs. The Yakuza also operate a number of orphanages, primarily in Japan. It is from here that over fifty per cent of young Yaks are recruited, the organization becoming a surrogate family for them.

The family aspect of the Yakuza cannot be overemphasized, as this facet is a recurring theme in their criminal lifestyle. One of their most revealing rituals is the *Demukai*, a ceremony carried out when a Yakuza is released from prison. His entire gang shows up to greet him in stretch limousines and expensive suits, welcoming their own back into the gang. This is an important symbol in showing the prison, and society, that their best efforts could not reform the Yakuza's convicted brethren.

Once you're "in", the Clan never lets you leave. Many young Yaks take to body tattooing to clearly identify their clan affiliations. Like the street gangs, they see these tattoos as their "colors" and, while not displaying them publicly, are equally proud of them. Yakuza tattoos cost around Eb

3,000 and always identify the clan they belong to. More than this, however, Yakuza tattoos mark them as misfits, unable and unwilling to adapt to society.

The Yakuza involve themselves in many activities, not all of them crime-related. Like most organized crime, this makes them a good deal tougher to weed out of their neighborhoods. The Yakuza's main investments are in drugs, gambling, transportation, real estate, construction, nightclubs, restaurants, bars, moneylending, chop shops, snack bars and street stalls. While they may engage in legitimate activity, the Yakuza will not hesitate to use underhanded methods such as intimidation, violence and corruption to achieve their aims.

The Yakuza do not accept failure well and have developed an elaborate ceremony to deal with it. Known as *Yubitsume*, or ritual finger cutting, the ceremony is performed when a Yakuza wishes to apologize to his immediate superior. Digit segments are severed from the offender's hands, starting with the little finger on the off-side. A small silver knife is placed over the finger and the Yakuza leans forward, his body weight causing the knife to snap the finger off cleanly. The piece of finger is then placed in a bottle and sent to the superior as a gift. Repeat offenders may lose any number of fingers (this often reduces the apologetic Yak's efficiency, leading to a downward spiral in digits).

Besides fingers, the Yakuza are very big on gift-giving of all kinds, and visiting Yakuza will always pay tribute to clan/gang chiefs. Among themselves, they are incredibly courteous, the smallest breach of conduct usually resulting in *Yubitsume* (or a gang war if the offense is not dealt with properly).

The Yakuza rigidly adhere to a set of tenets founded from the organization's beginning:

1. Never reveal the secrets of the organization.
2. Never violate the wife or children of another member.
3. No personal involvement with narcotics.
4. Do not withhold money from the gang.
5. Do not fail in obedience to superiors.
6. Do not appeal to the police or the law.

Obviously, some of these are broken all the time; these offenses inevitably lead to the gangs inflicting vicious punishments upon each other. In many ways, the Yakuza are more intolerant of each other's shortcomings than anyone else. They enforce their code of conduct with great vigor, and suffer outsiders with even less grace.

Since the arrival of the Yaks in the U.S., they have systematically attempted to take control of cities along the West Coast with varying degrees of

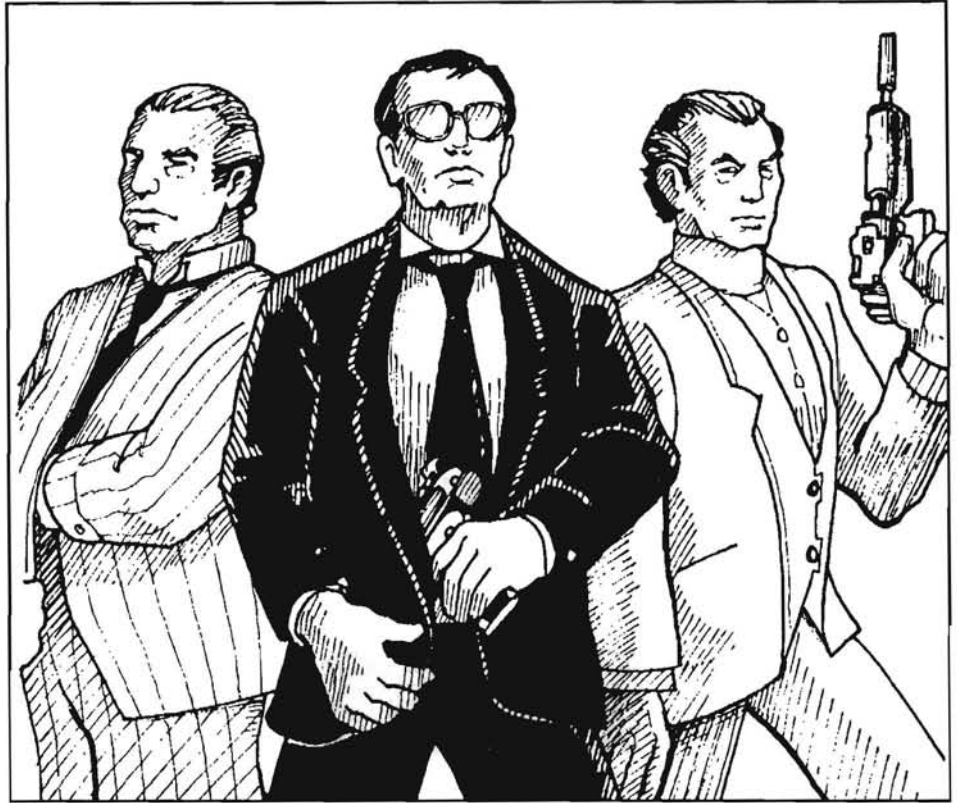

success. The East Coast remains relatively untouched—primarily due to Mafia interests there. Night City has been the site of one of the greatest intrusions of Yakuza over the last twenty years. Many legitimate organizations are controlled by the Yakuza and their criminal activities range from gangs, gambling, and illegal clubs, to a large drug network which the local, national, and international enforcement agencies have yet to crack.

While many think of the Yakuza as a romantic vestige of the past, the reality is a blood-streaked history of carnage as the organization wages war against the public, police, other criminals, and themselves in an effort to gain control.

### The Mafia

The Mafia (or just The Mob), originated from the Sicilian clan-families of the Cosa Nostra. For years, nobody believed the Mafia really existed, while they consolidated their position and utilized this refusal of acknowledgement to adopt the cloak of secrecy which now surrounds their actions.

Today, the Mob is still the single most powerful organized crime network in the U.S.; they have achieved this through violence, corruption and lots of hard work. Like many criminal syndicates, they maintain legitimate holdings, but make the bulk of their money through (semi-)illegal activities—unlike their rivals, they are barely visible, and rarely expected. They have become masters of striking from the shadows of

legitimate organizations, retreating before anyone realizes what went on. In many ways, this makes them more dangerous than other criminal organizations; you don't know you've upset them til you're dead.

One element of the Mob which remains from the old days is the principle of the Family. Even now, each Mafia Family "owns" a given city; they may have hundreds of "wiseguys" working for them, but the Family is in control and nobody forgets it. A Family is lead by a "Godfather" (or Capo)—always male—who hands his organization down to the elder son, or closest and eldest male relative. A "Commission" of Capos (family bosses) rules over all the Families in America, but they try to remain as far removed from illegal dealings as possible so as to remain untouchable in regards to the law. The Commission assigns cities and positions within the overall Mob network and they settle all major disputes. This Mafia course on Management for the Future is a proven success story.

The Mafia family provides the Italian community (and others) with a wealth of goods and services ranging from special offers on "surplus" goods, through loans of desperately needed cash, to settlement of domestic disputes. It is because of this support that the Mafia commands an amazing loyalty within their communities. "Payback" is a very familiar word within these lower middle-class neighborhoods, and



the Mob works primarily on the Payback way of life when asking for information and low-grade services. While the Mob employs a large group of core personnel, most of what can be termed Mafia people are merely regular people working on Payback.

The Mafia maintain their Number One position against the rising tide of foreign organized crime through their long-term interests, particularly through use of political corruption. No single organization is more successful or persuasive in this area. Corrupting officials is a way of life for the Mob; they are in a position to offer their "clients" a phenomenal amount of assistance with their careers, in addition to financial aid. In the *Cyberpunk* Mob, money doesn't just talk; it whispers seductively in your ear.

Mafia wrath is legendary, and rightly so. Once you've invoked it, your best option is prayer (but even then, the Mob knows God is on *their* side). The Mafia still utilizes the "contract" system when placing a "hit" on an individual. This allows all Mob personnel to earn some extra cash, should they ask for a chance at the hit. The Godfather ultimately decides who receives the contract, and for services rendered, the hitter gets a large cash bonus to his next payoff from the Mob. For the most part, however, a Godfather will only assign a contract to a trusted hitter who he knows will get the job done, then fade away without any trouble. Mafia hit men are some of the best hired killers around, equalling corporate solos in their dedication to the work.

Mafia interests are a mix of traditional and modern rackets: unions, loansharking and gambling, as well as stock fraud and money laundering. This allows them access to a great deal of money which the Treasury Department never

sees. Drugs are still frowned on, holding a stigma which has not been completely shaken yet. However, gone are the days of the Mob leaving their calling cards at a hit, and hanging around storefronts. Today, they are primarily a business (with a nice line in assassination). While they still occasionally organize "wars" against one another, they have become far more unforgiving to outsiders who dare cross them in their chosen areas of influence. This has led to ferocious battles against other organized criminals, especially the Triads. The Mafia are no longer hustling young men moving into the New World, they are businessmen with resources to rival those of a Corp. And business is good.

### The Triads

The Triads are the third largest criminal organization operating in the U.S. today. From initial beachheads in San Francisco, these Chinese mobs have created a stranglehold on Chinese communities throughout North America. The Triads originated in Hong Kong and Taiwan (which remains their international base) and have spread across the world, bringing their trademark of violence with them.

To understand the Triads, we must first look at the Tongs. A Tong is a secret (or not so secret) association of business and/or social leaders. Tongs always exist within any sizable Chinese community, working along similar lines to the early Sicilian Mafia. The Tong oversees the community's development and integration into a city. For the most part, a Tong is law-abiding; furthering the aims of their community and businesses. Almost as a sideline, a Tong will also look after the social interests of the community, policing itself.

#### THE YAKUZA HITTER

##### ROLE: SOLO

INT: 6	REF: 8/9	TECH: 3
COOL: 9	EMP: 6/6	ATTR: 7
LUCK: 8	MA: 8	BODY: 7
SAVE: 7	BTM: 2	

**SKILLS:** Combat Sense 4, Wardrobe & Style 8, Intimidate 6, Motorcycle 5, Streetwise 5, Handgun 9, Hide/Evade 5, M.A. Karate 7, Shadow Track 8, Melee 6, Dodge/Escapes 7, Stealth 5, Awareness 7, Social 4, Fencing 8.

**CYBERNETICS:** Pain Editor, Interface Plugs, Smartgun Link, Cyberoptic, Target Scope, Time Square, Low Lib, Adrenal Booster

**EQUIPMENT:** Arasaka WSA autopistol in Cybermatrix Speedholster, Kandachi M-33 Powersword, DUD Smartgun Controller, Digital Weapon Link, Mini-cellular phone, Creditchip account, small Silver knife, Kundalini Roadworks Shine performance speedbike

The Yakuza hitter is an arrogant and ruthless professional. His work is of the highest standard, and he expects high standards from the equipment he utilizes—he considers himself the Samurai of the 2020's. The current fashion favoured by Yak hitters is the popular Takanaka "Exec" Line—stylish and sophisticated, yet with a little alteration, providing excellent protection versus many modern firearms. The Yak hitter also bears the Yakuza tattoo, although, naturally, he hides it beneath his clothing—after all, he doesn't need to advertise; his reputation does that for him.

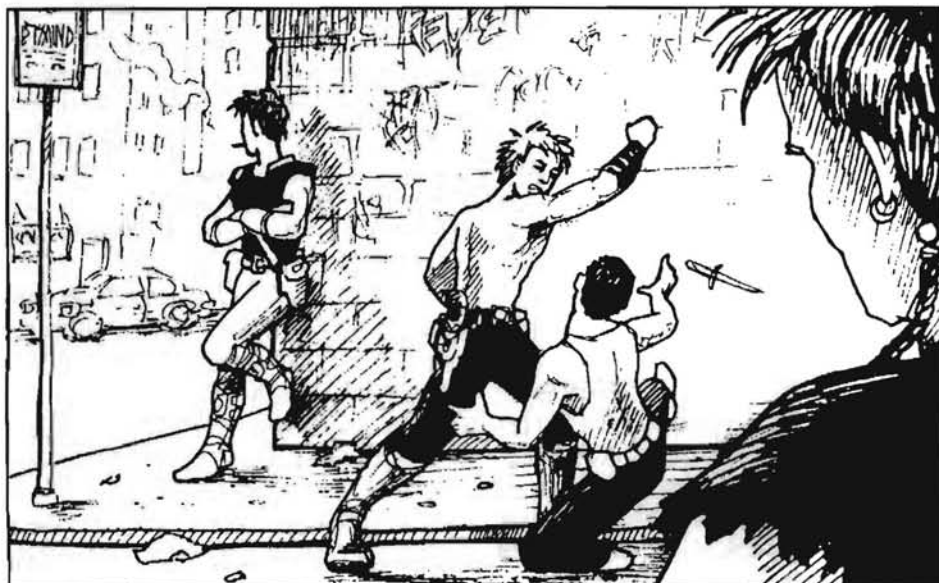





## THE MAFIA HITTER

Role: Solo

INT: 5	REF: 8	TECH: 4
COOL: 8	EMP: 6	ATTR: 6
LUCK: 6	MA: 8	BODY: 6
SAVE: 8	BTM: 3	

**SKILLS:** Combat Sense 5, Awareness 6, Personal Grooming 7, Hide/Evade 2, Wardrobe & Style 8, Shadow/Track 8, Intimidate 9, Brawling 7, Streetwise 7, Dodge/Escapes 4, Human Perception 5, Handgun 7, Social 2, Melee 6, Drive 7, SMG 9, Stealth 6.

**CYBERWARE:** Little or none. The Mafia are firm believers in relying upon their own skills, not placing their trust in large-scale cyberware.

**EQUIPMENT:** Colt AMT Model 2000—silenced, Barrett M-24 Advanced SMG—silenced, SPM-1 Battleglove, Mirrorshades, Cellular Phone, Credchip account, Countach replica sports car.

Still feared and respected for his efficiency and thorough loyalty to his 'family', even in the 2020's. He wears the accepted dress of the Mafia hitter—the range of Kevlar armor and designer suits marketed by the Cimano Bros. label. Sharply cut and radiating respectability, these suits also provide considerable protection for those with the need to look good, yet who want to stay alive.

He carries as little equipment as possible—who needs fancy gadgets when you've got the latest in military hardware at your disposal—and it's silenced loot. Don't underestimate this guy just because he isn't rigged into his weapon—if you have any doubts, he'll be happy to give you a demonstration of his skills. That is, if the price is right.

## THE COLUMBIAN HITTER

ROLE: SOLO

INT: 4	REF: 7	TECH: 3
COOL: 6	EMP: 6/3	ATTR: 6
LUCK: 3	MA: 7	BODY: 6
SAVE: 8	BTM: 3	

**SKILLS:** Combat Sense 3, Brawling 6, Streetwise 3, Dodge 4, Awareness 5, Driving 5, Hide/Evade 6, Handgun 7, Shadow/Track 3, Rifle 7, Melee 6.

**CYBERWARE:** Speedware (Sandevistan), Interface Plugs, Smartgun Link, Skin Weave, Scratchers, Cyberoptic, Targeting Scope.

**EQUIPMENT:** Federated Arms Light Assault 15, Milltech Crusher SSG, Goncz-Taurus 9mm Single Action pistol, Kevlar T-Shirt, Cheap Mirrorshades, several hits of Dorph or other similar drug.

He may not be as professional as the Mafia hitter, or as tough as the Triad, but the Columbian hitter has enough determination to keep up with the big boys. Yeah, so his equipment is slightly out of date, and his Kevlar suit has a few patched holes on the inside, but you can't deny the fact that he gets the job done.

He's had enough of the jokes and snubs he hears about the Columbians. His country's a bad place to live; they don't have the power that the other criminal groups have. That's why he uses such unorthodox methods to complete the job—that's also why he may be the only functioning hitter amongst the Columbians at the moment. Most of his colleagues are either in Memorial, the Stats Pen, or six feet under. But what the hell, the money sure is good!



## THE TRIAD HITTER

ROLE: SOLO

INT: 4	REF: 9/10	TECH: 3
COOL: 8	EMP: 6/2	ATTR: 4
LUCK: 5	MA: 9	BODY: 7
SAVE: 7	BTM: 2	

**SKILLS:** Combat Sense 4, Athletics 9, Strength Feet 7, Dodge/Escapes 7, Intimidate 3, M.A. Kung Fu 5, Streetwise 5, Awareness 8, Rifle 6, Shadow/Track 4, SMG 9.

**CYBERWARE:** Epsilon-strength Linear Frame, Pain Editor, Muscle and Bone Lace, Smartgun Link, Wolver, Interface Plug, Subdermal Armor, Cyberoptic, Targeting Scope, Infra-red vision.

**EQUIPMENT:** AKR-20 Med. Assault Rifle, Satsuko Arasaka "PMS" Advanced SMG, Assorted grenades (for special effects), case of Smash, multiple doses of drugs such as Black Lace, Slim, Blue Glass, etc.—the wilder and more physically damaging, the better! Harley-Davidson Thundergod motorcycle.



Out of all the hitters on the streets, this guy is without a doubt the craziest. Boosted up to the verge of cyberschizophrenia, and smashed out of his mind on a variety of illegal narcotics, this perp is seriously scary.

There is no set fashionware amongst the Triad hitters, but due to this particular hitter's status in the Boosergang world, he tends to dress hard, mostly in synthetic leathers and kevlar battle-chic. Not known for his sense of justice (or for rational thinking), the Triad hitter can be a terrifying force to reckon with—leave this one for the boys down at Max-Tac, it's their job!

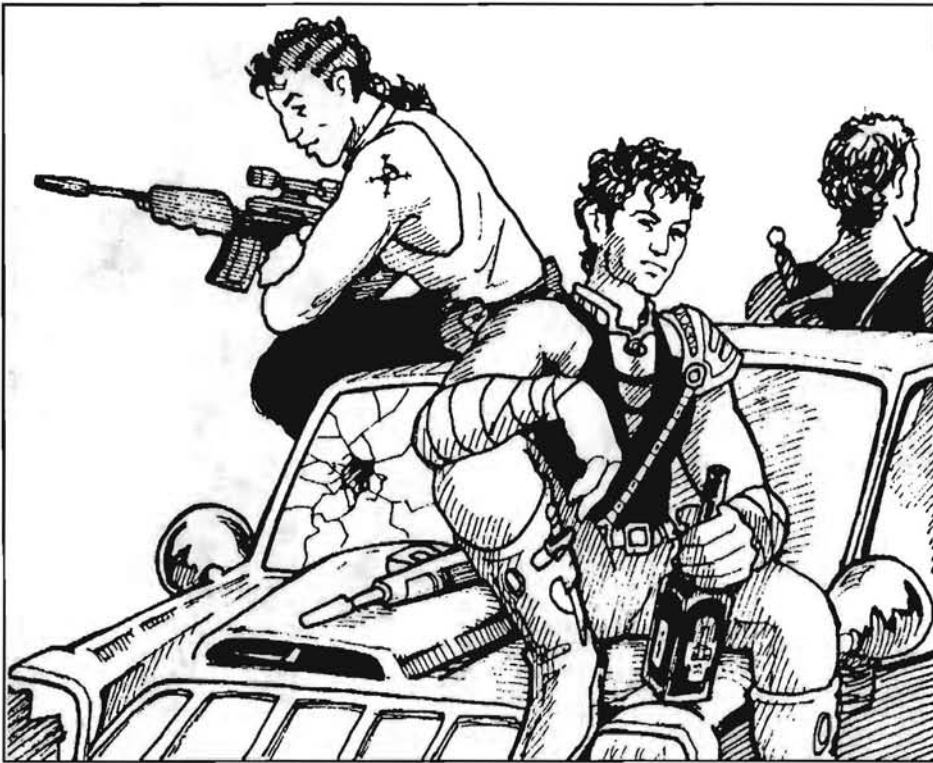

It is via this medium the Triads appeared, their fierce, cavalier attitudes in direct contrast and conflict to the older, more traditional ways of the Tongs. Triad gangs continually terrorized the Tongs into serving them. Worse than this, some of the more ambitious, less traditional, Tong counselors saw financial possibilities in less restrictive methods. Thus the Tongs became the Triads, and (in some cases) the Triads became the Tongs.

Today the Triads, while not as large (in the U.S.) as the Yakuza, or as commercially involved as the Mafia, control the majority of the Chinatowns in our cities. This manifests itself in two major ways: Triad gangs who lurk on every street corner and follow tourists up the alleyways (the Hung Kwan, or fighters), and the Triad hierarchy who arrange, control and maintain profitable (if illegal) commercial interests. This second group is a mix: from Tong Counselors and information brokers (Pak Tsz Sih/Chu Chi), to illegal dealers and those who provide "services" (Che Hai/Sze Kau). The Triads involve themselves directly with street profits: mainly drugs, prostitution, gambling, protection, stolen goods and pornography. They also protect themselves on the Street in a most blatant fashion. Chinatowns are never policed particularly well, so the Triads can issue their own form of justice: Those who cross them die. It's a simple principle, well backed by crazy gangs who are only too happy

to shoot up someone. More than this, the Triads are easily the most savage of organized criminals, killing or brutalizing entire families as warnings to those who offend them.

The Triads maintain a very high profile within their territory; those who come looking for trouble soon find themselves fighting over every inch of ground to get further in...or back out. Compared to other crime syndicates, the Triads are a far more reactionary group. Because of a lack of overall control, Triad members will overreact to provocation. This has many results, but the most obvious are the high body counts.

### **The Columbians (and other South Americans)**

Since the DEA destroyed the Columbians' hope of making it big back in the 90's, these remarkably inventive and persistent entrepreneurs have turned their attention to more generalized organized crime. This has not been particularly successful (for the same reasons as their previous attempts at criminal activity). While they can be brutal in their methods, the primary goal for Columbian criminals is to escape the incredibly poor standard of life within their own country. For this reason, most Columbians still attempt to "make it big" in one sweep. Unlike the older types of criminal organizations, their desperation causes them to take high risks for any rewards. This results in many situations where they find themselves trapped and preferring the "go down in a blaze of glory" option,

rather than the "go down for 15" option. Flamboyant, but dangerous for everyone.

## **CORPORATIONS**

### **OVERVIEW**

The hundreds of multinational corporations around the world practice legitimate business operations. True—and false. No Corporation considers the use of criminal activity too unethical when it might be a cost-effective part of their entire business strategy. Therefore, we must look at the various ways in which the law enforcement community comes into contact with Corps, and how to handle these slippery types.

The Law and Corporate interests do not mix well and the true extent of corporate criminal activity (if ever uncovered) would make most organized criminals look like petty thieves. Even a small Corp has an awesome array of resources and manpower with which to plan, execute and cover up its crimes.

Corp Crimes can be broken down into five major areas:

- Crimes against the Public
- Crimes against the Individual
- Crimes against other Corporations
- Crimes against the Environment
- Crimes against the Government

### **Crimes against the Public**

Tempted to cut corners while trying to maximize profits and reduce overhead, corporations often allow a vast amount of substandard, sometimes dangerous, products to find their way to the public. These products can come in any shape or form, ranging from pharmaceuticals with known (yet unpublicized) side effects, lethally malfunctioning machinery, all the way to contaminated food knowingly sold at knockdown prices. Many outwardly legitimate Corporations are only too willing to break the law when there's hard Euro involved.

Crimes against the general public are reasonably easy to monitor once they become known. However, many products (especially food and pharmaceuticals) cause such indirect effects it is believed only a fraction (15%) of these crimes are ever discovered. The Corporate Investigation Bureau (CIB) maintains a Task Force that constantly attempts to monitor these crimes. Lacking manpower, and facing the immense resources Corps can utilize in covering their tracks, they do not have a particularly successful record.

The Law states that a Corporation may be held directly responsible for its actions in committing, or conspiring to commit, crimes against



the public. However, if it can be shown that the Corporation, as a whole, had no knowledge of the situation, then individuals within the corporation must be found to be responsible. This makes these kinds of cases particularly difficult (if not impossible) to prosecute. The company starts by stating that it had no knowledge of the crime and passes the blame to an individual. The individual, in turn, if not immune (See *Corporate Immunity*) cannot pay the substantial damages involved (and more often than not is set up by the Corp as a scapegoat). The public never gets the damages they're owed; the Corp stays clean and nobody wins. Often, the Corp may have hired the individuals involved as freelancers, thus neatly washing their hands of any direct responsibility whatsoever.

### Crimes against the Individual

Fact—corporations exploit people. While they provide hundreds of thousands of jobs, they also exploit the public and their workers alike. In today's world, a good job with a regular wage is hard to find. Yet, as part of most employment contracts, most corporations ensure that their laborers sign away all rights to compensation due to damages caused while at work, or due to the nature of the work. Having signed these documents, the individual is forced to live with his loss of limb/debilitating disease/radiation sickness, etc. Despite frequent government warnings, most workers have no choice but to sign—the only other option is to starve.

There are also a large number of individuals who have suffered directly at the hands of a corporation—assault, torture, murder—these are all commonplace results of defying a corporation's agenda (this could as simple as living in a place where a Corp wants to build and refusing to leave). In these situations, there is no real difference between the actions of Corps and organized criminals. What is worse, Corps will often "hire" freelancers to perform these tasks, once again creating a deniable resource which allows them to avoid blame. These are euphemistically called "Black Operations" (see below).

Such crimes against individuals rarely result in a conviction against the relevant corporate parties, due to the power difference between a vast corp and the small man. Corporate Immunity sees to this.

### Corporate Immunity

Corporations are now like sovereign nations in many respects. Company property has become a safe haven where no unauthorized person may enter. Those that do enter are dealt with by Corp



Cops; this treatment tends not to be particularly courteous and is sometimes fatal. *Trespass at your own risk!*

If, and when, a corporate employee of sufficient status is arrested, detained or questioned with regard to criminal activity, that individual may, if authorized, declare Corporate Immunity. Once this is verified (about half an hour) the law enforcement community is required—by law—to return the individual to corporate property (any company-owned site; company property includes such things as company jets, vehicles, stores, offices and houses). It's assumed that the Corp will handle all necessary disciplinary action internally at this time (but this rarely happens). As you can see, this is not a happy situation.

Corporate personnel have been charged in the past with crimes ranging in severity across the six priorities, and in these cases Corporate Immunity has had varying degrees of success. As a general rule, Corporate Immunity should work infallibly; however, the CIB has seen to it that this is not always the norm. Immunity works well up to and including Priority 2—although Priority 2 is something of a gray area. If a Corp learns it has an employee being held by an enforcement agency, and he is protected under immunity, the Corp will bring varying amounts of legal, political and media pressure to bear in their attempts to get him back (this obviously depends on how much the Corp wants him back, of course, and how much he may know of their operations).

At Priority 1, the governmental law-enforcement community has a full set of "unofficial" rules

when dealing with immunity cases. They are unlikely to inform a Corp of the detention of one of their employees, and once the individual has been determined to be the perpetrator, he will be held in maximum secrecy while the agency involved decides his fate. Quite often, the guilty party simply disappears. When dealing with Corporate Immunity at Priority 1, the Ref will have to handle every case individually, and must take into account whether the Corp knows one of their own is being held. If they do, and they want him back, they'll go to any length to get him—or silence him for good before he squeals...

If a Company man is busted and goes down, it's highly unlikely he'll go down for long. He will probably be sent to an executive penal facility, complete with full leisure activity program.

### Crimes against other Corporations

When Corps aren't performing Black Ops against some innocent (or not so innocent) Jo, poisoning the food or getting out of jail free, they're warring against each other (hell, they're warring against each other when they do all that other stuff, too!).

Corps suffer from defectors, just like nations. They don't like this very much, especially when the defector signed a lifetime contract, but has just been airlifted to safety with his latest development as a bargaining chip...leaving several dead Corp security guards and personnel lying around. This is not good for business. So they get him back. How? The same way, of course: small operations teams loaded to the max with fully automatic weapons and lots of heavy hardware. This happens a lot. When Corps are not



engaged in these activities, they're busy stealing each other's special designs and projects.

(Industrial espionage is a bigger department than Advertising in most corporations these days—but don't use that word; it's called Operational Logistics now. And if some rival Corp is about to blow your latest scam/Logistical Development to Channel 77, what you do about it? Shut them up fast. How? Logistical Crisis Operatives i.e., Solos.)

Corporations openly dispute territory outside of cities, especially in Potential Exploitation Areas (i.e., developing countries). These "open disputes" are virtually full-scale wars, fueled with mercenaries, air power, and the latest military hardware money can buy. All the largest corps retain military personnel ready to fly out to various hotspots around the world at a moment's notice.

Corps will often utilize their Strategic Studies departments to maintain constant economic, political and personal wars against rivals. These can get very bloody indeed, once again reflecting the many similarities between the operations of Organized Crime and the Corporations. Current policy among the police with regard to many of these activities is to let them tear the hell out of each other. However, more often than not, corporate wars spill onto the streets, taking innocent lives in the constant struggle for that "substantial dollar value."

### Crimes against the Environment

This may come as something of a surprise, but many corporations do not have the environment's best interests at heart when conducting their activities. This crime occurs everywhere and takes on many shapes and forms. While Corp crimes against the global environment warrant special attention, it is not the responsibility of individual law enforcement agencies to enforce this. There are plenty of cases within the local environment which need attention.

The unwholesome truth is that Corps will dump their waste wherever and whenever they can. For example, last year it was discovered that Petrochem's vast "All-Purpose Waste Reprocessing Facility," as widely publicized and credited by the President, was nothing more than a large hole in the ground somewhere in the Nevada desert. Their excuse? They stated that "Board level approval had yet to be secured on this long-term plan." However, they did wholeheartedly agree their marketing division had overstepped the mark in releasing full publicity details and declaring the site open.

Not only do Corps dump their loads all over the place, they will also tear down anything that

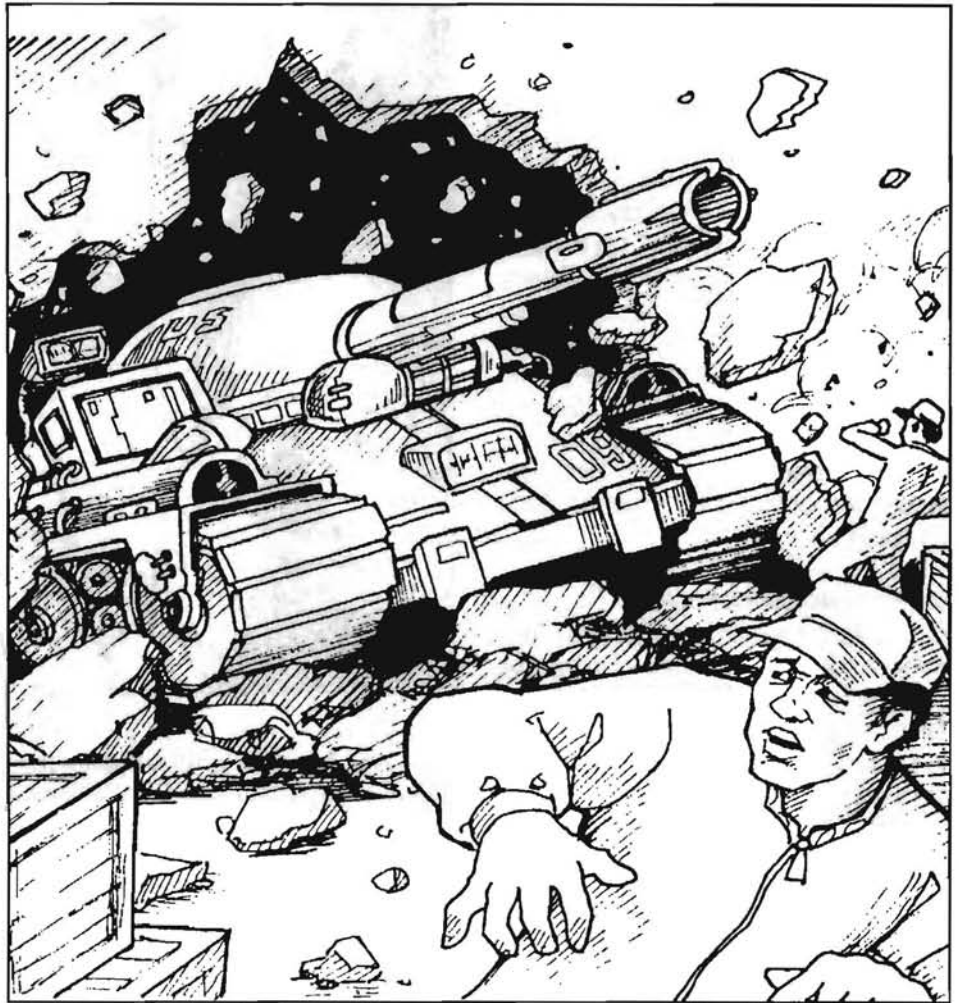

**U.S. Army MBT smashes its way into a Mantoga warehouse during the government's anti-corp campaign.**

gets in their way. Factories pollute the cities, and transportation of hazardous materials is unstable at best. The fact that Corps perform these activities in unmarked vehicles, or even vehicles painted up in other Corp's logos, makes these laws very difficult to enforce. Corps will often hire a third party to carry out many of these eco-violations.

### Crimes against the Government

***"I will not stand for corruption of any type. The corporations do not rule the United States of America. I promise the people of America that for as long as I am President of this country of ours, the law will be fair and that no man, whoever he may be, is above the law."***

**—President Henry T. Jacobi at his inauguration ceremony, moments before he was assassinated.**

Politicians giving you trouble? Get Public Relations onto it. They'll run a massive smear campaign that's sure to stop that man in his

tracks. Get Graphic Design onto some "live footage" of your man performing some embarrassing, but entertaining, feat. All they need are a few photos.

With cash and resources similar to those of large nations, Corps inevitably develop political interests. These interests are often the cause for friction between themselves and various countries they work within. With heavy dollar investment and long term returns, moving out is not a viable solution; it's better to find someone with whom you can deal. The result is corporations allying themselves to political factions, pouring large amounts of cash and resources into them to ensure the success and the fruition of long-term strategy.

Corporations indirectly involving themselves in politics are frowned upon by the CIA; direct involvement is usually unacceptable, and if discovered, is promptly stomped on. Or at least they try. Corporate sponsored kidnapping, assassination, corruption and bribery frequently occurs, and has been cause for CIA concern for some time. Multinationals tend to operate more blatantly in the U.S. than in other parts of the

civilized world, but will not hesitate to act even in the heart of the Eurotheatre if their assets are in danger of being reduced or neutralized.

Corps often have very long-term plans which may be affected by short-term politics. This sometimes causes them to act in a hostile manner toward their host governments. But normally they must tread carefully, lest they invoke a National Security threat (at which time discretion goes to the wind and minor warfare breaks out). For example, the Mantoga Corp (implicated in the assassination of President Jacobi) was deemed a threat to National Security and given four hours to leave the country. This threat was not taken seriously by Mantoga, and of their six thousand personnel on U.S. soil, only a thousand escaped airstrikes on their offices, and tank and AV-4 assaults on their storage facilities. Even those who left the U.S. were pursued. Four months later, Mantoga ceased to exist.

#### A Word on Japanese Corps

The Japanese Corps operate very efficiently (as we all know only too well). This does not change when executing their Black Ops. Many Japanese Corps retain a sizable contingent of "ninja" to perform the surgical strikes they have become reknowned for. Such groups have often been associated with a particular *zaibatsu* for decades. These ninja are totally loyal, totally fanatical, totally charged-up all-purpose killers. Most of the time, you don't see 'em coming; you don't see 'em getcha; you don't see 'em leave. Nobody ever knew they were there.

#### THE CORPORATE SOLO/HITTER

##### ROLE: SOLO

INT: 6 REF: 8 TECH: 5  
COOL: 8 EMP: 7/4 ATTR: 7  
LUCK: 5 MA: 7 BODY: 8  
SAVE: 8 BTM: -3

**SKILLS:** Combat Sense 5, Streetwise 3, Wardrobe & Style 7, Human Perception 5, Personal Grooming 6, Social 4, Intimidate 8, Awareness 9, Interrogation 6, Shadow/Track 5, Brawling 5, Dodge/Escapes 6, Driving 7, Handgun 8, Melee 6, Rifle 8

**CYBERWARE:** Interface Plugs, Smartgun Link, Chipware Socket, Skill Chips (dependant upon specific mission), Cyber-

optic, Target Scope, Times Square, Infra-red, Image Enhancement, Cyberaudio, Radio link, Frequency Changer

**EQUIPMENT:** Colt Alpha-Omega 10mm pistol-silenced, Militech MK IV Assault Weapon, Mirror shades, Cellular Phone, Sonar Scanner, Advanced Communication Suitcase, Credchip account

*Logistical Crisis Operative* is the title that this guy uses, but he knows (and everybody else knows) that he's just a solo. He doesn't care though—the Company has taken good care of him, given him a great place to live, a decent salary, even fixed him up after he almost got flat-lined by a couple of booster-freaks.

He dresses as an everyday company exec. Frack, why not? There's no point in standing out in a crowd, not in his line of work. If your target's wearing the latest line of Eji executive evening-dress, you have to as well. Anyhow, some of these new cuts are pretty wild for a working stiff.

He's cool and cocky, knows his capabilities and limitations, and most important of all, he's loyal to the Corporation. And in this day and age, as far as he's concerned, that's all that counts.

#### THE CORPORATE "NINJA"

##### ROLE: SOLO

INT: 8 REF: 10 TECH: 6  
COOL: 9 EMP: 8 ATTR: 5  
LUCK: 6 MA: 9 BODY: 6  
SAVE: 6 BTM: 2

**SKILLS:** Combat Sense 8, Hide/Evade 8, Endurance 6, Shadow/Track 9, Strength Feat 5, Athletics 8, Dodge/Escapes 8, Resist Torture /Drugs 7, Awareness 9, Handgun 6, Melee 7, Fencing 8, M.A. Karate 9, Rifle 8, M.A. Choi Li Fut 8, Stealth 9, M.A. Tae Kwon Do 5, SMG 6, Demolitions 5, Electronic Security 6, Pick Lock 6, Archery 6, Disguise 5

**CYBERWARE:** None—The ninja considers those who rely upon mechanical augmentation

of the human body to be worthless.

**EQUIPMENT:** Sternmeyer Type 35 Pistol-silenced, No-Dachi and Ninjato (Workmanship gives weapons capabilities of the Kendachi Mono Two), Militech-10 SMG with suppressor/ scopes/ Grenade Launcher, FEN Dz 22 Saucer Grenades, GPz-78 Mini-Grenades, Sonar Scanner, IR Cloak Suit (Black), Compact Climbing Kit (100m mono-line with grapnel), Det Cord, Advanced Alarm Removal Kit

He has a reputation for being the most deadly assassin in the city. His clients are amongst some of the most powerful men and women within the Corporate sector. He has no qualms concerning who he works for, as long as the price is proper, and his *zaibatsu* is satisfied. He has never failed on a mission, and not one of his employers knows his true name (or face).

The Ninja is the best of the worst, and uses this reputation to its full advantage. His favored form of dress is based closely upon the cos-



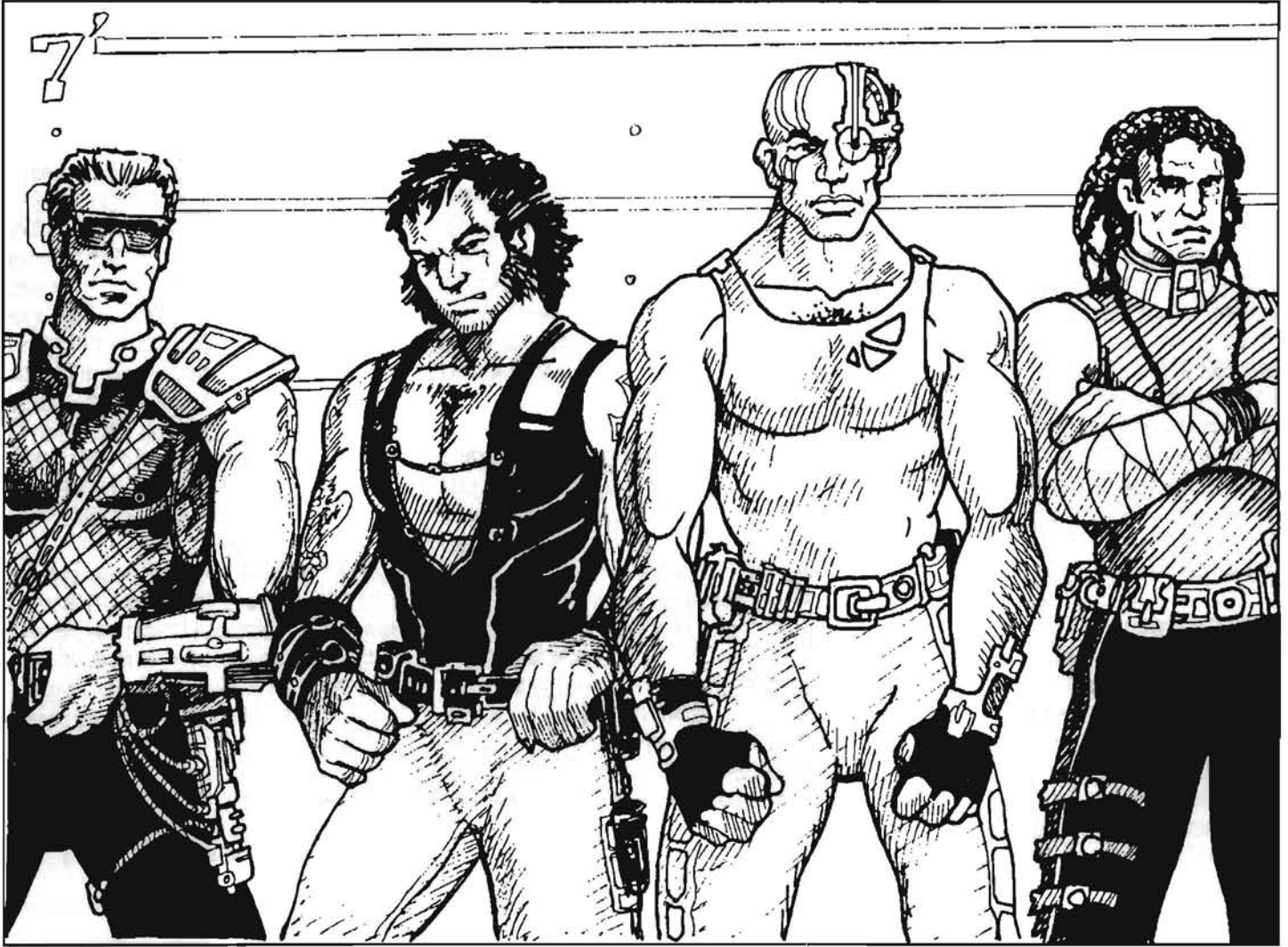

tumes of the ancient ninja: special black or chameleon coveralls, designed to allow freedom of movement, and to act as camouflage in the night. His equipment is especially imported from Japan, to ensure the highest quality possible. Everything about this man gives the impression of a professional, trained to never make mistakes and to always complete a contract.

## GANGS

*"They're like cockroaches...."*

### Overview

Street gangs in the cities have been a problem to everyone for a *very* long time. And it's getting worse. Every neighborhood has its own gang problem; every gang battles over turf, and every gang fights every other gang as it tries to stake its claim in the concrete jungle.

Gangs vary in size considerably; this is often the direct result of the latest turf war. As a rule, the bigger gangs are the more powerful

ones. Over the course of a year in a given city, many gangs will cease to exist; the problem is, so many new ones spring up in their place.

With no education, no career prospects and no real hope of ever "making it", many of the city's youth are sucked into the gangs. A great many kids who drift into town from the Outside also hook into gang life. In a way, a gang is a family of sorts, however bloody and hostile. Don't be misled into thinking the gangs are just lowlife, swimming around at the bottom of the sludge-pool. While this may be the case for some, many are jacked into big business. Crime, as we all know, pays well. With drug networks, protection rackets and theft, many gangs manage to earn good Euro. With the constant demand for "deniable resources" from the corporate sector, some gangs will even sell out to a company, enjoying the benefits of excellent equipment, weapons and legal protection, in addition to a monthly retainer of cash as long as they act when called on by "Mother Company." Many gang members are accomplished thieves, fixers and solos, and this provides them with the skills they need to "run their turf."

Unlike most organized crime, the gangs are high profile. They can be seen on every street, their colors clearly defining a given area as their turf. The streets are run by the gangs; while possibly being hired by (or serving) Corps or organized criminals, they know The Street belongs to them by right of conquest.

The gang presence on the street may vary from zone to zone, but almost always, the gang will be there. You may not see them, but they'll be keeping tabs on what's going down. Very little happens in a gang's domain without them knowing about it.

Gangs are one of the primary causes of rioting; this can range from a large-scale gang war with all affiliate members involved, to a gang invasion where the defending gang calls upon the locals to assist them. Sometimes the community itself will turn on its "home" gang and evict them with maximum force. The rise of Citizen Defense Leagues (CDLs) has seen more instances of unacceptable gangs being wiped out by popular demand. In many ways, today's



gang situation can be likened to football teams of old, where the local people either love them or hate them. Without much warning, neighbors can rally to rid themselves of a hated gang (in a similar manner to what happened in Cleveland back in the nineties).

Manpower, material resources and sociological difficulties mean the gangs present a big problem to local law enforcement agencies. This is because they exist on the hazy line between being useful and being very dangerous.

### Assessment

Gangs are made up of criminals, ranging from minor abusers to psychos. Gangs illegally rule their domain through threats and violence. They push hard drugs, illegal firearms, and many other controlled materials. Gangs war with each other, causing bloodshed on a massive scale. They are disrespectful to authority and very hard to weed out.

But...

A Gang knows exactly what's happening in its neighborhood; this can be very useful to the cops. Gangs, unlike organized criminals and corporate criminals, can also be controlled to a certain extent. They are far more visible, and therefore accessible for questioning. Gangs, unlike so many other criminals, are also predictable.

There are also the sociological ramifications. Pressure groups make everybody aware of how young many gang members really are. The media can come down very hard on the cops when they kill one. Especially if the zoned-out *Psycho Trooper* firing a Militech Ronin into the line outside the SIMplex was only eleven years old.

There is no standard policy when dealing with the gangs; they are so diverse and changable that there are few constants common to all. If a gang is burning up the street, then they're dealt with, fast. The use of deadly force is acceptable, as the risk to life when gangs are out of control is BIG. However, the general word is that the gangs can be left to get on with their business unless they become a problem. This allows a flow of hardcore data into street level enforcement, without which the cities would be a worse place to live in.

So, the word for now is: Tread Carefully.

## GANG TYPES

### Boostergangs

The Boosters are one of the most violent and threatening gang types in the city. These hard-

wired dudes are cybered up to the max; mostly showy, physical enhancements. They're very hot on weaponry, especially slash 'em attachments such as rippers. Many pack illegal cyberware and most of them are on, or over, the Edge.

There's only one real reason boostergangs appear: 'cuz they wanna bust heads! Other gangs', Jo's, each other's; heck, anybody's head will do. The boostergangs usually make special efforts to stay low; if they didn't, Max-Tac would blow them to pieces. These guys are Wanted almost all the time, and they don't make any friends. It's like a bunch of cyberpsychos all running rampage at the same time. They mostly move around at night, and they're very hard to deal with. A couple of street cops who run across several hardcore Boosters will be squashed like bugs, due to the gang boys' high-powered strength and enhanced reflexes, plus the fact nothing short of an Armalite .44 is likely to slow them.

It gets better: These guys will go out for a night's party with automatic weapons, after having dropped some nasty drugs to *get in the mood*.

The upside to all this (if there is an upside) is the fact that Boosters tend not to think too much. While the wars they wage are ferocious and leave lots of bodies on the Street, they are very predictable in their strategies. A war between two boostergangs is horrific, and often leaves both gangs permanently crippled. Because of their nature, Boosters are tied into illegal cyberware and equipment dealing, but they are more often arrested for violence-related crimes.

Boosters aren't quite so wary about their turf; while they may guard their borders and patrol regularly, they are not as visible as other gangs. They figure if any trouble goes down, they'll crack the guy open and sort it out (this works pretty well, too).

Boosters are very big on gruesome initiation rites; these are rumored to be as grotesque as those of the marauder gangs of the Road. Most boostergangs' objectives are to go out and rip into someone, get the latest chromed-up slicing cyberweapon, and have *fun* all the time. This means they don't try to expand a great deal, but tend to strike out from their turf at random.

Any rampaging booster counts as "authorized" for termination purposes.

### Chromers

Chromers=Dangerous groupies. These guys, all freaked out by their hero rock band, can be very volatile. They worship the bands they follow like gods, interpreting the lyrics as they see fit. With

so much rebel rock available today, these gangs are becoming more and more dangerous.

Chromers may travel around, following "their" band wherever they go. Most can't get the Euro together to settle down in a 'hood; many are failed rockerboys. Their favorite habits are watching their group perform, doing Simstim/Braindance, and "wrecking" in the name of their favorite lyrics. Obviously, insulting their heroes is a bad idea. The problem with Chromers is they're always about to burst. One minute they'll be fine, the next they'll be wrecking. Their leaders are charismatic; if a Chromer leader is taken down, the gang often falls apart. Chromer hangouts include clubs, concerts and Braindance arcades.

### Posergangs

While a heck of a lot less dangerous than your average boostergang, posergangs can, and do, cause big trouble. Not only do posers adopt the image of their particular hero, they also take on the attitude. This can lead to some pretty meek posers, but many can be incredibly dangerous if they adopt the mentality of a hard-sport star, terrorist, radical politician or imprisoned psycho.

Posergang activity can prove maddening for cops—especially as they all look the same. Visiting "enemies" of the posers can, and do, receive trouble. Back in 2015, Judge Lawrence J. Hick visited Night City, only to be shot and killed by six posers who all looked exactly like Harold Meech—a cyberpsycho whom Judge Hick had sent down to Death Row.

Posers, when not following their heroes about, will hold their own turf. The size of poser turf varies and is largely dependent upon the attitude of their hero. Posers will hook up to all kinds of activity if the money is good, though their one true love is being their hero.

### Culties

Culties are another highly dangerous gang type. Many Cultie gangs may go around offering cookies, selling Peace chips and being generally harmless. Some, however, will inflict their warped religious philosophy on all. Their unshaking faith in their "religion" is what makes them so potentially hostile. Charismatic leaders fuel the fires of hatred, bigotry, technophobia and a hundred other religious "causes." The followers become warriors, fighting their own personal crusades against those who would dare oppose their beliefs.

The problem with Culties is they're not afraid to die for the cause. This leads to suicide



tactics and other fanatical behaviour, which makes them as hard to deal with as terrorists.

There are some Culties who remain harmless; however, the trend seems to veer towards the violent, with such gangs as Klansmen, Red Chrome Legion, the Inquisitors and WorldGod. More and more Culties are utilizing terror tactics to further their particular message. This leads to greater retaliation, which results in the Culties becoming more determined. It is often said most Culties join solely to commit violent acts. Although there are many who truly "believe" in their varied causes, there are others who use it as an excuse for violent behaviour. Violent Culties are never tolerated, for as long as they continue to utilize terror tactics, they will be met with the full force of the law.

### Dorph-Heads

Dorph-Heads are the front line in getting drugs onto the street. Dorphgangs, while many members are hard-users, are responsible for much of the distribution of controlled substances at street level. It fuels their own habits, allowing them to continue their drug-warped existence, and the cash it brings in is phenomenal, some of which filters back up the line to the main dealers. Dorphers can be dangerous on occasion; this is attributed to the attitudes of the gang members themselves. Take a dorpher holding a

submachinegun in one hand and a big bag half full of Boost (the other half having been munched by him), and tell him he's under arrest! Chances are he'll let rip...

There are certain dorphgangs who never touch the stuff they push, but this is the exception to the rule. Most are drug-zoned dealers who will do *anything* to get their cash. There are many stories drifting around about "what happened to those guys who screwed the dorphers..."

LEDiv have a special code when dealing with dorphers, because shutting them down can mean blood on the streets. Many dorph gangs push low-grade substances and they work against each other. This fills the role of interdiction well—they control each other. Dorphgangs tend to be targeted only when certain priorities are crossed:

- Operating outside of acceptable boundaries.
- Pushing really BAD substances.
- Suspected Corporate involvement.
- Suspected Organized Crime involvement.
- Unacceptable hostilities.

Individual dorphers have proven to be excellent sources of information at street level. However, caution should be exercised when attempting this. Drugs=Unpredictable.

Some cities allow low-grade controlled substances to be sold if the individual is a permit holder. This course of action has shown some success in legalizing the drug trade. But the practice has yet to gain full approval in most states.

### Guardians

Guardian (or vigilante) gangs are something of a blessing in disguise, if taken seriously. These gangs will effectively police their own neighborhoods; their methods and attitudes being almost in line with the cops. Sometimes a Guardian gang can spring up in the middle of a hellhole; sometimes they even manage to stay there.

Other gangs tend to have a hard time with Guardians; this often escalates into open warfare, making the Guardian gang just another faction in the battle for turf. Some enforcement agencies will liaise directly with reputable Guardian gangs, exchanging information and resources. This has proven very useful in the past and leads to well-integrated policing. The worst Guardian gangs are nothing more than standard combat gangs defending their turf from all comers, their stated objectives just being an excuse to bang heads.

Many members of Guardian gangs often follow this path to the police force itself. Over the last few years more and more ex-Guardians have joined the ranks of the police. Where this is useful, the practice is greatly encouraged.

### Nihilists

*"When I saw fifteen Nihilists in black robes sitting in economy class, well, I just knew they were gonna be trouble. Two of 'em managed to pull their pins, but one didn't go off; the explosion was secured real fast and we only lost two nuns and a hostess."*

—Sgt. J. J. Torbrugg-NYPD MaxTac.

Nihilistic gangs are no better than terrorists. These gangs are united in the belief the world will end; futility and other dark philosophies are the only answers. Their goal: Spread the Word. In many ways, the Nihilists are just another Cultie offshoot; the problem is, all these guys are Nuts No. 1.

Thanks to their penchant for splashy public suicide, Nihilists can be a real problem. Many of their actions, such as self-immolation, are harmful only to themselves. However, there have also been many cases where Nihilist suicides have indirectly been responsible for mass



murder and serious property damage. Rappelling down buildings while laden with explosives is a popular Final Option, as is the old Kamikaze fly/drive into a structure full of people (like a Braindance arcade). As far as the law is concerned, these crimes are defined as acts of terrorism. There is a problem. Nihilists cannot be arrested unless they are committing a crime, this means they can only be arrested when attempting one of their suicide feats. That isn't easy.

### Party Gangs

Like Chromers, party gangs are not really a problem until they start on a burn. When they break out the booze, drugs and automatic weapons, they're gonna cause trouble. When it happens, the cops come down fast and hard; the worst ones get to come back down again and think about what they've done on Death Row. Treat like a Boostergang when rampaging.

### Gogangs

Inside the cities, the most dangerous bike (or go) gangs are the *Bosozuka*, Asian imports affiliated with the Yakuza. These gangs, while maintaining their own turf (normally within Yak territory), also serve the Yakuza and perform various operations on their behalf. Many are already on the Edge, fully equipped with Yak hardware and cybered up. Bosozuka can be one of the most fearsome, and fearless, gangs in the city.

And *don't* call them Bozos.

The HiWay troopers have their own problems with marauding roadgangs outside the cities. These can be the ever-changing Hiway Pirate/Marauder groups, pillaging at random, or sometimes Nomad packs gone bad. Because their actions are governed by less restrictive laws, HiWay troopers usually treat these people as the most dangerous of enemies, waging constant war against them.

### A Fast Word on Gang Structure

Gangs operate on a ranking system similar to organized criminals. At the top of the pile sits the Chief, or Warlord, or Hardest Man (or whatever he wants to name himself). His word is The Word.

Beneath him come a number of Lieutenants, who also have names like Right Hands, The Respected, Icemen. These are the guys who carry out the Chief's Word. They each command a small detachment of members and get away with most things, unless they upset the Chief.

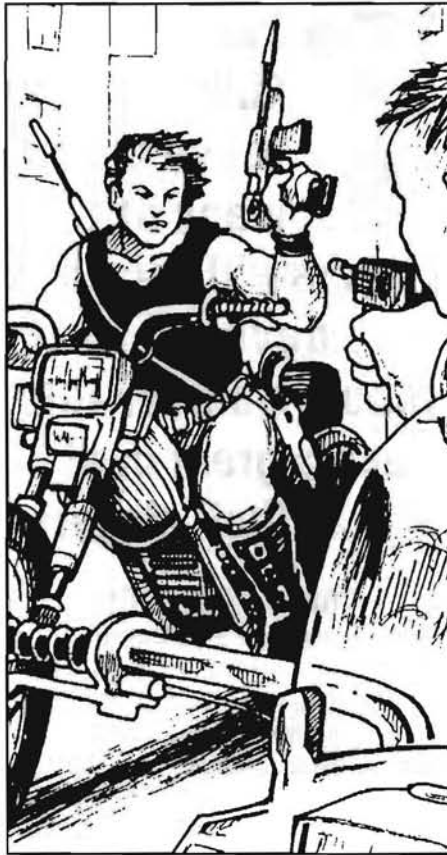

Under them come the hardcore membership: Homeboys and Bloodboys; the full-timers, all gang and nothing else. From this core element come all the specialists and troops. After that, there are affiliates, or part-timers. If the gang is in some kind of trouble (and it invariably is), then the affiliates might be called in to help. They are often called upon to perform some minor feat in order to demonstrate their loyalty. This is where most guys start. Those with the will, charisma or sheer brute strength climb from there.

Gang HQ's (Dens) are either a closely-guarded or heavily-defended secret. This is where they come together; it's always somewhere they can feel "safe." Large amounts of cash, hardware and other resources are often stored here—where the Chief can keep an eye on them.

### Typical Ganger

#### ROLE: BOOSTER

INT: 5 REF: 9 TECH: 5  
COOL: 7 EMP: 6/2 ATTR: 5  
LUCK: 5 MA: 8 BODY: 7  
SAVE: 7 BTM: 2

**SKILLS:** Combat Sense 4, Athletics 6, Strength Feat 7, Dodge/Escape 7,

Intimidate 8, Streetwise 5, Brawling 7, Awareness 8, Pistol 6, Stealth 4, Melee Weapons 8

**CYBERWARE:** Epsilon-strength Linear Frame, Pain Editor, Muscle and Bone Lace, Subdermal Armor, Basic Processor, Smartgun Link, Interface Plugs, Wolverers, Cybereye, Targeting Scope, Infra-red vision

#### ROLE: CHROMER

INT: 6 REF: 7 TECH: 7  
COOL: 7 EMP: 7/5 ATTR: 8  
LUCK: 5 MA: 6 BODY: 6  
SAVE: 7 BTM: 2

**SKILLS:** Charismatic Leadership 4, Play Instrument 4, Wardrobe/Style 6, Dodge/Escapade 3, Persuasion 6, Streetwise 4, Brawling 5, Awareness 6, Basic Tech 3, Perform 4, Melee Weapons 3

**CYBERWARE:** Interface Plugs, Chipware Socket, Machine Link, Cyberaudio, Enhanced Range, Level Damper

### JO and JOANNA

These are the small-timers among street criminals; the one-time lawbreakers that a cop will deal with by the dozens every day. They also make good working-stiff victims.

INT: 5 REF: 5 TECH: 3  
COOL: 5 EMP: 6/7 ATTR: 6  
LUCK: 3 (Jo's don't have any luck)  
MA: 5 BODY: 5  
SAVE: 5 BTM: 1

**SKILLS:** Common survival/working skills are at 0 or 1. They might have Melee/Brawling/Handgun at 1 (if they're lucky). Non-violent perps will have Pickpocket / Stealth/Basic Tech (burglary) 1

**CYBERWARE:** Are you kidding!?! ■



# 4 YOU'RE BUSTED!

7 ft.

6 ft.

5 ft.

4 ft.

3 ft.

2 ft.

1 ft.

**T**his chapter examines the crimes of 2020, providing a complete overview of the common types and describing many of the criminal elements that players will encounter. Part of this chapter is also devoted to the legal system; Ref's should go over this section carefully and make a great deal of this information available to their players.

## CRIME STATISTICS

As of 2020, Homicide is the leading cause of death in 75% of those 30 years old and under.

We have a problem.

The worldwide crime rate has risen phenomenally over the past thirty-five years, soaring to unprecedented heights in the last twenty. While new measures have been taken by both local and Government enforcement agencies, they have been unable to stem the tide of crime sweeping the United States. The "deterrents" of longer sentencing, braindance and execution seem to achieve little, so manpower priorities are now switching to more efficient and effective means of enforcement.

The statistics given here show three things:

- 1) Priority level of each crime. Since 2015 each crime has been listed with a Priority which denotes the seriousness of the crime in relation to others. The Priority system is also used when city Mayors allocate budgets to respective deterrent and manpower plans.
- 2) The yearly percentage rise of each listed crime.
- 3) The percentage level of the crime which is successfully dealt with by local and federal authorities.

## CRIMES AND SENTENCING

### THE BASICS

This section includes full details on the Uniform Civilian Justice Code, which came into effect in 2000. The details included here are from the Free State of Northern California version, although most states follow the same guidelines. The law is applied hard most of the time; very few judges

(and no AI's) dispense easy rides. With rising crime rates and incidents of violence on the increase, most people who commit crimes (and get caught) are dealt with severely.

Following is a section on the differing types of crimes, from disorderly conduct to murder, and the punishments issued by the Courts, ranging from fines to death.

## LOW PRIORITY CRIMES

### PRIORITY SIX

#### Buying, Receiving and Possession of Stolen Goods.

This crime covers the trade of stolen materials, whatever they may be, and can only be applied when it can be reasonably proven the individual knowingly Bought, Received or Possessed materials that had been stolen.

This crime occurs almost every day, with all sorts of equipment from leisure and entertainment gear to vehicles and computers being stolen and resold on the Street. Clean-up rate on recovering stolen goods is terrible, so when busts do occur, the sentences tend to be on the harsh side. Fixers beware!

SENTENCE: Return of all materials. Fine Eb50+ and/or Jail 1 Month-1 Year in Low Security Block.

#### Disorderly Conduct

Disorderly conduct is open to a great deal of interpretation. Any situation where a person can be deemed to be causing a nuisance and is not committing any other crime can be construed as Disorderly Conduct. This crime also includes offensive behavior and causing a disturbance.

CRIME	(Priority)	Rise	SuccessRate
Mass Murder	(1)	47%	65%
Murder 1	(2)	65%	58%
Murder 2	(2)	74%	72%
Manslaughter	(2)	72%	75%
Corporate Murder	(1)	60%	22%
Espionage	(1)	66%	31%
Kidnapping	(2)	57%	45%
Armed Robbery	(3)	72%	70%
Robbery	(4)	82%	73%
Burglary	(5)	44%	12%
Auto Theft	(5)	56%	44%
Grand Larceny	(4)	87%	38%
Larceny	(6)	92%	34%
Fraud	(5)	56%	20%
Counterfeiting	(2)	67%	05%
Embezzlement	(4)	64%	23%
Aggravated Assault	(3)	87%	64%
Assault	(4)	94%	50%
Rape	(4)	39%	12%
Extortion	(3)	70%	15%
Gambling	(3)	45%	20%
Liquor Laws	(6)	34%	07%
Prostitution & Non- Commerical Vice	(5)	67%	23%
Arson	(4)	40%	10%
Type A Trafficking	(1)	57%	23%
Type B Trafficking	(2)	75%	40%
Type C Trafficking	(3)	73%	50%
Buying/Receiving/Possession Stolen Goods	(6)	60%	15%
Possession of illegal cyberware	(5)	44%	12%
Use of illegal cyberware	(2)	82%	78%
Illegal Netrunning	(6)	59%	06%
Disorderly Conduct	(6)	94%	14%



SENTENCE: Up to a week in a Low Security Block.

### Illegal Netrunning

This is the Net equivalent of trespassing and is usually not the focus of major police or Netwatch activities (although any crime committed in addition to this can be heaped onto the Perp as well). This crime also covers unauthorized access to restricted areas, such as Police computer systems, Corp computer nets, etc.

SENTENCE: Fine Eb50+ and/or up to 5 Years in Low Security Block.

### Larceny

Larceny is the theft of goods or money up to the value of 50eb. Anything above this is either Grand Larceny or Robbery. If the theft is directly from an individual this counts as Robbery.

SENTENCE: Return of materials; 1-10 Years in Low Security Block.

### Liquor Laws

Any breach of Liquor Laws can result in an arrest. However, the only Liquor Law which is enforced to any extent is Drunkenness. This is a discretionary offense, although the arresting officer can make it stick if he wishes.

SENTENCE: Fine of Eb20-100.

### Obstruction of Justice

Any individual who illegally witholds information or attempts to stop, or hamper, an authorized investigation is guilty of Obstruction of Justice. Actually getting this to stick can be very difficult, as it is hard to prove and interpret.

SENTENCE: 1 Month-1 Year in Low Security Block.

### Traffic Offenses

This section includes all Traffic-related crimes from illegal parking, dangerous driving, and

driving without a licence to driving while under the influence of drugs and/or alcohol. With the advent of aerodyne vehicles and light aircraft within the airspace of major cities, these offenses have escalated in potential danger (and their penalties have followed suit).

SENTENCE: Fine Eb20–1,200 and/or Up to 3 Years in Low Security Block.

## PRIORITY FIVE

### Auto Theft

The theft of vehicles (including motorcycles, ground cars, aerodynes, etc) happens too often. There are dozens of vehicle thefts each hour in Night City alone, and the crime has become so commonplace that enforcement officials can do little about it. Vehicles can be stolen and stripped within an hour; if it happens to you, it's unlikely you'll ever see your vehicle again (unless you paid that very costly insurance premium...).

SENTENCE: Jail for 1–7 Years in Low Security Block or Exile.

Note: HiWay (see pg. 46) dispenses Death for major Autocrimes.

### Burglary

This is the crime of breaking into a private, public or commercial residence with the intent to steal goods. Unless your place has good security facilities, there's a very high chance of you being burgled. How do you stop this from happening? Good security facilities.

SENTENCE: Return of goods, Personality Adjustment and 1–6 Years in Low Security Block.

### Fraud

Gaining money and/or materials through deception. Although this happens a lot, most of it goes by unnoticed. The harshness of sentence primarily depends on who was screwed out of the cash, and for how much.

SENTENCE: Return of goods. Personality Adjustment and/or 1–20 Years in Low Security Block.

### Possession of Illegal Cyberware

Possession (either implanted or carried) of offensive, combat or restricted cyberwear. This covers the sometimes dangerous headware and enhancements that are always for sale on the Street (anything from illegal chips to huge cyberclaws). Most

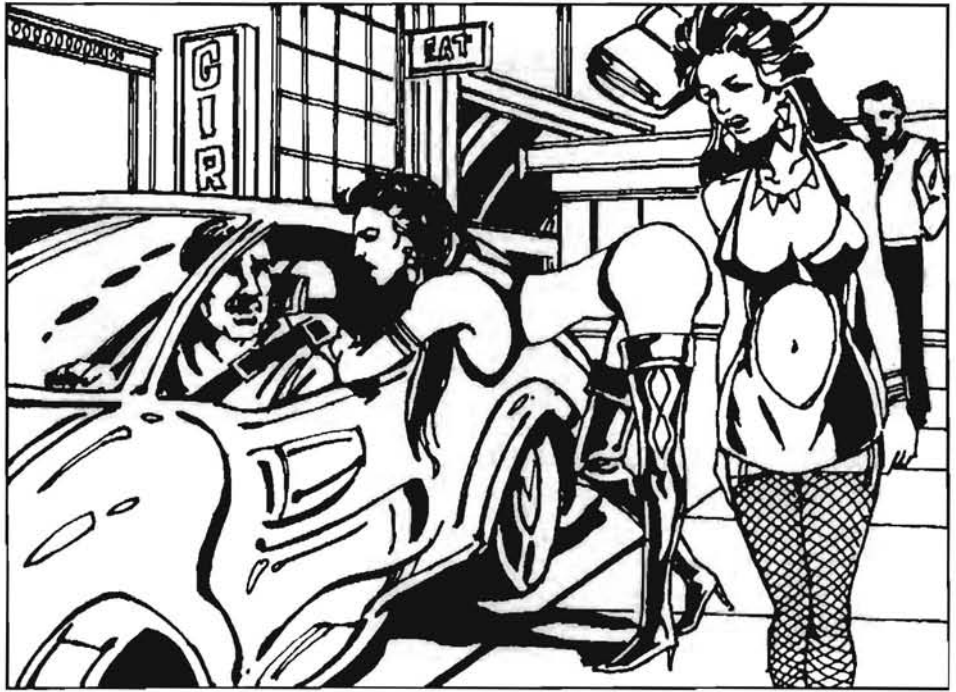

A good time costs money, even in 2020...

municipalities vary widely on their interpretation of what is illegal (just as courts in the 1900's varied on concealed weapons laws). Use of illegal cyberwear is considered to be a much higher priority (2) crime.

SENTENCE: Fine Eb: 100-500 and/or 1 Month–1 Year in Low Security Block

### Prostitution and Non-Commercialized Vice

This catch-all crime includes such offenses as soliciting sexual favors for money, making money from prostitution and illegal strip and sex acts. Cities vary widely on their interpretations of this offense, with some cities even licensing prostitution (licensed prostitutes must renew their 500eb permit every six months or be charged with this offense). In more restricted communities, there are occasional sweeps on known areas of prostitution, but more often this is done for political reasons.

SENTENCE: Fine Eb50–2000 or 1 Week to 2 Years (Pimping)

### Weapon Offenses

This crime relates directly to those possessing weapons without the correct permits or to the possession of support, fully automatic and other non-permitted weapons. Permit laws vary between municipalities; many law officers use this as a catch-all to run in "undesirables" or suspected go gangers. In general, the Federal Weapons Statute of 1999 has provisions that allow a "carry" permit to be issued for 25eb. This

permit allows handguns, semi-automatic rifles and knives no longer than 18" to be carried for personal defense.

SENTENCE: Fine Eb100–1,000 and/or 1 Month–10 Years in Low Security Block

## MID-PRIORITY CRIMES

### PRIORITY FOUR

#### Arson

Arson is defined as the unauthorized setting of fires, or using flammable devices with intent to destroy property or harm others. Arson is one of crimes that is the hardest to detect and prosecute, because most people consider it a victimless crime unless someone one is killed. Usually, when something somewhere goes up in flames, Jo tunes in and thinks the victim (often a Corporation) deserves it.

SENTENCE: Personality Adjustment and 1–20 Years in Mid Security Block or PsychoBlock.

#### Assault

The application of force upon another person, or the threat (implied or otherwise) of doing so. In these violent times, almost everyone gets assaulted at one time or another. Most people don't ever know who attacked them, making it hard for the cops to press the case.

SENTENCE: 1–7 Months in Mid Security Block.



**Bribery of an Enforcement Officer**

This crime is defined as the offering of money, gratuities or other favors in exchange for preferential treatment. This is a very serious offense and also includes Attempted Bribery. However, many municipal police departments are riddled with corruption, and bribery happens all the time.

SENTENCE: 1–6 Months in Mid Security Block.

**Embezzlement**

To unlawfully divert funds and/or materials for personal or commercial gain. Corporations lose millions of eurobucks each month to this crime. Illegal Netrunners are the major source of this crime, but disloyal employees within the corporation itself are also a factor.

SENTENCE: 1–20 Years in Mid Security Block

**Grand Larceny**

Theft of money or goods in excess of 50eb. If the theft is from an individual, this crime becomes Robbery.

SENTENCE: 1–20 Years in Mid Security Block and Personality Adjustment.

**Rape**

This is the forcing of a sexual act by use of violence, or the threat of violence.

SENTENCE: Exile or 1–15 Years in Mid Security Block, or PsychoBlock and Personality Alteration and/or Braindance. Note: HiWay (see pg. 46) dispenses Death for sex crimes.

**Rioting**

Rioting is defined as any illegal assembly of over three people for the purpose of causing property or personal damage. This crime was the major problem during the years of the Collapse, when riots swept almost every urban center with destruction and death (this is why the law is so strictly worded).

Even in 2020, riots still go on all the time; cops make arrests based on how sensitive the political situation is. This crime also includes incitement and Intent to Riot.

SENTENCE: 1 Month–1 Year in Mid Security Block or Exile.

**Robbery**

Robbery is the crime of theft from the individual, including pick-pocketing and mugging. Like Assault, this is very difficult to enforce, as many

victims often cannot provide adequate descriptions of the perps.

SENTENCE: 1–20 years in Mid Security Block and Personality Adjustment

**PRIORITY THREE****Aggravated Assault**

This crime is basically Assault with the intent to kill or inflict disabling injury. Falling just short of murder, this is a serious crime. Many victims, having been burned by a gang, are in no shape to provide a good description or are too frightened, making this a very hard crime for police to track and prosecute (one reason why self-defense laws in 2020 are so broadly interpreted).

SENTENCE: 1–7 Years in Mid Security Block or PsychoBlock and Personality Adjustment and/or Braindance

Note: HiWay (see pg. 46) dispenses Death for this crime.

**Armed Robbery**

Armed Robbery is Theft, or Robbery, with use, or threat, of deadly force (such as guns, knives or illegal cyberware). This can range from muggings to bank robbery.

SENTENCE: 4–15 Years in Mid Security Block or PsychoBlock and Personality Adjustment and/or Braindance.

Note: HiWay (see pg. 46) often dispenses Death for this crime.

**Extortion**

Gaining cash, goods or services through threat of sabotage or violence. Extortion is big business and can make a great deal of cash if managed on a citywide scale (which makes it particularly attractive to Organized Crime, Corps and gangs).

SENTENCE: 1–15 Years in Mid Security Block

**Gambling without Permit**

This crime is defined as the operation of games of chance and/or betting services for money or other stakes without proper permits. While gambling is legal on all licensed premises, many places operate without a license, protesting that the license costs are too high. Organized criminals often set up SIMplex arcades and casinos in direct breach of the law. Priority 4 in some areas.

SENTENCE: Fine Eb500+and Up to a Year in Mid Security Block

**Type C Trafficking**

Sale, manufacturing and distribution of Type C substances, such as Illegal Entertainment Software, Blue Grass, Stim, etc. Buying and Selling Type C substances is good business; it's also the most visible and allows the cops to clean up to a reasonable degree.

SENTENCE: 1–10 Years in Mid Security Block.



## HIGH PRIORITY CRIMES

### PRIORITY TWO

#### Counterfeiting

The manufacture and distribution of falsified currency and/or documents. Making funny money and selling it is a great way to get rich fast and destabilize the economy. The government has always come down hard on this crime, which also includes Forgery of any kind. Sometimes it's not so hard to spot counterfeit money, but finding the guys who are making it is always hell.

SENTENCE: 6–15 Years in Hi Security Block

#### Environmental Laws

There are a full array of laws protecting the environment including Dumping and Illegally Transporting Hazardous Materials, Unauthorized Pollution, and Unauthorized Damage to Items Protected Under Environment Laws. Enforcing this against corporations is difficult to impossible.

SENTENCE: Fine of Eb500+ and up to 3 Years in Hi Security Block

#### Kidnapping

To illegally carry away and detain another person against his will, through use of force, threat of force, fraud or other form of coercion. This often happens within the Corporate sector; cops' families sometimes get hit as well. While the clean up rate on this isn't bad, the only real precaution an individual can take if he feels that he or his family are in danger are better security facilities.

SENTENCE: 5–20 Years in Hi Security Block or Exile

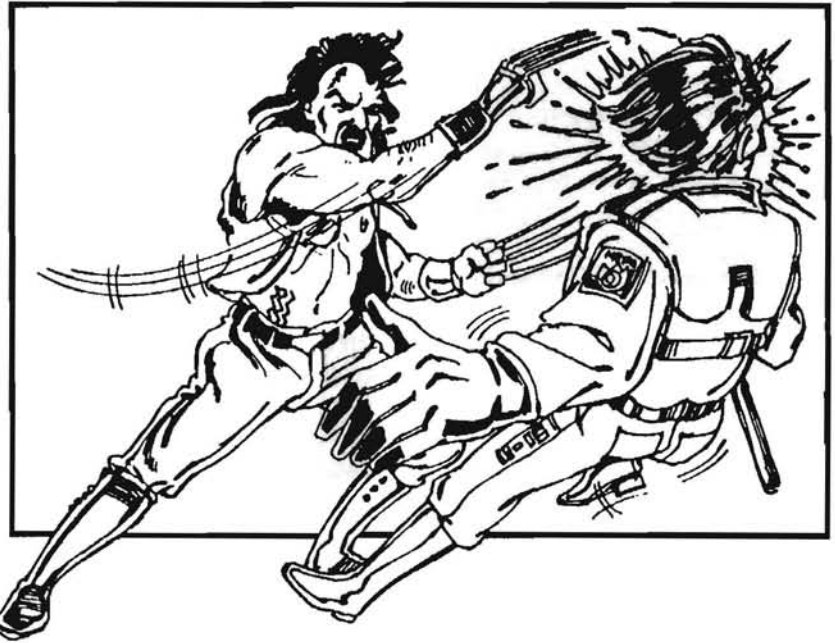

Cyberclaws are *not* legitimate self-defence weapons...

#### Manslaughter

Manslaughter includes both the killing of someone in mitigating circumstances, such as heat of passion or reasonable provocation, as well as the unintentional killing of someone while behaving in a reckless manner. Perps of the latter type are more likely to be sentenced leniently.

SENTENCE: 0–5 Years in Hi Security Block

#### Murder 1

1st degree murder is intentional and premeditated killing, or killing in association with another crime. Either way, it is not looked upon well.

SENTENCE: Death.

#### Murder 2

2nd Degree murder is the intentional but not premeditated killing of someone. This can often be very difficult to prove.

SENTENCE: 5–20 Years in Hi Security Block or PsychBlock and Personality Adjustment and Braindance. Note: HiWay (see pg. 46) dispenses Death for this crime.

#### Type B Trafficking

Sale, manufacture and distribution of Type B substances including Firearms, Explosives, Illegal Commercial Software, Synthcoke, Boost, Dorphs, etc. Trafficking in Type B substances tends to stay off the streets. Deals go on behind closed doors and in isolated places.

SENTENCE: 3–12 Years in Hi Security Block or Exile

#### Use of Illegal Cyberware

Use or threatened use of offensive, combat-oriented or restricted cyberwear. Possessing nasty cyberclaws is one thing, actually using them is something else.

SENTENCE: Removal of Cyberware, Up to 1 Year in Hi Security Block and Personality Adjustment

## TOP PRIORITY CRIMES

### PRIORITY ONE

#### Corporate Murder

Defined as any Corporation knowingly selling, manu-

facturing or distributing defective equipment resulting in death; failure to remove known hazards from the workplace resulting in death, or attempting to willfully murder an individual for the profit of the Corporation.

SENTENCE: Fine Eb1000+, 10–20 Years in Top Security Block, or Death. Note: HiWay (see pg. 46) often dispenses Death for the willful murder portion of this crime.

### Espionage

Spying on government plans, installations, individuals and organizations and providing this information to another agency, organization, corporation or government; also theft and distribution of secret or secured materials and information. This crime is taken very seriously, particularly by the remaining government agencies and the military police.

SENTENCE: 10–20 Years in Top Security Block and Braindance, or Death.

### Mass Murder

Mass murder is first degree murder of two or more individuals. While many mass murderers are total psychopaths, the serial killings which started decades ago have now become commonplace.

SENTENCE: Death.

### Terrorism

Any organized system of intimidation through force for political ends. Terrorists are dealt with as harshly as mass murderers.

SENTENCE: Death

### Type A Trafficking

Trafficking in any of the following substances: Black Lace, Werewolf and other dangerous drugs, Government software, Illegal Body Parts.

SENTENCE: 15–20 Years in Top Security Block and Braindance.

## IN THE MACHINE: THE LEGAL SYSTEM IN 2020

Once an individual is busted and charged, he becomes part of the Legal Machine. This section examines the various parts of that process and provides all the data required to get the machine up and running.

### RIGHTS

Crimes defined as felonies and misdemeanors disappeared after the Lawyers Purge in 1997. Now, crimes are listed in order of Priority: the

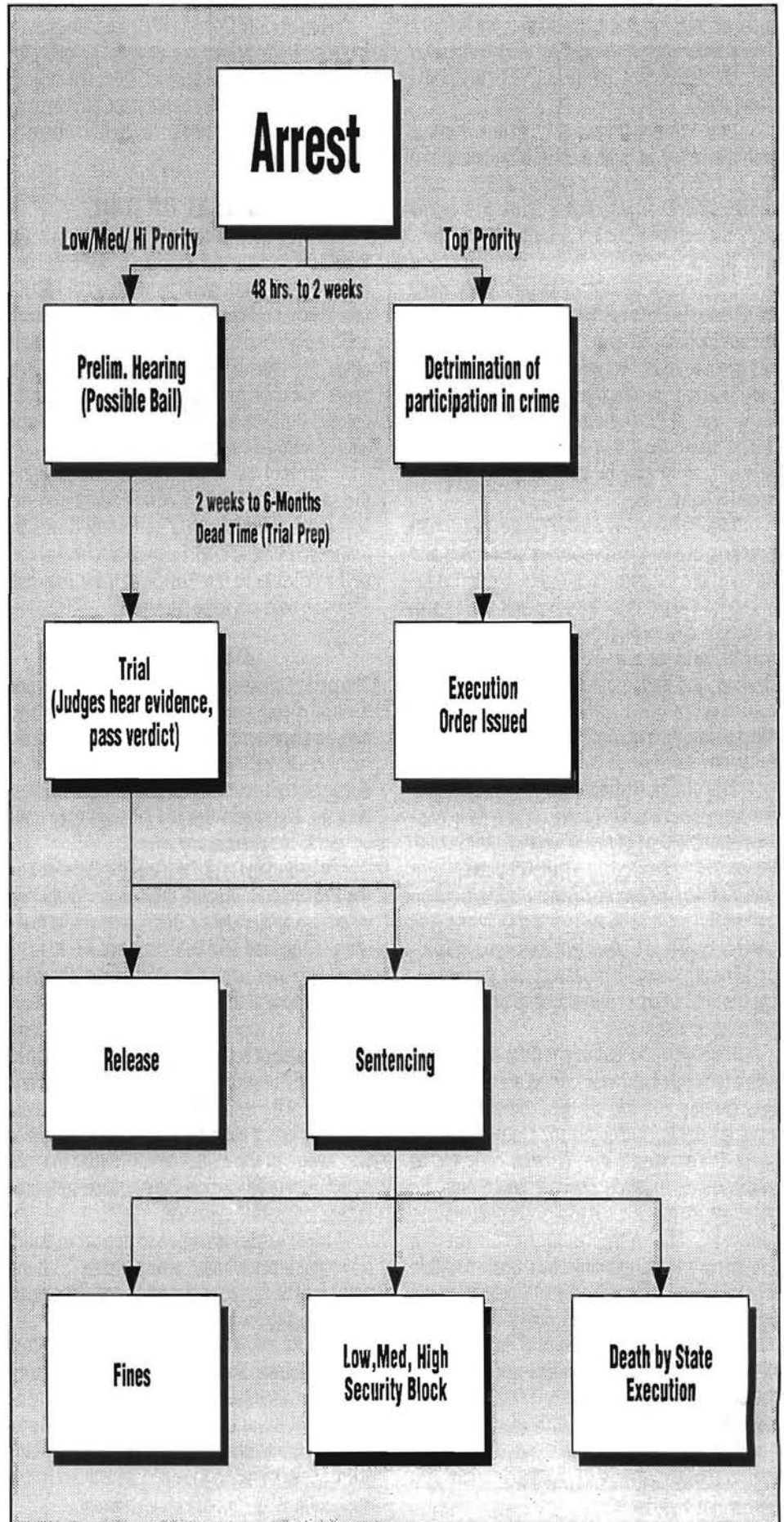



more serious the crime, the higher the Priority. This directly affects the rights of the individual as they are dependent on the nature of the crime committed.

Low-Priority Crimes (LPC) are any crime with a ranking of 5 or 6. These crimes afford the perp the most rights (which aren't much). Individuals charged with a Rank 5-6 crime have the right to secure a Defense Attorney; they are also allowed two phone calls and retain the "right to remain silent." They must be given a Preliminary Hearing within 48 hours (where bail may be set). The trial date must be set no later than two weeks from the preliminary hearing, or the trial is declared void. In most cases, LPC trials are presided over by a Judge who sets fines and short sentences; however, an AI may be used in some cases to speed the process.

Mid-Priority Crimes (MPC) are crimes with a ranking of 3 or 4. These crimes are serious and do not afford the perp many rights. The individual retains the right to remain silent and is still allowed to secure an Attorney in his defense. He may be held for a week before a Preliminary Hearing, and during that time he may not make contact with anyone: no phone calls, no visitors. Most of this time is likely to be spent in holding cells and interrogation cubicles.

The Judge (human or AI) may set bail, although the criminal is more often held in custody until the time of his or her trial. At the trial, the perp is confronted by a panel of three judges (AI's, humans, or a mix of both). The Prosecution makes its case, followed by the Defense (the Defense may be a Lawyer or the charged individual himself). A verdict is passed, and the individual is either freed or sentenced to one of many possible punishments.

High-Priority Crimes (HPC) are crimes with a ranking of 2. These crimes are considered very serious and the charged individual foregoes all rights, including the right to remain silent. Once charged, the perp may be forced to undergo interrogation under truth serums, lie detectors, psychological reality simulations and analysis. The perp must be allowed a Preliminary Hearing within two weeks. At this time, a Judge (human or AI) will determine the possibility of bail and set the date for a trial. The Judge will also decide whether to allow the defendant a Lawyer, dependent upon whether the Judge sees any ambiguity in the presented case. Anything more than a 20% margin of error and the Judge will allow a Defense Attorney. The trial is presided over by a Judge and four AI's who will pass sentence.

Top Priority Crimes (TPC) are crimes ranking at 1. These crimes are rated so seriously the perp has no rights whatsoever. Once the individual is determined as the perpetrator, an execution order can be issued and he may be terminated by any authorized body.

### REFUSAL OF BAIL

Police may attempt to ensure their perp stays locked up until the trial. This is a tricky procedure, and translates into game terms as a DIFFICULT Law Task requiring at least two hours of paperwork, and the signature of the DA or relevant prosecuting office. The Referee may adjust this difficulty level dependent upon the nature and seriousness of the charge. Political and other considerations may also be factored into this decision.

Terms of bail may change, but are generally the same everywhere. The defendant may not leave the country (this can sometimes be reduced to state or city). He must also make himself available to the Police at their request, although he is not to be harassed.

### DEAD TIME

The period between the Preliminary Hearing and the trial is commonly known as Dead Time. This can be anywhere between two weeks and six months. During this time, the defendant is either out on bail or in custody, and awaiting trial. Either way the Defense Attorney (if any) may have access to his client at any time.

It is during Dead Time that the Defense and the Prosecution prepare their cases, gathering witnesses and evidence. Both parties must make their witnesses and evidence known to each other. However, attorneys can bring in witnesses and evidence at the last minute under the legal maneuver of "Newly Discovered." This is a legitimate course of action, although both sides often abuse it by bringing in their key witnesses and evidence at the last minute when they knew about it long before. If it can be proven that the attorney was aware of the evidence for longer than 24 hours prior to admission, the evidence presented is "inadmissible" evidence.

Most witnesses agree to appear in court; however, a key witness who refuses to attend court may be issued with a subpoena. This legally requires the witness to attend the trial under penalty of committing a Priority 4 offense. Both the Prosecution and the Defense may issue subpoenas to witnesses. NOTE: For a subpoena to be issued, it must be served upon the person required to attend by a legal representative. Many witnesses, knowing they will be issued with a subpoena, may "disappear" for a while.

## THE TRIAL

Generally, the defendant is arrested and charged with a crime (or crimes). He is then officially arraigned and either released on bail or into custody until the trial. At the trial, it is the Prosecutor's job to show that the crime was committed by the defendant. The Defense attempts to show this is not true. Both parties may submit evidence, call witnesses, and interview them in addition to the defendant. Evidence must serve a purpose and questions to a witness must be obviously directed towards the Defense or Prosecution's goals, *character witnesses included*. The Judge ensures the process is carried out lawfully, and ultimately decides as to the defendant's guilt. The Judge then passes sentence. There are no jury trials in 2020.

Obviously, the Legal System is far more complex than this, but space does not permit us to perform an in-depth examination of the various technical aspects of the Court process. For game purposes, the Ref should examine the following points and utilize the simple system presented below:

- Judges: The GM should note down several Judges (human or AI's), detailing their political affiliations, likelihood of corruption, level of severity when passing sentence and general demeanor. A sample Judge is detailed at the end of the section on page 70.
- Prosecutors and Defense Attorneys: The Ref should also detail a list of attorneys including the DA and Federal Prosecutor in a similar manner as the Judges, including their level of competence. A sample Attorney is detailed at the end; page 70.

When a case comes to court, the Referee should assign a Judge, Prosecutor and note the defendant's Defense Attorney, if any. He must also decide how "strong" the case is, basing his decision on evidence and witnesses. The ability to prove guilt is based on three things:

**Motive**—A reason for performing the specific crime.

**Means**—The necessary tools, weapons or other equipment for the commission of said crime.

**Ability**—The physical and mental acuity necessary to perform said crime.

The weakness or strength of a case depends on how many of these points are known, and how

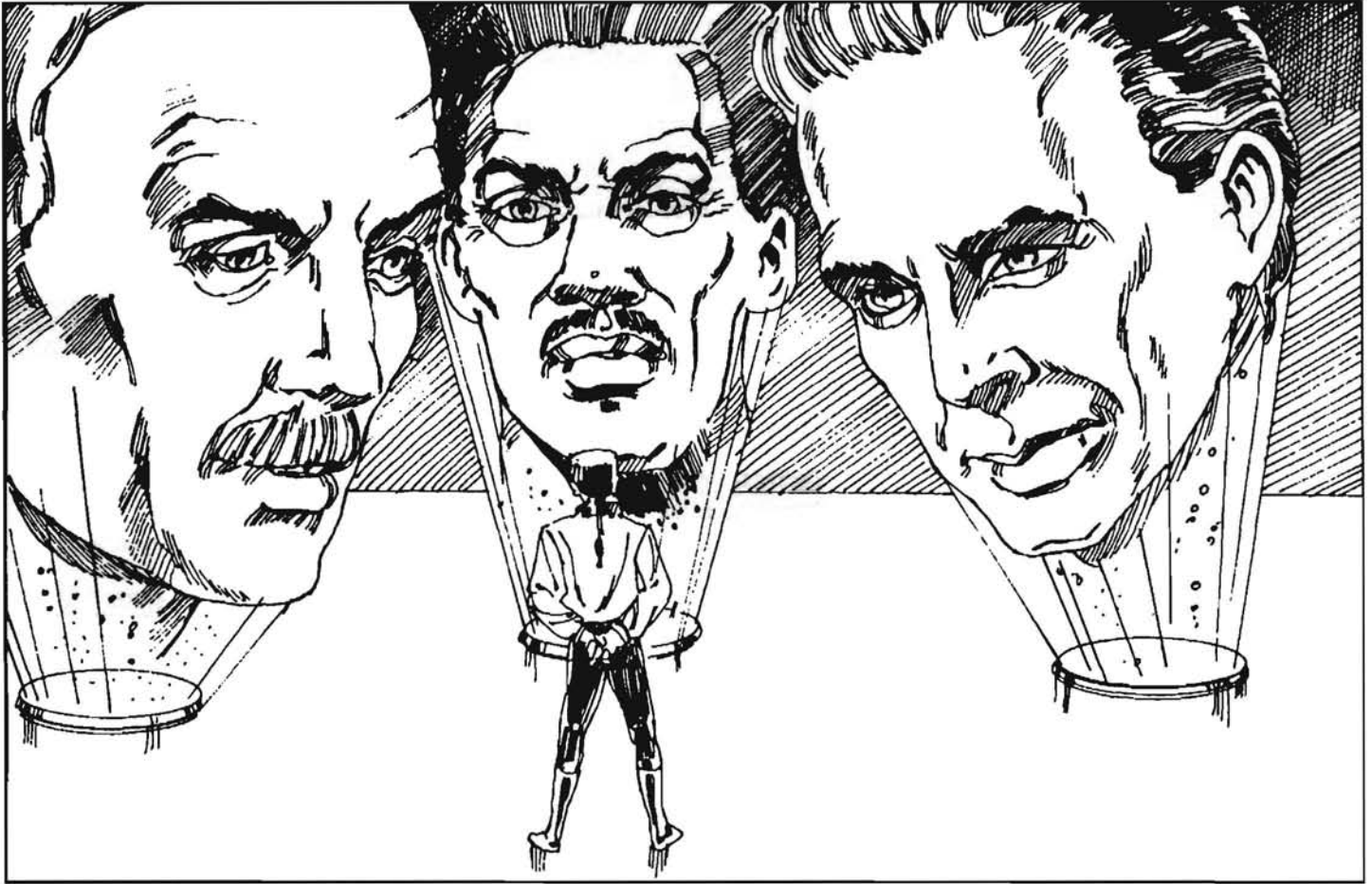

strong is the evidence or knowledge supporting these points. (Normally, two of the points must be at least known before a case can go to trial. Judge each point by weak, average, or strong merits; e.g., only 2 points are known, and they're weak=case is Very Weak, throw it out. All 3 points are known and are strongly supported=case is Very Strong, ironclad.)

Once done, the Ref should examine the various tables below and, starting at zero, add and subtract figures based on these points:

If the final result is a positive figure, the defendant will be found guilty and sentence will be passed. If it is a negative figure, the defendant is either found to be not guilty, or the case is thrown out of court. (Treat 0 as positive or GMs choice). This is just a guide and the Referee is encouraged to add further variables dependent upon each case.

Once the Ref has worked out the outcome, he must sentence the defendant NPC. Go now to the CRIMES and SENTENCING Section of this book (pg. 62).

### A NOTE ON INSANITY

Not surprisingly, many of the Perps the cops bust are total loony-tunes. They may range from hardcore psychopaths to mere kleptomaniacs. For a defendant to be pronounced insane, a counsel of three psychologists must examine the subject and rule on his relative sanity. In an insanity defense, the defendant does not stand trial, but is instead committed to a Psycho block until such time as he is fit to stand trial for his crime(s). However, in cases of Priority 1 crimes, this may be waived and the Judge may order termination if he/she believes the perp cannot, or will not, be rehabilitated.

### A NOTE ON TIMING

For game purposes, any arrests the characters make should go to court either between game time or during their next case. Unless the Ref has good reason, there is no need to run the trials during game time. However, you should definitely inform the characters of the outcome of all trials they were involved with. The Ref should also note which NPCs are incarcerated and keep track of how long they have to serve on their sentences.

After all, who *knows* what they'll do when they get out...

CASE	DEFENSE ATTORNEY	PROSECUTION
V. Weak= -10	Poor (skill 1-2)= +5	Poor= -5
Weak= -5	Average (skill 3-5)= —	Average= —
Average= —	Good (skill 6-7)= -5	Good= +5
Strong= +5	Excellent (skill 8-10)= -10	Excellent= +10
V. Strong= +10		
<b>JUDGE</b>		
Corrupted= -10 (AI's normally cannot be corrupted)		
Straight= —		
Harsh= +5		

The Ref must also decide what the defendant will do if they "get off." Their subsequent actions can turn into interesting side plots, or full-blown adventures, if they decide to seek vengeance against the characters or others...

## A FINAL NOTE ABOUT ATTORNEYS AND JUDGES

Even in 2020, attorneys have their own character skill packages. Their special ability is called Reasoning; it is the application of legal knowledge before the bench. With Reasoning, the attorney attempts to prove his theory by logic (linear or cyclical). This theory may have no bearing on the guilt or innocence of the defendant. The skill can be used as an opposed roll with two attorneys against each other, and the judge acting as referee. It can also be used in conjunction with *Persude* and *Notice* skills to influence judges and spot flaws in opponent's cases.

The *Expert: Law* skill is rote knowledge of procedural and written law. To learn the ability to analyze and apply legal situations, a student of law must pass a series of examinations, be assessed capable by a judge, and affiliate himself with a "bar" association. He may then accept clients and charge fees. Eventually, he may become a judge. (This involves a change in status only; the skill package is the same.)

The distinction between attorneys and paralegals (a person with *Law* skill only) is important; ever since the Purge of 1996, formal lawyers have been an endangered species. Streetcorner paralegals and Fixers have taken over much of the work. But in a real courtroom, even a knowledgeable Fixer has no chance against a trained attorney.

Because of their short supply, attorney's fees are somewhat high: an LPC trial will cost between 1500-2000eb, an MPC trial costs 3500-4000eb, and an HPC trial (if you can get one) will cost as much as 7000-8000eb. These fees don't include PI's costs, or any of the myriad expenses an attorney might dream up. If you want to find that missing witness, be prepared to shell out the Euro.

### ATTORNEY/JUDGE Skill Package:

#### Reason

Notice  
Expert: Law  
General Knowledge  
Persuasion  
Social  
Human Perception  
Composition  
History

### A typical Attorney

INT: 8 REF: 6 TECH: 5  
COOL: 8 EMP: 7/6 ATTR: 5  
LUCK: 7 MA: 7 BODY: 6

**SKILLS:** Reason 6, Expert (Law) 6, Social 5, Human Perception 6, Persuasion 5, Notice 4, Streetwise 3, Interrogation 3, Handgun 3, Education/Gen. Know. 5, Library Search 4, Driving 5, Interview 4, Personal Grooming 4, Wardrobe and Style 6

**CYBERNETICS:** Chipware Socket, Interface Plugs, DataTerm Link, Wet Drive

**EQUIPMENT:** Newsviewer, CabHailer, Image Wallet, Cellular Phone, EBM Carfaxx, Personal Body Alarm, Fed. Arms X-38 pistol, Bizwear suit w/protection SP = 7

### A typical Judge

INT: 9 REF: 5 TECH: 7  
COOL: 7 EMP: 7/7 ATTR: 6  
LUCK: 8 MA: 5 BODY: 7

**SKILLS:** Reason 8, Expert (Law) 6, Social 5, Education/Gen. Know. 6, Human Perception 6, Persuasion 4, Notice 4, Interrogation 4, Library Search 3, Leadership 6, Oratory 3, Driving 3, Personal Grooming 5, Wardrobe and Style 5, Melee 2

**CYBERNETICS:** Basic Processor, Chipware Socket

**EQUIPMENT:** Cellular Phone, EBM Carfaxx, Laptop Computer, Digital Recorder, Personal Body Alarm, Militech Taser, MicroCom Pagestar (*Corp-Book II*), Takanaka 'Exec' suit w/Salamander fire-proofing

## GOING DOWN: PUNISHMENT IN 2020

Unlike the days before the Uniform Civilian Justice

Code (UCJC), when death or incarceration were the only options, there are now a number of types of sentence which can be bestowed upon a criminal. These range from reasonably harsh (incarceration and braindance) to a slug in the back of the skull.

UCJC law says: The worse the crime, the more severe the punishment. For a time, many prisoner's rights groups demonstrated in opposition to the UCJC's draconian solutions; however, victims of crimes in general wholeheartedly support the system. The UCJC (and the punishments it issues) was not designed with public relations in mind, it was created and is enforced to maintain an effective system for dealing with the criminals in communities. While it isn't perfect, it sure is better than most country's systems.

Following are descriptions of the types of punishments available to the Courts of 2020.

## INCARCERATION

### SECURITY BLOCKS

Within the U.S., all states maintain an array of security blocks within their borders. These buildings are maintained primarily by State and National enforcement agencies, although many are supported to a certain extent by Corporations. The manpower and financial problems associated with running security blocks usually ensures Corporate involvement in almost every state.

Some states have one huge Security complex which encompasses all of the differing levels of security required for the containment of criminals. Others maintain different security blocks in separate areas (most criminals prefer the latter option, so as not having to run the risk of coming face to face with a psycho-killer when all they're in for is larceny). Obviously, security complexes usually segregate inmates of different security levels, but as many utilize the same facilities and have limited budgets, a great deal of sharing still occurs.

Low Security Blocks are containment facilities for petty criminals and those convicted of moderate offenses. Prisoners often share their own cells with one or more others. In many ways, Low Security facilities are very similar to prisons of the late 20th Century. They are manned by prison guards, either private or Corporate, who will not hesitate to shoot criminals who become a nuisance. Most prisoners are short-term; long-term prisoners can become Trustees, and may even be deputized and allowed access to non-lethal weapons if their psych reports permit this.

Low Security inmates are often required to work very hard at menial tasks. This can be likened



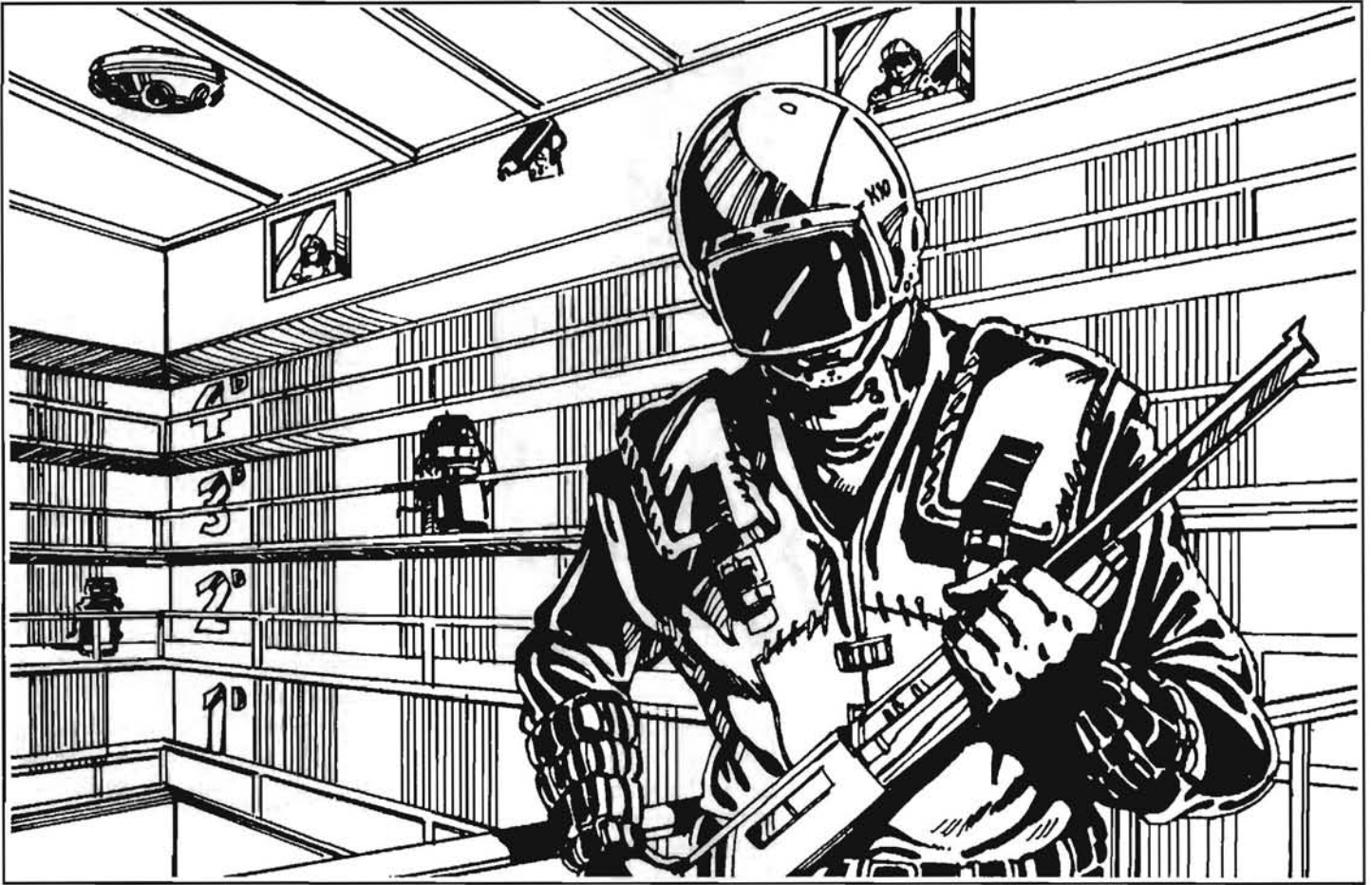

to the chain gangs of long ago, where prisoners were worked so hard that they didn't have the energy to cause trouble. Some Low Security facilities maintain dormitories instead of cells.

Inmates who cannot or will not accept their incarceration and are a constant cause of trouble may find themselves getting drilled by a guard. They may also be charged with a more serious crime and re-sentenced to a higher level security block. Sentence lengths are often extended when an inmate causes trouble. No court is required for this, only the Governor's signature.

### Medium Security Blocks

Medium Security Facilities primarily deal with violent and dangerous criminals. Their sentences are often long and the potential for dangerous behavior is high, which is the reason Braindance and Personality Adjustment are so often included as part of the sentence. These security blocks are manned by armed guards in addition to robo-sentries, cameras and auto-defenses. Supervision is required of the inmates at all times, and they are under one form of surveillance or another round the clock. Minor disturbances are dealt with automatically through AI guardians. The AI assesses the level

of offense and instantly assigns an appropriate sentence. This can range from an immediate addition to sentence length, immediate transfer to High Security facilities, or even execution. While this process is often viewed as harsh, it saves a great deal of administration and manpower costs. Inmates are informed in advance of this system, and are therefore aware of the repercussions of their security infringements prior to committing them.

Auto defense grids are set up in all non-authorized areas and are issued with commands to open fire immediately and with deadly force upon any persons not possessing a security tag (a small retinal scan device, worn as a badge, and containing eye patterns unique to the wearer. These may only be issued by a Security Supervisor).

Inmates are locked down into "coffins" (cramped bed chambers about twice the size of a real coffin) for the night. The coffins are fed air through a central circulation system. Inmates who become violent are fed sleep gas until they calm down. Good behavior may allow an inmate his own cell; these are only tiny rooms with a bunk, but one heck of an improvement on a coffin.

### High Security Block

High Security Blocks are containment facilities provided for the most dangerous of low and moderate offenders, who find themselves here through bad behavior in lower security facilities. They also house offenders dangerous to the public, the economy and the government.

Security is tight; guards are fitted in outfits similar to riot gear (SP 25). Nobody steps out of line. Surveillance is constant and the guards are often just the overseers of varying amounts of automated security equipment installed to observe and dispense justice. Robo-sentries patrol constantly and auto-defense grids are set up anywhere the inmates gather, ready to fire with autocannons on a rowdy crowd. In 2017, a riot by inmates in the Louisiana HSB (due to what inmates considered an unfair summary execution) was dispersed by an automated defense grid. There were no survivors.

At night, most inmates are locked down into Braindance while the guards run a security sweep of the entire facility to remove potential weapons and other dangerous equipment. Visits are not allowed and all correspondence must be delivered by video transmission (observed by an AI who can, and will, pull the plug if it observes any security risks).

Good behavior *may* get you transferred down to Mid Security facilities, although checks must be made with LEDiv first to ensure an individual is not deemed a long term threat to national security. Apart from Top Security, High Security is as hard as it gets on the individual prisoner.

### Top Security Block

Top Security provides containment facilities for the toughest offenders. Most are locked down almost all of the time. Interpersonal interaction between inmates is forbidden. You do time in Top and you're on your own—for the duration. Robo-sentries guard you round the clock and no infringement of security is allowed under penalty of death. Inmates come into contact with guards and other authorized personnel only when they are undergoing treatment of some kind.

The entire Top Security system is one big machine, usually overseen by a Governor (often an AI). All connection with night and day disappears as each inmate is assigned his own time pattern, going through the cycle of sleeping, eating, etc., with no knowledge of time; never seeing another inmate, just the Robo-sentries and the all too familiar blackness of Braindance.

### PsychoBlock

It doesn't matter what you've done, or who you've done it to. If you're nuts, this is where you go.

Unlike the years before the UCJC, when pulling a psycho-rap was an free ride, PsychoBlock is not easy. Not now. While a psycho-inmate is allowed far more interpersonal communication with other inmates and guards, he/she is far more likely to suffer at their hands. PsychoBlock doctors and other "qualified" personnel can be likened to ship's doctors of old; their incompetency ensures that they can't pick up a contract with a Corp or educational establishment. Many of them are little better than ripperdoc Techies.

Except that now they're in charge of a PsychoBlock.

Guards are used to restrain inmates suffering from drug-induced bouts of violence—this restraint usually comes in the form of nightsticks and hypos. Personality-inhibiting drugs are prescribed on a regular basis; many of these are experimental in the extreme. Braindance and artificial environments also allow the personnel to attempt rehabilitation through fear confrontation and induced nightmare analysis.

Many of the so-called "restraining drugs" allow the user full control over his mind, but not his body, in a way similar to Braindance. Often, Experimental Personality Adjustment techniques are tested here, prior to becoming available to other Security facilities. While the goal of the



PsychoBlock is to attempt rehabilitation, leading to the inmate standing trial for his or her crimes, many PsychoBlocks become Corporate pharmaceutical testing grounds. Draconian standards and practices ensure PsychoBlocks maintain their intimidating facades. Nobody willingly pulls a psycho-rap anymore, and that's just the way they want it.

### Personality Adjustment

Personality Adjustment is often used to augment a sentence when there is reasonable belief the criminal can be rehabilitated. P-Ad comes in many forms, ranging from deep psychological reconstruction assessment to interviews and diagnosis at its most basic form. Prescribed drugs (often Inhibitors) are sometimes successful, although there are few without side effects. Cyber-implantation of Personality Restraint chips is now becoming more popular. These chips cause the wearer to feel pain or other stimulating anti-effects when in the process of committing a given (or any) crime. Many states have yet to permit the usage of these, even though the Restraint Chip has shown excellent results against repeat offenses in Night City (which pioneered its development). Many groups draw attention to the psychological dismantling that P-Ad can cause, and claim it is just another step towards the creation of universal mind control.

Personality Adjustment can, and does, often take place in the Net. Scenarios and/or simulations of events help the user to experience situations and feelings beneficial in the real world. Use of so called "Nightmare" technology has yet to come into mainstream usage, due to claims of irreversible

psychological damage to those who experience (and do not adapt well to) Fear Confrontation.

Despite the fact that P-Ad comes in many different forms with varying degrees of success, there is still a great deal of room for improvement in this area. Future projects should be well funded, thanks to the involvement of the Corporations, who are now moving into the field of P-Ad for their own reasons.

### Braindance

Although Braindance therapy is often a common component of a criminal's sentence, most will do anything to avoid it. Although the body is cooled and no physical exertion is possible, the Braindancer's mind is fully active for the duration of the session. All he/she can really "see" is the endless blackness of total sensory deprivation. Fifteen years or more of this will cause even the most hardened perp to beg for another sentence. Many criminals are allocated periods of Braindance each day as a punishment, a relaxant, or even just to keep the numbers of active inmates down to a manageable low.

Many inmates come out of Braindance totally insane; however, guards and Robo-sentries are on hand to deal with *any difficulties* that may arise from this. Braindance is seen as an excellent way of getting difficult prisoners out of the way in lieu of executions (which are not always good for public relations).

### Exile

Exile Implants are often used as a sentencing option. An Exile Implant works in conjunction with a city's cellular net, preventing the criminal from re-entering a forbidden area by neurally transmitting waves of excruciating pain. New implant codes can be added for further cities (in the event of offenses committed elsewhere). Exile is a good deterrent, since almost everybody is afraid of having to live outside the urban megacities, where they would have to deal with roadgangs and the harsh justice of HiWay.

### Death

Death is the ultimate sentence. Execution is always performed by the State Executioner, an individual empowered with the right to administer lethal justice. Upon being sentenced to death there is a short appeal process while the convict waits on Death Row; this period lasts three months. After this, the convict is taken to the place of execution where the State Executioner administers the sentence. This is normally a slug in the back of the skull; the convict has the right to call for a public execution, although this is often waived by LEDiv if it is believed that it would cause a public disturbance. ■

**T**his chapter is primarily for Referee use only, as it deals with topics such as running a campaign, cop personnel files, disciplinary actions and a sample precinct.



**RUNNING A LAW ENFORCEMENT CAMPAIGN**

There are a few marked differences between running a standard game of *Cyberpunk* and running a game of *Cyberpunk* with your players as cops. In fact, as you read through the book you may have noticed a change in emphasis.

It's the same place, just as nasty and dark as the one we love so much, but there's a difference. A simple one, easy to miss. If you're a cop, you're on a different side! A "straight" game of *Cyberpunk* puts players in all sorts of positions and they play all sorts of people. They break the law, but frack, they're desperate people in a desperate world! This has to change with a law enforcement campaign; you're cops now and

you've got a job to do. You can still be a desperate dude, but you have to follow a certain code. You are the last representative of what little justice remains, and there's lots of people relying on you. The big difference is: RESPONSIBILITY.

You're responsible to the badge, your partner, your chief, etc. But most of all, you're responsible to the public. The difference is similar to watching a gangster movie where everyone's fighting against each other, and only the coolest gangster wins. Compare that to watching a cop movie where it's *good guy* cops versus *bad guy* criminals. You have to get a different mindset to make the change.

Experience shows that a cop campaign is better with a smaller playing group, but if you have

7  
6 ft.  
5 ft.  
4 ft.  
3 ft.  
2 ft.  
1 ft.

# JUST THE FACTS



a large group, it shouldn't be any problem arranging for all the players to be part of one section. S.I.N. is the best section for this; it's also the most diverse in terms of encounters and scenarios. Vice is a good section, too. Before you start, you want to ask your players what kind of Law Enforcement campaign they want to run through. If they all want to be LEDiv, then you just might have to let them play a Task Force. No problem, think of all the nasty types you can throw at them...

*Cyberpunk* is already filled with shades of gray, so don't get too much into the idea of Good guys and Bad guys. People don't commit crimes just because they're bad; they do it for a whole host of different reasons. Ask any *Cyberpunk* player.

The players are never going to save the city from crime, no sir. But they may win the occasional battle. Good game presentation can ensure players feel these accomplishments. In many ways, a Ref should try and present the game like a serialized cop show. Each week a new case, guest stars, old favorites, etc. This way, your players won't get bogged down in one case for too long, or deal with just one type of crime. At the end of the book, there are some episode suggestions which will keep any group on their toes for a while. There are loads of inspiration sources for this kind of game, and at the end of the section we've listed a few.

You won't lose the basic feel of the *Cyberpunk* game style when running a law enforcement campaign; it's just a change of perspective. Follow the original code and you won't go wrong:

1. Style over substance
2. Attitude is everything
3. Live on the Edge

Your *Cyberpunk* Cop probably won't be some namby-pamby college boy. Maybe he used to be a Nomad? Or a Gangboy? Now, with 100 man-hours on the range, thousands of dollars of hardware behind him (and a bad attitude in front), he's gonna give as hard as he gets when he rolls onto the streets. And if he's having a bad day...look out!

So you've gotta play by the rules? Ain't that a shame... Well, if there's nobody around to tell you different, you can do what you want, can't you? Maybe that makes life harder. But hey, if you can't take it, I've got a bag of pointy ears right here...

So your Lieutenant isn't happy with you; it was only a Patrol cruiser. He had a bazooka! Of course there was nothing you could do... And your wife's threatening divorce again, and the IAD want to talk to you about an unlawful shooting. So what? You've got an eight hour shift to pull, and if you're not 110% alert, some geek is going to send you to Memorial, maybe for good...

As a Ref, it's your job to keep the players on their toes. Never let up the pace: so they're just about to make the big bust when someone appears from the last game, looking for vengeance. Or maybe there's two gangs trying to hold up the bank (or worse)? Keep it moving all the time; in *Cyberpunk*, if someone sees a police officer, they're going to interact with them. Maybe threaten them, lie to them, or just have a chat. Maybe just run and hide, but nobody is going to leave these guys alone. And why is it everybody except cops can tell a cop in plain clothes?

If your players think straight *Cyberpunk* is rough, make 'em play cops—then they have to uphold laws instead of break them. It's one tough life.

## COP MOVIES

Bladerunner  
 Predator 2  
 Outland  
 Lethal Weapon 1 & 2  
 Extreme Prejudice  
 Cop  
 Mad Max  
 Assault on Precinct 13  
 Manhunter  
 To Live and Die in L.A.  
 Silence of the Lambs  
 Black Rain  
 Year of the Dragon  
 Best Seller  
 Robocop 1 & 2

## PERSONNEL FILES

**Note: This is what the GM keeps on Players in his group**

From the day you join the Academy and become an officer cadet, they keep a file on you; everything goes in it. You're tested, and notes are made of Blood Type, DNA, retina- and fingerprints. Your test results on all courses are input directly to your file, as are all cautionary and disciplinary actions taken against you.

This section examines the various ways a cop's personnel file will affect him/her throughout their career. Ref's are advised to take time out to create a file on each law enforcement player, updating it after every case and noting the important features therein.

The section on a cop's history will grow with him. Each time the character completes a case, the Ref should enter details in his file, describing the case, final results, ramifications, and noting any recognition he received.

As a cop completes more cases, his history will grow, commendations and black marks will

be awarded, and promotion will take place. The cop's file is an excellent tool in determining eligibility for promotion.

Events such as deaths of partners, close friends and any family members should also be noted. So should any investigations performed by IAD, and any disciplinary action taken against the officer. The psychological profile is also likely to change. (Not for the better either, I bet!)

## Disciplinary Actions

A cop's career in *Cyberpunk* is bound to be a mixture of commendations and results against a background of disciplinary actions and Black Marks. That's the way life is; there are no perfect cops out there. They're all people, just like you. Except they carry the Badge.

Disciplinary actions take place for a number of reasons; some, more lenient, ranking officers are unlikely to enforce regulations that have no effect on the job. However, some will. If you've got a good boss then you're lucky; if you haven't, then you're in trouble.

Not everyone plays by the rules, either. If you make enemies of fellow cops, especially if they outrank you, then you're in for a bad time...

## Black Marks

(See Cop Character Generation in HITTING THE STREETS, pg.7) Black Marks are picked up for bad calls. Anything that goes bad (and can be attributed to a player) may earn him a Black Mark. Breaking the law will pick up one (if it doesn't get the cop busted out), as will insubordination and negligence. Gross misconduct is always a good one. Media, political and corporate pressure can also get your players these. Five Black Marks and they're out, no pension. Change their names to *Ja*.

## Under Investigation

One day, you may be suspected of illicit behavior within your department; if this comes to light, Internal Affairs may develop an interest in you. Should you fall "under investigation" this should also be immediately referenced in your file, including details regarding the reasons why.

Perhaps you took a bribe, or unlawfully shot someone; any serious breach of procedure could warrant an investigation against you. Just being under investigation, you pick up 1 Black Mark on your file. Once IAD has come to a conclusion regarding your involvement with whatever took place, the result should then be noted in your file. If the result is anything but total acquittal, you may find other action will be taken against you.

## Suspension

You can be suspended for any breach of procedure not serious enough to warrant Gross Misconduct. You may also be suspended while under investigation if the charge against you is serious enough. Cops often get suspended when they become too "involved" in a case, or when they've freaked out and their boss thinks they need some time to calm down. Suspension can be with or without pay (suspending officer's discretion) and can last up to six months, after which time a decision must be made whether to remove the cop from the force, or take him back. Suspended officers must hand in their gun and badge immediately upon suspension.

## Disciplinary Days Off

For infractions that do not warrant a long suspension. Things like not waiting for backup, minor cases of excessive force, etc., are usually met with around one to thirty days off as a disciplinary action.

It's similar to suspension because you have to turn in your badge and during that time you are not a police officer, but it's on a shorter basis and is not associated with corruption or a big internal affairs investigation like normal suspensions are.

## Administrative Leave

This is paid leave where the officer still has police status and retains his badge and gun. Admin leave is usually used after a critical incident situation. This time allows the officer to go through psych evaluations and to generally "cool down" (plus it allows IAD time to investigate, should they choose to do so).

## Insubordination

Officers who constantly act insubordinately are likely to get away with it—once. After that, they will get into all sorts of trouble, depending on who they're insubordinate to. They can pick up Black Marks or suspension, and make enemies very easily this way. If this happens too often, the Black Marks alone will see to a cop's future.

## Getting Thrown off the Force

Apart from accumulated Black Marks, the only other way a cop can be forced to give up the Badge is through Gross Misconduct. This is always a serious charge to be brought against an officer. If it can be proven that a cop knowingly committed a serious crime, not in the course of his duty, he may be eligible for Gross Misconduct. Discretion is often exercised, as a Traffic violation is unlikely to get anyone thrown off, whereas Murder will, as will buying Stolen

Goods. This is a bad way for a cop to go; being a cop isn't just a job, it's a way of life. Getting thrown off the force is like being exiled; the cops (your buddies) want no more to do with you; you have become a Jo. There are probably lots of enemies waiting to hit back at you, now that you don't carry the badge.

## SAMPLE SETTING: MEGA-URBAN POLICE DEPARTMENT PRECINCT BUILDING

The streets of a *Cyberpunk* city are a deadly place, as everybody knows (and those that don't, soon find out). They crawl with cyberpsychos, punks, crazies, hitmen and just about every other type of lowlife you could name. Because of this, the precinct buildings of 2020 are a lot different from those of the late twentieth century. No longer are they simple concrete buildings designed to accommodate the police, and to keep offenders from escaping while being processed. The precinct building of 2020 is an armed and armored fortress, designed to keep the streetfreaks out, and to protect the police during the time between regular journeys onto the hellish streets.

The following details should give an idea of the design and defense of a typical police precinct.

### External Defenses

The entire complex is surrounded by a 3.5m tall reinforced concrete wall (SP=30, SDP=250), complete with three layers of razor-wire on top to discourage even the most persistent intruder. Each corner of the wall is mounted with a high-intensity searchlight system that provides full illumination to the courtyard below. As an extra defensive measure, the searchlights are armored to SP=15.

During the night, the perimeter of the wall and courtyard are patrolled by a pair of Lawtech Unlimited Police Robohounds, both programmed with a Kill directive (this is only if attacked, if not, they will attempt to disable and capture intruders). The Robohounds will not attack if the current identification password is given by the individual. This password is changed each week and issued to each officer working the night-shift at the station.

The main gates of the precinct wall (A) are fitted flush into the surrounding structure, and are armored to survive even a direct missile strike. The gates will only open after an officer identifies himself by radio, and then only when the security cameras have made a positive identification of the vehicle. The gates are kept shut at all times, only opening when necessary (there are no exceptions to this policy!). The gates are armored to SP=35, SDP=150.

The side entrance (B) is used by pedestrian officers and all visitors to the precinct. There is a standard set of doors here, but they are protected by an APEX Mobile Point-Defense system located above the doors, which will open fire on any target unless the operator is given the correct identification code. The APEX system may be over-ridden from within the precinct, and to ensure no accidents occur, a three second delay is built into the firing mechanism of the weapons.

### ROOF AREA (See Map for layout)

The roof of the concrete precinct building is used as the hangar area for AV flights that operate from the precinct.

All repair and maintenance work is carried out here in the covered, armored hangars. Any vehicles wishing to exit the area must receive authorization from the command center before the roof door slides aside to allow passage.

In addition to repair systems, there are also four refueling points inside the hangars, fed by a pipe system from the huge fuel reserve tanks imbedded beneath the entire complex, some 20m beneath the surface and encased in concrete (even so, this is still a non-smoking area!).

### GROUND FLOOR AREA (See Map)

1. Main Desk: This desk is constantly manned by a single uniformed officer (usually a sergeant), who sits behind a clear, armored safety shield (SP=25) and deals with the public. Both doors behind the security desk are code-locked and can only be opened by the desk sergeant, using a hand-print scanner on the desk.
2. Lounge Area: Originally a holding area for members of the public wishing to see friends or family currently under arrest. This area is now a worn-looking and dreary waiting room, with graffiti-covered walls, uncomfortable chairs and vomit-covered floors. The only points of interest are the plaques covering the walls naming all officers from the precinct who have died during active service (and there are one hell of a lot of them).
3. Dispatch/Communications Area: The police communication and command system is installed here. This area is used to carefully monitor all police activity within the precinct's jurisdiction. It is constantly manned by a team of officers, and is run in a manner similar to that of a military command post.

# PRECINCT FLOORPLANS

## BASEMENT

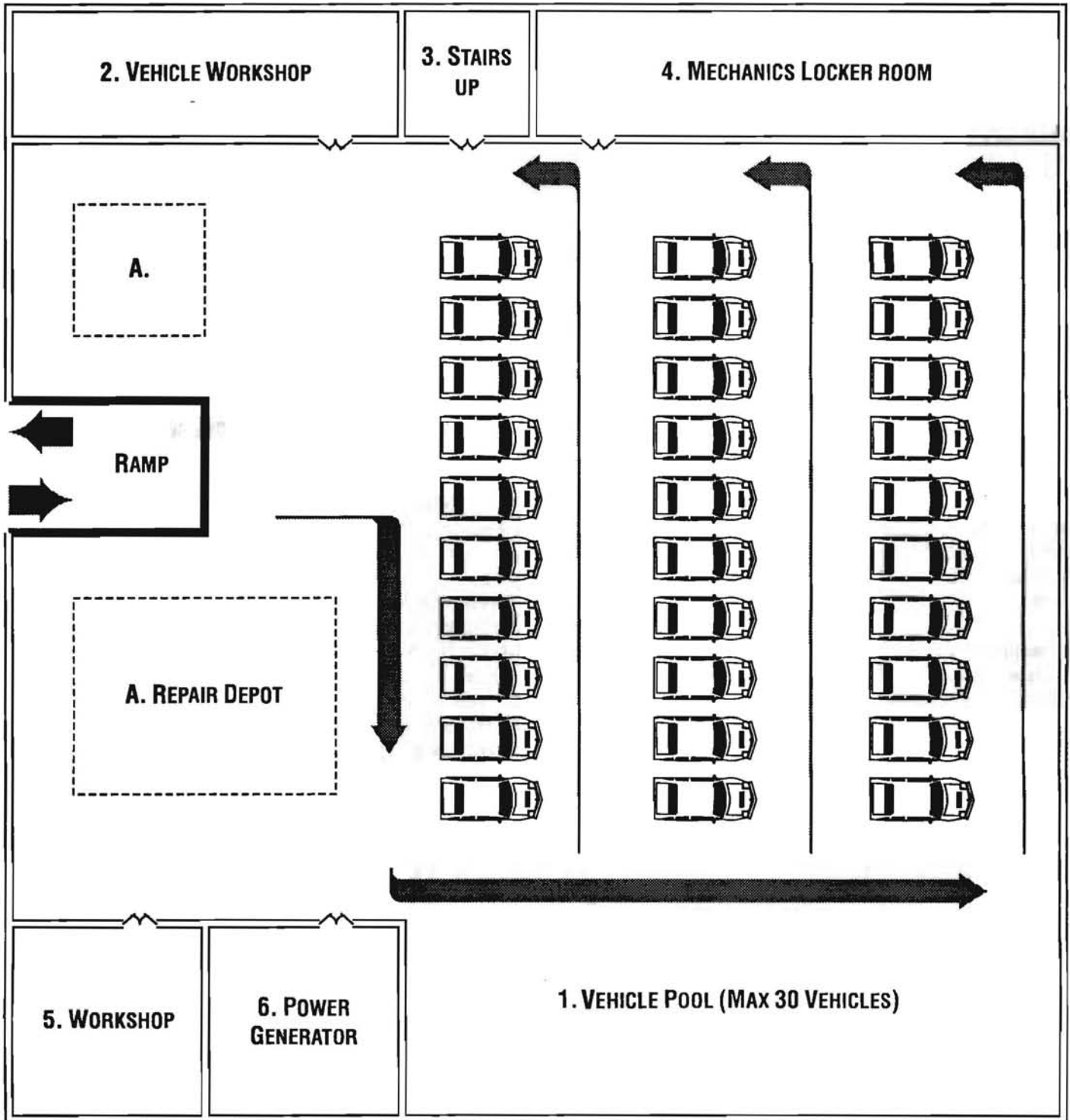



# PRECINCT FLOORPLANS

## GROUND FLOOR

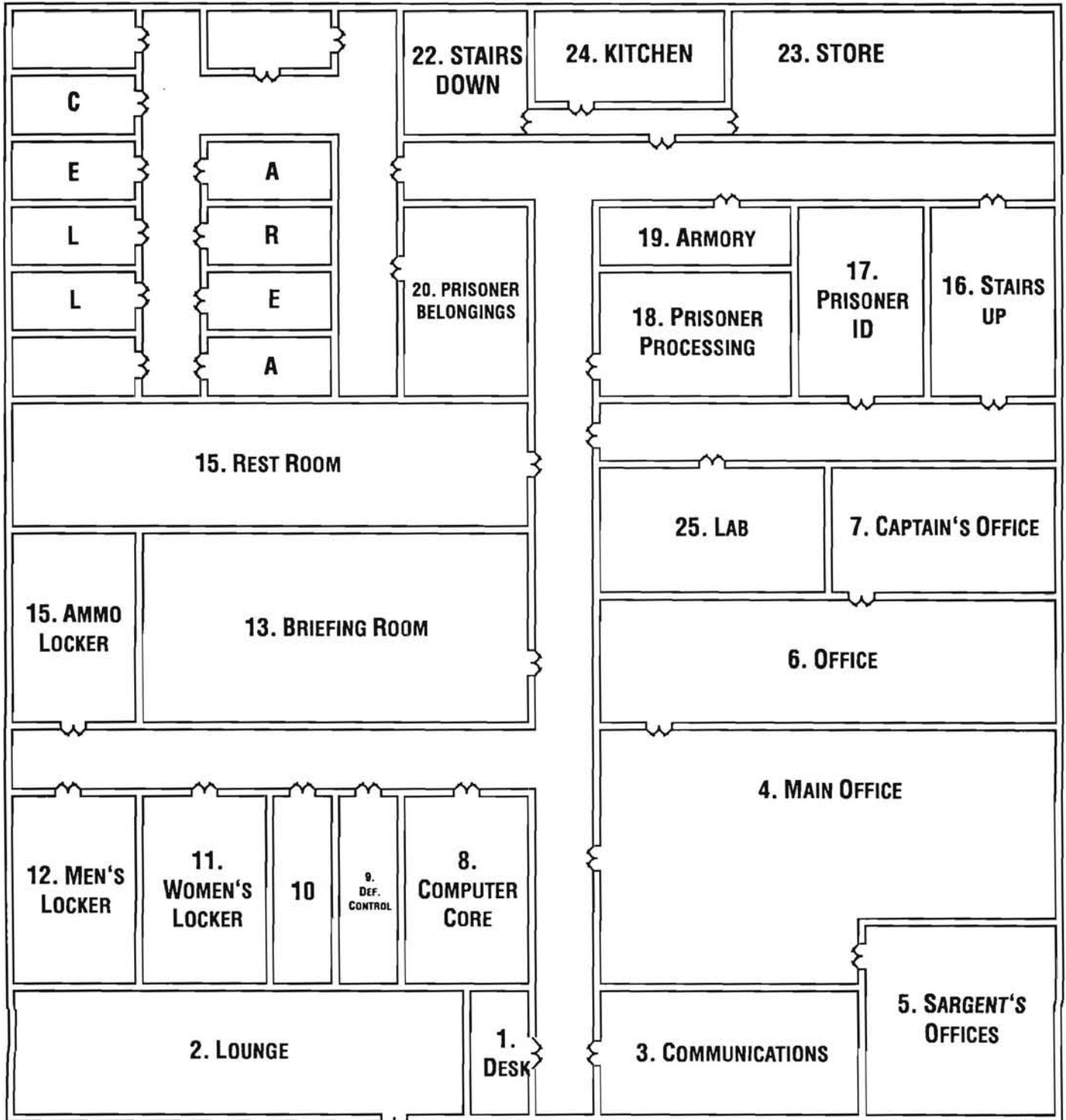

# WALL STRUCTURE

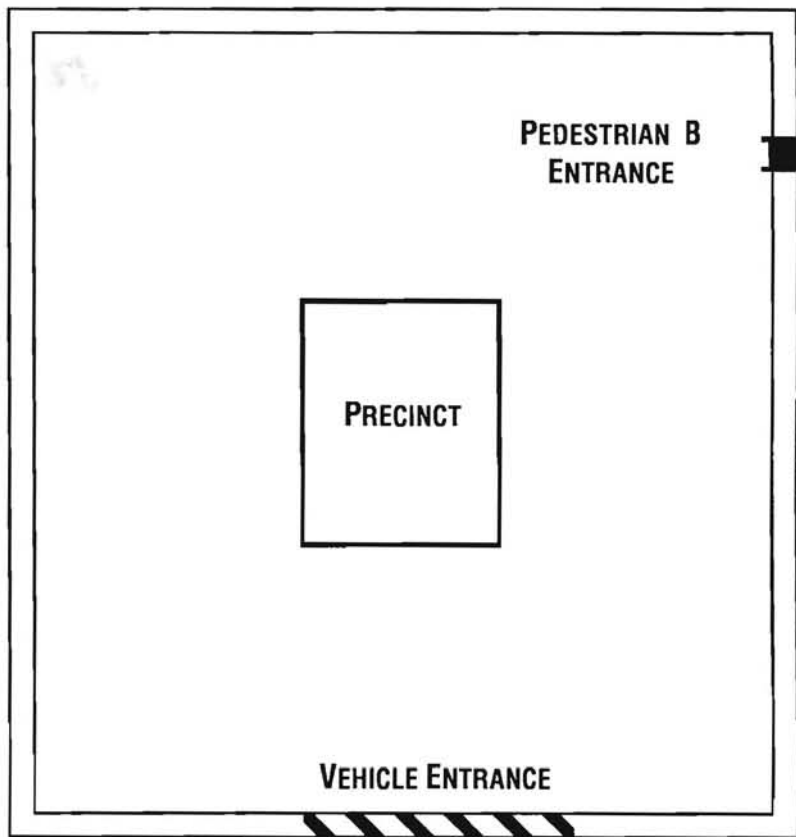

# ROOF

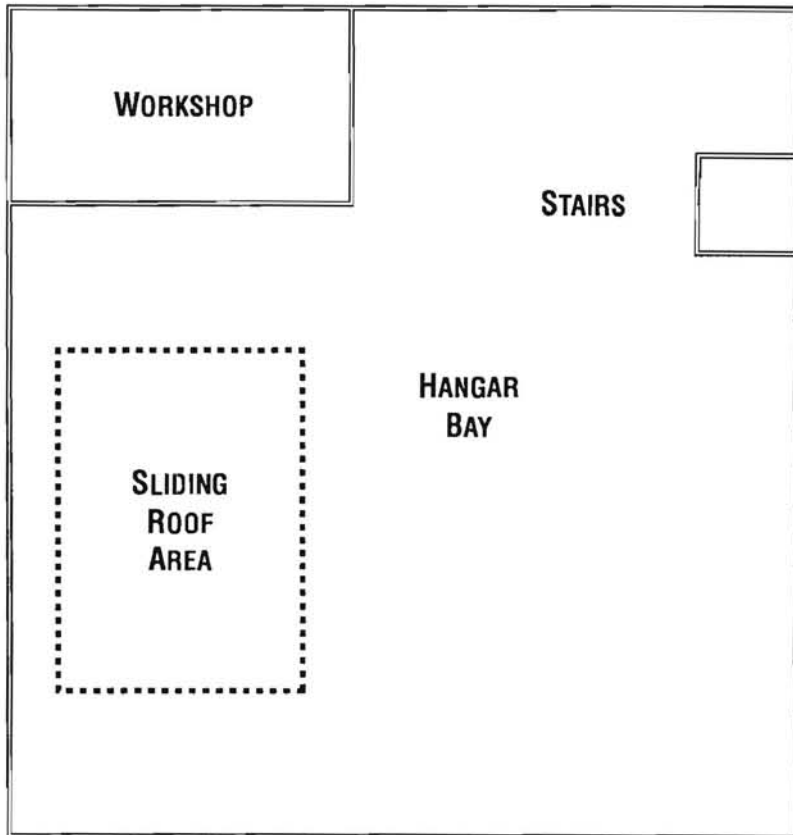

4. **Office Area:** Used by police officers to enter reports directly into the precinct computer. This area tends to be one of the most turbulent and chaotic rooms in the building.
5. **Sergeants' Desks:** Similar in purpose to the main office area, except the Sergeants tend to have better quality furnishing and cleaner offices.
6. **Officer's Desks:** This area is used as an office by some of the mid-rank police officers, especially the detectives. Furnishing and equipment are of better quality than in the other offices, but the atmosphere is still quite chaotic.
7. **Captain's Office:** The Captain has a quiet office at the back of the main office area. His room is clean, well-equipped and sound-proofed from the other offices. An armored window (SP=20) allows him to see out into the other offices.
8. **Computer Cores:** The doors of this area require a keycard, plus a retinal- and handprint scan for entry to be allowed. Inside are the central cores to the precinct computer. Access is limited to officers of the rank of Lieutenant and higher, and to authorized technicians. As an extra measure, the walls and doors of this area are shielded against EMP effects and computer jamming.
9. **Computer Defense Command:** All defensive systems (such as the Robohounds, doors, Apex turrets, etc.) are controlled from the central console of this room, which is linked directly to the main CPU next door.
10. **Toilets:** Male and Female. All have security cameras inside.
11. **Women's and Men's Shower and Locker rooms.**
12. **Women's and Men's Shower and Locker rooms.**
13. **Briefing Room:** This area is large enough to accommodate the entire precinct force if necessary, and is used for briefing officers on their duties and providing news updates concerning various cases. It is equipped with a variety of audio-visual equipment.
14. **Ammunition Locker:** Constantly manned by a uniformed officer, the ammunition store is kept locked at all times, and access can only be gained after a positive retinal scan has been made and the correct ID code entered. The officer within is always armed with a Hurricane Assault Shotgun.
15. **Ready Room:** Open to all precinct personnel, and fitted with a variety of recreational equipment. It also contains several vending machines for food and beverages, as well as the all-important cigarette machine.
16. **Stairwell to AV Hanger**
17. **Prisoner Identification:** All prisoners brought to the station are identified in this area. All personal details are recorded by computer and stored on datachip. Two armed officers stand guard here at all times, while a third sits behind the desk.
18. **Prisoner Processing:** This area is used for scanning the prisoners for cyberware, illegal substances within their blood-streams, etc. Again, there are two armed officers on guard at all times, and two police medics to carry out the examination.
19. **Armory:** All of the weapons not in use in the precinct are kept in this locked, security-coded room. An armed officer remains inside at all times. The same identification procedure as that used in the Ammunition Locker is required to enter the Armory.
20. **Prisoner Belongings:** All of the belongings of prisoners are tagged and stored in this area. An officer mans the desk at all times, protected by an armored screen (SP=15).
21. **Cells:** Two officers and a series of security cameras monitor this area at all times. Each cell is designed to hold two people (although they are normally overcrowded), and contains an open toilet in one corner.
22. **Stairs to Basement.**
23. **Storage:** A general storage area for office equipment, crime scene equipment, etc.
24. **Autokitchen:** Complete kitchen area for providing prisoner and officer meals. The food is slightly bland and looks rather dubious as to its origin.
25. **Forensics Lab:** Full facilities for Forensics teams working out of the Precinct. Autopsies cannot be performed here, but there is a decent laboratory.

Note: The walls of the building are armored to SP=20, and SDP=300.

### **BASEMENT AREA (See Map)**

1. **Main Vehicle Bay:** This area houses the precinct vehicles when they are not in use. A. Repair pit and refueling point from underground reserves. B. Entry/Exit Ramps: These two ramps lead up to the main courtyard of the precinct. In emergencies an armored metal gate can be lowered over these areas to prevent entry (SP=30, SDP=100).
2. **Workshop:** This area holds all of the precinct's spare parts for their fleet of ground vehicles. All intricate repair work is carried out in this area.
3. **Stairs to Ground Floor.**
4. **Mechanics' Locker and Shower Room.**
5. **Electronics Workshop:** All electronic repair work is carried out in this area. The precinct's Robohounds are kept within this area during the day, where they spend their time scaring the rookie mechanics (some say that the chief technician programmed them to do this).
6. **Independent Power Generator:** This generator is designed to act as an auxiliary power supply for the precinct should the external power be cut-off. It can run for a total of 30 days (approx.) before requiring refueling. ■



# 96 SCENARIO IDEAS

5 ft.

4ft.

3 ft.

2 ft.

1 ft.

**T**his chapter consists of several law enforcement mini-scenarios. The Referee will have to perform some preparation work before running any of them, but all the information to do this is included in each scenario description. (For speed of set-up we suggest you use the various sample cops, crooks, and victims on pgs.22-30, 52-61. Plus, if your GM owns *Night City Sourcebook*, many of the scenario settings can be staged in those familiar environs.)

**The following format is used:**

**Media Report:** A brief story about the situation covered in the adventure. This information is available to anyone with access to the media (that is, everyone).

**Police Report:** The official police briefing for the situation. Available to law enforcement officials only.

**Referee's Information:** The information the Ref needs to fully prepare the adventure.

## NO GREATER WRATH...

**Media Report**

"Another brutal incident occurred today on Main Street when cyber-enhanced youths attacked three young pedestrians. A young man was killed and two young women were kidnapped. One body was found two hours later by police robohounds on a routine sweep. The other woman remains missing."

**Police Report**

**Summary:** Four young women, believed to be members of the boostergang the *Daly Gang*, attacked and killed David Stevens. Anne Stevens and Carla Long were kidnapped. Anne Steven's body was found two hours later after the attack and Carla Long is still missing. The Daly Gang is believed to be based in an abandoned warehouse at 23456 West Anderson Street.

**Daly Gang:** An all-female boostergang, best known for their radical feminist philosophy and their violent attacks on males. They are also known to kidnap and "process" females in the hopes of increasing their membership. All members are enhanced and should be considered extremely dangerous.

**Assignment:** You are to investigate the abandoned warehouse at the above address.

**Referee's Information**

**Preparation:** Prepare a map of the warehouse and the surrounding streets. The "Daly Gang" can have from 10-30 members depending on the number of PC's and their resources. The gang members will have at least four pieces of cybergear each (implanted weapons are very common). They will be armed with heavy pistols and submachineguns and will be wearing flak jackets, Kevlar vests, or armored jackets.



For these gang members, Star Trek® is more than just a vid show...

**Action:** The gang members will snipe at the police as they enter gang turf (simply out of general meanness!), and they will intensify their attacks as the police get closer to their den. During combat, gang members will shout out slogans like "All men must die!" and so forth. They will concentrate their firepower on male cops first.

**Notes:** The kidnap victim will be guarded by two members at all times. She has been heavily drugged and is linked to a Braindance unit. She will have to spend several months in therapy before she returns to normal.

## YOU'RE DEAD, JIM

### Media Report

"Today was another scorcher with the temperature soaring to new heights. The increased violence between the Steel Eagles and the Trekkies shows that human temperatures are also running high again today. The leader of the Steel Eagles said he would nail 'Admiral Kirk's' head to a post before the end of the week. The police are ready, according to police spokesman James Rajid."

### Police Report

**Summary:** Gang violence has escalated recently. Of particular concern are the incidents between the *Steel Eagles* Boostergang and the *Trekkies* Posergang. It is believed that a full scale war is inevitable.

**Steel Eagles:** A recently-formed boostergang which was created by the banding together of the *Iron Fists*, *Cobras* and *Death Hawks*. All of these gangs suffered heavy losses during the last round of inter-gang warfare. Members are enhanced and many are skilled fighters.

**Trekkies:** A posergang in which the members act as characters from the 'Star Trek' tv shows and movies. Some members are enhanced with cybernetics or nanotech. The gang has a high number of techs who produce their exotic-looking weapons. Although generally well-behaved, they are certain to fight.

**Assignment:** You are to minimize the gang violence and maintain order. Close surveillance of gang activity is to be maintained, and early intervention is essential.

### Referee's Information

**Preparation:** Prepare maps of the city streets and any key buildings. Both gangs should be detailed. The Steel Eagles have from 20-40 members. They will typically have 3-4 (or more) pieces of cybergear. Many (the ex-Iron Fisters) will have BigKnucks. The gang members will have high combat skills, including martial arts. They are fairly well-armed with medium pistols and light submachineguns. The Trekkies are a fairly diverse group. The ones posing as humans (Kirks, McCoys, Scotties, Wesleys) will have been bodysculpted and may have neuralware. The ones posing as aliens may have cybernetics or nanotech (The Vulcans will have had bone/muscle lace and cyberaudio, Datas will have many cybernetics,

as will the "Borgs"). There are many techs in the Trekkies and they have constructed all sorts of equipment for them. For example, they have microwave weapons shaped as phasers, radar and IR scanners shaped as tricorders, and so forth. Their gang headquarters is decked out as a starship and is laden with tech stuff (including some laser weapons mounted on the outside!).

**Action:** At first, the PC's will be engaged in surveillance and dealing with minor incidents. Gradually, these incidents will escalate until a full-scale war erupts. It will be up to the PC's to bring order back to the streets.

**Notes:** This could make a good background adventure while PC's are focusing on other activities.

## FULL MOON

### Media Report

"Bizarre incidents of violence have plagued the city over the past two weeks. Victims have been found torn to shreds and some appear to have actually been chewed upon by their attackers. Police reports indicate these attacks are not the work of a single individual."

### Police Report

**Summary:** Fifteen people have been killed in the past two weeks. Each body has been severely mutilated, in many cases by the bare hands and teeth of the attacker. According to forensic reports, the attacks have not been the work of a single individual.

Traces of "Blissful Blossom" and an unidentified chemical interlocked with the "Blissful Blossom" compound have been found in residue left at the scenes of the attacks.

**Blissful Blossom:** A new street drug. It is reported to be an opium derivative and is also synthesized.

**Unidentified Chemical:** It is believed the attacks may have been caused by contaminated "Blissful Blossom," as the unidentified chemical is similar in composition to outlawed "berserker" drugs.

**Assignment:** You are to go undercover into the drug community, and attempt to determine the source of the contaminated drug and shut down their operations.

### Referee's Information

**Preparation:** The Referee will need to detail the undercover operation. NPC dealers and users will have to be generated as well as their hangouts. The base of operations is a lab in the basement of a store and this will also have to be mapped out. There are three chemists and six guards in the lab at any time. (The guards are enhanced and armed with submachineguns.) The lab is also protected with cameras and hand-print locks.

**Action:** The first part of the adventure will primarily be investigation as the PC's try to find out the source of the contaminated supply. This will be done by talking with dealers, users, and others in the drug culture. They will be fairly cooperative, as they don't like the situation anymore than anyone else. When the PC's begin to close in on the dealers, they will be subject to

attacks (generally, hired gang members armed with pistols and light SMG's). Finally, the PC's will go after the lab.

**Notes:** The lab is actually a distribution front for a corporation which is trying to produce a new line of military drugs. This can be determined by an examination of the drug, and the equipment in the lab. All are beyond the resources of a typical small-time producer. The adventure can be expanded by developing the corporate connection and involving the PC's with it. This will be very dangerous.

If the PC's get clumsy in their investigations, or have their cover blown, they will face great difficulty in finding the lab (which may move).

The drug: "Werewolf"

Type: Military drug, Strength: +2, Difficulty: 32, Cost: N/A, Duration: 1d6 x 10 minutes, Effects: +2 REF, +2 CL, Negates Pain Effects, and Reduces Stun.

Side Effects: Reduces INT, Paranoia, Psychotic Rage

Description: An experimental military drug. Due to its extreme complexity, the producers have not yet worked out all the problems.

## TROJAN HORSE

### Media Report

"The ravages of the modern highwaymen continue unabated. Today, an EBM transport was hijacked off I-95. The escorting AV's were both taken out with light anti-aircraft missiles and the solo teams in the escorting vans were killed in a firefight. A responding police helicopter was also shot down."

### Police Report

**Summary:** There have been four hijackings of Corporate transports on I-95 over the past few days. The hijackers have been focusing on hi-tech equipment. They are heavily armed with military-grade weaponry. So far there are no leads.

**Assignment:** The PC's have been assigned to this "Trojan Horse" operation. A Yakurichi-Ural BR70 has been provided by EBM and they have set up the necessary background. The police department will provide three unmarked interceptor vehicles and air support (an AV, helicopter gunship or a CityHawk). All officers will be heavily armed.

### Referee's Information

**Preparation:** The Referee should map out the section of the highway on which the action will occur. The hijackers should be detailed. There will be 8-16 attackers. They are enhanced and armed with military weapons, including shoulder-fired missiles and grenade launchers. For transport they have various AV's armed with a mix of LMG's.

**Notes:** The attackers are part of a terrorist group which is assembling equipment for a concentrated attack on U.S. installations via physical and Net methods. A follow-up to this adventure can have the PC's investigating the terrorist group, which is well-equipped and financed (it is actually backed by a corporation which is in stiff competition with many American-based corporations).





## THE NET STALKER

### Media Report

"We all know from the vids that people linked into the net can be injured, or even killed, by certain programs, but we were all taken by surprise when a psychopath began murdering people through their decks. Another netrunner was found dead in his burnt-out apartment after the fire sensors in the building detected the blaze."

### Police Report

**Summary:** There have been twelve deaths caused via computer interface in the past three days. Three of those killed have been known criminals and four were under investigation. Four were students and one was a corporate security Netrunner. While some of these deaths may be attributed to corporate or government Black Ice, it is thought that there is a killer at large. Investigation of the victims' deck memory units indicates that six of them were attacked by another operator in the NET while they were not engaged in any intrusive activities. In these six cases, the attack patterns and traces are identical.

**Assignment::** Liaise with NETSEC to capture the Net Stalker.

### Referee's Information

**Preparation:** The Net Stalker and his/her resources must be detailed. The Net Stalker is an "insane" Judicial AI system, backed up by an ex-NETSEC cop who now worships the AI. Both have gone vigilante.

**Action:** There will be real world and NET action. Obviously, at least one team will be attacked in the NET. In the outside world, the AI's and the rogue 'runner's skills will enable them to send trouble to the PC's in the form of hired guns, robots, electronic failures, etc.

## TOXIC AVENGERS

### Media Report

"Three area youth were killed after they stumbled onto a Corporate team dumping waste in an illegal zone. The activity was reported by the only survivor, whose name has been changed to protect his life. Police investigations promise justice will be served."

### Pooice Report

**Summary:** Three young men were killed at the city water supply station last night when they interrupted an illegal Corporate dumping. The one survivor is under Witness Protection.

**Assignment:** The PC's are to take the survivor (Derek Domino) to a safe house and protect him until the trial.

### Referee's Information

**Preparation:** Derek's stats must be generated. He is a young techie who was working at the water supply as a part-time job. He will insist that the police take his girlfriend "Lola Granola" into protective custody, too. She is

the lead singer of the poser band "Bloom Boingers" and will annoy the PC's with her singing (which resemble screaming fits) and dancing (beheaded chicken moves). The corporate team that will be sent to wipe out Derek must also be detailed.

**Action:** There will be an attack on the safe house after Lola breaks the security by making several phone calls to tell her friends what is happening. There will also be a follow-up attack before the trial (if the first attack fails).

**Notes:** The corporation will be heavily fined and investigated if Derek survives. After all, even a corp can't get away with almost poisoning half the city. The corporation didn't intend to dump the waste into the city water supply, but their hired help wasn't of a very high quality and decided to dump their stuff as quickly as possible and the water supply was handy.

## HUNTER KILLER

### Media Report

"The spree of the latest cop killer to hit Night City continues onward unchecked. Last night, two officers were killed in their cruiser, raising the total to eight dead."

### Police Report

**Summary:** Eight police officers have been killed as of (insert date). Forensic reports indicate a single individual has been responsible for all the killings. The specifics of the killings and certain incidents (uses of certain security codes, etc.) indicate the killer is well versed with police operations.

**Assignment:** The PC's are given the entire investigation. Find the killer. Stop him dead.

### Referee's Information

**Preparation:** The killer is actually a Max-Tac officer who has gone over the edge and has generated multiple personalities. His stats must be generated.

**Action:** The killer will be making attacks on officers until he, or she, is stopped. The attacker will also initiate copy-cat killings in the city which will make matters worse.

**Notes:** The officer in question acts perfectly normal until he, or she, is off-duty, when the person's alternate personality takes over. It is up to the PC's to find out what is going on and it is up to the Referee to maintain the mystery as long as possible.

## SMUGGLER'S BLUES

### Media Report

"Despite the efforts of LEDiv's Drug Enforcement Bureau and other police agencies, drugs continue to come across the borders of the United States. While this seems to be a losing battle for the brave defenders of the law, they haven't thrown in the towel."

### Police Report

**Summary:** Reliable sources indicate a shipment of Blue Glass is coming into the city tonight via the bay. The smugglers are believed to be using a hovercraft in this operation.

**Assignment:** The PC's are assigned to the team that is to stop the smugglers. The police forces consist of a police hydrofoil and air support (AV or Helicopter) in addition to a LEDiv DEB agent.

### Referee's Information

**Preparation:** The smugglers and NPC Police must be generated. There will be a smuggler pilot, six guards (enhanced and armed with assault rifles), and two dealers being brought in.

**Action:** The PC's will have to locate the hovercraft and then capture it. The smugglers, most of whom are wanted criminals, will resist violently.

**Notes:** The smuggler hovercraft is capable of 80KPH on flat surfaces, has SP=20 and an SDP=90. It has a forward pilot section, a crew section, and a cargo bay. It is carrying 20kg of Blue Glass, as well as three cases of assault rifles. The police hydrofoil is capable of 100KPH and is armed with a deck-mounted 20mm cannon (treat as B-A 20mm, but with ROF of 5 and 50 round magazine). The Hydrofoil has SP=20 and SDP=100. The DEB agent may be a traitor working with the dealers if you wish...

## GATOR BAIT

### Media Report

"Black Market cybernetics have been a problem for nearly a decade now, and a new wave of them has surfaced in Florida. In an exclusive interview with 'Metal Doc', this reporter learned that the famous Ripperdoc has been operating out of a laboratory hidden in the Florida swamps. When this reporter asked him why he revealed his hideout's location, he simply laughed and said 'The pigs will never find it. Out in the swamp, pigs are just more gator bait.'"

### Police Report

**Summary:** Dr. Lewis Ganser, a.k.a. "Metal Doc", has revealed that his base is located in the Florida Everglades. This is consistent with police intelligence reports. Dr. Ganser, an ex-corporate scientist, has long been producing and supplying Black Market cybertech. His base is undoubtedly well-hidden and well-guarded with boosted individuals.

**Assignment:** The PC's are to locate and neutralize the base, and capture Dr. Ganser. They will be supplied with appropriate vehicles and equipment.

### Referee's Information

**Preparation:** Maps of the Florida Everglades and Metal Doc's compound need to be made. The compound is constructed on pylons (like an offshore oil rig) and has a helicopter landing pad. It will be armed with a variety of heavy weapons. There will be a force of 15-35 cybered guards armed with assault rifles and submachineguns as well as 10-15 techs and Metal Doc himself. The interior will consist of living quarters and associated facilities as well as the production labs. There will be plenty of Black Market cybertech as well as several cases of weapons.



Lt. T. DelGrosso of Tactical Division leads a security sweep prior to Senator Henderson's downtown speech.

**Action:** The PC's will first have to find the base. Doing this may involve investigative work (that is, trying to find out where it is before leaving), or the PC's may go out into the swamps. Simply searching at random probably will not work, and they are apt to encounter other law breakers who will try to kill them. An aerial sweep is not a good idea as Metal Doc has hardware to shoot down anything that flies over his base. Once the PC's locate the base, they will have their hands full.

**Notes:** Small 4-man hovercraft (top speed 140 KPH, SP=6,SDP=35) are often used in the swamps. Don't forget the gators!

**Situation:** The police precinct the PC's are in has been cut off. Power lines, phone lines, water and so forth have been cut, and the station has been surrounded by armed rioters and gang members.

#### Referee's Information

**Preparation:** A map of the city area and maps of the police station need to be made. The police resources, in terms of personnel and equipment, need to be detailed.

**Action:** Being in the middle of a war zone with hundreds of people eager to kill will provide the PC's with plenty of action.

**Notes:** Military and police units will eventually restore order. Of course the PC's have to either survive to be rescued, or escape.

## SIEGE

#### Media Report

"Downtown is a complete war zone. Burning vehicles litter the street and bodies are strewn around like broken dolls. The sounds of battle echo through the buildings. All communication has been lost with the police precinct in the center of this chaos, and we can only hope the brave men and women in blue are still holding out."

#### Police Report

**Summary:** A series of riots have swept through the city in recent days and gangs have joined in, escalating the violence to greater levels.

## LIVE OR DIE

#### Media Report

"Senator Henderson will be participating in today's parade, despite the death threats made against him by various underworld groups. Senator Henderson is best known for his work as State Prosecutor, putting away such notables as the Sicilian Five, and his work for corporate supervision."



**Police Report**

**Summary:** There have been 27 death threats against the Senator in the past two days, and there have been two actual attempts.

**Assignment:** The PC's are assigned to help protect the Senator.

**Referee's Information**

**Preparation:** The Senator and his four Secret Service guards need to be generated. If needed, maps should be prepared of the parade route. There will be several assassination attempts and the participants will have to be generated.

**Action:** There will be several attempts on the Senator's life. One will occur in his hotel, another on the street, and at least two during the parade itself.

**Notes:** The PC's will become more and more responsible for the Senator as his Secret Service guards get killed off. If desired, one of them may also be an assassin...

## BUG HUNT

**Media Report**

"Another savage killing occurred last night in Night City. Police sources state that they believe they are dealing with a heavily enhanced cyberpsycho. Others are not so sure. Eye witnesses report an alien-looking attacker, which spoke in no known human language. There are rumors we have been invaded from outer space. So far there have been twenty such killings. Even today's numbed sensibilities are stirred by the thought of a killing machine loose among us, a killing machine that seems fueled by blood..."

**Police Report**

**Summary:** Based on site examinations, it is likely that a heavily enhanced individual is responsible for the killings. Police techs believe the individual is probably fully plated and has four or more cyberlimbs and possibly a linear frame. Built-in cyber weapons are also believed to be part of this individual's equipment.

**Assignment:** The PC's are assigned to track this individual down and deal with him or her in the appropriate manner.

**Referee's Information**

**Preparation:** The killer needs to be created. He or she is fully plated and has four cyber limbs and many other enhancements. He, or she, is convinced they are the last survivor of an alien race which is being hunted down by humans. Naturally, the person thinks he must kill any human he encounters.

**Action:** The first part of the adventure, the PC's will have to track down the killer. The second part will be the battle with the individual.

**Notes:** The killer is fully convinced he/she is an alien. This person has gone so far as to make up his own language and has a full delusory story about how humans destroyed his race. The person has modified his equipment to look utterly inhuman. Try to convince the PC's they are dealing with an alien (this can be done by having odd fluids left after the PC's fire upon him/her). Let them assume the chemicals are blood. Of course, if you want to have a really special adventure, generate a real extra-terrestrial. (See *Predator 2* for inspiration.)

## KOYANISQUAATSI

**Media Report**

"Concern grows as weather reports show record levels of pollution gathering in the atmosphere over Night City. Smog is keeping many citizens inside, however, and crime has dropped to its lowest level in 17 months."

**Police Report**

**Summary:** Due to a recent spate of unorthodox behavior, and the low in crime right now, you've been transferred to Beat for a week. Graveyard shift.

**Assignment:** Patrol your beat.

**Referee's Information**

**Preparation:** You'll need a map of the PC's beat zone and will have to generate a number of minor encounters which will happen during the early evening. You'll also need a couple of booster gangs, a good solo and an arsonist.

**Action:** The early evening will be fine: minor disturbances, that kind of thing. The smog makes life annoying but not difficult. Tension is low; you do notice a guy watching you every now and then (the arsonist)—but he's clean. Then, without warning a huge electrical storm breaks over Night City; within minutes the whole city is blacked out as *the power goes down!* 10:25PM Power down, 10:30PM Looting begins, 10:46PM 2 Local gangs begin war in PC's beat, 11:22PM Officers called to department store, scene of looting. While PC's are on third floor, a huge fire erupts on the ground floor. 11:43PM Retired Solo in drug warp begins sniping at Fire Department and everyone in vicinity. Midnight Power back on line. Return to normal.

**Notes:** This should provide the PC's with an evening's fun as what they thought was going to be a walk in the park turns into total chaos.

## HEY! REMEMBER THE ALAMO?

**Media Report**

"Today sees NCPD launch the new Arasaka Urban Assault and Pacification Vehicle, a revolutionary design in which the Police hope to gain the upper hand against crime."

**Police Report**

**Summary:** As we know, today sees the trial of our new toy. You're the lucky squad that gets to use it.

**Assignment:** You are to utilize the UAPV in a raid against the *Darkside Troopers* combat gang, who have declared the North side of 5th Avenue their territory. They're well-armed, so go in and get 'em.

**Referee's Notes**

**Preparation:** You'll need street and building plans for the area North of

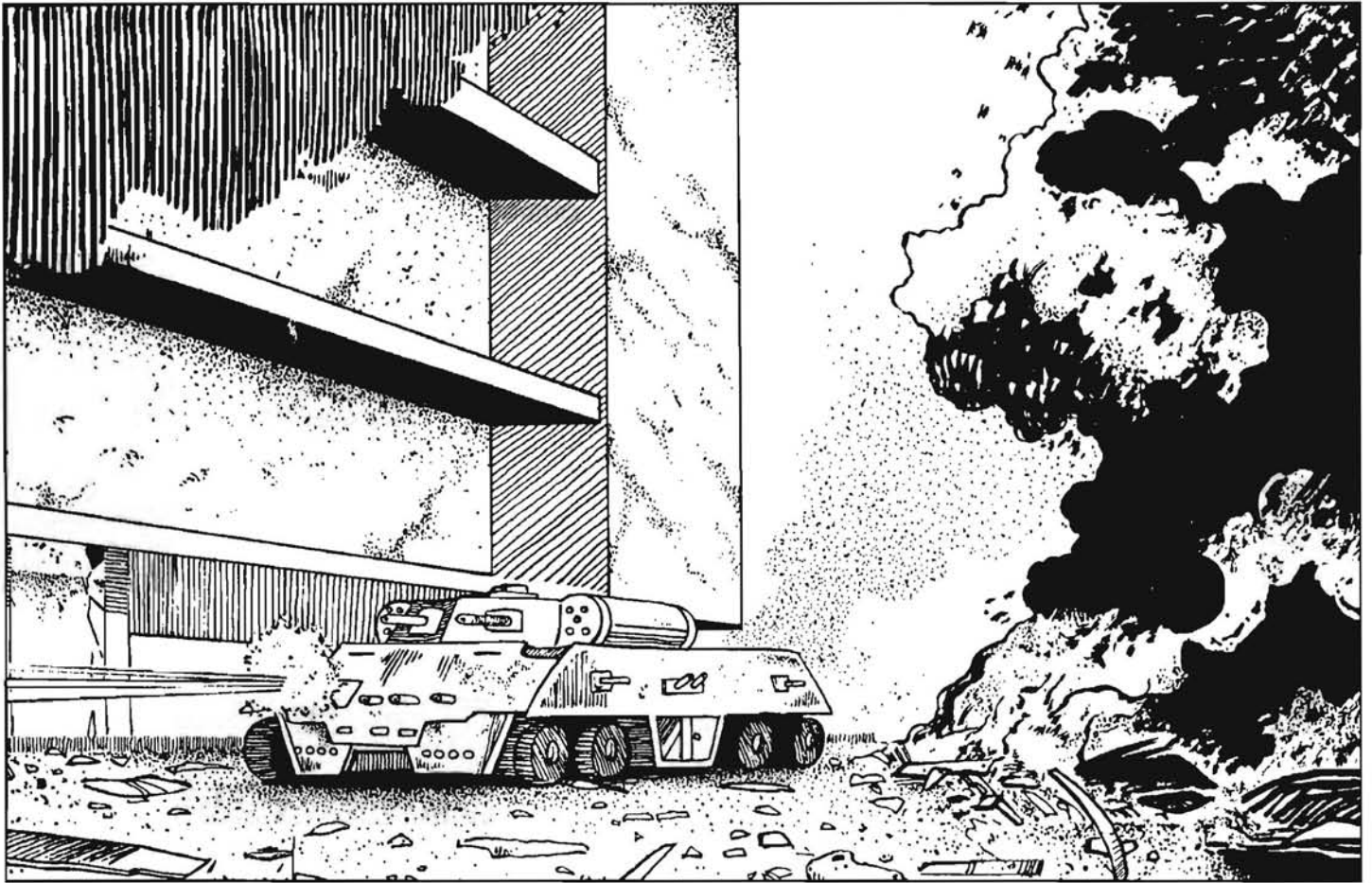

5th Avenue which is held by the Darkside Troopers. You'll also need stats for 15-30 non-enhanced but fully armed gangmembers. The UAPV should be designed around the Arasaka Riot VIII in the *Chromebook*, but add more weapons and more armor.

**Action:** This starts off well as the PC's roll in with their huge vehicle, bristling with weapons. The insane bunch of Darkside Troopers will war against it, using everything they've got, but they won't be able to get through the devastating walls of lead thrown their way. Until it breaks down...

**Notes:** A design glitch will cause all weapon systems to fail and the PC's will be left fighting a war with what little resources they have left. Meanwhile, the Darkside Troopers will be moving in for the kill to avenge the deaths of their comrades.

## ROAD HOGS

### Media Report

"Today's traffic advisory is brought to you by Toyota. There is a special today on vehicle armor at Burke's Toyota so stop by and get ready for the rush hour. Now for the report: Area 56 of Highway 17 should still be considered a Red Zone as the biker gang that has been disrupting traffic is still in action; sub area 23 of Area 45 on Highway 18 is closed due to a chemical spill, and there is a shootout occurring in Area 41 of Highway 17..."

### Police Report

**Summary:** A motorcycle gang, the Daemon Wheels, has been engaging in random attacks on Area 56 of Highway 17. So far, there have been three deaths, twenty-two serious injuries, and seven rapes.

**Daemon Wheels:** The Daemon Wheels are believed to be exiles from a Nomad group. They are not heavily enhanced, but are well-armed.

---

**"Area 56 should be considered a Red Zone as the biker gang disrupting traffic is still in action..."**

---

**Assignment:** The PC's are assigned to deal with the Daemon Wheels problem.

### Referee's Information

**Preparation:** The highway area will need to be mapped and Daemon Wheels will have to be generated. The gang consists of 8-16 Nomads on bikes. The motorcycles are of varying quality, but some have interface capacity. The gang members are armed with submachineguns and assault rifles.

**Action:** Being Nomads, the gang members are skilled at *hiding along* the roadside so the PC's will have difficulty locating them. The first part of the adventure will involve a search and a few minor encounters by the PC's and 2-4 gang members. Eventually the PC's will have a showdown with the full gang.

# CAN'T BEAT THE REAL THING...

## Media Report

"The DEA-Drug Cartel wars of the 1990's are well known to us from our school history lessons. Some of our viewers may even have been participants in this conflict [footage of the events shown, with brief soundbite summary]. It would appear that the real thing is back on our streets. According to a police source, natural cocaine has reappeared on the street. However, the police are not unduly concerned: 'We fixed them before, and we can fix the scum again.' said one officer.

## Police Report

**Summary:** Five kg. of natural cocaine was seized by DEB agents. Interrogation of the dealers revealed that a new batch of coca plants have been devised that are resistant to the DEA viruses used in the 1990's. The location of the plants has been determined and a raiding force has been assembled with the cooperation of the local government.

**Assignment:** The PC's are to be part of the team sent to South America to attack the dealers' base of operations.

## Referee's Information

**Preparation:** Maps of the area will need to be prepared. There is a house and a barracks building on the compound, which is located deep in the jungle. The area around the compound is littered with traps, mines, razor wire, fish hooks strung at eye level, etc. There are 20 workers on the site who will fight with machetes and some will have obsolete firearms. There are 10 guards armed with assault rifles and some are enhanced. Also present will be the compound manager and his bodyguard (a solo).

**Action:** The PC's will have to get through the jungle, which will be dangerous as there are plenty of people who hate the U.S. and the government of the country. (They are armed with obsolete weapons and many of their parents were put out of work by the DEA.) Once the PC's reach the compound, they will have to defeat the guards and workers, all of whom hate the United States and especially US Cops. They will not take any prisoners.

# REST IN PIECES

## Media Report

"Latest report just in: There's been a jailbreak at the High Rock Hi-Security facility. Unconfirmed reports indicate the remains of the Slammers boostergang broke out after a Braindance control unit malfunctioned. The Slammers were responsible for the Rainbow Nights massacre three years ago and were only caught through the intervention of now-retired police Captain Daniel Mason."

## Police Report

**Summary:** The Slammers are now in Night City and all available units are

joining the search for them. Psychologists predict an attempt to hit ex-Capt. Mason at his home. The Slammers are armed and dangerous.

**Assignment:** Ensure Capt. Mason's safety and escort him to a safehouse. Note: Capt. Mason is now in his seventies and rather senile, so be careful with him.

## Referee's Information

**Preparation:** Maps of Mason's home and the safehouse will be required, plus anywhere else the Slammers try to hit him. There are seven Slammers and they are armed with submachineguns and pistols; they have also secured a number of vehicles.

**Action:** Less than a day out of Braindance, the Slammers only goal is to take down Mason. The first hit will be at Mason's home and the PC's will not be able to get to the safehouse due to the fact the Slammers won't leave them alone.

**Notes:** Old cops never die, but they do get senile. Mason calls all the PC's by different names. He falls asleep often and is constantly changing the subject. He's a slow, dodderly old man, with incredible flatulence. He also happens to be the most heavily decorated cop in the history of Night City.

# THE CANDY MAN

## Media Report

"The Candyman once again dominates the morning's news. His latest victim is Jo Lydan, 26 and known drug user. Jo was found dismembered by what police believe to be a buzzsaw in her apartment. This is the fifth victim of the anti-drug psycho, the Candyman. And now, over to sport..."

## Police Report

**Summary:** The Candyman is the latest in the long line of Night City psychos. It appears he is an anti-drugs vigilante, favoring industrial equipment as murder weapons. His target group seems to be drug users, with no reference to age, sex or race.

**Assignment:** Locate and apprehend the Candy Man.

## Referee's Information

**Preparation:** One or two more victims will have to be set up and crime scenes detailed. You'll also need to generate the Candy Man himself along with a map of the derelict construction site he lives on. He favors weapons such as buzzsaws, industrial drills, nail guns etc. He is not enhanced. He gets access to these weapons because he used to work in construction.

**Action:** The first part of the adventure will be primarily investigation. To make matters worse, a pro-Candy Man media team will constantly annoy them. Once he is located the adventure will turn into a battle at the derelict construction site he lives on.

**Notes:** The Candy Man is no vigilante. He's a long time user of all sorts of substances; now it's fried his brain. When he isn't asleep, or suffering from side effects, he hunts other users down in order to steal their stash.





"It's midnite in the Zone... I'm on crutches (foot patrol)... All I had for dinner was a couple of bennies and a cold cup of coffee... The air stinks and a wino threw up on me... My wife left me for another woman... I've been shot six times, once last week... My feet hurt... Yeah, I love being a cop..." Officer E. Wells, 15-year veteran.

## WATCHING THE DETECTIVES

### Media Report

"Tonight Night City sees the arrival of the Iceman, Japan's leading Simstar. Here to plug his latest vid, *Black Ice Blues*; a high police presence is expected for the duration of his stay."

### Police Report

**Summary:** There have been a number of death threats made against the Iceman. Trouble is expected for the duration of his 72 hour stay.

**Assignment:** Pick up Iceman at the airport and babysit him for his whole stay. Make sure he stays in one piece.

### Referee's Information

**Preparation:** The Ref will need to generate the luxury hotel the Iceman will be staying in, also the TV studio where he'll be interviewed and the nightclub he'll be going to. A selection of assassins, ranging in competence, will be needed.

**Action:** The Iceman will be very cool throughout his entire stay, even though people are trying to kill him left, right, and center. His own guards will go down quite quickly, but the Iceman isn't bothered by anyone's death. Even his girlfriend's demise! The PC's will be ducking bullets for the whole 72 hours.

**Notes:** What the PC's won't know until the end is that the whole show has been one huge publicity stunt pulled by the entertainment man. Iceman knew all about it and was never in any danger. Lots of people died for this, and the PC's should get a chance to see justice done. (With a real assassin at the end, maybe. Iceman panics badly after having made his arrogant farewell speech to the PC's.)

## AND HERE IS THE NEWS!

### Media Report

"As a result of our highly successful *Police Watch* series, in which we highlight the NCPD and their incompetence in dealing with the soaring crime rate, we have obtained permission from City Hall to send a roving crew out with a typical street squad, to show you the people what it's like as a Lawman today."

**Police Report**

**Summary:** Now, you all know about these media-guys making us look bad on prime-time TV. Well, in their wisdom, City Hall have allowed them to send a team of vultures out with one of our street squads, to show 'just what being a cop's all about'.

**Assignment:** You guessed it guys, the Media team will be joining your unit for the day and filming you all of the way, so don't do anything too stupid today, not on camera, anyway.

**Referee's Information**

**Preparation:** A typical four-man Media team will be needed for this scenario. Make them as irritating and difficult for the group as you possibly can. A variety of punks and criminals will be needed to throw at the group as well.

**Action:** Practically anything can be thrown at the group, such as bank robberies, cyber-psychos on the rampage, or Corporate Hit Teams on the loose. Maybe even kidnapping one of the reporters isn't too bad an idea. Just make sure that the group are exhausted by the end of the day and that they get some incredibly bad and embarrassing press to deal with and to explain to their C/O.

# IN COUNTRY

**Media Report**

"Latest in: NCPD spokesmen are continuing to refuse to comment after last night's incident in which Max Molotov and his Flamers blasted their way out of Precinct 213. The boostergang is believed to have headed out of the city to regroup, although unconfirmed sources say the gang will make a revenge attack against the NCPD. We asked you on the street what should be done with such dangerous criminals..."

"Max who?"

"I didn't see nothing, man."

**Police Report**

**Summary:** Molotov and his gang broke city limits around 3 AM this morning. We believe they're heading for Mexico in several stolen vehicles. Their escape has caused embarrassment to NCPD and we want them back, even though it's not our jurisdiction.

**Assignment:** Go out into the desert and bring Molotov back—alive. Watch out for HiWay; they're not going to like this intrusion into their territory.

**Referee's Information**

**Preparation:** A large scale map from Night City to Mexico will be needed, and Max Molotov and the Flamers will need generating. They're all enhanced and packing police weapons in addition to being bombed out on a nasty cocktail of drugs. Also a variety of bad, mad exiles will be useful to throw at the PC's when things get slow. Oh yeah, and one (or more) dangerous HiWay cops in fast cars with SoCal accents and mirrorshades to harass the PC's every step of the way.

**Action:** This soiree out of the city should be total chaos. Not only do the PC's have to deal with Max and his boys, but other gangs, exiles, weirdos and maybe worst of all: HiWay. Watch out for military weapon testing zones, Corp strike teams, Toxic waste and buzzards. Eventually Molotov's gang will hole up in a deserted farmhouse and wait for the group to come to them. Real western.

**Notes:** This little adventure should make the PC's very glad to be back in behind the safe walls of Night City once more.

## TO ERR IS HUMAN

**Media Report**

"Today sees the launching of NCPD's latest development in its constant war against crime in our city: the all-new Enforcement Computer Control Grid. Saving thousands of hours and thousands of E-bucks on resources, the ECCG will take over the strategic planning, communication, tactical resource designation and control purposes of NCPD. Answerable only to the Chief, this new recruit will tailor specific assignments to specific officers, ensuring an efficient use of our finest boys and girls in blue."

**Police Report**

Your first ECCG assignment has come through; with this new resource management, you shouldn't get any more dull jobs. It's a bit of a letdown. You've been seconded to Vice to stakeout the docks and make a small-time drugs bust.

**Assignment:** Stakeout docks area. Target vehicle is metallic blue Spacewagon. Owners suspected of Type C Trafficking. Apprehend all Perps once situation clarified.

**Referee's Notes**

**Preparation:** You'll need a map of the relevant dock area. It's a street with warehouses to both sides, dock workers moving around most of the time. You'll need stats on the two petty dealers and the van, in addition to two small-time users who'll be looking to make a buy. You'll also need about ten well-armed and equipped bounty hunters...

**Action:** Everything will go well, the PC's will locate the van and eyeball a deal going down. The moment they make a move, ten bounty hunters will scream in with flashy vehicles and hardware. They're here to bust these guys too! Whatever the result, the PC's will have to call in to ECCG to inform it of the situation. Due to a glitch the message will be misinterpreted and it responds by telling PC's to wait where they are. Meanwhile it issues Termination Orders on all PC's, which go straight into the Bounty Net. In no time at all the PC's will be targeted by those same Bounty Hunters...

**Notes:** The PC's will suddenly find out that everyone is shooting at them, including the cops. Their only hope is to get to the Chief, as he's the only one who can override ECCG's commands. Once this is done, ECCG will be dismantled and not talked about very much anymore.

# A FAREWELL TO ARMS

## Media Report

"The escalating violence in Night City is spreading the police too thin in an effort to cope. With the police almost at breaking point, they are forced to take stronger measures in dealing with the threats. Dr. Larry Kasta, enforcement statistician claims the police must stop so many dangerous weapons reaching the street if they are going to have any chance in solving the problem."

## Police Report

**Summary:** A new strategy has been developed: Rather than react to the gang wars when they happen, the Police will attempt to restrict the amount of hardcore weaponry at their disposal, thus solving a problem before it starts.

**"They walk like us, talk like us. MAX-TAC are just criminals with a badge"**

*punk overheard in the Zone*

**Assignment:** You've been selected to try out this strategy, but you're starting small. The *Black Doves*, a small time gang, will be targeted first. They are known to have a number of weapons, but not an arsenal like so many bigger boostergangs. You are to seize all weapons currently held by the Black Doves. Oh yeah, you've got to do it in full uniform too. This is an exercise in logistics to determine if a small number of officers can handle a situation like this.

## Referee's Information

**Preparation:** You'll need to map out the Black Doves' headquarters, which is an abandoned factory in the Zone. You'll also need to generate the forty or so Black Doves who have about 20 or so weapons ranging from light pistols to submachineguns; the rest are geared up with baseball bats, machetes, etc. You'll also need to generate one suit and one Corporate solo...

**Action:** As the PC's approach the headquarters, all will be quiet. This is due to the deal currently going down inside. A Corp suit has just delivered a huge shipment of military weapons and explosives to the gang. By the time the PC's arrive, all the crates will have just been ripped open and the gang is about to try out some of their new toys before paying...

**Notes:** This should give the PC's quite a shock. Suddenly they will be faced with a fully-equipped small army. The suit and solo will try to get away, but the gang will stay put, supremely confident in their new weaponry. PC's can call in back up and should get it. So much for a logistical exercise huh?

# ROUGH JUSTICE

## Media Report.

"NETSEC are still refusing to make comment upon the release of Mad-dog Shannon by their Judicial AI earlier this week. As you may remember, Shannon was responsible for the deaths of thirty-five innocent civilians last month, many of whom he mutilated before killing. Meanwhile Harvey Edgeton, a retired communications clerk, was last night sentenced to twenty years with Braindance for two unpaid parking fines. Speculation continues as to the sanity of the AI responsible for these sentences."

## Police Report

**Summary:** Okay, so we do have a problem with the AI. Some netrunner has been playing around with its higher functions, and it's your job to find out who's doing it.

**Assignment:** NETSEC have been unable to locate the netrunner due to an impressive smokescreen that he has spread though half of the net. The runner accesses the AI on a regular basis, so next time, get a fix on him and bring the sucker in.

## Referee's Notes

**Preparation:** A set of stats for the Netrunner himself are required. He is a crippled seven-year old, with the genius of Einstein (Computer and scientific skills = level 10).

Also, he has become a hero to a lot of other 'runners, who have been helping him by creating that smokescreen, and generally watching his back for him. So have several other 'runners prepared as well.

In addition, he's been helping a lot of other people in his neighborhood (such as the local boostergang. He transferred some cash into their accounts as a good-will gesture), so have a lot of other types prepared, all ready to help defend the kid.

Finally, a map of the kid's neighborhood will be needed for the investigation.

**"...Mad Dog Shannon, responsible for 35 deaths last month was just released. Meanwhile, Harvey Edgeton, retired clerk, was sentenced to 20 yrs. with Braindance for unpaid parking fines last night..."**

**Action:** The police will firstly have to locate the kid, which will be difficult with the smokescreen running. Once the kid knows that the police are onto him, he will use his deck to hire a team of hitters (Corporate) to neutralize the group.

His friends and family will help defend him, many by simply running at the police screaming with weapons blazing.

Also, the media will pick up on this story and give the group as much bad publicity as possible, on prime-time.

Finally, one of the Corps the kid decked into is unhappy and is sending its own team to neutralize the kid, so the group had better hurry it up.

**Notes:** If the kid is apprehended, he cannot be charged due to his age, instead being given a warning and sent home.





## BETTER THE DEVIL YOU KNOW!

### Media Report

"The latest in the series of killings by 'the Necromancer' took place last night. This brings the total bodycount to twenty prostitutes. Police still have no leads."

### Police Reports

**Summary:** The Necromancer has got to be stopped; he's got all the perverts behind him, and the copycats have started. There's even a cultie gang started up. In tribute to him they call themselves the "Undead."

**Assignment:** You're handed the investigation and told to get some results.

### Referee's Information

**Preparation:** You'll need to create a short history for the 'Necromancer' case. The killer is not enhanced and possesses a flair for the occult and melodramatics. You'll also need a few future crime scenes, a handful of 'Undead' and a police psychologist who has created a profile of the killer.

**Action:** The killings will continue and the PC's will have no real leads to follow. The 'Undead' will become a problem too. The psychologist is actually the 'Necromancer'; the occult angle is a smoke screen. Something will happen to give this away and then it's a race to catch him, a desperate and psychotic individual. Notes: Once the 'Necromancer' realizes the PC's are onto him, he'll make good use of the 'Undead' in a getaway attempt. He's a very smart man and he already knows the PC's very well, and should he feel they're getting too close, he could always declare them unfit for duty.....

## SHALL WE PLAY A GAME?

### Media Report:

"The hunt goes on tonight for the 'runner

responsible for the launch initialization of six U.S. cruise missiles. Talks are still continuing between the Russian States and the U.S., but fears are growing that this is one crisis that may not be solved. Now here's the traffic with Johnny K, brought to you by Toyota."

#### **Police Report:**

**Summary:** Basically, a 'runner has set the six missiles on a hair-trigger system, so we can't disarm them except with his help. The government is gunning for us for letting it happen, the Air Force is gunning for the CIA for not finding out about it, and we're caught in the middle.

**Assignment:** Our intelligence suggests that several agencies will be attempting to locate the 'runner. The Mayor doesn't want the Secret Service crawling all through his city, so it's up to you guys to find the guy first. Good luck.

#### **Referee's Information**

**Preparation:** The 'runner's stats will be needed for this scenario. But if the players had to track down that seven-year old from the preceding scenario, use his stats. He's the one responsible for this as well!

Three separate Corporation hit teams, armed with SMGs and having some enhancement, will be needed. (The corps want the kid, too, for endangering their marketing plans.)

One experienced LEDiv team, armed similarly to the Corp teams, will be required, as will a highly-trained and heavily-equipped Military Intelligence unit.

Several Media teams will be needed to harrass the group and to generally get in the way when the bullets fly, as will the secret Russian team who will spend their time trying to track the kid down, while not being noticed by anyone else.

Also have the numerous deckers and punks from the previous scenario at hand, as well as the map of the neighborhood.

**Action:** The various hit teams will spend their time snooping around and running into each other, while the kid and his followers (including a gang of Nihilists who think he is the Angel of Death) stop all attempts to capture him.

The Media will make life hell for everyone, giving as much bad publicity as possible.

Total chaos will erupt if any of the teams gets too close to the kid's base, with street riots, arson, gang violence, you name it going on.

## BROTHERS IN ARMS

#### **Media Report**

"Unconfirmed sources claim several technicians and scientists were brutally slain at the Biotechnica Research Establishment. A spokesman for Biotechnica refused to comment."

#### **Police Report**

**Summary:** Something did happen at Biotechnica last night, and there were a number of killings. Biotechnica is on the streets in force today, so it looks like something big's going down.

**Assignment:** You've got this investigation. Check out Biotechnica to see if you can get anything there, and keep an eye on their street activities.

#### **Referee's Information**

**Preparation:** You'll need several mercenaries (solos), in addition to a Biotechnica security team (all heavily armed), plus a couple of Corporate suits. Each of the mercenaries is going to be killed, so you'll need crime scenes as well. You'll also need a totally cyber-enhanced solo, a real monster equipped with some nasty and illegal cyberware, in addition to a serious amount of automatic weapons.

**Action:** The solos are going to die, one by one. Biotechnica has been working on a supersoldier program. It got out of control and their prototype has turned into a monster. His brain has been fried and now he's targeting members of his own unit. This link will become apparent after a couple of murders. Biotechnica is out in force to get their prototype back, while he is on a burn, all the way down.

**Notes:** Apart from the PC's, there are no friendlies. The mercenaries are bloodthirsty murderers. The prototype cannot be reasoned with (and will just kill everyone, after he's eliminated the mercenaries), and the Corp will go to any lengths to get their supersoldier back.

## STICKS TO THE WALL

#### **Media Report**

"The war between the Mob and the East Asian syndicates intensified last night with four more contract killings. One suspected Mafia hitter was found dead in his hotel room and three known members of the Yakuza were killed in a driveby shooting in Japantown; four members of the public were also killed. This reporter wants to know: When are the cops gonna get off their butts and do something!?"

#### **Police Report**

**Summary:** The Mafia are back in town. This war is a longstanding feud between the Mafia and the Yakuza. Night City has long been Yakuza territory. It seems the mob have sent in a strike team against the Yakuza.

**Assignment:** Locate and round up all of those involved in this war.

#### **Referee's Information**

**Preparation:** You'll need to generate four Mob hitters and 6-10 Yakuza of varying ranks. The Yaks have a base in Japantown and the Mafia are moving around. You'll need to make a few maps of bases and shootouts.

**Action:** The PC's will have to wait for the next hit to get a fresh crime scene; clues will be waiting. The Mafia seem to have the advantage as they are much harder to find and blend in well. Things will change once the PC's become a big problem to the mob or the Yakuza, as both will put contracts out on the group.

**Notes:** This scenario will cover surveillance and investigation. The PC's are up against professional criminals and won't be allowed to make too many mistakes. Once the tables turn, they'll be in a whole world of trouble. ■

# NIGHT CITY POLICE DEPARTMENT FORM C-652 (CORONER'S DIV.)

**AUTOPSY**

**CASE NO.**

VICTIM'S NAME (LAST, FIRST, MIDDLE)

SEX	AGE	RACE	WEIGHT	HT
M    F				

DESCRIPTION OF CORPSE

---

---

---

---

EXTERNAL INJURIES

---

---

---

---

---

INTERNAL INJURIES

---

---

---

---

---

MEDICAL DIAGNOSIS

---

---

---

---

---

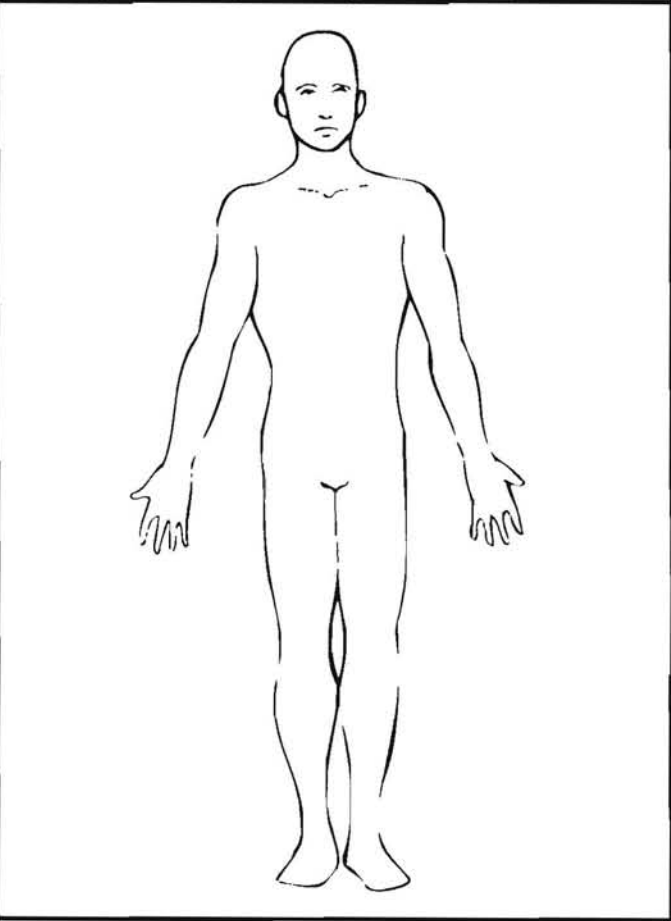

NOTES

---

---

---

---

---

---

---

---

---

INVESTIGATING OFFICER	RECORDING OFFICER	TYPED BY	DATE AND TIME	ROUTED BY
-----------------------	-------------------	----------	---------------	-----------

CORONER	FURTHER ACTION <input type="checkbox"/> YES <input type="checkbox"/> NO	RECEIVED BY
---------	--	-------------



# NIGHT CITY POLICE DEPARTMENT FORM #321-APDV

## Personnel Record

NAME (LAST, FIRST, MIDDLE)					(PHOTO)
SEX M    F	AGE	RACE	WEIGHT	HT	
ADDRESS _____ _____					
PHONE NUMBER					
BADGE NUMBER					
PRECINCT ID NUMBER					
JOINED: Year		RETIRES IN: Year			HISTORY (GAME NOTES) _____ _____ _____ _____ _____ _____ _____
QUALIFICATIONS: _____ _____ _____ _____ _____					
PSYCHOLOGICAL (CHARACTER TRAITS) _____ _____ _____ _____ _____					
BLACK MARKS: _____ _____ _____ _____ _____					
CAPTAIN	SERGEANT		TYPED BY	DATE AND TIME	ROUTED BY
FINGER PRINTS				RECEIVED BY	

# NIGHT CITY POLICE DEPARTMENT REPORT FORM 15-12 A

1. CASE NUMBER

OFFICER ID NUMBER

2. CODE SECTION

3. CRIME

4. CLASSIFICATION

5. REPORT AREA

6. DATE AND TIME OCCURRED-DAY

7. DATE AND TIME REPORTED

8. LOCATION

9. VICTIM'S NAME-LAST, FIRST, MIDDLE

10. RESIDENCE ADDRESS

11. RES. PHONE

12. OCCUPATION

13. RACE-SEX

14. AGE

15. DOB

16. BUS. PHONE

CODES FOR BOXES 19 AND 28

V=VICTIM W=WITNESS P=PARENT  
RP=REPORTING PARTY DC=DISCOVERED CRIME17. CHECK IF  
MORE NAMES 

18. NAME-LAST, FIRST, MIDDLE

19.

20. RESIDENCE ADDRESS

21. RES. PHONE

22. OCCUPATION

23. RACE-SEX

24. AGE

25. DOB

26. BUS. PHONE

27. NAME-LAST, FIRST, MIDDLE

28.

29. RESIDENCE ADDRESS

30. RES. PHONE

31. OCCUPATION

32. RACE-SEX

33. AGE

34. DOB

35. BUS. PHONE

## MODUS OPERANDI

36. DESCRIBE CHARACTERISTICS OF PREMISES AND AREA WHERE OCCURED

37. DECSRIBE BRIEFLY HOW OFFENSE WAS COMMITTED

38. DESCRIBE WEAPON, INSTRUMENT, TRICK OR FORCE USED

39. MOTIVE-TYPE OF PROPERTY TAKEN OR OTHER REASON FOR OFFENSE

41. ESTIMATED LOSS VALUE

42. WHAT DID SUSPECT SAY

43. TRADEMARK OR OTHER DISTINCTIVE ACTION

44. VEHICLE USED

INVESTIGATING OFFICER

RECORDING OFFICER

TYPED BY

DATE AND TIME

ROUTED BY

FURTHER ACTION  YES NO

RECEIVED BY

# CITY ON FIRE!



**T**ension was high. The apartment block was drenched in light and the shot-up police vehicles were providing cover for Taylor's boys. A pile of bodies had built up on the sidewalk outside the building. All was quiet except for the occasional scream from the top floor.

Lt. DeVris pulled up a headset and yelled into it. "Reece! Go!" The headset crackled as Reece's voice came back at him. "Okay, we're proceeding up the stairwell. I don't think there's as many as..." DeVris ripped the headset away from his ears as it emitted a shrill scream of static. The rig shook with an almighty blast from the booby-trapped stairwell. A police vehicle was flipped and another caught fire.

*Reece's men were gone...*

**I**N 2020 the Streets are ablaze, and the only Law comes from the barrel of a gun. Now R. Talsorian gives your *Cyberpunk Cop* character the tool he needs to hold the line against the rising tide of crime: **Protect and Serve**, the complete Law Enforcement supplement. Cop talk, cop cars, cop training, cop guns—everything to make the Super Cop of the Year 2020 a match for the Punks of the Dark Future!



A SOURCEBOOK  
FOR CYBERPUNK

**R. TALSORIAN  
GAMES, INC.**

Published By R. Talsorian Games  
P.O. Box 7356  
Berkeley, CA 94707  
Copyright 1992 by R. Talsorian Games Inc.  
Cyberpunk® and Protect & Serve are trademarks  
of R. Talsorian Games Inc. All rights reserved.